

Mile Partikov

MSc, Assistant

Ss. Cyril and Methodius University
Faculty of Civil Engineering – Skopje
partikov@gf.ukim.edu.mk

Petar Cvetanovski

PhD, Full Professor

University “Ss. Cyril and Methodius”
Faculty of Civil Engineering – Skopje
cvetanovski@gf.ukim.edu.mk

MODEL CALIBRATION OF WELDED SHS-TO-SHS T-JOINTS UNDER MOMENT LOADING

The behaviour of the semi-rigid joints can be obtained by laboratory tests or by an appropriate finite element analysis. This paper describes the process of modelling joints in the SOFISTIK software package and their calibration method.

The verification of the results obtained from the 3D models is performed with values obtained from laboratory tests. In the framework of the modelling and calibration process of the models, all parameters that influence the accuracy of the results are being reviewed.

Analyses performed with well-calibrated mathematical models including finite elements based on experimental research within certain parameters allow a large number of parametric analyzes to be faster and more economical if performed exclusively by laboratory tests.

Keywords: joint, hollow section, rotational stiffness

1. TESTING OF T JOINTS

A total of twelve joints (shown in Table 1), were examined for the purposes of the experimental research. The joints were divided into three series depending on the 2γ parameter, such as: J3, J4 and J5.

The parameter 2γ was selected according to Eurocode 3, Part 1-8 and CIDECT Design Guide 3's recommendations for this type of joints, where the lower limit of this parameter was set to 20 in order to enable the joint to fall into the group of semi-rigid joints ($2\gamma > 16$). Furthermore, the maximum allowable value for hollow section joints was selected as the upper limit, which is 33.3 for S235.

Each of the aforementioned series consists of four samples that vary the parameter $0.4 \leq \beta \leq 0.7$.

The thickness ratio parameter τ of the chord and brace walls is not varied and remains constant throughout the research paper.

The α parameter also remains constant for all examined samples and is 20.

Table 1. Tested Joints

Joint	α	β	2γ	τ
J3_40	20	0.4	33.3	1
J3_50	20	0.5	33.3	1
J3_60	20	0.6	33.3	1
J3_70	20	0.7	33.3	1
J4_40	20	0.4	25	1
J4_50	20	0.5	25	1
J4_60	20	0.6	25	1
J4_70	20	0.7	25	1
J5_40	20	0.4	20	0.8
J5_50	20	0.5	20	1
J5_60	20	0.6	20	1
J5_70	20	0.7	20	0.8

SHS 100x100 hollow sections with a length of 1000mm are being used for the chords, while SHS40x40 to SHS70x70 sections with a length of 400mm are being used for the brace.

Figure 1 shows the joint testing method and the positioning of the testing equipment.



Figure 1. Test layout

2. MODELLING OF T JOINTS

Three-dimensional solid elements (BRIC) (Figure 2) defined by the use of eight points in space and a 1:1 ratio of the sides, were used for modelling the geometry of the joint. Each of the points defining the geometry of the finite element has six degrees of freedom (DoF). This type of finite element was selected according to the recommendations by current studies on all

types of hollow section joints which indicate that it gives more accurate results than a four-node quadrilateral finite element (QUAD).

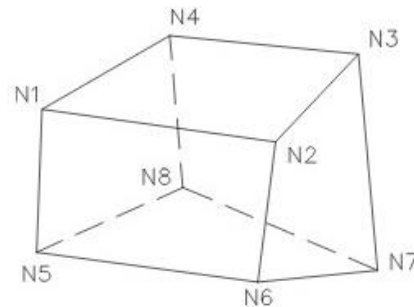

Figure 2. Three-dimensional Solid Element (BRIC)

2.1 MATERIAL MODELLING

What is typical for the hollow sections, within the unreinforced semi-rigid “T” joints, is that they quickly reach the yielding strength before reaching the design resistance given in Eurocode 3, Part 1-8 (Table 7.14).

The modelling method of the material and its nonlinear behaviour are given in Eurocode 3 Part 1-5 Annex C.

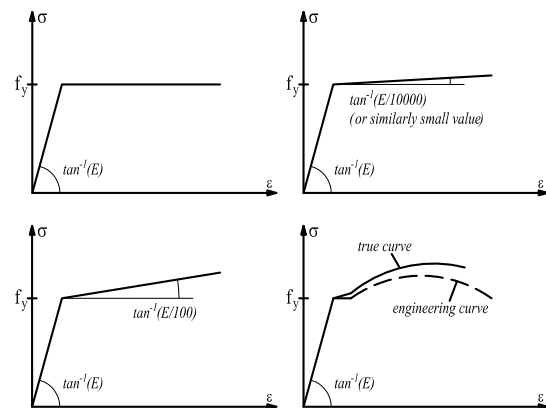

Figure 3. Material model

Material quality tests have been carried out for the purposes of the research paper, thus, the engineering stress-strain curve and the true curve is shown in Figure 4.

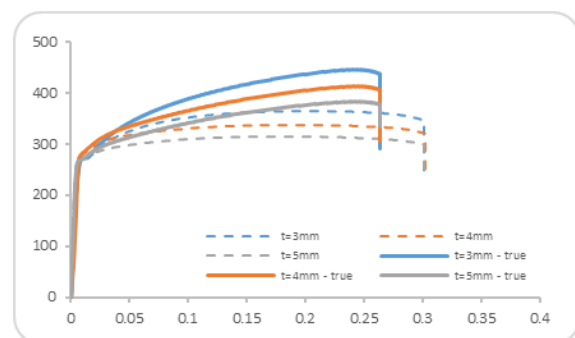

Figure 4. Stress-Strain curves for tested materials

The correction of the stresses and strains of the engineering curve is being performed with the following equations:

$$\varepsilon_T = \int_1^{1+\Delta l} \frac{dx}{x} = \ln \frac{1+\Delta l}{1} = \ln(1 + \varepsilon_E) \quad (1)$$

$$\sigma_T = \frac{A}{A_U} \sigma_E = \frac{A}{\frac{A}{1 + \varepsilon_E}} \sigma_E = \sigma_E(1 + \varepsilon_E) \quad (2)$$

Where,

- l is original gage length
- A is original cross-section area
- A_u is true cross section area
- ε_E is engineering strain
- ε_T is true strain
- σ_E is engineering stress
- σ_T is true stress

Due to the process of cold-forming, the yielding strength in the bending zones of the material has been increased. This additional material correction is made in accordance with the Eurocode 3 formula, as given below:

$$f_{ya} = f_y + k * n * \frac{t^2}{A} * (f_u - f_y) \quad (3)$$

Where,

- f_y is yielding strength of the material
- f_u is ultimate strength of the material
- t is the material thickness
- A is cross-section area
- k is coefficient depending on type of forming ($k=7$ for cold rolling)
- n is the number of 90° bends in the section with internal radius $<5t$
- f_{ya} should not exceed f_u or $1.2f_y$

In order to examine the material model influence for each of the joint series, a selection of one joint is made, which is solved with each of the four proposed models (Figures 5, 6 and 7).

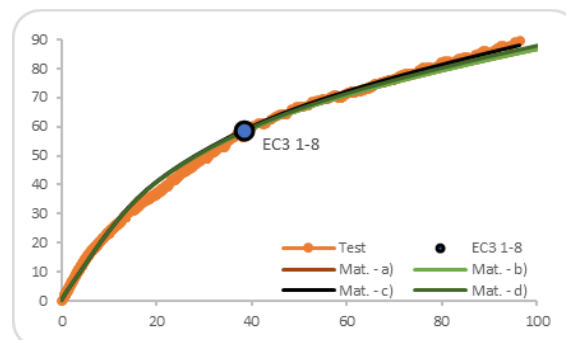

Figure 5. Influence of material model for „J3“

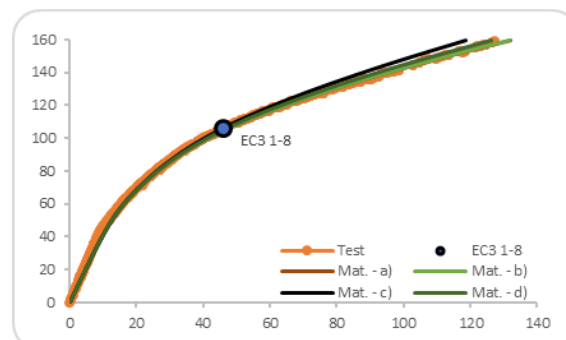

Figure 6. Influence of material model for „J4“

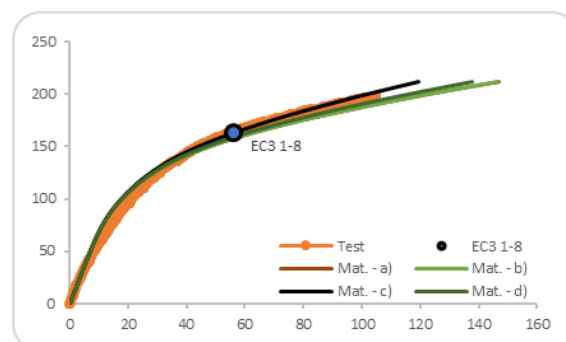

Figure 7. Influence of material model for „J5“

The diagrams show that all material models are very compliant with the tested values. However, material model with linear strain-hardening will be used for the further analysis, since it contributes to better convergence of solutions i.e., the residual forces from the analysis are quite small and within the limits of the required accuracy of the analysis.

2.2 FE MESH SIZE

The analytical study requires a test to find a balance between the finite element mesh density, the results obtained and the time required to complete the analysis. On one hand, too low density “rough” mesh may lead to unreliable results, but on the other, too high density “fine” mesh may increase the required time for analysis.

According to research recommendations so far, the dimensions of the finite elements for smaller cross-sections are 3x3mm, and for larger cross-sections up to 10x10mm. The discretization of the section thicknesses generally depends on the value of the 2γ parameter, for example, for “thick-walled” sections with $2\gamma \leq 20$, up to four divisions of thickness, and for “thin-walled” sections with $20 < 2\gamma \leq 33$, up to two divisions of thickness. Based on these recommendations, an analysis of all 2γ parameter values covered by the laboratory tests was performed, with the models varying the size of the finite elements and the number of wall thickness divisions.

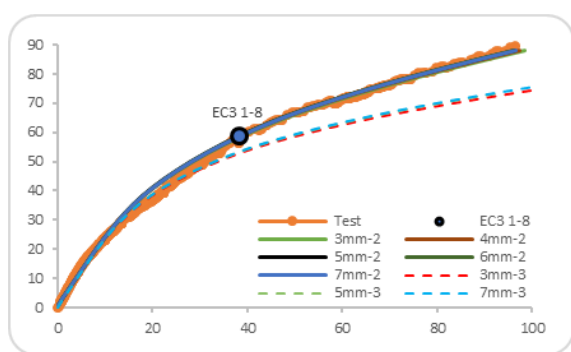

Figure 5. Influence of material model for „J3“

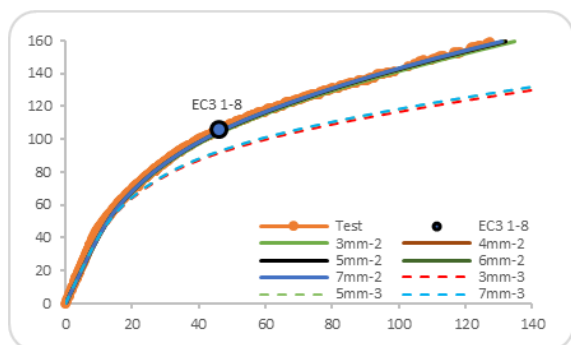

Figure 6. Influence of material model for „J4“

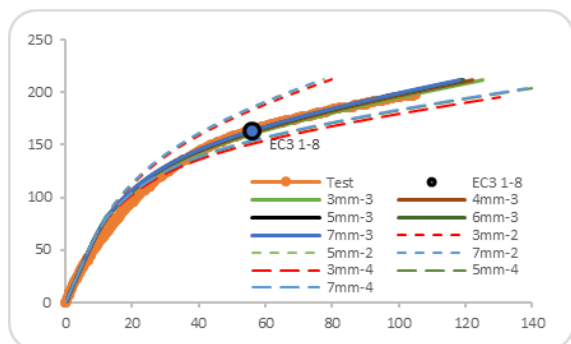

Figure 7. Influence of material model for „J5“

A total of three joints with five different dimensions of the finite elements were considered, i.e. finite elements with 3, 4, 5, 6

and 7mm. In terms of wall thickness, the “J3” and “J4” joint series have been treated with two or three divisions and the “J5” joint series with two, three and four wall thickness divisions.

It can be clearly seen from the diagrams that the models for “J3” and “J4” joint series give excellent results for two wall thickness divisions, while in the “J5” joint series this is repeated with three wall thickness divisions. These values for wall thickness divisions are adopted for further analysis.

As presented in Figure 8, the decreasing trend of the time required for analysis observed in terms of finite element size occurs for values of 3mm to 5mm, thus, it can be noted that further increase in dimensions do not have much effect on time.

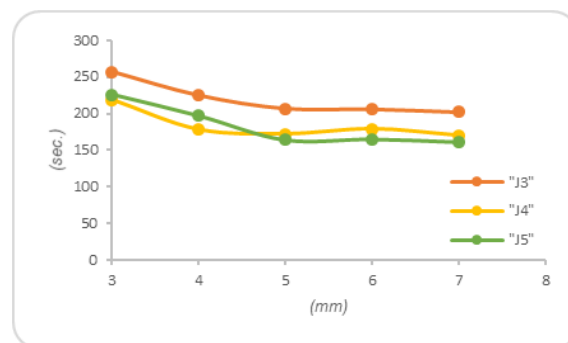

Figure 8. Influence of material model for „J5“

Considering the results of the convergence of the mathematical model, the following finite element values have been adopted:

- Top and bottom part of chord – 10mm
- Contact wall/side of chord – 5mm
- Remaining chord walls – 8mm
- Brace – 5mm
- Sections radiuses – 6 segments
- Weld – 2 segments

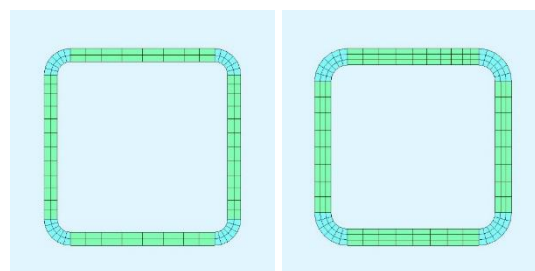

Figure 9. Cross sections

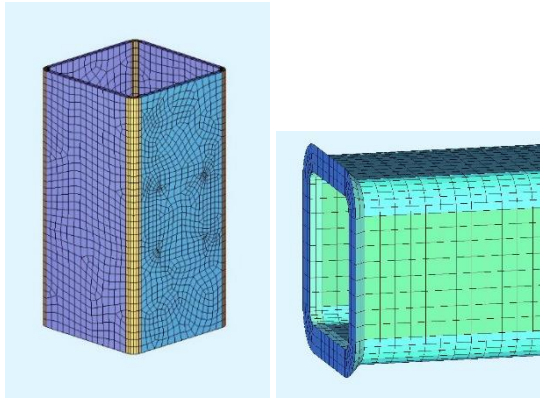

Figure 10. FE Mesh for chord and brace members

2.4 WELD MODELLING

The joints between the bracing and the chord are constructed with arc welding in protective atmosphere of CO₂ gas. In accordance with the CIDECT recommendations, fillet weld details have been used for all joints as shown in Figure 11.

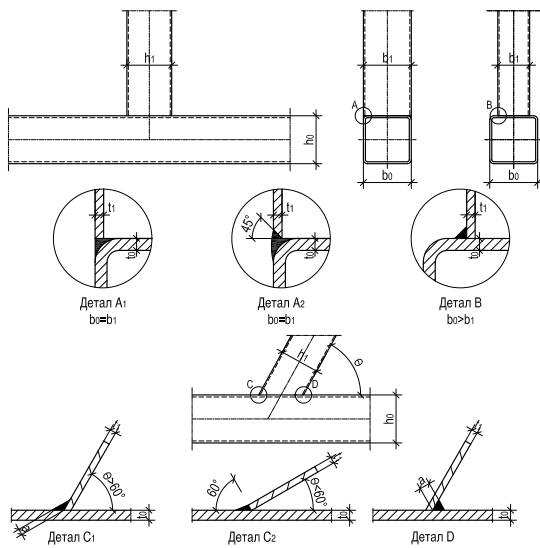

Figure 11. Weld details

Welds for three-dimensional solid elements (BRIC) models can be modelled in three ways as shown in Figure 12.

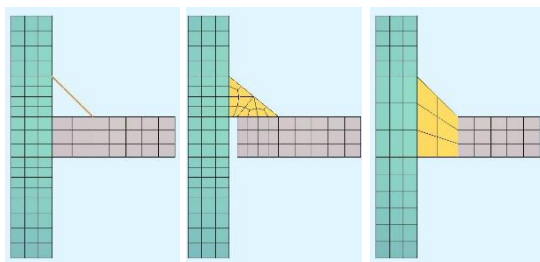

Figure 12. Weld models

The first model represents a “hybrid” model proposed by van der Vegte. He suggests the weld to be fastened to the chord using a rigid connection and the weld to be modelled with shell elements to form a ring throughout the section.

In the second model, the weld has been modelled by using three-dimensional solid elements (BRIC) in full scale thus, the brace has no contact with the chord. According to the recommendations, the distance must not exceed 2mm.

The third model used to model the welds for this research paper, suggests that the weld must be modelled by using three-dimensional solid elements (BRIC) with a full rigid connection between the weld and the chord. This model was selected as a result of the type of welding performed on the tested models (welding with full penetration). For modelling the material properties of the weld, the same properties were used as those of the braces.

Figures 13, 14 and 15 show the results for three joints with different values of the 2γ parameter showing the weld influence on the moment-rotation.

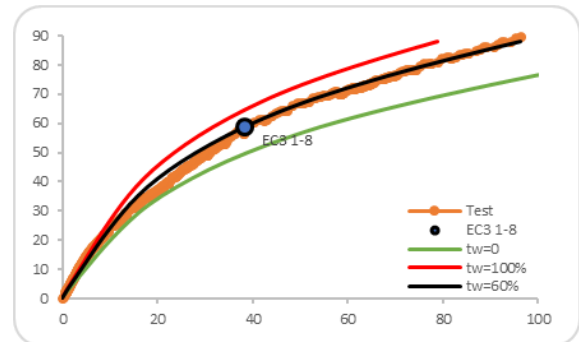

Figure 13. Influence of weld size for „J3“

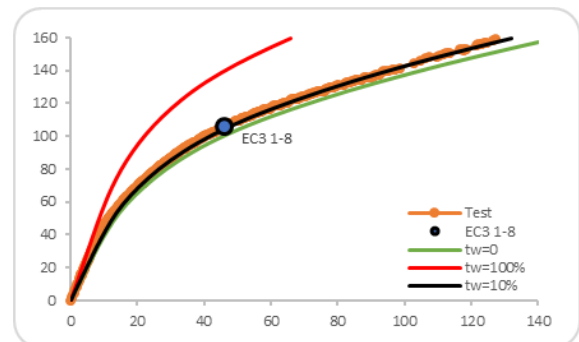

Figure 14. Influence of weld size for „J4“

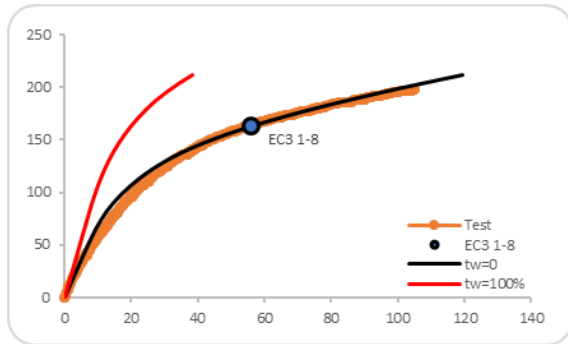

Figure 15. Influence of weld size for „J5“

2.5 ANALYSIS

The SOFISTIK software package for solving these models by using three-dimensional solid elements (BRIC) offers two analysis types such as: first order elastic-plastic analysis which includes only the effects of the nonlinear material behaviour and second or third order elastic-plastic analysis. For this case with three-dimensional solid elements (BRIC), a third order analysis (TH3) has been used, which takes into account geometrical nonlinearity in addition to material nonlinearity.

Both analysis express relatively good results overlapping until reaching the design resistance. The differences are larger for lower values of 2γ , so for the value of the bending moment equal to the design resistance according to Eurocode 3 it can be noted that for the joint with $2\gamma = 33.3$ the third order analysis gives a 7.7% lower rotation, however, for the joint with $2\gamma = 25$, that difference is 9.8% and for the joint with $2\gamma = 20$ the difference is 13.4%.

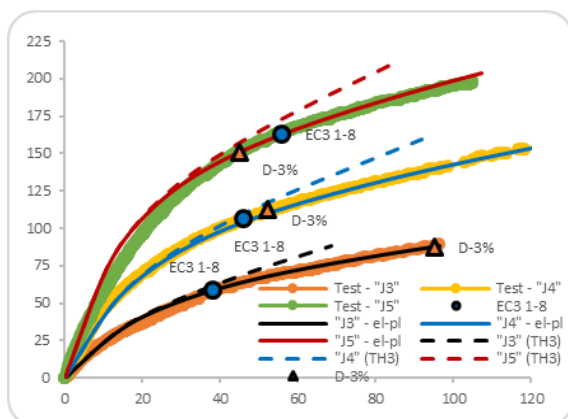

Figure 16. Influence of analysis type

3. CONCLUSION

The solutions of the mathematical models for the tested joints by including all previously described variables that influence their behaviour give results that are largely consistent with the results obtained from laboratory tests. The models developed and calibrated with the methods and analysis types presented in this paper, illustrate the behavior of hollow sections “T” joints and can be used in further parametric studies within the ranges of the parameters considered, $0.4 \leq \beta \leq 0.7$, $20 \leq 2\gamma \leq 33$ and $0.8 \leq \tau \leq 1.0$.

REFERENCES

- [1] EN 1991-1-1: Eurocode 3: Design of steel structures – Part 1-1: General rules and rules for buildings, CEN 2005.
- [2] EN 1991-1-5: Eurocode 3: Design of steel structures – Part 1-5: Plated structural elements, CEN 2005.
- [3] EN 1991-1-8: Eurocode 3: Design of steel structures – Part 1-8: Design of joints, CEN 2005.
- [4] J.A. Packer, J. Wardinier, X.-L. Zhao, G.J. van der Vegte and Y. Kurobane, Design Guide 3 for rectangular hollow section (RHS) joints under predominantly static loading, CIDECT 2008
- [5] Y. Kurobane, J.A. Packer, J. Wardinier, N. Yeomans, Design Guide 9 for structural hollow section column connections, CIDECT 2004