

BOOK OF PROCEEDINGS



*VII International Scientific Agriculture Symposium
Jahorina, October 06-09, 2016*



AGRO 2016
sym

BOOK OF PROCEEDINGS

**VII International Scientific Agriculture Symposium
“Agrosym 2016”**

AGROSYM 2016



Jahorina, October 06 - 09, 2016

Impressum

VII International Scientific Agriculture Symposium „Agrosym 2016“

Book of Proceedings

Published by

University of East Sarajevo, Faculty of Agriculture, Republic of Srpska, Bosnia
University of Belgrade, Faculty of Agriculture, Serbia
Mediterranean Agronomic Institute of Bari (CIHEAM - IAMB) Italy
International Society of Environment and Rural Development, Japan
Balkan Environmental Association, B.EN.A, Greece
University of Applied Sciences Osnabrück, Germany
Selçuk University, Turkey
Perm State Agricultural Academy, Russia
Voronezh State Agricultural University named after Peter The Great, Russia
Biotechnical Faculty, University of Montenegro, Montenegro
Institute for Science Application in Agriculture, Serbia
Institute of Lowland Forestry and Environment, Serbia
Academy of Engineering Sciences of Serbia, Serbia
Agricultural Institute of Republic of Srpska - Banja Luka, Bosnia and Herzegovina
Maize Research Institute „Zemun Polje“ Serbia
Institute of Field and Vegetable Crops, Serbia
Institute of Forestry, Podgorica, Montenegro
Balkan Scientific Association of Agricultural Economics, Serbia
Institute of Agricultural Economics, Serbia

Editor in Chief

Dusan Kovacevic

Technical editors

Sinisa Berjan
Milan Jugovic
Velibor Spalevic
Noureddin Driouech
Rosanna Quagliariello

Website:

<http://www.agrosym.rs.ba>

CIP - Каталогизacija у публикацији
Народна и универзитетска библиотека
Републике Српске, Бања Лука

631(082)(0.034.2)

INTERNATIONAL Scientific Agricultural Symposium "Agrosym
2016" (7 ; Jahorina)

Book of Proceedings [Elektronski izvor] / VII International
Scientific Agriculture Symposium "Agrosym 2016", Jahorina,
October 06 - 09, 2016 ; [editor in chief Dušan Kovačević]. - East
Sarajevo =Istočno Sarajevo : Faculty of Agriculture =Poljoprivredni
fakultet, 2016. - 1 elektronski optički disk (CD-ROM) : tekst, slika ;
12 cm

CD ROM čitač. - Nasl. sa nasl. ekrana. - Registar.

ISBN 978-99976-632-7-6

COBISS.RS-ID 6216984

VII International Scientific Agriculture Symposium “Agrosym 2016” Jahorina, October 06-09, 2016, Bosnia and Herzegovina

HONORARY COMMITTEE

STEVO MIRJANIC, Minister of Agriculture, Water Management and Forestry of Republic of Srpska, Bosnia, JASMIN KOMIC, Minister of Science and Technology of Republic of Srpska, Bosnia, DANE MALESEVIC, Minister of Education and Culture of Republic of Srpska, Bosnia, RADOSLAV GRUJIC, Rector of the University of East Sarajevo, Bosnia, MILICA PETROVIC, Dean of the Faculty of Agriculture, University of Belgrade, Serbia, COSIMO LACIRIGNOLA, Director of the Mediterranean Agronomic Institute of Bari, (Italy) and Secretary General of the International Centre for Advanced Mediterranean Agronomic Studies (CIHEAM), MARIO T. TABUCANON, President of the International Society of Environment and Rural Development, Japan, FOKIAON K. VOSNIAKOS, President of the Balkan Environmental Association (B.EN.A), Greece, BERND LEHMANN, Vice-President of the University of Applied Sciences Osnabruck, Germany, MUSTAFA ŞAHIN, Rector of the Selcuk University, Turkey, IURII ZUBAREV, Rector of the Perm State Agricultural Academy, Russia, NIKOLAY I. BUKHTOYAROV, Rector of the Voronezh State Agricultural University named after Peter The Great, Russia, MIOMIR JOVANOVIĆ, Dean of the Biotechnical Faculty, University of Podgorica, Montenegro, SNEZANA JANKOVIC, Director of the Institute for Science Application in Agriculture, Serbia, SASA ORLOVIC, Director of the Institute of Lowland Forestry and Environment, Serbia, BRANKO KOVACEVIC, President of the Academy of Engineering Sciences of Serbia, Serbia, VOJISLAV TRKULJA, Director of Agricultural Institute of Republic of Srpska - Banja Luka, Bosnia and Herzegovina, BRANKA KRESOVIC, Director of the Maize Research Institute “Zemun Polje”, Serbia, JAN TURAN, Director of the Institute of Field and Vegetable Crops, Serbia, RADOVAN PEJANOVIC, President of Balkan Scientific Association of Agricultural Economics, Serbia, JONEL SUBIC, Director of the Institute of Agricultural Economics, Serbia

SCIENTIFIC COMMITTEE

DUSAN KOVACEVIC, Faculty of Agriculture, University of Belgrade, Serbia, WILLIAM MEYERS, Howard Cowden Professor of Agricultural and Applied Economics, University of Missouri, USA, JOHN BRAYDEN, Norwegian Agricultural Economics Research Institute (NILF), Norway, STEVE QUARIE, Visiting Professor, School of Biology, Newcastle University, United Kingdom, ATEF HAMDY, Emeritus Professor, Land and Water Resources Department; IAMB, Italy, DANI SHTIENBERG, full professor, Department of Plant pathology and Weed Research, ARO, the Volcani Center, Bet Dagan, Israel, THOMAS G. JOHNSON, University of Missouri – Columbia, USA, DIETER TRAUTZ, University of Applied Science, Germany, MACHITO MIHARA, Tokyo University of Agriculture, Japan, MARKUS SCHERMER, Department of Sociology, University of Innsbruck, Austria, SERGEI ELISEEV, Vice-Rector for Research and Innovations, Perm State Agricultural Academy, Russia, RICHARD BARICHELLO, Faculty of Land and Food Systems, University of British Columbia, Canada, NOVO PRZULJ, Faculty of Agriculture, University of Banjaluka, Bosnia and Herzegovina, TATIANA SIVKOVA, Faculty for Veterinarian Medicine and Zootechny, Perm State Agricultural Academy, Russia, ADRIANO CIANI, Department of Agricultural, Foods and Environmental Sciences, Perugia University, Italy, ALEKSEJ LUKIN, Voronezh State Agricultural University named after Peter The Great, Russia, MATTEO VITTUARI, Faculty of Agriculture, University of Bologna, Italy, VELIBOR SPALEVIC, Institute of Forestry, Montenegro, EMMANOUIL KABOURAKIS, Institute of Olive Tree, Subtropical Plants and Viticulture, Greece, LAHCEN KENNY, Hassan II Institute of Agronomy & Veterinary Medicine – CHA (Agadir), Morocco, ARDIAN MACI, Faculty of Agriculture and Environment, Agricultural University of Tirana, Albania, REGUCIVILLA A. POBAR, Bohol Island State University, Philippines, SUDHEER KUNDUKULANGARA PULISSERY, Kerala Agricultural University, India, EPN UDAYAKUMARA, Faculty of Applied Sciences, Sabaragamuwa University, Sri Lanka, VLADIMIR SMUTNÝ, full professor, Mendel University, Faculty of agronomy, Czech Republic, FRANCO BAVEC, full professor, Faculty of Agriculture and Life Sciences, Maribor, Slovenia, NICOLAE ISTUDOR, full professor, Academy of Economic Studies, Bucharest, Romania, JAN MOUDRÝ, full professor, Faculty of Agriculture, South Bohemia University, Czech Republic, STEFAN TYR, full professor, Faculty of Agro-biology and Food Resources, Slovakia, NATALIJA BOGDANOV, Faculty of Agriculture, University of Belgrade, Serbia, SABAHUDIN BAJRAMOVIC, Faculty of Agriculture and Food Sciences, University of Sarajevo, Bosnia, FRANCESCO PORCELLI, University of Bari Aldo Moro, Italy, VASILJE ISAJEV, Faculty of Forestry, University of Belgrade, Serbia, ELAZAR FALLIK, Agricultural Research Organization (ARO), Volcani, Israel, JUNAID ALAM MEMON, Pakistan Institute of Development Economics, Pakistan, HIROMU OKAZAWA, Faculty of Regional Environment Science, Tokyo University of Agriculture, Japan, PANDI ZDRULI, Land and Water Resources Department; IAMB, Italy, MLADEN TODOROVIC, Land and Water Resources Department; IAMB, Italy, HAMID EL BILALI, Sustainable Agriculture, Food and Rural Development Department. IAMB, Italy, NOUREDDIN DRIOUECH, Coordinator of MAIB Alumni Network (FTN), Mediterranean Agronomic

Institute of Bari, Italy, ION VIOREL, University of Agronomic Sciences and Veterinary Medicine of Bucharest, Romania, LALITA SIRIWATTANANON, Faculty of Agricultural Technology, Rajamangala University of Technology Thanyaburi (RMUTT), Thailand, ABID HUSSAIN, International Centre for Integrated Mountain Development (ICIMOD), Nepal, AMRITA GHATAK, Gujarat Institute of Development Research (GIDR), India, NASER SABAGHNIA, University of Maragheh, Iran, MÁRTA BIRKÁS, full professor, St. Istvan University, Godollo – Hungary, UDAI PRATAP SINGH, Department of Mycology and Plant Pathology, Banaras Hindu University, India, ANDRZEJ KOWALSKI, Director of the Institute for Agricultural and Food Economy, Warszawa-Poland, YALCIN KAYA, The Director of the Plant Breeding Research Center, University of Trakya, Turkey, SANJA RADONJIC, Biotechnical Faculty, University of Montenegro, Montenegro, VJEKOSLAV TANASKOVIC, Ss. Cyril and Methodius University in Skopje, Faculty of Agricultural Sciences and Food, Republic of Macedonia, BRANKA KRESOVIC, Director of the Maize Research Institute “Zemun Polje”, Serbia, KOSANA KONSTATINOV, Academy of Engineering Sciences of Serbia, Serbia, SNEZANA MLADENOVIC-DRINIC, Maize Research Institute “Zemun Polje”, Serbia, NEBOJSA MOMIROVIC, Faculty of Agriculture, University of Belgrade, Serbia, ZORAN JOVOVIC, Biotechnical Faculty, University of Montenegro, Montenegro, VLADIMIR VUKADINOVIĆ, full professor, Faculty of Agriculture, University of Osijek, Croatia, DANIJEL JUG, associate professor, Faculty of Agriculture, University of Osijek, Croatia, VLADO KOVACEVIC, full professor, Faculty of Agriculture, University of Osijek, Croatia, MILAN MARKOVIC, Biotechnical Faculty, University of Montenegro, Montenegro, ZELJKO DOLJANOVIC, Faculty of Agriculture, University of Belgrade, Serbia, DOBRIVOJ POŠTIĆ, Institute for plant protection and environment, Belgrade, Serbia

ORGANIZATION COMMITTEE

VESNA MILIC, Dean of the Faculty of Agriculture, University of East Sarajevo, Bosnia, DEJAN BOKONJIC, Vice rector of the University of East Sarajevo, Bosnia, SLAVISA MOLJEVIC, Vice rector of the University of East Sarajevo, Bosnia, ROBERTO CAPONE, Mediterranean Agronomic Institute of Bari, Italy, ROSANNA QUAGLIARIELLO, Mediterranean Agronomic Institute of Bari, Italy, NOUREDDIN DRIOUECH, Coordinator of MAIB Alumni Network (FTN), Mediterranean Agronomic Institute of Bari, Italy, ALEKSANDRA DESPOTOVIC, Biotechnical Faculty Podgorica, University of Montenegro, Montenegro, MILIC CUROVIC, The journal “Agriculture and Forestry”, Biotechnical Faculty Podgorica, University of Montenegro, Montenegro, SANJA VASILJEVIC, Institute of Field and Vegetable Crops, Serbia, VELIBOR SPALEVIC, Institute of Forestry, Montenegro, OKSANA FOTINA, International Relations Center, Perm State Agricultural Academy, Russia, TATIANA LYSAK, International Relations Office, Voronezh State Agricultural University named after Peter The Great, Russia, DRAGI DIMITRIEVSKI, Ss. Cyril and Methodius University in Skopje, Faculty of Agricultural Sciences and Food, Republic of Macedonia, VEDRAN TOMIC, Institute for Science Application in Agriculture, Serbia, MILAN STEVANOVIC, Maize Research Institute “Zemun Polje”, Serbia, SRDJAN STOJNIC, Institute of Lowland Forestry and Environment, Serbia, MORTEZA BEHZADFAR, Tarbiat Modares University, Tehran, Iran, ULRIKE SCHLIEPHAKE, Dipl. agr.oec., University of Applied Science, Germany, BILJANA GRUJIC, Institute of Agriculture Economics, Serbia, MERSIDA JANDRIC, Faculty of Agriculture, University of Belgrade, Serbia, GORAN PERKOVIC, Faculty of Agriculture, University of East Sarajevo, Bosnia, VESNA TUNGUZ, Faculty of Agriculture, University of East Sarajevo, Bosnia, DEJANA TESANOVIC, Faculty of Agriculture, University of East Sarajevo, Bosnia, MIRJANA RADOVIC, Faculty of Agriculture, University of East Sarajevo, Bosnia, MILAN JUGOVIC, Faculty of Agriculture, University of East Sarajevo, Bosnia, IGOR DJURDJIC, Faculty of Agriculture, University of East Sarajevo, Bosnia, MILENA STANKOVIC, Faculty of Agriculture, University of East Sarajevo, Bosnia, STEFAN STJEPANOVIC, Faculty of Agriculture, University of East Sarajevo, Bosnia, STEFAN BOJIC, Faculty of Agriculture, University of East Sarajevo, Bosnia, SINISA BERJAN, Faculty of Agriculture, University of East Sarajevo, Bosnia, General secretary

PREFACE

Dear Colleagues,

In your hands are the *Proceedings* of the 7th International Scientific Agricultural Symposium “AGROSYM 2016”, which I hope you will find useful in your research, education and professional activities and endeavors.

AGROSYM 2016 themes cover all branches of agriculture and are divided into seven sessions: 1) Plant production, 2) Plant protection and food safety, 3) Organic agriculture, 4) Environmental protection and natural resources management, 5) Animal husbandry, 6) Rural development and agro-economy, and 7) Forestry and agroforestry.

Keynote papers dealt with organic agriculture from different perspectives as well as international cooperation in agricultural and rural development, climate change and forestry. Organic farming is a holistic production management system of agricultural, food and other products, combining good agricultural practices, a high degree of biodiversity, conservation of natural resources, and application of high standards of animal welfare.

Food production, food security and production of raw materials for other industries determine multiple environmental, economic and social roles of agriculture (including crop production, animal husbandry, forestry and fisheries) in all countries, both developed and developing ones, as well as its multi-functionality; including its contribution to rural development. This is clearly highlighted in the numerous contributions included in these *Proceedings* alongside the challenges that agriculture sector is facing and the negative impacts of industrial agriculture on the environment.

I do believe that the research results reported here will be significant in the dissemination of knowledge to the wider audience about the importance of agriculture as a strategic sector in many countries.

AGROSYM 2016 made an important contribution to the agriculture theory, knowledge and practice in different areas. During the four-day symposium on October 6-9, 2016, over 1100 contributions were presented (either as oral or poster presentations) to more than 1000 participants representing 78 countries.

The *Proceedings* comprise an edited selection of the papers submitted to the symposium. Each paper included in the *Proceedings* was positively reviewed by referees.

AGROSYM 2016 was made possible through the commitment and contributions of a wide range of partners and sponsors. Many thanks to all authors, reviewers, session moderators and colleagues for their help in editing these *Proceedings*. Special thanks go to all co-organizers for their unselfish collaboration and comprehensive support.

East Sarajevo, 05 October 2016

Prof. Dušan Kovačević, Faculty of Agriculture, University of Belgrade

Proceedings Editor in Chief – President of the Scientific committee of AGROSYM 2016



1. PLANT PRODUCTION	44
AGRONOMIC EVALUATION OF SOME PERENNIAL GRASS CULTIVARS IN ALGERIAN SEMI-ARID CONDITIONS	
Mohamed MEFTI, Hamena BOUZERZOUR, Abderrezak CHEBOUTI, Aissa ABEDLEGUERFI ...	45
POSSIBILITY OF PEPPER PRODUCTION BY DIRECT SOWING	
Goran PERKOVIĆ, Aleksandra GOVEDARICA-LUČIĆ, Saša LALIĆ	51
PHYSIOLOGICAL RESPONSES OF POTATO EXPOSED TO DROUGHT STRESS: STOMATAL CONDUCTANCE, LEAF WATER POTENTIAL AND GROWTHPARAMETERS	
Mirjana JOVOVIĆ, Zorica JOVANOVIĆ, Radmila STIKIĆ	56
THEORY OF IMPACT INTERACTION BETWEEN THE FEELER AND STANDING SUGAR BEET ROOT CROWNS DURING THEIR SCALPING	
Volodymyr BULGAKOV, Valerii ADAMCHUK, Margus ARAK, Jüri OLT'	63
WEATHER CONDITIONS IN THE 2013 - 2015 WHEAT GROWING SEASON IN CROATIA AND BOSNIA AND HERZEGOVINA	
Mirta RASTIJA, Vlado KOVAČEVIĆ, Domagoj RASTIJA, Ilija KOMLJENOVIC, Georg DREZNER	71
REAL-TIME IRRIGATION SCHEDULINGCHARTS FOR APPLE (<i>Malusdomestica</i>) IN THE CENTRAL-EASTERN AREAS OF BOSNIA AND HERZEGOVINA	
Sabrija ČADRO, Jasminka ŽUROVEC, Mirjana RADOVIĆ	77
EFFECT OF LIMING OF THE CONTENT OF TOTAL SUGARS, TITRATABLE ACIDS AND pH IN DIFFERENT WINE GRAPE VARIETIES	
Krasimir TRENDAFILOV, Mladen ALMALIEV	84
DETERMINATION OF NUTRITIONAL CONTENT OF SOME SILAGE CORN VARIETIES IN TERMS OF ANIMAL FEED POTENTIAL	
Bilal KESKİN, Süleyman TEMEL, Barış EREN, Bahattin KARAKUŞ	89
GROWTH AND PRODUCTIVITY OF LEMON VERBENA (<i>Aloysia triphylla</i> L.) AS AFFECTED BY IRRIGATION IN CENTRAL GREECE: FIRST YEAR (ESTABLISHMENT) RESULTS	
Konstantinos MARTINOS, Elpiniki SKOUFOGIANNI, Nicholas G. DANALATOS	95
A STUDY OF THE EFFECTS OF DIFFERENT BIO-FERTILIZERS AND AMMONIUM PHOSPHATE LEVELS ON THE YIELD OF SUNFLOWER	
Morteza BARMAKI	100
THE INFLUENCE OF COLD STORAGE ON SOME QUALITY TRAITS OF CARROT CULTIVARS	
Marek GAJEWSKI, Olga SOBOCIŃSKA, Marta PUDZIANOWSKA, Monika SITAREK, Anna SEREDA	104
PROBLEMS OF PEACH WINTER HARDINESS IN THE STEPPE CRIMEA	

Tatyana LATSKO	110
IMPACT OF CLIMATE FACTORS ON AGRO BIOLOGICAL CHARACTERISTICS OF PINOT NOIR VARIETY IN TREBINJE VINEYARD	
Tijana BANJANIN, Zorica RANKOVIĆ-VASIĆ	116
INFLUENCE OF EXPLANT SOURCE AND PLANT GROWTH REGULATORS ON CALLUS INDUCTION AND SHOOT REGENERATION OF CHICORY (<i>Cichorium intybus</i> L.)	
Mehdi MOHEBODINI, Homeira HADIZADEH, Behrouz ESMAEILPOUR, Esmail CHAMANI	122
WILD ALMOND SPECIES IN TURKEY AND USE OPPORTUNITIES	
Safder BAYAZIT, Oguzhan CALISKAN	129
GENETIC DIVERSITY OF ORNAMENTAL PEACH FROM NIKITA BOTANICAL GARDENS COLLECTION STUDIED BY AFLP-ANALYSIS	
Larisa KOMAR-TYOMNAYA, Aya TRIFONOVA.....	136
WATER–YIELD RELATIONS OF MAIZE IN SEMIARID CLIMATE CONDITIONS	
Borivoj PEJIĆ, Ksenija MAČKIĆ, Vladimir SIKORA, Livija MAKSIMOVIĆ, Jan BOĆANSKI, Ivica DJALOVIĆ	142
THE INFLUENCE OF Nano-Gro® PREPARATION ON GROWTH, DEVELOPMENT AND YIELD OF SWEET BASIL (<i>OCIMUM BASILICUM</i> L.)	
Wiesława ROSŁON, Olga KOSAKOWSKA, Anna AMBROSZCZYK, Ewa OSIŃSKA	149
EFFECT OF PLANT GROWTH REGULATORS ON IN VITRO MICROPROPAGATION AND EVALUATION OF ANTIMICROBIAL ACTIVITY EXTRACTS FROM EX VITRO, IN VITRO AND CALLUS OF RUE (<i>RUTA GRAVEOLENS</i> L.)	
Zakaria I. Al-ALOUNI, Shifaa ABBAS, Mohamad A. SHATNAWI, Ibrahim Al-MAKHADMEH	157
PRODUCTIVITY OF SOME DUTCH POTATO VARIETIES IN THE MOUNTAIN REGION OF MONTENEGRO	
Zoran JOVOVIĆ, Andrey SKRYABIN, Ana VELIMIROVIĆ, Željko DOLIJANOVIĆ, Milica BUĆKOVIĆ	165
IN VITRO SHOOT AND ROOT REGENERATION IN ERCIS CABBAGE (<i>BRASSICA OLERACEAE</i> VAR. <i>CAPITATA</i>)	
Ferit ERTAŞ, Burcu TUNCER.....	170
MICROMORPHOLOGY OF POLLEN GRAINS OF SOME GRAPE CULTIVARS	
Zeliha GÖKBAYRAK, Hakan ENGIN	176
INFLUENCE OF TEMPERATURE, PRECIPITATION AND INSOLATION ON THE DEVELOPMENT RATE OF ANNUAL CARAWAY (<i>Carum carvi</i> var. <i>annua</i>)	
Milica AĆIMOVIĆ, Vladimir FILIPOVIĆ, Miroslav UROSEVIĆ, Snezana OLJAČA, Željko DOLIJANOVIĆ, Nevena DOJČINOVIĆ, Vesna GRŠIĆ	181
DETERMINATION OF BIO-VARIATION AMONG DIFFERENT MULBERRY SPECIES GROWN IN TOKAT REGION BY MOLECULAR MARKERS	
Cetin CEKIĆ, Z. Selcen OZMEN	188

SELECTION OF WHEAT SUPERIOR GENETIC VARIATION FOR GROWING IN HALOMORPHIC SOIL CONDITIONS	
Sofija PETROVIĆ, Miodrag DIMITRIJEVIĆ, Borislav BANJAC, Velimir MLADENOV.....	193
COMBINED CULTIVATION OF EDDIBLE MUSHROOMS AND VEGETABLES	
Agnieszka JASIŃSKA, Ewelina WOJCIECHOWSKA, Ketil STOKNES, Katarzyna KRAJEWSKA	200
PEACH CUTIVARS RESEARCH AND BREEDING IN NIKITA BOTANICAL GARDEN	
Anatolij SMYKOV, Olga FEDOROVA, Tatyana SHISHOVA, Julija IVASHCHENKO.....	207
GROWTH AND PRODUCTIVITY OF <i>Rosmarinus officinalis</i> L. AS AFFECTED BY IRRIGATION AND NITROGEN FERTILIZATION IN CENTRAL GREECE: FIRST YEAR (ESTABLISHMENT) RESULTS	
Konstantinos MARTINOS, Elpiniki SKOUFOGIANNI, Nicholas G. DANALATOS.....	215
PRESENT AND FUTURE EFFECTS OF CO₂ ON VARIOUS FIELD CROPS: A GENERAL EVALUATION	
Hakan ULUKAN.....	220
GROWTH AND PRODUCTIVITY OF LEMON VERBENA (<i>Aloysia triphylla</i> L.) AS AFFECTED BY NITROGEN FERTILIZATION IN CENTRAL GREECE: FIRST YEAR (ESTABLISHMENT) RESULTS	
Konstantinos MARTINOS, Elpiniki SKOUFOGIANNI, Nicholas G. DANALATOS.....	227
GROWING TRITICALE BIOMASS AT VARIOUS NITROGEN FERTILIZATION RATES AND HARVESTING PHASES	
Hristina NEDEVA, Hristina YANCHEVA, Radka IVANOVA.....	232
EFFECTS OF SOME APPLICATIONS ON <i>IN VITRO</i> POLLEN GERMINATION OF CAPRIFIG GENOTYPES (<i>Ficus carica</i> var. <i>caprificus</i>)	
Oguzhan CALISKAN, Safder BAYAZIT, Muruvvet ILGIN, Nesrin KARATAS, Hilmi KOCATAS	238
CHARACTERISATION OF ECONOMICALLY IMPORTANT MEDICINAL AND AROMATIC PLANTS BELONGING TO THE LAMIACEAE FAMILY DISTRIBUTED IN THE RIZE PROVINCE, TURKEY	
Emine YURTERI, Fatih SEYİS, Kudret KEVSEROĞLU, Hüseyin BAYKAL, Yusuf ŞAVŞATLI, M. İkbal ÇATAL	245
ANTIFUNGAL ACTIVITY OF <i>SISYMBRIUM SOPHIA</i> EXTRACTS AGAINST PHYTOPATHOGENIC FUNGI	
Yusuf BAYAN.....	251
PHENOLOGICAL AND POMOLOGICAL TRAITS OF SOME INDIGENOUS APPLE GENOTYPES FROM THE <i>ex-situ</i> COLLECTION OF THE FRUIT RESEARCH INSTITUTE, ČAČAK (REPUBLIC OF SERBIA)	
Slađana MARIĆ, Milan LUKIĆ, Sanja RADIČEVIĆ, Olga MITROVIĆ, Milena ĐORĐEVIĆ.....	255
THE EFFECT OF GENOTYPE ON THE MORPHO-PRODUCTIVE CHARACTERISTICS OF SOYBEAN [<i>Glycine max.</i> (L) Merr.] AS SECOND CROP	

Dragan TERZIĆ, Vera POPOVIĆ, Bora DINIĆ, Vera RAJIČIĆ, Jela IKANOVIĆ, Tanja VASIĆ, Jasmina MILENKOVIĆ.....	261
EFFECT OF THE ENVIRONMENTAL CONDITION ON YIELD AND AGRONOMIC TRAITS OF THE BREAD WHEAT (<i>Triticum aestivum</i> L.) GENOTYPES	
İrfan ÖZTÜRK, Turhan KAHRAMAN, Remzi AVCI, Kemal AKIN, Adnan TÜLEK, Mehmet AYBEKE, Bülent TUNA.....	268
EVALUATION of SOME SESAME (<i>Sesamum indicum</i> L.) VARIETIES' PERFORMANCES UNDER MICRO-CLIMATE CONDITIONS of IGDİR-TURKEY	
Tamer ERYIGIT, Ali Rahmi KAYA, Murat TUNCTURK, Resit ALDEMIR, Bunyamin YILDIRIM	276
DRY MATTER YIELD AND FORAGE QUALITY OF PROMISING BITTER VETCH (<i>VICIA ERVILIA</i> (L.) WILLD.) LINES	
Mehmet Salih SAYAR.....	283
GLOBAL WARMING, INCREASING INVASIVE SPECIES AND THEIR EFFECTS ON CEREAL CULTIVATION	
Ersin DİLBER, Mustafa GÜLER.....	292
INFLUENCE OF SALT AND OSMOTIC STRESS ON GERMINATION OF DIFFERENT DOMESTIC WHEAT (<i>Triticum aestivum</i> L.) CULTIVARS UNDER LABORATORY CONDITION	
Branka GOVEDARICA, Igor ĐURĐIĆ, Tanja JAKIŠIĆ, Mirjana JOVOVIĆ, Vesna MILIĆ	298
WATER PRODUCTIVITY OF MAIZE GROWN UNDER DIFFERENT IRRIGATION REGIMES IN VOJVODINA (SERBIA)	
Branka KRESOVIĆ, Boško GAJIĆ, Angelina TAPANAROVA, Ljubomir ŽIVOTIĆ.....	304
DETERMINATION OF GENOTYPE X ENVIRONMENT INTERACTIONS OF SOME AGRONOMIC CHARACTERS OF COWPEA (<i>Vigna unguiculata</i> L.)	
Hatice BOZOĞLU, Reyhan KARAYEL, Nurdoğan TOPAL, Gülbahar ÇULHA.....	315
THE INFLUENCE OF NANO-GRO® PREPARATION ON GROWTH, DEVELOPMENT AND YIELD OF PEPPERMINT (<i>MENTHA</i> x <i>PIPERITA</i> L.)	
Ewa OSIŃSKA, Olga KOSAKOWSKA, Anna AMBROSZCZYK, Wiesława ROSŁON	323
HAWTHORN SPECIES FROM TURKEY AND POTENTIAL USAGE FOR HORTICULTURE	
Oguzhan CALISKAN, Safder BAYAZIT, Kazim GUNDUZ.....	330
PHARMACEUTICAL COMPOUNDS IN LEAVES AND FLORAL STEM OF GLOBE ARTICHOKE (<i>CYNARA CARDUNCULUS</i> L. VAR. <i>SCOLYMUS</i> (L.) FIORI)	
Andrzej SAŁATA, Halina BUCZKOWSKA, Renata NURZYŃSKA-WIERDAK, Salvador V. LOPEZ GALARZA, Anna STĘPNIOWSKA.....	337
A STUDY ON THE DETERMINATION OF YIELD PROPERTIES AND FACTORS THAT AFFECT THE YIELD IN COWPEA UNDER KIRSEHIR/TURKEY ECOLOGICAL CONDITIONS	
Omer SOZEN, Ufuk KARADAVUT	343

GENOTYPIC SPECIFICS OF TRITICALE VARIETIES (*X TRITICOSECALE* WITTM.) AS A FUNCTION OF THE NITROGEN FERTILIZATION LEVEL

Hristofor KIRCHEV..... 352

GROWING POSSIBILITIES OF FORAGE RAPE WITH SOME ANNUAL CROPS

Zeki ACAR, Suleyman ZEYBEK..... 359

THE EFFECT OF ORGANIC AND MINERAL FERTILIZATION IN DIFFERENT CROPPING SYSTEMS OF MAIZE

Milena SIMIĆ, Vesna DRAGIČEVIĆ, Nebojša MOMIROVIĆ, Milan BRANKOV, Igor SPASOJEVIĆ..... 366

INFLUENCE OF RACHIS POSITION ON PHYSICAL AND COMPOSITIONAL PARAMETERS OF CABERNET SAUVIGNON BERRIES

Tatjana JOVANOVIĆ-CVETKOVIĆ, Rada GRBIĆ, Borut BOSANČIĆ, Nemanja MIŠIĆ..... 373

DETERMING THE POPULATION DYNAMICS INFESTATION OF TUTA ABSOLUTA MEYRICK (LEPIDOPTERA: GELECHIDAE) BY DIFFERENT TRAPS ON TOMATO IN AYDIN PROVINCE, TURKEY

Muammer DEMIROZ, Ibrahim GENCISOYLU 380

COVER CROPS EFFECT ON STATUS OF MAIN ANTIOXIDANTS IN SWEET MAIZE

Vesna DRAGIČEVIĆ, Željko DOLIJANOVIĆ, Biljana JANOŠEVIĆ, Milena SIMIĆ, Margarita DODEVSKA, Milan BRANKOV, Jelena MESAROVIĆ 386

THE INFLUENCE OF MINERAL NUTRITION ON WINTER WHEAT YIELD

Vera ĐEKIĆ, Jelena MILIVOJEVIĆ, Miodrag JELIĆ, Vera POPOVIĆ, Snežana BRANKOVIĆ, Mirjana STALETIĆ, Dragan TERZIĆ..... 392

A PLANT (*Bituminaria bituminosa*) SUITABLE TO PRODUCE FORAGE WITH LOW INPUT IN MEDITERRANEAN ENVIRONMENT

Zeki ACAR, İlknur AYAN, Mehmet CAN..... 399

VARIABILITY OF COCKSFOOT (*Dactylis glomerata* L.) AUTOCHTHONOUS POPULATIONS COLLECTED IN SERBIA

Snezana BABIC, Dejan SOKOLOVIC, Jasmina RADOVIC, Zoran LUGIC, Snezana ANDJELKOVIC, Tanja VASIC, Aleksandar SIMIC..... 406

FRUIT CHARACTERISTICS OF THE FIVE MERLOT CLONES IN BELGRADE WINEGORWING REGION, SERBIA

Branislava SIVČEV, Zorica RANKOVIĆ-VASIĆ, Aleksandar PETROVIĆ, Kristina LEONTIĆ ... 413

SOME PLANT PROPERTIES INTERACTIONS AND L-DOPA CONTENT OF FABA BEAN (*Vicia faba* L.) THAT DIFFERENT SOWING TIME

Nurdogan TOPAL, Hatice BOZOGLU..... 419

GENOTYPE AND FERTILIZATION INFLUENCES ON ZINC STATUS IN MAIZE IN TEMPERATE SEMIARID CONDITIONS

Ivica DJALOVIC, Goran BEKAVAC, Srđan ŠEREMEŠIĆ, Dragiša MILOŠEV, Darinka BOGDANOVIĆ 427

EFFECTS OF FERTILIZATION ON PRODUCTION TRAITS OF TRIJUMF CULTIVAR OF TRITICALE

Vera ĐEKIĆ, Jelena MILIVOJEVIĆ, Mirjana STALETIĆ, Milivoje MILOVANOVIĆ, Dragan TERZIĆ, Vera POPOVIĆ, Ivica ĐALOVIĆ 433

KARYOLOGICAL INVESTIGATIONS ON SOME NIGELLA L. SPECIES

Osman GEDİK, Ömer Süha USLU, Ali Rahmi KAYA, Adem EROL 440

PROHEXADIONE-CALCIUM AFFECTS VEGETATIVE GROWTH AND YIELD OF PEPPER

Nusret ÖZBAY, Recai METIN..... 446

THE EFFECTS OF SOME ROOTSTOCKS ON BIOLOGICAL AND PHENOLOGICAL PROPERTIES OF NAVEL ORANGE TYPES IN TURKEY

Ertugrul TURGUTOGLU, Sadiye GOZLEKCI..... 454

THE NEW WALNUT VARIETY BREEDING PROGRAM IN TURKEY

Yaşar AKÇA, Mehmet SÜTYEMEZ, Sebahattin YILMAZ, Hakan KARADAĞ 461

GRAIN YIELD AND YIELD COMPONENTS IN SPRING MALTING BARLEY

Milomirka MADIĆ, Dragan ĐUROVIĆ, Aleksandar PAUNOVIĆ, Desimir KNEŽEVIĆ, Miodrag JELIĆ 467

CHERRY BREEDING WORK AT FRUIT RESEARCH INSTITUTE – ČAČAK (REPUBLIC OF SERBIA)

Sanja RADIČEVIĆ, Radosav CEROVIĆ, Slađana MARIĆ, Milena ĐORĐEVIĆ..... 472

SIGNIFICANCE OF AGRO-ECOLOGICAL CONDITIONS ON TRAIT FORMATION OF MAIZE HYBRID SEED

Marijenka TABAKOVIĆ, Snežana JOVANOVIĆ, Rade STANISAVLJEVIĆ, Ratibor ŠTRBANOVIĆ, Miloš CREVAR, Dobrivoj POŠTIĆ, Jasna KOJIĆ 479

DETERMINATION OF SOME EAR CHARACTERISTICS OF LOCAL POP CORN (*Zea mays L. everta*) GENOTYPES IN KAHRAMANMARAS CONDITIONS (TURKEY)

Gülây ZULKADİR, Leyla İDİKUT, Mustafa ÇÖLKESEN 484

FIELD PEA AS A PROTEIN SOURCE IN CROP ROTATIONS UNDER MODERN PRODUCTION SYSTEMS

Nikola BOKAN, Đura KARAGIĆ, Voja MIHAILOVIĆ, Dalibor TOMIĆ, Vladeta STEVOVIĆ, Branko MILOŠEVIĆ 491

EFFECTS OF FERTILIZERS ON YIELD OF MAIZE HYBRIDS WITH DIFFERENT KERNEL COLOUR

Snežana OLJAČA, Milena SIMIĆ, Vesna DRAGIČEVIĆ, Željko DOLIJANOVIĆ, Jasmina OLJAČA 497

STUDY OF THE LEAF AREA AND DRY MATTER IN NEW WHEAT VARIETIES DEPENDING ON THE APPLIED NITROGEN FERTILIZATION

Ivan YANCHEV, Dafinka IVANOVA 502

EFFECT OF HEADING CUT POSITION AND DATE OF HEADING DURING EARLY SUMMER PRUNING ON THE OCCURRENCE AND PROPERTIES OF SYLLEPTIC SHOOTS IN APRICOT	
Ivan GLIŠIĆ, Dušan MIKIĆ, Tomo MILOŠEVIĆ, Gorica PAUNOVIĆ, Radmila ILIĆ	508
WALNUT VARIETY BREEDING UPDATE TO 2015	
Yaşar AKÇA, Sebahattin YILMAZ, Mehmet SÜTYEMEZ, Hakan KARADAĞ, Serpil ArslanYILDIZ	514
PRODUCTIVITY OF SOME DUTCH POTATO VARIETIES IN THE MOUNTAIN REGION OF MONTENEGRO	
Zoran JOVOVIĆ, Andrey SKRYABIN, Ana VELIMIROVIĆ, Željko DOLIJANOVIĆ, Milica BUĆKOVIĆ	520
EFFECTS OF DIFFERENT TYPES OF CYTOPLASM ON PLANT HEIGHT OF MAIZE INBRED LINES	
Snežana V. JOVANOVIĆ, Marijenka TABAKOVIĆ ¹ , Goran TODOROVIĆ ¹ , Jasna KOJIĆ ¹ , Ratibor ŠTRBANOVIC, Rade STANISAVLJEVIĆ, Svetlana TURUDIJA ŽIVANOVIĆ	525
SOME EARLINESS ENHANCING METHODS IN SWEET CORN PRODUCTION	
Ferenc OROSZ.....	531
APPLICATION OF LIQUID ORGANIC FERTILIZER ON RED CLOVER PRODUCTION ON ACID SOIL	
Dalibor TOMIĆ, Vladeta STEVOVIĆ, Dragan ĐUROVIĆ, Đorđe LAZAREVIĆ, Nikola BOKAN, Jasmina KNEŽEVIĆ	537
COMPARATIVE TESTING OF MAIZE HYBRIDS (ZEA MAYS L.), CULTIVATED FOR GRAIN, UNDER NON-IRRIGATION IN CENTRAL NORTH BULGARIA	
Vanya DELIBALTOVA	543
NUTRITIVE VALUE OF OYSTER MUSHROOM DEPENDING ON THE SUBSTRATE	
Dušanka BUGARSKI, Maja KARAMAN, Jelica GVOZDANOVIĆ-VARGA, Janko ČERVENSKI, Lutvija KARIĆ	549
CHANGE NUMBER OF MICROORGANISMS IN THE RHIZOSPHERE OF ALFALFA AS RESULT OF INOCULATION RHIZOBIA AND AZOTOBACTER	
Snežana ANĐELKOVIĆ, Tanja VASIĆ, Jasmina RADOVIĆ, Snežana BABIĆ, Jasmina MILENKOVIĆ, Goran JEVTIĆ, Simonida ĐURIĆ.....	556
EFFECTS OF BRASSINOSTEROIDS AND GIBBERELIC ACIDS APPLIED <i>IN VITRO</i> CONDITIONS ON POLLEN VIABILITY AND GERMINATION OF SOME GRAPE CULTIVARS	
Zeliha GÖKBAYRAK, Hakan ENGİN	562
THE EFFECTS OF OMEGA FATTY ACIDS ON HUMAN HEALTH	
Merve GÖRE, M. Safa HACIKAMILOĞLU, Orhan KURT	568
POPULATION DYNAMICS OF APHIDS AND NATURAL ENEMIES ON DIFFERENT WHEAT CULTIVARS IN AYDIN PROVINCE, TURKEY	
Yunus CAVDIR, Ibrahim GENCSOYLU	574

RESULTS OF INVESTIGATION ON SOME BIO -MORPHOLOGICAL TRAITS OF BURLEY TOBACCO VARIETIES	
Karolina KOCOSKA, Ilija RISTESKI	580
STABILITY OF SPIKE WEIGHT AND GRAIN WEIGHT PER SPIKE OF DIFFERENT WHEAT GENOTYPES	
Veselinka ZEČEVIĆ, Mirela MATKOVIĆ, Sofija PETROVIĆ, Miodrag DIMITRIJEVIĆ, Desimir KNEŽEVIĆ	587
EFFECT OF ESSENTIAL OIL AND EXTRACTS OF ROSEMARY ON THE STABILITY OF FRYING OIL	
Ebru Sandal TANRIVERDI, Mehmet Musa ÖZCAN, Fahad AL-JUHAIMI.....	594
EFFECTS OF DEFICIT IRRIGATION ON YIELD AND YIELD COMPONENTS OF GRAIN CORN (<i>Zea mays</i> L.)	
Hakkı AKDENİZ, Bilal KESKİN, İbrahim Hakkı YILMAZ	602
AGRICULTURAL MECHANIZATION IN FIELD CROPS IN THRACE REGION OF TURKEY	
Bahattin AKDEMİR.....	612
VARIATION IN FINAL LEAF NUMBER IN WINTER BARLEY (<i>Hordeum vulgare</i> L.)	
Vojislava MOMČILOVIĆ, Milan MIROSAVLJEVIĆ, Vesna MILIĆ, Miloš NOŽINIĆ, Novo PRŽULJ	621
DETERMINATION OF PHENOLOGICAL, POMOLOGICAL AND YIELD CHARACTERISTICS OF LOW CHILLING APPLE CULTIVARS BUDDED ON M9 AND MM 106 ROOTSTOCKS	
Ali IKINCI, Ibrahim BOLAT	627
DISPONIBILITY AND PERFORMANCE OF BENTONITE IN TOP WORKING OF WALNUT TREES AS GRAFTING WAX	
Sebahattin YILMAZ, Halil KAKÇI, Yaşar AKÇA	637
LONG-TERM EFFECTS OF STRAW INCORPORATION AND INCREASING DOSES OF NITROGEN ON THE WHEAT YIELD	
Goran JAĆIMOVIĆ, Vladimir AĆIN, Milan MIROSAVLJEVIĆ, Jovan CRNOBARAC, Branko MARINKOVIĆ, Dragana LATKOVIĆ	644
CONTENT OF β-GLUCAN INCREASES THE PRODUCTIVITY OF BARLEY KERNELS	
Sveto RAKIĆ, Snežana JANKOVIĆ, Suzana ĐORĐEVIĆ MILOŠEVIĆ, Radojica RAKIĆ, Jela IKANOVIĆ	650
YIELD AND POMOLOGICAL TRAITS OF RED CHIEF AND MONDIAL GALA APPLE CULTIVARS IN SUBTROPICAL CONDITIONS OF TURKEY	
Safder BAYAZIT, Oguzhan CALISKAN, Kazım GUNDUZ.....	655
DETERMINATION OF YIELD AND YIELD CHARACTERISTICS OF SOME SMALL SIZED RED LENTIL LINES (<i>Lens culinaris</i> Medik.) IN F5 AND F6 LEVEL	
Ayşe Gülgün ÖKTEM, Abdullah ÖKTEM.....	662

DETERMINING THE PRODUCTION AMOUNT OF LEAF TOBACCO USING GOAL PROGRAMMING	
Altay Uğur GÜL, Funda GENCLER	669
THE EFFECTS OF SEED PRIMING AND NITROGEN DOSES ON SEEDLING GROWTH TRAITS OF BREAD WHEAT (<i>TRITICUM AESTIVUM</i> L.) VARIETIES	
Bekir ATAR, Zekeriya AKMAN	676
DETERMINATION OF MYROBOLAN 29C ROOTSTOCKS REACTIONS AGAINST DROUGHT STRESS <i>IN VITRO</i> CONDITIONS	
Muzaffer İPEK, Lütfi PIRLAK	684
THE EFFECTS OF DIFFERENT COVER CROPS ON WEED INFESTATION IN POPCORN (<i>ZEA MAYS</i> L. SSP. <i>EVERTA</i> STURT)	
Željko DOLIJANOVIĆ, Milena SIMIĆ, Snežana OLJAČA, Dušan KOVAČEVIĆ, Vesna DRAGIČEVIĆ, Zoran JOVOVIĆ, Đorđe MORAVČEVIĆ	692
EFFECTS OF 18 LOCAL BEAUVARIA BASSIANA (BALSAMO) VUILLEMIN ENTOMOPATHOGEN FUNGI ISOLATES ON PINK CORN BORER SESAMIA CRETICA LED. UNDER LABORATORY CONDITIONS	
Dürdane YANAR, Yusuf YANAR, Turgut ATAY, Murat YALÇIN, Orhan BELDEK	699
ACCUMULATION OF NPK AND S BY WINTER OILSEED RAPE DEPENDING ON FERTILIZATION LEVEL AND BIOSTIMULANT APPLICATION	
Małgorzata SZCZEPANEK, Anetta SIWIK-ZIOMEK	704
OSMOTIC STRESS TOLERANCE OF FIELD PEA SEEDLINGS	
Violeta MANDIĆ, Zorica BIJELIĆ, Vesna KRNJAJA, Zorica TOMIĆ, Dragana RUŽIĆ-MUSLIĆ, Violeta CARO-PETROVIĆ, Aleksandar STANOJKOVIĆ	711
SOME LEAF PROPERTIES OF NATURAL <i>Laurus nobilis</i> L. POPULATION IN KARABURUN PENINSULA (IZMIR/TURKEY)	
Aysun BOZA, Serra HEPAKSOY	717
RELATIONS BETWEEN FRUIT BEARING HABIT, AND CARBOHYDRATE / NITROGEN LEVELS IN ‘HACIHALILOGLU’ APRICOT CULTIVAR	
Ibrahim BOLAT, Mustafa SAHIN	723
MINIMIZATION OF THE COST OF CONTRACTED TOBACCO PRODUCTION USING LINEAR PROGRAMMING	
Funda GENCLER, Altay Ugur GUL	729
VITAMIN PROFILES OF MAIZE LANDRACES FROM A MINI CORE COLLECTION FOR GRAIN QUALITY	
Jelena VANČETOVIĆ, Jelena MESAROVIĆ, Dragana IGNJATOVIĆ-MIČIĆ, Sofija BOŽINOVIĆ, Ana NIKOLIĆ, Dragana MRĐEN, Milan STEVANOVIĆ	735
THE EFFECTS OF IRRIGATION WATER AMOUNTS ON LEAF CHLOROPHYLL AND NUTRIENT CONTENTS OF IZMIR 1 POMEGRANATE VARIETY	
Ahmed BAHAYLDDİN, Serra HEPAKSOY	742

EFFECT OF SALT STRESS (NaCl) ON GERMINATION AND PLANT PARAMETERS OF THREE VARIETIES OF BASIL (<i>Ocimum basilicum</i> L.)	
Hassiba FRAJ, Maher SOUGUIR, Stefaan WERBROUCK, Chérif HANNACHI	750
CROP YIELD AND SELECTED SOIL PHYSICAL PROPERTIES UNDER DIFFERENT TILLAGE	
Rastislav BUŠO, Roman HAŠANA, Ivana KAŠIČKOVÁ, Soňa GAVURNÍKOVÁ	757
ADAPTATION OF WINTER WHEAT GENOTYPES TO LOW SOIL pH AND HIGH LEVELS OF MOBILE AL IN THE SOIL	
Miodrag JELIĆ, Jelena MILIVOJEVIĆ, Aleksandar PAUNOVIĆ, Milomirka MADIĆ, Vera ĐEKIĆ	762
EFFECT OF DIFFERENT HARVESTING TIMES TO YIELD AND EAR CHARACTERISTICS OF BABY CORN OBTAINED FROM SWEET CORN	
Abdullah ÖKTEM, Ayşe Gülgün ÖKTEM.....	768
IDENTIFICATION OF AGRICULTURAL CHARACTERISTICS OF CERTAIN LINES AND SPECIES OF GRASS PEA IN KAHRAMANMARAS CONDITIONS TURKEY	
Ömer Süha USLU, Adem EROL, Gökhan Osman CENGİZ.....	775
TESTING PRODUCT AND PRICE RELATIONS IN THE COBWEB THEORY USING ALMON MODEL: DRY ONION FOR TURKEY	
Mehmet Arif ŞAHINLI, Ahmet ÖZÇELİK	781
PHENOLOGICAL TRAITS, YIELD AND FRUIT QUALITY OF PLUM CULTIVARS BRED AT THE FRUIT RESEARCH INSTITUTE IN ČAČAK, SERBIA	
Dragan MILATOVIĆ, Dejan ĐUROVIĆ, Gordan ZEC, Mirjana RADOVIĆ	789
ANALYSIS OF TOTAL POLYPHENOLS FROM POSTDESTILLATION WASTE MATERIAL OF DIFFERENT CORIANDER ACCESSIONS GROWN IN SERBIA	
Milica AĆIMOVIĆ, Dimitrije MARA, Vele TEŠEVIĆ, Jovana STANKOVIĆ, Mirjana CVETKOVIĆ, Miroslav UROŠEVIĆ, Vladimir FILIPOVIĆ	796
DETERMINATION OF YIELD AND SOME PLANT CHARACTERISTICS IN SOME SILAGE CORN VARIETIES	
Bilal KESKİN, Hakkı YILMAZ, Süleyman TEMEL, Barış EREN	803
EFFECTS OF RAIN-SHIELD CULTIVATION SYSTEM ON MORPHOMETRIC AND CHEMICAL PROPERTIES OF BLACKBERRIES ČAČANSKA BESTRNA	
Žaklina KARAKLAJIĆ-STAJIĆ, Mihailo NIKOLIĆ, Rade MILETIĆ, Jelena TOMIĆ, Marijana PEŠAKOVIĆ, Svetlana M. PAUNOVIĆ.....	808
EFFECT OF MULCH TYPE ON THE PRODUCTIVITY OF POTATO	
Jasmina OLJAČA, Nebojša MOMIROVIĆ, Zoran BROČIĆ, Dušan KOVAČEVIĆ, Dobrivoj POŠTIĆ, Danijel PANTELIĆ, Ivana MOMČILOVIĆ	815
EFFECT OF GROWING SEASONS ON SOME QUALITY PROPERTIES OF WINTER WHEAT GENOTYPES	
Kristina LUKOVIĆ, Milivoje MILOVANOVIĆ, Veselinka ZEČEVIĆ, Slaven PRODANOVIĆ, Kamenko BRATKOVIĆ	821

EFFECT OF AMMONIUM FERTILIZER ON GROWTH AND QUALITY OF <i>Cichorium spinosum</i> PLANTS	
Stavroula ANESTI, Konstantina FASOLI, Spyridon PETROPOULOS, Georgia NTATSI, Vasilios ANTONIADIS, Isabel C.F.R. FERREIRA	827
EFFECT OF CLIMATIC FACTORS ON FRUIT QUALITY OF BLACK CURRANT (<i>RIBES NIGRUM</i> L.) CULTIVARS	
Svetlana M. PAUNOVIĆ, Mihailo NIKOLIĆ, Rade MILETIĆ, Mira MILINKOVIĆ, Žaklina KARAKLAJIĆ-STAJIĆ, Jelena TOMIĆ.....	834
INFLUENCE OF ROOTSTOCKS ON THE PROPERTIES OF FRUITING TWIGS IN PLUM CULTIVARS	
Mirjana RADOVIC, Dragan MILATOVIĆ, Gordan ZEC	839
EFFECT OF SOME PLANT GROWTH PROMOTING RHIZOBACTERIA ON GROWTH, LEAF WATER CONTENT AND MEMBRANE PERMEABILITY OF TWO CITRUS ROOTSTOCK UNDER SALT STRESS CONDITION	
Şeyma ARIKAN, Muzaffer İPEK, Lütfi PIRLAK	845
YIELD AND CHEMICAL COMPOSITION OF CAULIFLOWER (<i>BRASSICA OLERACEA</i> L.VAR. <i>BOTRYTIS</i>) CULTIVATED USING MICROBIOLOGICAL FERTILIZER	
Daniela DIMOVSKA, Marija ZDRAVKOVSKA, Igor ILJOVSKI, Dzoko KUNGULOVSKI, Natalia ATANASOVA - PANCHEVSKA	851
EFFECTS OF BRT® EVERGREEN AND AQUA +3 APPLICATION ON <i>AQUILEGIA FLABELLATA</i> VAR. <i>PUMILA</i> AND <i>PELARGONIUM PELTATUM</i> 'RAINBOW ROSE'	
Ildikó KOHUT, Anna RADÓ-TAKÁCS, Ildikó RISZTER, Andrea TILLYNÉ MÁNDY	859
THE EFFECT OF N-FERTILIZATION ON <i>ROSMARINUS OFFICINALIS</i> L. (AN UPRIGHT VARIETY) YIELD IN CENTRAL GREECE	
Eleni WOGIATZI-KAMWOUKOU, Nickolaos GOUGOULIAS, Zoi PAPADOULI, Baia THEODOSIOU, Kyriakos D GIANNOULIS	866
BREEDING LOW LINOLENIC ACID CONTENTED LINSEED VARIETIES FOR SAMSUN ECOLOGICAL CONTIDITONS	
M. Safa HACIKAMİLOĞLU, Merve GÖRE, Orhan KURT	872
FORAGE YIELD AND QUALITY PERFORMANCE OF HUNGARIAN VETCH AND ANNUAL RYEGRASS MIXTURES UNDER DRY LAND CONDITIONS	
Süleyman ŞİMŞEK, Tamer YAVUZ.....	877
EFFECTS ON SOME PLANT GROWTH PARAMETERS OF GA3 APPLICATIONS IN PEPPER PLANTS UNDER SALT STRESS	
Ozlem UZAL, Fikret YASAR.....	883
DETERMINATION OF PROPAGATION PERFORMANCE FROM SEEDS IN RHODODENDRON SPECIES	
Bahadır ALTUN, Hüseyin ÇELİK.....	889
MAIZE POPULATIONS AS A SOURCE OF MICRONUTRIENT IMPROVEMENT	

Snežana MLADENović DRINIĆ, Jelena MESARović, Violeta ANĐELKOVIĆ, Dragan KOVAČEVIĆ, Vojka BABIĆ	895
MEDICINAL AND AROMATIC PLANT POTENTIAL OF RIZE/TURKEY	
Fatih SEYİS, Yusuf ŞAVŞATLI, Emine YURTERİ, Aysel ÖZCAN	901
THE DETERMINATION OF SOME MEDICINAL PROPERTIES OF BERMUDAGRASS, WHITE CLOVER AND BUCKWHEAT USING AS FORAGE CROPS	
Nur KOC, Sadiye Ayse CELIK, Ramazan ACAR, Yuksel KAN.....	906
DETERMINATION OF ALKALOIDS AND OIL RATIIONS IN SOME POPPY (<i>Papaver somniferum</i> L.) VARIETIES AND LINES	
Levent YAZICI, Güngör YILMAZ, Neşet ARSLAN, Kübra YAZICI	912
DETERMINATION OF SOME BOTANICAL AND AGRICULTURAL CHARACTERISTICS IN OPIUM POPPY (<i>Papaver somniferum</i> L.) VARIETIES AND LINES	
Levent YAZICI, Güngör YILMAZ, Neşet ARSLAN Sezai GÖKALP, Başak ÖZYILMAZ	919
TOTAL PHENOLIC CONTENT OF DIFFERENT APPLE CULTIVARS	
Mirko KULINA, Gorica PAUNOVIĆ, Mirjana RADOVIĆ	926
DEPENDENCE QUALITY INDICATORS OF PEPPER SEEDS OF TESTING METHOD	
Dobrivoj POŠTIĆ, Nebojša MOMIROVIĆ, Željko DOLIJANOVIĆ, Jasmina OLJAČA, Ratibor ŠTRBANOVIĆ, Marijenka TABAKOVIĆ, Rade STANISAVLJEVIĆ	931
SEED QUALITY PARAMETERS IN A SET OF SINGLE CROSS MAIZE HYBRIDS, THEIR INBRED COMPONENTS AND RECIPROCAL CROSSES	
Olivera ĐORĐEVIĆ, Sofija BOŽINOVIĆ, Jelena VANČETOVIĆ, Radmila VUKADINOVIĆ, Marija MILIVOJEVIĆ, Milan STEVANOVIĆ.....	935
EVALUATION OF THE EFFECTS OF PARTIAL ROOT ZONE DRYING IRRIGATION ON CORN YIELD AND YIELD COMPONENTS	
Mahmoud RAEINI-SARJAZ, Mohammad HOSSEINI, Ali SHAHNAZARI.....	941
GERMINATION TEST METHODS OF INSECTICIDE-TREATED SEEDS	
Jasna KOJIĆ, Marija MILIVOJEVIĆ, Tanja PETROVIĆ, Dragana BRANKOVIĆ RADOJČIĆ, Snežana JOVANOVIĆ, Marijenka TABAKOVIĆ.....	946
THE EFFECT OF CULTIVAR AND HARVESTING DATES ON ROOT YIELD AND SUGAR CONTENT OF WINTER SOWN SUGAR BEET	
Süreyya Gülfem ALTUNBAY.....	950
IMPACT OF LIMING ON CHEMICAL PROPERTIES OF SOIL IN RASPBERRY ORCHARD	
Ljiljana BOŠKOVIĆ-RAKOČEVIĆ, Gorica PAUNOVIĆ, Radmila ILIĆ, Goran DUGALIĆ, Ivan GLIŠIĆ.....	955
EFFECT OF PLANTING DATES AND SPACING ON THE GROWTH AND YIELD OF TURMERIC (<i>Curcuma longa</i> L.).	
Timothy Alaba FARIYIKE, Omowumi. M. ODELEYE, Oyeboade. S. ADEBAYO	961

EFFECT OF INOCULATION ON SOME IMPORTANT CHARACTERISTICS OF PEAS GROWN IN HERZEGOVINA REGION (BOSNIA AND HERZEGOVINA)	
Višnja VASILJ, Marin ŠEGO, Adrijana FILIPOVIĆ, Sanja SIKORA, Ana MANDIĆ	965
THE EFFECT OF DIFFERENT DOSES OF NITROGEN ON THE YIELD AND THE EXUBERANCE OF CHAMOMILE	
Aleksandra GOVEDARICA-LUČIĆ, Goran PERKOVIĆ, Ivana RAŠEVIĆ, Ivana BOŠKOVIĆ, Alma RAHIMIĆ.....	972
YIELD POTENTIAL OF LINES AND VARIETIES OF TRITICALE IN THE BREEDING PROGRAM OF THE AGRICULTURAL INSTITUTE OF REPUBLIC OF SRPSKA – BANJA LUKA (BOSNIA AND HERZEGOVINA)	
Dragan MANDIĆ, Goran ĐURAŠINOVIĆ, Iskra ARAPOVIĆ, Novo PRŽULJ, Dijana MIHAJLOVIĆ, Zoran JOVOVIĆ	977
BIOLOGICAL AND POMOLOGICAL CHARACTERISTICS OF INTRODUCED PLUM VARIETIES (<i>Prunus domestica</i> L.)	
Nada ZAVIŠIĆ, Željko ROSIĆ.....	984
STUDY OF THE EFFECT OF DROUGHT STRESS ON GERMINATION AND SEEDLINGS GROWTH OF FIVE VARIETIES OF RAPESEED (<i>BRASSICA NAPUS</i>)	
Souhail CHANNAOUI, Rahal ELKAKAHI, Hamid MAZOUZ, Jamal CHARAFI, Mohamed EL FECHTALI, Abdelghani NABLOUSSI.....	990
PRODUCTIVITY OF HEXAPLOID SPELT WHEAT - <i>TRITICUM AESTIVUM</i> SPP. <i>SPELT</i> GROWN ON DEGRADED SOIL	
Jela IKANOVIĆ, Vera POPOVIĆ, Snezana JANKOVIC, Gordana DRAŽIĆ, Ljubiša ŽIVANOVIĆ, Željko LAKIĆ, Mladen TATIC, Jasna SAVIĆ.....	996
EFFECT OF MODIFIED ATMOSPHERE PACKAGING ON QUALITY OF FRESH PROCESSED TUNISIAN POMEGRANATE ARILS CV. <i>GABSI</i>	
Mouna BEN AMARA, Raoudha KHANFIR, Sabrine ABDELLI, Jameleddine BEN ABDA	1005
THE VARIATION OF SOME SOIL TRAITS UNDER LEGUME X CEREALS MIXTURE AND SILAGE CORN ROTATION	
Erdem GULUMSER, Zeki ACAR	1012
TOTAL PHENOLIC CONTENT AND ANTIOXYDANT ACTIVITY OF RHODODENDRON SPECIES COLLECTED FROM THE RİZE PROVINCE (TURKEY)	
Aysel ÖZCAN, Emine YURTERI, Fatih SEYİS	1019
DETERMINING THE APPROPRIATE PLANTING TIME FOR PEANUT (<i>Arachis hypogaea</i> L.) PLANT IN CONDITIONS OF GAP REGION	
Halil HATIPOĞLU, Servet ABRAK, Mehmet KARAKUŞ, Hüseyin ARSLAN, M. Atilla GÜR ..	1025
EVALUATION OF MACRO PROPAGATION TECHNIQUE ON <i>Ananas comosus</i> cv <i>smooth cayenne</i> (PINEAPPLE) STUMP AND NURSERY PERFORMANCE OF PLANTLETS	
Vincent Onah EBRE, Julius Akinyemi FAGBAYIDE, Semeton Akinduro AMOSU, Oladiran OLALEYE	1031

AIRJECTION® INTO SUB-SURFACE DRIP IRRIGATION SYSTEMS AS A TOOL FOR CLIMATE-SMART IRRIGATION	
Michael DAVIDSON	1037
VARIATION IN <i>Digitalis ferrugineae</i> L. MULTIPLICATED WITH SEED UNDER THE PROVINCE RIZE CONDITIONS IN TURKEY	
Yusuf SAVSATLI, Muhammed İkbal CATAL, Fatih SEYİS	1043
PROLONGING STORAGE LIFE OF '0900 ZIRAAT' CHERRIES BY USE OF MODIFIED ATMOSPHERE PACKAGING (MAP)	
Mehmet Seckin KURUBAS, Mustafa ERKAN	1049
NOZZLES TRANSVERSE DISTRIBUTION MODEL DEVELOPMENT: EFFECT OF PRESSURE AND ANTI DRIFT NOZZLE	
Vladimir VIŠACKI, Aleksandar SEDLAR, Rajko BUGARIN, Jan TURAN, Lazar PAVLOVIC, Sanja LAZIĆ, Dragana ŠUNJKA	1056
BIOETHANOL PRODUCTION FROM SUGAR BEET	
Süreyya Gülfem ALTUNBAY	1061
THE EFFECTS OF DIFFERENT TIMES APLICATIONS OF IRRIGATION TERMINATION ON CORN	
Leyla IDIKUT, Mehmet DAVUT SAHIN	1066
DETERMINATION OF YIELD AND SOME PLANT FEATURES OF GRAIN CORN VARIETIES	
Bariş EREN, Bilal KESKİN, İbrahim H. YILMAZ, Bahattin KARAKUŞ	1073
CORRELATION BETWEEN CLIMATIC CONDITION, YIELD AND CHEMICAL COMPOSITION IN MUST ON THREE GRAPES VARIETY	
Violeta DIMOVSKA, Fidanka ILIEVA, Nataša GUNOVA, Vesna GUNOVA	1079
USE OF EFFECTIVE MICRO-ORGANISMS TO ENHANCE THE PRODUCTIVITY AND QUALITY OF DRY BIOMASS OF THE BASIL CULTIVAR "SITNOLISNI AROMATIČNI"	
Vladimir FILIPOVIĆ, Gorica CVIJANOVIĆ, Vladan UGRENOVIĆ, Milica AĆIMOVIĆ, Vera POPOVIĆ, Dragoja RADANOVIĆ, Slađan STANKOVIĆ	1085
TEXTURAL AND PHYSICO-CHEMICAL CHARACTERISTICS OF ŞALAK (APRICOSE) APRICOT CULTIVAR	
Ersin GÜLSOY, Tuncay KAYA, Mücahit PEHLUVAN, Berna DOĞRU ÇOKRAN	1092
THE YIELD TRAITS OF SOME COWPEA (<i>Vigna sinensis</i> L.) GENOTYPES CULTIVATED IN KIRŞEHİR PROVINCE OF TURKEY	
Omer SOZEN, Ufuk KARADAVUT	1099
QUALITATIVE AND PRODUCTIVE PROPERTIES OF BIO-FORTIFICATION SOFT WHEAT OF THE VARIETIES , "RADIKA"	
Marija MENKINOSKA, Valentina PAVLOVA, Tatijana BLAZEVSKA	1108
STABILITY OF FLOWER HEAD YIELD IN CHAMOMILE VARIETIES (<i>Chamomilla recutita</i> L. Rausch.)	

Slobodan DRAŽIĆ, Tomislav ŽIVANOVIĆ, Snežana PAVLOVIĆ, Svetlana TURUDIJA-ŽIVANOVIĆ, Đorđe MORAVČEVIĆ	1115
THE EFFECT OF MINERAL NITROGEN NUTRITION ON THE PRODUCTIVE ELEMENTS OF SPRING MALTING BARLEY EARS	
Jasmina KNEŽEVIĆ, Desimir KNEŽEVIĆ, Miroljub AKSIĆ, Nebojša GUDŽIĆ, Dalibor TOMIĆ, Dragan TERZIĆ	1120
CHANGES IN PROTEIN CONTENT IN DIFFERENT PLANT PARTS OF PEA DURING VARIOUS GROWTH STAGES	
Hatice SARI, Ali GÜLÜMSER	1126
HERITABILITY OF YIELD AND YIELD COMPONENTS OF ZAER LENTIL LANDRACE	
Nadia BENBRAHIM, Fatima GABOUN, Mona TAGHOUTI	1133
GROWTH AND PRODUCTIVITY OF THYME AS AFFECTED BY NITROGEN FERTILIZATION IN CENTRAL GREECE: FIRST YEAR (ESTABLISHMENT) RESULTS	
Konstantinos MARTINOS, Elpiniki SKOUFOGIANNI, Nicholas G. DANALATOS.....	1142
GROWTH AND PRODUCTIVITY OF THYME AS AFFECTED BY IRRIGATION IN CENTRAL GREECE: FIRST YEAR (ESTABLISHMENT) RESULTS	
Konstantinos MARTINOS, Elpiniki SKOUFOGIANNI, Nicholas G. DANALATOS.....	1147
THE INFLUENCE OF ZEOLITE ON THE MORPHO-PRODUCTIVE CHARACTERISTICS OF <i>GLYCINE MAX. L.</i> IN ORGANIC FARMING SYSTEM	
Vera POPOVIĆ, Vladimir SIKORA, Mladen TATIĆ, Livija MAKSIMOVIĆ, Dragan TERZIĆ, Vladimir FILIPOVIĆ, Gordana DOZET, Vera ĐEKIĆ.....	1152
THE EFFECT OF STAND DENSITY ON CONFECTIONARY SUNFLOWER SEED QUALITY	
Jovan CRNOBARAC, Igor BALALIĆ, Nenad DUŠANIĆ, Goran JAĆIMOVIĆ, Dragana LATKOVIĆ	1160
PRELIMINARY DATA ON GENETIC VARIATION BETWEEN NATURAL POPULATIONS OF <i>Salvia officinalis</i> L OF NORTHERN ALBANIA BASED ON RAPDs	
Stela PAPA, Ariola BACU	1167
COMPARATIVE EXTRACTION PROTOCOLS FOR AN EFFICIENT GENOMIC DNA FROM <i>Salvia officinalis</i> L.	
Stela PAPA, Ariola BACU	1172
ALLELOPATHIC EFFECTS OF OREGANO AND ROSEMARY ESSENTIAL OILS ON GERMINATION AND SEEDLING GROWTH OF DURUM WHEAT	
Mehmet ATAK, Kazım MAVİ, İlhan ÜREMİŞ	1178
THE EFFECTS OF SOME POSTHARVEST TREATMENTS AND MODIFIED ATMOSPHERE PACKAGING (MAP) ON QUALITY AND POSTHARVEST LIFE OF BABY CUCUMBERS	
Jasmina SABOTIC, Adem DOGAN, M. Seckin KURUBAS, Mustafa ERKAN.....	1184
EFFECTS OF SALT AND OSMOTIC STRESS ON GROWTH AND GERMINATION OF DOMESTIC WHEAT CULTIVARS (<i>Triticum aestivum</i> L.)	

Branka GOVEDARICA, Igor ĐURĐIĆ, Tatjana IGNJIĆ, Maja MITROVIĆ, Vesna MILIĆ	1192
THE EFFECT OF VARIETY AND WATER DEFICIENCY ON PRODUCTIVE QUALITIES OF POTATO	
Branka GOVEDARICA, Tanja JAKIŠIĆ, Igor ĐURĐIĆ	1200
EFFECT OF GROWTH REGULATORS AND THEIR MIXTURES ON WINTER WHEAT GROWTH, COLD RESISTANCE AND PRODUCTIVITY	
Virgilija GAVELIENĖ, Lina PAKALNIŠKYTĖ, Leonida NOVICKIENĖ	1208
ETHYL METHANE SULFONATE AND ITS EFFECT ON MUTAGENESIS IN RICE CROP IMPROVEMENT	
Hamid DOROSTI, Peiman ZANDI, Saikat Kumar BASU, Shahram Khademi CHALARAS	1215
EFFECTS OF HYBRIDES AND SALT CONCENTRATION ONTO GROWTH AND DEVELOPMENT OF SPROUTING EMBRYO	
Igor ĐURĐIĆ, Branka GOVEDARICA, Tanja JAKIŠIĆ	1221
EFFECT OF DIFFERENT DOSES OF NAA (0, 125, 250, 500 AND 1000 PPM) ON MOUNTAIN THYME (<i>Thymus kotschyanus</i> Boiss. & Hohen.) ROOTING	
Amir RAHIMI, Mohammad Reza ZARDASHTI, Sadegh TGHIPOUR, Dogan ARSLAN	1228
CANADA GOOSE (<i>Branta canadensis</i> L.): AN ICONIC SYMBOL OF WILD CONTINENTAL NORTH AMERICA	
Saikat Kumar BASU, Peiman ZANDI, Shahram Khademi CHALARAS	1233
FORAGE FENUGREEK (<i>Trigonella foenum-graecum</i> L.) PRODUCTION: A BOON FOR SEMI-ARID AGRICULTURAL REGIONS	
Saikat Kumar BASU, William CETZAL-IX, Peiman ZANDI	1237
2. PLANT PROTECTION AND FOOD SAFETY.....	1242
DETERMINATION METHODOLOGY OF PENCONAZOLE AND MYCLOBUTANIL RESIDUES IN APPLES	
Edlira SHAHINASI, Ferdi BRAHUSHI, Vjollca VLADI	1243
ENTOMOFAUNA OF PEARS IN EAST SARAJEVO AREA (BOSNIA AND HERZEGOVINA)	
Dejana TEŠANOVIĆ, Radoslava SPASIĆ, Radenko RADOVIĆ	1249
CONTROL OF HIGHLY BLENDED WEEDING AT MAIZE (<i>ZEA MAYS</i> L.)	
Tonyo TONEV, Miroslav TITYANOV, Anyo MITKOV, Mariyan YANEV, Nesho NESHEV	1256
EVALUATION OF WATER CONTAMINATION USING PHYTOINDICATORS	
Antonije ŽUNIĆ, Slavica VUKOVIĆ, Sanja LAZIĆ, Maria Fátima ALPENDURADA, Dragana ŠUNJKA	1263
DIAPORTHE ERAS AS A PATHOGEN OF QUINCE FRUIT (<i>CIDONIA OBLONGA</i>) IN SERBIA	
Danijela RISTIĆ, Miloš STEVANOVIĆ, Stefan STOŠIĆ, Ivan VUČUROVIĆ, Katarina GAŠIĆ, Veljko GAVRILOVIĆ, Svetlana ŽIVKOVIĆ	1270
OZONE FUMIGATION FOR QUARANTINE AND PRE-SHIPMENT TREATMENTS AS ALTERNATIVES TO METHYL BROMIDE	

Ali Arda IŞIKBER, Hasan TUNAZ, Mehmet Kubilay ER.....	1276
FUMIGANT TOXICITY OF GARLIC ESSENTIAL OIL AND THEIR ACTIVE COMPONENTS AGAINST LIFE STAGES OF CONFUSED FLOUR BEETLE, TRIBOLIUM CONFUSUM Jacquelin du Val.	
Ali Arda IŞIKBER, Hasan TUNAZ, Mehmet Kubilay ER, Özgür SAĞLAM.....	1283
MICROBIAL CONTAMINANTS AT VARIOUS STAGES OF BREWING PROCESS	
Linda LUARASI, Rozana TROJA, Luljeta PINGULI.....	1290
PHYSICAL AND CHEMICAL CHARACTERISTICS OF FLORAL, MEADOW AND FOREST HONEY IN THE AREA OF GORAZDE MUNICIPALITY (BOSNIA AND HERZEGOVINA)	
Amna BIJEDIĆ, Alma MIČIJEVIĆ, Harun KURTAGIĆ, Hanadija OMANOVIĆ	1295
VARIABILITY OF GRAIN MASS PER SPIKE IN CULTIVARS OF TRITICALE (X TRITICOSECALE WITTM.)	
Desimir KNEZEVIĆ, Gordana BRANKOVIĆ, Danijela KONDIĆ, Sretenka SRDIĆ, Veselinka ZECEVIĆ, Mirela MATKOVIĆ, Srdjan ATANASIJEVIĆ.....	1299
APPLICATION OF MEASURING TECHNIQUES IN TESTING MACHINES FOR THE PROTECTION OF PLANTS IN THE REPUBLIC OF SERBIA	
Dragoslav DJOKIĆ, Jordan MARKOVIĆ, Jasmina MILENKOVIĆ, Dragan TERZIĆ, Rade STANISAVLJEVIĆ, Saša BARAĆ, Ranko KOPRIVICA.....	1306
HAZELNUT KERNEL DEFECTS AND ASSOCIATED FUNGI IN THREE PROVINCES IN TURKEY	
Arzu SEZER, Fatma Sara DOLAR.....	1312
THE COMBINE EFFECTS OF EICOSANOID BIOSYNTHESIS INHIBITORS AND TWO NATIVE ISOLATES OF BEAVERIA BASSIANA ON MORTALITY OF SPODOPTERA LITTORALIS LARVAE	
Hasan TUNAZ, Ali A. IŞIKBER, Mehmet Kubilay ER.....	1319
EFFECTS OF POST-HARVEST DIPPINGS OF CALCIUM OXIDE ON AROMA VOLATILE COMPOUND OF PINK LADY APPLE CULTIVAR	
Neslihan EKİNCİ1, Murat ŞEKER2, Mehmet Ali GUNDOĞDU3	1325
TOXICITY OF SPINOSY INSECTICIDE, SPINOSAD AGAINST COWPEA WEEVIL, (CALLOSOBRUCHUS MACULATUS (F.) (COLEOPTERA: BRUCHIDAE)	
Özgür SAĞLAM, Mert SULAR, Ali Arda IŞIKBER.....	1332
HERBICIDE CONTROL OF WILD HEMP (CANNABIS SATIVA L.) AT SUNFLOWER GROWN BY "EXPRESS SUN" TECHNOLOGY	
Chavdar DOCHEV, Anyo MITKOV, Mariyan YANEV, Nesho NESHEV, Tonyo TONEV.....	1339
THE VALIDATION OF (ALTAIR AGRAR) MODEL AS A DECISIONS TOOL OF IPM PROGRAMES IN COTTON FIELDS	
Ahmed ABDO HAMED AMIN.....	1345
EFFICIENCY OF BIOLOGICAL AGENTS IN CONTROLLING OF SEEDS AND ROOTS DISEASES OF EGGPLANT	

Nadeem A. RAMADAN, Peris T. AKRAWI	1352
ANTAGONISTIC EFFECT OF <i>TRICHODERMA HARZIANUM</i> AND <i>BACILLUS</i> SP. AGAINST THE LETTUCE PATHOGEN <i>SCLEROTINIA SCLEROTIUM</i>	
Svetlana ŽIVKOVIĆ, Veljko GAVRILOVIĆ, Katarina GAŠIĆ, Danijela RISTIĆ, Ivica DIMKIĆ, Slaviša STANKOVIĆ, Đorđe FIRA	1363
FIRST RECORD OF AN EGG PARASITOID FOR İĞDIR PROVINCE, TURKEY ELM LEAF BEETLE, <i>XANTHO GALERUCA LUTEOLA</i> (MULLER 1766) (COLEOPTERA: CHRYSOMELLIDAE)	
Celalettin GÖZÜAÇIK, Pınar SOYCAN.....	1369
WHEN SHOULD THE FRUIT BE CONSUMED IN TERMS OF NUTRITION?	
Kazim GUNDUZ, Safder BAYAZIT, Oguzhan CALISKAN.....	1373
RESISTANCE OF SOME WHEAT VARIETIES TO <i>BLUMERIA GRAMINIS TRITICI</i> IN SERBIA	
Mirjana STALETIĆ, Vera ĐEKIĆ, Milivoje MILOVANOVIĆ	1380
THE VIRULENCE SPECTRUM OF <i>PUCCINIA GRAMINIS TRITICI</i> FROM DIFFERENT <i>BERBERIS</i> SPECIES	
Mirjana STALETIĆ, Vera ĐEKIĆ, Milivoje MILOVANOVIĆ, Vladimir PERIŠIĆ, Kristina LUKOVIĆ.....	1385
EFFECT OF RAINFALL AND HUMIDITY DURING SHOOTING AND GRAIN FILLING PERIOD ON YIELD AND QUALITY IN BREAD WHEAT (<i>Triticum aestivum</i> L.) CULTIVARS	
İrfan ÖZTÜRK, Turhan KAHRAMAN, Remzi AVCI, Vedat Çağlar GİRGIN, Orhan Onur AŞKIN, Buket AŞKIN, Bülent TUNA, Adnan TÜLEK.....	1392
WEED CONTROL IN SUNFLOWERS WITH <i>CLEARFIELD PLUS</i> TECHNOLOGY	
Todor MANILOV, Ivan ZHALNOV	1401
HARMFUL ORGANISMS OF GRAIN AS POTENTIAL RISKS TO HUMAN HEALTH	
Vesna ĐUROVIĆ, Snežana TANASKOVIĆ, Dragutin A. ĐUKIĆ, Leka MANDIĆ, Desimir KNEŽEVIĆ	1408
EFFECTS OF MODIFIED ATMOSPHERE CONDITIONS ON BETA CAROTENE AND ANTHOCYANIN CONTENTS OF <i>ARBUTUS UNEDO</i> L. FRUITS	
Neslihan EKINCI, Fatma AYDIN, Murat ŞEKER.....	1415
THE CITRUS SANITATION PROGRAM IN TUNISIA	
Asma NAJAR, Kaouther BEN MAHMOUD, Nebiha METOUI, Emna JEDIDI, Rachida GHEZAL, Ahmed JEMMALI	1422
NITROGEN CONTENT IN VEGETABLES AND NITROGEN EFFECT ON THEIR NUTRITIONAL VALUE	
Mariola KODRA, Ariola DEVOLLI, Edlira SHAHINASI, Dhurata FETA.....	1429
ASSORTMENT OF EASTERN PERSIMMON AND THE WAYS OF ITS IMPROVEMENT	
Sergey KHOKHLOV	1435

EVALUATION OF NEW APRICOT CULTIVARS INTRODUCED IN NIKITA BOTANICAL GARDEN	
Valentina GORINA, Vadim KORZIN, Natalya MESYATS	1439
OBSERVATIONS ON THE DISTRIBUTION, MORPHOLOGY AND SOME BIOECOLOGICAL ASPECTS OF <i>CICADA MORDOGANENSIS</i> BOULARD (HEMIPTERA: CICADIDAE) IN IZMIR, TURKEY	
Cevdet KAPLAN, Serdar TEZCAN	1446
CONTROL OF CYDIA POMONELLA L. IN APPLE ORCHARDS WITH ACETAMIPRID	
Slavica VUKOVIĆ, Sanja LAZIĆ, Srđana PETROVIĆ, Dragana ŠUNJKA, Antonije ŽUNIĆ.....	1451
<i>Tymus vulgaris</i> – ANTIMICROBIAL DRUG FROM NATURE	
Vesna KALABA, Vesna GOJKOVIĆ, Željka MARJANOVIĆ BALABAN, Dragana KALABA ..	1456
IMPROVING THE VIRULENCE OF A NATIVE BEAUVERIA BASSIANA ISOLATE AGAINST RHYZOPERTHA DOMINICA ADULTS	
Mehmet Kubilay ER, Hasan TUNAZ, Ali Arda IŞIKBER.....	1464
EFFECT OF SHORT TIME EXPOSURE OF RHYZOPERTHA DOMINICA ADULTS TO BEAUVERIA BASSIANA CONIDIA MIXED IN WHEAT GRAINS	
Mehmet Kubilay ER, Ali Arda IŞIKBER, Hasan TUNAZ.....	1470
IMPORTANCE OF INSECT IMMUNITY FOR BIOCONTROL: INFECTIONS IN FIELD-TRAPPED INSECTS FROM OSMANIYE (TURKEY)	
Hasan TUNAZ, Mehmet Kubilay ER, Ali A. IŞIKBER.....	1475
MORPHOLOGICAL AND MOLECULAR IDENTIFICATION OF A NEW ALFALFA PARASITE - COLLETOTRICHUM LINICOLA IN SERBIA	
Tanja VASIĆ, Darko JEVREMOVIĆ, Snežana ANDJELKOVIĆ, Jordan MARKOVIĆ, Vladimir ZORNIĆ, Snežana BABIĆ, Aleksandar LEPOSAVIĆ	1480
SUSCEPTIBILITY OF ONION THRIPS, THRIPS TABACI LINDEMAN (THYSANOPTERA: THIRIPIDAE) TO OLD AND NEW GENERATION OF SPINOSYN PRODUCTS UNDER LABORATORY CONDITIONS	
Sobhy A. TEMERAK.....	1486
EFFECT OF HERBICIDES ON MAIZE (<i>ZEA MAYS</i> L.) LINES	
Milan BRANKOV, Milena SIMIĆ, Vesna DRAGIČEVIĆ, Branka KRESOVIĆ, Snežana MLADENOVIĆ DRINIĆ	1493
EVALUATION OF PRECISION FARMING RESEARCH AND APPLICATIONS IN TURKEY	
Bahattin AKDEMIR.....	1498
SPATIAL AND TEMPORAL VARIABILITY OF NECROPHAGOUS DIPTERA IN AL-BALQA REGION IN JORDAN	
Hazem S. HASAN.....	1505
OROBANCHE (OROBANCHE SPP.) AND PHELIPANCHE (PHELIPANCHE SPP.) IN LENTIL (<i>LENS CULINARIS</i> MEDIC.): IMPACTS ON YIELD, QUALITY AND MARKETING PRICES	

Fethiye OZBERK, Irfan OZBERK, Abuzer YUCEL, Imam MECCA, Sengül ALTUNDAL.....	1514
DETERMINATION OF CYPRODINIL AND FLUDIOXONIL RESIDUES IN LETTUCE BY LIQUID CHROMATOGRAPHY/DIODE ARRAY DETECTION	
Sanja LAZIĆ, Dragana ŠUNJKA, Milica PANTELJIĆ, Slavica VUKOVIĆ.....	1523
RESPONSE OF THE PARLATORIA CITRUS SCALE INSECTS (HEMIPTERA, COCCOIDEA) TO COLOURED STICKY TRAPS	
Hanen JENDOUBI, Pompeo SUMA, Agatino RUSSO.....	1529
THE EFFICACY OF SOME ESSENTIAL OIL COMPONENTS AGAINST CONFUSED FLOUR BEETLE, TRIBOLIUM CONFUSUM DUVAL. (COLEOPTERA: TENEBRIONIDAE) AT DIFFERENT TEMPERATURES	
Özgür SAĞLAM, Nihal ÖZDER.....	1536
STUDY OF LEVEL FLUCTUATIONS OF THAUMETOPOEA PITYOCAMPA AND A BIOLOGICAL CONTROL TEST	
Fatima Zohra BISSAAD, Farid BOUNACEUR.....	1545
COMPARATIVE TESTING OF STOMP 33 EC AND WING P IN VINE NURSERY	
Neli PRODANOVA-MARINOVA , Maya DIMITROVA, Iliyan ZHELJAZKOV.....	1555
BIOLOGICAL CONTROL OF THE DATE PALM TREE BORERS, <i>ORYCTES</i> SPP. (COLEOPTERA: SCARABAEIDAE: DYNASTINAE)	
Mohammed KHALAF, Hussain ALRUBEAI, Falah NAHER, Mustafa JUMAA.....	1561
ANTITERMITIC ACTIVITIES OF PINUS ROXBURGHII WOOD EXTRACTIVES AGAINST THE HETEROTERMES INDICOLA (WASMANN) (ISOPTERA: RHINOTERMITIDAE)	
Babar HASSAN, Sohail AHMED, Muhammad MISBAH-UL-HAQ, Mark E. MANKOWSKI, Nasir MEHMOOD.....	1567
EFFECT OF DEEP FREEZING AND AIR DRYING STORAGE ON CONTENT OF FATTY ACIDS OF ROSE HIP SEEDS	
Mehmet GÜNEŞ, Ümit DÖLEK, Gökür ŞAHİN, Mahfuz ELMASTAŞ.....	1576
SEASONAL OCCURRENCE OF THRIPS ON TABLE GRAPES IN NORTHERN ALGERIAN VINEYARDS	
Sabah RAZI, Farid BOUNACEUR, Fatima Zohra BISSAAD, Bahia DOUMANDJI-MITICHE ...	1582
SEASONAL DYNAMICS OF AEROALLERGENIC WEED POLLEN IN BANJA LUKA CITY AREA (BOSNIA AND HERZEGOVINA) DURING 2011-2015	
Gordana BABIĆ, Bojana ĆURKOVIĆ, Vojislav TRKULJA.....	1586
HERBICIDE EFFICIENCY TESTING IN SOYBEAN DURING 2014 AND 2015– COOPERATIVE DANUBE-SOYA PROGRAM	
Gordana BABIĆ, Bojana ĆURKOVIĆ, Vojislav TRKULJA, Miloš NOŽINIĆ, Drago SPREMO, Jovo STOJČIĆ.....	1592
INTROGRESS OF <i>FOC 4</i> QTL LOCUS TO DEVELOP “SUPER ANNIGERI-1” CHICKPEA VARIETY RESISTANT TO FUSARIUM WILT THROUGH MABC	

Durdanappa M. MANNUR, S. B. YERI, M. MAHIBOBSA, I. SHANKERGOUDA, Mahendra THUDI, R. K. VARSHNEY, P. M. GAUR, S. K. JAYALAKSHMI	1598
THE EFFECTS OF GA3 APPLICATION IN DIFFERENT ENVIRONMENTAL CONDITIONS ON THE SURVIVAL ABILITY OF THE SEEDS OF PISTACIA SPECIES AND CULTIVARS	
Yusuf NIKPEYMA	1604
IDENTIFICATION OF LEAF RUST RESISTANCE GENES IN BL CULTIVARS AND BREEDING LINES OF WINTER WHEAT	
Vojislav TRKULJA, Jelena MIHIĆ SALAPURA, Dragana KOVAČIĆ JOŠIĆ, Gordana BABIĆ, Bojana VUKOVIĆ, Bojana ĆURKOVIĆ, Dragan MANDIĆ	1610
TESTING FOR THE PRESENCE OF GENETICALLY MODIFIED LIVING PLANTS, PLANT PARTS AND PLANT PRODUCTS IN THE ENTITY OF REPUBLIC OF SRPSKA (BOSNIA AND HERZEGOVINA) IN 2015	
Vojislav TRKULJA, Jelena MIHIĆ SALAPURA, Dragana KOVAČIĆ JOŠIĆ, Bojana ĆURKOVIĆ, Bojana VUKOVIĆ, Jelena VASIĆ, Gordana BABIĆ	1616
PRESENCE OF AFLATOXIN B1 IN FOOD AND FEED SAMPLES IMPORTED TO THE ENTITY OF REPUBLIC OF SRPSKA (BOSNIA AND HERZEGOVINA) DURING 2013-2015	
Vojislav TRKULJA, Bojana VUKOVIĆ, Jelena VASIĆ, Dragana KOVAČIĆ JOŠIĆ, Jelena MIHIĆ SALAPURA, Jovana PRIJIĆ	1621
A NEW BACTERIAL ENDOSYMBIONT OF SUNN PEST, EURYGASTER INTEGRICEPS	
Nurper GUZ	1625
INTEGRATED PEST MANAGEMENT OF THE TOMATO LEAF MINER, <i>TUTA ABSOLUTA</i> (MEYRICK) (LEPIDOPTERA: GELECHIIDAE) IN TOMATO FIELDS IN EGYPT	
Goda N. F., A. H. EL-HENEIDY, Djelouah K., Hassan N.....	1631
NOZZLES APPLICATION QUALITY IN WHEAT: EFFECT OF SINGLE, DOUBLE AND TRIPLE FLAT FAN NOZZLES	
Aleksandar SEDLAR, Vladimir VIŠACKI, Rajko BUGARIN, Jan TURAN, Lazar PAVLOVIC, Sanja LAZIĆ, Dragana ŠUNJKA	1640
BREAD PRODUCTION LEFTOVERS AS POTENTIALLY VALUABLE RAW MATERIALS IN BIOTECHNOLOGY	
Zvonko NJEŽIĆ, Jasmina ŽIVKOVIĆ, Dragan PSODOROV	1645
BIOLOGICAL CONTROL AGAINST SOILBORNE FUNGI OF CUCURBITS	
Yosraben M'HENNI, Ibtissem SALEM, Naima BOUGHALLEB-M'HAMDI	1650
SCREENING OF SOME CUCURBITS CULTIVARS FOR TOLERANCE TO BACTERIAL FRUIT BLOTCH PATHOGEN <i>ACIDOVORAX CITRULLI</i> IN TURKEY	
Nursen USTUN, Neziha ARSLAN.....	1658
STUDY OF THE LARVICIDAL ACTIVITY OF HYDRO-ALCOHOLIC EXTRACTS OF <i>NERIUM OLEANDER</i> L. AND <i>RICINUS COMMUNIS</i> L. ON <i>TUTA ABSOLUTA</i>.	

Boualem MALIKA, Osmane BADIAA, Saïah FARIDA	1662
HOW PLANT SILICA AFFECT ON MAIZE RESISTANCE TO THE EUROPEAN CORN BORER, <i>OSTRINIA NUBILALIS</i> (HÜBNER)	
Ankica SARAJLIĆ, Emilija RASPUDIĆ, Ivana MAJIĆ, Zdenko LONČARIĆ, Marko JOSIPOVIĆ	1669
THE EFFICIENCY OF <i>BT</i> CORN EXPRESSING ENTOMOCIDAL PROTEIN CRY1AB ON BIOCHEMICAL PARAMETERS OF <i>SESAMIA CRETICA</i> (LEDERER) (LEPIDOPTERA: NOCTUIDAE)	
Hassan F. DAHI, Mohamed Z. Y. ALY, Mahmoud M. M. SOLIMAN, Sherehan A. R. SALEM..	1675
DO BUR CUCUMBER POPULATIONS EXHIBIT DIFFERENCES IN SEED DORMANCY?	
Cumali OZASLAN, Sonnur TAD, Huseyin ONEN, Shahid FAROOQ	1682
3. ORGANIC AGRICULTURE.....	1688
EFFECT OF BIOPULS APPLICATION ON GROWTH AND YIELD OF TOMATO, CUCUMBER AND STRAWBERRY	
Luiza DAWIDOWICZ, Lidia SAS PASZT, Jerzy KRUK	1689
LOSSES CAUSED BY DISEASES ATTACK QUINOA IN EGYPT	
Tawfik H. ABD-ELMOITY, Ayat M. ALI.....	1697
THE ORGANIC MILK PRODUCTION IN POLAND – ECONOMIC ASPECTS AND PROSPECTS FOR DEVELOPMENT	
Marcin ŻEKAŁO	1705
USING MOISTURE CONTROLLING SUPERABSORBENTS FOR IMPROVEMENT OF BARLEY YIELD CAPACITY	
Vyacheslav A. KUZNETSOV, Maria. S. LAVLINSKAYA, Irina V. OSTANKOVA, Victor N. SEMENOV, Vladimir F. SELEMENEV, Alexey L. LUKIN, Olga B. MARAEVA, Sergey N. SELYAVKIN, Denis E. SHEVTSOV.	1712
HOMEOPATHIC EXTRACTS INFLUENCE ON FRUIT QUALITY OF TOMATOES (<i>SOLANUM LYCOPERSICUM</i> MILL.)	
Rasa KARKLELIENĖ, Danguolė JUŠKEVIČIENĖ, Audrius RADZEVIČIUS, Pranas VIŠKELIS, Audrius SASNAUSKAS	1720
EFFECT OF ORGANIC PRIMING ON SEEDLING EMERGENCE OF WATERMELON UNDER LOW TEMPERATURE STRESS	
Kazım MAVİ, Mehmet ATAK	1727
EFFECT OF ORGANIC GROWING SYSTEM ON MICROBIAL POPULATION IN RHIZOSPHERE OF MEDICINAL AND AROMATIC PLANT SPECIES	
Nastasija MRKOVAČKI, Dragana BJELIĆ, Ivica ĐALOVIĆ, Dušan ADAMOVIĆ, Jelena MARINKOVIĆ, Marija ŠKRINJAR	1733
EVALUATION OF ANTI-FUNGAL EFFECTS OF PROPOLIS EXTRACTS	
Yusuf YANAR, Sabriye BELGÜZAR, Dürdane YANAR.....	1739
INFLUENCE OF SPECIAL HERBAL PREPARATION ON GROWTH AND DEVELOPMENT OF CUCUMBER, PEPPER AND TOMATO	

Srdjan LJUBOJEVIĆ, Viktor I. ELISEEV	1745
COMPARATIVE EVALUATION OF SUPPRESSIVE EFFECTS OF ESSENTIAL OILS ON FUNGAL PATHOGENS	
Raoudha KHANFIR BEN JENANA, Chourouk ZAHAF, Hazem BEN BRAHIM, Cherif HANACHI	1755
SUSTAINABLE WHEAT VARIETIES FOR ORGANIC PRODUCTION FOCUSING HARD CONTINENTAL CLIMATE	
Zoran JERKOVIĆ, Željana PRIJČ, Radivoje JEVTIĆ.....	1762
EFFECT OF ORGANIC AND CONVENTIONAL PRODUCTION ON SELECTED CHARACTERISTICS OF DRY BEAN (<i>Phaseolus vulgaris</i> L.)	
Bojana PETROVIC, Simonida DJURIC, Mirjana VASIC, Vesna TUNGUZ, Robert POKLUDA .	1769
COMPOST EFFECT ON THE YIELD AND COMPOSITION OF ESSENTIAL OILS OF <i>OCIMUM BASILICUM</i> "FIN VERT"	
Raoudha KHANFIR BEN JENANA, Ferdaws SMARI, Cherif HANACHI.....	1775
MYCOFLORA ANALYSIS AND INTERACTION STUDY OF PATHOGENS-ANTAGONISTS FUNGI ON WATERMELON DEVELOPMENT IN TUNISIA	
Ibtissem BEN SALEM, Abdelhak RHOUMA, Hiba ALLAGUI, Naima BOUGHALLEB-M'HAMDI	1780
SCREENING OF SEED-BORNE FUNGI OF VEGETABLES CROPS AND THEIR EFFECT ON ORGANIC GROWING PLANTS IN TUNISIA	
Naima BOUGHALLEB-M'HAMDI, Ibtissem BEN SALEM, Yosra ABDELKHALEK, Néji TARCHOUN, Mahmoud M'HAMDI.....	1790
4. ENVIRONMENT PROTECTION AND NATURAL RESOURCES MANAGEMENT 1798	
CHLORINE IN RENEWABLE FUELS - MOBILITY AND EFFECTIVENESS OF BINDING IN THE BOILER FURNACE	
Danuta KRÓL, Sławomir POSKROBKO.....	1799
EROSION PROCESSES IN THE DRAINAGE BASIN OF THE PREDEJANE RIVER (SOUTHEASTERN SERBIA) IN THE PERIOD 1953-2012	
Sonja BRAUNOVIĆ, Mihailo RATKNIĆ, Tatjana RATKNIĆ, Ljubinko RAKONJAC, Aleksandar LUČIĆ.....	1808
GIS BASED LAND USE MODELLING USING SOIL DATA: A CASE STUDY IN THE SURUC PLAIN, SOUTHEASTERN TURKEY	
Yüksel ŞAHİN, Mehmet Ali ÇULLU.....	1815
DEVELOPMENT OF IRRIGATION AUTOMATION SYSTEM (IAS) USING BY PROGRAMMABLE LOGIC CONTROLLER (PLC) AND ITS APPLICATION ON IRRIGATION SCHEDULING CREATED USING CLASS A PAN	
Cafer GENÇOĞLAN, Serpil GENÇOĞLAN.....	1823
CFD MODELLING OF AIR VELOCITY IN A TRACTOR CABIN FOR WINTER CONDITIONS	
Serap AKDEMİR, Serhat ÖZTÜRK, Poyraz ÜLGER	1829

SOILS OF EASTERN HERZEGOVINA AND WRB CLASSIFICATION SYSTEM	
Vesna TUNGUZ, Ljiljana NESIC, Jovica VASIN	1836
THE EVALUATION OF AIR POLLUTION IN SOUTH-EASTERN REGION OF ALBANIA	
Lirim BEKTESHI, Pranvera LAZO, Trajçe STAFILLOV	1843
LONG TERM VARIATION OF RAINFALL IN SOUTHEASTERN ANATOLIAN PROJECT (GAP) AREA	
Kadri YUREKLI	1850
USE OF PASSIVE SAMPLING TECHNIQUES FOR MONITORING OF PESTICIDES IN SURFACE WATER	
Dragana ŠUNJKA, Sanja LAZIĆ, Slavica VUKOVIĆ	1856
EFFECT OF CLIMATE CHANGE ON AGRO HYDROLOGICAL BALANCE FOR SOME REGIONS IN BOSNIA AND HERZEGOVINA	
Sabrija ČADRO, Jasminka ŽUROVEC, Ajla MRKULIĆ, Dženita ŠEHIĆ, Amela ŠERO, Gvozden MIĆIĆ	1863
EFFECT OF COMPOST APPLICATION ON CHEMICAL COMPOSITION AND QUALITY OF ORIENTAL TOBACCO KRUMOVGRAD 90	
Violina ANGELOVA, Venelina POPOVA, Radka IVANOVA, Givko TODODROV, Krasimir IVANOV	1870
VISUAL IMPACT OF WIND TURBINES IN LITHUANIAN LANDSCAPE	
Jonas ABROMAS, Dovilė KALKĖ	1879
CHEMICAL-LIMNOLOGICAL ASSESSMENT OF WATER QUALITY OF VIROI LAKE (ALBANIA)	
Marsela ALIKAJ, Irena DUKA, Romina KOTO, Ferdi BRAHUSHI	1888
ASTERACEAE IN THE FLORA OF THE JAHORINA MOUNTAIN (BOSNIA AND HERZEGOVINA)	
Sladjana PETRONIC, Natasa BRATIC	1895
COMPARISON WITH EMPIRICAL METHODS OF ACTUAL WATER CONSUMPTION VALUES DETERMINED FOR SUGAR BEET (<i>BETA VULGARIS</i> L.) IN THE KIRŞEHİR PROVINCE CONDITIONS, TURKEY	
Sultan KIYMAZ, Çağlar SAĞMAKLI, Ahmet ERTEK	1905
DYNAMICS OF WASTEWATER QUALITY BEFORE AND AFTER TREATMENT THROUGH PILOT PLANT	
Irena DUKA, Seit SHALLARI, Romina KOTO, Marsela ALIKAJ, Ardian MAČI, Julian SHEHU	1914
DETERMINATION OF BIOGAS PRODUCTION POTENTIAL AND ENERGY VALUE FROM ANIMAL MANURE IN TURKEY (AFYONKARAHİSAR PROVINCIAL EXAMPLE)	
Cengiz KARACA	1922
BATCH PROCESS TESTING FOR ANAEROBIC CO-DIGESTION AS AN ALTERNATIVE FOR RENEWABLE BIOGAS	

Ilijan MALOLLARI, Xhaklina CANI, Jorgaq KAÇANI, Lorina LIÇI, Redi BUZO, Mirela QYRA	1929
THE COMPARISON OF SOWING METHODS ON <i>DICHONDRA REPENS</i> IN IGDİR CONDITIONS (TURKEY)	
İbrahim HOSAFLIOĞLU, Hakkı AKDENİZ, M. Kazım KARA	1935
RUDERAL ASSOCIATION <i>SAMBUCETUM EBULI</i> FELFÖDY 1942. OF THE MUNICIPALITY OF PALE (BOSNIA AND HERZEGOVINA)	
Sladjana PETRONIĆ, Nataša BRATIĆ	1942
AN IMPROVED SIMULATION METHOD OF CRUDE OIL FRACTIONAL SEPARATION TO ACHIVE A HIGHER QUALITY IN NATURAL SOURCE MANAGEMENT	
Xhaklina CANI, Ilijan MALOLLARI, Ismet BEQIRAJ, Lorina LIÇI.....	1948
MORPHOLOGICAL DIVERSITY OF WILD MYRTLE (<i>MYRTUS COMMUNIS</i> L.) POPULATIONS IN ALBANIA	
Dhimitër PEÇI, Alfred MULLAJ, Xhensila METKO, Gledjan CAKA, Aida DERVISHI	1954
ASSESSMENT OF LARGE SCALE IRRIGATION SCHEMES USING IRRIGATION INTENSITY INDICATOR IN TURKEY	
Hasan DEĞİRMENÇİ, Çağatay TANRIVERDİ	1961
SPRINKLER IRRIGATION MANAGEMENT FOR PASTURE IN LOAM SOIL	
Vladimir ZHALIAZKO, Viktor LUKASHEVICH, Otilija MISECKAITE	1968
CONSERVATION OF BIODIVERSITY AND GEOGRAPHICAL INDICATIONS IN MOUNTAIN AREA OF ALBANIA	
Roland BARDHI, Alban IBRALIU	1975
SHORT- AND LONG-TERM EXPERIMENTS. HOW CAN WE INTERPRET THE RESULTS?	
Marianna MAKÁDI, Ibolya DEMETER, Tibor ARANYOS, Viktória OROSZ, Bernadett FEHÉR, József MÉSZÁROS, Attila TOMÓCSIK.....	1982
CHANGES OF THE SOL PHYSICAL PROPERTIES IN AREA IMPACT OF ZAGREB-SPLIT HIGHWAY IN CROATIA	
Danijela JUNGIĆ, Vida VLADIMIR, Stjepan HUSNJAK	1988
THE EVALUATION RESULTS OF CLIMATE CHANGES FOR SLCAL BENEFICIARIES' PROJECT	
Mohammed HUSSEIN, Mohamed ELRAEE	1995
BEHAVIOUR OF SEVERAL APPLE (<i>MALUS DOMESTICA</i> BORKH.) CULTIVARS GROWN UNDER AGRO-ECOLOGICAL CONDITIONS OF GJAKOVA, KOSOVO	
Gjokë DUHANAJ, Lush SUSAJ	2002
QUALITY ANALYSIS OF THE MISCANTHUS X GIGANTEUS BIOMASS CULTIVATED IN AGROECOLOGICAL CONDITIONS OF THE REPUBLIC OF SERBIA	
Jelena MAKSIMOVIĆ, Željko DŽELETOVIĆ, Zoran DINIĆ, Aleksandra STANOJKOVIĆ-SEBIĆ, Radmila PIVIĆ	2008

FUEL CELLS: A PRACTICAL ANSWER TO THE WORLD'S PRESSING NEED FOR CLEAN AND EFFICIENT POWER	
Pramod KUMAR OMRE.....	2015
EFFECTS OF FRUIT THINNING METHOD ON FRUIT QUALITY INDICATORS OF "ROYAL GALA" APPLE CULTIVAR, UNDER GJAKOVA'S CLIMATE CONDITIONS	
Gjokë DUHANAJ, Lush SUSAJ, Elisabeta SUSAJ, Nikollaq ROSHANJI	2019
PREDICTION OF AVAILABLE SOIL ZINC USING CHEMICAL EXTRACTANTS	
Jelena MILIVOJEVIĆ, Vera ĐEKIĆ, Miodrag JELIĆ, Zoran SIMIĆ, Vesna PERIŠIĆ	2026
CHANGES IN SOIL PHYSICAL PROPERTIES WITH HAZELNUT HUSK AND TOBACCO WASTE APPLICATIONS	
Coskun GÜLSER	2032
THE POSSIBILITY OF USING HOUSEHOLD FOOD WASTE IN REDUCING NICOTINE CONTENT IN TOBACCO WASTE	
Vesna RADOJIČIĆ, Nemanja MANDIĆ, Maja MALNAR, Boris PISINOV	2037
SEX RATIO IN LOCAL POPULATION OF SPECIES <i>Chondrostoma phoxinus</i> Heckel, 1843 (Teleostei: Ostaryophysi, Cyprinidae) FROM Buško LAKE	
Denisa ŽUJO ZEKIĆ, Mirzeta KAŠIĆ-LELO, Suvad LELO, Aida ABAZA	2043
EFFECT OF DIFFERENT ORGANIC WASTES ON MICROBIAL PROPERTIES OF MAIZE (<i>Zea Mays Indendata</i>) RHIZOSPHERE AND ROOT FREE SOIL	
Rıdvan KIZILKAYA, Coskun GULSER	2052
TREATED SEWAGE SLUDGE APPLICATIONS: HEAVY METAL CONTENTS OF CORN AND SECOND CROP WHEAT SEEDS GROWN IN SANDY CLAY SOIL	
Sezai DELİBACAĞ, Ali Rıza ONGUN	2059
VARIABILITY ANALYSIS ON WATER QUALITY OF STREAMFLOW FROM YESILIRMAK BASIN IN TURKEY	
Kadri YUREKLI	2066
COMPARATIVE STUDY OF COLD PRESS AND ACCELERATED SOLVENT OIL EXTRACTION FROM <i>CAMELINA SATIVA</i> AND <i>BRASSICA CARINATA</i>	
Umesh Chandra LOHANI, Vijay SUNDARAM, Kasiviswananthan MUTHUKUMARAPPAN ...	2071
THE POSSIBILITY OF OBTAINING ORGANIC FERTILIZER FROM TOBACCO WASTE	
Nemanja MANDIĆ, Maja MALNAR, Vesna RADOJIČIĆ, Boris PISINOV	2082
THE INFLUENCE OF LAND USE ON WATER-PHYSICAL PROPERTIES OF SOILS IN VOJVODINA (SERBIA)	
Ljiljana NEŠIĆ, Katarina MILUNOVIĆ, Milivoj BELIĆ, Vladimir ĆIRIĆ, Jovica VASIN, Lazar PAVLOVIĆ.....	2088
THE POSSIBILITY OF USING BURLEY TOBACCO STALKS AS A BIOFUEL	
Maja MALNAR, Vesna RADOJIČIĆ, Gordana KULIĆ, Nemanja MANDIĆ, Savo SKOČIĆ.....	2095
EFFECT OF WATER HOLDING POLYMERS AND WATER RESTRICTION ON GROWTH OF TOMATO CULTIVATED IN DIFFERENT SOILLESS CULTURES	

Hakan BAŞAK, Emre ŞAHİN, Sultan KIYMAZ	2101
THE STABILITY OF STRUCTURAL MICROAGGREGATES AND THE RISK OF THE SOIL CRUSTING IN THE AREA OF THE FLOODED AGRICULTURAL SOILS OF THE REPUBLIC OF SERBIA	
Radmila PIVIĆ, Zoran DINIĆ, Jelena MAKSIMOVIĆ, Aleksandar STANOJKOVIĆ, Dragana JOŠIĆ, Aleksandra STANOJKOVIĆ-SEBIĆ	2109
POTENTIAL USES OF SPENT MUSHROOM SUBSTRATE IN AGRICULTURE	
Funda ATİLA	2116
THE EFFECT OF LONG-TERM USE OF PHOSPHATE FERTILIZERS ON THE CONTENT OF EXCHANGEABLE BASES IN VERTISOL	
Nebojša GUDŽIĆ, Miroljub AKSIĆ, Slaviša GUDŽIĆ, Gordana ŠEKULARAC, Aleksandar VUKOVIĆ	2125
IMPROVING MANAGEMENT OF AGRICULTURAL WATER RESOURCES: TECHNICAL OPTIONS AND STRATEGIC OPPORTUNITIES	
Atef HAMDY, Adel ALY	2131
THE REDUCTION OF NICOTINE CONTENT IN THE COMPOSTING PROCESS OF TOBACCO WASTE MIXING WITH SHEEP AND CHICKEN DROPPINGS	
Gordana KULIĆ, Nemanja MANDIĆ, Vesna RADOJIČIĆ, Maja MALNAR	2139
PHYSICAL AND CHEMICAL CHARACTERISTICS OF RAW WASTEWATER FROM MEAT PROCESSING PLANTS IN ALBANIA	
Ilijana BOCI, Xhuljeta HAMITI, Sonila VITO	2144
CHARACTERISTICS OF SOIL AROUND THE MAIN DUMP IN NOVI SAD (SERBIA) AND PROPOSAL FOR ITS RECULTIVATION	
Ljiljana NEŠIĆ, Dunja KRSTIĆ, Lazar PAVLOVIĆ, Milivoj BELIĆ, Jovica VASIN, Vladimir ĆIRIĆ	2149
THE ANALYSIS OF BROWN BEAR (<i>URSUS ARCTOS</i> L.) POPULATION CONDITION IN BOSNIA AND HERZEGOVINA WITH REFERENCE TO THE REGION	
Siniša CINCAR, Damir MRĐENOVIĆ, Aleksandar TEPAVAC	2155
RESERVOIR TILLAGE TECHNIQUE	
İlknur DURSUN, Ergin DURSUN	2161
APPLICATION OF INTERO MODEL FOR SOIL LOSS ESTIMATION CASE STUDY: S7-1 WATERSHED OF SHIRINDAREH RIVER BASIN, IRAN	
Leila GHOLAMI, Pedro Veloso Gomes BATISTA, Atefeh BEHZADFAR, Abdulvahed KHALEDI DARVISHAN, Morteza BEHZADFAR	2169
REPRESENTATION OF THE CONTENT OF INORGANIC NITROGEN IN ELESKA RIVER	
Tatjana BLAZHEVSKA, Marija MENKINOSKA, Valentina PAVLOVA, Viktorija STAMATOVA, Nikola LEKOVSKI	2178
EFFECTS OF IRRIGATION AND FERTILIZATION ON THE NUMBER OF FORMED FLOWERS AND FRUITS SETS IN PRUNED PEPPER	

Vjekoslav TANASKOVIK, Ordan CUKALIEV, Velibor SPALEVIC, Milena MOTEVA, Mile MARKOSKI.....	2184
AGRO-CHEMICAL CHARACTERISTICS OF SOIL IN RASPBERRY-GROWING REGION OF IVANJICA (SERBIA)	
Mira MILINKOVIC, Rade MILETIC, Milan LUKIC	2193
PHYSICAL ATTRIBUTES IN SOIL QUALITY FOR SUSTAINABLE SOIL MANAGEMENT	
Coskun GÜLSER, Rıdvan KIZILKAYA'	2200
SPATIAL ANALYSES OF PLANT AVAILABLE PHOSPHORUS CONCENTRATION UNDER DIFFERENT MANAGEMENT PRACTICES	
Mesut BUDAK, Hikmet GÜNAL, Nurullah ACİR, İsmail ÇELİK, Hakan YILDIZ.....	2205
FACTORS AFFECTING AVAILABLE PHOSPHORUS CONCENTRATION IN NATURALLY FORMED SALINE ALKALINE SOILS	
Mesut BUDAK, Hikmet GÜNAL.....	2211
SPATIAL DISTRIBUTION OF SOIL SALINITY WITH DIFFERENT INTERPOLATION METHODS	
Şeydagül ÖZDEMİR, Hikmet GÜNAL, Hakan ARSLAN, Nurullah ACIR.....	2218
ASSESSMENT OF HEAVY METALCONTAMINATION IN SEDIMENTS AND VEGETATION OF THE KARAVASTA LAGOON, ALBANIA	
Romina KOTO, Aida BANI, Irena DUKA, Marsela ALIKAJ	2225
EFFECTS OF ENTOMOPATHOGENIC BACTERIA ON HONEYBEES APIS MELLIFERA INTERMISSA. EVALUATION OF PHYSIOLOGICAL CHANGES.	
Hakima OULEBSIR-MOHANDKACI, Farida BENZINA, Arezki MOHAMMEDI	2233
STANDARDIZATION OF METHYL ESTERIFICATION PROCESS FOR REFINED COTTONSEED OIL USING RESPONSE SURFACE METHODOLOGY	
Jayant SINGH,Rajesh U. MODI, T.K BHATTACHARYA.....	2243
STUDY ON USE OF COMPOSITE MATERIAL TO REPLACE THE WOODEN COMPONENTS IN ANIMAL DRAWN HILL EQUIPMENT	
Jayant SINGH	2250
DEVELOPMENT OF A RESOURCE CONSERVATION MACHINE FOR SUGARCANE CULTIVATION	
Rajnarayan PATERIYA, Himanshu ADHIKARI.....	2256
5. ANIMAL HUSBANDRY	
FEASIBILITY STUDY ON USING ZIGBEE NETWORKS IN AGRICULTURAL APPLICATIONS	
Temuçin Göktürk SEYHAN, YASİN KAHYA, Sinem ÇAMURCU.....	2264
A COMPARATIVE ANALYSIS OF THE EXTERIOR IN LOCAL GOAT BREEDS FROM SOUTHWEST BULGARIA	
Atanas VUCHKOV, Doytcho DIMOV.....	2271

ROLE OF INFORMATION AND COMMUNICATION TECHNOLOGIES IN INNOVATION OF LIVESTOCK SYSTEMS AND TERRITORY PROMOTION. A CASE STUDY OF CALABRIA REGION, ITALY	
Adriano CIANI, Annalisa GAMBARDELLA	2279
DETERMINATION OF SOME EGGS TRAITS OF WHITE AND BRONZE TURKEYS IN A FREE-RANGE SYSTEM	
Atila TASKIN, Ufuk KARADAVUT, Huseyin CAYAN, Ahmet SAHIN	2286
IDENTIFICATION AND PHENOTYPIC CHARACTERIZATION OF FIVE LOCAL CATTLE OF BUSHA TYPE FARMED IN ALBANIA AND KOSOVO	
Naim REXHAJ, Lumturi PAPA, Kristaq KUME	2291
INTESTINAL PARASITES OF SALMO OHRIDANUS (STEINDACHNER, 1892) FROM OHRID LAKE	
Katerina BELICHOVSKA, Daniela BELICHOVSKA, Dimitar NAKOV, Metodija TRAJCHEV ..	2297
RED CLOVER QUALITY AFFECTED BY CULTIVAR, CUT AND STAGE OF GROWTH	
Jordan MARKOVIĆ, Tanja VASIĆ, Mirjana PETROVIĆ, Dragoslav ĐOKIĆ, Zoran LUGIĆ, Dragan TERZIĆ, Bora DINIĆ	2303
IMPACT OF THAWING TEMPERATURE ON MOTILITY PARAMETERS OF BULL'S SEMEN	
Stoja JOTANOVIĆ, Marija JOVIČIĆ, Đorđe SAVIĆ, Marinko VEKIĆ, Borut BOSANČIĆ, Milenko ŠARIĆ, Ivan STANČIĆ	2310
DETECTION OF β-LACTOGLOBULIN GENE POLYMORPHISM OF RAISED HAIR GOATS IN ANTALYA PROVINCE BY USING PCR-RFLP METHOD	
Taki KARSLI, Murat Soner BALCIOĞLU, Emine ŞAHİN, Hüseyin Göktuğ FİDAN, Kemal KARABAĞ	2315
TOLERANCE OF HONEY BEES ON COMMON JUNIPER (<i>Juniperus communis</i>) AND SCOTS PINE (<i>Pinus silvestris</i>) ESSENTIAL OILS	
Nebojša NEDIĆ, Miroslav KOSTIĆ, Tatjana MARKOVIĆ, Kazimir MATOVIĆ, Miša MARKOVIĆ	2319
TRENDS IN POLISH INTERNATIONAL TRADE IN EGGS PRODUCTS IN THE PERIOD 2006-2015	
Dorota PASIŃSKA	2325
PROTECTIVE ACTIVITY OF RONCOLEUKIN® - IN COMBINED DRUG AGAINST SECONDARY ECHINOCOCCOSIS MULTILOCULARIS INFECTION	
Olga V. RUDNEVA, Vera K. BEREZHKO, Marina R. SASIKOVA.....	2335
IMPORTANCE OF THE GOAT BREEDING IN SOUTHEASTERN ANATOLIA REGION (TURKEY)	
Ali Murat TATAR, H. Deniz ŞIRELİ, S. Seçkin TUNCER	2342
PRELIMINARY DATA ON GROSS MARGIN ANALYZE OF DAIRY FARMS IN KOSOVO	
Medin ZEQRIRI, Ylli BIÇOKU, Grigor GJEÇI, Ergent PIRE.....	2347

INTRA AND INTER-POPULATION VARIABILITY OF HIND WINGS ANGLES IN HONEYBEE FROM SERBIA	
Goran JEVTIĆ, Bojan ANDELKOVIĆ, Mića MLADENOVIĆ, Kazimir MATOVIĆ, Nebojša NEDIĆ, Zoran LUGIĆ, Bora DINIĆ	2353
UTILIZATION OF ENZYMES IN NON RUMINANT'S ANIMAL NUTRITION, AS A BIOTECHNOLOGY FOR REDUCING POSPHORUS IN ANIMAL MANURE	
Rezana PENGU, Etleva DELIA, Edmond HALA	2359
TOTAL BILIRUBIN CONCENTRATION AND AST ACTIVITY IN SERUM OF SIMMENTAL COWS IN DIFFERENT GEOGRAPHIC REGIONS OF BOSNIA AND HERZEGOVINA	
Jelena NIKITOVIC, Tatjana PANDUREVIC, Marko LAZIC	2363
BEHAVIORAL PATTERNS OF GOATS	
S. Seçkin TUNCER, H. Deniz ŞİRELİ, Ali Murat TATAR	2369
THE EFFECTS OF MICROBIAL PHYTASE ON IMPROVING OF GROWTH PERFORMANCE AND DIETARY PHYTATE-PHOSPHORUS UTILIZATION BY PIGLETS	
Rezana PENGU, Etleva DELIA	2375
PHOTOMETRIC EVALUATION OF EFFECT OF CLAW DISORDERS ON CLAW CONFORMATION	
Michal VLČEK, Ján TOMKA, Radovan KASARDA	2380
CLASSIFICATION OF SCIENTIFIC INTEREST IN SERBIAN ANIMAL HUSBANDRY	
Marko LAZIC, Zvonko SPASIC, Jelena NIKITOVIC, Milun PETROVIC, Nikola STOLIC, Gjoko BUNEVSKI, Bratislav PESIC	2385
EFFECT OF ENSILING MILK THISTLE (<i>SILYBUM MARIANUM</i> L. GAERTH) WITH MOLASSES OR UREA ON SILAGE QUALITY AND <i>IN VITRO</i> DIGESTIBILITY	
Hatice BASMACIOĞLU MALAYOĞLU, Pınar OZDEMIR, Hasan Hüseyin IPCAK, Bora UNLU, Amir Hasan TAGHILLOOFAR, Emine BAYRAM	2391
MOLECULAR DETECTION OF PROTOZOAN PATHOGENS IN COMMERCIAL BUMBLEBEE (<i>B. terrestris</i> L.)	
Bahar ARGUN KARSLI, Fehmi GÜREL	2398
NATIVE DOG BREEDS OF TURKEY	
Orhan YILMAZ	2404
HONEY BEE BIOLOGY IN TURKEY	
Orhan YILMAZ, Y. Erdal ERTURK	2413
CHEMICAL COMPOSITION AND TANNIN CONTENT OF AGRO-INDUSTRIAL BY-PRODUCTS AS SUITABLE FOR RUMINANT FEED	
Myriam R. VENTURA, Marta BARBERÁ, Pedro SAAVEDRA, Luis REY, J. Ignacio R. CASTANON	2419
METHOD OF MOVING HIVES WHEN PREPARING HONEYBEE COLONIES FOR ACACIA FLOW	

Duška SLIJEPAC, Dejan POPOVIĆ	2425
EFFECTS OF TANNIN-RICH EXTRACT (FARMATAN) ON GROWTH PERFORMANCE, CARCASSES AND MEAT QUALITY TRAITS OF FATTENING BOARS	
Diana BILIĆ-ŠOBOT, Marjeta ČANDEK-POTOKAR, Valentina KUBALE, Dejan ŠKORJANC	2431
THE RATE OF INFECTION OF DOMESTIC AND WILD CARNIVORES BY TAENIA HYDATIGENA CESTODES IN KABARDINO-BALKARIA	
Amina THAKAHOVA, Vera BEREZKO, Asiyat BITTIROVA.....	2437
IMPORTANCE OF HUMAN RESOURCES ACTIVITIES IN THE FISH MEAL AND FISH OIL FACTORIES IN THE LIGHT OF TECHNOLOGICAL DEVELOPMENTS	
Günseli ACAR, Şennan YÜCEL	2442
EFFECT OF NON-GENETIC FACTORS ON 305-DAYS MILK YIELD IN SIMMENTAL COWS REARED IN SUBTROPICAL CLIMATE CONDITION	
Yahya ÖZTÜRK, Memis BOLACALI	2446
INFLUENCE OF BITUMINARIA BITUMINOSA FEED FORM (FRESH AND DRIED) ON PREFERENCE AND VOLUNTARY INTAKE IN POULTRY	
Marta BARBERÁ, María P. FLORES, José I.R. CASTANON, Erik DIAZ-AVILA, María.C. MUÑOZ, Myriam R. VENTURA.....	2450
THE EFFECT OF THE USE OF CRUDE SOYBEAN IN THE FINAL MIXTURES FOR BROILER CHICKEN ON CHEMICAL AND AMINO ACID COMPOSITION OF MEAT	
Veselin PETRIČEVIĆ, Miloš LUKIĆ, Zdenka ŠKRBIĆ, Snežana BOGOSAVLJEVIĆ-BOŠKOVIĆ, Vladimir DOSKOVIĆ, Simeon RAKONJAC, Maja PETRIČEVIĆ	2455
THE EFFECT OF LAYERS FEED SUPPLEMENTATION WITH ORGANIC SELENIUM ON THE QUANTITATIVE AND QUALITATIVE INDICATORS OF PRODUCTION	
Vezir JANUZI, Lumturi SENA.....	2461
IMPACT OF THAWING TEMPERATURE ON QUALITY PARAMETERS OF BULL'S SEMEN	
Stoja JOTANOVIĆ, Marija JOVIČIĆ, Đorđe SAVIĆ, Marinko VEKIĆ, Borut BOSANČIĆ, Ivan STANČIĆ.....	2467
EFFECTS OF PARTIAL REPLACEMENT OF FISH MEAL BY DDGS ON BLOOD HEMATOLOGICAL AND BIOCHEMICAL PARAMETERS OF RAINBOW TROUT	
Baki AYDIN, Erkan GÜMÜŞ.....	2472
PRELIMINARY DATA ON DAIRY FARMERS' LEVEL OF EDUCATION: THE CASE OF ALBANIA	
Grigor GJEÇI, Ylli BIÇOKU, Medin ZEQRIRI.....	2477
TAENIIDOSES IN DOGS AND LARVAL CESTODOSES IN SHEEP AT FARMS IN KABARDINO-BALKARIA	
Vera BEREZKO, Amina THAKAHOVA	2482
PROTECTIVE EFFECT OF IMMUNOSTIMULATORY DRUGS IN EXPERIMENTAL TRICHINOSIS OF MICE	

Liudmila A. NAPISANOVA, Olga V. RUDNEVA, Vera K. BEREZHKO, Amina A. THAKAHOVA	2487
DIAGNOSIS OF METABOLIC DISORDERS IN TRANSITIONAL DAIRY COWS BASED ON CHANGES IN CHARACTERISTIC BLOOD BIOCHEMICAL INDICATORS	
Radojica DJOKOVIC, Marko CINCOVIC, Vladimir KURCUBIC, Zoran ILIC, Milun PETROVIC, Miroslav LALOVIC, Milos PETROVIC.....	2491
SURVIVAL ANALYSIS AND APPLICATION IN ANIMAL SCIENCE	
Ercan EFE, Burecu KÜLEY	2497
GENETIC POLYMORPHISM AT CSN1S2 LOCUS IN HAIR GOATS REARED IN ANTALYA	
Murat Soner BALCIOĞLU, Taki KARSLI, Emine ŞAHİN, Eymen DEMİR, Kemal KARABAĞ	2504
USING OF CYPHENOTHIN FOR ECTOPARASITOSEs TREATMENT FARM ANIMALS	
Mihail V. ARISOV, G.M. MAGOMEDSHAPIEV, E.A. RUDAKOVA	2510
THE EFFECT OF THE AGE ON SOME OF THE REPRODUCTIVE TRAITS IN HOLSTEIN-FRIESIAN COWS	
Jelena ČABARKAPA, Tatjana PANDUREVIĆ, Miroslav LALOVIĆ, Svjetlana MIČIĆ, Jelena VLAČIĆ, Darko VUJIČIĆ.....	2517
POTENTIAL TARGET SPECIES FOR SURVEILLANCE ON A BOVINE TUBERCULOSIS ENDEMIC AREA	
Agnes CSIVINCSIK, Zsuzsanna RÓNAI, Gábor NAGY	2522
THE EFFECT OF REPLACING CORN AND SOYA BEANS BY WHITE SORGHUM AND HORSE BEANS ON RUMEN METABOLISM AND IN SITU DEGRADABILITY IN SHEEP	
Imtiaz BOUZARRAA', Abdulbaset Zidane SHRIF, Hammadi ROUISSI.....	2527
EFFECTS OF EGG WEIGHT AND SHAPE INDEX ON INCUBATION RESULTS OF THE WHITE ITALIAN GOOSE	
Sreten MITROVIĆ, Tatjana PANDUREVIĆ, M. MILOJEVIĆ, Živan JOKIĆ, Vladan ĐERMANOVIĆ, Svjetlana MIČIĆ, Jelena VLAČIĆ.....	2534
INFLUENCE OF PLANT OILS ON CERTAIN PHYSICO-CHEMICAL CHARACTERISTICS OF FRANKFURTERS	
Daniela BELICHOVSKA, Zlatko PEJKOVSKI, Katerina BELICHOVSKA, Aleksandra SILOVSKA-NIKOLOVA.....	2541
EFFECTS OF NATURAL PIGMENT SOURCES AND STORAGE DURATIONS ON EGG QUALITY	
Esin UNVER, Aylin AGMA OKUR	2547
6. RURAL DEVELOPMENT AND AGRO-ECONOMY	2553
PROTECTION AND PROMOTION OF DOMESTIC EGG PRODUCTION:EXAMPLES FROM THE REPUBLIC OF CROATIA	
Dubravka ŽIVODER, Josipa PAVIČIĆ.....	2554
POSITION OF THE POLISH FOOD PROCESSING IN THE FOOD CHAIN	

Agnieszka JUDZIŃSKA, Robert MROCZEK.....	2560
DEVELOPING GOAT KID MEAT VALUE CHAIN BASED ON GEOGRAPHIC INDICATIONS: AN APPROACH FOR RURAL DEVELOPMENT IN ALBANIA	
Petrit DOBI, François LERIN, Roland BARDHI, Claire BERNARD, Besmira MEDOLLI, Alice GARNIER	2569
OPTIMIZATION OF ENZYMATIC SACCHARIFICATION FOR QUALITY IMPROVEMENT OF BIO-OIL FROM RICE STRAW	
Khan CHAND, Manish PANT.....	2575
DESIGN OF A SMALL-SIZE MILKING PARLOR AND ITS MANAGEMENT VIA PROGRAMMABLE DIGITAL CONTROLLERS	
Metin DEMIRTAS, Yasin AYDIN, Seydi DOĞAN, Ayhan ISTANBULLU, Suat ONUR, Cevdet KELOGLU	2588
FRUIT GROWING IN EAST MARMARA REGION OF TURKEY: KOCAELI SAMPLE FROM PAST TO FUTURE	
Melekber SULUSOGLU DURUL, Bahar AYDIN CAN, Serdar MEMIS	2595
DETERMINANTS OF RURAL TOURISM: A CASE STUDY OF KASTAMONU, TURKEY	
Ilknur ZEREN, Hakan SEVIK, Mehmet CETIN	2603
RURAL ECONOMIC DEVELOPMENT STRATEGY THROUGH PRIORITY RURAL SECTORS IN THE REPUBLIC OF MACEDONIA	
Blagoj GORGIEVSKI, Marija GJOSHEVA KOVACHEVIKJ	2610
THE COMPETITIVENESS OF POLISH FOOD PRODUCTS ON THE INTERNATIONAL MARKET	
Małgorzata BUŁKOWSKA	2616
SELECTION OF FARMS FOR THE FARM ACCOUNTANCY DATA NETWORK SYSTEM IN THE REPUBLIC OF SERBIA	
Mirjana BOJCEVSKI, Zorica VASILJEVIĆ, Vlado KOVACEVIC.....	2623
KNOWLEDGE-BASED ECONOMY: THE POLISH CASE	
Bożena NOSECKA, Łukasz ZAREMBA	2629
IMPACT OF TOURISM DESTINATION ENVIRONMENT ON COMPETITIVENESS OF RURAL DESTINATIONS IN VOJVODINA (SERBIA) AND HUNGARY	
Dunja DEMIROVIĆ, Adriana RADOSAVAC, Marko PETROVIĆ.....	2636
MOVING TOWARDS SUSTAINABLE RURAL DEVELOPMENT: GENDER EQUALITY AND RURAL WOMEN EMPOWERMENT	
Rosanna QUAGLIARIELLO, Atef HAMDY, Chiara CIANNAMEA.....	2643
ECONOMIC BUSINESS ANALYSIS OF DAIRIES FROM PESTER AREA	
Mersida JANDRIĆ, Zoran RAJIĆ, Dragić ŽIVKOVIĆ, Milovančević ZORAN.....	2651
ECONOMIC DIVERSIFICATION OF RURAL HOUSEHOLDS IN THE REPUBLIC OF MACEDONIA	
Marija GJOSHEVA KOVACHEVIKJ, Blagoj GORGIEVSKI.....	2658

STATUS OF AGRICULTURAL TOOLS AND MACHINERY CAPITAL IN TURKISH AGRICULTURAL ESTABLISHMENTS AND EVALUATION OF ADEQUACY	
Mehmet Arif ŞAHINLI, Ahmet ÖZÇELİK	2665
THE SHORTAGE OF AGRICULTURAL LABOUR FORCE IN ALGERIA: A CASE STUDY	
Slimane BEDRANI, Marouane CHAAMI, Fatma Zohra TAIBI, Bochra BOUHENDJEUR	2675
POSSIBILITIES DEVELOPMENT OF NEW RISK MANAGEMENT TOOLS IN AGRICULTURE	
Joanna PAWŁOWSKA-TYSZKO	2681
ENZYMATIC PRE-TREATMENT FOR QUALITY IMPROVEMENT OF BIO-OIL FROM SUGARCANE RESIDUE	
Abhishek KUMAR, Navin C.SHAHI	2689
AGRICULTURAL ADVISORY SERVICES AS A FACTOR OF ECONOMIC DEVELOPMENT OF AGRICULTURE IN NORTH KOSOVO	
Tatjana IVANOVIĆ, Goran MAKSIMOVIĆ	2700
THE SENSITIVITY OF NET FARM INCOME IN THE ZLATIBOR DISTRICT (SERBIA) TO CHANGES IN GOVERNMENT SUPPORT	
Vladimir JOVANOVIĆ, Danijela PETKOVIĆ, Julijana MIJAILOVIĆ, Vlade ZARIĆ	2706
ENERGY EFFICIENCY FOOD RETAILERS	
Radojko LUKIC, Srdjan LALIC	2710
AGRICULTURAL COOPERATIVE AS A FACTOR OF INCREASING AGRICULTURAL PRODUCTION IN NORTHERN KOSOVO	
Goran MAKSIMOVIĆ, Božidar MILOŠEVIĆ, David JOVOVIĆ, Tatjana IVANOVIĆ	2718
COMPARATIVE ANALYSIS OF AGRICULTURAL PRODUCTION SYSTEMS PERFORMANCES: CASE OF MILLET AND SORGHUM IN MALI.	
Penda SISSOKO, Philippe LEBAILLY	2722
SERVICES IN RURAL TOURISM IN THE REPUBLIC OF SERBIA	
Gordana RADOVIĆ, Radovan PEJANOVIĆ, Dunja DEMIROVIĆ, Zoran NJEGO VAN	2729
THE IMPORTANCE OF RURAL AREAS FOR RURAL TOURISM DEVELOPMENT OF SERBIA	
Jelena PREMOVIĆ, Agneš BOLJEVIĆ, Ljiljana ARSIĆ	2735
DISTRIBUTION CHANNELS OF APPLES IN THE REPUBLIC OF SERBIA	
Marija UROSEVIC, Borislav RAJKOVIC, Vladimir JOVANOVIC, Vlade ZARIC	2741
THE POTENTIALS AND PERSPECTIVES OF ORGANIC AGRICULTURE IN FRUŠKA GORA (VOJVODINA PROVINCE, SERBIA)	
Sanja ĐUKIĆ, Radovan PEJANOVIĆ, Mirela TOMAŠ-SIMIN, Danica GLAVAŠ-TRBIĆ	2745
ACCREDITATION IN HIGHER EDUCATION IN THE FIELD OF AGRICULTURE IN SERBIA	
Sofija PEKIĆ QUARRIE, Ratko NIKOLIĆ, Slavica SPASIĆ	2751

LOCAL SUSTAINABLE DEVELOPMENT: THE 21TH CENTURY PARADIGM OF SMART COMMUNITIES AND SMART TERRITORIES

Adriano CIANI, Antonio BOGGIA, Donatello CARUSO, Annalisa GAMBARDELLA, Filippo Fiume FAGIOLI..... 2756

IRRIGATED FOOD SYSTEMS IN MARADI, REPUBLIC OF NIGER: A COMPARISON BETWEEN OPERATING ACCOUNTS

Ludovic ANDRES, Lawali DAMBO, Sambo BODE, Awal BABOUSSOUNA, Martha POPULIN, Boubacar YAMBA, Philippe LEBAILLY..... 2763

PREVALENCE OF CENTRAL OBESITY IN SCHOOL STUDENTS (AGED 8-16 YEARS) OF RURAL SOUTHERN WEST BENGAL, INDIA: BASED ON ANTHROPOMETRICAL STUDIES

Ratnabali SENGUPTA, Narayan GHORAI, Saikat Kumar BASU, Peiman ZANDI, Siniša BERJAN, Shahram Khademi CHLALARAS, Silanjan BHATTACHARYYA 2768

ECONOMIC EFFECTS OF PLUM PRODUCTION ON FAMILY FARMS IN THEREPUBLIC OF SERBIA

Jasmina FILIPOVIĆ, Sladjan STANKOVIĆ, Dragan RAHOVIĆ, Ivana BAKIĆ, Robert RADIŠIĆ, Vedran TOMIĆ 2779

GROSS MARGIN OF PEPPER PRODUCTION IN THE POMORAVLJE REGION, SERBIA

Jasmina FILIPOVIĆ, Snezana JANKOVIĆ, Sladjan STANKOVIĆ, Janja KUZEVSKI, Robert RADIŠIĆ, Vedran TOMIĆ 2784

ADVISORY SERVICES: VARIOUS MODELS OF FINANCING

Snezana JANKOVIĆ, Sladjan STANKOVIĆ, Robert RADIŠIĆ, Vedran TOMIĆ, Nikola LJILJANIĆ, Nenad KATANIĆ, Bratislav PEŠIĆ 2790

MARKET PERFORMANCE OF SELECTED PEPPER SPICES IN IBADAN METROPOLIS, OYO STATE, NIGERIA

Catherine A. AKINPELU, Kemisola O. ADENEGAN..... 2795

7. FORESTRY AND AGRO-FORESTRY..... 2801

GLOBAL CLIMATE CHANGE AND FORESTRY

Michal V. MAREK, 2802

SEASONAL VARIABILITY OF THE CHEMICAL COMPOSITION OF BIRCH SAP OBTAINED THROUGH TAPPING (*Betulae sucus recens*)

Srdjan LJUBOJEVIĆ, Ladislav VASILIŠIN, Goran VUČIĆ, Aleksandar SAVIĆ, Dušan MIODRAGOVIĆ 2810

ANALYZE OF RATIONALITY OF SETTINGS WATCHTOWERS BY GEOGRAPHIC INFORMATION SYSTEM TOOLS

Radenko PONJARAC, Zoran GALIĆ, Alen KIŠ, Rasko GRUJIĆ, Milko OSTOJIĆ..... 2818

STUDY OF THREE DIFFERENT METHODS FOR SUPPRESSION OF ASH WEEVIL

Milan DREKIĆ, Leopold POLJAKOVIĆ - PAJNIK, Verica VASIĆ, Andrej PILIPOVIĆ, Predrag PAP..... 2825

SPECIAL NATURE RESERVE “KOVILJ-PETROVARADIN MARSHES” – REVIEW AND ANALYSIS OF THE PROCLAMATION PROCESS, OBJECTIVES AND INTEGRATED MANAGEMENT MEASURES	
Albina TARJAN TOBOLKA, Mirjana STEVANOV, Zoran GALIĆ, Alen KIŠ.....	2830
THE EFFECTS OF ENVIRONMENTAL IMPACT ON CONIFEROUS FORESTS OF THE WESTERN PART OF LATVIA	
Oskars ZAĻKALNS, Imants LIEPA	2836
AREA POTENTIALLY AVAILABLE AND ITS CORRELATION WITHGROWTH OF TREES IN THE PLANTATION OF POPLAR CLONE B-229	
Siniša ANDRAŠEV, Vladislava GALOVIĆ, Martin BOBINAC.....	2842
APHID FEEDING EFFECTS ON PHYSIOLOGICAL PARAMETERS OF POPLAR CULTIVARS	
Leopold POLJAKOVIĆ-PAJNIK, Olivera PETROVIĆ-OBRAĐOVIĆ, Milan DREKIĆ, Saša ORLOVIĆ, Verica VASIĆ, Branisav KOVAČEVIĆ, Magdalena KACPRZYK, Nataša NIKOLIĆ.....	2848
THE COMPARISON OF GREY ALDER’S (<i>ALNUS INCANA</i> (L.) <i>MOENCH</i>) VEGETATION ON ABANDONED AGRICULTURAL LANDS AND RIPARIAN FORESTS IN LATVIA	
Inga STRAUPE, Liga LIEPA, Santa SIRMOVICA	2856
CONTRIBUTION TO KNOWLEDGE OF STRUCTURE OF MIXED BLACK LOCUST AND COMMON HACKBERRY STANDS IN THE AREA OF SUBOTICA-HORGOS SANDS (SERBIA)	
Siniša ANDRAŠEV, Martin BOBINAC, Karoly REDEI.....	2862
THE EFFECT OF MEDIUM pH ON WHITE POPLAR SHOOTS’ GROWTH <i>IN VITRO</i>	
Vanja VUKSANOVIĆ, Branislav KOVAČEVIĆ, Saša ORLOVIĆ, Dragana MILADINOVIĆ, Marina KATANIĆ, Marko KEBERT	2868
COMPARISON ON THE DENDROMETRIC PROPERTIES OF SILVER BIRCH <i>BETULA PENDULA</i> ROTH AND DOWNY BIRCH <i>B. PUBESCENS</i> EHRH. GROWING IN THE SIMILAR CONDITIONS	
Imants LIEPA, Olga MIEŽĪTE, Dagnija BĒRZIŅA, Aigars INDRIKSONS, Linards SISENIS.....	2874
VARIABILITY OF MORPHOLOGICAL CHARACTERISTICS OF FRUITS AND SEEDS OF WILD CHERRY (<i>PRUNUS AVIUM</i> L.) IN NATURAL POPULATIONS IN THE REPUBLIC OF SRPSKA (BOSNIA AND HERZEGOVINA)	
Milena STANKOVIC, Vasilije ISAJEV, Sasa ORLOVIC, Srdjan STOJNIC	2879
FOREST AREAS AS KEY INDICATOR FOR SUSTAINABLE FOREST MANAGEMENT IN SERBIA	
Zvonimir BAKOVIĆ, Branko STAJIĆ, Vladimir VASIĆ	2885
HYDROLOGICAL PROPERTIES OF EUGLEY SOIL IN THE MIDDLEDANUBE BASIN	
Saša PEKEČ, Marina KATANIĆ	2893
EDUCATIONAL PERSPECTIVES IN URBAN FORESTRY - OVERVIEW IN THE FEDERATION OF BOSNIA AND HERZEGOVINA	
Selma HARAČIĆ-BERBIĆ, Senka MUTABDŽIJA BEĆIROVIĆ.....	2898

USING PINE (<i>Pinus</i>) AND SPRUCE (<i>Picea</i>) STUMP SURFACE PATTERNS FOR THE DETERMINATION OF FELLING TIME	
Aleksandr ROMANOV, Igor SMIRNOV	2904
SPATIAL GENETIC PROFILE OF MARGINAL POPULATION OF SILVER FIR (<i>Abies alba</i> (var. '<i>Pyramidalis</i>')) FROM SERBIA USING SSR MARKERS	
Branislav TRUDIĆ, Alen KIŠ, Srđan STOJNIĆ, Saša ORLOVIĆ, Biljana PANJKOVIĆ	2910
ECTOMYCORRHIZAL FUNGI ON BEECH IN SERBIA	
Marina KATANIĆ, Saša ORLOVIĆ, Marko BAJC, Tine GREBENC, Bratislav MATOVIĆ, Saša PEKEČ, Hojka KRAIGHER	2917
BIOCLIMATIC MAPPING OF RURAL AREAS IN BOZKURT, TURKEY, FOR RECREATION	
Mehmet CETIN, Ilknur ZEREN	2924
ECOLOGY OF SPIDERS IN DIFFERENT ORCHARDS AT THE HUNTING RESERVE OF ZERALDA (ALGERIA)	
Salma CHAIB, Badea BASSA, Amina SAADI, Ahlem RAYANE, Ourida KHERBOUCHE-ABROUS, Lynda BELADJAL	2932
ECOLOGY AND BIODIVERSITY OF ISOPODA (ARTHROPODA, CRUSTACEA) IN DIFFERENT ORCHARDS AT HUNTING RESERVE OF ZERALDA (ALGERIA)	
Ahlem RAYANE, Meriem KROUN, Salma CHAIB, Ilham SAHKI, Ourida KHERBOUCHE-ABROUS, Lynda BELADJAL	2939
COENOLOGICAL ADAPTABILITY AND VITALITY OF ARTIFICIALLY ESTABLISHED BROADLEAF STANDS IN HUNGARIAN OAK AND TURKISH OAK FOREST TYPE IN LIPOVICA NEAR BELGRADE, SERBIA	
Rajko MILOŠEVIĆ, Marijana NOVAKOVIĆ-VUKOVIĆ	2944
ECOLOGICAL-COENOLOGICAL RELATIONS OF BLACK PINE IN SITE CONDITIONS OF DIFFERENT FOREST TYPES IN THE VICINITY OF BELGRADE, SERBIA	
Rajko MILOŠEVIĆ	2952
AUTHOR INDEX	2959
Regional Rural Development Standing Working Group (SWG) in Southeastern Europe	
Introduction to SWG GIZ project	2970

1. PLANT PRODUCTION

AGRONOMIC EVALUATION OF SOME PERENNIAL GRASS CULTIVARS IN ALGERIAN SEMI-ARID CONDITIONS

Mohamed MEFTI^{1*}, Hamena BOUZERZOUR², Abderrezak CHEBOUTI³, Aissa ABEDLEGUERFI¹

¹LRGB - National High School of Agronomy, ENSA, Algiers, 16200, Algeria

²Biology Department, Faculty of Science, University of Sétif, 19000, Algeria

³CRP Baraki, INRAA, Algeria

*Corresponding author: mmeftidz@yahoo.fr

Abstract

Selection of perennial forage grasses is aimed at improving the economic and environmental sustainability of cattle and sheep production. Tolerance to drought conditions, water use efficiency, persistence and high forage yields are the major traits that determine the adaptability of the tested genotypes. This study was conducted at the experimental site of the ITGC institute in Sétif during the cropping seasons 2005/06, 2006/07 and 2007/08 with the objective to evaluate the performance of 13 varieties of perennial grasses, belonging to two species: *Festuca arundinacea* Schreb. And *Dactylis glomerata* L. in a semi-arid region. Characterization has focused on various morphological traits in order to assess their adaptability to drought prone environments. The results showed the existence of a wide range of variability due to the diversity of responses of the evaluated varieties of both species, particularly regarding biomass production, production cycle, persistence and water use efficiency, which is considered as one of the most important factors in the success of artificial grasslands in semi-arid areas. These results show high potential for the selection of a plant material adapted to the specific conditions of the semi-arid areas of the Algerian high plains. Indeed, this study allowed us to discriminate the most adapted genotypes characterized by high performance, good height growth, earliness in heading and good persistence.

Keywords: *Festuca arundinacea* Schreb., *Dactylis glomerata* L., morphological traits, drought.

Introduction

The use of perennial grasses in the semi-arid Mediterranean environment requires a high capacity to survive the severe thermal and water stress of summer and the ability to provide a high biomass yield in autumn-winter (Copaniet *al.*, 2012). Among the perennial grass species of common interest across the Mediterranean basin, tall fescue (*Festuca arundinacea* Schreb.) and cocksfoot (*Dactylis glomerata* L.) are of paramount importance (Mousset, 1995). However, these species have mostly been bred in and for more temperate climates, and the attempt to simply introduce cultivars selected under different conditions into the Mediterranean region has repeatedly proven unsuccessful. Therefore, all the attempts of introduction of high yielding genotypes bred in temperate climates should be preceded by studies about their adaptation to semi-arid conditions. On the basis of the importance of studies that evaluate yield adaptation to Mediterranean locations of both species, the present study was undertaken to compare 13 cultivars (6 *Dactylis glomerata* L. and 7 *Festuca arundinacea* Schreb.) in an Algerian drought prone environment for yield and other relevant phenotypic traits, in order to identify the best adapted plant material.

Material and Methods

The field trial was carried out over three consecutive cropping seasons (*i.e.*, 2005/2006, 2006/2007, 2007/2008) at the Agricultural Research Station of the Field Crop Institute of Sétif (Algeria) (1081 m a.s.l.; 36°12'N, 5°24'E), which has a long-term mean annual rainfall of 387 mm. The soil is classified as clayloam, with 45% clay, 41% silt, 13.9% sand, and 1% organic matter, and pH (H₂O) 8.2. The climate is temperate continental, and varies from arid to semi-arid. The monthly rainfall and mean monthly temperatures recorded at the experimental site during the trial are shown in Figure 1. The trial was run under rain-fed conditions, except for the sward establishment year, in which 40 mm irrigation was given in March 2006, after a severe drought spell. The soil was prepared in the autumn of 2005, after chickpea as the previous crop. Before ploughing, 18 kg/ha P was applied as triplesuperphosphate fertiliser (18% P, 9% S), as the standard application for cereal production in the area.

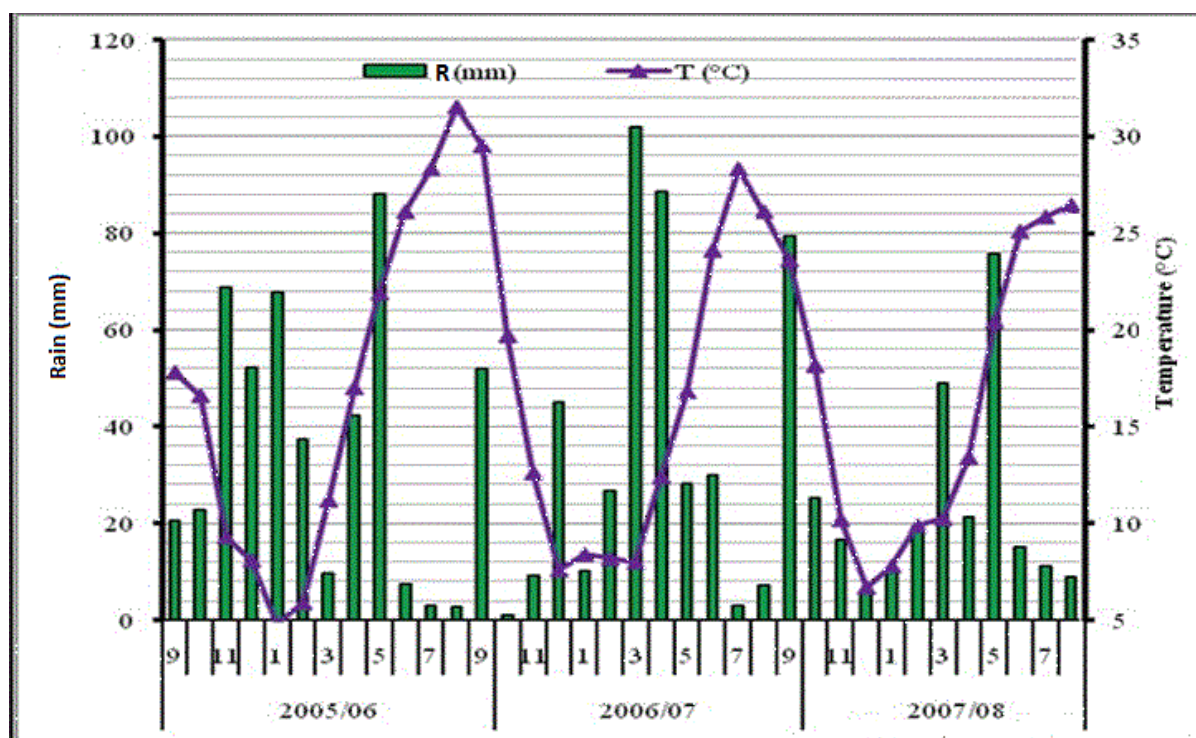

Figure 1. Mean monthly temperatures and rainfall recorded at the experimental site (Sétif, Algeria) for the years of the study.

The six cultivars of cocksfoot and seven of tall fescue obtained via the “PerMed” European project (Meftiet *al.*, 2014) were endophyte free (E-), except E-542 (E+), which is ‘Flecha’ infected by the endophyte AR542. Each grass cultivar was hand sown in a Lattice design in October 2005 on a 10-row plot, with 2.5-m-long rows and 0.20-m spacing between the rows. Nitrogen fertiliser was applied in November 2006 and in March 2006, 2007 and 2008, at a rate of 35 kg/ha of N asurea (35% N).

Measurements

The inner six rows were harvested to determine dry matter yield after drying a sample of 500g in a forced air oven at 70 °C for 48 h at each harvest (autumn and spring). The heading date (HD) was recorded in spring on undisturbed rows in each plot, and expressed as the number of days from 1 January needed to reach 50% heading of the plot. Recovery from each cut (REC) was expressed as the row cover percentage; i.e., the percentage of the row space occupied by living grown tissue. This was measured after each harvest, to determine the persistence of each of the cultivars.

Soil water measurements were carried out with a neutron probe moisture meter (CPN Corp., Pacheco, CA, USA) twice a year: at the start of the cropping season in September, and just after the last cut in May-June. The measurements of the water content were made in plot soil to a depth of 100 cm, where we observed that most root biomass was concentrated. The moisture readings were calibrated against the soil water content, which was determined gravimetrically for each soil depth layer, as: 0-20 cm, 20-40 cm, 40-60 cm, 60-80 cm and 80-100 cm, and converted to volumetric measures. The total water evapotranspired (TWU) by the crop was then estimated according to Chen *et al.* (2003), as:

$$TWU = ASW_{09} + Rainfall - ASW_{06}(1),$$

where ASW_{09} is the available soil water at the start of the productive season, measured in September, $Rainfall$ is the accumulated rainfall during the season, which was recorded at the national weather station located 5 km from the experimental field, and ASW_{06} is the available soil water measured just after the last harvest in May-June.

The WUE was expressed as kg forage dry-matter yield per hectare accumulated between the two harvests/mm total water evapotranspired (TWU), according to Chen *et al.* (2003), as:

$$WUE = DMs/TWU \quad (2).$$

The field-collected data during the three cropping seasons were analysed using the balanced **generalised linear model** (GLM) subroutine of the Systat12 software (Systat Software, Chicago, IL, USA), as a factorial in randomised complete block design.

Results and Discussion

Persistence and earliness

Variations among the cultivars and years for row cover (REC) reached significance of at least $P < 0.01$ in both of the seasons over the 3 years of the experiment, but there were no significant effects of species, or for the double and triple interactions (Table 2). The mean of the sward persistence averaged over the years, ranged from 46.24% (cocksfoot ‘Ottava’) to 71.33% (tall fescue ‘Tanit’) in autumn, and from 46.62% (tall fescue ‘Sisa’) to 69.31% (cocksfoot ‘Jana’) in spring. (Table 1).

The number of days to flowering showed highly significant differences between the genotypes (G), years (Y), $G \times Y$, and $G \times SP(\text{species}) \times Y$ interactions ($P < 0.001$; Table 2). The swards took a longer time to flower during the first year of establishment, compared to the second and third years, with the mean number of days to flowering averaged over the genotypes of 134.6 (cocksfoot, 137.0; tall fescue, 131.0) in 2005/2006, compared to 113.7 days and 101.8 days in 2006/2007 and 2007/2008, respectively. Tall fescue cultivars ‘Flecha’ and ‘E-542’ showed the earliest flowering dates across the years (109 days), while the cocksfoots ‘Jana’ and ‘Delta-1’ and the tall fescues ‘Tanit’ and ‘Lutine’ were the latest to head over the 3 years of the study (Table 1).

Dry-matter yields

The dry-matter yields were relatively low during the autumn compared to the spring harvests, with a 3-year average of 0.48 t/ha for the autumn harvest (DMA) for both cocksfoot and tall

fescue, and 1.12 t/ha for the spring harvest (DMs) for cocksfoot *versus* 1.50 t/ha for tall fescue (Table 1). The analysis of the variance of DMA accumulated across the years of the study did not indicate any differences between species, or genotypes, or any interactions, with a significant effect of year only (Table 2). For the spring dry-matter yield (DMs), the ANOVA was highly significant ($P < 0.001$) for species, genotype and year effects, together with a significant triple interaction (*i.e.*, genotype \times species \times year; Table 1). The mean DMs across the 3 years indicated that ‘Flecha’ (1.77 t/ha), ‘E-542’, ‘Centurion’ and ‘Fraydo’ were the top yielding cultivars, all of which are tall fescues, with cultivars of tall fescue being generally higher yielding in spring than cocksfoot. The lowest yielding cultivar was the cocksfoot ‘Ottava’, with a mean spring biomass harvest of only 0.87 t/ha (Table 1). When the individual years were examined, the yields for the second year were higher for both species, while the third year was the lowest also for DMs. The tall fescue ‘Flecha’ was the highest yielding cultivar in year 1 (2005/2006; 1.92 t/ha), while it gave the same yield as the tall fescues ‘E-542’, ‘Centurion’, ‘Lutine’, ‘Fraydo’, and as the cocksfoot ‘Medly’ in the second year (2006/2007).

Water-use efficiency

The WUE varied significantly between the years, species, genotypes, G \times Y, and G \times SP \times Y year interactions (Table 2). For individual years, the establishment year (2005/2006) showed far less efficiency in terms of water use for all of the cultivars tested, with ‘Flecha’ showing the highest WUE of all the tall fescue and cocksfoot cultivars. The WUE was higher in the second year (2006/2007), with nearly identical effects in the two grass species. Indeed, the cocksfoot ‘Kasbah’ showed the lowest WUE during the first year (2005/2006; together with ‘Delta-1’, ‘Ottava’ and ‘Lutine’), but ranked second for WUE for the third year (2007/2008), after ‘E-542’. Tall fescue cultivars ‘Flecha’, ‘E-542’ and ‘Fraydo’ showed generally high WUEs for each year than cocksfoots.

Table 1. Three-year means for the agronomical traits for the cocksfoot and tall fescue cultivars.

Species	Cultivar	Dry-matter yield		Recovery		HD	WUE
		DMA	DMs	RECa	RECs		
Cocksfoot	‘Jana’	0.47	1.17	68.63	69.31	122.0	5.68
	‘Medly’	0.42	1.35	65.15	65.00	115.7	6.38
	‘Kasbah’	0.60	1.20	55.68	59.97	113.3	6.08
	‘Delta-1’	0.45	1.07	48.89	60.52	122.3	5.23
	‘Currie’	0.46	1.04	53.44	61.00	117.7	5.02
	‘Ottava’	0.43	0.87	46.24	47.38	117.3	5.34
Mean		0.48	1.12	56.34	60.53	118.1	5.62
Tall fescue	‘Tanit’	0.47	1.13	71.33	66.34	123.3	5.83
	‘Sisa’	0.43	1.24	51.45	46.62	116.0	5.51
	‘E-542’	0.47	1.65	58.51	59.85	109.0	8.23
	‘Centurion’	0.51	1.47	64.71	60.57	115.3	6.57
	‘Flecha’	0.48	1.77	63.53	66.19	109.0	7.50
	‘Lutine’	0.42	1.28	51.98	46.72	122.3	6.15
‘Fraydo’	0.56	1.56	54.76	52.02	114.0	7.04	
Mean		0.48	1.50	57.06	55.13	114.2	6.83
Lsd (p=0.05)		0.21	0.42	12.06	10.72	3.73	1.34

DMA_s = Dry matter yield in autumn (a) and spring (s) (t/ha); RECa_s = recovery as row cover percentage (%), in autumn (a) and spring (s); HD = number of days from January 1st to heading; WUE = water use efficiency (kg/ha mm). SEN = Leaf senescence in summer (%).

Table 2. Mean square of the combined analysis of variance for dry-matter yield, recovery, days to heading, water-use efficiency and leaf senescence.

Source of variation	D.F.	DMA	DMs	RECa	RECs	HD	WUE
Genotype (G)	12	0.018 ^{ns}	0.61 ^{***}	566.03 [*]	557.9 [*]	208.6 ^{***}	7.9 ^{***}
Species (SP)	1	0.001 ^{ns}	3086 ^{***}	284.9 ^{ns}	382.5 ^{ns}	167.8 ^s	33.3 ^{***}
Year (Y)	2	0.088 [*]	30.2 ^{***}	773.7 [*]	3927.7 ^{***}	10.8 ^{***}	517.4 ^{***}
G × Y	24	0.025 ^{ns}	0.24 ^{ns}	170.3 ^{ns}	78.8 ^{ns}	50.6 ^{***}	4.2 [*]
SP × Y	2		2.26 ^{ns}	192.7 ^{ns}	64.92 ^{ns}	31.6 ^{ns}	3.2 ^{ns}
G × SP × Y	24	0.03 ^{ns}	2.68 ^{**}	214.6 ^{ns}	401.1 ^{ns}	947.3 ^{***}	47.1 ^{***}
Residual	78	0.017	0.23	288.5	238.3	18.4	2.36
Lsd (<i>P</i> =0.05)		0.21	0.42	12.06	10.72	3.73	1.34

Prolonged summer droughts and poor management practices adversely affect persistence; and as a result, swards are short-lived and require frequent re-establishment (Malinowski *et al.* 2005). However, increased persistence was not always shown to be of benefit in terms of production. In fact, a comparison between the two tall fescue cultivars has been done by Hayes *et al.* (2012) showed that the more summer active cultivar, Demeter, failed to persist beyond year 1; cv. Fraydo, by contrast, persisted to at least year 3; however, the cumulative herbage production during the entire experimental period of cv. Demeter was 59% greater than that of cv. Fraydo.

For our results, Flecha was selected in difficult conditions in Argentina (Pecetti *et al.*, 2011). It has at least two characters that contribute to its drought tolerance (i) the deep root system plays a large role in enhancing plant survival (Volaire, 2008), and (ii) the development of an extensive senescent leaves around young tillers during the summer, increasing the survival of tillers under drought conditions (Norton *et al.* 2006). Poor persistence of cocksfoot variety Ottawa and tall fescues CVs Lutine and Sisa, is related to their non summer dormancy. Their origin in temperate regions of Europe explains also the difficulties of adaptation despite their good performance during the first two years.

Heading date, which is dependent on both genotype and environment has led to distinguish a late heading year, corresponding to the year of installation where endophyted Flecha, Flecha and Centurion were the earliest varieties with a period of 123, 127 and 128 days, respectively, while Medly, delta 1 and Lutine were the latest to head. In earlier year Flecha, endophyted Flecha, Fraydo and Medly were the earliest with periods ranging from 95.0 to 98.0 days, while Delta 1 is the latest with a heading date of 110 days.

Dry-matter yield is a very important trait determining the choice of perennial grass cultivars. Humphreys *et al.* (2006) reported that increasing dry-matter yield was the main objective of grass breeding programmes and breeding has achieved mean productivity increases of 0.5% per year. In the present study, there were differences in dry-matter yield between the cultivars studied. This variation arose from differences in the forage dry-matter yield per annual cycle and differences in cultivar (G) production across the years. The autumn dry-matter yield (DMA) was constantly lower than DMs, and this was explained by the decrease in soil moisture content (data not shown). In fact, in such drought-prone Mediterranean environments a commonly observed phenomenon is that autumn rains arrive very late and rainfall in summer may be completely absent.

In the present study, WUE varied greatly between the years, and also between varieties within the individual years. The WUE, which is defined as the ratio between the plant dry-matter production and the water transpired, represents a measure of the ability for a plant to perform well under incipient drought (Thomas, 1997). Blum (2009) considered that the WUE is an

important determinant of the yield under stress, and even as a component of the crop drought resistance. In the present study, the highest yielding varieties also had high WUE.

Conclusion

These traits showed the possibility to select an adapted material of *Dactylisglomerata* and *Festucaarundinacea* to specific conditions of the semi-arid areas of the Algerian high plains, where annual rainfalls rarely exceed 400 mm per year. Flecha, Fraydo and Kasbah showed superior adaptation for the measured traits. There was evidence for better drought tolerance of earlier-heading varieties.

References

- Blum A. (2009). Effective use of water (EUW) and not water-use efficiency (WUE) is the target of crop yield improvement under drought stress. *Field Crop Research*, vol. 112, pp. 119-123.
- Chen C, Payne AW, Smiley RW, Stoltz M (2003). Yield and water use efficiency of eight wheat cultivars planted on seven dates in north-eastern Oregon. *Agronomy Journal*, vol.95, pp. 836-843.
- Copani V., Testa G., Lombardo A., Cosentino S.L. (2012). Evaluation of populations of *Dactylisglomerata* L. native to Mediterranean environments. *Crop and Pasture Science*, vol. 63, pp. 1124-1134.
- Hayes R.C., Dear B.S., Li G.D., Virgona J., Conyers M.K., Hackney B.F., Tidd J. (2010). Perennial pastures for recharge control in temperate drought-prone environments. Part 1: productivity, persistence and herbage quality of key species. *New Zealand Journal of Agricultural Research*, vol. 53 (4), pp. 283-302.
- Humphreys M.W., Yadav R.S., Cairns A.J., Turner L.B., Humphreys J., Skøt L. (2006). A changing climate for grassland research. *New Phytologist*, vol. 169, pp. 9-26.
- Malinowski D.P., Zuo H., Kramp B.A., Muir J.P., Pinchak W.E. (2005). Obligatory Summer-Dormant Cool-Season Perennial Grasses for Semiarid Environments of the Southern Great Plains. *Agronomy Journal*, vol. 97, pp. 147-154.
- Mefti M., Djemel A., Bouzerzour H., Chebouti A., Abedleguerfi A. (2014). Agronomic performance of some perennial grass cultivars in Algerian semi arid conditions. Forage resources and ecosystem services provided by mountain and Mediterranean grasslands and rangelands. C. Porqueddu (eds), *Options Méditerranéennes, Series A, N°109*, pp. 185-188.
- Mousset C. (1995). Les dactyles ou le genre *Dactylis*. In 'Ressources génétiques des plantes fourragères et à gazon'. (Eds JM Prosperiet al.) pp. 28-52. (Institut National de la Recherche Agronomique, Bureau des Ressources Génétiques, Paris).
- Norton M.R., Volaire F., Lelièvre F. (2006). Summer dormancy in *Festucaarundinacea* Schreb.: the influence of season of sowing and a simulated mid-summer storm on two contrasting cultivars. *Australian Journal for Agricultural Research*, vol. 57, pp. 1267-1277.
- Pecetti L., Annicchiarico P., Abdelguerfi A., Kallida R., Mefti M., Porqueddu C., Simões N.M., Volaire F., Lelièvre F. (2011). Response of Mediterranean tall fescue cultivars to contrasting agricultural environments and implications for selection. *Journal of Agronomy and Crop Science*, vol. 197, pp. 12-20.
- Thomas H. (1997). Drought resistance in plants. In 'Mechanisms of environmental stress resistance in plants' (Eds S Basra, RK Basra) pp. 1-42. (Harwood Academic Publishing: Amsterdam, the Netherlands)
- Voltaire F. (2008). Plant traits and functional types to characterise drought survival of pluri-specific perennial herbaceous swards in Mediterranean areas. *European Journal of Agronomy*, vol. 29, pp. 116-124.

POSSIBILITY OF PEPPER PRODUCTION BY DIRECT SOWING

Goran PERKOVIĆ^{1*}, Aleksandra GOVEDARICA-LUČIĆ¹, Saša LALIĆ²

¹Faculty of Agriculture, University of East Sarajevo, Bosnia and Herzegovina

²Ministry of Agriculture, Forestry and Water Management of RS, Banja Luka, Bosnia and Herzegovina

*Corresponding author: perkan66@gmail.com

Abstract

The aspiration for economic, yielding and qualitative production has led to the introduction of the improved technology for pepper cultivation by direct sowing of seed with the application of the specific machinery and a suitable protection from pests. The aim of the pepper production by direct sowing is neither an early harvest nor big fruits. It is a high yield, a single harvest and the simple economic cultivation practices. In pepper production by a direct sowing the period of disease is avoided, and a possibility of the occurrence of a disease is a lot lower in comparison to the peppers that are produced from seedlings. The share of human labor during the production is much smaller and the greatest part of cultivation practices is done by machinery; the production is more simple and safer, and the yield and quality of fruits are at the level of the yield of a classical production of pepper from seedlings. The advantage of pepper production by direct sowing is also reflected in the achievement of plant spacing per hectare that is by even 4 to 6 times larger compared to the classical system of cultivation. Such a cultivation system introduces a low yield per a plant, but a high total yield. Beside all these statements, the pepper production by direct sowing is little present on the plots in Semberija because of many restrictions in the production.

Key words: *pepper, direct sowing, seedling, yield, a number of plants.*

Introduction

Production of pepper from seedlings is the most common production system, but more rational technologies of pepper production by direct sowing are being more and more accepted. The main disadvantages of cultivation of pepper from seedlings are large total costs, significant energy consumption, bigger risk of disease occurrence and very high involvement of human labor. The total yield depends on the quality of seedlings. The seedling production requires very high level of skills, as well as constant investing in new technologies of the production of seedlings.

The pepper production by direct sowing does not require any additional investments, equipment or building of additional facilities. Because of these facts, the pepper production by direct sowing is coming to be more and more interesting and widespread. The results of the trial can be added to this, as well as production practices which speak in favor of production by direct sowing. The pepper that is planted late gives a lower yield as a rule. The reduction of the yield will occur if we plant the seedlings that are not suitable for seeding because they are underdeveloped, too young or they have overgrown the optimal phase for seeding. The results of Lazić (1975) confirm that in the production of the pepper by direct sowing higher yields are realized than in the production of pepper from seedlings if the planting happened after 20th of May, so called the late phase. We specially have to emphasize the advantages of a thicker plant spacing of pepper in the production by direct sowing which also Zatyko (1979) points to in his researches. He points out that the advantage of pepper production by direct sowing is that we achieve larger plant spacing by an area unit, even by 4 to 5 times larger compared to the planting which gives a low yield per a plant, but a high total yield per area

unit. Therefore, the aim of this research is that we, beside determining the most yielding way of pepper production, make an analysis of ecological conditions and the effect of the applied cultivation practices on the reduction of unfavorable conditions.

Material and methods

The studies about possibilities of pepper production by direct sowing have been carried out on a soil which belongs to grey and brown non-calcareous chernozem and which is at the same time the most prevailing soil at the territory of Semberija region (entity of Republic of Srpska, Bosnia and Herzegovina).

A general trait of this soil is weak acid reaction with the PH value of 6.41 and it is also characterized by relatively low content of humus substances that ranges from 2.37 to 2.71%. The soil has good physical properties, emphasized crumbly structure but it is typical that during the process of production in unfavorable climatic conditions a crust occurs. The soil is well provided with nutrients, the content of basic nutritive substances does not represent a limitation in the production.

The preparation of soil has been done with the application of standard mechanization and with the usual pattern of cultivation practices which is a standard in pepper production at the territory of Semberija. During autumn, cow dung and mineral fertilizer NPK 8:16:24 were applied. Ploughing down was done after spreading of fertilizer at the depth of 25 to 30 cm. During spring, the other part of mineral fertilizer NPK 15:15:15 was applied in the plot after which the preparation of soil for sowing and planting was approached to. The direct sowing on an open field was done on 5th of April and the planting of seedlings from container and bare roots seedlings was done on 10th of May. Sowing and planting were done with the 55-cm row distance. The trial was set by 4-replicate randomized complete block design and the Palanačka Babura variety was used in the trial. With the aim of solving the task, a trial with the direct sowing of pepper on an open field was carried out but the trial also included the variants of pepper cultivation from the different ways of seedling cultivation namely the seedlings from a container and the bare roots seedlings. All of the applied cultivation practices were common for all the variants of the trial. At the end of the trial, the level of yield was being determined, and the results obtained were compared to results from the literature.

Results and discussion

The success in the production of pepper largely depends on the series of factors. For a successful production of pepper it is necessary to provide fertile soil with good structure, harvest the best preceding crop, cultivate the soil well and apply, on good time, the necessary measures of care during the vegetation. During performing of the trial, it was obvious that the applied cultivation practices affect the yield, but also that the ecological conditions have a great influence, which Wells (1967), Somos (1984) and Marković (1998) also concluded in their researches.

The results of the researches of Špaldon et al. (1972) indicate that pepper in the early stages goes through the basic phases of organogenesis, especially of generative organs. In this period, the pepper must have optimal conditions for growing and development in order to make a yield as great as possible.

Table No. 1 An average pepper yield by different means of production t/ha

Means of production	I	II	III	AVERAGE VALUE
Papper from direct sowing	31	30	40,80	33,93
Pepper from bare root seedlings	31,60	36	48,24	38,61
Papper from seedlings from container	32,48	40,16	60,64	44,42

Table 1: Experiments source results

The table above clearly indicates that the highest yield, in all of the three years of examination, was achieved in the production of pepper from container seedlings. It is obvious that the yield achieved is significantly higher compared to the other means of pepper cultivation. If we compare the average yields within some means of pepper cultivation, we will see that there are significant differences within some means of pepper cultivation in the sense of the level of the yield, which depends on the year of examination. It is a general conclusion that the pepper yield is a very variable trait which depends on the series of factors and that it is changeable depending on the means of production, but it also depends on the conditions of production within the individually observed ways of production.

The highest average yield was achieved in the pepper production from container seedlings which was 44.42 t/ha. During the cycle of research, the lowest yield was obtained in the first year of the trial, 32.48 t/ha, and the highest yield was achieved in the third year (60.64 t/ha) where the difference is 28.16 t/ha.

In the pepper production by direct sowing on an open field the lowest yields were obtained in all of the three years of examination. The average yield was 33.93 t/ha and the lowest yield was obtained in the second year (30 t/ha) while in the third year it was highest (40.8 t/ha) just like in all other variants of the trial, where the difference is 10.8 t/ha. Just like in the case of the seedlings from container, during the production of pepper from bare root seedlings the lowest yield was obtained in the first year (31.6 t/ha), while it was highest in the third year of the trial (48.24), with the difference of 16.64 t/ha. The average yield of the pepper cultivated from the seedlings from container (44.42 t/ha) was higher for 10.49 t/ha than the yield of the pepper cultivated by the means of direct sowing, and it was higher for 5.81 t/h than the yield of the pepper cultivated from the bare root seedlings.

Based on the data above, we can see that the variations of the yield by years of examination within some ways of cultivation were more pronounced than they were among the different ways of cultivation. An emphasis should be put on a cause which was long rainy and non-rainy periods followed by significant oscillations of high and low temperatures that were followed by unfavorable relative air humidity.

The results presented confirm so far researches which emphasize that the pepper production from container seedlings has numerous advantages.

By producing the pepper from seedlings, we obtain higher yields; is this enough for a clear recommendation? What are the possibilities and perspectives like for the pepper production by direct sowing? Which moments do the producers have to pay a special attention to? The success in the production of pepper by direct sowing is related to the soil and the climatic conditions during the process of production. The most fertile structural soils should be chosen for the pepper production. Fertile alluvial soils and chernozems, the soils with good water and

air regime, good physical and chemical properties are the most favorable soils for pepper production by direct sowing. The soil has to have a good aeration because the roots of peppers are sensitive to the lack of oxygen. The soils that are liable to forming of a crust make the pepper production more difficult, and exactly such soils occupy the largest part of arable land in Semberija.

The largest part of human labor use is related to breaking a crust especially in the period after the sowing and in the first stages after cropping up when pepper is most sensitive to the occurrence of crust. During this period, the efficient breaking of crust is possible only with regular irrigation of the sown plots.

The stoppage in cropping up and the speed of the passing of the first phases of growing and development is mostly related to occurrence of crust which in the final result leads to the decrease of yield.

The pepper from direct sowing requires greater involvement of human labor in the first part of vegetation, while in the production of pepper from seedlings greater involvement of human labor is in the second part of vegetation.

The first part of vegetation is a critical period in the production of pepper by direct sowing and it is necessary to pay more attention to it in that period.

The data from literature confirm our results and observations.

In order to make the yield of pepper from direct sowing as great as possible, the preparation of the soil must be as high-quality as possible and the sowing as early as possible. It is best to do the sowing from the end of March till 10th April, which matches with the conclusions from the researches done by Marković (1988). Gvozdenović et al (2006), just like Marković (2001), in their researches, confirm our facts that starting from the choosing of soil and all the way to the care of pepper all the measures for the cultivation practices have very large influence on the yield.

During the researches, we came to a clear conclusion that ecological conditions have very large influence on the yield, and that the measures of cultivation practices must be adapted to the ecological conditions which Marković (1995) also concluded in his researches.

The results of the research show that the yield of pepper from direct sowing was significantly higher in the third year of the trial.

It is necessary to emphasize that satisfactory yields can be achieved in the production of pepper by direct sowing, which was also a conclusion of the researches of Lazić et al (1971).

Conclusion

On the basis of the practical results and observations that have been noticed, the following conclusions can be made:

There are favorable agro-ecological conditions, at the territory of Semberija region, which give a firm basis for a successful cultivation of pepper by direct sowing on an open field.

The conditions for the production are not ideal (only favorable), but with intensified cultivation practices, timely and coordinated care measures, pepper can be very successfully produced directly from seed.

For a successful production of pepper, a special attention should be paid to choosing a high-quality soil, which, above all, must be very fertile, with good structure and other favorable physical and chemical properties.

The research also shows that in this production great attention must be paid to the high-quality cultivation of soil and measures for care of crops.

An important factor for the success in the pepper production by direct sowing are climatic conditions during the vegetation which cannot be influenced, but with a right choice and timely applied measures for cultivation practices, their negative effect can be reduced.

The pepper yield depends on numerous factors during the production, but in this production a satisfactory yields can be easily achieved.

The yield of pepper by direct sowing is lower than the production from seedlings, but it also has a series of advantages which are reflected in easier and simpler cultivation practices followed by higher economic profitability of production.

References

- Lazić B., Gavrić M., Đurovka M., (1971) The studies on possibilities of pepper production directly from the seed, Hranaproduct, Zagreb.
- Marković V. (1988) The variety as a basis of an intensive pepper production by direct sowing from seed. Yugoslav Symposium 'Intensive production of vegetables' Cavtat 345-353.
- Ilić Z., Savić V., (1992) The possibility of production of different varieties of pepper directly from seed. Modern Agriculture vol 40, No 1-2, pp. 51-54, Novi Sad
- Marković V. (2001) Modern pepper growing practices. Collection of works, volume 35, pp. 341-348, Novi Sad
- Marković V., (2001) Growing practices for spice paprika, Modern Agriculture Practices, vol 27, No 1-2., pp. 51-57. Novi Sad
- Marković V. (1995) The variety and factors of cultivation practices of the production of high-quality spice paprika. Collection of works, The Institute of Field and Vegetable Crops, vol 23, pp. 353-360, Novi Sad
- Gvozdenović Đ., Bugarski D., Takač A., Červenski J. (2006) The production of vegetable pepper from seedlings on an open field. Collection of works, vol 42. Scientific Institute of Field and Vegetable Crops Novi Sad
- Somos A., (1984). The paprika, Akademia Kiado, BudPEST.
- Špaldon E., Gvomova Z., Study of morphogenesis root pepers. Agriculture 6, pp. 445-458
- Wells, O.S. (1967) the effect of night temperature on fruit set of the pepper. Diss Abstract, Arbov. Micm. Sect B.27.
- Marković V. (1999), The effect of ecological conditions and measures of cultivation practices on the yield of pepper in the production by direct sowing from the seed in Vojvodina. Collection of works, volume 31 pp. 297-305. The Institute for Field and Vegetable Crops Novi Sad.

PHYSIOLOGICAL RESPONSES OF POTATO EXPOSED TO DROUGHT STRESS: STOMATAL CONDUCTANCE, LEAF WATER POTENTIAL AND GROWTH PARAMETERS

Mirjana JOVOVIĆ^{1*}, Zorica JOVANOVIĆ², Radmila STIKIĆ²

¹University of East Sarajevo, Faculty of Agriculture, Bosnia and Herzegovina

²University of Belgrade, Faculty of Agriculture, Serbia

*Corresponding author: mirjanamojevic@gmail.com

Abstract

The aim of this study was to investigate the mechanisms which are responsible for the growth inhibition of plants under drought conditions and it is carried out by measuring the plant growth parameters and water regime. The research was carried out under controlled conditions and potato (*Solanum tuberosum* L.) cultivar Liseta was used for investigation. During the vegetative period the plants were grown by the applied two different irrigation regimes: optimal irrigation - soil is watered every day until the optimum water capacity and soil water content in the substrate at field water capacity was 36% and water deficit - the drought caused by interruption of watering the substrate in the tuber initiation stage. The results of this study show that drought caused the reduction of the leaf and stem growth (leaf area, dry weight of leaves and stem) and development. On the basis of the results of measured water regime parameters (water content in a substrate, leaf water potential and stomatal conductance) and their correlative relationships it was confirmed that the decrease of water content in a substrate caused induction and interaction of both types of signals (chemical and hydraulic signals).

Key words: *water, drought, stomatal conductance, leaf, water potential*

Introduction

In the face of increasing frequency of extreme climatic events, crop plants are often exposed to multiple abiotic stresses at the same stage of growth (Walter et al., 2012). As a result of global climate change and excessive pollution have decreased the amount of water available for agricultural production. Drought stress becomes a significant stress factor that may limit agricultural production worldwide. Therefore, improving drought resistance of plants is difficult to achieve without understanding the effect of drought on plants.

Drought particularly affects the breeding and productivity of crops, especially vegetables, including potatoes. Potato is an important crop worldwide and due to its sparse and shallow root system is very sensitive to soil drying (Yuan et al., 2003). In potato like in many agricultural crops yield depends on how much dry matter is partitioned to reproductive organs (tubers). Even mild levels of water stress reduce potato productivity by limiting canopy expansion and increasing senescence rate and by the delay of tuber initiation and bulking (Fabeiro 2001; Lahlou et al., 2005; Hassanpanah, 2010).

Drought mainly affects the plant-water relations on cellular even the whole-plant level, resulting in reductions of leaf water potential and stomatal conductance (Rampino et al., 2006; Neumann, 2008). The traditional view of drought is that soil drying induces restriction of water availability and decreasing water and turgor potentials. Changes in plant water regime and the development of water deficits in leaves present a hydraulic signal of drought that lead the reduction of leaf growth (Dodd 2009). However, many results indicated that leaf growth could be reduced without any changes in leaf water status (Bahrun et al., 2002; Schachtman and Goodger, 2008; Fernandez et al., 2003) and that these changes are linked with soil water status. This kind of reaction requires

that the plants have some mechanism to sense the soil water availability. A number of experiments done in control and field conditions have shown that primary sensors of soil drying are roots which produce different chemical signals. Many experiments (Reddy et al., 2004; Davies et al., 2002, Liu et al., 2006) confirmed that this chemical signal is a stress hormone ABA that is produced in roots in the response to soil drying. Abscisic acid is transported via xylem to the shoots and caused stomatal closure and reduced leaf area. As an additional signal in the plant response to soil drying can be changes in concentrations of other hormones (cytokinins), mineral composition and pH of xylem sap (Schachtman and Goodger, 2008; Wilkinson and Davies, 2008, Vystskaya et al., 2009) increasing of xylem pH has been suggested as a drought signal that reduces the leaf elongation rate through an ABA-dependent mechanism (Wilkinson, 1999). The impact of drought on physiological processes of plants is complex and depends on its intensity, duration, and of plant species exposed to stress. Drought has an effect on almost all processes in the plant and growth process is most sensitive to the water deficit. In drought conditions shoot growth inhibition is associated with the closure of stomata and caused a decrease in transpiration (Wilkinson and Hartung, 2009). Reducing of stomatal conductance in early stages of water stress inhibits transpiration rate more than it reduces the intercellular CO₂ concentration. The objective of a present study were to investigate the mechanisms responsible for the potato growth inhibition under drought conditions, measuring parameters plant growth, water regime and compared these results with control.

Materials and methods

Experimental design

Potato (*Solanum tuberosum* L.) cultivar Liseta was used for investigation. In the experiment under controlled conditions, we studied the effect drought of potato plants at an early phenological phase of growth. Potato tubers are uniform and germinated tubers were sown in containers with soil as substrate (Potground H, Klasmann-Deilmann, Germany). Plants were grown in phytotronic chamber at a temperature 25/18° C, relative humidity 70% and light intensity 300 $\mu\text{molm}^{-2}\text{s}^{-1}$. After planting, all plants were watered up to the field water capacity. During the vegetative period the plants were grown by the applied two different irrigation regimes:

- Optimal irrigation - soil is watered every day until the optimum water capacity and soil water content in the substrate at field water capacity was 36%;
- Water deficit - the drought caused by interruption of watering the substrate in the tuber initiation stage.

Experimental measurements

Measurements of plant water regime parameters included leaf water potential (Ψ_l) and stomatal conductivity. The leaf water potential (Ψ_l) was measured using the pressure chamber (Scholander et al., 1965), while stomatal conductivity was measured using diffusion porometer AP4 (Delta-T Devices). Soil water content measurements was done by using teta probes (ML2X, Delta - T Device Ltd., United Kingdom) at a depth of 20 cm.

During the experimental period we measured parameters of growth and productivity (leaf area, dry weight of leaves and stem). Leaf area was determinate destructively by sampling leaves from plants and scanning by scanner (Mustec Scan Express A3 USB). Plant biomass (leaf and stem dry weight) was measured after oven drying to constant weigh at 80°C. The measured traits have been analyzed for statistically significant differences by Students unpaired t - tests (Sigma Plot 6.0 for Windows –SPW 6.0, Jandel Scientific, Erckhart, Germany).

Results and discussion

Water content in the substrate and plants water status

Changes in water content in substrate or soil water content, leaf water potential and stomatal conductance in the control and plants exposed to drought during the experiment are shown in Fig 1. The values of water content in the substrate in control plants during the study period were maintained at approximately the same level. Water content in the substrate at the beginning of the experiment was 35.5%, and then was a slight increase in 9-th day, where they recorded the maximum value of 37.6% and a gradual decrease until the end of the study where the water content was 33%.

Maximum values of water in the substrate in plants exposed to drought were at the beginning of the measurements, 33.5%, and then the value of the 5-th day fell to 30.6% and had a more pronounced decrease in the last day of drought where values were 16.7%. Tests of the water content in the substrate during the experiment under controlled conditions, showed that the values of water content in the substrate in plants exposed to drought were significantly lower than in control plants. Water content in control plants kept close to field water capacity, while in the plants exposed to drought decreased from the beginning of experiment until the end of the study where the reduction of water content in the substrate was 49% compared to control. Similar results were obtained by Liu et al., (2005).

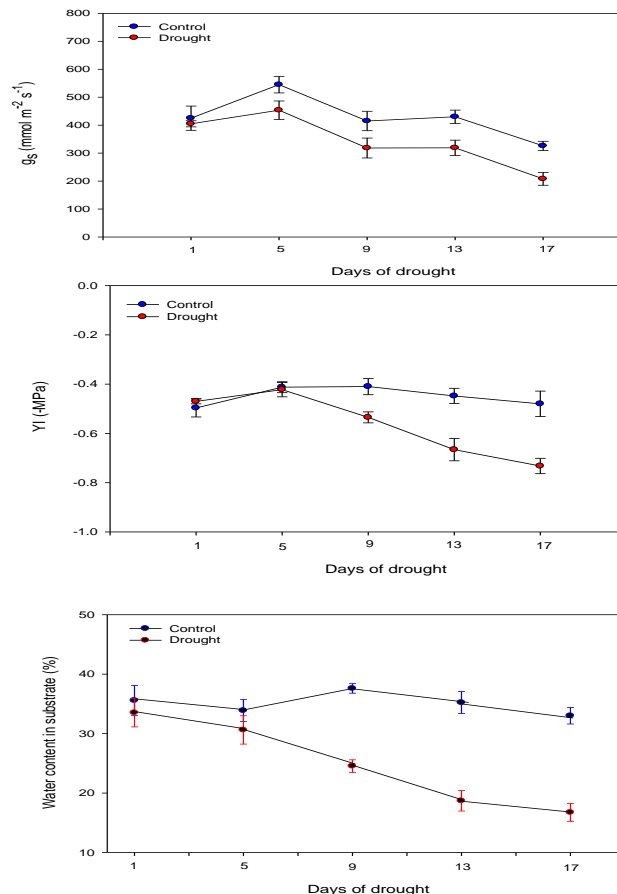

Fig. 1. Changes in water content, stomatal conductance (g_s) and leaf water potential (Ψ_l) in the control and plants exposed to drought during the experiment

During the experimental period, stomatal conductance and leaf water potential in both applied irrigation regimes followed the changes of water content in the substrate. Our results measuring stomatal conductance and leaf water potential was accompanied with a change in water content in the substrate. The results showed that leaf water potential in controlled and plants exposed to drought was similar until the 5-day (0.41 and -0.42 MPa). Drought caused a statistically

significant reduction in leaf water potential at the end of study where water potential in droughted plants was reached -0.73 MPa which is 34% of reduction compared to control. The results of stomatal conductance in control and drought plants had similar trend as a water potential, an increase up to 5-th day, and decreased at the end of experiments. Maximum values for both, controlled and drought exposed plants were at 5-th day (545.0 and 453.6 $\text{mmol m}^{-2}\text{s}^{-1}$). Stomatal conductance in both treatments decreased until the end of experiment (326.0 and 208.0 $\text{mmol m}^{-2}\text{s}^{-1}$). Results showed statistically significant reduction of 37% in stomatal conductance compared to the control. Our results are consistent with the majority of published papers on which the conditions of water deficit has been a reduction of stomatal conductance (Liu et al., 2006, 2008). The results of Liu et al., (2005) showed that the soil drying effect on the reduction of stomatal conductance and leaf water potential of potato, but also increase xylem ABA. Misson et al. (2004) found that g_0 decreases with declining the pre-dawn leaf water potential. In study of Ahmadi et al., (2009) measurements of the leaf water potential on potato resulted that a lower leaf water potential leads to a higher g_s . The decrease in stomatal conductance may occur before there is a drop in the substrate water content and leaf water potential. Such reactions of plants indicates a non-hydraulic (chemical) signals of stress. Correlation analysis (Fig.3) found a linear relationship of water potential and stomatal conductance (coefficient of 0.72) and water potential and water content in the substrate (coefficient 0.85), indicating the presence of hydraulic drought signal. By reducing the water content in the substrate there was a decrease in leaf water potential. These results are consistent with studies Tarideu et al., (1996) where the reduction of leaf water potential leads to decrease in stomatal conductance with increasing number of dry days. Also in the later stages of drought we found a positive correlation between water content in the substrate and stomatal conductance (Fig.2) indicating the presence of chemical signals and drought. The correlation coefficient is 0.57 and determined the linear decreasing dependence, the reduction of water content in the substrate was accompanied by a significant decrease in stomatal conductance.

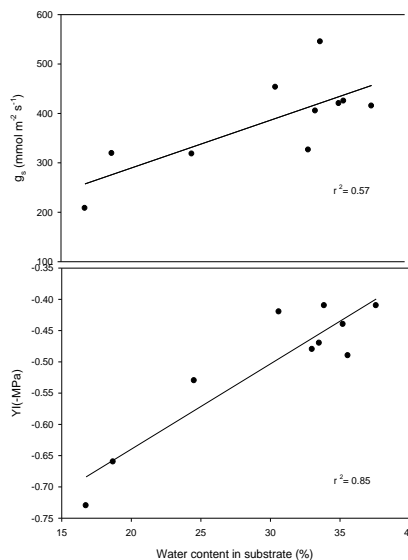

Fig.2. Correlation between water content in the substrate and water potential (A) and water content in the substrate and stomatal conductance (B)

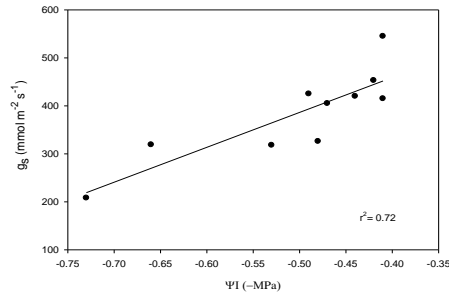

Fig.3. Correlation between stomatal conductance (g_s) and leaf water potential (Ψ_l)

Growth parameters

During the experiment under controlled conditions, measurement of physiological parameters as leaf area and dry leaf and stem biomass were measured at an early phenological phase of growth. Leaf area was increased in controlled plants during the entire period and maximum values of 4250 cm^2 were recorded at the end of the experiment (Tab. 1). In plants exposed to drought leaf area was increased until the 9-day and maximum values were 3250 cm^2 , and then there was a reduction until the end of the period, where the leaf area was 2903 cm^2 . The t-test showed a statistically highly significant reduction in leaf area in droughted plants by 55% compared to the control. The results show that the leaf dry weight at the beginning of the studies were similar in control and plants exposed to drought (12.4 g and 12.1 g, respectively). During the experiment, there has been an increase in dry weight in controls so that at the end of the experiment, leaf dry weight of the control plant was 24.5 g. In plants under drought conditions there was a decrease in values ranging of 9 days starting with the drought and on the end of experiment they reached a value of 11.0 g. Drought caused a statistically significant reduction in leaf dry mass by 55% compared to the control plants. The results of measurements of stem dry weight at the start of measurements for both control and drought plants were 9.1 g and 8.5 g. Dry weight of stem values were rising to 9-th day for both tested treatments, and then there was a decline in the value of plants exposed to drought increasing the number of days of drought. At the end of the experiment, dry weight of stem plants in plants exposed to drought was 10.25 g, which presents statistically significant reduction of 41% compared to control plants.

Decrease in leaf expansion decrease the use of carbon and energy, and a higher proportion of the plant assimilates is distributed to the root system and support further root development. A reduction of dry weight aboveground portion probably comes because the less inhibited root growth in relation to shoot growth and an increases translocation of biomass from aerial parts of the roots of potatoes. Similar to our results, has received Mingo et al., (2004) in studies on tomato. The cause of the reduction in growth under drought conditions, an increase in activity of cell wall hydrolytic enzymes, especially antioxidants (Aganchich et al., 2007), which can induce or cause lignification inactivation of auxin leading to suspension growth.

Table 1. Results of plants leaf area, dry weight of leaf, dry weight of stem in the control and plants exposed to drought

Days of drought	Leaf area		Dry weight of leaf		Dry weight of stem	
	Control	Drought	Control	Drought	Control	Drought
1	2350±150.16	2298±298.85	12.4±0.35	12.1±0.10	9.1±0.9	8.0±0.05
5	2969±235.75	2813±186.68	14.1±0.85	14.5±0.50	10.8±0.7	11.3±0.6
9	3523±323.00	3250±250.00	16.1±0.50	15.4±1.40	13.25±0.75	12.5±0.75
13	3950±50.00	3090±239.07	13.0±1.00	18.0±1.00	14.9±0.90	11.55±0.55
17	4250±250.0	2903±119.45	11.0±0.60	24.5±1.50	17.4±0.60	10.25±0.75

Conclusion

In the experiment under controlled conditions results measurements of stomatal conductance and leaf water potential followed a change of water content in the substrate. These results showed that the test plant at the end of the experiment were exposed to a significant degree of drought stress. On the basis of the results of measured water regime parameters (water content in a substrate, leaf water potential and stomatal conductance) and their correlative relationships it was confirmed that the decrease of water content in a substrate caused induction and interaction of both types of signals (chemical and hydraulic signals).

The results of measurements the parameters of plant growth showed that in plants exposed to drought significantly decreased plant biomass that can be explained by reduction of dry weight of plants and plant leaf area. Measurement results showed that the drought has led to a reduction that is probably due to the translocation of dry matter to the roots, as well as the reduction of leaf area. The results investigated plants growth parameters are indirectly indicate that the effect of the drought influenced assimilate synthesis and partitioning, which is of importance for understanding the impact of drought on the yield of the tested plants.

References

- Aganchich, B., Tahi, H., Wahbi, S., Elmodaffar, C., Serraj, R., 2007. Growth, water relations and antioxidative defence mechanisms of olive (*Olea europea* L.) subjected to partial root drying (PRD) and regulated deficit irrigation (RDI). *Plant Biosyst.* 141, 252–264.
- Ahmadi, S.H., Andersen, M.N., Plauborg, F., Poulsen, R.T. Diurnal and seasonal responses of field-grown potato to partial root-zone drying, deficit and full irrigation: ABA signalling, gas exchange and water use efficiency, submitted for publication.
- Bahrin A., Jensen C.R., Asch, F., and Mogensen, V.O. 2002. Drought-induced changes in xylem pH, ionic composition and ABA concentration act as early signals in field grown maize (*Zea mays* L.). *Journal of Experimental Botany*, 53, 251–63.
- Davies W.J., Wilkinson, S., Loveys, B. 2002. Stomatal control by chemical signalling and the exploitation of this mechanism to increase water use efficiency in agriculture. *New Phytol.* 153, 449–460.
- Dodd, I.C., Theobald, J.C., Sarah, K., Richer, S.K., Davies, W.J. 2009. Partial phenotypic reversion of ABA-deficient flacca tomato (*Solanum lycopersicum*) scions by a wild-type rootstock: normalizing shoot ethylene relations promotes leaf area but does not diminish whole plant transpiration rate. *J. Exp. Bot.* 60, 4029–4039.
- Fabeiro, C., Martin de santa Olalla, F., De Juan, J.A., 2001. Yield and size of deficit irrigated potatoes. *Agricultural Water Management* 48, 255–266
- Fernández, J.E., Palomo, M.J., Diaz-Espejo, A. and Girón, I.F. 2003. Influence of partial soil wetting on water relation parameters of the olive tree. *Agronomie* 23, 545–552.
- Hassanpanah, D., 2010. Evaluation of potato cultivars for resistance against water deficit stress under in vivo conditions. *Potato Research* 53, 383–392.
- Lahlou, O; Ledent, JF. 2005. Root mass and depth, stolons and roots formed on stolons in four cultivars of potato under water stress. *European Journal of Agronomy*, 22, 159–173.

- Liu, F., Jensen, C.R., Shahnazari, A., Andersen, M.N., Jacobsen, S.E., 2005. ABA regulated stomatal control and photosynthetic water use efficiency of potato (*Solanum tuberosum* L.) during progressive soil drying. *Plant Science* 168, 831–836.
- Liu, F., Shahnazari, A., Andersen, M.N., Jacobsen, S.E., Jensen, C.R., 2006. Physiological responses of potato (*Solanum tuberosum* L.) to partial root-zone drying: ABA signalling, leaf gas exchange, and water use efficiency. *Journal of Experimental Botany* 57, 3727–3735.
- Liu, F., Song, R., Zhang, X., Shahnazari, A., Andersen, M.N., Plauborg, F., Jacobsen, S.E., Jensen, C.R., 2008. Measurement and modeling of ABA signaling in potato (*Solanum tuberosum* L.) during partial root-zone drying. *Environmental and Experimental Botany* 63, 385–391.
- Mingo, D.M., Theobald, J.C., Bacon, M.A., Davies, W.J., Dodd, I.C., 2004. Biomass allocation in tomato (*Lycopersicon esculentum* L.) plants grown under partial root zone drying: enhancement of root growth. *Funct. Plant Biol.* 31, 971–978
- Misson, L., Panek, J.A., Goldstein, A.H., 2004. A comparison of three approaches to modelling leaf gas exchange in annually drought-stressed ponderosa pine forests. *Tree Physiol.* 24, 529–541.
- Neumann PM 2008: Coping mechanisms for crop plants in drought-prone environments. *Annals of Botany* 101, 901–907.
- Rampino P, Pataleo S, Gerardi C, Mita G, Perrotta C 2006 : Drought stress response in wheat: physiological and molecular analysis of resistant and sensitive genotypes. *Plant, Cell & Environment* 29, 2143–2152.
- Reddy, A.R.; Chaitanya, K.V. & Vivekanandan, M. 2004. Drought-induced responses of photosynthesis and antioxidant metabolism in higher plants. *Journal of Plant Physiology*, Vol.161, No.11, pp. 1189–1202, ISSN 0176-1617.
- Schachtman, D.P., Goodger, J.Q.D. 2008. Chemical root to shoot signaling under drought. *Trends Plant Sci.* 13, 281–287.
- Tardieu, F., Lafarge, T., Simonneau, T., 1996. Stomatal control by fed or endogenous xylem ABA in sunflower: interpretation of correlations between leaf water potential and stomatal conductance in anisohydric species. *Plant, Cell and Environment* 19, 75–84.
- Vysotskaya, L.B., Korobova, A.V., Veselov, S.Y., Dodd, I.C., Kudoyarova, G.R. 2009. ABA mediation of shoot cytokinin oxidase activity: assessing its impacts on cytokinin status and biomass allocation of nutrient-deprived durum wheat. *Funct. Plant Biol.* 36, 66–72.
- Walter, J., Jentsch, A., Beierkuhnlein, C., Kreyling, J. 2012. Ecological stress memory and cross stress tolerance in plants in the face of climate extremes. *Environmental and Experimental Botany* 94, 3–8.
- Wilkinson, S. 1999. pH as a stress signal. *Plant Growth Regul.* 29, 87–99.
- Wilkinson, S., Hartung, W. 2009. Food production: reducing water consumption by manipulating long-distance chemical signalling in plants. *J. Exp. Bot.* 60, 1885–1891.
- Wilkinson, S., Davies, W.J. 2008. Manipulation of the apoplastic pH of intact plants mimics stomatal and growth responses to water availability and microclimatic variation. *J. Exp. Bot.* 59, 619–631.
- Yuan, B., Nishiyama, S., Kang, Y. 2003. Effects of different irrigation regimes on the growth and yield of drip irrigated potato. *Agri. Water Manage.* 63, 153–167.

THEORY OF IMPACT INTERACTION BETWEEN THE FEELER AND STANDING SUGAR BEET ROOT CROWNS DURING THEIR SCALPING

Volodymyr BULGAKOV¹, Valerii ADAMCHUK², Margus ARAK³, Jüri OLT^{3,*}

¹National University of Life and Environmental Sciences of Ukraine, Ukraine

²National Scientific Centre, Institute for Agricultural Engineering and Electrification, Ukraine

³Estonian University of Life Sciences, Institute of Technology, Estonia

*Corresponding author: jyri.olt@emu.ee

Abstract

The removal of sugar beet haulm is a topical research-and-technology problem of the sugar beet growing industry. Solving it would facilitate a considerable increase in sugar yield per hectare of the harvested crop acreage. The use of haulm as a source in the biogas production further increases the priority of this problem. Therefore, finding an optimal design and kinematic parameters of a new feeling unit for the standing root scalper on the basis of a theory on the impact interaction between a passive feeler and standing beet root crowns during their scalping is a high-priority task for scientists. This paper presents new analytical research on the process of interaction between the passive feeler and the beet root crown. Thus, the impact momentum has been determined and the conditions needed for the effective feeling and scalping of the standing root's crown without dislodging the root from soil have been established. The numerical calculation of the derived analytical expression performed on a PC has facilitated the plotting of a curve, which shows the efficient root crown feeling to be at a travelling speed of $V = 2 \text{ m s}^{-1}$ and a comb feeler elevation angle of $\alpha = 0.3 \text{ rad}$ (or 17°).

Keywords: *sugar beet root, harvesting, scalper, modelling, constructive and kinematic parameters.*

Introduction

Today's sugar beet root harvesting technologies involve initial chopping of the bulk of the haulm followed by final scalping of the standing root's crown prior to lifting the root from the soil (Gu et al., 2014; Sarec et al., 2009; Wang & Zhang, 2013; Wu et al., 2013). Therefore, the efficient performance of the majority of beet harvesters depends on how sensitively and accurately the feeling of the roots standing in the row with their crowns rising to different heights above the soil surface is done (Gruber, 2005; Schulze Lammers, 2011). This applies to most of the haulm gatherers, root crown after-cleaners, scalpers and certain designs of lifting tools (Schulze Lammers & Schmittmann, 2013). In international practice, various mechanical feeling devices are now widely used, which feel the standing beet roots and adjust the elevation of the tools accordingly, as required. They can be passive feelers, active (powered, drum-type) and even combined ones. However, the requirements of achieving the needed performance level under various harvesting conditions, design simplicity and reduced metal and power intensity are not always met.

A lot of studies have recently been published covering the issues of the removal of residual sugar beet haulm after the total topping of the standing roots with the cutting apparatus (Pogorely et al., 1983; Bulgakov 2002, 2011; Bentini et al., 2005; Zhang et al., 2013). These studies dealt with root crown cleaners of different designs: vane, ring, sector and drum as well as paraboloid types. The most widely used standing root crown cleaners are those which do not require noticeably accurate and sensitive feeling of each of the beet root crowns rising to different heights above the soil surface in the row. The processes of haulm harvesting are

largely similar for sugar beet and fodder beet, but only experimental studies have been carried out with regard to fodder beet haulm harvesting (Pogorely&Tatyanko, 2004). The aim of this study was to find the optimal constructive and kinematic parameters of a feeling unit for the standing root crown scalper on the basis of the development of a theory of the impact interaction between the passive feeler and standing root crowns during their scalping.

Materials and methods

This research used methods of generating mathematical models of operation of agricultural machines and their tools with the use of fundamental provisions of mathematics and theoretical mechanics, principles of program construction and numerical computation on PCs..

We have developed a new passive-type design of standing sugar beet root crown scalper. Its design and process flow schematic model are presented in Fig. 1. It comprises frame 1 rigidly attached to the rear part of the main frame of the haulm gatherer (which performs total chopping of the bulk of the haulm with no prop and no feeler) above each row of root crops and vertical support 2 with the tools, which is connected to frame 1 by two pairs of link rods 3 and 4 in the parallelogram linkage. Link rod 3 has a screw mechanism to adjust its length. Vertical support 2 holds passive runner-type feeler 5 attached to its bottom at an adjustable elevation angle of α and flat passive knife 6 with a length of l attached behind the feeler and vectored at an angle of γ to the line of travel (V). All moving members of the scalper are connected to each other with hinge joints 8, while link rods 3 and 4 are in addition connected with spring mechanism 7.

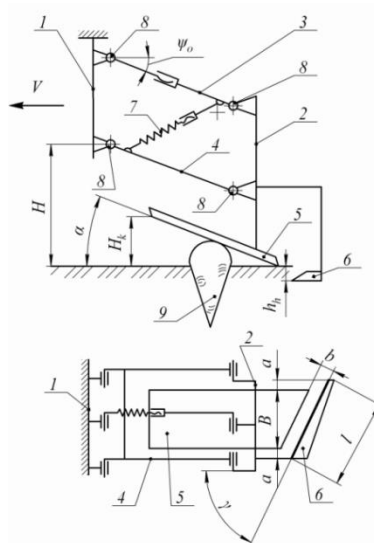

Fig. 1. Design and process flow schematic model of the root crown scalper: 1 – frame, 2 – support; 3 and 4 – link, 5 – passive runner-type feeler, 6 – flat passive knife, 7 – spring mechanism, 8 – hinge, 9 – root.

The root crown scalper operates as follows. During its movement along the planted row of sugar beet roots, feeler 5 runs into root 9 and while travelling over its crown raises vertical support 2 with knife 6 upwards. By the time, when the rear part of the feeler reaches the tip of the crown, knife 6 finally settles at the needed scalping height. During the following translational movement of the scalper, knife 6 scalps flat the root crown.

Depending on the clearances h_h and b , the root crown scalping height changes. The values of the clearances are stipulated by the statistical sizes of the sugar beet roots and adjusted individually for each beet field. Spring mechanism 7 is employed to dampen the galloping of

the scalper's moving part, when it travels over the root crowns reaching different heights, – it presses feeler 5 down to root crown 9.

Based on the statistical dimension and mass properties of the sugar beet roots and their positions in the planted rows, some of the main design parameters of the scalper can be assumed as required by the design or calculated using relatively simple established dependencies. Thus, the feeler's width B is assumed to be within $B = 160...210$ mm; H_k – feeler 5 front end setting height is selected to be greater than the elevation of sugar beet root 9 above the soil surface level and it cannot be less than 150...170 mm; H – elevation of lower hinge joint 8 in the parallelogram carrier is selected in accordance with the design and it must be within 250...350 mm. At the same time, the elevation H must be sufficient to provide a haulm gatherer transport clearance of at least 300 mm. The length of feeler 5 depends on the maximum elevation of root crown 9 and can be determined using the following dependency:

$$L_k = \frac{H_k}{\sin \alpha} \quad (1)$$

The vertical clearance h_k between knife 6 and feeler 5 depends on the elevation of the beet root crown and must be within 10...50 mm. The horizontal clearance b between feeler 5 and knife 6 depends on the maximum diameter of the crown of root 9 and ranges within $b = 0...80$ mm. The angle γ must ensure secure sliding of the scalped root crown and other crop residues off the blade of knife 6. This can be found from the following formula:

$$\gamma = 90^\circ - \varphi, \quad (2)$$

where φ – angle of repose of haulm on the knife blade $45^\circ > \varphi > 40^\circ$.

The length l of knife 6 can be derived from the following dependency:

$$l = \frac{B+2a}{\cos \varphi}, \quad (3)$$

where a – overlap of knife 6 and the width of feeler 5, selected according to the design.

The effective operation of such a design of haulm gatherer can be expected only when the force parameters of the interaction between the passive feeler and the root crown comply with the requirement to avoid dislodging the latter from the soil in the course of operation and ensure minimum damage of the roots under high travel speed.

In the next section we build a mathematical model of the interaction between a passive feeler and a root crown rigidly fixed in the ground. As the operation of a scalper always involves the feeler striking at the root crown, it would be necessary to study the effect that the design and force parameters of the scalper have on its performance quality.

Theory and modelling

Let's analyse the process of interaction between the passive feeler and the root, when the former moves along the planted row of sugar beet and makes contact with the latter's still standing crown at point A (Fig. 2). It is assumed that the feeler inclined at an angle α to the horizontal strikes the beet root crown during its translational movement.

Let's find the total force Q acting on the beet root crown, when the feeler strikes it. The force will be equal to the algebraic sum of the projections of all forces applied at contact point A on axis n :

$$Q = F_{s.t.} + mg \cos \alpha + P_n + F \quad (4)$$

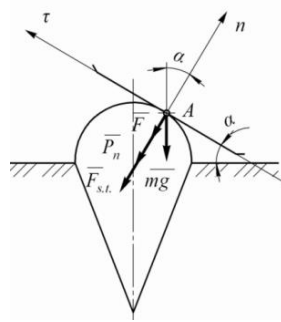

Fig. 2. Force diagram of interaction between passive feeler and beet root.

Now we are going to generate the differential equation of motion of the feeler running into the beet root crown. According to the fundamental law of dynamics (Dreizler&Lüdde, 2010), the following differential equation can be given:

$$m \frac{d\bar{V}}{dt} = \bar{Q} \quad \text{or} \quad m d\bar{V} = \bar{Q} dt \quad (5)$$

where m – reduced mass of the beet root crown scalper at point A.

Taking the integral of equation (6) from $t = 0$ to $t = \tau$, (where τ – time of action of the impact), we obtain:

$$\int_{\bar{V}_p}^{\bar{V}} m d\bar{V} = \int_0^{\tau} \bar{Q} dt \quad (6)$$

or

$$m(\bar{V} - \bar{V}_p) = \int_0^{\tau} \bar{F}_{s.t.} dt + \int_0^{\tau} \bar{P}_n dt + \int_0^{\tau} \bar{F} dt + \int_0^{\tau} \overline{mg} \cos \alpha dt, \quad (7)$$

where \bar{V}_p – the feeler's speed before the impact; \bar{V} – the feeler's speed after the impact.

According to the mean value theorem from the integral calculus course (Pogorely et al., 1983), the following can be derived:

$$m(\bar{V} - \bar{V}_p) = \int_0^{\tau} \bar{F}_{s.t.} dt + \bar{P}_{n.med.} \cdot \tau + \bar{F}_{med.} \cdot \tau + \overline{mg} \cos \alpha \cdot \tau, \quad (8)$$

where $\bar{P}_{n.med.}$ – mean value of force P_n on interval $[0, \tau]$; $\bar{F}_{med.}$ – mean value of force F on interval $[0, \tau]$.

As $\tau \rightarrow 0$ in case of an impact, we have:

$$m(\bar{V} - \bar{V}_p) = \bar{S} + \lim_{\tau \rightarrow 0} \bar{P}_{n.med.} \cdot \tau + \lim_{\tau \rightarrow 0} \bar{F}_{med.} \cdot \tau + \lim_{\tau \rightarrow 0} \overline{mg} \cos \alpha \cdot \tau, \quad (9)$$

where impact momentum

$$\bar{S} = \lim_{\tau \rightarrow 0} \int_0^{\tau} \bar{F}_{s.t.} \cdot dt \quad (10)$$

The three last limits in expression (9) are equal to zero, because $\bar{P}_{n.med.}$ and $\bar{F}_{med.}$ vary arbitrarily, while force $mg \cos \alpha$ does not change at all, hence, in time interval $[0, \tau]$, where $\tau \rightarrow 0$, we can consider them to be almost constantly finite quantities.

Thus, taking into consideration expressions (10), we finally obtain:

$$m(\bar{V} - \bar{V}_p) = \bar{S} \quad (11)$$

where \bar{S} – impact momentum vector directed along the common normal line n drawn through the feeler and the root crown at contact point A.

If we know such values as ε – coefficient of restitution for the impact of the feeler on the root crown and α – angle between the impact direction and the feeler plane, then we can find the impact momentum in accordance with the established theory of impact (Bulgakov, 2002).

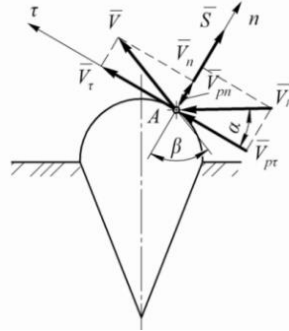

Fig. 3. Equivalent schematic model of impact of the feeler on a beet root crown.

To find them, let's examine again the impact of the feeler on the root crown. We have drawn an equivalent schematic model, in which a system of coordinates $A\tau n$ is shown as well as the vectors of speed before and after the impact of the feeler on the root crown (Fig. 3). In this model, as mentioned earlier, V_p – the feeler's speed before the impact; V – the feeler's speed after the impact; S – impact momentum vector.

After mathematical transformations, we obtain the following equations:

$$\varepsilon = \frac{V_p \cos \alpha \cos \beta}{V \sin \beta \sin \alpha} = \frac{\cos \alpha}{\cos \alpha} \cdot \frac{\cos \beta}{\sin \beta} = \frac{\cot \beta}{\tan \alpha} \quad (12)$$

if $\cot \beta = \varepsilon \tan \alpha$, then $\beta = \cot^{-1}(\varepsilon \tan \alpha)$;

$$S = m(1 + \varepsilon)V_p \sin \alpha \quad (13)$$

where m – reduced mass of the beet root crown scalper at point A,

$$F_{s.t.} \approx 6m(1 + \varepsilon)V_p^2 \sin \alpha, \quad (14)$$

where m – reduced mass of the scalper at point A; ε – coefficient of restitution; V_p – travelling speed; α – feeler's elevation angle, and

$$\alpha = \arcsin \frac{-(P_n + F) + \sqrt{(P_n + F)^2 + 240 m(1 + \varepsilon)V_p^2}}{12m(1 + \varepsilon)V_p^2}. \quad (15)$$

Results and discussion

Thus, we have analytically found the law that allows us to determine the optimal kinematic and design parameters for the feeling unit of a standing root crown scalper. To put these equations to use it is necessary to know the reduced mass of the scalper – m , the coefficient of restitution of the feeler striking on the beet root crown – ε , and the forces – P_n and F , which will depend on the specific engineering solution.

Now we can carry out the numerical calculation of expression (15). The calculation will be based on the following values of the constituent parameters: $P_n = 98$ N, $F = 18$ N, $m = 18$ kg, $\varepsilon = 0.72$. Considering the condition $0 < \alpha < \pi/2$, we obtain the interval $0 < \alpha < 1.006$ rad or 0

$\alpha < 57.667^\circ$, on which effective values of the speed V_p exist. The curve generated as a result of the numerical calculations is presented in Fig. 4, where the values of angle α in radians are shown.

From the graph in Fig. 4, we can conclude that the efficient feeling of root crowns takes place at a travel speed of $V = 2 \text{ m s}^{-1}$ and a comb feeler elevation angle of $\alpha = 0.3 \text{ rad}$ (or 17°).

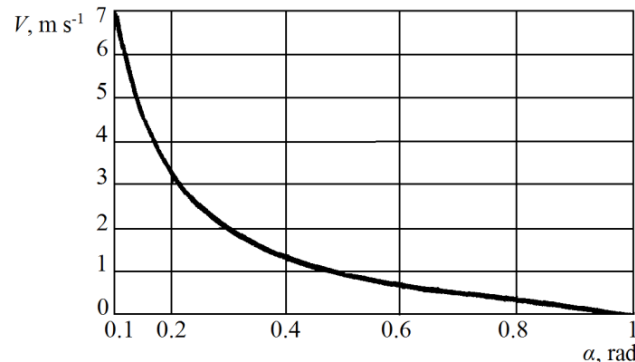

Fig. 4. Relation between feeler elevation angle α and translational motion speed V_p (Bulgakov, 2002).

We have tested the operating efficiency of the new design of the sugar beet root crown scalper experimentally under field conditions. Fig. 5 shows the appearance of a row of roots after the scalper made a pass along it (the white line shows the centre line of the planted row of sugar beet).

It has been found that, despite the impact interaction between the passive feeler and the beet root, dislodging of the latter from the ground is virtually absent.

Meanwhile, the main measure of quality of the scalper's operation is the amount of the tops left on the beet root crowns, which in the test were collected from a unit of area of the planted row equal to 1 m^2 and weighed on electronic scales.



Fig. 5. Row of sugar beet roots after scalping.

The results obtained from the field trial and processed on a PC enabled us to plot diagrams that showed the dependencies between the amount of the haulm (uncut parts) left on the root crowns after their scalping and the design and kinematic parameters (Fig. 6). The angles of inclination of the passive feeler of the root crown scalper were set within a range of $\alpha = 15 \dots 17^\circ$, the cutting height varied within a range of $0.03 \dots 0.12 \text{ m}$, while the translational movement speed V changed from 1.2 m s^{-1} to 2.0 m s^{-1} .

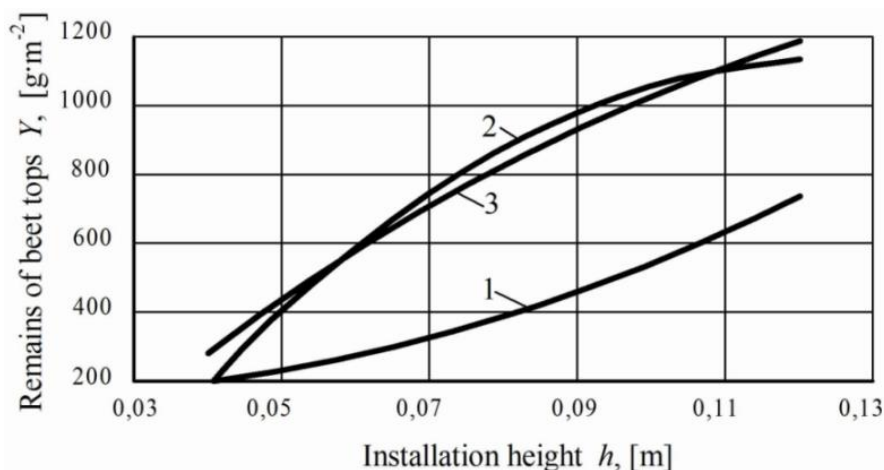

Fig. 6. Amount of haulm left on beet roots Y as a function of preset cutting height h and translational movement speed V : 1 – $V = 0.7 \text{ m s}^{-1}$; 2 – $V = 1.2 \text{ m s}^{-1}$; 3 – $V = 2.0 \text{ m s}^{-1}$.

Figure 6 shows that the dependencies of haulm remaining on installation height and speed were close to linear. When the cutting height h was set below 0.03 m, the scalper became virtually inoperative; hence, the lowest value of this design parameter should be within a range of 0.05 m to 0.07 m. Using other values of this design parameter resulted in a considerable increase of the amount of haulm (uncut parts) left on the beet root crowns. Although the highest quality of sugar beet root crown scalping with the removal of haulm remains was achieved at a scalper travelling speed of 0.7 m s^{-1} , the process parameters stipulate that the working speed (which has to conform with the haulm gatherer's working travelling speed) should be close to 2.0 m s^{-1} , which would increase, the amount of haulm left on the root crowns.

The overall measures of quality of the sugar beet root crown scalping performed by the new design scalper were, according to the results of the field experimental studies, as follows: root dislodging from soil – 0...0.5%, root mass loss – 2.0...2.5%, root crown surface damage – 0...1%, amount of normally scalped crowns – 95...98%.

Conclusions

A new design of standing sugar beet root crown scalper has been developed, its experimental analysis and field testing have produced positive results supporting the operating efficiency and high quality of the tool. First, the analytical mathematical model of the process of interaction between a passive feeler and a sugar beet root crown was generated. For this purpose, the force diagram of the interaction between a passive feeler and the spherical surface of a beet root crown and the equivalent schematic model of their impact was drawn out. All forces acting during the impact contact and the speeds before and after the impact were applied at the points of contact in these diagrams. Thereafter, the impact momentum was determined and the conditions needed for the effective feeling and scalping of the standing root's crown without dislodging the root from the soil were established. The numerical calculation of the derived analytical expression performed on a PC facilitated the plotting of a curve, which showed efficient root crown feeling to be at a scalper travelling speed of $V = 2 \text{ m s}^{-1}$ and its passive comb feeler elevation angle of $\alpha = 0.3 \text{ rad}$ (or 17°).

The obtained values of the design and kinematic parameters of the scalper that removes the haulm remains off the root crowns allow us to achieve operation quality measures (root dislodging from soil – 0...0.5%, root mass loss – 2.0...2.5%, root crown surface damage – 0...1%, amount of normally scalped crowns – 95...98%).

References

- Bentini, M., Caprara, C., Rondelli, V. 2005. Mechanical properties of sugar beet roots. *Transactions of the American Society of American Engineers* 48(4), 1429–1439.
- Bulgakov, V.M. 2002. Study on the interaction of feeler and roots within the topping process of sugar beet. *Bulletin of the Transilvania University of Brasov* 9(44), 1-6.
- Bulgakov, V.M. 2011. Sugar beet harvesting machines. Kiev: *Agricultural Science*, 245 pp.
- Dreizler, R.M., Lüdde, C.S. 2010. *Theoretical Mechanics*. Springer, 402 pp.
- Gruber, W. 2005. Trends in sugar beet harvesting. *Landtechnik* 60(6), 320–321.
- Gu, F., Hu, Z., Wu, H., Peng, B., Gao, X., Wang, S. 2014. Development and experiment of 4LT-A staggered-dig sugar beet combine. *Nongye Gongcheng Xuebao/Transactions of the Chinese Society of Agricultural Engineering* 30(23), 1–9.
- Pogorely, L.V., & Tatyanko, N.V. 2004. *Beet-harvesting machines: History, Construction, Theory, Prognosis*, Feniks, Kyiv, 232 pp. (in Ukrainian).
- Pogorely, L.V., Tatyanko, N.V., & Bray, V.V. 1983. *Beet-harvesting machines (designing and calculation)*. Tehnika, Kyiv, 168 pp.
- Sarec, P., Sarec, O., Przybyl, J., & Srb, K. 2009. Comparison of sugar beet harvesters. *Listy cukrovarnické a reparské* 125(7-8), 212–216. (in Czech).
- Schulze Lammers, P. 2011. Harvest and loading machines for sugar beet – new trends. *International Sugar Journal* 113(1348), 253–256.
- Schulze Lammers, P., Schmittmann, O. 2013. Testing of sugar beet harvesters in Germany 2012. *International Sugar Journal* 115(1370), 100-106.
- Wang, F., Zhang, D. 2013. Design and experiment of disc-dig sugar beet combine. *Nongye Gongcheng Xuebao/Transactions of the Chinese Society of Agricultural Engineering* 29(13), 7–14.
- Wu, H., Hu, Z., Peng, B., Wang, H., Wang, B. 2013. Development of auto-follow row system employed in pull-type beet combine harvester. *Nongye Gongcheng Xuebao/Transactions of the Chinese Society of Agricultural Engineering* 29(12), 17–24.
- Zhang, G., Xu, W., Fan, S. 2013. Analysis and parameter optimization of adjustable beet top cutting mechanism. *Nongye Gongcheng Xuebao/Transactions of the Chinese Society of Agricultural Engineering* 29(18), 26–33.

WEATHER CONDITIONS IN THE 2013 - 2015 WHEAT GROWING SEASON IN CROATIA AND BOSNIA AND HERZEGOVINA

Mirta RASTIJA^{1*}, Vlado KOVAČEVIĆ¹, Domagoj RASTIJA¹, Ilija KOMLJENović²,
Georg DREZNER³

¹Faculty of Agriculture in Osijek, Josip Juraj Strossmayer University of Osijek, Osijek, Croatia

²Faculty of Agriculture, University of Banja Luka, Banja Luka, Bosnia and Herzegovina

³Agricultural Institute Osijek, Osijek, Croatia

*Corresponding author: mrastija@pfos.hr

Abstract

Winter wheat is a very important field crop on the arable lands in Croatia and Bosnia and Herzegovina (B&H). Wheat production is often characterized by significant yield variations, as affected by unfavorable weather conditions. The aim of this study was to analyze wheat yield in relation to weather data (precipitation and mean air temperature) in Croatia and B&H in the 2012/2013, 2013/2014 and 2014/2015 growing seasons. The data from four meteorological stations in Croatia situated in the east and north of the country and data from four stations in the northern B&H were analyzed. Average wheat yields were 4.9, 4.2 and 5.4 t ha⁻¹ (Croatia), and 3.9, 2.9 and 3.5 t ha⁻¹ (B&H), for harvest in 2013, 2014 and 2015, respectively. The 2013/2014 growing season was less favorable for winter wheat growing as precipitation sums in the October-June period were considerably higher compared to the long-term reference mean (1961 – 1990), while mean air temperatures were significantly higher. The main cause of lower yields in 2014 for both countries was excessive precipitation in the period April-June, in some places also accompanied with floods. In the remaining two growing seasons, precipitations in both countries were mainly favorably distributed and temperatures somewhat lower compared to the 2013/2014 season.

Key words: *wheat yield, precipitation, temperature, Croatia, Bosnia and Herzegovina*

Introduction

Winter wheat is a very important field crop on the arable lands in Croatia, where is the second ranked crop, and Bosnia and Herzegovina (B&H) as well. Degree of arable land utilization becomes a serious problem of agriculture in both countries, because significant share of arable land is unfarmed. In the 2001-2010 period, wheat was grown in Croatia on 184 500 ha on average with the mean yield 4.42 t ha⁻¹, and on about 74 000 ha in B&H with average yield 3.12 t ha⁻¹. According to the available statistical data (FAOSTAT, 2016, CBS, 2016) yield variations among years for mentioned ten year period were from 2.96 to 5.50 t ha⁻¹ in Croatia and from 2.26 to 3.78 t ha⁻¹ in B&H. Such yield variation is attributed to weather conditions, especially precipitation and temperature regimes. The lower yields of wheat are usually connected to precipitation deviation, either by excessive precipitation in autumn/winter period or drought periods in growth stages from stem elongation to ripening (Dencic *et al.*, 2000; Gupta *et al.*, 2008; Marijanovic *et al.*, 2010; Pepo and Kovacevic, 2011; Jolankai and Birkas, 2013; Majdancic *et al.*, 2016). Variation of yields among years is also associated with recently climate change which has often adverse influences on field crops yields (Adams, R. M. *et al.*, 1998; IPCC, 2007; Kovacevic *et al.*, 2013).

Aim of this study was survey of wheat yield in relation to weather data (precipitation and mean air-temperature) in Croatia and B&H in the 2012/2013, 2013/2014 and 2014/2015 growing seasons with emphasis on climate change.

Material and methods

Meteorological data, precipitation and mean air-temperatures were provided by courtesy of State Hydrometeorological Service in Zagreb (Croatia), Federal Hydrometeorological Institute in Sarajevo (entity of Federation of Bosnia and Herzegovina) and Hydrometeorological Institute of Republic of Srpska in Banja Luka (entity of Republic of Srpska, Bosnia and Herzegovina). Data were collected from eight meteorological stations of which four are in Croatia (Osijek, Bjelovar, Sisak and Varaždin), and four in B&H (Bijeljina, Tuzla, Banja Luka and Bihać). Those towns are situated in the east, the central and the north part of Croatia in Pannonian region and in northern Bosnia, representing the main wheat growing area in both countries. Meteorological data were compared with reference long term mean (1961-1990). Database of FAOSTAT and Croatian Bureau of Statistics were used as sources of data for wheat harvested areas and yields for analyzed period.

Results and discussion

The average wheat harvested area in Croatia in the decade 2001-2010 were 184 500 ha, while in the last three year period 2013-2015 it was about 167 000 ha or by 10% lower, indicating decreasing trend of wheat growing. In B&H also some reduction of wheat growing area is present (Table 1). It can be observed that higher wheat yield is achieving in Croatia as average wheat yield in the decade period were 4.42 t ha⁻¹ in Croatia while 3.12 t ha⁻¹ in B&H. In the analyzed three-year period, average yields of wheat were also by almost 30 % higher in Croatia. Great yield variability was found, not only between countries, but also among three years, especially in the last growing season. Average wheat yield in the 2015 in Croatia was quite above average (5.4 t ha⁻¹) and by 22% higher compared to the previous ten-year mean, while in the 2014 it was 4.2 or by 5% lower. The highest annual yield of wheat in B&H in analyzed three-year period was 3.9 t ha⁻¹ in 2013. The lowest yield in both countries was recorded in 2014 (Table 1).

Table 1. Arable land and gardens (ALG), wheat harvested area (ha) and wheat yields (t ha⁻¹) in the growing seasons 2012/2013 to 2014/2015 and averages for the 2001-2010 period in Croatia and Bosnia and Herzegovina

Year of wheat harvest	Croatia			Bosnia and Herzegovina		
	ALG	Wheat		ALG	Wheat	
	ha	ha	t ha ⁻¹	ha	ha	t ha ⁻¹
Mean 2001-2010	859 800	184 500	4.4	1 014 800	73 700	3.1
2013	874 800	204 500	4.9	1 010 000	67 600	3.9
2014	811 100	156 100	4.2	1 011 000	67 600	3.0
2015	841 900	140 700	5.4	1 029 000	61 900	3.5
Mean 2013-2015	842 600	167 100	4.8	1 016 667	65 700	3.1

The analyzed region is characterized by typical continental climate (Bertić, 1987). Precipitation quantities are increasing from the east to the west and from the north toward south, what was confirmed also in our study. Long-term mean (LTM) values of precipitation in October-June period for diagonal-positioned towns Osijek (NE point) and Bihać (SW point) is 482 mm and 982 mm, respectively (Table 2). In the lowland area of the northern Croatia there is tendency of temperature decreasing from the east toward to the west (Osijek 7.9°C and Varaždin 7.2°C), while in the tested sites of B&H this tendency is somewhat lower (Bijeljina 8.3°C and Bihać 8.0°C).

In accordance with global warming, three growing seasons included in our study were warmer compared to LTM in average by 1.2°C, 2.4°C and 1.9°C, respectively (averages of all eight sites for the October-June period). Increased mean air-temperatures are recorded in all months

of winter growing season, but they were particularly high during winter period (Table 3). At the same time, precipitation was higher by around 20 % in all three growing seasons (Table 4).

Table 2. Reference values of long-term means (LTM; 1961-1990) for precipitation (mm) and mean air-temperatures (°C) in selected sites in Croatia and B&H

LTM (1961-1990)		Month of wheat growing season									Sum (mm)/ Mean (°C)
		Oct.	Nov.	Dec.	Jan.	Feb.	Mar.	Apr.	May	June	
Osijek	mm	41	57	52	47	40	45	54	58	88	482
	°C	11.2	5.4	0.9	-1.2	1.6	6.1	11.3	16.5	19.5	7.9
Bjelovar	mm	55	85	61	50	47	54	63	79	96	590
	°C	10.4	5.2	0.6	-1.1	1.6	6.0	10.8	15.6	18.7	7.5
Sisak	mm	64	90	68	52	50	58	73	82	91	628
	°C	10.8	5.6	1.0	-0.7	1.9	6.3	11.1	15.8	19.1	7.9
Varaždin	mm	69	83	58	45	45	55	70	84	98	607
	°C	10.1	4.9	0.5	-1.3	1.3	5.4	10.3	15.1	18.3	7.2
Bijeljina	mm	75	77	59	82	52	49	68	81	86	629
	°C	12.1	5.6	2.0	-1.1	1.9	6.8	11.0	16.3	19.8	8.3
Tuzla	mm	56	71	72	59	55	61	76	92	111	653
	°C	10.6	5.6	0.9	-0.8	1.7	5.7	10.4	14.8	17.8	7.4
Banja Luka	mm	72	91	86	69	63	79	87	98	111	756
	°C	10.8	5.9	1.2	0.7	1.9	6.1	10.9	15.6	18.9	8.0
Bihać	mm	109	146	111	86	91	99	115	116	109	982
	°C	11.3	6.3	1.7	0.3	2.3	6.1	10.7	15.1	18.3	8.0

Sum of precipitation and their monthly distribution was different among analyzed localities and years (Table 3), but the 2013/2014 growing season was very specific regarding winter wheat growing and less favorable compared to the other two seasons. Consequently, in both countries the lowest yield was achieved in the 2014 (Table 1). Precipitation and temperature in the October-June period for this season quite deviated from LTM, especially regarding precipitation distribution, so the main cause of lower yields in 2014 for both countries was excessive precipitation in the period April-June, in some places also accompanied with floods. The greatest deviation was found for Tuzla region, where in that three-month period was recorded more than a double sum of precipitation in comparison with reference LTM (590 vs. 279 mm). In Banja Luka precipitation was higher by 79 %, in Bijeljina by 71 %, in Osijek by 66 %, and in Sisak by 59 %. In the east Croatia wheat yield reduction is usually associated to precipitation surplus during autumn and winter period or drought stress in the spring period (Iljkić *et al.*, 2010.). The least affected regions by the flood or excessive water supply were the areas of Bihać in B&H and Varaždin in Croatia (Table 3).

At the same time, in 2013/2014 growing season mean air-temperatures were unusually high, particularly during winter and early spring period from December to March. It is well known that in typical continental climate January is the coldest month with mean temperatures around or below 0 °C (Table 2), but in 2014 the mean value of air temperature for that month in all eight analyzed localities ranged from 4 °C to more than a 6 °C (Table 4). Values of mean air-temperatures for that growing season varied from 9.8 °C (Varaždin) to 10.4 °C (Bijeljina, Banja Luka).

Wheat top dressing with nitrogen as well as protection from weeds and diseases are applied later, due to long rain periods.

In the remaining two growing seasons, in both countries precipitation was mainly favorable distributed and temperatures something lower compared to the 2013/2014 (Tables 3 and 4).

Table 3. Monthly values of precipitation in eight selected sites in Croatia and B&H during winter wheat growing seasons 2012/2013 to 2014/2015

Locality	Year	Oct	Nov	Dec	Jan	Feb	Mar	Apr	May	June	Sum (mm)
Osijek	2012/13	65	50	104	61	86	84	45	119	63	677
	2013/14	52	64	0	52	48	39	81	159	91	586
	2014/15	88	9	66	74	57	51	13	113	17	488
Bjelovar	2012/13	69	79	104	116	75	144	56	94	53	790
	2013/14	25	142	2	75	127	26	106	168	80	751
	2014/15	137	26	67	68	74	19	21	145	39	596
Sisak	2012/13	72	100	123	147	102	137	76	58	35	850
	2013/14	42	173	6	56	139	48	124	193	74	855
	2014/15	137	51	94	84	102	30	50	171	62	781
Varaždin	2012/13	109	108	54	122	128	113	62	96	60	852
	2013/14	22	215	7	49	139	10	105	109	118	774
	2014/15	97	46	63	76	95	16	21	165	79	658
Bijeljina	2012/13	52	62	5	58	63	74	28	182	57	581
	2013/14	62	69	4	31	36	73	83	252	67	677
	2014/15	56	13	76	58	63	74	28	182	57	607
Tuzla	2012/13	72	34	89	82	80	80	31	168	74	710
	2013/14	58	96	2	29	39	72	187	339	64	886
	2014/15	94	23	76	77	101	142	211	217	236	1177
Banja Luka	2012/13	88	78	146	94	116	89	63	120	54	848
	2013/14	68	156	1	52	74	91	214	218	97	971
	2014/15	117	42	83	111	91	79	54	118	61	756
Bihać	2012/13	130	166	193	169	221	160	88	98	73	1298
	2013/14	107	339	20	92	176	144	187	199	87	1351
	2014/15	189	101	97	61	70	139	218	225	295	1395

Precipitation in the October-June period in 2012/2013 were lower in the east-positioned Bijeljina, Osijek and Tuzla (average 656 mm) compared to the remaining five towns (average 928 mm), particularly in Bihać (1298 mm), while values of mean air-temperature ranged from 8.2 °C in Varaždin to 9.8 °C in Bijeljina. However, in the remaining six towns, mean air-temperature was higher with range from 8.9 °C to 9.5 °C. In that season, the highest yield in B&H is achieved (3.9 t ha⁻¹) or by 25 % higher compared to the decade (2001-2010) average (Table 1).

In general, the growing season 2014/2015 was the most suitable for wheat growing in Croatia compared to the previous two seasons, and very high average wheat yield achieved (Table 1), while in B&H excessive precipitation in some places (Tuzla 1177 mm and Bihać 1395 mm) probably led to reduced yields in B&H. For example, precipitation in the same period in Osijek, Bjelovar, Sisak and Varaždin was lower (Table 3). Regarding the temperature regime, in Tuzla was something colder (mean 9.0 °C) than in remaining towns (from 9.4 °C in Varaždin to 10.0 °C in Sisak). Weather conditions were more favorable for wheat growing particularly in the eastern part of Croatia. For this reason, average yields of wheat in some places in the east Croatia were about 8.0 t ha⁻¹ to more than 9 t ha⁻¹ (personal communication).

Table 4. Monthly values of mean air temperatures in eight selected sites in Croatia and B&H during winter wheat growing seasons 2012/2013 to 2014/2015

Locality	Year	Oct	Nov	Dec	Jan	Feb	Mar	Apr	May	June	Mean
----------	------	-----	-----	-----	-----	-----	-----	-----	-----	------	------

											(°C)
Osijek	2012/13	12.1	9.0	0.4	2.1	2.9	5.2	13.1	16.7	20.2	9.1
	2013/14	13.7	7.8	1.6	3.7	5.6	9.5	13.2	16.1	20.4	10.2
	2014/15	13.3	8.3	3.5	2.9	2.5	7.5	12.1	17.8	20.8	9.9
Bjelovar	2012/13	11.6	8.8	1.1	1.0	1.9	4.5	13.1	16.5	20.0	8.7
	2013/14	13.3	6.9	2.8	4.6	5.1	10.2	13.0	15.4	20.1	10.2
	2014/15	13.1	8.4	4.0	3.0	2.2	7.6	12.1	17.2	20.8	9.8
Sisak	2012/13	11.8	9.0	1.4	1.3	1.8	5.0	13.4	16.5	20.2	8.9
	2013/14	13.2	7.1	2.7	5.1	5.4	10.3	13.1	15.8	20.3	10.3
	2014/15	13.5	8.8	4.4	3.5	1.9	7.6	12.2	17.4	20.8	10.0
Varaždin	2012/13	11.2	8.6	1.2	0.8	0.9	3.5	12.2	15.7	19.4	8.2
	2013/14	13.1	6.9	2.6	4.3	4.9	9.3	12.7	15.0	19.3	9.8
	2014/15	13.3	8.6	3.8	3.2	1.7	6.7	11.4	16.4	19.8	9.4
Bijeljina	2012/13	13.0	10.0	1.0	3.0	3.6	6.2	13.2	17.1	20.7	9.8
	2013/14	13.7	8.1	1.6	4.5	5.8	9.5	13.1	16.1	20.8	10.4
	2014/15	13.0	8.7	3.9	3.0	3.6	6.2	13.2	17.1	20.7	9.9
Tuzla	2012/13	12.3	9.5	0.9	2.7	2.5	5.7	12.8	15.7	18.6	9.0
	2013/14	12.9	7.6	1.4	5.3	6.7	8.6	11.5	14.5	18.5	9.7
	2014/15	12.2	8.7	2.9	2.3	2.3	6.0	10.7	16.6	19.0	9.0
Banja Luka	2012/13	12.5	9.9	1.3	2.8	2.3	6.1	13.4	16.7	20.4	9.5
	2013/14	13.1	7.4	2.5	5.6	6.5	9.6	13.1	15.8	20.3	10.4
	2014/15	13.5	8.9	4.0	3.4	2.4	7.3	11.8	17.4	20.9	9.6
Bihać	2012/13	12.0	9.9	2.2	2.4	1.1	5.0	12.5	15.4	19.3	8.9
	2013/14	13.6	7.1	3.6	6.4	6.0	9.0	12.3	14.9	19.5	10.3
	2014/15	13.5	9.7	4.8	4.0	1.2	7.1	11.6	17.3	20.0	9.5

Conclusions

Great wheat yield variability was found, not only between countries, but also among three analyzed growing season. Yields of wheat in Croatia and B&H are under considerable impacts of weather characteristics, mainly precipitation and temperature regimes. In general, balanced monthly distribution as well as temperature regime without excessive cold or warm periods characterized favorable growing seasons, whereas precipitation deviations toward extremes in combination with the higher temperatures in the winter and/or spring are accompanied with the lower yields. The main cause of lower yields in 2014 for both countries was excessive precipitation in the period April-June, in some places also accompanied with floods. Generally, higher wheat yield is achieving in Croatia.

References

- Adams R. M., Hurd B. H., Lenhart S., Leary N. (1998). Effects of Global Climate Change on Agriculture: An Interpretative Review, *Climate Research*, 11, 19-30.
- Bertić I. (1987). Great Geographic Atlas of Yugoslavia. University Publisher Liber, Zagreb (in Croatian).
- CBS (2016): Crop production, 2015, Croatian Bureau of Statistics Zagreb, First release No 1.1.14.; 12 May 2016.
- Dencic S, Kastori R, Kobiljski B, Duggan B. (2000). Evaluation of grain yield and its components in wheat cultivars and land races under near optimal and drought conditions, *Euphytica* 113 (1), 43-52.
- FAO (2016): FAOSTAT database

- Gupta N.K., Gupta S., Kumar A. (2008). Effect of Water Stress on Physiological Attributes and their Relationship with Growth and Yield of Wheat Cultivars at Different Stages, *Journal of Agronomy and Crop Science* 186 (1), 55-62.
- IPCC (2007). *Climate Change 2007: Impacts, Adaptation and Vulnerability. Contribution of Working Group II to the Fourth Assessment Report of the Intergovernmental Panel on Climate Change*, M.L. Parry, O.F. Canziani, J.P. Palutikof, P.J. van der Linden and C.E. Hanson, Eds., Cambridge University Press, Cambridge, UK, 976pp. (https://www.ipcc.ch/pdf/assessment-report/ar4/wg2/ar4_wg2_full_report.pdf)
- Ijkić D., Kovačević V., Kovačević J., Lalić A., Drezner G. (2010). Weather impacts on yields of wheat and barley. In: *Proceedings of 45th Croatian and 5th International Symposium of Agriculture*, Opatija 15-19 February 2010 (Marić S. and Lončarić Z. Editors), Faculty of Agriculture in Osijek, p. 737-740.
- Jolankai M, Birkas M. (2013). Precipitation impacts on yield quantity and quality of wheat crop. In: *Proceedings of the 48th Croatian & 8th International Symposium on Agriculture* 17.-22. February 2013 Dubrovnik (Maric S. and Loncaric Z. Editors), Faculty of Agriculture, University J., J. Strossmayer in Osijek, p. 489-493.
- Kovacevic V., Kovacevic D., Pepo P., Markovic M. (2013). Climate change in Croatia, Serbia, Hungary and Bosnia and Herzegovina: comparison the 2010 and 2012 maize growing seasons. *Poljoprivreda / Agriculture*, 19 (2), 16-22.
- Majdancic M. Basic M., Salkic B., Kovacevic V., Rastija M., Jovic J. (2016). Weather conditions and yield of wheat in Bosnia and Herzegovina with emphasis on climatic change and Tuzla Canton. *Journal of Agriculture and Ecology Research International* 7(2), 1-9.
- Marijanovic M, Markulj A, Tkalec M., Jozic A, Kovacevic V. (2010). Impact of precipitation and temperature on wheat (*Triticum aestivum* L.) yields in eastern Croatia, *Acta Agriculturae Serbica* XV (29), 117-123.
- Pepo P, Kovacevic V. (2011). Regional analysis of winter wheat yields under different ecological conditions in Hungary and Croatia, *Acta Agronomica Hungarica* 59, 23–33.

REAL-TIME IRRIGATION SCHEDULING CHARTS FOR APPLE (*Malus domestica*) IN THE CENTRAL-EASTERN AREAS OF BOSNIA AND HERZEGOVINA

Sabrija ČADRO^{1*}, Jasminka ŽUROVEC¹, Mirjana RADOVIĆ²

¹Faculty of Agriculture and Food Sciences, University of Sarajevo, Bosnia and Herzegovina

²Faculty of Agriculture, University of East Sarajevo, Bosnia and Herzegovina

*Corresponding author: s.cadro@hotmail.com

Abstract

The majority of smallholders in Bosnia and Herzegovina (B&H), who are engaged in fruit production, have a lack of experience regarding irrigation in general. Irrigation systems are usually installed without proper guidelines, design, operation and maintenance practices and farmers are not familiar with scheduling techniques and proper management. This often results in poor irrigation efficiency and unsustainable production. Due to increasingly common transfer from extensive to intensive production systems and the increased frequency of drought periods, especially during the vegetation months, fruit producers in the central-eastern, hilly areas of B&H are becoming increasingly aware of the importance of irrigation. To resolve the previously mentioned issues, we propose a simple tool for real-time irrigation scheduling called *Irrigation Charts*. These charts are based on the *Food and Agriculture Organization* (FAO) methodology for computing crop water requirements, which considers crop characteristics, length of the growing season, soil properties and climate data (precipitation, temperature, humidity, insolation and wind speed). The charts for day-to-day apple irrigation guide the users how to adjust the irrigation interval to the actual weather conditions throughout the growing session. As the pilot study, irrigation charts for intensive apple production at the central-eastern hilly areas of B&H were developed by using climate data from four meteorological stations: Zenica, Sarajevo, Goražde and Foča. With Irrigation Charts, apple producers will be able to achieve better irrigation efficiency, better quality and quantity of yields, leading to a better and sustainable position in the local market.

Keywords: *Irrigation, Chart, Irrigation calendar, Scheduling, Apple.*

Introduction

The performance of apple in terms of crop yield, fruit size, fruit quality, storability, and long-term productivity are highly dependent on irrigation and irrigation management. Irrigation level and water status are known to affect yield and yield components: crop yield, fruit size and quality, growth habit, precocity, and long-term productivity (Steduto, et al., 2012).

To avoid crop water stress, the root zone depletion should not exceed the threshold value for no stress (lower limit). If so, the depletion will be larger than readily available water (RAW) and the crop will experience water stress. On the other hand, to avoid water losses, the soil water content in the root zone after an irrigation event should not exceed field capacity (upper limit). By altering the irrigation interval during the season, one is able to keep the root zone depletion between the lower and upper limit (Reas, et al., 2002).

In Bosnia and Herzegovina (B&H) agriculture is highly vulnerable to climate change. Higher temperatures and changes in precipitation are reducing crop yields and increasing the likelihood of short-term crop failures and long-term production declines (Žurovec, et al., 2015). The positive linear trend of soil moisture deficit that have recently had its record value (315 mm in 2012) was determined in central B&H, indicating the urgent need to start with climate change adaptation, otherwise, agriculture of the area and therefore the people engaged in it, will face significant negative consequences (Žurovec, Jasminka, et al., 2015).

Due to increasingly common transfer from extensive to intensive production systems and the increased frequency of drought periods, especially during the vegetation months, smallholder fruit producers in the central-eastern, hilly areas of B&H are becoming increasingly aware of the importance of irrigation. Due to the lack of experience, their irrigation systems are usually installed without proper guidelines, design, operation and maintenance practices and farmers are not familiar with scheduling techniques and proper management.

In this paper, we outline a methodology to develop, present and use irrigation scheduling charts (calendars) that give smallholder farmers simple guidelines on how to adjust their irrigation during the growing session to the actual weather conditions.

Irrigation charts are based on information concerning the actual weather conditions, local and technical aspects of the used irrigation systems and the crop response to water. The combination of all these information results in an irrigation calendar that is specific for a given location and adjustable to the actual weather conditions (Jabloun, et al., 2007).

Materials and methods

In this paper, tool for real-time irrigation scheduling called *Irrigation Charts* (Reas, et al., 2000; 2002; Jabloun, et al., 2007) was used to create apple irrigation calendars. These calendars are based on the *Food and Agriculture Organization* (FAO) methodology for computing crop water requirements (Allen, et al., 1998), which considers climate data, crop characteristics, length of the growing season and soil properties.

The development of irrigation calendars requires a good knowledge of the meteorological conditions of the region, especially the reference evapotranspiration (ET_o) levels that can be expected in a 10-day period.

The ET_o is derived from monthly climatic data of the central-eastern B&H by means of the FAO Penman-Monteith equation (Allen et al. 1998) using FAO *ET_oCalc* software. Irrigation calendars are created throughout a soil water balance technique using *CROPWAT* 8.0 (Smith, et al., 1994) software.

Apple varieties Idared (I) and Gala (G) are chosen for this research, which are frequently grown in the study area. The data on the lengths and start dates of vegetation periods were collected at producers' fields. Crop evapotranspiration (ET_c) is calculated by multiplying ET_o by K_c for certain apple growth stage. We used FAO crop coefficients for mature apple trees in intensive production, with active ground cover in the area with killing frosts (Allen et al., 1998).

To represent the meteorological conditions for the central-eastern hilly areas of B&H, we used the data from meteorological stations (MS) Zenica, Sarajevo, Goražde and Foča (Table 1), provided by *Federal Hydrometeorological and Republic Hydrometeorological Institute*.

Table 1. Location and length of time series for used meteorological stations (MS)

MS	Longitude	Latitude	Altitude	Used time series	No. of years
Zenica	17° 54'	44° 12'	344m.a.s.l	1966-2015	50
Sarajevo	18° 25'	43° 52'	630m.a.s.l	1966-2015	50
Goražde	18° 59'	43° 40'	345m.a.s.l	1972-91	20
Foča	18° 48'	43° 30'	260m.a.s.l	1962-63; 1986-90; 2006-2015	17

Rainfall and ET_o levels that are expected in 2 (2/10), 4 (4/10), 6 (6/10) and 8 (8/10) years out of 10, were statistically derived from the 10-day rainfall and ET_o records with the help of *RAINBOW* (Reas, et al., 1996) software. By combining various probability levels of ET_o and rainfall, four weather conditions are distinguished; hot weather conditions without any rainfall (2/10 ET_o and no rain), dry (4/10 ET_o and 8/10 rain), normal (mean ET_o and rain) and humid (6/10 ET_o and 2/10 rain) weather conditions.

The critical depletion or factor p is a function of the evaporation power of the atmosphere and it depends of ETo level. In this study, p was calculated based on methodology by Allen et al. (1998), for all four ETo levels.

Soil characteristics in the analyzed area are represented through available water content in one meterlayer amounting 200 mm of totally available water (TAW), which is in average 100 mm of RAW. At the beginning of the vegetation period, the soil water content is considered to be at field capacity (FC) as a result of a pre-irrigation or spring rainfall.

The charts are developed for drip irrigation, which is the most frequently used method of irrigation in intensive apple orchards in the central-eastern hilly areas of B&H.

For the design of apple irrigation scheduling charts, the application depth is considered as fixed. Fixed application depths in combination with a variable irrigation interval results in an efficient use of the irrigation water (Reas, et al., 2000). Since the net irrigation water requirement during the peak period at this area is about 7 mm/day, 70 m³/ha is selected as the net application depth in this study. The gross application depth, the irrigation depth applied by the producers, will be determined in an operation phase when irrigation efficiency at field level will be considered.

Results and discussion

The used crop coefficients (Kc_{ini} , Kc_{dev} , Kc_{mid} and Kc_{end}) and field collected data on length of the growing stages for four locations and two varieties are presented in table 2.

Table 2. Crop coefficients (Kc) and their starting dates for apple growth stages

Location	Variety	Kc for growth stage				Total (days)
		Kc_{ini}	Kc_{dev}	Kc_{mid}	Kc_{late}	
		0.5	0.5-1.2	1.2	1.2-0.95	
		Growth stage (date)				
Zenica	I	16.04.	01.05.	14.06.	16.09.	166
	G	09.03.	30.04.	24.05.	24.08.	175
Sarajevo	I	20.04.	04.05.	16.06.	19.09.	165
	G	10.03.	07.05.	31.05.	26.08.	176
Goražde	I	15.04.	28.04.	11.06.	13.09.	166
	G	08.03.	05.05.	29.05.	23.08.	172
Foča	I	14.04.	27.04.	10.06.	11.09.	165
	G	06.03.	04.05.	30.05.	21.08.	173

The designed irrigation schedule charts (calendars) consist of dependable rainfall graphs (Graph 1-4) and drip irrigation interval tables (Table 3-7). The charts present guidelines for adjusting the irrigation interval to the actual weather conditions for the specific apple varieties (I – Idared; G – Gala) and locations. For the irrigation charts to be used, it is necessary to daily monitor rainfall on field. Simple manual rain gauge can be used to measure rainfall on the field. In order to determine the actual weather conditions, farmer records the daily amounts of rainfall and creates a summarized decade rainfall, which is then compared with dependable rainfall for that decade on specific location (Graph 1-4). Depending on location, irrigation interval can be used from irrigation interval tables for the previously determined weather conditions (Table 3-7). The orchards should be irrigated according to the interval between two irrigations calculated in the table for the particular weather conditions until the end of that decade or change in weather conditions. In our case, the irrigation interval is the number of days between irrigations, which should settle the irrigation water requirements of 7 mm. The farmer should continue to monitor daily rainfall during the vegetation period and adjust irrigation interval based on actual weather conditions.

For MS Zenica, decade rainfall amounts expected during dry, normal and wet weather conditions are shown in Graph 1. Indicative irrigation intervals are given in Table 3, for the four considered weather conditions in a certain decade and for two apple varieties.

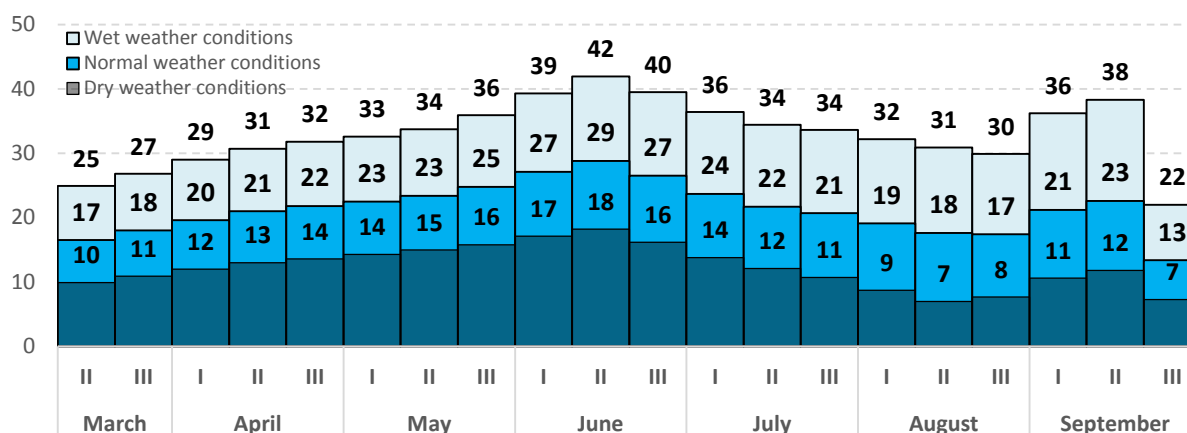

Graph 1. Dependable rainfall at Zenica MS (mm/decade)

Table 3. Apple, drip irrigation intervals for MS Zenica in days

	Month	March			April			May			June			July			August			September				
		Decade	I	II	III	I	II	III	I	II	III	I	II	III	I	II	III	I	II	III	I	II	III	
Gala	Hot + Dry									2														
	Dry													3	2	1		2						3
	Normal															2		3						5
	Wet																							5
Idared	Hot + Dry											3												
	Dry													5	2	1		2						3
	Normal															4		3						5
	Wet																							5

For the area of MS Sarajevo, dependable decade rainfall amounts are given in Graph 2, and irrigation intervals for Idared and Gala apple varieties in Table 4.

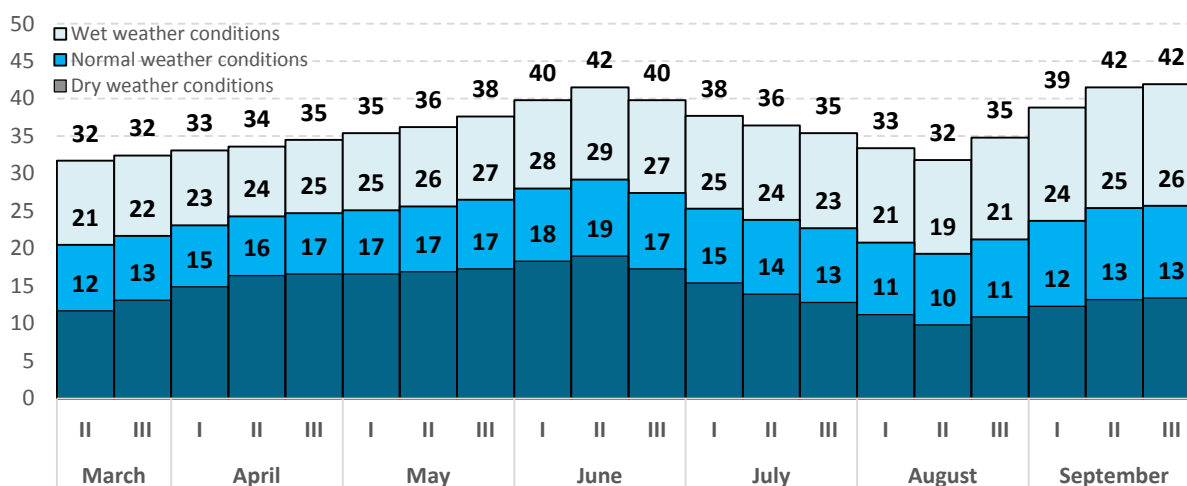

Graph 2. Dependable rainfall at MS Sarajevo (mm/decade)

Similar values of rainfall for dry, normal and wet weather conditions between MS Zenica (Graph 1) and Sarajevo (Graph 2) are determined.

The total length of growing periods of two analyzed apple varieties (Idared and Gala) are differentiated only by few days (165-176), while the growth stages (Table 2) vary sometimes

more than a month. As a result, significant differences in the need and intensity of irrigation between apple varieties are noticeable.

Table 4. Apple, drip irrigation intervals for MS Sarajevo in days

	Month	March			April			May			June			July			August			September					
	Decade	I	II	III	I	II	III	I	II	III	I	II	III	I	II	III	I	II	III	I	II	III			
Gala	Hot + Dry	3									1						2								
	Dry										5		2	1	2										
	Normal													5	2	3	4								
	Wet																								
Idared	Hot + Dry							10		2	1			2			5		2			5			
	Dry							3		2	1	2		3	4	3			4						
	Normal										3	2	3	6	10										
	Wet																								

For the area of MS Goražde, dependable decade rainfall amounts are given in Graph 3, and irrigation intervals in Table 5.

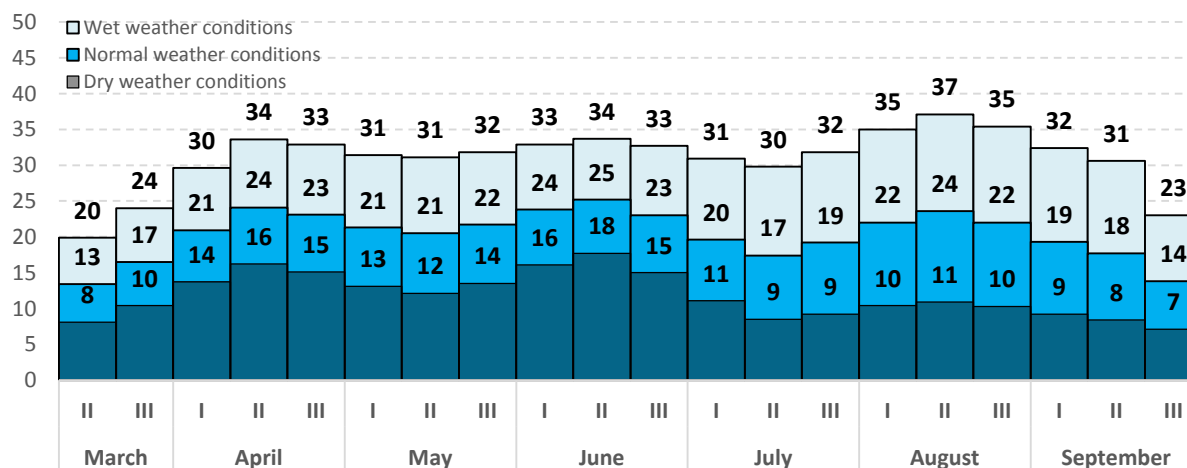

Graph 3. Dependable rainfall at MS Goražde (mm/decade)

Table 5. Apple, drip irrigation intervals for MS Goražde in days

	Month	March			April			May			June			July			August			September				
	Decade	I	II	III	I	II	III	I	II	III	I	II	III	I	II	III	I	II	III	I	II	III		
Gala	Hot + Dry	4									1						2							
	Dry										3		1	2										
	Normal													4	2	3								
	Wet													10	3	4	10							
Idared	Hot + Dry							2		1			2			4		2			4			
	Dry							2		1	2		3	4	2			8						
	Normal										5	2	1	2	3	4								
	Wet													5	10									

Compared to other MS rainfall for dry, normal and wet weather conditions at MS Foča are slightly lower, especially for August.

References

- Allen, R. G., Pereira, L. S., Raes, D. Smith, M. (1998): Crop Evapotranspiration Guidelines for Computing Crop Water Requirements, FAO Irrigation and Drainage Paper, No. 56, Rome.
- Jabloun, M., Sahli, A. (2007) Chart for Monitoring Wheat Irrigation in Real Time. National Agronomic Institute of Tunisia.
- Reas, D., Sahli, A., Van Looij, J., Ben Mechlia, N., Persoons, E. (2000) Charts for Guiding Irrigation in Real Time. *Irrigation and Dreingae systems* 14: 343-352.
- Reas, D., Smith, M., De Nys, E., Holvoet, K., Makarau, A. (2002) Charts with Indicative Irrigation Intervals for Various Waether Conditions. Irrigation Advisoty Services and Perticipatory Extension in Irrigation Management. Workshop organised by FAO – ICID. Montreal, Canada.
- Raes, D. Mallants, D. & Song, Z. 1996. RAINBOW – software package for analysing hydrologic data. In W.R. Blain (ed.) *Hydraulic Engineering Software VI*. ComputationalMechanics Publications, Southampton, Boston: 525–534.
- Smith, M. (1992): CROPWAT a Computer Program for Irrigation Planning and Management, FAO Irrigation and Drainage Paper, No. 46, Rome.
- Steduto, P., Hsiao, T., C., Fereres, E., Reas, D. (2012) Crop Yield Response to Water. *Irrigation and Drainage Paper*, No. 66, Food and Agriculture Organization of the United Nations, Rome.
- Žurovec Jasminka, Čadro, S. (2015) Temporal Drought And Soil Moisture Variability In The Arable Land Of Spreča Valley. 26th International Scientific expert Conference in Agriculture and Food Industry, Sarajevo.
- Žurovec, O., Vedeld, P.O., Sitaula, B.K. (2015) Agricultural Sector of Bosnia and Herzegovina and Climate Change—Challenges and Opportunities. *Agriculture* 2015, 5, 245-266; doi:10.3390/agriculture5020245.

EFFECT OF LIMING OF THE CONTENT OF TOTAL SUGARS, TITRATABLE ACIDS AND pH IN DIFFERENT WINE GRAPE VARIETIES

Krasimir TRENDAFILOV, Mladen ALMALIEV*

Agricultural University-Plovdiv, Bulgaria

*Corresponding author: mladenalmaliev@abv.bg

Abstract

In a two-year field experiment, the effect of liming with $\text{Ca}(\text{OH})_2$ was studied at rates of 1; 2,5 and 5 t/ha on the content of total sugars, titratable acidity and pH in the grapes of varieties Sauvignon Blanc, Chardonnay, Cabernet Sauvignon and Merlot, planted on Chromic luvisols in the land of Mezek village, Svilengrad municipality, Bulgaria. The grapes of all varieties were studied immediately after harvest in technological maturity, simultaneously with the mass harvesting of the variety in the vineyards, where was the lime experiment. Generally in the white varieties, liming causes increase in the level of total sugars. Relatively stable is the tendency to reduce the content of titratable acids, simultaneously with increase of the lime rate. During the second year, increase in the content of total sugars and reduction of the level of titratable acids in the white varieties was found only in the highest applied ameliorative lime rate of 5 t/ha. Liming affects technological indicators of the grapes mainly in the white studied varieties and causes an increase in the content of total sugars and reduce the titratable acidity.

Key words: *Liming, Wine grape varieties, Sugars, Titratable acids*

Introduction

The creation of large vineyards in the wide area of Sakar mountain in southeastern Bulgaria in recent years, and the fact, that the most of them not only entered in active fruiting, but also established themselves as brands of the wine market, has led to expansion of the vineyards area, as a result were planted and areas with limited suitability for this type of production. The soil in these terrains are usually located on hilly areas, which as a result of erosion, there is too wide variety of their properties. This affects the depth of the soil profile, soil texture, amount and type of skeletal materials and their distribution in the depth of the soil profile and other factors with significant impact on the quality of the vineyards. In fact, the diversity of the region in regard to the following characteristics is its essential feature and defines its individuality.

The soil acidity, considered in this context also characterized by very wide variety of the elements, which determining them.

The concept of the chemical amelioration of the vineyards, in the research area must be built precisely on the requirement to provide minimum sufficient calcium and magnesium levels in the soil, which are necessary to overcome the deficit of them as nutrients and ions, defining the point and sustainability of acid-alkaline balance in the soil (Totev and Palaveev, 1979).

The practice of planting large part of modern plantations of vineyards in the country on genetically acid soils, the proven in recent years unfavorable affect of the soil acidity of on the quality of wine grapes (Soyer et al., 1995) and higher requirements of the modern and most often introduced pad combinations to the soil quality (Roberto, et al., 1991) resumed the actuality of this task, and its technological complexity called the need to test new chemical meliorants for liming.

Materials and methods

The studies have been conducted in a two-year field experiment in vineyards in Mezek village, Svilengrad municipality, Bulgaria. The the experiment was set by the method of Shanin, 1965, as in the distribution of the variants was included control variant without fertilization and liming, variant without liming, but with combined nitrogen, phosphorus and potassium fertilization, and three increasing rates of liming with hydrated lime (BS EN 459-1 CL 90-S) - 1, 2,5 and 5 t/ha.

The content of CaO in the used by us hydrated lime, determined after reaction of the starting material with HCl and a subsequent titration with NaOH, at bromtimolblau indicator was 94%. Each variants was in three repetitions. The experiment was set after the end of the third vegetation. All varieties included in the study were planted on the pad Berlandieri X Riparia, selection Openhaim 4 (SO4). Meliorants were applied in the period from August to September. One month after liming were applied phosphorus and potassium fertilizers, in the form respectively of triple superphosphate and potassium sulphate, and nitrogen fertilizer in the form of NH_4NO_3 was applied in February, before the next vegetation.

The grapes of the four varieties were studied immediately after harvest in technological maturity, simultaneously with the mass harvesting of the variety in the vineyards, where was the lime experiment.

Harvested grapes was analyzed to determine the content of total sugars (BDS 7169:1989), titratable acids in the grapes (fresh weight) were analyzed titrimetrically with NaOH in indicator phenolphthalein and pH in grapes of wine varieties.

Results and discussion

The effect of liming on the content of total sugars, titratable acidity and pH of the grapes was studied. The data are shown in Table 1. The effect of the factor "liming" on the main technological indicators of the grapes was evaluated by ANOVA of replications, formed for each of the studied four varieties. In the role of factor variables are set the year of sampling (first and second) and the applicable rate of liming (0, 1, 2,5 and 5 t/ha).

The liming has a proven effect on the content of total sugars and titratable acids, but did not affect the pH of the grapes of variety Chardonnay. The impact on the amount of the sugars increased on average by about 1,5-2% total for limed varieties, as the effect was tangible in high lime rates – 2,5 and 5 t/ha. As a result of liming, the titratable acids decreased from 6 to about 3 mg/l by increasing the rate of the ameliorant, as dependence was with characteristics approaching to linear. Proven differences between the measurements in two consecutive years of measurement were not found.

In the variety Sauvignon Blanc, statistically proven differences between limed variants and the variants without liming were not found in terms of the three studied indicators. There is a tendency to increase the content of total sugars, but the tendency is disturbed by the result, obtained by applying the rate of 2,5 t/ha lime material, which found lower sugar content compared to the control variant without liming. If excluded this value, the difference between limed variants and the variants without liming becomes essential.

In the variety Merlot, the average content of total sugars content is increased with increase of the lime rate, but the titratable acidity and pH of the grapes reduced. These tendencies are prominent, but the differences between limed variants and the variants without liming indicators were not statistically proven under the criteria of the set level of guarantee probability of 95%.

In the variety Cabernet Sauvignon, in the variants with liming was found statistically proven lower levels of total sugars, compared with the control variant. The difference was on average less than 1% between limed variants and the variants without liming. Liming did not lead to proven differences in terms of titratable acidity and pH of the grapes for this variety.

Table 1. Contents of total sugars [%], titratable acids [mg] and pH of the grapes of varieties Chardonnay, Sauvignon Blanc, Merlot and Cabernet Sauvignon, depends on the liming rate with hydrated lime

Year	Direction of growth	Variety	Hydrated lime (t/ha)	Total sugars %	Titratable acids (mg)	pH (grape)
1	2	3	4	5	6	7
1	White	Chardonnay		21.6	7.41	3.57
			1	21.4	6.76	3.20
			2.5	24.1	4.37	3.60
			5	23.6	3.82	3.50
		Sauvignon Blanc		21.9	5.52	3.67
			1	23.4	5.72	3.90
			2.5	22.0	7.57	4.40
	Red	Cabernet Sauvignon		24.0	5.25	4.43
			1	22.3	5.28	4.10
			2.5	20.9	5.93	4.40
			5	22.2	5.84	4.30
		Merlot		25.0	5.51	3.93
			1	24.9	5.22	3.50
			2.5	26.3	5.61	4.30
	5	26.9	4.77	4.20		
2	White	Chardonnay		21.2	7.36	3.50
			1	20.4	6.49	3.20
			2.5	22.5	4.85	3.50
			5	21.9	3.80	3.20
		Sauvignon Blanc		21.5	5.39	3.57
			1	22.5	5.63	3.60
			2.5	20.9	7.28	4.30
		5	23.1	5.74	3.40	
	Red	Cabernet Sauvignon		23.3	5.66	4.23
			1	20.9	5.23	4.10
			2.5	20.4	5.53	4.10
			5	21.6	5.16	4.10
		Merlot		24.6	6.04	3.80
			1	24.9	5.42	3.60
2.5			24.3	5.58	4.00	
	5	26.1	4.14	4.00		

The contradictory results, obtained about the effect of the liming on the composition of the grapes, assessed separately for each of the studied varieties gave us the idea to analyze the effect of conducted liming on a more generalized samples, as unite white and red varieties and apply the same model of variance single factor analysis at a level of guarantee probability of 95%, however separate the replications, formed by the two years of sampling.

The results can be summarized as follows:

Overall in white varieties liming in the specified level of significance, caused proven increase in the level of total sugars, as in the control variant without liming was average 21,75%, in liming at rate of 1 t/ha – 22,40%, and in higher rates reached respectively 23,05 and 24,2%. The effect on the titratable acidity and pH of the grapes was unproven at the specified level of significance.

During the second year, increase in the content of total sugars and decrease of the level of titratable acidity in white varieties was found only at the highest applied ameliorative lime rate of 5 t/ha. In the other variants with lower lime rates applied did not affect the studied indicators of the grapes.

Proven effect of liming on the indicators, characterizing the composition of the grapes in the red varieties was not found, as well in the first and in the second year of the study.

The unbalanced application of high rates of calcium containing ameliorants in the soils, characterized by strong deficit of bases in exchange easily mobile exchangeable form in the complex can lead to higher than optimum ratio between the two elements in the foliage. The application of calcium containing ameliorants increases the degree of heterogeneity of the calcium content in the foliage. The reason for it is probably due to positional inaccessibility of the lime materials in the soil.

The increased rate of absorption of Ca in the foliage of the vines leads to increase the intensity of the entrance of magnesium, independently, that its level in the soil did not change. (Valcheva and Trendafilov, 2015), which lead to proven change in the technological indicators of the grape, mainly in the white studied varieties.

Conclusions

Overall in white varieties liming caused proven increase in the level of total sugars, as in the control variant without liming was average 21,75%, in liming at rate of 1 t/ha – 22,40%, and in higher rates reached respectively 23,05 and 24,2%. The effect on the titratable acidity and pH of the grapes was unproven at the specified level of significance.

Liming affects technological indicators of the grapes mainly in the white studied varieties and causes an increase in the content of total sugars and reduce the titratable acidity. In red varieties proven dependencies in this direction was not found.

Relatively stable is the tendency to reduce the content of titratable acids, simultaneously with increase of the lime rate.

During the second year, increase in the content of total sugars and reduction of the level of titratable acids in the white varieties was found only in the highest applied ameliorative lime rate of 5 t/ha.

References

- BDS 7169/89 Products of Processed fruit and vegetables. Determination of sugars content, № 59
- Roberto L. M., Junquera, B., Gonzales-Sanjose, M.L., Barron, R. (1991), Biochemical events during ripening of grape berries, Italian Journal of Food Science, 3, 3:173-180
- Soyer J.P., Molot C., Barbier J. (1995), Fertilization potassium, distribution of cations and acids in the compartments of the bay and acidity of the wine. Oenology 95, 5th International Symposium dOenologie, Coordinator Lonvaud-Funel, A., Univ. Bordeaux TEC-DOC, Pp 19-23
- Shanin, (1965), Methodology of the field experiment., Published by Bulgarian Sciences Academy, Book, Sofia
- Totev, T., Palaveev, T. (1979), Acidity of the soils and agrochemical methods for its removal, Sofia, Page 59

Valcheva V., K. Trendafilov, S. Todorova, M. Almaliev, (2015), Influence of liming with different forms of calcium on the content of calcium and magnesium in the foliage of wine grape varieties, International Conference, Soil and agricultural technology in a changing world, Institute of soil science, agricultural technology and plants protection "Nikola Poushkarov" May 11 to 15, Sofia, electronic publication

DETERMINATION OF NUTRITIONAL CONTENT OF SOME SILAGE CORN VARIETIES IN TERMS OF ANIMAL FEED POTENTIAL

Bilal KESKİN*, Süleyman TEMEL, Barış EREN, Bahattin KARAKUŞ

Iğdir University, Faculty of Agriculture, Department of Agronomy, Iğdir, Turkey

*Corresponding author: bilalkeskin66@yahoo.com

Abstract

This research was conducted to compare feed quality characteristics of some silage corn varieties in the irrigated experimental field of the Agricultural Research and Application Center of Iğdir University in 2015. In research, ten silage corn varieties were established according to randomized complete blocks experimental design with three replications. CP (Crude protein), NDF (Neutral Detergent Fiber), ADF (Acid Detergent Fiber) ADL (Acid Detergent Lignin), DMD (Dry matter digestibility), DE (Digestible energy), ME (Metabolizable energy), DMI (Dry matter intake), and RFV (Relative feed value) of corn varieties were determined and results varied significantly between varieties. According to results following values were found for different varieties: CP 8.72% (OSSK-602) with 5.98% (HİDO), NDF 52.18% (OSSK-644) with 39.51% (TK-6060), ADF 23.37% (HİDO) with 14.72% (72 MAY 80), ADL 3.71% (OSSK-602) with 1.57% (TK 6063), DMD 74.55% (72 MAY 80) with 66.83% (HİDO), DE 3.46 Mcal kg⁻¹ (72 MAY 80) with 3.13 Mcal kg⁻¹ (HİDO), ME 2.84 Mcal kg⁻¹ (72 MAY 80) with 2.57 Mcal kg⁻¹ (HİDO), DMI 3.04% (TK 6060) with 2.30% (OSSK 644) and RFV 62.18% (TK 6060) with 56.80% (HİDO). According to these results OSSK-602, 72MAY80, Shemall and RX-9292 varieties have been found to be most suitable varieties for this area and animal feed.

Key Words: *Silage corn, nutrient content, animal feed.*

Introduction

When compared with the developed countries, low proportions of areas cultivated with fodder crops within the field crop production in Turkey together with erroneous management of pastures that does not follow proper pasture management principles and lack of improvement in pasture areas, have resulted in an increase in the gap between the amount of coarse fodder demanded by farms and the amount of produced coarse fodder. This has resulted in improper nutrition of animals. The demand for quality coarse fodder is especially high in Turkey during winters. Because of this science people and producers have been looking for alternatives which can give much higher yields of feedstuff per unit area cultivated with fodder crops. Corn is an advantageous plant, which has been gaining importance throughout the World as well as in Turkey, for overcoming this gap in coarse fodder production, since it produces higher amounts of green material per unit area, has higher amount of calories and since it is suitable for silage production and mechanized agriculture (Kılıç, 1986; Ayaz et al., 2013).

Besides its usage in human nutrition and in various industries, increasing preference of Corn (*Zea mays* L.) plant as a source of silage material in animal nutrition has resulted in an increase in corn farming and corn production amounts both in Turkey and in the World. As of today, the total corn cultivation area around the World totals to 183 Million hectares and the total amount of silage corn produced is 1.008 Million tons. Meanwhile, total cultivation area of fodder crops among all cultivated field crops in Turkey 1.862.758 hectares and the share of corn cultivated areas within the total is 22.71%, which amounts to 423.123 hectares. Total amount of silage corn produced from this area is 19.7 Million tons (Anonymous, 2015a).

As known, silage is the process of acetifying fresh or wilted plant material containing humidity, dry matter and soluble carbohydrates through lactic acid fermentation under anaerobic conditions. Properly prepared silage feed conserves a great proportion of the nutritional value of the green plants and provides a succulent feed material for the animals during winters. Although silage can be made with many feed material and low-quality grass, plants with high carbohydrate content are preferred. Thus, the quality of silage is closely related to nutritional content rather than morphological and physiological characteristics of the produced feedstuff. Suitability of the content of feedstuff for silage production is determined through chemical analyses.

The aim of this research was to determine the nutritional content of 10 silage corn varieties for animal nutrition produced under the conditions of Iğdir province (Turkey).

Material and Methods

The research was conducted in experimental field of the Agricultural Research and Application Center of the Iğdir University in 2015. Ten (10) corn varieties (72 MAY 80, OSSK-644, TK-6063, OSSK-596, TK-6060, HİDO, RX- 9292, 71 MAY 69, SHEMALL, OSSK-602) were used in the research. Varying climatic conditions of Iğdir Province, where the research was carried out, during 6 months in 2015 are given in Table 1. According to Table 1, monthly average amount of precipitation is 30 mm, monthly average temperature is 23.2°C and monthly average relative humidity ratio is 44.2. Trial area is classified as clay-loamy soil, highly-alkaline (pH: 8.6), lightly saline (EC: 1.37 dS/m), low in organic matter (1.20%) and rich in lime content (CaCO₃: %22.27). Moreover, available phosphorus and potassium contents of the soil are determined as 51.7 ppm and 852.4, respectively (Erdogan, 2013).

Table 1. Some Climatic Features of Iğdir Province in 2015 (Anonymous, 2015b)

Months	Monthly Total Precipitation (mm)	Monthly Average Temperatures (°C)	Monthly Average Relative Humidity (%)
March	52.0	11.0	50.8
April	44.1	16.4	47.7
May	41.5	21.3	52.9
June	27.8	28.5	40.0
July	0.3	31.8	33.6
August	14.3	30.2	40.7
Average	30	23,2	44,2

The research was established according to randomized complete blocks experimental design with three replications. Seeds were sown on 04.04.2015 by hand using markers with 70 cm row spacing and 15 cm intra-row spacing distance. Each parcel area in the study was set as 17.5 m² (5 m x 3.5 m). 80 kg/ha N and 80 kg/ha P₂O₅ phosphorus was applied at the sowing and an additional amount of 80 kg/ha N fertilizer was applied when the plants reached 50 cm of height.

Moisture content of the soil was regularly measured with soil moisture measurement device and the plants were started to be irrigated only after 50% of the available field moisture capacity was utilized. Irrigation was carried out by sprinklers until the plants reached a height of 40-50 cm, and by furrows thereafter. Hoeing and weed prevention were carried out when the plants reached 10-20 cm of height, and hoeing and middlebreaking were conducted with the second application of nitrogen when the plants reached 40-50 cm of height. Harvest was

carried out on 09.07.2015 and all plant samples taken from each parcel were first weighed fresh, then kept out in the open air for a while and then dried in a drying oven set at 70°C until their weights were stabilized. After drying, grass samples were ground in order to enable them to pass through 1 mm sieve and feed samples were readied for quality analyses (CP, NDF, ADF, ADL, DMD, DE, ME, DMI and RFV).

Nitrogen (N) content of the samples of used materials was determined using Kjeldahl Method and obtained %N values were multiplied by 6.25 coefficients to determine CP (Crude Protein) content (AOAC, 1990). NDF (Neutral Detergent Fiber), ADF (Acid Detergent Fiber) and ADL (Acid Detergent Lignin) contents, on the other hand, were determined by the method suggested by Van Soest et al. (1991).

Dry Matter Digestibility (DMD) was determined using the formula $(DMD (\%) = 88.9 - (0.779 \times \% ADF))$ suggested by Oddy et al. (1983). DMD values were used in the regression equation $(DE = 0.27 + 0.0428 \times DMD)$ developed by Fannesbeck et al. (1984) to determine DE (Digestible Energy) values. After this, Metabolizable Energy (ME) was calculated using the formula $(ME = 0.821 \times DE)$ developed by Khalil et al. (1986). Dry-Matter Intake (DMI) and Relative Feed Value (RFV) were found using the equations suggested by Sheaffer et al., (1995) $(DMI = 120/NDF)$ and $RFV = [DMD \times DMI]/1.29$, respectively).

The data were exposed to GLM (General Linear Models) with SPSS (version 20) on the basis of main effects. Mean separation were performed by using Duncan test.

Results and Discussion

CP (Crude protein) (%)

CP ratios were varied significantly between the varieties. CP ratios of corn varieties varied between 5.98 and 8.72 and were found to be statistically significant. The highest CP ratios were observed in OSSK 602 (8.72%) and SHEMALL (8.09%) while the lowest were seen in HİDO (5.98%) variety. In a study conducted by Erdal et al. (2009), the highest and the lowest CP ratios for different varieties were determined as 8.2% and 7.4%, respectively. In another study, average CP ratios of corn plants were reported to be varying between 5.5% and 8.1% (Akdeniz et al., 2004). All these results are in parallel to our findings.

CP is particularly important in silage corn production. CP must not be lower than 7.0% in silage corn. In our research carried out under the ecological conditions of Iğdir, it was observed that CP ratios of all corn varieties studied were over 7.0%.

NDF (Neutral Detergent Fiber), ADF (Acid Detergent Fiber) and ADL (Acid Detergent Lignin) (%)

High contents of NDF, ADF and ADL ratios in fodder crops adversely affect the quality and, thus, preference of the feedstuff. Presence of these structures also decreases the digestibility of the crop. Because of these reasons, it is known that NDF, ADF and ADL are undesired structures in fodder crops (Temel et al., 2015). NDF, ADF and ADL ratios of 10 corn varieties tried under Iğdir conditions were varied between 39.51-52.18%, 14.72-23.37% and 1.57-3.71%, respectively and significant differences were observed among varieties. The highest NDF ratio was measured in TK 6060 (39.51%) variety. The lowest ADF ratios were observed in 72 MAY 80 (14.72%) and TK 6060 (15.06%) varieties. The lowest ADL ratio was 1.57% and was observed in TK 6063 variety. In many studies conducted under different ecologies, NDF, ADF and ADL ratios of the investigated plants were reported to show significant differences and it was explained that these differences may be a result of different genotypes. NDF, ADF and ADL ratios of different varieties are reported to be varying between 38.2-46.0%, 28.3-37.7% and 8.03-15.1%, respectively (Canbolat and Karaman, 2009), 46.6-55.9%, 24.9-32.6% and 6.3-8.1%, respectively (Canbolat, 2012), 44.4-59.5%, 26.3-31.5% and 2.6-5.0%, respectively (Ergul et al. 2001). In addition, it was reported that the

NDF content for corn plant is determined as 53.2%, while ADF ratio is 30.1% and ADL ratio 6.3% (Canbolat, 2012).

Table 2. CP, NDF, ADF, ADL, and DMD Ratios of Investigated Corn Varieties According to Dry-Matter Content

Varieties	CP (%)	NDF (%)	ADF (%)	ADL (%)	DMD (%)
72 MAY 80	7,38 ab	45,43 ab	14,72 e	2,28 bc	77.0 a
OSSK 644	7.39 ab	52,18 a	19,96 abc	2,59 b	73.0 ab
TK 6063	6,08 b	44,73 ab	22,19 ab	1,57 c	71.0 b
OSSK 596	7,69 ab	47,57 ab	18,89 bcd	2,12 bc	73.3 ab
TK 6060	7,10 ab	39,51 b	15,06 e	1,89 bc	77.0 a
HİDO	5,98 b	46,69 ab	23,37 a	2,61 b	70.3 b
RX 9292	7,19 ab	44,27 ab	17,38 cde	2,34 bc	75.0 ab
71 MAY 69	6,74 ab	49,31 ab	18,86 bcd	2,29 bc	73.6 ab
SHEMALL	8,09 ab	45,79 ab	15,62 de	2,15 bc	76.6 a
OSSK 602	8,72 a	49,29 ab	20,96 abc	3,71 a	72.0 ab
Mean	7,23	46,47	18,70	2,35	73.8

* Values indicated with different letters are significantly different at $P < 0,05$

DMD (Dry matter digestibility) (%)

DMD (Dry matter digestibility) values were determined to differ significantly between corn varieties. DMD ratios of the varieties were ranged between 70.3% and 77.0%. The highest DMD ratio was observed in 72MAY80 variety with 77.0% while the lowest was determined in HİDO variety with 70.3%. As known, DMD values are calculated based on ADF contents of the feedstuff. As it can be seen in Table 2, ADF contents were varied among corn varieties and thus the differences in DMD ratios is thought to be a reflection of this variation. In other research conducted with different forage species, DMD ratios were determined as 76.6-87.3% (Ergül et al. 2001), 59.5-66.8% (Canbolat and Karman, 2009) and 63.6-69.5% (Canbolat, 2012).

DE (Digestible energy) and ME (Metabolizable energy) (Mcal kg⁻¹)

Significant differences were observed among DE (Digestible Energy) and ME (Metabolizable Energy) values of varieties studied in the trial. Looking at Table 3, it can be seen that DE and ME values of corn varieties ranged between 3.13-3.46 and 2.87-2.84 Mcal kg⁻¹, respectively. The highest DE and ME amounts were observed in 72MAY80 variety as 3.46 and 2.86 Mcal kg⁻¹, respectively while the lowest DE and ME amounts were detected in HİDO variety as 3.13 and 2.57 Mcal kg⁻¹, respectively. In other studies conducted with different fodder crops ME amounts were reported to vary between 9.3-11.1 Mcal kg⁻¹ (Canbolat ve Karaman, 2009), 9.1-10.9 Mcal kg⁻¹ (Canbolat, 2012) and 10.22-11.08 Mcal kg⁻¹ (Metcalf et al. 2008).

DMI (Dry matter intake) (%)

Dry Matter Intake (DMI) ratios of corn varieties were observed to vary between 2.30% and 3.04%. Statistical comparisons among means showed that the highest DMI ratio was detected in TK 6060 variety with 3.04% while the lowest ratios were seen in OSSK 644, OSSK 602 and 71 MAY 69 varieties with 2.30%, 2.45% and 2.46%, respectively.

RFV (Relative feed value)

Relative Feed Values (RFVs) of the corn varieties investigated in the study were varied between 131.3 and 182.0. According to the results of Duncan Multiple Range Test which was conducted to determine the differences between RFVs of corn varieties, the highest RFV of 182.0 was measured in TK 6060 variety while the lowest value of 131.3 was detected in OSSK-644 variety (Table 3). Considering together with Table 2, it can be seen that varieties with higher content of cell wall components as NDF, ADF and ADL, which make digestion difficult, have lower RFVs and RFVs of such varieties are negatively influenced by presence of higher amounts of such components. However, since RFVs of all investigated varieties found to be over 100, it was determined that all feed obtained from these varieties are of high quality. In other studies conducted in different regions with different plants RFVs are found to be ranging from 120.3-159.9 (Canbolat and Karaman, 2009), 105.8-138.7 (Canbolat, 2012), and 75.6-119.5 (Jahansouz et al. 2014).

Table 3. DE, ME, DMI and RFV Ratios of Corn Varieties

Varieties	DE (Mcal kg ⁻¹)	ME (Mcal kg ⁻¹)	DMI (%)	RFV
72 MAY 80	3,46 a	2,84 a	2,64 ab	158,3 b
OSSK 644	3,27 cd	2,68 cd	2,30 b	131,3 c
TK 6063	3,17 de	2,60 de	2,73 ab	152,3 bc
OSSK 596	3,31 bc	2,72 bc	2,52 ab	144,3 bc
TK 6060	3,44 ab	2,82 ab	3,04 a	182,0 a
HİDO	3,13 e	2,57 e	2,58 ab	141,8 bc
RX 9292	3,36 abc	2,76 abc	2,74 ab	160,3 b
71 MAY 69	3,30 c	2,71 c	2,46 b	142,3 bc
SHEMALL	3,44 ab	2,82 ab	2,63 ab	156,3 b
OSSK 602	3,26 cd	2,68 cd	2,45 b	138,0 bc
Mean	3,31	2,72	2,61	150,69

* Values indicated with different letters are significantly different at P<0,05.

Conclusion

Some nutritional values of 10 corn varieties, which are widely-sowing, those are important for animal nutrition, were determined with this research. In addition to productivity per unit area values of the varieties, knowledge of nutritional (quality) characteristics and selection of fodder crops to-be-produced in different regions according to these criteria is very important for animal nutrition.

According to the findings of the study, when Crude Protein (CP), which is one of the most important quality characteristics for animal nutrition, considered, OSSK-602 variety should be preferred. For many other nutritional characteristics (NDF, ADF, ADL, DMD, DE, ME, DMI and RFV) TK-6060, 72MAY80, SHEMALL and RX-9292 varieties are determined to be more preferable than other species.

References

- Akdeniz, H., Yılmaz, İ., Andıç, N and Ş. Zorer, (2004). A Study on Yield and Forage Values of Some Corn Cultivars. YYÜ, Ziraat Fakültesi, Tarım Bilimleri Dergisi (J. Agric. Sci.) 14 (1): 47-51.
- Anonymous, (2015a). Turkey Statistical Institute, Crop Production Statistics. <http://tuikapp.tuik.gov.tr/bitkiselapp/bitkisel.zul>. (Date of access: 16. June 2016).
- Anonymous, (2015b). Iğdir Regional Directorate of Meteorology data.
- AOAC (1990). Official Method of Analysis. 15th. edn. Association of Official Analytical Chemist, Washington, DC. USA.
- Ayaz, M., Özpınar, H., Yaman, S., Acar, A., Aksu, Y., Yavrutürk, Y., Niksarlı İnal, F., Aksu, S., Aygün, Y. (2013). Analysing Yield and Quality Characteristics of Silage Maize

- Cultivars Which are Used Commonly or may be Usefor Main Crop. Harran TarımveGıdaBilimleriDergisi, 17:(1-11).
- Canbolat, O., (2012). Comparison of *in vitro* Gas Production, Organic Matter Digestibility, Relative Feed Value and Metabolizable Energy Contents of Some Cereal Forages. KafkasUniv Vet FakDerg 18 (4): 571-577.
- Canbolat, O., Karaman, S., (2009). Comparison of *in Vitro* Gas Production, Organic Matter Digestibility, Relative Feed Value and Metabolizable Energy Contents of Some Legume Forages. TarımBilimleriDergisi 15(2) 188-195.
- Erdal, Ş., Pamukçu, M., Ekiz, H., Soysal, M., Savur, O., Toros, A. (2009). The Determination of Yield and Quality Traits of Some Candidate Silage Maize Hybrids. Akdeniz ÜniversitesiZiraatFakültesiDergisi, 22(1), 75-81.
- Erdogan, H. E. (2013). Soil Identification Guide. ISBN: 978-605-4672-20-2.
- Ergül, M., Alçiçek, A., Ayhan, V., Kılıç, A., Özkul, H., Basmacıoğlu, H., Karaayvaz, K., (2001). Feeding Value and Ensilage Possibility of Poultry Litter with Some Feed Resources I: Feeding Value and Ensilage Possibility of Sugar Beet Pulp with Broiler Litter. Ege Üniv. ZiraatFak. Derg., 2001, 38 (1).
- Fonnesbeck PV, Clark DH, Garret WN, Speth CF, (1984). Predicting energy utilization from alfalfa hay from the Western Region. Proc. American Animal Science, 35: 305 - 308.
- Jahansouz, M.R., Afshar, R.K., Heidari, H., Hashemi, M. (2014). Evaluation of Yield and Quality of Sorghum and Millet as Alternative Forage Crops to Corn under Normal and Deficit Irrigation Regimes. Jordan Journal of Agricultural Sciences, 10 (3):699-715.
- Khalil JK, Sawaya WN, Hyder SZ, (1986). Nutrient composition of Atriplex leaves grown in Saudi Arabia. Journal of Range Management, 39: 104-107.
- Kılıç, A., (1986). Silo Feed (Teaching, Learning and Practice Recommendations), BilgehanBasımevi, Bornova-İzmir, 327 s.
- Metcalf, J. A., Mansbridge, R. J., Blake, J. S., Oldham, J. D., Newbold, J. R., (2008). The efficiency of conversion of metabolisable protein into milk true protein over a range of metabolisable protein intakes. Animal 2(8): 1193-1202.
- Oddy VH, Robards GE, Low SG, (1983). Prediction of *in vivo* dry matter digestibility from the fiber nitrogen content of a feed. In: Robards, G.E., Packham, R.G. (Eds.), Feed Information and Animal Production. Commonwealth Agricultural Bureaux, Farnham Royal, UK, pp. 395-398.
- Sheaffer CC, Peterson MA, Mccalin M, Volene JJ, Cherney JH, Johnson KD, Woodward WT, Viands DR, (1995). Acide Detergent Fiber, Neutral Detergent Fiber Concentration and Relative Feed Value. North American Alfalfa İmprovement Conference, Minneapolis.
- SPSS, Inc., (1991). Statistical package for the social sciences (SPSS/PC+). Chicago, IL.
- Temel, S., Keskin, B., Yıldız, V., Kır, A. E. (2015). Investigation of Dry Hay Yield and Quality Characteristics of Common Vetch (*Vicia sativa* L.) Cultivars for in Iğdir Plain Download Conditions. Iğdir Univ. J. Inst. Sci. & Tech. 5(3): 67-76.
- Van Soest PJ, Robertson JD, Lewis BA, (1991). Methods for diatery fibre, neutral detergent fibre and non-starch polysaccharides in relation to animals nutrition. Journal of Dairy Science, 74: 3583-3597.

GROWTH AND PRODUCTIVITY OF LEMON VERBENA (*Aloysia triphylla* L.) AS AFFECTED BY IRRIGATION IN CENTRAL GREECE: FIRST YEAR (ESTABLISHMENT) RESULTS

Konstantinos MARTINOS^{*}, Elpiniki SKOUFOGIANNI, Nicholas G. DANALATOS

Laboratory of Agronomy and Applied Crop Physiology, Department of Agriculture, Crop Production and Rural Environment, University of Thessaly, Volos, Greece

^{*}Corresponding author: kmartin@agr.uth.gr

Abstract

The first-year of a lemon verbena (*Aloysia triphylla* L.) crop's growth and productivity as affected by irrigation was investigated under field conditions in central Greece. In April 2015, winter cuttings of lemon verbena were transplanted to an experimental field installed in Nea Aghialos, Magnesia, central Greece. The experimental design was a completely randomized design with three drip irrigation levels (0, 50, and 100% of potential evapotranspiration) in four replications. The growth and final productivity of the crop was measured in three destructive samplings of the crop during the summer of 2015. The results demonstrated the paramount effects of irrigation on lemon verbena productivity and final yield already in the first year of crop establishment.

Keywords: *lemon verbena, irrigation, growth, evapotranspiration.*

Introduction

Lemon verbena, (syn.: *Aloysia citriodora* A. *citrodora* Palau, *A. triphylla*, *Lippia citriodora* L. *triphylla*) is an evergreen perennial aromatic plant. It likes warm moist conditions with plenty of sunlight. When exposed to frost, it becomes deciduous. belongs to the Verbenaceae family. The genus *Lippia* (Verbenaceae) brings together about 200 species and lemon verbena is native in Latin America as well as North Africa (Morocco), and was introduced to Europe during the 17th century (Carnat et al., 1999; Botta, 1979; Rotman and Mulgura Romero, 1999). Lemon verbena is an aromatic perennial shrub that is valued for its medicinal use (as a tea or tincture) as a digestive aid, antimicrobial, antispasmodic, analgesic, diuretic plant; besides, it is used as a treatment for cold, insomnia and anxiety (Botta, 1979; Carnat et al., 1999; Rotman and Mulgura Romero, 1999). Antioxidant and antibacterial qualities of *Aloysia citriodora* have been found in its essential oil, tea and tincture (Bilia et al., 2008; Cowan, 1999; Pereira and Meireles, 2007; Ohno et al., 2003; Sartoratto et al., 2004). This aromatic plant has a widespread market in the western world (Di Leo Lira, et al., 2013), its compounds have widespread uses in foods, cosmetics and household products (Catalan and Lampasona, 2002; Santos-Gomes et al., 2005). The essential oil contained in the plant and its leaves are used in the perfume industry and the production of flavored beverages and food preparations (Pascual, Slowing, Caretero, Mara, & Villar, 2001). In the United States, lemon verbena is listed in Generally Regarded As Safe (GRAS) for human consumption in alcoholic beverages (Gomes, Oliveira, Vicente, & Ferreira, 2006). Whereas very low researches have been applied on enhancement of medicinal plants production, presenting the appropriate planting methods is very important for increasing the quantity and quality of medicinal plants (Farooqi & Sreeramu, 2001). The purpose of trading production of medicinal plants is obtaining further amount of biomass in area (Nematian, Dalvandi, & Shariati, 2014). In view of the commercial value of lemon verbena, and considering that plants can display significant genetic biodiversity and variations in their morpho type due to differences in the edaphic or climatic conditions of their habitat (Molina et al., 2003), it is very important that these factors are studied and somehow controlled to ensure better yields.

The purpose of this study was to evaluate the effect of nitrogen fertilization on the growth parameters of a lemon verbena crop.

Materials and methods

Crop establishment

The experiment was set up in the rural area of Nea Aghialos in Central Greece (39°16'02.3"N 22°47'47.5"E) on May 5, 2015. The soil of the experimental plots was a sandy loam one with a pH of 6.8 and an organic carbon (C) of 1.5 g kg⁻¹. Lemon verbena cuttings (40 days old) were obtained from a local nursery. The soil was prepared and divided into plots; each of them was 4,2 m \times 2,4 m and contained three drip rows. The cuttings were transplanted on May 5. Distance between plants and distance between rows were both 60 cm. Twelve plots containing a total of 216 plants were arranged in a completely randomized design with irrigation being the main factor and nitrogen fertilization the factor split into sub-plots. Each experimental unit consisted of three rows of plants, 0.6 m apart, with the two outer rows serving as buffers while plants were spaced at 60 cm apart.

Fertilization

A nitrogen dressing was manually applied (100 kg ha⁻¹) in the form of a urea fertilizer on June 9 of 2015.

Irrigation

The amount of irrigation water was equal to 0% (rainfed – 110 mm), 50% (281 mm) and 100% (562 mm) of the recorded evaporation values of a class-A pan. Irrigation water was applied by drip irrigation system and the irrigation interval was seven days. Surface drip irrigation system consists of an irrigation pump connected to sand and screen filter and a hydraulic fertilizer injection pump was used. The actual water discharge rate was 8 L h⁻¹ along the drip lines. Weed control was carried out via application of a polyethylene transpiring mulch as this material has demonstrated a 100% efficiency in weed control among other tested mulches according to Hoeberechts et al (2004).

Harvesting and Drying

Harvests (destructive samplings) were carried on transplant – May 5, June 29, July 29 and finally August 28. Two plants per plot were harvested and all aerial parts of the plants were cut 10 cm above ground and the following growth parameters were determined: plant height, fresh weight of leaves/plant and fresh weight of stem/plant. LAI was measured via destructive methods using a calliper. The same parameters were determined after drying plant material in dark storage rooms on specially designed shelves. This method of drying was chosen as it is the method most commercial growers in Greece actually use. The results of the three final harvests are demonstrated in this paper.

Statistical analysis

All recorded values of this experiment were statistically analyzed using analysis of variance through the Genstat Program. Means were compared using revised L.S.D. test at 0.05 levels. The first harvest was not subjected to analysis of variance due to extensive rainfall during June.

Results and discussion

During the second harvest (29/07/2015) none of the variables were significantly affected by irrigation volume. During the third and final harvest (28/08/2015) irrigation volume significantly increased LAI and dry leaf yield (Figure 1, 2). LAI means were 0.72, 1.47, 1.98 (Figure 2) and dry leaf yields were 0.87, 1.34 and 1.9 t ha⁻¹ (Figure 1) for treatments I1, I2 and I3 respectively. Plant height remained unaffected by irrigation volume throughout the experiment. The LSD test showed that dry leaf yields of treatment I3 differed greatly than the rest during the final harvest (Table 1). Moreover the LSD test showed differences between all

irrigation volumes regarding LAI during the final harvest. Finally, an interesting effect of water deficiency was that plants started shedding leaves after the second harvest and LAI was lower at the time of the third and final harvest while leaf color shifted to yellow.

Figure 1 Dry leaf yield (t ha⁻¹) means grouped by irrigation volume during the experiment.

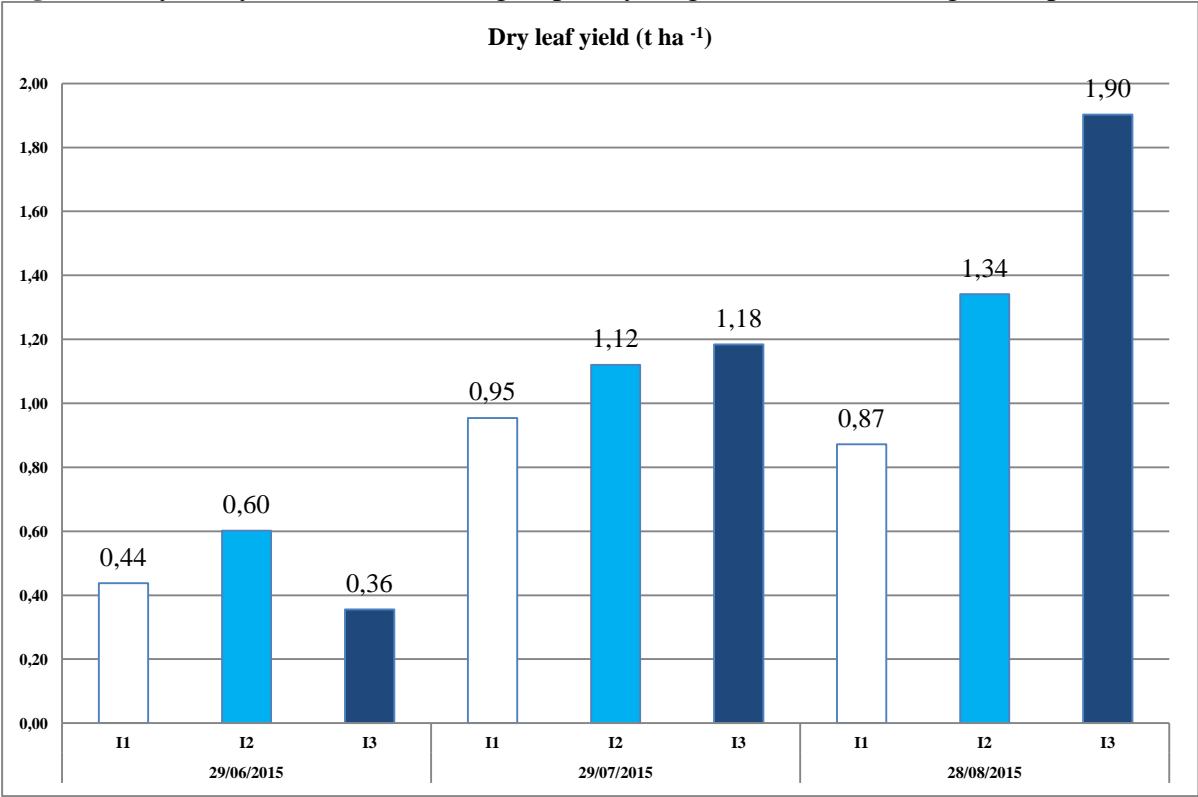

Figure 2 LAI (leaf area index) means grouped by irrigation volume during the experiment.

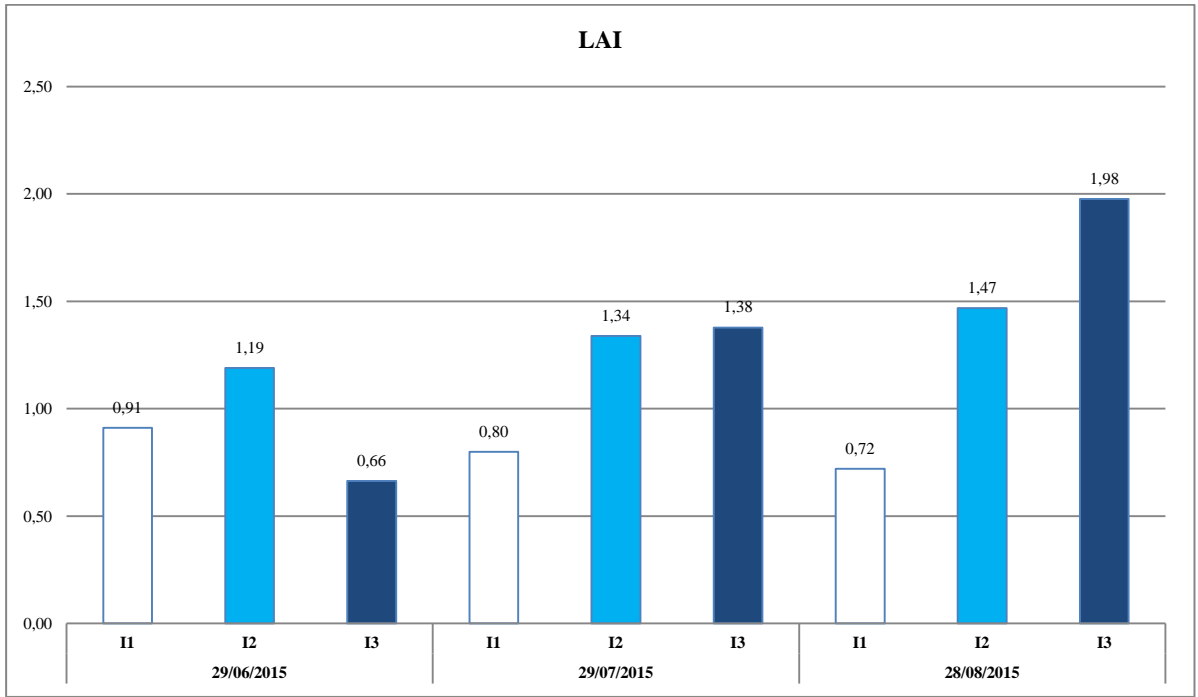

Table 1. Means of vegetative growth data of lemon verbena as affected by different irrigation volumes during the experimental season.

Harvest date	Nitrogen treatment	Plant height (m)	LAI	Dry stem yield (t ha ⁻¹)	Dry leaf yield (t ha ⁻¹)
29/06/2015	I1	0,49	0,91	0,21	0,44
	I2	0,52	1,19	0,31	0,60
	I3	0,51	0,66	0,17	0,36
29/07/2015	I1	0,88a	0,80a	0,77a	0,95a
	I2	0,87a	1,44a	0,92a	1,12a
	I3	1,01a	1,38a	0,98a	1,18a
28/08/2015	I1	0,98a	0,87a	1,34a	0,87a
	I2	1,06a	1,47b	1,83a	1,34a
	I3	0,99a	1,98c	2,19a	1,90b

Conclusions

During the establishment year of the, irrigation had a significant effect on plant growth. Future experiments for consecutive growing seasons and in different soil types are recommended in order to assess the prospects of lemon verbena cultivation in Greece and the possible financial interest of the crop. It seems that water is a vital input for lemon verbena crops in central Greece as lack of it leads to a smaller vegetative period. As water becomes scarce in the Mediterranean and nitrogen fertilization is always a cost for producers, these inputs should be carefully calculated in terms of sustainability and cost efficiency.

References

- Bilia, A., Giomi, M., Innocenti, M., Gallori, S., & Vincieri, F. (2008). HPLC-DAD-ESI-MS analysis of the constituents of aqueous preparations of verbena and lemon verbena and evaluation of the antioxidant activity. *Journal of Pharmaceutical and Biomedical Analysis* (46), 463-470.
- Botta, S. (1979). Las especies argentinas del genero *Aloysia* (Argentine species of the genus *Aloysia*) (Verbenaceae). *Darwiniana* (22), 67-108.
- Carnat, A., Carnat, A., Fraisse, D., & Lamaison, J. L. (1999). The aromatic and polyphenolic composition of lemon verbena tea. *Fitoterapia* (70), 44-49.
- Catalan C.A.N., Lampasona P.D. (2002). The chemistry of the genus *Lippia* (Verbenaceae). In S.E. Kintzios, (ed.) *Oregano: The genera Origanum and Lippia*, Taylor and Francis; London, 127-149.
- Cowan, M. (1999). Plant products as antimicrobial agents. *Clinical Microbiology Reviews* (12), 564-582
- Di Leo Lira, P., van Baren, C., Lopez, S., Molina, A., Heit, C., Vitturo, C., et al. (2013). Northwestern Argentina: a center of genetic diversity of lemon verbena (*Aloysia citriodora* PALÁU, Verbenaceae). *Chem Biodivers*, 2 (10), 251-261.
- Molina G.E., Belarbi E.H., Ación Fernández F.G., Robles Medina A., Yusuf Chisti, (2003). Recovery of microalgal biomass and metabolites: process options and economics, *Biotechnology Advances*, 20 (7-8), 491-515.
- Farooqi, A.A. and Sreeramulu, B.S., (2001), *Cultivation of Medicinal and Aromatic Crops*, University Press (India) Ltd., Hyderabad, India.
- Gomes, P., Oliveira, H., Vicente, A., & Ferreira, M. (2006). Production, transformation and essential oils composition of leaves and stems of lemon verbena [*Aloysia triphylla* (L'Herit.) Britton] grown in Portugal. *Rev. Bras. Pl. Med.* (8), 130-135.

- Hoeberechts, J., Nicola, S. and Fontana, E. (2004). Growth of lavender (*Lavandula officinalis*) and rosemary (*Rosmarinus officinalis*) in response to different mulches. *Acta Hort.* 629, 245-251.
- Nematian, A., Dalvandi, G., & Shariati, M. (2014). Effect of planting density and sowing date on the essential oil content and composition of lemon verbena (*Lippia citriodora*). *Int. J. Biosci.* , 2 (5), 56-63.
- Ohno, T., Kita, M., Yamaoka, Y., Imamura, S., Yamamoto, T., Mitsufuji, S., et al. (2003). Antimicrobial activity of essential oils against *Helicobacter pylori*. *Helicobacter* (8), 207-215.
- Pascual, M., Slowing, K., Caretero, E., Mara, K., & Villar, A. (2001). *Lippia*: Traditional uses, chemistry and pharmacology. A Review. *J. Ethnopharmacol* (76), 201-214.
- Pereira, C., & Meireles, M. (2007). Evaluation of global yield, composition, antioxidant activity and cost of manufacturing of extracts from lemon verbena (*Aloysia triphylla* [L'herit.] Britton) and mango (*Mangifera indica* L.) leaves. *Journal of Food Process Engineering* (30), 150-173.
- Rotman, A., & Mulgura de Romero, M. (1999). *Verbenaceae*. *Flora del Valle de Lerma* (5), 1-37.
- Santos-Gomes, P., Fernandes-Ferreira, M., & Vicente, A. (2005). Composition of the volatile oils from flowers and leaves of Vervain (*Aloysia triphylla* (L'Herit.) Britton) grown in Portugal. *J. Essent. Oil Res.* (17), 73-78.
- Sartoratto, A., Machado, A., Delarmelina, C., Figueira, G., Duarte, M., & Rehder, V. (2004). Composition and antimicrobial activity of essential oils from aromatic plants used in Brazil. *Brazilian Journal of Microbiology* (35), 275-280.

A STUDY OF THE EFFECTS OF DIFFERENT BIO-FERTILIZERS AND AMMONIUM PHOSPHATE LEVELS ON THE YIELD OF SUNFLOWER

Morteza BARMAKI*

Department of Agriculture and Natural Resources, University of Mohaghegh Ardabili, Ardabil, Iran.

*Corresponding author: barmakimorteza@gmail.com

Abstract

Sunflower (*Helianthus annuus* L.) is one of the main crops producing the oil requirements of the Iran. This experiment was conducted in Ardabil plain to study the effects of different biological and chemical nutrition systems on Sunflower (Sanbro cultivars) yield, in 2013. A factorial field experiment in a randomized complete block design with three replications was done. The first factor was ammonium phosphate levels (zero, 150 and 300 kg ha⁻¹) and the second factor was seed inoculation with Mycorrhiza (*Glomus etanicatum*), Azotobacter, Mycorrhiza plus Azotobacter as bio-fertilizer and control without any bio-fertilizers. The results showed that grain and oil yield of sunflower were significantly affected by ammonium phosphate levels and biofertilizers as well. Also, there were interaction effects between ammonium phosphate levels and bio-fertilizer types on oil percentage and oil yield. Applying the highest levels of ammonium phosphate (300 kg ha⁻¹) had the maximum grain yield (4584.1 kg ha⁻¹) and the minimum (2708.3 kg ha⁻¹) was obtained from control. The application of mycorrhiza as bio-fertilizer on grain yield of sunflower was more effective than Azotobacter and increased it to more than 500 kg ha⁻¹. Means comparison of interaction effects between Ammonium phosphate and bio-fertilizer showed that combination use of 300 kg ha⁻¹ of ammonium phosphate with both types of bio-fertilizers compared to control without any fertilizers could triple the oil yield.

Keywords: *Sunflower, Bio-fertilizer, Chemicals, Yield, Ardabil*

Introduction

Sunflower (*Helianthus annuus* L.) is one of the main suggested oil crops to solve edible vegetable oil shortage in the world that seeds contain 24-49% of oil and the cake contains 25-35% of protein (Henen, 2011). In Iran, sunflower is also one of the main crops producing the oil requirements of the country. It has an important position in crop rotation system of many Iranian farmlands so achieving a sustainable system for sunflower cultivation would be of great value in agricultural management in the region. Overuse of different chemical fertilizers is one of the causes for the degradation of environment and soil. Bio fertilizers are the newest and most technically advanced way of supplying mineral nutrients to crops. Compared to chemical fertilizers, their supply nutrient for plant needs, minimizes leaching, and therefore improves fertilizer use efficiency (SeyedSharifi, 2009). Bio-fertilizers play vital role for increasing the number of microorganisms and accelerate certain microbial process in plants which can change the available form of many nutrients for crops (Abou-Khadrah *et al.*, 2000). Bio-fertilizers such as Azotobacter, have a positive effect on growth, yield and yield component of many crops. Fertilizer management is one of the most important factors in successful cultivation of crops affecting yield quality and quantity (Tahmasbi *et al.*, 2011). Phosphorus and nitrogen are essential elements required in sunflower cropping which can significantly affect seed yield and oil content (Zubillaga *et al.*, 2002). The symbiosis of plant roots with mycorrhizal fungi is known to be one of the most ancient and widespread plant strategies to enhance nutrient acquisition and to cope with environmental stress (Brachmann and Parniske, 2006). The intra-radical mycelium of these soil fungi proliferates in the root

cortex of the host plant. Extra radical Mycorrhizal fungi hyphae spread in the soil around the root and provide the surface area by which the mycorrhizal fungi absorbs nutritional elements such as phosphorus (P), nitrogen (N), zinc (Zn) or copper (Cu) for transport and transfer to the host plant (Smith and Read, 2008). Therefore this study was designed to evaluate the influence of a biofertilizers containing Azotobacter and Mycorrhiza (*Glumus etanicatum*) in addition to Ammonium phosphate levels on sunflower cropping in the region of Ardabi, north west of Iran.

Materials and methods

This experiment was conducted in Ardabil plain on the research field of University of Mohaghegh Ardabili (Iran), with longitude of 48°15' and latitude of 38°15' and cold semi-arid climate (Emberger method) to study the effects of different biological and chemical nutrition systems on Sunflower (Sanbro cultivars), in 2013. A factorial field experiment was done in a randomized complete block design with three replications. The first factor was Ammonium phosphate levels (zero, 150 and 300 kg ha⁻¹) mixed with the soil before planting, and the second factor was seed inoculation with Mycorrhiza (*Glumus etanicatum*), Azotobacter, Mycorrhiza plus Azotobacter as bio-fertilizer and control without any bio-fertilizers. There were 5 rows with 6 meters long in any of 27 plots with 0.6 m row spacing. At maturity, two outer rows for each plot, 50 cm from each end of the plots, were left as borders and the middle 4 m² of the three central rows were harvested. Seeds oil was determined by Sucsilate machine. Then oil yield was determined by following formula:

Oil yield= % oil × seed yield

All data were subjected to analysis of variance (ANOVA) and differences among treatment means were tested by Duncan's multiple range test (at $P \leq 0.05$) using MSTAT-C software.

Results and discussion

The results showed that grain and oil yield of sunflower were significantly affected by ammonium phosphate levels and biofertilizers as well. Also, there were interaction effects between ammonium phosphate levels and bio-fertilizer types on oil percentage and oil yield (table 1).

Applying the highest levels of ammonium phosphate (300 kg ha⁻¹) had the maximum grain yield (4584.1 kg ha⁻¹) and the minimum (2708.3 kg ha⁻¹) was obtained from control (table 2). Soleimani (2008) reported that application of nitrogen fertilizer increased grain yield of safflower. The positive effect of phosphorus fertilizer on the yield of sunflower by Zubillaga *et al.* (2002) have been reported.

The application of mycorrhiza as bio-fertilizer on grain yield of sunflower was more effective than Azetobacter and increased it to more than 500 kg ha⁻¹(table 3). Soleimanzadeh *et al.* (2010) has stated that application of mycorrhiza had an appropriate performance and could increase grain yield and oil production of sunflower to an acceptable level, so it could be considered as a suitable substitute for chemical phosphorus fertilizer in organic agricultural systems.

Means comparison of interaction effects between ammonium phosphate and bio-fertilizer showed that combination use of 300 kg ha⁻¹ of ammonium phosphate with both types of bio-fertilizers compared to control without any fertilizers could triple the oil yield (table 4). Ekin (2010) reports that application of chemical fertilizer with bio-fertilizer in sunflower cropping was more profitable than single usage. Observation of sunflower oil percentage in means comparison didn't show a clear trend.

Table 1. Analysis of variance for Grain yield, oil yield and Oil percentage of sunflower under application of Ammonium phosphate levels and bio-fertilizers

Dependent variable	Df	Independent variable (mean square)		
		Grain yield	Oil percentage	Oil yield
Replication	2	1860141/2	3/69	278278/9
Ammonium phosphate (A.P.)	2	7964055/8**	16/75	1763210/9**
Bio-fertilizers (B.F.)	2	3141735/0**	6/67	736313/1**
(A.P.) * (B.F.)	4	653907/5	20/60*	80519/7*
Error	16	294788/5	5/72	27460/7

*and ** show significant difference at 5 and 1%, respectively

Table 2: Effect of Ammonium phosphate levels on grain yield of sunflower

Ammonium phosphate level (kg ha ⁻¹)	Grain yield(kg ha ⁻¹)
0	2708.3 c
150	3521.0 b
300	4584.1 a

Means with the same letters are not significantly different (Duncan's multiple range test)

Table 3: Effect of bio-fertilizer types on grain yield of sunflower

Bio-fertilizer type	Grain yield(kg ha ⁻¹)
Mycorrhiza	4164.7 a
Azotobacter	3661.4 b
Control	2887.2 c

Means with the same letters are not significantly different (Duncan's multiple range test)

Table 4: Interaction effects between Ammonium phosphate levels and bio-fertilizer types on oil percentage and oil yield of sunflower

Ammonium phosphate level (kg ha ⁻¹)	Bio-fertilizer type	Oil percentage	Oil yield
0	Mycorrhiza	40.82 bc	1586.2 bc
	Azotobacter	43.55 ab	1250.3 d
	Control	41.85 abc	612.3 e
150	Mycorrhiza	42.13 abc	1522.5 bc
	Azotobacter	38.21 c	1403.7 cd
	Control	41.84 abc	1325.1 cd
300	Mycorrhiza	44.78 a	2203.5 a
	Azotobacter	45.11 a	2008.2 a
	Control	39.50 bc	1462 b

Means with the same letters in each column are not significantly different (Duncan's multiple range test)

Conclusion

This research emphasizes the dominant role of chemicals with nitrogen and phosphorus in oil crops production. Using mycorrhiza and Azotobacter as bio-fertilizers with ammonium phosphate can increase the sunflower quantity and quality characteristics specially the oil yield. Biofertilizers are very safe because they do not pollute the environment. They can be very functional in sustainable agriculture.

References

- Brachmann, A., Parniske, M., 2006. The most important symbiosis on earth. *Soil Biol.* Vol. 4, No.7: 239.
- Ekin, Z. 2010. Performance of phosphate solubilizing bacteria for improving growth and yield of sunflower (*Helianthus annuus* L.) in the presence of phosphorus fertilizer. *African Journal of Biotechnology* Vol. 9, No.25: 3794-3800.
- Henen, M.E. 2011. Response of some sunflower to water stress and biofertilization. Ph.D. Thesis (unpublished), Fac. of Agric. Saba Basha, Alex. Univ.
- SeyedSharifi, R., 2009. *Industrial Plants*. University of Mohaghegh Ardabili and Amidi press. 422 pp.
- Smith, S.E., Read, D.J., 2008. *Mycorrhizal Symbioses*, third ed. Academic Press, UK. 803pp.
- Soleimanzadeh, H., Habibi, D., Ardakani, M.R., Paknejad, F., Rejali, F. 2010. Response of sunflower (*Helianthus annuus* L.) to inoculation with Azotobacter under different nitrogen levels. *American- Eurasian J. Agric. & Environ. Sci.* Vol.7, No.3: 265-268.
- Soleimanzadeh, H., 2010, Effect of VA-Mycorrhiza on growth and yield of sunflower (*Helianthus annuus* L.) at different phosphorus levels, *International Journal of Biological, Biomolecular, Agricultural, Food and Biotechnological Engineering* Vol:4, No:11, 2010.
- Tahmasbi, D., Zarghami, R., Azghandi, A.V., Chaichi, M. 2011. Effects of nanosilver and nitroxin biofertilizer on yield and yield components of potato minitubers. *Int. J. Agric. Biol.*, Vol. 13, No. 6: 986–990.
- Zubillaga, M.M., Aristi, J.P., Lavado, R.S. 2002. Effect of phosphorus and nitrogen fertilization on sunflower (*Helianthus annuus* L.) nitrogen uptake and yield. *J. Argon. Crop Sci.* Vol. 188: 267-274.

THE INFLUENCE OF COLD STORAGE ON SOME QUALITY TRAITS OF CARROT CULTIVARS

Marek GAJEWSKI^{1*}, Olga SOBOCIŃSKA¹, Marta PUDZIANOWSKA¹, Monika SITAREK,¹ Anna SEREDA²

¹ Warsaw University of Life Sciences - SGGW, Warszawa, Poland

² SVZ Tomaszów Lubelski, Poland

*Corresponding author: marek_gajewski@sggw.pl

Abstract

The objective of the study was to determine quality changes for different carrot cultivars during 5-month cold storage. Seven popular carrot cultivars were investigated: ‘Abledo’ F₁, ‘Bastia’ F₁, ‘Karotan’, ‘Kazan’ F₁, ‘Sirkana’ F₁, ‘Trafford’ F₁ and ‘Warmia’. The observations were performed in monthly regime, from mid-October (harvest time) till mid-March, i.e. in five terms. The roots were stored at the temperature of 0-1°C and RH 98%. The following items were determined: nitrate (NO₃), soluble solids (°Brix) and β-carotene contents, juice colour in CIE L*a* b* system. The results showed that soluble solids content differed among the cultivars and the highest content was characteristic to ‘Kazan’, followed by ‘Bastia’. Generally, an increase of soluble solids content during storage was observed. Nitrate content in the roots was generally on a low level and during the storage the content showed a decreasing tendency, but related to the cultivars. The lowest nitrate content showed ‘Abledo’, ‘Bastia’, ‘Karotan’ and ‘Sirkana’, and the highest content was found in ‘Trafford’. The β-carotene content in the roots showed small decreasing tendency during storage, but after 3 months small increase was observed. The highest content was found in ‘Abledo’ and ‘Kazan’. The L* (lightness) and a* (redness) decreased during storage, however at the end of storage small increase of a* parameter was observed. The highest a* was characteristic to ‘Kazan’ and ‘Karotan’. The b* (yellowness) decreased during storage, however at the end of storage small increase of the b* was observed. The highest b* value was noted for ‘Kazan’. The cultivar was characterized also by very high β-carotene and soluble solids contents, low content of nitrate and high a* and b* parameters. ‘Karotan’ was also very good in this respect.

Keywords: *carrot, cultivars, cold storage, quality*

Introduction

Carrot (*Daucus carota* L.) is an important vegetable crop, consumed during the whole-year period, in fresh or processed form. High biological value of carrot is mainly due to the presence of carotenoid compounds in the roots. The main carotenoid in carrots are α-carotene and β-carotene, which account for more than 90% of their total content (Mayer-Miebach and Spiess 2003). Carotenoid content is highly differentiated among carrot cultivars and ranges usually from 4 to 25 mg 100 g⁻¹ f.w. (Rubatzky et al,1999). According to Skrede et al. (1997) and Seroczyńska et al. (2006), high carotenoid content in resulted in more reddish and darker colour of plant flesh tissue.

Soluble sugars are the main storage compounds in carrots. They account for 34-70% of dry weight of the roots. Sucrose is the predominant sugar in the roots at their full maturity, and the amount reaches 3.6% f.w. Growing method or storage conditions affect the content of sugars in carrots (Lee 1986, Seljasen et al. 2001, Gajewski et al. 2007).

Carrot roots are prone to nitrate accumulation during the vegetation. Nitrate accumulation by vegetable plants is of high importance to a consumer due to potential negative influence on health. According to the Joint FAO/WHO Expert Committee on Food Additives, the acceptable daily intake of nitrate (NO₃) is on the level of 3.7 mg/kg of body weight per day, what is the equivalent to 222 mg of nitrate per day for adult of 60 kg of body weight (Santamaria 2005). Several factors which affect nitrate accumulation in different plants, including fertilization, environmental conditions and harvest date, were investigated by several authors (Gutezeit and Fink 1999, Santamaria 2005, Kona 2006).

Storage conditions are among the main factors influencing degradation of carrots quality during postharvest (Seljasen, 2001). Mature carrots can be stored in regular cold stores for 4–6 months, depending on the cultivar and roots initial quality. Recommended storage conditions for carrots are: temperature of 0–1°C and 95–98% RH (Brecht, 2003). According to Kidmose et al. (2004) and Koca and Karadeniz (2008), carotenoid content in carrot roots is little affected by storage. Sometimes even an increase of carotenoid content is observed (Kopas-Lane and Warthesen 1995). According to Suojala (2000) an increase of hexoses and decrease of sucrose contents take place during storage of carrots.

The objective of the study was to determine quality changes for popular 7 cultivars of carrot during 5-month storage in a cold store, at recommended thermal and humidity conditions. In the study we determined following quality traits: soluble solids (°Bx), nitrate (NO₃), β-carotene contents, as well as juice colour parameters in CIE L*a*b* system.

Material and Methods

In the study 7 carrots cultivars, listed below, were investigated. Carrot roots were obtained from a farm localized in Tomaszów Lubelski region (south-east part of Poland). The plants were grown in humus-rich black soil on ridges and fertilized with standard doses of NPK fertilizers. Harvest time of the roots was mid-October.

Characteristics of the cultivars (data provided by Rijk Zwaan seed company): ‘Abledo’ F₁ - cultivar with long, conical-shaped root, of high carotenoid, sugars and soluble solids contents. Good for making juice and for freezing. Shows low tendency to nitrate accumulation and is resistant to diseases of the leaves. ‘Bastia’ F₁ - a new cultivar, of conical-shaped roots, intensive roots colour and of high content of sugars and soluble solids. The cultivar is recommended for juice production and freezing. ‘Karotan’ – cultivar in ‘Flakkee’ type, high content of carotenoid, sugars and dry matter, and low tendency to nitrate accumulation. Standard cultivar for processing industry. ‘Kazan’ F₁ - cultivar of slightly conical root shape. Roots of dark orange colour, with unpronounced core. Resistant to fungi diseases and good for freezing. ‘Sirkana’ F₁ - cultivar in ‘Nantes’ type, roots of intensive orange colour. Resistant to diseases of leaves. Good for production of juice and shredded roots. ‘Trafford’ F₁ - cultivar in ‘Flakkee’ type. High content of sugars and soluble solids. Long roots, of intensive orange colour. Good for freezing and juice production. ‘Warmia’ - cultivar in ‘Flakkee’ type, with high content of sugars and soluble solids. Resistant to leaves diseases caused by *Alternaria* sp. Roots used for drying and freezing, show low tendency to nitrate accumulation.

The roots were transported from the farm and put to the experimental cold store at the University in plastic 20-kg crates (5 crates/cultivar). One crate with carrots was a replicate. Storage conditions were: temperature of 0-1°C, 98% RH, ambient atmosphere.

The experiment was established as the two-factorial, in 5 replicates. The first factor (A) was the cultivar (7 cultivars) and the second one (B) was storage duration - directly after harvest, after 1-month storage, after 2-month, after 3-month, after 4-month, after 5-month.

Following chemical analyses and measurements were performed: nitrate (NO₃) content in the roots, beta-carotene content, juice colour in CIE L*a* b* system, soluble solids content. Analyses were performed in 5 replicates.

Soluble solids (°Bx) content was determined with the digital refractometer (Index Instruments, UK). To obtain the juice, 6 randomly selected healthy carrot roots were chosen for one replicate.

Nitrate (NO₃) content in the roots was determined spectrophotometrically with Fiastar 5000 Analyzer (Tecator, Sweden). 10 g of fresh finely fragmented roots were extracted on laboratory shaker with 100 ml 2% acetic acid + charcoal for 30 min. Extracts were filtered. Data were shown as mg NO₃/kg f.w.

The β-carotene content was determined with spectrophotometrical method. Carotenoid compounds were extracted from the roots with hexane and light absorbance was determined with the wavelength 450 nm, using UV-1201V (Shimadzu, Japan) spectrophotometer. 5 g of fresh roots was finely fragmented with 30 g sodium sulfite Na₂SO₄. 50 mL of hexane was added and the solution was put to dark place for 24 h. Then 2 mL of the extract was taken and 8 mL of hexane was added. Absorbance was measured at wavelength 450 nm, using UV-1201V (Shimadzu, Japan) spectrophotometer. Carotenoid content, expressed as β-carotene, was determined with the calibration curve. Data were shown as mg·100 g⁻¹ f.w.

To determine carrot juice colour MiniScan XE (HunterLab, USA) spectrophotometer was used (the measure conditions: D65, 10° Observer). There were determined: L* - lightness, a* - redness, b* - yellowness. The juice was obtained with a professional juice maker and the measurements were done in 5 replicates.

Statistical analysis was performed with Statgraphics 4.1.Plus™ software, using two-way ANOVA. Tukey's HSD test was used to determine significance of differences between means, with probability level P>0.95.

Results and Discussion

To obtain good quality carrots during prolonged period after harvest, i.e. in winter and spring months, optimal storage conditions should be applied. However, as it is reported by many authors (Suojala 2000, Seljasen 2001, Brecht 2003, Koca and Karadeniz, 2008), quality degradation of the roots during storage is observed, even at cold-store conditions. In the study we tried to determine how the cold-store conditions affect some quality parameters of carrots cultivars which are grown for processing industry purposes, especially.

Table 1. Determined quality traits of carrot cultivars (means of storage periods)

Cultivars	Soluble solids (°Bx)	Nitrate (mg NO ₃ kg ⁻¹)	β-carotene (mg/100 g)	L*	a*	b*
Abledo	11.3 a	38 a	16.1 c	45.4 a	26.7 ab	31.7 ab
Bastia	13.0 b	58 b	12.6 a	45.6 a	25.8 a	31.4 a
Karotan	11.2 a	60 b	14.6 b	45.6 a	27.5 b	32.0 b
Kazan	14.8 c	74 b	16.0 c	47.1 b	28.6 c	34.0 c
Sirkana	11.5 a	61 b	13.0 a	46.0 ab	25.8 a	31.7 ab
Trafford	11.6 a	102 c	13.6 a	45.2 a	26.1 a	31.7 ab
Warmia	11.9 a	106 c	12.8 a	45.3 a	26.8 ab	31.3 a

Note: means which differ significantly according to Tukey's HSD test at P>0.95 are marked with different letters

The data obtained are shown as the means for the cultivars in Tab. 1, and as the means for the storage periods - in Tab. 2. Also values for each cultivar at all storage terms are shown in Tab. 3. As regards soluble solids content, it can be seen that it was differentiated among the cultivars. The highest soluble solids content was characteristic to 'Kazan' F₁, followed by 'Bastia' F₁ (Tab. 1). An increase of the content during storage of the roots took place (Tab. 2).

It could be explained partly by water loss from the roots as the result of transpiration, as well as by starch hydrolysis to simple sugars. The water loss was about 5-6% of carrots mass after 5-month storage (data not shown). Suojala (2000) reported increase of hexoses in carrots during prolonged storage. Hexoses accumulation during storage was explained by starch enzymatic decomposition.

Based on means of storage terms, it can be noted that the cultivars of the lowest nitrate content were 'Abledo' F₁, 'Bastia' F₁, 'Karotan' and 'Sirkana' F₁, and of the highest content 'Trafford' (Tab. 1). Nitrate content in the roots was generally on low level in all terms of storage (Tab. 2). However, differences between cultivars were observed (Tab. 3). During storage nitrate content showed decreasing tendency, but related to the cultivars. The amount of nitrates was generally low compared to recommended tolerable amounts of nitrate in carrots (Santamaria 2005, Kona 2006).

The highest β -carotene content was found for 'Abledo' and 'Kazan' cultivars (Tab. 1). The β -carotene content in the roots showed small decreasing tendency during storage period, but after 3 months of storage small increase of β -carotene was observed (Tab. 2). Similar tendency for carotenoid content increase for stored carrots was also reported by Lee (1986) and Kopas-Lane and Warthesen (1995).

The highest L* value (lightness) was characteristic to 'Kazan' and 'Sirkana' cultivars (Tab. 1). The L* values showed decreasing tendency during the storage period (Tab. 2). As regards a* values, the highest values were observed for 'Kazan' and 'Karotan' cultivars. The a* values decreased during storage period, however after 5 months of storage small increase of a* value was observed, in general. The highest b* values were noted for 'Kazan'. The b* values decreased during storage of carrots, however after 5 months small increase of the b* parameter was observed. The a* and b* values for carrots are good indices of carotenoid presence in the roots and are very important parameters taken into account in the case of carrots used for processing industry (eg. for juice concentrate production, freezing and drying) (Seroczyńska et al. 2006).

Table 2. Determined quality traits of carrots in relation to storage period (means of cultivars)

Storage period	Soluble solids (°Bx)	Nitrate (mg NO ₃ kg ⁻¹)	β -carotene (mg 100 g ⁻¹)	L*	a*	b*
Directly after harvest	11.3 a	78.1 b	15.1 b	46.0 ab	27.1 b	32.5 b
1 month	12.0 b	71.9 b	13.6 a	46.5 b	27.0 b	32.6 b
2 months	11.8 b	93.4 c	13.3 a	45.2 a	26.4 ab	31.8 ab
3 months	12.0 b	51.1 a	15.3 b	45.9 ab	26.7 ab	31.6 ab
4 months	12.6 c	77.3 b	14.1 ab	45.2 a	26.2 a	31.3 a
5 months	13.2 d	55.6 a	13.4 a	45.7 ab	27.4 b	32.1 a

Note: means which differ significantly according to Tukey's HSD test at P>0.95 are marked with different letters

Table 3. Determined quality traits of carrots in relation to the cultivar and storage period

Storage period	Cultivar	Soluble solids (°Bx)	Nitrate (mg NO ₃ kg ⁻¹)	β-carotene (mg 100 g ⁻¹)	L*	a*	b*
Directly after harvest	Abledo	10.4 a	43 a	18.4 d	46.8 ab	27.7 ab	33.4 b
	Bastia	11.7 ab	65 ab	11.0 a	45.5 a	25.4 a	31.6 a
	Karotan	10.9 a	99 c	14.9 b	46.2 ab	29.0 b	33.3 b
	Kazan	12.7 b	73 b	15.9 bc	46.3 ab	27.6 ab	32.8 ab
	Sirkana	11.0 a	45 a	16.6 cd	46.1 ab	26.2 ab	32.2 ab
	Trafford	11.2 a	84 c	14.1 b	45.7 a	26.4 ab	32.4 ab
	Warmia	11.2 a	138 d	14.9 b	45.7 a	27.2 ab	31.7 a
1 month	Abledo	11.4 a	44 a	15.3 b	46.6 ab	27.1 ab	32.4 ab
	Bastia	12.8 b	68 ab	13.9 b	46.0 ab	26.7 ab	31.4 a
	Karotan	10.2 b	49 a	13.5 ab	46.2 ab	26.8 ab	32.6 ab
	Kazan	15.8 d	104 d	16.7 cd	47.8 b	29.5 b	35.2 b
	Sirkana	11.5 ab	51 a	11.4 a	47.1 b	26.6 ab	33.0 b
	Trafford	11.3 a	82 c	12.7 ab	45.6 a	25.1 a	31.8 a
	Warmia	11.1 a	105 d	12.0 a	45.9 a	26.9 ab	31.9 a
2 months	Abledo	10.8 a	43 a	15.5 bc	44.4 a	25.4 a	30.5 a
	Bastia	14.0 bc	82 c	14.3 b	44.9 a	25.8 a	31.2 a
	Karotan	11.3 a	45 a	12.9 ab	44.7 a	27.1 ab	31.7 a
	Kazan	13.7 b	87 c	14.8 b	47.2 b	28.6 b	34.8 b
	Sirkana	10.7 a	98 cd	10.9 a	44.8 a	24.3 a	30.6 a
	Trafford	10.8 a	144 e	14.4 b	45.0 a	26.2 ab	32.1 ab
	Warmia	11.4 a	155 e	10.0 a	45.3 a	27.1 ab	31.8 a
3 months	Abledo	11.5 ab	25 a	14.5 b	44.9 a	26.9 ab	31.5 a
	Bastia	13.5 c	33 a	15.1 b	46.4 ab	26.6 ab	31.9 a
	Karotan	10.9 a	42 a	17.7 cd	46.5 ab	27.7 ab	31.9 a
	Kazan	13.6 b	84 b	18.3 d	47.0 b	28.3 b	33.2 b
	Sirkana	11.1 a	56 a	14.0 b	46.1 ab	24.8 a	30.9 a
	Trafford	12.1 b	43 a	13.6 ab	45.3 a	25.9 a	30.9 a
	Warmia	11.3 a	75 ab	14.0 b	45.0 a	26.4 a	30.9 a
4 months	Abledo	12.1 b	35 a	17.6 d	45.4 a	26.8 ab	31.5 a
	Bastia	13.3 b	60 ab	11.9 a	44.9 a	25.0 a	30.7 a
	Karotan	11.2 a	89 b	14.5 b	44.7 a	26.3 a	30.7 a
	Kazan	16.0 d	50 a	15.4 bc	46.8 ab	28.5b	33.6 b
	Sirkana	12.3 b	58 a	12.6 ab	45.8 ab	26.4 ab	31.9 a
	Trafford	11.6 ab	162 e	13.6 b	45.0 a	26.3 ab	31.4 a
	Warmia	11.7 ab	87 b	13.1 ab	43.8 a	24.1 a	29.0 a
5 months	Abledo	11.6 ab	36 a	15.5 b	44.5 a	26.2 ab	31.0 a
	Bastia	13.1 bc	38 a	11.3 a	45.8 a	25.6 ab	31.7 a
	Karotan	12.3 b	37 a	14.1 ab	45.2 a	28.2 b	31.6 a
	Kazan	15.9 c	48 a	15.0 b	47.5 b	29.4 b	34.6 a
	Sirkana	12.0 b	58 ab	12.2 a	45.9 a	26.5 ab	31.9 a
	Trafford	12.9 b	99 b	13.0 ab	44.8 a	26.7 ab	31.6 a
	Warmia	14.3 c	73 b	12.9 ab	46.1 ab	29.3 b	32.6 ab

Note: values which differ significantly at P>0.95 are marked with different letters

Conclusion

Investigated carrot cultivars differed significantly in respect of contents of β-carotene, nitrate (NO₃), soluble solids, as well as juice CIE L*a*b* colour parameters. ‘Kazan’ F₁ was characterized by very high β-carotene and soluble solids contents, low content of nitrate, high

a* and b* juice colour parameters, what indicates especially good suitability of this cultivar for concentrate production. 'Kerotan' was also very good cultivar in this respect. Storage of carrots in cold store conditions for 5 months influenced following changes of quality: β -carotene content decreased in a low degree in the case of all cultivars, nitrate content showed also a tendency to decrease. The L*, a* and b* colour parameters of the juice decreased slightly and soluble solids content showed a tendency to increase during storage.

References

- Brecht J.K. (2003). Underground storage organs. In: Barz, J. A., Brecht, J. K. (Eds.): Postharvest physiology and pathology of vegetables. M. Dekker, Inc, N. York: 625-648.
- Gajewski M., Szymczak P., Elkner K., Dąbrowska A., Kret A., Danilcenko H. (2007). Some aspects of nutritive and biological value of carrot cultivars with orange, yellow and purple-coloured roots. *Veg. Crops Res. Bull.* 67: 149-161.
- Gutezeit B., Fink M. (1999). Effect of cultivar and harvest date on nitrate content of carrot roots. *J. Hortic. Sci. Biotechnol.* 74(3): 297-300.
- Kidmose U., Hansen S.L., Christensen L.P., Edelenbos M., Larsen E., Norbek R. (2004). Effects of genotype, root size, storage, and processing on bioactive compounds in organically grown carrots (*Daucus carota* L.). *J. Food Sci.* 69(9): 388-394.
- Koca N., Karadeniz F. (2008). Changes of bioactive compounds and anti-oxidant activity during cool storage of carrots. *Int. J. Food Sci. Technol.* 43(11):2019-2025.
- Kona J. (2006). Nitrate accumulation in different parts of carrot root during vegetation period. *Acta Hortic. et Regiotecturae* 9: 22-24.
- Kopas-Lane L.M., Warthesen J.J. (1995). Carotenoid Photostability in Raw Spinach and Carrots During Cold Storage. *J. Food Sci.* 60(4): 773-776.
- Lee C. (1986). Changes in carotenoid content of carrots during growth and post-harvest storage. *Food Chem.* 20(4): 285-293.
- Mayer-Miebach E., Spiess W.E.L. (2003). Influence of cold storage and blanching on carotenoid content in Kintoki carrots. *J. Food Engin.* 56: 211-213.
- Rubatzky V.E., Quiros C.F., Simon P.W. (1999). Carrots and Related Vegetable *Umbelliferae*. CABI Publishing: 22-30.
- Santamaria P. (2005). Nitrate in vegetables: toxicity, content, intake and EC regulation. *J. Sci. Food Agric.* 86(1): 10-17.
- Seroczyńska A., Korzeniewska A., Sztangret-Wiśniewska J., Niemirowicz-Szczytt K., Gajewski M. (2006). Relationship between carotenoids content and flower or fruit flesh colour of winter squash (*Cucurbita maxima* Duch.). *Folia Hortic.* 18/2: 51-61.
- Lee C. (1986). Changes in carotenoid content of carrots during growth and post-harvest storage. *Food Chem.* 20(4): 285-293.
- Seljasen R., Bengtsson G., Hoftun H., Vogt G. (2001). Sensory and chemical changes in five varieties of carrot in response to mechanical stress and postharvest. *J. Sci. Food Agric.* 81: 436-447.
- Skrede G., Nilsson A., Baardseth P., Rosenfeld H.J., Enersen G., Slinde E. (1997). Evaluation of carrot varieties for production of deep fried carrot chips. *Food Res. Internat.* 30: 73-81.
- Suojala T. 2000. Variation in sugar content and composition of carrot storage roots at harvest and during storage. *Sci. Hort.* 8: 1-19.

PROBLEMS OF PEACH WINTER HARDINESS IN THE STEPPE CRIMEA

Tatyana LATSKO

Nikitsky Botanical Garden (NBG), Yalta, Russian Federation

Corresponding author: cr_way@mail.ru

Abstract

Culture *Prunus persica* (L.) Batsch came to the Crimea and began to develop at the end of the 19th century. Since then, it has won high popularity among the amateur gardeners, and eventually has become a commercial fruit crop. Agro ecological conditions of the Crimean region, especially the southern coast are favorable for the cultivation of this crop. Unfortunately the areas suitable for the peach are limited. The steppe part of Crimea, with large spaces, suitable for horticulture, is often subjected to cold invasions from the north, damaging the generative buds of peach and destroying the potential yield. Extreme critical temperatures occur in winter period (20-30% years) and in the spring (25%). The intensive peach breeding has been carried out from mid-20th century till nowadays. One of the main breeding in the NBG is to create resistant to cold samples. As parental forms were used Domestic and foreign winter-hardy cultivars: Veteran, Pushystiy Ranniy, Crimskiy Feyerverk etc. Over 100 created peach cultivars are included in the Register and regionalized. In the late 50's, the peach had spread in the steppe part of the Crimea, and then in the southern regions of Ukraine. Assessment of winter hardiness of hybrids was carried out by means of laboratory and field methods in test years. As a result of researches, winter-hardy peach cultivars and hybrids have been selected, and they have been recommended for commercial fruit growing and breeding. These included 'Osvezhayuschiy', 'Demerdzhinskiy' and 'Kandidatskiy' etc.

Keywords: *Prunus persica*, winter hardiness, cultivar, hybrids, breeding.

Introduction

Culture *Prunus persica* (L.) Batsch came to the Crimea and began to develop at the end of the 19th century. Since then, it has won high popularity among the amateur gardeners, and eventually has become a commercial fruit crop. Agro ecological conditions of the Crimean region, especially the southern coast are favorable for the cultivation of this crop. Unfortunately the areas suitable for the peach are limited. The steppe part of Crimea, with large spaces, suitable for horticulture, is often subjected to cold invasions from the north, damaging the generative buds of peach and destroying the potential yield. Extreme critical temperatures occur in winter period (20-30% years) (Antyufyev *et al.*, 2002) in time of the deep rest and in the spring (25%) before and after flowering in different phase's development of generative organs (Latsko, 2015). There are risks of spring frost damage of the peach and in warmer countries, such as Spain (Iglesias, 2013). Significant results in the study of plant adaptation mechanisms to adverse or extreme environmental factors are achieved. Physiological and biochemical processes in various sustainability peach cultivars grown in different soil-climatic regions of the Crimea were studied (Yelmanova, 2010). Extensive research on a peach and breeding carried out since the mid 20th century to the present day (Smykov *et al.*, 2010). More than 100 peach cultivars were established, most of them are regionalized (Nikolić, 2013).

In the late 50's peach recently launched to the steppe part of Crimea, and then to the southern regions of Ukraine: Kherson, Odessa, Zaporozhye and Mykolayiv. The area of peach distribution in the Crimea, in the south of Russia and Ukraine is due, primarily, the temperature factor and the low winter hardiness (Smykov, 1990; Latsko, 2005).

It is believed that temperatures (-21°C) – (-27°C), causes the death of peach generative buds at stage sporogenous tissue in the Crimea. According to other authors, the critical temperature range for the peach in a period of deep dormancy (from December to January 1-20) in the Crimea is (-22) - (-24) °C (Orehova and Latsko, 2001). Many of the commercial cultivars of peach had insignificant damages of flower buds at lower frost (-25) - (-26) °C in the Moldova (Sokolov and Sokolova, 1987). In connection with the above the study of the peach gene pool and search for the most resistant to frost cultivars and hybrids are highly relevant for the further breeding of peach and promotion of culture in steppe regions. The aim of this work is to evaluate damage of generative buds of the peach collection in test winters, to identify the most resistant samples and to recommend them for commercial or scientific use.

Materials and M

The object of the study was resistance to negative air temperatures of peach cultivars and hybrids. Evaluation of winter hardiness is carried by laboratory and field methods in test years according to Sedov and Ogolcova (1999) and Methodical recommendations (Smykov, 1990; Yelmanova, 2010). Research was conducted in 1992-2016 years at the collection garden, which was located on the border of the steppe and foothill soil-climatic zones of the Crimea. The climate is dry, moderately hot, with short, unstable winter and return spring frosts (Antyufeyev *et al.*, 2002). Planting distance was 6 × 3 m.

Protection from pests and diseases were carried by technologies and systems adopted in the steppe Crimea. Land was kept under fallow, irrigation was performed by furrows, one times during the growing season in the amount of 300 m³/ ha and once before the winter. Observation and analysis of weather conditions was carried out by a meteorological station of the Steppe department NBG (Ryabov, 1999). Peach cultivars are distributed into five groups according to the degree of damage of flower buds: high winter hardiness (0-10.4%), winter-hardy (10.5-30.4%), mid winter-hardy (30.5-60.4%), low winter hardy (60.5-90.4%), not winter-hardy (90.5-100%).

Results and Discussion

Resistance to cold remains a major problem for Russia in breeding peach. Winter hardiness of plants is a vast concept, combining many complex and simple signs, which are determined by polygenes and oligogenes (Hesse, 1975; Latsko, 2005, 2012). These include the ability to hardening frost resistance vegetative and generative parts of structures in a period of deep dormancy (December-January), resistance to late spring frosts of flower buds (buds, pistils), as well as resistance to low temperatures roots (rootstock). Winter hardiness, in the narrow sense, it is the resistance of plants to low temperatures, that is cold resistance. Winter hardiness in a broader sense include the ability of plants to hardening, frost resistance of various tissues and parts of plants in different stages of ontogeny. Some authors believe (Pomology, 1997), that the winter hardiness – a stability not only to the low temperatures, but also to the entire range of the cold season of adverse factors. These include especially the temperature regime, the drying effect of wind, ice and sunburn, especially in the southern area of horticulture. The commercial value of the cultivar is determined, first of all yield of fruits, and flower buds are the beginnings of a future harvest. The article will be considered primarily this aspect of winter hardiness, namely stability of generative buds or flower buds to winter and spring air negative temperatures.

There are 15 extremely cold years for the study in the 1972-2016 periods in the steppe Crimea (34% years): 1972, 1976, 1979, 1980, 1982, 1985, 1989, 1990, 1994, 2002, 2006, 2007, 2010, 2012, and 2015. Return spring frosts recorded 16 times (36% years): 1972, 1980, 1981, 1985, 1988, 1989, 1990, 1991, 1992, 1993, 1994, 1999, 2004, 2009, 2012 and 2016. The lowest temperature was fixed at 02.21.1985 (-28.8°C). The scale and depth of the damage are

maximized this year. Generative and vegetative buds, twigs, bark and wood have been damaged. Cambium remained at the level of the skeletal branches of the first order of more winter-hardy cultivars. Very low negative temperature (-27.1°C) was registered 23.01.2006. Peach plants were at this time in a deep state of rest or an exit from it. Damage to generative buds was highest. The extent of frost damage to the vegetative parts of plants varied depending on the by cultivars. Bark, cambium, wood, core and of thin shoots or shoots terminations was mostly damaged by 4 points (on 5-point scale). The greatest damage was observed in of timber: 1-4 points. Cultivars of American origin were badly damaged of timber (3-4 points): Flacar, Harbrite, Hardbound, Harbella, Slanche and the nectarine Anderson. Vegetative buds were not injured. The cambium is intact in most cultivars. It is helped to keep plants, having made renewal pruning up to skeletal branches.

09.01.2002 the frost was registered (-24.6°C). The plants were in a state of deep physiological rest, i.e. in the period of its maximum frost resistance. Examination of flower buds after exposure to such cold identified frost resistant cultivars and hybrids of peach: G.Lebedev, Osvezhayuschiy, Posol Mira, Favorite Morettiny, Comanche, Early Red Haven, Reliance, C4/210, C4/110, C8/163, C4/38 and C4/57. Field evaluation of the peach in general confirmed the results of laboratory tests. A number of cultivars and forms showed high hardiness: Ak-Cheftalyu-2, Baten Kaisev, Iftihor, Ranniy-84, Panniy-85, nectarines Yevpatoriyskiy and Zee Gold. Winter-hardy cultivars include Candidatskiy, C1/227, Alma-Atinskij, Start, Peach Sungen de Toamna, Superba de Toamne, Pegaso, Mireille, Fairhaven, NSF2, mutants Sovetskiy 37-167 and 63-30, nectarines Ichunskiy, May Grand and Fantasia.

23.02.2007 the late winter frosts (-19.1°C) was marked. The duration of the frost period was 162 hours from 21 to 28 February. At first glance, not very a low temperature, but it struck a powerful irreversible damage: flower buds of all cultivars were damaged by 100%.

The winter 2006/2007 was unique. It has demonstrated effect of several factors hardiness: autumnal hardening, an early exit from the physiological rest, the frost resistance of flower buds in February, resistance to prolonged cold exposure. These factors have been reinforced pre-drought and frost of the previous year (23.01.2006 -25.6°C). Trees have been weakened. Even the most winter-hardy cultivars were severely damaged. Not only generative buds, but also vegetative parts of the plant were damaged: bark, wood, core, infrarenal tissue.

10.01.2010 January frosts (-21.1°C), that were close to the critical temperature negative for medium-hardy cultivars, had a great influence on the crop of peaches. Damage assessment showed that it is not winter-hardy and low hardy cultivars were severely damaged generative buds (60-100%). These include 'Kremlevskiy', 'Ryabovskiy', hybrid '84-2445' etc. High winter hardy and hardy cultivars have had little or poor (30%), moderately hardy – average (30-60%) and significant (60%) damage to of flower buds. Medium and minor damage generative buds have not affected the yield of peach. These cultivars bloomed well in spring on 4-5 points (for a 5-point scale). These include 'Posol Mira', 'Red Haven', 'G.Lebedev', 'Nikitskiy Podarok' et al (Table.1). Damage to the flower buds cultivar Ryabovskiy estimated on 74%, significantly influenced the force of flowering (2 points) and reduced yield. Sorts Osvezhayuschiy and Clown are characterized by profuse the formation of generative buds. Despite the considerable them destruction of (61 and 74.8%, respectively), a good harvest is marked. 'Ifthor', 'Posol Mira', 'Red Haven' also refer to this category cultivars with the profuse formation of generative buds. This fact has significant advantages when choosing cultivars for orchards.

Average damage of flower buds were somewhat smaller in the garden near the v.Lobanovo (Dzhankoy, Crimea), although the cold there was stronger by one degree. 'Red Haven' had 28% damaged buds there, compared with 48% – in the v.Novyi Sad. Probably less frost damage of generative buds is associated with better agricultural background, plants be healthier physiologically and young plants (Tabl. 1).

Table 1. Damage of peach flower buds with the frost (-21.1)°C 10.01.2010 in the steppe Crimea.

Cultivars, hybrid	Damage of generative buds, %	Blooming, points ¹	Frost resistance generative buds ²
v.Novyi Sad, Simferopol (-21.1)° C			
G.Lebedev	21	5	high
C4/57	33	3,4	medium
C4/210	35	4	medium
C4/110	36	4	medium
Perekopskiy Krupnoplodnyiy	37	4	medium
C 7/6	45,5	4	medium
Red Haven	48	4	medium
Osvezhayuschiy	61	4,2	medium
Zolotoy Yubiley	65	3	low
Pushistiy Ranniy	68	3,3	low
Ryabovskiy	74	2	low
v.Lobanovo, Dzhankoy (-22.1)° C			
Posol Mira	21,6	4,5	high
Red Haven	28,3	4,5	high
Zolotaya Moskva	36,6	4	medium
Tourist	47,2	3	medium
Vavilovskiy	52,6	3	medium
Clown	74,8	3	low

¹ average value on a 5-point-scale;

² Evaluation of frost resistance generative buds.

Winter 2012 was a very interesting and special. The peculiarity of it is that frosts occur in a very short time, in February, so it was very cold (-19° – -23° C). The February cold spell was preceded by several warming and cooling in the December and January. In 02.02.2012 temperature have reached their extreme the value – (-23.6°C) on the stage of forced rest. The destructive action of the frost was accompanied by strong north-easterly winds, which blew continuously from 1 to February 10, with a force of 14 to 34 m / sec. In such unfavorable for fruit crops weather conditions chance for harvest did not remain. Flower buds of most cultivars of peaches and nectarines have been damaged to the maximum extent; they have survived only in very winter-hardy cultivars. The nature of damage is browning of pistils and anthers. 576 cultivars and forms of all were examined. 8 cultivars and perfect forms highlighted with power of flowering, estimated at 4 points, 9 – with the flowering of 3 points, 29 – with the flowering of 1-2 score and 85 – with a single flowering (on a 5-point scale). So, more than 60 winter-hardy cultivars and hybrids had allocated in extreme temperature conditions, the first decade of February 2012 (-19° – -23.6°) C. High winter hardy cultivars include Demerdzhinskiy, Candidatskiy, Crimskiy Feyerverk, Sochniy, Yubileyniy Ranniy, Sun Crest, Ranniy-84, Melitopolskiy Yasniy, elite forms C7/6, 10487, C16/87, hybrids 84-2468, 84-2445, №5714, *etc.*

The minimum air temperature (-24.1°S) was recorded 08.01.2015. Evaluation of flower buds 30 cultivars and 20 hybrids of peach were carried out by means of laboratory and field methods. Selections of hybrid families with one or two hardy parents, such as Valiant's Crimean Fireworks were evaluated. Most samples had hundred percent damages of flower buds. Some generative buds of hybrids №80-426 (Valiant's Favorite Morettini) and №84-485 (Red Haven's Starking) had remained intact (5.3 and 0.7% respectively).

In 2016 are marked January frosts (-15,8°C) and spring frosts depth of -6.5°C and -8.5°C with an interval of 3 days 16.03 and 19.03.2016 (Table 2).

Table 2. Damage of peach generative buds by spring recurrent frosts in the steppe Crimea v.Novi Sad, Simferopol

Cultivar, hybrid	Flowers type	Phase	Damage of generative buds, %		Notes
			16.03.16 (-6,5°C)	19.03.16 (-8,5°C)	
Nikitskiy Podarok	Bell	Tb ¹	-	3,7	
Osvezhayuschiy	Bell	Tb	5	8,6	
Pushistiy Ranniy	Rose	Tb	-	8	
10607	Bell	Lfb	-	13,9	
Demerjinskiy	Rose	Lfb	-	26,7	
Posol Mira	Bell	Tb	8	28,4	
Sochniy	Rose	Tb	-	34,2	
Startoviy	Rose	Lfb ²	-	36,4	
Clown	Bell	Lfb	-	36,9	
Red Haven	Bell	Tb	9	40,3	
C 7/6	Rose	Tb - Lfb	61	30,1	27% Lfb
C 16/87	Rose	Lfb	-	48,4	
C4/210	Bell	Tb - Lfb	-	50	45% Lfb
Favorite Morettiny	Rose	Lfb	51	58,6	
Iftihor	Bell	Lfb	-	68,1	
Crimskaya Osene	Rose	Lfb	-	70,4	
Rumyanyiy Nikitskiy	Bell	Lfb	-	74,2	
Zolotaya Moskva	Rose	Lfb	69	79	
Vavilovskiy	Rose	Lfb	26	80	

¹Tight flower bud

²Loose flower bud

January frosts hadn't detrimental effect on the generative buds of peach, nectarine and peach decorative, as they were not deep enough (-15.8°C). Flower buds frost resistance of 12 cultivars and four hybrids of peach in the phase of formation of pollen (the appearance of the petals, tight or loose bud) were tested. Cultivars with high resistance to negative air temperatures (-6,5°C), and (-8,5°C) at this developmental stage were obtained. These include 'Nikitskiy Podarok', 'Osvezhayuschiy', 'Pushistiy Ranniy', and '10607'. Percentage generative buds damage them was 3.7, 8.6, 8 and 13.9%, respectively. Cultivars 'Demerjinskiy', 'Startoviy' have also shown relatively high cold resistance (damage to flower buds up to 30%) compared to 'Zolotaya Moskva' (79%), 'Rumyanyiy Nikitskiy' (74%) and 'Crimskaya Osene' (70%).

Latest returnable spring frosts were recorded 06.05.99 (-2.2)°C. Such extreme temperature weren't more than 100 years ago. Virtually all of sets were damaged by that frost, and the harvest was destroyed. Return spring frosts of depth -10.4° C were fixed in April 2004 (04.04.04). Peach plants were in the phase of a "pink loose bud". In this year was allocated one cultivar of nectarine Crimchanin.

In 2009, two waves of cold weather were marked April 11-13 (-5° C) and April 21-23 (-6° C). The second wave of cold was greater in absolute value. With all other things being equal, cultivars with the rose-type flower (Candidatskiy, Crimskiy Feyerverk, C 7/6, C 16/87 and other) had less damage than ones with the campanula-type flower.

Some peach cultivars were allocated in test years with various extreme temperature factors, for example: Demerjinskiy, Osvezhayuschiy, Crimskiy Feyerverk, Posol Mira, Startoviy, Yubileyniy Ranniy and etc. These cultivars are adapted well to agro-climatic conditions of

the steppe Crimea. They were characterized by the high yield, the excellent taste and good biochemical parameters of fruits.

Conclusions

Evaluation of winter hardiness cultivars and forms of the peach gene pool of Nikitsky Botanical Gardens based on years of research is given, and very hardy specimens were identified. These include cultivars and advanced selections of peach Demerdzhinskiy, Ranniy 84, Andrey Lupan, Osvezhayuschiy, Candidatskiy, C7/6, C16/87ES, Melitopolskiy Yasnyiy, Nikitskiy Podarok, Comanche, Reliance, Sun Crest, '10487', '11417', '9978', '6312', '6610', '6331', '9381', '80-429', '172-88' and others. They are recommended for the state cultivar testing, for commercial use or for breeding. Thus, the creation and selection of hardy and very winter-hardy cultivars of peach allows them to grow in conditionally favorable regions of the steppe Crimea and Russia, where low winter-hardy cultivars of peach are not profitable.

Acknowledgement

This study was funded by the research grant №14-50-00079 of the Russian Science Foundation.

References

- Antyufeyev, V.V., Vazhov, V.I. and Ryabov, V.A. (2002). The reference book about the climate of the Steppe department of Nikitsky Botanical Gardens. Yalta: NBG-NNC.
- Hesse, C.O. (1975). Peach. In: Advances in fruit breeding. Purdue Univ. Press, West Lafayette, Ind., pp. 390-462.
- Iglesias I. (2013). The peach production in Spain: current situation and trend, from production to consumption/ Inovacije u voćarstvu. IY. Univ. u Beogradu. Beograd, pp. 75-98.
- Yelmanova, T.S. and Opanasenko, N.E. (2010). Ecological and physiological characteristics of the peach. K.: Agrarian Sciences.
- Nikolić D. and Fotirić-Akšić M. (2013). Peach breeding in the world. In: Inovacije u voćarstvu. IY. Univ. u Beogradu. Beograd, pp. 5-27.
- Latsko, T.A. (2005). Winter-hardy peach cultivars. J. Bul. Nikit. Botan. Gard. Yalta, vol. 91, pp. 68–71.
- Latsko, T.A. (2012). Achievements and problems of genetics, plant breeding and biotechnology/ Proceedings of the IX Congress UTGiS, Kiev: LOGOS, vol. 3, 474-478.
- Latsko, T.A. (2015). Peach breeding results for the winter hardiness in the steppe Crimea/ X Int. Sci. konf. 10/06/15. Novosibirsk: CPNS, pp. 74-90.
- Orekhova, V.P., Latsko, T.A. (2001). Varietal study results of peach in the steppe zone of the Crimea. J. Bul. Nikit. Botan. Gard. Yalta. Vol. 84, pp. 70–73.
- Pomology (1997). Ed. Andrienko M.V. K: Urozhay, Vol.3, pp. 69-222.
- Ryabov, V.A. (1999). Climate monitoring of fruit plantations. Yalta: NBG-NNC.
- Smykov, V.K. (1990). Methodic recommendations of the peach selection. M: VASHNIL, Russia.
- Sedov, E.N. and Ogolcova, T.P. (1999). Program and methods of the cultivar investigation of fruit, berry and nut crops. Orel: VNIISPK, Russia.
- Smykov, V.K., Smykov, A.V., Latsko, T.A., Richter, A.A., Lobanovskaya, V.F. and Fedorova, O.S. (2010). Gene fond of south fruit crops and its use. Works Nikit. Botan. Gard. Yalta, vol. 132, pp. 19-33.
- Sokolova, S.A. and Sokolov, B.V. (1987). Persik. Kartya Moldovenyaske, Kishinev.

IMPACT OF CLIMATE FACTORS ON AGRO BIOLOGICAL CHARACTERISTICS OF PINOT NOIR VARIETY IN TREBINJE VINEYARD

Tijana BANJANIN^{1*}, Zorica RANKOVIĆ-VASIĆ²

¹Faculty of Agriculture, University of East Sarajevo, Republic of Srpska, Bosnia and Herzegovina

²Faculty of Agriculture, University of Belgrade, Serbia

*Corresponding author: tijanapekic@hotmail.com

Abstract

The paper presents the results of studies on important agro biological characteristics of the variety Pinot Noir, during the growing season in 2013 and 2014, in Trebinje. The tests of agrobiological characteristics which were done included: phenological properties, fruitfulness of buds and shoots and yield. During the years 2013 and 2014 a significant influence of climatic factors on the phenological characteristics of the studied varieties was observed. The observed climatic factors have influenced the development of a large number of fruitful shoots (12) and bunches per vine (14) in 2013 compared to 2014, when the number of fruitful shoots was 10.5 and the number of bunches per vine was 13.4. During 2014 there was a larger number of clusters per bud (1.12) and per fruitful shoot (1.59) compared to 2013. The yield of grapes per bud (110 g) and per fruitful shoot (137.5 g) was higher in 2013, compared to 2014 when the grape yield per bud was 84 g and the yield per fruitful shoot was 120 g. The higher yield of grapes per vine (1.65 kg) and per hectare (7638.88 kg/ha) was also recorded in 2013, while in 2014 the yield per vine of 1.26 kg and the yield per hectare of 5832.54 kg/ha was determined.

Keywords: *Pinot Noir, phenological characteristics, fertility of buds and shoots, yield*

Introduction

Due to climatic conditions, vine occupies a wide area of distribution. *Vitis* varieties are grown in zones of moderately - continental, subtropical and Mediterranean climate (Žunić and Garić, 2010). Climatic conditions (solar radiation, heat accumulation, rainfall, frost, temperature, humidity, etc.) have a strong impact on viticulture, affecting grapevine growth, chemical and sensory characteristics of the wine. Out of all the climatic factors, temperature appears to be one of the most important (Ruml *et al.*, 2012). 'Pinot Noir' originates from the Burgundy region in France which means that its adaptation is very specific to this environment. Now 'Pinot Noir' has become an international variety and it is grown in a large number of viticultural regions all around the world (Ranković-Vasić *et al.*, 2015). The reconstruction of the vineyards in the area of Herzegovina started in the last decade and new varieties have been introduced since then, Pinot Noir variety is one of them.

The aim of this study was to investigate the basic agro biological properties of this variety and the possibility of its cultivation in climatic conditions of the city of Trebinje and other wine regions of similar agro ecological conditions.

Material and methods

The research of agrobiological characteristics of Pinot Noir variety was carried out during the growing season in 2013 and 2014, in Trebinje area (Entity of Republic of Srpska, Bosnia and Herzegovina). The experiment was set up at the location of Zasad polje. This vineyard was founded in 2008 at an altitude of 273 m. The distance between plantings was 2.4 x 0.9 m. 10 vines were selected for the research, and each vine served as a separate experimental unit in the research. During the pruning, 15 buds were left on the vine. Basic measures of pruning were applied during the two years of research in experimental plantation, as well as basic measures for the protection of the most important causes of disease and pests. During the research, the "drop by drop" method of irrigation was used on the plantations. Agrobiological

characteristics of the variety which were investigated were: phenological characteristics, fertility of buds and shoots and yield. Phenological observations were carried out on the basis of monitoring and inspecting of the pheno-phases in the annual cycle of development of the vine. Phenological characteristics of the variety which were monitored were: the beginning of tearing, the beginning of budding, beginning, fullness and end of blooming, duration of flowering, the growth of berries, the beginning of a hinge and maturing of berries. The load of fruitful buds significantly has an impact on productivity and the development of vines. The indicators of fertility of buds and shoots which were studied were: the number of buds per vine, the number of fertile shoots, number of bunches per bud, the number of bunches per vine and the number of clusters per shoot. The yield of analyzed variety of grape is registered by specifying different categories of fertility: per bud, per bearing shoot, (expressed in g / bud, and bearing shoot) per vine (expressed in kg / vine) per unit area (kg / ha). The data from Hydrometeorological Institute of the Republic of Srpska was used for the analysis of meteorological conditions observed during the two years.

Results and discussion

Trebinje is located in a zone of altered Mediterranean climate. It is characterized by a large number of sunny days (260), low relative humidity and cloudiness, rains in winters and warm summers. Autumn is significantly warmer than spring, the snow falls very rarely, and when it falls, it does not stay for too long. The relief of the municipality is dominated by the mountain Leotar, the river Trebišnjica, and Trebinje field and Popovo field. Compared to long-term averages (1997-2012) both observed years were warmer and had more rainfalls (Graph 1. and Graph 2.). The average monthly air temperature for the period from January to March was significantly higher in 2014, while in the period from April to September temperatures were higher in 2013. Average maximum temperature in July and August, and the average minimum temperature increased in 2013, while in January, February, and March average maximum and minimum temperatures were higher in 2014 (Graph 3.). In February and March of 2013, rainfall was considerably higher than in 2014, while in June, July and September rainfall was considerably higher in 2014. During 2014 there was 70 mm more rainfall than in 2013.

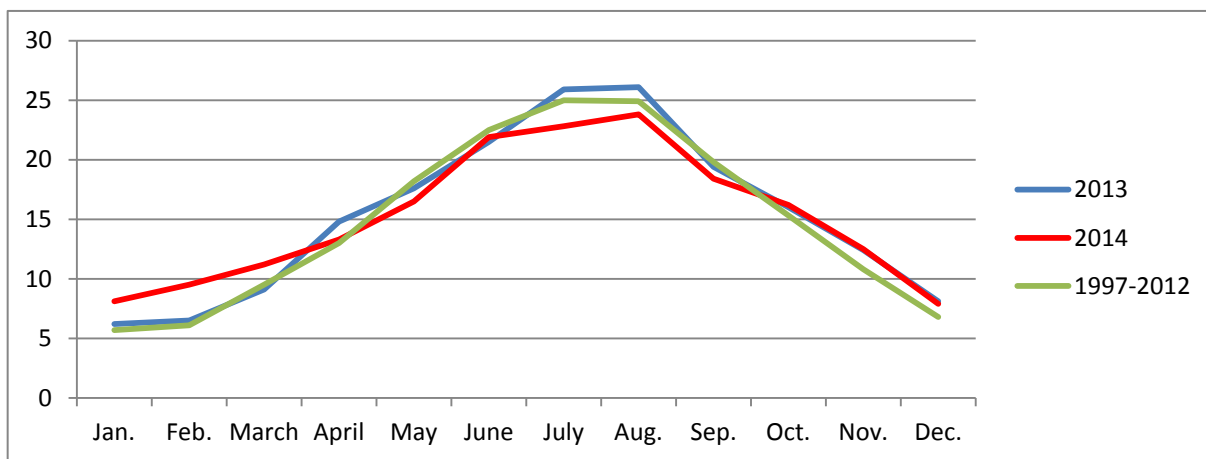

Graph 1. - Average monthly temperature for the period of 1997-2012 as well as for 2013 and 2014 years.

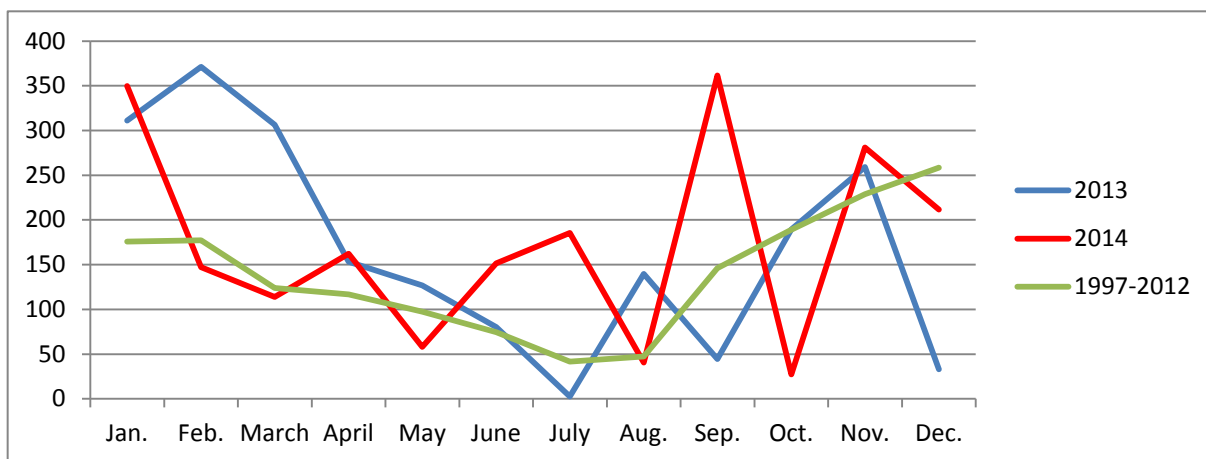

Graph 2. - Average monthly rainfall for the period of 1997-2012 as well as for 2013 and 2014 years.

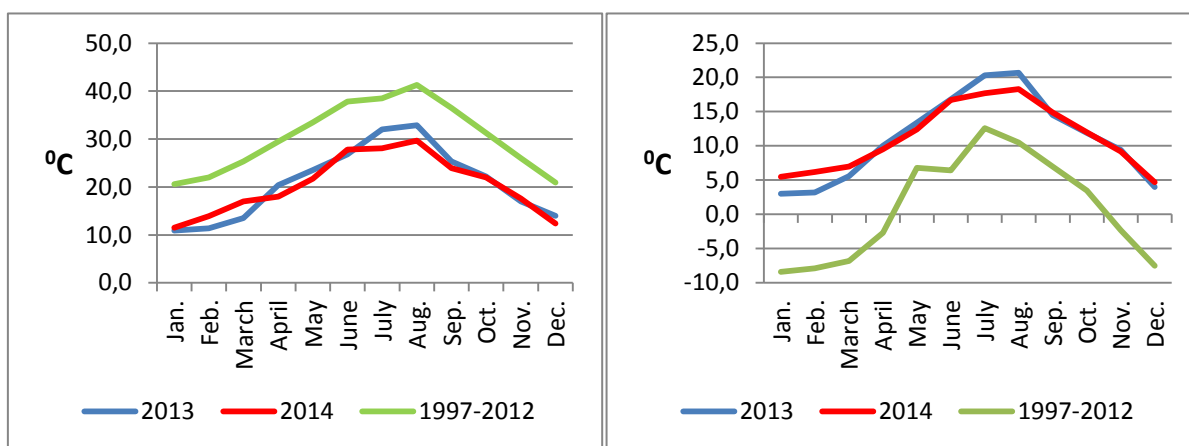

Graph 3. – Average monthly maximum and minimum temperatures for the period of 1997-2012 as well as for 2013 and 2014 years.

Monitoring of phenological development of the vine varieties in certain agro ecological conditions is of great importance from the point of analysis of fruiting and quality of grapes. The course of duration of certain stages in the annual cycle of development of Pinot Noir variety in conditions of Trebinje area can be seen from the data presented in Table 1.

Analysis of data from Table 1. shows that pheno-phase of tearing started earlier in 2014 (March 10). This happened because of the slightly higher temperature during the month of March in 2014 (Graph 1. and Graph 3.). The results, which are shown in Table 1. showed that Pinot Noir variety had earlier beginning of budding in 2014 (March 15). The range of vegetation movement and the opening of buds, amounted to 16 days. The beginning of flowering began earlier in 2013 (May 19), when the temperature was slightly higher than in 2014 and than the average of several years (Graph 1.). The beginning of flowering of this variety began somewhat later compared to the results cited by *Garić et al.* (2007) for the conditions of Aleksinac sub-region, which can be explained by different climatic conditions. Pheno-phases of full flowering occurred 5 to 10 days after the beginning of flowering, May 23 in 2013 and May 25 in 2014. End of flowering occurred on 31 May in both years. The blossoming of studied varieties in average lasted for 11 days. Pheno-phase of berry growth lasts from beginning of the seeding of the berries and lasts until the beginning of their maturation, the hinge of the grapes. Berry growth pheno-phase in 2014 began on June 5, and in 2013 it began a little later (June 12). Pheno-phases of the hinge (Table 1.) started earlier in

2014 (July 20). The moment of getting to full maturity varies greatly from year to year, and depends even more on the range in which the variety is grown and climatic conditions (*Artem et Antoc*, 2013). The full maturity of this variety occurred earlier in 2013 (August 30), while in 2014, due to heavy rainfall, it occurred somewhat later (September 8) (Graph 2.).

Table 1. – Beginning time of certain pheno-phases of Pinot Noir variety

Pinot Noir	2013	2014
The beginning of tearing	26.03.	10.03.
Beginning of budding	01.04.	15.03.
Beginning of blooming	19.05.	22.05.
Full blooming	23.05.	25.05.
End of blooming	31.05.	31.05.
Duration of blooming (days)	13	9
Growth of berries (6-7 mm)	12.06.	05.06.
Hinge	22.07.	20.07.
Full maturity	30.08.	08.09.

The degree of the load with fruitful buds significantly impacts on productivity and the development of vines, yield and quality of grapes (*Nakalamić and Marković*, 2009). Based on the data presented in Graph 4., the analysis of the search results can be carried. During pruning 15 buds were left on each vine. The number of fruitful shoots depended on the weather conditions in certain years. The number of fruitful shoots is higher in 2013 (Graph 4.). The number of clusters per bud and fruitful shoot was within the limits stated by *Avramov* (2001) and *Garić et al.* (2007). The number of clusters per vine was satisfactory for achievement of normal yield of grapes.

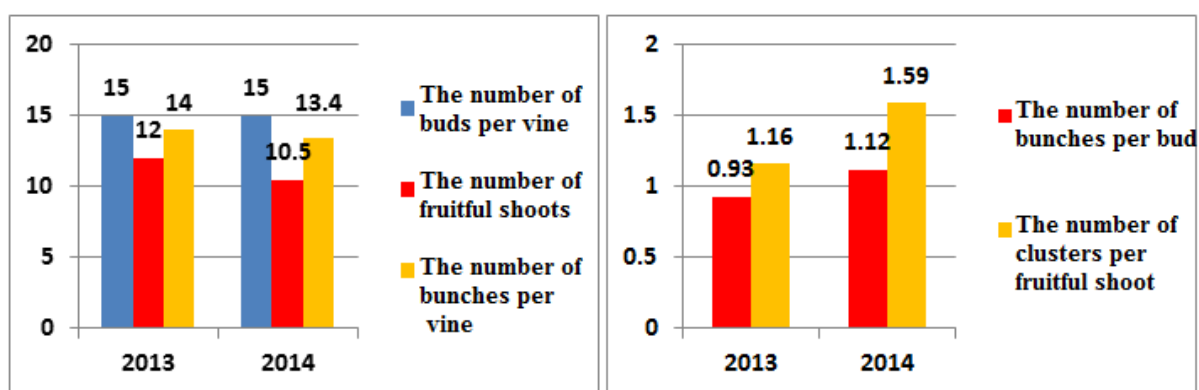

Graph 4. – Fruitfulness of buds and shoots

Grape yield depends on several factors, among which the biological characteristics of grown varieties, environmental conditions and the way of growing grapes stand out. In one variety in the same agro ecological conditions, the yield varies depending on the age of the plant, as well as vegetative and fruitful potential of vines. The variation in yield in native vineyard

during the years is 10% to 20%, depending on the meteorological conditions and applied agro-techniques (Nakalamić and Marković, 2009). Based on the analysis of the data presented in Graph 5., it can be seen that the yield of grapes per bud (110 g) and productive shoot (137.5 g) was higher in 2013 compared to 2014, when the yield per bud was 84 g, and the yield per bearing shoot was 120 g. Higher yield of grapes per vine (1.65 kg) and per hectare (7638.88 kg / ha) was also recorded in 2013, while in 2014 the yield per vine of 1.26 kg and the yield per hectare of 5832.54 kg / ha was recorded, Graph 6. These results are consistent with results of Burić (1995), Avramaov *et al.* (2001) and Ranković-Vasić *et al.* (2011).

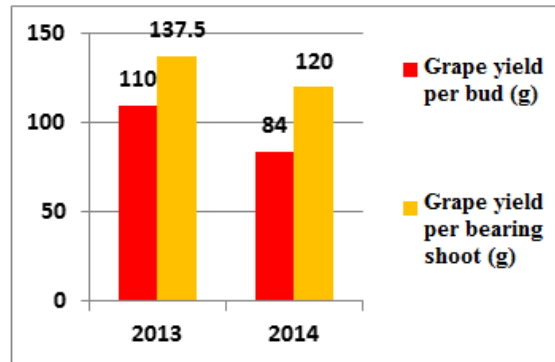

Graph 5. – Grape yield per bud and bearing shoot

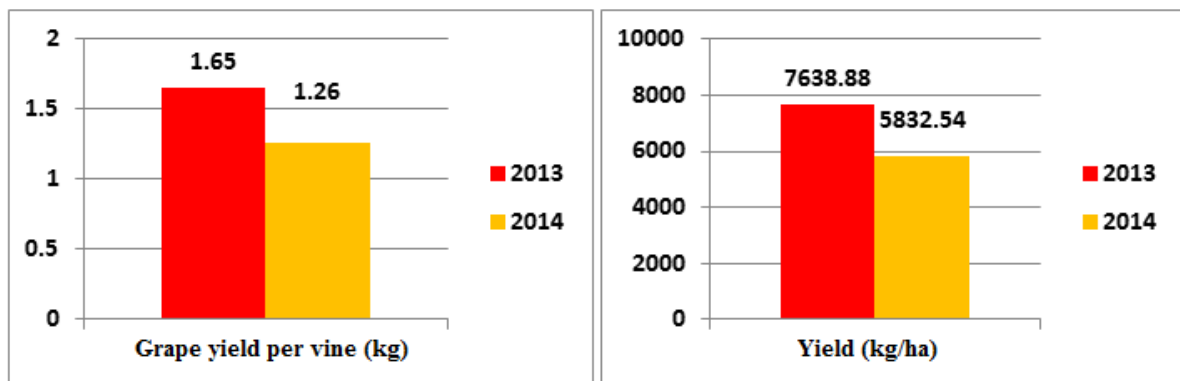

Graph 6. – Grape yield per vine and per hectare

Conclusions

Based on the results presented on agro biological properties of Pinot Noir variety cultivated in agroecological conditions of Trebinje the following conclusions can be formed:

- A significant impact of climatic factors on the beginning time of pheno-phases this variety is detected.
- The observed climatic factors influenced the development of a large number of productive shoots, bunches per vine, grape yield per bud, grape yield per bearing shoot, grape yield per vine and per hectare in 2013 compared to 2014.
- In 2014, a larger number of clusters per bud and per productive shoot were detected compared to the year 2013.
- Pinot Noir variety shows positive properties in agroecological conditions of Trebinje city area.

References

- Artem, V., Antoce, A. O. (2013). The influence of climatic conditions on the grape quality in the wine center of Murfatlar in 2012. *Scientific Papers. Series B, Horticulture*. Vol. LVII.
- Avramov, L., Žunić, D. (2001). *Posebno vinogradarstvo (Special viticulture)*, University of Belgrade, Faculty of Agriculture Belgrade – Zemun. Belgrade.
- Burić, S. (1995). *Savremeno vinogradarstvo (Contemporary viticulture)*, Novi Sad.
- Garić, M., Ćirković, B., Ristić, M., Ivanović, R. (2007). Agrobiološka svojstva sorte burgundac crni u Aleksinačkom podrejonu. *Savremena poljoprivreda (Agrobiological characteristics of Pinot Noir variety in Aleksinac sub-region. Contemporary viticulture)*, 56 (6), 274-279.
- Jovanović-Cvetković, T., Mijatović, D. (2008). Commercial-technological characteristics of interspecies hybrids under conditions in winegrowing Kutina area. *Zbornik naučnih radova Instituta PKB Agroekonomik (Collected scientific papers of PKB Agroekonomik Institute)* 14(5), 97-104.
- Nakalamić, A., Marković, N. (2009). *Opšte vinogradarstvo. (General viticulture)* University of Belgrade, University of Agriculture Belgrade – Zemun. Belgrade.
- Ranković-Vasić, Z., Atanacković, Z., Vujadinović, M., Vuković, A., Sivčev, B. (2011): Uticaj klimatskih faktora na kvalitet grožđa sorte burgundac crni u vršačkom vinogorju. (The influence of climatic factors on the quality of grapes of Pinot Noir variety in Vršac area) *International Scientific Symposium of Agriculture „Agrosym Jahorina 2011“*, Collected papers, pages 177-183, Jahorina.
- Ranković-Vasić Z., Nikolić D., Atanacković Z., Sivčev B., Ruml M. (2015). Characterization and adaptation of some 'Pinot Noir' clones to the environmental conditions of Serbian grape growing regions. *Vitis* 54 (Special Issue), 147–149.
- Ruml, M., Vuković, A., Vujadinović, M., Đurđević, V., Ranković-Vasić, Z., Atanacković, Z., Sivčev, B., Marković, N., Matijašević, S., Petrović, N. (2012). On the use of regional climate models: Implications of climate change for viticulture in Serbia. *Agric. Forest Meteorol.* 158-159, 53-62.
- Van Leeuwen, C., Seguin, G. (1994). Incidences de l'alimentation en eau de la vigne, aprecieeparl, etathydrique du feuillage, sur le developpment de l'appareilvegetatif et la maturation du raisin (Vitisviniferavar. Cabernet Franc). *Journal International des Sciences de la Vigneet du Vin*, 28:81-110.
- Žunić, D., Garić, M. (2010). *Posebno vinogradarstvo. (Special viticulture)* Ampelografija 1. University of Belgrade, University of Agriculture Belgrade – Zemun, Belgrade.

INFLUENCE OF EXPLANT SOURCE AND PLANT GROWTH REGULATORS ON CALLUS INDUCTION AND SHOOT REGENERATION OF CHICORY (*Cichorium intybus* L.)

Mehdi MOHEBODINI*, Homeira HADIZADEH, Behrouz ESMAEILPOUR, Esmaeil CHAMANI

Department of Horticulture, Faculty of Agriculture, University of Mohaghegh Ardabili, Ardabil, Iran.

*Corresponding author: Mohebodini@uma.ac.ir

Abstract

Chicory (*Cichorium intybus* L.) is an important medicinal plant used traditionally to cure various diseases. The whole plant contains various medicinally important compounds and the concentrations of the compounds vary in different tissues. Callus induction and shoot regeneration of Chicory using leaf and petiole explants were investigated by studying the effects of different combinations of plant growth regulators. Leaf and petiole explants were cultured on MS medium supplemented with different concentrations of IAA/KIN and NAA/TDZ. In leaf and petiole explants highest callus induction were obtained in the medium containing 0.3 mg l⁻¹ IAA with 0.5 mg l⁻¹ KIN and 0.6 mg l⁻¹ NAA with 0.02 mg l⁻¹ TDZ. The results showed that the highest regeneration percentage and the number of regenerated shoots were obtained in the medium containing 0.1 mg l⁻¹ IAA with 1.5 mg l⁻¹ KIN in leaf and petiole explants. In addition, the highest regeneration percentage and the number of regenerated shoots were obtained in the medium containing 0.1 mg l⁻¹ NAA with 0.5 mg l⁻¹ TDZ in leaf explant and no regenerated shoots were produced in the presence of NAA and TDZ in all combination tested in petiole explant.

Keywords: *Cichorium intybus* L., Callus induction, Explant, Plant growth regulators, Regeneration.

Introduction

Chicory (*Cichorium intybus* L.) belonging to Asteraceae family is commonly known as witloof chicory (Bais and Ravishankar, 2001). The leaves and the roots of this medicinal plant are edible and commonly used as salad and some varieties are cultivated for coffee substitute after roasting the roots. In folk medicine, the plant is used for the treatment of diarrhea, spleen enlargement, fever, and vomiting. Antihepatotoxic activity on damaged rat's liver sections (Zafar and Ali, 1998) and anti-bacterial activity of this crop (Petrovic *et al.*, 2004) has been recently reported. The alcoholic extract of Chicory is also used against pyorrhea or gingival inflammation (Patel and Bhatt, 1985) and contains large numbers of pharmaceutically important phytochemicals including sesquiterpene, lactones, glycosides flavonoids, coumarins, anthocyanins, organic acids, and cytokinins (Bais and Ravishankar, 2001) Rehman *et al.*, (2003) reported *in vitro* regeneration from leaf explants and various hormonal combinations. Nandagopal *et al.*, (2007) studied *in vitro* regeneration of Chicory from cotyledon explants and different combinations of plant growth regulators. Yucesan *et al.*, (2007) developed a protocol for the regeneration of plantlets from leaf and petiole explants of witloof chicory. Geun- Won *et al.*, (2009) also studied *in vitro* regeneration for genotypes, Radcchio and Italiana of *Cichorium intybus* L. var *foliosum*, using leaf and petiole explants. Lastly, Maroufi *et al.*, (2012) studied *in vitro* regeneration of *Cichorium intybus* var. *sativum* from leaf and cotyledon explants and different combinations of plant growth regulators. The aim of the present investigation was optimization of callus induction and shoot regeneration from leaf and petiole tissues of landrace genotype of Chicory (Esfahan) and this

protocol will effectively be used in *Agrobacterium* mediated gene transformation for Chicory breeding.

Materials and Methods

Esfahan genotype (Pakan Bazr Ltd) was used in this investigation. Seeds of chicory were first washed with running tap water for 30 min then seeds were surface sterilized by dipping in 70% ethanol for 90 s and rinsed with sterile distilled water, followed by immersing in 5% sodium hypochlorite solution for 25 min and thereafter rinsed for 30 min with sterile distilled water. Sterilized seeds were germinated on MS medium (Murashige and Skoog, 1962) supplemented with 0.8% agar and 3% sucrose. The basal medium used in this investigation was MS (Murashige and Skoog, 1962). For shoot regeneration, leaf and petiole explants (5 mm segments) excised from 4-week-old sterile seedlings were cultured on MS medium containing different concentrations and combinations of IAA/KIN and NAA/TDZ in two separate experiments. The cultures were incubated in a growth chamber at $25 \pm 2^\circ\text{C}$ under 16/8 h (light/darkness) photoperiod using white fluorescent light. Experiments were performed factorial based on completely randomized design and four replicates per treatment with 8 explants for each replicate were used. The percentage of callus induction and shoot regeneration were calculated for the leaf and petiole explants that had been cultured for 4 weeks. Data was subjected for analysis of variance (ANOVA) and compare means using SPSS 16.0.

Results and Discussion

The effect of different concentrations and combinations of the selected plant growth regulators were investigated on callus induction from leaf and petiole explants (Table 1 and 2). In consistent with the results presented in Table 3 and 4, explants cultured on medium containing either no plant growth regulators (control) or cytokinins alone produced no callus at all and other different concentrations of IAA/KIN and NAA/TDZ, callus formation from leaf and petiole explants was observed in all hormone combinations after 2 week. In leaf and petiole explants highest callus induction were obtained in the medium containing 0.3 mg l^{-1} IAA with 0.5 mg l^{-1} KIN and 0.6 mg l^{-1} NAA with 0.02 mg l^{-1} TDZ (100%).

Table 1. Different concentrations of the IAA and KIN in MS medium used for callus induction and regeneration in leaf and petiole explants

Medium)mg l ⁻¹ (Hormones	Medium)mg l ⁻¹ (Hormones
R1	0IAA + 0KIN	R11	0.3IAA + 1KIN
R2	0IAA + 0.5KIN	R12	0.3IAA + 1.5KIN
R3	0IAA + 1KIN	R13	0.6IAA + 0 KIN
R4	0IAA + 1.5KIN	R14	0.6IAA + 0.5KIN
R5	0.1IAA + 0KIN	R15	0.6IAA + 1 KIN
R6	0.1IAA + 0.5KIN	R16	0.6IAA + 1.5KIN
R7	0.1IAA + 1KIN	R17	1IAA + 0 KIN
R8	0.1IAA + 1.5KIN	R18	1IAA + 0.5KIN
R9	0.3IAA + 0 KIN	R19	1IAA + 1KIN
R10	0.3IAA + 0.5KIN	R20	1IAA + 1.5KIN

Table 2. Different concentrations of the NAA and TDZ in MS medium used for callus induction and regeneration in leaf and petiole explants

Medium)mg l ⁻¹ (Hormones	Medium)mg l ⁻¹ (Hormones
M1	0NAA + 0TDZ	M16	0.3NAA + 0.1TDZ
M2	0NAA + 0.005 TDZ	M17	0.3NAA + 0.3TDZ
M3	0NAA + 0.02 TDZ	M18	0.3NAA + 0.5TDZ
M4	0NAA + 0.1 TDZ	M19	0.6NAA + 0TDZ
M5	0NAA + 0.3 TDZ	M20	0.6NAA + 0.005TDZ
M6	0NAA + 0.5 TDZ	M21	0.6NAA + 0.02TDZ
M7	0.1NAA + 0 TDZ	M22	0.6NAA + 0.1 TDZ
M8	0.1NAA+ 0.005TDZ	M23	0.6NAA + 0.3TDZ
M9	0.1NAA + 0.02TDZ	M24	0.6NAA + 0.5TDZ
M10	0.1NAA+ 0.1TDZ	M25	1NAA + 0 TDZ
M11	0.1NAA+ 0.3TDZ	M26	1NAA + 0.005TDZ
M12	0.1NAA + 0.5 TDZ	M27	1NAA + 0.02TDZ
M13	0.3NAA + 0TDZ	M28	1NAA + 0.1TDZ
M14	0.3NAA + 0.005TDZ	M29	1NAA + 0.3TDZ
M15	0.3NAA+ 0.02TDZ	M30	1NAA + 0.5TDZ

Table 3. Mean comparison of effects of different combinations of IAA and KIN on different evaluated traits in Leaf and petiole explants

Medium	Leaf explant			Petiole explant		
	Regeneration percentage	Mean number of shoots	Callus induction percentage	Regeneration percentage	Mean number of shoots	Callus induction percentage
R1	0 ^e	0 ^e	0 ^g	0 ^e	0 ^e	0 ^f
R2	0 ^e	0 ^e	0 ^g	0 ^e	0 ^e	0 ^f
R3	0 ^e	0 ^e	0 ^g	0 ^e	0 ^e	0 ^f
R4	0 ^e	0 ^e	0 ^g	0 ^e	0 ^e	0 ^f
R5	0 ^e	0 ^e	0 ^g	0 ^e	0 ^e	0 ^f
R6	25 ^c	0.4 ^e	28 ^e	9.5 ^d	0.09 ^c	43.75 ^c
R7	22 ^c	0.38 ^e	44 ^d	25 ^c	0.37 ^{cd}	68.75 ^b
R8	71 ^a	2.4 ^a	69 ^{bc}	62.5 ^a	1.13 ^a	90.6 ^a
R9	0 ^e	0 ^e	0 ^g	0 ^e	0 ^e	0 ^f
R10	46.8 ^b	1 ^{cd}	100 ^a	3.2 ^e	0.03 ^e	100 ^a
R11	46.8 ^b	1.28 ^{bc}	55 ^{cd}	31.2 ^b	0.59 ^{bc}	60 ^b
R12	50 ^b	1.25 ^{cd}	31 ^e	19 ^c	0.18 ^{de}	37.5 ^d
R13	0 ^e	0 ^e	0 ^g	0 ^e	0 ^e	0 ^f
R14	50 ^b	1.42 ^{bc}	84 ^{ab}	19 ^c	0.18 ^{de}	96.75 ^a
R15	46.8 ^b	1.25 ^{cd}	53 ^{cd}	31.5 ^b	0.81 ^b	62.5 ^c
R16	56 ^{ab}	1.8 ^{ab}	62 ^c	31.2 ^b	0.37 ^{cd}	71 ^b
R17	0 ^e	0 ^e	0 ^g	0 ^e	0 ^e	0 ^f
R18	6.25 ^d	0.13 ^e	59 ^c	3.1 ^e	0.03 ^e	62 ^b
R19	19 ^d	0.15 ^e	31 ^e	9.3 ^d	0.12 ^{de}	43.75 ^c
R20	22 ^c	0.45 ^{de}	13 ^f	3.1 ^e	0.06 ^e	25 ^e

Means with similar letters in each column are not significantly different

Table 4. Mean comparison of effects of different combinations of NAA and TDZ on different evaluated traits in Leaf and petiole explants

Medium	Leaf explant			petiole explant
	Regeneration percentage	Mean number of shoots	Callus induction percentage	Callus induction percentage
M1	0 ^g	0 ^c	0 ^f	0 ^e
M2	0 ^g	0 ^c	0 ^f	0 ^e
M3	0 ^g	0 ^c	0 ^f	0 ^e
M4	0 ^g	0 ^c	0 ^f	0 ^e
M5	0 ^g	0 ^c	0 ^f	0 ^e
M6	0 ^g	0 ^c	0 ^f	0 ^e
M7	0 ^g	0 ^c	0 ^f	0 ^e
M8	0 ^g	0 ^c	0 ^f	0 ^e
M9	0 ^g	0 ^c	0 ^f	0 ^e
M10	22 ^{de}	0.4 ^{bc}	91 ^{ab}	91.6 ^a
M11	30 ^{cd}	0.76 ^{bc}	95.8 ^{ab}	53.5 ^c
M12	75 ^a	3.1 ^a	95.8 ^{ab}	83.3 ^{ab}
M13	0 ^g	0 ^c	0 ^f	0 ^e
M14	0 ^g	0 ^c	16.6 ^e	38 ^d
M15	12.5 ^f	0.29 ^{bc}	83.3 ^{abc}	79.1 ^{ab}
M16	12.5 ^f	0.29 ^{bc}	75 ^{abc}	46 ^{cd}
M17	16.6 ^{ef}	0.26 ^{bc}	58.3 ^{abc}	91.6 ^a
M18	58 ^{ab}	2.3 ^a	70 ^{abc}	87.5 ^a
M19	0 ^g	0 ^c	0 ^f	0 ^e
M20	13.3 ^f	0.43 ^{bc}	79.1 ^{abc}	42 ^{cd}
M21	22 ^{ef}	0.5 ^{bc}	100 ^a	100 ^a
M22	30.1 ^{cd}	0.73 ^{bc}	91.6 ^{ab}	79.1 ^{ab}
M23	30.3 ^{cd}	0.73 ^{bc}	100 ^a	95.6 ^a
M24	46 ^{bc}	2.1 ^a	100 ^a	87.5 ^a
M25	0 ^g	0 ^c	0 ^f	0 ^e
M26	5.3 ^g	0.1 ^{bc}	61 ^{bc}	74 ^{ab}
M27	37 ^c	0.96 ^b	91.6 ^{ab}	70 ^{abc}
M28	18.3 ^{ef}	0.4 ^{bc}	100 ^a	56 ^{bcd}
M29	28 ^{de}	0.56 ^{bc}	100 ^a	71.3 ^{abc}
M30	28 ^{de}	0.59 ^{bc}	100 ^a	77.3 ^{ab}

Means with similar letters in each column are not significantly different

Leaf and petiole explants excised from 4-week-old sterile seedlings were cultured on MS medium containing different concentrations and combinations of KIN with IAA and NAA with TDZ. Explants cultured on medium containing no plant growth regulators (control treatment) and IAA and NAA alone produced no shoots at all in both types of explants. The combination of 0.1 mg l⁻¹ IAA and 1.5 mg l⁻¹ KIN was the most successful of the treatments tested, producing a mean of 2.4 shoots per explant at 71% shoot regeneration frequency in leaf explant and mean of 1.13 shoots per explant at 62.5% shoot regeneration frequency in petiole explants. In leaf explants mean number of shoots per explant was achieved nearly twice more than the petiole explant. The results also showed that the highest regeneration

percentage and the number of regenerated shoots were obtained in the medium containing 0.1 mg l^{-1} NAA and 0.5 mg l^{-1} TDZ in leaf explants (75% regeneration shoots and 3.1 shoots per explant respectively) (Figure 1). No regenerated shoots were produced in the presence of NAA and TDZ plant growth regulators in all combination tested in petiole explant. To identify the relationship between callus induction and shoot regeneration, Pearson's correlation coefficient was computed. Pearson's correlation coefficient identified that callus induction was correlated with shoot regeneration. These variables were positively correlated (0.848), and the correlation was statistically significant at the 0.01 level.

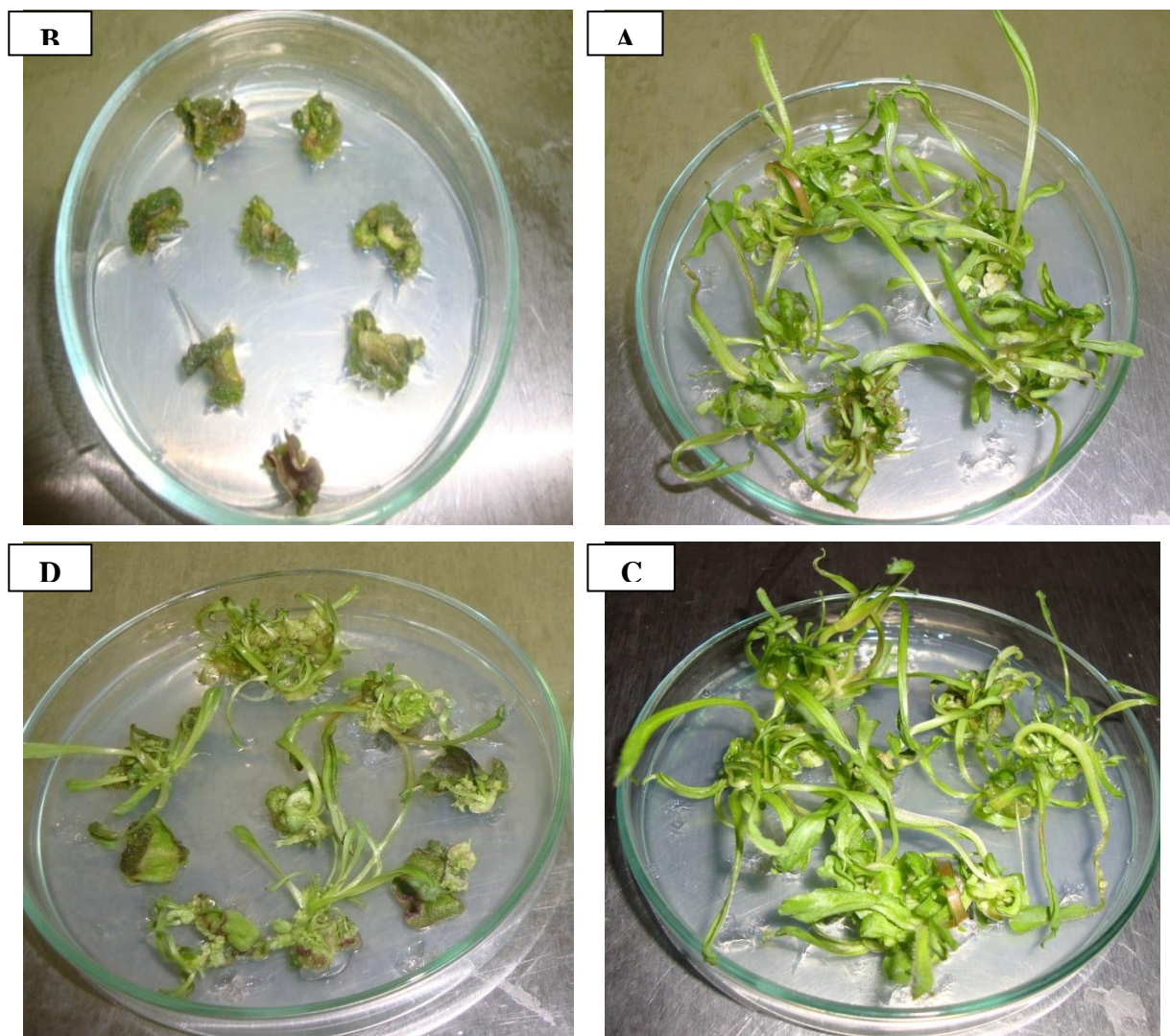

Figure 1.A: Effect of NAA and TDZ on leaf explant regeneration B: Effect of NAA and TDZ on petiole explant callus induction C: Effect of IAA and KIN on leaf explant regeneration D: Effect of IAA and KIN on petiole explants regeneration

Callus induction and shoot regeneration are *in vitro* tissue culture methods, which depend on environmental conditions and plant growth regulators. Optimization of these factors is essential to establish a high frequency of callus induction and shoot regeneration and gene transfer to this plant. Plant growth regulators and types of explant are the most important factors for callus induction and shoot regeneration phases (Mineo, 1990). The application of different concentrations of plant growth regulators had a significant influence on callus development and organogenesis. The response of explants to form callus was seen within two

weeks incubation on callus inducing medium containing different plant growth regulators for both explants (leaf and petiole) of chicory. The same observations were reported by Nandagopal and Ranjitha (2007). In this study, the combinations of IAA/KIN and NAA/TDZ showed a positive effect on cell division for both leaf and petiole explants. Lim *et al.*, (2003) obtained maximum callusing for both explants leaf and petiole of chicory in combination 0.1 mg l⁻¹ IAA and 0.2 mg l⁻¹ TDZ. Yucesan *et al.*, (2007) reported that NAA alone or in combination with 6-BAP produced considerably more callus with green-to-yellowish and highly friable callus. Velayutham *et al.*, (2007) reported that a higher frequency of callus was observed on MS medium supplemented with NAA (1.86 mg l⁻¹) in combination with BAP (0.45 mg l⁻¹). In shoot inducing phase, shoots were produced within three to four weeks. The number of induced-shoots was found to vary in the different combinations of IAA/KIN or NAA/TDZ. High promotion of shoot regeneration in the presence of IAA/KIN or NAA/TDZ in this study is compatible with several reports for different chicory cultivars by Park and Lim (1999); Velayutham *et al.*, (2007); Nandagopal and Ranjitha (2006); Yucesan *et al.*, (2007); Hyeon-Jeon *et al.*, (2009); Geun-Won *et al.*, (2009); Maroufi *et al.*, (2012).

Both direct and indirect shoot regeneration require plant cells to undergo dedifferentiation and redifferentiation, both of which are known to be affected by not only exogenous plant growth regulators but also endogenous content of the hormones (Trigiano and Gray, 2000). Different tissues may have different levels of endogenous hormones and, therefore, the type of explant source would have a critical impact on the regeneration success. In our study, when leaf and petiole explants were compared, it was clear that leaf explants were much more productive for shoot formation than petiole explants, in the combinations of IAA/KIN producing nearly two times more shoots (2.4 shoots per explant compared to 1.13, respectively). In the combinations of NAA/TDZ, highest regeneration percentage and the number of regenerated shoots were 75% regeneration shoots and 3.1 shoots per explant respectively in leaf explants. No regenerated shoots were obtained in the presence of NAA and TDZ plant growth regulators in all combination tested in petiole explant. Park and Lim (1999); Yucesan *et al.*, (2007); also found that leaf segments were more productive for both callus and shoot development than petiole segments although there was a clear genotypic variation among the eight *Cichorium intybus* cultivars tested. Karam and Al-Majathoub (2000) reported that the cells most competent to differentiate into shoots are located at the petiole base, but to express their totipotency, they are dependent on some factors contributed by the leaf. An increased amount of vascular tissue and thus levels of endogenous hormones and metabolites in the leaf might be responsible for the increase in shoot regeneration ability.

References

- Bais, HP, Ravishankar, GA. (2001) *Cichorium intybus* L. cultivation, processing, utility, value addition and biotechnology, with an emphasis on current status and future prospects. *Journal of Science Food and Agriculture*.18:467–484.
- Geun-Won, CH, Dae-Sung, K, Hyeon-Jeong, H, Won Byoung , CHandYoun-Hyung, L. (2009) Plant regeneration from cotyledon explants in leaf chicory (*Cichorium intybus* L. var. foliosum). *Hort. plant tissue organ Environ. Biotechnol.* 1: 40 - 44.
- Hyeon-Jeon, H, Hea-Jung, Jand Geun-Won, CH. (2009) Shoot regeneration from cotyledon explants in root chicory affected by culture temperature and medium composition, *Korean Journal of Horticultural Science and Technology*. 4: 662-667.
- Karam, NS, and Al-Majathoub, M. (2000) Direct shoot regeneration and microtuberization in wild *Cyclamen persicum* Mill. using seedling tissue. *Sci Hort.* 86:235–246.
- Lim, TL, Park EJ, Lee JY, Chun, IJ and An, GH. (2003) High plant regeneration and ectopic expression of OsMADS1 gene in root chicory (*Cichorium intybus* L. var. *sativus*). *Journal of Plant Biotechnology*. 4: 215- 219.

- Mineo, L. (1990) Plant tissue culture techniques. Tested studies in laboratory teachings Proc. ABLE. 11:151-174.
- Murashige, T and Skoog, FA. (1962) A revised medium for rapid growth and bioassays with tobacco tissue cultures. *Physiol Plant*. 15:473–497.
- Nandagopal, Sand RavjithaKumari, BD. (2006) Adeninsulphate induced high frequency shoot organogenesis in callus and in vitro flowering of *Cichorium intybus* L. cv. Focus-apotent medicinal plant. *Acta agriculture slovenica*. 2: 415-425.
- Park, EJ and Lim, HT. (1999) Establishment of an efficient *in vitro* plant regeneration system in chicory (*Cichorium intybus* L. var *sativus*). *Acta Horticulturae*. 483:367–370.
- Patel, VK, and Bhatt, HV. (1985) Toxicity and antiseptic effect of chicory root extract in pyorrea. *Antiseptic*. 31:904–906.
- Rehman, RU, Israr M, Srivastava, PS, Bansal, KC and Abdin, MZ. (2003) *In vitro* regeneration of witloof chicory (*Cichorium intybus* L.) from leaf explants and accumulation of esculin. *In Vitro Cellular & Developmental Biology-Plan*. 39:142–146.
- Trigiano, RN, and Gray, DJ. (2000) *Plant tissue culture: concepts and laboratory exercises*, 2nd edn. CRC Press. 430 pp.
- Velayutham, P, Ranjithakumari BD and Baskaran, P. (2006) An efficient *in vitro* plant regeneration system for *Cichorium intybus* L. an important medicinal plant. *Journal of Agricultural Technology*, 2: 287-298.
- Yucesan, B, Turker AU and Gurel, E. (2007) TDZ-induced high frequency plant regeneration through multiple shoot formation in witloof chicory (*Cichorium intybus* L.). *Plant Cell tissue organ Culture*. 91: 243-250.
- Zafar, Rand Ali, SM. (1998) Anti-hepatotoxic effects of root and callus extracts of *Cichorium intybus* L. *Journal of Ethnopharmacol*. 63:227–231

WILD ALMOND SPECIES IN TURKEY AND USE OPPORTUNITIES

Safder BAYAZIT^{1*}, Oguzhan CALISKAN¹

¹Mustafa Kemal University, Faculty of Agriculture, Department of Horticulture, Antakya, Hatay, Turkey

*Corresponding author: sbayazit@mku.edu.tr

Abstract

Due to the suitable climatic conditions, Turkey is one of the most important growing center for wild and domesticated species/varieties of almond. Because of the adaptability of wild almond species to severe environmental conditions and resistance to drought, salinity and some pest and diseases, these can be used as rootstock for almond cultivars and in breeding programs for rootstock improvement in Turkey. In this review, we evaluated the distribution of *A. orientalis*, *A. turcomanica*, *A. arabica* and *A. webbii* almond species in Turkey and its potential as a multi-purpose crop. These species are naturally widespread as genetic resources in many regions of Turkey. Seedlings of these species can be used for dwarf rootstocks for almond cultivars due to them are growing weak. In addition, the species show a great tolerance to abiotic stresses such as drought, salinity, low soil fertility and low winter temperatures; therefore the species may present an important genetic resource to be used for development of new cultivars and rootstocks that are more adapted to differ climate change in almond breeding programs.

Keywords: *wild almond, species, breeding, rootstock*

Introduction

Turkey is located at a significant position in the world from the viewpoint of plant genetic resources and genetic diversity. It is scientifically agreed that two of the centers of diversity and centers of origin; the Near Eastern and the Mediterranean overlap at Turkey. Turkey is the meeting ground of three phytogeographical regions; Euro-Siberian, Mediterranean and Irano-Turanian. Due to its great variety in geomorphology, topography and climate, Turkey has large diversity of habitats so it is very rich in plant species and endemism. Based on the information given by Davis et al. (1988) the number of native ferns and seed plant species were stated as 8.745 by Kaya et al. (1998), 2.763 of which are endemic. In addition to these figures about 1.000 new species were listed by Güner et al. (2000). Altogether the number comes to a total of approximately 10.000.

The cultivated almond [*Prunus dulcis* (Mill.) D.A. Webb syn. *P. amygdalus* (L.) Batsch] belonging to *Rosaceae* family, subfamily *Prunoideae*, is originated from Central Asia (Grasselly, 1976). Wild populations of almond species representing a wide range of morphological characteristic have been widely spread in these areas (Browicz and Zohary 1996; Kester and Gradziel 1996). Turkey is especially rich in native germplasm of these wild species such as *A. orientalis*, *A. turcomanica*, *A. webbii* and *A. arabica* that are naturally distributed throughout the country (Bayazit, 2007; Bayazit et al., 2011). These wild species relative of almond play a socio-economical and ecological role in this region (Bayazit, 2007). They not only have been used as direct consumption, but also have been used as a rootstock, and in semi-desert areas to control soil erosion and to stabilize water sheds (Mortazavi 1986). Wild species also provide an extended germplasm for breeding improved cultivars, contributing useful traits such as late bloom, self fertility, and drought and salinity tolerance (Denisov 1988; Gradziel et al. 2001). Recent studies have been performed using morphological and pomological, molecular markers for the genetic characterization of these Turkish wild *Amygdalus* species (Martinez-Gomez et al. 2003; Bayazit, 2007).

The genus *Amygdalus* L. contains some 26 well defined species (Table 1), as well as a long list of additional binomials.

Table I. Species in *Amygdalus* L. and their taxonomic grouping (Kester et al., 1991; Ladizinsky, 1999)

Subgenus <i>Amygdalus</i>	
i. Section <i>Amygdalus</i> [Syn.: Sect. <i>Euamygdalus</i> Spach]	
<u>a. <i>Communis</i> species group</u>	
<i>A. communis</i> L. [including <i>A. korshinskvi</i> (Hand,-Mazz.)Bornm]	<i>A. browic-ii</i> Freitag [including <i>A. zabilica</i> Seraf.]
<i>A. trichamygdalus</i> (Hand,-Mazz.) Woronow	<i>A. kuramica</i> Korsh.
<i>A. fenzliana</i> (Fritsch) Lipsky	<i>A. bucharica</i> Korsh
<i>A. webbii</i> Spach	<i>A. tangutica</i> (Batalin) Korsh. [including <i>A. dehiscens</i> Koehne]
<i>A. haussknechtii</i> (C. Schneider) Bornm	
<u>b. <i>Orientalis</i> species group</u>	
<i>A. orientalis</i> Duhamel	<i>A. kotschyi</i> Boiss. & Hohen
<i>A. graecae</i> Lindley	<i>A. carduchorum</i> Bornm
<i>A. elaeagnifolia</i> Spach [including <i>A. leiocarpa</i> Boiss.]	<i>A. mongolica</i> Maxim
ii. Section <i>Chamaeamygdalus</i> Spach	
<i>A. nana</i> L	<i>A. ledebouriana</i> Schlecht.
<i>A. georgica</i> Desf.	<i>A. petunnikovii</i> Litv.
iii. Section <i>Spartioides</i> Spach	
<i>A. arabica</i> Olivier [including <i>A. agrestis</i> Boiss.]	<i>A. scoparia</i> Spach
2. Subgenus <i>Dodecandra</i> (Spach) Browicz [Syn : Sect. <i>Lycioides</i> Spach]	
<i>A. lycioides</i> Spach [including <i>A. horrido</i> Spach];	<i>A. spinosissima</i> Bunge [including <i>A. turcomanica</i> Lincz.]
<i>A. ebutnea</i> Spach	<i>A. brahuica</i> Boiss.
<i>A. enoclada</i> Bornm.	

Properties and distribution of the almond species in Turkey

There are several wild almond species in Turkey included *Amygdalus orientalis* (Mill.), *Amygdalus turcomanica* (Lincz.), *Amygdalus fenzliana* (Fritsch) Lipsky, *Amygdalus trichamygdalus* (Hand.-Mazz.) Woronow, *Amygdalus arabica* (Olivier), and *Amygdalus webbii* (Spach). These species offer a great value for the almond improvement; we studied the distribution area on Turkey and morphological and pomological properties of these almond species. Distribution areas and properties of naturally grown almonds species in Turkey are provided below.

***Amygdalus trichamygdalus* (Hand.-Mazz.):** A narrowly distributed East Anatolian species, and one of the least known members of the *Communis* group. Only a few scattered stands of this wild almond have been discovered up to date in eastern Turkey and in adjacent areas in Iran. They grow on limestone slopes and in rock gorges at 1250-1900 (-2100) m elevation. Spineless shrubs up to 3 m tall (sometimes small trees) closely resembling *A.*

communis but with characteristic short-petioled leaves, bearing relatively large (3.0 × 2.0 cm) compressed fruits (Browicz & Zielifiski, 1984).

***Amygdalus fenzliana* (Fritsch) [Syn.: *Prunus fenzliana* Fritsch]:** A subspinescent shrub usually 2-3 m tall (and more rarely a small tree up to 4 m height), with rather large (2.5 x 1.5 cm) tomentose fruits. A Caucasian element extending to northeast Turkey and northwest Iran and Armenia growing mainly in stony or rocky slopes occupied by sparse xerophytic woody vegetation or in open steppe communities, mostly between 700-1800 m altitude (Browicz & Zielifiski, 1984). Nuts are small, flat, and hard shelled. The shell surface has sparse, shallow holes. Kernels are bitter (Kester et al., 1991).

***Amygdalus webbii* Spach, [Syn.: *A. salicifolia* Boiss. & Bal.]:** Much branched spinose shrubs or small trees usually attaining the height of 2-3 m. A very variable wild almond in terms of leaf size and fruit shape, with linear oblong to lanceolate leaves and relatively small fruits. A Balkano-Anatolian species, extending to Puglia district in south Italy and to Sicily. It was also reported growing spontaneously in Spain (Felipe & Socias i Company, 1977). According to the Vlasic (1977). This primarily European species occurs in a range extending from western Turkey into the balcan peninsula including Greece, Bulgaria, and Yugoslavia. *A. webbii* grows in open sunny places in limestone rocks or gravelly slopes from sea level up to 900 m altitude. Few stands were recorded up to 1200-1600 m (Browicz & Zielifiski, 1984).

***Amygdalus graeca* Lindley, [Syn.: *A. discolor* (Spach) *Prunus discolor* (Spach)]:** A shrub or small tree 1-4 m tall, resembling *A. orientalis* in its growth form but more spinescent and with glabrous dorsal leaf surface. The main range of *A. graeca* is in southwest Anatolia and in some of the adjacent Greek Islands, particularly Rhodos. *A. graeca* reappears in Aleppo district, Syria and near Ankara, Turkey, but in these localities it is represented only by few stands. *A. graeca* is a xerophylous shrub growing on rocky calcareous slopes mainly in phrygana-type vegetation. In few places (in Anatolia) it occurs side by side with *A. orientalis*. However such contacts are relatively rare since *A. graeca* is distinctly a low altitude plant, growing mainly at altitudes ranging from 10 to 500 m (Browicz & Zielifiski, 1984).

***Amygdalus kotschyi* Boiss. & Hohen., [Syn.: *Prunus kotschyi* (Boiss. & Hohen.)]:** A small subspinescent shrub scarcely 30-45 cm tall, characterized by very dense, soft, long, yellowishgrey hairy cover on the shoots, leaves and fruits. A montane species confined mostly to the Zagros mountain range of west Iran and north Iraq as well as few sites in southeast Anatolia. It grows on limestone rocks, bolders and screes and in dry and open places in the upper margins of the oak and pistachio park-forest zone, and also in the thorny cushion-type vegetation above the forest belt, in altitudes between 1800 and 2500 m (Browicz & Zielifiski, 1984).

***Amygdalus carduchorum* Bornm., [Syn.: *Prunus carduchorum* (Bornm.)]:** A small subspinescent shrub 0.5-1.0 m high with narrow, lanceolate or linear leaves and with globose or ovate-globose slightly compressed up to 15 mm long fruits. A narrowly distributed montane species, restricted to a small area in North Iraq on the border between Turkey, Iraq and Iran. It occurs mainly close to the upper limits of the oak park-forest belt, and in the zone of the thorny cushion-type vegetation above it, growing on rock slopes and screes, in open places or in degraded oak forests in altitudes between 1500 and 3000 m (Browicz & Zielifiski, 1984).

***Amygdalus arabica* Olivier, [Syn.: *A. spartioides* Spach, *Prunus spartioides* (Spach)]:** *A. Arabica* is a Near Eastern plant. Its range covers southeastern Anatolia, Iraq and Syria. An erect, broom-like shrub up to 1.5-2.5 m in tall, characterized by stiff, long, permanently green, glabrous, angled branches. Throughout most of the year the shrubs are leafless since they shed their leaves at the beginning of the dry season. This almond grows on dry bare limestone rocks and sandstone cliffs, both in lowland and in hilly terrains. In the

northern parts of its distribution it occurs in degraded oakwoods, while in the more arid south it enters forest-steppe, steppe and semi-desert formations. *A. arabica* is also found in sandy places and in wadi beds. Its altitude range is between 150-1200 m, rarely up to 1500 m (Browicz & Zielifiski, 1984). In Turkey, this species can be found in rocky and mountainous areas (about 400 m to 1500 m), steppes, and semiarid to arid habitats. They may grow in a wide range of habitats including stony to sandy slopes, dry valleys of Adiyaman and Gaziantep cities in southeastern region (Atli, 2008).

***Amygdalus spinosissima* Bunge. [Syn.: *Prunus spinosissima* (Bunge)]:** A very prickly shrub, 1.5-2.0 m tall or rarely a small tree. The first year twigs are purple-red and lustrous, the older twigs are grey while the bark of well developed trunks is almost black. The fruits are variable, up to 2 cm long. Two subspecies have been recognized in this almond: Relatively taller forms (subsp. *spinosissima*), with long-ovate to ovate lanceolate and more or less flattened drupes occur in the eastern part of this species range. Somewhat lower forms (subsp. *turcomanica* (O. Lincz.) Browicz.), with smaller and globular fruits grow in the west part of the range (Browicz & Zielifiski, 1990).

***Amygdalus turcomanica* Linczis:** Essentially the same species as *A. spinosissima* but grows at a lower elevation (Denisov, 1988). Typically, the plants are small bushes (1 to 1.5 m) very thorny and adapted to extreme xerophytic conditions of Gaziantep and Şanlıurfa cities of Turkey. Leaves are very small and dark green color. Nuts are very small and generally round shape (Bayazit, 2007).

***Amygdalus orientalis* Duhamel, [Syn. *A. argentea* Lam., *Prunus argentea* (Lam.) Rehder]:** A subspecies shrub 1-2(3) m tall, characterized by white tomentose shoots, leaves and fruits, particularly when of young age. The fruits are very variable in size and shape. *A. orientalis* is a Near East species. In northeast Iraq and in south and central Anatolia it is one of the most common wild almond species. Specimens with large (up to 3 cm) and much flattened fruits occur in the southern part of its distribution range. *A. orientalis* mainly occupies open, sunny niches such as sandy hills covered with steppe or steppe forest vegetation, loose gravel and limestone cliffs or rock slopes. *A. orientalis* is a low altitude plant, growing mainly in altitudes between 600 and 1200 m (Browicz & Zielifiski, 1984) nuts are small, hard shelled and have grooved (Kester et al., 1991). According to the Bayazit and Küden (2007) *Amygdalus orientalis* is widely grown in Middle and Southeast Anatolia while *A. turcomanica* is prevalent in the Southeast Anatolia region. Nut weights of *A. orientalis* types were higher than those from *A. turcomanica* types in Birecik, Şanlıurfa. Types of *A. orientalis* had higher kernel weight and nut length and lower shell thickness compared to types of *A. turcomanica*. Types of *A. orientalis* from Middle Anatolia had higher nut and kernel weight, nut width and length, shell thickness compared to types from Southeast Anatolia region. All types had bitter kernel in both species and regions (Table 2).

Table 2. Fruit quality and pollen characteristics of important almond species (Bayazit et al., 2011; Bayazit et al., 2012)

Species	NW (g)	KW (g)	NWI (mm)	NL (mm)	PV	PN/A	PN/F
<i>A. orientalis</i> (Southeast Anatolia)	0.46	0.19	8.70	17.10	82.8	2185	46.114
<i>A. orientalis</i> (Central Anatolia)	0.85	0.27	11.54	21.74	72.90	873.1	13.410
<i>A. turcomanica</i> (Southeast Anatolia)	0.46	0.18	9.18	13.43	84.1	1932	25.557

NW; nut weight, KW; kernel weight NWI; nut width, NL; nut length, PV; pollen viable, PN/A; pollen number/Anther, PN/F; pollen number/flower

Potential usage of almond species for horticulture

Several almond species such as *A. orientalis* (Mill.), *A. turcomanica* (Lincz.), *A. fenzliana* (Fritsch) Lipsky, *A. trichamygdalus* (Hand.-Mazz.) Woronow, *A. arabica* (Olivier), and *A. webbii* (Spach) are found in Anatolia. Some of these species has been partly domesticated and they might offer some possibilities for horticultural utilization. For example, Kester and Gradziel (1996) reported that immense possibilities exist for rootstock improvement through the use of other almond species either by direct selection within the species or by their hybridization with almond cultivars. Thus, these species are important germplasm sources of almond and their wide genetic diversity present among related almond species provides an enlarged pool of available germplasm that has not been sufficiently exploited. There is not any important restriction regarding hybridization and backcrossing of species in almond breeding studies involving the species present in Anatolia.

Successful almond production under different ecological region and conditions requires breeding of resistant individuals. For these purposes; *A. davidiana* (Carr.) and *A. mira* Koehne are used for disease resistance of peach and self-fertile cultivars of almond,

A. orientalis is used for cold resistance and self-fertile cultivar breeding of almond,

A. bucharica Korschinsky is used self fertile cultivars of almond, cold resistance breeding of cultivars and crown development control of almond,

A. kuramica Korschinsky is used for development of self-fertile types and breeding disease resistance of almond,

A. webbii (Spach) is used for breeding self-fertile cultivars and crown development control of almond (Kester and Gradziel, 1996; Gradziel *et al.*, 2001). In contrast with most other almond species, at least some populations (or individuals) of *A. webbii* are self-fertile (Socias i Company, 1990). It was suggested that also the rare self-compatible almond cultivars acquired their self-fertility through hybridization with local *A. webbii* (Socias i Company, 1990).

Among the wild almond species of Turkey, *A.orientalis* is present at the Central and Southeast Anatolia Regions, while *A. turcomanica* is present in Southeast Anatolia Region. High lime content along with very low yearly precipitation (around 340 mm) is typical for Southeast Anatolia Region. Being present under these conditions suggest that these species might be tolerant against unfavorable soil conditions such as lime, rocky soil and drought. The plants of *A. orientalis* present under Central Anatolia Region had an average plant height of 151 cm while they had an average of 238 cm plant height under and Southeast Anatolia Region (Bayazit and Küden, 2007). These averages suggest that this is a relatively short species and might have a potential for a dwarfing rootstock. Indeed, Atlı (2008) reported that *A. orientalis* can be utilized as a rootstock for cultivated almond without any incompatibility problem. The researchers also reported that while ‘Nonpareil’ grafted on ‘Texas’ gave an accumulative yield of 83.8 kg at the end of the 4-yr period, ‘Nonpareil’ grafted on *A. orientalis* gave 351.1 kg for the same time interval. Both *A. turcomanica* and *A. orientalis* are known as late flowering almond species. Bayazit (2007) reported that the flowering date of *A.turcomanica* was 3-7 d later than those of *A. orientalis* suggesting a possible avoidance against late spring frosts as well.

Conclusion

Turkey is one of the genetic centers for almond species. In the present, more than 9 *Almond* species have been identified in Turkey. Especially, *A. orientalis*, *A. webbi* and *A. turcomanica* genotypes are found to be promising for rootstocks breeding programs. Seeds and seedlings are also serving as rootstocks for almond cultivars. Shrubs of this species show great tolerance to abiotic stresses such as drought, salinity, low soil fertility and low winter temperatures; therefore these species may present an important genetic resource to be used in

breeding programs to generate new cultivars and rootstocks that are more adapted to climate change. Another feature of this almond species are to be dwarf compared to *A. communis*. Therefore also be used in breeding dwarf rootstock.

References

- Atlı, H.S. (2008). Determination of rootstocks characterizations of *Amygdalus orientalis* Mill, types. Publication N° 37. 14 p. Republic of Turkey, Ministry of Agriculture and Rural Affairs, General Directorate of Agricultural Research.
- Bayazit, S. (2007). Phenological, morphological, pomological and molecular characteristics of the wild almond genotypes collected from different ecotypes of Turkey. (Ph.D. Thesis), p: 309. Department of Horticulture, Institute of Natural and Applied Sciences, University of Çukurova, Turkey.
- Bayazit, S., Caliskan, O., Imrak, B. (2011). Comparison of pollen production and quality characteristics of cultivated and wild almond species. *ChileanJar*, 71(4); 536-541.
- Bayazit, S., Küden, A.B. (2011). Fruit Characteristics of Some Selected *A. orientalis* Mill. and *A. turcomenica* Lincz. Types. Vth IS on Pistachios and Almonds. 912, 415-422.
- Bayazit, S., Imrak, B., Caliskan, O. (2012). Determination of Pollen Production and Quality attributes of some Almond Cultivars (*Prunus dulcis*) and Selected Wild Almond (*Amygdalus orientalis*) Genotypes. *Int. J. Agric. Biol*, 14(3); 425-429.
- Browicz, K., Zielifiski, J. (1984). Chorology of trees and shrubs in south-west Asia and adjacent regions, Vol. 4. Polish Scientific Publishers, Warszawa-Poznani. 80 p.
- Browicz, K., Zohary, D. (1996). The genus *Amygdalus* L.: Species relationships, distribution and evolution under domestication. *Genetic Resources Crop Evolution*, 43: 229-247.
- Davis, P.H., Mill, R.R., Tan, K. (1988). *Flora of Turkey and the East Aegean Islands*, vol. 10, Edinburgh University Press, 590p.
- Denisov V.P. (1988). Almond genetic resources in the USSR and their uses in production and breeding. *Acta Horticulturae*, 224: 299-306.
- Felipe, A.J., Socias i Company, R. (1977). A wild almond, *A. webbii* probably not even mention Spain 3rd Symposium of the research group and mediterranean tenepour the pistachio and almond GREMPA, CIHEAM. Bari, Italy. 78-79.
- Güner, A., Özhatay, N., Ekim, T., Başer, H.C. (2000). *Flora of Turkey and the East Aegean Islands*, Vol.11, Edinburgh Univ. Press. Edinburgh.
- Gradziel, T.M., Martínez-Gómez, P., Dıcenta, F., Kester, D.E. (2001). The utilization of *Prunus* species for almond variety improvement. *Journal American Pomological Society*, 55: 100-108.
- Grasselly, C. 1976. Origin and Evolution of the almond tree grow. *Mediterranean options Origine*, 32: 45-49.
- Kester, D.E., Gradziel, T.M. Grasselly, C. (1991). Almond (*Prunus*) In: *Genetic Resources of Temperate Fruits and Nut Crops*. Morre, J.N. and Ballington, I.R. (Eds). Intl. Soc. Hort. Sci. Wageningen, p 701-758.
- Kester, D.E., Gradziel, T.M. (1996). Almonds In: *Fruit Breeding*. Janick, J., Moore, J.N. (Eds)., vol. III. Nuts'. John Wiley and Sons: New York, p 1-97.
- Ladizinsky, G. (1999). On the origin of almond. *Genetic Resources and Crop Evaluation*. 46:143-147.
- Martínez-Gómez P., Arulsekhar, S., Potter, D., Gradziel, T.M. (2003). Relationships among peach and almond and related species as detected by SSRs. *Journal of the American Society for Horticultural Science*, 128: 667-671.
- Mortazavi, M. (1986). Problems of grafting of cultivated almond on wild almond. *Iranian Scientific and Specific Journal in Agriculture "Zeitun"*, 71: 15-21.

- Vlasic, A. (1977). L'*Amygdalus webbii* Spach ed i suoi ibridi col pesco corn portaninnerstro del mandrolo. 3 e Colloque du groupe de recherche et d'etude m6diterran6ene pour le pistachier et l'amandier GREMPA, CIHEAM. Bail, Italy. pp. 80--81.
- Watkins, R. (1976). Chery, plum, peach, apricot and almond. In: Simmonds, N.W. (Ed.), Evolution of Crop Plants. Longman, London. p. 342-347.

GENETIC DIVERSITY OF ORNAMENTAL PEACH FROM NIKITA BOTANICAL GARDENS COLLECTION STUDIED BY AFLP-ANALYSIS

Larisa KOMAR-TYOMNAYA^{1*}, Aya TRIFONOVA²

^{1*}Nikita Botanical Gardens - National Scientific Center, Russian Academy of Sciences, Yalta, Russia

²Institute of General Genetics, named N. I. Vavilov, Russian Academy of Sciences, Moscow, Russia

*Corresponding author: larissadkt@mail.ru

Abstract

Among the flowering trees, ornamental peaches are important as landscape dominants in early spring. The genetic similarity of 23 ornamental peach genotypes, originated from *Prunus mira*, *P. davidiana*, *P. persica* and *P. kansuensis* was studied by AFLP-analysis. Eight (8) combinations of primer/enzyme were used in the study. Totally, 162 fragments including 90 (56.2%) polymorphic ones were obtained. Primer combinations with three selective nucleotides (E41/M59, E36/M61, E45/M59) were the most informative. Jaccard similarity coefficient ranged from 0.52 to 1. The analysis by the method of principal coordinates demonstrated that *P. persica* cultivars were quite similar and clustered in two compact groups on the graph. The first group included pink-flower cultivars 'Yu Tao', 'Vesna', 'Yugoslavsky Decorativny' and 'Assol'. The second group combined 'Manific' and its seedlings, 'Iransky Decorativny', 'Iransky Pestrotsvetkovy', 'Bi Tao' and 'Sahong Tao', with red, pink and variegated colorings, similar in the shape of flowers. Wild species *P. mira* and its cultivar 'Lel', *P. davidiana* and its cultivars 'Alba' and 'Belosnezhka', hybrid of *P. kansuensis* 'Malenky Prince' were at a significant distance from *P. persica* cultivars, on the graph. Hybrid cultivars 'Zhisele', 'Ruthenia', 'Decorativny Ryabova', 'Mily' and 'Lubava' were intermediate between wild species and *P. persica* cultivars but more similar to the group of wild peaches. Thus, AFLP-analysis demonstrated genetic remoteness of wild species from *P. persica* cultivars, the close relationships between wild peach and 8 hybrid cultivars originated from those species and also 2 groups of closely related *P. persica* cultivars obtained from different regions of introduction.

Key words: *breeding, DNA, cultivar, hybrid, identification*

Introduction

Ornamental peaches have been grown since ancient times in China and other countries in South-East Asia. From there they spread to Persia, and then to the gardens of European countries, where are cultivated for more than three centuries (Bean, 1950). Since the late of 19th century peaches from China began to be collected on the American continent (Werner and Okie, 1998). Showy flowering peaches with double flowers of white, rose, red and variegated colors found its admirers and it is widespread in the world. Now these plants can be found in every country, wherever the cultivation of peaches exists. In the Botanical gardens and breeding centers new and original varieties have been obtained (Hu and Zhang, 2001; Komar-Tyomnaya, 2015; Yoshida M. *et al.*, 2000; Jacobson, 1996; Dumitru *et al.*, 2006). As a result of the introduction and breeding programmes considerable gene pool of ornamental cultivars was accumulated, genetic relationships of which are not always precisely known. There are cases when the cultivar falls into the collection without a name, under a wrong name or name information is lost, and the descendants of the varieties continue to engage in breeding practice. Modern methods of DNA-genealogy help to establish the validity in such cases. One of them is the method of analysis of amplified fragment length polymorphism (AFLP-analysis). AFLP-analysis is informative and effective method for studying genetic polymorphism at intraspecific and interspecific levels, determination the

degree of relationship of different cultivars groups of varieties, as well as in other practical purposes. The positive results of using this method for ornamental peach has been demonstrated by D. Hu *et al.* (2005) in the study of ornamental peach taxa from the collections of the Beijing Botanical Garden (China), National Institute of Fruit Tree Science (Tsukuba, Japan), the JC Raulston Arboretum, and North Carolina State University (USA). The aim of this study was to investigate the genetic similarity of the genotypes of ornamental peach from the collection of Nikita Botanical Garden (NBG-NSC), the relationship between them were unknown, questionable, or required confirmation.

Materials and methods

Plant material. The genetic similarity of 23 ornamental peach genotypes, originated from *Prunus mira*, *P. davidiana*, *P. persica* and *P. kansuensis* were included in the study. The 13 accessions bred in Nikitsky Botanical garden, had famous parents or at least a female form (Table 1). Other everywhere accessions were obtained from various regions in different years. The real name of some of them was not always known and it was given by us conditionally according to the region of introduction. All plants are characterized by upright crown and semi-double or double flowers, with the exception *P. mira*, *P. davidiana*, *P. davidiana* 'Alba' and 'Decorativny Ryabova' with five petals.

DNA extraction. DNA was extracted from leaves of germinated cuttings of peach plants by the method of Puchooa (2004).

AFLP-procedure. AFLP-analysis was performed by the standard method (Vos *et al.*, 1995). Genomic DNA of each sample hydrolyzed with restriction enzymes EcoRI and Me (NEB). In this study we used different combinations of EcoRI/Me primers with one selective nucleotide on the 3'end for the first round PCR, with three or four selective nucleotides for the second round). Primer sequences are given on the Standard List for AFLP® Primer Nomenclature. Fractionation of amplification products was performed by polyacrylamide gel electrophoresis. Electrophoresis in polyacrylamide gel was carried out in the chamber Sequi-Gen® GT Sequencing Cell (BIO-RAD) using the 3000/300 POWER SUPPLY (BIO-RAD), with small deviations from the protocol of the manufacturer. As a buffer system was used TBE. Gel was showed by the method 3 of Benbouza *et al.* (2006).

AFLP data analisis. The presence (absence) of the amplification products on the gel were detected visually, the results are recorded in a binary matrix (1 is the presence of a fragment, 0 – no). Statistical data processing was performed using the program PAST 1.67 b, which carried out the calculation of the Jaccard similarity coefficient between pairs of samples. Based on the matrix of similarity the analysis was done by the method of Principal Coordinate Analysis.

Results and discussion

In general, the resulting AFLP-analysis of 23 samples of ornamental peach using 8 primer combinations 162 fragment were obtained, of which 90 (56.2%) were polymorphic (Table 2). The number of DNA fragments detected by various primer combinations ranged from 17 to 30. The largest number and the clearest specters were obtained by use E41 / M59 primer combination. Combinations of primers with three selective nucleotides were more informative. The number of polymorphic fragments ranged from 6 to 23 for one primer combination. The level of polymorphism ranged from 35.3% (for the primer combinations E45 / M50) to 76.7% (for the primer combinations E41 / M59).

Table 1. Species, cultivars and hybrids of ornamental peach, studied by the method of AFLP-analysis.

Species, cultivars and hybrids	Country of origin	Parentage	Number in the study
<i>Prunus davidiana</i> and cultivars			
<i>P. davidiana</i>	China	<i>P. davidiana</i>	21
<i>P. davidiana</i> var. <i>alba</i>	China	<i>P. davidiana</i> var. <i>alba</i>	1
'Belosnezhka'	Russia, NBG-NSC	<i>P. persica</i> 'Vostorg' x <i>P. davidiana</i> var. <i>alba</i>	2
'Mily'	Russia, NBG-NSC	<i>P. persica</i> 'Vostorg' x 'Nectadiana 26-76' (<i>P. persica</i> var. <i>nucipersica</i> 'Lola' x <i>P. davidiana</i>)	12
<i>P. mira</i> and cultivars			
<i>P. mira</i>	China	<i>P. mira</i>	20
'Zhizele'	Russia, NBG-NSC	<i>P. mira</i> x 'Effect' (F ₄ <i>P. mira</i> free polination)	13
'Lel'	Russia, NBG-NSC	'Vesna' x <i>P. mira</i>	23
'Lyubava'	Russia, NBG-NSC	<i>P. mira</i> x <i>P. persica</i>	4
'Decorativny Ryabova'	Russia, NBG-NSC	<i>P. mira</i> x <i>P. amygdalus</i>	11
'Ruthenia'	Russia, NBG-NSC	'Vesna' x 'Decorativny Ryabova'	14
'Vesna'	Russia, NBG-NSC	F ₄ <i>P. mira</i> free polination	6
<i>P. kansuensis</i> cultivar			
'Malenky Prince'	Russia, NBG-NSC	<i>P. persica</i> 'Vostorg' x <i>P. kansuensis</i>	22
<i>P. persica</i> cultivars			
'Assol'	Russia, NBG-NSC	<i>P. persica</i> , ornamental cultivars free pollination	18
'Yugoslavsky Decorativny'*	Yugoslaviya	<i>P. persica</i> , unknown	15
'Yu Tao'	Japan	<i>P. persica</i> , unknown	3
'Manific'	France	<i>P. persica</i> , unknown	5
'Adalary v Snegu' – red	Russia, NBG-NSC	<i>P. persica</i> 'Manific' free pollination	7
'Adalary v Snegu' – pink	Russia, NBG-NSC	<i>P. persica</i> 'Manific' free pollination	9
'Adalary v Snegu' – versicolor	Russia, NBG-NSC	<i>P. persica</i> 'Manific' free pollination	17
'Iransky Decorativny'*	Iran	<i>P. persica</i> , unknown	16
'Iransky Pestrocvetkovy'*	Iran	<i>P. persica</i> , unknown	8
'Bi Tao'	China, Beijing Botanical Garden	<i>P. persica</i> , unknown	19
'Sahong Tao'	China, Beijing Botanical Garden	<i>P. persica</i> , unknown	10

* - the name is not original.

Table 2. Information indicators of primer combinations.

Primer combinations	The total number of fragments in the spectrum	The number of polymorphic fragments in the spectrum	Polymorphic loci, %
E32/M50g	26	14	53.8
E32/M52a	17	9	52.9
E32/M52g	19	7	36.8
E36/M59	21	11	52.4
E36/M61	18	12	66.7
E41/M59	30	23	76.7
E45/M50	17	6	35.3
E45/M59	14	9	64.3
In total	162	90	56.2

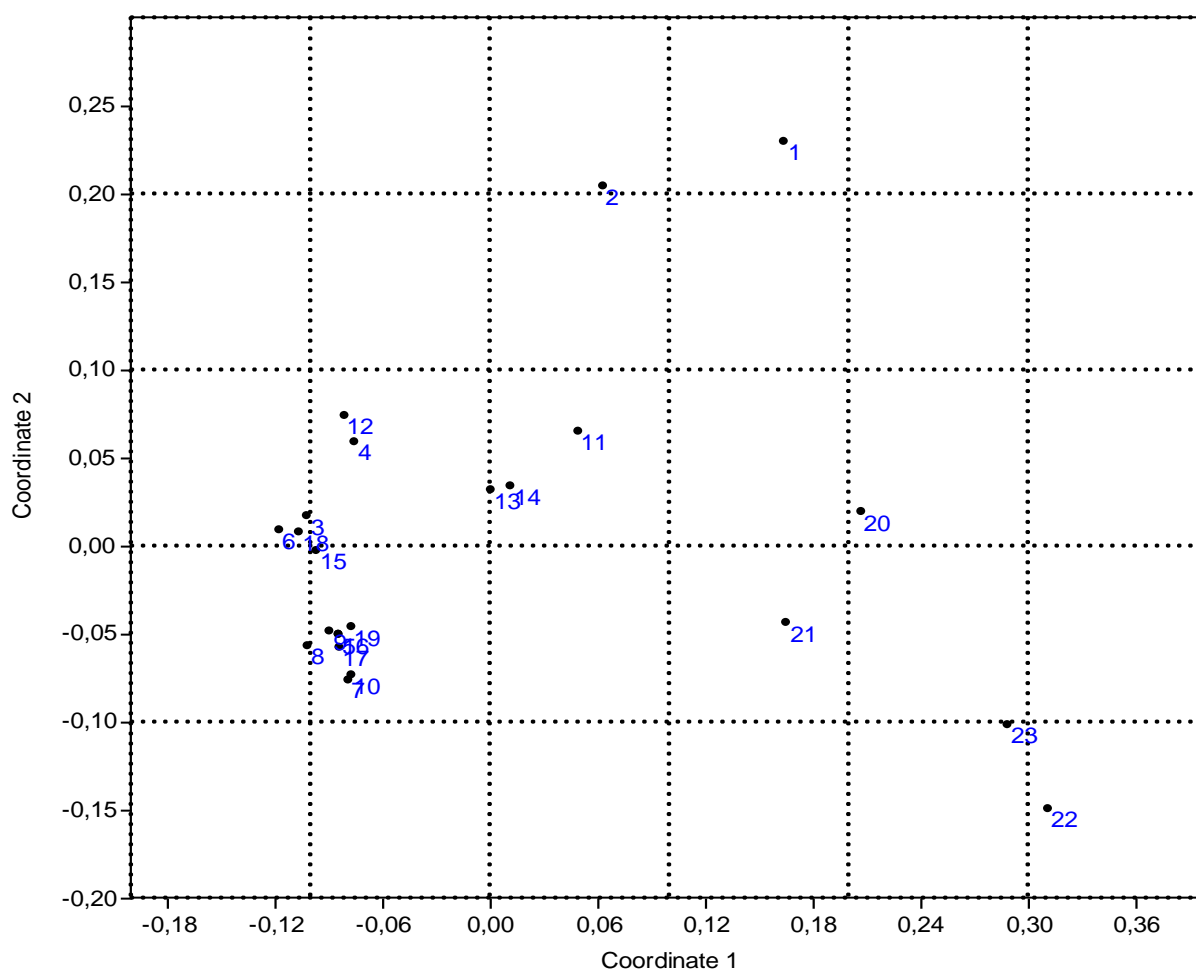

Fig. 1. Principal Coordinate Analysis of ornamental peach according to AFLP-analysis.

Jaccard similarity coefficient ranged from 0.52 (between *P. kansuensis* 'Malenky Prince' and complex hybrid of *P. mira* and *P. persica* 'Lyubava') to 1 (between cultivars *P. persica* 'Manific' and 'Iransky Decorativny'). This result is quite expected; typically varieties differences are smaller than differences between species.

Data obtained by us are consistent with the results of other authors. Thus, D. Hu and X. Zhang (Hu and Zhang, 2005) in the study of 51 samples of ornamental peaches showed that the genetic differences ranging from 0.044 (between *P. persica* cultivars) to 0.4 (between *P. persica* and *P. davidiana*).

The method of Principal Coordinate Analysis showed that the cultivars with *P. persica* morphotype are quite similar and form on the graph two compact groups. The first group includes pink-flowers cultivars 'Yu Tao', 'Vesna', 'Yugoslavsky Decorativny', 'Assol', despite the fact that they have different geographical origins and vary in shape of a flower. Of these, the most important for us was to determine the genealogical relationship of cultivar 'Vesna', which by the breeding book was listed as a descendant of *P. mira* (F₄ *P. mira* free polination). AFLP-analysis showed a significant distance of these two samples, which is also confirmed by the lack of significant morphological similarities between them.

The second group of *P. persica* cultivars combined 'Iransky Decorativny', 'Iransky Pestrocvetkovy', 'Bi Tao', 'Sahong Tao', 'Manific' and his seedlings 'Adalary v Snegu'. This group of cultivars is characterized, above all, by a similar form of the flower, which is called peony or wide-chrysanthemum and oval petals, which number is counted from 35 to 60 and even more. Their corolla color may be monochrome, for example, purple-red, like 'Manific', or variegated, such as pink with red in 'Iransky Pestrocvetkovy', or white with red and pink in 'Adalary v Snegu' and 'Sahong Tao'. Seedlings from open pollination of this cultivars group, as a rule, have a variegated coloring. Probably, these varieties have a common ancestor. Cultivar 'Iransky Decorativny' is characterized by pink flowers, but sometimes the petals have mild white strokes. Seedlings from open pollination of this cultivar have red flowers, very similar to the flowers 'Manific'. Considering the high genetic similarity coefficient (1), the nature of the flower color splitting and morphological similarity, we assume that the 'Manific' is a direct descendant of 'Iransky Decorativny'.

Wild species *P. mira* and its cultivar 'Lel', *P. davidiana*, *P. davidiana* 'Alba' and its cultivar 'Belosnezhka', *P. kansuensis* hybrid 'Malenky Prince' are at a considerable distance from the cultivars of *P. persica* on the graph. In addition, in AFLP-spectrum of these samples several unique fragments were revealed.

Hybrid varieties 'Zhizele', 'Ruthenia', 'Decorativny Ryabova', 'Mily' and 'Lyubava' occupy an intermediate position between wild species and cultivars of *P. persica*, but still, closer to the group of wild peaches. This is confirmed by their morphological characteristics described by us previously (Komar-Tyomnaya, 2015).

Conclusion

AFLP-analysis allowed revealing genetic relationship between the studied samples of ornamental peach. The genetic distance of wild species of *P. mira* and *P. davidiana* from cultivars of *P. persica* was confirmed. Closely relationships between 8 hybrid cultivars and wild species of peach, whose descendants they are, were confirmed. 2 groups of closely related *P. persica* cultivars obtained from different regions of introduction were determined. The obtained data have significant theoretical and practical value. They help to organize the collection funds for taxonomic and geographical criteria; give an idea about the history of the varieties spreading and allow to orientate better in the genotypes selection for crossings, etc. This is always actual for the botanical gardens and breeding centers.

Acknowledgement

This study was funded by a research grant № 14-50-00079 of the Russian Science Foundation.

References

- Bean W. J. (1950). Trees and shrubs, hardy in the British Isles. Vol.2. M. London: 564.
- Benbouza, H., Jacquemin, J.M., Baudoin, J.P., Mergeai, G. (2006). Optimization of a reliable, fast, cheap and sensitive silver staining method to detect SSR markers in polyacrylamide gels. *Biotechnol. Agron. Soc.*, Vol. 10, pp. 77 – 81.
- Dumitru L.M., Spita V., Zamfir G.H., Stanica F. and Caretu G. (2006). Studies regarding the creation and the cultivation of ornamental peach tree varieties in the Romanian parks. *Acta Hort.* 713, pp. 103-106.
- Hu D. and Zhang X. (2001). Breeding of early ornamental peach cultivars (in Chinese). *J. Beijing For. Univ.* No. 23, pp. 39-40.
- Hu D., Zhang Z., Zhang Q., Zhang D., and Li J. (2005). Genetic Relationship of Ornamental Peach Determined Using AFLP Markers. *HortScience*, Vol. 40 (6), pp. 1782-1786.
- Jacobson A.L. (1996). North American landscape trees. Ten Speed Press, Berkeley, California: pp. 511-519.
- Komar-Tyomnaya L.D. (2015). Use of Wild Species in Ornamental Peach Breeding. *Acta Horticulturae*, 1087, pp. 415-421.
- Puchooa D. (2004). A simple, rapid and efficient method for the extraction of genomic DNA from lychee (*Litchi chinensis* Sonn.). *Afr. J. Biotechnol.* V. 3, No 4, pp. 253–25.
- Standard List for AFLP® Primer Nomenclature // <http://wheat.pw.usda.gov/ggpages/keygeneAFLPs.html> Accessed on 12/04/2014.
- Vos P., Hogers R., Bleeker M., Reijans M., van de Lee T., Hornes M., Frijters A., Pot J., Peleman J., Kuiper M. and Zabeau M. (1995). AFLP: a new technique for DNA fingerprinting. *Nucleic Acids Research*, No. 23, pp. 4407-4414.
- Werner D.J., Okie W.R. (1998). A History and Description of the *Prunus persica* plant introduction collection. *HortScience*, Vol. 33(5), pp. 787-793.
- Yoshida M., Yamane K., Ijiro Y., Fujishige N., Yamaguchi M. and Takahashi E. (2000). Studies on ornamental peach cultivars (in Japanese). *Bull. College of Agri. Utsunomiya Uni.* No. 17(3), pp. 1-14.

WATER–YIELD RELATIONS OF MAIZE IN SEMIARID CLIMATE CONDITIONS

Borivoj PEJIĆ^{1*}, Ksenija MAČKIĆ¹, Vladimir SIKORA², Livija MAKSIMOVIĆ², Jan BOČANSKI¹, Ivica DJALOVIĆ²

¹Institute of Field and Vegetable Crops, Department for Maize, Novi Sad, Serbia

²University of Novi Sad, Faculty of Agriculture, Department of Field and Vegetable Crops, Novi Sad, Serbia

*Corresponding author: pejic@polj.uns.ac.rs

Abstract

Deficit irrigation creates water stress that can affect the growth and development of maize plants. Effects of water stress on maize include the visible symptoms of reduced growth, delayed maturity and reduced crop yield. A field study was carried in 2015 in order to determine the water – yield relationship of maize in the Vojvodina region, a northern part of the Republic of Serbia. Maize sensitivity to water stress was determined using a yield response factor (K_y). To assess the irrigation effects on maize yield, irrigation water use efficiency (I_{wue}) and evapotranspiration water use efficiency (ET_{wue}) were determined. Irrigation has significantly increased the yield of maize. The yield in irrigation conditions (11698 kg ha^{-1}) was 39.3% higher as compared with control without irrigation (8395 kg ha^{-1}). K_y value of 0.52 in the growing season indicates that maize is moderately sensitive to water stress under semi-arid climate conditions of Vojvodina region. The amounts of water used on evapotranspiration under irrigated (ET_m) and non-irrigated conditions (ET_a) were 512 and 234 mm, respectively. The values of I_{wue} and ET_{wue} were 1.16 and 1.19 kg m^{-3} , respectively. K_y , I_{wue} and ET_{wue} can be used as a good basis for maize growing in the region in terms of optimum water use, and also for the improvement of crop technology.

Key words: *Maize, Water stress, Water use efficiency, Yield.*

Introduction

Maize (*Zea mays* L.), one of the most important field crops, is grown on approximately 24% of areas cultivated with cereals (about 155 million ha). Furthermore, the participation of maize in grain production amounted to approximately 30% (i.e. about 609 million tons), while the average yield was 4.97 t ha^{-1} in the period 2006–2015 (FAO Statistical Yearbook, 2015). In Vojvodina, a northern part of the Serbia Republic, maize is the dominant field crop, grown on average in 640,000 ha, or about 42% of the total arable land. The average yield in the period 2006-2015 was 5.0 t ha^{-1} , with a significant variation from 2.94 to 6.44 t ha^{-1} (Statistical Yearbook of Serbia, 2015), correlated, first of all, with the sum and distribution of precipitation..

It is generally considered that maize is resistant to drought and that maize plants use water economically. Nevertheless, maize consumes great amounts of water due it is large vegetative mass, high yields and a long growing season. In the case of water deficiency, maize successfully overcomes drought, but yields less, because plants consume less readily available categories and forms of water from the soil (Bošnjak et al., 2005). Based on long-term experiments carried out under the conditions of Vojvodina, Bošnjak et al. (2005) pointed out to maize yields lower by 28.7% as a result of a deficit of easily available soil water with a remark that yield can be lower by 147–159% in extremely dry years in relation to yields recorded under irrigation conditions. Cakir (2004) emphasizes the yield amount of 15 t ha^{-1} under irrigation conditions in north-western parts of Turkey, while the amount of 5 t ha^{-1} under rainfed conditions. A striking example of low yields of maize (ranging from 1.22 to

4.63 t ha⁻¹) under rainfed conditions is provided by studies carried out by Vasić et al. (1997) in the arid region of eastern Serbia. The effect of irrigation on the increase of maize yields depends on weather conditions of the year, primarily on the sum and distribution of precipitation. In dry years, it can be great (Bošnjak and Pejić, 1994), while in wet years, it can be very modest or even it can be omitted (Pejić et al., 2011).

The actual evaluation of stress related to the yield due to soil water deficit during the maize growing season can be obtained by the estimation of the yield response factor (K_y), that represents the relationship between a relative yield decrease ($1 - Y_a/Y_m$) and a relative evaporation deficit ($1 - ET_a/ET_m$). In fact it is the amount of yield (Y) lost per unit of evapotranspiration (ET) loss. A larger K_y value indicates larger yield losses due to water deficit. Doorenbos and Kassam (1979) estimate 1.25 of K_y for the maize growing season. Vaux and Pruitt (1983) suggest that it is highly important to know not only the K_y values from the literature but also those determined for a particular crop species under specific climatic and soil conditions. This is because K_y may be affected by other factors besides soil water deficiency, namely soil properties, climate (environmental requirements in terms of evapotranspiration), growing season length and inappropriate growing technology. In order to approach the implementation of any idea on the intensive utilization of agroecological conditions or the development of new procedures for the irrigation regimes of crops, it is necessary to know precise water needs of plants, i.e. potential evapotranspiration (ETP). Water requirements of maize under agroecological conditions of the Vojvodina region vary from 450 to 540 mm (Bošnjak, 1982, Vasić, 1984, Pejić, 2000).

The estimation of water use efficiency in relation to evapotranspiration (ET_{wue}) can show a more realistic evaluation of irrigation effects, i.e. of the irrigation regime applied in maize crops. Also, the importance of analyzing ET_{wue} is illustrated by the efforts of numerous studies that consider the total water use for evapotranspiration towards transpiration use as to the productive part of water to plants (Howell et al., 1997). The parameter ET_{wue} mostly depends on precipitation amount and distribution and establishes whether the growing period is favorable for plant production or not. Wang et al. (1996) pointed out that crop yield depends on the rate of water use and all the factors that increase yield and decrease water used for ET favorably affect the water use efficiency. Howell (2001) indicated that ET_{wue} generally is highest with less irrigation, implying full use of the applied water and perhaps a tendency to promote deeper soil water extraction to make better use of both the stored soil water and the growing-season precipitation. An even clearer estimation of irrigation effects and the applied irrigation regime can be obtained by the evaluation of irrigation water use efficiency (I_{wue}). If the irrigation regime is not synchronized with water needs of crops, water and physical properties of soil and weather conditions, the effect of irrigation can fail, that is the I_{wue} values can be below the optimum. The parameter, I_{wue} , generally tends to increase with a decline in irrigation if that water deficit does not occur at a single growth period (Howell, 2001).

The objective of the study was to estimate the yield response factor (K_y) and on the basis of this factor to analyze a seasonal maize response to water stress and in such a way to obtain additional information that can be useful in the improvement of maize growing practices under climate conditions of Serbia. The established values of ET_{wue} and I_{wue} will be used in analyses of the applied irrigation regime and effects of irrigation on maize yields with the aim to use water more efficiently in irrigation practice. Estimated values of water use on maize evapotranspiration will be compared with previously established water requirements by maize under agroecological conditions of Serbia.

Material and Methods

The experiment with irrigated corn was conducted at Bački Petrovac experimental field of Institute of Field and Vegetable Crops in Novi Sad (N 45° 19', E 19° 50') on the calcareous

chernozem soil on the loess terrace in 2015. Over the 1964 to 2014 period, the annual mean air temperature, precipitation and relative humidity were 11.2⁰C, 598.7 mm and 76% respectively. According to the Hergreaves climate classification system, the study area is classified as arid in the summer period, from Jun to August (Bošnjak, 2001). In the growing season (16 April to 25 August), the mean air temperature and total rainfall were 20.2⁰C and 220 mm respectively. As expected, rainfall is not sufficient for maize production. For this reason, irrigation is needed for acceptable yields of maize grown in the region. The amount of water added by irrigation was 285 mm (Fig. 1, Tab. 2). Maize hybrid NS 6030 was used for the trials. The row spacing was 0.70 by 0.24 m. The size of the experiment unit was 50.0 m² (2.1 x 24.0 m) and was replicated three times.

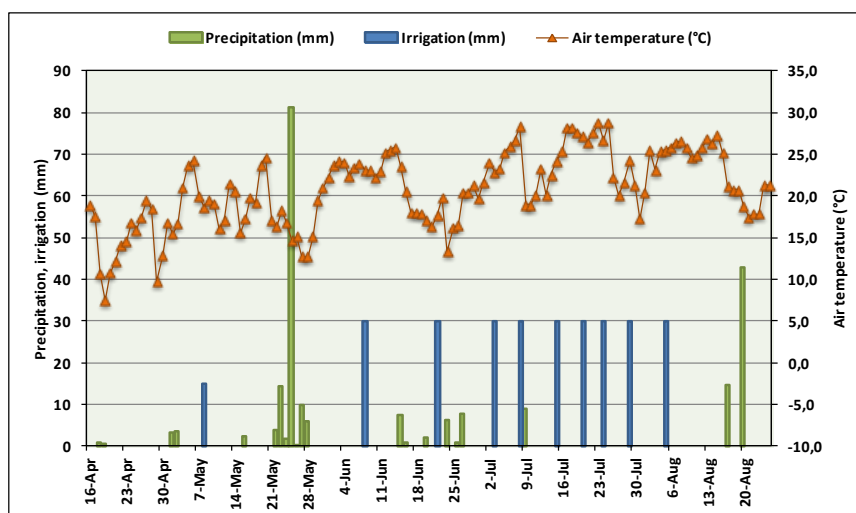

Figure 1. Irrigation schedules, irrigation water applied and meteorological data for the experimental year

The trial was established in a system of random blocks and adapted to technical specifications of drip irrigation system. The plants were irrigated with a lateral row per plant row with drippers spaced every 0.1 m. The drippers had an average flow of 1.4 l/h under a pressure of 70 kPa. The trial included irrigated and non-irrigated, control variants. Irrigation was scheduled on the basis of water balance method using reference evapotranspiration (ET_o) and crop coefficients (k_c). ET_o was calculated by Hergreaves equation (Hergreaves and Samani, 1985).

$$ET_o = 0.0023(T_m + 17.8) \left(\sqrt{T_{max} - T_{min}} \right) R_a$$

ET_o – reference evapotranspiration (mm day⁻¹), T_m – the average daily air temperature (°C), T_{max} – the maximum daily temperature (°C), T_{min} – the minimum daily temperature (°C), R_a – the extraterrestrial radiation (mm d⁻¹).

Daily water used on plants evapotranspiration (ET_d) was calculated by multiplying ET_o with k_c values (according to FAO, 2015) for initial stage 0.3–0.55, crop development stage 0.7–0.85, mead season stage 1.05–1.2 and late season stage 0.8–0.9 (Fig. 2).

$$ET_d = ET_o \cdot k_c$$

Irrigation started when readily available water in the soil layer of 40 cm was completely absorbed by plants.

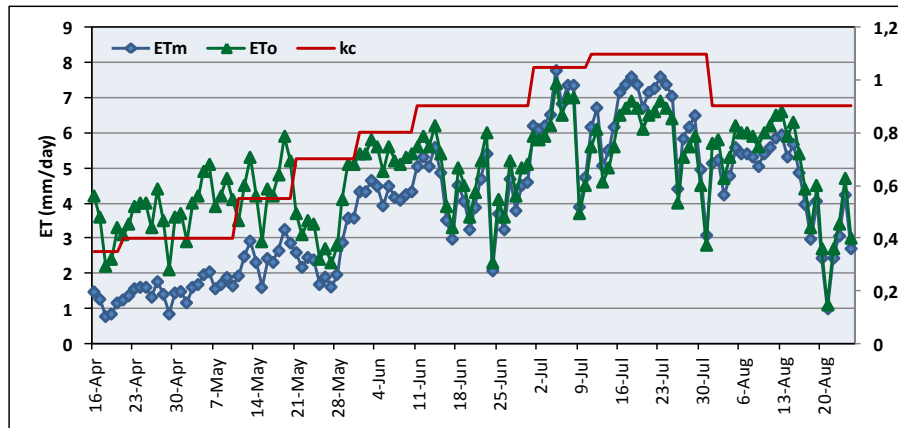

Figure 2. Daily evapotranspiration and crop coefficient of maize

Yield response factor: The yield response factor (K_y) for total growing season was determined using the Steward's model (Doorenbos and Kassam, 1979) as follows:

$$\left(1 - \frac{Y_a}{Y_m}\right) = K_y \left(1 - \frac{ET_a}{ET_m}\right)$$

Where: Y_a = the actual harvested yield (non-irrigated, kg ha^{-1}), Y_m = the maximum harvested yield (under irrigation, non limiting conditions, kg ha^{-1}), K_y = the yield response factor, ET_a = the actual evapotranspiration (mm) corresponding to Y_a , ET_m = the maximum evapotranspiration (mm) corresponding to Y_m , $(1 - ET_a/ET_m)$ = the relative evapotranspiration deficit, and $(1 - Y_a/Y_m)$ = the relative yield decrease.

Water productivity: Irrigation water use efficiency (I_{wue} , kg m^{-3}) and evapotranspiration water use efficiency (ET_{wue} , kg m^{-3}) were estimated as Bos (1981, 1985).

$$I_{wue} = \frac{Y_m - Y_a}{I}$$

$$ET_{wue} = \frac{Y_m - Y_a}{ET_m - ET_a}$$

Where: I = the amount of irrigation water applied (mm)

All recommended agronomic practices were applied for cultivation and plant protection at the experimental site. A total of 130 kg N/ha, 75 kg P_2O_5 /ha and 75 kg K_2O /ha fertilizer was applied according to recommendations based on the results of the soil analysis. The technological maturity of the crop was detected on 25 August, but maize was harvested by hand on 30 September. Precipitation and air temperature data were obtained from Meteorological Station located at Bački Petrovac experimental field (Figure 1). Grain yield was expressed in kg ha^{-1} adjusted to 14% moisture content. Statistical processing of data was done by the analysis of variance (ANOVA) and testing the obtained results by the Fisher's LSD test ($P < 0.05$ levels between the means).

Results and Discussion

Irrigation has significantly increased the yield of maize. The yield in irrigation conditions (11698 kg ha^{-1}) was 39.3% higher as compared with control without irrigation (8395 kg ha^{-1}) (Tab. 2). Results are in agreement with many studies conducted in a wide range of environments which confirm that irrigation can significantly affect the yield increase of maize

(Istanbulluoglu et al., 2002, Cakir, 2004, Pejić et al., 2010, 2011, 2013). In the study period, evapotranspiration rate in irrigation conditions (ET_m) and in rainfed control variant (ET_a) was 512 mm and 234 mm respectively (Tab. 1 and 2). The calculated value of maize ET_m of 512 mm is in accordance with values previously recorded for the agroecological conditions of the Vojvodina region. Bošnjak (1982), Vasić (1984), Pejić (2000) determined in field plots that water requirements of maize for the conditions of Vojvodina varied from 460 to 530 mm. Škorić and Berić (1994) have determined for the same climate conditions by the calculation over reference evapotranspiration (ET_o) and crop coefficients (k_c) that water requirements for normal growth and development of maize amounted to 523 mm. Stegman (1986) reported similar values of seasonal water use of maize for North Dakota of 432–514 mm. The calculated values of the deficit in readily available soil water of 278 mm (Tab. 1) point to the fact that the genetic potential for yield of otherwise very high-yielding maize hybrids will not be fully realized, since the amount of precipitation determines the potential yield levels.

Table 1. Water balance of maize

Elements	Month					
	April	May	Jun	July	August	Growing season
ET_m (mm)	19	62	120	195	116	512
P (mm)	1	126	25	9	59	220
Δ	-18	+28	-60	0	0	
r (mm)	30	12	60	0	0	
ET_a (mm)	19	62	85	9	59	234
d (mm)	0	0	35	186	57	278
s (mm)	0	16	0	0	0	16

ET_m – the maximum evapotranspiration–irrigated (mm), P – monthly rainfall sum (mm), Δ ± – difference in rainfall (P) and ET_m represents deficit or suficit after consuming or filling the reserve of readily available water, ET_a – the actual evapotranspiration – rainfed (mm), d – deficit of readily available water (mm), s – suficit (mm)

Agriculture in Vojvodina indubitably lacks water as one of the cornerstones of crop production (Vučić, 1976). The value of K_y of 0.52 recorded for the maize growing season (Tab. 2) is lower than values established by other researchers based on results obtained under arid climatic conditions (Doorenbos and Kassam, 1979, 1.25 FAO publication, Howell et al. 1997, 1.47 for Bushland in Texas, Cakir, 2004, 1.36 for arid conditions of Turkey). Obtained K_y value of 0.52 is in accordance with results obtained under moderate climate. Furthermore, Kanber et al. (1990) and Istanbulu et al. (2002) have established values of 0.93 and 0.76 for coastal areas of Turkey. Pejić et al. (2009) point out that the K_y value of 0.65 determined for climate conditions of Vojvodina is the result of weather conditions, first of all, of precipitation amount and their distribution. Value of 0.52 in the growing season indicates that maize is moderately sensitive to the soil water deficit under climatic conditions of Vojvodina. On average, relative evapotranspiration decrease was 73%, resulted with yield reduction of 28% (Tab. 2).

Table 2. Yield response factor and water productivity of maize

ET_m	ET_a	Y_m	Y_a	$1-Y_a/Y_m$	$1-ET_a/ET_m$	K_y	I	I_{wue}	ET_{wue}
512	234	11698 ^a	8395 ^b	0.282	0.732	0.52	285	1.16	1.19

The best method to describe the role that irrigation has in water use efficiency (WUE) in irrigated agriculture is by expressions given by Bos (1981, 1985). Many researchers have evaluated water use efficiency in different ways (Bos, 1985, Howell, 2001, Payero et al.,

2006). Consequently, care should be taken when comparing WUE values. Gained results under given agroecological conditions can be compared only in the approximately same temporal distance, because not only genetic potential of yielding was smaller more than 30 years ago (Pejić, 2013), but also growing practices have been significantly modified (Videnović et al., 2007). Irrigation water use efficiency (I_{wue}) and evapotranspiration water use efficiency (ET_{wue}) determined in the period of investigation was 1.16 kg m^{-3} and 1.19 kg m^{-3} , respectively (Tab. 2). Obtained values are congruent with results of Yazar et al. (2009) gained for the conditions of the Mediterranean climatic conditions in Southern Turkey, for the maize irrigated by drip system ($I_{wue} 1.61 \text{ kg m}^{-3}$, $ET_{wue} 1.54 \text{ kg m}^{-3}$). Pejić et al. (2010) determined for the conditions of Vojvodina region I_{wue} and ET_{wue} 1.8 kg/m^3 to 2.8 kg/m^3 , respectively. Robertson et al. (1980) recorded maximum values of I_{wue} (4.5 kg m^{-3}) for the conditions of Florida noting that the highest maize yields were recorded when I_{wue} ranged from 2.0 to 3.0 kg m^{-3} .

Conclusion

Based on obtained results it can be concluded that irrigation significantly influenced yield of maize in semi-arid climatic conditions of the Vojvodina region. The yield in irrigation conditions (11698 kg ha^{-1}) was 39.3% higher as compared with control without irrigation (8395 kg ha^{-1}). Evapotranspiration rate in irrigation conditions (ET_m) and in rainfed control variant (ET_a) were 512 mm and 234 mm respectively. The value of K_y in this study of 0.52 indicates that maize is moderately sensitive to the soil water deficit under climatic conditions of Vojvodina. I_{wue} and ET_{wue} were 1.16 kg m^{-3} and 1.19 kg m^{-3} respectively. These results could be used as a good platform for maize growers in the region in terms of improvement of the cropping technology, optimum utilization of irrigation water and for the planning, design and operation of irrigation projects.

References

- Bošnjak, D.J. (1982). Evaporation from free water surface as a base for irrigation scheduling and its relationship to ETP of maize and soybean. Ph. D thesis, Agriculture faculty, University of Novi Sad, 1-132 (In Serbian).
- Bošnjak, D.J., Pejić, B. (1994). Rational irrigation scheduling of maize. Proceedings of the IX Conference of Yugoslav Society for Soil Investigation, Novi Sad, pp. 624–631 (In Serbian).
- Bošnjak, D.J. (2001). The problems of drought in the Vojvodina province and drought control measures. A Periodical of Scientific Research on Field and Vegetable Crops, 35:391–401.
- Bošnjak, D.J., Pejić, B., Maksimović, L. (2005). Irrigation, a condition for high and stable corn production in the Vojvodina Province. Contemporary Agriculture 3–4: 82–87.
- Bos, M.G. (1980). Irrigation efficiencies at crop production level. ICID Bull. 29: 18-25.
- Bos, M.G. (1985). Summary of ICID definitions of irrigation efficiency. ICID Bull. 34: 28–31.
- Çakir, R. (2004). Effect of water stress at different development stages on vegetative and reproductive growth of corn. Field Crops Res. 89: 1–6.
- Doorenbos, J., Kassam, A. K. (1979). Yield response to water. Irrigation and Drainage Paper 33. FAO, United Nations, Rome, pp. 176.
- FAO Statistical Yearbook (2015). <http://www.fao.org/documents/card/en/c/383d384a-28e6-47b3-a1a2-2496a9e017b2/>. Accessed on 15/06/2016.
- Hergreaves G.H., Samani Z.A. (1985). Reference crop evapotranspiration from temperature. Applied Engineering in Agriculture, 1: 96–99.
- Howell, T.A., Schneider, A.D., Evett, S. D. (1997). Influence of subsurface and surface microirrigation of corn. Southern High Plains. Trans. ASAE., 40: 635–641.

- Howell, A. (2001). Enhancing water use efficiency in irrigated agriculture. *Agron. J.* 93: 281–289.
- Istanbulu, A., Kocman, I., Konucu, F. (2002). Water use-production relationship of maize under Tekirdag conditions in Turkey. *Pakistan J. Biol. Sci.* 5: 287–291.
- Kanber, R., Yazar, A., Eylem, M. (1990). Yield response of maize grown as second crop after wheat to water under Cukurova conditions. Directorate of Rural Services, Tarsus Research Institute, Publications No 173/108, Tarsus–Turkey.
- Payero, J.O., Melvin, S.R. Irmak, S., Tarkalson, D. (2006). Yield response of corn to deficit irrigation in a semiarid climate. *Agric. Water Manage.* 84: 101–112.
- Pejić, B. (2000). Evapotranspiration and morphological characteristics of corn depending on the depth of soil wetting and their relationships with yield. Ph. D thesis, Agriculture faculty, University of Novi Sad, 1-109 (In Serbian).
- Pejić, B., Bošnjak, Dj., Mačkić, K., Stričević, R., Simić, D., Drvar, A. (2009). Response of maize (*Zea mays* L.) to soil water deficit at specific growth stages. *Annals of Scientific Work*, 33: 155–166 (In Serbian).
- Pejić, B., Djalović, I., Šeremešić, S. (2010). Yield and water use efficiency of irrigated corn in the climate conditions of Vojvodina. *Field Crop Production*, 45th Croatia and 5th International Symposium on Agriculture, pp. 878–882 (In Serbian).
- Pejić, B., Maheshwari, B.L., Šeremešić, S., Stričević, R., Pacureanu–Joita, M., Rajić, M., Ćupina, B. (2011). Water-yield relations of maize (*Zea mays* L.) in temperate climatic conditions. *Maydica* 56 (4): 315–323.
- Pejić, B., Kresović, B., Tapanarova, A., Gajić, B., Mačkić, K. (2013). Effects of water stress on water use and yield of maize. *Contemporary Agriculture* 62 (1–2): 35–45.
- Robertson, W.K., Hammond, J.T., Johnson, J.T., Boote, K.J. (1980). Effect of plant management on yield and water–input efficiency of corn. *Agron. J.* 72: 548–550.
- Statistical Yearbook of Serbia (2015): <http://pod2.stat.gov.rs/ObjavljenePublikacije/G2008/Pdf/G20082003.pdf>. Accessed on 15/06/2016.
- Stegman, E.C.(1986). Efficient irrigation timing methods for corn production. *ASAE*, 29: 203–210.
- Škorić, M., Berić, M. (1994). Determining the necessary amount of water for irrigation of corn and wheat in the dry 1993. Proceedings of the Conference “Irrigation and drainage in Serbia”, Svilajnac, pp. 66–68 (In Serbian).
- Vasić, G. (1984). The effect of irrigation on the water regime of Zemun polje and yield of corn. *Journal for scientific and agricultural research* 45: 65–96 (In Serbian).
- Vasić, G., Kresović, B., Tolimir, M. (1997). Effects of drought on maize production. *Acta Biologica Yugoslavica, Plant and Soil* 46 (2): 117–125.
- Vaux, H., Pruitt, W.O. (1983). Crop-water production functions. *In: D. Hillel, eds. Advances in Irrigation* 2: 61–93, Academic Press, New York, USA.
- Videnović, Ž., Stefanović, L., Simić, M., Kresović, B. (2007). Trends in maize growing practices in Serbia. *Herbologia* 8 (2): 85–94.
- Vučić, N. (1976). Irrigation of agricultural crops. Agriculture faculty, University of Novi Sad.
- Wang, Z., Zerihum, D., Feyen, J. (1996). General irrigation efficiency for field water management. *Agric. Water Manage.* 30: 123–132.
- Yazar, A., Gokcel, F., Sezen., M.S. (2009). Corn yield response to partial rootzone drying and deficit irrigation strategies applied with drip system, *Plant and Soil Environ.*, 55 (11): 494–503.

THE INFLUENCE OF Nano-Gro® PREPARATION ON GROWTH, DEVELOPMENT AND YIELD OF SWEET BASIL (*OCIMUM BASILICUM* L.)

Wiesława ROSŁON^{1*}, Olga KOSAKOWSKA¹, Anna AMBROSZCZYK², Ewa OSIŃSKA¹

¹Department of Vegetable and Medicinal Plants, Warsaw University of Life Sciences – SGGW, Poland

²Department of Vegetable and Medicinal Plants, University of Agriculture in Kraków, Poland

*Corresponding author: wieslawa_roslon@sggw.pl

Abstract

Sweet basil is a species with high environmental requirements, especially temperature conditions. Therefore, in Polish climate, its cultivation in the field is difficult. The solution of the problem may be e.g. modern fertilizers that positively influence on the general condition of the plants so that they can increase their yield. In this work, morphological and developmental traits (plant height, number of lateral shoots per plant, number of leaves) as well as the yield and quality of sweet basil herb were determined. Herb was collected twice: in July and in September (regrowth). The raw material was assessed in respect of essential oil content and its chemical composition, as well as flavonoids and polyphenolic acids content. Plant height ranged average from 31.65 to 32.50 cm, the number of lateral shoots from 10.01 to 10.73 pcs, the number of leaves per plant from 59.73 to 68.88 pcs. Mass of herb depended only on the term of harvest and for the first harvest it was 121.92 g dry mass·m⁻², for second harvest – 314.69 g dry mass·m⁻². Essential oil content ranged from 0.620 to 0.72 ml·100g⁻¹. Its main components were: linalool, 1.8 cineol and eugenol. Flavonoids content ranged from 0.31 to 0.39 g·100 g⁻¹, polyphenolic acids from 0.63 to 1.48 g·100g⁻¹.

Keywords: *Basil, growth stimulator, biometric features, essential oil, polyphenolics*

Introduction

Medicinal plants have been the main source of drugs for a long time and the knowledge of their application and activity was passed down from generation to generation. Currently, interest in herbal medicines is very large and still increasing (Keh-Shaw *et al.*, 1993; Newman and Cragg, 2007). Many medicinal plants are also used as spices, and their medicinal and aromatic properties have a beneficial effect on the digestion process and absorption of nutrients. Such a plant is sweet basil, *Ocimum basilicum* L., used not only as a spice plant, but also as an aromatic, medicinal and cosmetic agent (Loughrim and Kasperbauer 2001; Aburjai and Natsheh, 2003; Makri and Kintzios, 2007; Khan *et al.*, 2011). In connection with such a comprehensive use of basil, the request for raw material and seeds of this specie is constantly increasing. In turn to get raw material of very good quality it is important to develop effective and safe for the environment and consumer method to control growth and development of that plant. Still looking for a modern means of production, which would mitigate the negative effect of the climate on yields of thermophilic plants, making them less sensitive to stress conditions. In order to improve these processes bio-stimulators can be used. They do not affect directly life processes of plants, but the impact on their metabolism. They provide macro- and micronutrients, thereby causing an increase in resistance to diseases and pests. The use of growth stimulants can play an important role in increasing the yield and quality of crops, as well as in improving the health and the overall condition of plants (Dyśko, 2008). The aim of the experiment was to evaluate the effect of the Nano-Gro® on the growth of sweet basil (*Ocimum basilicum* L.). It included the characteristics of morphological and development traits as well as yield and quality of the basil herb. The quality of the above raw

material was determined on the basis of chemical analyzes, including the content of essential oil and its chemical composition, as well as flavonoids and polyphenolic acids content.

Materials and Methods

Seedlings to establish the experiment were produced in the greenhouse of Department of Vegetable and Medicinal Plants, Warsaw University of Life Sciences (SGGW) (Poland), from seeds bought in the garden shop. When the seedlings have developed one pair of true leaves they were transplanted into multipalets. After the formation four pairs of true leaves the plants were planted into a field at a spacing 30x40 cm, on plots of 5 m², in the first decade of June 2014 and 2015. The experiment was set in four replications, randomized block.

Experiment factors:

- Variants of Nano-Gro[®] application

Variant 1 (V1) - seeds/plants were not treated Nano-Gro[®] - control

Variant 2 (V2) - seeds were not treated Nano-Gro[®]. After germination, when the seedlings were reached approximately 2 cm in height, plants were sprayed the above preparation.

Variant 3 (V3) - seeds were treated Nano-Gro[®] (soaking for 30 seconds directly before sowing). After quilting seedlings to multipalets, plants were sprayed of Nano-Gro[®].

Variant 4 (V4) - seeds were treated Nano-Gro[®] (as above). Directly after planting in the field, the seedlings were sprayed Nano-Gro[®]

Solutions of Nano-Gro[®] for seed soaking and plants spraying were prepared according to the manufacturer's instructions on the package.

- Term of observation of morphological and development traits.

In each plot 5 plants were randomly selected (20 plants for each combination), for observations of morphological and developmental characteristics. Research was carried out in 4 stages of plants development: the vegetative stage (third decade of June), before flowering (first decade of July), in full flowering stage (third decade of July) and the after flowering plants (third decade of August). At any term of observation plant height, number of lateral shoots, number of leaves per plant and mass of one plant were measured.

- Term of herb harvest

Herb was harvested twice. The first harvest was carried out in the second decade of July, when the plants were at the beginning of flowering. All the plants of plot (except the selected for observation) were cut down about 10 cm above the ground. The second harvest was made in the first decade of September (regrowth - the plants were in the vegetative phase). Raw material from both harvests was dried in drying chamber at 35 °C and air-dry mass of the herb received. The results were calculated per 1 m².

In the air-dry herb, the content of essential oil and its chemical composition as well as the content of flavonoids and polyphenolic acids were determined.

The content of essential oil was determined by steam distillation, according to a method described in Polish Pharmacopoeia X (2014). Separation of essential oil compounds was performed by gas chromatography (HP Model 6890) in the following conditions: temperature of detector – 250 °C, temperature of injector – 220 °C, temperature programme – 60 °C – 220 °C, 5C·min⁻¹, capillary column – Carbovax 20m x 0.32 mm, 25m x 0.2 mm. Identification of essential oil components was carried out by comparing their time of retention with adequate standards.

The content of polyphenolic acids and flavonoids were determined according to Polish Pharmacopoeia X (2014)

Total content of polyphenolic acids (calculated as caffeic acid) was made from aqueous solution with Arnov reagent, in the presence of 1n HCL and 1n NaOH. Absorbance of the obtained solution was measured at 490 nm length wave.

Total content of flavonoids were quantified by using the chelating properties of the molecules towards AlCl₃, with quercetin used as standard. The raw materials was extracted with acetone.

The hydrolysis of flavonoids was done by using of hydrochloric acid (28 g·l⁻¹). Flavonoids were extracted from acetone extract with ethyl acetate. Absorbance of the obtained flavonoids solution was measured at 425 nm length wave.

The presented results (except essential oil composition) are the mean from the two-year experiment. Chromatographical analysis of essential oils were made only in 2014.

The results were subjected to statistical evaluation using ANOVA 1 and ANOVA 2 programmes and Tukey's test at the significance level $\alpha=0.05$.

Results and Discussion

Sweet basil (*Ocimum basilicum* L.) is a popular aromatic, medicinal, spice and cosmetic plant (Loughrim and Kasperbauer, 2001; Aburjai and Natsheh, 2003; Khan *et al.*, 2011). In connection with such diverse possibilities of its use, the demand for its raw material (herb), is constantly increasing. However, the cultivation of this species in Polish climatic conditions is not easy, due to the high thermal requirements of this plant. Therefore it is necessary to search for such methods of cultivation that would mitigate the negative effects of our climate making sweet basil less sensitive to stress conditions. This role may fulfill modern fertilizers, which besides a favorable impact on yield also improves the overall condition of the plant. An example of such a measure is the Nano-Gro[®] preparation (Wallace, 2006). In this experiment we analyzed the effect of the Nano-Gro[®] on the growth and yield of sweet basil, as well as on the content of selected chemical components of the herb: essential oils, flavonoids and polyphenolic acids. Numerous studies point to the positive impact of the above preparation on the yield of agricultural plants, fruit, vegetables and flowering plants but there is no information about its direct impact on the behavior of the herbal plants, including sweet basil. Effects of other bio-fertilizer and bio-stimulators (e.g. Kadostim and Nitroxin) on morphological traits of sweet basil were studied by Rahimi *et al.*, (2013). Preparations influenced stimulating inter alia, on the height of basil plant analyzed by these authors. Plants treated by these fertilizers were clearly higher in comparison with the control plants. Kwiatkowski and Juszczak (2011) also observed that spraying of basil plantation such preparations as Asahi SL and Titanite resulted in about a 12% increase in plant height, compared to the control plants. The above-mentioned bio-stimulators also had a significant effect on the growth of the shoots relative to the control group (for Asahi SL -16.7; for Titanite - 15.5%). In the present study no significant differences were observed in plant height and number of lateral shoots between the control and plants treated with Nano-Gro[®]. Similar results obtained Rosłon *et al* (2011) for such bio-fertilizers as Aminoplant, Goëmar Goteo and Goëmar BM86 used in the cultivation of sweet basil. Application of Nano-Gro[®] significantly influenced only on the number of leaves, with the proviso that clearly more leaves was observed in the case of control plants compared with these treated above preparation. On the examined characteristics significant impact had only term of observation. In all variants of experiment, the highest plants, with the highest number of lateral shoots and leaves were observed in the last period of observation (Table 1, Table 2, Table 3).

Table1. The influence of Nano-Gro® application and term of observation on height of plants [cm]

Variant of Nano-Gro® application	Term of observation				Mean
	Third decade of June	First decade of July	Third decade of July	Third decade of August	
V1	14.35 b	19.75 b	24.65 b	69.40 a	32.04 A
V2	15.25 b	20.50 b	25.65 b	68.60 a	32.50 A
V3	13.25 b	18.60 b	26.55 b	68.20 a	31.65 A
V4	14.75 b	20.95 b	25.25 b	66.30 a	31.81 A
Mean	14.40 C	19.95 BC	25.53 B	68.13 A	

Table 2. The influence of Nano-Gro® application and term of observation on number of lateral shoots [pcs per plant]

Variant of NanoGro® application	Term of observation				Mean
	Third decade of June	First decade of July	Third decade of July	Third decade of August	
V1	7.30a	10.35 a	12,50 a	12.75 a	10.73 A
V2	7.25 a	10.40 a	11,50 a	12.00 a	10.29 A
V3	6.85 a	9.75 a	11.20 a	12.25 a	10.01 A
V4	7.50 a	10.20 a	12.10 a	12.5 a	10.58 A
Mean	7.23 C	10.18 BC	11.83 B	12.38 A	

Table3. The influence of NanoGro® application and term of observation on number of leaves [pcs per plant]

Variant of Nano-Gro® application	Term of observation				Mean
	Third decade of June	First decade of July	Third decade of July	Third decade of August	
V1	19.50 e	42.00 d	60.50 c	153.50 a	68.88 A
V2	19.25 e	42.50 d	60.25 c	117.00 b	59.73 C
V3	18.00 e	38.75 d	59.50 c	157.70 a	68.49 B
V4	20.50 e	39.80 d	53.00 dc	144.50 a	64.28 BC
Mean	19.31 D	40.76 C	58.31 B	143.18 A	

Application of Nano-Gro® not significantly impact the growth of plant height and number of lateral shoots. However, there was a significant influence on the increase in the number of leaves. Clearly more leaves during vegetation were created by plants from the variant 3 (139.70 pcs), only slightly less control plants, substantially less leaves, however, created plants in variant's 2 and 4 (Table 4). Wallace (2006) testing Nano-Gro® on another herbal specie - tobacco observed that tobacco plants treated above preparation grew faster compared with the control plants, produced also about 30% more leaves.

Table 4. Increase in plant height, number of shoots and number of leaves during the vegetation

Variant of Nano-Gro [®] application	The increase in height [cm]	The increase in the number of lateral shoots [pcs per plant]	The increase in the number of leaves [pcs per plant]
V1	55.05 a	5.45 a	134.00 a
V2	53.35 a	4.75 a	97.75 c
V3	54.95 a	5.40 a	139.70 a
V4	51.55 a	5.00 a	124.00 b

Evaluation of yielding of sweet basil showed that the use of Nano-Gro[®], irrespective of the application way, does not affect the mass of herb. It is true that the highest air-dry mass of herb was obtained for variant, wherein seeds was soaked and plants was sprayed Nano-Gro[®] after planting in the field (the average of 225.30 g·m⁻²), but it was not significantly higher mass, compared to control plots. Different results obtained Rahimi *et al.* (2013), who showed that the use of biological fertilizers such as Fosnutren and Nitroxin significantly increases total fresh and air-dry mass of basil herb. In this experiment on the tested parameter significantly affected only the term of harvest. Plants collected in the flowering stage (the first term of harvest) gave two and a half lower mass of the dry herb, compared with plants collected in the second term (regrowth). That was respectively 121.92 and 314.69 g·m⁻² (Table 5).

Table5. The influence of Nano-Gro[®] application and term of harvest on air-dry mass of herb [g·m⁻²]

Variant of Nano-Gro [®] application	First term of harvest	Second term of harvest	Mean
V1	125.23 b	314.70 a	219.97 A
V2	122.01 b	308.34 a	215.18 A
V3	119.49 b	306.03 ab	212.76 A
V4	120.93 b	329.67 a	225.30 A
Mean	121.92	314.69*	

*p=0.05

In the cultivation of herbs draws attention not only on the yield but also the quality of obtained raw material. Herb of sweet basil is primarily investigated for content of essential oil. Hussain *et al.* (2008) report that the essential oil content in above raw material is from 0.5% to 0.8%. The results obtained in this experiment were similar. Content of essential oil ranged from 0.58 to 0.73 ml·100 g⁻¹. The highest content of this component was determined for variant 4, while the lowest - for plants from untreated seeds, sprayed after germination (variant 2). However, there were not found significantly differences in the content of essential oil depending on the variant of application Nano-Gro[®]. This parameter is not significantly affected also by term of harvest of raw materials, but a higher content of essential oil was characterized by the material collected in the second term (regrowth). Effects of other bio-fertilizer (Aminoplant, Goëmar Goteo and Goëmar BM86) on the content of essential oil in the sweet basil herb studied Rosłon *et al.*, (2011). Of the three above-mentioned preparations only Goëmar Goteo significantly influenced the content of essential oil (decreased it). The chromatographic analysis of obtained essential oils showed that the important components in

the tested oils, irrespective of the variant of Nano-Gro[®] application were linalool, 1.8-cineol, eugenol and eugenol derivatives. Similar results were obtained by many authors (Lee *et al.*, 2005; Hussain *et al.*, 2008; Carović-Stanko *et al.*, 2010) (Table 6, Table 7).

Table 6. The influence of Nano-Gro[®] application and term of harvest on essential oil content (ml·100 g⁻¹)

Variant of Nano-Gro [®] application	First term of harvest	Second term of harvest	Mean
V1	0.65 a	0.68 a	0.67 A
V2	0.58a	0.65 a	0.60 A
V3	0.68 a	0.73 a	0.71 A
V4	0.73 a	0.70 a	0.72 A
Mean	0.66	0.69	

Table 7. Identified components of sweet basil essential oil and their percentage share [for first time of harvest, 2014]

Chemical compound	Variant of Nano-Gro [®] application			
	V1	V2	V3	V4
	[%]			
α -pinene	0.61	0.65	0.75	0.40
β -pinene	1.24	1.25	1.47	0.81
β -myrcen	1.66	1.90	2.08	1.18
1.8-cineol	11.63	10.31	12.72	7.40
γ -terpinene	0.10	0.10	0.10	1.69
Camphor	0.24	0.39	0.27	1.21
Linalool	50.03	53.61	55.71	32.97
Terpinene-4-ol	4.83	5.24	4.31	2.50
Methylchavicol	3.62	1.15	1.46	3.00
α -terpineol	1.06	1.02	1.07	2.17
Eugenol	8.55	6.15	6.20	4.40
Eugenol deriv.	3.56	3.76	3.27	2.62

Besides essential oil an important components of the sweet basil herb are polyphenols, including flavonoids and polyphenolic acids (Javanmardi *et al.*, 2003; Lee and Scagel 2009). The presence of flavonoids was pointed out many authors (Grayer *et al.*, 1996, Harnafi *et al.*, 2009). In the present study we demonstrated that the application of Nano-Gro[®] significantly affect the content of these compounds. The highest content of flavonoids were characterized by control plants (average 0.39 g·100g⁻¹), the lowest – for plants from seed treated and sprayed preparation Nano-Gro[®] after planting them in the field (average 0.31 g·100g⁻¹). The content of these compounds influenced also term of harvest. Significantly more flavonoids were determined in the raw material obtained from first term of harvest in compare to the second harvest. Analyzing, in turn, the results on the content of phenolic acids it was observed that significantly more of these compounds there are in plants from variant 4 than in the other variants, including control plants. Higher content of polyphenolic acids also was observed in the raw material collected in the second term (regrowth) (Table 8, Table 9).

Table 8. The influence of Nano-Gro[®] application and term of harvest on flavonoids content [g·100 g⁻¹]

Variant of Nano-Gro [®] application	First term of harvest	Second term of harvest	Mean
V1	0.47 a	0.31cd	0.39 A
V2	0.35 cd	0.29 cd	0.32 C
V3	0.38bc	0.28 cd	0.33 BC
V4	0.37bcd	0.26 d	0.31 D
Mean	0.39*	0.28	

*p=0.05

Table 9. The influence of Nano-Gro[®] application and term of harvest on polyphenolic acids content [g·100 g⁻¹]

Variant of Nano-Gro [®] application	First term of harvest	Second term of harvest	Mean
V1	0.52 c	0.80 b	0.66 B
V2	0.44 c	0.83 b	0.63 B
V3	0.49 c	0.89 b	0.69 B
V4	1.35 a	1.61 a	1.48 A
Mean	0,70*	1,03	

*p=0.05

Conclusions

The obtained results indicate that the yield of sweet basil and quality of obtained raw material most of all is affected by proper cultivation and optimally chosen term of harvest of raw material. Preparation Nano-Gro[®] used in the sweet basil cultivation not significantly affected both the morphological features as well as herb yield and its quality. Application of the above preparation in the cultivation of basil is not justified.

Acknowledgement

We would like to thank AGRARIUS Ltd. per financial support and the opportunity to test preparation Nano-Gro[®] in the cultivation of medicinal plants.

References

- Aburjai T., Natsheh F.M. (2003). Plants used in cosmetics, *Phytotherapy Research*, Vol. 17, (9), 987-1000.
- Carović-Stanko K., Orlić S., Politeo O., Strikić F. Kolak I. (2010). Composition and antibacterial activities of essential oils of seven *Ocimum* taxa. *Food Chemistry*, Vol.19 (1), 196-201.
- Dyśko J. (2008). Nano-Gro[®] - stymulator wzrostu w bezglebowej uprawie pomidora. *Owoce Warzywa Kwiaty*, Vol.48 (24), 14-16.
- Grayer R.J., Kite G.C., Goldstone F.J., Bryan S.E., Paton A., Putievsky E. (1996): Intraspecific taxonomy and essential oil chemotypes in sweet basil (*Ocimum basilicum*). *Phytochemistry*, Vol.43 (5), 1033-1039.
- Harnafi H., Aziz M., Amrani S. (2009). Sweet basil (*Ocimum basilicum* L.) improves lipid

- metabolism in hypercholesterolemic e-SPEN the European e-Journal of Clinical Nutrition and Metabolism, 4, e181-e186
- Hussain A.I., Anwar F., Sherazi S.T.H., Przybylski R. (2008). Chemical composition, antioxidant and antimicrobial activities of basil (*Ocimum basilicum*) essential oils depends on seasonal variations. Food Chemistry, 108, 986–995.
- Javanmardi J., Stushnoff S., Locke E., Vivanco J.M. (2003) Antioxidant activity and total phenolic content of Iranian *Ocimum* accessions. Food Chemistry, Vol. 83 (4), 547-550.
- Keh-Shaw C., Chia-Liang T., Te-hsien L. (1993). Trace elements in natural drugs determined by INAA. Journal of Radioanalytical and Nuclear Chemistry, Vol. 170 (1), 265-280.
- Khan M.S., Shoaib K.M., Said G., Naveed A., Ghulam M. (2011). Phytochemical Constituents and Pharmacological Activities of Sweet Basil-*Ocimum basilicum* L. (Lamiaceae). Asian Journal of Chemistry, Vol. 23 (9), 3773-3782.
- Kwiatkowski C.A., Juszczak J. (2011). The response of sweet basil (*Ocimum basilicum* L.) to the application of growth stimulators and forecrops. Acta Agrobotanica, Vol. 64 (2), 69-76.
- Lee J., Scagel C.F. (2009): Chicoric acid found in basil (*Ocimum basilicum* L.) leaves. Food Chemistry, 115, 650-656.
- Lee S. J., Umamo K., Shibamoto T., Lee K. G. (2005). Identification of volatile components in basil (*Ocimum basilicum* L.) and thyme leaves (*Thymus vulgaris* L.) and their antioxidant properties. Food Chemistry, 91, 131-137.
- Loughrim J.H., Kasperbauer M.J. (2001). Light Reflected from Colored Mulches Affects Aroma and Phenol Content of Sweet Basil (*Ocimum basilicum* L.) Leaves. J. Agric. Food Chem., Vol. 49 (3), 1331–1335
- Makri, O., Kintzios, S. (2007). *Ocimum* sp. (basil): Botany cultivation, pharmaceutical properties and biotechnology. Journal of Herbs, Spices & Medicinal Plants, 13, 123-50.
- Newman D., Cragg G.M. (2007). Natural Products as Sources of New Drugs over the Last 25 Years. J. Nat. Prod., Vol. 70 (3), 461–477.
- Polish Pharmacopoeia X. (2014). ISBN: 978-83-63724-47-4, PTFarm. Warsaw.
- Rahimi S.A., Dehghani-Meshkani M.R., Mehrafarin A., Khalighi-sigaroodi F., Naghdi B.H. (2013). Changes in Essential Oil Composition and Leaf traits of Basil (*Ocimum basilicum* L.) Affected by Biostimulators/fertilizers Application. Journal of Medicinal Plants, Vol. 12 (47), 83-92.
- Rosłon W., Osińska E., Bączek K., Węglarz Z. (2011). The influence of organic-mineral fertilizers on yield and raw material quality of chosen plants of the Lamiaceae family from organic cultivation. Acta Sci. Pol., Hortorum Cultus, Vol. 10 (1), 147-158.
- Wallace T. (2006). agrarius.eu/plik,95,tyton-usa.pdf.

**EFFECT OF PLANT GROWTH REGULATORS ON IN VITRO
MICROPROPAGATION AND EVALUATION OF ANTIMICROBIAL ACTIVITY
EXTRACTS FROM EX VITRO, IN VITRO AND CALLUS OF RUE (RUTA
GRAVEOLENS L.)**

Zakaria I. Al-ALOUNI^{1*}, Shifaa ABBAS¹, Mohamad A. SHATNAWI², Ibrahim Al-MAKHADMEH¹

¹Department of Plant Production, College of Agriculture, Jordan University of Science and Technology, P. O. Box 3030, Irbid 22110, Jordan

²Biotechnology Department, Faculty of Agricultural Technology, Al-Balqa Applied University, 19117 Al-Salt, Jordan Jordan

*Corresponding author: ziajlouni@just.edu.jo

Abstract

Micro-propagation, callus and antimicrobial activity developed efficient protocols of *R. graveolens* were used under controlled conditions to overcome limitations of the conventional propagation methods. MS medium supplemented with different plant growth regulators IBA, IAA, 2,4-D and NAA using different concentrations of 0.0, 0.4, 0.8, 1.2, 1.6, 1.8 and 2.0 mg/l were evaluated for their effects on adventitious root induction. Our result showed that the highest number of new root (3.25 cm) was obtained using MS medium with 0.4 mg/l 2,4-D. Whereas, using 0.2 mg/l 2,4-D resulted in highest root length per explants. In our research the Antimicrobial activity of different extract types and volume (40 or 80 µl) was studied using agar-well diffusion assay against five bacterial species of three gram positive bacteria (*Staphylococcus aureus*, *Bacillus cereus*, *Micrococcus latus*), two gram negative bacteria (*Escherichia coli*, *Salmonella typhmurim*), and four fungal species (*Alternariasolani*, *sclerotiniasclerotiorum*, *Fusariumoxosporium*, and *Verticillium dahlia*). Results indicated that all tested extracts at different volume revealed antimicrobial activities against all tested bacterial species and did not display antifungal activity against *Alternariasolani*, *Sclerotiniasclerotiorum* and *Verticillium dahlia* except *Fusariumoxosporium*.

Key words: *In vitro*, *Ruta Graveolens*, *Antimicrobial*, *Ex Vitro*

Introduction

Ruta graveolens is an important medicinal plant belongs to the family *Rutaceae* and is a small aromatic perennial shrub, which grows throughout Jordan and is native to the Mediterranean region (Khouri and El-Akawi, 2005). It is currently used by many people in Jordan as an aphrodisiac, fertility promoting agent antispasmodic, diuretic, sedative, and analgesic effects and externally for its antirheumatic effect (Khouri and Akawi, 2005). In addition, it's have antifungal properties that could be beneficial to agriculture and medicine (Ojala *et al.*, 2000). Previous study by (Ojala *et al.*, 2000) indicated that extract of *R. graveolens* showing high toxicity against *Rhizoctonia solani*. Furthermore, growth of *Heterobasidium annosum* was inhibited, whereas that of *Phytophthora cactorum* was promoted by the extracts. The antifungal activities of six natural coumarin compounds were weak, except for the inhibitory effect against *Fusarium culmorum* (Ojala *et al.*, 2000). Moreover, *R. graveolens* showed antimicrobial activity against some bacterial species *Escherichia coli*, *Streptococcus pneumonia*, *Salmonella typhi*, *Klebsiella pneumonia* and *Proteus vulgaris*. Karouei *et al.*, (2011) showed that root ethanolic extract of *R. graveolens* had antifungal effects and prevented from *saprolegnia* growth. Furthermore, (Dababneh and Khalil, 2007) reported that *Achillea santolina* extract inhibits growth of *Fusarium oxysporum* and

Rhizoctonia solani of about 42%. Moreover, the volatile oil has a pungent smell and bitter taste, and possesses antibacterial activity against *Micrococcus pyogenes* and *Escherichia coli* (Anonymous, 2003).

In vitro propagated medicinal plants provide a ready source of uniform, sterile, and compatible plant material for biochemical characterization and identification of bioactive constituents (Mahmoud *et al.*). Faisal *et al.*, (2005) reported direct shoot bud induction in nodal segments of *R. graveolens* through axillary shoot multiplication. In addition, secondary metabolites from tissue cultures may be more easily purified because of simple extraction procedures and absence of significant amounts of interfering pigments, which it will minimize the cost of purifying and producing such valuable compounds (Nalawade and Tsay, 2004). Therefore, the goal of this study is to determine the effect of different *in vitro*, *ex vitro* and callus of *R. graveolens* extracts against some microbes as a possible alternative to antibiotic drugs.

Materials and methods

Source material and explants preparation

In vitro cultures were established at the Al-Balqa Applied University before being used in laboratory. Seed were collected from five years old *R. graveolens* from the Al-Sareeh, Irbid, Jordan (about 600 meters above sea level, 32.3306° N latitude and 35.8951° E Longitude).

Shoot induction, callus formation, *in vitro* rooting and acclimatization

Plantlet were subcultured onto 250 ml Erlenmeyer flask containing about 60 ml MS medium supplemented with 30 g/L sucrose and 0.3 mg/l BAP, 0.05 mg/l IBA and 1.0 mg/l GA3 in order to multiplication of plant *in vitro*. Calli were initiated from leaves on MS media supplemented with 1.0 mg/L 2,4-D or NAA. Moreover, in order to induce root, microshoots with 10 mm length were subcultured on MS medium containing indole-3-butyric acid (IBA), indole acetic acid (IAA), 2,4-Dichloromethoxy acetic acid (2,4-D) or naphthalene acetic acid (NAA) at 0.0, 0.4, 0.8, 1.2, 1.6, 1.8 or 2.0 mg/l, and 0.2 mg/l in case of NAA and 2,4-D with the supplemented of 0.5 g/L charcoal. After that *In vitro* rooted plantlets were removed from the medium, wash in a water bath at 25-30 °C and transplanted to plastic pots containing sterile autoclaved mixture of 1 peat: 1 perlite and covered with transparent plastic bag.

Secondary metabolites extraction

Healthy callus, *ex vitro* and *in vitro* plants of *R. graveolens* were dried at 80 °C. The dried plant materials were separately extracted at room temperature with absolute ethanol and methanol separately at 10:1 (v/w) (Green, 2004). The mixture was placed at room temperature for two days with occasionally shaking to dissolve secondary metabolites properly. The extracts were then filtrated on Whatman no. 1 filter paper. In order to remove the solvents the filtrate place in water path at 40 °C to dryness.

Microbes culture

Five bacterial species were used in this research work, and these are listed as follows: three gram positive bacteria (*Staphylococcus aureus*, *Bacillus cereus*, *Micrococcus latus*) and two gram negative (*Escherichia coli*, *Salmonella typhmurim*) cultured on nutrient agar. These species were obtained from the laboratory of microbiology, Yarmouk University, Jordan. Four fungal species were included in this study and these are listed as follows: *Alternaria solani*, *sclerotinia sclerotiorum*, *Fusarium oxosporium*, and *Verticillium dahlia* Fungi cultured on potato dextrose agar (PDA) were obtained from Plant Pathology Laboratory from Jordan University of science and Technology.

Antibacterial activity assay

Antimicrobial activity against the test organism was performed using the agar diffusion method (Perez *et al.*, 1990). The bacterial species were spreaded on nutrient agar plates with sterile swap. Plates were divided into 4 quadrates, wells were made on the plates with a sterile cork borer of 6 mm diameter to contain the different extracts, *R. graveolens* extract aliquots (40 μ l and 80 μ l) at (250 μ g/ μ l) concentration were added into wells and left for one hour to diffuse, then the plate were incubated at 37 °C for 24 h. The antibiotic Oxytetracycline were used as positive control and prepared in (250 μ g/ μ l) and their antimicrobial activity was tested in the same manner, also the solvent dimethylesulfoxide DMSO (negative control) was added, the zones of inhibition was measured in mm at the end of the incubation period. Microbial growths were determined by measuring the diameter of the zone of inhibition and were compared with standard antibiotic (oxytetracycline).

Antifungal activity assay by the agar well diffusion method

An aliquot of 100 μ l spore suspension (1×10^8 spores/ml) of each isolate were streaked in radial patterns on the surface of complete media plates. Plates were divided into 4 quadrates, wells were made on the plates with a sterile cork borer of 6 mm diameter to contain the different extracts, *R. graveolens* extract aliquots (40 μ l and 80 μ l) at (250 μ g/ μ l) concentration were added into wells and left for one hour to diffuse, then the plates were incubated at 30 °C for 48 h. The antifungal (Cyclohexamine; positive control) was prepared in (250 μ g/ μ l) and their antimicrobial activity was tested in same manner, also the solvent dimethylesulfoxide (DMSO) (negative control) was added, the zones of inhibition were measured in mm at the end of the incubation period. Microbial growths were determined by measuring the diameter of the zone of inhibition and were compared with standard antifungal (Cyclohexamine).

Experimental design and statistical analysis

Data were subjected to one-way analysis of variance ANOVA; differences between individual means were determined by least significant difference (LSD) test at 0.05 level of probability.

Result and discussion

In vitro shoot formation and callus induction

All established cultures gave healthy shoots when sub-cultured on the multiplication medium. Initially small yellowish calli developed on the cut ends within 7 days of inoculation which subsequently covered the entire surface of the explants with the used of 2,4-D and NAA. After two months better callus texture, color and maximum fresh weight were obtained when MS media was supplemented with 2,4-D or NAA (figure, 1) our results agreed with Al-Ajlouni *et al.*, (2015).

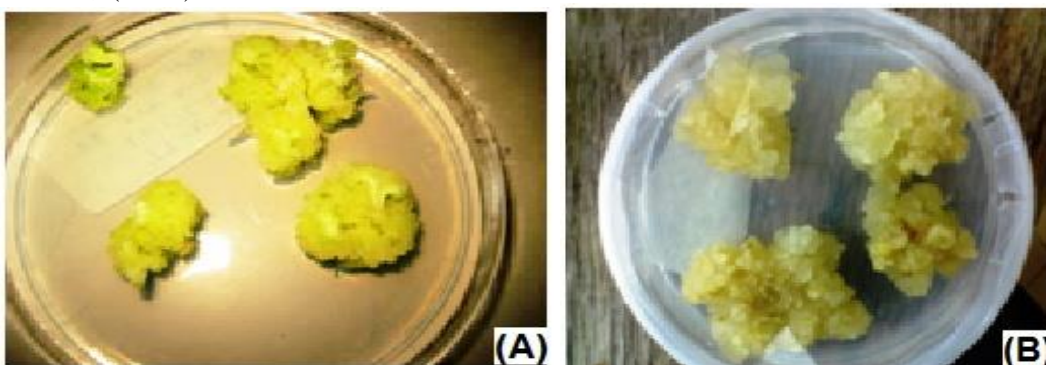

Figure1: (A) Callus formation after six weeks of culture on full strength media supplemented with 2mg/l 2,4-D, (B) Callus subculture on MS with 1mg/l 2,4-D.

***In vitro* root formation and acclimatization**

Table (1) shows effect of different auxins concentration on root formation. The use of auxins hormones enhance shoot formation compared with the controls. Maximum root number was obtained on medium supplemented with 0.4 mg/l IBA, where the means root number was 1.6. Maximum root length (0.55 cm) was obtained on medium supplemented with 1.2 mg/l IBA. Bohidhar *et al.*, (2008) reported that IBA induced root formation on MS media supplemented with 0.5mg/l IBA. Faisal *et al.*, (2005, 2006) had reported rooting of microshoots of *R. graveolens* on MS media supplemented with IBA (0.1 mg/l). Using IAA maximum root number (1.6 roots per explants) was obtained at 0.4 mg/l IAA. Moreover, maximum root length (0.44 cm) was occurred on medium containing 0.4 or 1.2 mg/l IAA (Table 1). No callus formation appeared at the base of each cutting. This has also been found in previous studies, where *in vitro* shoots of *Artemisia herba alba* were reported to root with a supplement of IBA, IAA or NAA (Shatnawi *et al.*, 2011). Gurudeeban *et al.*, (2012) reported that *R. graveolens* was rooted on MS media supplemented with 0.5 mg/l IAA. On the other hand, Bohidhar *et al.*, (2008) reported that no healthy roots were observed on MS media containing IAA. The number of roots formed per microshoots was affected by the concentration of 2,4-D. Maximum root number and long root were obtained from MS media supplemented with 0.4 mg/l 2,4-D where the means number of new root and root length was 3.25 and 0.96 cm. Callus was induced on MS media with different concentration of 2,4-D. Root initiation was appeared from the bases of shoots after incubation on solid MS medium containing NAA. Maximum root number (1.15 root/ex-plant) with 0.41 cm length of was obtained on MS medium containing 1.2 mg/l NAA. However, number of roots per explant varied with increasing NAA concentration and ranged from 0.2 to 1.15 (P=0.05) (Table 1). The role of NAA in root induction of *in vitro* derived shoots has been well documented. Survival of the rooted plants was up 100% under acclimatization conditions in the greenhouse (Data not shown).

Table 1: Effect of different concentration of Auxins on roots formation of *in vitro* grown *Ruta graveolens* after six weeks growth periods.

Auxins type Conc. (mg/L)	Number of new root *				Maximum root length*			
	IBA	IAA	2,4-D	NAA	IBA	IAA	2,4-D	NAA
0.0	0.000 ^b	0.000 ^b	0.000 ^e	0.000 ^b	0.000 ^b	0.000 ^b	0.000 ^d	0.000 ^b
0.2	NF**	NF	2.200 ^{ab}	0.60 ^{ab}	NF	NF	0.915 ^a	0.48 ^a
0.4	1.600 ^a	1.600 ^a	3.250 ^a	0.45 ^{ab}	0.070 ^b	0.435 ^a	0.955 ^a	0.34 ^{ab}
0.8	0.600 ^b	0.600 ^b	0.700 ^{de}	0.40 ^{ab}	0.105 ^b	0.140 ^{ab}	0.295 ^{bcd}	0.32 ^{ab}
1.2	0.500 ^b	0.500 ^b	0.900 ^{cde}	1.15 ^a	0.550 ^a	0.435 ^a	0.300 ^{bcd}	0.41 ^a
1.6	0.450 ^b	0.450 ^b	1.950 ^{bc}	0.85 ^{ab}	0.115 ^b	0.115 ^{ab}	0.545 ^b	0.16 ^{ab}
1.8	0.450 ^b	0.450 ^b	0.400 ^{de}	0.20 ^b	0.340 ^{ab}	0.220 ^{ab}	0.110 ^{cd}	0.12 ^{ab}
2.0	0.650 ^{ab}	0.650 ^{ab}	1.250 ^{bcd}	0.25 ^{ab}	0.340 ^{ab}	0.210 ^{ab}	0.340 ^{bc}	0.15 ^{ab}
LSD	0.9748	0.9748	1.2167	0.9489	0.3905	0.3551	0.3275	0.3785

*Means followed by the same letter within the column are not significantly different according to LSD test at P≤ 0.05. Each treatment consisted of 20 replicates. ** NF means not found

Antibacterial activity

The control (negative) by using Dimethylsulfoxide (DMSO) alone failed to suppress all involved bacterial growth and therefore had negative results. Results obtained show that the reference antibiotic Oxytetracycline exhibited positive results shown as zone of inhibition (11.33 mm) (figure 2 and figure 3). It is clear that *Micrococcus latus* showed high sensitivity to all extract culture types of *R. graveolens* compared to other bacterial species were used. The *in vitro* extract had the highest antibacterial activity in all cases (13.00 mm and 12.33 mm) using 80µl from ethanolic and methanolic respectively (figure 2 and figure 3F). Our results confirmed the observation of Ivanova *et al.*, 2005 who reported that extracts of *R.*

graveolens showed antibacterial activity against *Staphylococcus aureus*, *Staphylococcus epidermidis* and *Bacillus cereu*, while no activity was shown against *Escherichia coli*. Moreover, and Ojala *et al.*, (2000) reported that extracts using methanol solvent were more active than those extracted by ethanol against *Bacillus* spp. and *S. aureus*. LI Fang, (2001) reported that the alcoholic extract of *R. graveolens* have the same weak bacteriostasis on the following bacteria: *Streptococcus purulent*, *Micrococcus luteus*, *Staphylococcus aureus*, *Streptococcus B*, *Streptococcus pneumoniae*, *Pseudomonas aeruginosa*, *Escherichia coli* and *Salmonella species*. In contrary, the results of this study showed that *Micrococcus luteus* and *Salmonella typhmurim* were highly affected with alcoholic extract. Moghadam *et al.*, (2012) reported that ethanol extract of *R. graveolens* has no inhibitory effect on *staphylococcus aureus*. It seems that there might be more antibacterial components in methanol and also in pure ethanol extract from callus, *in vitro* and *ex vitro*. Furthermore, Pandey *et al.*, (2011) also reported that extracts of *R. graveolens* stem using ethanol showed the most potent antibacterial activity against *S. aureus* and *B. subtilis*.

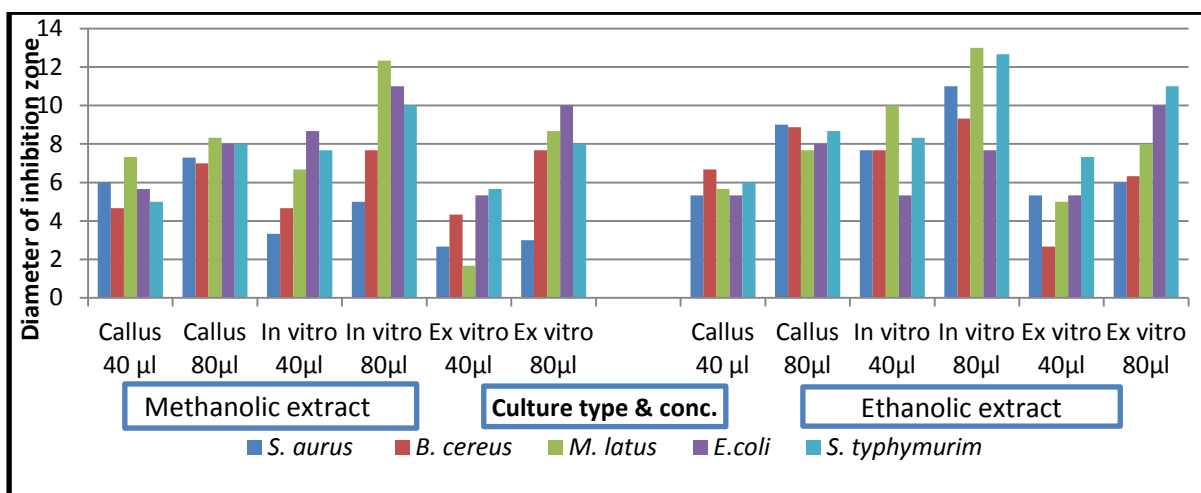

Figure 2: Antibacterial activity of different culture types of *Ruta graveolens* against five bacterial species at different volume (40 µl and 80 µl) using well diffusion method.

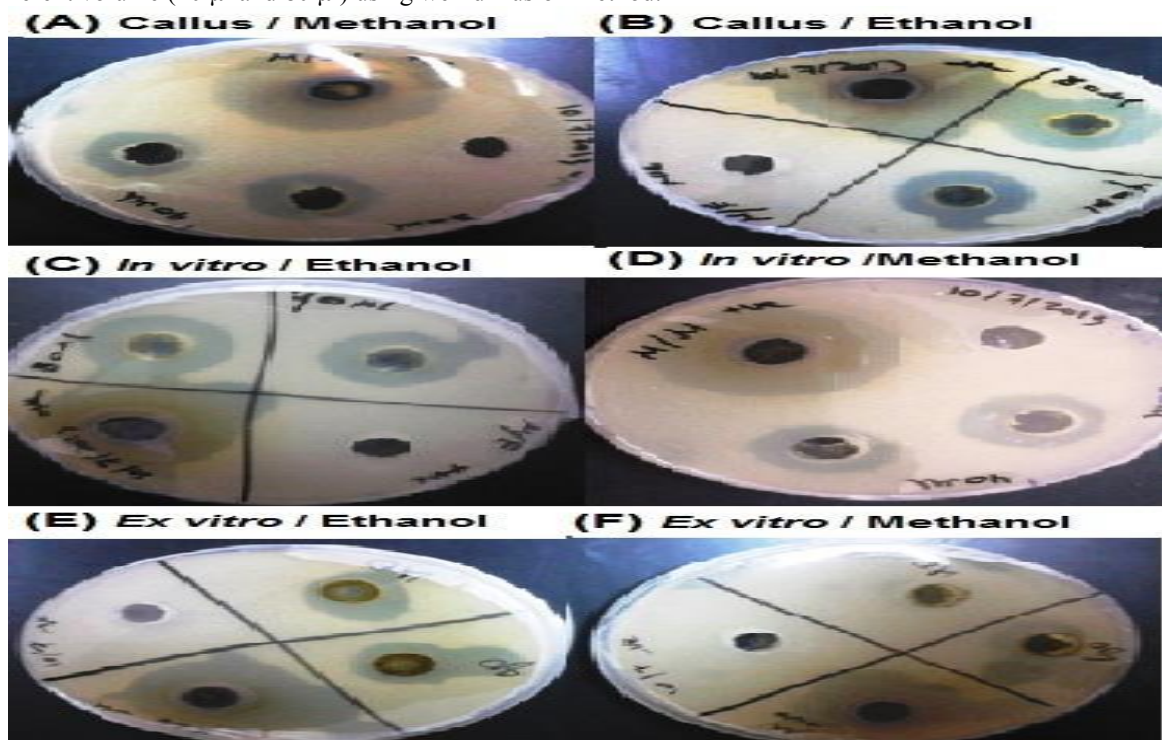

Figure 3: Agar well-diffusion assay of *R. graveolens* extracts against *M.latus*, (A) activity of callus extracted by methanol, (B) activity of callus extracted by ethanol, (C) activity of *in vitro* extracted by ethanol, (D) activity of *in vitro* extracted by methanol, (E) activity of *ex vitro* extracted by ethanol and (F) activity of *ex vitro* extracted by methanol. Inhibition zone was observed around the well.

Antifungal activity

In vitro ethanolic extracts was shown the highest activity against *Fusarium oxosporium*, it was 12.33 mm and 10.33 mm inhibition zone in *in vitro* methanolic extracts (Figure 4). The antifungal of callus extract against *Fusarium oxosporium* was in methanol 8.66 mm and in ethanol was 9.00 mm at 80 μ l. *Ex vitro* extract was also had inhibitory effect on *Fusarium oxosporium*, it was in ethanolic extract 8.67 mm and in methanolic extract was 7.67 mm at 80 μ l, Figure (4). Meepagala *et al.*, (2005) reported that the ethylacetate extract from roots of *R.graveolense* had shown fungicidal activity against several agriculturally important pathogenic fungi like *Colletotichum fragariae*, *C.gloeosporioides*, *C.acutatum*, *Botrytis cineara* and *Fusarium oxysporium*. Moreover, Pandey *et al.*, 2011 reported that ethanolic extract of *R. graveolens* stem showed moderate antifungal activity except *Fusarium oxosporium*, it was high inhibition activity. *Saprolegnia* also prevented from growth by root ethanolic extract of *R. graveolens* (Karouei *et al.*, 2012).

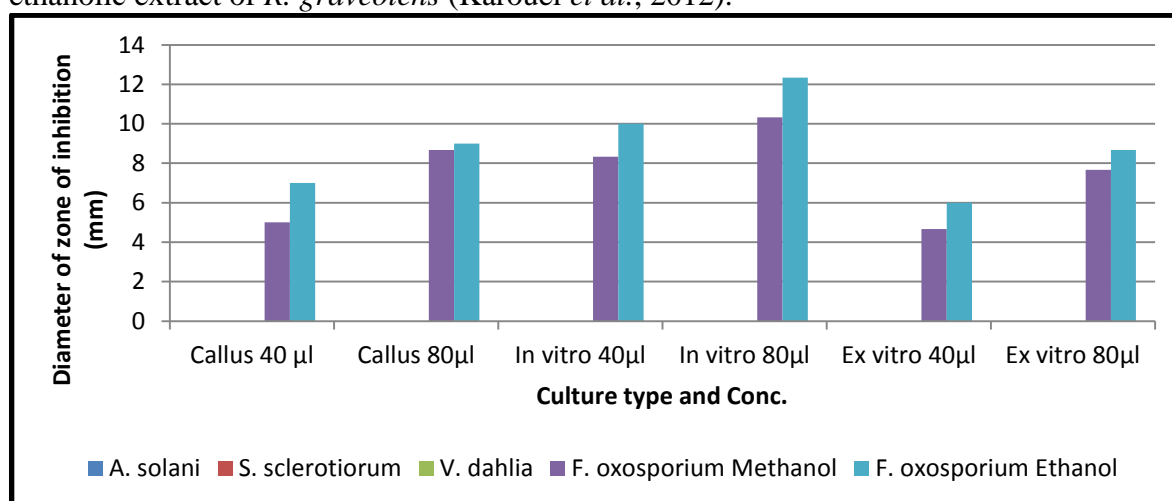

Figure 4: Antifungal activity of different culture types of *Ruta graveolens* against four fungal species at different volume (40 μ l and 80 μ l) using well diffusion method.

In vitro extracts shows to give high antimicrobial activity against tested bacterial and fungal species, it may due to presence of high concentration of toxic compounds as results in HPLC analysis (Al-Ajlouni *et al.*, 2015).

Conclusion

Adventitious roots were successfully induced from shoot tip segments of *R. graveolens* on MS medium supplemented with 0.4 mg/L IBA. In addition, callus was successfully induced from leaf segments on MS media supplemented with 4.0 mg/L NAA under dark condition. For the antimicrobial activity of *R. graveolens* would help for development of a new alternative medicine system which has no side effects. *R. graveolens* stem extracts possess a broad spectrum of activity and open the possibility of finding new clinically effective antimicrobial compounds for *R. graveolens*.

Acknowledgments:

We gratefully acknowledge the Deanship of Scientific Research, Jordan University of Science and Technology, for their financial support (Research Project # 20130008).

References

- Al-Ajlouni, Z. I., Shifaa, A., Mohamad, S and Ibrahim, M. (2015). In vitro propagation, callus induction, and evaluation of active compounds on *Ruta graveolens*. *Journal of Food, Agriculture & Environment*. Vol.13 (2): 101-106.
- Anonymous, (2003). The wealth of India, Raw Material. Publication and Information Directorate. CSIR, New Delhi, India. 95-96.
- Bohidhar, S., Thirunavoukkrasu M. and Roa T. V. (2008). Effect of plant growth regulators on in vitro micropropagation of Garden Rue (*Ruta graveolens* L.). *International Journal of integrative biology*, 3, 36-43.
- Dababneh B. and Khalil A., (2007). The Inhibitory Effect of Extracts from Jordanian Medicinal Plants Against Phytopathogenic Fungi. *Plant Pathology Journal*, 6, 191-194.
- Faisal, M., Ahmad N. and Anis M. (2005). In vitro regeneration and mass propagation of *Ruta graveolens* L., A multipurpose shrub. *Horticultural science*, 40(5), 1478-1480.
- Faisal, M., Ahmad N. and Anis M. (2006). In vitro regeneration via de novo shoot organogenesis in callus culture of *Ruta graveolens*- A plant with medicinal and horticultural potential. *Phytomorphology*, 56,183-187.
- Fang, L. (2001). Study on the bacteriostasis in vitro of compound *Ruta graveolens* L. Tablets. *LiShiZhen Medicine and Materia Medica Research*. 11.
- Green, R. J. (2004). Antioxidant activity of peanut plant tissues. Master's Thesis. North Carolina State University. USA.
- Gurudeeban, S., Satyavani K., Ramanathan T. and Balasubramanian T. (2012). Effect of antioxidant and anti-aggregating properties of micro-propagated plantlets of *Ruta graveolens*. *Asian journal of biotechnology*, 11, 1497-1504.
- Ivanova, A., Mikhova B., Majdenski H., Tsvetkova I. and Kostova I. (2005). Antimicrobial and cytotoxic activity of *Ruta graveolens*. *Fitoterapia*, 76, 7-344.
- Karouei, H. S., Haji S. M. and Gho (2012). Isolation of *Saprolegnia* and the Influence of Root Ethanolic Extract of *Ruta graveolens* on *Saprolegnia*. Spp. Growth. *International journal of bioscience, biochemistry and bioinformatics*, 2(1), 64-68.
- Khoury, N. A., and El-Akawi, Z. (2005). Antiandrogenic activity of *Ruta graveolens* L. in male albino rats with emphasis on sexual and aggressive behavior. *Neuroendocrinology letters*, 26, 823-829.
- Mahmoud, Mohamed, H., and Ibrahim, T. (2012). Enhanced in vitro production of *Ruta graveolens* L. coumarins and rutin by mannitol and ventilation. *Plant cell, tissue and organ culture*, (111), 335-343.
- Meepagala, K. A., Schrader K. K., Wedge D. E. and Duke S. O. (2005). Algicidal and antifungal compounds from the roots of *Ruta graveolens* and synthesis of their analogs. *Phytochemistry*, 66, 2689-2695.
- Moghadam, M. A., Honarmand H., Falah-Delavar S. and Saeidinia A. (2012). Study on antibacterial effect of *Ruta graveolens* extracts on pathogenic bacteria. *Annals of biological research*, 3(9), 4542-4545.
- Nalawade, M. S. and Tsay, H. (2004). In vitro propagation of some important Chinese medicinal plants and their sustainable usage. *In vitro cellular and developmental biology – plant*, 40, 143-154.
- Ojala, T., Remes S. and Haansuu P. (2000). Antimicrobial activity of some coumarin containing herbal plants growing in Finland. *Ethnopharmacol*, 73(1-2), 299-305.
- Pandey, P., Mehta A. and Hajra S. (2011). Evaluation of antimicrobial activity of *Ruta graveolens* stem extracts by disc diffusion method. *Phytology*, 3(3), 92-96.
- Perez, C., Pauli M. and Bazerque P. (1990). An antibiotic assay by agar-well diffusion method. *Acta biologiae et medecine experimentaalis*, 15, 113-115.

Shatnawi, M. A., Shibli R. A., Abu-Romman S. M., Al-Mazra'awi M. S., Al Ajlouni Z. I., Shatanawi W. A. and Odeh W. H. (2011). Clonal propagation and cryogenic storage of the medicinal plant *Stevia rebaudiana*. Spanish journal of agricultural Research, 9, 213-220.

PRODUCTIVITY OF SOME DUTCH POTATO VARIETIES IN THE MOUNTAIN REGION OF MONTENEGRO

Zoran JOVOVIĆ¹, Andrey SKRYABIN², Ana VELIMIROVIĆ¹, Željko DOLIJANOVIĆ³,
Milica BUČKOVIĆ¹

¹University of Montenegro, Biotechnical Faculty Podgorica, Montenegro

²Plant Growing Department, Perm State Agricultural Academy, Russia

³University of Belgrade, Agricultural Faculty, Serbia

Abstract

This paper presents the results of a two-year study of six Dutch potato varieties in agroecological conditions of northern Montenegro. The two-year average of the highest number of tubers were found in the variety Arnova (8.4), while the lowest tuber number was obtained in varieties Arrow (6.8), Rudolph (6.8) and Riviera (6.9). Increasing the number of tubers in the variety Arnova compared to other varieties was statistically significant. Varieties Rudolph (116.5 g) and Kuroda (100.5 g) gave averagely biggest tubers. The average weight of tuber of other varieties studied was approximately at the same level, and ranged from 80.4 g, for the cultivar Arrow to 88.6, for the Arnova. Rudolph and Kuroda were, compared with all other varieties, had significantly larger tubers. The highest yield in trials was on plots planted with varieties Rudolph - 33.7, Kuroda - 32.0 and Arnova - 31.5 tha^{-1} . The lowest yield was measured at variety Arrow - 23.2 tha^{-1} . Yields of varieties Rudolph, Kuroda and Arnova were compared to all other investigated varieties statistically significant. This research showed that the highest yields of tubers in agroecological conditions of mountain climates are achieved by growing medium late and middle early varieties of potatoes.

Keywords: potato, tuber number, tuber weight, yield

Introduction

Potato is among the most important and most profitable crops in many countries of the world. On a global scale, after rice, wheat and maize, potato is the fourth largest source of food. The economic importance of potato in Montenegro is very significant, especially for the mountainous area where it is predominantly grown.

Potato is a plant of temperate climate and is grown in almost all latitudes. However, the best zone for potato growing is considered the area of temperate zone (40-60° north latitude), as well as areas under 40° of north latitude at high altitudes (Muminović et al., 2014). Due to the very pronounced polymorphism, potatoes easily adapt to different environmental conditions. Thanks to this feature, potato is now grown even in poor production conditions and high altitudes, even where the cultivation of other agricultural crops is not possible (Jovović et al., 2015).

Potatoes prefer chilly nights, but nights like that are less and less. The increasing climate variability poses a serious threat to its further cultivation. Climate change has increasingly negative impact on potato crop production leading to large seasonal fluctuations in the amount and quality of yields. Therefore, in the future potato production is gradually moving from the warmer south to colder northern areas and higher mountain regions (Jovović et al., 2016).

The systematic study of the different genotypes in different environmental conditions is of great importance resulting with wider selection of varieties adapted to the specific conditions (Yang, 2002). Yields of potatoes, in addition to the variety, greatly depend on the agroecological conditions, but also on nature of interaction between genotype and environment. The reaction of individual varieties to different environmental conditions is conditioned by

their genetic predisposition. Knowing very complex relations existing between genotype and environment is of paramount importance when selecting varieties (Jovović et al., 2012).

As different production areas are governed by very different environmental conditions, variety performance is different as well. Therefore, knowledge on the productivity of potato varieties and their reactions to the specific conditions of production regions is one of the most important preconditions for achieving high and stable yields (Momirović et al., 2000). Consequently, the study of the productivity of different potato varieties in different agro-ecological conditions has outstanding practical significance. In this way, there is very reliable information about the cultivated varieties that will allow maximum utilization of genetic resources and thus achievement of high and stable yields (Yang, 2002).

The aim of this study was examination of yield and other indicators of productivity for six Dutch potato varieties in mountain areas of Montenegro.

Materials and methods

The study of the productivity of six promising Dutch potato varieties was carried out during 2013 and 2014 in Kolašin, on the alluvial-deluvial soil at an altitude of 900 m. Varieties with different length of vegetation and skin colour were tested - early varieties: Riviera (1) and Arrow (2); medium early: Tresor (3) and Arnova (4) and medium-late varieties of red epidermis: Kuroda (5) and Rudolph (6).

The experiments were conducted in a completely randomized block design, with 4 replicates and the surface of the single experimental plot of 15 m². Planting of potatoes was carried out on May 20 2013 and 15 May 2014, by hand, at a distance of 70 x 33 cm, with the resulting density of 43300 plants per hectare. The basic tillage, pre-sowing preparation and fertilization were conducted as standard agricultural practices for potato crop. The protection of crops from weeds, pests and disease-causing agents was conducted timely. Potato harvesting was carried out on 15 September in both years.

Table 1. Chemical characteristics of soil in the experimental field

Depth (cm)	pH		CaCO ₃ %	Humus %	Soluble mg/100 g	
	H ₂ O	nKCl			P ₂ O ₅	K ₂ O
40	6,29	5,55	1,1	4,53	2,4	16,0

Table 2. Meteorological condition during the experiment

Year	Month					Average
	May	June	July	August	September	
Air temperature (°C)						
2013.	12,4	15,7	18,1	18,4	12,7	15,5
2014.	11,3	15,3	17,3	17,5	12,8	14,8
Precipitation sum (mm)						
2013.	301,3	125,0	32,9	67,8	118,3	645,3
2014.	96,6	150,3	114,7	69,1	233,2	663,9

Determination of the number of tubers and their mass was performed after complete maturation on average sample of 10 potato plants from a row in each repetition. Total yield per hectare was calculated according to the theoretical categories of crop density.

Soil in experimental plots has favourable water and air properties, high humus content, low phosphorus and calcium and moderate potassium content (table 1). Meteorological data for the experimental period are given in table 2. Statistical analysis was performed by the method of factorial analysis of variance (ANOVA), and the score difference between the mean values using LSD test.

Results and discussion

The measurement results given in Table 3 show that the largest number of tubers in the experiment was found in variety Arnova - 8.4 (7 in 2013 and 9.8 in 2014), while the lowest tuber number was measured in Arrow - 6.8 (6.2 and 7.3), Rudolph - 6.8 (7.2 and 6.3) and Riviera - 6.9 (6.3 and 7.4). In two-year average, variety Arnova had significantly higher number of tubers compared with other varieties. The significant increase in the number of tubers was determined in varieties Kuroda (7.5) and Tresor (7.3) compared to Errow (6.8), Rudolph (6.8) and Riviera (6.9).

Table 3. Results of studies for Dutch varieties

Parameter	Year	Variety						Average
		Riviera	Arrow	Tresor	Arnova	Kuroda	Rudolph	
Average number of tubers	2013.	6,3	6,2	6,6	7,0	7,8	7,2	6,9
	2014.	7,4	7,3	8	9,8	7,1	6,3	7,7
	Average	6,9	6,8	7,3	8,4	7,5	6,8	7,3
Average tuber weight (g)	2013.	82	87	86	96	85	108	90,7
	2014.	84	74	76	81	116	125	92,7
	Average	83,0	80,5	81,0	88,5	100,5	116,5	91,7
Yield (t.ha ⁻¹)	2013.	22,0	23,1	24,5	28,7	28,5	33,4	26,7
	2014.	26,6	23,2	26,0	34,2	35,4	33,9	29,9
	Average	24,3	23,2	25,3	31,5	32,0	33,7	28,3

	Year	lsd 0,05	lsd 0,01
Average number of tubers	2013.	0,463	0,629
	2014.	0,670	0,909
	2013-14.	0,327	0,444
Average tuber weight (g)	2013.	5,921	8,034
	2014.	14,415	19,556
	2013-14.	6,765	9,179
Yield (t.ha ⁻¹)	2013.	1,833	2,487
	2014.	3,956	5,367
	2013-14.	2,021	2,742

The average number of tubers is a very important parameter of productivity on which depends the production per plant of potatoes, and finally the total yield per unit area (Bugarčić et al., 2000). The variability of the number of tubers, except genetic differences between the varieties of potato, largely depends on the interaction between genotype and environmental factors (Nacheva, 2006). In compared studied years, slightly higher average number of tubers was found in 2014 as a result of higher rainfall in June, when potato plant tuberisation is occurring.

Tuber size is an important parameter of productivity and is basically a varietal characteristic, but above all it depends on the level of agricultural practices, soil type and weather conditions during the vegetation period (Jovović et al., 2011). In two-year studies, plots with the highest average tuber weight measured, were planted with varieties Rudolph (116.5 g) and Kuroda (100.5 g). The smallest tubers were measured in varieties Arrow, Tresor and the Riviera (80.5, 81 and 83 g). Analysis of variance of the average tuber weight showed a highly significant increase in tuber weight of varieties Kuroda and Rudolph as compared to other varieties. Differences in tuber weight between Rudolph and Kuroda are also statistically significant. Increase in number of tubers in the variety Arnova compared with varieties Arrow and Tresor was statistically significant.

Number and size of tubers depend on the number of primary shoots formed on single plant. Bigger number of primary shoots, bigger number of tubers formed, but not their weigh too (Butorac and Bolf, 2000). The results of this study are correlated with this statement.

The highest yields were obtained in experiments on plots cultivated with varieties Rudolph - 33.7, Kuroda - 32.0 and Arnova - 31.5 tha⁻¹, while the lowest yielding varieties were Arrow -

23.2, Riviera – 24.3 and Tresor - 25.3 tha^{-1} . Rudolph, Kuroda and Arnova as compared to other varieties yielded a significantly higher tuber yield. Arrow, Riviera and Tresor yields were statistically highly significant. The significant increase in yield was found in the variety Tresor compared with Arrow, as well as between varieties Rudolph and Arnova. As 2014 had a slightly greater quantity and a better distribution of rainfall during the growing season of potato, and lower average air temperatures, it resulted with higher yields in this year (29.9 in 2014 and 26.7 tha^{-1} 2013).

Proper selection of varieties could significantly reduce adverse environmental effects. For these reasons, the study of potato varieties in the mountain area of Montenegro should continue.

Conclusion

Based on said above it can be concluded:

- With proper variety selection, high potato yields can be achieved even in mountainous areas of Montenegro.
- In two-year studies, the highest yielding varieties were Rudolph - 33.7, Kuroda – 32.0 and Arnova - 31.5 tha^{-1} , while the lowest yields were measured in plots planted with varieties Arrow - 23.2, Riviera - 24.3 and Tresor and - 25.3 tha^{-1} .
- The largest number of tubers per plant was determined in cultivar Arnova (8.4), while the lowest tuber number was found in varieties Arrow and Rudolph (6.8). The number of tubers in the variety Arnova compared to other varieties was statistically significant.
- Tubers with the highest average weight were obtained from varieties Rudolph (116.5 g) and Kuroda (100.5 g), while the smallest tubers were measured in the varieties Arrow and Tresor (80.5 and 81.0 g).
- The highest yields are achieved growing medium late and medium early potato varieties in mountainous area of Montenegro.

Literature

- Bugarčić, Ž., Rose Aboth Bugarčić, Đekić, R., Jelena Ivan (2000): Testing productivity of Dutch potato varieties in different agro-ecological conditions of Serbia. *Archive of Agricultural Sciences* 61, 215 (vanr. sv.), 143–150.
- Butorac, J., Bolf, M. (2000): Production of potatoes, Library "Cooperative enterprise adviser ' Zagreb.
- Jovovic, Z., Micev, B., Velimirovic, A. (2016): Impact of climate change on potato production in Montenegro and options to mitigate the adverse effects. *Acad. J. Environ. Sci.* 4(3): 047-054, West Yorkshire, England.
- Jovović, Z., Dolijanović, Ž., Velimirović, Ana, Poštić, D., Milošević, D. (2015): Examination of some Dutch white flesh potato varieties in mountainous region of Montenegro. VI International Symposium „Agrosym 2015“, Jahorina, October 15-18, 2015, Bosnia and Herzegovina, Book of abstracts, 681-684.
- Jovović, Z., Dolijanović, Ž., Kovačević, D., Velimirović, Ana, Biberdžić, M. (2012): The productive traits of different potato genotypes in mountainous region of Montenegro. *Genetika*, Vol. 44, No 2, 389-397, Belgrade.
- Jovović, Z., Kovačević, D., Milošević, D. (2011): Effect of weed control on photosynthetic activity and size of biological potato production. XVI conference on biotechnology. *Proceedings*, 391-396, Čačak.
- Momirović, N., Mišović, M., Bročić, Z. (2000): Modern technology of growing multi-purpose potato. *Journal of Scientific agricultural research*. Vol. 61, No 215, 45–70, Belgrade.
- Muminović, Š., Karić, Lutvija, Jovović, Z., Žurovec, Jasminka (2014): Potato. Monograph, University of Sarajevo, Faculty of Agriculture Sarajevo.

- Nacheva, E. (2006): Testing of yield components in the selected material of potatoes. Plant breeding and Seed production, Vol. 12, No. 3-4, pp 9-13, Belgrade.
- Yang, C. (2002): Analysis of genotype and environment (GxA) interaction in grain yield and leaf blast reaction of rice varieties through multi-location trials. Dissertation, Kangwon National University. Korea, pp. 34-50.

IN VITRO SHOOT AND ROOT REGENERATION IN ERCIS CABBAGE (BRASSICA OLERACEAE VAR. CAPITATA)

Ferit ERTAŞ, Burcu TUNCER*

Department of Horticulture, Faculty of Agriculture, Yuzuncu Yil University, Van, Turkey

*Corresponding author: brctuncer@gmail.com

Abstract

Ercis head cabbage which is a population local to the Van province of Turkey was tested for ability to regenerate shoots and roots *in vitro*. Cotyledon and hypocotyl explants were excised from 7 day old *in vitro* seedlings, germinated on Murashige and Skoog (MS) medium, and cultured on MS medium supplemented with benzylaminopurine (BAP) (0.5 mg/l, 1.0 mg/l, and 2.0 mg/l) and naphthaleneacetic acid (NAA) (0, 0.05 mg/l, and 0.1 mg/l). The highest shoot regeneration (100%) was achieved in hypocotyls explants with MS7 (MS + 2 mg/l BAP) and 91.6% with MS6 (MS + 1 mg/l BAP + 0.1 mg/l NAA), MS4 (MS + 1 mg/l BAP), and MS3 medium (MS + 0.5 mg/l BAP+ 0.1 mg/l NAA). The MS4 medium (5.2 shoot/explant) was the most successful in terms of the number of shoots per explant. The highest shoot regeneration from cotyledon explants was obtained from MS1 (MS + 0.5 mg/l BAP) and MS9 (MS + 2 mg/l BAP + 0.1 mg/l NAA) mediums with 91.6%. In hypocotyls explants, indirect shoot regeneration was induced in all media combinations and the rate of regeneration was found to be higher than in cotyledon explants. In root regeneration trials, 4 different indolebutyric acid (IBA) doses (0 mg/l, 0.5 mg/l, 1.0 mg/l and 1.5 mg/l) were tested on 1/2 MS medium, and 100% rooting was achieved from the control and 0.5 mg/l IBA doses.

Keywords: *Regeneration, Cabbage, Hypocotyl, Cotyledon*

Introduction

Cabbage vegetables of the *Brassicaceae* family are economically significant vegetable species. This family includes approximately 350 genera and 3000 species (Şalk et al., 2008). The total production of *Brassica* group vegetables in Turkey is 935,230 t, 492,610 t of which is white head cabbage (Anonymous, 2014). Turkey is as rich in terms of its cabbage genetic resources as it is in cabbage production (Balkaya et al., 2005). Different types of cabbage are cultivated in each region in Turkey. For example leaf cabbage is cultivated in the Black Sea Region while white head cabbage is cultivated in Eastern Anatolia, and red head cabbage is cultivated in Western and Southern Regions of Turkey. The Ercis cabbage is a local head cabbage population that is cultivated in the Van province of the Eastern Anatolian Region of Turkey. Due to its loose and large head (average of 1.0 kg) and thin leaf properties it is more suited for stuffing or pickling, and is a significant source of income for the region's population.

Currently in breeding studies on *Brassica* species, biotechnological methods and genetic transformation approaches are widely used in addition to traditional plant breeding methods. However the success of these approaches depends on the use and development of an effective and suitable system of *in vitro* regeneration. Therefore studies are required to optimize the regeneration system for every species, in fact for every genotype. Cotyledon (Daud et al., 2015) and hypocotyl explants (Hazrat et al., 2007; Cristea et al., 2010; Gerszberg et al., 2015) taken from seedling cultivated *in vitro* are widely used in plant regeneration and genetic transformation studies on *Brassica* species.

Munshi et al. (2007) have reported that the highest shoot regeneration in cotyledon and hypocotyl explants taken from 7 day old *in vitro* seedlings of head cabbage (*B. oleracea* var. *capitata*) was observed on 1/2 MS containing 0.5 mg/l BA and that 98% rooting had been

achieved on 1/2 MS fortified with 0.5 mg/l IBA. In a study performed on 8 different head cabbage (*Brassica oleracea* var. *capitata*) varieties, it is stated that the highest shoot regeneration in 5 varieties was obtained from the MS + 8.88 μ M BAP + 0.53 μ M NAA medium in 10 day old hypocotyl and cotyledon explants cultured *in vitro*, and that hypocotyl explants had been more successful in terms of callus stimulation and organogenesis. The same researchers have also stated that rooting was achieved in all varieties and that an increase was observed in the number of healthy and strong roots in the MS + 5.37 μ M NAA medium (Gerszberg et al., 2015).

Sharma et al. (2014) have tested 36 different hormone combinations in head cabbage (*Brassica oleracea* L. var. *capitata*). They have reported that the highest shoot regeneration in cotyledon explants had been obtained from the MS + 1.5 mg/l BAP + 0.50 mg/l NAA and MS + 2 mg/l BAP + 0.25 mg/l IAA medium, and that 90% root regeneration was achieved from MS + 0.1 mg/l IBA as rooting medium. Daud et al. (2015) have used stalk, root, leaf, and leaf stem explants taken from 7 day old seedlings of head cabbage that had developed *in vitro*. They have determined that plantlets had been obtained more quickly from calluses obtained from stalk and root explants cultured in the MS + BAP (1 mg/l) + NAA (0.5 mg/l) medium. In another study that had been performed on 2 genotypes of head cabbage, it is stated that the maximum shoot regeneration in hypocotyl explants taken from 5 day old seedlings developed *in vitro* had been observed on MS containing 9.1 μ M zeatin and 2.8 μ M IAA (Cristea et al., 2010).

The present study was undertaken to investigate the effect of MS medium formulations and different explant types (cotyledon and hypocotyl) on shoot and root regeneration in Ercis cabbage. This is the first report on *in vitro* regeneration of Ercis head cabbage.

Material and methods

Seeds belonging to the 'Ercis cabbage population' obtained from the Ercis district of Van province in Turkey have been used in the study. The seeds were washed several times under tap water, eliminating inorganic materials from the seeds. Then they were kept for 30 seconds in 70% ethyl alcohol within a laminar flow container, washed several times with double distilled water, removing ethyl alcohol. The seeds were then kept for 15 minutes in 20% commercial sodium hypochlorite solution to which a few drops of Tween-20 had been added, and finally washed by being shaken in double distilled water 3 times, 6 minutes each time. The sterilized seeds were germinated in hormone-free MS (Murashige and Skoog, 1962) medium (30 g/l sucrose, 7 g/l agar, PH: 5.8) within 6 cm glass Petri dishes (6-7 seeds/Petri dish). Cotyledon and hypocotyl explants were excised from 7 day old seedlings, and cultured on MS containing various concentrations of BAP (0.5, 1.0, and 2.0 mg/l) and NAA (0, 0.05, and 0.1 mg/l). All the cultures were kept under a 16 h photoperiod (3000 lux, approx.) regime at $23 \pm 2^\circ\text{C}$. Shoots that reach an approximate length of 3 cm were transferred to 1/2 MS rooting medium containing IBA (0, 0.5, 1.0, and 1.5 mg/l) in 4 different concentrations. 4 weeks later, the number of shoot per explant and percentage, average shoot length, the number of roots obtained per explant and percentage and the average root length was calculated in the cultures.

Shoot regeneration trials were conducted with 3 repetitions for each application, and root regeneration trials were conducted with 6 trials. Variance analysis was performed in comparisons of properties investigated in the trial. The level of statistical significance was taken as 5% in calculations, and the SPSS (ver. 13) statistics package software was used for calculations.

Results and discussion

In vitro shoot regeneration trials, cotyledon and hypocotyls explants were excised from 7 day old *in vitro* seedlings, and cultured in the MS medium in 9 different hormone combinations

containing BAP and NAA (Table 1). The swelling and growths that occurred in explants 7-9 days after being planted in the MS medium were determined as development, and the number of explants which had shown development were recorded. Shoot regeneration was achieved from all explants that had observed development and growth. Hypocotyl explants were found to be more successful than cotyledon explants in terms of explant development and shoot regeneration, except in the MS1 (0.5 mg/l BAP) and MS9 (2 mg/l BAP + 0.1 mg/l NAA) mediums. While all explants (100%) registered growth in the MS7 (2 mg/l BAP) medium in hypocotyl explants, this was followed with MS6 (1 mg/l BAP + 0.1 mg/l NAA), MS4 (1 mg/l BAP), and MS3 (0.5 mg/l BAP + 0.1 mg/l NAA) with a 91.6% percentage of regeneration. MS9 (2 mg/l BAP + 0.1 mg/l NAA) was found to be the least successful medium with a 58.3% rate of regeneration.

In cotyledon explants, the highest shoot ratio was obtained in MS1 (0.5 mg/l BAP) and MS9 (2 mg/l BAP + 0.1 mg/l NAA) mediums with a 91.6% rate of regeneration, and this was followed by MS4, MS5, and MS8 in that order. MS6 and MS7 mediums were found to be least successful in terms of shoot regeneration with a 41.6% rate of regeneration. Indirect shoot regeneration was occurred in all medium combinations in hypocotyl explants (Figure 1). The rate of callus formation ranged between 41.6 – 100% in hypocotyl explants, and between 0-33.3% in cotyledon explants (Table 2).

Table 1. Effect of BAP and NAA in the MS medium on the number of shoots per explants, regeneration rate and on shoot length.

Medium	Hormone (mg/l)		Shoot number/explant and regeneration rate (%)				Shoot length (cm)	
	BAP	NAA	Hypocotyl	R.R (%)	Cotyledon	R.R (%)	Hypocotyl	Cotyledon
MS1	0.5	0	3.16 bc	83.3	2.92 ab	91.6	1.83 bc	2.33 a
MS2	0.5	0.05	3.75 b	83.3	0.66 c	50.0	3.80 a	1.60 ab
MS3	0.5	0.1	4.42 ab	91.6	0.75 c	58.3	2.60 ab	1.60 ab
MS4	1.0	0	5.25 a	91.6	2.58 b	83.3	2.0 bc	1.63 ab
MS5	1.0	0.05	2.42 cd	83.3	1.16 c	75.0	1.53 bc	1.66 ab
MS6	1.0	0.1	4.33 ab	91.6	0.41 c	41.6	2.60 ab	1.0 b
MS7	2.0	0	4.33 ab	100	0.75 c	41.6	2.03 bc	1.40 ab
MS8	2.0	0.05	2.33 cd	75.0	1.36 c	66.0	1.83 bc	2.0 ab
MS9	2.0	0.1	1.16 d	58.3	3.75 a	91.6	1.0 c	2.26 a
LSD.05			1.21		1.09		1.28	1.03

R.R.: Regeneration rate

While the highest number of shoots per explant was obtained from the MS4 (5.25 shoot/explant) medium in hypocotyl explants, this was followed by the MS3 (4.42 shoot/explant), MS6 (4.33 shoot/explant), and MS7 (4.33 shoot/explant) mediums that are included in the same statistical group, in that order. The MS9 medium was found to be the least successful environment in terms of the number of shoots per explants (Table 1). In many studies conducted on cabbage, it is reported that the composition of the medium and type of explant are influential on shoot regeneration, and that hypocotyl explants yield more successful results as compared to other explant types in terms of the rate of shoot regeneration (Munshi et al., 2007; Dai et al., 2009; Ravanfar et al., 2009; Pavlovic et al., 2010). Figure 1 shows shoot formation from cotyledon and hypocotyl explants.

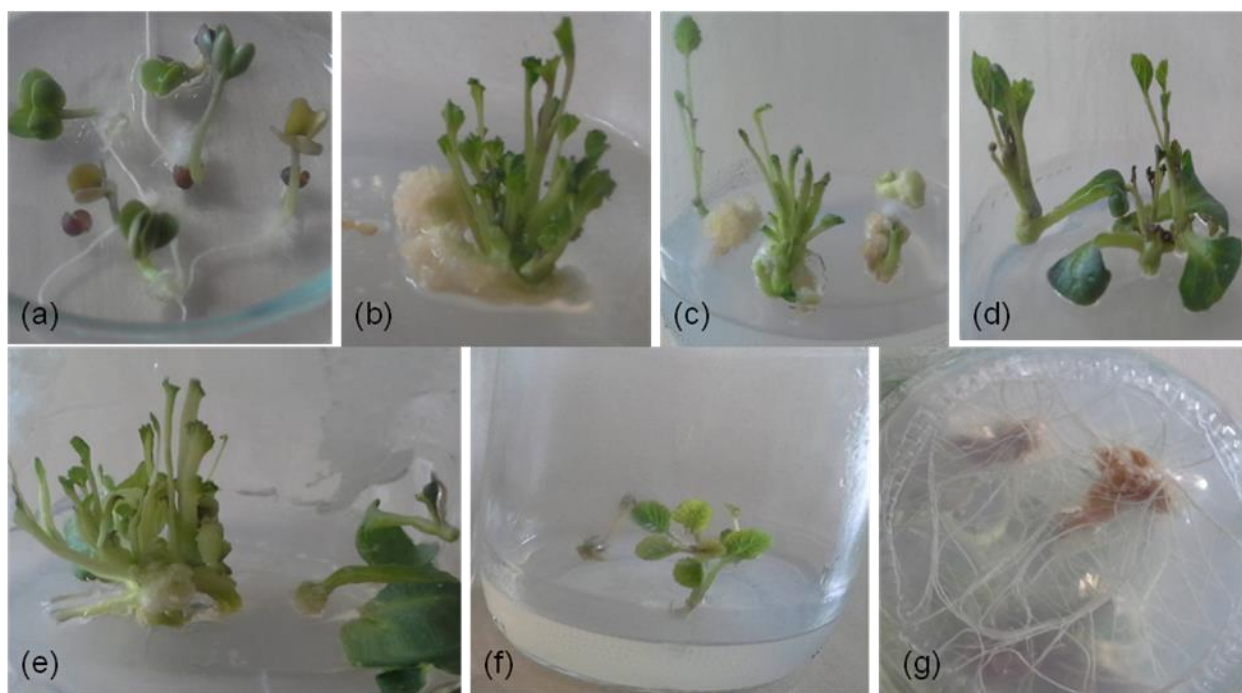

Figure 1. In Ercis head cabbage, (a) 7 day old in vitro germinated seedlings, (b, c) indirect shoot formation from hypocotyl explants, (d, e) direct shoot formation from cotyledon explants, (f) plants transferred to rooting medium, (g) root formations in rooting medium.

Table 2. Effect of BAP and NAA in the MS medium on the rate (%) of callus formation

Medium	Hormone (mg/l)		Callus formation rate (%)	
	BAP	NAA	Hypocotyl	Cotyledon
MS1	0.5	0	66.6	0.0
MS2	0.5	0.05	91.6	16.6
MS3	0.5	0.1	100.0	16.6
MS4	1.0	0	100.0	0.0
MS5	1.0	0.05	91.6	0.0
MS6	1.0	0.1	66.6	8.3
MS7	2.0	0	58.3	25.0
MS8	2.0	0.05	41.6	33.3
MS9	2.0	0.1	50.0	33.3

The results of our study also have been found to support this literature, and more successful results have been obtained from hypocotyl explants in terms of shoot regeneration. A statistically significant decrease has been determined in the number of shoots obtained from cotyledon explants. While the highest number of shoots was obtained from the MS9 (3.75 sürgün/eksplant) medium, this was followed by the MS1 (2.92 shoot/explant) and MS4 (2.58 shoot/explant) mediums. The number of shoots that was obtained from other medium combinations were found to be low, and the differences between them were found to be statistically insignificant (Table 1). It has been determined that various doses of are BAP (1.0 – 3.5 mg/l) and NAA (0.1-0.5 mg/l) are generally used in shoot regeneration studies in studies conducted on various *Brassica* species (Basak et al, 2012; Sharma et al, 2014). Shoot length

ranged between 1.0 – 3.8 cm in shoots developing from hypocotyl explants, and 1.0 – 2.33 cm in shoots developing from cotyledon explants (Table 1).

Literature scans performed have indicated that various doses of IBA (0 – 1.0 mg/l) or NAA (0.1 – 4.0 mg/l) are generally used as rooting medium on *Brassica* species, and that the results obtained are successful (Munshi et al, 2007; Ravanfar et al., 2009; Sharma et al., 2014; Daud et al., 2015; Gerzberg et al, 2015). In our study, considering these literature statements, the shoots obtained were transferred to rooting mediums containing various doses of IBA (0 mg/l, 0.5 mg/l, 1.0 mg/l, and 1.5 mg/l) in a 1/2 MS medium. The impact of various concentrations of IBA on the number of roots obtained per shoot, root length, and the rate of regeneration are shown in Table 3. The highest number of roots per shoot (14.16 root/shoot) was obtained from the 0.5 mg/l IBA dose. The number of roots per shoot decreased in other doses, while the differences between the doses were found to be statistically insignificant (Table 3). While a higher result in terms of root length was obtained from the control group to which no hormones had been added, no positive effects on root length of increased IBA doses were found.

Table 3. Effect of various concentrations of IBA in the 1/2 MS medium on rooting

Hormone (mg/l)	Root number/shoot	Root length (cm)	Regeneration rate (%)
IBA			
0	8.50 b	2.35 a	100
0.5	14.16 a	1.82 ab	100
1.0	8.30 b	1.78 ab	83.3
1.5	8.16 b	1.56 b	66.6
LSD.05	1.84	0.66	

Conclusion

It has been concluded that in future studies that will be conducted on *in vitro* shoot regeneration in the ‘Ercis’ head cabbage genotype, it would be beneficial to use hypocotyl explants taken from 7 day old sterile seedlings, and make trials with a higher number of repetitions using 0.5 – 2.0 mg/l doses of BAP in the MS medium. In terms of *in vitro* rooting, it is recommended that no hormones be added to the nutrient medium, or that a dose of 0.5 mg/l IBA not be exceeded in future studies.

Acknowledgement

This study was supported by Yuzuncu Yil University Scientific Research Project Council (YYU BAP, Project No: 2014-FBE-YL105).

References

- Anonymous, 2014. Turkish Statistical Institute. Web: <http://www.tuik.gov.tr>. Accessed on 18.01.2010.
- Balkaya, A., Yanmaz, R., Apaydın, A., Kar, H., 2005. Morphological characterization of white head cabbage (*Brassica oleraceae* var. *capitata* subvar. *alba*) genotypes in Turkey. New Zealand Journal of Crop and Horticultural Science, 33: 333-341.
- Basak, H., Biswas, B.K., Azad, M.A.K., Arifuzzaman, M., Sharmeen, F., 2012. Micropropagation of mustard (*Brassica* spp.) from leaf explants. Thai Journal of Agricultural Science, 45 (2): 75-81.
- Cristea, T.O., Prisecaru, M., Calin, M., 2010. Preliminary studies on the influence of exogenous hormonal factors on the “*in vitro*” organogenesis of *Brassica oleracea* L. var. *capitata*. Studii și Cercetări Biologie, 18: 95-98.

- Dai, X.G., Shi, X.P., Ye, Y.M., Fu, Q., Bao, M.Z., 2009. High frequency plant regeneration from cotyledon and hypocotyl explants of ornamental kale. *Biologia Plantarum*, 53 (4): 769-773.
- Daud, N.F.A., Hasbullah, N.A., Azis, N.A., Rasad, F.M., Amin, M.A.M., Lassim, M.M., 2015. *In vitro* regeneration of *Brassica oleracea* L. var. *capitata* through stems, roots, leaves and petioles culture. International Conference of Agriculture, Ecological and Medical Sciences, April 7-8 2015, Phuket Tailanad.
- Gerszberg, A., Hnatuszko-Konka, K., Kowalczyk, T., 2015. *In vitro* regeneration of eight cultivars of *Brassica oleracea* var. *capitata*. *In Vitro Cellular and Developmental. Biology-Plant*, 51 (1):80-87.
- Hazrat, A., Zahir, A., Haidar, A., Sultan, M., Wiqar, A., 2007. *In vitro* regeneration of *Brassica napus* L., cultivars (star, cyclone and westar) from hypocotyls and cotyledonary leaves. *Pakistan Journal of Botany*, 39 (4): 1251-1256.
- Munshi, M. K., Roy, P.K., Kabir, M.H., Ahmed, G., 2007. *In vitro* regeneration of cabbage (*Brassica oleracea* L. var. *capitata*) through hypocotyl and cotyledon culture. *Plant Tissue Culture and Biotechnology*, 17 (2): 131-136.
- Murashige, T., Skoog, F., 1962. A revised medium for rapid growth and bioassays with tobacco tissue cultures. *Physiology Plantarum*, 15: 473-497.
- Pavlović, S., Vinterhalter, B., Mitić, N., Adžić, S., Pavlović, N., Zdravković, M., Vinterhalter, D., 2010. *In vitro* shoot regeneration from seedling explants in *Brassica* vegetables: Red cabbage, broccoli, Savoy cabbage and cauliflower. *Arch. Biol. Sci.*, 62 (2), 337-345.
- Ravanfar, S. A., Aziz, M. A., Kadir, M., A., Rashid, A. A., Sirchi, M. H. T., 2009. Plant regeneration of *Brassica oleracea* subsp. *italica* (Broccoli) cv green marvel as affected by Plant growth regulators. *African Journal of Biotechnology*, 8 (11): 2523- 2528.
- Sharma, S., Gambhir, G., Srivastava, D.K., 2014. High frequency organogenesis in cotyledon and hypocotyl explants of cabbage (*Brassica oleracea* L. var. *capitata*). *Natl. Acad. Sci. Lett.*, 37 (1):5-12.
- Salk, A., Arin, L., Deveci, M., Polat, S. 2008. Özel Sebzecilik (Special Vegetable). Namik Kemal University Faculty of Agriculture, pp.488, ISBN 978-9944-0786-0-3, İstanbul/Turkey.

MICROMORPHOLOGY OF POLLEN GRAINS OF SOME GRAPE CULTIVARS

Zeliha GÖKBAYRAK*, Hakan ENGIN

Department of Horticulture, Faculty of Agriculture, Çanakkale Onsekiz Mart University, Çanakkale /TURKEY.

*Corresponding author: zgokbayrak@comu.edu.tr

Abstract

Micromorphological characteristics of the pollen grain are one of the most important parameters to identify plant material. Pollen grains in various species are characterized by surface features, the length of polar axis (P) and the equatorial axis (E) of grain and P/E ratio. In this study, pollen grains of two cultivars of *Vitis vinifera* (Cardinal and Cabernet Sauvignon) collected from South Marmara of Turkey were examined for their micromorphological characterization through scanning electron microscopy. The length of polar axis (P), the equatorial axis (E), and P/E ratio were compared. There is no difference in size between ‘Cabernet Sauvignon’ and ‘Cardinal’ cultivar. Pollen from both cultivars is about 25 μm . The P/E ratio was 1.09 in ‘Cabernet Sauvignon’ and 1.08 in ‘Cardinal’. The pollen grains shape is classified as elliptical-oval.

Keywords: *Vitis vinifera*, Pollen Grains, Micromorphology, SEM

Introduction

Palynology has presented considerable opportunities for cultivar identification in grapevines, besides its importance in plant taxonomy (Marasalı et al 2005). The elements of the pollen aperture complex, such as polar and equatorial axes and exine ornamentation are used in the description of the pollen (Roytchev 1995). Roytchev (1997) stated that shape, depth and size of the surface ornamentations and most of the pollen aperture complex traits are cultivar-specific. Using pollen morphology in identification has become more important since the advent of the scanning electronic microscope (SEM) (Roytchev et al. 1994; Fogle, 1977; Cargnello et. al, 1980; Hebda et.al., 1988; Perveen and Qaiser, 2003; Engin and Unal, 2007). Vallania et al. (1996) reported differences in exine ornamentation that could be useful for cultivar identification in *Vitis vinifera* L. Liu et al. (1997) observed pollen morphology of 10 *Vitis* species with SEM and found that there were some differences in the size and shape of the pollens.

The objective of this study was to investigate in detail the pollen morphology of two cultivars of *Vitis vinifera* using SEM.

Material and methods

Pollens of the grape cultivars, ‘Cabernet Sauvignon’ and ‘Cardinal’ (*Vitis vinifera* L.) were utilized as plant materials. The vines were located at the experimental vineyard at the Dardanos Campus of Canakkale Onsekiz Mart University (Turkey). Inflorescences were collected in the morning hours at the 23rd stage (full bloom) of Eichorn and Lorenz (1977) classification. Inflorescences were brought into lab and all unopened flowers were emasculated and later, anthers were collected in petri dishes. Anthers were allowed to burst for 24 hours at room temperature. The pollen was further dried up at room temperature for 14-16 hours, put into brown glass vials. Samples were stored in a refrigerator at +4 °C until examined.

Preparation of pollen for analysis was performed by mounting two-layer transparent tape on the object carrier on the microscope and applying pollen with a brush. Prepared using methods described by Engin and Unal (2007) for scanning electron microscopy (SEM).

Coating of pollen samples was performed with a layer of gold using Sputter-Coater BAL-TEC SCD 005. Observation of the prepared samples was carried out with a scanning electron microscope (SEM) JEOL JSM-7100F (Tokyo, Japan) at 15 kV. Sixty pollen grains from both of cultivars were examined for their size and shape. Morphological characters measured were; length of polar axis (P), length of equatorial axis (E) and ratio of polar axis to equatorial axis (P/E).

The experiment was carried out in three replicates. In each replicate, ten pollen grains were analyzed. The statistical analysis was performed using statistical analysis software MINITAB software (Minitab Inc., ver.16) to determine differences in P , E , and P/E ratio. Significant differences between the mean values was determined using Tukey's test for significance at $p \leq 0.05$.

Results and discussion

Based on the analysis conducted by SEM, pollens from both cultivars, 'Cabernet Sauvignon' and 'Cardinal', are similar. The pollen grains can be characterized as elliptical-oval with a smooth exine surface (Figure 1). There were no perforations on the surface of pollen grains of the cultivars. The surface of the exine of both of cultivars was striate, with more or less parallel longitudinal ridges (Figure 2), which agrees with the results obtained by Marasali et al (2005). The ridges were more parallel in 'Cabernet Sauvignon' and less parallel in 'Cardinal'. Perforation of the exine was not more pronounced compared to other cultivars reported in the work of Roytchey et al (1994) who found that the perforation on the pollen surface in seedless grapes are more clear. This indicates that perforations in the grape are cultivar specific.

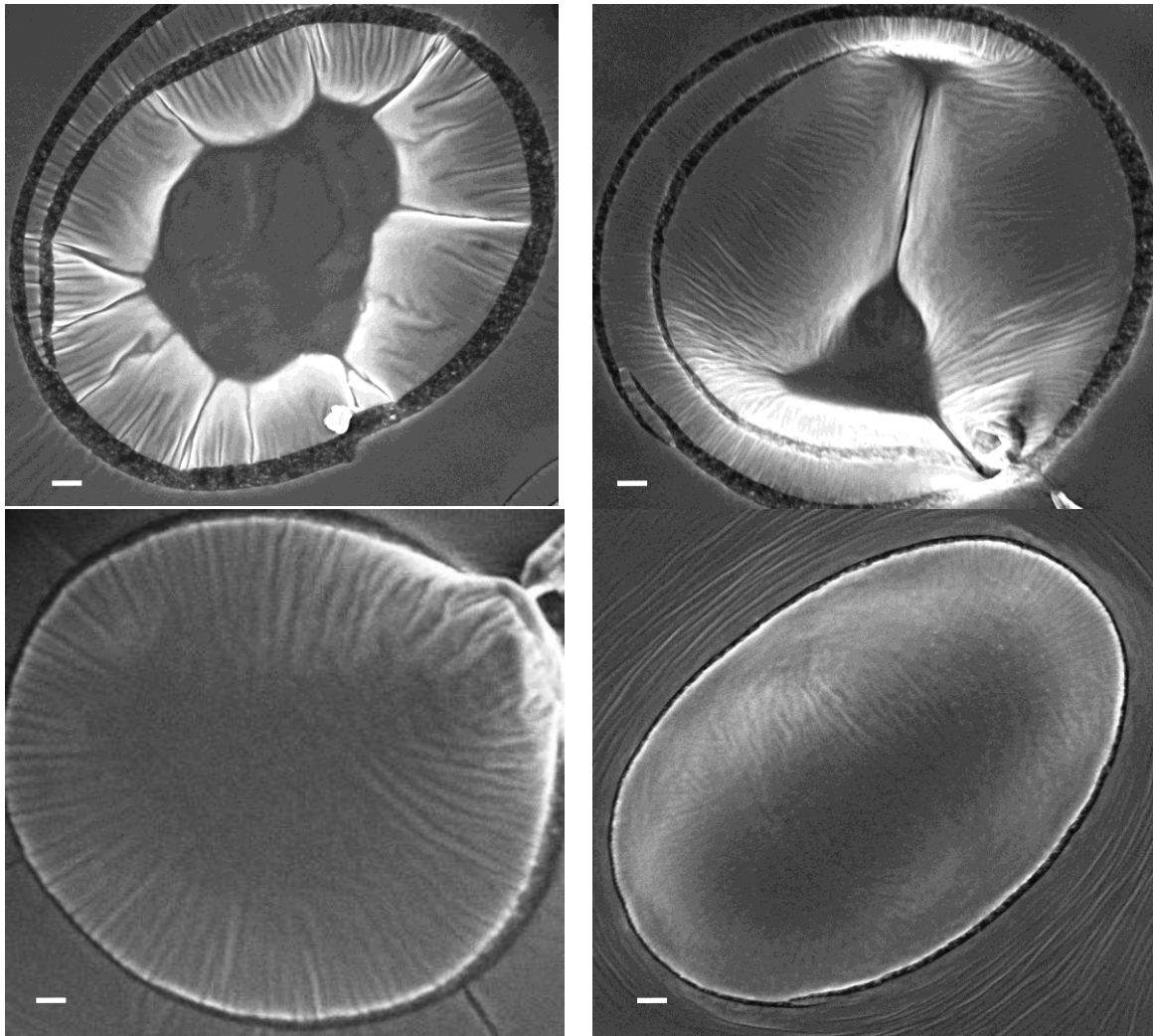

Figure 1. Pollen grain from ‘Cabernet Sauvignon’ flowers (left) and from ‘Cardinal’ flowers (right) in grape (*Vitis vinifera* L.). Bars: 1 μ m.

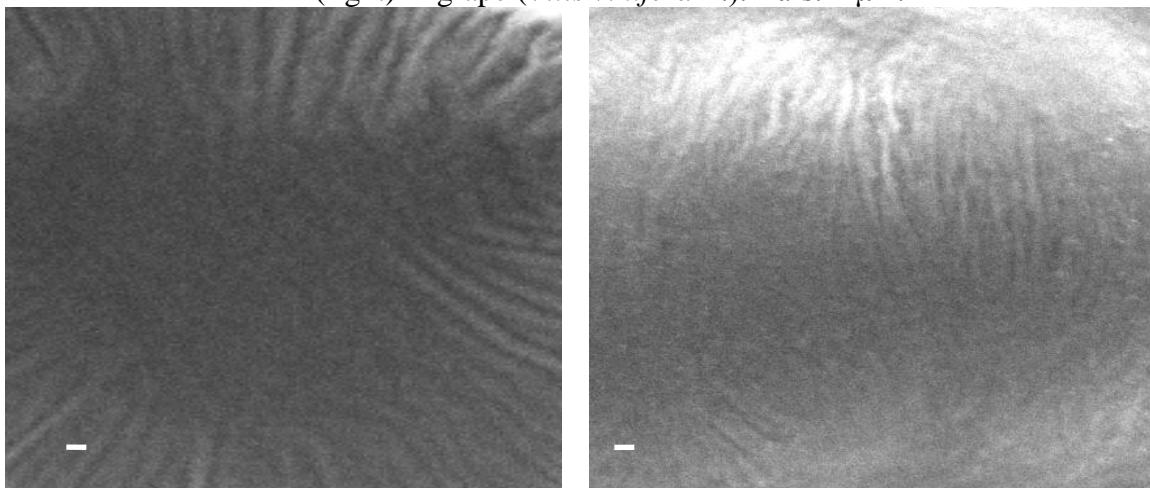

Figure 2. Pollen exine surface from ‘Cabernet Sauvignon’ flowers (left) and from ‘Cardinal’ flowers (right) in grape (*Vitis vinifera* L.). Bars: 1 μ m.

Length of the axes (P and E), ratio of polar axis to equatorial axis (P/E) of pollen grains from ‘Cabernet Sauvignon’ and ‘Cardinal’ flowers were demonstrated in table 1.

Table 1. The measured characteristics of pollen grains in grape (*Vitis vinifera* L.). ‘Cabernet Sauvignon’ and ‘Cardinal’ flowers.

	Polar axis (<i>P</i>) μm		Equatorial axis (<i>E</i>) μm		<i>P/E</i> ratio	shape
	Variation range	Mean value	Variation range	Mean value		
Cabernet S.	21.84-36.40	27.22	18.48-33.04	24.92	1.09	prolate
Cardinal	21.84-33.60	27.12	16.24-27.44	24.97	1.08	prolate
Grape (Mean)		24.94		27.17		

The size and shape of pollen grains of ‘Cabernet Sauvignon’ and ‘Cardinal’ did not differ significantly. The maximum length of pollen grains was determined in the ‘Cabernet Sauvignon’ cultivar (36.40 μm) and the lowest in both cultivars (21.84 μm). The width of pollen grains ranged from 16.24 μm (Cardinal) to 33.04 μm (Cabernet Sauvignon). The pollens were medium sized. In relation to the results reported by Marasalı et al (2005), the polar axis values obtained in our studies were higher in both of cultivars. Estimation of the axes might change with mounting medium (Punt et al. 2003).

According to findings of Sotonyi et al. (2000), the dimensions of the pollen grain are, to a large extent, genetically determined and of great importance for cultivar characterization. In accordance with the classification given by Erdtman (1969), the shape of pollen grains varies on the basis of the ratio of the pollen grains polar axis to equatorial axis from prolate (length/width ≤ 2) to prolate (length/width > 2). From this point of view, the pollen grains of both cultivars are prolate ($P/E = 1.08-1.09$). A certain degree of homogeneity for *P* and *E* values and ratio were observed. Generally, the *P* and *E* values measured in the ‘Cabernet Sauvignon’ and ‘Cardinal’ pollens changed within a very small range. Marasalı et al (2005) determined that the cultivars studied had small range of *P* and *E* values, but the shapes changed from suboblate prolate-spheroidal. Inceoglu et al (2000) stated that pollens of *Vitis sylvestris* ranged from prolate-spheroidal and subprolate pollen shape.

Conclusion

Morphological characteristics of pollens did not show significant differences among these grape cultivars. These properties are the most influential for classification of cultivars into particular groups. The pollen of the investigated cultivars were medium sized with a smooth exine surface. The shape of the pollen grains was elliptical-oval (prolate). The pattern of the exine of both of cultivars was striate, with parallel longitudinal ridges.

References

- Cargnello, G., Carraro, L., Lombardo, G., Gerola, F.M. (1980). Pollen morphology of Picolit grown in different Italian regions. *Vitis*, 19, 2016.
- Eichhorn, K.W., Lorenz, H. (1977). Phaenologische entwicklungsstadien der rebe. *Nachrichtenblatt des deutschen pflanzenschutzdienstes (Braunschweig)*. 29, 119-120.
- Engin, H., Unal, A. (2007). Examination of flower bud initiation and differentiation in sweet cherry and peach by using scanning electron microscope. *Turk. J. Agric. For.*, 31, 373-379.
- Erdtman, G. (1969). An introduction to the study of pollen grains and spores. Copenhagen, Denmark: Munksgaard, pp. 486.
- Fogle, H.W. (1977). Identification of clones within four tree fruit species by pollen exine patterns. *J. Amer. Soc. Hort. Sci.*, 102, 552-560.
- Hebda, R.J., Chinnappa, C.C., Smith, B.M. (1991). Pollen morphology of the *Rosaceae* of Western Canada. IV. *Luetkea*, *Oemleria*, *Physocarpus*, *Prunus*. *Can. J. Bot.*, 69, 2583-2596.

- Inceoglu, O., Pinar, N.M., Donmez Oybak, E. (2000). Pollen morphology of wild *V. slyvestris* Gmelin (Vitaceae). Turk. J. Bot., 24, 147-150.
- Liu, S., Kong, Q., Gu, H. (1997). Studies on the taxonomy of wild grape species native to China by the palynology. Journal of Fruit Science, 14(2), 100-104.
- Marasali, B., Pinar, M., Büyükkartal, N. (2005). Palynological study on the pollen grains of selected Turkish grape (*Vitis vinifera* L.) cultivars. Turk. J. Agric. For., 29, 75-81.
- Perveen, A., Qaiser, M. (2003). Pollen flora of Pakistan – XVII Illecebraceae. Pak. J. Bot., 35 (2), 141-144.
- Punt, W., Marks, A., Hoen, P., (2003). The Northwest European pollen flora, 64, Vitaceae. Rew. Palaeobot. Palyn., 123, 67-70.
- Roytchev, V., Terziisky, D., Dimova, D., Karageorgiev, S. (1994). Scanning electron microscopy study of pollen morphology in seedless grape (*Vitis vinifera* L.) cultivars. Vitis, 33, 105-108.
- Roytchev, V. (1995). Palynobiometric studies in vines (*Vitis vinifera* L.). Vitis, 34, 197-200.
- Roytchev, V. (1997). Palynobiometric investigation of grapevine seedless cultivars and hybrid forms. Lozarstvo i Vinarstvo, 3, 3-7.
- Sotonyi, P., Szabo, Z., Nyeki, J., Benedek, P., Soltesz, M. (2000). Pollen morphology of fruit species. International Journal of Horticultural Science, 6, 49-57.
- Vallania, R., Caramiello, R., Miaja, M.L, Me, G., Gianotti, C. (1996). Pollen morphology and viability of three *Vitis vinifera* L. cultivars (Dolcetto, Delight, Queen of the Vineyards) and two Queen of the Vineyards mutants. Allionia (Turin), 34, 19-28.
- Wetzstein, H.Y., Ravid, N., Wilkins, E., Martinelli, A.P. (2011). A morphological and histological characterization of bisexual and male flower types in pomegranate. J. Amer. Soc. Hort. Sci., 136(2), 83-92.

INFLUENCE OF TEMPERATURE, PRECIPITATION AND INSOLATION ON THE DEVELOPMENT RATE OF ANNUAL CARAWAY (*Carum carvi* var. *annua*)

Milica AĆIMOVIĆ*, Vladimir FILIPOVIĆ, Miroslav UROSEVIĆ, Snezana OLJAČA⁴,
Željko DOLIJANOVIĆ⁴, Nevena DOJČINOVIĆ, Vesna GRŠIĆ

¹Institute of Field and Vegetable Crops, Novi Sad, Serbia

²Institute of Medicinal Plants Research “dr Josif Pancic”, Belgrade, Serbia

³Scientific Institute for Reproduction and Artificial Insemination of Domestic Animals “Temerin”, Serbia

⁴Faculty of Agriculture, University of Belgrade, Serbia

⁵Faculty of Science, University of Novi Sad, Serbia

⁶Agrozima doo, Kulpin, Serbia

*Corresponding author: acimovicbabicmilica@gmail.com

Abstract

Caraway (*Carum carvi* L.) is a plant from the Apiaceae family (Umbelliferae). It has two forms: annual (*C. carvi* var. *annua*), which usually grows in warm climates, and biennial (*C. carvi* var. *biennis*), which grows in cooler climates. In our region, the biennial caraway is usually grown, because it has higher seed yield and essential oil content. However, introducing the annual caraway to agroecological conditions of Serbia has the purpose of shortening the production cycle of this plant as the biennial variety is not profitable during the first year, requires significant investment and occupies space. The purpose of this research was to determine the duration of the vegetation period, the requirements for temperature, moisture and insolation of annual caraway during the phenological stages. The experiment was conducted during two years at three locations in Vojvodina Province. The sowing-harvest period of annual caraway lasts from 136-177 days, requires above 3000 degree days, whereas the amount of precipitation needs to be a minimum of 200 mm, and number of sunshine hours between 1250 and 1480. There is a strong relationship between temperature, precipitation and insolation that influences the development rate during the caraway vegetation period.

Keywords: *caraway, production cycle, temperature, moisture, insolation*

Introduction

Caraway (*Carum carvi* L.) is a plant from the Apiaceae family (Umbelliferae). It has two forms: annual (*C. carvi* var. *annua*), which usually grows in warm climates, and biennial (*C. carvi* var. *biennis*), which grows in cooler climates. However, both forms have the tap root system, white or pale yellow, 15–20 cm long and 1–2 cm thick. Caraway germinates with two lanceolate descending cotyledons, while the first true leaf is feathery and unequally divided. The leaves of the leaf rosette and lower leaves are on long petioles, with 6–12 lobes that are double or triple pinnate. The leaves on the stem are arranged alternately, and the leaves at the top are thread-like. Biennial caraway forms only the leaf rosette in the first year, which consists of 7–18 leaves usually up to 20 cm long. With the end of the vegetation period the above-ground part dies, while the root winters. In the spring, the development of the plant starts early, and 4–5 weeks after the first shoots appear, a flower stem develops. The vegetation period of this form of caraway usually lasts 440–460 days. In contrast, annual caraway forms a leaf rosette with fewer leaves (usually up to five), and the umbel quickly starts developing. The vegetation period lasts 140–160 days. The flower stem is upright with a branching upper part, each branch ends in an umbel, which consists of 5 to 16 primary rays – umbelletes. The flowers consist of five petals which are white or pale pink with tips bent upward (Aćimović 2016).

Caraway fruit (*Carvi fructus*) is a schizocarp, a seed (reproductive plant organ) and drug (medicinal raw material) as well as spice at the same time. The fruit is gray brown in color, 3–7 mm long, 1–1.25 mm wide, with a crescent curve. Usually, a schizocarp separates spontaneously into two mericarps. Each mericarp has nine longitudinal ridges, between which are the channels with essential oil. Caraway fruit contain from 1 to 6% of essential oil (*Carvi aetheroleum*) that gives caraway its characteristic aroma (Sedláková et al. 2003). There are approximately 30 compounds in caraway essential oil, among which carvone and limonene account for about 95%. Other components are present in small proportions (Bouwmeester et al. 1995). These two components have a wide range of applications.

The biennial caraway is usually grown in our region, because it has higher seed yield and essential oil content. However, introducing annual caraway to the agroecological conditions of Serbia has the purpose of shortening the production cycle of this plant as the biennial variety is not profitable during the first year, requires significant investment and occupies space. The purpose of this research was to determine the duration of the vegetation period, the association of annual caraway productivity with temperature, moisture and insolation during the phenological stages.

Material and methods

The seed used in this study was an annual local ecotype of caraway seed. The field experiment was carried out during 2011 and 2012 at three localities in Vojvodina Province, Serbia: Mošorin (latitude 45°18'5"N; longitude 20°09'32"E), Veliki Radinci (latitude 45°02'26"N; longitude 19°40'15"E) and Ostojićevo (latitude 45°53'16"N; longitude 20°09'31"E).

The climate in Vojvodina Province is moderate continental with some tendencies towards continental. The whole region is located in a semi-arid area where variations in the amount of precipitation, air temperature and other important climatic elements are substantial over the years. The weather conditions in 2011 and 2012 indicate that they were moderately (2011) to severely dry (2012) in during the active growing season (April–September), in relation to long-term averages. Temperature conditions during both years, at the three localities, were similar, but there were significant variations in the amount and distribution of rainfall between the locations and years. Meteorological data were obtained from the meteorological stations nearest to the experimental fields, and are shown in Figure 1.

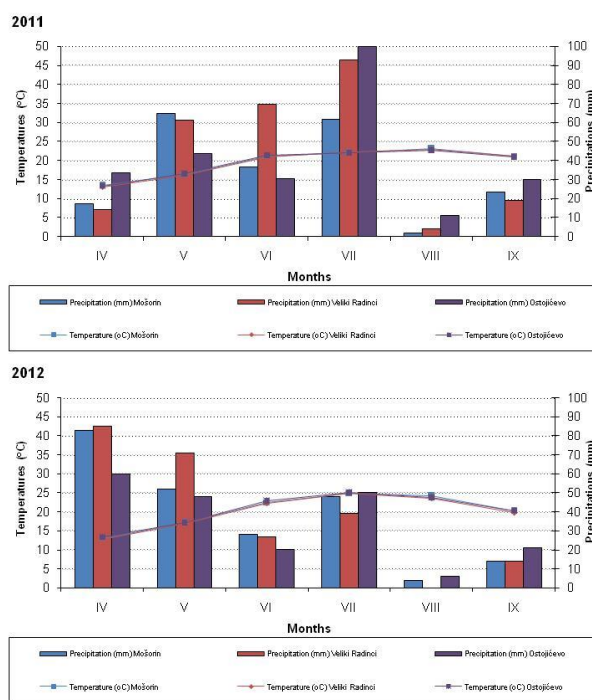

Figure 1. Average daily temperatures (°C) and precipitation (mm) during 2011 and 2012 at three localities

Caraway seed was sown in the first decade of April (optimal time in Serbian agroecological conditions), with row spacing of 0.35 m, and density of 200 plants/m². The size of the experimental plots was 5 m². Weeds were controlled by hoeing and weeding when needed. Measures of protection from diseases and insects were not used. Harvest was carried out by hand in the phase of full maturity. In 2011, the harvest was performed in the middle of September, and in 2012 because of water deficit and high temperatures the vegetation period was shortened and the harvest was performed in the last decade of August.

The development of the caraway plant was checked daily. Four phenological stages were determined: (1) germination, (2) stem elongation, (3) flowering and (4) fruit formation and maturation. The exact occurrence of these stages was registered both years at the three localities. The duration of each phenological stage was measured in days. Optimum parameters necessary for the cultivation of annual caraway were obtained by comparing the duration of each stage with the sum of effective temperatures (GDD) which present a sum of average daily temperatures above 5 °C, sum of precipitation and insolation.

Results and discussion

The growth and development of an annual caraway plant is shown in Figure 2, while the duration of phenological stages in both experimental years in three experimental fields is shown in Figure 3. The vegetation period of annual caraway lasted from 136 to 177 d. It lasted longer in 2011 (an average of 169.0 d) than in 2012 (140.7 d). The germination period lasted 14–19 d, and the period from germination to stem elongation, i.e. leaf rosette formation, was the longest (between 40 and 51 d). Caraway needed 16–27 d from the start of stem elongation to flowering. Flowering lasted 15–29 d, and fruit formation and maturation 40–51 d. All phenological stages during 2012 were shorter on average by 5.7 d compared with 2011, which in the end resulted in the shortening of the total vegetation period by 28.3 d.



Figure 2. Growth and development of *Carum carvi* var. *annua*

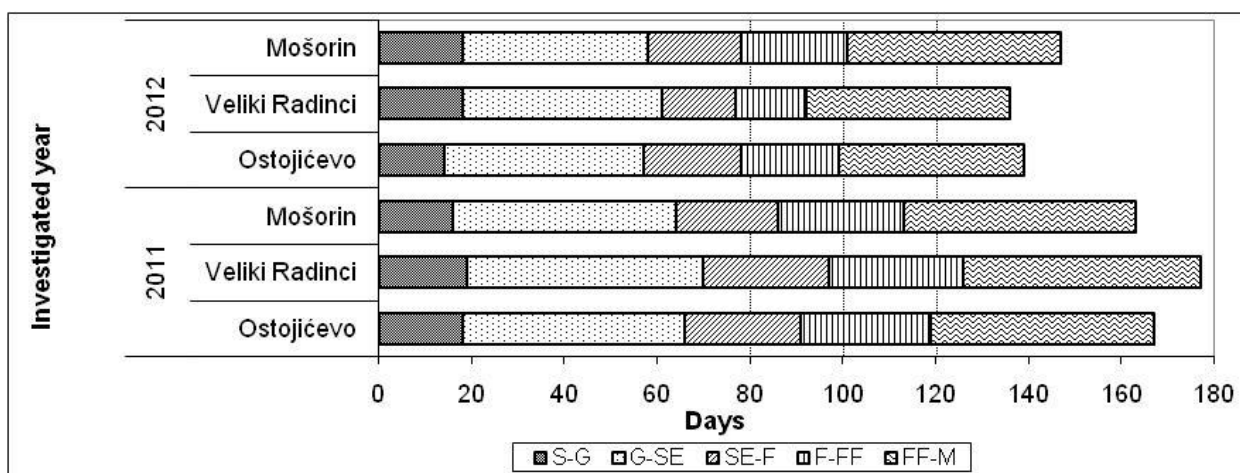

Figure 3. Duration of phenological stages of annual caraway during 2011 and 2012 at three localities (S–sowing, G–germination, SE–stem elongation, F–flowering, FF–fruit formation and maturation, H–harvest).

The GDD during phenological stages of annual caraway in both years is shown in Figure 4. In 2011, which was more favorable for caraway yield formation, the average sum of effective temperatures was 3207 °C (3048–3317 °C). During 2012, the sum of effective temperatures was lower by 13.2% and the average was 2783 °C (2693–2960 °C). During the period from sowing to germination, the sum of effective temperatures was 170 °C (in 2011), and 179 °C (in 2012). For the period from forming a leaf rosette until maturation, the sum of temperatures was lower in 2012 in comparison with 2011. In 2012, during the period of leaf rosette formation, a sum of effective temperatures lower by 63 °C was recorded when compared with the previous year. During the period of flowering, this difference was 83 °C, in the period of fruit formation 212 °C, and during maturation 75 °C. However, during the second year, the mean daily temperatures were higher on average by 1.2 °C. Higher average daily temperatures could have caused shortening of the caraway vegetation period in the second year of the study.

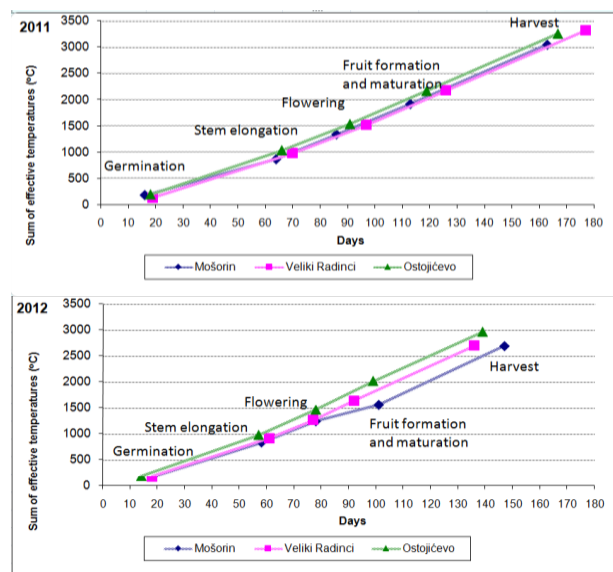

Figure 4. The sum of effective temperatures (GDD) during phenological stages of annual caraway in 2011 and 2012 at three localities

Precipitation during the vegetation period in 2011 was 20% higher on average than in 2012. Also, the precipitation in the first year was better distributed during the vegetation period. However, the lowest precipitation was noted from sowing to germination. Nevertheless, the seed used moisture reserves from the winter period, so this deficit had no negative influence on germination. During the rest of the 2011 growing season, rainfall was evenly distributed and sufficient for the formation of high yield.

In 2012, in the period from sowing to germination there was enough rainfall (34–50 mm) which enabled uniform and fast germination of caraway seed. Also, during the period of leaf rosette formation (from germination to stem elongation) the quantity of rainfall was optimal. However, in the period from stem elongation until flowering, there was a significant rainfall deficit. The dry period continued during the stage of fruit formation, which had a negative impact on the thousand fruit mass and germinability. In the period of fruit maturation there was an average of 47 mm of rainfall, but it had no effect on the increase of fruit yield. Thus, drought in the generative stages had a negative effect on the caraway fruit yield formation.

The influence of insolation on the duration of the caraway vegetation period and some phenological stages are shown in Figure 5. During the caraway vegetation period in 2011, the average duration of insolation was 1442 h. In 2012, the average number of sunshine hours was lower by 117, amounting to 1325 h. Compared with 2011, in 2012, a higher number of sunshine hours was recorded only in the period of leaf rosette formation. In all other phenological stages, the amount of insolation was smaller in the second year.

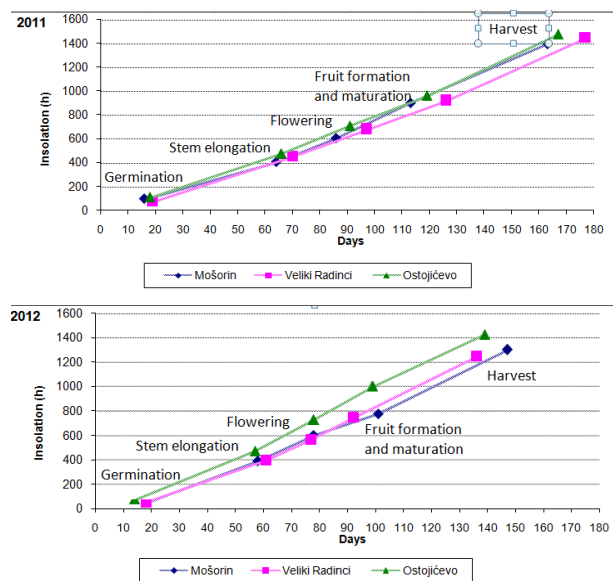

Figure 5. Insolation (h) during phenological stages of annual caraway in 2011 and 2012 at all three localities

Weather conditions influenced qualitative parameters of caraway fruits such as essential oil content, oil component ratios, thousand fruit mass, and seed germination (Aćimović et al. 2014; Aćimović et al. 2015). Weather conditions also influenced morphological parameters such as plant height, umbel diameter, number of umbels per plant, as well as whole plant mass, yield of fruits per plant, and harvest index.

Fruit yield per plant was strongly influenced by weather conditions in 2011 and 2012 (Table 1). In the favorable year (2011), the yield of fruits per plant was 4.25 g, while in the dry year (2012) it was significantly lower (only 0.96 g). The yield of fruits per plant is determined by the number of umbels per plant, number of fruits per umbel and thousand fruit mass. All these parameters were significantly higher in 2011 than in 2012.

During a dry year in Hungary, the yield of annual caraway fruit per plant was very low, ranging between 0.02–0.82 g, while in moderate drought conditions it was slightly higher, reaching 1.73 g (Valkovszki 2011). In Tunisia the yield of fruit per plant was between 0.70–1.33 g, while in Lithuania it was 1.1–2.9 g (Laribi et al. 2010; Petraityte 2005).

Whole plant mass was also significantly influenced by weather conditions (Table 1). In the favorable year, across the three trial locations average mass per plant was 10.02 g, while in the dry year it was only 4.21 g, a reduction of 58%. In a study by Laribi et al. (2010), whole plant mass was reduced by 20 to 40%, depending on the drought level. These results demonstrate that water deficit is a factor limiting the growth and development of caraway.

Harvest index shows the division of photosynthesis products between fruits and vegetative parts of a plant. In 2011 harvest index was 43.16%, but only 22.65% in 2012.

Table 1. Fruit mass per plant, whole plant mass and harvest index of annual caraway depending on weather conditions of the year (mean \pm SD)

	Fruit mass per plant (g)	Whole plant mass (g)	Harvest index (%)
2011	4.25 \pm 1.02	10.02 \pm 2.58	43.16 \pm 1.09
2012	0.96 \pm 0.47	4.21 \pm 1.89	22.65 \pm 2.07
Average	2.61	7.12	32.91

Conclusion

There is a strong relationship between temperature, precipitation and insolation that influences development rate during the caraway vegetation period. However, these parameters primarily affected harvest index, as well as yield of caraway fruit.

References

- Aćimović M. (2016): Caraway (*Carum carvi* L.). Andrejević Endowment, Belgrade.
- Aćimović M., Filipović V., Stanković J., Cvetković M., Đukanović L. (2015): The influence of environmental conditions on *Carum carvi* L. var. *annuum* seed quality. *Ratarstvo i povrtarstvo*, 52(3):91-96.
- Aćimović M., Oljača S., Tešević V., Todosijević M., Đisalov J. (2014): Evaluation of caraway essential oil from different production areas of Serbia. *Horticultural Science (Prague)*, 41(3):122-130.
- Bouwmeester H.J., Davies J.A.R., Smid H.G., Welten R.S.A. (1995). Physiological limitations to carvone yield in caraway (*Carum carvi* L.). *Industrial Crops and Products*, 4:39-51.
- Laribi B., Kouki K., Mougou A., Marzouk B. (2010): Fatty acid and essential oil composition of three Tunisian caraway (*Carum carvi* L.) seed ecotypes. *Journal of the Science of Food and Agriculture*, 90:391-396.
- Petraityte N. (2005): Phenotypic and genetic diversity of caraway (*Carum carvi* L.) population in Lithuania. Doctoral dissertation, Lithuanian University of Agriculture.
- Sedláková J., Kocourková B., Lojková L., Kubáň V. (2003): The essential oil content in caraway species (*Carum carvi* L.). *Horticultural Science (Prague)*, 30:73-79.
- Valkovszki N.J. (2011): Optimization of conditions of growing technology of annual caraway (*Carum carvi* L. var. *annuum*) on chernozem meadow soil. Ph.D. Thesis Booklet Corvinus University of Budapest, Faculty of Horticultural Sciences.

DETERMINATION OF BIO-VARIATION AMONG DIFFERENT MULBERRY SPECIES GROWN IN TOKAT REGION BY MOLECULAR MARKERS

Cetin CEKİC^{1*}, Z. Selcen OZMEN²

¹Department of Horticulture, Faculty of Agriculture, Gaziosmanpaşa University, Tokat, Turkey

²Middle Black Sea Transitional Zone Agricultural Research Institute, Tokat, Turkey

*Corresponding author: cetin.cekic@gop.edu.tr

Abstract

In this study, 38 different mulberries genotypes collected from Tokat region in Turkey were used. ISSR-PCR analyses were carried on the DNA of genotypes isolated using mini-CTAB extraction method. The levels of polymorphism between genotypes were determined using the UBC-ISSR primers. A total of 96 bands were obtained from 15 UBC ISSR primers. Out of 96 bands, 80 bands were polymorphic. The number of bands obtained per primer ranged between 4 and 11, the average number of bands were determined as 6.4. The average number of polymorphic bands per primer was 5.33. Similarities and differences between genotypes have been studied at the molecular level. The data used for statistical analysis were obtained by the evaluation of ISSR bands. Similarity coefficient and UPGMA dendrogram were built using the Basic Coordinates Analysis. According to the dendrogram, the genotypes have been divided in two main groups, one small and other large group. While the small group was only comprised of black mulberry genotypes, the large group included white mulberry, weeping mulberry and wild white mulberry genotypes. Different mulberry species have been divided into different sub groups within the large group. The polymorfizm level within the species was lowest in black mulberry genotypes, and this was followed by weeping mulberry, white mulberry and wild white mulberry genotypes, respectively.

Keywords: *Mulberry, molecular, genotype, marker, ISSR*

Introduction

Mulberry is a perennial fruit species belongs to the genus *Morus* of the family Moraceae. (Datta, 1992, Anonymous, 2006). *Morus*, a genus of flowering plants in the family Moraceae, deciduous trees commonly known as mulberries, growing wild and under cultivation in many temperate world regions. The origin of mulberry is Asia (Awasthi et al., 2004). Over 150 species names have been published, and although differing sources may cite different selections of accepted names, only 10–16 are generally cited as being accepted by the vast majority of botanical authorities. *Morus* classification is even further complicated by widespread hybridisation, wherein the hybrids are fertile. Mulberry trees are either dioecious or monoecious and sometimes will transform from one sex to another. The flowers are held on short, green, pendulous, nondescript catkins that emerge in the axils of the current season's growth and on spurs on older wood. They are wind pollinated and some cultivars will set fruit without any pollination (Anonymous, 2009).

Black, red, and white mulberry are widespread in southern Europe, the Middle East, northern Africa and Indian subcontinent, where the tree and the fruit have names under regional dialects. The most important mulberry species are *Morus alba* (white mulberry), *Morus australis* (Chinese mulberry), *Morus indica* (Indian mulberry), *Morus microphylla* (Texas mulberry), *Morus nigra* (Black mulberry), *Morus rubra* (Red-purple mulberry) and *Morus serrata* (Himalian mulberry) (Tutin, 1996; Vijayan et al., 2004). The mulberry plants are deciduous and are produced for their fruit and leaves in all parts of Turkey (Anonymous, 2005). The species *M. alba*, *M. nigra* and *M. rubra* are common in Turkey (Ercisli, 2004;

Ercisli and Orhan, 2007; Özgen et al., 2009). The main mulberry production areas of Turkey are Black Sea Region and Eastern and Central Anatolian Regions.

Turkey has very old mulberry cultivation, and mulberries are one of the main fruits grown by Turkish farmers. The four mulberry species (*Morus alba*, *Morus nigra*, *Morus rubra*, *Morus laevigata*) can be seen in different agro-climatic regions in Turkey. There is no registered mulberry cultivar in Turkey but each region has its own local genotypes which propagated by budding or grafting over many years (Ercisli and Orhan, 2008).

Tokat Province of Turkey, at the mid Black Sea region of Anatolia, has a hot-summer Mediterranean climate with considerable maritime and continental influences. Most parts of province are suitable for mulberry production, and some species of mulberry spread over the province. Although there is no intensive mulberry production by producers, one or two mulberry trees can be seen almost in every orchard, especially near by homes.

The aim of this research is to determine diversity of mulberries grown in North Anatolia (Tokat Province) between or within species by ISSR markers.

Material and Methods

Plant Material; For research purposes, a total of 38 different mulberries genotypes from Tokat region in Turkey were used. Out of total number 15 belongs to black, 13 to white, 5 to pendulous, 2 to everbearing mulberry and 3 to wild mulberry,.

DNA extraction; Total genomic DNA was extracted according to the CTAB method (Doyle and Doyle, 1987). DNA sample concentration was determined using a fluorometer employing a Hoechst dye (Hoefer Inc., San Francisco, CA, USA), and the DNA samples were diluted to a final concentration of 10 ng/μl with 1 × TE buffer and stored at -20 °C prior to polymerase chain reaction (PCR) amplification.

ISSR amplification; 15 primers that produced clear and reproducible fragments were selected out of a hundred UBC primers, which were previously tested for further analyses (Table 2). ISSR amplification was performed in a 20 μl volume containing 20 ng genome DNA, 1 × Taq buffer, 2.0 mM MgCl₂, 0.2 mM dNTPs, 0.75 μM primer, 0.5 units of Taq DNA polymerase. The amplification reaction consisted of an initial denaturation step at 94 °C for 5 min, followed by 45 cycles of 45 s at 94 °C, annealing at 50 °C–56 °C for 45 s, extension at 72 °C for 90 s, and ended with extension at 72 °C for 7 min. The amplified products were resolved electrophoretically on 2.0% agarose gels run at 100 V in 1.0 × TBE buffer, visualized by staining with ethidium bromide (0.5 μg/ml), and photographed under ultraviolet light (Charters et al., 1996, Rafalski et al., 1996) The amplifications were repeated twice and only clear repetitive bands were used in data analysis, and molecular weights were estimated using a 100 bp DNA marker (Vivantis).

Data analysis; The amplified fragments were scored for band presence (1) or absence (0) with all the accessions studied. Similarities and differences between genotypes have been studied at the molecular level. The data used for statistical analysis were obtained by the evaluation of ISSR bands. Similarity coefficient and UPGMA dendrogram were built using the Basic Coordinates Analysis.

Results and Discussion

On the basis of the number, intensity and reproducibility of ISSR bands 15 primers were selected out of a hundred UBC primers, which were previously tested (Cekic et al., 2001). Bands with the same mobility were treated as identical fragments. Weak bands with negligible intensity and smear bands were both excluded from final analysis. Each primer was evaluated for total band number (TBN), polymorphic band number (PBN) and the ratio of polymorphism (PR= PBN/TBN X 100).

The number of scored bands varied from four to eleven with an average of 6,4 bands per primer and an average of 5,33 polymorphic bands per primer. In total, 80 bands out of 96 derived from 15 primers were polymorphic.

Table 1. Band number, Polymorphic band number and Polymorphic band ratio(%) in mulberry genotypes

	ISSR Primer Code	Primer Sequence and Anchors	Band Number	Polymorphic Band Number	Polymorphic Band Ratio(%)
1	807	AGAGAGAGAGAGAGAGT	11	9	81,81
2	808	AGAGAGAGAGAGAGAGC	5	5	100,00
3	810	GAGAGAGAGAGAGAGAT	8	6	75,00
4	811	GAGAGAGAGAGAGAGAC	7	6	85,71
5	826	ACACACACACACACACC	6	6	100,00
6	835	AGAGAGAGAGAGAGAGYC	7	6	85,71
7	841	GAGAGAGAGAGAGAGAYC	6	4	66,67
8	842	GAGAGAGAGAGAGAGAYG	10	9	90,00
9	844	CTCTCTCTCTCTCTRC	4	3	75,00
10	856	ACACACACACACACACYA	4	3	75,00
11	881	GGGTGGGTGGGTGGGT	5	4	80,00
12	888	B DBCACACACACACACA	7	6	85,71
13	889	DB DACACACACACACAC	4	3	75,00
14	890	VH VGTGTGTGTGTGTGT	7	6	85,71
15	891	HV HTGTGTGTGTGTGTG	5	4	80,00
Average			6,4	5,33	82,76
Total			96	80	

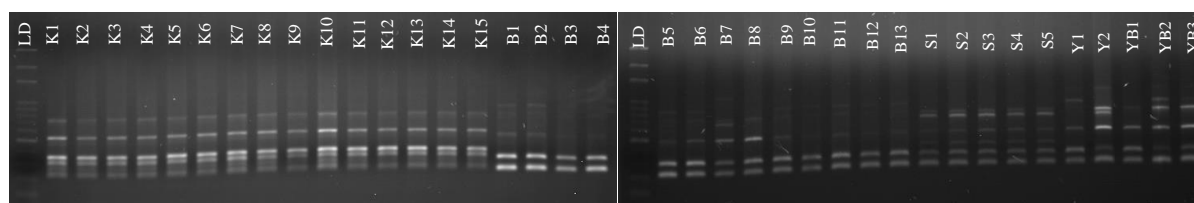
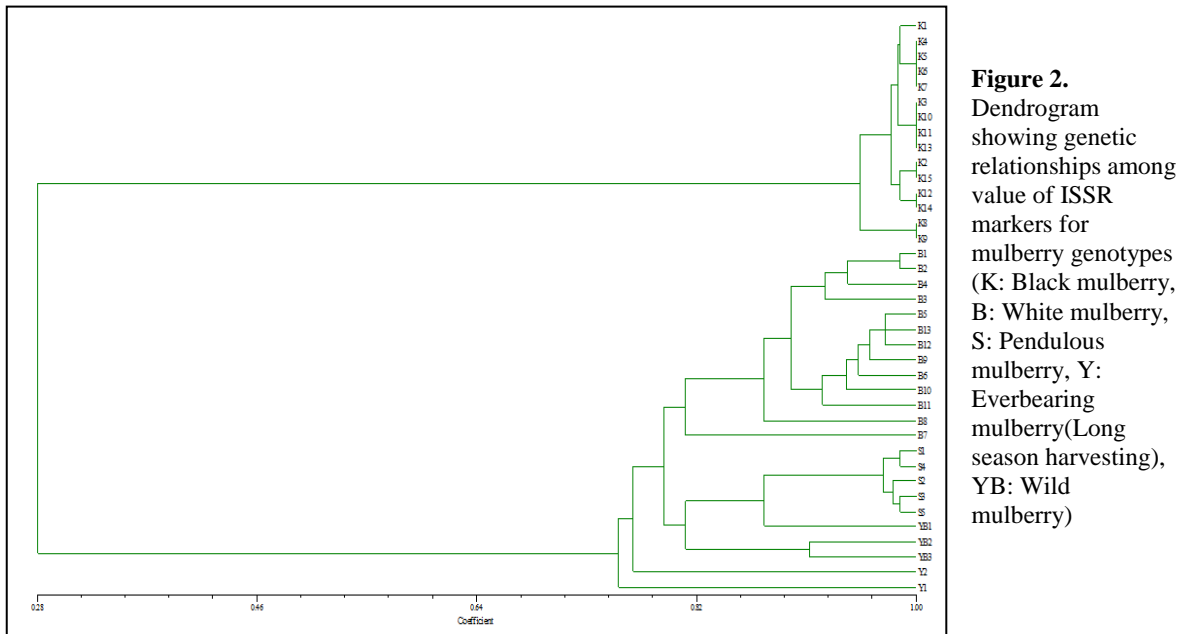

Figure 1. Agarose gel of polymorphic DNA amplification profiles of different mulberry genotypes ((K: Black mulberry, B: White mulberry, S: Pendulous mulberry, Y: Everbearing mulberry(Long season harvesting), YB: Wild mulberry) obtained with UBC ISSR primer 811. (LD: 100 bp LADDER -Vivantis)

Cluster analysis: Genetic similarity among varieties was estimated using dissimilarity coefficient matrix based on ISSR bands scored. Pairwise values of dissimilarity coefficients ranged from 0.27 for genotypes with the same scored bands to 1.00 for the most similar genotypes. The dendrogram was constructed based on the similarity matrix, using UPGMA method (Rohlf, 1992). The 38 mulberry genotypes were divided into two main clusters (Figure 2), in which black mulberry genotypes in one group and the rest of the genotypes falling under the other group. While the first major group contained only black mulberries, the second major cluster was further separated into subgroups. The first subgroup contained black mulberry genotypes, respectively which showed very close ISSR profile exhibited the highest genetic similarity ranges (0,95-1,00). On the other hand, the similarity of the second varied 0.75 to 0.96, in which different mulberry species (White mulberry, Pendulous mulberry,

Everbearing mulberry, Wild mulberry) separated in different clusters at various stages (Figure 2).



Also, the principle component analysis generally put the genotypes into different clusters as parallel to morfological differences of the mulberry species.

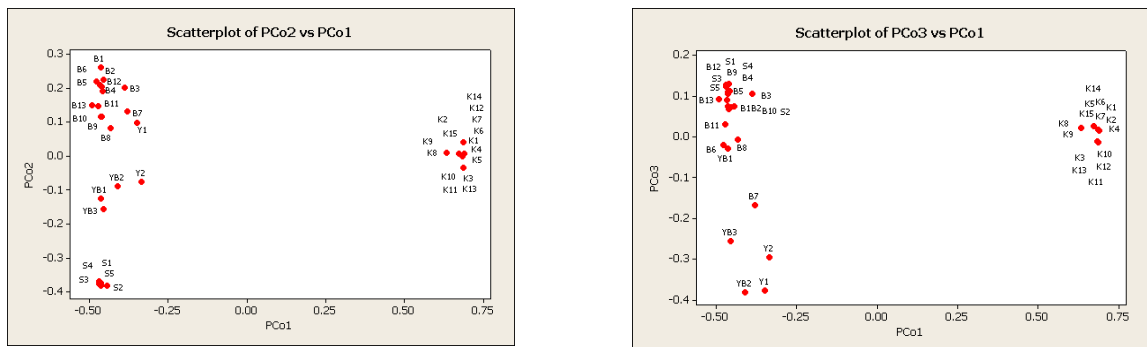

Figure 3. The principle component analysis of mulberry genotypes according to 15 ISSR primers

Conclusion

Screening of the 38 genotypes of different mulberry species revealed that banding profiles obtained with fifteen ISSR primers were enough to distinguish the diversity between species or within the species. The results indicated that the ISSR technique is effective to develop genotype-specific banding patterns valuable for genotype identification. Since ISSR-PCR technique does not require previous DNA sequence information and uses very small quantity of DNA, it is considered as one of the most widely used techniques for genotype identification and genetic diversity studies. These results mean that molecular tools are more reliable than the phenotypic observations for evaluating variations and monitoring genetic stability.

References

- Anonymous (2006). TÜBİTAK-The databases of Turkey Taxonomic Species. <http://biow.tubitak.gov.tr/present/taxonForm1.jsp?taxon=4480>
- Anonymous (2009). Mulberry. <http://www.crfp.org/pubs/ff/mulberry.html>
- Awasthi AK, Nagaraja GM, Naik GV, Kanginakudru S, Thangavelu K, Nagaraju J (2004). Genetic diversity and relationships in mulberry (genus *Morus*) as revealed by RAPD and ISSR marker assays. *BMC Genetics*, 5: p. 1. <http://www.biomedcentral.com/1471-2156/5/1>
- Cekic C, Battey NH, Wilkinson MJ (2001). The potential of ISSR-PCR Primer Pair Combinations for Genetic Linkage Analysis using the Seasonal Flowering Locus in *Fragaria vesca* as a Model. *Theoretical and Applied Genetics*, 103:4, 540-546
- Charters YM, Robertson A, Wilkinson MJ, Ramsay G (1996). PCR analysis of oilseed rape cultivars (*Brassica napus L ssp oleifera*) using 5'-anchored simple sequence repeat (SSR) primers, *Theoretical and Applied Genetics*, 92:3-4, 442- 447
- Datta RK (2002). Mulberry Cultivation and Utilization in India. Mulberry for Animal Production, FAO Animal Production and Health Paper 147: 45-62.
- Doyle JJ, Doyle JL (1987). A rapid DNA isolation procedure for small quantities of fresh leaf tissue, *Phytochemical Bulletin*, 19:11-15.
- Ercisli S (2004). A short review of the fruit germplasm resources of Turkey. *Gen. Res. Crop Evaluation*, 51: 419-435.
- Ercisli S, Orhan E (2007) Chemical composition of white (*Morus alba*), red (*Morus rubra*) and black (*Morus nigra*) mulberry fruits. *Food Chem.* 103: 1380-1384.
- Erdoğan Ü, Pırlak L (2005). Utilization and Production of Mulberry (*Morus spp.*) in Turkey. *Alatırım*, 4(2): 38-43.
- Özgen M, Serçe S, Kaya C (2009). Phytochemical and antioxidant properties of thocyanin-rich *Morus nigra* and *Morus rubra* fruits. *Sci. Hortic.* 119: 275-279
- Rafalski JA, Vogel JM, Morgante M, Powell W, Andre C, Tingey SV (1996). Generating new DNA markers in plants. *In Non-mammalian genomic analysis: A practical guide. Edited by B. Birren and E. Lai.* Academic Press, New York.
- Rohlf, F.J., (1992). NTSYS-pc Numerical Taxonomy and Multivariate Analysis System Version 1.8. *Appl. Biostatistics*, New York.
- Tutin GT (1996). *Morus L.* In: Tutin GT, Burges NA, Chater AO, Edmondson JR, Heywood VH, Moore DM, Valentine DH, Walters SM, Webb DA (eds.). *Flora Europaea*, Vol 1. Psilotaceae to Platanaceae. 2nd ed. Cambridge University Press, Australia.
- Vijayan K, Srivastava PP, Awasthi AK (2004). Analysis of phylogenetic relationship among five mulberry (*Morus*) species using molecular markers. *Genome*, 47(3): 439-448.

SELECTION OF WHEAT SUPERIOR GENETIC VARIATION FOR GROWING IN HALOMORPHIC SOIL CONDITIONS

Sofija PETROVIĆ*, Miodrag DIMITRIJEVIĆ, Borislav BANJAC, Velimir MLADENOV

Faculty of Agriculture, University of Novi Sad, Serbia

*Corresponding author: sonjap@polj.uns.ac.rs

Abstract

With the dramatically increment of human population, demand for food will increase significantly. In order to enhance food amount, there is a need for utilization of all available ways to produce food. One of those ways is the exploitation and utilization of production unsuitable and less productive soil. Solonetz is a type of soil characterized by increased alkaline reaction, high sodium content and unfavorable water-physical characteristics. Solonetz is mainly used as a destitute pasture, covering about 135 million hectares, about 20 million hectares in Europe, while in Serbia occupies about 80,000 hectares, mainly in Vojvodina. Trials were set up at two localities that differ in agro-ecological conditions, especially in terms of land. The experimental field of the Novi Sad Institute of Field and Vegetable Crops has been used as control part of the trial having normal growth conditions on chernozem soil. The other locality is in the village of Kumane in Banat. The aim of perennial trials conducted on chernozem and solonetz types of soil is to select usable genetic variation from the existing wheat gene pool and to create a novel genetic variability for the halomorphic soil growing conditions. Multiyear results show that desirable genetic variability could be selected within the existing genetic variation and that novel genetic variability of the enhanced tolerance to abiotic stress conditions of high sodium content and higher alkalinity could be selected in progenies of suitably chosen parents.

Key words: *wheat, abiotic stress, solonetz, breeding, genetic variation.*

Introduction

Agricultural production intensification has almost reached the border at given technology development. However, there is still a space to increase food production by utilizing agriculturally less suitable land. There is a space of 2.7 billion ha potentially useful to some degree for broadening food harvest area. One of the ways for broadening land for food production is putting in use types of soil with less favorable conditions for crop production. Solonetz represent the type of soil characterized with a high content of sodium, alkaline reaction and clayey subsurface horizon. Appears, normally, in a steppe climate. Commonly is utilized as rangeland or just lies idle. There is about 135 million ha of solonetz in the World. In Europe, solonetz covers about 0.5%. Concerning Serbia, about 3.6% of arable land is solonetz soil (Miljković, 1996). About 67% is settled in Vojvodina (Belić *et al.*, 2012; Djordjević and Radmanović, 2016). The crops growth on the soil as solonetz, represents abiotic stress environment for plants that reflects their yield and overall production. Consequently, beside the reclamation practice, a novel, better adapted genetic variability is needed. A desirable genetic variability could be found in taxonomically distant organisms, wild relatives, landraces, older varieties that had been of a good adaptability, but not suitable for an intensive agricultural production, green revolution type, and among novel varieties bred for the modern agricultural practice. A new genetic variability could be created vertically through gene recombination using classic hybridization methods, or by horizontal gene transfer using gene insertion by means of transgenic technology (Munns *et al.*, 2012; Jiang *et al.*, 2014, respectively). A crop of choice for targeted agro-ecological production conditions is

an important decision. Hexaploid wheat (*Triticum aestivum* L.) meets the requirements. Wheat has moderate salt tolerance level (Arshad, 2008). It plays a key role in food supply, as well. Wheat is durable, adaptable, having genes (*Nax*) for Na⁺ exclusion in its ancestry (Borelli *et al.*, 2011). This cultivar is not very demanding and costly in respect of crop care during the vegetation, and has broad genetic variability among cultivated varieties, and its wild relatives, like closely linked *Aegilops* sp. (Colmer *et al.*, 2006). The aim of the article is to present a survey of long-standing efforts to single out a desirable genetic variability in bread wheat, as well as, *in situ* obtained novel genetic variability, under selection pressure of high potassium content, and overall abiotic stress conditions of solonetz soil.

Materials and methods

The wheat cultivars of the Institute of Field and Vegetable Crops in Novi Sad, have been put in long-standing trials, established at two localities: Kumane village (45.5219940N, 20.1949190E, altitude 73m, pH = 9.86) on solonetz soil, and Rimski Šančevi experimental field of the Institute of Field and Vegetable Crops in Novi Sad (45.3249360N, 19.8428830E, pH=6.86) on chernozem, as a parallel control trial. Plant traits, the yield components, were followed, as well as, grain yield per unit area. Phenotypic expressions of individual plant traits, and the grain yield, were selection criteria for desirable genotype selection in an existing germplasm, as well as, in novel genetic variability. The existing genetic variability was tested in a randomized block design (RCBD) trial with three replications, in 1m long rows 20 cm apart. The wheat varieties in RCBD were parallel observed in micro trials established at the locality of Kumane that were to simulate a wide production conditions with 1m wide and 150m long rows, with the 12.5cm, space between rows. Fifty kilograms of NPK 15:15:15 fertilizer was applied along with sowing, and 150kg of Potassium ammonium nitrate was additionally applied in spring. In order to follow the reaction of genotypes, reclamation was partly applied with 25t/ha and 50t/ha of phosphor-gypsum. Elementary statistics, as well as, models for sources of variation identification and quantification with the emphasis on genotype by environment interaction have been calculated for studied traits. The mode of inheritance has been established using t-test.

Results and discussion

Germplasm testing sample - criteria and variability. *In situ* breeding program was developed in two phases. The first phase was forming and testing a germplasm that has been selected. The general idea was to use available Serbian wheat genetic variability, since Serbia has a well developed wheat breeding programs. The institution of the first choice was the Institute of Field and Vegetable Crops (IFVC) and its wheat varieties. IFVC is settled in the town of Novi Sad area that is about 60km from *in situ* breeding programe in the village of Kumane sharing very similar climatic and weather conditions. Moreover, IFVC Experimental field in Rimski Sancevi (RS) has a chernozem soil type that could be used as quality bases for control part of trials. Having Kumane (solonetz soil type) and the experimental polygon and RS (chernozem) as a control, the variation of abiotic environmental conditions has been diminished, except the soil type difference that was in a scope of the investigation.

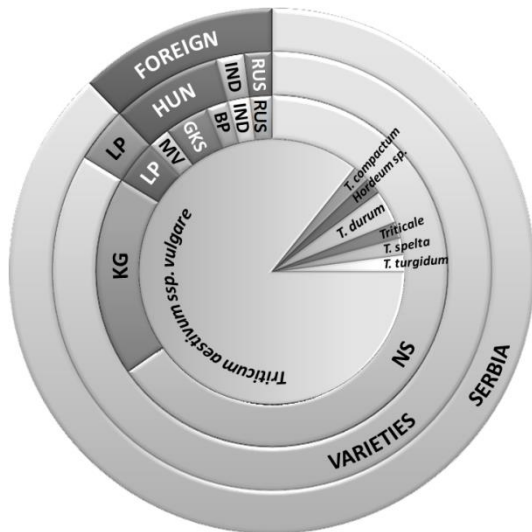

Figure 1. Genotypes in *in situ* breeding program established on solonetz soil, where all varieties were roughly classified according to the country of origin (Serbia and foreign) in the outer cycle. Secondary classification is on varieties and local populations (LP) within genotypes from Serbia and countries of origin within the group of foreign varieties Hungary (HUN), India (IND), Russia (RUS). Thirdly, the breeding institutions or origin - Novi Sad (NS), Kragujevac (KG), Local populations (LP), Martonvasar (MV), Szeged (GKS), Bred Population (BP). The inner split is according to taxa.

The selection criterion for the first set of wheat varieties for testing to adaptability to abiotic stress growth conditions of halomorphic soil was the overall adaptations to target environment of steps. That is the reason that 63.3% of all tested varieties (49), through years, have been originated in IFVC wheat breeding program. In a later stage of testing, 10 wheat varieties from the former Small Grains Research Center in Kragujevac were included (20.4%). Consequently, the predominant share of 87.8% represented wheat varieties from Serbia, as well as, bread wheat (*T. aestivum spp. vulgare*) up to 85.7%. The rest were local populations of wheat, barley and some other *Triticum* species. Among these occasionally tested genotypes, two are of special interest - Old Banatka, as local population obtained by instinctive selection and largely grown in Vojvodina at the beginning of XX Century, and Bankut 1205, tall old bred Hungarian variety that replaced local wheat populations in Vojvodina by the quarter of the previous century (fig. 1).

Genetic variability of genotype sample populations tested in different environments. The representative sample population was formed out of total germplasm collection that has been tested through years. The part of the trials conducted in

the agro environment of the IFVCNS experimental field in Rimski Sancevi was used as a pillar of a behavior of corresponding tested sample comparison, in the part of the trial conducted in Kumane. The conditions in Rimski Sancevi could be characterized as normal, conducted on chernozem. Kumane part of the trial was conducted on solonetz soil. Having in mind geographical closeness of these two sites (about 60km), the difference in soil type could be considered as a major source of phenotypic variation. The genotype by environment interaction (GEI) was the main source of total variation particularly closer observed. Two types of GEI variation were looked for - the small GEI over all the environments, followed by acceptable yield average, as well as, higher GEI value that shows a positive reaction of the particular genotype to reclamation by phosphor gypsum. For example, the wheat variety Pobeda is a perfect example of the first selection criterion, holding a small GEI and the yield in Kumane about 48% of the yield achieved in Rimski Sancevi, with no obvious effect of reclamation. The wheat variety Renesansa exhibited quite different GEI variation, reacting to reclamation by enhancing the yield positively correlated to the level of reclamation. Varieties Simonida and NSR-5 behaved the same way, where the later one had expressed very positive reaction to reclamation. The third type was "economic variation". That kind of reaction exhibited varieties Evropa 90 and Rapsodija, in a smaller extent. Both of them had a higher grain yield under 25t/ha phosphor gypsum reclamation treatment, than under 50t/ha. The fourth GEI interaction pattern could be described as "durable one". Triticale variety Odisej had the best performance in a part of the experiment conducted on solonetz with no amelioration. A similar way behaved local wheat population Banatka, and old bred variety Bankut 1205, as well as, modern variety Cipovka and facultative bread wheat Nevesinjka.

This reaction is particularly interested because is kind of unexpected. However, local population Banatka was grown in this part of Vojvodina for decades up to the WWI and could be considered as well adapted by the instinctive selection. The variety Bankut 1205 was Hungarian bred variety that successfully replaced Banatka in the region, for a while. The variety Nevesinjka is a special facultative durable genotype, because it came from a part of breeding program that was conducted in former SFR Yugoslavia for particular requirements of national defense. The standard for that kind of variability was *Triticale* Odisej. Varieties Pobeda, Nevesinjka, Banatka 1205, local population Banatka had on characteristic uncommon. They used the best their yield potential in abiotic stress conditions of solonetz with no reclamation, realizing 47-54% of the grain yield they gave in normal production conditions of even more expressive in that way (65%), fig 2.

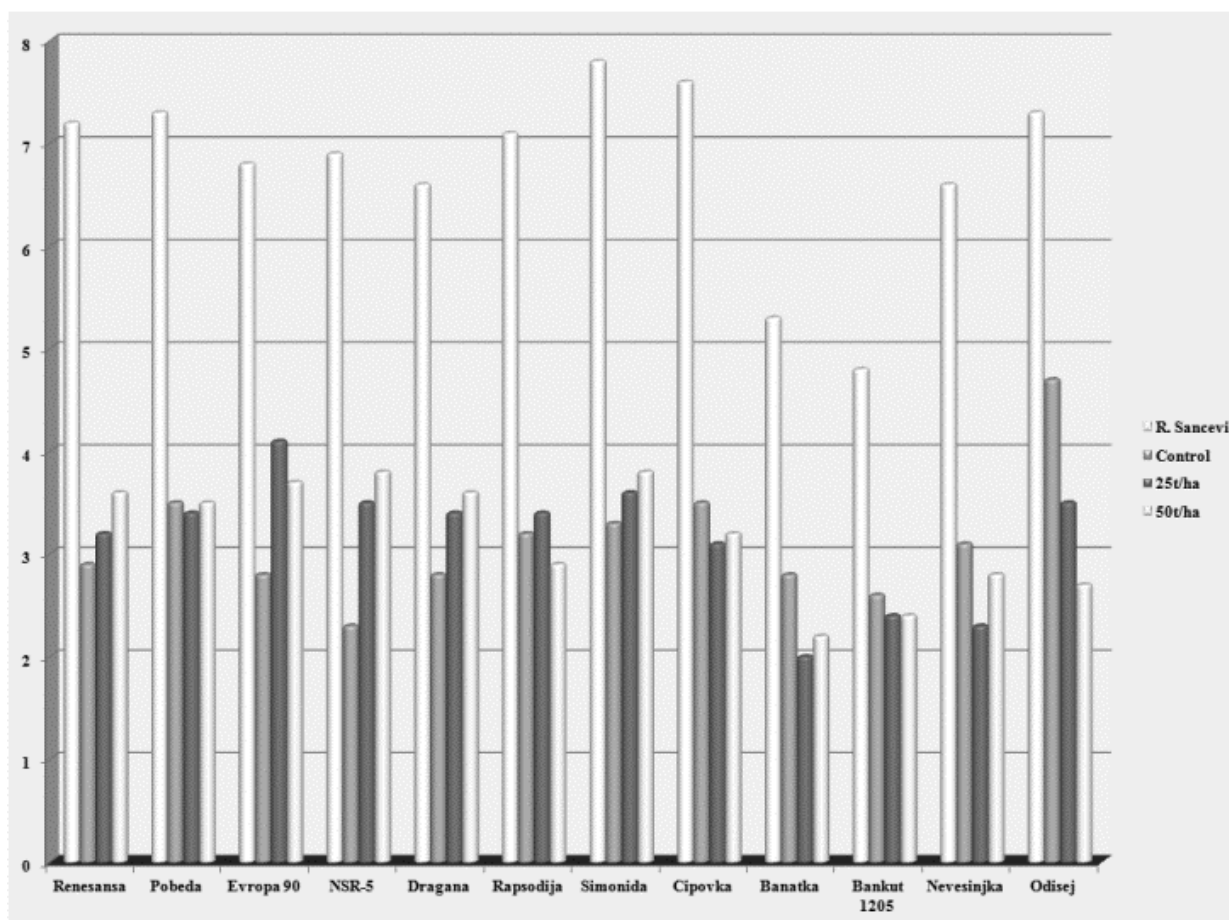

Figure 2. The grain yield (t/ha) of 12 genotypes (11 bread wheat varieties + *Triticale* Odisej) compared in 4 environments - Rimski Sancevi (chernozem soil type), and Kumane (solonetz soil type) with control and two reclamation treatments (25t/ha and 50t/ha of phosphor gypsum)

Rimski Sancevi. *Triticale* Odisej was

According to previously reported results, diminished soil productivity enhances cross over interaction, more over the effect of reclamation highly depends on overall agro-ecological conditions. The differences in grain yield between the control and 25t/ha of phosphor-gypsum reclamation varied from 8 to 24% depending on year and genotype tested, while grain yield on solonetz soil was between 41 and 52% comparing to the yield on chernozem (Dimitrijević, *et al.*, 2009; Dimitrijević, *et al.*, 2011).

The variation of the grain yield components. In order to perceive the effect of the soil type, as pure as possible, a representative sample of genotypes (11 entries out of 49) was tested on different soil types, humoglay and solonetz, at the same locality by year, to lessen abiotic

environmental factors as the variation source (Dimitrijević, *et al.*, 2009; Petrović, *et al.*, 2013). Humogley exhibits less favorable water-physical properties, while solonetz represents sodium reach, alkaline soils with a subsurface clay horizon. The pattern that could be observed is that length traits (plant height, and spike length) were of higher average value on humogley that could be considered as more favorable environment concerning soil type. Mass parameters (spike weight, and grain weight per spike), on the contrary, were of higher mean values on solonetz soil type. In the same time mean values of the number of grains per spike were about at the same level. A plant puts an effort to secure embryo with nutrients in order to provide a better start to its offspring. Denčić *et al.* (2000) affirmed the view that some individual plant traits, like grain weight per spike, have a significant positive direct effect on grain yield in abiotic stress conditions.

Crosses and progenies. After multiyear varietal screening, several wheat varieties were selected as parents for crosses. The criterions of parental selection were: small GE interaction - the reaction as stable as possible, but followed by acceptable mean values of traits - grain yield components, as well as, grain yield and good reaction to soil proclamation. Wheat varieties Renesansa, Pobeda, Pema, Sara, and Partizanka have been selected for the first set of crosses.

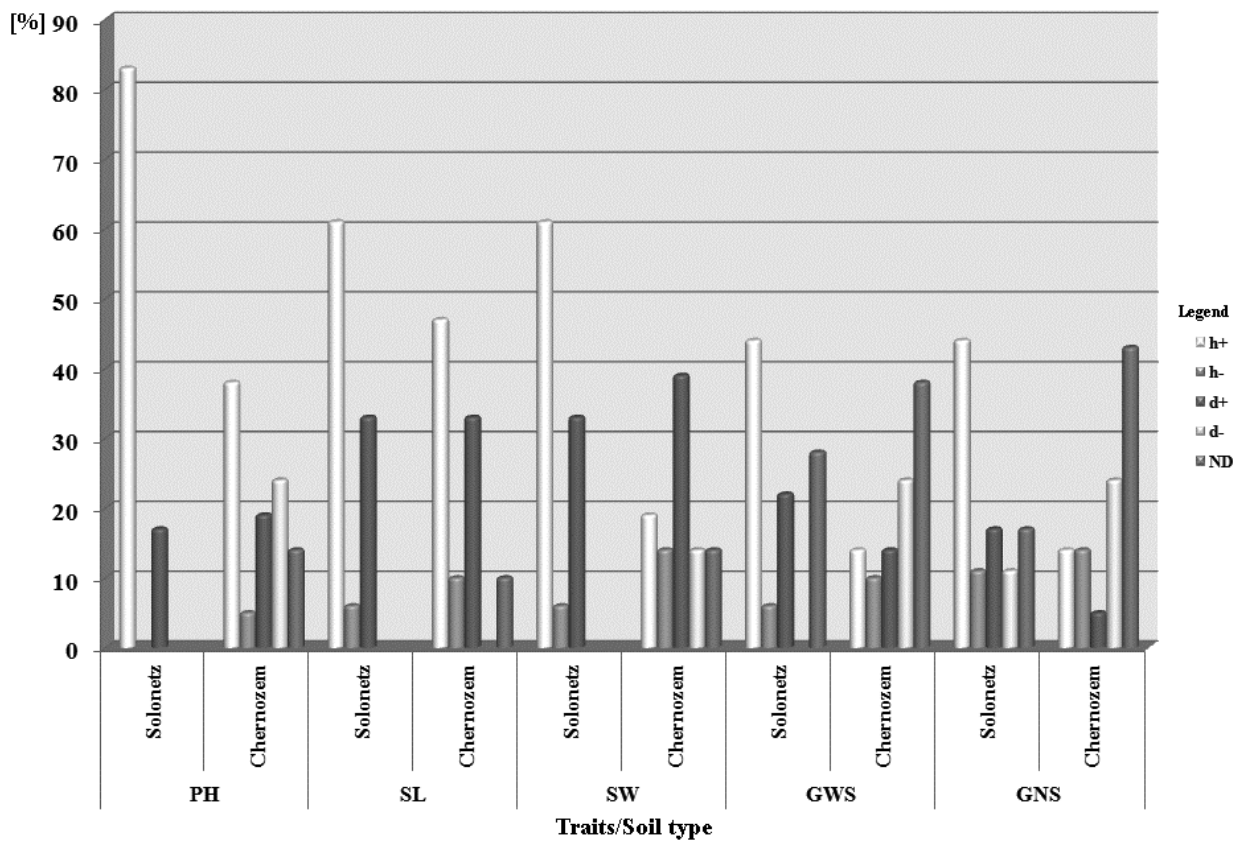

Figure 4. The mode of inheritance of five traits, the yield components, - plant height (PLH) in cm, spike length (SL) in cm, spike weight (SW) in g, grain weight per spike (GWS) in g, and grain number per spike (GNS) in F_2 progenies of 5 bread wheat varieties crosses compared in Kumane (solonetz soil type), and Rimski Sancevi (chernozem soil type)

Progenies of crosses were parallel sown on chernozem and solonetz soil, with full awareness of genetic variability in early progenies, F_2 in particular. Variability of the grain yield components, as well as, the mode of inheritance was followed. In three years period a certain pattern could be observed. The mode of inheritance in F_2 progenies grown on solonetz soil was positive heterotic effect, predominantly, for all traits that were followed (fig. 4). As

previously reported by Dimitrijevic et al. (2012, 2013), a genetic variability in F₂ for all examined traits, the yield components (plant height, spike length, spike weight, grain weight per spike, and grain number per spike), on solonetz soil, where a positive heterotic effect was denoted, was not only at the same level as on chernozem, but also of higher mean values. Having in mind that the selection criterion in early offspring could not be based on the grain yield *per se*, but on traits of individual plants, as phenotypic markers, the results of the trials are encouraging. There is a space within the existing wheat genetic variability, as well as, within newly created genetic variation to select perspective genotypes for growing in halomorphic soil conditions.

Conclusion

A discussion on advances and setbacks of *in situ* breeding programs has been going on within a breeder's community, for decades. That goes for breeding programs established in stressful growing conditions, in particular. *Ex situ* breeding for special purposes is more secured, harvest is reliable and better, however has to be combined with lab and markers, and still it's outcome is unreliable depending on a number of variation sources of multivariate nature. *In situ* breeding has its setbacks, as well. The harvest is not certain and commonly is of smaller quantity. The process is time consuming, as well, and could appear more expensive, particularly because parallel trials in normal conditions are recommendable. However, working in very conditions requires no or very limited lab assistance and MAS, since the environment is truly the same as in wide production in that environment. Plants adapt from the very beginning and their reaction is very and thru. Environmental conditions influence total genome. Genes are not isolated units. They work together, as a genome in a whole. The thru environment is, wherever is possible, better solution than MAS. MAS could follow predominantly major genes; the rest is statistical estimation of minor genes highly depending on the environment and genome interaction. Lab testing gives pure gene effects and intra genome interaction, but lacks the environment and the effect of plant population that is very important for plant breeding. According to the results of this program, a desirable and useful genetic variation could be selected effectively, using a classical plant breeder's approach.

References

- Arshad, M.A., (2008). Soil salinity and salinization, In: Chesworth W (ed) Encyclopedia of soil science. Springer, Dordrecht, 699–704
- Belić, M., Nesić, Lj., Dimitrijević, M., Petrović, S., Ćirić, B., Pekeč, S., Vasin, J., (2012). Impact of reclamation practices on the content and qualitative composition of exchangeable base cations of the solonetz soil, Australian Journal of Crop Science, 6 (10), 1471-1480.
- Borelli, G.M., Ficco, D.B.M., Giuzio, L., Pompa, M., Cattivelli, L., and Flagella, Z., (2011). Durum Wheat Salt Tolerance in Relation to Physiological, Yield and Quality Characters, Cereal Research Communications, 39(4), 525–534.
- Colmer, T.D., Flowers, T.J., and Munns, R., (2006). Use of wild relatives to improve salt tolerance in wheat, Journal of Experimental Botany, Vol. 57, No. 5, 1059–1078.
- Denčić S., Kastori R., Kobiljski B., Duggan B. (2000). Evaluation of grain yield and its components in wheat cultivars and landraces under near optimal and drought conditions. Euphytica. 113(1), 43-52.
- Dimitrijević, M., Petrović, S., Mladenov, N., Belić, M., Hristov, N., Banjac, B., Vukosavljev, M., (2009). Phenotypic reaction of wheat grown on different soil types. Genetika, 41, 2, 169-177.

- Dimitrijević, M., Petrović, S., Belić, M., Banjac, B., Vukosavljev, M., Mladenov, N., and Hristov, N., (2011). The Influence of Solonetz Soil Limited Growth Conditions on Bread Wheat Yield. *Journal of Agricultural Science and Technology*, 5, 2, 194-201.
- Dimitrijević, M., Petrović, S., Banjac, B., (2012). Selection criteria in wheat breeding for abiotic stress tolerance on alkaline soil. In *Proceedings 47th Croatian & 7th International Symposium on Agriculture*, Feb. 13 – 17, 2012., Opatija, Croatia, 265-269. [*orig. in Cro.*]
- Dimitrijević, M., Petrović, S., Banjac, B., (2013). In situ breeding for soil abiotic stress tolerance in wheat. *Book of proceedings 4th International Scientific Symposium "Agrosym 2013"*, October 3-6, Jahorina, Republic of Srpska (B&H), 77-83.
- Djordjević, A.R., Radmanović, S.B., (2016). *Pedologija, Univerzitet u Beogradu - Poljoprivredni fakultet*, 346-350. [*Pedology, University of Belgrade, Faculty of Agriculture*]
- Jiang, Q., Hu, Z., Zhang, H., Ma, Y., (2014). Overexpression of GmDREB1 improves salt tolerance in transgenic wheat and leaf protein response to high salinity, *The Crop Journal*, 2, 120 – 131
- Miljković, N., (1996). *Osnovi Pedologije*, PMF, Institut za geografiju, Novi Sad, 233-235. [*Basics of Pedology, University of Novi Sad, Faculty of Sciences, Inst*]
- Munns, R., James, R.A., Xu, B., Athman, A., Conn, S.J., Jordans, C., Byrt, C.S., Hare, R.A., Tyerman, S.D., Tester, M., Plett, D., Gilliam, M., (2012). Wheat grain yield on saline soils is improved by an ancestral Na⁺ transporter gene. *Nat. Biotechnol.*, 30, 360-364.
- Petrović, S., Dimitrijević, M., Banjac, B., (2013). Spike traits variability in wheat grown on solonetz and humoglay. *Fourth International Scientific Symposium „AgroSym“ Jahorina*, 3-6. october, *Proceedings*, 178-183.

COMBINED CULTIVATION OF EDDIBLE MUSHROOMS AND VEGETABLES

Agnieszka JASIŃSKA^{1*}, Ewelina WOJCIECHOWSKA¹, Ketil STOKNES², Katarzyna KRAJEWSKA²

¹ Poznan University of Life Sciences, Department of Vegetable Crops, Poznan, Poland

²Lindum AS, Drammen, Norway

*Corresponding author: jasinska.a@gmail.com

Abstract

Sustainable crop production nowadays is assumed crucial for agriculture to survive. Not only does it mean environmentally friendly protection or renewal of agricultural-natural resources (no spent substrate, less CO₂ footprint, less water consumption), but also for growers and consumers this means producing foodstuff without chemical inputs. Whenever feasible, sustainable agriculture relies upon crop rotations, crop residues, animal manures, off-farm organic wastes, mechanical cultivation, mineral-bearing rocks, and aspects of biological pest control to maintain the soil and its tillage, to supply plant nutrients, and to control insects and weeds. In this study we evaluated possibility of combined cultivation of edible mushrooms and vegetables as a sustainable, vertical system of growing. Mushroom compost (MC) was spawned with *Agaricus subrufescens*. Overgrown mushroom compost, produced in plastic bags was released, shredded and formed in 20-30 cm high heaps in the cultivation container. Cultivation substrate – garden compost (GC) was placed between rows and on top of MC, and used instead of peat as casing. This prevents MC from drying out and is necessary for fructification as a water holding layer. Cowpea (*Vigna unguiculata*) was planted in between rows. Climbing plants formed shades for mushroom and created specific microclimate. CO₂ produced by mushrooms in respiration process is used by plants for plant tissue production. Results of experiment show the potentiality incorporating plant (legumes) cultivation system with mushroom growing. Yield of cultivated mushrooms was similar to control, however increase in yield of beans compared to control was observed.

Keywords: *crop growing, fungi, substrate, sustainability, legumes.*

Introduction

Yearly losses of food around the world are estimated in range of 1.3 billion tones. In Europe and North America food waste is dominated by consumer waste and it range 95–115 kg of food each year, while in African and Asian areas it is 6-11 kg a year (FAO, 2011). This process influence human-generated greenhouse gas emissions (it is 6% to 10 %) (Vermeulen et al., 2012). Anaerobic digestion (AD) of organic matter generates biogas for energetic purposes and influence on decreasing of atmospheric emissions of methane (Horn et al. 1994). Zhang et al. (2007) and Bouallagui et al. (2003) indicate that food waste is a needed substrate for anaerobic digesters it is high biodegradable and increase methane production.

Biogas projects which process biological wastes are established in many countries as a policy of decreasing greenhouse production and waste management. A great deal of byproducts such as biogas slurry (BS) is produced during the process. Recycling of biogas byproducts via vegetable production can be sustainable, multi beneficial approach regarding agriculture and environment. The BS contains abundant nutrients and phyto-beneficial substances. Many authors claimed biogas slurry can be used in plant production (Alam and Chong 2010, Hasselgren 1998, Michitsch et al. 2008). In his study, Liu et al. (2009) describes approach on the utilization of BS in soilless vegetable cultivation. The commercial use of the AD byproducts is, still, little known and developed worldwide due to unstable or low yields of

vegetables. The main problems appearing when biogas byproducts are used as a component for plant nutrition is unstable composition which varies during the year (Govasmark et al. 2011). This instability can influence growth and yields of vegetable crops. It is crucial for vegetable cultivation to optimize composition of biogas byproduct if used commercially.

The choice of plants was triggered by leaf surface area and ability of the plant to be formed (i.e. climbing plants). This is due to form plants into shades for mushroom and to create specific microclimate. *Vigna unguiculata* (cowpea) is one of several species of widely cultivated genus *Vigna*, however the most important food legume crops in semiarid tropics of Asia, southern Europe, Central and South America (Singh et al. 2003). This plant is warm-weather crop; drought tolerant is well adapted to drier regions. Cowpea is shade tolerant, so is compatible as intercrop with maize, millet, sorghum, sugarcane, and cotton (Blade et al. 1997). This makes cowpeas an important component of traditional intercropping systems, especially in the complex and elegant subsistence farming systems of dry savannas in sub-Saharan Africa. In these systems the haulm (dried stalks) of cowpea is a valuable by-product, used as animal feed. According to the USDA food database, the leaves of cowpea plant have the highest percentage of calories from protein among vegetarian foods (Rangel et al. 2003, Phillips et al. 2003, Shaw 2007).

Agaricus subrufescens is a Brazilian mushroom which is popularly known as a sun mushroom widely used not only as a gourmet foods but also as medicine. The Almond mushroom is a heat loving species (23-27°C) and lower humidity requirements (75-85%), Chang (2008). The mushroom contains among others, bioactive polysaccharides and protein complexes (PSPC) which vitalize production of interferon and interleukin and is used in the cancer treatment (Nakajima et al. 2002). What is more it was also found to have beneficial activity in the treatment for AIDS, diabetes, hypotension and hepatitis (Mizuno 2002, Endo et al. 2010, Oliveira Lima et al. 2011). The growing interest in cultivation of this species and its requirements suiting with the cowpea was triggering the choice for our experiment.

The conducted experiment was performed in the scope of Food to Waste to Food (F2W2F) project focused on closing “loop” in biogas and food production. Soap bubbles isolated greenhouse was build, which differ from traditional greenhouse both in better energy savings and in recycling CO₂ from biogas production. Additionally digestate, liquid-like wastes after anaerobic digestion in biogas production was used for plant and mushroom cultivation. Many authors indicated on difficulties with proper yielding and environmental safety in food production combined with digestate. Yet, in most of our experiments yields were comparable with control treatments (mineral fertilizers), we focused on local recycling and safety both for human health and environment.

The following experiment was a preliminary trial of possible incorporation of combined cultivation system of mushroom and plants. The aim of research was to show the prospect of horizontal cultivation structure for future implementation in ecological design and cultivation.

Materials and Methods

Mushroom compost preparation

Compost substrates (wheat straw, shredded paper, chicken manure) were gained from local sources (farm areas near Drammen, Norway). Straw and chicken manure were derived from local farms, shredded office paper – collected from offices in the neighborhood area (local businesses – City of Drammen). The digestate from anaerobic digestion (AD) of source separated household food waste was separated using a decanter centrifuge. The resulting digestate solid was added to *phase I* substrate, and further prepared according to commercial *Agaricus* production.

First substrate components were mixed according to substrates dry matter (DM): straw – 18%, paper 36%, chicken manure – 3%; gypsum 3% and digestate – 40%. Later substrate was

composted in rotating composter drums. After few days compost loses volume due to heat generation and was mixed and moved to insulated containers with controlled flow of air through the substrate (to obtain similar conditions as in commercial bulk systems; 70-80°C and 6-9% O₂ v/v). The substrate was turned (reloaded) subsequently again twice at an interval of 2 days, giving total of 10 days for *phase I*. The compost was loaded into a miniature *phase II* tunnel for pasteurisation. The temperature was gradually increased to 60°C through 24 hours and maintained for 6 hours of pasteurisation, then decreased to 55°C, for another 6 hours and subsequently to 50°C where it was maintained for conditioning until ammonia (NH₃ gas) had dissipated (below 10 ppm).

Substrate incubation

Polypropylene 50 micron, autoclavable plastic bags (capacity of 7 liters, flat size 38 cm wide x 57 cm high), with four linear ventilation filters were applied were filled with approximately 3 kg of composted, pasteurized compost and left for cooling to room temperature (approx. 22°C). Substrate was inoculated with granular spawn of *Agaricus subrufescens* (Mycelia BVG) on wheat grain as amount of 3% of fresh substrate weight. The bags were sealed with adhesive tape and shaken by hand until the spawn appeared evenly distributed. The spawning was performed in stable controlled conditions, at 25°C.

Overgrown mushroom compost (MC), was released, shredded but not too much and formed in little heaps in cultivation container (number of rows depends on the container). The heaps were 20-30 cm high (for mycelium to easily grow and prevent compost from drying out). In between the rows proper cultivation substrate, here garden compost (GC) was placed. Garden compost was also placed on the top of MC, and used instead of peat as a casing. This prevents MC from drying out and was necessary for mushroom fructification as a water holding layer.

Combined cultivation design

Cultivation container was aluminum table sized 100x100 cm. MC were formed in 2 rows. The cowpea plants (*Vigna unguiculata*) were planted in 3 rows in between MC rows. The plants were grown in such way to shade mushrooms and also to allow easy harvesting of legume. The air humidity for fruit body development was held at 85-95%. The CO₂ produced by mushrooms was used by plants and converted to O₂. Cultivation room was aired not to allow CO₂ concentration to exceed 1000 ppm (higher CO₂ levels inhibit mushroom primordia formation). Water was applied by individual dripping system which was placed on top of mushroom heap, watering both mushrooms and plants. Later in cultivation vermicompost, for nutrition addition, was applied on the top of mushroom heap. The dripping water was making a leakage and nutrition was washed out to plants. Mushrooms appeared on the top and also can appear on the sides of heap, 2-3 weeks beginning of cultivation (after mycelium recovered and fully overgrown casing soil). Temperature during this period (esp. inside the MC heap should remain between 22-25°C). The mushroom harvest was led until the end of cultivation period of legume plants 8-10 weeks. The legumes were collected gradually when ripe.

Experiment have been performed in 3 replications of spring-summer season 2013, cultivation time was 8-10 weeks in greenhouse conditions. Daytime temperature was maintained on 21-25°C, decreased in nighttime to 17-19°C.

When comparing the experimental results, the analysis of variance for one factorial experiments was applied (ANOVA, level of significance $\alpha=0.05$).

Results and discussion

In following experiment we examined possibility of combined cultivation of legume plant – *Vigna unguiculata* and mushroom – *Agaricus subrufescens*. The trial shows yield of both examined objects depended on cultivation system. Yield of almond mushroom, *A. subrufescens* was slightly higher in the control trial; however statistical difference between combinations was insignificant. In the contrary, there was great difference of yield of cowpea – *V. unguiculata*. The legume plant yielded significantly higher in the combined cultivation system than in the control cultivation system (Fig.1-2).

Average yield of *A. subrufescens* from control trial was 84 g/kg⁻¹ of substrate, and in combined cultivation design showed 62 g/kg⁻¹. This corresponds with research of other scientists on almond mushroom. Eira et al. (2005) and Llarena-Hernandez et al (2013) report yield of *A. subrufescens* to reach 80-200 g/kg⁻¹ fresh substrate. The average yield of cowpea is reported to reach 1.8-3.0 kg/m². In our experiment yield was much lower than reported in literature; however it was significantly increased in combined cultivation system (Blade et al. 1997, Phillips et al. 2003, Rangel et al. 2003, Singh et al. 2003). In literature there are several research describing combined cultivation of different mushroom-plant systems (not mentioning omnipresent mycorrhiza dependence between higher plants and mushrooms). *Stropharia rugoso-annulata* is grown together with maize – 20% of yield increase, while combination of *Hypsizygus ulmarius* and Brussel sprouts because 25% of yield increase (Wang et al. 1984, Dallon 1987, Levanon and Danai 1995, Maher et al. 2000, Mullen and McMahon 2001, Williams et al. 2001, Prabu et al. 2014). Mushroom hyphae wrap around roots and increase water and minerals availability for plants – which lead to higher biomass production – higher yields. In the other hand, mushroom compost is nutrient rich product, highly assimilable by plants. Yield increase in cowpea can be explained by high nitrogen content (1m³ of MC contain same amount of N present in cow manure). MC contain also around 20% of calcium carbonate, therefore regardless of pH has great potential for substrate deacidification (Nizewski et al. 2006). Lower mushroom yield could be caused to rich casing material (vermicompost), critical moment in *A. subrufescens* production, which might inhibit fruiting bodies development (Zied et al.2012).

This trial experiment show the potential of vertical cultivation in terms of CO₂ production/disposal as well as waste treatment and limited space needed for cultivation. However further investigation should be performed in order to evaluate more possibilities of plant-mushroom combination.

Conclusions

Combined cultivation of plant (legumes) and mushroom was possible. Yield of cultivated mushrooms was similar to control. Yield of cowpea was higher compared to control.

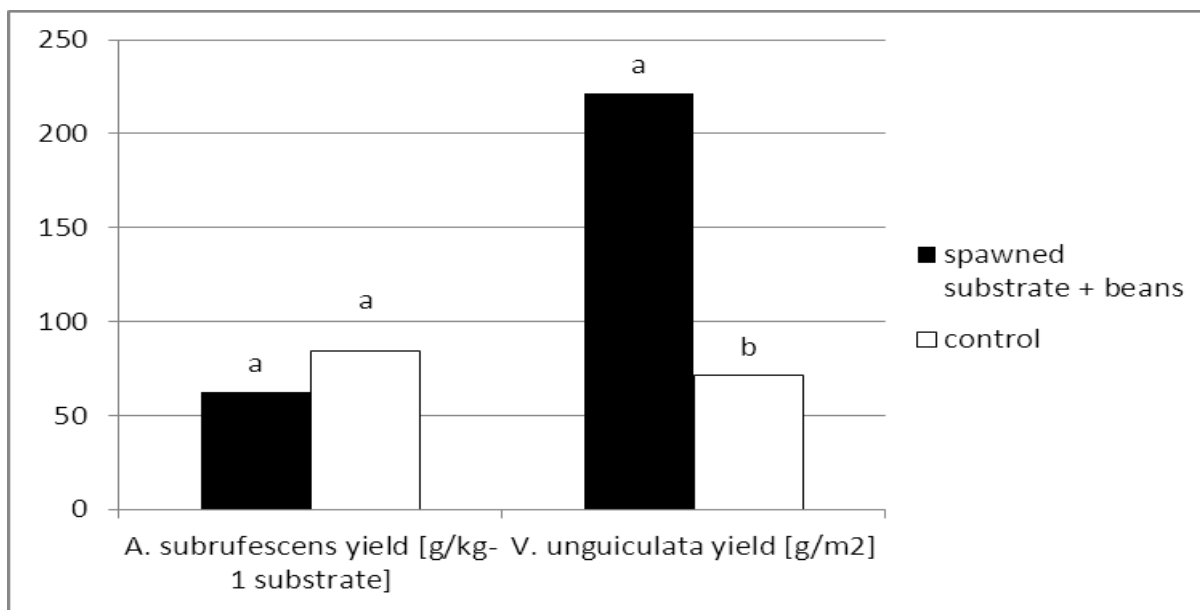

Fig. 1. Yield of *A. subrufescens* and *V. unguiculata* in combined cultivation [g/m^2]



Fig. 2 Combined cultivation system of mushroom (*A. subrufescens*) and legume plant (*V. unguiculata*)

Acknowledgement

Scientific work financed from the funds for science in 2012-2015 granted to international cofounded project No 179/CIPUE/2012 and PULS Young Researchers Subsidy No 507.649.68.

References

- Alam Z.M., Chong, C. (2010). Recycled liquid cattle manure as a sole fertilizer source for growing container nursery stock in a closed system. *HortScience*, 45 (1): 157-160.
- Blade S.F., Shetty S.V.R., Terao T., Singh B.B. (1997). Recent developments in cowpea cropping systems research. In: Singh B.B., Mohan Raj D.R., Dashiell K.E., Jackai L.E.N. (Eds.). *Advances in Cowpea Research*. International Institute of Tropical Agriculture and Japan International Research Center for Agricultural Sciences.
- Bouallagui H., Cheikh, R.B., Marouani, L., Hamdi, M. (2003). Mesophilic biogas production from fruit and vegetable waste in a tubular digester. *Bioresource Technology*, 86(1), 85-89.
- Dallon, J. (1987). Effects of spent mushroom compost on the production of greenhouse-grown crops. Combined proceedings of the International Plant Propagators Society, Ramapo College of New Jersey, USA, 37, 323-329.
- Eira A.F., Kaneno R., Filho E.R., Barbisan L.F., Pascholati S.F., Piero R.M.D. (2005). Farming technology, biochemistry characterization, and protective effects of culinary-

- medicinal mushrooms *Agaricus brasiliensis* S. Wasser et al. and *Lentinus edodes* (Berk.) Singer: five years of research in Brazil. *Int J Med Mushrooms*, 7, 281-299.
- Endo M., Beppu H., Akiyama H., Wakamatsu K., Ito S., Kawamoto Y., Shimpo T., Koike T., Matsui T. (2010). Agaritine purified from *Agaricus blazei* Murrill exerts antitumor activity against leukemic cells. *Biochimica et Biophysica Acta*, v.1800, p.669673.
- FAO (2011). Global food losses and food waste – Extent, causes and prevention. Rome, ss. 37, ISBN 978-92-5-107205-9, Italy.
- Govasmark E., Stab J., Holen B., Hoorstra D., Nesbakk T., Salkinoja-Salonen M. (2011). Chemical and microbiological hazards associated with recycling of anaerobic digested residue intended for agricultural use. *Waste Management*, 31, 2577-2583.
- Hasselgren K. (1998). Use of municipal waste products in energy forestry: highlights from 15 years of experience. *Biomass and Bioenergy*, 15 (1), 71-74.
- Horn Van H.H., Wilkie A.C., Powers W.J., Nordstedt R.A. (1994). Components of Dairy Manure Management Systems. *Journal of Dairy Science*, 77(7), 2008-2030.
- Levanon D., Danai O., (1995). Chemical, physical and microbiological considerations in recycling spent mushroom compost. *Compost Science Utilization*, 3(1), 72-79.
- Liu WK., Yang Q.C., Du L.F. (2009). Soilless cultivation for high-quality vegetables with biogas manure in China: feasibility and benefit analysis. *Renewable Agriculture and Food System*, 24, 300-307.
- Llarena-Hernández R.C., Largeteau M.L., Farnet A.M., Foulongne-Oriol M., Ferrer N., Regnault-Roger C., Savoie J.M. (2013). Potential of European wild strains of *Agaricus subrufescens* for productivity and quality on wheat straw based compost. *World Journal of Microbiology and Biotechnology*, 29 (7), 1243-1253.
- Maher M.J., Smyth S., Dodd V.A., McCabe T., Magette W.L., Duggan J., Hennerty M.J. (2000). *Managing Spent Mushroom Compost*, Teagasc, Dublin, 1-4.
- Michitsch R.C., Chong C., Holbein B.E., Voroney R.P., Liu H-W. (2008). Fertigation of cool season turfgrass species with anaerobic digestate wastewater. *Floriculture, Ornamental and Plant Biotechnology*, 2(2), 32-38.
- Mizuno T. (2002). Medicinal properties and clinical effects of culinary-medicinal mushroom *Agaricus blazei* Murril (*Agaricomycetidae*). *Int. J. Med. Mushrooms*, 4, 299-312.
- Mullen G.J., McMahon C.A. (2001). The effects of land spreading and soil incorporation of spent mushroom compost on Co. Monaghan grassland soils. *Irish Journal of Agricultural and Food Research*, 40, 189-197.
- Nakajima A., Ishida T., Koga M., Takeuchi T., Mazda O., Takeuchi M. (2002). Effect of hot water extracts from *Agaricus blazei* Murril on antibody-producing cells in mice. *Int. Immunopharmacol.*, 2, 1205-1211.
- Niżewski P., Dach J., Jędrus A. 2006. Management of mushrooms substrate waste by composting process. *J. Res. Application Agric. Eng.* Vol. 51(1): 24-27.
- Oliveira Lima, C.U.J., de Almeida Cordova, C.O., de Toledo, N.O., Funghetto, S.S., de Oliveira, G., Karnikowski, M. (2011). Does the *Agaricus blazei* Murrill mushroom have properties that affect the immune system? An integrative review. *J Med Food.*, 14, 2-8.
- Phillips R.D., McWatters K.H., Chinnan M.S., Hung Y.C., Beuchat L.R., Sefa-Dedeh S., Sakyi-Dawson E., Ngoddy P., Nnanyelugo D., Enwere J. (2003). Utilization of cowpeas for human food. *Field Crops Res.*, 82, 193-213.
- Prabu M., Jeyanthi C., Kumuthakalavalli R. (2014). Spent mushroom substrate: An enriched organic manure for improving the yield of *Vigna unguiculata* (L.) Walp (Cowpea) leguminous crop. *SIRJ-APBBP*, Vol. 1, Issue 3, 7-14.
- Rangel A., Domont G.B., Pedrosa C., Ferreira S.T. (2003). Functional properties of purified vicilins from cowpea (*Vigna unguiculata*) and pea (*Pisum sativum*) and cowpea protein isolate. *Journal of agricultural and food chemistry*, 51, 5792-5797.

- Shaw M. (2007-10-28). 100 Most Protein Rich Vegetarian Foods. SmarterFitter Blog. <http://smarterfitter.com/100-most-protein-rich-vegetarian-foods/> Accessed on 06/04/2008.
- Singh B., Ajeigbe H.A., Tarawali S.A., Fernandez-Rivera S., Abubakar M. (2003). Improving the production and utilization of cowpea as food and fodder. *Field Crops Research* 84, 169-150.
- Vermeulen S.J., Campbell B.M., Ingram J.S.I. (2012). Climate change and food systems. *Annual Review of Environment and Resource*, 37, 195-222.
- Wang S.H., Lohr V.I, Coffey D. (1984). Growth response of selected vegetable crops to spent mushroom compost application in a controlled environment. *Plant and Soil*, 82, 31-40.
- Williams B.C., McMullan J.T., McCahey S. (2001). An initial assessment of spent mushroom compost as a potential energy feedstock. *Bioresource Technology*, 79(3), 227-230.
- Zhang R., El-Mashad H.M., Hartman K., Wang F., Liu G., Choate C., Gamble P. (2007). Characterization of food waste as feedstock for anaerobic digestion. *Bioresource Technology*, 98, 9(4), 929-935.
- Zied D.C. Pardo-Gimenez A., Almeida Minhoni M.T., Villas Boas R.L., Alvarez-Orti M., Pardo-Gonzalez J.E., 2012. Characterization, feasibility and optimization of *Agaricus subrufescens* growth based on chemical elements on casing layer. *Saudi J Biol Sci*. 2012 Jul;19(3):343-7. doi: 10.1016/j.sjbs.2012.04.002.

PEACH CUTIVARS RESEARCH AND BREEDING IN NIKITA BOTANICAL GARDEN

Anatoliy SMYKOV*, Olga FEDOROVA, Tatyana SHISHOVA, Juliia IVASHCHENKO

Nikita Botanical Garden - Federal Research Center of RAS, Yalta, Russian Federation

*Corresponding author: fruit_culture@mail.ru

Abstract

Peach breeding was focused on obtaining cultivars with high commercial properties, enhanced adaptability to frosts, drought and fungus diseases. Gene fund is the basis for breeding. Peach collection on the southern coast of Crimea, owned by Nikita Botanical Garden, includes 483 cultivars, 103 elite hybrid forms and above 2000 hybrid seedlings. Gene fund has been formed by means of introduction and inclusion of cultivars and forms from own breeding. Gene fund is systematized on grounds of belonging to certain ecogeographical groups and ecotypes, among them were recognized carriers of economical valuable features and was showed efficiency of their selection amid diverse ecogeographical groups for use in the breeding. Evaluation of selected varieties and their comparison with the cultivar model based on cluster analysis allowed to determine the degree of similarity between them after a complex of characteristics. Together with intraspecific (direct, reciprocal and back-crossing as also inbreeding) was effected distant (interspecific, intergeneric) hybridization, without and with treatment of pollen by mutagens. Clone selection of somatic mutations was effected without and with treatment of vegetative buds and seeds by mutagens. As a result of cultivars research and breeding were selected 28 new peach cultivars, afterwards included into Plant Varieties Register of Russia and Ukraine.

Keywords: *gene fund, ecogeographical groups, ecotypes, hybridization, cultivars.*

Introduction

Common Peach (*Persica vulgaris* Mill.) is one of the most important stone fruit crops cultivated in Southern Russia. In the Republic of Crimea it occupies an area of 2.63 thousand ha, which amounts to 25.2% of the total area of fruit crops. The peach is notable for excellent commercial properties of fruits, a wide range of ripening terms and is in great demand in the market. But the existing assortment of this culture includes too little early maturing cultivars, especially with yellow flesh, and late ripening terms. It is necessary to increase the resistance of cultivars to adverse abiotic and biotic factors of the environment and improve the commercial properties of fruits.

At present, the most significant is the classification of Ryabov I.N. (1953), based on botanical and geographical peach groups. Within the peach *Persica vulgaris* Mill. selected two kinds of varieties: with pink flowers - *P. vulgaris* var. *Rosaeflorae* Riab. and bell flowers *P. vulgaris* var. *Campanulaeflorae* Riab. Among varieties with bell-flowered dominated the middle and late ripening, and about equally there were varieties with white and yellow colored flesh. They belong to the Iranian eco-geographical group of varieties. Among the varieties with pink flowers were many early ripening samples. Varieties of early, middle and late ripening are distributed in roughly equal proportions with white colored flesh forms. They belong to the North Chinese eco-geographical group of varieties.

The main base for breeding is the gene fund of fruit crops, used by NBG, is formed by cultivars and forms, which were introduced from various natural regions of the CIS, Europe and America, and by self-bred forms and varieties (Plugatar, 2016; Ryabov, 1969; Smykov,

2001; Smykov, 2008; Smykov, 2015; Hesse, 1981; Infante et al., 2008; Ogundiwinet al., 2009; Sansavini, 2006).

In this regard, the aim of research was to develop theoretical foundations for improving the techniques used in peach varieties research and breeding as a basis for optimization of the breeding process and the development of new cultivars for commercial horticulture in Crimea and southern Russia.

Materials and Methods

The material of the research was a peach gene fund, represented by 483 cultivars, bred and introduced by Nikita Botanical Gardens and by 103 elite forms, as well as more than 2 thousand hybrid seedlings. Research were carried out for 2000 - 2015 years. For a comprehensive assessment of varieties the gene fund was systematized by eco-geographical groups and ecotypes with the definition of the incidence of economically important traits in each group and ecotype. The research on the gene pool and on the breeding process was carried out according to the techniques by NBG (Smykov and Lishchuk, 1999), the "Programme and technique for research on varieties of fruit, small-fruit and nut crops" (Sedov, 1995), "Programme and technique for breeding of fruit, small-fruit and nut crops" (Sedov and Ogoltsova, 1999).

Results and Discussion

The breeding was based on the scheme developed and used by us. Gene fund has been formed by means of introduction and inclusion of self-bred cultivars and forms. Together with intraspecific (direct, reciprocal and back-crossing as also inbreeding) was effected distant (interspecific, intergeneric) hybridization, with and without dust treatment with mutagens (Sedov and Ogoltsova, 1999). Embryos from the seeds of early maturing maternal varieties were grown up by the in vitro culture (Department of Biotechnology).

Clone selection of somatic mutations was performed without and with treatment of vegetative buds and seeds by mutagens. To stimulate development in the in vitro culture, the immature embryos were irradiated at small doses (Smykov and Lishchuk, 1999).

The obtained hybrid seedlings and clones were studied on the complex of economically valuable traits in greenhouses and breeding garden during a several of years after the fruiting. Selected elite forms were grafted into rootstock and planted in amount of 5-10 plants in the collection garden for a comprehensive assessment according to the technique of primary research, involving specialists from other departments (biotechnology, biochemistry, phytopathology, agroecology and others.) (Sedov, 1995).

The forms, with better economical valuable features than used cultivars have been passed in State service of varieties test, and then were passed to the firms for production testing. Last stages of the breeding process are the patenting entry in the Russian Register of Breeding Achievements and conclusion of license agreements with nurseries for industrial reproduction of new cultivars.

Accomplished researched allowed to identify diverse eco-geographical groups, ecotypes and cultivars with high intensity of blossom (the North-Chinese ecogeographical group, the European ecotype of North-Chinese group, 16 cultivars), with late blossom (North-Chinese group, the European ecotype of the North-Chinese group, 17 cultivars), with long-lasting blossom, (the Iranian group, the American ecotype of the Iranian group, 22 cultivars), with early bearing age (the Iranian group, the European ecotype of the Iranian group, 60 cultivars), high-yielding (North-Chinese group, Transcaucasian ecotype of the Iranian group, 14 cultivars), early ripening (Iran group, the American ecotype of the Iranian group, 60 cultivars), late ripening (North-Chinese group, Transcaucasian ecotype North-Chinese group, 6 cultivars), with high commercial properties (Iranian group, the European ecotype of the

Iranian group, 111 cultivars), with high adaptability to frost (North-Chinese group, European ecotype Northern-group, 14 cultivars), to drought (Iranian group, the Central Asian ecotype of North-Chinese group, 32 cultivars), to leaf curl (*Tarphina deformans* Tul.) (North-Chinese group, the Central Asian ecotype of the North-Chinese group, 4 cultivars), to powdery mildew (*Sphaerotheca pannosa* Lev. var. *persica* Woronich) (North-Chinese group, Chinese ecotype of the North-Chinese group, 10 cultivars).

In our investigations we used the developed by us cultivar model criteria, based on 35 features: a tree with a moderate growth of 1.8-2.0 m, narrow revertive-pyramidal compact shape of the top, early productivity (starting from the second year after planting), a long deep rest period (over 100 days), a late blossom (more than 50 days after the start of the growing season), plenty blossom (5 points), long-lasting blossom (over 18 days), high-yielding (above 50 kg per tree and 10 kg per 1 m² of the top projection), a high productivity factor of leaf apparatus (CPWL above 3.0), high resistance to frost: flower buds damaging do not exceed 10 per cent (1 point), a very low susceptibility to leaf curl (0.5 points), to powdery mildew (0.1 points), high drought tolerance (5.0 points), the duration of the yielding period over 20 years.

Average fruit weight amounts to 120 - 150 g, round in shape, fruit have a poor pubescence, yellow, melting or non-melting, dens flesh, carmine-dark-red surface colouring, which covers 100 percent of the fruit surface, a little (less than 4 g) stone, free stone, have an excellent appearance and taste, have universal using, high content of biologically valuable substances: dry substance (above 20 percent), sugars amount (above 12 percent), ascorbic acid (> 10 mg/100 g), leucoanthocyanins (above 120 mg/100 g), flavons (above 24 mg/100 g), pectic substances (above 1.2 percent), carotin (above 1.6 mg/100 g).

For comparing the top 25 cultivars of peach, selected from the collection, by means of cultivar model based on 15 main features, we have used the cluster analysis technique (see table.). This technique allowed us to determine the degree of similarity between these cultivars and the cultivar model based on Euclidean distance. All objects are grouped into a classification tree, which is reflected in a dendrogram (figure 1).

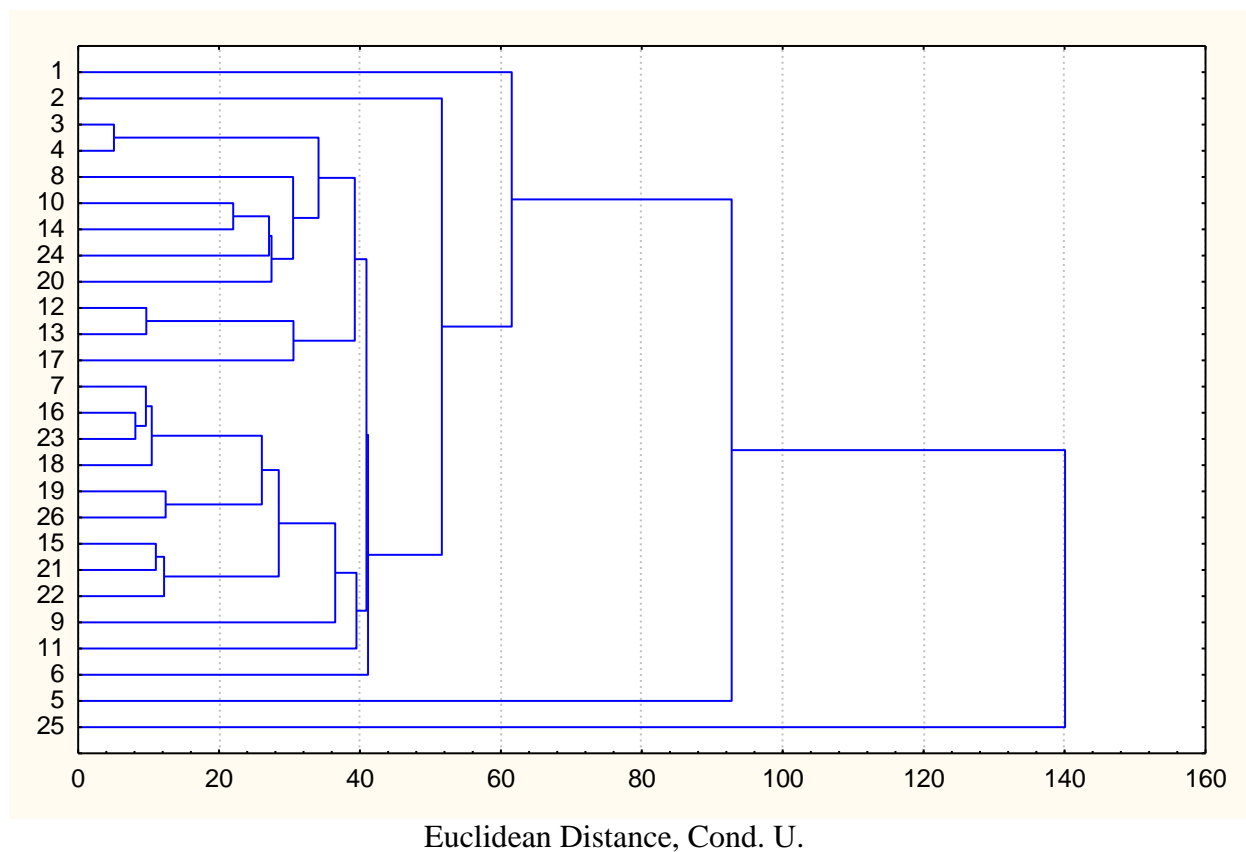

Figure 1. Cluster analysis of similarity between peach cultivars and cultivar model:

1. Cultivar Model, 2 Gagarinskiy, 3. Gartvis-72, 4. German Titov,
5. GorniyTsvetok, 6. DruzhbaNarodov, 7. Kodru, 8.KrasaKavkaza,
9. Kremlyovskiy, 10. Lebedev, 11.Muza, 12.Pamyat Simirenko, 13.Tyulpan,
14. Baby Gold-6, 15. Conharmony, 16.Early Coronet, 17.Early Red, 18. Elvira,
19. Golden, 20. Harbell, 21. Harken, 22. Monroe, 23.Redcap, 24.Redhaven, 5.Rihven, 26. Sun Beam

According to the similarity of the features and their values the cultivars, united in clusters (groups), are close: 1. Gartvis 72 и German Titov; 2. Lebedev, Baby Gold-6, Redhaven, Harbell; 3. PamyatSimirenko, Tyulpan; 4. Kodru, Early Coronet, Redcap, Elvira; 5. Golden, Sun Beam; 6. Conharmony, Harken, Monroe.

According to the complex of features as the most close to model (62 units of Euclidean distance) were marked eight cultivars: Gagarinskiy (51 units), Druzhba Narodov (42 units), Muza (39 units), Kremlyovskiy (37 units), Krasa Kavkaza (35 units), Early Red (30 units), Harbell (28 units), Redhaven (27 units).

To determine the interdependence between economically-valuable signs based on evaluation of 110 cultivars we performed a correlation analysis on 15 indicators and detected varying degree of their interrelation.

The highest correlation coefficient was observed between fruit quality - appearance (0.9) and the taste (0.83); ripening term - weight (0.5) and the percentage of surface colouring (-0.6); period and duration of blossom (-0.66); appearance and taste of fruits (0,55), and others.

Breeding was focused on developing new cultivars with low susceptibility to powdery mildew and leaf curl, with early and late ripening terms, high commercial properties and enhanced resistance to frost. The total number of crossing combinations was 380.

Most combinations with a high percentage of seed formation was observed in crosses on the earliness with the participation of the middle ripening parent cultivars.

The most high-self-fertile and self-fertile cultivars belonged to the Iranian ecological-geographic group, and the American ecotype. In the high-self-fertile group were marked 13 cultivars, among self-fertile samples - 18 cultivars.

Hybridological analysis allowed to detect cultivars and forms - donors of qualitative signs: 14 donors of round shape, 19 - non-melting flesh, 3 - of white flesh colouring, 11 - of tender flesh density, 2 - free stone, as well as quantitative signs: 2 donors of early ripening, 4 - of medium terms, 7 - of the medium and large fruit, 8 - of a better colouring, 5 - of good taste of fruits, 9 - of high yields, 10 - of low susceptibility to leaf curl, 3 - of low susceptibility to powdery mildew, 2 - comprehensive donors of low susceptibility to diseases.

Through investigation seedlings from gene fund on fruits quality we selected 47 forms (the most of them (68,8 per cent) were obtained by crossing of cultivars belonging to different eco-geographical groups and ecotypes), with high productivity - 32, low susceptibility to leaf curl - 36, to powdery mildew - 38.

In the course of research was evaluated radiosensibility and the fertility of gamma-irradiated pollen of 23 peach cultivars, used in breeding programs.

Thereby were detected optimal doses and plants variation range after exposure of seeds to gamma-radiation in combination with growth substances «Fumar», IBA and by treatment of vegetative buds with chemical mutagens EI, NEU, NMU in combination with gamma radiation and these growth substances.

By means of radiation mutagenesis were detected 49 promising forms that were evaluated on a range of economically valuable signs.

Among them 13 radioforms were marked by frost resistance, 11 - by drought resistance, and 8 forms with high content of biologically valuable substances in fruits.

In the course of research have been studied the specifics of differential chromosome colouring in gamma-irradiated peach forms of cultivar Sovetskiy (figure 2).

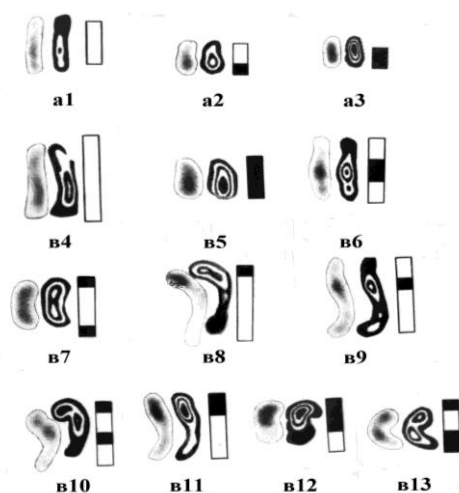

Figure 2. The classification of types of peach chromosomes at the stage of cell division prophase-prometaphase.

In variants with radiation, especially at a dose of 50 Gy, were marked differences in the ratio of hetero- and euchromatin blocks, changing area, the total optical density of the cell nucleus, the appearance of cells with micronuclei, bridges and polyploid set of chromosomes (Table).

Table. Abnormalities in the mitotic division of somatic cells in the irradiated peach.

Cultivar	Variant of radiation Gy	The number of studied cells	Area core		The total optical core density		Amount of micro-cores	Amount of cells with briges	Amount of polyploid cells
			Pixel ²	V, %	sumgrey	V, %			
Barkhatistiy (control)	0	100	2515.9	20.4	10.7	18.4	0	2	1
Barkhatistiy	50	96	2402.8	22.2	9.5	19.7	4	7	2
Sovetskiy (control)	0	100	3342.9	28.0	12.3	23.3	1	0	0
Sovetskiy	50	100	2827.7*	38.9	10.9*	39.4	0	5	0
Kudesnik (control)	0	100	7565.9	26.6	23.4	14.6	1	2	0
Kudesnik	50	112	5262.7*	32.5	26.8*	19.0	6	7	4

Significant differences with control at P = 0.95 for the core area and the total optical density

Based on the study of the gene fund, the selection of the source cultivars and forms for hybridization, evaluation of breeding material, we selected 28 new peach cultivars: Sonata Tavridy, Ulublenniy, PamyatnyiNikitskiy, Pontiyskiy, Granatoviy, Podarok Like, Strelets, Soprano, KrymskiyShedevr, Rodzinka, Karnavalniy, Lakomiy, Naryadniy, Nikitskiy, Otlichnik, NikitskiyPodarok, Dostoyniy, Kloun, Temisovski, KrymskiyDiamant, YuzhnayaGarmoniya, RummyaniNikitskiy, Merkuriy, Serdolik, Ozhidaniye, KrymskiySonet, PivdenaFantasiya, Etyudniy, Persey, which have been included into Russian Register of Breeding Achievements (Division Republic of Crimea). Some of these cultivars are shown in figure 3.



Cultivar Pontiyskiy



Cultivar Pivdena Fantasiya



Cultivar Yuzhnaya Garmoniya



Cultivar Rodzinka

Figure 3. Promising cultivars of peach.

Conclusions

Thus, the comprehensive study of the peach gene fund on the basis of dividing cultivars into according eco-geographical groups and ecotypes, determining their frequency of occurrence of valuable signs, the criteria of cultivar model, correlation interdependence between signs, selection of sources and donors of economically valuable properties, including them in crossing combinations on the principle of distant origin, application of radiation and chemical mutagenesis allowed to optimize the breeding process and to make it more effective. On this basis we obtained 28 new peach cultivars, which were included into Russian Register of Breeding Achievements.

Acknowledgements

The study was funded by a research grant № 14-50-00079 of the Russian Science Foundation.

References

- Hesse, K.O. (1981). Peach. The Breeding of fruit Crops. Kolos, Moscow, 1981. pp. 390-462.
- Infante, R., Martinez-Gomez, P., and Predieri, S (2008). Quality oriented fruit breeding: Peach [*Prunus persica* (L.) Batsch]. J. Food Agric. Environ, 2008. 6. pp. 342–356.
- Intensification of Breeding of Fruit Crops / under the editorship of V.K. Smykov, A.I. Lishchuk. – Yalta, 1999. 216 p.
- Ogundiwin, E.A., Peace, T.M., Gradziel, D.E., Parfitt, D.E., Bliss, F.A., and Crisosto C.H. (2009). A fruit quality gene map of *Prunus*. BMC Genomics 10, 587 <http://dx.doi.org/10.1186/1471-2164-10-587>.
- Plugatar Y. (2016). Nikita Botanical Garden as a Research Institution // Vestnik Rossiiskoi Akademii Nauk, 2016. Vol. 86. №2. pp. 120-126.
- Programme and Technique for Breeding of Fruit, Small-Fruit and Nut Crops / under the science editorship of E. N. Sedov, T.P. Ogoltsova. Orel, 1999. 606 p.
- Programme and Technique for Research on Varieties of Fruit, Small-Fruit and Nut Crops / under the science editorship of E. N. Sedov. Orel, 1995. 499 p.
- Ryabov I. (1953). Varieties of fruit and berry crops: Collection of scientific papers. M., 1953. pp. 5-81.
- Ryabov I. (1969). Research on Varieties and Primary Cultivar Testing of Stone Fruit Crops in the State Nikita Botanical Garden. Research on Varieties of Stone Fruit Crops in the South of the USSR: Collection of scientific papers. M. Kolos, 1969. Vol. 41. pp. 5-83.
- Sansavini, S. (2006). Peach breeding, genetics and new cultivar trends. Acta Hort. 713, 23–48 <http://dx.doi.org/10.17660/ActaHortic.2006.713.1>.

- Smykov A. (2001). Gene Pool of Stone Fruit Crops of Nikita Botanical Garden and Breeding at the turn of millennium. – K., 2001. pp. 440-443.
- Smykov A. (2008). Gene Fund of Fruit, Subtropical and Nut Crops of Nikita Botanical Garden. Crimean industrial horticulture. Simferopol: Tavria, 2008. pp. 485-486.
- Smykov A. (2015). Gene Fund and creating cultivars of southern fruit crops for the Crimea and southern Russia. Scientific papers of the Nikita Botanical Garden, 2015. Vol. 140. pp. 19 – 23.

GROWTH AND PRODUCTIVITY OF *Rosmarinus officinalis* L. AS AFFECTED BY IRRIGATION AND NITROGEN FERTILIZATION IN CENTRAL GREECE: FIRST YEAR (ESTABLISHMENT) RESULTS

Konstantinos MARTINOS*, Elpiniki SKOUFOGIANNI, Nicholas G. DANALATOS

Laboratory of Agronomy and Applied Crop Physiology, Department of Agriculture, Crop Production and Rural Environment, University of Thessaly, Fytokou Str., 38446, N. Ionia, Volos, Greece

*Corresponding author: kmartinos@agr.uth.gr

Abstract

Rosemary (*Rosmarinus officinalis* L.) is an evergreen plant endemic and typical of the Mediterranean region. Rosemary has long been considered an important plant for its essential oil used vastly in the perfume and medicine industry. The plant has been reported to possess several medicinal properties. The first-year of a rosemary (*Rosmarinus officinalis* L.) crop's growth and productivity as affected by irrigation and N fertilization was investigated under field conditions in central Greece. In April 2015, winter cuttings of a native rosemary cultivar were transplanted to an experimental field installed in Nea Aghialos, Magnesia, central Greece. The experimental design was a 2³ factorial split plot design with three drip irrigation levels (0, 50, and 100% of potential evapotranspiration) comprising the main plots, and three nitrogen dressings (0, 50, 100, kg N ha⁻¹) comprising the subplots in four replications (blocks). The growth and final productivity of the crop was measured in four destructive samplings of the crop during the summer 2015. The results demonstrated the paramount effects of both irrigation and nitrogen fertilization on thyme productivity and final yield already in the first year of crop establishment.

Keywords: *rosemary, irrigation, nitrogen, fertilization, evapotranspiration*

Introduction

Rosemary (*Rosmarinus officinalis* L.) is an evergreen woody aromatic herb with a characteristic aroma and lavender-like leaves. The plant is native to the Mediterranean region where it grows abundantly. Rosemary is cultivated on a large scale in Spain, Italy, France, Algeria, and Portugal for its essential oil. Morocco, one of the world's leading producers of rosemary oil, is second only to Spain and Tunisia in terms of volume of production (Bolens 1985). The leaves of rosemary are also used for culinary purpose and are reported to possess antioxidant properties. Rosemary is also used in food products.

Water availability plays an important role in plant growth and productivity (Singh and Goswamy, 2000). Deficit irrigation, one of the environmental stresses, is the most significant factor restricting plant growth and crop productivity in the majority of agricultural fields of the world (Abedi and Pakniyat, 2010). Field experiments on water requirements of rosemary in Egypt revealed that irrigation once every 14 days resulted in high herbage and oil yield (Kandeel, 2001). It was demonstrated that irrigation once a week is sufficient (Farooqui and Sreeramulu, 2001). Identifying growth stages of a particular cultivar under local conditions of climate and soil fertility allows irrigation scheduling to maximize crop yield and most efficient use of scarce water resources (Puttanna et al, 2010; Mahal and Sidhu, 2006).

Besides irrigation, Nitrogen fertilization is very important affecting leaf area index and dry herb yield of rosemary plants as shown in previous studies (Singh, 2013; Singh and Wasnik, 2013). Studies conducted in Italy (Sardinia) on fertilizer dose and weed management revealed that applying 80 kg N ha⁻¹ coupled with hand weeding of the major weeds increased herbage yield and oil (Milia *et al.*, 1996). Fertigation with water-soluble fertilizers (80% WSF)

coupled with micronutrients were reported to increase growth, yield and quality traits of rosemary (Vasundhara *et al.*, 2002).

The objective of the present work is to determine the growth and productivity of rosemary under field conditions during the first year of establishment under optimum and sub-optimum irrigation and N-fertilization inputs in a typical Mediterranean site, e.g. central Greece.

Materials and methods

Crop establishment

The experiment was set up in the rural area of Nea Aghialos in Central Greece (39°16'02.3"N 22°47'47.5"E) on May 5, 2015. The soil of the experimental plots was a sandy loam one with a pH of 6.8 and an organic carbon (C) of 1.5 g kg⁻¹. Rosemary cuttings (43 days old) were obtained from a local nursery. The soil was prepared and divided into plots; each of them was 4,2 m \times 2,4 m and contained three drip rows. The cuttings were transplanted on May 5. Distance between plants and distance between rows were both 60 cm. Nitrogen was applied in three levels: N0, N50 and N100 (0, 50 and 100 kg ha⁻¹ respectively) in the form of a urea fertilizer on June 9 of 2015. Thirty-six plots containing a total of 648 plants were arranged in a split plot design with irrigation being the main factor and nitrogen fertilization the factor split into sub-plots. Each experimental unit consisted of three rows of plants, 0.6 m apart, with the two outer rows serving as buffers while plants were spaced at 60 cm apart.

Irrigation

The amount of irrigation water was equal to 0% (rainfed – 110 mm), 50% (281 mm) and 100% (562 mm) of the recorded evaporation values of a class-A pan. The irrigation water was applied by drip irrigation system and the irrigation interval was seven days. Surface drip irrigation system consists of an irrigation pump connected to sand and screen filter and a hydraulic fertilizer injection pump was used. The actual water discharge rate was 8 L h⁻¹ along the drip lines. Weed control was carried out via application of a polyethylene transpiring mulch as this material has demonstrated a 100% efficiency in weed control among other tested mulches according to Hoeberechts *et al* (2004).

Harvesting and Drying

Two plants per plot were harvested on three dates in the experimental season, all aerial parts of the plants were cut 5 cm above ground and the following growth parameters were determined: plant height, fresh weight of leaves/plant and fresh weight of stem/plant. LAI was measured via destructive methods using a calliper. The same parameters were determined after drying plant material in dark storage rooms on specially designed shelves. This method of drying was chosen as it is the method most commercial growers in Greece actually use. The results of the final harvest (28/08/2016) are demonstrated in this paper.

Statistical analysis

All recorded values of this experiment were statistically analyzed using analysis of variance through the Genstat Program. Means were compared using revised L.S.D. test at 0.05 levels.

Results and discussion

Irrigation effect on plant growth parameters including LAI, plant height and dry leaf weight

Irrigation had a significant effect on dry leaf weight. The I3 treatment gave higher dry leaf yields in all nitrogen treatments (0.50, 0.77, 1.21 t ha⁻¹ for nitrogen treatments N0, N50 and N100 respectively) compared to lower volume of irrigation as it is apparent in Figure 3.

The same significant effect appeared in LAI measurements and the means were 0.3, 0.51 and 0.84 for nitrogen treatments N0, N50 and N100 respectively (Figure 1). Irrigation had no significant effect on plant height, although plant height trended to higher values as water volume increased (Figure 2).

Nitrogen effect on plant growth parameters including LAI, plant height and dry leaf weight

Nitrogen had a highly significant effect on dry leaf weight ($F_{\text{prob}} < 0.001$). The N100 treatment gave higher dry leaf yields in all irrigation treatments (0.84, 0.93, 1.21 t ha⁻¹ for irrigation treatments I1, I2 and I3 respectively) compared to lower levels of nitrogen per hectare as it is apparent in Figure 3. The same highly significant effect was witnessed in LAI measurements and the means were 0.64, 0.67 and 0.84 for irrigation treatments I1, I2 and I3 respectively (Figure 1). Nitrogen fertilization had no significant effect on plant height, although plant height trended to higher values as nitrogen per hectare increased (Figure 2).

The LSD test demonstrated that the I3N100 combination differed than the rest regarding LAI while treatment combinations I1N100, I2N100 and I3N100 were different than the rest when it came to dry leaf yield (t ha⁻¹).

Figure 3. Leaf area index (LAI) of plants, primarily grouped by irrigation level and secondly by nitrogen level.

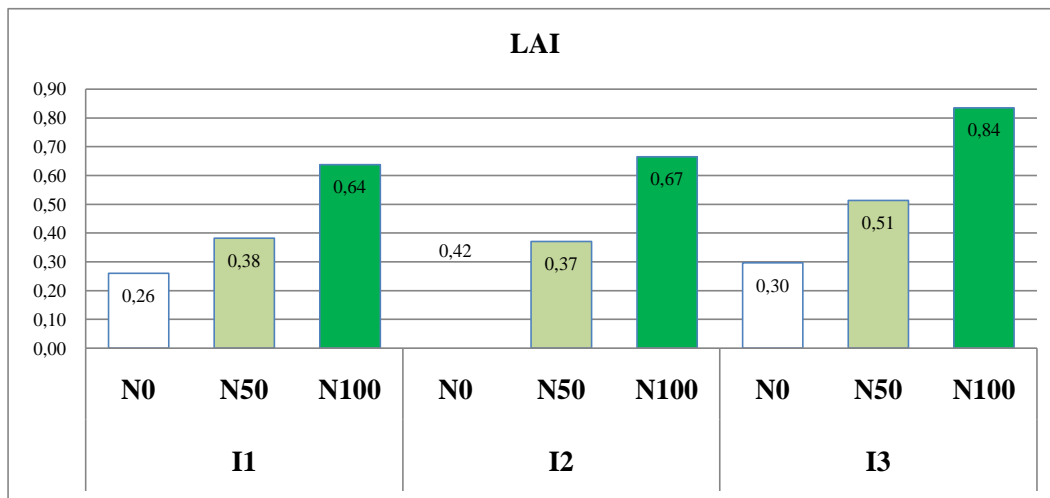

Figure 4. Plant height (cm) of plants, primarily grouped by irrigation level and secondly by nitrogen levels.

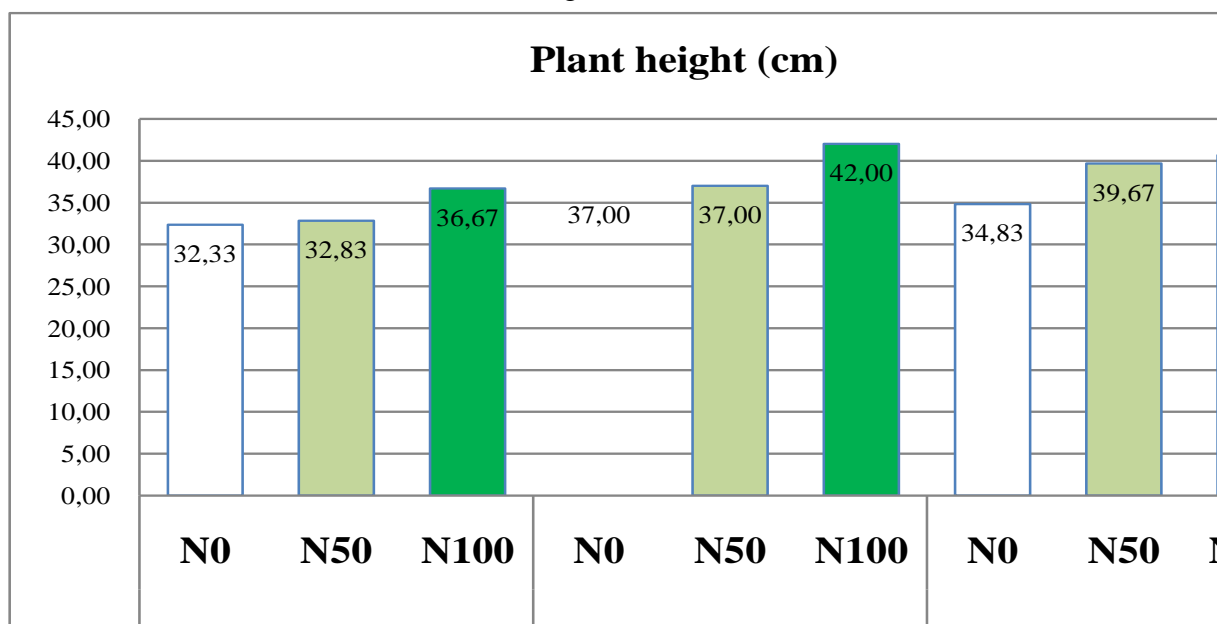

Figure 5. Dry leaf yield ($t\ ha^{-1}$) of plants, primarily grouped by irrigation level and secondly by nitrogen level.

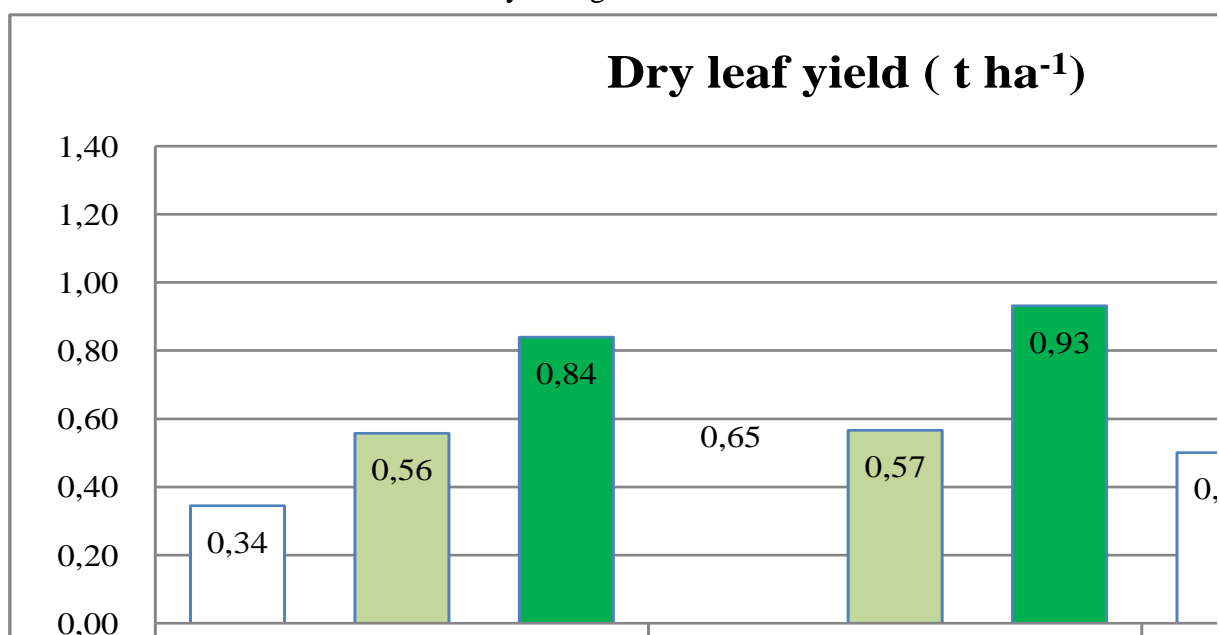

Table 2. Means of vegetative growth data of rosemary as affected by different water regimes and nitrogen fertilization level at the end of the experimental season.

Irrigation level	Nitrogen level	Plant height (cm)	LAI (Leaf Area Index)	Dry leaf yield ($t\ Ha^{-1}$)
0%	N0	32,33a	0,26a	0,360a
	N50	32,83a	0,38b,c	0,557a
	N100	36,67a	0,63e	0,840b,c
50%	N0	37a	0,41c	0,654b
	N50	37a	0,37b,c	0,5670a
	N100	42a	0,66e	1,01c
100%	N0	34,83a	0,29a,b,c	0,501a
	N50	39,67a	0,51d	0,773b
	N100	40,67a	0,83f	1,21c

Means followed by different letters were significantly different according to revised L.S.D. test at 0.05 level.

Conclusion

During the first year of the crop's establishment, irrigation and nitrogen's paramount effects were demonstrated. Future experiments for consecutive growing seasons and in different soil types are recommended in order to assess the prospects of rosemary cultivation in Greece and the possible financial interest of the crop. As water becomes scarce in the Mediterranean and nitrogen fertilization is always a cost for producers, these inputs should be carefully calculated in terms of sustainability and cost efficiency. As soil erosion continues to be a problem in Greece (Kosmas et al, 2001), perennial crops like rosemary make suitable candidates for the eradication of the problem.

References

- Abedi, T. and Pakniyat, H. (2010). Antioxidant Enzyme Changes in Response to Drought Stress in Ten Cultivars of Oilseed Rape (*Brassica napus* L.). *Czech J. Genet. Plant Breed.*, 46(1): 27-34.
- Bolens M. H. (1985). The Essential Oil from *Rosmarinus officinalis* L., *Perfum. Flav.* 10, 21-37.
- Kosmas, C., Danalatos N., Kosmopoulou P. (2001). Soil erosion in Greece. In: Boardman, J. & J. Poesen (Eds), *Soil erosion in Europe*. J. Wiley & Sons Ltd., London.
- Duppong, L. M., Delate, K., Liebman, M., Horton, R., Romero, F., Kraus, G., Petrich, J., Chowdbury, P. K. (2004). The Effect of Natural Mulches on Crop Performance, Weed Suppression and Biochemical Constituents of Catnip and St. John's Wort. *Crop Science*, 44(3), 861–869.
- Farooqi, A.A. and Sreeramulu, B.S., (2001), *Cultivation of Medicinal and Aromatic Crops*, University Press (India) Ltd., Hyderabad, India.
- Hoeberechts, J., Nicola, S. and Fontana, E. (2004). Growth of lavender (*Lavandula officinalis*) and rosemary (*Rosmarinus officinalis*) in response to different mulches. *Acta Hort.* 629, 245-251.
- Kandeel A.M. (2001). Effect of irrigation intervals on the growth and active ingredients of *Rosmarinus officinalis* L. plants. *Arab Univ. J. Agric. Sci.*, 9(2), 825–38.
- Mahal S.S, Sidhu A.S. (2006). Effect of different irrigation schedules and nitrogen levels on growth yield attributes and seed yield of hybrid canola (*Brassica napus* L.) *Environ. Ecol.*, 24S (4), 1108–1111.
- Milia M., Pinna M.E., Satta M., Scarpa G.M. (1996). Preliminary examinations of agronomic aspects in *Rosmarinus officinalis* L., Seminario Internazionale di Chiusura del Progetto PIM Sardegna, Cagliari, 18–19 Nov, 1994. *Rivista Italiana EPPOS*(19), 125–30.
- Puttanna K., Prakasa Rao E. V. S., Singh R., Ramesh S. (2010). Influence of Nitrogen and Potassium Fertilization on Yield and Quality of Rosemary in Relation to Harvest Number. *Communications in Soil Science and Plant Analysis* Vol. 41(2).
- Singh K.K, Goswami T.K (2000). Thermal properties of cumin seed, *Journal of Food Engineering*, 45(4), 181-187.
- Singh M. (2013). Influence of organic mulching and nitrogen application on essential oil yield and nitrogen use efficiency of rosemary (*Rosmarinus officinalis* L.), *Archives of Agronomy and Soil Science*, 59(2), 273-279.
- Singh M., Wasnik K. (2013). Effect of Vermicompost and Chemical Fertilizer on Growth, Herb, Oil Yield, Nutrient Uptake, Soil Fertility, and Oil Quality of Rosemary, *Communications in Soil Science and Plant Analysis*, 44(18), 2691-2700.
- Vasunhara M., Khan M.M., Farooqi A.A., Nuthan D. (2002), Effect of drip fertigation on yield and cost economics in rosemary (*R. officinalis* L.). *Indian Perfumer*, 46(2), 179–90.

PRESENT AND FUTURE EFFECTS OF CO₂ ON VARIOUS FIELD CROPS: A GENERAL EVALUATION

Hakan ULUKAN*

¹Department of Field Crops, University of Ankara, Faculty of Agriculture, Ankara, Turkey

*Corresponding author: ulukan@ankara.edu.tr

Abstract

It was generally examined and been informed the present and future effects of carbon dioxide (CO₂) on field crops which were grown on the earth as morphologically, physiologically, agriculturally, etc. in this poster presentation. As known, agricultural sector is very sensitive to the global warming effects on field crops. Almost in each country, agriculture is the second or first largest direct or indirect contributor for the global warming. Especially, this phenomenon contributes to unwanted effect(s) through the emission of carbon dioxide (CO₂), methane (CH₄), nitrous oxide (N₂O), chlorofluorocarbons (CFCs), etc. Especially, from them CH₄ has the highest global warming potential that is about 300 times than the potential of CO₂, and about 20 times than that of the N₂O. It was found that the average temperature of the Earth would be rise up to (1.4–5.8 °C) by the 2100, and some agricultural practices (poly, mono and mixed cropping) and ecosystems (such as agro-forestry, agro-silvo-pastoral systems, landscape, aquaculture, rangelands, wetlands, fallows, etc.) will be affect at different levels. It was verified by the satellite images, increasing in the CO₂ concentration (Its level in March 2016 is 404.83 ppm) will make accelerate plant growth, increase of water use efficiency (WUE) and physiological/metabolic activity (ies), reduce the grain filling period, nutrient efficiency, incubation and flowering periods. The purpose of this paper is to give some important, valuable and practical information(s) on the present and future effects of carbon dioxide (CO₂) on various field crops.

Keywords: *Global Warming, CO₂, Field Crops, Water Use Efficiency.*

Introduction

Increase in the CO₂ concentrations will be profound effects on the various field crops growth and productivity (Reddy et al. 2010). It is expected to reach 550 ppm by 2050 according to IPCC, and a 75 % increase from 315 ppm measures in 1960 (Tausz et al. 2013), however and its (present) level is 407.40 ppm in 11 June 2016 (Anonymous, 2015a, 2015b).

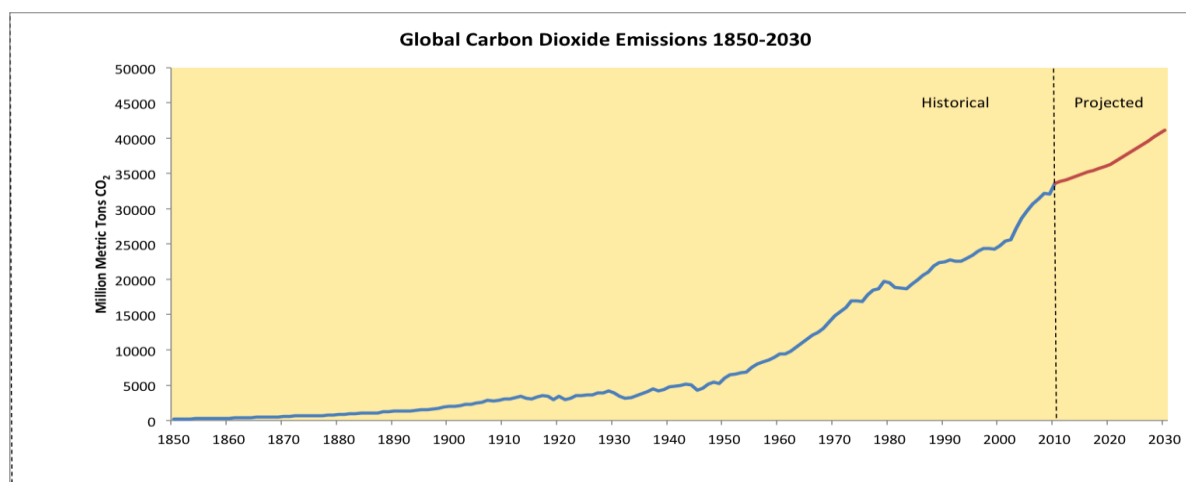

Figure 1. Global CO₂ emissions trend between 1850 and 2030 years (Anonymous, 2015c)

Plants are grouped into (3) classes as C₃ (e.g. wheat (*Triticum* spp.), rice (*Oryza* spp.), soybean (*Glycine* spp.), potato (*Solanum* spp.)), C₄ (maize (*Zea mays* L.), sorghum, sugarcane (*Saccharum* spp.), trees, grain legumes, rice, potato, vegetables, millet, soybean) and CAM (e.g. pineapple (*Ananas comosus* (L.) Merr., Papaya (*Carica papaya* L.) according to their stable carbon isotopes' number at the end of photosynthesis. With the C₃ photosynthetic pathway, they often exhibit greater growth response relative to those with a C₄ (Prior et al. 2013). So, their reaction(s) differ from each other to the elevated CO₂. The C₃ plants under the elevated CO₂ have indicated photosynthetic acclimation, which might be due to soil and nutrient limitation associated with reduced root volume, some showed also significant increases in light-saturated rates of photosynthesis in the several C₃ plants. They have a lower water usage efficiency (*the WUE*) compared with the other C₄ field crops (Fuhrer, 2009). Under the elevated CO₂, it is exclusively assimilated and enhances growth 33% to 40% in the C₃ plants, but 10% to 15% increase in the C₄ plants (Tausz et al. 2013). The CAM and the C₄ plants use a series of enzymes that initially combine of the CO₂ (DaMatta et al. 2009), (*Crassulacean Acid Metabolism*) plants. They (The CAM plants) are inherently high in *the WUE*, due to their ability to open their stomata at night to take into the CO₂ (Ulukan, 2008).

Material and methods

Increasing in the CO₂ concentration can have a positive impact/s on yield by stimulating their photosynthesis and reducing of water losing via respiration. Since, this kind of the CO₂ acceleration role on yield level (*CO₂ fertilization*) is a strong effect esp. in the grain legumes and the C₃ plants (Zhai and Zhuang, 2009), but the *WUE* decreases when the CO₂ concentration increases (Dhakhawa and Campbell, 1998). The C₄ plants had higher *the WUE* than the C₃ plants due to their convertibility *of the WUEs'* for the photosynthetic components in the plants and it is (nearly) two times higher than that of the C₃'s (Zhengbin et al. 2011). Studies showed that the CO₂ concentration increasing would have dramatic effects/results on the growth and development of various field crops (Romanova, 2005) in present, in future for *the WUE* esp. in the pulse crops (legumes) (Cutforth et al. 2007)). Studies have showed that the sensitivity of C₃ photosynthesis to temperature declines as plants become limited by the CO₂, much like the patterns exhibited by the C₄ plants (Ward et al. 2009). Gas accelerates the photosynthesis and its concentration is increasing, the productivity of C₃ plants do not drop (generally) in contrast increase by 36% (Uzmen, 2007), compared with 35-80% in the grain legumes (Ziska et al. 2001). Similarly, according to satellite imaginaries there will be shift for the harvest and threshing dates between five days and three weeks (Cutforth et al. 2007).

Results and Discussion

The future (elevated) CO₂ effect/s on various field crops will be/can be mentioned generally as follow(s) (Anonymous, 2010): *i*) Due to level of the CO₂ extreme meteorological events such as droughts, floods, hurricane, etc. will be/can be happen; *ii*) Because of them, crop production or agricultural production etc. will be/can be affected negatively; *iii*) Quality and quantity of the products, and its price will be/can be also negatively affected; *iv*) hungry, diseases, water scarcely, forest fire(s), etc. will be/can be burst at different level; *v*) phenological changes/lateness up to 4 or more weeks can be emerged in root ad tuber crops; *vi*) morphological deformations/disorders will be/can be seen on esp. roots (e.g. sugar beet) as discoloration and photosynthesis area losing; *vii*) With the interaction other meteorological, andropogenic and ecological parameters all possible hazards will be/can be arisen.

Table 1. Effect of elevated CO₂ to various field crops agronomical, botanical traits (Modified and adapted from Krupa, 1997; Peet and 1997; Dhakhawa and Campbell, 1998; Tubiello and Ewert, 2002).

Trait	Elevated CO₂
Photosynthesis	Increase in the C ₃ up to 100%; less happens or not in the C ₄
<i>Inhibition of photosynthesis by source-sink imbalance</i>	<i>Response occurs in many species.</i>
Leaf Area and conductance	Decrease in the C ₃ and the C ₄ but the C ₄ responds more
<i>Leaf photosynthetic rates</i>	<i>Increase in all plants on first exposure, the C₃ respond more than the C₄, little responses above 1000 ppm, and levels above 2000 ppm may be toxic.</i>
Leaf Anatomical and Biochemical Adaptation	Leaf area, weight per unit area, thickness, and number of mesophyll cell layers in many species
<i>Leaf Thickness</i>	<i>Increase</i>
Canopy Leaf Area	Usually increases
<i>Branching, Flowering and Fruiting</i>	<i>Initiation and/or retention of these organs is increased in many species</i>
Maturity	Increase happens early
<i>Flowering</i>	<i>There is a big difference in the C₃ and the C₄</i>
Fruit and seed	Increases in number and/or size fruits and seeds
<i>Dry Matter Prod. & Yield</i>	<i>Doubled (almost) in the C₃ but it is unclear in the C₄ Increases 32% on average between 300 and 600 ppm for plants in favorable conditions.</i>
WUE	Increase in the C ₃ and the C ₄ more in the C ₃
<i>Species and Cultivars</i>	<i>Different</i>
Susceptibility	Different
<i>Susc. to Drought Stress</i>	<i>Different</i>

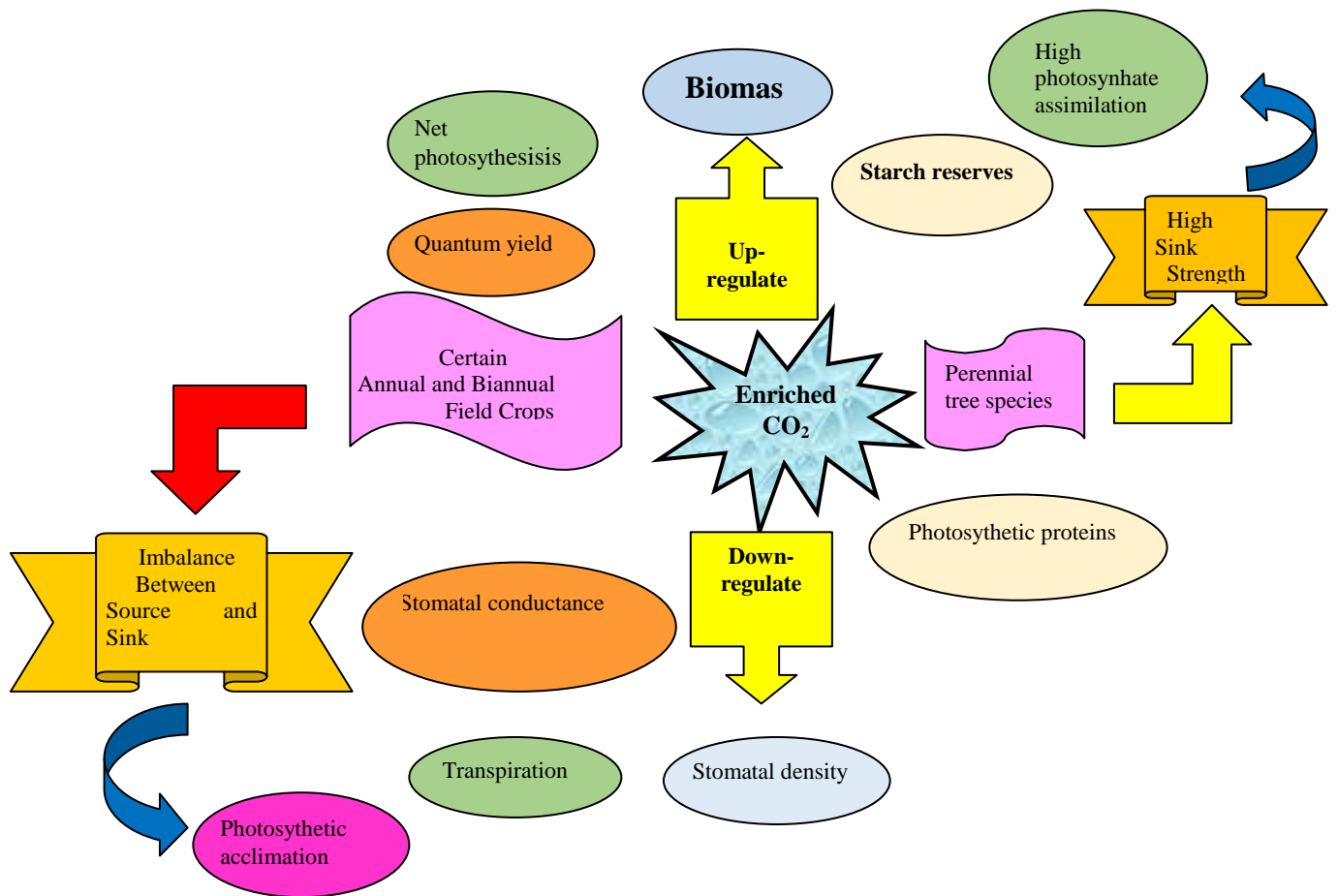

Figure 2. Schematic (biochemical) representation of the effects of elevated CO₂ on the various field crops' at biochemical level (Reddy et al. 2010).

High concentrations of CO₂ produces some morphological effects on growth such as increasing in the rate of photosynthesis, and in branching of both woody and herbaceous plants, greater stem elongation, in root/shoot (Peet and Krizek, 1997). For instances, it was seen elevated increasing the tuber formation in potatoes (*Solanum tuberosum* L.), recorded that stomatal conductivity trait is clearly reduce in corn (*Zea mays* L.) and bean (*Vicia faba* L.), but not in sunflower (*Helianthus annuus* L.).

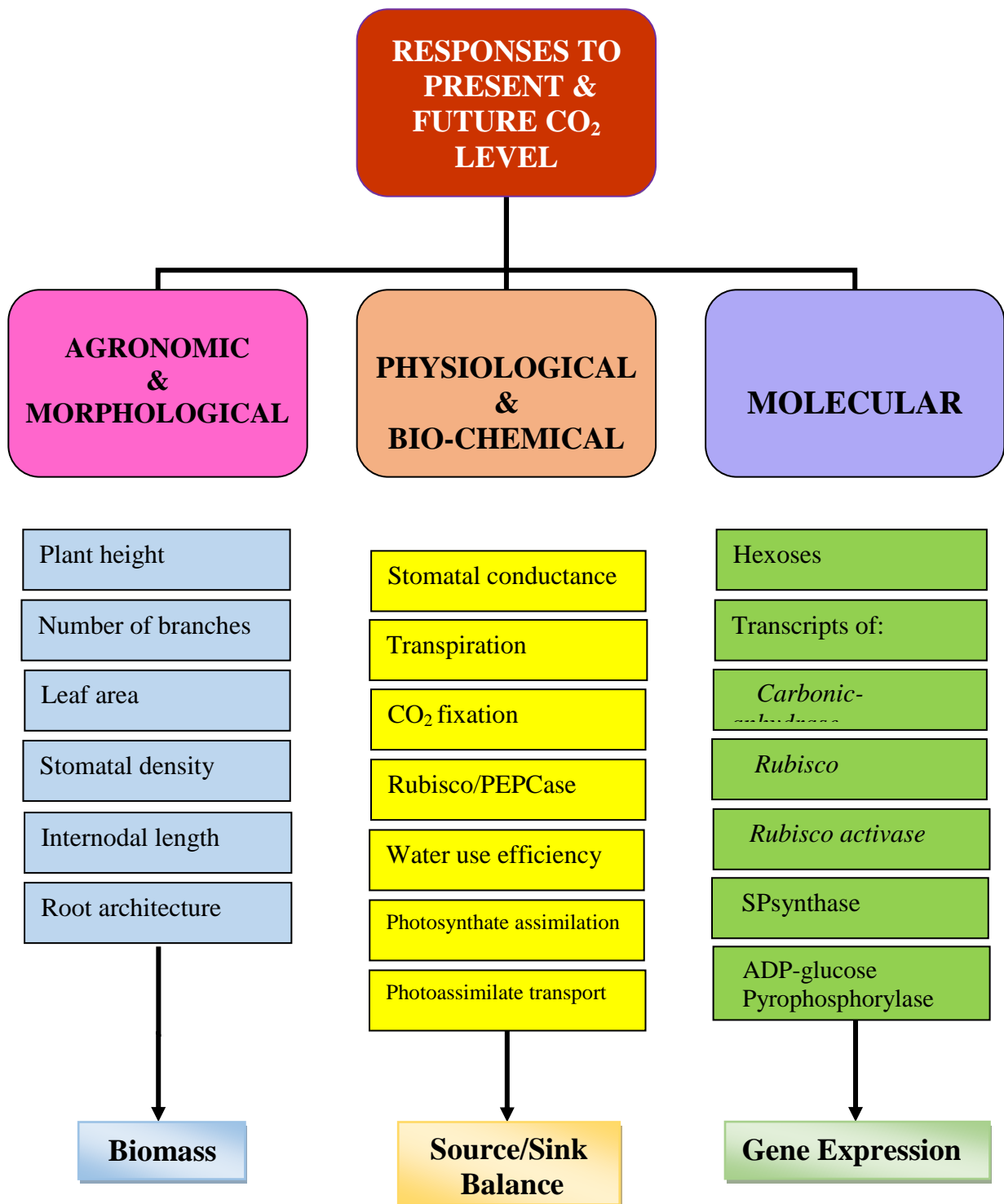

Figure 3. Agronomic & Morphological, Physiological & Bio-Chemical and Molecular Responses of the various field crops' at the present & future CO₂ level (Adapted from Reddy et al. 2010).

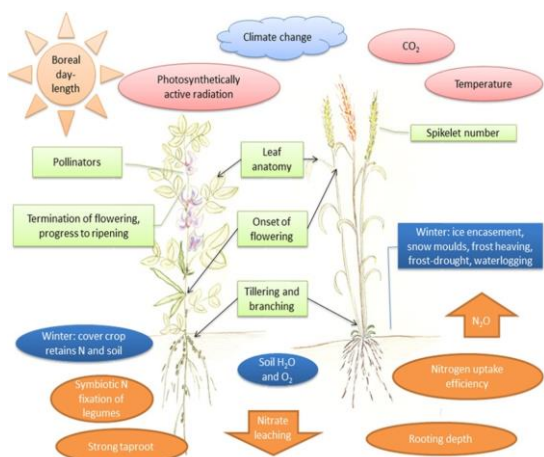

Figure 4. CO₂ effect of various field crops yield and yield components as a biological solutions cycle (Adapted from Frederick et al. 2011)

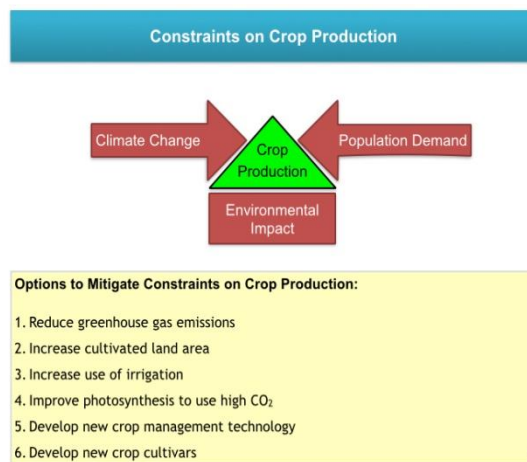

Figure 5. CO₂ effect to crop production and possible (From Anonymous, 2015d)

Conclusion

Elevated CO₂'s, level of its increasing, present effects are getting sensed itself by various signs by anybody and in the future, it will be very sharp according to level of the elevated CO₂. In terms of the elevated CO₂ effect to the various field crops', due to belonging to the C₃, C₄ or CAM, responses will be different. But in any case, not only solely but also with other climatic factors such as (mainly) temperature, precipitation, *the WUE*, etc. morphologically, plant height (and yield (dry matter) components esp. such as number of branches, leaf area, stomatal density, roots (fibrous) some differences are seen. Especially these formations are very clear in industrial crops. Physiologically and biochemically changes are majority linked with the microscopic structure of the leaf that called "*stomata*". Esp. stomatal density, environmental temperature and hormonal/enzyme equilibrium (For ABA, Rubisco, etc.) is a very crucial. Additionally, molecular changes (gene expression) involved; but, details are not known clearly as today.

References

- Anonymous, 2010. Issue brief: Climate change: Impacts on global agriculture, WMO, FIPA, IFAP, the farmers' voice at the world level, pp. 1–6.
- Anonymous, 2015a. Earth' CO₂ Home page, <https://www.co2.earth/> (Access date: 08.05.2015)
- Anonymous, 2015b. National Oceanic and Atmospheric Administration, <https://www.noaa.gov/> (Access date: 08.05.2015)
- Anonymous, 2015c. C2ES, Center for climate and energy solutions, International Emissions, <http://www.c2es.org/facts-figures/> (Access date: 18.05.2016)
- Anonymous, 2015d. Options to mitigate the effects of climate change on crop production. <https://www.linkedin.com/pulse/20141106155943-143081770-options-to-mitigate-the-effects-of-climate-change-on-crop-production/> (Access date 18.05.2016)
- Cutforth, H.W., McGinn, S.M., McPhee, E. and Miller, P.R. 2007. Adaptation of pulse crops to the changing climate of the northern great plains, *Agronomy Journal*, 99: 1684–1699.
- DaMatta, F.M., Grandis, A., Arenque, B.C., Buckeridge, M.S. 2009. Impacts of climate changes on crop physiology and food quality, *Food Research Intl*, DOI: 0.1016/j.foodres.2009.11.001.
- Dhakhawa, G.B. and Campbell, C.L. 1998. Potential effects of differential day-night warming in global climate change on crop production, *Climate Change*, 40: 647–667.

- Frederick, L.S., Pirjo, Mäkelä, S.A., Puhakainen, T. 2011. Adaptation of boreal field crop production to climate change, climate change-research and technology for adaptation and mitigation, Dr. Juan Blanco (Ed.), InTech, DOI: 10.5772/25258. Available from: <http://www.intechopen.com/books/climate-change-research-and-technology-for-adaptation-and-mitigation/adaptation-of-boreal-field-crop-production-to-climate-change>
- Fuhrer, J. 2009. Climate change—risks and opportunities for agriculture, 1st Int. Congress on Global Climate Change and Agriculture, May 28-30, Tekirdağ, Türkiye, 81–87.
- Krupa, S.V. 1997. Global climate change: Processes and products-An overview, *Environmental Monitoring and Assessment*, 46: 73–88.
- Peet, M.M. and Krizek, D.T. 1997. Carbon dioxide. In: *Plant Growth Chamber Handbook*, Langhans R.W. and Tibbits, T.W. (eds.), North Cereal Regional Research Publication, No 340, Iowa State Agr. & Home Econ. Exp. Stat. Rpt. No 99, Ames. pp. 65-79.
- Prior, S.A., Runion, G.B., Marble, S.C., Rogers, H.H., Gilliam, C.H., Torbert, H.A. 2013. A review of elevated CO₂ effects on plant growth and water relations: Implications for horticulture, *Hortscience* 46(2): 158–162.
- Reddy, A.R., Rasineni, G.K., Raghavendra, A.S. 2010. The impact of global elevated CO₂ concentration on Photosynthesis and plant productivity, *Current Science*, 99 (1–10): 46-57.
- Romanova, A.K. 2005. Physiological and biochemical aspects and molecular mechanisms of plant adaptation to the elevated concentration of CO₂. *Russian Journal of Plant Physiology*, 52: 112–126.
- Tubiello, F.N. and Ewert, F. 2002. Simulating the effects of elevated CO₂ on crops: Approaches and applications for climate change, *European Journal of Agronomy*, 18: 57–74.
- Tausz, M., Tausz-Posch, S., Norton, R.M., Fitzgerald, G.J., Nicholas, M.E., Seneweera, S. 2013. Understanding crop physiology to select breeding targets and improve crop management under increasing atmospheric CO₂ concentrations, *Environmental and Experimental Botany*, 88: 71–80
- Ulukan, H. 2008. Agronomic adaptation of some field crops: A general approach, *Journal of Agronomy and Crop Science*, 194: 169–179.
- Uzmen, R. 2007. Global warming and climate changing, Is it a catastrophe for the humanity? *Knowledge and Culture Publ.*, No 221, Ankara, Turkey, pp. 176 [in Turkish]
- Ward, J.K., Uzun, B., Pascoal, C., Cassio, F. 2009. Responses of aquatic fungal communities on leaf litter to temperature-change events, *International Review of Hydrobiology*, 94: 410–418.
- Zhai, F., and Zhuang, J. 2009. Agricultural impact of climate change: A general equilibrium analysis with special reference to Southeast Asia. ADBI Working Paper 131. Tokyo: Asian Development Bank Institute. 21pg.
- Zhengbin, Z, Ping, X., Hongbo, S., Mengjun, L., Zhenyan, F., Liye, C. 2011. Advances and prospects: biotechnologically improving crop water use efficiency, *Critical Reviews in Biotechnology*, 31(3): 281–293.
- Ziska, L.H., Bunce, J.A., Caulfield, F.A. 2001. Rising atmospheric carbon dioxide and seed yield of soybean genotypes, *Crop Science*, 41: 385–391.

GROWTH AND PRODUCTIVITY OF LEMON VERBENA (*Aloysia triphylla* L.) AS AFFECTED BY NITROGEN FERTILIZATION IN CENTRAL GREECE: FIRST YEAR (ESTABLISHMENT) RESULTS

Konstantinos MARTINOS*, Elpiniki SKOUFOGIANNI, Nicholas G. DANALATOS

Laboratory of Agronomy and Applied Crop Physiology, Department of Agriculture, Crop Production and Rural Environment, University of Thessaly, Volos, Greece

*Corresponding author: kmartinos@agr.uth.gr

Abstract

Lemon verbena is an aromatic perennial shrub that is valued for its medicinal use as a digestive aid, antimicrobial, antispasmodic, analgesic, diuretic herb and it is also used as a treatment for cold, insomnia and anxiety. The first-year of a lemon verbena (*Aloysia triphylla* L.) crop's growth and productivity as affected by irrigation was investigated under field conditions in central Greece. During the spring of 2015, winter cuttings of lemon verbena were transplanted to an experimental field set up in Nea Aghialos, Magnesia, central Greece. The experimental design was a completely randomized design with three nitrogen dressings (0, 50, 100, kg N ha⁻¹) in four replications. The growth and final productivity of the crop was measured in three destructive samplings of the crop during the summer of 2015. The results demonstrated that nitrogen fertilization played a significant role on lemon verbena productivity and the final yield of the crop in the first year of crop establishment.

Keywords: *lemon verbena, fertilization, growth, nitrogen, evapotranspiration.*

Introduction

Lemon verbena, (syn.: *Aloysia citriodora* A. *citrodora* Palau, *A. triphylla*, *Lippia citriodora* L. *triphylla*) is an evergreen perennial aromatic plant. It likes warm moist conditions with plenty of sunlight. When exposed to frost, it becomes deciduous. belongs to the Verbenaceae family. The genus *Lippia* (Verbenaceae) brings together about 200 species and lemon verbena is native in Latin America as well as North Africa (Morocco), and was introduced to Europe during the 17th century (Carnat et al., 1999; Botta, 1979; Rotman and Mulgura Romero, 1999). Lemon verbena is an aromatic perennial shrub that is valued for its medicinal use (as a tea or tincture) as a digestive aid, antimicrobial, antispasmodic, analgesic, diuretic plant; besides, it is used as a treatment for cold, insomnia and anxiety (Botta, 1979; Carnat et al., 1999; Rotman and Mulgura Romero, 1999). Antioxidant and antibacterial qualities of *Aloysia citriodora* have been found in its essential oil, tea and tincture (Bilia et al., 2008; Cowan, 1999; Pereira and Meireles, 2007; Ohno et al., 2003; Sartoratto et al., 2004). This aromatic plant has a widespread market in the western world (Di Leo Lira, et al., 2013), its compounds have widespread uses in foods, cosmetics and household products (Catalan and Lampasona, 2002; Santos-Gomes et al., 2005). The essential oil contained in the plant and its leaves are used in the perfume industry and the production of flavored beverages and food preparations (Pascual et al., 2001). In the United States, lemon verbena is listed in Generally Regarded As Safe (GRAS) for human consumption in alcoholic beverages (Gomes et al 2006). Whereas very low researches have been applied on enhancement of medicinal plants production, presenting the appropriate planting methods is very important for increasing the quantity and quality of medicinal plants (Farooqi and Sreeramulu, 2001). The purpose of trading production of medicinal plants is obtaining further amount of biomass in area (Nematian et al., 2014). In view of the commercial value of lemon verbena, and considering that plants can display significant genetic biodiversity and variations due to differences in soil or climatic

conditions of their habitat (Molina et al.,2003), it is very important that these factors are studied and somehow controlled to ensure better yields.

The purpose of this study was to evaluate the effect of nitrogen fertilization on the growth parameters of a lemon verbena crop.

Materials and methods

Crop establishment

The experiment was set up in the rural area of Nea Aghialos in Central Greece (39°16'02.3"N 22°47'47.5"E) on May 5, 2015. The soil of the experimental plots was a sandy loam one with a pH of 6.8 and an organic carbon (C) of 1.5 g kg⁻¹. Lemon verbena cuttings (40 days old) were obtained from a local nursery. The soil was prepared and divided into plots; each of them was 4,2 m \times 2,4 m and contained three drip rows. The cuttings were transplanted on May 5. Distance between plants and distance between rows were both 60 cm. Twelve plots containing a total of 216 plants were arranged in a completely randomized design with irrigation being the main factor and nitrogen fertilization the factor split into sub-plots. Each experimental unit consisted of three rows of plants, 0.6 m apart, with the two outer rows serving as buffers while plants were spaced at 60 cm apart.

Fertilization

Nitrogen dressings were manually applied in three levels: N0, N50 and N100 (0, 50 and 100 kg ha⁻¹ respectively) in the form of a urea fertilizer on June 9 of 2015.

Irrigation

The amount of irrigation water was equal to 100% (562 mm) of the recorded evaporation values of a class-A pan. Another 110mm of rain fell during the months of the experiment. Irrigation water was applied by drip irrigation system and the irrigation interval was seven days. Surface drip irrigation system consists of an irrigation pump connected to sand and screen filter and a hydraulic fertilizer injection pump was used. The actual water discharge rate was 8 L h⁻¹ along the drip lines. Weed control was carried out via application of a polyethylene transpiring mulch as this material has demonstrated a 100% efficiency in weed control among other tested mulches according to Hoeberechts et al (2004).

Harvesting and Drying

Harvests (destructive samplings) were carried on transplant – May 5, June 29, July 29 and finally August 28. Two plants per plot were harvested and all aerial parts of the plants were cut 10 cm above ground and the following growth parameters were determined: plant height, fresh weight of leaves/plant and fresh weight of stem/plant. LAI was measured via destructive methods using a calliper. The same parameters were determined after drying plant material in dark storage rooms on specially designed shelves. This method of drying was chosen as it is the method most commercial growers in Greece actually use. The results of the three final harvests are demonstrated in this paper.

Statistical analysis

All recorded values of this experiment were statistically analyzed using analysis of variance through the Genstat Program. Means were compared using revised L.S.D. test at 0.05 levels. The first harvest was not subjected to analysis of variance because the date nitrogen application was too close to the harvest.

Results and discussion

During the second harvest (29/07/2015) LAI, dry leaf yield (t ha⁻¹) and dry stem yield (t ha⁻¹) were significantly affected by nitrogen fertilization level. LAI means were 0.85, 1.38 and 1.60 for treatments N0, N50 and N100 respectively. Dry stem yield means were 0.86, 0.98 and 2.27 t ha⁻¹ for treatments N0, N50 and N100 respectively while dry leaf yield means were

0.76, 1.18 and 1.63 t ha⁻¹ for treatments N0, N50 and N100 respectively. During the third and final harvest (28/08/2015) nitrogen fertilization significantly increased LAI and dry leaf yield (Figure 1, 2). LAI means were 1.13, 1.47, 2.08 and dry leaf yields were 1.16, 1.34 and 1.80 t ha⁻¹ for treatments N0, N50 and N100 respectively. Plant height remained unaffected by nitrogen fertilization during the experiment. The LSD test showed that dry leaf yields of treatment N100 differed greatly than the rest during the final harvest (Table 1).

Figure 1. LAI (leaf area index) means grouped by nitrogen level fertilization level during the experiment.

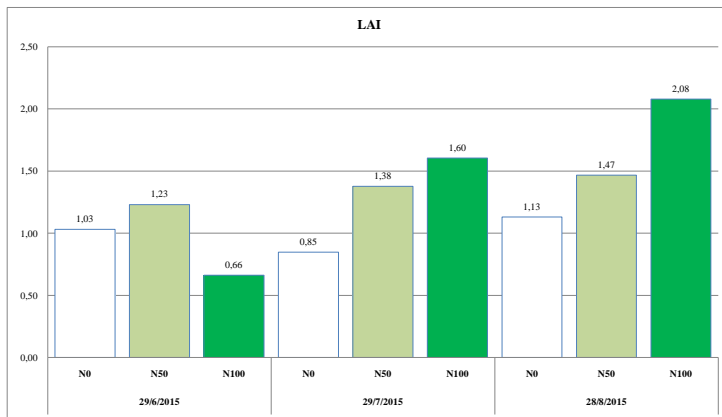

Figure 2. Dry leaf yield (t ha⁻¹) means grouped by nitrogen fertilization level during the experiment.

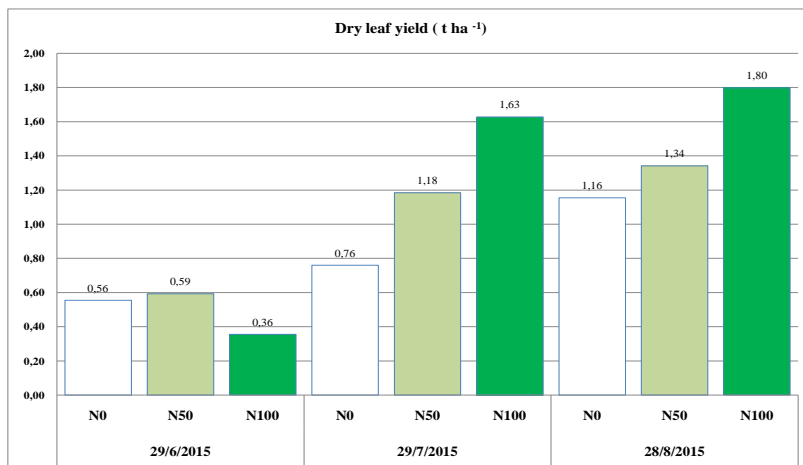

Table 1. Means of vegetative growth data of lemon verbena as affected by different nitrogen fertilization regimes and nitrogen during the experimental season.

Harvest date	Nitrogen treatment	Plant height (m)	LAI	Dry stem yield (t ha ⁻¹)	Dry leaf yield (t ha ⁻¹)
29/06/2015	N0	0,71	1,03	0,31	0,56
	N50	0,68	1,23	0,29	0,59
	N100	0,51	0,66	0,17	0,36
29/07/2015	N0	0,94a	0,85a	0,86a	0,76a
	N50	1,01a	1,38b	0,98a	1,18a
	N100	1,04a	1,60b	2,27b	1,63b
28/08/2015	N0	1,17a	1,13a	1,44a	1,16a
	N50	1,06a	1,47b	1,83a	1,34b
	N100	1,21a	2,08c	2,40a	1,80c

Means followed by different letters were significantly different according to revised L.S.D. test at 0.05 level.

Conclusion

During the first year of the crop's establishment nitrogen's paramount effects were demonstrated. Future experiments for consecutive growing seasons and in different soil types are recommended in order to assess the prospects of lemon verbena cultivation in Greece and the possible financial interest of the crop. As nitrogen pollution of underground water reserves has been prominent in the past years in Greece, this crop shows potential as it can prove lucrative with little nitrogen inputs when compared to other traditional crops of central Greece. Finally, soil erosion continues to be a problem in Greece (Kosmas et al, 2001), making perennial crops like lemon verbena a suitable candidate for the eradication of the problem.

References

- Bilia, A., Giomi, M., Innocenti, M., Gallori, S., & Vincieri, F. (2008). HPLC-DAD-ESI-MS analysis of the constituents of aqueous preparations of verbena and lemon verbena and evaluation of the antioxidant activity. *Journal of Pharmaceutical and Biomedical Analysis* (46), 463-470.
- Botta, S. (1979). Las especies argentinas del genero *Aloysia* (Argentine species of the genus *Aloysia*) (*Verbenaceae*). *Darwiniana* (22), 67-108.
- Carnat, A., Carnat, A., Fraisse, D., & Lamaison, J. L. (1999). The aromatic and polyphenolic composition of lemon verbena tea. *Fitoterapia* (70), 44-49.
- Catalan C.A.N., Lampasona P.D. (2002). The chemistry of the genus *Lippia* (*Verbenaceae*). In S.E. Kintzios, (ed.) *Oregano: The genera Origanum and Lippia*, Taylor and Francis; London, 127-149.

- Cowan, M. (1999). Plant products as antimicrobial agents. *Clinical Microbiology Reviews* (12), 564-582
- Kosmas, C., Danalatos N., Kosmopoulou P. (2001). Soil erosion in Greece. In: Boardman, J. & J. Poesen (Eds), *Soil erosion in Europe*. J. Wiley & Sons Ltd., London.
- Di Leo Lira, P., van Baren, C., Lopez, S., Molina, A., Heit, C., Vitturo, C., et al. (2013). Northwestern Argentina: a center of genetic diversity of lemon verbena (*Aloysia citriodora* PALÁU, Verbenaceae). *Chem Biodivers*, 2 (10), 251-261.
- E Molina Grima, E.-H Belarbi, F.G Acién Fernández, A Robles Medina, Yusuf Chisti, (2003). Recovery of microalgal biomass and metabolites: process options and economics, *Biotechnology Advances*, 20 (7–8), 491-515.
- Farooqi, A.A. and Sreeramulu, B.S., (2001), *Cultivation of Medicinal and Aromatic Crops*, University Press (India) Ltd., Hyderabad, India.
- Gomes, P., Oliveira, H., Vicente, A., & Ferreira, M. (2006). Production, transformation and essential oils composition of leaves and stems of lemon verbena [*Aloysia triphylla* (L'Herit.) Britton] grown in Portugal. *Rev. Bras. Pl. Med.* (8), 130-135.
- Hoeberechts, J., Nicola, S. and Fontana, E. (2004). Growth of lavender (*Lavandula officinalis*) and rosemary (*Rosmarinus officinalis*) in response to different mulches. *Acta Hort.* 629, 245-251.
- Molina G.E., Belarbi E.H., Acién Fernández F.G., Robles Medina A., Yusuf Chisti, (2003). Recovery of microalgal biomass and metabolites: process options and economics, *Biotechnology Advances*, 20 (7–8), 491-515.
- Nematian, A., Dalvandi, G., & Shariati, M. (2014). Effect of planting density and sowing date on the essential oil content and composition of lemon verbena (*Lippia citriodora*). *Int. J. Biosci.*, 2 (5), 56-63.
- Ohno, T., Kita, M., Yamaoka, Y., Imamura, S., Yamamoto, T., Mitsufuji, S., et al. (2003). Antimicrobial activity of essential oils against *Helicobacter pylori*. *Helicobacter* (8), 207-215.
- Pascual, M., Slowing, K., Caretero, E., Mara, K., & Villar, A. (2001). Lippia: Traditional uses, chemistry and pharmacology. A Review. *J. Ethnopharmacol* (76), 201-214.
- Pereira, C., & Meireles, M. (2007). Evaluation of global yield, composition, antioxidant activity and cost of manufacturing of extracts from lemon verbena (*Aloysia triphylla* [L'herit.] Britton) and mango (*Mangifera indica* L.) leaves. *Journal of Food Process Engineering* (30), 150-173.
- Rotman, A., & Mulgura de Romero, M. (1999). Verbenaceae. *Flora del Valle de Lerma* (5), 1-37.
- Santos-Gomes, P., Fernandes-Ferreira, M., & Vicente, A. (2005). Composition of the volatile oils from flowers and leaves of Vervain (*Aloysia triphylla* (L'Herit.) Britton) grown in Portugal. *J. Essent. Oil Res.* (17), 73-78.
- Sartoratto, A., Machado, A., Delarmelina, C., Figueira, G., Duarte, M., & Rehder, V. (2004). Composition and antimicrobial activity of essential oils from aromatic plants used in Brazil. *Brazilian Journal of Microbiology* (35), 275-280.

GROWING TRITICALE BIOMASS AT VARIOUS NITROGEN FERTILIZATION RATES AND HARVESTING PHASES

Hristina NEDEVA*, Hristina YANCHEVA, Radka IVANOVA

Department of Crop Science, Faculty of Agronomy, Agricultural University, Plovdiv, Bulgaria

*Corresponding author: h_nedeva@abv.bg

Abstract

The study was carried out in the field of Crop Science Department at the Agricultural University–Plovdiv, during the period 2013-2015. The experiment was set up following blok method with four replications, and 20m² for each experimental plot. That is why the purpose of our study was to determine the green biomass yield in the triticale varieties Musala and Attila which are grown under different nitrogen fertilizer rates (N₀; N₁₂₀; N₁₆₀; N₂₀₀; N₂₄₀). The varieties are harvested in heading stage and milk maturity stage and are grown in the region of Central South Bulgaria. During the first year of our experiment, in the two stages of the **harvesting** cultivar Musala and entered the coming later than the Atila. During the second year of the study, in the two stages of the **harvesting** cultivar Atila and entered the coming later than the cultivar Musala. During both years of the experiment, average over the study period in the two stages of the **harvesting** higher green biomass yield average for the two years was obtained at Attila variety in both **harvesting** stages. Depending on the nitrogen fertilizer rates, in both harvesting phases and two cultivars highest yield was obtained with nitrogen fertilization N₂₀₀. The higher rate among organs that form the plants at the coming to ear stage, followed by leaves and ears. At the milky ripeness stage, the share of stems and ears increases while the share of leaves decreases compared to the coming to ear stage. With increasing nitrogen fertilizer rate, the share of all studied indicators increases up to fertilizer rate N₂₀₀ and then drops at N₂₄₀.

Keywords: *triticale, variety, nitrogen fertilization, yield.*

Introduction

In recent years, with the decline of livestock farming in Bulgaria the interest in growing cereals for biomass is decreasing. Therefore, studies in this field are very limited.

The increasing shortage of fossil fuels on global scale leads to growing interest in green biomass as a possible source of renewable energy. Biomass from various crops is more and more used for the production of biogas. The use of renewable energy sources of vegetal origin helps to protect the world biosphere, to solve issues relating to global air pollution, to preserve the planet's biodiversity threatened by anthropogenic factors, and to decrease the dependence of individual countries on fuel import. In the practice, the most commonly used crop is corn followed by some cereals, including triticale. Most studies, both at global and national scale, show that triticale is a high-yield crop and exceeds the other cereals in terms of biomass yield as well as in dry mass (Yoshihira et al., 2000; Oettler et al., 2001; Motzo et al., 2001; Rosenberger et al., 2002; Dekić et al., 2013; Bassu et al., 2013). Todorov's studies (2009) have shown that biomass yield from triticale in Bulgaria exceeds by 20% to 30% that of rye. When harvested during the coming to ear stage, it gives between 5 and 6 tonnes of raw material, which is equal to 1000 to 1200 kg of dry mass.

Various methods to increase the quantity of biomass have been tested. Many authors have tried growing triticale at various fertilization rates and harvesting at different stages for green feed (Tosheva, 1994; Tonev, 1995; Jansone et al., 2011; Kirchev et al., 2013).

Lately there have been very few studies in the area. Therefore, we set ourselves the objective to establish which of the studied nitrogen fertilization rates and harvesting stages for the two new tested varieties led to higher yield of green biomass.

Material and methods

The experiment was set in 2013/2014 and 2014/2015 at the experimental facility of the Plant-growing department of the Agricultural University of Plovdiv, using the block method with test plots of 20 m² each, in 4 repetitions. Two varieties of triticale were tested: Musala, selected at the Institute for plant and genetic resources of Sadovo, and Attila, selected at the Institute for wheat and sunflower of General Toshevo. The crops were sowed after rape predecessor. The varieties have been grown at the following fertilization rates: N₀, N₁₂₀, N₁₆₀, N₂₀₀ and N₂₄₀/ha. Nitrogen fertilizers have been applied twice: once in the autumn during the soil preparation for sowing, and once in the spring, for nutrition, at first occasion. Green biomass yield was accounted for during the coming into ear and milky ripeness stages. We identified the stages of development of the two varieties and the following indicators: weight of the whole plant (g), weight of the stem of one plant (g), weight of the leaves of one plant (g), weight of the ears of one plant (g), and ratio of the organs – stems/leaves/ears of one plant (%). Statistical data processing was carried out in fourfold repetition. The experimental results were processed by one-way ANOVA, with the authenticity of differences was determined by Student's t criterion at the following levels according to: ns - no evidence of a difference; Gd = 5,0%; Gd = 1,0%; Gd = 0,1%.

Results and discussion

Data characterizing the monthly average air temperature and the precipitations over the periods 2013/2014 and 2014/2015 are shown in figures 1.

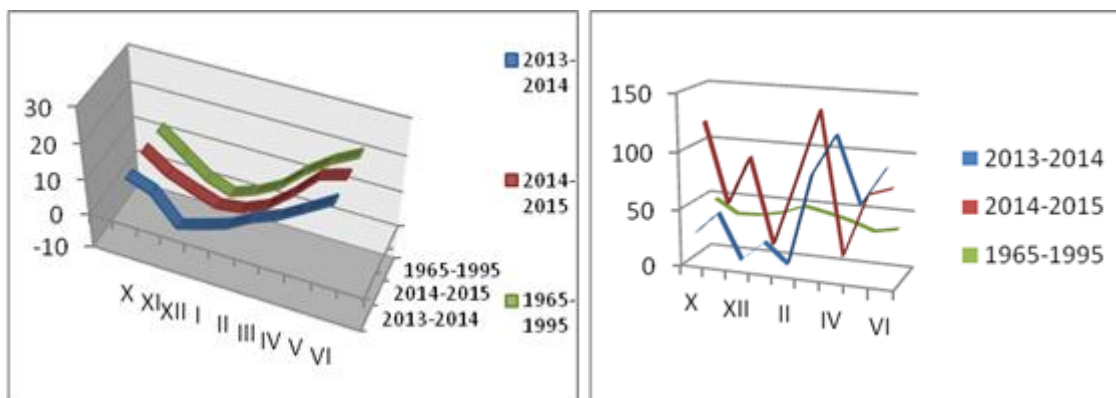

Fig 1. Average monthly temperatures / t⁰C/ and rainfall / mm/ for the region of Central South Bulgaria, from 2013/2014; 2014/2015 and multiannual period

They show that during the two years of the study significant deviations from the daily average temperature for Central South Bulgaria compared to the multiannual period were not observed. Relatively favourable daily average temperatures in the autumn and in the winter create conditions for optimal development of plants, their good tempering and successful overwintering. More important differences were observed in terms of precipitations during the two years of the experiment. The precipitations during the 2014/2015 (655.8 mm) significantly exceed both the precipitations during the former year (161.5 mm) and those of the multiannual period (236.8 mm). To the difference of the former year, the precipitations were evenly distributed over the whole period of vegetation. The total precipitation during the first year of the experiment (494.3 mm) is less than that of the second year but more than the

multiannual period. It should be noted that the distribution of precipitation was extremely uneven, especially with the large quantity (123.0 mm) in April. During both years of the experiment, the development stages in Central South Bulgaria occur at different times depending on the weather conditions and the specific features of tested varieties (Table 1).

Table 1. Phenological observations

Stages	Years			
	2013 /2014		2014/ 2015	
	Variety			
	Musala	Atila	Musala	Atila
Sowing	22.10.	22.10	16.10	16.10
Germination	31.10.	31.10	24.10	27.10
3 rd leaf stage	15.11.	15.11.	07.11	12.11.
Tillering	07.12.	07.12.	05.12	10.12.
Finish vegetation	14.12.	14.12	19.12	19.12.
Beginning vegetation	23.02.	23.02.	20.02.	20.02.
Stem elongation	23.03.	13.03.	25.03.	27.03.
Heading	25.04.	15.04.	27.04.	07.05.
Milk maturity stage	15.05.	29.04	11.05.	21.05.

Favourable weather conditions at the time of sowing during the two experimental years have secured quick germination of seeds (8 to 9 days). During the first year of our experiment, no genotypic differences between the tested varieties were observed up to the stage of stem elongation. All development stages occur simultaneously in the two tested varieties.

Genotypic differences in the development of these two varieties were only observed at the stem elongation stage when the weather factors such as temperature (6-7 °C) and precipitation (57.4 mm) were closer to the requirements of the Attila variety, which has been selected in Northern Bulgaria, i.e. in cooler and more humid climate. The increasing temperatures during the second and third 10-day period of March (11.5 °C and 10.7 °C) along with twice lower precipitations favour the development of the Musala variety and it enters the stem elongation stage just 10 days after the Attila variety. The high precipitation levels during the period of coming to ear and milky ripeness in Musala (157 mm) extended the period of coming to ear and milky ripeness and the variety enters these stages 10 and 14 days (25.04 and 15.05) later than the Attila (15.04 and 29.04 respectively).

During the second year of the study, higher daily average temperatures in November and December compared to the multiannual period created unfavourable conditions for the development of the Attila variety, which fell behind Musala by five days at the third leaf stage. 28 days later both varieties entered the tillering stage at which they overwintered.

During both years of the study, by mid-December with continuous drop of temperatures the crops suspended their vegetation.

Upon resuming vegetation (20.02.2015) the two varieties entered the stem elongation stage almost simultaneously. As a result of higher temperatures and absence of moisture in April, the Attila fell significantly behind in its development and entered the coming to ear stage 10 days later than the Musala. This trend remained unchanged over the following stage.

Biomass yield over the two years of the study, from the two varieties at different stages of harvesting and varying nitrogen fertilizer rates is shown in Table 2.

The results from our experiment show that depending on weather conditions biomass yield varies over the study years.

Table2. Yields green mass - kg/ha

Variants of fertilization kg/ha	Variety Musala							
	Heading maturity stage				Milk maturity stage			
	2014	2015	Average	%	2014	2015	Average	%
N ₀	20420 ^c	27580 ^e	24000	100	35000 ^d	37300 ^e	36150	100
N ₁₂₀	26720 ^b	33010 ^d	29870	124	35760 ^c	43780 ^c	39770	110
N ₁₆₀	26880 ^b	37710 ^b	32300	135	38260 ^b	44580 ^b	41420	115
N ₂₀₀	30200 ^a	38150 ^a	34180	138	38840 ^a	46350 ^a	42595	118
N ₂₄₀	26800 ^b	36330 ^c	31570	132	38230 ^b	42950 ^d	40590	112
	Variety Attila							
N ₀	29280 ^d	24780 ^e	27030	100	38110 ^e	33680 ^e	35895	100
N ₁₂₀	34340 ^c	31850 ^d	33100	122	41040 ^d	40710 ^d	40875	114
N ₁₆₀	37040 ^b	35550 ^b	36300	134	43420 ^b	41600 ^b	42510	118
N ₂₀₀	39150 ^a	36760 ^a	37970	140	46980 ^a	45720 ^a	46350	129
N ₂₄₀	36900 ^b	35400 ^c	36150	134	42220 ^c	40990 ^c	41605	116

*Values with the same letters do not differ significantly

During the first year of the experiment, biomass yield from the Attila exceeded that of the Musala. The reason for that are the drastic differences in precipitations during the period of coming to ear for the Musala. The high precipitation level of 121.5 mm during the period of coming to ear of the Musala (25.04.2014) beat down the plants and resulted in lower yield.

The precipitation had no negative impact on the biomass yield of the Attila as it came to ear (15.04.2014) earlier than the Musala.

During the second year of our experiment, as a result of the drought in April that covered the coming to ear stage for the crops the biomass yield from the Attila was lower than that of the Musala. In the Attila variety, the yield varied between 24780 kg/ha and 36760 kg/ha whereas for the Musala it varied between 27580 kg/ha and 38150 kg/ha respectively.

During this stage, the lowest biomass yield was obtained from implementations without fertilization. With increasing nitrogen fertilizers rates, both during the two years of study and as average for the period the biomass yield increased. The highest yield was obtained at nitrogen fertilizer rate of N₂₀₀ and at higher rates the yields decreased. The results from all implementations with fertilization and the control group have been mathematically proved. The results from all implementations have been proved by the N₂₀₀ implementation. At later growth stages the yield significantly increased. When harvested at the stages of coming to ear and milky ripeness during the first year of the experiment, the yield from the Attila variety (38110 kg/ha and 46980 kg/ha respectively) exceeded the yield from the Musala variety (35000 kg/ha and 38840 kg/ha respectively). As a result from higher temperatures and lower humidity during the milky ripeness stage in the second year, the Musala outdid the Attila in terms of productivity. The results from all implementations with fertilization and the control group have been mathematically proved. The results from all implementations have been proved by the N₂₀₀ implementation. At the coming to ear stage, the Musala exceeds the control by 24% in the N₁₂₀ implementation and up to 38% in the N₂₀₀ implementation while for the Attila these values vary between 22% and 40%. At the stage of milky ripeness, the Musala exceeds the control by between 10 and 18%, and the Attila by 14 to 29%.

Diagram 2 shows that stems have the higher rate among organs that form the plants at the coming to ear stage, followed by leaves and ears.

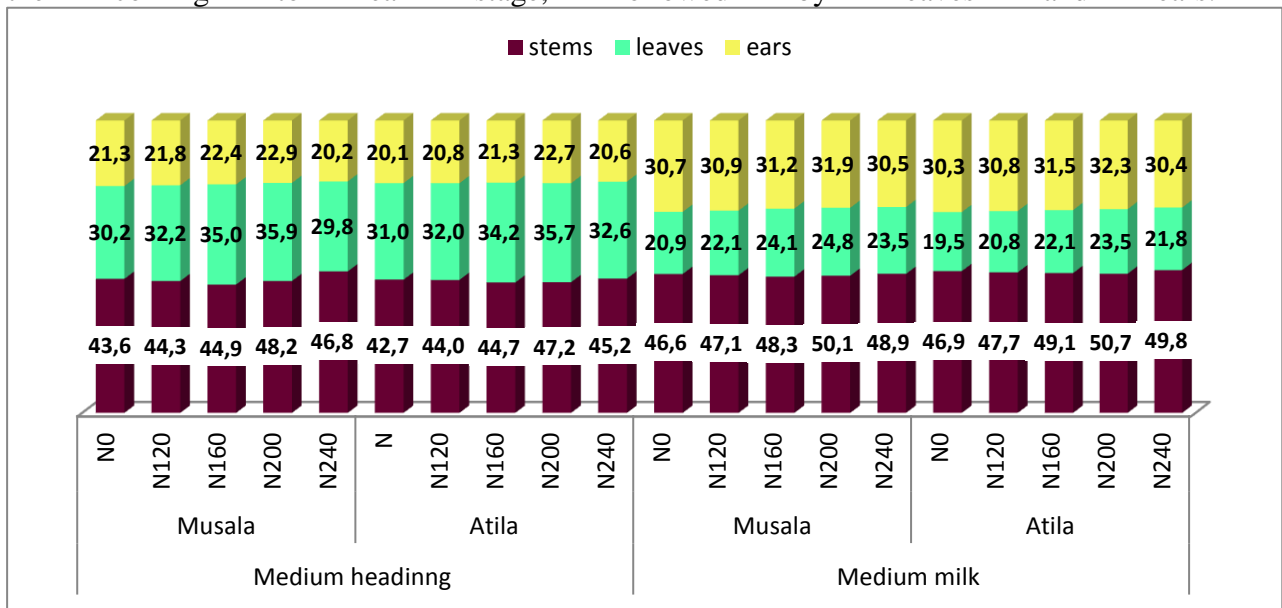

Fig2. Share of fresh biomass on triticale plant components, at different varieties of fertilization and heading and milk maturity stages

The percentage of stems from the total weight of the plant is the highest at the coming to ear stage. In average over the study period, the ratio of stems in the Musala variety (between 43.56% and 48.24%) exceeds that of the Attila variety (between 42.74% and 47.18%).

Leaves have a smaller share of the plant organs. The higher ratio of leaves in the Attila is due to the lower ratio of stems. The percentage of ears from the whole plant is the lowest with an average between 20.11% and 22.69% for the Attila and between 21.34% and 22.88% for the Musala variety over the whole period. With increasing nitrogen fertilizer rate, the share of all studied indicators increases up to fertilizer rate N₂₀₀ and then drops at N₂₄₀. At the milky ripeness stage, the share of stems and ears increases while the share of leaves decreases compared to the coming to ear stage, which is due to fading and drying of the lower leaves.

In average over the period of the study, the ratio of stems for the Attila variety (between 46.88% and 50.68%) is a little bit higher than the ratio for the Musala variety (between 46.64% and 50.12%). The trend is inversed for leaves which have the lowest share during the milky ripeness stage. At that stage, ears have a higher ratio than leaves. The percentage is similar in both varieties with Musala slightly prevailing. In terms of fertilization rates, the trend remains the same as during the coming to ear stage.

Conclusions

During the first year of our experiment, in the two stages of the **harvesting** cultivar Musala and entered the coming later than the Attila. During the second year of the study, in the two stages of the **harvesting** cultivar Attila and entered the coming later than the cultivar Musala.

During both years of the experiment, average over the study period in the two stages of the **harvesting** higher green biomass yield average for the two years was obtained at Attila variety in both **harvesting** stages. Depending on the nitrogen fertilizer rates, in both harvesting phases and two cultivars highest yield was obtained with nitrogen fertilization N₂₀₀.

The higher rate among organs that form the plants at the coming to ear stage, followed by leaves and ears. At the milky ripeness stage, the share of stems and ears increases while the share of leaves decreases compared to the coming to ear stage. With increasing nitrogen

fertilizer rate, the share of all studied indicators increases up to fertilizer rate N₂₀₀ and then drops at N₂₄₀.

References

- Bassu S., Asseng S., Giunta F., Motzo R. (2013). Optimizing triticale sowing densities across the Mediterranean Basin. *Field Crops Research*, 144, 167-178.
- Đekić V., Staletić M., Milovanović M., Đurić N., Popović V. (2013). Study on productivity and quality of the kg winter triticale varieties. *Zbornik naučnih radova Instituta PKB Agroekonomik*, 19(1-2), 53-60.
- Jansone I., Gaile Z. (2011). Razas svetki "Vecauce - 2011": LLU macibu un petijumu saimniecibai Vecauce - 90: Zinatniska seminara rakstu krajums Jelgava, Latvijas Lauksaimniecibas Universitate (LLU), 2011, 27-31.
- Kirchev H., Kolev T., Yanchev I., Delibaltova V. (2013). Extraction of green forage triticale depending on the variety and nitrogen fertilization. *Journal of Mountain Agriculture on the Balkans*, vv. 906-917, №2.
- Motzo R., Giunta F., Deidda M. (2001). Factors affecting the genotype x environment interaction in spring triticale grown in a Mediterranean environment. *Euphytica*, 121, 3, 317-324.
- Oettler G., Becker H. C., Hoppe G. (2001). Heterosis for yield and other agronomic traits of winter triticale F1 and F2 hybrids. *Plant breeding*, 120, 4, 351-353.
- Rosenberger A., Kaul H. P., Senn T., Aufhammer W. (2002). Costs of bioethanol production from winter cereals: the effect of crowing conditions and crop production intensity levels. *Industrial Crops and Products*, 15, 2, 91-102.
- Todorov N. (2009). Guide to best practices in dairy farming. "Matkom" Ltd. 978 9930 59 7.
- Tonev T. K. (1995). "Amendment of the components of the green mass of triticale under the influence of mineral fertilization." *Plant Science*, 1995, № 5, vv. 118-120, №4.
- Tosheva E. (1994). "Optimizing fertilization of triticale for green mass leached vertisol different preservation of nutrients." *Plant Science*, 1994., № 5-6, vv. 56-58, №1.
- Yoshihira, T., T. Karasawa, K. Nakatsuka. 2000. Yielding ability of winter triticale in snow heavy area of central Hokkaido. *Japanese Journal of Crop Science*, 69, 2, 165-174.

EFFECTS OF SOME APPLICATIONS ON *IN VITRO* POLLEN GERMINATION OF CAPRIFIG GENOTYPES (*Ficus carica* var. *caprificus*)

Oguzhan CALISKAN^{1*}, Safder BAYAZIT¹, Muruvvet ILGIN², Nesrin KARATAS³, Hilmi KOCATAS⁴

¹Mustafa Kemal University, Faculty of Agriculture, Department of Horticulture, Antakya, Hatay, Turkey

²Kahramanmaraş Sutcu Imam University, Faculty of Agriculture, Department of Horticulture, Kahramanmaraş, Turkey

³Alata Horticultural Research Institute, Erdemli, Mersin, Turkey

⁴Erbeyli Fig Research Institute, İncirliova, Aydın, Turkey

*Corresponding author: ocaliskan@mku.edu.tr

Abstract

Fig (*Ficus carica* L.) is a gynodioecious species which has male and female fruits on the different trees. Smyrna type figs are needed to pollination for the enough fruit set. Therefore, caprification (meaning the transfer of pollen grains from male trees to female trees by a vector, *Blastophaga psenes* L.) are commonly used for the figs. The aim of the study was to carry out and evaluate the effects of some applications on pollen germination of caprifig genotypes (*Ficus carica* var. *caprificus*). For this purpose, we investigated effects of light and dark conditions, pH of medium, sucrose, glucose and fructose levels and H₃BO₃, Ca(NO₃)₂, MgSO₄, KNO₃ concentrations in petri dishes on the temperature of 24°C for 24 h. Pollens from caprifigs were collected from anthers cracking on the June 10-25 from eastern Mediterranean region of Turkey. Germination rates of the caprifig genotypes were higher in the dark conditions (44.41%) compare to light conditions (30.65%). pH of medium were significantly affected on germination rates and optimal germination was obtained from pH 5.0 (56.39%). As a result, best condition for *in vitro* caprifig germination were in 1% agar+3% sucrose +100 ppm H₃BO₃+300 ppm (CaNO₃)₂+200 ppm MgSO₄+100 ppm KNO₃tests in pH 5.0 and dark conditions.

Keywords: *fig, caprifig, pollen, germination.*

Introduction

Fig tree (*Ficus carica* L.) is a typical species of Mediterranean countries. The *Ficus* species are gynodioecious and functionally dioecious. Trees producing only ovule bearing fruit are functionally female whereas trees producing only pollen are functionally male. Figs are typically pollinated by pollen-carrying wasps (Kjellberg et al., 1987).

The fig is an important fruit worldwide for dry and fresh consumption, and recently their nutritive and pharmacological values have been investigated. A major benefit of the Mediterranean diet is its high level of natural antioxidants derived from vegetables and fruits, including figs. In addition to contributing antioxidant vitamins, figs have some of the highest polyphenol levels in commonly available fruits. Traditional Mediterranean fruit and nut crops include grapes, olives, figs, almonds, hazelnuts, pistachios, pomegranates, apricots, and citrus (Caliskan and Polat, 2011; Caliskan, 2015).

The caprification is a common practice in all of fig grown regions and is known as an important factor affecting the quality of fig fruits (Condit, 1947). The main characteristics for the caprifigs (profichi crop) are as follows: Fruit size, amount of fruit number per shoot, ripening period, amount of gall and male flowers, amount of pollen production, pollen viability and germination ratios, include of the mammoni and mamme crops, and free from disease and pests (Aksoy et al., 2001; Caliskan et al., 2016).

In Turkey a large number of caprifigs can be found with a great diversity based on color, shape and ripening periods. Fig cultivation on the coastal region of the Mediterranean in Turkey has a long history and a promising future (Caliskan and Polat, 2012). The region is very important for fresh fig cultivation after Bursa province in Turkey. In this region, a lot of caprifig genotypes that are used for caprification are grown in natural population, but there are not found enough information included plant, fruit and pollinizer traits (Caliskan et al., 2016). Stanley and Linskens (1974) indicated that there is a linear relation between pollen viability and germination capability in many fruit species. Some of the factors which influence pollen germination in plants are carbohydrate (sugar), boron, calcium, enzymes, plant hormones, magnesium, potassium, agar, pH and certain physical factors such as temperature and light. The requirements are species specific (Johri and Vasil, 1961). However, effects of different applications for pollen germination of caprifigs have not been investigated in detail. The objective of this study was to determine effects of some applications on *in vitro* pollen germination of caprifig genotypes.

Material and methods

In the study some caprifig cultivars ('Ak İlek', 'Armut İlek', 'Elma İlek', 'Hamza', 'Küçük Konkur', and 'Taşlık') and genotypes (Hatay18, Hatay28, Hatay34, Hatay36, Hatay37, Osmaniye11) was used for pollen germination tests. The cultivars were obtained from Fig Research Institute, Aydın and the genotypes were selected from Hatay and Osmaniye provinces, Eastern Mediterranean Region of Turkey. Pollens collection was done according to the technique adopted by Storey (1975). Thirty profichis per genotype were harvested in full maturity period (10-25 June) and transferred to the laboratory. Ripe caprifigs were taken to a warm, dry place, split open longitudinally, and spread out to dry on aluminum foil at the laboratory bench. After 2-3 days, fruits were dried and all of anthers have dehisced. The pollens were taken in glass jars (100 ml). It was stored at +4°C in a refrigerator until use.

Table 1. Sucrose and nutrition levels used *in vitro* pollen germination of caprifig in 1% agarose

Medium	Nutrition	Medium	Nutrition
I	3% sucrose	VIII	5% sucrose +100 ppm H ₃ BO ₃
II	5% sucrose	IX	3% sucrose +100 ppm H ₃ BO ₃
III	10% sucrose	X	3% sucrose +300 ppm Ca(NO ₃) ₂
IV	15% sucrose	XI	3% sucrose +100 ppm KNO ₃
V	20% sucrose	XII	3% sucrose +200 ppm MgSO ₄
VI	25% sucrose	XIII	3% sucrose +100 ppm H ₃ BO ₃ +300 ppm (CaNO ₃) ₂ +200 ppm MgSO ₄ +100 ppm KNO ₃
VII	30% sucrose	XIV	%5 sucrose +100 ppm H ₃ BO ₃ +300 ppm (CaNO ₃) ₂ +200 ppm MgSO ₄ +100 ppm KNO ₃

In vitro germination was assessed with the petri-agarose method (Eti, 1991). Pollen germination was determined by placing a small drop of germinating media on a cover glass; pollen grains were sown on the drops with a clean brush. Components were subtracted from the medium or the levels modified as described in the Table 1 and 2.

In the pH tests, sucrose was dissolved first, then the other materials added, and the pH measured using pH meter and adjusted to 4.0, or to other values described in the Table 2, with dilute NaOH or HCl solution. The germination experiments, fresh pollen were evenly dusted onto germination solutions and incubated at 25°C constant temperature for 24 h. A pollen grain was considered to be germinated when the length of the pollen tube was equal to or

longer than the diameter of the grain. Germination was scored by a light microscope (Nikon Eclipse E200, Japan) in four random fields of three petri dishes for each caprifig genotype.

Table 2. Some application levels used *in vitro* pollen germination tests

Application	Level
Light	Light and Dark
pH	4, 4.5, 5.0, 5.5, 6.0, 6.5 and 7.0
Sugar (Glucose, Fructose and Sucrose)	3% and 5%
H ₃ BO ₃	100 ppm in 3% and 5% sucrose
Ca(NO ₃) ₂	300 ppm in 3% sucrose
MgSO ₄	200 ppm in 3% sucrose
KNO ₃	100 ppm in 3% sucrose

Germination percentage (%) was evaluated by dividing the number of germinated pollen grains per field of view by the total number of pollen per field of view.

Data were analyzed using SAS software and procedures (SAS, 2005). Analysis of variance (ANOVA) tables were constructed with Tukey's Honestly Significant Difference (HSD) method at $p < 0.05$.

Results and Discussion

1. The effects of light and dark conditions on pollen germination: The light is one of the factors which influence pollen germination in plants and they the requirements are species specific (Johri and Vasil, 1961). According to our results, germination of caprifig pollens were significantly affected by the dark conditions (Figure 1). Pollen germination percentages were highest in the dark condition (44.41%) compared to the light condition (30.65%). Similarly, Hoyo et al. (2014) showed that light is not effective factor for the pollen germination.

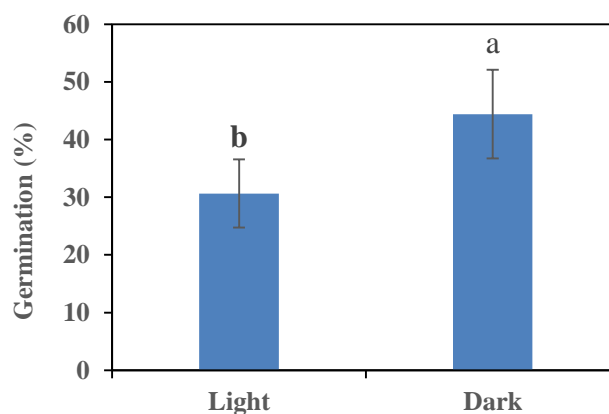

Figure 1. Effects of light and dark conditions on pollen germination. Bars show standard errors, the different letters show statistical significance on treatments.

2. The influence of different sugar compositions and levels on pollen germination: Two levels of sucrose, glucose and fructose plus nutrition medium were designed to evaluate the effect of sugars on pollen germination of caprifigs. Analysis of variance showed that there were statistically significant differences for both sugar compositions and levels (Figure 2). The highest pollen germination of caprifigs was detected in sucrose, followed by glucose and fructose. Levels of 3% (24.57%) and 5% (22.17%) of sucrose was shown to be the best sugar for pollen germination. Sucrose is generally considered to serve two functions in the medium, that of an energy source and an osmotic. The externally supplied sucrose maintains the

osmotic pressure and acts as a substrate for pollen metabolism (Hecker and McClintock, 1988). However, researchers showed that sucrose level can to be changed to fruit species (Ilgin et al., 2007; Bayazit et al., 2011).

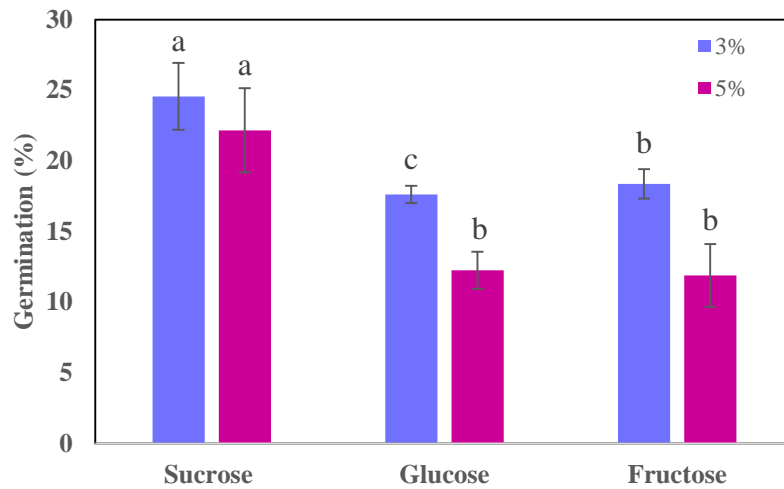

Figure 2. Effects of different sugar compositions and levels on pollen germination. Bars show standard errors, the different letters show statistical significance on treatments.

3. The effect of pH levels on pollen germination: pH has been reported to have a significant effect on pollen germination (Boavida and McCormick, 2007). Using our standard nutrition and agarose medium we varied the pH from 4.0 to 7.0. There was found that pollen germination percentage was the highest values 56.39% at pH 5.0 whereas, the lowest values of germination were 3.0% and 1.44% at pH 4.0 and 7.0 respectively (Figure 3). The results obtained from the present study showed that the acidity of germination media is one of the important factors related to pollen performance of caprifigs. Similarly, the pH of the germination medium has been shown to affect pollen germination in apple (Munzuroglu et al., 2003), banana (Soares et al., 2008) and pistachio (Acar et al., 2010).

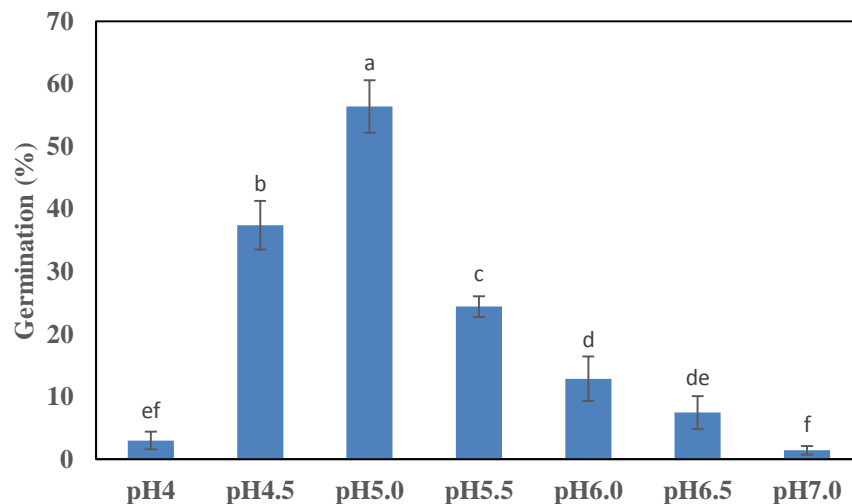

Figure 3. Effects of variation of pH on pollen germination. Bars show standard errors, the different letters show statistical significance on treatments.

4. Influence of some nutrition mediums on pollen germination: To determine the effect of the composition of the growth medium on caprifig pollen germination, we devised a series of

experiments of our medium including sucrose, boric acid (H_3BO_3), calcium nitrate [$(CaNO_3)_2$], and potassium nitrate (KNO_3). Effects of the nutritious on *in vitro* pollen germination of caprifigs summarized in Figure 4. The highest germination percentages were found in 3 % sucrose +100 ppm H_3BO_3 +300 ppm $(CaNO_3)_2$ +200 ppm $MgSO_4$ +100 ppm KNO_3 (24.57% in XIII medium) and 5 % sucrose +100 ppm H_3BO_3 +300 ppm $(CaNO_3)_2$ +200 ppm $MgSO_4$ +100 ppm KNO_3 (22.17% in XIV medium)(Figure 5). This result was in agreement with previous studies in caprifigs (Zeybekoglu et al., 1998). Increasing sucrose concentrations up to 5% improved pollen germination percentages whereas, germinations not detected with higher sucrose concentrations (20, 25 and 30%; V, VI and VII medium). This results showed the negative effect of higher sucrose concentrations on pollen germination as reported in caprifigs (Zeybekoglu et al., 1998; Ilgin et al., 2007). In addition, influence of potassium nitrate was not observed on pollen germination (XI).

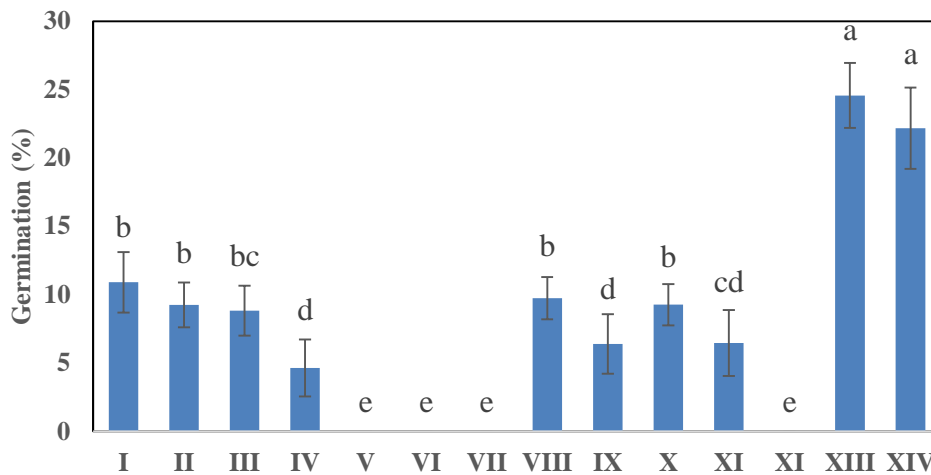

Figure 4. Effects of some nutrition media on *in vitro* pollen germination in 1% agarose. Bars show standard errors, the different letters show statistical significance on treatments.

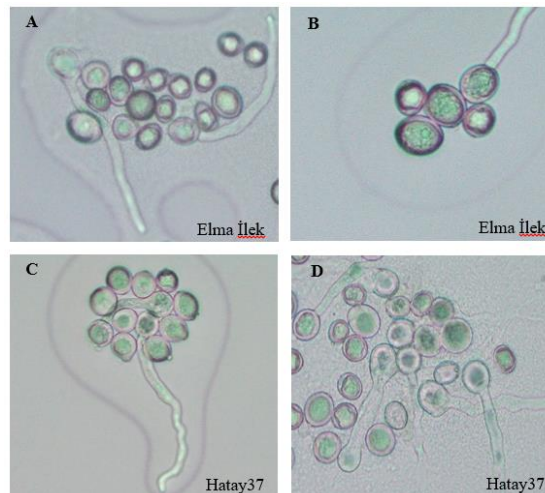

Figure 5. Pollen germination in Elma İlek cultivar and Hatay37 genotype XIII medium (A, C) and XIV medium (B, D) (40x)

Conclusion

The pollen quality is one of the desired parameter for the caprification. The germination tests also can be used to evaluate the pollen quality. In this study, the darkness, sugars, pH, and some nutritions on *in vitro* caprifig pollen germination were found to be highly significantly. As a result, best condition for *in vitro* caprifig germination were in 3% sucrose +100 ppm H₃BO₃+300 ppm (CaNO₃)₂+200 ppm MgSO₄+100 ppm KNO₃ tests in pH 5.0 and dark conditions in 1% agar.

Acknowledgements

We would like to thank the Scientific and Technological Research Council of Turkey (TÜBİTAK-TOVAG-114O034) for its financial support.

References

- Acar, I., Arpacı, S., Eti, S. (2010). Pollen susceptibility of *Pistachio* species to different pH medium. African Journal of Agricultural Research 5(14), 1830–1836.
- Aksoy, U., Can, H. Z., Hepaksoy, S., Şahin, N. (2001). Fig culture. Turkish Agriculture Research Project Publishing, p.45.
- Bayazit, S., Çalışkan, O., İmrak, B. (2011). Comparison of pollen production and quality characteristics of cultivated and wild almond species. Chilean Journal of Agricultural Research 71(4), 536–541.
- Boavida, L.C., McCormick, S. (2007). Temperature as a determinant factor for increased and reproducible *in vitro* pollen germination in *Arabidopsis thaliana*. Plant Journal 52, 570–582.
- Caliskan, O., Polat, A.A. (2011). Phytochemical and antioxidant properties of selected fig (*Ficus carica* L.) accessions from the Eastern Mediterranean region of Turkey. Sci. Hortic. 128, 473–478.
- Caliskan, O., Polat, A.A. (2012). Morphological diversity among fig (*Ficus carica* L.) accessions sampled from the eastern Mediterranean region of Turkey. Turk. J. Agric. For. 36, 179–193.
- Caliskan, O. (2015). Mediterranean Figs (*Ficus carica* L.) Functional Food Properties. The Mediterranean Diet an Evidence-Based Approach (Eds. Preedy, V.R., Watson, R.R.). Elsevier Publishing, Chapter 56, 629–639.
- Caliskan, O., Bayazit, S., İlgin, M., Kocatas, H., Karatas, N. (2016). Caprification and its importance in fig cultivation. Color Ofset Press, Hatay, Turkey. p.28.
- Condit, I.J. (1947). The Fig. Massachusetts: Chronica Botanica Waltham, MA, USA, p.222.
- Eti, S. (1991). The pollen viability and germination ratios in the some fruit species and cultivars by *in vitro* tests. Cukurova Univ. Journal of Agriculture Faculty. 6, 69–80.
- Hecker, R.J., McClintock, M. (1988). Sugarbeet pollen germination *in vitro*. Journal of Sugar Beet Research 25(1), 42–54.
- Hoyo, Y., Fujiwara, K., Hoshino, Y. (2014). Effects of different wavelengths of LED light on pollen germination and direction of pollen tube elongation in *Cyrtanthus mackenii*. Adv. Hort. Sci. 28(4), 190–194.
- İlgin, M., Ergenoglu, F., Çağlar, S. (2007). Viability, germination and amount of pollen in selected caprifig types. Pakistan Journal of Botany 39, 9–14.
- Johri, B.M., Vasil, I.K. (1961). Physiology of pollen. Bot. Rev. 27, 325–381.
- Kjellberg F., Gouyon, P.H., Ibrahim, M., Raymond, M., Valdeyron, C. (1987). The stability of the symbiosis between dioecious figs and their pollinators: A study of *Ficus carica* L. and *Blastophaga psenes* L. Evolution 41, 693–704.

- Munzuroglu, O., Obek, E., Gecgil, H. (2003). Effects of simulated acid rain on the pollen germination and pollen tube growth of apple (*Malus sylvestris* Miller cv. Golden). *Acta Biol. Hung.* 54(1), 95–103.
- SAS (2005). SAS online doc, version 9.1.3. SAS Inst., Cary, NC, USA.
- Soares, T.L., Silva, S.O., Carvalho Costa, M.A.P., Santos-Senejo, J.A., Souza, A.S., Lino, L.S.M., Souza, E.H., Jesus, O.N. (2008). *In vitro* germination and viability of pollen grains of banana diploids. *Crop Breeding and Applied Biotechnology* 8, 111–118
- Stanley, R. G., Linskens, H. F. (1974). *Pollen: Biology, Biochemistry, Management*, Springer, New York, NY, USA.
- Storey, W. B. (1975). “Figs,” in *Advances in Fruit Breeding*, J. Janick and J. Moore, Eds., pp. 568–589, Purdue University Press, West Lafayette, Ind, USA.
- Zeybekoğlu, N., Mısırlı, A., Gülcan, R. (1998). Researches on pollen germination ability of some caprifig varieties. *Acta Horticulturae* 480, 125–128.

CHARACTERISATION OF ECONOMICALLY IMPORTANT MEDICINAL AND AROMATIC PLANTS BELONGING TO THE LAMIACEAE FAMILY DISTRIBUTED IN THE RIZE PROVINCE, TURKEY

Emine YURTERI¹, Fatih SEYİS¹, Kudret KEVSEROĞLU², Hüseyin BAYKAL³, Yusuf ŞAVŞATLI¹, M. İkbal ÇATAL¹

¹Field Crops Department, Faculty of Agriculture and Natural Sciences, Recep Tayyip Erdogan University, Rize, Turkey

²Field Crops Department, Faculty of Agriculture, Ondokuz Mayıs University, Samsun, Turkey

³Department of Plant and Animal Production, Vocational High School, Recep Tayyip Erdogan University Rize, Turkey

*Corresponding author: fatih.seyis@erdogan.edu.tr

Abstract

Regarding biodiversity the Black Sea region belongs to one of the richest regions of Turkey. Totally 2239 species are present in the East Black Sea region, 514 of them are endemic and the endemism ratio is ca. 23 %. More than half of the plants distributed at the East Black Sea region are present in the Rize province. 70 % of the plants are of medicinal and aromatic value. 4 *Mentha* species, 3 *Origanum* species, 3 *Thymus* species, 2 *Salvia* species, 2 *Stachys* species and 1 *Calamintha* species were collected from 19 different localities in Rize during 2015. A field nursery was established using collected material. Traits like plant height, number of branches, stem diameter, leaf area, dry drog weight, fresh drog weight, dry drog yield, fresh drog yield, seed weight and essential oil yield were determined. Principal Component Analysis was performed to assess the diversity regarding with the investigation of characters. Based on obtained data large diversity could be determined. Collected materials can be used as genetic resources for further investigations.

Keywords: *Lamiaceae, medicinal and aromatic plants, characterization.*

Introduction

Natural environment has been a source of medicinal agents for thousand of years, since healing with plants dates back probably to the evolution of mankind (Mathe, 2015). As well known about 80 % of human in the World rely mainly on traditional medicines for their primary health care, while medicinal plants continue to play an important role in the health care system of the remaining 20 %. Partly based on their use in traditional medicine, an impressive number of modern drugs have also been isolated from natural plant species. Remarkably, even today there is no real definition for this special group of plants that has been accompanying mankind through history. Medicinal and aromatic plants form a numerically large group of economically important plants which provide basic raw materials for medicines, perfumes, flavours and cosmetics. These plants and their products not only serve as a valuable source of income for small land holders farmers and entrepreneurs but also earn valuable foreign exchange by way of export facilities.

Turkey is one of the countries with richest plant diversity in the Mediterranean (Davis 1965-1986; Davis *et al.*, 1988; Guner *et al.*, 2001). A number of human races and tribes have settled here during different periods bringing in different cultures and customs. As a result of this we come across a great accumulation of knowledge of traditional medicine in the country. A recent survey of traditional and folk medicine in Turkey has revealed that most of these plants are still in use by the local inhabitants (Yesilada and Sezik, 2003).

Turkey is located in three biogeographical regions: Anatolian, Mediterranean, the Black Sea region, and their transition zones. Its climatic and geographical features change within short

intervals of space due to the country's position – a bridge between two continents. Thanks to its location, Turkey's biological diversity can be compared to that of a small continent: the country's territory consists of forests, mountains, steppe, wetlands, coastal and marine ecosystems and different forms and combinations of these systems. This extraordinary ecosystem and habitat diversity has produced considerable species diversity (Kahraman *et al.*, 2011; Kahraman *et al.*, 2012). Regarding biodiversity the Black Sea region belongs to one of the richest regions of Turkey. Totally 2239 species are present in the East Black Sea region, 514 of them are endemic and the endemism ratio is ca. 23 %. More than half of the plants distributed at the East Black Sea region are present in the Rize province. 70 % of the plants are of medicinal and aromatic value.

4 *Mentha* species, 3 *Origanum* species, 3 *Thymus* species, 2 *Salvia* species, 2 *Stachys* species and 1 *Calamintha* species were collected from 19 different localities in Rize during 2014. Different traits were determined, but only the differences between these species based on their essential composition will be discussed.

Materials and methods

The research material was collected during 2015 in the Rize province (Turkey). The collected species, the localities and the altitudes are given in Table 1.

Table 1: Collected species and their localities

Species	Collected locality	Altitude	Species	Collected locality	Altitude
<i>Mentha aquatica</i>	Handüzi route	455 m	<i>Thymus longicaulicus</i>	Anzer	1534 m
	Ormanlı	160 m		Anzer	2106m
<i>Mentha puligeum</i>	Hamidiye	33 m		Cimil	2145 m
	Hamidiye	41 m		Cimil	2154 m
	Orta Mahalle	350 m	<i>Thymus praecox</i> subsp. <i>caucasicus</i>	Çağırankaya	2038 m
	Subaşı	300 m	Çağırankaya	2122 m	
	Şehitlik	500 m	<i>Thymus praecox</i> subsp. <i>caucasicus</i> var.	Anzer	1534 m
<i>Mentha x piperita</i>	Şehitlik	450 m	<i>caucasicus</i> var.	Anzer	1750 m
<i>Mentha longifolia</i> subsp. <i>longifolia</i>	Anzer	1533 m	<i>caucasicus</i>	Anzer	2106 m
	Anzer	1800 m	<i>Thymus praecox</i> subsp. <i>grosheimii</i> var.	Polovit	2400 m
	Anzer	2075 m		Cimil	2145 m
	Anzer	2139 m		Cimil	2154 m
	Amlakit	1901 m		Çağırankaya	2122 m
	Amlakit	1998 m	Handüzü	1833 m	
	Anzer	2106 m	<i>Thymus praecox</i> subsp. <i>grosheimii</i> var. <i>medwedewii</i>	Başyayla	2558 m
	Cimil	1819 m	<i>Salvia glutinosa</i>	Çat	1295 m
	Cimil	2145 m	<i>Salvia verticillata</i> subsp. <i>verticillata</i>	Anzer	1533 m
	Çamlıhemşin	1838 m		Anzer	1533 m
	Çat	1299 m		Anzer	1800 m
<i>Origanum vulgare</i> subs. <i>hirtum</i>	Çat	1209 m		Anzer	1850 m
	<i>Origanum vulgare</i> subsp. <i>viride</i>	İkizdere		314 m	Anzer
		İkizdere	787 m	Cimil	2099
		İkizdere	1533 m	Çat	1321
Uğrak		496 m	Çat	1412 m	
<i>Calamintha nepata</i> subsp. <i>glandulosa</i>	Amlakit	1900 m			
<i>Stachys annua</i> subsp. <i>annua</i> var. <i>annua</i>	Anzer	1533 m			

Essential oil analysis:

The essential oil composition of collected samples was done using an SHIMADZU GC/MS device. An 30 m column and related detection programme was used.

Statistical analysis:

Principal component and Biplot analysis was used to distinguish the collected samples regarding their essential oil composition (Backhaus et al, 1989). Principal component and Biplot analysis was performed using XLSTAT2016 Trial Version. The collected samples were diversified using all essential oil components, in Biplot only highly detected essential oil components were used. The calculated first two Principal Components are corresponding in % to the present variation regarding investigated trait.

Results and discussion

1. *Mentha* species: Fig.1 shows the distribution of investigated *Mentha* species based on most detected essential oils.

As can be seen in Fig. 1 *Mentha* species collected from different localities and altitudes showed different essential compositions. Specially in *M. longifolia* subsp. *longifolia* large variation was detected. The same can be said for *M. puligeum* collected from different localities and altitudes.

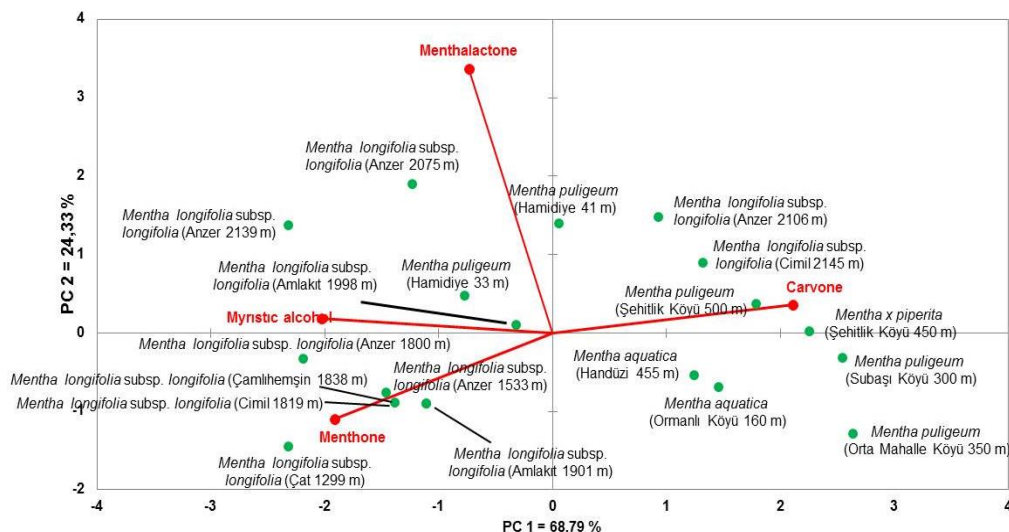

Fig. 1: Biplot analysis of *Mentha* species based on differentiating essential oils

The essential oil menthone was detected specially in *M. longifolia* subsp. *longifolia*. Carvone, myristic alcohol and menthalactone was useful in separating the other collected samples.

1. *Origanum* species: Fig.2 shows the distribution of investigated *Origanum* species based on most detected essential oils. *Origanum vulgare* subsp. *viride* samples collected from different altitudes of İkizdere and from Uğrak showed different essential oil composition compared with the other *Origanum* species. Specially *Origanum vulgare* subsp. *vulgare* collected from Cimil and *Origanum vulgare* subsp. *hirtum* collected from Çat showed different essential oil compositions. *Origanum vulgare* subsp. *hirtum* collected from Çat and *Origanum vulgare* subsp. *viride* collected from İkizdere at 1533 altitude could be differentiated from other samples regarding Carvacrol.

Origanum vulgare subsp. *viride* collected from İkizdere at 787 altitude and from Uğrak could be separated from other collected samples regarding the compounds Isoborneol and Myristic.

Origanum vulgare subsp. *vulgare* collected from Cimil stand out regarding Tymol from the other samples; *Origanum vulgare* subsp. *viride* collected from İkizdere at 314m altitude showed differences regarding Hmachalene alpha. The compound linaool was useful to separate all investigated samples.

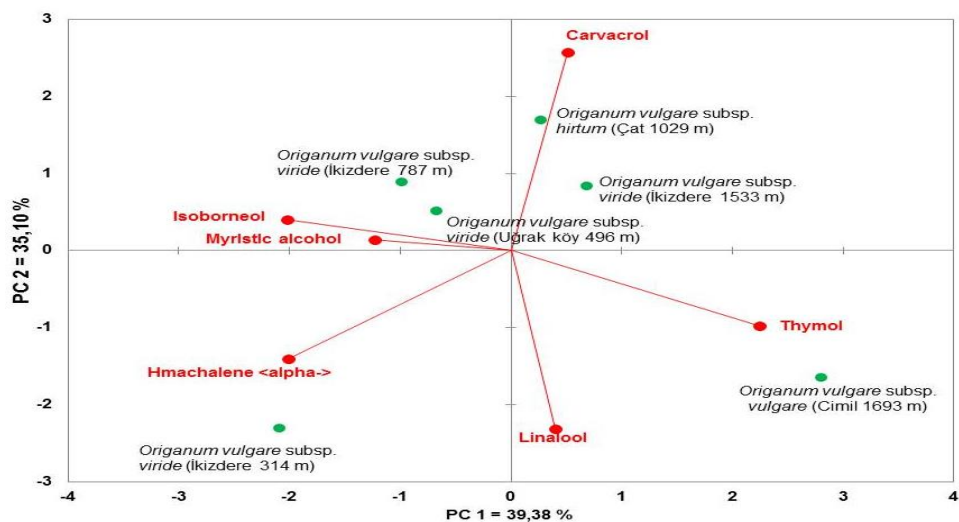

Fig. 2: Biplot analysis of *Origanum* species based on differentiating essential oils

2. Thymus species: Fig. 3 shows the Biplot analysis of collected *Thymus* samples based on their essential oil composition.

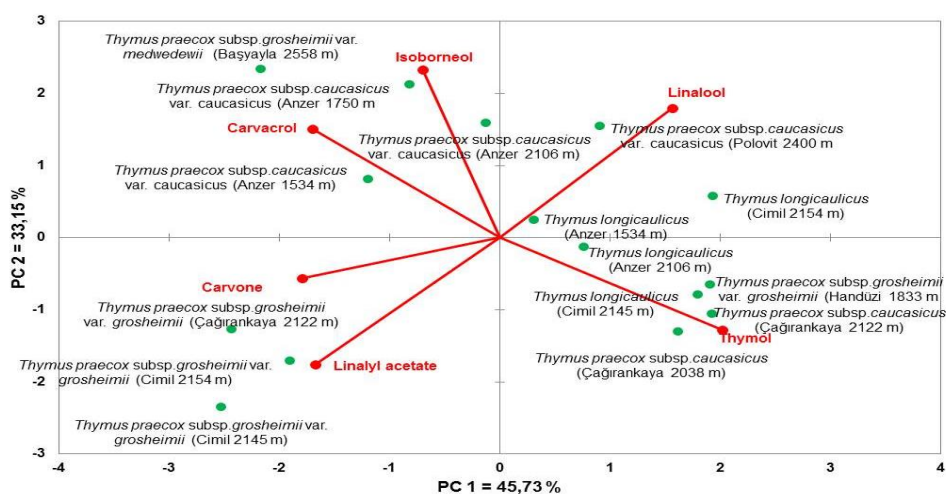

Fig. 3: Biplot analysis of *Thymus* species based on differentiating essential oils

T. praecox subsp. *grosheimii* var. *grosheimii* samples collected from Cimil and Çağırankaya showed similar essential oil compositions. Only the same species collected from Handüzi displayed similar composition with the species *T. longicaulicus* and *T. praecox* subsp. *caucasicus*. Further, *T. praecox* subsp. *grosheimii* var. *medwedewii* showed similar essential oil composition with *T. praecox* subsp. *caucasicus* var. *caucasicus* samples collected from Polovit and different altitudes of Anzer.

T. praecox subsp. *grosheimii* var. *medwedewii* collected from Baş Yayla, *T. praecox* subsp. *caucasicus* var. *caucasicus* collected from Anzer and Polovit and *T. longicaulicus* collected

from Cimil and Anzer 1534 showed differentiation from the other samples regarding the essential oil compounds Linalool, Isoborneol and Carvacrol.

Carvone and linalyl acetate were helpful to separate *T. praecox* subsp. *grosheimii* var. *grosheimii* collected from Cimil and Çağırnkaya from the other species. *T. Longicaulis* collected from Cimil, *T. praecox* subsp. *caucasicus* collected from Çağırnkaya and *T. praecox* subsp. *grosheimii* var. *grosheimii* collected from Handüzi were different from the other samples regarding Thymol.

3. Salvia, Stachys and Calamintha species: Fig. 3 shows the Biplot analysis of collected Salvia, Stachys and Calamintha samples based on their essential oil composition.

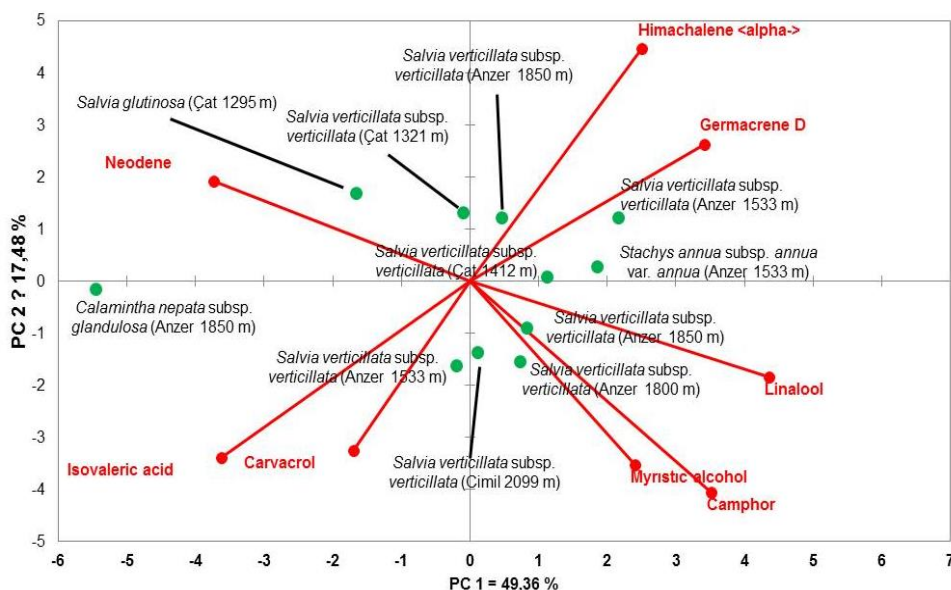

Fig. 4: Biplot analysis of Salvia, Stachys and Calamintha species based on differentiating essential oils

Salvia glutinosa, *Calamintha nepeta* subsp. *glandulosa* and *Stachys annua* subsp. *annua* var. *annua* differed from the other species regarding their essential oil composition. Samples of the species *Salvia verticillata* subsp. *verticillata* showed nearly similar essential oil compositions.

Calamintha nepeta subsp. *glandulosa* differed from the other samples regarding neodene, carvacrol and isovaleric acid. Further, *Salvia glutinosa* displayed different neodene composition. *Stachys annua* subsp. *annua* var. *annua* on the other side could be differentiated based on germacrene D and linalool.

The presence, yield and composition of secondary metabolites in plants, viz. the volatile components and those occurring in essential oils, can be affected in a number of ways, from their formation in the plant to their final isolation (Figueiredo *et al.*, 2008). Several of the factors of influence have been studied, in particular for commercially important crops, to optimize the cultivation conditions and time of harvest and to obtain higher yields of high-quality essential oils that meet market requirements.

Knowledge of the factors that determine the chemical variability and yield for each species are thus very important. These include: (a) physiological variations; (b) environmental conditions; (c) geographic variations; (d) genetic factors and evolution; (e) political/social conditions; and also (f) amount of plant material/space and manual labour needs. In our case it could be stated that different species collected from different localities and altitudes showed variation regarding their essential oil composition due to environmental conditions, geographic variations and genetic factors, which of course needs further investigation.

Conclusion

Medicinal plants and their various products can be viewed as an important commodity items for sustainable economic development of developing countries. There is globally also need of organised marketing and trade of medicinal plants and their various products. To meet the internal and international demands, it has now become imperative to produce the quality raw materials in significant quantities. This can only be achieved to promote the domestication and cultivation of medicinal plants which have internal demand in large quantity and have export and import potential. During this study, the essential oil composition of different species of the Lamiaceae family were determined. Obtained data revealed that large variation exists based on the chemical compounds of species collected from different locations and altitudes. The investigated material will serve as genetic material for further breeding purposes.

Acknowledgement:

This work was supported by Research Fund of the Recep Tayyip Erdogan University. Project Number 2014.112.02.02.

References

- Backhaus, K., Erichson B., Plinke W., Weiber R. (1989). *Multivariate Analysis Methods*. Springer Verlag, Heidelberg.
- Davis PH. (1965-1985) *Flora of Turkey and the East Aegean Islands*. Vol 1-9 Edinburgh Press Edinburgh.
- Davis PH., Mill RR., Tan K. (1988). *Flora of Turkey and the East Aegean Islands*. Vol 10. Edinburgh University Press, Edinburgh.
- Figueiredo AC., Barroso JG., Pedro LG., Scheffer JJC. (2008). Factors affecting secondary metabolite production in plants: volatile components and essential oils. *Flavour and Fragrance Journal* 23: 213–226.
- Guner A., Ozhatay N., Ekim T. (2001). *Flora of Turkey and the East Aegean Islands*, Volume 11, Edinburgh University Press, Edinburgh.
- Kahraman A., Doğan M., Celep F. (2011). *Salvia siirtica* sp. nov. (Lamiaceae) from Turkey. *Nord J Bot* 29: 397–401.
- Kahraman A., Bagherpour S., Karabacak E., Doğan M., Doğan H.M., Uysal İ., Celep F. (2012). Reassessment of conservation status of *Salvia L.* (Lamiaceae) in Turkey II. *Turk J Bot* 36: 103–124.
- Mathe A. (2015). *Medicinal and Aromatic Plants of the World Scientific, Production, Commercial and Utilization Aspects*. pp. 460. Springer
- Yesilada E., Sezik E. (2003). A survey on the traditional medicine in Turkey: semi-quantitative evaluation of the results. In: Singh, V.K., Govil, J.N., Hashmi, S., Singh, G. (Eds.), *Recent Progress in Medicinal Plants*, vol. 7: *Ethnomedicine and Pharmacognosy II*. Studium Press LLC, Houston, TX, USA; pp. 389–412.

ANTIFUNGAL ACTIVITY OF *SISYMBRIUM SOPHIA* EXTRACTS AGAINST PHYTOPATHOGENIC FUNGI

Yusuf BAYAN

Department of Plant Protection, Faculty of Agriculture, AhiEvrans University, 40100, Kirsehir, Turkey

*Corresponding author: yusufbayan@gmail.com

Abstract

The purpose of this study was to assess the effectiveness of methanol and aquatic extracts from *Sisymbrium sophia* against the plant pathogens, *Fusarium oxysporum* f. sp. *radicis-lycopersici* (FORL) (Sacc.) W.C.Synder and H.N. Hans, *Rhizoctonia solani* J.G. Kühn., *Sclerotinia sclerotiorum* (Lib.) de Bary, *Verticillium dahliae* Kleb., and *Alternaria solani*. Various volumes of methanol and aquatic extracts were mixed with the sterile PDA in order to obtain different concentrations. Antifungal activity assessments were performed under *in vitro* conditions using 60 mm diameter petri dishes containing potato dextrose agar (PDA). Plant pathogen mycelial discs of 5 mm diameter were inoculated onto Petri dishes containing PDA medium (10 mL petri⁻¹). Then the mycelial growth inhibition (MGI) was calculated. Additionally, the antifungal activity of plant extracts was evaluated statistically. Methanol 100 mg, 200 mg 400 mg/mL and 5%, 10% and 20% aquatic extracts of plant extract doses were used respectively. *Sisymbrium sophia* methanol and aquatic extracts showed distinguished antifungal activity. These results revealed that methanol and aquatic extracts of *Sisymbrium sophia* could be of use for the future development of plant disease agents.

Keywords: *Antifungal effect, plant extracts, Sisymbrium sophia, Plant pathogenic fungi*

Introduction

Brassicaceae a major plant family with 390 genera and 3000 species, among which is *Sisymbrium sophia* L., syn *Descurainia sophia* (Shahina, 1994). The plant is shows distribution in the different regions of the world. *Descurainia sophia* high germination, particularly in late autumn and premature spring (Peng *et al.*, 1997; Li *et al.*, 2005). It is known as herb Sophia and tansy mustard. Propagated by seeds, it forms erect, furcate stem between 10 and 72 cm tall. *S. sophia* is an annual weed prevalently scattered in cultivated crops and forage throughout the world. Also, its special seed can be used for food, having medicinal and industrial properties (Anonymous, 2016).

The purpose of this study, determine *in vitro* antifungal activity of the methanol and aquatic extract obtained from *Sisymbrium sophia* L. to plant pathogenic fungi: *Alternaria solani*, *Verticillium dahliae*, *Rhizoctonia solani*, *Fusarium oxysporum* f. sp *radicis-lycopersici* and *Sclerotinia sclerotiorum*.

Material and Method

Plant material

The above ground parts of *Sisymbrium sophia* were collected during 2015 and 2016 from the Kirsehir, Turkey.

Plant Extracts

Methanol Extracts: 100 grams of plant materials was put into a 1 liter Erlenmeyer flask containing 600 ml methanol. Mixture was left for 24 hours at room temperature and subsequently in an orbital shaker at 120 rpm. Extract was filtered using filter paper. The Rotary evaporator 40 °C was removed with the aid of solvents. The residual extract was used

to prepare a stock solution with 1% DMSO identified. Several concentrations to be used in the study (100, 200, 400 mg /100 ml PDA) were prepared (Bayan and Akşit, 2016).

Aquatic Extracts: Dried plant materials were grinded and 20g of material was put in a glass vessel containing 100ml of distilled water and shaken for 24 hours at 120 rpm in an orbital shaker. Shaking mixture was then filtered through filter aid paper. Several concentrations to be used in the study (5%, 10%, 20% ml/100 ml PDA) were prepared (Yılar and Kadioğlu, 2016).

Fungal Culture: The plant pathogenic fungi used in this study were obtained from stock cultures of Department of Plant Protection, Faculty of Agriculture, Phytopathology laboratories at Ahi Evran University. Fungal cultures were plated in 90 mm Petri dishes containing 20 ml of potato dextrose agar (PDA) and incubated for 7 days at 23±2 °C.

***In- vitro* antifungal activity of plant extracts**

These assays were carried out to determine the effects of *Sisymbrium sophia* methanol and aquatic extracts against *A. solani*, *F. oxysporum* f. sp *radicis-lycopersici*, *S. sclerotiorum*, *R. solani* and *V. dahliae*. The obtained methanol and aquatic extracts were added to PDA at 40°C to at final concentrations of 100, 200 and 400 mg/ml and 5, 10 and 20% for each extracts respectively. The PDA was poured into 60-mm Petri plates (10 mL plate⁻¹) and 5mm mycelial disc were placed onto the medium and incubated for 7 days at 25°C. Fungal development was recorded after 7 days. Inhibition in the development in fungal growth was calculated using the following formula (Pandey, 2009). PDA amended with synthetic Thiram 80% (Hektas, Turkey) was used at the indicated concentration for the disease a positive control. At the indicated concentration for the disease. All experiments were repeated twice and each with 4 replications.

$$I = 100 \times (DC - DT) / DC$$

I: Inhibition percentage compared to the control

DC: Mycelium development in the control

DT: Mycelium development in plant extract applications

Results and Discussion

***In- vitro* antifungal activity of plant extracts**

The antifungal activity of plant extracts against mycelial growth of tested plant pathogenic fungi are presented in Figures 1 and 2).

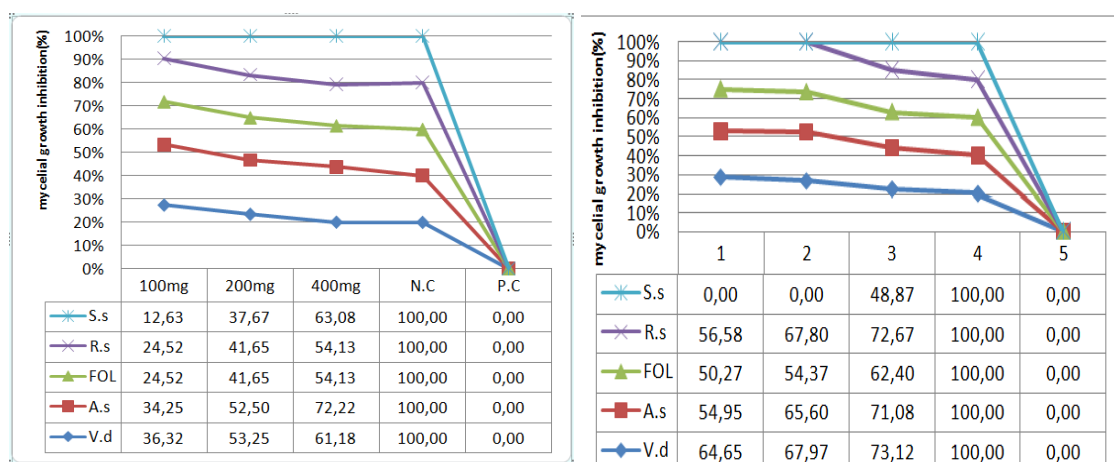

Figure 1-2. The effect of *Sisymbrium sophia* L methanol and aquatic extract on the mycelial growth inhibition of *A. solani* (A.s.), *F. oxysporum* f. sp *radicis-lycopersici* (FOL), *S. Sclerotiorum* (S.s.), *R. solani* (R.s.) and *V. dahliae* (V.d.), Figure 2. 1-5 (5%, 10%, 20%, Negative control (N.C), Positive control (P.C))

In operating results; methanol and water extract: not fungi mycelium is blocking the development of 100%. However, compared to control, MGI is increasing as the concentration increases. The highest antifungal effect was observed in *S. sophia* methanol extracts in concentration of 400 mg mL⁻¹ against *A. solani*, *S. sclerotiorum*, *V. dahliae* *R. solani* and *F. oxysporum* f. sp. *radicis- lycopersici*, which had MGIs of 72.22, 63.08, 61.18, 54.13 and 54.13%, respectively. Similarly, the highest antifungal effect was observed in *Sisymbrium sophia* L 20% aquatic extracts against *Verticilium dahliae*, *Rhizoctania solani*, *Alternaria solani*, *Fusarium oxysporum* f. sp. *radicis- lycopersici*, and *Sclerotinia sclerotiorum* having MGI 73.12, 72.67, 71.08, 62.40 and 48.87%, respectively. Species within family Brassicaceae are reported to have anti-microbial activity has been identified (Panghal *et al.*, 2011). The aqueous extract reported of *Sisymbrium irio* showed antibacterial activity (Khan *et al.*, 2011). *Sisymbrium sophia* L antipyretic, anti-inflammatory and analgesic activity plant extract has been determined (Mohamed and Mahrous, 2009). The effects of water extracts of different *Sisymbrium sophia* L parts obtained such as root, stem and leaves. The germination of wheat seeds have identified a preventive effect.

Conclusions

As a result, the plant methanol and aquatic extracts used in study were determined to have different level of antifungal effect. Antifungal activities opposite all test organisms have reduced mycelium growth at the grade of visible in a dose dependent way. Promising results were acquired from the use of plant extract plant pathogenic fungi controls.

Acknowledgement

This work was supported by the Ahi Evran University Scientific Research Projects Coordination Unit. Project Number ZRT.E2.16.011

References

- Anonymous. (2016). Wikipedia. https://en.wikipedia.org/wiki/Descurainia_sophia (Erişim Tarihi: 27.01.2016)
- Bayan Y and Akşit H. (2016). Antifungal Activity of Essential Oils and Plant Extracts From *Sideritis Germanicopolitana* Bornm. Grown In Turkey *Egyptian Journal of Biological Pest Control*, 26(2),333-337
- Edrisi S.H., Farahbakhsh A. (2011). Allelopathic Effects of *Sisymbrium irio* L. and *Descurainia sophia* (L.) Schur on the Germination of Wheat (*Triticum aestivum* L.). World Academy of Science, Engineering and Technology International Journal of Biological, Biomolecular, Agricultural, Food and Biotechnological Engineering Vol:5, No:2,
- Li W., Liu X., Khan M.A., Kamiya Y., Yamaguchi S. (2005). Hormonal and environmental regulation of seed germination in flixweed (*Descurainia sophia*). *Plant Growth Regul*, 45: 199-207.
- M. Ashfaque Khan., Rajesh Prakash., Shehbaz Ali., Ahmed Aljarbou., Masood A. Khan. (2011). Comparative Study of Antibacterial Activity and Toxicity of Certain Plants used in Unani Medicine. *Advances In Bioresearch*. Volume 2, Issue 2: 10 – 13 P-ISSN 0976-4585.
- Mohamed N.H., Mahrous A.E. (2009). Chemical Constituents of *Descurainia sophia* L. and its Biological Activity. *Rec. Nat. Prod.* 3:1 58-67
- Pandey D.K. (2009). Allelochemicals in *Parthenium* in response to biological activity and the environment. *Indian Journal of Weed Science*. 41(3&4) : 111-123.
- Panghal M., Kaushal V., Yadav J.P. (2011). *In vitro* antimicrobial activity of ten medicinal plants against clinical isolates of oral cancer cases. *Annals of Clinical Microbiology and Antimicrobials*.;10;11-21.

- Peng L., Yi Y., Fu-li G., Ze-qü L,. (1997). A preliminary study on the introduction of *Descurainia sophia*, an oil plant species for industrial uses. *Acta Botanica Sinica*, 39: 447-479.
- Shahina A.G. (1994). Hand book of Arabian medicinal plants. CRC. Press, p.265.
- Yılar M., Kadiođlu, İ (2016). Antifungal Activities Of Some *Salvia* Species Extracts On *Fusarium Oxysporum* F. Sp. *Radici- Lycopersici* (Forl) Mycelium Growth *İn-Vitro*. *Egyptian Journal of Biological Pest Control*, 26(1), 115-118

**PHENOLOGICAL AND POMOLOGICAL TRAITS OF SOME INDIGENOUS
APPLE GENOTYPES FROM THE *ex-situ* COLLECTION OF THE FRUIT
RESEARCH INSTITUTE, ČAČAK (REPUBLIC OF SERBIA)**

Slađana MARIĆ*, Milan LUKIĆ, Sanja RADIČEVIĆ, Olga MITROVIĆ, Milena
ĐORĐEVIĆ

Fruit Research Institute, Čačak, Republic of Serbia

*Corresponding author: nidzovicsladja@yahoo.com

Abstract

This study was conducted on five genotypes from the Fruit Research Institute (FRI), Čačak (Republic of Serbia) Apple Collection – ‘Bošnjanka Sejanac’, ‘Jevtović Milutin’, ‘Jusuf Bećović’, ‘Tip 3’ and ‘Valjnika’ – in order to determine the main biological properties. Flowering phenophase (onset, full and end of flowering), harvest maturity, pomological properties (morphometric and chemical) and disease susceptibility to scab [*Venturia inaequalis* (Cooke) Wint.], mildew [*Podosphaera leucotricha* (Ell. & Ev.)] and fireblight [*Erwinia amylovora* (Burnill)] were studied using Apple Descriptors, and standard morphometric and chemical methods. Regarding full flowering, the genotypes were classified from very early (‘Jusuf Bećović’) to late (‘Tip 3’ and ‘Valjnika’). From the aspect of the fruit ripening time, all genotypes belong to the group of winter apples (from late September/early October to mid October). The average fruit weight ranged from 86.01 g (‘Valjnika’) to 135.21 g (‘Tip 3’). The highest average fruit height and width were determined in ‘Tip 3’ and ‘Jusuf Bećović’ (58.51 mm and 68.12 mm, resp.), while the lowest was in ‘Jusuf Bećović’ and ‘Valjnika’ (50.77 mm and 56.67 mm, resp.). Regarding fruit quality among the assessed genotypes, the highest soluble solids content and total sugars were found in ‘Jusuf Bećović’ (15.10% and 12.83%, resp.). The highest content of total acids was found in ‘Tip 3’ (0.64%), accompanied with the lowest pH value (3.15%). ‘Valjnika’ showed low field susceptibility to scab and powdery mildew. All of the studied genotypes showed field resistance to fireblight, except for the ‘Jevtović Milutin’.

Keywords: *Malus × domestica*, autochthonous genotype, biological properties, resistance

Introduction

Apple (*Malus × domestica* Borkh.) is one of the most important fruit crops of temperate regions in the world with the cultivation history dating as early as 1000 BC (Zohary and Hopf, 2000). Apple germplasm is genetically and phenotypically diverse, due to the fact that multiple *Malus* species contributed to the cultivated apple and possession of self-incompatibility system leading to obligatory outcrossing. Brown (2012) stated that diversity within cultivated apple is a great benefit to breeders, as well as that older genotypes are used extensively to breed new, superior cultivars.

FRI, Čačak has a long tradition of collection, characterization, evaluation and utilization of indigenous apple genotypes, which can potentially provide useful genetic variability, especially for resistance and fruit quality traits (Marić *et al.*, 2013). It is obvious that some of autochthonous apple genotypes carry useful genes which, if not preserved, will no longer be available. In recent years, there have been considerable advances in evaluation of autochthonous apple material at FRI, Čačak through the application of a uniform approach (Apple Descriptors) and the analysis of *ACS1* and *ACO1* genes encoding the enzymes that catalyse the two final reaction steps in the ethylene biosynthetic pathway (Marić *et al.*, 2005), as well as *ETR1* gene encoding the ethylene receptor (Marić *et al.*, 2007, 2015).

This work studied phenological and pomological properties, and field resistance to major causal agents of economically important diseases in five indigenous genotypes from the *ex-situ* Apple Collection of the FRI, Čačak.

Material and Methods

Five autochthonous genotypes ('Bošnjanka Sejanac', 'Jevtović Milutin', 'Jusuf Bećović', 'Tip 3' and 'Valjnika') from the Apple Fruit Collection of FRI, Zdravljak, near Čačak (Republic of Serbia) were analysed over a two-year period. The collection was established in 1986, at a spacing of 4 × 1.5 m. The apple genotypes were grafted on 'M26' rootstocks and planted three trees each.

The tree habit and fruit properties of the assessed genotypes were characterized using the Apple Descriptors of the International Board for Plant Genetic Resources (IBPGR, 1982).

The flowering phenophase was assessed by monitoring the onset, full and end of flowering (10% open flowers, 80% open flowers and 90% worn flowers, respectively) according to Wertheim (1996). The samples of 20 fruits in three replications per genotype were harvested randomly at the stage of physiological ripeness.

The fruit morphometric properties (fruit weight, height and width) were determined using the standard methods, whereas fruit shape index (height-to-width ratio) was calculated. The fruit chemical composition was assessed on the basis of the following parameters: soluble solids content – using the portable refractometer; total and invert sugars content – according to the Luff-Schoorl method (Egan *et al.*, 1981); sucrose content – calculated as the difference between the total and invert sugars, multiplied by coefficient of 0.95; total acids content – expressed in malic acid (titration of 0.1 N NaOH with the presence of phenolphthalein as indicator); pH value of the fruit juice – using the CyberScan 510 pH meter.

The field susceptibility to causal agents of scab [*Venturia inaequalis* (Cooke) Wint.], powdery mildew [*Podosphaera leucotricha* (Ell. & Ev.)] and fireblight [*Erwinia amylovora* (Burnill)] was evaluated in accordance with the Apple Descriptors (IBPGR, 1982), on the scale from 1 to 9 (where 3 is low, 5 is medium and 7 is high susceptibility); the scale corresponds to the Van der Zwet scale and the portion of the tree blighted.

Fruit morphometric parameters were statistically analysed using the two-factor analysis of variance (ANOVA). The significance of differences among mean values was determined by Fisher's LSD multiple range tests at $P \leq 0.05$. Statistical analyses were performed using 'Statistica 10' software package (StatSoft, Tulsa, OK).

Results and Discussion

Based on Apple Descriptors (IBPGR), the assessed genotypes were characterised by the following biological properties:

'Bošnjanka Sejanac'. The tree is moderately vigorous, with spreading branches and intermediate to late blooming. It ripens in late September – early October. The fruit is small, flat-globose, of green ground colour and no overcolour. The flesh is of intermediate to good texture, pale greenish white, sweet to slightly acidic.

'Jevtović Milutin'. The tree is vigorous, with upright branches and intermediate to late blooming. It ripens in the first half of October. The fruit is small, globose-conical, of green-yellow ground colour with mottled dark red overcolour. The flesh is of a coarse texture, pale creamy white, sweet in taste.

'Jusuf Bećović'. The tree is moderately vigorous, with upright branches and very early blooming. It ripens in the second decade of October. The fruit is small to medium, flat, of a green-yellow ground colour and streaked with red blush. The flesh is of an intermediate texture, pale creamy white, slightly sweet in taste.

'Tip 3'. The tree is vigorous, with upright branches and late blooming. It ripens in the first half of October. The fruit is small, globose-conical, of green-yellow ground colour with mottled dark red overcolour. The flesh is of a coarse texture, pale creamy white, sweet in taste.

'Valjnika'. The tree is moderately vigorous, with upright branches and late blooming. It ripens in late September–early October. The fruit is small, globose-conical, of green ground colour and no overcolour. The flesh is of a coarse texture, whitish, slightly sweet in taste.

Blooming season of the assessed apple genotypes based on preliminary results over a two-year period is shown in Figure 1. The earliest average onset of blooming was recorded in 'Jusuf Bećović' (April 25th), while April 26th noted for the other apple genotypes. There was an approximately 7–day difference in full flowering between the earliest and latest genotypes. Among the studied local apple cultivars from southern Serbia, Mratinić and Fotirić Akšić (2011) reported a 16–day difference in full bloom. Regarding full flowering, the genotypes were classified into three groups, from very early – 'Jusuf Bećović' to late – 'Tip 3' and 'Valjnika'. Blažek *et al.* (2015) pointed out that late blooming apple genotypes should be favoured because of their capacity to avoid a risk of crop loss due to late spring frosts. Nevertheless, the late flowering of apple genotypes is in connection with reducing the risk of fire blight spread (Aldwinkle *et al.*, 1976).

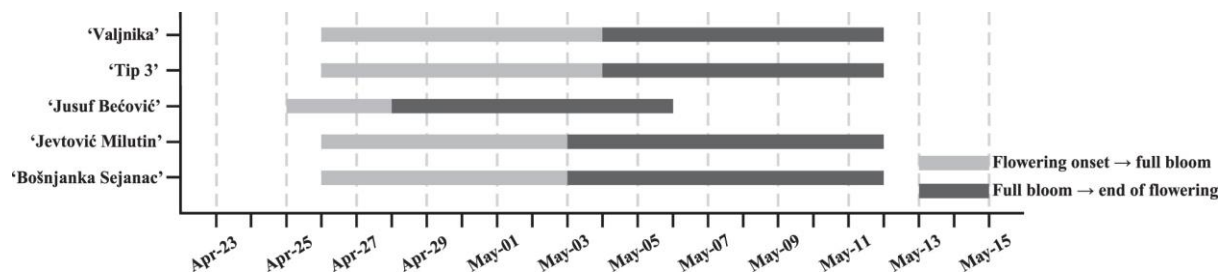

Figure 1. Flowering phenophase of the assessed apple genotypes.

Regarding the ripening time, the genotypes were classified into late ('Bošnjanka Sejanac' and 'Valjnika') and very late apples ('Jevtović Milutin', 'Jusuf Bećović' and 'Tip 3'). Apple is a climacteric fruit and its ripening is physiologically related to internal levels of ethylene. Based on studies of genes involved in ethylene biosynthesis and perception, Marić *et al.* (2005, 2007, 2015) reported the *ACSI*, *ACO1* and *ETR1* genotypes in some Serbian autochthonous apple genotypes and pointed out that the allele *d* of *ETR1* gene was identified only in the indigenous genotypes, i.e. 'Tip 3', but not in commercially grown apple cultivars.

Based on the fruit size, the genotypes were classified as small and small to medium, whereas the average fruit weight ranged from 86.01 g ('Valjnika') to 135.21 g ('Tip 3'). Variability in average fruit weight in autochthonous apple cultivars, as one of the most important properties, was confirmed by Gaši *et al.* (2011), Mratinić and Fotirić Akšić (2011) and Pirlak *et al.* (2003), who reported that the fruit weight varied from 97.90 g to 276.18 g, 70.0 g to 193.3 g and 49.5 g to 152.2 g, respectively. The statistical significance of the impact made by the variability factors interaction points to the fact that the expression of the genotype-specific properties related to the fruit weight, height, width and shape was modified by uneven influence of agro-ecological conditions prevailing in corresponding years (Table 1). Since apple is self-incompatible fruit crop, certain impact made by pollenizers (metaxenia effect) on the fruit morphometric properties is presumed (Kumar *et al.*, 2005; Lukić and Marić, 2014), which could have also contributed to a total effect of manifestation of the variability factors interaction.

Table 1. Morphometrical properties of the assessed autochthonous apple genotypes.

FACTOR		Fruit weight (g)	Fruit height (mm)	Fruit width (mm)	Height/width ratio	
CULTIVAR (A)	‘Bošnjanka Sejanac’	99.42 ± 14.86 c ¹	51.67 ± 1.84 c	61.57 ± 3.59 a	0.84 ± 0.02 d	
	‘Jevtović Milutin’	103.48 ± 15.04 bc	54.53 ± 2.62 b	62.44 ± 3.48 c	0.87 ± 0.01 c	
	‘Jusuf Bećović’	113.78 ± 6.56 b	50.77 ± 0.96 c	68.12 ± 1.49 a	0.75 ± 0.00 e	
	‘Tip 3’	135.21 ± 22.08 a	58.51 ± 4.10 a	64.68 ± 5.0 b	0.91 ± 0.01 b	
	‘Valjnika’	86.01 ± 14.35 d	55.22 ± 2.84 b	56.67 ± 3.23 d	0.98 ± 0.01 a	
YEAR (B)	I	75.71 ± 4.34 b	48.73 ± 0.34 b	55.29 ± 1.38 b	0.89 ± 0.02 a	
	II	139.45 ± 6.61 a	59.55 ± 1.40 a	70.10 ± 1.11 a	0.85 ± 0.02 b	
A × B	‘Bošnjanka	I	66.27 ± 1.95 e	47.58 ± 0.57 e	53.55 ± 0.40 d	0.89 ± 0.01 d
	Sejanac’	II	132.57 ± 0.91 b	55.75 ± 0.20 c	69.58 ± 0.29 b	0.80 ± 0.00 f
	‘Jevtović	I	69.92 ± 1.46 e	48.67 ± 0.19 e	54.67 ± 0.03 d	0.89 ± 0.00 d
	Milutin’	II	137.04 ± 1.56 b	60.39 ± 0.18 b	70.21 ± 0.21 b	0.86 ± 0.00 e
	‘Jusuf	I	99.64 ± 3.31 d	48.82 ± 0.74 e	64.91 ± 0.95 c	0.75 ± 0.00 g
	Bećović’	II	127.92 ± 2.07 bc	52.73 ± 0.52 d	71.32 ± 0.05 b	0.74 ± 0.01 g
	‘Tip 3’	I	87.01 ± 5.43 d	49.49 ± 1.48 e	53.59 ± 0.95 d	0.92 ± 0.02 c
		II	183.41 ± 9.28 a	67.54 ± 0.73 a	75.77 ± 1.07 a	0.89 ± 0.00 d
	‘Valjnika’	I	55.69 ± 1.11 e	49.11 ± 0.17 e	49.72 ± 0.25 e	0.99 ± 0.01 a
		II	116.33 ± 10.47 c	61.34 ± 1.74 b	63.63 ± 1.94 c	0.96 ± 0.01 b
ANOVA						
A		* ²	*	*	*	
B		*	*	*	*	
A × B		*	*	*	*	

¹Mean values followed by the different lower-case letters in column represent significant differences.

²*Indicates statistical significance at $P \leq 0.05$, according to LSD test.

The fruit chemical composition of the assessed autochthonous apple genotypes is shown in Table 2. The highest soluble solids content and total sugars were found in ‘Jusuf Bećović’ (15.10% and 12.83%, respectively), whereas inverted sugars and sucrose content ranged from 7.95% (‘Bošnjanka Sejanac’) to 9.52% (‘Jevtović Milutin’) and 2.65% (‘Tip 3’) to 3.75% (‘Bošnjanka Sejanac’), respectively. The fruit of the ‘Tip 3’ genotype is characterised by the highest content of total acids (0.64%), accompanied with the lowest pH value (3.15%). Apple taste is mostly related to the balance between sugars and acids. According to Goodenough and Atkin (1981), the high quality dessert apples are in medium acid category (pH 3.2–3.5) and have a relatively high sugar content (14–16%), whereas the best cooking apples have high acidity (pH 2.8–3.2) and moderate sugar content (11–13%). Since the cultivars with sugar/acid ratio lower than 20 are suitable for processing, genotype ‘Tip 3’ can be recommended for this purpose, whilst ‘Bošnjanka Sejanac’, ‘Jevtović Milutin’, ‘Jusuf Bećović’ and ‘Valjnika’ are suitable for fresh consumption. Slightly higher values of soluble solids content (12.55–19.24%) of some autochthonous apple cultivars collected in southern part of the Republic of Serbia were stated by Mratinić and Fotirić Akšić (2011).

Table 2. Fruit chemical composition of the assessed autochthonous apple genotypes (average for a two-year period).

Genotype	Soluble solids (%)	Sugar content (%)			Total acids (%)	pH value
		Total	Inverted	Sucrose		
‘Bošnjanka Sejanac’	13.98	11.89	7.95	3.75	0.49	3.28
‘Jevtović Milutin’	15.05	12.45	9.52	2.78	0.26	3.71
‘Jusuf Bećović’	15.10	12.83	9.45	3.68	0.47	3.16
‘Tip 3’	14.05	11.33	8.54	2.65	0.64	3.15
‘Valjnika’	14.50	11.83	8.09	3.63	0.13	4.43

The assessed apple genotypes showed a wide range of field susceptibility to scab, powdery mildew and fireblight (Figure 2). With regard to scab susceptibility, the genotypes can be classified into three groups, from 4–6% (2 on the scale) to 76–88% (7 on the scale). ‘Valjnika’ showed low field susceptibility to *Venturia inaequalis* (Cooke) Wint. (2 on the scale). Medium and high scab susceptibility was observed in one (6 on the scale) and three genotypes (7 on the scale), respectively. Regarding susceptibility to powdery mildew, the genotypes were divided into two groups, from 4–6% (2 on the scale) to 7–12% (3 on the scale). All of the studied genotypes showed low mildew susceptibility (ranging from 2 to 3 on the scale). The best performance in terms of field resistance to *Podosphaera leucotricha* (Ell. & Ev.) was observed in ‘Jusuf Bećović’ and ‘Valjnika’ (rated 2 on the scale). Field resistance to fireblight (rated 1 on the scale) was observed in all of the assessed apple genotypes, except for ‘Jevtović Milutin’. This genotype showed medium susceptibility (rated 4 on the scale) to *Erwinia amylovora* (Burnill).

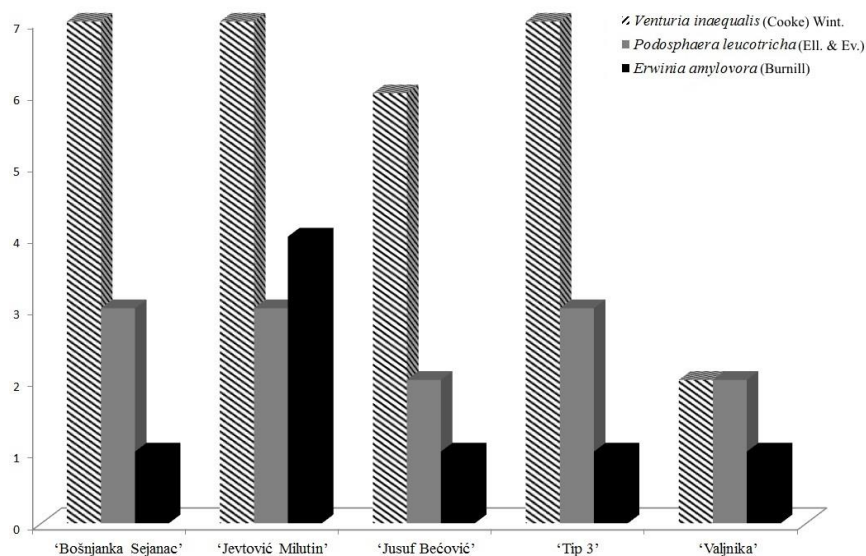

Figure 2. Susceptibility of autochthonous genotypes to causal agents of economically important apple diseases under field conditions.

Conclusions

The assessed autochthonous apple genotypes in this study with useful traits have substantial potential to be used as parents in future apple breeding programmes. Further studies should aim to continue research in the field of collection, evaluation using standard and novel molecular methods, as well as utilization of autochthonous apple genotypes for different purposes.

Acknowledgements

This work was conducted under the Project TR–31064 ‘Development and preservation of genetic potential of temperate zone fruits’, supported by the Ministry of Education, Science and Technological Development of the Republic of Serbia.

References

- Aldwinkle, H.S., Way, R.D., Livermore, K.G., Preczewski, J.L., Beer, S.V. (1976). Fire blight in the Geneva apple collection. *Fruit Varieties Journal*, 30, 42–55.
- Blažek, J., Paprštein, F., Křelinová, J. (2015). Heritability of flowering time within apple progeny. *Czech Journal of Genetics and Plant Breeding*, 51, 23–28.

- Brown, S. (2012). Apples. In Badnes, M.L. & Byrne, D.H. (eds.), "Handbook of plant breeding", Springer, New York, pp. 329–367.
- Egan, H., Kirk, R., Sawyer, R. (1981). The Luff School method. Sugars and preserves. In Egan, H., Kirk, R.S., Sawyer, R. & Pearson, D. (eds.), "Pearson's Chemical Analysis of Foods", Churchill Livingstone, Edinburgh, pp.152–153.
- Gaši, F., Šimon, S., Pojskić, N., Kurtović, M., Pejić, I. (2011). Analysis of morphological variability in Bosnia and Herzegovina's autochthonous apple germplasm. *Journal of Food, Agriculture & Environment*, 9 (3/4), 444–448.
- Goodenough, P.W., Atkin, R.K. (1981). Quality in stored and processed vegetables and fruit. Academic Press, New York.
- IBPGR (1982). Descriptor list for apple (*Malus*). ECSC, EEC, EAEC, Brussels and Luxembourg, and International Board of Plant Genetic Resources, Rome.
- Kumar, R., Sharma, R.L., Kumar, K. (2005). Results of experiments on metaxenia in apple. *Acta Horticulturae*, 696, 43–48.
- Lukić, M., Marić, S. (2014). Effect of pollinisers on pomological properties of the 'Rajka' apple cultivar. *Journal of Mountain Agriculture on the Balkans*, 17, 1510–1526.
- Marić, S., Bošković, R., Tešović, Ž., Lukić, M. (2005). Genetical polymorphism of ACC synthase and ACC oxidase in autochthonous apple cultivars. *Journal of Pomology*, 39, 139–148.
- Marić, S., Bošković, R., Lukić, M. (2007). The polymorphism of *ETRI* gene in autochthonous apple cultivars. *Genetika*, 39, 387–394.
- Marić, S., Lukić, M., Radičević, S., Milošević, N. (2013). Properties of some indigenous apple genotypes grown in region of Serbia. *Acta Horticulturae*, 981, 53–58.
- Marić, S., Lukić, M., Radičević, S. (2015). Determination of *ACSI*, *ACO1* and *ETRI* allelic constitutions in autochthonous apple (*Malus × domestica* Borkh.) genotypes. Book of Abstracts of 2nd International Conference on Plant Biology, 21st Symposium of the Serbian Plant Physiology Society and COST Action FA1106 QualityFruit Workshop, Serbian Plant Physiology Society and Institute for Biological Research „Siniša Stanković“, University of Belgrade, Belgrade, 122.
- Mratinić, E., Fotirić Akšić, M. (2011). Evaluation of phenotypic diversity of apple (*Malus* sp.) germplasm through the principle component analysis. *Genetika*, 43, 331–340.
- Pirlak, L., Güleriyüz, M., Aslantas, R., Esitken A. (2003). Promising native summer apple (*Malus domestica*) cultivars from north-eastern Anatolia, Turkey. *New Zealand Journal of Crop and Horticultural Science*, 31, 311–314.
- Wertheim, S.J. (1996). Methods for cross pollination and flowering assessment and their interpretation, *Acta Horticulturae*, 423, 237–241.
- Zohary, D., Hopf, M. (2000). Domestication of plants in the old world: the origin and spread of cultivated plants in West Asia, Europe and the Nile Valley. Oxford University Press, Oxford.

THE EFFECT OF GENOTYPE ON THE MORPHO-PRODUCTIVE CHARACTERISTICS OF SOYBEAN [*Glycine max.* (L) Merr.] AS SECOND CROP

Dragan TERZIĆ^{1*}, Vera POPOVIĆ², Bora DINIĆ¹, Vera RAJIČIĆ³,
Jela IKANOVIĆ⁴, Tanja VASIĆ¹, Jasmina MILENKOVIĆ¹

¹Institute for Forage Crops, Globoder Kruševac, Serbia

²Institute of Field and Vegetable Crops, Maksima Gorkog 30, Novi Sad, Serbia

³Center of small grains, Save Kovačevića 31, Kragujevac, Serbia

⁴University in Belgrade, Faculty of Agriculture, Nemanjina 6, Zemun, Serbia

*Corresponding author: dragan.terzic@ikbks.com

Abstract

Soybean is one of the most important legumes. Due to the extremely favourable chemical composition of the grain, surfaces under soybean in the world and in Republic of Serbia are showing a tendency to increase. Soybean is cultivated for the production of grain or green fodder, whole plant silage, in regular or second cropping. When cultivated for green fodder and silage, it is grown alone or in a mixture with maize, sorghum, and other crops. As green fodder it retains high quality proteins, vitamins and is useful in feeding livestock. In this study, two soybean varieties with different vegetation were examined in order to determine which one has higher biomass yields when grown as a second crop in agro-ecological conditions of Serbia intended for conservation by ensiling. Based on research results, it is evident that the variety had a statistically significant effect on plant height and dry matter yield. Average dry biomass yield was 5307.17 kg ha⁻¹. Higher dry biomass yield (6630.57 kg ha⁻¹), plant height (64.92 cm), the height of the first pod (7.76 cm) and weight of the plants (130.00 cm) was recorded in the variety with a longer vegetation (Valjevka) while the variety with short vegetation (NS Kaća) had higher percentage of dry matter. The differences obtained were significant, and indicate the possibility of achieving higher plants and higher yields of dry biomass by planting varieties with longer vegetation period as second crop.

Key words: *soybean, second crop, morphological characteristics, biomass yield*

Introduction

Soybean contains is widely used in the diet of humans and domestic farm animals, and in many industries. Soybean is one of the most important legumes that are used in the production of more than 20,000 products for human consumption, in nutrition of domestic farm animals and it is also used for industrial processing. Soybean has huge agro-technical character. Thanks to the symbiosis of soybean with a specific nitrogen-fixing bacteria, *Bradyrhizobium japonicum*, living on its root, it satisfies up to 70% of its nitrogen requirements, and also enriches the soil by this ingredient. Therefore, the soybean is highly valued as the preceding crop in the rotation for many other crops, especially cereals (Popović (2010, 2015), Popović et al. (2013) and therefore plays an important role in the system of climate smart agriculture.

As green fodder it contains high quality proteins, vitamins (A, B1, B2, C, D, E, K) and is useful in feeding livestock (Gagro and Herceg, 2005). All this makes soybean extremely valuable in nutrition of domestic farm animals, especially in combination with silage maize, which has low content of proteins of low biological value. Soybean is cultivated for the production of grain or green fodder, whole plant silage, as regular or second crop. For green fodder or silage it is grown alone or in a mixture with maize, sorghum, and other crops.

Terzić et al. (2001), state that the soybean grown in the system of intercropping with maize and cultivated as a second crop achieved by 16% higher yield (LER = 1.16) than when maize and

soybean crops are grown separately. Terzić et al., (2014) state that a mixture of maize and soybean formed more MJha⁻¹ compared to the mixture of soybean grown with sorghum. Livestock consume readily soybean as fodder, particularly late maturation varieties/cultivars, leafy and with large habitus. Soybean in the green state has favourable impact on smell and taste of milk (Gagro 1997, Glamočlija et al. 2015, Zivanovic & Popovic, 2016). Dinić et al. (1999) state that when biomass soybean silage is mixed with maize the ensiling of soybean is successful and that the share of soybean should not exceed 50%. Market has a wide range of high yielding varieties that can be adapted to the purpose of cultivation. In the main sowing/planting, the varieties of longer vegetation (II, I and 0) are commonly used in regular cropping, and early varieties (00 and 000) in second cropping. In the model of the second crop, varieties of shorter vegetation period are recommended so that they could mature before the end of the season. However, for ensiling, soybean before grains maturation is used and it should be further inquired which soybean varieties are better adapted to such a system of cultivation. In this study, two soybean varieties were examined in order to determine which one has higher yields when grown as a second crop in agro-ecological conditions of Republic of Serbia and is intended for conservation by ensiling.

Material and methods

The studies were conducted in 2015, on the production areas of the Correctional facility for youth in Kruševac. Two varieties were planted: NS Kaća (000 MG) and Valjevka (0 MG). Varieties, NS Kaća and Valjevka, were created at the Institute of Field and Vegetable Crops in Novi Sad. For NS Kaća, the duration of the growing/vegetation period is about 105 days and for Valjevka 120 days. Varieties have coarse grain, with an average weight of 1000 grains of 180-200 g (Popović et al., 2016). The experiment was set up as a single factorial design—the varieties were the factor. The studies were conducted by a block system in five repetitions. Soybean was planted/sowed at a distance of 70 cm. The amount of 30 kg N, 30 kg P₂O₅ and 30 kg K₂O per hectare were incorporated into soil. The crop is grown under irrigation. The following parameters were observed in the research: plant height-stem-cm, height of first pod-cm, the weight of above ground parts of the plant-g, dry biomass yield-kg/ha, participation of leaves, stems and pods, %. The obtained results were analysed by descriptive statistics and analysis of variance using the statistical package Statistica for Windows 12. The most important characteristics are presented in tables and graphs.

Results and Discussion

Meteorological conditions during the trial

The required amount of water necessary during the soybean vegetation period ranges around 450 mm, and is especially important in the summer, June-August, when there were optimal amounts of rainfall (Popović, 2010). The vegetation period of 2015 (April-September) on the territory of Serbia was warmer with less precipitation compared to the multiannual average (Graph 1). Summer 2015 (June-August) was characterized by warmer weather than usual with much less rainfall in relation to multiannual average. In addition to the unfavourable quantity, also the distribution of rainfall during the summer was unfavourable.

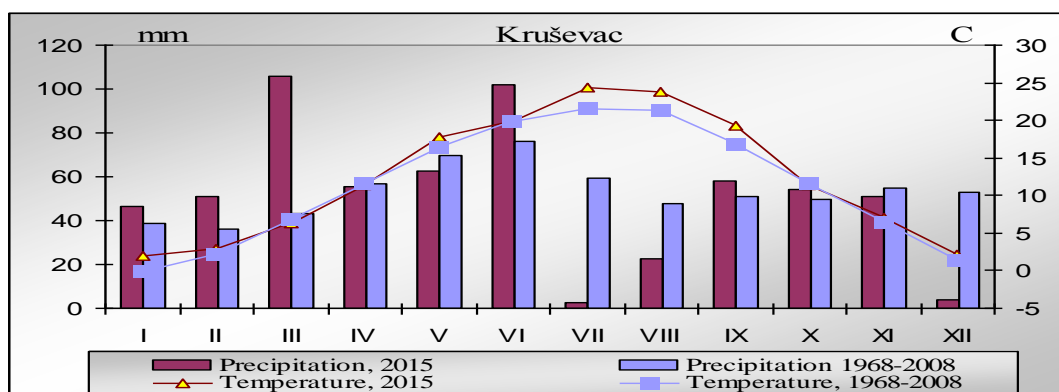

Graph 1. Temperature and precipitation in 2015, Kruševac, Serbia

Morpho-productive traits of soybean for silage

Variety showed statistically significant effect on plant height and dry biomass yield.

Table 1. The effect of the variety on morpho-productive characteristics of biomass soybean

Effect						
Genotype	No. replication	Mean	Std.Dev	Std.Err	-95,00%	+95,00%
Plant height, cm*						
NS Kaća	5	44.52	7.661	3.426	56.686	75.713
Valjevka*	5	64.92	6.107	2.731	37.016	52.183
Height of the first pod, cm						
NS Kaća	20	7.60	1.782	0.796	5.387	9.812
Valjevka	20	7.76	1.479	0.662	5.923	9.597
Plant weight, g						
NS Kaća	5	116.40	29.262	13.087	80.066	152.734
Valjevka	5	130.00	33.369	14.923	88.566	171.433
% Dry matter percentage*						
NS Kaća*	10	30.16	1.643	0.734	28.120	32.199
Valjevka	10	27.12	0.884	0.394	26.022	28.218
Share leaf, %						
NS Kaća	10	16.60	1.140	0.509	15.184	18.016
Valjevka	10	15.80	0.804	0.374	14.461	16.838
Share stem *						
NS Kaća	10	15.10	0.089	0.090	13.989	16.210
Valjevka*	10	20.01	0.158	0.070	18.067	21.963
Share pod						
NS Kaća	5	69.40	7.536	3.370	60.042	78.757
Valjevka	5	64.60	9.266	4.142	53.098	76.101
Dry matter of yield, kg ha ⁻¹ *						
NS Kaća	5	3,983.76	597.15	267.05	3242.2	4725.98
Valjevka*	5	6,630.57	536.32	239.85	5964.64	7296.51

LSD	Plant height	Height of the first pod	Plant weight	Share leaf	Share stem	Share pod	Dry matter percentage	Dry matter of yield
0.5	10.11	2.39	45.77	0.015	0.019	0.123	1.924	827.74
0.1	14.70	3.47	66.59	0.021	0.027	0.179	2.799	1204.28

Significantly higher dry mass yield ($6630.57 \text{ kg ha}^{-1}$), plant weight (130.00g), was recorded for the variety Valjevka compared to the cultivar NS Kaća ($3983,76 \text{ kg ha}^{-1}$), Graphs 2 and 3.

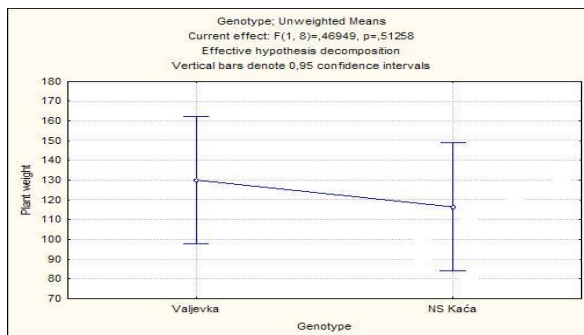
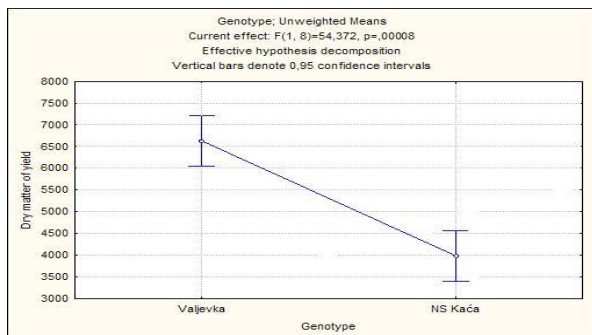

Graph 2 and 3. The effect of the variety on the plant weight and dry matter yield

The differences dry mass yield were significant, and indicated the possibility of achieving higher plants and higher yields of dry mass by planting varieties with longer vegetation period, Tab. 1. The results obtained by Terzić et al. (2001, 2003), are within the mentioned limits; the variety of shorter vegetation/growing period (Danica) grown as a second crop achieving 4563 kg ha^{-1} .

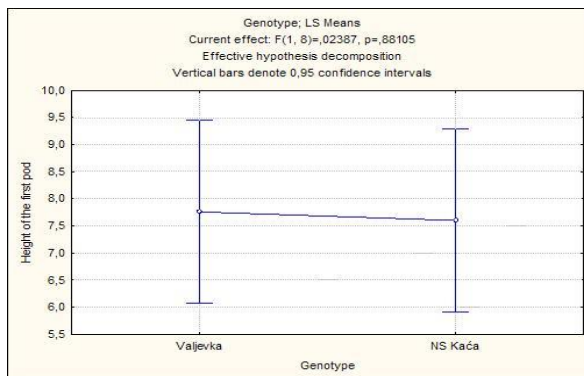
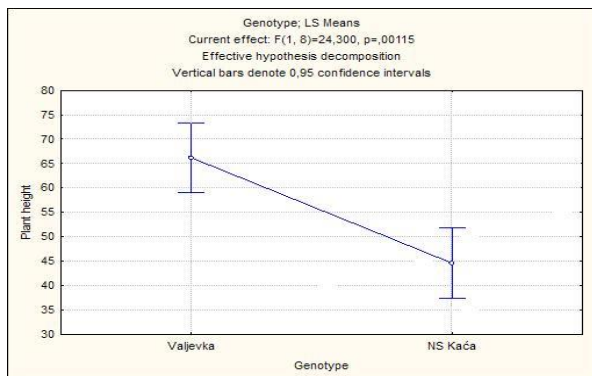

Graph 4 and 5. The effect of the variety on plant height and height if the first pod

Significantly higher plant height (64.92 cm), was recorded for the variety Valjevka compared to the cultivar NS Kaća (44.52 cm), Graph 4. The standard error for the height of the plants was, on average, 4.15 , Table 1, Graphs 4. The average plant height was 54.72 cm , while the plant weight on average was 123.20 g . Weight plants showed a significant correlation with an overall yield (Tab.2). The standard error for the plant weight was on average 0.641 , Table 1, Graph 3.

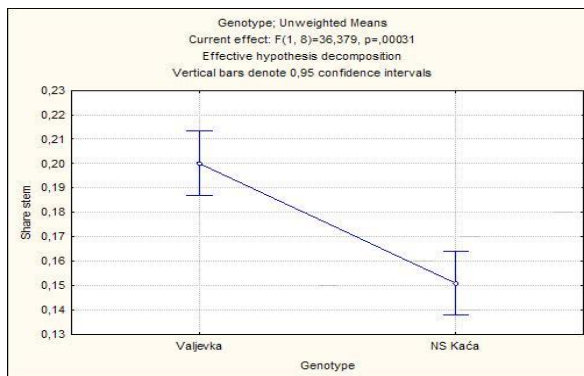
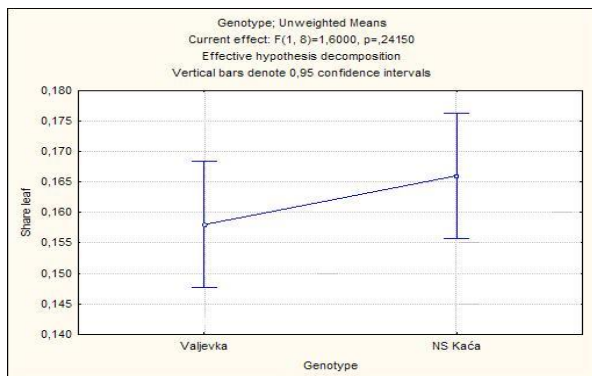

Graph 6 and 7. The effect of variety on the share of leaves and stems

NS Kaća variety had a higher share of pods (69.40%) compared to the variety Valjevka (64.60%), Graph 8. The cultivar Valjevka had a greater height of the first pod (7.76 cm), which is important because of the losses in the ensiling process. It is preferable that the height of the first pod is greater in order to reduce the losses. NS Kaća had higher share of leaves (16.60%) compared to the variety Valjevka (15.80%), Graph 6. The variety Valjevka had a statistically significantly higher share of stems (20.01%) compared to the cultivar NS Kaća (15.10%), Graph 7. Variety NS Kaća showed higher (30.16%) percentage of dry matter, than Valjevka (27.12%) Table 1 and Graph 9. The dry matter difference is statistically significant, but this not much of a influence on the quality of ensilage process.

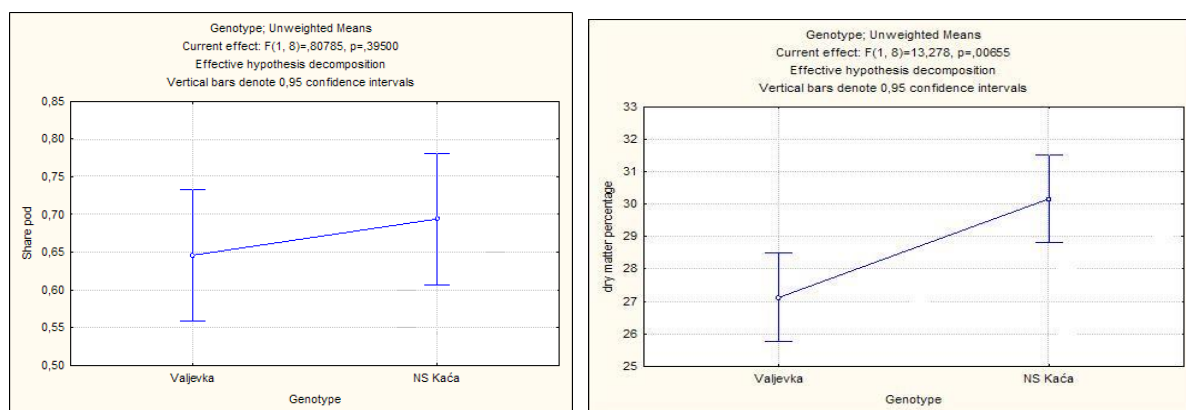

Graph. 8 and 9. The effect of variety on the share of pods and dry matters

Correlations between studied traits/characteristics

Positive correlations between examined parameters of soybean are recorded in the study. The yield of dry matter was highly positively correlated with the plant height ($r = 0.76^*$). Also, a positive significant correlation was achieved between the height of plants and weight ($r = 0.64^*$), Table 2.

Table 2. Correlations between studied traits

Variable	Dry matter of yield	Plant height	Height of the first pod	Plant weight
Dry matter of yield	1.00	0.76*	0.24 ^{ns}	0.08 ^{ns}
Plant height	0.76*	1.00	0.12 ^{ns}	0.64*
Height of the first pod	0.24 ^{ns}	0.12 ^{ns}	1.00	0.14 ^{ns}
Plant weight	0.08 ^{ns}	0.64*	0.14 ^{ns}	1.00

^{ns} - non significant; * - significant at 0.5

Non-significant positive correlations were recorded between other investigated parameters, Table 2. Similar results were obtained in studies and Popović et al. 2012 and 2013. The authors state that the significant interactions of the examined factors suggest that the factors mutually synergized their effects ($p < 0.05$). Yield was positively correlated with oil content (0.37), the height of first pod (0.22) and the plant height (0.07) and negatively correlated with protein content (-0.34) and the 1000-grain weight (-0.27).

Conclusion

Based on the research results, in regard to the silage, and in order to obtain the better yield, the following can be concluded:

- Variety had a statistically significant effect on plant height and dry mass yield.

- Second crops can provide a significant amount of quality forage. The average dry biomass yield was 5307.17 kg ha⁻¹. Higher dry biomass yield (6630.57 kg ha⁻¹), plant height (64.92 cm), the height of the first pod (7.58 cm) and plant weight (129.25 cm) were recorded for the variety Valjevka while the variety NS Kaća had higher percentage of dry matter had.
- The variety NS Kaća had statistically significantly higher percentage of dry matter (30.16%) compared to the variety Valjevka (27.12%).
- Dry matter yield was highly positively correlated with plant height ($r=0.76^*$). Also, a positive significant correlation was realized between the height of plants and weight ($r=0.64^*$).
- Based on the test results of the study of two varieties of different vegetation period, grown as a second crop and intended for biomass production for silage, variety with longer vegetation showed better results in terms of yield per unit area, plant height, plant weight and height of first pod.

Acknowledgement

The study is the result of research realized within the projects: TR 31057 and 166102; financed by the Ministry of education, Science and Technological Development of the Republic of Serbia.

References

- Dinić, B., D. Terzić, N. Đorđević, D. Lazarević, (1999): Effects of individual stubble crops share on silage. Book of Proceedings, IX International Symposium on Forage Conservation, September 6-8, 1999, Nitra, Slovak Republic, pp. 146-147.
- Gargo M., Herceg N. (2005): The impact of a cultivar and planting time on some properties of silage soybean. *Sjemenarstvo*. 22, 3-4, 123-132
- Gagro, M.: Cereals and grain legumes. 1997.
- Glamočlija, Đ., Janković, S., Popović, Vera, Filipović, V., Kuzevski, J., Ugrenović, V. (2015): Alternatively crop plants in conventional and organic growing systems. Monograph. IPN Belgrade Monografija. IPN Beograd. 1-355, 175-180.
- Popović, V. (2010): Influence of agro-technical and agro-ecological practices on seed production of wheat, maize and soybean. Doctoral Thesis, University of Belgrade, Faculty of Agriculture, 1-145, 6-9.
- Popović V., Vidić M., Jocković Đ., Ikanović J., Jakšić S. and Cvijanović G. (2012): Variability and correlations between yield components of soybean [*Glycine max* (L.) Merr.]. - *Genetika*, Vol. 44, No. 1, 33 - 45. DOI: 10.2298/GENSR1201033P
- Popović Vera, Glamočlija Đ., Sikora V., Đekić V., Červenski J., Simić D., Ilin S. (2013): Genotypic specificity of soybean [*Glycine max*. (L) Merr.] under conditions of foliar fertilization. *Romanian agricultural research*, No. 30. 259-270; DII 2067-5720RAR 255
- Popović Vera, Vidić M., Maksimovic L., Đukić V., Antonić Ž., Čobanović L., Kiprovski B. (2016): NS Kaća-Yield and Technological quality of grain. 57th Conference Production and processing of oilseeds, with international participation. Herceg Novi, Montenegro, 19-24. june 2016. p. 51-60.
- Popović M. Vera (2015): The concept, classification and importance of biological resources in agriculture. Editor. Milovanovic Jelena, Đorđević Slađana: Conservation and enhancement of biological resources in the service of ecoremediation. Monograph. Futura. Belgrade. ISBN 978-86-86859-41-9; 1-407. 29-51.
- Terzić, D., Stošić, M., Dinić, B., Lazarević, D., Radović, Jasmina. (2001): Productivity of maize and soybean as mixed crops in double cropping. *Archive of Agricultural Sciences*. Vol. 62, No. 220, 151-159.

- Terzić D., Stošić M., Dinić B., Lazarević D., Radović Jasmina (2003): Productivity of sorghum and soybean as after-crops. 7th International Symposium "Modern Trends in Livestock Production". Biotechnology in Animal Husbandry. Vol 20, 3-4. 171-179.
- Terzić, D., Dinić, B., Stanisavljević, R., Đokić, D., Milenković, J., Vasić, T., Marković, J. (2014): Energy and protein value of mixtures of corn and sorghum with soy bean as intercropping in second crops. XIX Conference on Biotechnology with international participation. Čačak, 07-08. mart 2014. vol. 19, (21), 99-103.
- Živanović Ljubiša & Popović Vera (2016): Production of soybean (*Glycine Max.*) In the world and in the Republic of Serbia. Proceedings of the XXI Conference on Biotechnology with international participation, 11-12. March Čačak, vol. 21 (23), 129-135.

**EFFECT OF THE ENVIRONMENTAL CONDITION ON YIELD AND
AGRONOMIC TRAITS OF THE BREAD WHEAT (*Triticum aestivum* L.)
GENOTYPES**

*İrfan ÖZTÜRK¹, Turhan KAHRAMAN¹, Remzi AVCI¹, Kemal AKIN¹, Adnan TÜLEK¹,
Mehmet AYBEKE², Bülent TUNA¹

¹Trakya Agriculture Research Institute, Edirne, Turkey

²Trakya University, Faculty of Science, Biology Department, Edirne Turkey

*Corresponding author: irfanozturk62@hotmail.com

Abstract

Wheat production area is not to large but environmental factors varies across location. Biotic and abiotic stress affected grain yield and agronomic characters of wheat cultivars. This research was carried out to determine of the yield, some agronomic, quality and leaf disease traits of the bread wheat genotypes. This research was established with 25 genotypes in randomized completely blocks experimental design with 4 replications and at three locations in Edirne, Kırklareli and Lüleburgaz in Trakya region in 2007-2008 growing season. In this research, grain yield, days to heading and days to maturing, plant height, lodging resistance, thousand kernel weight, test weight, protein, sedimentation, leaf rust, powdery mildew, and relationship between these characters were investigated. According to the results it was found significant differences among location, genotypes and studied characters. The mean yield of the genotypes was 664.5 kg/da. Kate A-1 had the highest yield with 753.7 kg/da over three environments. Edirne was the highest yielding (808.3 kg/da) location. Grain yield was significantly negative correlated with protein ratio ($r = -0.689^{**}$). There was a negative correlation between days to heading with TKW ($r = -0.479^*$), protein content ($r = -0.288$) and sedimentation ($r = -0.340$). Also, it was found significant relation between days to maturing and protein content ($r = -0.445^*$) and sedimentation ($r = -0.514^{**}$). Plant height was also correlated with thousand kernel weight ($r = 0.539^{**}$) and test weight ($r = 0.731^{**}$). Leaf rust negatively affected TKW and test weight, also there was negative relation between leaf rust with days to heading and maturing, plant height. The higher infection of Leaf rust was determined in Edirne and there were differences among location and genotypes.

Key words: *Bread wheat, genotypes, yield, quality, leaf disease*

Introduction

Bread wheat is an important crop is grown in Trakya region (Turkey) and it covers 5-6% of the total wheat area of Turkey. Wheat production area is about 650.000 hectares and average wheat yield is almost 5.0 tons/ha per year in the region (Anonymous, 2012). Genotype-environment (GE) interactions are extremely important in the development and evaluation of plant varieties because they reduce the genotypic stability values under diverse environments (Hebert et al., 1995). Almost all breeding programs in the world aim to improve varieties with stable yields. The yield stability is generally grouped as static or dynamic stability (Pfeiffer and Braun, 1989). Consistency in yield has always been a problem in crop production due to the strong influence of environmental effects during the various stages of crop growth (Yan and Hunt, 2001; Viana and Cruz, 2002). In bread wheat varieties for irrigated environments, it must be decided whether to select directly in the irrigated or indirectly in a rainfed environment. In addition, it is concluded that thousand seed weight and test weight values of wheat will be selected by indirect selection in rainfed conditions (Tosun et al., 2006). In

wheat, grain yield and baking quality are dependent on the environment, genetic factors and the interaction between them (Yan; Holland, 2010; Coventry et al., 2011). On the other hand, both the quality and the content of the wheat protein are affected by the climatic conditions during wheat maturation (Johnson et al., 1972; Johansson and Svensson, 1988). Success of a wheat breeding program depends on the regional adaptability of the cultivars improved and adaptability of such cultivars in the target environments determined by its tolerance to biotic and abiotic stresses (Altay, 2012). Leaf rust caused by *Puccinia triticina* is one of the most important and widespread diseases of common wheat (*Triticum aestivum* L.) worldwide. It is adapted to a wide range of environments occurs wherever wheat is grown, and can cause significant yield and economic losses (Wamishe and Milus, 2004). The purpose of the present study was to investigate the some agronomical and quality characteristics of some widely cultivated varieties and advanced lines. In addition to some of biotics stress factors and relationship between these characters were investigated.

Materials and methods

The experiment was conducted at three locations in Trakya region (Turkey) in 2007-2008 growing seasons. Twenty five winter wheat genotypes, 6 of them were local check and 19 advanced lines, were examined under field condition, with RCBD with four replications. All plots were sown into 6 rows, and plot sizes were 6 m² at harvesting. In the experiment 500 seeds/m² was used at planting. Sowings were performed by using a plot drill and fertilizer was applied at three times. Also, chemical was used for weed control.

Table 1. Precipitation and temperature of the 2007-2008 growing year in three locations

Months	Rainfall (mm)			Mean temperature (°C)		
	Edirne	Kırklareli	Lüleburgaz	Edirne	Kırklareli	Lüleburgaz
October 2007	40,5	56,8	22,0	15,2	16,1	15,4
November 2007	147,1	97,3	98,7	8,1	9,1	8,7
December 2007	85,0	53,0	55,0	2,7	3,6	3,2
January 2008	32,4	25,8	30,4	1,1	2,0	1,4
February 2008	2,8	0,3	6,7	4,4	4,4	4,3
March 2008	31,3	49,8	38,3	10,9	9,8	10,1
April 2008	44,1	48,4	62,6	14,3	13,2	13,5
May 2008	33,4	21,4	54,0	18,0	17,1	17,4
June 2008	45,7	68,4	90,4	23,3	22,4	22,7
Total/Mean	462,3	421,2	458,1	10,9	10,9	10,8

In this research; grain yield, plant height, days of heading and maturing were investigated. Also, 1000 kernel weights, test weight, protein ratio (Perten H. 1990) and sedimentation (Köksel et al., 2000; Anonymous, 1990) were investigated. The genotypes evaluated under natural field condition and reaction types and rust levels scored using the Modified Cobb scale (Peterson et. al., 1948; Roelfs et al., 1992; Saari and Prescott, 1975; Stubbs et al., 1986; Prescott et al., 1986) in three locations. A uniform epidemic was achieved and susceptible genotypes were rated as 80-100S. For powdery mildew (Jin Y., 2011; McIntosh et al., 1995) determining double digit (00-99) scale was used. The statistical analyses of measurements data was performed by using statistics program and the differences among the means were compared with LSD at a 5% significant level (Kalaycı, 2005).

Results and discussion

The results of variance analysis are presented in Table 2. There was statistically difference among genotypes in yield according to all locations. The mean yield was 664.5 kg/da. According to location the highest yield were obtained in Edirne (808.3 kg/da) and the lowest yield in Kırklareli with 452.6 kg/da. The highest grain yields were determined in Kate A-1 cultivar with 753.7 kg/da. Other highest yielding genotypes were Gelibolu and entry number 22, 23 and 24 lines. Based on GxE interaction the highest yield was determined in Kate A-1 and Gelibolu cultivars with 936.8 kg/da and 903.0 kg/da respectively in Edirne location.

Table 1. The determined Leaf rust and Powdery mildew incidence according to locations

Entry No	Genotypes	Powdery mildew (0-99)			Leaf rust		
		Edirne	Kırklareli	L.Burgaz	Edirne	Kırklareli	L.Burgaz
1	Bezostaya	44	69	21	20S	TR	5R
2	TE5519-2	42	77	21	5R	0	TR
3	TE5519-3	32	58	31	5R	0	TR
4	TE5402-4	35	89	55	0	0	TR
5	Pehlivan	33	88	45	60S	TR	10MS
6	OK81306/STAR-6	22	65	44	TR	0	TR
7	OK81306/STAR-7	43	74	43	0	0	TR
8	OK81306/STAR-8	57	88	63	TR	0	TR
9	TE5554-9	57	68	22	60S	0	TR
10	Flamura-85	41	79	21	60S	TR	10MS
11	TE5393-11	42	69	41	10MR	0	5R
12	TE5605-12	43	69	53	40S	5R	10MS
13	TCI001183-13	21	88	63	20S	5R	5R
14	TCI001117-14	0	37	34	0	0	0
15	Kate A-1	0	58	35	80S	TR	40S
16	TCI001136-16	0	32	0	80S	40S	40S
17	TCI001136-17	0	42	0	80S	20S	60S
18	TCI001136-18	0	32	0	80S	60S	40S
19	TCI001257-19	44	68	64	80S	40S	10MS
20	Gelibolu	35	58	55	20S	10MS	10MS
21	TCI001257-21	42	67	67	60S	20S	10MS
22	CMSW97WM00518S-22	42	33	54	5R	0	TR
23	CMSW97WM00518S-23	0	21	11	5R	0	5R
24	CMSW97WM00518S-24	0	21	43	10MR	0	5R
25	Tekirdağ	42	43	32	TR	TR	5R

Wheat leaf rust is the most destructive and widespread diseases in Trakya region and susceptible cultivars leading to serious yield losses. There were differences among location according to leaf rust (*Puccinia recondita*) infection. There is a high incidence of wheat leaf rust in Edirne location because of suitable environmental condition in spring, and disease severities on susceptible varieties reached 80%. In Kırklareli and Lüleburgaz location there is generally a low incidence. Among genotypes ten genotypes were resistant in Edirne location including Tekirdağ cultivar. Nineteen genotypes were resistant to leaf rust in Kırklareli and fifteen genotypes were resistant, 6 genotypes moderately resistant to leaf rust in Lüleburgaz location. Five genotypes were resistant to leaf rust at three locations (Table 1).

Powdery mildew is considered of economic significance only in areas with high rainfall where the climate is favourable for disease. Powdery mildew caused by *Bluminera graminis* DC f. sp. *tritici* is an important disease of wheat (*Triticum aestivum*) growing area. Powdery

mildew disease usually occurs from February to April depending on the growing area, variety planted, and environmental conditions in Trakya region. There were differences among location and genotypes according to powdery mildew (*Blumeria graminis*) infection. In this study especially suitable environmental condition high infection of powdery mildew occurred in Kırklareli location. Five genotypes (entry number 16, 17, 18, 23 and 24 lines) and Tekirdağ cultivar tolerant to powdery mildew over three locations (Table 1).

Table 2. Correlation coefficients among the tested characters of the cultivars

Traits	GY	DH	DM	PH	LOD	TKW	TW	PRT	SED	PM
DH	0.029									
DM	0.003	0.818**								
PH	0.150	-0.234	0.028							
LOD	-0.007	-0.363	-0.092	0.931**						
TKW	-0.065	-0.479*	-0.208	0.539**	0.528**					
TW	0.187	-0.151	0.163	0.731**	0.634**	0.688**				
PRT	-0.689**	-0.288	-0.445*	-0.037	0.080	-0.023	-0.335			
SED	-0.175	-0.340	-0.514**	-0.057	-0.011	0.137	-0.169	0.315		
PM	-0.312	-0.107	0.225	0.082	0.081	0.563**	0.374	0.017	-0.264	
LR	-0.002	-0.302	-0.439*	-0.384	-0.355	-0.402*	-0.382	0.281	0.304	-0.353

Note: Significance at **: $P < 0.01$ and *: $P < 0.05$; GY: Grain yield (kg/da), DH: Days of heading, DM: Days of maturing, PH: Plant height (cm), LOD: Lodging resistance (1-9), TKW: Thousand kernel weight (g), TW: Test weight (kg), PRT: Protein ratio (%), SED: Sedimentation (ml), PM: Powdery mildew (0-99), LR: Leaf rust

In this study it was investigated in order to determining correlation coefficient of the characters. It was found significant relation among investigated parameters. There was slightly positive relation between grain yield and plant height ($r=0.150$), test weight ($r=0.187$) and negative relation with powdery mildew ($r=-0.312$). It was found significant negative relation between grain yield and protein ratio ($r = -0.689$). Days to heading was also negative correlated with thousand kernel weight ($r= -0.479^*$), protein content ($r= -0.288$) and sedimentation ($r= -0.340$). Also it was found significant negative relation between days to maturing and protein content ($r= -0.445^*$) and sedimentation ($r= -0.514^{**}$). These results showed that earliness in genotypes have advantages for better quality. There was positive highly significant correlation between plant height and 1000-kernel weight ($r= 0.539^{**}$) and test weight ($r= 0.731^{**}$). Leaf rust in genotypes negatively affected almost all parameters yield, plant height, TKW and test weight, excepted protein ratio and sedimentation. Leaf rust was negative correlated with days to heading and days to maturing (Table 2).

Plant height is an important trait to evaluation genotypes especially for lodging resistance. Lodging is one of the mainly problem in Trakya region. In this study plant height ranged from 71.7 cm up to 115.0 cm and mean was 90.7 cm. Earliness is other important characters because of to grow forage crops within same growing cycle in the region. There was significant difference among genotypes according to earliness. Mean of the heading days was 125.6 days and maturing days 164.4 days. Heading days ranged from 120.3 days up to 133.3 days and maturing days from 161.7 to 170.3 days (Table 3).

Some quality parameters were investigated. These characters are affected by environmental conditions, agronomic practice and genotypic traits. Grain weight and test weight in wheat varies by cultivar x genotypes interactions. There was a wide variability both in thousand kernel weights and test weight. In this study 1000 kernels weights ranged between 27.5 g (Entry 18) and 44.0 g (Pehlivan). The mean thousand kernels weights was 35.9 g. (Table 3).

Table 3. The mean value of the agronomic, physiological, morphological and quality characters of the genotypes

Entry No	Genotypes	GY	PH	LOD	DH	DM	TKW	TW	PRT	SED
1	Bezostaya	565.5 l	115.0 a	7.7 a	126.3 c-f	166.3 bcd	40.8 bcd	82.8 a	15.0 a	48.0 a-e
2	TE5519-2	646.7 f-j	95.0 c-f	6.0 bc	122.7 e-h	163.0 fg	37.0 f-j	79.3 c-g	14.4 a-e	44.0 c-1
3	TE5519-3	636.8 g-j	100.0 bcd	5.7 bcd	123.7 e-h	163.3 efg	38.0 d-1	79.9 b-g	14.7 abc	42.3 d-1
4	TE5402-4	670.7 d-1	91.7 efg	4.3 de	122.0 fgh	161.7 g	42.3 ab	80.6 a-f	13.7 b-h	46.3 b-g
5	Pehlivan	667.0 e-1	100.0 bcd	4.7 cde	123.3 e-h	162.3 fg	44.0 a	81.0 a-d	13.7 b-g	40.3 g-j
6	OK81306/STAR”S”-6	665.0 e-1	91.7 efg	3.3 ef	127.3 b-e	166.0 cd	36.2 hij	77.7 gh	14.0 a-f	39.7 g-j
7	OK81306/STAR”S”-7	693.1 cde	95.0 c-f	3.3 ef	125.3 d-h	165.7 cde	36.4 g-j	78.4 efg	13.8 b-g	39.3 g-j
8	OK81306/STAR”S”-8	632.8 hij	86.7 g	2.3 fg	129.0 a-d	167.0 bc	31.1 m	78.9 d-g	13.4 e-1	37.3 ij
9	TE5554-9	615.8 jk	76.7 h	1.0 g	122.0 fgh	162.0 fg	38.3 c-1	79.0 d-g	13.8 b-g	48.0 a-e
10	Flamura-85	645.8 f-j	93.3 d-g	4.3 de	121.3 fgh	163.0 fg	40.1 b-e	81.0 a-d	13.6 c-h	52.7 ab
11	TE5393-11	631.8 ij	101.7 bc	4.3 de	124.0 d-h	164.3 def	41.1 abc	78.8 d-g	14.3 a-e	54.3 a
12	TE5605-12	669.3 d-1	71.7 h	1.0 g	125.3 d-h	166.0 cd	37.0 f-j	77.9 gh	12.4 ij	45.0 c-h
13	TCI001183-13	582.4 kl	76.7 h	1.0 g	133.3 a	170.3 a	30.3 mn	78.2 fg	13.8 b-g	33.7 j
14	TCI001117-14	674.8 c-g	105.0 b	7.0 ab	126.0 c-g	166.3 bcd	35.4 ijk	79.1 c-g	12.1 j	43.3 c-1
15	Kate A-1	753.7 a	113.3 a	6.7 ab	121.0 gh	163.3 efg	34.7 jkl	81.9 ab	13.0 f-j	41.0 e-1
16	TCI001136-16	642.7 g-j	73.3 h	1.0 g	124.7 d-h	162.0 fg	28.0 n	75.6 h	14.5 a-e	48.7 a-d
17	TCI001136-17	648.5 f-j	75.0 h	1.0 g	124.7 d-h	162.0 fg	27.7 n	75.6 h	14.7 ab	48.3 a-d
18	TCI001136-18	659.7 e-1	76.7 h	1.0 g	124.7 d-h	162.0 fg	27.5 n	75.4 h	14.6 a-d	49.7 abc
19	TCI001257-19	671.7 d-h	88.3 fg	2.3 fg	125.7 d-g	165.7 cde	38.9 c-h	80.5 a-f	13.5 e-1	47.7 a-f
20	Gelibolu	708.2 bcd	96.7 cde	4.0 e	120.3 h	164.3 def	39.6 b-f	81.6 abc	12.1 j	40.7 f-j
21	TCI001257-21	675.2 c-g	86.7 g	2.3 fg	126.0 c-g	166.3 bcd	37.7 e-j	80.7 a-e	12.8 g-j	39.0 hij
22	CMSW97WM518S-22	712.0 bc	88.3 fg	2.3 fg	134.0 a	168.7 ab	32.6 klm	79.6 b-g	12.6 hij	45.0 c-h
23	CMSW97WM518S-23	746.9 ab	91.7 efg	2.3 fg	131.0 abc	166.7 bcd	32.9 klm	80.7 a-e	12.0 j	37.7 ij
24	CMSW97WM518S-24	713.1 bc	90.0 efg	2.3 fg	131.7 ab	167.0 bc	32.3 lm	79.7 b-g	12.0 j	48.0 a-e
25	Tekirdağ	683.0 c-f	88.3 fg	2.3 fg	125.7 d-g	162.7 fg	39.4 b-g	79.0 d-g	13.5 d-1	48.7 a-d
Mean		664.5	90.7	3.3	125.6	164.4	35.9	79.3	13.5	44.3
CV (%)		39.4	4.5	3.3	2.4	0.9	5.2	2.0	4.9	10.0
LSD (0.05)		7.5	6.7	1.6	5.1	2.4	3.0	2.5	1.1	7.3
F		**	**	**	**	**	**	**	**	**

Note: Significance at **: P<0.01 and * :P<0.05; GY: Grain yield (kg/da), PH: Plant height (cm), LOD: Lodging resistance (1-9), DH: Days of heading, DM: Days of maturing, TKW: Thousand kernel weight (g), TW: Test weight (kg), PRT: Protein ratio (%), SED: Sedimentation (ml)

Test weight of the genotypes ranged between 75.4 kg and 82.8 kg, while mean test weight was 79.3 kg. The highest test weight was obtained from Bezostaya, which is followed by Kate A-1, Gelibolu and Pehlivan cultivars (Table 3). Table 3 shows mean and ranges of variation for protein ratio in all genotypes were evaluated during 2007-2008 at three locations. Protein ratio ranged from 12.0% to 15.0% among genotypes and mean protein was 13.5%. The highest protein ratio was measured in Bezostaya cultivar. Sedimentation ranged in genotypes from 33.7 ml to 54.3 ml and the highest test weight scaled in entry number 11 and Flamura-85 genotypes. The mean sedimentation was 44.3 ml (Table 3).

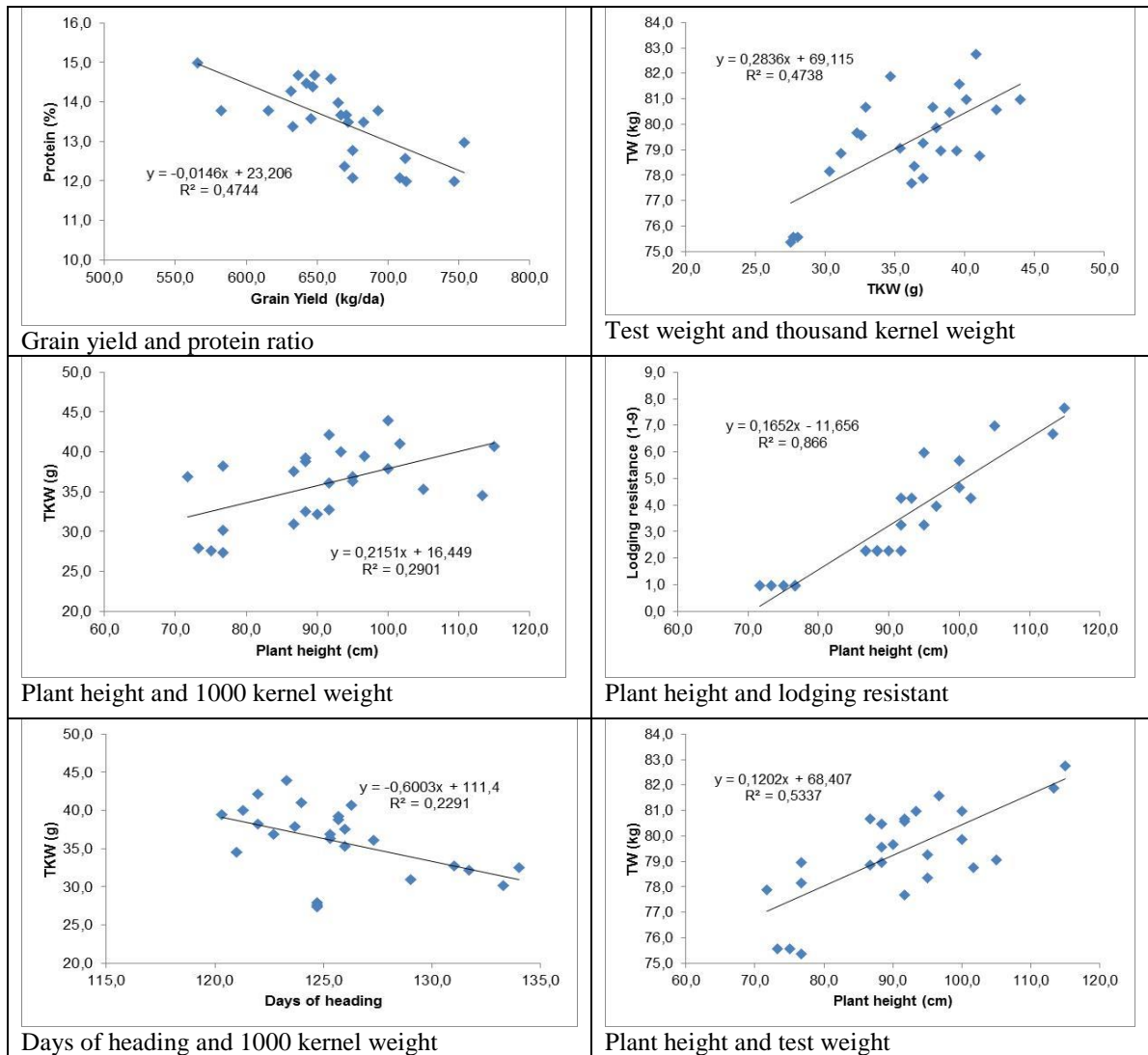

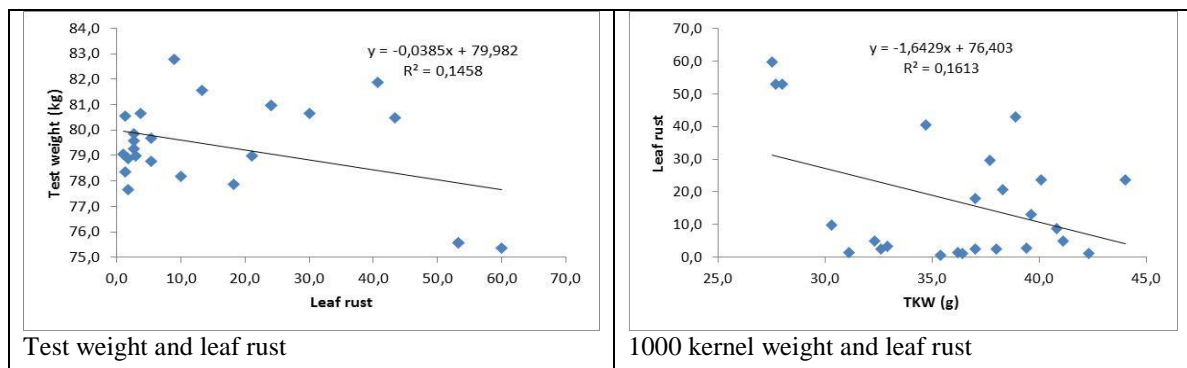

Figure 1. Relationship between some investigated characters

Grain yield, some physiological, agronomic and quality traits which was investigated in this study, was affected from environmental fluctuations. In this research these characters were examined and assessed for relationship amongst them. As it expected there was negatively relation between grain yield and protein ratio ($R^2=0.474$), and positive relationship between grain yield and plant height ($R^2=0.473$). It was found highly positive relation between plant height and lodging resistant ($R^2=0.866$), it means that genotypes which have short plant height resistant to lodging. There was negative relation between earliness and 1000 kernel weight ($R^2=0.229$) (Figure 1). Leaf rust in wheat negatively affected and decreased test weight and thousand kernel weight.

Conclusion

Wheat yield potential in Trakya region changes across region due to various environmental conditions. Because of various environmental conditions there was significant difference among genotypes and locations over studied characters. Grain yield was significantly negative correlated with protein ratio. There was a negative correlation between days to heading with thousand kernel weight, protein ratio and sedimentation value. Also, it was found significant relation between days to maturing and protein content and sedimentation value. These results showed that earliness in genotypes have advantages for better quality in Trakya region. Plant height was also positive correlated with thousand kernel weight and test weight. The higher infection of leaf rust was determined in Edirne and there were differences among location and genotypes. Leaf rust in genotypes negatively affected almost all parameters grain yield, thousand kernel weight and test weight. Leaf rust negatively affected and reduced 1000-kernel weight and test weight. Also, there was negative relation between leaf rust with days to heading and maturing so earliness in genotypes has disadvantages for rust disease in Trakya region.

References

- Akçura M, and Kaya Y. 2008. Non-parametric stability methods for interpreting genotype by environment interaction of bread wheat genotypes (*Triticum aestivum* L.). *Genetics and Molecular Biology*, 31, 4, 906-913.
- Altay F. 2012. Yield stability of some Turkish winter wheat (*Triticum Aestivum* L.) genotypes in the western transitional zone of Turkey. *Turkish Journal of Field Crops*, 2012, 17(2): 129-134
- Anonymous, 2012. Trakya Tarımsal Araştırma Enstitüsü. Araştırma Projeleri Raporu. Edirne. (unprinted) (Trakya Agr. Res. Inst Report of the Project. Edirne, Turkey)
- Coventry D. R, Gupta R. K, Poswal R. S, Chhokar R. S, Sharma R. K, Yadav V. K, Gill S. C, Mehta A, Kleemann S. G. L, Bonamano A, Cummins J. A. 2011. Wheat quality and

- productivity as affected by varieties and sowing time in Haryana, India. *Field Crops Research*, v. 123, n. 3, p. 214-225,
- Eberhart S.A, and Russell W.A. 1966. Stability parameters for comparing varieties. *Crop. Sci.*6: 36-40.
- Finlay K.W, and Wilkinson G.N. 1963. The Analysis of Adaptation in a Plant Breeding Programme. *Aust. J. Agric.Res.*, 14: 742-754.
- Hebert Y, Plomion C, and Harzic N. 1995. Genotypic x environment interaction for root traits in maize as analysed with factorial regression models. *Euphytica* 81: 85-92
- Jin Y. 2011. Role of *Berberis* spp. as alternate hosts in generating new races of *Puccinia graminis* and *P. striiformis*. *Euphytica* 179:105–108.
- Johnson J.A, Khan M, Sanchez C.R. 1972. Wheat cultivars, environment and bread-making quality. *Cereal Sci. Today*, 17, 323–326.
- Johansson E, and Svensson G. 1998. Variation in bread making quality: Effect of weather parameters on protein concentration and quality in some Swedish wheat cultivars grown during the period 1975–1996. *J. Sci. Food Agric.* 78, 109–118.
- Kalaycı M. 2005. Örneklerle Jump Kullanımı ve Tarımsal Araştırma için Varyans Analiz Modelleri. Anadolu Tarımsal Araştırma Enst. Müd. Yayınları. Yayın No: 21. Eskişehir. (Example for Jump Use and Variance Analysis Model for Agricultural Research. Anotolia Agr. Res. Inst, Pub. No: 21 Eskişehir, Turkey).
- Köksel H, Sivri D, Özboy O, Başman A, Karacan H.D. 2000. Hububat Laboratuvarı El Kitabı. Hacettepe Üni. Müh. Fak. Yay. No: 47, Ankara. (Handbook of the Cereal Laboratory. Hacettepe Uni. Fac. of Eng. No: 47, Ankara, Turkey).
- McIntosh R.A. 1998. Breeding wheat for resistance to biotic stresses. In H.J. Braun *et al.*, eds. *Wheat prospects for global improvement*, p. 71-86. Dordrecht, Netherlands, Kluwer Academic Press.
- Peterson R.F, Campbell A.B, and Hannah A.E. 1948. A diagrammatic scale for estimating rust intensity on leaves and stems of cereals. *Can. J. Res.*, 2: 496-500.
- Perten H. 1990. Rapid Measurement of Wheat Gluten Quality by the Gluten Index, *Cereal Foods World*, 35: 401-402.
- Pfeiffer W.H, Braun H.J. 1989. Yield stability in bread wheat. In J.R. Anderson and P.B Hazel, eds. *Variability in Grain Yields*. Washington D.C.: John Hopkins Univ. and the Int. Food Policy Res. Inst.
- Prescott J.M, Saari E.E, and Dubin H.J. 1986. *Cereal Disease Methodology Manual*, CIMMYT, Mexico, 46 p.
- Roelfs A.P, Singh R.P, and Saari E.E. 1992. *Rust Diseases of Wheat: Concepts and Methods of Diseases Management*, 81 P., Mexico.
- Saari E.E, and Prescott J.M. 1975. A scale for appraising the foliar intensity of winter wheat diseases. *Plant Dis. Rep.*, 595: 337–380.
- Wamische Y.A, and Milus E. A. 2004. Seedling resistance genes to leaf rust in soft red winter wheat. *Plant Dis.* 88:136-146.
- Viana J.M.S, and Cruz C.D. 2002. Analysis of stability and adaptability through different models of linear regression. *Cienc Agrotec Lavras*, 26: 455-462.
- Yan W, and Hunt L.A. 2001. Interpretation of genotype x environment interaction for winter wheat yield in Ontario. *Crop Sci.*, 41: 19-25.
- Yan W. Holland J. B. 2010. A Heritability-adjusted GGE biplot for test environment evaluation. *Euphytica*, v. 171, n. 3, p. 355-369.

EVALUATION of SOME SESAME (*Sesamum indicum* L.) VARIETIES' PERFORMANCES UNDER MICRO-CLIMATE CONDITIONS of IGDİR-TURKEY

Tamer ERYIGIT^{1*}, Ali Rahmi KAYA², Murat TUNCTURK³, Resit ALDEMİR⁴, Bunyamin YILDIRIM⁵

¹Yuzuncu Yil University, Gevas Vocational School, Department of Plant and Animal Production, TR-65700 Van-Turkey

²Kahramanmaraş Sutcu Imam University, Faculty of Agricultural, Department of Field Crops, TR-46000 Kahramanmaraş-Turkey

³Yuzuncu Yil University, Faculty of Agricultural, Department of Field Crops, TR-65080 Van-Turkey

⁴University of Yuzuncu Yil, Gevas Vocational School, TR-65700 Van-Turkey

⁵Iğdir University, Faculty of Agricultural, Department of Field Crops, TR-76000 Iğdir-Turkey

*Corresponding Author: tamyigit@hotmail.com

Abstract

The yield of any crop is directly or indirectly a function of the interaction between the crop's genotype and the existing climatic and ecological factors. This study was carried out to determine the performances of some sesame cultivars under Iğdir plain ecological conditions in Iğdir - Turkey, 2012. Cumhuriyet-99, Kepsut-99, Muganlı-57, Orhangazi-99, Osmanlı-99, Tan-99, Tur-S-90 and Tur-S-203 varieties were used as trial materials. The study was conducted in the Randomized Blocks Experimental Design with three replications to investigate plant height, number of branch per plant, first pod height, pod length, pod width, number of pod per plant, number of seed per pod, 1000 seed weight and seed yield. Results of experiment revealed that all investigated properties showed significant differences among the genotypes. Plant height varied among 121.0-147.1 cm, number of branch 3.6-7.2, first pod height 43.6-67.1 cm, pod length 25.3-28.6 mm, pod width 4.8-6.5 mm, number of pod per plant 56.1-125.5, number of seed per pod 53.2-72.3, 1000 seed weight 2.85-3.67 g and seed yield 523.3-1005.9 kg ha⁻¹. The highest seed yields were obtained from Orhangazi-99 while the lowest seed yield was recorded from Tan-99.

Keywords: *Sesame, Sesamum indicum, variety, yield, yield components*

Introduction

Sesame (*Sesamum indicum* L., Pedaliaceae) is an important ancient annual spice and oilseed crop which is widely cultivated all over the world for its seeds. Sesame seeds contain about 40-60% (Doğan and Zeybek, 2009) oil and 20-30% of protein (Öz and Karasu, 2010). In general, it has high stability and quality oil which contains about 47% oleic acid (C18:1), 39% linoleic acid (C18:2), 9.0% palmitic acid (C16:0), 4.1% stearic acid (C18:0), and 0.7% arachidic acid (C20:0) (Weiss, 1983). As a "queen of oilseeds" (Al-Yemeni *et al.*, 2000), it was cultivated during ancient Harappan, Mesopotamian, and Anatolian eras, and throughout the Graeco-Roman world (Bedigian, 2003) for its high oil yield, mildness and pleasant taste (Al-Yemeni *et al.*, 2000) and also because of its rich and nutty flavor it is a common ingredient in cuisines across the world (Obiajunwa *et al.*, 2005). As a good source of protein and fat for humans and livestock (Adebisi *et al.*, 2005) sesame seeds are also used in baking and making candy, while its oil in addition to cooking is used in the manufacture of perfumes, pharmaceuticals, soaps, insecticides, paints (Alege *et al.*, 2013; Amara *et al.*, 2008).

Sesame has many species, most of them are wild and native to Turkey. The cultivated type is *Sesamum indicum* which originated in India and is tolerant to drought-like conditions, where other crops fail in Turkey. Sesame is known as a medicinal and spice oilseed crop in Turkish culture. Because of its high production cost and low yield, it has a limited production, therefore, its oil is not commonly used in meals in Turkey, instead, its seeds are mostly used in tahini and halvah production and also, sesame is the only condiment of world famous the Turkish bagel (simit). Despite, its most and widely consumption, the sesame production is far below the need of the country. Turkey sesame production deficit are tried to close by imports whereas even the half of annual needs of Turkey cannot be provided (Doğan and Zeybek, 2009; Şahin, 2014).

It is one of warm-season crops, and must be sown after last frost days; it adapts well to high temperatures, but it cannot tolerate waterlogged soil (Bedigian and Harlan, 1986). It need optimum 20-25 °C of soil temperature for germination. So in eastern Anatolia only some plain which has microclimate conditions ensure this temperature during germination in spring months. Therefore, it is necessary to determine the varieties with high seed yield in ecology where it can grow well. Iğdır plain is one of the most suitable one where sesame can easily be cultivated.

The aim of this study was to evaluate the best sesame cultivar which could be well adapted to conditions of Iğdır Plain (Turkey).

Material and Methods

Iğdır is a province in eastern Anatolia-Turkey, located along closed border with Armenia which follows Aras River, Azerbaijan (the area of Nakhichevan Autonomous Republic), and Iran. Its adjacent provinces are Kars to the northwest and Ağrı to the west and south. It occupies an area of 3.587 km². Because of its mountains, Eastern Anatolia average altitude is approximately 2 000-2 200 m. Therefore, it was called as “Roof of Turkey”. Turkey's highest mountain, Mount Ararat (Ağrı Dağı) is in Iğdır, but much of the land is a wide plain far below the mountain which has lowest altitude (850 m) of Eastern Anatolia Region-Turkey. Therefore, it has a warmest climate in this part of Turkey where cotton can be grown.

The study was carried out at the trial field of Agricultural Research and Training Center (lat. 39° 55'-N, long. 44° 5'-E and the alt. 851 m above sea level) of the Iğdır University, Turkey during 2012 growing season in order to compare the sesame varieties adaptation performance according to some quantitative properties (plant height, number of branch per plant, first pod height, pod length, pod width, number of pod per plant, number of seed per pod, 1000 seed weight and seed yield).

The soil samples, where the research took place, were taken to identify physical and chemical characteristics of the research field which results are presented in Table 1.

Table 1. The soil characteristics of the research field

Soil texture (Type)	EC (mmhos/cm)	pH	Lime (CaCO ₃) (%)	Total N (%)	Organic matter (%)	Available plant nutrients (kg ha ⁻¹)	
						P ₂ O ₅	K ₂ O
Clay - Loam	1.85	7.99	11.81	0.98	2.1	34	271

As can be seen in Table 1, the soil type is clay-loam with a pH of 7.99 and low organic matter. The meteorological data during the study periods in 2012 are presented in Figure 1. The averages of monthly mean temperatures during the growing period (April-September) consistently higher than Long Term (LT). The higher temperatures were observed during the reproductive stages. As

seen in Figure 2, the total precipitation (153.2mm) of 2012 was approximately similar to the long-term. Monthly precipitation differed in 2012 at the growth stages. During the vegetative stages (May, July and September), the crops received higher precipitation in 2012 than in LT. However, the plants received lower precipitation during reproductive stages (April, June and August) in 2012 compared to LT (Figure 2). The average of relative humidity (64.2 %) of 2012 was higher than the LT average (48.4).

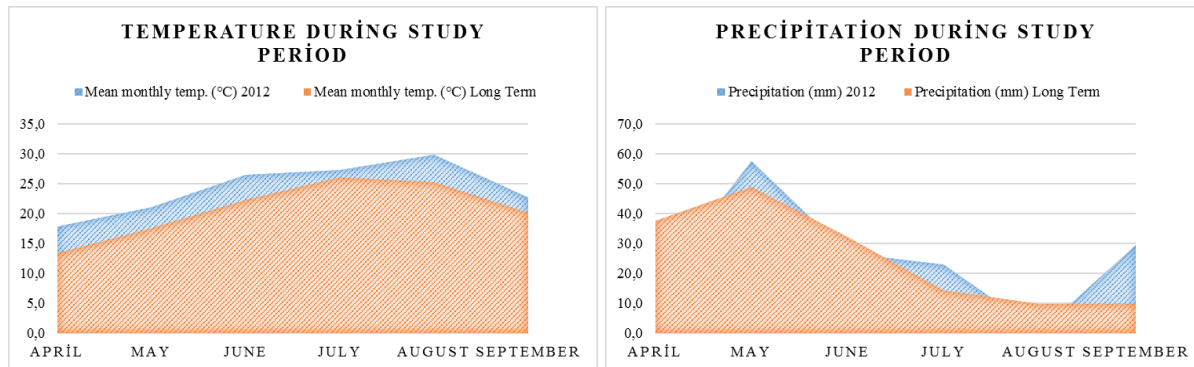

The study was conducted with a total of 8 varieties containing yellow (Tur-S-90, Tur-S-203, Munganlı-57 and Orhangazi-99) and white (Cumhuriyet-99, Kepsut-99, Osmanlı-99 and Tan-99)(Tan, 2011) sesame groups in 2012 growing season in Iğdır Plain based on Randomized Complete Block Design with three replications. The experimental plots consisted of four rows 4 m in length 65 cm apart and were sown by hand at 30 May in 2012. Sprinkler irrigation was maintained immediately after sowing and thereafter used when necessary based on soil and plants conditions. Nitrogen, phosphorus and potassium were applied at a rate of 70kg ha⁻¹ at sowing. The half of nitrogen fertilizer was applied during seedbed preparation, and the other was applied while the plant height was approximately 30 cm. After emergence, thinning was done to obtain row distances (15 cm) and weeding was applied before stem elongation manually.

Yield and yield components data were determined on 10 plants randomly selected from two middle rows in each plot where the harvesting areas determined after deletion of the plot sides and 30cm from the top and bottom of two middle rows.

The variance analysis of data for each properties and analysis of the randomized complete block design were computed using the IBM SPSS computer program (v.23.0). The LSD multiple range tests were used to test the significance of main effects at the 5 % level of probability. The Spearman correlation equation between the traits mean as the dependent variables of sesame as the independent variable are calculated.

Results and Discussion

Table 2 shows the comparisons of varieties according to the plant height, number of branch per plant, first pod height, pod length, pod width, number of pod per plant, number of seed per pod, 1000 seed weight and seed yield.

Plant height: The means comparison for this trait (Table 2) indicated that sesame in 2012 was faced a more favorable thermal and moisture regime (Figure 1 and 2). The plant height had a significant (%5) difference among the varieties. This could be due to the differential response of varieties to environmental conditions based on their genetic variations (de la Vega, 1996). The plant heights differed from 121.0-147.1 cm. The highest plant was observed from Tur-S203

which had no statistically difference with Muganlı-57, Tur-S-90, Orhangazi-99 and Kepsut-99 (146.63, 146.50, 145.87 and 144.47 cm), respectively and the shortest plants were obtained from Tan-99. Supporting evidences were reported by Öz and Karasu, (2010) who showed that Orhangazi-99 had maximum plant heights among 7 varieties and Tan, (2011) monitored that the plant heights changed between 110 – 128.9 cm.

Number of branch per plant: As can be seen in Table 2, number of branch/plant significantly (%5) varied among varieties. According to the means comparison, the maximum number of branches (7.17) was observed from Orhangazi-99 which had no statistically significant difference with the other varieties except Tan-99 which had the minimum number of branch/plant (3.63). These results are in concordance with Sağır *et al.*, (2010). Contrasting results were obtained by Öz and Karasu, (2010) who stated that the number of branch didn't changed according to the genotypes.

First pod height: Results obtained from the 8 varieties indicate that there exist wide variations among the varieties. The distance from the first pod down to the base of the plant was between 43.60 - 67.07 cm (Table 2) and was significant at %5 statistical level. The maximum height was observed from Tan-99 where the shortest plants were obtained from Orhangazi-99. The study results agree with the previous findings of Ansah *et al.*, (2015). The maximum height observed from Muganlı-57 while the minimum height determined from Cumhuriyet-99.

Pod length: The remaining one of morphological traits; pod length had significant (%5) differences among the varieties. The pod length was between 25.33-28.07 mm which had a good line Öz and Karasu, (2010) findings. The longest pods were screened from Orhangazi-99 while the shortest pods were observed from Tan-99. These differentials were in accordance with Alege *et al.*, (2013) who reported the pod length is stable to variations in soil fertility condition and are therefore under strong genetic influence.

Pod width: Table 2 shows that there were significant (5%) differences in the pod widths of varieties. As seen in Table 2, the highest pod width value (6.50 mm) was obtained from Orhangazi-99 while the lowest determined from Tan-99 (4.83 mm). These results has good line with Alege *et al.*, (2013) and Öz and Karasu, (2010) findings.

Number of pod per plant: In the present study, significant (5%) differences were occurred among varieties regards to number of pod/plant (Table 2). The highest number of pod/plant value (125.50) was obtained in plots of Orhangazi-99, where the lowest number of pod/plant (56.07) was produced from Muganlı-57 sown plots which had no statistically significant (5%) difference with Tan-99 (58.27) (Table 2). The results of study are in accordance with Öz and Karasu, (2010) who stated the number of pod had a significant effect on seed yield.

Number of seed per pod: According the data presented in the Table 2, the number of seed per pod had a significant (5%) differential among the varieties. The highest value (72.37) was obtained from Orhangazi-99 while the minimum values (53.20) were produced by Tan-99 variety (Table 2). Supporting evidence were reported by Lal *et al.*, (2016) who stated the number of seed per pod increased with increasing of pod length and width under optimum conditions as a morphologically reality.

1000 seed weight: In the present experiment, 1000 seed weight exerted significant (5%) differences among varieties (Table 2). The highest values (3.67 g) was obtained in Muganlı-57, where the minimum value (2.85 g) was observed in Kepsut-99 (Table 2). The supporting evidence had been reported by Li *et al.*, (2015) who stated the 1000 seed weight was mainly controlled by the maternal genotype under optimum conditions.

Seed yield: Seed yield is directly related to the number of branches, but the total number of pod/plant and the number of seed/pod has the greatest direct effect on seed yield (Lal *et al.*, 2016). The number of pod/plant is directly related to the number of flowers, but climatic conditions can affect the percentage of fertilized flowers. The short photoperiods can increase the number of pod/plant on early and medium-late genotype (Söğüt, 2009). The direct effect of the number of fruiting branches on seed yield in sesame was considerable, as shown by (Uzun *et al.*, 2002). On the bases of this, there was a highly significant (5%) difference in seed yield among eight varieties (Table 2). The maximum seed yield (1005.87 kg ha⁻¹) obtained from Orhangazi-99 variety where minimum seed yield (523.33 kg ha⁻¹) obtained from Tan-99 (Table 2). The supporting data were reported by Öz and Karasu, (2010).

Table 2. The multi-comparison test of LSD's mean for the effects of varieties on observed quantitative characters of sesame

Varieties	Plant height (cm)	Number of branch per plant	First pod height (cm)	Pod length (mm)	Pod width (mm)	Number of pod per plant	Number of seed per pod	1000 seed weight (g)	Seed yield (kg ha ⁻¹)
Cumhuriyet-99	135.97 ab	5.77 a	48.37 cd	26.83 ab	5.63 abc	122.40 a	68.50 ab	3.07 bc	949.73 b
Kepsut-99	144.47 a	5.47 a	53.33 bc	26.13 ab	5.90 ab	94.27 bc	64.43 b	2.85 d	834.93 d
Muganlı-57	146.63 a	5.47 a	50.50 cd	26.63 ab	5.83 ab	56.07 d	69.30 ab	3.67 a	889.83 c
Orhangazi-99	145.87 a	7.17 a	43.60 d	28.07 a	6.50 a	125.50 a	72.37 a	3.01 bcd	1005.87 a
Osmanlı-99	130.57 ab	5.57 a	48.63 cd	26.23 ab	5.80 ab	90.03 c	66.87 ab	3.03 bcd	947.23 b
Tan-99	121.03 b	3.63 b	67.07 a	25.33 b	4.83 c	58.27 d	53.20 c	2.91 cd	523.33 e
Tur-S-203	147.10 a	5.50 a	59.70 b	26.53 ab	5.50 bc	71.70 cd	63.50 b	2.91 cd	903.30 c
Tur-S-90	146.50 a	6.50 a	59.73 b	26.73 ab	5.93 ab	119.77 ab	65.93 b	3.11 b	874.03 c
LSD 0.05	15.454	1.526	6.443	1.793	0.881	25.571	5.846	0.172	32.776
CV %	6.314	15.464	6.830	3.855	8.749	15.828	5.096	3.205	2.161

Means with similar letters within each column for each treatment are not significantly different (LSD 5%).

The seed yield is the most important target in sesame cultivation, but also, the seed yield is under effect of lots of factors such as genotype, environmental (climatic and soil) conditions and the traits factors of farmers. Because of these reasons, the results of most sesame agronomic studies can be different.

Traits Correlations

The studied traits correlations are shown in Table 3. The correlations between plant height and number of seed/pod, pod length, pod width were observed positive and significant (5%). Number of branch/plant showed positive and highly significant (1%) correlation with number of pods/plant, number of seed/pod, pod width, seed yield and also significant (5%) correlation with pod length and 1000 seed weight but, had negative and highly significant (1%) correlation with first pod height. These results suggest that improvement in these properties could be with an increase in number of branch/plant (Lal *et al.*, 2016) with less first pod height.

The correlations of number of pod/plant with number of seed/pod, pod length and pod width are positive and significant (5%) and also had a positive and significant (1%) correlation with seed yield which suggest that the increase in these yield components could be with an increase in the number of seed/pod. But, a negative and significant (5%) correlation was screened with first pod height which suggested that an increase in number of pod/plant could be obtain with low first pod height.

The number of seed/pod was positive and significantly (1%) correlated with length of pods and seed yield while it had negative and significant (1%) correlation with first pod height. This indicates that the maximum length of pods and seed yield can be determined with a high number of seed/pod and low height of first pod.

The correlation of first pod height with pod length, pod width and seed yield was significantly (5% and 1%) negative which suggests that the first pod height could bring decrease in yield and yield parameters. Therefore, it will be a good step to improve a balance between these important components when breeding for high yield improvement in sesame (Lal *et al.*, 2016).

Pod length, pod width and 1000 seed weight were positive and significantly (5% and 1%) correlated with seed yield. This means that an increase in these parameters will occur high yield in sesame.

Table 3. The correlation values of plant parameters based on means of 8 varieties in 2012 growing seasons at Spearman

	Plant height (PH)	Number of branch/plant (NB/P)	Number of pod/plant (NP/P)	Number of seed/pod (NS/p)	First pod height (FPH)	Pod length (PL)	Pod width (PW)	1000 seed weight (TSW)	Seed yield (SY)
PH	1	0.220	0.190	0.355 *	-0.040	0.383 *	0.359 *	0.160	0.180
	NB/P	1	0.645 **	0.512 **	-0.540 **	0.425 *	0.640 **	0.350 *	0.489 **
		NP/P	1	0.461 *	-0.466 *	0.471 *	0.423 *	0.110	0.519 **
			NS/p	1	-0.607 **	0.747 **	0.310	0.330	0.547 **
				FPH	1	-0.376 *	-0.676 **	-0.320	-0.787 **
					PL	1	0.320	0.010	0.413 *
						PW	1	0.180	0.535 **
							TSW	1	0.362 *
								SY	1

** . Correlation is significant at the 0.01 level

* . Correlation is significant at the 0.05 level

Conclusions

According to results of the study, it can be concluded that to increase seed yield in sesame, the attributes like number of branch/plant, number of pods/plant number of seed/pod, pod length, pod width and 1000 seed weight should be increased to achieve potential yield of sesame in Iğdır plain conditions. And also, in order to cultivate sesame as an oil crop in conditions similar to the region of this experiment, Orhangazi-99 was recommended.

References

- Adebisi, M., Ajala, M., Ojo, D., and Salau, A. (2005). "Influence of population density and season on seed yield and its components in Nigerian sesame genotypes". *Journal of tropical agriculture* 43 (1-2):13-18.
- Al-Yemeni, M., Hussain, M., and Basahy, A. (2000). "Mineral composition of some sesame seeds (*Sesamum indicum* L.) grown in the Gizan area of Saudi Arabia". *Phyton* 67:121-125.
- Alege, G. O., Mustapha, O. T., Ojo, S., and Awosemo, M. B. (2013). "The morphological, proximate and mineral responses of sesame to different nutrient source". *G.J.B.B.* 2 (1):12-16.

- Amara, A., El-Masry, M. H., and Bogdady, H. H. (2008). "Plant crude extracts could be the solution: extracts showing in vivo antitumorigenic activity". *Pak. J. Pharm. Sci* 21 (2):159-171.
- Ansah, K. D., Sintim, H. O., Awuah, S., Ali, J. E., and Oteng, G. (2015). "The Adoption of Temperate Selected Sesame Accessions in the Tropics: Selected for Japan and Grown in Ghana". *Journal of Agricultural Science* 7 (5):47-55.
- Bedigian, D. (2003). "Evolution of sesame revisited: domestication, diversity and prospects". *Genetic resources and crop evolution* 50 (7):779-787.
- Bedigian, D., and Harlan, J. R. (1986). "Evidence for cultivation of sesame in the ancient world". *Economic botany* 40 (2):137-154.
- de la Vega, M. P. (1996). "Plant genetic adaptedness to climatic and edaphic environment". *Euphytica* 92 (1-2):27-38.
- Doğan, T., and Zeybek, A. (2009). "Improving the traditional sesame seed planting with seed pelleting". *African Journal of Biotechnology* 8 (22):6120-6126.
- Lal, M., Dutta, S., Saikia, D., and Bhau, B. S. (2016). "Assessment of Selection Criteria in Sesame by using Correlation and Path Coefficient Analysis under High Moisture and Acidic Stress Soil Condition". *Indian Journal of Science and Technology* 9 (4).
- Li, N., Peng, W., Shi, J., Wang, X., Liu, G., and Wang, H. (2015). "The Natural Variation of Seed Weight Is Mainly Controlled by Maternal Genotype in Rapeseed (*Brassica napus* L.)". *PloS one* 10 (4):e0125360.
- Obiajunwa, E., Adebisi, F., and Omode, P. (2005). "Determination of essential minerals and trace elements in Nigerian sesame seeds, using TXRF technique". *Pakistan Journal of Nutrition* 4 (6):393-395.
- Öz, M., and Karasu, A. (2010). "Bazı Susam (*Sesamum indicum* L.) Çeşit ve Hatlarının Bursa Koşullarında Performanslarının Belirlenmesi". *HR.Ü.Z.F. Dergisi*, 2010, 14(2): 21-27 14 (2):21-27.
- Sağır, P., Sağır, A., and Söğüt, T. (2010). "The effect of sowing time and irrigation on Charcoal rot disease (*Macrophomina phaseolina*), yield and yield components of sesame". *Plant Protection Bulletin* 50 (4):157-170.
- Söğüt, T. (2009). "Effect Of Main And Second Cropping On Seed Yield, Oil And Protein Content Of Sesame (*Sesamum indicum* L.) Genotypes". *Turkish J. Of Field Crops* 14 (2):64-71.
- Şahin, G. (2014). "Sesame as an Important Oil Plant With Decreasing Production". *Journal of the Human and Social Science Researches* 3 (2):404-433.
- Tan, A. Ş. (2011). "Bazı Susam Çeşitlerinin Menemen Koşullarında Performansları". *ANADOLU, J. of AARI* 21 (2):11-28.
- Uzun, B., Ülger, S., and Çağırğan, M. İ. (2002). "Comparison of Determinate and Indeterminate Types of Sesame for Oil Content and Fatty Acid Composition". *Turk J. Agric. For.* 26:269-274.
- Weiss, E. A. (1983). "*Sesame. In: Oilseed crops*". New York: Longman Inc.p: 282-340.

DRY MATTER YIELD AND FORAGE QUALITY OF PROMISING BITTER VETCH (*VICIA ERVILIA* (L.) WILLD.) LINES

Mehmet Salih SAYAR

Department of Crops and Animal Production, Bismil Vocational Training High School, Dicle University, 21500,
Bismil, Diyarbakır, Turkey

*Corresponding author: msalihsayar@hotmail.com

Abstract

The major limiting factor to livestock production in Southeastern Anatolia region is the inadequate quality roughage supply. The introduction of leguminous forage species in crop rotation systems are of great importance. Accordingly; two years field trials (2008-09 and 2009-10) were conducted to determine performance of some promising bitter vetch lines, provided from International Center for Agricultural Research in Dry Areas, Aleppo, Syria (ICARDA) in highland of Southeastern Anatolia Region of Turkey. Field experiments of the study were designed according to randomized blocks design with three replications. According to two years average, the examined traits were ranged among the genotypes as follow; dry matter yield (DMY) 4.13-5.40 t ha⁻¹, dry matter crude protein content (CP) 16.53-18.52%, acid detergent fiber (ADF) 21.30-23.52%, neutral detergent fiber (NDF) 29.81-32.04%, dry digestible matter (DDM) 70.58-72.31%, dry matter intake (DMI) 3.75-4.03%, total digestible nutrients (TDN) 69.3-71.9, relative feed value (RFV) 205-226, calcium (Ca) content 0.42-0.71%, magnesium (Mg) content 0.20-0.23% potassium (K) content 3.01-3.22%, and phosphorus (P) content 0.29-0.31%. In the study; inverse relation was determined between the two growing season for dry matter yield and crude protein contents. Namely, crude protein content of bitter vetch genotypes were lower in high dry matter yield obtained growing season. Results of the study revealed that Ca, Mg, K and P contents of the bitter vetch forages are sufficient for the optimum performance of ruminants, and, the forages obtained from the bitter vetch lines are of the best quality, when by taking into consideration the RFV values of forages.

Key words: *Bitter vetch (Vicia ervilia (L.) WILLD), dry matter yield, forage quality, ADF, NDF*

Introduction

The genus *Vicia* (vetches) includes about 160 annual and perennial species distributed throughout temperate regions of Europe, Asia, and the Americas (Alkin *et al.*, 1986; Maxted, 1995, Larbi *et al.*, 2011). According to Elci and Acikgoz (1993) 59 of them find in native flora of Turkey, and 14 species of vetches are cultivated in arable land of Turkey. The most grown ones in Turkey are respectively *Vicia sativa* L. (common vetch) and *Vicia pannonica* Crantz (Hungarian vetch). *Vicia ervilia* (L) Willd. (Bitter vetch) is also important annual vetch species. It has been cultivated by farmers since ancient times in Anatolia.

Shortage of quality forages presents a serious problem to animal husbandry of the Southeastern Anatolia Region of Turkey, known as Upper Mesopotamia, is located within the 'Fertile Crescent'. Accordingly, livestock are fed predominantly by cereal chaff and straw, which have low nutritional values and are used as filler material to keep livestock from feeling hungry. However, in order to obtain animal products from the livestock in desired levels, they should be fed with quality roughage obtained from forage crop species (Sayar *et al.*, 2010). Bitter vetch is

highly resistant against adverse environmental conditions, drought and poor soil conditions. Hence it is cultivated almost in all parts of Turkey as a forage crops for both its high quality forage and its grains (Serin *et al.*, 1997; Ayan *et al.*, 2006; Kaplan *et al.*, 2014). Objective of this study is to determine dry matter yield and forage quality of some promising bitter vetch (*Vicia ervilia* (L) Willd) lines in Hazro district, having higher altitude, lower winter temperatures and more rainy than central of Diyarbakır province.

Material and Methods

This study was conducted for two consecutive growing seasons (2008-2009, 2009-2010) in farmer's field of Sarıcanak village of Hazro district, Diyarbakır, Turkey (38°10'37 N; 40°45'41 E). The study materials consisted of seven promising lines and one control local bitter vetch population. The genetic materials and their origins are listed in Table 1. The promising lines (G1, G2, G3, G4, G5, G6) were provided from International Center for Agricultural Research in Dry Areas, Aleppo, Syria (ICARDA). The bitter vetch lines we used were previously determined to be promising as the result of trials previously conducted at the GAP International Agricultural Research and Training Centre (GAP IARTC), Diyarbakır, Turkey. In addition, one line (G7) and one local population (G8) were used as genetic materials. Since there was not any registered suitable bitter vetch cultivar in Turkey, we used the local population (G8) as a control cultivar.

The research fields were flat or near flat with very little erosion, and the soil layer had a deep or medium deep profile, and altitude of the research area was 815 m. The soil analysis of experimental area showed that, the experimental area soils (0-30 cm) had a clay loam structure, and were red-brown in color. Furthermore, the soils were rich in terms of calcium (16.45%) and potassium (520 kg ha⁻¹ K₂O) contents, whereas organic matter (1.53%), phosphorus (30.5 kg ha⁻¹ P₂O₅) and salt (0.063%) contents were relatively low. Also, due to the high limestone content, the pH status of the soils was slightly alkaline (pH: 7.67).

The Southeastern Anatolia Region is one of Turkey's seven census-defined geographical regions, and is characterized by a continental climate. In this region, summers are dry and hot, whereas winters are cool and rainy. Rainfall in the region is variable both within and among years. The experiments were conducted under rainfed conditions during 2008–2009 and 2009–2010 growing seasons. Monthly average temperature and total precipitation records during the study years, and the long-term averages, are summarized in Figure 1. The region's forage and seed yields obtained from annual legume crops depend greatly on the spring rainfall.

The experiments were conducted under rainfed conditions according to a randomized complete block design with three replications. Each plot consisted of six rows 5 m in length, and rows were spaced 20 cm apart. Diammonium phosphate fertilizer (DAP 18-46-00) (150 kg ha⁻¹) was applied in the experimental plots with the sowings. Weeds appearing in the experimental area were controlled by hand. The seeding rate was 200 seeds m⁻² (Anonymous, 2001). The sowings were using an experimental drill. The sowing dates for first and second growing seasons were on November 06, 2008 and November 17, 2009 respectively.

In the experiments; after a half-meter at the beginning and end of each plot was neglected to account for edge effects, half of each plot was harvested separately in May to calculate fresh forage yield, and the fresh forages weighed as soon as possible without losing weight. Fresh forage samples were weighted for each plot (0.5 kg). Then, the samples were dried at 70 °C in a drying cabin for 48 hours for determining hay yields. In order to determine dry matter content of forages, milled 5 grams dried forages samples of each plots were dried at 105 °C in a drying oven, until the weight becomes constant.

Table 1- The used genetic materials in the study

Number	The genotypes	Origin
G1	IFVE 248 SEL 2785	ICARDA
G2	IFVE 973 SEL 2795	ICARDA
G3	IFVE 2698 SEL 2798	ICARDA
G4	IFVE 2920 SEL 2801	ICARDA
G5	IFVE 3977 SEL 2802	ICARDA
G6	IFVE 3351 SEL 2804	ICARDA
G7	D-357	GAPIARTC
G8	D-42	GAPIARTC

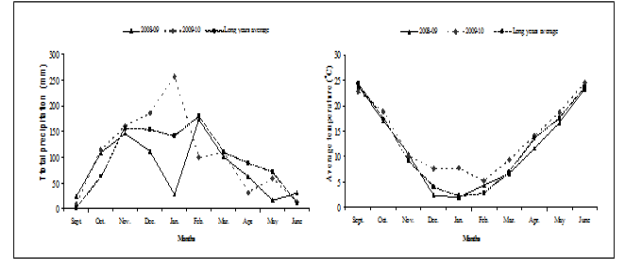

*Data from the Regional Directorate of Meteorology, Diyarbakir, Turkey

Figure 1. Monthly total rainfall and average temperature records of experimental area for the growing seasons (2008-09, 2009-10) and long years average (1975-2011).

Table 2. Dry matter yields, dry matter crude protein content and some forage quality parameters of the bitter vetch genotypes

Genotypes	Dry matter yield (t ha ⁻¹)		Crude protein content (%)		ADF (%)		NDF (%)		Dry digestible matter (DDM)		Dry matter intake (DMI)											
	2008-09	2009-10	Mean	2008-09	2009-10	Mean	2008-09	2009-10	Mean	2008-09	2009-10	Mean										
G1	4.30	3.76	e	4.13	d	16.88	20.17	18.52	21.92	22.00	21.96	29.41	29.41	30.15	71.82	71.76	71.79	4.09	3.89	3.99		
G2	5.18	b-c	4.52	c-e	4.85	a-c	16.57	19.55	18.06	21.96	22.97	22.47	28.52	28.52	30.51	71.79	71.00	71.40	4.21	3.69	3.95	
G3	4.97	c-d	4.04	d-e	4.51	c-d	14.72	18.35	16.53	23.93	23.12	23.52	32.10	32.10	32.04	70.26	70.89	70.58	3.74	3.76	3.75	
G4	5.22	b-c	4.52	c-e	4.87	a-c	15.44	19.17	17.30	21.93	23.37	22.65	30.24	30.24	31.49	71.82	70.69	71.26	3.98	3.67	3.82	
G5	6.05	a-b	4.52	c-e	5.28	a-b	14.99	20.31	17.65	21.94	22.30	22.12	30.11	30.11	30.94	71.81	71.53	71.67	3.99	3.78	3.88	
G6	4.45	c-e	5.29	b-c	4.87	a-c	14.70	19.48	17.09	21.07	21.53	21.30	29.40	29.40	29.81	72.49	72.13	72.31	4.09	3.97	4.03	
G7	4.55	c-e	4.78	c-d	4.67	b-d	15.40	20.55	17.98	21.35	22.29	21.82	29.57	29.57	29.99	72.27	71.53	71.90	4.06	3.96	4.01	
G8	6.44	a	4.36	c-e	5.40	a	14.09	20.06	17.08	22.81	23.97	23.39	30.71	30.71	31.37	71.13	70.23	70.68	3.92	3.75	3.83	
Mean	5.17	a	4.48	b	4.82		15.34	19.70	17.53	22.12	22.70	22.41	30.01	31.57	30.79	71.67	71.22	71.45	4.01	3.81	3.91	
CV (%)			12.24				11.53			6.60		5.06				1.63					5.12	
LSD (0.05)																						
Year (Y)			0.35**				1.07**		0.88ns		0.92**		0.92**		0.67ns		0.67ns		0.12**		0.12**	
Genotype (G)			0.71*				2.17ns		1.76ns		1.82ns		1.82ns		1.37ns		1.37ns		0.24ns		0.24ns	
G × Y			0.98**				4.08**		2.48ns		2.6ns		2.6ns		1.95ns		1.95ns		3.28ns		3.28ns	

+, means with different letters in the same column are significantly different (P < 0.05); significant at *, P ≤ 0.05; **, P ≤ 0.01; ns, non-significant

Table 3. Total digestible nutrients and relative feed value values; and Ca, Mg, K, P contents of forages of the bitter vetch genotypes

Genotypes	Total digestible nutrients (TDN)		Relative feed value (RFV)		Calcium (Ca) content (%)		Magnesium (Mg) content (%)		Potassium (K) content (%)		Phosphorus (P) content (%)																	
	2008-09	2009-10	Mean	2008-09	2009-10	Mean	2008-09	2009-10	Mean	2008-09	2009-10	Mean																
G1	71.1	71.0	71.1	228	216	222	0.80	a	0.30	h	0.55	b	0.26	a	0.19	e-f	0.23	a	2.83	g-h	3.30	b-c	3.06	c-e	0.29	0.31	0.30	
G2	71.1	69.9	70.5	234	203	219	0.72	b	0.28	h	0.50	c	0.23	a-d	0.18	f	0.21	a-b	2.98	d-e	3.29	b-c	3.13	b-c	0.28	0.30	0.29	
G3	68.8	69.8	69.3	204	207	205	0.55	e	0.43	f	0.49	c	0.21	c-e	0.20	e-f	0.21	a-b	3.06	d	3.28	b-c	3.17	a-b	0.28	0.30	0.29	
G4	71.1	69.5	70.3	222	201	211	0.65	c	0.31	g-h	0.48	c	0.25	a-b	0.18	f	0.22	a-b	2.80	h	3.33	b	3.07	c-e	0.28	0.32	0.30	
G5	71.1	70.7	70.9	222	210	216	0.61	d	0.35	g	0.48	c	0.24	a-c	0.19	e-f	0.22	a-b	2.88	f-h	3.24	b-c	3.06	d-e	0.28	0.32	0.30	
G6	72.1	71.6	71.9	230	222	226	0.55	e	0.28	h	0.42	d	0.24	a-c	0.19	e-f	0.21	a-b	2.91	e-g	3.32	b	3.12	b-d	0.27	0.31	0.29	
G7	71.8	70.7	71.3	228	220	224	0.58	d-e	0.30	h	0.44	d	0.23	b-d	0.18	f	0.20	b	2.97	d-f	3.47	a	3.22	a	0.29	0.32	0.31	
G8	70.1	68.8	69.4	216	204	210	0.61	d	0.80	a	0.71	a	0.24	a-c	0.21	d-e	0.23	a	2.82	h	3.21	c	3.01	e	0.27	0.31	0.29	
Mean	70.9	70.3	70.6	223	210	217	0.63	a	0.38	b	0.44	d	0.24	a	0.19	b	0.21	a	2.91	a	3.31	b	3.11	a	0.28	b	0.31	
CV (%)			2.43				5.63		4.01		7.94		1.85														10.81	
LSD (0.05)																												
Year (Y)			1.01ns				7.21**		0.0123**		0.010**		0.013**		0.013**		0.018**		0.018**		0.018**		0.018**		0.018**		0.018**	
Genotype (G)			2.03ns				14.45ns		0.267**		0.020ns		0.068**		0.068**		0.059ns		0.059ns		0.059ns		0.059ns		0.059ns		0.059ns	
G × Y			2.85ns				20.42ns		0.389**		0.029ns		0.096**		0.096**		0.055ns		0.055ns		0.055ns		0.055ns		0.055ns		0.055ns	

+, means with different letters in the same column are significantly different (P < 0.05); significant at *, P ≤ 0.05; **, P ≤ 0.01; ns, non-significant

After cooling the samples were weighed, dry matter percent was determined for each plot. Afterwards; determined dry matter percent by proportionalizing with fresh forage yield, dry matter yield was found for each plot. Dried forage samples pass through a 1 mm sieve. Crude Protein (CP), Acid Detergent Fiber (ADF), Neutral Detergent Fiber (NDF), Ca, P, Mg and P content of samples were determined by using Near Reflectance Spectroscopy (NIRS, 'Foss XDS') with software package program 'IC-0904FE' (Hoy *et al.*, 2002; Basaran *et al.*, 2011; Cinar, 2012). Dry digestible matter (DDM), dry matter intake (DMI), total digestible nutrients (TDN), and relative feed value (RFV) were calculated according to the equations of Schroeder (1994), as follows:

$$\text{DDM}\% = 88.9 - (0.779 \times \text{ADF}\%)$$

$$\text{DMI}\% = 120 / \text{NDF}$$

$$\text{TDN}\% = 96.35 - (\text{ADF}\% \times 1.15)$$

$$\text{RFV} = (\text{DDM}\% \times \text{DMI}\%) / 1.29$$

Also quality classes of the forages were determined according to Lacefield (1988). All statistical analyses of data were performed using the JMP 5.0.1 statistical software package (SAS Institute, 2002), and the differences between means were compared using least significant difference (LSD) test at the 0.05 probability level (Steel and Torrie, 1980).

Results and Discussion

The combined variance analysis over the 2 years showed that years, genotypes and genotype \times year interaction were highly significant ($P < 0.01$) for dry matter yield trait. Similarly, Bilgili *et al.* (2009) and Orak and Nizam (2005) reported that different environmental conditions among the growing conditions caused differed ranking of dry matter yield in various forage crops. Dry matter yield obtained in 2008-09 growing season (5.17 t ha^{-1}) was higher than that of in 2009-10 growing season (4.48 t ha^{-1}) (Table 2). Regular and higher rainfall amount and cooler temperatures in spring months can be specified as a cause of higher dry matter yield in 2008-09 growing season (Figure 1). Similarly, Karadag and Büyükbuc (2004) and Sayar and Han (2014) reported that forage yield of annual forage legumes greatly depend on suitable climatic conditions, more rainfall and cooler temperatures of spring months in Turkey. The combined variance analysis over the two years showed that dry matter yields among the bitter vetch genotypes ranged from 4.13 to 5.40 t ha^{-1} . Respectively G8, G5, G6, G4 and G2, sharing the same statistical group, were found to be the most productive genotypes for dry matter yield. Previous studies, using bitter vetch genotypes under various ecological conditions reported that the dry matter yield ranged between 2.39 t ha^{-1} and 6.90 t ha^{-1} (Cakmakcı and Cecen, 1999; Mihailović *et al.*, 2006; Sayar, 2014; Basbag *et al.*, 2015). The reported bitter vetch dry matter yield data confirm our findings.

The combined variance analysis over the 2 years showed that genotypes and genotype \times year interaction were not significant ($P > 0.05$) for crude protein contents. This indicated no significant differences in terms of protein content among the genotypes. Moreover, the environmental conditions of growing seasons did not effected ranking of genotypes for crude protein content. However, a great significant differences were determined between growing seasons in terms of dry matter crude protein content of bitter vetch genotypes. The second year (2009-10) dry matter protein content (19.70%) was found higher than in that of the first year (2008-09) (15.34%). The striking point is that although the forage dry matter yield of the second year (2009-10) was found lower than the first year (2008-09), crude protein content in this year (2009-10) was found higher (Table 2). This can be explained by the inverse relationship between forage yield and forage

quality. Findings determined in this study related to dry matter crude protein content (14.09-20.55%) in bitter vetch genotypes complied with findings of Larbi *et al.* (2011) (14.6-17.2%). On the other hand, Kaplan *et al.* (2014) reported that crude protein contents of bitter vetch genotypes changed between 22.12% and 24.96% at the beginning of flowering stage, and between 20.87% and 23.10% at full-bloom stage of the plants. Cited alfalfa (*Medicago sativa* L.) forage protein content ranged from 16.35 to 24.05% (Geren *et al.*, 2009; Saruhan and Kusvuran, 2011), which indicates that crude protein contents of bitter vetch and alfalfa are almost equal.

Acid detergent fiber (ADF) and neutral detergent fiber (NDF) contents are important quality parameters of forages (Schroeder, 1994; Caballero *et al.*, 1995; Sayar *et al.*, 2014) Although ADF refers to the cell wall portions of a forage that are made up of cellulose and lignin, NDF refers to the total cell wall, which is comprised of the ADF fraction plus hemicellulose. As the ADF and NDF percentages increase, quality and digestibility of a forage usually decrease (Lacefield, 1988; Schroeder, 1994; Sayar *et al.*, 2014). In the study; genotype \times year interactions were found non-significant for ADF and NDF contents, also, there weren't found significant differences ($P>0.05$) among bitter vetch genotypes for the two traits. Although there weren't significant differences among growing seasons for ADF content trait, the NDF content in the second growing season (31.57%) was found higher than that of the first growing season (30.01%). In the study; ADF contents of forage dry matter in bitter vetch genotypes changed between 21.06% and 23.97%; NDF contents changed between 28.52% and 32.74% (Table 2). Similarly; Larbi *et al.* (2011) reported that ADF contents of 25 bitter vetch genotypes changed between 20.0% and 23.0%, NDF contents varied between 33.5%-38.9%. Moreover; Kaplan *et al.* (2014) cited that ADF contents of 16 bitter vetch genotypes varied between 20.41% and 22.57% at the beginning of flowering stage, and changed between 21.98% and 24.80% at full-bloom stage of plants, and NDF contents ranged from 25.10% to 31.64% at beginning flowering stage; ranged from 29.52% to 34.10% in the full-bloom stage. Accordingly, we determined a full conformity between data Kaplan *et al.* (2014) related to ADF, NDF contents and our data. However, there were a full agreement between our ADF contents data and Larbi *et al.* (2011) for ADF contents, their NDF contents were slightly higher than our findings.

There is inverse relation between ADF content of a forage and its dry digestible matter (DDM) and total digestible nutrients (TDN) values and likewise; similar relation has between NDF content of a forage and its dry matter intake (DMI) value. Namely, as ADF content of a forage increase, its dry matter digestibility and total digestible nutrients by livestock decreases, similarly, as NDF percent of a forage increases, intake amount of the forage by livestock decreases (Lacefield, 1988; Schroder, 1994; Sayar *et al.*, 2014). Also; RFV is an index combining the important nutritional components of intake and digestibility of forages. Although the index has no units, comparisons forage qualities of grasses, legumes, and intercropping mixtures can be made by using the index. A forage with 41% ADF and 43% NDF has 100 RFV value. The other forages can be evaluated with this value. As ADF and NDF percents decrease, the RFV value increases (Schroder, 1994). The combined variance analysis over the two years for DDM, DMI, TDN and RFV values indicated that differences among genotypes, and genotype \times year interactions weren't significant ($P>0.05$) for these traits. However, significant differences were determined between growing years for DMI and RFV values ($P<0.01$), in contrast to DDM and TDN values ($P>0.05$). In the study, among growing years and genotypes DDM, DMI, TDN and RFV values had ranges as follows respectively; 70.26-72.27%; 3.67-4.21% ; 68.8-72.1% and 201-234 (Table 2 and Table 3).

By taking into consideration the RFV value of forages, Lacefield (1988) devoted the forages to quality classes. In this classification; if a forage RFV value is bigger than 151, it is accepted as

the best quality forage. In the study RFV values of all of the bitter vetch genotypes were higher than 151. Therefore, the forages obtained from the bitter vetch genotypes had the best quality.

Variance analysis of Calcium (Ca) content indicated that differences among years, genotypes, and genotype \times year interaction were highly significant ($P < 0.01$) for the trait. Ca contents of bitter vetch ranged from 0.28 to 0.80% among genotypes in the two years. According to two years mean, the highest Ca contents was determined in G8 (0.71%), and the lowest was determined in G6 (0.42%) (Table 3). Khan *et al.* (2007) reported that Ca content of pasture forages varied from 0.315 to 0.492% dry matter (DM). Their Ca content findings confirm our findings. Also, they cited that the forage Ca values were adequate for the optimum performance of ruminants. Similarly; Reuter and Robinson (1997) suggested Ca requirement for maintenance, growing and lactating sheep to be 1.200-2.600 mg kg⁻¹ (0.12-0.26%). Temperate forages generally contain more Ca, Mg than those grown in the tropics (Khan *et al.*, 2007). According to Sabah and Celik (2001) and Basbag *et al.* (2011) Ca deficiency leads to bone softening in young animal and bones deformations in the elderly ones. Additionally, it causes thin-shelled eggs in poultry. On the other hand, according to cited in Khan *et al.* (2007) it is generally recommended that diets of livestock should have Ca:P ratio of about 1:1 to 2:1 (Underwood, 1981). Livestock will tolerate dietary Ca:P ratios of more than 10:1 without any serious effect provided the P intakes are adequate (Ternouth, 1990). In the study, bitter vetch Ca:P ratios were 2.25:1 for 2008-09 growing season and 1.23:1 for 2009-10 growing season (Table 3). These Ca:P ratios are adequate for the optimum performance of ruminants.

Variance analysis of magnesium (Mg) content indicated that differences among years, genotypes, and genotype \times year interaction were found to be non-significant ($P > 0.05$) for the trait. Mg contents of bitter vetch varied from 0.18 to 0.26% among genotypes in the two years (Table 3). Khan *et al.* (2007) reported that Mg content of pasture forages varied from 0.235 to 0.268% of dry matter (DM). Their determined Mg content findings completely consisted with ours. Also, they cited that their determined forage Mg contents in forages had slightly higher levels of Mg than the recommended requirement of 0.12-0.20% DM in the diet of ruminants (ARC, 1980, National Research Council, 1985). Magnesium is known as "anti-stress mineral". Since it helps to calm down in livestock, by reducing the hypersensitivity of the nervous system. Furthermore, it takes part in the mobilization of enzymes and the transformation sugar into energy in the blood. Also, Mg deficiency in the livestock causes "grass tetany" or "hypomagnesemic tetany, spasms in the legs, head backwards removal (Ensminger *et al.*, 1990).

Variance analysis of Potassium (K) content indicated that differences among years, genotypes, and genotype \times year interaction were found to be highly significant ($P < 0.01$) for the trait. K contents of bitter vetch ranged from 2.80 to 3.47% among genotypes in the two growing seasons. According to two years mean, the highest K contents was determined in G7 (3.22%), and the lowest was determined in G8 (3.01%) (Table 3). In the same way; Bařbag *et al.* (2011) reported that K contents of dry matter ranged from 1.54% to 3.82 % in different 10 vetch species. According to Khan *et al.* (2007) 0.8% K content in dry matter is sufficient for normal animal requirements (ARC, 1980). Our K contents data is higher than the required amount (Table 3).

The combined variance analysis over the 2 years showed that genotypes and genotype \times year interaction were non-significant ($P > 0.05$), in contrast, statically significant differences were found between the two growing seasons in terms of phosphorus (P) contents in the bitter vetch genotypes. P contents of bitter vetch means varied from 0.27 to 0.32% among genotypes in the two years (Table 3). Our determined P contents in bitter vetch is in complete consistency with cited P contents data in various forages in MFC (2008). According to cited in MFC (2008) the phosphorus content of all forages from all pastures, both fertilized and unfertilized, is sufficient

to meet phosphorus requirements of all classes of cattle. However, the phosphorus content of forage from the unfertilized pastures was borderline.

Conclusion

Results of the study showed that the tested promising bitter vetch lines had potential to produce high quality forage when taking into account the examined forage quality parameters. Also, Ca, Mg, K and P contents of the bitter vetch forages are sufficient for the optimum performance of ruminants. As a result, introduction and cultivation the promising bitter vetch lines not only will provide high quality forage for livestock, but also will improve soil conditions for plant growing in the Southeastern Anatolia region.

References

- Aklin R., Goyder D.J., Bisby F.A., White R.J. (1986). Names and Synonyms of Species and Subspecies in the *Viceae*: Issue3. *Viceae Database Project*, Publication No 7. University of Southampton, Hampshire, U.K.
- Anonymous. (2001). Technical Instruction for Registration Trials in Annual Forage Legumes Species. Publication of Seed Registration and Certification Centre, Ankara, Turkey, pp.36.
- ARC. (1980). The Nutrients Requirements of Ruminant Livestock. 4th ed. 73-310. CAB International, Wallingford.
- Ayan I, Acar Z, Basaran U, Asci O.O., Mut H. (2006). Determination of forage and grain yields of some *Vicia ervilia* L lines in Samsun ecological conditions. *J. Fac. Agric. OMU* 21:318–322.
- Basaran, U., Mut, H., Onal, O., Acar, Z. and Ayan, I. (2011). Variability in forage quality of Turkish grass pea (*Lathyrus sativus* L.) landraces. *Turk. J. Field Crops* , vol. 16, pp. 9-14.
- Basbag M., Cacan E., Aydın A., Sayar M.S., (2011). Determination forage quality traits of some vetch species collected from native flora Southeastern Anatolia. International Participation I. Ali Numan Kırac Agricultural Congress and Fair. April 27 to 30, 2011. Eskişehir, Turkey.
- Basbag M., Sayar M.S., Aydın A., Hoşgören H., Demirel R. (2015). Some agronomical and quality traits in nine vetch (*Vicia* ssp.) species cultivated in Southeastern Anatolia, Turkey. *Turkish Journal of Agricultural and Natural Sciences*, vol. 2(1), pp. 69–77.
- Bilgili U., E. Aydoğan Cıfci, H. Hanoglu, K. Yagdi and E. Acıkgoz. (2009). Yield and quality of triticale forage. *Journal of Food, Agriculture & Environment*, 7 (3-4): 556-560.
- Caballero A.R., Goicoechea-Oicoechea E.L., Hernaiz-Ernaiz P.J. (1995). Forage yields and quality of common vetch and oat sown at varying seeding ratios and seeding rates of vetch. *Field Crops Res.*, vol. 41, pp. 135-140.
- Cakmakçı S., Çeçen S. (1999). The possibilities at entering crop rotation system of certain annual legume plants in Antalya. *Turkish Journal of Agriculture and Forestry*, vol.23 (1) pp. 119-123.
- Cınar S. (2012). Determination of yield and quality characteristics of some cultivars and populations of tall fescue (*Festuca arundinaceae* Schreb.) in Cukurova Region. *Journal of Agric. Fac. of Gaziosmanpasa Univ.* vol. 29 (1), pp. 29–33.
- Elci S. Acıkgoz, E. (1993). *Legumes and Forage Grasses Identification Guide*. Afsaroglu Press. Ankara.
- Ensminger M.E., Oldfield J.E., Heinemann W.W. (1990). *Feeds & Nutrition*, second ed., The Ensminger Publishing Company, California, U.S.A., p: 890.
- Geren H., Kir B, Demiroglu G., Kavut, Y.T. (2009). Effects of different soil textures on the yield and chemical composition of alfalfa (*Medicago sativa* L.) cultivars under Mediterranean climate conditions, *Asian Journal of Chemistry*, 21(7):5517-5522.

- Hoy M.D., Moore K.J., George J.R., Brummer E.C. (2002). Alfalfa yield and quality as influenced by establishment method. *Agronomy Journal* Vol. 94, pp. 617-620.
- Kaplan M., Uzun S., Kokten K. (2014). Effects of harvest time on hay yield and quality of different bitter vetch (*Vicia ervilia* L.) lines. *Legume Res.*, 37(2) : 188 – 194.
- Karadag Y., Buyukburc U. (2004). Forage qualities, forage yields and seed yields of some legume–triticale mixtures under rainfed conditions, *Acta Agriculturae Scandinavica*, Section B - Soil & Plant Sci., vol. 54, pp. 140-148.
- Khan Z.I., Ashraf M., Hussain A. (2007). Evaluation of macro mineral contents of forages: influence of pasture and seasonal variation. *Asian-Aust. J. Anim. Sci.*, vol. 20, no. 6 : pp. 908 – 913.
- Lacefield G.D. (1988). Alfalfa Hay Quality Makes the Difference. University of Kentucky Department of Agronomy AGR-137, Lexington, KY.
- Larbi A., Abd El-Moneim A.M., Nakkoul H., Jammal B., Hassan S. (2011). Intra-species variations in yield and quality determinants in *Vicia* species: 1. Bitter vetch (*Vicia ervilia* L.) *Animal Feed Science and Technology*. Vol.165: 278–287.
- Maxted N. (1995). An Ecogeographical Study of *Vicia* subgenus *Vicia*. Systematic and Ecogeographic Studies on Crop Gene pools 8. International Plant Genetic Resources Institute, Rome, Italy
- MFC. (2008). Forage quality: Impact of alfalfa and fertilizer on pastures. Manitoba Forage Council Technical Bulletin http://mbfc.s3.amazonaws.com/2008_fact_sheets/p_forage_quality_final_june_26_08_p.pdf.
- Mihailović V., Mikić A., Čupina B., Katić S., Karagić D., Pataki I., Erić P., (2006). Yield and forage yield components in winter vetch cultivars. *Grassland Science in Europe*, vol. 11, pp. 255-257.
- National Research Council. (1985). Nutrient requirements of domestic animals, Nutrient Requirements of Sheep (5th ed.) Natl. Acad. Sci. NRC, Washington, DC.
- Orak, A., I. Nizam. (2004). Agronomic and Morphological Characters of Some Common Vetch (*Vicia sativa* L.) Genotypes under Trakya Region Conditions, *Journal of Agronomy*, vol 3, pp. 72-75.
- Reuter D.J., Robinson J.B. (1997). *Plant Analysis. An Interpretation Manual*. 2nd ed. CSIRO Publishing: Melbourne.
- Sabah E., Çelik M.Y. (2011) Investigation on availability of marble wastes of İncehisar (Afyon) as additive feeding material of animals. Turkey III. Marble Symposium (Mersem 2001) May 3-5, 2001, Afyon, Symposium Proceedings Book.
- Saruhan, V. and A. Kusvuran. (2011). Determination of yield performances of some lucerne (*Medicago sativa* L.) cultivars and genotypes under the Southeastern Anatolian region conditions. *J. Agric. Fac. Ege. U.*, vol. 48 (2), pp: 133-140 (in Turkish).
- SAS Institute. (2002). *JMP Statistics*. Cary, NC, USA: SAS Institute, Inc. 707 p.
- Sayar M.S., Anlarsal A.E. and Basbag M. (2010). Current situation, problems and solutions for cultivation of forage crops in the Southeastern Anatolian Region. *J. Agric. Fac. HR. U.*, 14 :59-67.
- Sayar, M.S. (2014). Determination of forage yield performance and the possibilities at entering crop rotation system for some annual forage legumes species in ecological conditions of Çınar district. *Dicle University Journal of Institute of Natural and Applied Science*, vol., 3(1), pp. 19-28.

- Sayar, M.S., Han, Y. (2014). Determination of forage yield performance of some promising narbon vetch (*Vicia narbonensis* L.) lines under rainfed conditions in Southeastern Turkey. *Tarım Bilimleri Dergisi-Journal of Agricultural Sciences*, 20(4): 376-386.
- Sayar M.S., Han Y., Yolcu H., Yücel H. (2014). Yield and quality traits of some perennial forages as both sole crops and intercropping mixtures under irrigated conditions. *Turkish Journal of Field Crops*, vol., 19(1), pp. 59-65.
- Schroeder J.W. (1994). *Interpreting Forage Analysis*. Extension Dairy Specialist (NDSU), AS-1080, North Dakota State University.
- Serin Y., Tan M., Çelebi H.B. (1997). Erzurum yöresine uygun burçak (*Vicia ervilia* (L.) Willd.) hatlarının belirlenmesi. *Tarla Bitkileri Merkez Arastırma Enstitüsü Dergisi*, 6(2):13-22.
- Steel, R.G.D., J.H. Torrie. (1980). *Principles and Procedures of Statistics: A Biometrical Approach*. 2. ed. New York: McGraw-Hill Publ. Company.
- Underwood E.J. (1981). *The Mineral Nutrition of Livestock*. Commonwealth Agricultural Bureaux, London.
- Ternouth J.H. (1990). Phosphorus and beef production in northern Australia. 3. Phosphorus in cattle-a review. *Tropical Grasses* 24:159-69.

GLOBAL WARMING, INCREASING INVASIVE SPECIES AND THEIR EFFECTS ON CEREAL CULTIVATION

Ersin DİLBER¹, Mustafa GÜLER^{2*}

¹General Directorate of Plant Production, Ministry of Food, Agriculture and Livestock, Ankara, Turkey

²Department of Field Crops, Faculty of Agriculture, Ankara University, Ankara, Turkey

*Corresponding author: mguler@ankara.edu.tr

Abstract

Global warming is an expression meaning rising temperature due to climate changes in the atmosphere. Our world has been facing the threat of global warming more and more for a few decades. According to studies, a global temperature increase of above 2 °C may cause problematic situations in many parts of the world. One of the problems caused by the global warming is the change in the floristic structure at different latitudes and altitudes of the earth due to rising temperatures. In this context, certain species, also known as invasive species and exotic species, have been encountered recently as new threats in cereal cultivation. These invasive species have been observed to negatively affect the bio region and the habitat in aspects of economics, environment and ecology. As long as these negative effects on agricultural production continue to threaten food security, it is inevitable that the estimated number of malnourished people (805 million) in the world will increase further. In this review paper, the floristic structure changes due to possible global warming and the foresights about invasive new species in cereal cultivation and related research results will be revealed.

Keywords: *Global warming, invasive species, changed floristic structure*

Introduction

Possible changes in the earth's atmosphere due to the global warming will threaten all aspects of the agricultural industry, especially crop production. Crop production industry is an important sector constituting the primary nutritional source for people, animals and all other living beings. As the production area of some plants will change, some plants will lead to new weed species which would infest the crops due to global warming. Being an important part of the ecosystem, weeds are cosmopolitan plants capable of adapting to various climatic and soil conditions, can survive and maintain the fertility even under extreme environmental conditions (Yıldırım and Ekim, 2003).

Due to their competitive abilities and genetic diversity, weeds can be easily adapted through the grassland areas of agricultural land, the archaeological area of the park, the wetlands of the sports fields of habitat, land and various environments from the roadside to railways (Özer et al., 2001). Unless necessary measures are taken against such species, product losses can be anywhere between 20 to 100% depending on the type of crop. Longitudes and latitudes which plants can grow would change due to increased temperature and atmospheric structural changes in the world. Some species will be exhibited as invasive character as a result of these changes (Atay et al., 2015).

Invasive plants (weeds), in general, are the species that grow better in areas where they moved because of the absence of natural enemies which is an important suppressor factor on the populations. Unlike other plants, their effect is not only in the cultivated areas, but also extremely wide area in natural ecosystems which have very different properties. With their settlements and

high adaptability in a short time they moved to areas with different ecological conditions are spreading into agricultural and non-agricultural areas (Atay et al., 2015).

Global Warming, Causes and Effects

Global warming is an expression meaning rising temperature due to climate changes in the atmosphere as a result of the activities of human. The amounts of certain gases in the atmosphere are increasing due to human activities such as increasing world population, the rapid development of industry, fossil fuel, the accumulated rubbish, waste water, transportation, deforestation and agricultural activities. These gases which keep a portion of the reflected beam from the sun to the earth or vice versa enable the earth to remain at a certain temperature. This warming effect and keeping the heat within the Earth atmosphere are called the greenhouse effect. Gases demonstrating this effect are called greenhouse gases. The most abundant greenhouse gases in Earth's atmosphere are: water vapor (H_2O), carbon dioxide (CO_2), methane (CH_4), nitrous oxide (N_2O), ozone (O_3), and chlorofluorocarbons (CFCs). Some gases have indirect radiative effects (whether or not they are greenhouse gases themselves). This happens in two main ways. One way is that they break down in the atmosphere and produce other greenhouse gases. For example, methane and carbon monoxide (CO) are oxidized to give carbon dioxide (and methane oxidation also produces water vapor; that will be considered below). Oxidation of CO to CO_2 directly produces an unambiguous increase in radiative forcing although the reason is subtle. Without greenhouse gases, the average temperature of Earth's surface would be about $-18\text{ }^\circ\text{C}$ ($0\text{ }^\circ\text{F}$), rather than present average of $15\text{ }^\circ\text{C}$ ($59\text{ }^\circ\text{F}$) in the solar system (Treat et al., 2007). Especially in the last 30-year period, the effects of global warming continue to increase due to triggering of the excessive fuel consumption, emissions of greenhouse gases increase in the atmosphere, increase in population and the depletion of the ozone layer.

According to the fifth assessment report of the Intergovernmental Panel on Climate Change (IPCC); each of the last three decades has been successively warmer at the Earth's surface than any preceding decade since 1850 (see Figure 1). In the Northern Hemisphere, 1983–2012 was likely the warmest 30-year period of the last 1400 years. The globally averaged combined land and ocean surface temperature data as calculated by a linear trend show a warming of 0.85 [0.65 to 1.06] $^\circ\text{C}$, over the period 1880 to 2012, when multiple independently produced datasets exist. The total increase between the average of the 1850–1900 period and the 2003–2012 period is 0.78 [0.72 to 0.85] $^\circ\text{C}$, based on the single longest dataset available. For the longest period when calculation of regional trends is sufficiently complete (1901 to 2012), almost the entire globe has experienced surface warming (IPPC., 2013).

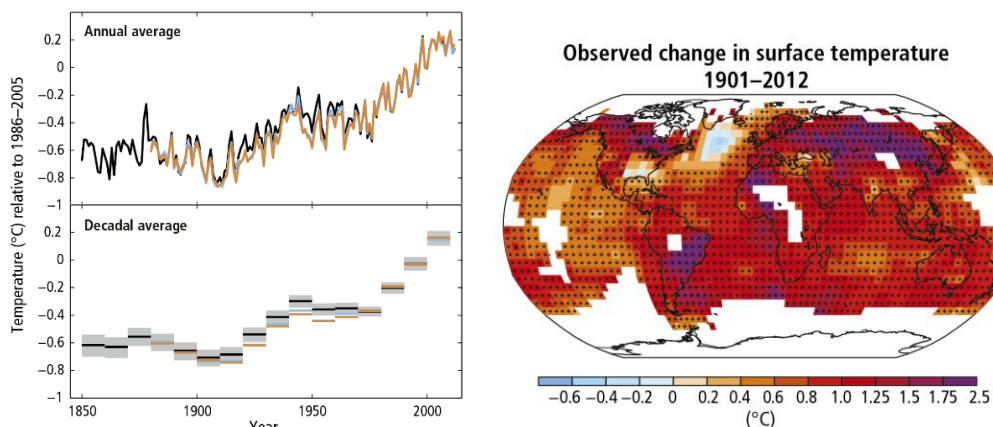

Figure 1. Observed change in temperature

Global climate change has already had observable effects on the environment. Glaciers have shrunk, ice on rivers and lakes is breaking up earlier, plant and animal ranges have shifted and trees are flowering sooner. Effects of global climate change predicted by scientists in the past have started to take place: loss of sea ice, accelerated sea level rise and longer, more intense heat waves (Turkeş et al., 2000).

The Effects of Global Warming on Plants

Climate change is related to extreme weather events such as atmospheric CO₂ concentration, precipitation, temperature, solar radiation, floods, droughts, and erosion. As the most important input for photosynthesis reaction, carbon dioxide concentration directly and/or indirectly affect plant growth and productivity. While direct effect of rising CO₂ concentrations emerges increasing photosynthesis, indirect effect decreases water loss in plants. Water loss decreases and the rate of photosynthesis increases due to the closed stomata at high CO₂ concentration conditions. This so-called CO₂ fertilization process is a useful effect increasing the concentration of CO₂ in the atmosphere (Bongaart, 1994).

Temperature and humidity are the factors which play an important role in agricultural production. Increases in temperature extend the vegetation period especially in high altitude regions due to limited plant growth opportunities. Normally, plant vegetation period is shortened by rising temperature. Also, heated atmosphere shows a beneficial effect on the plant growth in semi-arid regions by holding more water vapour.

Droughts and other anticipated changes in precipitation may be particularly potent selective factors, especially in arid regions. To demonstrate the evolutionary response of an annual plant, *Brassica rapa*, to a recent climate fluctuation resulting in a multiyear drought, ancestral (predrought) genotypes were recovered from stored seed and raised under a set of common environments with descendant genotypes and with ancestor×descendant hybrids. As predicted, the abbreviated growing seasons caused by drought led to the evolution of earlier onset of flowering. Descendants bloomed earlier than ancestors, advancing first flowering by 1.9 days in one study population and 8.6 days in another. The intermediate flowering time of ancestor×descendant hybrids supports an additive genetic basis for divergence. Experiments confirmed that flowering time was heritable, and that selection intensities in the field were more than sufficient to account for the observed evolutionary change. Natural selection for drought escape thus appears to have caused adaptive evolution in just a few generations. A systematic effort to collect and store propagules from suitable species would provide biologists with materials to detect and elucidate the genetic basis of further evolutionary shifts driven by climate change. (Franks et al., 2007)

The rate of plant growth depends on temperature and CO₂ content. The rate of plant growth rises quickly depend on rising temperature and CO₂ concentration, and thus the vegetation period is shortened. The duration of the increased temperature accelerates the cereal grain filling period. Shortened grain filling period has negative effect on grain yield due to rising temperature (Bongaart, 1994). Increased evaporation from the soil and plants, increased extreme precipitation, extreme climatic conditions such as drought with increasing temperature are not desirable for most agricultural products. Likewise, increasing temperature decreases crop yield in the tropical and subtropical zones since most plants in these zones are already grown at a temperature close to the level of tolerance. More temperature increases could put the plants under temperature stress (Bongaart, 1994).

Global Warming, Invasive Species

It is predicted that the distribution of vegetation will take place at higher latitudes and higher altitudes due to global warming. This distribution will cause alien invasive species to emerge. These species, which can be more easily adapted to changing environmental conditions than the plant species found in the natural flora will easily spread. Invasive species distribution will change in accordance with different adaptation capacity, changeable genetic pattern and shortening growing period. Invasive species have significant negative effects on biodiversity, ecosystem function, agricultural productivity, and human health. Only, the estimated annual cost of invasive species exceeds \$120 billion in the United States (Pimentel et al., 2005). It has been hypothesized that climate change will exacerbate the impacts of non-native species naturalization and subsequent invasion across communities.

A researcher groups identified that non-native species differ dramatically from natives in their ability to respond to climate change. Non-natives are significantly better able to track seasonal temperatures than native species. In particular, invasives track seasonal temperature variation better than natives and non-native non-invasives, although the difference between invasives and non-native non-invasives is not significant. Invasives have also significantly shifted their flowering time over the last 100 years to be 11 days earlier than natives and 9 days earlier than non-native non-invasives. Concordant with these phenological results, non-native and particularly invasive species have significantly increased in abundance since 1900 relative to the native flora. Finally, aside from having slightly larger flowers than natives, which is likely due to the fact that many non-natives are escaped ornamentals (Mack and Erneberg, 2002), non-native species showed no appreciable difference in the other traits their examined (Willis et al., 2010).

These results provide the strongest link to date between climate change and non-native species' naturalization and subsequent invasion at the community level. While the evolutionary and ecological mechanisms for these results require further investigation, these results nevertheless highlight the utility of phenological response as an important tool for assessing the likelihood of future naturalizations and subsequent invasions by non-native species. Specifically, these results indicate that information on flowering time tracking may allow us to determine if a non-native species is more likely to become naturalized in its introduced range. In addition, the likelihood that a non-native species will become invasive will benefit most from data on species flowering time shift. For example, in Concord, mayweed chamomile (*Anthemiscotula* L.) has greatly shifted its flowering time 23 days earlier since 1900. While mayweed chamomile has yet to be classified as an invasive in Massachusetts, this results from above suggest that it has a high potential of becoming invasive with continued climate change (Willis et al., 2010).

The Effect of Global Warming on Cereal Production

Cereals are today used in many fields from human and animal nutrition to industry. Also, cereals are major compounds in mankind's basic necessities. It is inevitable that cereal production is likely to be affected first, considering vast production area in case of a possible threat of global warming on the Earth's surface. There are lots of scenarios about grain production in case of a global temperature rise.

The first scenario of rising temperatures is declining grain yield and quality due to reduced ripening time. Increased temperatures accelerate the grain filling period of cereals, therefore grain yield and quality characteristics vary. Wheat production area will also move to the polar regions due to rising temperature, and the size of wheat cultivable areas will decrease and consequently wheat production will decrease. Besides, the reduction of areas suitable for agriculture, yield of grain and other crops will lead to a decrease in the efficiency. Although some production rise will

occur at increasing temperatures and carbon dioxide levels, real losses will emerge in the coming period due to the increase of carbon accumulation and reduction of production area. According to a survey conducted in India about this subject, if a temperature increase of 4°C occurs in terms of possible effects of global warming, it is assumed to decrease cereal production by 25-40%, rice production by 15-25%, wheat production by 30-35% (Mendelsohn, 2000).

Global warming and rising temperatures will increase the diseases and pests that threaten crop production. In this case, cereals will be directly affected with respect to yield and quality. In particular, invasive plants including weeds competing with crops will threaten production. Rice and corn mainly grown in irrigated conditions will be reduced with increasing temperature and the reasons such as decreasing of the water source, disappearance of water resources. Most produced and most important crops such as corn and rice in the world will face product losses due to possible global warming. These losses will create serious gaps in human and animal nutrition. In this case, wheat, barley and other species adapting to dry conditions will spread better.

Conclusion

Climate change will affect large geographical areas with similar characteristics. In recent years, staple grains absolutely necessary for human nutrition will become increasingly more important because of decreasing yield, changing growing zone, rising diseases and pests, rising weed threats and changing adaptability. Especially, contraction in grain zones where they can be grown and increasing pressure of invasive species will continue to threaten production in grain growing areas. Growing population and sufficient and balanced nutrition of the population, increasing demand for food, by adding to the threat of global warming, the world will be faced with intractable table every day.

As a number of changes in the earth atmosphere occur as a result of global warming, agriculture is the most affected one among all sectors which trying to conform to these changes. According to various scenarios in this regard, mankind will be confronted with hunger owing to some threat such as drought, pests and diseases, the spread of invasive species and desertification.

Many product groups, especially cereals will be under threat due to decreasing yield and quality with changing production zones. In the face of possible scenarios, international cooperation and strategies are more important than mankind's contribution alone. International partnership plans such as "climate change agreements", "actions for the economic use of water resources" and "drought action plans" will be even more important. Environmentally friendly production techniques, especially applications reducing greenhouse gas emissions in the agricultural sector, will gain importance. It is inevitable that the grain growing system will change under these conditions. No-till farming, conservation tillage, strip tillage which are mainly based on the retention of water in soil environmentally friendly practices such as good farming, organic /ecological agriculture will be much more important to grow cereals.

References

- Akın, G. 2006. Global Warming, Cause and Effect. Ankara University Journal of Languages and History-Geography, 46 (2), 29-43.
- Atay, T. Asav, Ü. Önen, H. Kara, K. 2015 Turkey Invasive Plants Catalog, General Directorate Of Agricultural Research and Policies, Ankara, 81.
- Bongaart, J., 1994 . Can the growing human population feed itself? ScientificAmerican, 270, 36-42

- Franks S. J., S. Sim, and A. E. Weis. 2007. Rapid evolution of flowering time by an annual plant in response to a climate fluctuation. *Proceedings of the National Academy of Sciences USA* 104: 1278–1282.
- IPCC, 2013: Summary for Policymakers. In: *Climate Change 2013: The Physical Science Basis. Contribution of Working Group I to the Fifth Assessment Report of the Intergovernmental Panel on Climate Change* [Stocker, T.F., D. Qin, G.-K. Plattner, M. Tignor, S. K. Allen, J. Boschung, A. Nauels, Y. Xia, V. Bex and P.M. Midgley (eds.)]. Cambridge University Press, Cambridge, United Kingdom and New York, NY, USA
- Karl, T.R., J.M. Melillo, ve T.C. Peterson .2009. *USGCRP*. Global Climate Change Impacts in the United States . United States Global Change Research Program. Cambridge University Press, New York, NY, USA.
- Le Treut H.; Somerville R.; Cubasch U.; Ding Y.; Mauritzen C.; Mokssit A.; Peterson T.; Prather M. (2007). Historical overview of climate change science. In: *Climate change 2007: The physical science basis. Contribution of Working Group I to the Fourth Assessment Report of the Intergovernmental Panel on Climate Change* (Solomon S., Qin D., Manning M., Chen Z., Marquis M., Averyt K. B., Tignor M. and Miller H. L., editors) (PDF). Cambridge University Press. Retrieved 14 December 2008.
- Mack RN, Erneberg M (2002) The United States naturalized flora: largely the product of deliberate introductions. *Ann Mo Bot Gard* 89: 176–189.
- Mendelsohn, R. 2000. Measuring the effect of climate change on developing country agriculture. In: *Essays on Climate Change and Agriculture: A Developing Country Perspective*. Food and Agriculture Organization of the United Nations. Rome. 2-23.
- Özer, Z., Kadioğlu, İ., Önen H ve Tursun, N. 2001. Herbology. Gazi Osmanpaşa University, *Journal of Faculty of Agriculture*, 20, 409.
- Pimentel D, Zuniga R, Morrison D. 2005. Update on the environmental and economic costs associated with alien-invasive species in the United States. *EcolEcon* 52: 273–288.
- Türkeş, M., Sümer, U. M. ve Çetiner, G. 2000. 'Global climate change and its possible effects', Ministry of Environment. The United Nations Framework Convention on Climate Change. Seminar Notes (13 April 2000, İstanbul Chamber of Industry), 7-24, Ankara.
- Willis CG, Ruhfel BR, Primack RB, Miller-Rushing AJ, Losos JB, et al. (2010) Favorable Climate Change Response Explains Non-Native Species' Success in Thoreau's Woods. *PLoS ONE* 5(1): e8878. doi: 10.1371/journal.pone.0008878
- Yıldırım, A ve T. Ekim, 2003. Weed Flora of the Central Anatolia Region. *Plant Protection Bulletin*, 43(1–4): 1–98.

INFLUENCE OF SALT AND OSMOTIC STRESS ON GERMINATION OF DIFFERENT DOMESTIC WHEAT (*Triticum aestivum* L.) CULTIVARS UNDER LABORATORY CONDITION

Branka GOVEDARICA, Igor ĐURĐIĆ, Tanja JAKIŠIĆ, Mirjana JOVOVIĆ, Vesna MILIĆ¹

¹University of East Sarajevo, Faculty of Agriculture, Vuka Karadjica 30, Bosnia and Herzegovina
Corresponding author: vesnamlc@yahoo.co.uk

Abstract

The aim of this research was to identify the cultivars of winter wheat which tolerate drought and increased salinity at the germination stage. The testing was carried out under controlled conditions with an aim to test reaction of 3 different cultivars of winter wheat to salinity and osmotic stress during the early stage of a seedling's growth. The test included examination of germination energy and percentage of germinated seeds. After being sterilized in 96% ethanol and rinsed with distilled water, 50 uniform seeds were transferred to Petri dishes (divided on genotype and treatment) filled with a solution (Mannitol and salt) in which the water potential was of almost 0 (control), -0.3 and -0.6 MPa. Alcohol Mannitol was used to create water stress and NaCl to create salt stress. Seedlings were incubated for 7 days at 25°C. The results showed that the benchmark water potential (under the influence of Mannitol and salt), in which all varieties can germinate and have a good growth of seedlings, is of -0.3 MPa, i.e. of the low stress. Under the stronger stress (-0.6 MPa) all the varieties showed reduction in all measured parameters. Bosanka cultivar showed the best result of germination and germination energy under the influence of water and salt stress when compared to other cultivars. An exception was the cultivar Orion where stress conditions had inhibited germination energy and germination, when compared to other cultivars. Reasons for stronger resistance, or sensitivity, of certain varieties may be numerous and further studies conducted on this or other varieties of wheat would contribute to understanding and explanation of these differences.

Keywords: *germination, cultivars, Mannitol, salt, drought.*

Introduction

Successful production of cultivated plants occurs as a result of a number of metabolic and physiological processes, and one of initial and the most important is the seed germination. Productivity analysis is done primarily by measuring seed germination, where a large number of genotypes can be tested simultaneously and also determine their resilience on different stress factors. Knowledge of these processes and individual genotypes resilience can contribute to achieving the potentials of fertility in certain agro-ecological conditions.

Drought, increased salt concentration as well as other abiotic factors, adversely affecting the quality (Wang *et al.*, 2011; Roy *et al.*, 2011) and the amount (Dolferus *et al.*, 2011) all produced grains, including wheat, which in the future could create very big problems since grains are important food for most of the world population. Salinization of land can create external osmotic potential that can limit the absorption of water by the seed, or the sodium and chloride ions can accumulate in the seed that germinates, and has a toxic effect. The salinity of the soil affects the germination of both sides, either as osmotic stress or a toxic effect of ions.

The selection of genotypes that tolerate drought and salt stress in this stage is therefore important, especially if the tolerance in the germination stage correlated with tolerance to drought and salt, with the period of grain filling (Jovovic *et al.*, 2015). Therefore, it is necessary through various surveys to better meet the physiological and biochemical processes that make the plant tolerant to drought.

The selection of genotypes that can tolerate the stress of draught and salts is important. Drought and increased concentration of salts lead to drop in photosynthesis rate, decrease in biomass and yield (Bala *et al.*, 2006; Hnilička *et al.*, 2007). Laboratory research of drought impact, as well as impact of other environmental stress factors, on tolerance mechanisms have an advantage compared to field experiments, when it is necessary to keep track of changes caused by just one stress factor.

Materials and methods

The tests included examination of germination parameters of three different winter wheat cultivars (Jelena, Bosanka and Nova Bosanka) under controlled conditions. The seeds were selected in the Agricultural Institute of the Republic of Srpska. The experiment was set up in the laboratory of the Faculty of Agriculture in East Sarajevo. Only completely healthy and clean seeds were left for testing. Then the seeds were sterilized in 96 % alcohol for 30 seconds, then washed with distilled water several times, and 50 uniform, healthy seeds were transferred into sterile Petri dishes. The cups were with double layer of filter paper, soaked in saline certain concentration (Mannitol and salt, Table 1.), and it dissolves with water potential close to zero were controls, then, -0.3 and -0.6 Mpa (Braccini *et al.*, 1996). 15 ml of solution was poured into each Petri dish. Control Petri dishes were with distilled water. Alcohol Mannitol was used to induce water stress and sodium chloride to induce stress of salt. The experiment was set with four replicates per each treatment and each variety separately. Seedlings were incubated in an incubator (Binder) for 7 days at a temperature of 25°C, till the appearance of the first true leaf. As the start of germination was recorded the day when the primary roots reached a length of 2 mm. During the experiment we measured germination energy on the 4th day of the experiment, where we numbered all germinated seeds to that period and expressed in percentage compared to the total number of seeds. On the 7th day of the experiment, i.e., at the appearance of the first leaf, we measured total number of germinated seeds in relation to the total number of seeds from one variant.

Table 1. Amounts of sodium chloride and Mannitol used to obtain different levels of water deficit

ΨO the level of MPa	NaCl (g/l distilled water)	Mannitol (g/l distilled water)
0	0	0
-0.3	4.20	22.29
-0.6	8.40	44.58

Traits measured were energy of germination (EG), germination percentage (GP), seed vigor testing (SVT) radicle length (RL), plumule length (PL), and the ratio of radicle to plumule (radicle/plumule – RL/PL).

Statistical analysis was made by MSTAT-C and Excel and the data were analyzed through variance analysis method and means compared by using Duncan's multiple range test at 5% probability level.

Results and discussion

The effects of different NaCl salt and the alcohol Mannitol on germination energy, germination percentage, percentage strong seeds, radicle length, plumule length as well as the ratio of radicle to plumule in all three domestic cultivars (Bosanka, Nova Bosanka and Jelena) is depicted in table 2., as well as charts 1, 2, 3, 4, 5 and 6. All of the tested qualities had the best values in control variety. Nova Bosanka cultivar in control variety had the biggest germination energy, germination percentage, seed vigor testing, radicle length, plumule length, while the Bosanka cultivar had the largest ratio of radicle to plumule. Differences that are determined were statistically significant. In the Nova Bosanka cultivar there were increases in germination energy and plumule length with the increase of salt concentration, and the same case was with Bosanka cultivar where slightly bigger plumule was found in a bigger salt concentration, while the similar deviations were not noted for other tested parameters. *Hadi et al.* (2007) reported that seed germinating rate will be declined when salt content increased. The Jelena cultivar appeared to be the most sensitive because, with increase of salt concentration, it had the lowest germination energy, germination percentage, radicle length, plumule, as well as the ratio between radicle to plumule, while the Bosanka cultivar, with the increase of salt concentration had the smallest seed vigor testing. De Lima and Torres (2009) reported similar results and concluded that the effect of salt stress depends on the plant species. Salt stress affects many physiological aspects of plant growth. Increasing the concentration of salt in the growth medium results in an increase in shoot and root respiration.

Table 2. Mean comparison of the traits of wheat (by Duncan's multiple range test)

Conc. (g)	Variety	EG (%)	GP (%)	SVT (%)	RL (cm)	PL (cm)	RL/PL (cm)
0 (control)	Bosanka	88 b	97.75a	67.75c	6.85b	4.93b	1.39a
	Nova	96.5a	99a	82.25a	7.95a	6.90a	1.15b
	Bosanka Jelena	73c	98.25a	73.75b	5.43c	4.53c	1.19b
NaCl 4.20	Bosanka	81.5b	84.5b	43.5c	6.48b	4.40b	1.47a
	Nova	87.25a	86.75a	55.25a	7.55a	5.15a	1.46a
	Bosanka Jelena	72c	71.75c	49.5b	5.23c	3.90c	1.34b
NaCl 8.40	Bosanka	75.5b	75.75b	42c	5.88b	4.45b	1.32a
	Nova	87.5a	85.25a	51.75a	6.88a	5.63a	1.22b
	Bosanka Jelena	64c	64.75c	50b	4.75c	3.85c	1.23b
Mannitol 22.29	Bosanka	80.5a	83.5b	42c	5.18b	4.25b	1.22a
	Nova	86.5a	86.75a	54a	6.03a	5.08a	1.19b
	Bosanka Jelena	69.5c	71c	49.5b	4.08c	3.80c	1.07c
Mannitol 44.58	Bosanka	73b	73.5b	41c	4.70b	4.40b	1.07a
	Nova	83a	83.5a	51a	5.88a	5.55a	1.06a
	Bosanka Jelena	62.25c	62.5c	48.75b	3.95c	3.70c	1.07a

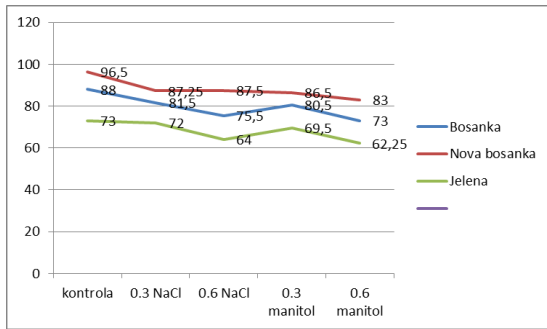

Fig. 1. Effect of NaCl and Mannitol on the germination energy of three domestic wheat varieties

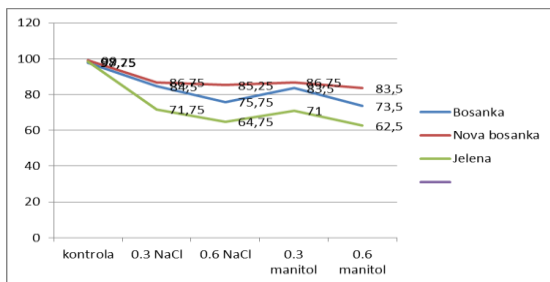

Fig. 3. Effect of NaCl and Mannitol on the seed vigor testing

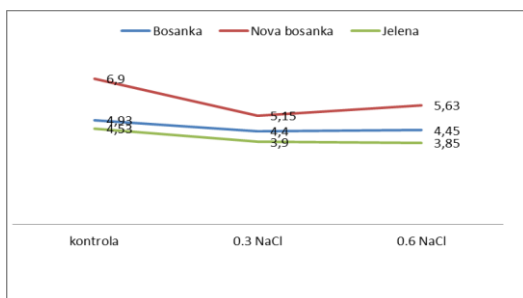

Fig. 5. Effect of NaCl and Mannitol on the plumule length

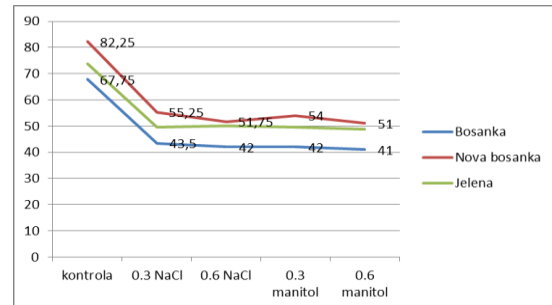

Fig. 2. Effect of NaCl and Mannitol on the germination of three domestic wheat varieties

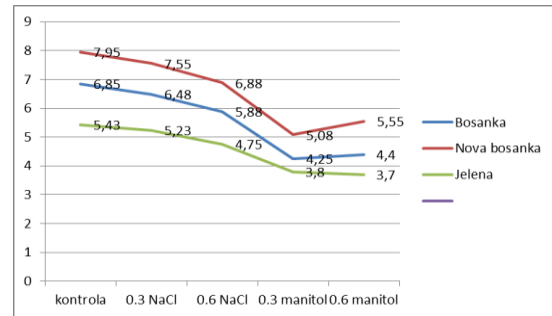

Fig. 4. Effect of NaCl and Mannitol on the radicle length

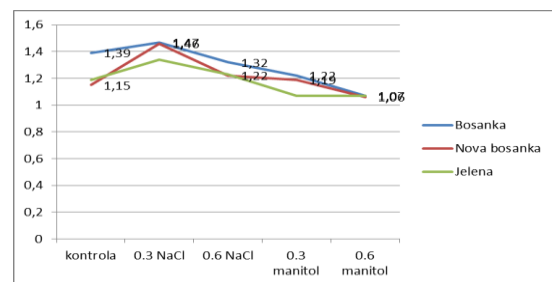

Fig. 6. Effect of NaCl and Mannitol on the ratio of radicle to plumule (radicle/plumule – RL/PL)

For winter crops, which include winter wheat, land for sowing may contain more salt at the time of sowing due to high evapotranspiration during the previous summer, where salt migrates to the surface of the land, and as the seed sown at 10 cm depth that part and contains the most salt. To seed germinated in such medium, must have strong vigor, that he survive and passed through a layer of salt on the surface land (*Huang et al.*, 1995).

Alcohol Mannitol is used to induce water stress (*Chen et al.*,2010), as osmoticum in the germination test because it does not damage the embryo and causes the inhibition of seed germination by affecting the adoption of water energy.

By analyzing the effects of increase in mannitol concentration for all cultivars we determined best results in control variety, while the increase of Mannitol concentration caused tested qualities to decrease (germination energy, germination percentage, perantage strong seds, radicle length, pulmule length as well as radicle to pulmule ratio). The Nova Bosanka cultivar proved to be the most resilient to all tested treatments, compared to other cultivars.

Yang et al. (2010) in tests on *Picea asperata* published that with increasing water potential and the degree of stress tends to fall germination percentage and germination index, especially at -0.6Mpa.

The results showed a significant difference between cultivars with different treatments. Changes in water potential to more negative, cause the reduction in germination, proven *Pratap and Sharma* (2010) in studies on seed. Stronger deficit of water has led to highly significant reduction in the percentage of germination of all cultivars. In -0.6 MPa worst result had Vigna, where energy and germination percentage was inhibited by increasing the osmotic potential.

Conclusion

Based on the examination of the effect of stressful conditions, different strengths of the osmotic potential and salinity, it can be concluded that all the varieties showed a reduction of all measured parameters, in medium (-0.6MPa) and it could be an indication of their sensitivity to stressful conditions.

Cultivar Nova Bosanka showed significantly better result of germination percentage, energy of germination, seed vigor testing, radicle length and plumule length, while the cultivar Bosanka showed significantly better result ratio of radicle to plumule (radicle / plumule) in conditions of water deficit and salinity, as compared to other tested cultivars.

We can conclude that the limit values of water resources when plant, under the influence of mannitol and sodium chloride, in all varieties can germinate quite well and have a good increase in seedling were at -0.3 MPa, i.e. in low stress.

Acknowledgements

This work is the result of the project „Resistance variety of some domestic field crops to stress caused by drought“, which is supported by the Ministry of Science and Technology of the Republic of Srpska.

References

- Balla, K. , Bedo, Z., Veisz, O.(2006) : Effect of heat and drought stress on the photosynthetic processes of wheat. *Cereal Research Communications*, 34: 1. p. 381-384.
- Chen, K., Arora, R., Arora, U. 2010. Osmopriming of Spinach (*Spinacia Oleracea* L. Cv. Bloomsdale) Seeds and Germination Performance under Temperature and Water Stress. *Seed Sci. Technol.* 38: 36-48.
- De Lima, B.G. and Torres, S.B. 2009. Water and Saline Stresses on the Germination of *Zizyphus Joazeiro* Mart. (*Rhamnaceae*) Seeds. *Revista Caatinga*, 22: 93-99.
- Dolferus R., Ji X., Richards R.A., (2011): Abiotic stress and control of grain number in cereals. *Plant.Sci*181:331-341.
- Hadi MR, Khavarinejad RA, Khosh-Kholgh S. 2007. NaCl Effects on Accumulation of Minerals (Na⁺, K⁺, Cl) and Proline in *Triticum turgidum* L. *Asian Journal of Plant Science* 6, 423-426. <http://dx.doi.org/10.3923/ajps.2007.379.383>
- Hnilička, F., Hniličková, H., Martinkova, J., Blaha, L.(2007). The influence of drought and the application of 24-epibrassinolide on the formation of dry matter and yield in wheat. *Cereal Research Communications*, 35: 2.p. 457-460.
- Huang, J., Reddman, R.E. 1995. Salt tolerance of *Hordeum* and *Brassica* species during germination and early seedling growth. *Can. J.Plant Sci.*, 75: 815-819.
- Pratap, V., Sharma, Y.K. 2010. Impact of Osmotic Stress on Seed Germination and Seedling Growth in Black Gram (*Phaseolus Mungo*). *J. Environ. Bio.* 31:721-726.
- Roy S.J., Tucker E.J., Tester M. (2011): Genetic analysis of abiotic stress tolerance in crops. *Curr Opin. Plant Biol* 14: 232-239.

- Jovovic Mirjana , Govedarica-Lucic Aleksandra, Tesanovic Dejana, Tunguz Vesna (2015): Influence of Salt and Osmotic Stress on Germination of Different Wheat Cultivars. *International Journal of Crop Science and Technology*, Volume 1, Issue 2, 47-53.
- Yang, Y., Liu, Q., Wang, G.X., Wang, X.D., Guo, J.Y. 2010. Germination, Osmotic Adjustment, and Antioxidant Enzyme Activities of Gibberellin-Pretreated *Picea Asperata* Seeds under Water Stress. *New Forests*, 39:231-243.
- Wang, K., Liu, Y., Dong, K., Dong, J., Kang, J., Yang, Q., Zhou, H., Sun, Y. 2011. The effect of NaCl on proline metabolism in *Saussurea amara* seedlings. *Afr. J. Biotechnol.* 10: 2886-2893.

WATER PRODUCTIVITY OF MAIZE GROWN UNDER DIFFERENT IRRIGATION REGIMES IN VOJVODINA (SERBIA)

Branka KRESOVIĆ¹, Boško GAJIĆ^{2*}, Angelina TAPANAROVA², Ljubomir ŽIVOTIĆ²

¹ Maize Research Institute “Zemun Polje”, Slobodana Bajića 1, 11185 Belgrade, Serbia

² University of Belgrade, Faculty of Agriculture, Institute of Soils and Melioration, Nemanjina 6, 11080 Belgrade, Serbia

*Corresponding author: bonna@agrif.bg.ac.rs

Abstract

The objectives of this study were to compare the effect of different regimes of sprinkler irrigation of maize on its productivity and water use efficiency, on experimental fields of the Maize Research Institute of Zemun Polje, Serbia. Four irrigation regimes were studied: full irrigation (I_{100}), 75% of I_{100} (I_{75}), 50% of I_{100} (I_{50}), and no irrigation (I_0), in 2007 and 2008. The crop water use efficiency (CWUE), irrigation water use efficiency (IWUE) and evapotranspiration water use efficiency (ETWUE) are used to assess the water productivity of each studied treatment. The efficiency of the same treatment differs between the study years as it depends on seasonal water availability, weather conditions and their impact on grain yields. In general, CWUE increases with irrigation. In the two growing seasons, IWUE and ETWUE decreased with increasing ET_a and the amount of water added by irrigation. On average, treatments I_{50} and I_{75} resulted in similar or higher WUE and ETWUE than treatment I_{100} in both years. IWUE rose as the amount of irrigation water increased in 2007, whereas the opposite was the case in the drier year 2008. Under the agroecological conditions such as exist in Vojvodina, treatments with 50% and 75% of I_{100} compare very well to full irrigation, in terms of productivity, such that they represent a sustainable irrigation strategy for improving the water productivity of maize, with an average of 43% and 27% less irrigation water, respectively, in which case the grain yields are reduced by 17% and 10%, respectively, on average.

Keywords: *Water management, Water stress, Crop water productivity, Irrigation water use efficiency, Evapotranspiration water use efficiency, Silty-clay soil.*

Introduction

According to the UN Food and Agriculture Organization (FAO, 2003), 93 developing countries are expected to increase their agricultural production in the period from 1998 to 2030 by 49% in rainfed areas and 81% in irrigated areas. A large portion of the agricultural output will come from irrigated farmlands, three-fourths of which are in developing countries. Compared to the year 1962, irrigated areas in these countries doubled by 1998. However, FAO estimates that irrigated farming in the 93 countries will actually expand by only 23% in the period 1998–2030. Still, given intensified farming, the assessment is that areas of effectively harvested irrigated crops will grow by 34%. This means larger areas need to be irrigated to produce more crops with currently available water resources.

Serbia's Province of Vojvodina (land area 21,506 km²) is one of its most important agricultural regions. Farming is increasingly irrigated and maize is the main crop (grown on 640,000 ha). Precipitation levels in this region vary from year to year. The perennial average in the growing season is about 384 mm (Kresović *et al.*, 2016). The perennial average actual evapotranspiration (ET_a) of maize is 540 mm, much greater than the amount of rainfall in the growing season

(Kresović *et al.*, 2014). As such, irrigation is needed to compensate for the rain deficit and sustain a high grain yield (GY). Water is most often scarce in July and August, when maize undergoes flowering, pollination and grain-filling.

Irrigation water is an increasingly limited resource in many areas of southern Europe and that necessitates proper irrigation scheduling to maximize water use efficiency (WUE) and profits (Di Paolo and Rinaldi, 2008).

According to Ali and Talukder (2008), maximized yield per unit of water (water productivity, WP), not yield per unit of soil (soil productivity), is the better strategy for rainfed crop farming. In such circumstances, a more efficient management approach is required for increasingly scarce water resources. Water and nutrient deficits often hinder crop growth and the production potential of agroecosystems, given that most crops are sensitive to a short supply of water and nutrients in different critical stages of growth. On the other hand, excessive soil moisture tends to increase farming costs and pollute the environment (as fertilizers and other agrochemicals are carried away). As such, improving water productivity (WP), also referred to as water use efficiency (WUE), is very important in agriculture. The widespread opinion is that increasing water productivity in agriculture is key for mitigating water scarcity and addressing environmental challenges.

According to literature sources, water productivity varies not only between regions but between fields as well, because it depends on many factors such as crop rotation, cropping pattern, climate, irrigation treatment, water/soil/crop management practices, genetic potential of the hybrid, and agritechnology (Gregory *et al.*, 2000; Hatfield *et al.*, 2001; Ali and Talukder, 2008; El-Hendawy *et al.*, 2008; Katerji and Mastrorilli (2009); Djaman and Irmak, 2012). Additionally, the same crop can exhibit different CWUE responses to full and deficit irrigation and rainfed conditions, in different stages of growth on the same location.

Reports on WUE of different crops, including maize, show that variable efficiency between different regions, for the same crop, justifies local determination of this indicator. Ko and Piccinni (2009) found that maize grain yield increases with increasing irrigation and believe that deficit irrigation at 75% ET (evapotranspiration) is an acceptable strategy that reduces grain yield by 10% while increasing CWUE.

Given that WUE of the same crop differs between regions, a local database of CWUE, IWUE and ETWUE needs to be developed (Djaman and Irmak, 2012). The data and information can help better estimate crop yield response to the amount of water added by irrigation in local farming conditions. Therefore, the objective of the present research was to determine and compare CWUE, IWUE and ETWUE of maize under full and deficit sprinkler irrigation and rainfed conditions in the agroecosystem of Vojvodina.

Material and Methods

Site description

Experimental research was conducted on the trial fields of the Maize Research Institute of Zemun Polje in 2007 and 2008. The study area features a moderate continental climate influenced by the Mediterranean. The main characteristics of this climate are severe winters and long and warm summers. The perennial average amount of precipitation is 638 mm, of which 384 mm during the growing season. The perennial average air temperature is 11.9°C and in the growing season 18.6°C. The precipitation total during the growing season of 2007 was 105 mm lower, and in 2008 about 159 mm lower, than the perennial average, while the air temperature was 0.9°C and 0.7°C higher, respectively. Figure 1 shows average monthly air temperatures and precipitation

levels in 2007 and 2008. The experiment was conducted on carbonate, silty clay chernozem, whose field capacity was $0.34 \text{ m}^3 \text{ m}^{-3}$ and wilting point $0.15 \text{ m}^3 \text{ m}^{-3}$ (Kresović *et al.*, 2016).

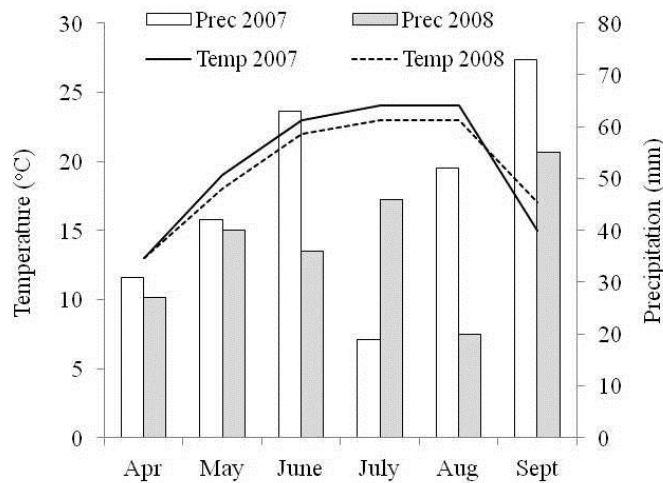

Figure 1. Average monthly temperatures and precipitation levels in the growing seasons of 2007 and 2008.

Experiment plan

Four irrigation treatments were studied: full irrigation (I_{100}), 75% of I_{100} (I_{75}), 50% of I_{100} (I_{50}), and no irrigation (I_0). The setup was of a randomized block design, with four replications. The basic plot size was about 150 m^2 and the harvested area 10 m^2 .

The crop was semi-late maize hybrid ZPSC 684 (FAO 600), selected at the Maize Research Institute of Zemun Polje. The sowing density on all experimental plots was 55,000 plants per hectare (70 cm x 26 cm). Sowing was completed in the last decade of April and the harvest at the beginning of the second decade of October. Identical agrotechnical measures were undertaken on all plots, as needed. At the end of maturity, two central rows, 7.14 m long, were hand-picked from each plot. Grain yield was reported at 14% moisture.

Irrigation was applied by a portable sprinkler irrigation system with sprinkler heads on a square (12 m x 12 m) grid (model RINKA). The irrigation depth and time were determined based on the soil moisture in the effective zone of the root system (0–60 cm deep). Soil water content was measured periodically throughout the growing season (from the beginning of sowing to harvest), on each experimental plot, in 10 cm layers up to a depth of 100 cm, using thermogravimetric methods.

Water use efficiency indicators

The literature proposes different WUE estimation formulas (Tanner i Sinclair, 1983; Boss, 1980, 1985; Katerji *et al.*, 2010). CWUE, IWUE and ETWUE were selected to assess the efficiency and productivity of maize in different irrigation treatments. CWUE was the quotient of grain yield (Y) and crop water demand, expressed as seasonal actual evapotranspiration (ET_a) (Boss, 1980, 1985):

$$CWU = Y/ETa \quad (1)$$

where the CWUE, Y and ETa units are kg m^{-3} , kg m^{-2} and mm .

ETa was determined using the soil water balance equation:

$$ETa = P + I + U + Ron - Roff - D \pm SW \quad (2)$$

where P is precipitation (mm), I is the amount of water added by irrigation (mm), U is the upward flux of soil water (mm), Ron is the surface runoff to the field (mm), $Roff$ is the surface runoff from the field (mm), D is deep percolation (mm) below the root zone, and ΔSW is the change in stored water in the soil cross-section (mm).

Although a useful indicator in many analyses and assessments of WUE, CWUE does not take into account the role of irrigation. To determine the impact of irrigation on crop water productivity (CWP), Bos (1980, 1985) proposed two new indicators – ETWUE and IWUE:

$$ETWUE = (Y_i - Y_r)/(ET_i - ET_r) \quad (3)$$

$$IWUE = (Y_i - Y_r)/I_i \quad (4)$$

where ETWUE and IWUE are expressed in kg m^{-3} , Y is the yield by treatment (kg m^{-2}), ET and I are the seasonal actual evapotranspiration and the amount of water added by irrigation per treatment (mm), and subscripts i and r denote the level of irrigation (or lack thereof).

The effect of the studied irrigation treatments on maize grain yield, CWUE, IWUE and ETWUE were analyzed applying the variance method and LSD test for significance levels of 5% and 1%. SPSS 17.0 software was used.

Results and Discussion

Effect of irrigation treatment on maize grain yield

In the studied irrigation treatments, the maize grain yield varied, on average, from 10.7 to 16.3 t ha^{-1} in 2007 and from 8.7 to 14.3 t ha^{-1} in 2008 (Fig. 2). The most distinct yield variation between the study years was noted in the rainfed treatment because the yield depended mostly on the seasonal amount and distribution of rainfall. The rainfed yield peaked at 10.7 t ha^{-1} in the relatively wet year 2007. A linear correlation was established between grain yield and watering depth; yield grew as irrigation increased from I_0 to I_{100} (Fig. 2). However, when the values for the two years are combined, the plot of grain yield vs. irrigation depth exhibits a quadratic function ($R^2 = 0.744$). On average, irrigation increased grain yields in both years by about 40, 51 and 63% at I_{50} , I_{75} and I_{100} , respectively. The results of the present research are similar to those reported by Széles *et al.* (2012) for maize irrigated by a Valmont linear system in the extremely dry year 2007 in Hungary, where the soil and climate conditions are comparable. However, for the growing season of 2008, which featured sufficient rainfall for maize (484 mm) and a favorable distribution, those researchers reported that irrigation reduced yields (by -1.9 t ha^{-1} on average), compared to the rainfed treatment, to a significance level of 0.1%. Other studies have also found that maize grain yields increased considerably with increasing amounts of irrigation water (Di Paolo and Rinaldi, 2008; Aydinsakir *et al.*, 2013; Rudnick and Irmak, 2013).

In the present research, CWUE exhibited erratic variations from I_0 to I_{100} (Fig. 3). CWUE varied from 3.35 to 3.90 kg m^{-3} (average 3.59 kg m^{-3}) in 2007 and from 2.77 to 3.27 kg m^{-3} (average

3.02 kg m⁻³) in 2008. In the growing season of 2007, CWUE increased with irrigation depth, reached maximum values in treatment I₅₀ and then gradually declined as the amount of water added by irrigation increased. In 2008, CWUE increased with irrigation in treatments I₅₀ and I₇₅, and then rapidly declined, reaching the lowest value of 2.77 kg m⁻³ in treatment I₁₀₀. Contrary to 2008, the rainfed maize exhibited the lowest CWUE – 3.35 kg m⁻³ in 2007. One of the reasons for CWUE variation between the years in the same treatments was the dependency on seasonal water supply, effect of water supply on water extraction, and climate conditions and their effect on yields. According to Irmak *et al.* (2016), a broad CWUE range during the year translates into a high potential for maintaining or increasing agricultural output. The results presented here are considerably higher than the CWUE interval from 0.80 to 1.60 kg m⁻³ described in FAO 33 (Doorenbos and Kassam, 1979), which shows that maize grown in the agroecological conditions that prevail in Vojvodina uses water sparingly.

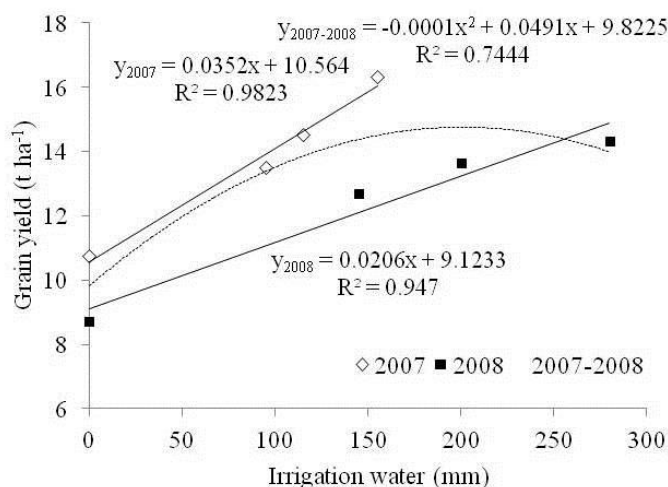

Figure 2. Maize grain yield vs. seasonal irrigation.

Effect of irrigation treatment on CWUE

Katerji *et al.* (2010) determined that CWUE varied depending on the year and location in Mediterranean ecological conditions and that the interval was from 1.34 to 1.81 kg m⁻³. Djaman and Irmak (2012) applied different deficit irrigation treatments in Nebraska and reported CWUE values from 1.89 to 2.58 kg m⁻³, the lowest achieved under rainfed conditions. Rudnick and Irmak (2013) reported similar CWUE values. In conditions similar to those that exist in Vojvodina, after a three-year study in Romania Stan and Năescu (1997) recorded CWUE values from 1.19 kg m⁻³ to as much as 3.78 kg m⁻³, depending on the area and the maize hybrid. Results similar to those reported in the present paper (2.14–3.99 kg m⁻³) were recorded by Kang *et al.* (2000) in arid conditions in northwestern China, with alternating furrow irrigation of maize. El-Hendawy *et al.* (2008) reported a much smaller CWUE interval, from 0.35 to 1.45 kg m⁻³, for maize grown on sandy soil with subsurface drip irrigation in Egypt. The results reported in the present paper concur with the opinion of Taner and Sinclair (1983), who claim that maize CWUE is higher (> 2.5 kg m⁻³ on average) in humid than in relatively dry regions.

The regression analysis in Fig. 4 shows a linear CWUE increase with grain yield ($R^2 = 0.85$) and irrigation ($R^2 = 0.92$) in 2007, while the CWUE decreased linearly with grain yield ($R^2 = 0.96$) and irrigation ($R^2 = 0.96$) in 2008. By contrast, Djaman and Irmak (2012) determined a linear CWUE increase with increasing yield in both study years (2009 and 2010). Contrarily to our

study, the cited researcher reported quadratic relationship between maize CWUE, grain yield and seasonal irrigation in both years.

Effect of irrigation treatment on IWUE

IWUE variation did not exhibit a clear pattern with regard to the irrigation treatments (Fig. 3). In 2007, IWUE increased (by about 24%) with increasing amounts of irrigation water, peaking in treatment I₁₀₀. However, in 2008, IWUE decreased considerably (by about 37%) with decreasing irrigation and was the lowest in treatment I₁₀₀. In 2007, IWUE varied from 2.92 kg m⁻³ (I₅₀) to 3.61 kg m⁻³ (I₁₀₀) (average 3.28 kg m⁻³). In 2008, it varied from 1.99 kg m⁻³ (I₁₀₀) to 2.73 kg m⁻³ (I₅₀) (average 2.39 kg m⁻³). IWUE was therefore higher in 2007 (average 3.28 kg m⁻³) than in 2008 (average 2.39 kg m⁻³). In the relatively drier growing season of 2008, IWUE was much higher in the stress treatments (I₅₀ and I₇₅) than in treatment I₁₀₀. The reason might be inefficient water use and inefficient repositioning of grain assimilates with increasing water supply. Lower IWUE in 2008 in treatment I₁₀₀, compared to 2007, could be a result of the fact that the percent grain yield increase was smaller than the increase in the amount of applied irrigation water. Compared to CWUE, IWUE exhibited much higher variability and much higher IWUE values throughout the range in 2008, compared to 2010 (Fig. 3).

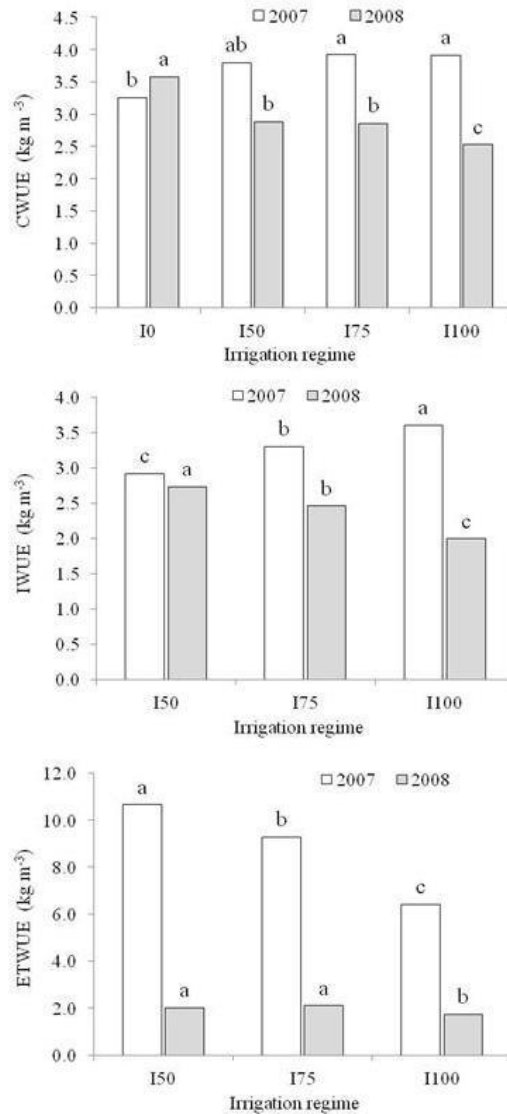

Figure 3. CWUE, IWUE and ETWUE indicators of maize in different irrigation treatments. Histograms with the same letters do not differ considerably at significance level $P < 0.05$ according to LSD test.

Similar IWUE trends and values have been reported in the literature. Djaman and Irmak (2012) compared CWUE, IWUE and ETWUE of maize under full, deficit and no irrigation in South Central Nebraska and found that IWUE varied from 3.63 kg m^{-3} (100% FIT – fully irrigated treatment) to 5.90 kg m^{-3} (50% FIT) in 2009, and from 2.52 kg m^{-3} (50% FIT) to 3.24 kg m^{-3} (75% FIT) in 2010, with a center pivot irrigation system. Their results in 2009, regardless of treatment, were higher than those of the present research. In soil and climate conditions similar to those of the present study Pejić *et al.* (2011) reported that the IWUE interval was from 0.47 to 3.00 kg m^{-3} (average 1.72 kg m^{-3}). Similar to the 2008 results reported in the present research, other studies noted that IWUE decreased with increasing amounts of irrigation water (Di Paolo and Rinaldi, 2008; Djaman and Irmak, 2012). The cited researchers found IWUE to be higher than CWUE. Additionally and contrary to other reports on research undertaken primarily in arid and semi-arid areas, in the present research stored soil moisture played a key role in rainfed grain

yields. The results of the present study are similar to those of Rudnick and Irmak (2013). In their research, CWUE was higher than IWUE and IWUE was much lower and varied from -0.08 kg m^{-3} to 1.78 kg m^{-3} .

Figure 4 shows a linear increase in IWUE with grain yield ($R^2 = 0.95$) and irrigation ($R^2 = 0.93$) in 2007, while the IWUE decreased linearly with grain yield ($R^2 = 0.94$) and irrigation ($R^2 = 0.99$) in 2008. In contrast to our results, Djaman and Irmak (2012) reported a quadratic IWUE decrease with increasing yield. The cited researcher reported that IWUE decreased quadratically with irrigation amount in 2009, but in the 2010 IWUE was inversely related to irrigation. Evett et al. (2006) reported a quadratic increase of IWUE with declining irrigation depth, and their IWUE values ranged from 2.0 to 4.5 kg m^{-3} .

Effect of irrigation treatment on ETWUE

IWUE provides valuable information about the effect of irrigation on grain yield increase, compared to rainfed treatment. However, IWUE can be inconsistent because of potential out-of-purpose use of irrigation water (e.g. runoff, deep percolation, soil water retention, etc.) (Rudnick and Irmak (2013). Another expression – ETWUE (Bos, 1980, 1985) has been proposed to better assess the effect of irrigation water. In the present research, ETWUE of maize varied from 6.42 kg m^{-3} at I_{100} to 10.65 kg m^{-3} at I_{50} in 2007 (Fig. 3). In 2008, the ETWUE interval was much smaller, from 1.73 kg m^{-3} at I_{100} to 2.10 kg m^{-3} at I_{75} . Similar to CWUE and IWUE, ETWUE was higher in 2007 than in 2008. ETWUE was higher than CWUE in all treatments in 2007 because of the smaller ETa difference between the irrigated treatments and rainfed treatment. Contrary to 2007, in the drier year 2008 ETWUE was much lower than CWUE in all treatments.

The two-year average ETWUE rapidly declined with increasing amounts of water added by irrigation. There were much greater differences between I_{75} and I_{100} in 2007 than in 2008. ETWUE was the highest at ETa of 356 mm in 2007 and 478 mm in 2008. This means that in the reported experimental, climate and agrotechnical conditions, the maximum achievable ETWUE is at an ETa lower than that with full irrigation in a dry year, such as 2008. Consequently, I_{75} and I_{50} are sustainable practices of deficit irrigation under the given experimental conditions.

In general, the 2008 results are consistent with those reported by Howell (2001), who found that ETWUE was generally the highest with the least irrigation. The results of the present research are similar to those of Irmak *et al.* (2016), who reported that ETWUE of maize grown on silty clay soil in the USA varied from 1.4 to 11.3 kg m^{-3} . However, it was much higher than reported by Pejić *et al.* (2011), who determined an ETWUE of maize between 0.67 and 2.34 kg m^{-3} (eight-year average 1.50 kg m^{-3}), and Rudnick and Irmak (2013) who reported ETWUE from -0.14 to 3.65 kg m^{-3} . Similar to the results of the present research, Djaman and Irmak (2012) applied different deficit irrigation treatments to maize and recorded ETWUE values from 4.65 to 6.73 kg m^{-3} , but there was no clear-cut trend.

One of the reasons why ETWUE varies to a large extent between studies is because it is the most dependent on the amount and distribution of rainfall (Pejić *et al.*, 2012). Howell (2001) stated that the highest ETWUE was generally achieved with the least amount of irrigation water, meaning that the applied irrigation water was fully utilized. In effect, ETWUE shows whether the growing season favors plant production.

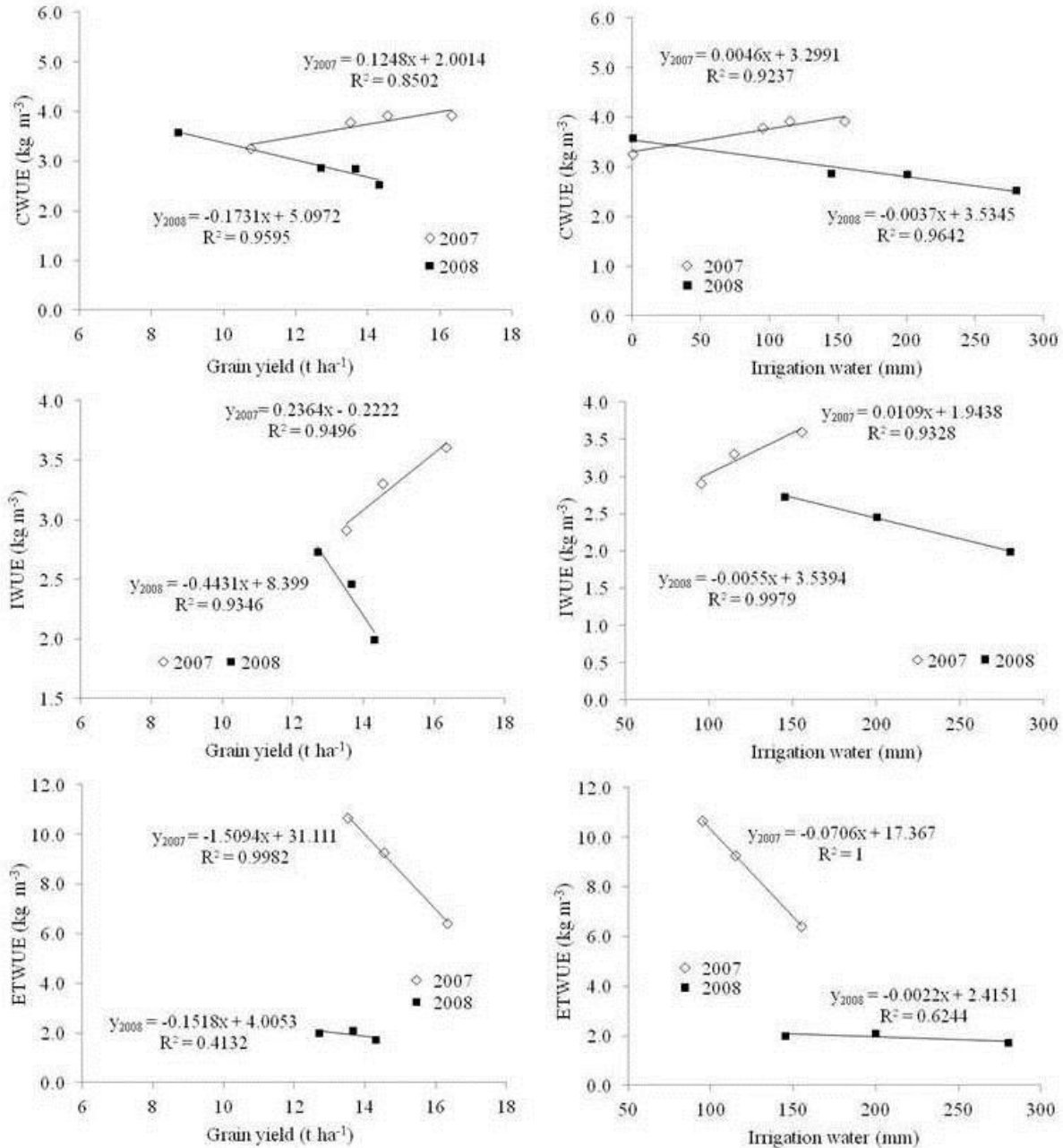

Figure 4. Correlation between grain yield (left) and irrigation (right) vs. crop water use efficiency (CWUE), irrigation water use efficiency (IWUE), and evapotranspiration water use efficiency (ETWUE).

In the present research, ETWUE inversely correlated with grain yields and irrigation amounts. The year 2007 exhibited a steeper regression curves than in 2008 (Fig. 4). Djaman and Irmak (2012), in the year 2009 of their experimental research, also determined a linear decrease in ETWUE with increasing yield and irrigation amounts. Contrary to results of 2009, these authors observed a gradual increase of IWUE with increasing grain yield and irrigation in 2010. Differences in CWUE, IWUE and ETWUE across years are partially due to weather differences.

Conclusions

The results of the present study show that in Vojvodina, irrigation is of vital importance as a means of increasing maize output and WUE. Higher grain yields were achieved in 2007 than in 2008, but the percent yield increase in all irrigation treatments, compared to the rainfed treatment, were much higher in the dry year 2008 than in the wetter year 2007. Treatments I₅₀ and I₇₅ recorded relatively high yields, comparable to full irrigation. The finding is that deficit irrigation is a sustainable strategy for increasing CWP of maize, when 50% or 25% less water is used in the given experimental, soil and crop management, and climate conditions. In brief, the study shows that maximizing CWUE, IWUE or ETWUE should be the primary objective of maximizing crop water productivity with irrigation of maize in regions that feature soil and climate conditions and apply agritechnologies similar to those in Vojvodina.

Acknowledgement

Angelina Tapanarova undertook this research as a part of her PhD studies under the supervision of Dr. Branka Kresović. This study was carried out as a part of the Maize Institute in Zemun Polje project, entitled “Development of new lines of maize, soya bean and other field crops” and Contract Nos. III 43009 and TR 31037, both supported by the Ministry of Education, Science and Technological Development of the Republic of Serbia.

References

- Ali, M.H., Talukder, M.S.U. (2008). Increasing water productivity in crop production – A synthesis. *Agric. Water Manage.* 95, 1201–1213.
- Aydinsakir, K., Erdal, S., Buyuktas, D., Bastug, R., Toker, R. (2013). The influence of regular deficit irrigation applications on water use, yield, and quality components of two corn (*Zea mays* L.) genotypes. *Agric. Water Manage.* 128, 65–71.
- Bos, M.G. (1980). Irrigation efficiencies at crop production level. *ICID Bull* 29(2): 18-25, 60.
- Bos, M.G. (1985). Summary of ICID definitions of irrigation efficiency. *ICID Bull* 34(1), 28–31.
- Di Paolo, E., Rinaldi, M. (2008). Yields response of corn to irrigation and nitrogen fertilization in a Mediterranean environment. *Field Crops Res.* 105, 202–210.
- Djaman, K., Irmak, S. (2012). Soil water extraction patterns and crop, irrigation, and evapotranspiration water use efficiency of maize under full and limited irrigation and rainfed settings. *Trans. ASABE* 55(4), 1223–1238.
- Doorenbos, J., Kassam, A.H. (1979). Yield response to water. *FAO Irrigation and Drainage Paper* 33. Rome, Italy: United Nations FAO.
- El-Hendawy, S.E., Abd El-Lattief, E.A., Ahmed, M.S., Schmidhalter, U. (2008). Irrigation rate and plant density effects on yield and water use efficiency of drip-irrigated corn. *Agric. Water Manage.* 95, 836–844.
- Evet, S.R., Peters, R.T., Howell, T.A. (2006). Controlling water use efficiency with irrigation automation: Cases from drip and center-pivot irrigation of corn and soybean. In *Proc. 28th Annual Southern Conservation Systems Conference*, 57–66. Bushland, Texas: USDA-ARS Conservation and Production Research Laboratory.
- FAO (2003). *World agriculture: towards 2015/2030*. Earthscan Publications Ltd., London, 432 pp.
- Gregory, P.J., Simmonds, L.P., Pilbeam, C.J. (2000). Soil type, climatic regime, and the response of water use efficiency to crop management. *Agron. J.* 92, 814–820.
- Hatfield, J.L., Thomas, J.S., John, H.P. (2001). Managing soil to achieve greater water use efficiency: a review. *Agron. J.* 93, 271–280.

- Howell, T.A. (2001). Enhancing water use efficiency in irrigated agriculture. *Agron. J.* 93, 281–289.
- Irmak, S., Djaman, K., Rudnick, D.R. (2016). Effect of full and limited irrigation amount and frequency on subsurface drip-irrigated maize evapotranspiration, yield, water use efficiency and yield response factors. *Irrig. Sci.* 34, 271–286.
- Kang, S., Shi, W., Zhang, J. (2000). An improved water-use efficiency for maize grown under regulated deficit irrigation. *Field Crops Res.* 67, 207–214.
- Katerji, N., Mastrorilli, M. (2009). The effect of soil texture on the water use efficiency of irrigated crops: Results of a multiyear experiment carried out in the Mediterranean region. *Eur. J. Agron.* 30(2), 95–100.
- Katerji, N., Mastrorilli, M., Cherni, H.E. (2010). Effects of corn deficit irrigation and soil properties on water use efficiency: A 25-year analysis of a Mediterranean environment using the STICS mode. *Eur. J. Agron.* 32(2), 177–185.
- Ko, J., Piccinni, G. (2009). Corn yield responses under crop evapotranspiration-based irrigation management. *Agric. Water Manage.* 96(5), 799–808.
- Kresovic, B., Matovic, G., Gregoric, E., Djuricin, S., Bodroza, D. (2014). Maize Irrigation as a climate change impact mitigation measure: An agronomic and economic assessment of maize production in Serbia. *Agric. Water Manage.* 139, 7–16.
- Kresović, B., Tapanarova, A., Tomić, Z., Životić, Lj., Vujović, D., Sredojević, Z., Gajić, B. (2016). Grain yield and water use efficiency of maize as influenced by different irrigation regimes through sprinkler irrigation under temperate climate. *Agric. Water Manage.* 169, 34–43.
- Pejić, B., Maheshwari, B., Seremesić, S., Stricević, R., Pacureanu-Joita, M., Rajić, M., Cupina, B. (2011). Water-yield relations of maize (*Zea mays* L) in temperate climatic conditions. *Maydica* 56(4), 315–321.
- Rudnick, D.R., Irmak, S. (2013). Impact of water and nitrogen management strategies on maize yield and water productivity indices under linear-move sprinkler irrigation. *Trans. ASABE* 56(5), 1769–1783.
- Széles, A. V., Megyes, A., Nagy, J. (2012). Irrigation and nitrogen effects on the leaf chlorophyll content and grain yield of maize in different crop years. *Agric. Water Manage.* 107, 133–144.
- Stan, I., Năescu, V. (1997). Maize response to water deficit. *Romanian Agric. Res.* Number 7–8, 77–90.
- Tanner, C.B., Sinclair, T.R. (1983). Efficient water use in crop production: research or re-research? In: Taylor, H.M., Jordan, W.R., Sinclair, T.R. (Eds.), *Limitations to Efficient Water Use in Crop Production*. Am. Soc. Agron., pp. 1–27.

DETERMINATION OF GENOTYPE X ENVIRONMENT INTERACTIONS OF SOME AGRONOMIC CHARACTERS OF COWPEA (*Vigna unguiculata* L.)

Hatice BOZOĞLU^{1*}, Reyhan KARAYEL², Nurdoğan TOPAL³, Gülbahar ÇULHA¹

¹Ondokuz Mayıs University, Faculty of Agriculture, Department of Field Crops Atakum/Samsun, Turkey

²BlackSea Agriculture Research Institute, Samsun, Turkey

³Uşak University, Faculty of Agriculture and Natural Sciences, Department of Field Crops, Uşak, Turkey

*Corresponding author:hbozoglu@omu.edu.tr

Abstract

Cowpea, with its temperature and drought resistance, is one of the best legume plants and more adaptable to dry environments compared to the common bean. Flowering and pollination period of common bean has suffered due to recent temperature increases in our region. Expected temperature increases in the forthcoming years will further affect bean cultivation, and thus will lead to widespread cultivation of cowpea thanks to its substitution of bean in foods as either in the dry seed or fresh pod form. In this study, 16 cowpea genotypes (14 lines and 2 registered varieties) from four different environments (2 years and 2 locations) were evaluated for genotype (G) x environment (E) interactions and for stability parameters of regression coefficient and mean square of deviation from the regression. The effects of genotype, environment and GxE interactions on seed yield, plant height and biological yield were highly significant. It was found that 5 lines for plant height, 4 lines and 1 registered variety for biological yield and 4 lines for seed yield were stable. The seed yield of genotypes was 126-226 kg da⁻¹.

Keywords: *Cowpea, genotype x environment interaction, stability*

Introduction

Cowpea is grown in a total of 11.2 million ha area in the world (FAO, 2014). It is a remarkable plant, particularly for its low soil requirements and drought resistance and can also be included in crop rotation as a type of legume. It has been reported that it can grow under humid and semi-arid conditions and even under conditions with no precipitation due to its resistance to drought. From this point of view, cowpea is an important plant that can make positive contributions to the Middle Black Sea Region, similar to the examples in the world, with its integration into the system via studies on crop rotation and organic rice cultivation. As a superior legume in terms of temperature and drought tolerance in semi-arid and tropical regions of the world (Hall *et al.*, 2003; Hall, 2004), cowpea is a remarkable plant in Turkey where the temperature continuously increases and the water sources decline due to global climate change. It was noticed that cowpea had a better resistance to drought in such areas compared to that of beans, therefore it was more advantageous both for using as food and animal feed (Gençkan, 1983).

Organic vegetable producers in the United States of America have difficulty providing sufficient nitrogen to their crops. A nematode resistant cowpea cultivar grown in rotation could be used to enhance the fertility of the soil and suppress weeds and nematode pests. Young and tender leaves are prepared as a pot herb in a manner similar to that of spinach in the USA and Africa that is the largest growing area in the world (Ronde and Spreeth, 2007).

Although it has not been evaluated in agricultural statistics for the recent years, cowpea has a cultivation area of 3040 ha in Turkey. and is mostly cultivated in the Aegean, Mediterranean and Southern Eastern Regions of Turkey. The previous studies conducted in our region determined that adaptation requirements of cowpea fit to the Samsun conditions and the plant is suitable for

both monocrops and intercropping in the region (Bozoğlu and Gülümser, 1995). As a result of our selection studies initiated in 1996 for variety registration, which we consider the first step to agricultural development, 14 lines were determined as promising for dry seed cultivation purposes. In their pursuit of determining candidate variation lines, plant breeders carry out replicated trials revealing genotype x environment interactions, and thus find the most stable varieties that are least affected from the fluctuations occurring in the given environmental conditions. As a result of these trials, stable lines and adaptation classes of the lines are determined (Bozoğlu and Gülümser, 2000).

This study aimed to determine the genotype x environment interactions and stability of 14 cowpea lines selected in the region as well as to determine the candidate genotypes suitable for the Middle Black Sea Region in Turkey.

Materials and Methods

The experiments were carried out in two locations that represent the Middle Black Sea Region: Amasya represents the continental climate of the interior region, whereas Samsun represents the moderate climate of the coastal region.

In the Amasya region soil texture was: with high levels of phosphorus and potassium, clay loam, alkaline, slight salt weak organic matter, medium lime for the first year; medium organic matter and without lime in the second year. In the Samsun region soil texture was: with high levels of phosphorus and low levels of potassium, clay, neutral, without salt, medium organic matter, without lime for both years. Some climate data from locations for both years and the long term period are shown in Table 1.

Table 1. Some climate data from experiment locations

		May	June	July	August	September	Total or Mean
Rainfall (mm)							
Amasya	Long term	56.2	13.7	12.8	19.5	43.1	145.3
	First year	66	10	15	5	8	104
	Second year	37	6	-	-	36	79
Samsun	Long term	50.6	47.9	31.3	31.5	50.9	212.2
	First year	44.2	37.4	12.6	0.8	137.5	232.5
	Second year	58	37.7	16.4	0.2	150.2	262.5
Temperature (°C)							
Amasya	Long term	17.7	21.3	25.3	24.9	19	21.64
	First year	17.8	20.9	25.5	26.1	20.7	22.2
	Second year	14.8	20.4	20.9	25.6	17.9	28.5
Samsun	Long term	15.3	20	23.1	23.2	19.8	20.3
	First year	15.7	19.3	23.4	24.8	20.4	20.7
	Second year	14.4	20.8	22	24.9	19.7	20.4

Fourteen lines determined by individual plant selection from the population that was collected from different regions of Turkey and two registered varieties were the materials of this trial (Karagöz, Akkız). The experiments were set up as randomized complete block design with three replications and carried out in two locations (Amasya- Gokhoyuk and Samsun-Kampus) for two years. Sowing was done on the last week of May for both years in the Samsun-Kampus region; the second week of May of the first year and the last week of May of the second year in the Amasya-Gokhoyuk region. Row spacing was 60 cm with intervals of 15 cm between plants and five rows per plot. Four kg per decare of nitrogen fertilizer was used at the emergence time of plant. Irrigation

was conducted for three times in the Samsun location; for four times in the first year and three times in the second year in the Amasya location. Agronomic observation and measurements were determined for 10 plants chosen randomly from each plot. Analysis of variance using the MSTATC program was performed after data was collected over the years and locations. LSD test was used for grouping the characteristics that were deemed significant. In accordance with Finlay Wilkerson (1963) and Eberhard Russell (1966), stability parameters to be calculated were selected as the regression coefficient (b_i) and deviation from regression (S^2_d) with TARIST computer program. A stable genotype is above the general average, regression coefficient is equal to 1, and deviation from regression is zero or close to zero. Confidence limits (CL) for the regression coefficient and the mean of trial were calculated and showed in the stability graph as 9 different adaptation classes (Bozoğlu and Gülümser, 2000). The genotypes that are in the medium compliance group for all environments are accepted as stable (Arshad, 1990).

Results and Discussion

GxE interaction variance should be significant in order to determine the stability and adaptation classes of candidate variation genotypes selected via long breeding studies (Özbek, 1990). Analysis of variance for this study showed that GxE interactions, the number of pods per plant, the number of seeds per pod, 100-seed weights and crude protein ratio in the seed were not significant, whereas plant height, biological yield, seed yield and harvesting period values were statistically significant. Location, genotype mean values and multiple comparison test results for the number of pods per plant, the number of seeds per pod, 100-seed weights and crude protein ratio in the seed properties are shown in Table 2, whereas the mean values and stability parameters for plant height, harvesting period, biological yield, dry seed yield are shown in Table 3.

The number of pods in the plant were statistically different in both locations and the genotypes (Table 2). The average trial value for Amasya, which represents the warmer and inner areas of the region, was 13.3 and it significantly differed ($P < 0.01$) from the Samsun location (9.8) by the sea. The control variety Akkız had the highest number of pods (15.6), whereas the G₁₁ line had the lowest values (7.9). Gülümser *et al.* (1989) reported that the number of pods in the plant varied between 6.7 and 10.0 under the conditions of Samsun. On the other hand, Karasu (1999) determined the number of pods in the plant as 29.4-40.6, whereas Adiphala *et al.* (2001), in their study on eight cowpea genotypes, determined the number of pods in the plant between 19 and 41. Geetha and Varughese (2001), in their study conducted in India, reported the number of pods in the plant between 51.7 and 60.4, whereas Umaharan *et al.* (1997) reported values between 21.0 and 30; Negri *et al.* (2000) in their study on 13 cowpea varieties, reported the number of pods in the plant between 14.9 and 39.2.

Cowpea is highly variable in terms of pod length and the number of seeds in the pod vary depending on this parameter. However, the genotypes used in this trial were selected from materials suitable for dry agriculture, and therefore pod length and the number of seeds in the pod varied in a narrow range. The number of seeds per pod varied between 8.6 and 9.1 in the control variety, whereas it varied between 8.4 and 10.6 in the genotypes (Table 2). Omoigui *et al.* (2006) determined the number of seeds per pod in cowpea between 7.0 and 11.4, whereas Magloire (2005) reported these numbers between 6.6 and 12.9. In two different studies conducted in India, it was reported that the number of seeds per pod was the character which was least affected from the environment and it was one of the characters with the highest degree of inheritance (Singh *et al.*, 2006; Suganthi and Murugan, 2008). Muli and Saha (2000), in their study conducted at two different locations, used eight cowpea varieties and determined that the pod lengths varied between 13.0 and 20.3 cm

Table 2. Mean of some agronomic properties of cowpea line/varieties grown in the Amasya and Samsun locations

	Pods per plant			Seeds per pod			100 seed weight (g)			Raw protein ration in seed (%)		
	Amasya	Samsun	Mean**	Amasya	Samsun	Mean**	Amasya	Samsun	Mean**	Amasya	Samsun	Mean**
G1	13.5	11.9	12.7a-e	7.5	9.3	8.4f	21.9	23.3	22.6a	18.9	19.6	19.3bc
G2	9.8	8.5	9.2efg	8.1	8.7	8.4f	21.6	21.1	21.4ab	22.9	21.0	21.9a
G3	13.6	8.9	11.3b-g	7.9	9.3	8.6f	17.9	19.2	18.5c	20.2	20.6	20.4abc
G4	10.4	9.2	9.8d-g	8.3	8.7	8.5f	22.1	22.7	22.4a	20.9	20.8	20.9ab
G5	13.0	10.2	11.6b-f	9.2	10.1	9.6b-e	20.8	19.4	20.1bc	19.8	19.2	19.5bc
G6	15.7	10.8	13.2a-d	8.9	8.6	8.8def	19.4	20.4	19.9bc	19.8	19.3	19.6bc
G7	14.2	5.1	9.6d-g	10.4	10.8	10.6ab	12.7	11.0	11.8e	22.2	20.3	21.2ab
G8	11.8	10.1	10.9b-g	9.2	10.2	9.7a-d	19.7	21.6	20.7ab	19.2	18.3	18.7c
G9	14.1	13.3	13.7abc	8.5	8.9	8.7ef	18.1	19.0	18.6c	21.4	20.3	20.9ab
G10	11.1	6.6	8.9fg	8.5	9.4	8.9c-f	22.0	21.7	21.8ab	20.7	21.4	21.0ab
G11	10.1	5.7	7.9g	9.8	11.4	10.6a	15.9	13.9	14.9d	20.9	19.6	20.2abc
G12	16.2	11.9	14.1ab	9.2	9.1	9.1c-f	20.8	19.9	20.4bc	20.2	18.9	19.6bc
G13	12.5	8.2	10.4c-g	9.8	10.0	9.9abc	21.4	21.8	21.6ab	21.2	19.7	20.4abc
G14	16.2	12.2	14.2ab	8.6	9.8	9.2c-f	14.4	11.7	13.1de	21.8	20.6	21.2ab
Karagöz	12.1	10.9	11.5b-g	8.6	8.5	8.6f	21.0	20.3	20.7ab	19.2	19.7	19.4bc
Akkız	17.8	13.5	15.6a	9.2	8.9	9.1c-f	13.5	12.2	12.8e	22.2	21.8	21.9a
Mean	13.3a**	9.8b		9.1b	9.2a		18.95	18.70		20.7	20.1	

One of the most important agronomic properties that affect the yield is 100-seed weight. In the present study, 100-seed weight values differed only between the genotypes whereas no statistically significant differences were found between the environmental conditions. Thousand-seed weight of the genotypes varied between 11.8 and 22.6 g. The control variety Karagöz was in the same group with the line that has the highest weight value, whereas Akkız was the genotype with the lowest weight value. Olapade *et al.* (2002), in their study on cowpea, determined the 100-seed weight between 9.9 and 24.4 g, whereas Omoigui *et al.* (2006) determined the 100-seed weight between 12.3 and 29.3 g.

Legumes are protein rich plants and contain high levels of protein in their dry seeds. The degree of inheritance of protein is very high, therefore it is not much affected from the environmental factors. Indeed, in our study, it was found that the environmental factors had no effect on the protein ratio. In the genotypes, protein ratio varied between 18.7 and 21.9 %. Akkız genotype had the highest protein ratio. Ten genotypes were statistically in the same group with Akkız. Gençkan (1983) reported that the protein ratios in cowpea varieties were between 23 and 31%. Özturan and Gülümser (2004) determined the highest protein ratio as 22 %. Ünlü (2005) determined the protein ratios in cowpea between 29.32 and 41.79 %. In a study conducted at two different locations that represent the Middle Black Sea Region, where one of them represented the temperate climate whereas the other represented the continental climate, plant height of cowpea genotypes varied between 65.6 and 107.7 cm.

Table 3. Stability parameters and mean of some properties of cowpea genotypes

Genotyp es	Plant height (cm)			Harvesting day			Biological yield per plant (g)			Seed yield per plant (g)		
	Mean**	Bi	S ² d	Mean**	Bi	S ² d	Mean**	Bi	S ² d	Mean**	bi	S ² d
G1	100.4 abc	1.66	68.5	116.1 d	1.25	5.8	51.4 a-e	0.78	89.0	12.6 abc	0.79	9.7
G2	95.9 a-e	2.00	38.9	119.7 abc	1.14	1.4	57.6 abc	1.30	153.9	10.4 a-d	0.85	1.4
G3	95.9 a-e	0.81	175.9	116.3 cd	0.79	4.1	52.1 a-e	0.89	79.1	9.6 abc	1.4	0.4
G4	116.3 cd	1.47	32.1	116.3 cd	0.91	15.7	54.3 a-e	0.90	48.9	11.1 a-d	1.05	2.4
G5	98.3 a-d	1.18	356.0	119.6 a-d	1.19	13.6	64.1 ab	1.79	368.5	12.8 ab	1.04	3.4
G6	96.5 a-e	0.96	66.6	117.3 bcd	0.92	0.9	38.0 efg	0.72	62.9	13.4 a	1.23	0.2
G7	99.2 abc	0.92	477.1	118.2 bcd	1.10	27.7	27.2fg	0.73	134.7	7.6 e	0.7	15.3
G8	93.9 b-f	1.08	263.1	117.9 bcd	1.11	0.7	59.7 abc	1.22	82.6	12.9 ab	1.01	0.1
G9	76.8 gh	1.24	111.1	118.5 a-d	1.09	2.2	43.8 c-f	0.98	139.5	13.1 ab	1.41	2.5
G10	107.7 a	0.90	260.8	120.5 ab	1.22	4.7	56.2 a-d	0.53	192.7	8.9 c-e	0.38	9.3
G11	92.5 c-f	-0.04	50.1	116.6 cd	0.88	2.5	24.7 g	0.64	36.1	8.6 de	0.62	3.4
G12	97.6 a-e	0.39	168.6	118.3 bcd	0.75	5.9	55.8 a-e	1.71	1544.4	13.6 a	0.30	16.8
G13	107.2 ab	0.68	167.4	117.6 bcd	0.48	55.1	69.0 a	0.02	35.2	11.8 a-d	1.16	0.8
G14	65.6 h	0.45	113.2	119.0 a-d	1.10	3.8	38.5 def	1.13	301.0	9.8 b-e	0.93	2.8
Karagöz	84.3 efg	1.87	65.0	120.8 ab	1.54	27.1	50.5 b-e	1.17	107.1	13.1 ab	2.25	21.6
Akkız	85.3 d-g	0.43	37.6	121.8 a	0.52	1.4	49.4 b-e	1.50	186.3	9.9 b-e	0.88	1.0
Mean	92.5	1		118.4	1		49.5	1		11.2	1	
CL	$\bar{x} \pm 9.01$	$Bi \pm 0.41$		$\bar{x} \pm 1.28$	$\bar{x} \pm 0.2$		$\bar{x} \pm 9.08$	$\bar{x} \pm 0.33$		$\bar{x} \pm 1.4$	$\bar{x} \pm 0.3$	

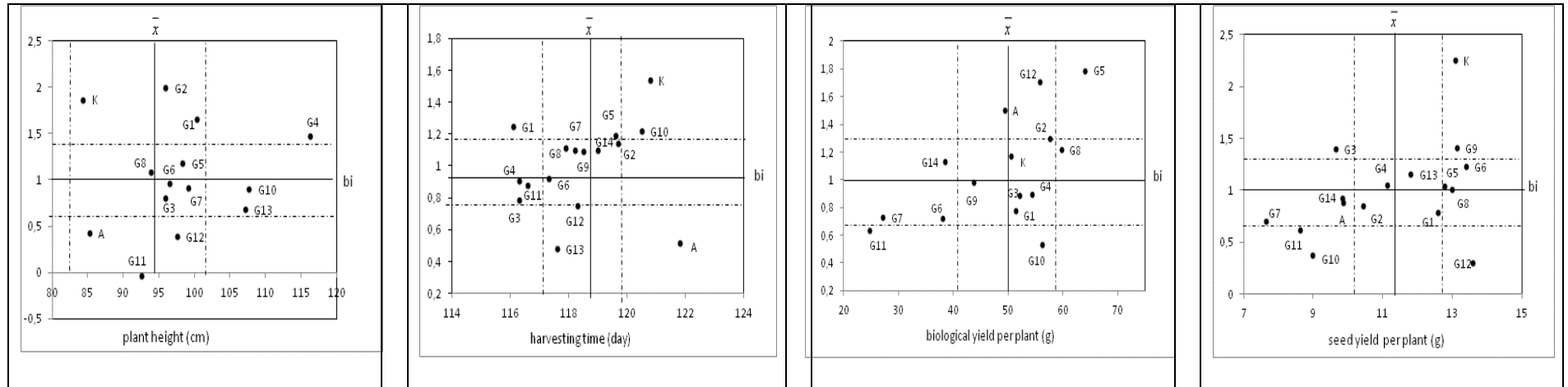

Figure 1. Adaptation classes of some properties of cowpea genotypes

The mean value for the trial was 92.5 cm. To comply with the field agriculture, genotypes that have the longer height and require any support are not preferred. Plant height is a character that is affected from environmental factors and height in cowpea can vary depending on the conditions. Therefore, stability is very important in terms of height. As a result of the stability test conducted (Figure 1), the G₃, G₅, G₆, G₇, G₈ genotypes were found to be stable. Ceylan and Sepetoğlu (1980) determined the plant height in cowpea between 52.3 and 161.3 cm. In addition, the researchers have determined that plant heights and the number of side branches varied depending on the genotype. Gülümser *et al.* (1989), in their study conducted under the ecological conditions of Samsun, have reported that the plant heights of cowpea varieties changed between 74 and 136 cm.

Cowpea is a temperate climate legume that demands high temperatures and thus, can extend its vegetation in areas with mild climate characteristics such as the Middle Black Sea Region. The average vegetation period in the present study was 118 days. Therefore, the dry harvests in the region were carried out in September. For a region that receives heavy rains in autumn, dry harvesting period should not be prolonged in order to eliminate harvest losses and facilitate an easy harvest. The stability tests showed that the G₆, G₇, G₈, G₉ and G₁₂ genotypes were stable during the harvest period. It was determined that the control variety Karagöz can adapt well to good environmental conditions, whereas Akkız can adapt well to bad environmental conditions. Ceylan and Sepetoğlu (1980), in their study on domestic and foreign cowpea genotypes in Bornova, determined that vegetation periods of the genotypes differed and the number of days between first sprouting and ripening was 88-192 days in 1976 and 77-109 days in 1977. Gülümser *et al.* (1989), in their study conducted under the ecological conditions of Samsun, have reported that vegetation period of cowpea varieties changed between 127 and 152 days.

Legumes, whose seeds are used for human nutrition while the remaining straws can be used as animal feed, are rich sources of nitrogen. Therefore, determining the biological yields of plants is important. Biological yield per plant varied between 24.7 and 69.0 g. The average for the trial was found as 49.5 g. The Karagöz, G₁, G₂, G₃, G₄ and G₉ genotypes were found stable.

Seed yield is an important character for all types of field crops, and as a legume whose seeds are consumed as food, that applies to, cowpea as well. For the materials suitable for fresh consumption, it is also important to determine the dry seed yield in terms of sowing seeds. Yield per plant varied between 8.6 and 13.6 g. This value corresponds to 950-1510 kg for the number of plants in one decare. The average value for the trial was 11.2 g and the values for 8 genotypes were higher than the average value. The G₁, G₂, G₄ and G₁₃ genotypes were stable, whereas the G₉ and Karagöz commercial varieties had a good adaptation to good environment, whereas Akkız had a poor adaptation to all environmental conditions (Figure 1). Ceylan and Sepetoğlu (1980) determined that seed yields of the genotypes were 146.6-271.1 kg/da in 1976 and 21.4-267.1 kg/da in 1977. Gülümser *et al.* (1989), in their study conducted under the ecological conditions of Samsun, reported that the seed yield in cowpea varieties changed between 129 and 169 kg⁻¹da.

Conclusion

The stability analysis of fourteen lines that were used as dry seeds and tested as 2 control varieties from 2 years and 2 locations showed that the lines 2, 4 and 13 were the most stable. The control variety Karagöz had a good adaptation to good environment, whereas Akkız had a poor adaptation to all environmental conditions (Figure 1). In light of these information, and particularly for the seed yield, plant height, biological yield values, the genotypes G₄ (with black hilum rings) and G₁₃ (with brown hilum rings) can be recommended as the candidate variation

line. The Karagöz, one of two of our registered varieties had black hilum, whereas Akkız, the other registered variety, had white hilum. In addition, there are also other cowpea varieties that are defined as brown color type and have brown hilum and one of the lines we recommended also have this characteristic.

References

- Adiphala E., Nampala P., Biruma M., Warren W., Wilson H. (2001). Evaluation of cowpea germplasm for agronomic traits, disease and pest resistance in Uganda. Annual Report of the Integrated Pest Management, Colaborative Research Support Program (IPM CRSP).
- Arshad Y. (1990). Genotiplerin çevreye uyum yeteneklerini belirlemede kullanılan bazı stabilite parametreleri üzerinde arařtırmalar (Basılmamıř Yk. Lis. Tezi). İzmir.
- Bozođlu H., Glmser A. (1995). Samsun ilinde brlce yetiřtirilebilme olanakları. Karadeniz Blgesi Tarımının Geliřtirilmesinde Yeni Teknikler Kongresi, 10-11 Ocak 1995, OM Zir.Fak. Samsun.
- Bozođlu H., Glmser A. (2000). Determination of genotype x enviroment interactions and stability of some agronomic characters in dry bean (*Phaseolus vulgaris* L.). *Turkish Journal Agricultural and Forestry* TUBITAK, 24, 211-220. (in Turkish).
- FAO (2014). <http://faostat.fao.org/site/567/DesktopDefault.aspx?PageID=567#ancor> (27 March 2014).
- Gençkan MS. (1983). Yem Bitkileri Tarımı. Ege niversitesi Ziraat Fakltesi Yayınları, No:467, Bornova/İzmir.
- Glmser A., Tosun F., Bozođlu H. (1989). Samsun ekolojik řartlarında brlce yetiřtirilmesi zerinde bir arařtırma. 19 Mayıs niv. Zir. Fak. Der., 4(1-2) 49-65.
- Hall AE., Cisse N., Thiaw. S., Elawad HOA., Ehlers JD. (2003). Development of cowpea cultivars and germplasm by the Bean/Cowpea CRSP. *Field Crops Research* Volume: 82. Issue: 2-3. Pages: 103-134.
- Hall AE., (2004). Breeding for adaptation to drought and heat in cowpea. *European Journal of Agronomy* 21. 4. 447-454.
- Karasu A. (1999). A research on the agronomic charachters of some cowpea (*Vigna unguolata* L) cultivars and ecotypes in ecological condition of Isparta area. Turkey III. Field Crops Congr. s.371-376, Adana. (in Turkish).
- Magloire N. (2005). The genetic, morphological and physiological evaluation of African cowpea genotypes. University of The Free State, Bloemfontein, Master Thesis. 119s.
- Muli M.B., Saha H.M. (2000). Participatory evaluation of cowpea cultivars for adaptation and yield performance in costal Kenya. Proceedings of the 2nd Scientific Conference of the Soil Management and Legume Research Network Projects June 2000 Mombasa, Kenya.
- Negri V., Tosti N., Falcinelli M., Veronesi F. (2000). Characterisation of thirteen cowpea landraces from Umbria (Italy). Strategy for their conservation and promotion. *Genetic Resources and Crop Evaluation*, 47; 141-146.
- Olapade AA., Okafor GI., Ozumba AU., Olatunji O. (2002). Characterization of common Nigerian cowpea (*Vigna unguiculata* L. Walp.) varieties. *Journal of Food Engineering*, 55; 101-105.
- Omoigui LO., Ishiyaku, MF., Kamara AY., Alabi SO., Mohammed SG. (2006). Genetic variability and heritability studies of some reproductive traits in cowpea (*Vigna unguiculata* L. Walp.). *African Journal of Biotechnology*, 5(13); 1191-1195.

- Özturan, Y., Gülümser, A., (2004). The effects of row spacing and nitrogen fertilization on yield and yield components of cowpea (*Vigna unguiculata* (L.) Walp.). Journal of Agriculture Faculty, ODU., 19(3): 41-49 (in Turkish).
- Ronde JA., Spreeth MH. (2007). Development and evaluation of drought resistant mutant germplasm of *Vigna unguiculata*. African Journal Online, vol 33 no:3
- Singh I., Badaya SN., Tikka SBS. (2006). Combining ability for yield over environments in cowpea (*Vigna unguiculata* L. Walp). Indian Journal Crop Science, 1(1-2); 205-206.
- Suganthi S., Murugan S. (2008). Association analysis in cowpea. Legume Research, v: 31, issue:2.
- Umaharan P., Ariyanayagam RP., Haque SQ. (1997). Genetic analysis of pod quality characteristics in vegetable cowpea (*Vigna unguiculata* L. Walp.). Scientia Horticulturae, 70(4): 281-292 (12).
- Ünlü H. (2005). The effect of different sowing times on quality and yield properties of cowpea (*Vigna unguiculata* (L.) Walp.) in arid and irrigated conditions. Süleyman Demirel Üniversitesi, Fen Bilimleri Enstitüsü Dergisi, 9-3, Tez. (in Turkish).

THE INFLUENCE OF NANO-GRO® PREPARATION ON GROWTH, DEVELOPMENT AND YIELD OF PEPPERMINT (*MENTHA x PIPERITA* L.)

Ewa OSIŃSKA^{1*}, Olga KOSAKOWSKA¹, Anna AMBROSZCZYK², Wiesława ROSŁON¹

¹Department of Vegetable and Medicinal Plants, Warsaw University of Life Sciences – SGGW, Poland

²Department of Vegetable and Medicinal Plants, University of Agriculture in Kraków, Poland

*Corresponding author: ewa_osinska@sggw.pl

Abstract

Peppermint is one of the most popular medicinal plants cultivated in Poland. Over the years, the demand for herbs, leaves and essential oil of this species is very high and still increasing. Therefore, it has been looking for methods for improving the yield and the quality of the raw materials. The aim of this study was to analyze morphological and developmental characteristics (e.g. plant height, number of leaves, number of lateral shoots per plant) of peppermint plants treated and untreated with NANO-GRO® preparation. Evaluation of yield and quality of the herb including essential oil content and its chemical composition, were analyzed. The influence of harvest time of raw material and the impact of different methods of application NANO-GRO® were determined. Herb was collected twice: in first decade of July and in third decade of August (regrowth). Plant height ranged from 43.44 to 76.94 cm, the number of lateral shoots from 0.91 to 9.69 pcs, the number of leaves per plant from 19.30 to 92.76 pcs. Method of application of NANO-GRO® did not significantly affect plant height, while it increased the number of leaves and lateral shoots. Different variants of NANO-GRO® application significantly affect the mass of dry herb. This parameter was also influenced by the date of harvest of raw material. All factors used in experiment influenced the content of essential oil in peppermint herb.

Keywords: *Morphological features, yield of herb, essential oil, menthol*

Introduction

Peppermint (*Mentha x piperita* L.) is one of the most popular herbal plant cultivated in Poland. Its raw material e.g. herb, leaves, essential oil and its main component – menthol are components of many tinctures or extracts used mainly in disorders of the digestive system. They have also astringent, antiseptic, antipyretic, antispasmodic, antimicrobial, stimulant and anti-aging properties (Ali *et al.*, 2002; McKay and Blumberg, 2006; Para *et al.*, 2013). The demand for above raw materials is very large therefore many years people was working on increasing the yield of peppermint and improving the quality of herb obtained from this species. It should be emphasized that the climatic conditions in Poland are conducive to the cultivation of peppermint, but there are also some dangers that make the growing of mint may be unreliable (frost in snowless winters, drought, the attack of fungal diseases, etc.). Therefore innovative solutions are quest that will avoid these risks as well as will have stimulating influence on the growth and development of plants peppermint. The answer to such goals can be modern fertilizer preparations. They contain a number of components, which influence on plant metabolism and stimulate their growth whereby increasing the yield. In addition to the effects on metabolic processes, these preparations additionally increase plant resistance to external conditions, among others, frosts, drought, salinity, disease and other infections. Such preparation is organic fertilizer NANO-GRO®, which according to the information of manufacturer's affects the growth of the aboveground part of plants and the development of the root system. Usage of this preparation

results in stimulation of the natural resistance of plants to abiotic stress. This leads to the production of growth hormones (auxin, gibberellins, cytokinins). This, in turn, makes the absorption of nutrients and water is getting better, which increases the yield and improves the quality of obtained raw material (Dyśko, 2008). So far, the action of the preparation was studied on vegetables and cereals, and the results confirmed stimulating effect NANO-GRO[®] on the ability of seed germination, growth, development and yield of the test plants, as well as to strengthen their resistance to adverse environmental conditions (Janas, 2011; Jankowski *et al.*, 2012).

The aim of this study was to evaluate the effect of the preparation NANO-GRO[®] on growth, development and yield of peppermint, as well as to determine the impact of the above fertilizer on the quality of the yield of raw material (herb), i.e. the content of essential oil and its chemical composition. The impact of term of herb harvest on the tested parameters also was evaluated

Materials and Methods

The investigation was carried out on experimental field at the Department of Vegetable and Medicinal Plants'Warsaw University of Life Sciences – SGGW (Poland) in 2014 and 2015. Seedlings for plantation establishment were prepared in a greenhouse. Rhizome-shoots seedlings were collected from the plantation located at the Experimental Field in early spring 2014 and 2015 and were placed in boxes filled with a mixture of peat and sand (1:1). In the second decade of May seedlings were planted in a field on the plots of 5m² in the spacing of 30x40 cm. The experiment was randomized block with 4 replications.

The experimental factors were: method of application of NANO-GRO[®] and the term of peppermint herb collecting.

Four different methods of application NANO-GRO[®] were used:

Variant I (V1) - control - seedlings were planting in the boxes, and then (after their rooting) in the field, without the application of NANO-GRO[®].

Variant II (V2) - before planting in the boxes, seedlings were soaked for 60 sec. in a solution of preparation NANO-GRO[®], after that rooted cuttings were planted in the field.

Variant III (V3) - seedlings were planted in boxes, without soaked of solution of NANO-GRO[®]. When the two pair of real leaves were created, the plants were sprayed of NANO-GRO[®].

Variant IV (V4) - seedlings rooted in boxes, without soaked of solution of NANO-GRO[®]. Immediately after planting them in the field, the plants were sprayed above preparation.

Solutions of NANO-GRO[®] for seedlings soaking and plants spraying were prepared according to the manufacturer's instructions on the package.

In each plot 5 plants were randomly selected (20 plants for each combination), for observations of morphological and developmental characteristics. Research was carried out in 4 stages of plants development: the vegetative stage (first decade of June), before flowering (third decade of June), in full flowering stage (second decade of July) and the after flowering plants (third decade of August). At any term of observation plant height, number of lateral shoots, number of leaves per plant were measured. Herb were harvested twice. The first harvest was carried out in the second decade of July, when the plants were at the full flowering phase. All the plants of plot (except the selected for observation) were cut down about 10 cm above the ground. The second harvest was made in the third decade of August (regrowth - the plants were in the vegetative phase). Raw material from both harvests was dried in drying chamber at 30 °C and air-dry mass of the herb was received. The results were calculated per 1 m².

In the air-dry herb, the content of essential oil and its chemical composition were determined.

The content of essential oil was determined by steam distillation, according Polish Pharmacopoeia X (2014).

Separation of essential oil compounds was performed by gas chromatography (HP Model 6890) in the following conditions: temperature of detector – 250°C, temperature of injector – 220°C, temperature programme – 60°C – 220°C, 5C·min⁻¹, capillary column – Carbovax 20m x 0.32 mm, 25m x 0.2 mm. Identification of essential oil components was carried out by comparing their time of retention with adequate standards.

The presented results (except essential oil composition) are the mean from the two-year experiment. Chromatographical analysis of essential oils was made only in 2014.

The results were subjected to statistical evaluation using ANOVA 1 and ANOVA 2 programmes and Tukey's test at the significance level $\alpha=0.05$.

Results and discussion

Peppermint is one of the most important herbal plants. Its raw materials - herb, leaves, essential oil and menthol, are used in many areas of the polish economy (pharmaceutical industry, food industry, cosmetics industry and others), which makes the demand for its raw materials is very large, there is therefore a need to increase their production (Kołodziej 2008; Newerli-Guz and Kobylańska, 2013; Kiełtyka-Dasiewicz *et al.*, 2016). To achieve this goal, it must increase the yield of this species and at the same time improve the quality of the herb of peppermint. This can be obtained by introducing new agronomic solutions, which include among others, the application of modern fertilizers that stimulates plant growth and development. One of such preparation is NANO-GRO[®] (Jędrszczyk and Ambroszczyk, 2016). NANO-GRO[®] preparation so far has been tested on cereals, vegetables and fruit plants, such research were not carried out on herbal plants. In the available literature we can find only the results of research on the use of other bio-fertilizer on growth of peppermint plants. Kołodziej (2008) for example, demonstrated stimulating growth of that plant, under the influence preparation Asahi SL. Also Rosłon *et al.* (2011) in studies on the effect on morphological features of peppermint such bio-fertilizers as Aminoplant, Goëmar Goteo and Goëmar BM86 demonstrated the positive impact of the first two preparations at the height of the plants of this species. In this experiment NANO-GRO[®] did not significantly affect this trait, although the highest plants were obtained when plants were sprayed above preparation after planting them in the field (V4) (approximately 61.40 cm), while the lowest were the control plants (V1) (an average of 57.99 cm). Tested trait depended only from term of observation. The lowest were the plants at the beginning of the growing season, the highest in the last period of observation (Table 1).

Table 1. The influence of NANO-GRO[®] application and term of observation on height of peppermint plants [cm]

Variant of NANO-GRO [®] application	Term of observation				Mean
	First decade of June	Third decade of June	Second decade of July	Third decade of August	
V1	43.61 d	47.89 cd	63.50 abc	76.94 a	57.99 A
V2	43.44 d	49.11 cd	67.44 abc	75.49 a	58.20 A
V3	40.59 d	49.22 cd	69.00 ab	74.00 a	58.87 A
V4	49.67 bcd	53.27 bcd	67.50 abc	75.18 a	61.40 A
Mean	44.32 C	49.87 C	66.86 B	75.40 A	

An important attributes affecting the mass of the peppermint herb are the number of produced lateral shoots as well as the number of leaves. On these parameters clearly influenced application NANO-GRO[®] and term of observation. The number of lateral shoots was higher in plants treated NANO-GRO[®] compared with the control plants. Assessing the impact of the method of application of NANO-GRO[®] has been observed that most of the lateral shoots produced plants in variant 4, the lowest in variant 3. In the case of the number of leaves significantly less leaves created control plants as compared to plants treated NANO-GRO[®]. Most number of leaves were determined in the case of plants for variant 4 (Table 2 and Table 3). Similar results were obtained by Kołodziej (2008) and Rosłon *et al.* (2011) for such preparations as Asahi SL, Aminoplant and Goëmar Goteo. As in the case of number of leaves and lateral shoots, the lowest results were obtained in the first period of observation, the highest in the last one.

Table 2. The influence of NANO-GRO[®] application and term of observation on number of lateral shoots of peppermint plants [pcs per plant]

Variant of NANO-GRO [®] application	Term of observation				Mean
	First decade of June	Third decade of June	Second decade of July	Third decade of August	
V1	0.91 g	2.33 fg	4.71 cdef	6.88 bcd	3.71 C
V2	2.73 efg	4.16 def	6.41 bcd	8.71 ab	5.50 AB
V3	2.59efg	3.49 efg	5.27 cde	7.29 abc	4.66 BC
V4	3.17 efg	4.58 cdef	6.77 bcd	9.69 a	6.05 A
Mean	2.35 D	3.64 C	5.79 B	8.14 A	

Table 3. The influence of NANO-GRO[®] application and term of observation on number of leaves [pcs per plant]

Variant of NANO-GRO [®] application	Term of observation				Mean
	Third decade of June	First decade of July	Third decade of July	Third decade of August	
V1	19.30 h	33.60 gh	46.12 efg	77.24 abc	44.07 C
V2	36.12 g	53.43 def	62.78 cd	81.99 ab	58.58 B
V3	42.00 fg	46.26 efg	61.77 cde	86.82 ab	59.21 B
V4	47.67 defg	55.50 def	71.76 bc	92.70 a	66.91 A
Mean	36.27 D	47.20 C	60.61 B	84.69 A	

No influence of application NANO-GRO[®] on mass of herb collected on the first term of harvest (full flowering phase) was observed, provided that the lowest mass was obtained for control plots (average 203.33 g·m⁻²) the highest for variant 2 (293.33g·m⁻²). Distinct differences in mass of herb whereas were observed in the second term of harvest (regrowth) where higher mass of herb was obtained from plots where the plants were sprayed NANO-GRO[®] immediately after planting in the field (V4). It was also found that a significantly higher mass of herb was obtained on the second term compared with the first term of harvest. Analyzed preparation significantly influenced also on total mass (sum first and second harvest). The highest mass of herb was obtained for variant 4 (total mass: 943.34 g·m⁻²), the lowest for the control and variant 2 (total mass: 840 g·m⁻²). It is possible that high mass of the raw material obtained in variant 4 is correlated with the highest number of lateral shoots and leaves obtained in this variant (Table 4).

Table 4. The influence of NANO-GRO[®] application and term of harvest on air-dry mass of peppermint herb [g·m⁻²]

Variant of NANO-GRO [®] application	First term of harvest	Second term of harvest	Total mass
V1	203.33 c	636.67 ab	840.00 AB
V2	293.33 c	546.67 b	840.00 AB
V3	236.67 c	526.67 b	763.34 B
V4	260.67 c	682.67 a	943.34 A
Mean	248.50	598.17*	

*p=0.05

Peppermint herb is a raw material standardized for essential oil content, and therefore obtained raw materials was rated for the content of this substance. Qualitative and quantitative analysis of essential oil also was carried out. In this experiment, content of essential oil averaged 2.65 ml·100g⁻¹, which is consistent with the results obtained by many authors (Picuric-Jovanovic *et al.*, 1997; McKay and Blumberg, 2006; Kaul *et al.*, 2001.). Significantly more essential oil was obtained in the raw material from variant 4, in comparison with other variants of experiment. It was also found that more essential oil was in the herb collected in the full flowering phase in comparison to the herb obtained from the regrowth (Table5). On the increase in the content of essential oil under the influence of other bio-fertilizer indicate also Roston *et al.* (2011).

Table 5. The influence of NANO-GRO[®] application and term of harvest on essential oil content (ml·100 g⁻¹)

Variant of NANO-GRO [®] application	First term of harvest	Second term of harvest	Mean
V1	2.91 a	2.27 b	2.58 B
V2	2.85 a	2.37 b	2.61 B
V3	2.85 a	2.30 b	2.58 B
V4	2.76 a	2.87 a	2.82 A
Mean	2.84*	2.45	

*p=0.05

Assessing, in turn, the chemical composition from investigated essential oils was found that in all variants major compounds were menthol and menthone. 1.8 cineole and terpinene-4-ol were also present in high amounts. This is consistent with results presented by other authors (McKay and Blumberg, 2006, Dimandja *et al.*, 2000; Gherman *et al.*, 2000). In the case of menthone obtained results are in the range required by the FP X (2014), which determines the content of that compound from 14.0 to 32.0%. For the menthol - the requirements of above standards specify that it should be 30.0 to 55.0%. Results obtained in this work were lower only for control, in the case of essential oil from variant 2, 3 and 4 (for all variants where the NANO-GRO[®] was used) the percentage of menthol satisfy the requirements of this standard and was the highest for the oil in variant 4 (36.54%) (Table 6).

Table 6. Identified components of peppermint essential oil and their percentage share [for first time of harvest, 2014]

Variant of NANO-GRO [®] application				
Chemical compound	V1	V2	V3	V4
α -pinene	0,92	0,91	0,89	0,73
β -pinene	1,21	1,22	1,19	1,08
β -myrcen	0,62	0,32	0,62	0,54
Limonene	1,65	1,69	1,81	1,47
1.8-cineol	6,29	6,64	6,34	5,05
Menthone deriv.	16,82	14,43	15,21	10,34
Menthone	22,83	21,00	19,58	17,32
Citronellal	3,42	3,24	3,13	2,91
Mentofuran	0,16	0,15	0,16	0,16
Terpinene-4-ol	3,29	3,57	2,83	2,09
Menthol	27,78	31,34	31,60	36,54
Borneol	2,17	1,84	1,98	4,91
Carvon	0,32	0,30	0,30	1,88
Percentage share of sum of all detected components	87.48/100	86.65/100	85.64/100	85.02/100

Conclusion

Application of NANO-GRO[®] significantly affects some morphological features of peppermint, for example the number of lateral shoots and the number of leaves. Under the conditions of this experiment the highest values for these parameters were obtained when the peppermint seedlings were sprayed NANO-GRO[®] directly after planting them in the field. In this variant the highest mass of herb was also obtained both for analyzed terms of harvest as well as for total mass. The raw material from plots where seedlings sprayed directly after planting them in a field characterized by a significantly higher content of essential oil and a high, consistent with the requirements of Polish Pharmacopoeia X (2014) participation of main component - menthol. Taking into consideration obtained results it can be said that properly chosen application of preparation NANO-GRO[®] in the cultivation of peppermint can increase the yield of this species and improve the quality of the herb. The recommended procedure that allows to obtain positive results is to spray rooted cuttings of this species directly after planting them in the field.

Acknowledgement

We would like to thank AGRARIUS Ltd. per financial support and the opportunity to test preparation NANO-GRO[®] in the cultivation of medicinal plants.

References

- Ali M.A., Saleem M., Ahmad W., Parvez M., Yamdagni R. (2002). Chlorinated monoterpene ketone, acylated-sitosterol glycosides and a flavanone glycoside from *Mentha longifolia* (Lamiaceae). *Phytochemistry*, Vol. 59, No. 8, pp. 889-895.
- Dimandja J.M.D., Stanfill S., Grainger J., Patterson D.G. Jr. (2000). Application of

- comprehensive two-dimensional gas chromatography (GCxGC) to the qualitative analysis of essential oils. *J High Resolut Chromatogr.*, No. 23, pp. 208-214.
- Dyśko J. (2008). Nano-Gro - stymulator wzrostu w bezglebowej uprawie pomidora. *Owoce Warzywa Kwiaty*, Vol. 48, No. 24, pp. 14-16.
- Gherman C., Culea M., Cozar O. (2000). Comparative analysis of some active principles of herb plants by GC/MS. *Talanta*, No. 53, pp. 253-262.
- Janas R. (2011). The influence of biological compounds with different mechanisms of action on the metabolism of plants and seed quality of garden rocket. *Biul. Inst. Hod. i Aklim. Roś.*, No. 262, pp. 197-206.
- Jankowski K., Deska J., Truba M., Jankowska J. (2012). Impact of Nano-Gro stymulator on the seeds germination and growth kinetics of seedlings of selected grass and legumes species. *Versita*, Vol. 24, No. 1(55), pp. 23-26.
- Jędrszczyk E., Ambroszczyk A.M. (2016). The influence of NANO-GRO® organic stimulator on the yielding and fruit quality of field tomato (*Lycopersicon esculentum* Mill.). *Folia Horticulturae*, Vol. 28, No. 1, pp. 87-94.
- Kaul P.N., Bhattacharya A.K., Singh K, Rao B.R.R., Mallavarapu G.R., Ramsh S. (2001). Chemical investigation of peppermint (*Mentha piperita* L.) oil. *Journal of essential oil-bearing plants*, Vol. 4, No. 2-3, pp. 55-58.
- Kieltyka-Dadasiewicz A., Jabłońska-Trypuć A., Taraseviciene Z., Kubat-Sikorska A. (2016). Characteristics and Functional Properties of Mint's Raw Materials. *Towarozn. Probl. Jakości* No. 1, pp. 93-104.
- Kołodziej B. (2008). The effect of the term of plantation establishment, rejuvenating ploughing and Asahi SL application in peppermint culture. *Ann. Univ. Mariae Curie-Skłodowska. Sectio E, Agricultura*, Vol. 63, No 4, pp. 10-16.
- McKay D.L., Blumberg J.B. (2006). A review of the bioactivity and potential health benefits of peppermint tea (*Menthapiperita* L.). *Phytotherapy Research*, Vol. 20, No. 8, pp. 619-633.
- Newerli-Guz J., Kobyłańska A. (2013). Quality evaluation of herbal teas – on the example of *Mentha piperita*. *Probl. Hig. Epidemiol.*, Vol. 94, No. 4, pp. 862-865.
- Para S., Sridhar T.M., Josthna P., Naidu C.V. (2013). Antibacterial activity and phytochemical analysis of *Mentha piperita* L. (peppermint) – an important multipurpose medicinal plant. *American Journal of Plant Sciences*, Vol. 4, No. 1, pp. 77-83.
- Picuric-Jovanovic K, Milovanovic M, Poludyonny LV. (1997). Chemical composition of essential oils of several wild-growing species of *Mentha piperita* L. *Zbornik Radova Poljop Fak*, No. 42, pp. 243-248.
- Polish Pharmacopoeia X. (2014). ISBN: 978-83-63724-47-4, PTFarm. Warsaw.
- Rosłon W., Osińska E., Bączek K., Węglarz Z. (2011). The influence of organic-mineral fertilizers on yield and raw material quality of chosen plants of the Lamiaceae family from organic cultivation. *Acta Sci. Pol., Hortorum Cultus*, Vol. 10, No. 1, pp. 147-158.

HAWTHORN SPECIES FROM TURKEY AND POTENTIAL USAGE FOR HORTICULTURE

Oguzhan CALISKAN*, Safder BAYAZIT, Kazim GUNDUZ

Mustafa Kemal University, Faculty of Agriculture, Department of Horticulture, Antakya, Hatay, Turkey

*Corresponding author: ocaliskan@mku.edu.tr

Abstract

In the review, we aimed to investigate distribution of hawthorn species from Turkey and potential usage for horticulture. Many hawthorn species are grown for their edible fruit in Asia, Central America, and the Mediterranean. Turkey is one of the genetic centers for hawthorn species. Due to its positive effects on the cardiovascular system, *Crataegus* genus has recently become quite a popular herbal medicine in phototherapy. Currently, more than 20 *Crataegus* species have been identified in Turkey, including *C. monogyna* Jacq., *C. pentagyna* Willd., *C. azarolus* L. (synonym *C. aronia*), *C. orientalis* M. Bieb., *C. rhipidophylla* Gaud. and *C. laevigata* (Poir) DC. In different regions of Turkey, hawthorn plants are known by many different names, including ‘alıç’, ‘yemişen’ and ‘haziran’. They are usually utilized for scattered hedgerow planting in orchards and along road borders. In recent years, the hawthorn has become favored for both fruit size and sweet-sour fruit taste. Especially, *C. azarolus* genotypes are grown in regular orchards for fresh fruit consumption in Hatay and Mersin provinces, Eastern Mediterranean region of Turkey. The fruits has been sold at higher prices in the local markets. There is not yet found a standard hawthorn cultivar although some genotypes has perfect fruit quality characteristics. The most important limiting factor for the hawthorn growing is propagation. Hawthorns can be propagated either seeds or grafting. Generally, *C. monogyna* seeds that has higher seed germination than other species are used as rootstock for the *C. azarolus* genotypes. As a result, we can say that *C. azarolus* and *C. orientalis* will be potential as horticultural crops in the future.

Keywords: Turkey, Hawthorn species, Horticulture, Fruit.

Introduction

Crataegus species form a well-defined genus known as hawthorns that belongs to the tribe *Crataegeae* and subfamily *Maloideae* of the *Rosaceae*. The subfamily *Maloideae* comprises about 28 genera and 940 species of ecologically and economically important trees and shrubs (Evans and Campbell, 2002). The genus is placed in the subfamily *Maloideae* and it is closely related to the genera *Pyracantha* M.Roem., *Mespilus* L. and *Hesperomeles* Lindl. The latest phylogenetic analysis of the genus shows that it is closest to the genus *Mespilus* L. (Hummer and Janick, 2009). The genetic diversity center of the section *Crataegus* ranges from Turkey to Iran.

Crataegus fruit generally persists on the shrubs throughout winter and represents an important source of food for many birds and small mammals. In some parts of the world, humans also eat hawthorn fruit, and it is reported to have high flavonoid, vitamin C, glycoside, anthocyanin, saponin, tannin, and antioxidant levels as well as phenolics (Ljubuncic et al., 2005; Caliskan et al., 2012; Caliskan, 2015).

In most European, Mediterranean, and Asian countries, herbs and phytomedicines are treated as drugs to be used in conjunction with conventional medicines. Some of the most important natural health products are employed to treat cardiovascular ailments, and these substances account for

over 25% of phytomedicine sales in the European Union. These herbal treatments include products derived from *Crataegus* species, which are widely available in Europe, Asia, and North America. *Crataegus*-derived medicines can take the form of tinctures, tablets, teas, and aqueous extracts of the plant's leaves, flowers, and fruits (Edwards et al., 2012; Caliskan, 2015).

In Turkey, hawthorn plants are known by many different names, including 'alıç', 'yemişen' and 'haziran', and generally they are used for scattered hedgerow planting in orchards and along road borders. In recent years, the hawthorn has become favored for both fruit size and sweet-sour fruit taste. In this review, we aimed to investigate distribution of hawthorn species in Turkey and their potential usage for horticulture.

Distribution of the hawthorn species in Turkey

Many hawthorn species are grown for their edible fruit in Asia, Central America, and the Mediterranean, with *Crataegus monogyna* Jacq. being the species commonly cultivated in Mediterranean countries. Turkey is one of the genetic centers for *Crataegus*, but few studies have attempted to describe the *Crataegus* strains in Turkey. Browicz (1972) described some of Turkey's *Crataegus* species in Flora of Turkey and the East Aegean Islands, and studies by Donmez have contributed information about new and existing *Crataegus* species (Donmez, 2007). Currently, more than 20 *Crataegus* species have been identified in Turkey, including *C. monogyna* Jacq., *C. pentagyna* Willd., *C. azarolus* L., *C. orientalis* M. Bieb., *C. rhipidophylla* Gaud., and *C. laevigata* (Poir) DC (Table 1). In addition, there are some hybrid species in different ecological regions (Table 2). There is several research on the molecular characterization of the species. Yilmaz et al. (2010) showed that *C. x bornmuelleri* hybrids are very close to *C. orientalis* as genetically. In addition, Serce et al. (2011) indicated that *C. aronia* var. *aronia* genotypes are closely related to *C. aronia* var. *dentata* genotypes, however *C. monogyna* var. *azarella* genotypes are not included in same clustered with *C. aronia*.

Table 1. Hawthorn species are found in Turkey

Species	Species
<i>C. tanacetifolia</i> (Poir.) Pers	<i>C. meyeri</i> Pojark.
<i>C. orientalis</i> M.Bieb. Fl. taur.-caucas	<i>C. caucasica</i> C.Koch
<i>C. x bornmuelleri</i> Zabel in Beissner	<i>C. ambigua</i> C.A.Mey. ex Backer
<i>C. azarolus</i> L. Sp.	<i>C. heterophylloides</i> Pojark
<i>C. pontica</i> C.Koch Verh	<i>C. longipes</i> Pojark.
<i>C. pentagyna</i> Waldst. and Kit.	<i>C. microphylla</i> C.Koch
<i>C. davisii</i> Browicz	<i>C. rhipidophylla</i> Gand.
<i>C. pseudoheterophylla</i> Pojark.	<i>C. monogyna</i> Jacq.

Table 2. Hybrid hawthorn species in the flora of Turkey

Parents	Hybrid species
<i>C. orientalis</i> x <i>C. tanacetifolia</i>	<i>C. x bornmuelleri</i>
<i>C. monogyna</i> x <i>C. tanacetifolia</i>	<i>C. x yosgatica</i>
<i>C. azarolus</i> x <i>C. monogyna</i>	<i>C. x sinaica</i>
<i>C. monogyna</i> x <i>C. pentagyna</i>	<i>C. x rubrinervis</i>
<i>C. microphylla</i> x <i>C. rhipidophylla</i>	<i>C. x browicziana</i>
<i>C. monogyna</i> x <i>C. rhipidophylla</i>	<i>C. x kyrtostyla</i>

Donmez (2004) indicated that 30% of the species are hybrid in origin. In addition, Turkey have specific ecological conditions for the hawthorn species in the different regions. The regions have at least one characteristic species and other secondary or common species with local genotypes. There are no hawthorn species growing either in the high mountain zone or in forests far from habitation in Turkey. *C. monogyna* Jacq. is widespread in Turkey. It has been given as *C. monogyna* var. *monogyna* and var. *azarella*. Generally, hawthorn species are distributed in temperate zone areas of Turkey. However, some hawthorn species are growing in low altitudes (300-500 m) areas of subtropical conditions in Turkey.

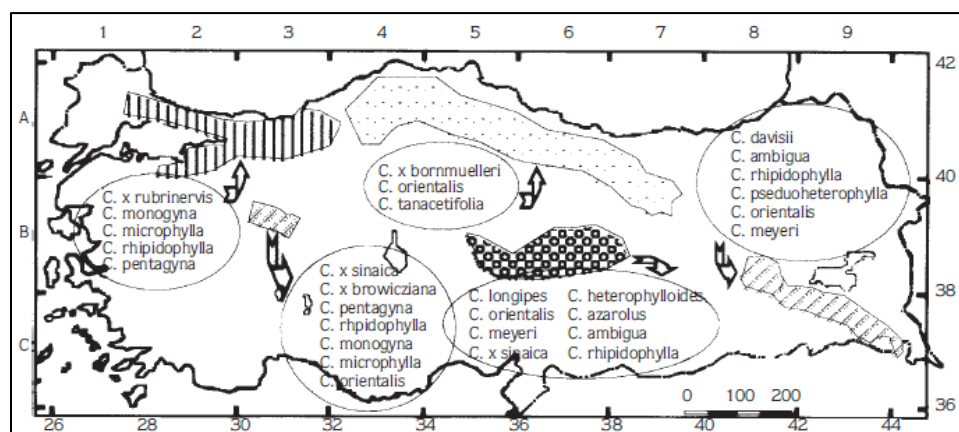

Figure 1. Distribution of the hawthorn species in Turkey (Donmez, 2004)

Traditional use

Crataegus species have been used since ancient times, and the antioxidant constituents of the plant may account for its therapeutic effects in the world. Several hawthorn species are also used as folk medicine. These species include *C. pinntifida* (China), *C. pubesens* (Mexico), *C. cuneata* (Japan), *C. laevigata* and *C. monogyna* (Europe), *C. oxycantha* and *C. aronica* (Middle East), *C. phaenopyrum* (America), and *C. ambigua* (Russia) (Ljubuncic et al., 2005; Caliskan, 2015).

In Europe, the fruit, leaves, and flowers of the plant were traditionally employed in the treatment of heart problems because of their antispasmodic, cardiotonic, hypotensive, and antiatherosclerotic effects, in addition to being ingredients in wine, jam, and candy (Ljubuncic et al., 2005; Caliskan, 2015). Common throughout Turkey, *C. monogyna* Jacq. is one of the species that is highly recommended in folk medicine, and in Spain and Portugal, its fruit is often consumed by shepherds, hunters, and children because it is considered to be “healthy” and nutritious (Carvalho, 2010). In Turkey, the leaf, flower, sprout, and root of *Crataegus* species have been used in traditional medicine to address various diseases such as cough, flu, asthma, stomach ache, rheumatic pain, nephritis, hemorrhoids, and cardiac diseases. The flowers and fruit of the hawthorn plant treat cardiovascular, hypertension, and diabetic diseases. Hawthorn vinegar is produced in some local areas of Turkey, and the fruits and flowers of hawthorn also are consumed as tea. Generally, hawthorn species are evaluated in Turkey as following;

- a. *Crataegus azarolus*, *Crataegus orientalis* and *Crataegus monogyna* species are consumed for fresh fruits,
- b. The fruits are used for marmalade,
- c. The flowers and fruits are evaluated as medicinal plant for cardiovascular and high blood pressure disease,

- d. Hawthorn seedlings are used as rootstock for apple, pear and loquat,
- e. *C. monogyna* can be used as ornamental plant,
- f. The fruits is used as a food source for forest animals,
- g. Hawthorn wood is used in the furniture (especially, walking stick).

Potential usage of hawthorn species for horticulture

Fruit quality characteristics of important hawthorn species: The hawthorn fruits like a small apple, the thin skin covering a fleshy pulp. The color of the ripe fruit ranges from yellow, through green to red and on to dark purple-black. Fruit size varies from species to species. *Crataegus azarolus*, *Crataegus orientalis* and *Crataegus monogyna* species are very promising for the horticulture. The species are used for fresh fruit consumption in Turkey. In recent years, especially *C. azarolus* are grown in regular orchards in Hatay and Mersin provinces, Eastern Mediterranean region of Turkey due to the fruits has been sold at higher prices in the local markets. Most of the species are ripened their fruit in September and October months. *C. aronia* (syn. *C. azarolus*) genotypes has bigger fruit size whereas *C. monogyna* has smaller fruit size (Table 3). Mean seed numbers per fruit of hawthorn are ranged between 1.0 (*C. monogyna*) and 2.7 (*C. aronia*). *C. aronia* and *C. orientalis* are included more total soluble solids compared to *C. monogyna*. In addition, *C. orientalis* and *C. monogyna* has the red skin colors (positive a* values, lower while chroma and hue angle values) while *C. aronia* has the green-yellow skin color (Table 4). *C. aronia* and *C. orientalis* can be promising for horticulture based on the fruit quality characteristics and taste.

Table 3. Fruit quality characteristics of important hawthorn species (Serce et al., 2011)

Species	FW (g)	FD (mm)	FL (mm)	SN	SW (g)	TSS (%)	pH	Acidity (%)
<i>Crataegus aronia</i> var. <i>aronia</i>	3.4	17.8	15.8	2.5	0.7	14.8	3.1	1.6
<i>Crataegus aronia</i> var. <i>dentata</i>	8.5	24.7	21.7	2.3	1.3	16.0	3.2	1.4
<i>Crataegus aronia</i> var. <i>minuta</i>	9.2	24.6	20.6	2.7	1.9	22.5	3.5	1.5
<i>Crataegus orientalis</i> var. <i>orientalis</i>	4.1	18.7	18.8	2.5	0.9	22.5	3.3	1.5
<i>Crataegus monogyna</i> subsp. <i>azarella</i>	1.4	9.3	9.6	1.0	0.1	6.1	4.0	1.0

FW; fruit weight, FD; fruit diameter, FL; fruit length, SN; seed number per fruit, SW; seed weight, TTS; total soluble solids

Table 4. Fruit skin color characteristics of important hawthorn species (Serce et al., 2011)

Species	L*	a*	b*	C	h°
<i>Crataegus aronia</i> var. <i>aronia</i>	73.8	-1.2	52.4	53.0	91.7
<i>Crataegus aronia</i> var. <i>dentata</i>	76.8	-3.4	50.9	51.4	94.3
<i>Crataegus aronia</i> var. <i>minuta</i>	73.0	-1.5	55.9	56.2	91.6
<i>Crataegus orientalis</i> var. <i>orientalis</i>	54.3	30.0	36.8	47.9	51.1
<i>Crataegus monogyna</i> subsp. <i>azarella</i>	35.9	29.2	30.1	42.1	46.3

The high L* values indicate lightness. Negative a* values indicate green color and positive a* values indicate red color. The C value, shows color intensity. The h°, a parameter that indicated to be effective in predicting visual color appearance.

Cultivars and growing areas: The hawthorn cultivars are grown as ornamental plants in the world due to the intensity of their flower production and the diversity of colors in their fruits

make them excellent cultivars for use as ornamentals in gardens and large landscaped areas. Generally, hybrids are used as ornamental. The hybrids are obtained from *C. laevigata* x *C. monogyna* (for example, ‘Plena’, ‘Crimson Cloud’, ‘Rosea Flore Pleno’, and ‘Pauls’s Scarlet’ cultivars). ‘Chapeado’, ‘Calpan Gold’, ‘Tempranero’, ‘Centenario’, ‘Eli’ cultivars also used for ornamental plants in Mexico (Nieto-Angel et al., 2013). In China, about 150 cultivars used in the major hawthorn production areas are mainly from *C. pinnatifida* and late ripening cultivars are suitable for fresh consumption (Guo and Jiao, 1995). Li et al. (2015) indicated that hawthorn cultivar (*C. pinnatifida*) ‘Dajinxing’, is one of the most popular cultivar with wide adaptability across different hawthorn-growing regions of China.

Most popular hawthorn species is *C. azarolus* in Turkey. We have not yet a hawthorn cultivar(s) originated from Turkey. However, we can say that the cultivar(s) can be development in the coming years based on results of the resources on the hawthorns. In addition, genotypes of *C. azarolus* are planted as 4x5, 5x5 and 6x6 and drip irrigation are used in new hawthorn orchards. The plants are pruned as open center shape.

Caliskan et al (2012) reported some local hawthorn genotypes (*C. azarolus*) resources are found in Belen, Hatay province, Eastern Mediterranean region of Turkey. Since the 2008s, some promising genotypes have been selected (B3 and B7) and studies continues for commercial production (Serce et al., 2011). The genotypes are found to be commercially very promising because of its size (fruit weight >10 g), total soluble solids (TSS), total phenolic, antioxidant activity and antioxidant capacity. Genotypes of this species are grown in Benlidere (eight producers) and Kömürçukuru (two producers) districts, Belen, Hatay and fruits of this species have been sold in local markets at higher prices. Therefore, some farmers, especially in Belen County, are trying for the orchard establishment with plants of this species. The area is one of the most important hawthorn production center of Turkey, and hawthorn scions are taken from this area for the propagation. New hawthorn orchards are establishment in Kahramanmaraş, Malatya, Mersin and Aksaray provinces of Turkey. *C. orientalis* genotypes with big fruit size and reddish-orange skin color are also consumed as fresh fruit collected from natural populations. In addition, *C. monogyna* that is small fruit size and red skin color is evaluated as fresh fruit, but they fruits are not valuable seen based on horticultural potential. *C. monogyna* can be used for both rootstock and ornamental plants.

Propagation: Vegetative propagation of hawthorns by cutting is not a usefully method because of their rooting percentage is very lower. Grafting and budding can be used for propagation of hawthorns. T-budding is one of the most suitable vegetative propagation methods employed for a wide range of cultivars of hawthorns (Hartmann et al., 2002). Currently, we have not detail information about grafting and budding methods for hawthorn. Already, we are carried out an investigation for the effects of different grafting (whip grafting) and budding (T-budding and chip budding) methods in spring stage for *C. azarolus*. First results are showed that whip grafting method is highly successful at the March and April months for the hawthorns in the ecological conditions of Eastern Mediterranean region of Turkey (unpublished data). Seed propagation is used for rootstock, but a long time is needed for seed germination. For oneseed hawthorn, ISTA (1993) prescribes 90 days of incubation at 25 °C, followed by 9 months of moist-prechilling at 3 to 5 °C. Generally, *C. monogyna* seeds that has higher seed germination than other species are used as rootstock for the *C. azarolus* genotypes. In addition, hawthorn seedlings can be used as rootstock for apple, pear and loquat, but they are not common applications.

Main Problems of the hawthorn growing in Turkey: Basic problems for hawthorn growing are as follows:

- a. The registered cultivar(s) are not yet found,
- b. Standard method are not development to obtain seedlings,
- c. The timing of grafting or budding methods are not unknown,
- d. There are not found enough information about technical and cultural practices such as pruning shape, fertilization, irrigation etc.
- e. There is no detailed information about diseases and pests in the hawthorns. However, fire blight disease can be severe in some years in the natural populations of Turkey.

Conclusion

Turkey is one of the genetic centers for hawthorn species. In the present, more than 20 *Crataegus* species have been identified in Turkey. Especially, *C. azarolus* and *C. orientalis* genotypes are found to be promising in front of fruit quality characteristics in horticultural sector. There is not development a standard hawthorn cultivar whereas some genotypes has perfect fruit quality characteristics. The most important limiting factor is propagation for the hawthorn growing. We can say that more detail studies are needed for the widespread of hawthorn growing in the future.

References

- Browicz, K. (1972). *Crataegus*. In: Davis PH, editor. Flora of Turkey and the east Aegean Islands, No 22: Edinburg: Edinburg University Press, UK.
- Caliskan, O., Gunduz, K, Serce, S, Toplu C, Kamiloglu O., Sengul M, Ercisli, S. (2012). Phytochemical characterization of several hawthorn (*Crataegus* spp.) species sampled from the eastern Mediterranean region of Turkey. *Pharmacogn Mag.* 8, 16–21.
- Caliskan, O. (2015). Mediterranean Hawthorn Fruit (*Crataegus*) Species and Potential Usage. *The Mediterranean Diet an Evidence-Based Approach* (Eds. Preedy, V.R., Watson, R.R.). Elsevier Publishing, Chapter 55, 621–628.
- Carvalho, A.M. (2010). Plants and wisdom of the Natural Park Montesinho. An ethnobotanical study in Portugal. *Science Library*, 35. Madrid Superior Council for Scientific Research (CSIC), Madrid, Spain.
- Donmez, A.A. (2004). The Genus *Crataegus* L. (Rosaceae) with special reference to hybridisation and biodiversity in Turkey. *Turk J Bot* 28 (2004) 29-37
- Donmez, AA. (2007). Taxonomic note on the genus *Crataegus* (Rosaceae) in Turkey. *Bot. J. Linn Soc.* 155, 231–40.
- Edwards, J.E., Brown, P.N., Talent, N., Dickinson, T.A., Shipley, P.R. (2012). A review of the chemistry of the genus *Crataegus*. *Phytochemistry* 79, 5–26.
- Evans, R.C., Campbell, C.S. (2002). The origin of the apple subfamily (Maloideae; Rosaceae) is clarified by DNA sequence data from duplicated GBSSI genes. *Am. J. Bot.* 89, 1478–84.
- Guo, T., Jiao, P. (1995). Hawthorn (*Crataegus*) Resources in China. *HortScience* 30, 1132–1134.
- Hartmann, H.T., Kester, D.E., Davies, J.R., Geneve, R.L. (2002). *Hartmann and Kesters' plant propagation: principles and practices*. 7th ed. Upper Saddle River, NJ: Prentice Hall. 880 p.
- Hummer, K.E., Janick, J. (2009). *Rosaceae: Taxonomy, Economic Importance, Genomics*. Eds. Foltá, K.M., Gardiner, S.E., *Crops and Models* 1–16.
- ISTA (1993). *Rules for testing seeds: rules 1993*. *Seed Science and Technology* 21 (Suppl.), 1–259.

- Li, W., Hu, Q., P., Q., Xu, J.G. (2015). Changes in physicochemical characteristics and free amino acids of hawthorn (*Crataegus pinnatifida*) fruits during maturation. *Food Chemistry* 175, 50–56.
- Ljubuncic, P., Portnaya, I., Cogan, U., Azaizeh, H., Bomzon, A. (2005) Antioxidant activity of *Crataegus aronia* aqueous extract used in traditional Arab medicine in Israel. *J Ethnopharmacol* 101, 153–61.
- Nieto-Angel, R., Michal, W.B., Betancourt-Olvera, M., Martínez-Solís, J. (2013). Hawthorn (*Crataegus* spp.) as an ornamental plant. *Acta Hortic.* 977, 61–66.
- Serce, S., Simsek, O., Toplu, C., Kamiloglu, O., Caliskan, O., Gunduz, K., Ozgen, M., Kacar, Y.A. (2011). Relationships among *Crataegus* accessions sampled from Hatay, Turkey, as assessed by fruit characteristics and RAPD. *Genet. Resour. Crop Evol.* 58, 933–942
- Yilmaz, K.U., Yanar, M., Ercisli, S., Sahiner, H., Taskin, T., Zengin, Y. (2010). Genetic relationships among some hawthorn (*Crataegus* spp.) species and genotypes. *Biochem. Genet.* 48, 873–878.

**PHARMACEUTICAL COMPOUNDS IN LEAVES AND FLORAL STEM OF GLOBE
ARTICHOKE (*CYNARA CARDUNCULUS* L. VAR. *SCOLYMUS* (L.) FIORI)**

Andrzej SAŁATA^{1*}, Halina BUCZKOWSKA¹, Renata NURZYŃSKA-WIERDAK¹, Salvador
V. LOPEZ GALARZA², Anna STĘPNIOWSKA³

¹Department of Vegetable Crops and Medicinal Plants, University of Live Sciences in Lublin, Poland

²Department of Plant Production, Universitat Politècnica de València, Spain

³Department of Biochemistry and Toxicology, University of Live Sciences in Lublin, Poland

*Corresponding author: andrzej.salata@up.lublin.pl

Abstract

The phenolic composition of *Cynara scolymus* L. was determined by analyzing the methanol extracts of the different morphological parts of the plant. More total phenolic compounds in calculation for gallic acid was noted in floral stem and receptacle and inner bracts of capitula. Artichoke plants accumulated 3.9 times less total phenolic compounds in outer bracts, while in leaves the content was more than 9 times lower. The dominant phenolic compound in leaves and floral stem of artichoke was chlorogenic acid. Significantly more chlorogenic acid was noted in floral stem and receptacle and inner bract, over 2.2 times more than in leaves and over 4.1 times more than in outer bracts of capitula. Cynarin was the main hydroxycinnamic acid in artichoke extracts, particularly in leaves extract. Apigenin represented the most abundant flavonoids in cultivated artichoke extracts, especially in capitula receptacle extract, and floral stem. The highest mean content of luteolin characterized leaves of artichoke than floral stem and receptacle with inner bracts capitula. Our results showed that the extraction of phenolic compounds from all morphological parts of artichoke can be integrated in an industrial value chain, involving nutraceuticals and as animal feedstuff.

Keywords: *Globe artichoke, Caffeoylquinic acids, Flavonoids, Cynarin, HPLC*

Introduction

An artichoke (*Cynara cardunculus* L. var. *scolymus* (L.) Fiori) belongs to the *Asteraceae* family and is a commonly cultivated plant in Southern Europe around the Mediterranean region (Sonnante et al. 2002). Globe artichoke is a perennial, rosette plant, widely cultivated for the large fleshy head or capitula (immature flowers). The edible parts of the artichoke are the tender inner leaves (bracts) and receptacle commonly known as ‘heart’ (Lombardo et al. 2010, Sałata and Gruszecki, 2010).

Artichoke plays an important role in human nutrition, especially in the Mediterranean area. In addition, artichoke contributes significantly to the Mediterranean agricultural economy, where more than 50% of the total world production is produced (FAO, 2016). Italy is a leading producer (about 470.000 t annually) followed by Spain (215.000 t), France (55.000 t) and Greece (25.000 t).

Plants produce a diverse array of organic compounds, that majority of which are not directly involved in growth and development. Such compounds, often referred to as secondary metabolites, generally have unknown functions, they are thought to benefit plants by mediating a wide range of interaction between plants and their environment (Kähkönen et al. 1999). Many secondary metabolites act a defensive agents against pathogens and herbivores and provide reproductive advantages as attractants of pollinators and seed disperses. There is also growing

evidence that secondary metabolites have a host of physiological activities related to protection against various form of environmental stress. The function of these secondary metabolites seems to be involved in plant defense against abiotic (i.e. UV irradiation, wounding) and biotic (pathogen attacks) stresses (Lombardo et al. 2012). In fact, the enzymatic steps involved in this pathway are under the control of corresponding genes which are induced by signal molecules involved in local and systemic defense signaling (Lombardo et al. 2010).

These compounds are generally classified into three major groups, based on their biosynthetic origin: terpenoids, alkaloids and phenolics (often referred to as polyphenols). The major classes of phenolic are the hydroxycinnamic acids, flavonoids, anthocyanins and tannins. According to many opinions, poliphenolic compounds found in artichoke plants, especially mono- and di-caffeoylquinic acids and flavonoids, decide about their health-enhancing and antioxidant properties (Kukić et al. 2008, Lattanzio et al. 2009).

Artichoke contains a high level of phenolic compounds, especially in capitula, as reported by several authors (Fратиanni et al., 2007; Falleh et al., 2008; Pandino et al., 2011a). In available literature the wide therapeutic spectrum of poliphenolic compounds included in artichoke capitula is emphasized (Pandino et al., 2011a). The phenolics include cynarin (1,3-di-O-caffeoylquinic acid), luteolin, cynaroside (luteolin-7-O-glucoside), scolymoside (luteolin-7-rutinoside) and phenolic acids such as caffeic, coumaric, hydroxycinnamic, ferulic, and caffeoylquinic acid derivatives, mono- and dicaffeoylquinic acids (Pandino et al., 2011a).

The pharmacologic properties of artichoke is well documented in several in vivo and in vitro studies for the treatment of hepato-biliary dysfunction, dyspeptic syndromes, gastric diseases, as well as inhibition of cholesterol biosynthesis and low density lipoproteins (LDL) oxidation – agents responsible for arteriosclerosis and coronary hearth diseases (Speroni et al., 2003, Rossoni et al., 2005, Brat et al. 2006, Bundy et al., 2008, Lattanzio et al. 2009)

The aims of the undertaken research were to investigate the phenolic profile of different parts (outer, intermediate and inner bracts, and receptacle) of capitula artichoke.

Material and methods

Plant materials

The plant materials were artichoke globe plants cultivar ‘Symphony F1’ that is frequently cultured in Spain. Plants were cultured in the Cajamar Fields (Station in Paiporta, SW Valencia, Spain) in 2013 under standard growth conditions and management practices.

The seed was sown on 6 June 2012 and planted on 25 July 2012 in sandy clay loam soil (59% sand; 18% silt; 23% clay), pH=8.4, organic matter=1.29 %; CE (1:5)=0.168 dSm⁻¹. Average temperatures between August 2012 and May 2013 ranged between 26.5°C and 11.2°C, maximum temperatures between 31.6°C and 16.5°C, and minimum temperatures between 21.4°C and 4.6°C.

Plants were arranged in a completely randomized manner with three replicates of eight plants per plot. Fertilization and irrigation were performed following Pomares et al. (2004). Management of weed and pests was in accordance to standard commercial practices.

Plants were separated in stalk, capitula and leaves, and transported to the laboratory at 4°C. At the laboratory, samples were washed, examined to eliminate damaged samples, were separated in receptacle with inner bracts (edible parts) and outer bracts (non-edible part) of capitula and floral stalk (non-edible part), freeze-dried, milled and stored in sailing bags until chemical analyses.

Samples preparation for HPLC analyses

The phenolic extract was obtained by solvent extraction with methanol (1:10) in a reflux condenser at the temperature of the solvent boiling point for 3 h. After percolation, the material was treated again with 80% methanol and was extracted twice for 2 h. Methanol extracts were joined, the solvent was evaporated, and the remains were eluted with hot water (50 ml). Water solutions were left in a refrigerator for 24 h. The separated tarry residues that contained ballasts were filtered and rinsed with distilled water. Having been obtained in this way, the filtrate was degreased by shaking 3 times with light petroleum (30 ml each). Then purified water solutions were extracted 10 times with diethyl ether (20 ml each). Joined ether extracts were concentrated to a 100-ml volume and shaken 10 times with a 5% water solution of NaHCO₃ (10 ml each) to transform phenolic acids into salts that were readily soluble in water. Bicarbonate fractions, including phenolic acids salts, were acidified with 35% HCl to pH=3. In this way free phenolic acids were obtained, which were again extracted with diethyl ether by shaking with this solvent 10 times (10 ml each). Ether extracts were joined and dried with anhydrous Na₂SO₄. The solvent was then distilled until dry to give free phenolic acid fractions.

HPCL determination of polyphenols

HPLC separation was performed on a UFLC Shimadzu series instrument (Japan) coupled to a diode-array detector (DAD). Separation was performed in a Phenomenex Synergi Fusion-RP column (4µm, 250×4.6 mm i.d.; Phenomenex) with a sample injection volume of 20µL. The mobile phase was composed of acetonitrile (A) and water/formic acid (100/0.1, v/v) (B). A gradient programme was followed as so: 20% A (0 min), 25% A (10 min), 25% A (20 min), 50% A (40 min), 100% A (42–47 min), 20% A (49–55 min). The mobile phase flow rate was 1 mL/min; the chromatogram was recorded at 280 nm and 320 nm, and the spectral data for all the peaks were accumulated within the 190–400 nm range. Column temperature was controlled at 30°C (Gouveia and Castilho, 2012).

Statistics

The results of the polyphenolic content in the different artichoke head parts were statistically processed by Statgraphics Centurion XV (Manugistics Inc., Rockville, MD, USA). The statistical analysis of polyphenols concentrations was done by an analysis of variance (one-way ANOVA). The least significance (LSD) procedure was used to test for the differences between averages at the 5% level of significance.

Results and discussion

The content of total phenolic compounds in different parts of inflorescences and leaves artichoke is presented in Table 1. More total phenolic compounds in calculation for gallic acid was noted in floral stem, mean 1550 mg 100 g dry weight, and receptacle and inner bracts, means 1538 mg 100 g dry weight. Artichoke plants accumulated 3.9 times less total phenolic compounds in outer bracts, while in leaves the content was more than 9 times lower. The phenolic contents in different morphological parts of cultivated artichoke are the same trend of this described for different varieties of *Cynara cardunculus* L. (Fratiani et al. 2007, Pandino et al. 2011b, Ramos et al. 2014).

The qualitative content of phenolic acids was very different depending on the morphological parts of heads (table 2). Among identified phenolic acids, the highest share had derivatives of cinnamic acid: chlorogenic acid (5-O-caffeoylquinic acid) and cynarin (1,3-O-dicaffeoylquinic acid). Significantly more chlorogenic acid was noted in floral stem and receptacle and inner bract (815 and 677 mg 100 g⁻¹ of DM respectively), over 2.2 times more than in leaves and over 4.1 times more than in outer bracts of capitula.

In an earlier research it was proved that artichoke plants accumulate more hydroxycinnamic acids in flower heads than in leaves (Romani et al. 2006; Fratiani et al. 2007, Ramos et al. 2014). The dominant compound was chlorogenic acid, known to have antioxidant activities and

anticarcinogenic properties (Rossoni et al. 2005). The large content of this substance explains its important role in biochemical reactions leading to form different polyphenolic compounds (Pandino et al. 2011b).

The content of cynarin in leaves was mean 26.7 mg 100 g⁻¹ of DM and it was almost 2 times higher than edible parts of capitula (receptacle with inner bract). The less of this compound was marked in outer bracts and floral stems. Cynarin is considered the one with the highest capacity to inhibit cholesterol biosynthesis and LDL oxidation (Lattanzio et al. 2009).

The statistical analysis of normal and mean values of apigenin showed the highest content in receptacle with inner bract (742 mg 100 g⁻¹ of DM) and floral stem (611.3 mg 100 g⁻¹ of DM). The content of apigenin in leaves was 2.3 times lower, and in outer bracts it was 3 times lower than in in receptacle with inner bract.

The highest mean content of luteolin characterized leaves of artichoke (4.3). The content of luteolin in heads of artichoke was more even, the highest level of this compound was marked in receptacle with inner bracts (mean 2.3 mg 100 g⁻¹ of DM) and floral stem (mean 2.0 mg 100 g⁻¹ of DM), while less in outer bracts, mean 1.8 mg 100 g⁻¹ of DM. This values agree with those reported by other authors (Pandino et al. 2011a, Lombardo et al. 2012). Pandino et al. (2011b) also reported that the artichoke leaves, in general, were rich in luteolin and apigenin while the main sources of caffeoylquinic acid isomers is the floral stem.

Table1. Total phenolic content from several morphological parts of artichoke (mg GAE·100 g⁻¹ DW)

Flolar stem	Receptacle and inner bracts	Outer bracts	Leaves	Mean	α
1550±46a	1538±57a	395±36b	170±22c	913.2±518	***

Means with different letters are significantly different. Significance level (α):*** p<0.001

Table 2. Content dicaffeoylquinic acids and flavonoids from several morphological parts of artichoke (mg 100 g⁻¹ of DM)

Compound	Flolar stem	Receptacle and inner bracts	Outer bracts	Leaves
1-O-caffeoylquinic acid	12.0±1.2a	nd	49.1±5.0b	9.1±6.7a
3-O-caffeoylquinic acid	3.1±0.5a	7.4±0.7b	40.1±4.5c	nd
5-O-caffeoylquinic acid	815.0±13.0a	677.0±45a	194.4±11.7b	360.2±0.0c
4-O-caffeoylquinic acid	7.3±0.7a	nd	6.4±0.8a	nd
1,3-O-dicaffeoylquinic acid	1.2±0.2c	13.2±1.3a	1.3±0.2c	26.7±6.0b
3,4-O-dicaffeoylquinic acid	8.5±1.3a	nd	6.5±0.9a	nd
3,5-O-dicaffeoylquinic acid	20.8±0.8c	37.8±2.7b	70.1±3.6a	0.1±0.0d
1,5-O-dicaffeoylquinic acid	1.6±0.2c	14.3±0.4a	0.8±0.0d	7.5±1.1b
4,5-O-dicaffeoylquinic acid	9.7±0.8a	1.4±0.3b	nd	nd
Total caffeoylquinic acid	879.2±33	751.1±276	368.7±118	403.6±275
Luteolin	2.3±0.0a	2.0±0.1ac	1.8±0.0c	4.3±0.6b
Apigenin	611.3±39.0a	742.0±37.3a	200.5±24.7c	258.3±35.5b
Total flavonoids	613.6±575	744.0±567	202.3±118	262.6±198

Means with different letters for the same row are significantly different. Significance level (α):*** p<0.05; nd - not detected

Conclusions

The analysis of the most important polyphenols present in globe artichokes (i.e. chlorogenic acid, apigenin and cynarin) demonstrated the high content of these chemical species in Spanish cultivars 'Symphony F1'. The most abundant species was chlorogenic acid, followed by apigenin and cynarin. Apigenin and cynarin accumulated mainly in the receptacle and inner bracts, chlorogenic acid predominated in stems and in the receptacle and inner bracts. These data suggest the importance of those cultivars not only in the food industry, but also in the pharmaceutical one where industrial waste could be used to produce concentrated phenolic extracts. Finally, the present work shows that extraction of phenolic compounds from all morphological parts of inflorescences artichoke can be good valuable material for herbal industry and nutraceuticals production. Regarding the large diversity of phenolic compounds found in flower heads the interest in their use for production of health-enhancing functional food increases.

References

- Brat P., Geogé S., Bellamy A., Du Chaffaut L., Scalbert A., Mennen L., Arnault N., Amiot M.J., 2006. Daily polyphenol intake in France from fruit and vegetables. *J. Nutrition*. 136 (9): 2368-2373.
- Bundy R., Walker A.F., Middleton R.W., Wallis C., Simpson H.C.R. 2008. Artichoke leaf extract (*Cynara scolymus*) reduced plasma cholesterol in otherwise healthy hypercholesterolemic adults: A randomized, double blind placebo controlled trial. *Phytomedicine*, 15: 668-675.
- Falleh H., Ksouri R., Chaieb K., Karray-Bouraoui N., Trabelsi N., Boulaaba M., Abdelly C., 2008. Phenolic composition of *Cynara cardunculus* L. organs, and their biological activities. *C.R. Biologies*, 331: 372-379.
- Fратиани F., Tucci M., De Palma M., Pepe R., Nazzaro F., 2007. Polyphenolic composition in different parts of some cultivars of globe artichoke (*Cynara cardunculus* L. var. *scolymus* (L.) Fiori). *Food Chem.*, 104 (3): 1282-1286.
- Gouveia S.C., Castilho P.C., 2012. Phenolic composition and antioxidant capacity of cultivated artichoke, Madeira cardoon and artichoke-based dietary supplements. *Food Res. Inter.* 48: 712-724.
- Kähkönen M.P., Hopia A.I., Vuorela H.J., Rauha J.P., Pihlaja K., Kujala T.S., 1999. Antioxidant activity of extracts containing phenolic compounds. *J. Agric. Food Chem.* 47: 3954-3962.
- Kukić J., Popović V., Petrović S., Mucajić P., Ćirić A., Stojković D., Soković M., 2008. Antioxidant and antimicrobial activity of *Cynara cardunculus* extracts. *Food Chem.* 107: 861-868.
- Lattanzio V., Kroon P.A., Linsalata V., Cardinali A., 2009. Globe artichoke: a functional food and source of nutraceutical ingredients. *J. Funct. Foods*, 1 (2): 131-144.
- Lombardo S., Pandino G., Ierna A., Mauromicale G., 2012. Variation of polyphenols in a germplasm collection of globe artichoke. *Food Res. Inter.* 46 (2): 544-551.
- Lombardo S., Pandino G., Mauromicale G., Knödler M., Carle R., Schieber A., 2010. Influence of genotype, harvest time and plant part on polyphenolic composition of globe artichoke [*Cynara cardunculus* L. var. *scolymus* (L.) Fiori]. *Food Chem.*, 119 (3): 1175-1181.
- Pandino G., Lombardo S., Mauromicale G., Williamson G., 2011a. Profile of polyphenols and phenolic acids in bracts and receptacles of globe artichoke (*Cynara cardunculus* var. *scolymus*) germplasm. *J. Food Compos. Anal.* 24 (2): 148-153.
- Pandino G., Lombardo S., Mauromicale G., Williamson G., 2011b. Phenolic acids and flavonoids in leaf and floral stem of cultivated and wild *Cynara cardunculus* L. genotypes. *Food Chem.* 126: 417-422.

- Pomares F., Baixauli C., Aguilar J.M., Giner A., Tarazona F., Gómez J., Albiach R., 2004. Effects of water and nitrogen fertilization on seed-grown globe artichoke. *Acta Hort.* DOI: 10.17660/ActaHortic. 2004.660.43
- Ramos P.A.B., Santos S.A.O., Guerra A.R., Guereiro O., Freire C.S.R., Rocha S.M., Duarte M.F., Silvestre A.J.D., 2014. Phenolic composition and antioxidant activity of different morphological parts of *Cynara cardunculus* L. var. *altilis* (DC). *Ind. Crops Prod.*, 61: 460-471.
- Romani A., Pinelli P., Cantini C., Heimler D., 2006. Characterization of Violetto di Toscana, a typical Italian variety of artichoke (*Cynara scolymus* L.). *Food Chem.* 65: 221-225.
- Rossoni G., Grande S., Galli C., Visioli F., 2005. Wild artichoke prevents the age associated loss of vasomotor function. *J. Agric. Food Chem.* 53: 10291-10296.
- Sałata A., Gruszecki R., 2010. The quantitative analysis of polyphenolic compounds in different parts of the globe artichoke (*Cynara scolymus* L.) depending on growth stage of plants. *Acta Sci. Pol., Hortorum Cultus*, 9 (3): 175-181.
- Sonnante G., De Paolis A., Lattanzio V., Perrino P., 2002. Genetic variation in wild and cultivated artichoke revealed by RAPD markers. *Genet. Resour. Crop Evol.* 49: 247-252.
- Speroni E., Cervellati R., Covoni P., Guizzardi S., Renzulli C., Guerra M. 2003. Efficacy of different *Cynara scolymus* preparation of liver complaints. *J. Ethnopharmacology*, 86: 203-211.

A STUDY ON THE DETERMINATION OF YIELD PROPERTIES AND FACTORS THAT AFFECT THE YIELD IN COWPEA UNDER KIRSEHIR/TURKEY ECOLOGICAL CONDITIONS

Omer SOZEN^{1*}, Ufuk KARADAVUT²

1Department of Field Crops, Faculty of Agriculture, Kırsehir, Turkey
2 Department of Animal Science, Faculty of Agriculture, Kırsehir, Turkey
*Corresponding author: ekim_55@hotmail.com

Abstract

This study aimed to determine cowpea seed varieties that may be suitable for the production efficiency and affecting yield factors in Turkey's located Middle Anatolia Kırsehir ecological conditions. The study was conducted for 2 years in 2014-2015. In research, 4 cowpea varieties (Amazon, Sırma, Karagoz, Akkız) and control Nevşehir / Hacıbektas, obtained from the district domestic genotype 1, were used. Research was conducted in a randomized complete block experimental design with three replications. Sowing was performed on 10 May 2014 and on 8 May 2015. The local cowpea cultivars and genotypes according to the two-year average grain 50% flowering number of days 68-80 days, 50% pod connecting number of days 93-102 days, plant height 41-83 cm, pod number in plant 2-10 pieces/plant, pod length of 5-15 cm/pod, 100 seed weight and seed yield 11.46-18.75 g per plant between 1:21 to 6:19 g/plant ranged. As a result, number of pods per plant and seed per plant, plant and yield per plant and the number of days between the number of pods per pod connect with biological yield was found to be very important relationship. At the same time the first pod height, plant height and number of pods with one seed per plant were among the important relationships that were identified in both years. In cowpea breeding programs, in the number of pods per plant, yield per plant, number of pods per plant and has laid the biological traits could be used as selection criteria.

Key words: *Kırsehir, cowpea, local genotypes, yield, yield components*

Introduction

Cowpea is an important food legume as fresh and dry seed in human diet and as animal feed and green fertilizer for the improvement of soil fertility (Akcın, 1988). Depending on the cultivar and environment conditions, it contains 18-31.6% protein, 50-67% carbohydrates, 1.3% oil, 3.9% cellulose and 3.6% ash. Fresh pods and dry seeds of cowpea are used as edible legumes. Due to eating habits in human diet, priority is given to the consumption of animal-derived proteins. However, for a healthy diet, plant-derived proteins, as well as animal-derived proteins, should be consumed. Because, cowpea plant is rich in amino acids, lysine, tryptophan, carotene and B1 vitamin (Ozturk, 2010). Cowpea which is an edible legume is the third in legume production in the world following beans and chickpeas with 11.926.786 ha cultivation area, 6.224.698 tons of production and 52 kg/da yield. In Turkey, it is fifth in legume production following chickpeas, beans, lentils and broad beans with 1.941 ha cultivation area, 2.006 tons of production and 103 kg/da yield (FAO, 2013). Cowpea cultivation in Turkey is unsatisfactory. Cowpea cultivation should be developed and a cultivator culture should be established on this subject. As in other culture plants, it is of great importance, as well as other cultural applications, to use cultivars suitable to the ecological conditions for increasing the yield per unit area (Sert ve Ceyhan, 2012).

Ozturan and Gulumser (2004), in their study on Akkız and Karagoz cultivars, determined some yield properties including plant height, pod number in plant, yield per plant, seed yield, 1000-seed weight and crude protein have reported the highest seed yield as 273.1 kg⁻¹. The researchers obtained the highest seed yield per plant in Karagoz cultivar (69.0 g). Oztokat and Demir (2010), in their study on 31 different cowpea genotypes in Aegean region, determined the highest yield as 84.20 kg⁻¹. Vural et al. (2000), in their study, stated that growing condition is the most important factor that affects the yield. The researchers have reported that ecological conditions seriously affect the fertility. Tomer and Verma (1989) have reported that seed weight had a sufficient effect on the growth and development in cowpea. Gul (1996) has reported that the humidity should be high for the germination of cowpea. The researchers determined that cowpea may not germinate in soils where most of the legume types easily can.

Kırsehir is ecologically suitable for cowpea cultivation. However, the production level is not satisfactory due to the consumption habits of the producers. The aim of this study is to determine the genotypes of cowpea (line/variety) in terms of yield suitable for Kırsehir/Turkey ecological conditions which features all the characteristics of Central Anatolian ecological conditions.

Material and Methods

The present study aims to determine the yield and some agronomic properties of cowpea (*Vigna sinensis* L.) genotypes under Kırsehir/Turkey ecological conditions. The study was conducted for 2 years in 2014-2015 at trial farmlands located at Mucur country in Kırsehir. The altitude of Mucur country in which the study was carried out is about 80 m and it is located at 39°3'48.00"K latitude and 34°22'19.71"D longitude (Figure 1).



Figure 1. Locations where the conduct of the trials

Examining the analysis results for the soil used in the study, it was seen that the soil had a clayey-loamy structure with mild alkaline characteristics, saltless, calcareous, moderate in phosphorus, rich in potassium and moderate in organic substance for the every both years.

The average monthly temperatures and relative humidity ratios for both years were highly similar to those of long-term temperature and relative humidity values. However, examining the monthly total precipitation values, the total precipitation values for all months for both 2014 and 2015 were considerably higher compared to the long-term average values. Particularly, 161.4 mm precipitation value for June 2015 was 11 times higher than the long-term average values (Table 1).

The study was established according to the randomized complete block experimental design in three replications. Four cowpea standard cultivars (Akkız, Amazon, Karagoz, Sırma) and one native population, a total of five cowpea genotypes were included in the study. The seeds were sown in plots consisting of 4 rows which were prepared using a 5 m marker with 60 row spacings (5 x 2.40 m= 12 m²) and 10 cm intra-row spacings manually between 10 May 2014 and 8 May 2015. In addition to planting, the necessary fertilization (15 kg diamonium phosphate per decare)

was distributed among the plots homogeneously and herbicide application was carried out before planting and sprouting. Additionally, necessary irrigation was carried out during the required period for the plants. Harvest was carried out manually between 14 September 2014 and 11 September 2015. In each plot consisting of 4 rows, the 1st and the 4th rows of the plots and 50 cm distances from the starting point of each plot was removed as the edge impact and total harvesting was performed in the remaining area.

Flowering and pod setting values of all cowpea genotypes in all plots for the two years and phenological and agronomic properties including plant height (cm), first pod height (cm), the number of pods per plant (piece/plant), the number of seed per pod (piece/pod), the number of seed per plant (piece/plant), seed yield per plant (g), 100 seed weight (g), pod height (cm) and biological yield (g) for 10 plants randomly selected from each plot were determined according to Akcin (1974) and Gulumser (1981).

Table 1. Climate data for the Kirsehir.

Climatic Factors	Years	Months				
		May	June	July	August	September
Total Rainfall (mm)	2014	46.6	36	13	17	30.4
	2015	39.2	161.4	20.6	11.8	1
	ALY*	10.7	13.9	2.9	1	2.6
Average temperature (°C)	2014	16.9	20.8	27.6	28.2	20.1
	2015	16.4	18.9	24.9	25.9	23.8
	ALY*	16.2	20.6	24.8	24.9	19.6
Average Relative Humidity (%)	2014	59.5	51.6	33.6	33.6	50.8
	2015	57.5	65.6	41.5	45.4	41.1
	ALY*	56.2	50.9	38.4	37.6	43.3

*ALY: Average Long Years

The combined data of the two years were subjected to the ANOVA using JUMP5.0 statistical software. The “LSD Multiple Comparison Test” was used for the comparison between the significant differences between the average values. The study comprised combined data of the each property examined for the both years.

Results and Discussion

50% The Number of Flowering and Pod Connecting Days

In terms of the average 50% number of flowering days for the both years, the differences between the cowpea genotypes were very significant ($P < 0.01$). The genotypes with the longest 50% flowering periods were sirma and akkız genotypes with 75.9 days and 75.5 days, respectively (Table 2). The shortest 50% flowering period was determined in the native genotype with 69.5 days. The average 50% flowering period for all genotypes were 73.2 days. These results were in line with the results reported by Gulumser et al. (1989) who have reported that the flowering period for native cowpea genotypes varied between 66 and 73 days. Similarly, Buyukkılıç (1995), in their study conducted under Sanlıurfa conditions have reported that flowering period varied between 56 and 57 days. This was associated with the different ecological conditions in terms of humidity and temperature of the area that the study was conducted. Pod connecting and flowering periods are directly related to each other. 50% pod connecting period is described as the number of days for the plant until the date of 50% pod connecting. The average pod setting for the two years in the study was determined as 96.7 days and the differences between the

genotypes were statistically not significant (Table 2). The genotype with the longest pod connecting period was sirma with 99 days whereas the shortest pod setting period was determined in the native population with 94.5 days.

Plant Height

The average values of plant height for cowpea genotypes for the two years and the LSD groups are shown in Table 2. Analysis of variance revealed that the differences between the average plant heights of cowpea genotypes for the two years were very significant ($P < 0.01$). The genotypes with the highest plant heights were sirma, amazon and native cowpea genotypes with 61.5 cm, 59.9 cm and 57.7 cm, respectively. The lowest plant heights were determined in akkız and karagoz genotypes with 45.8 cm and 47.6 cm, respectively. The average plant height was determined as 54.5 cm. The difference between the plant heights of the highest genotype and the lowest genotype was 15.7 cm. In a study on the determination of the effects of different intra-row spacings and via on seed yield and some agronomic properties of cowpea (*Vigna sinensis* (L.) Savi) cultivars under Hatay province ecological conditions, the plant height values varied between 33.22 cm and 60.37 cm (Sert, 2011). In another study on the determination of plant properties and ability of cowpea cultivars under Hatay ecological conditions, the differences between the plant height values of ecotypes were statistically significant (Atıs ve Yılmaz, 2005). The results obtained by the researchers were in line with the results obtained in the present study.

First Pod Height

Results for the analysis of variance for first pod height values of the cowpea genotypes and the LSD groups in the study are shown in Table 2. As seen in Table 2, the differences between the first pod height values of the genotypes were statistically significant ($P < 0.05$). Examining the average values for the two years, first pod height varied between 21.3 cm and 25.4 cm. The highest first pod height values were determined in amazon and akkız genotypes with 25.4 cm and 25.1 cm, respectively.

These two genotypes were statistically located in the same group (a). The lowest first pod height was determined in native cowpea genotype with 21.3 cm. The average first pod height for the cowpea genotypes was 23.9 cm (Table 2). The higher first pod height values obtained in the present study was associated with high plant height values. Karasu (1999), in their study on the determination of the agronomic characteristics of some cowpea ecotypes under Isparta ecological conditions 1996-1997, have reported the first height between 17.8 cm and 22.7 cm. Although the variation was high, our results were within this variation.

Table 2. Two-year average of the investigated properties for cowpea genotypes

Genotypes	50% flowering number of days	50% pod connecting number of days	plant height (cm)	first pod height (cm)
sirma	75,9 a	99	61.5 a	24.5 ab
akkız	75,5 a	95.5	45.8 b	25.1 a
karagoz	74,5 b	96.5	47.6 b	23.4 ab
amazon	70,5 c	98	59.9 a	25.4 a
local	69,5 d	94.5	57.7 a	21.3 b
average	73.2	96.7	54.5	23.9
materiality	**	ns	**	*

ns, *, ** =not significant and significant effect at 5 and 1 % respectively

The Number of Pods in the Plant

One of the most important components that affect the yield is the number of pods in the plant. As a result of the analysis of variance for the combined data of the two years, the differences between the genotypes in terms of the number of pods in the plant were significant ($P < 0.01$). The groups formed in terms of the number of pods in the plant and LSD values are shown in Table 3. Examining Table 3, it was seen that the number of pods in the genotypes varied between 3.7 and 6.5 pieces. Genotypes with the highest number of pods were akkız, amazon, sırma and native genotype with 6.5, 5.5, 5.5 and 5.5 pieces respectively. The genotypes were statistically located in the same group (a). The lowest number of pods were determined in karagoz genotype with 3.7 pods. The difference between the lowest and the highest number of pods (between sırma and akkız genotypes) was 2.8.

Ceylan and Sepetoglu (1983), in their study, have reported that the number of pods in cowpea genotypes varied between 2.1 and 26.5. On the other hand, Karasu (1999) have determined the number of pods in the plant between 29.4 and 40.6. In a study on the determination of the effects of different row spacings and via on seed yield and some agronomic characteristics conducted under Hatay ecological conditions in 2009, have reported the number of pods in the plant between 12.19 and 14.59 (Sert, 2011).

The number of pod obtained in the present study was lower than those obtained by other researchers. This was mainly associated with the decrease in plant growth in pod connecting period as well as the increase in high temperatures.

The Number of Seeds per Pod

The average number of seeds per pod values of cowpea genotypes and the groupings are shown in Table 3. Examining Table 3, the differences between the genotypes in terms of the number of seeds per pod were significant ($P < 0.01$).

The number of seeds per pod varied between 4.1 and 5.6. The highest number of seeds per pod was determined in amazon genotype with 5.6 seeds. This genotype was statistically located in (a) group. This genotype was followed by akkız, sırma and karagoz genotypes with 5.3, 4.6 and 4.4 seeds, respectively. These three genotypes were located in the same group (ab). The lowest numbers of pods were determined in native genotype with 4.1 pods.

Clarke and Skeete (1982), in their study on arauca cowpea cultivars, have reported that, in five different plant spacing applications, planting spacing frequency had no effects on the number of seeds per pod and 100-seed weight. Bahceci (1987), in their study conducted under Cukurova ecological conditions, have reported that the number of seeds per pod increased as the intra row space increased.

In a study on the effects of different row spacings and nitrogen fertilization on the yield and yield components of akkız and karagoz cowpea cultivars under Samsun ecological conditions, the number of seeds per pod varied between 10.4 and 11 (Ozturan, 2003).

Pod Length

The average pod length values of cowpea genotypes for the two years are shown in Table 3. The differences between the genotypes in terms of pod lengths were found to be statistically not significant. Pod lengths of the genotypes in the study varied between 8.7 and 9.6 cm and other genotypes varied between these two genotypes.

The average pod length of the genotypes was 9.12 cm. The highest pod length value was determined in Amazon genotype with 9.6 cm whereas the lowest pod length values was in karagoz genotype with 8.7 cm. In a study on the determination of physiological and

morphological properties and yield and yield components of cowpea (*Vigna Sinensis L.*) ecotypes cultivated under Ordu ecological conditions, it has been reported that pod length values varied between 15.1 and 19.8 cm (Ozturk, 2010).

In another study on the determination of the most suitable variety and seed planting period for cowpea *Vigna unguiculata* (L.) Walp) under dry and aqueous ecological conditions of Isparta, the highest pod length value was determined in akkız cultivar with 16.19 cm whereas the lowest pod length values was determined in sarıgobek cultivar with 12.34 cm (Unlu, 2004). Pod length values obtained by the researchers were substantially higher than those obtained in the present study. This was associated with the increase in temperature and the decrease in humidity in the area that the study was conducted during pod setting period and the decrease in plant growth.

Table 3. Two-year average of the investigated properties for cowpea genotypes

Genotypes	the number of pods per plant	the number of seed per pod	pod length
akkız	6,5 a	5.3 ab	9.0
amazon	5,5 a	5.6 a	9.6
sırma	5,5 a	4.6 ab	9.0
local	5,5 a	4.1 b	9.3
karagoz	3,7 b	4.4 ab	8.7
average	5.34	4.8	9.12
materiality	**	**	ns

ns, *, ** =not significant and significant effect at 5 and 1 % respectively

100 Seed Weight

The average 100 seed weight values of cowpea genotypes and statistical groupings are shown in Table 4. The effect of genotypes on 100 seed weight was statistically very significant ($P<0.01$). 100 seed weight values of the genotypes varied between 13.56 g and 16.94 g and the highest 100 seed weight value was determined in sırma genotype with 16.94 g. On the other hand, the lowest 100seed weight values were determined in native genotype and akkız genotype with 13.56 g and 14.24 g, respectively. These two genotypes were statistically located in the same group. The difference between the highest and the lowest 100 seed weight values was 3.38 g and the average 100 seed weight was 15.36 g. In a study on the determination of plant characteristics and adaptation capabilities in different cowpea ecotypes obtained from different parts of Turkey under Hatay ecological conditions, 100 seed weight value varied between 12.93 and 21.94 g (Atış, 2000). In a study on the determination of the most suitable cowpea cultivar (akkız, karnıkara and sarıgobek) and seed planting period under dry ecological conditions in Isparta, 100seed weight was reported between 12.55 and 21.53 g (Unlu, 2004).

Seed Yield per Plant

The average seed yield per plant values and statistical groupings are shown in Table 4 and the differences between the genotypes in terms of seed yield per plant values were very significant at 1% level.

Examining Table 4, seed yield per plant values varied between 1.916 and 3.003 g. The two genotypes with the highest seed yield per plant values were akkız and amazon cowpea genotypes with 3.003 g and 2.998 g, respectively. These two genotypes were statistically located in the same group (a). This was followed by sırma and native genotypes with 2.684 g and 2.382 g and these

two genotypes were statistically located in the same group (ab). The lowest seed yield per plant was determined in karagoz genotype with 1.916 g.

The difference between the highest and the lowest seed yield per plant values was 1.087 g. In a study conducted under Cukurova conditions, Bahceci and Engin (1989) have reported that the highest seed yield per plant values were determined in karagobek cultivar in 30 cm (44.03 g) and 25 cm (35.53 g) planting spacings, respectively, and in kırmızı cultivar in 25 cm (32.35 g) and 30 cm (28.30 g) planting spacings, respectively.

In another study conducted under Samsun ecological conditions, seed yield per plant values varied between 48.4 and 69 g (Ozturan, 2003). The seed yield per plant values obtained in the present study were lower than those obtained by other researchers. This associated with the effect of temperatures much above 30 °C in maturation period on seed maturation.

Table 4. Two-year average of the investigated properties for cowpea genotypes

Genotypes	seed yield per plant	100 seed weight
akkız	3,003 a	14.24 c
amazon	2,988 a	15.81 b
sırma	2,684 ab	16.94 a
local	2,382 ab	13.56 c
karagoz	1,916 b	16.22 ab
average	2.594	15.36
materiality	**	**

ns, *, ** =not significant and significant effect at 5 and 1 % respectively

Conclusion

The aim of the present study was to determine the yield properties and the factors that affect the yield in cowpea under Kırsehir/Turkey ecological conditions 50% flowering number of days, 50% pod connecting number of days, plant height (cm), first pod height (cm), the number of pods per plant (piece/plant), the number of seed per pod (piece/pod), seed yield per plant(g/plant), 100 seed weight (g) and pod length (cm) values were examined and compared with other studies.

In conclusion, the results obtained for the two years were not satisfactory to make a clear conclusion. However, the result obtained in terms of yield components in particular, the number of seeds, 100 seed weight and the yield per plant were promising for some cultivars. Indeed, high yields were obtained from akkız, sırma and amazon cultivars. In order to acquire better results on cowpea cultivation, it was concluded that the study should be conducted for a couple more years in Kırsehir and neighboring locations.

Considering the importance of edible legumes in human diet, there is need for research and development on the breeding and cultivation techniques for cowpea. These research studies will contribute to the development of agricultural production and hence the elevation of socio-economic structure.

Acknowledgement

“This work was supported by the Ahi Evran University Scientific Research Projects Coordination Unit. Project Number:ZRT.E2.16.015”

References

- Akcin, A. (1974). An Investigation of the Effect of Fertilization, Planting Time and Row Spacing on Grain Yield and Phonological, Morphological and Technological Characters Some Dry Bean Varieties Under Grown Erzurum Ecological Conditions. *Journal of Agricultural Faculty of Ataturk University, Erzurum*, 157: 1-112 p.
- Akcin, A. (1988). *Legumes*. *Journal of Agricultural Faculty of Selcuk University, Konya*, 43(8): 377 p.
- Atis, İ. (2000). Determination of Yield and Yield Components Cowpea (*Vigna sinensis* L.) That Can Be Grown Second Crop Conditions to Obtain Seed and Green Grass in Hatay Conditions. Institute of Science of Mustafa Kemal University, Hatay, Master's Thesis, 73 p.
- Atis, İ., Yılmaz, S. (2005). Determination of Yield and Yield Components Cowpea (*Vigna sinensis* L.) That Can Be Grown Second Crop Conditions to Obtain Green Grass in Hatay Conditions. *The Sixth Field Crop Congress, Antalya, Part: II*, 985-988 p.
- Bahceci, B. (1987). Effects of Some Plant and Agricultural Characteristics of Different Sowing in Two Cowpea Varieties. Institute of Science of Cukurova University, Adana, Master's Thesis, 47 p.
- Bahceci, B., Engin, M. (1989). A Study on the Effects of Some Herbal and Agronomic Traits in Two Different Sowing Cowpea Varieties. *Cukurova University, Institute of Science and Technology*, 3 (3): 21-27 p.
- Ceylan, A., Sepetoglu, H. (1983). Cowpea (*Vigna unguiculata* (L.) Walp) Research on the Variety-Planting Time. *Journal of Agricultural Faculty of Ege University*, 20 (1): 25-40 p.
- Clarke, B.A., Skeete, S.A. (1982). Response of cowpea (*Vigna unguiculata* (L.)), cultivar arauca, to planting density. 18th Annual Meeting, *Carribean Food Crops Society*, 98-103 s.
- Fao, (2013). faostat.fao.org/site/Desktop.PageID=336.
- Gul, K., (1996). A Study on to Determine of Adaption to Tokat-Kazova Ecological Conditions and Favorable Sowing Time of Cowpea (*Vigna Sinensis* (L.) Endi) Institute of Science of Gaziosmanpasa University Master's Thesis, Tokat.
- Gulumser, A. (1981). Effects of Nitrogen Fertilization, Irrigation Grain Yield and Its Protein Content in Peas. *Field Crop, Faculty of Agricultural, Ataturk University, Erzurum, Doctorate Thesis*.
- Gulumser, A., Tosun, F., Bozoglu, H. (1989). A Research On Cowpea Cultivation in Samsun Ecological Conditions. *Journal of Agricultural Faculty of Ondokuzmayıs University*. 4 (1-2) 49-65 p.
- Karasu, A. (1999). Agronomic Research in Character Some of Cowpea (*Vigna angulate* L.) Cultivar and Ecotype of in Isparta Ecological Conditions. *Türkiye The Third Crop Science Congress, Adana*, 371-376 p.
- Öztokat, C., Demir, İ. (2010). The Comparison Of Some Cowpea Populations According to Their Growth, Yield and Seed Quality. In: 2nd International Symposium on Sustainable Development, Sarajevo.
- Özturan, Y. (2003). The Effects of Different Row Spacing and Nitrogen Fertilization on Yield and Yield Components of Cowpea (*Vigna unguiculata* (L.) Walp.) Under Samsun Conditions. Institute of Science of Ondokuzmayıs University, Samsun, Master's Thesis, 77 p.
- Özturan, Y., Gülümser, A. (2004). The Effects of Row Spacing and Nitrogen Fertilization on Yield and Yield Components of Cowpea (*Vigna unguiculata* (L.) Walp.). *Journal of Agriculture Faculty*, 19(3): 41-49 p.

- Öztürk, D. (2010). Determination of Some Physiological and Morphological Features With Production and production Element of Cowpea Ecotypes That Wil Be Cultivated in ordu Ecological Conditions. Institute of Science of Ordu University, Ordu, Master's Thesis, 77 p.
- Sert, H. (2011). The Effects of Seed Yield and Some Agricultural Characters of Plant Density on Cowpea (*vigna sinensis*(l.) *savi*) in Hatay Ecological Conditions. Institute of Science of Selcuk University, Konya, Master's Thesis, 52 p.
- Sert, H., Ceyhan, E. (2012). The Effects of Seed Yield and Some Agricultural Characters of Different Plant Density on Cowpea (*Vigna sinensis* (L.) Savi) in Hatay Ecological Conditions. Selcuk Journal of Agricultural and Food Sciences. 26 (1): (2012) 34-43p.

GENOTYPIC SPECIFICS OF TRITICALE VARIETIES (*X TRITICOSECALE* WITTM.) AS A FUNCTION OF THE NITROGEN FERTILIZATION LEVEL

Hristofor KIRCHEV

Department of Crop Science, Faculty of Agronomy, Agricultural University, Plovdiv, Bulgaria

*Corresponding author: hristofor_kirchev@abv.bg

Abstract

A field experiments were conducted during three growing seasons, from 2012 to 2014, at the experimental field of Department of Crop Science in Agricultural University – Plovdiv. The experiment consisted of a randomized complete block design after predecessor rapeseed with three replicates and plots of 10 m² planted at a sowing rate of 550 viable seeds m⁻². Three triticale (*xTriticosecale* Wittm.) cultivars, one Bulgarian and two Spanish were studied – Rakita, Bulgarian standard, breeding at the Dobruja Agricultural Institute – Gen. Toshevo, Trujillo and Senatrit, created in Spain. Three nitrogen fertilization level has been studied – N₀, N₈₀ and N₁₆₀ kg ha⁻¹ nitrogen expressed as ammonium nitrate – 1/3 of nitrogen was introduced after sowing, and the remaining 2/3 in early spring. To establish the productivity of the tested varieties of triticale under the influence of nitrogen fertilization were determined following parameters: grain yield, after plots were harvested at ripening and yield was expressed on a 13% grain moisture basis; number of spikes per m²; plant height, cm; spike length, cm; number of spikelets per spike; number of grain per spike; mass of grain per spike, g; weigh of glumes per spike, g and spike harvest index, calculated as: (spike grain yield/total spike biomass) x 100.

Keywords: *triticale, variety, nitrogen fertilization, yield.*

Introduction

The combination of the resistance to biotic and abiotic stresses of rye with the high yield potential and good grain quality of wheat resulted in the man-made small grain Triticale (*xTriticosecale* Wittmack). This artificial plant is of interest due to its nutritional value which largely surpasses in many aspects those of wheat and rye. Triticale breeding programs are mostly focused on major economic traits such as grain yield, biomass yield, nutritional value, earliness and grain filling percentage (Grabovets and Popova, 2015; Moskalets et al., 2016; Priya et al., 2015; Stoyanov and Baychev, 2015).

Apart from the variety, many researches have been conducted on crop nutrients management and optimization. These studies (Bielski et al., 2015; Gerdzhikova et al., 2013a,b; Gerdzhikova, 2014; Jorgensen et al., 2007; Kolev et al., 2011; Kirchev et al., 2012; Kirchev et al., 2014; Madic et al., 2015; Wojtkowiak et al., 2015) have revealed the significant importance of nitrogen fertilizer optimization for triticale. Keeping in view the importance of nitrogen fertilization for triticale, the present study was conducted to evaluate the response of triticale varieties to various levels of nitrogen.

Material and methods

Field trials

A field experiments were conducted during three growing seasons, from 2012 to 2014, at the experimental field of Department of Crop Science in Agricultural University – Plovdiv

(42°08'26.2"N 24°48'21.1"E). The experiment consisted of a randomized complete block design after predecessor rapeseed with three replicates and plots of 10 m² planted at a sowing rate of 550 viable seeds m⁻².

Three triticale (*xTriticosecale* Wittm.) cultivars, one Bulgarian and two Spanish were studied: Rakita (Cooring x 35-131-5, a complete type triticale) Bulgarian standard, breeding at the Dobruja Agricultural Institute – Gen. Toshevo, Trujillo – derived from CIMMYT germplasm, a ‘Juanillo’ sister line (a complete type triticale) and Senatrit, released by the Spanish company SENASA, a substituted type.

Three nitrogen fertilization level has been studied – N₀, N₈₀ and N₁₆₀ kg ha⁻¹ nitrogen expressed as ammonium nitrate – 1/3 of nitrogen was introduced after sowing, and the remaining 2/3 in early spring.

Estimation methods

To establish the productivity of the tested varieties of triticale under the influence of nitrogen fertilization were determined following parameters: grain yield, after plots were harvested at ripening and yield was expressed on a 13% grain moisture basis; NSM – number of spikes per m²; PH – plant height, cm; SL – spike length, cm; NSS – number of spikelets per spike; NGS – number of grain per spike; MGS – mass of grain per spike, g; WGS – weigh of glumes per spike, g and SHI – spike harvest index, calculated as: (spike grain yield/total spike biomass) x 100.

Statistical analysis

The results were analyzed using the software package IBM SPSS Statistics 22. A two-way analysis of variance were used to determine the influence of various factors.

Results and discussion

The grain yield of studied triticale varieties under the influence of nitrogen fertilization, set over three harvest years is presented in table 1. In the first year of the study, lowest yield from the variants without nitrogen fertilization was obtained from variety Trujillo - 1.183 t ha⁻¹. Second in productivity is variety Rakita, and the highest yield was obtained from variety Senatrit - 1.353 t ha⁻¹. Under the average nitrogen rate of 80 kg nitrogen, highest yield was obtained from variety Trujillo - 3.030 t ha⁻¹, followed by Rakita, and the low productive is Senatrit - 2.847 t ha⁻¹. When fertilizing with 160 kg nitrogen per hectare, the low productive is variety Senatrit - 5.017 t ha⁻¹, followed by Trujillo and the highest yield was obtained from variety Rakita - 5.520 t ha⁻¹.

Table 1. Grain yields, t ha⁻¹

Varieties	Nitrogen fertilization	Years		
		2012	2013	2014
Rakita	0	1,220a	1,173a	1,350a
	80	2,943b	2,823b	3,060b
	160	5,520c	5,240c	5,747c
Trujillo	0	1,183a	1,153a	1,233a
	80	3,030b	2,933b	3,143b
	160	5,237c	5,033c	5,397c
Senatrit	0	1,353a	1,124a	1,447a
	80	2,847b	2,773b	2,943b
	160	5,017c	4,877c	5,177c
<i>LSD 5%</i>		<i>0.31</i>	<i>0.28</i>	<i>0.34</i>

*Values with the same letters do not differ significantly

In the second harvest year, with the variants without nitrogen fertilization lowest yield was obtained from variety Senatrit - 1.124 t ha⁻¹. Second in productivity is variety Trujillo and the highest yield was obtained from variety Rakita - 1.173 t ha⁻¹. Under the average nitrogen rate of 80 kg nitrogen highest yield was obtained from variety Trujillo - 2.933 t ha⁻¹, followed by Rakita, and the low productive is sort Senatrit - 2.733 t ha⁻¹. Under fertilizing with 160 kg nitrogen per hectare, most low productive is Senatrit - 4.877 t ha⁻¹, followed by Trujillo and the highest yield was obtained from variety Rakita - 5.240 t ha⁻¹.

Table 2. Analysis of variance.

<i>Source of Variation</i>	<i>df</i>	<i>MS</i>
N fertilization	2	360822,062*
Variety	2	579,728*
Interaction	4	842,877*
Within	18	15,704
Total	26	

* - statistical significant by P=0.05

In the harvest 2014, with the variants without nitrogen fertilization lowest yield was obtained from variety Trujillo - 1.233 t ha⁻¹. Second in productivity is variety Rakita, and the highest yield was obtained from variety Senatrit - 1.447 t ha⁻¹. Under the average nitrogen rate of 80 kg nitrogen highest yield was obtained from variety Trujillo - 3.143 t ha⁻¹, followed by Rakita, and the low productive is variety Senatrit - 2.943 t ha⁻¹. Under fertilizing with 160 kg nitrogen per hectare, most low productive is Senatrit - 5.177 t ha⁻¹, followed by Trujillo and the highest yield was obtained from variety Rakita - 5.747 t ha⁻¹.

Two-way analysis of variance (Table 2) can be seen strongly expressed influence as a variety of factors and factor nitrogen fertilization. The impact of both factors and the interaction between them is statistically significant.

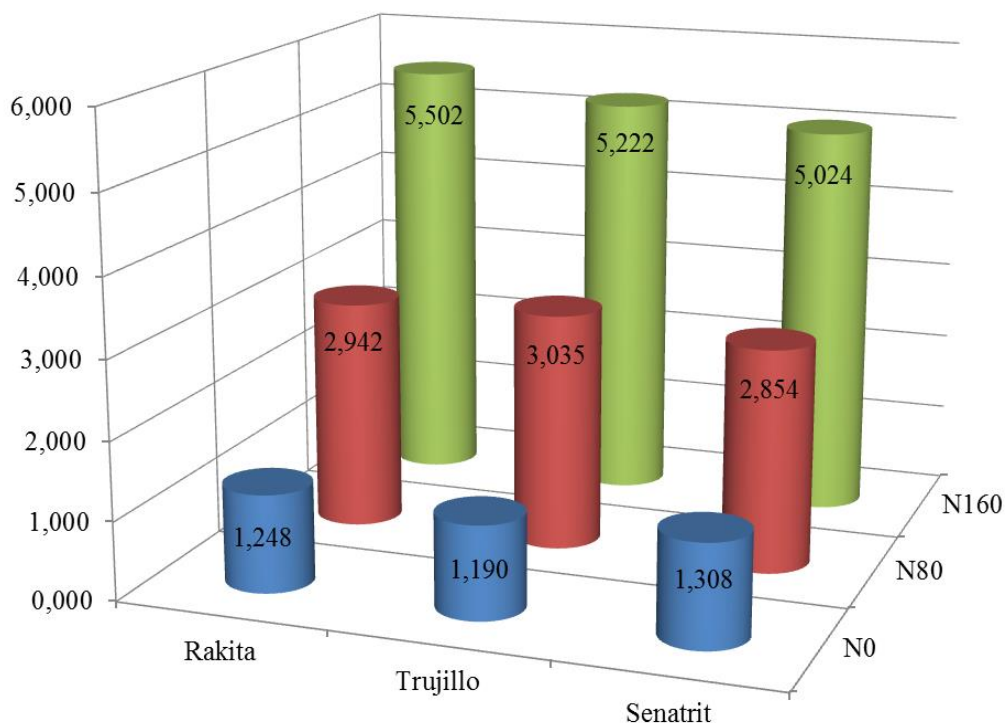

Figure 1. Average grain yields, t ha⁻¹

Average for the three years of the study variety Senatrit appears as the most productive in terms of nitrogen deficiency (N₀) - 1,308 t ha⁻¹ followed by Rakita, and the lowest average grain yield was obtained from variety Trujillo - 1.190 t ha⁻¹ (Fig. 1). In increasing nitrogen fertilization to 80 kg nitrogen, highest average grain yield is derived from a variety Trujillo - 3.035 t ha⁻¹, followed by Rakita, and the lowest average grain yield in these conditions of nitrogen nutrition is derived from a variety Senatrit - 2,854 t ha⁻¹. At the maximum tested nitrogen fertilizer rate of 160 kg highest average grain yield is derived from a variety Rakita - 5.502 t ha⁻¹, followed by Trujillo, and the low productive – variety Senatrit - 5.024 t ha⁻¹.

From the results it can be concluded that when nitrogen deficiency, variety Senatrit, being substituted type triticale, is manifested as more productive, than both complete type variety. The complete type varieties Rakita and Trujillo exerted their productive potential best at high nitrogen fertilization rates, while at nitrogen starvation they give very low yields.

The main structural elements affecting grain yield are presented in Table 3, the data is an average of the three harvest years.

In variety Rakita variation in the number of spikes is between 468 at no-fertilization variant and 688 at the maximum tested fertilizer norm. Most spikes in variety Trujillo are formed upon fertilization with N₈₀ - 680 spikes, while at the variety Senatrit variation between three background of nitrogen fertilization is weakest. Exactly this variety forms most spikes with no fertilization with nitrogen - 488 spikes. At the maximum tested nitrogen rate of 160 kg nitrogen most spikes formed the variety that gave the highest grain yield in these conditions - variety Rakita (688 spikes).

The height of plants is significant different between the two types of triticale - at complete types varieties Rakita and Trujillo plant height varies between 90-110 cm, while the substituted type

triticale Senatrit is lower than the two complete type varieties. As expected, nitrogen fertilization leads to increase plant height and the all varieties of triticale.

Similar trends has and in the next linear parameter - length of spikes: Variety Rakita and Trujillo are characterized by longer spikes as variety Senatrit average of about 1-2 cm, and the increase in nitrogen rate leads to the formation of longer spikes in all three tested varieties. Longer spikes in complete type varieties Rakita and Trujillo are a sign that leads to the formation and more spikelets in the spike – between 23 and 27. In variety Senatrit this feature has a low performance – between 20 and 22 spikelets in the spike. Nitrogen fertilization leads to proven increases in this feature about 4 pieces in complete varieties, while the variety Senatrit increase in nitrogen rate up to 160 kg changing this feature with only 2 spikelets.

Table 3. Structural parameters of the plants (average for 3 years).

Varieties	N level	NSM	PH	SL	NSS	NGS	MGS	WGS	SHI
Rakita	0	468a	90,5b	10,5b	23,5b	41,2a	1,32a	0,58a	69,47b
	80	635b	93,5b	11,2b	25,1c	45,7b	1,84c	0,62b	74,80c
	160	688c	110,4c	12,4c	27,4c	48,2c	1,95c	0,68c	74,14c
Trujillo	0	472a	91,3b	10,1b	23,6b	40,2a	1,54b	0,61a	71,63b
	80	680c	95,8c	12,2b	27,5c	47,2c	1,65c	0,68c	70,82b
	160	675b	104,2c	12,5c	27,7c	47,8c	1,84c	0,71c	72,16b
Senatrit	0	488b	78,1a	9,5a	20,7a	42,1a	1,28a	0,64b	66,67a
	80	592b	79,8a	10,2a	21,5a	44,5b	1,32a	0,66c	66,67a
	160	661c	85,4b	10,8b	22,8b	45,1b	1,57b	0,68c	69,78b
<i>LSD 5%</i>		<i>12,1</i>	<i>2,4</i>	<i>0,8</i>	<i>1,8</i>	<i>2,4</i>	<i>0,41</i>	<i>0,38</i>	<i>3,1</i>

*Values with the same letters do not differ significantly

The number of grains per spike with no fertilization with nitrogen variants is highest in the variety, gave the highest yield in terms of nitrogen deficiency – Senatrit. In this variety increasing nitrogen rate increases the grains per spikes by only 3 pieces. In complete type varieties, the number of grains in the spike vary between 41-48 grains, indicating that these two varieties the increasing of nitrogen rate leads to a significant increase in the number of grains per spike about 7 grains - double than the variety Senatrit.

The mass of grains per spike in all tested variants is greater than 1 gram, ranging between 1.28 g under no fertilization variant variety Senatrit and 1.95 g at fertilization with maximum nitrogen rates tested variety Rakita. In another sign of the spikes weight - the weight of glumes, the highest values occurred in varieties Senatrit and Trujillo. In variety Rakita glumes are the lowest weight.

The differences in accumulation of biomass in two main parts of the spike – grains and glumes leading to their different ratio, expressed as a harvest index of the spike (Hucl and Graf, 1992). Higher values of this indicator in complete type varieties: Rakita – between 69.47 and 74.80 and variety Trujillo – between 70.8 and 72.16. In variety Senatrit values are significant less – between 66.67 and 69.78.

Conclusions

Under nitrogen deficiency, variety Senatrit, being substituted type triticale, is manifested as more productive, than both complete type varieties. The complete type varieties Rakita and Trujillo exerted their productive potential best at high nitrogen fertilization rates, while at nitrogen starvation they give very low yields.

Variety Senatrit forms most spikes with no fertilization with nitrogen. Exactly at this variety variation between three backgrounds of nitrogen fertilization is weakest. At the maximum tested nitrogen rate most spikes formed the variety that gave the highest grain yield in these conditions – Rakita.

The height of plants is significant different between the two types of triticale – at complete types Rakita and Trujillo plant height varies between 90-110 cm, while the substituted type triticale Senatrit is lower. Similar trends has and in the next linear parameter - length of spikes.

The number of grains per spike with no fertilization with nitrogen variants is highest in the variety, gave the highest yield in terms of nitrogen deficiency – Senatrit. In this variety increasing nitrogen rate increases the grains per spikes by only 3 pieces. In complete type varieties the increasing of nitrogen rate leads to a significant increase in the number of grains per spike about 7 grains - double than the variety Senatrit.

The differences in accumulation of biomass in two main parts of the spike – grains and glumes leading to their different ratio, expressed as a harvest index of the spike. Higher values of this indicator in complete type varieties: Rakita and Trujillo. In variety Senatrit values are significant less.

References

- Bielski, S., Dubis, B., Budzyński, W. 2015. Influence of nitrogen fertilization on the technological value of semi-dwarf grain winter triticale varieties Alekto and Gniewko. Pol. J. Natur. Sc., Vol 30(4): 325–336.
- Grabovets, A. I., Popova, O. G. 2015. Breeding of winter triticale for use in confectionery production. Russian Agricultural Sciences, 41(6), 411-414.
- Gerdzhikova, M., D. Pavlov, Ts. Zhelyazkova, L. Plescuta. 2013. Dry matter weight, crop growth rate, relative growth rate of triticale grown with the increasing nitrogen fertilizer rates and after different predecessors. Journal of Mountain Agriculture on the Balkans, 16, 5, 1133-1157.
- Gerdzhikova, M., D. Pavlov, Ts. Zhelyazkova. 2013. Leaf Area Index and Net Assimilation Rate of Triticale (*Triticosecale* Wittmack), Grown with the increasing nitrogen fertilizer rates and after different predecessors. Journal of Mountain Agriculture on the Balkans, 16, 6, 1360-1380.
- Gerdzhikova, M. 2014. Influence of N fertilization and predecessors on Triticale yield structure characteristics, Balkan Agriculture Congress, September 08-11, 2014, Edirne, Turkey, Turkish Journal of Agricultural and Natural Sciences, Special Issue 2, 1922-1932.
- Hucl, P. and Graf, R. J. 1992. Variation in spike harvest index among diverse genotypes of spring wheat and triticale. Can. J. Plant Sci. 72: 257 -261.
- Jorgensen, JR, Deleuran, LC, Wollenweber, B. 2007. Prospects of whole grain crops of wheat, rye and triticale under different fertilizer regimes for energy production. Biomass and Bioenergy, 31(5): 308-317.
- Kolev T., G. Todorov, L. Koleva, 2011. Testing of fertilizers for foliar application in triticale. Plant Science. XLVIII, 5, 495-498.

- Kirchev, H., V. Delibaltova, I. Yanchev, I. Zheliazkov, 2012. Comparative investigation of rye type triticale varieties, grown in the agroecological conditions of Thrace valley. *Bulgarian Journal of Agricultural Science*, 18: 5, 696-700.
- Kirchev, H., V. Delibaltova, A. Matev, T. Kolev, I. Yanchev. 2014. Analysis of productivity of triticale varieties grown in Thrace and Dobrudja depending on nitrogen fertilization. *Journal of Mountain Agriculture on the Balkans*, 17: 2, 328-335.
- Madic, M., Đurovic, D., Paunovic, A., Jelic, M., Knežević, D., Govedarica, B. 2015. Effect of nitrogen fertilizer on grain weight per spike in triticale under conditions of central Serbia. Sixth International Scientific Agricultural Symposium "Agrosym 2015", Jahorina, Bosnia and Herzegovina, October 15-18, 2015. *Book of Proceedings 2015*, 483-487.
- Moskalets, T. Z., Vasykivskyi, S. P., Morgun, B. V., Moskalets, V. I., Moscalets, V. V., Rybalchenko, V. K. 2016. New genotypes and technological indicators of winter triticale. *Biotechnologia Acta*, (9, № 1), 79-86.
- Priya, B., Diyali, S., Mukherjee, S., Srinivasarao, M. 2015. Genetic diversity based on cluster and principal component analysis in wheat and triticale genotypes. *Research on Crops*, 16(4), 712-718.
- Stoyanov, H., V. Baychev. 2015. Correlations between spike parameters of first generation direct and reciprocal crosses of triticale (\times *Triticosecale* Wittm.). *Agrarni Nauki*, 7(18), 25-34.
- Wojtkowiak, K., Stępień, A., Markowska, M. 2015. Effect of nitrogen fertilization method on the yield and quality of Milewo variety spring triticale grain. *Pol. J. Natur. Sc.*, Vol 30(2): 173–184.

GROWING POSSIBILITIES OF FORAGE RAPE WITH SOME ANNUAL CROPS

Zeki ACAR*, Suleyman ZEYBEK

Ondokuz Mayıs University, Agricultural Faculty, Department of Agronomy, Samsun, Turkey

*Corresponding author: zekiacar@omu.edu.tr

Abstract

In Turkey, there are more than 14 million livestock as Animal Units. But, meat and milk production of livestock is very low compared to European countries. Main reason is lack of forage production in high quality. Some farmers have to feed livestock with straw and chaff during winter period. On the other hand, generally warm season main crops such as; corn, cotton, sugar beet, sesame, soya bean, rice, tobacco are grown in fertile and irrigated coastal areas in summer period. If we put some annual, and high yielding forage crops in quality such as forage rape, oat, vetch, forage pea into crop rotation system, it would be possible to increase high quality forage production. In 2015, we started to carry out a project aimed to determine yield and the other traits of forage rape, common vetch, Hungarian vetch, forage pea and oat grown alone and forage rape binary mixtures with others during winter period. According to the first year results, plant height of forage rape and the other crops decreased in mixtures. While branch number of forage rape increased into the mixture with common and Hungarian vetch, it decreased in the other binary mixtures. Stem diameters of forage rape increased in binary mixtures with legumes. All binary mixtures gave higher hay yield than sown alone, except oat. While hay yield was 5.90 ton ha⁻¹ for sole forage rape, it increased to 9.44 ton ha⁻¹ for forage rape + oat binary mixture. The early results showed that forage rape was very promising crop for forage production during winter period in northern coastal areas of Anatolia.

Keywords: *forage rape, vetch, oat, forage pea, hay production*

Introduction

Intercropping includes the simultaneous growing of two or more species in the same area for a significant period of time, but without necessarily being sown and harvested together. Intercropping is a practice that is used in low-input cropping systems especially in the developing countries (Lithourgidis *et al.* 2011a; Dordas *et al.* 2012). Intercropping can provide numerous benefits to cropping systems through increasing total yield and land use efficiency (Dhima *et al.* 2007); improving yield stability of cropping systems (Lithourgidis *et al.* 2006); enhancing light, water, and nutrient use (Lithourgidis *et al.* 2007); improving soil conservation (Anil *et al.* 1998); and controlling weeds, insects, or diseases (Vasilakoglou and Dhimna, 2008). Moreover, intercropping can facilitate mechanical harvest, whereas legumes in mixtures with cereals can improve the quality of forage (Javanmard *et al.* 2009). In temperate climates, intercropping has been more successful when used for forage production than for grain production (Anil *et al.* 1998). However, intercropping of legumes with cereals have the disadvantages of including extra work in preparing and planting the seed and the lack of tolerance to herbicides of the mixed crops (Anil *et al.* 1998).

Generally, intercropping legumes with cereals increases protein yield compared with cereals alone (Carr *et al.* 2004). However, there are contradictory data about the productivity of intercropping systems. In particular, many studies reported that intercropping legumes with

cereals provided more efficient utilisation of the available resources and increased productivity compared with each sole crop (Hauggaard-Nielsen *et al.* 2001; Agegnehu *et al.* 2006). On the other hand, in some studies there was no significant effect on forage yield (Lithourgidis *et al.* 2007, 2011b), whereas in other studies intercrops yielded lower DM as compared with cereal monocrops (Caballero *et al.* 1995; Lithourgidis and Dordas 2010).

Brassica species have been used as forage for centuries (Altinok and Karakaya, 2003). The exploitable features of *Brassica* crops include: (i) abundant forage at a time when most warm and cool-season grasses are unproductive (Wiedenhoeft and Barton, 1994) and (ii) high yields of readily consumed energy and protein compared with cereals and perennial grasses (Kay, 1975). Most *Brassica* species are relatively low in dry matter content, although their total dry matter production per unit area is high relative to most cereals and forage grasses. Not only they are high yielding crops, but they also have good nutritional quality (Rao and Horn, 1986). Forage rape is a short season (fast-maturing) crop (Altinok and Karakaya, 2003).

The aim of this study was to determine yield and the other morphological and chemical traits of forage rape, common vetch, Hungarian vetch, forage pea and oat grown alone and forage rape binary mixtures with others during winter period.

Material and Methods

The study was carried out according to randomized complete block design with 4 replicates at the experimental area of Agricultural Faculty in Samsun, Turkey in 2015-2016 growing period (From October to April). In the study Lenox cultivar of forage rape, Özkayrak cultivar of forage pea, Tarım 98 cultivar of Hungarian vetch, Nilüfer cultivar of common vetch and Faikbey cultivar of oat was used. Monthly temperature and rainfall data from October 2015 to April 2016 of the experiment site were 17.5, 14.5, 8.5, 7.5, 11.3, 10.4, 13.8 °C and 72.3, 31.3, 100.0, 88.1, 18.1, 63.4, 49.9 mm, respectively. The soil of the experiment site was rich in terms of organic matter and potassium and poor for phosphorus. Seed bed preparation was performed in October. Before seeding, 150 kg ha⁻¹ DAP (27 kg N and 69 kg P₂O₅) was applied. The experimental plots consisted of 6 rows with 20 cm row spacing. At the mixture plots, forage rape and other species were sown in alternate rows. Experiment was established in October and harvested at the beginning of blossoming stage of forage rape at the end of April. Weeds were removed by hand pulling and hoeing when needed. No irrigation was applied. Forage samples taken from each plot were oven-dried at 60 °C and ground to pass through a 1 mm screen for chemical analysis. Crude protein, acid detergent fibre (ADF), neutral detergent fibre (NDF), Potassium (K), Magnesium (Mg), Calcium (Ca) and Phosphorus (P) contents of samples were determined by using near infrared reflectance spectroscopy (NIRS) with software program coded IC-0904FE. The data were subjected to analysis of variance (ANOVA) and, computation was performed by means of SPSS 10.0 V. (SPSS Inc., 1999). Means were separated using Least Significance Difference (LSD) test.

Results and Discussion

Significant ($P \leq 0.01$) differences amongst the treatments were figured out in terms of all investigated traits. The plant heights were found higher in forage pea and forage rape grown as sole crop. Plant height decreased in all species when they were grown in binary mixture (Table 1 and Figure 1). This reduce could probably be attributed to competition for light, water and plant nutrition inputs between different species. Plant height values of forage rape obtained from this study were about doubled compared to Altinok and Karakaya (2003) findings between 44 cm to 73 cm plant heights of forage rape sown in spring and summer in Ankara conditions. The reasons

of differences could probably be caused by cultivar effect and favourable climatic conditions in Samsun. Although there was no statistical difference, branch number of forage rape, forage pea and common vetch decreased in binary mixtures, while it increased for Hungarian vetch and oat (Table 1). Stem diameter of forage rape increased when it was grown in binary mixture with legume species. On the other hand, the same values for legume species decreased in binary mixture with forage rape. The highest stem diameter values were measured on forage rape compared to the other species (Table 1).

The highest hay yield was obtained from forage rape+forage pea, forage rape+oat and sole oat plots. In all binary mixture plots hay yield increased compared to their sole plots, except oat (Table 1 and Figure 2). Previous researchers indicated hay yield of forage pea as 2128 kg ha⁻¹ (Darby, 2011); as between 5527 and 11529 kg ha⁻¹ (Altinok and Karakaya, 2003). Generally mixtures had higher yields than monocrops (Dordas *et al.* 2012; Uzun and Asik, 2012). In consider botanical composition of binary mixtures, forage rape had significant dominancy to oat while Hungarian vetch and forage pea were dominant to forage rape (Table 1).

Table 1. Some morphological and agronomical traits of the plants grown as sole and as binary mixture*

Treatments**	Plant height (cm)	Branch number	Stem diameter (mm)	Hay yield (kg ha ⁻¹)	Botanical composition (%)
1. Forage rape (sole)	132.6 ab	3.50 ab	9.43 a	5900 bc	100
2. Rape +Hungarian vetch	121.5 bc	3.07 ab	10.07 a	7087 b	47.0 bc
3. Rape +Oat	122.3 bc	2.70 bc	8.23b	9238 a	58.0 a
4. Rape +Forage pea	123.6 bc	2.70 bc	9.76 a	9444 a	48.8 bc
5. Rape +Comman vetch	124.0 bc	3.70 ab	9.95 a	7087 b	50.8 b
6. Hungarian vetch (sole)	122.2 bc	4.30 a	3.44 cd	6093 bc	100.0
7. Hungarian vetch +rape	107.6 cd	4.42 a	3.37 cd		53.0 ab
8. Oat (sole)	103.5 cd	4.25 a	4.19 bc	9254 a	100,0
9. Oat +rape	94.8 d	4.40 a	4.00 cd		42.0 c
10. Forage pea (sole)	147.6 a	1.75 cd	5.10 c	5211 c	100.0
11. Pea +rape	120.8 bc	1.65 d	4.25 bc		51.2 ab
12. Comman vetch (sole)	120.2 bc	4.55 a	3.27 cd	5490 bc	100.0
13. Comman vetch +rape	97.2 d	4.35 a	3.10 d		49.2 b

*There is no significant ($P \leq 0.01$) difference amongst the numbers had the same letter at the same column.

**The numbers belongs to the plant written in bold.

There were significant ($P \leq 0.01$) differences amongst the treatments in terms of all investigated chemical traits (Table 1). ADF contents of treatments varied from 25.83% to 37.15%, while NDF values were between 64.87% and 33.59%. Evaluating the species grown as solely, the rank from the highest to the lowest was oat, forage pea, Hungarian vetch (ADF values of forage pea and Hungarian vetch very close to each other), common vetch and forage rape. Fibre (ADF and NDF) level of the species generally decreased, except common vetch and forage rape grown in the mixture with Hungarian vetch (Table 2 and Figure 3). ADF content of forage rape was reported as between 19.0% to 20.3% while NDF was 19.7-24.3% (Darby, 2011; Westwood and Mulcock,

2012; Luo *et al.* 2014). ADF and NDF levels of forage rape obtained from this study were higher than previous results. The reason was probably differences of cultivar, climatic conditions and agricultural practices.

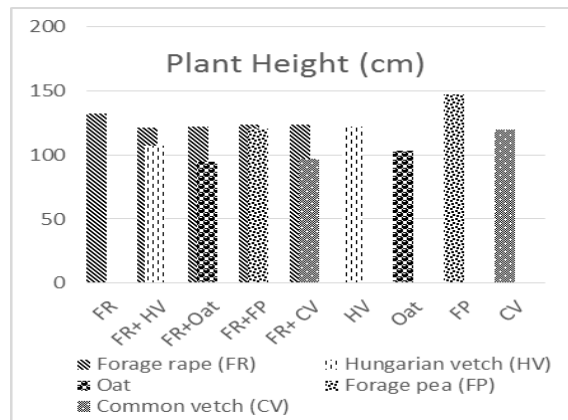

Figure 1. Plant height of treatments

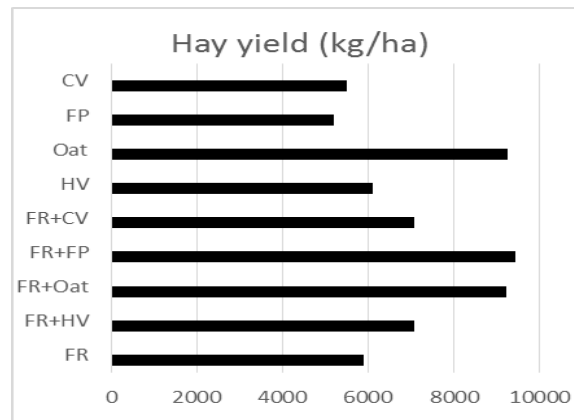

Figure 2. Hay yields obtained from the treatments

Table 2. Chemical traits of the plants grown as sole and as binary mixture*

Treatments**	ADF (%)	NDF (%)	Ca (%)	K (%)	Mg (%)	P (%)	Protein (%)
Forage rape (sole)	31.49 abcd	39.91 cde	1.44 abc	2.87 abc	0.29 abcd	0.39abc	20.81 bc
Rape +Hungarian vetch	32.26 abc	41.12 cd	1.41 abc	2.95 abc	0.29 bcd	0.38c	20.23 c
Rape +Oat	27.55 cd	36.13 de	1.47 ab	2.96 abc	0.33 a	0.42 ab	24.78 ab
Rape +Forage pea	30.94 abcd	38.79 cde	1.32 cd	3.15 a	0.29 abcd	0.41 abc	21.20 bc
Rape +Comman vetch	25.83 d	33.59 e	1.49 a	3.07 ab	0.32 ab	0.43 a	25.67 a
Hungarian vetch (sole)	34.91 ab	42.83 bcd	1.27 de	3.05 ab	0.29 bcd	0.42 abc	19.78c
Hungarian vetch +rape	30.24 bcd	40.66 cd	1.12 f	2.84 abc	0.27 cd	0.41 abc	19.26 c
Oat (sole)	37.15 a	64.87 a	0.46 g	2.62cd	0.12 e	0.39abc	10.42 d
Oat +rape	35.74 ab	62.27 a	0.44 g	2.65 cd	0.11 e	0.39 abc	9.85 d
Forage pea (sole)	34.17 ab	48.92 b	1.34 bcd	2.34 de	0.31 abc	0.38 bc	19.32 c
Pea +rape	29.91 bcd	45.27 bc	1.13 ef	2.24 e	0.27 d	0.38 c	17.42 c
Comman vetch (sole)	30.17 bcd	42.34 bcd	1.19 ef	2.77 bc	0.32 ab	0.39 abc	21.32 bc
Comman vetch +rape	31.59 abcd	41.22 cd	1.16 ef	2.87 abc	0.28 bcd	0.39 abc	19.50 c

*There is no significant ($P \leq 0.01$) difference amongst the numbers had the same letter at the same column.

**The numbers belongs to the plant written in bold.

In terms of Ca and Mg ratios, the lowest values were obtained from oat. Ca content of forage rape was higher than legume species used in this study. On the other hand, Ca level of legume species grown in mixture with forage rape decreased. Mg values determined for treatments were very close to each other, except oat. K ratios of treatments altered between 3.15% and 2.24%. K values

of forage rape increased grown in mixture with the other species. The lowest K levels were determined in the hay samples obtained from forage pea plots. Although there were significant ($P \leq 0.01$) differences amongst the treatments for P content, all values were very close to each other and it varied from 0.43% to 0.38%. Except forage pea and forage rape grown in mixture with Hungarian vetch, all treatments were in the same statistical group (Table 2). Crude protein proportions of the treatments altered between 25.67% and 17.42%. The highest values were recorded in forage rape grown in mixture with common vetch and oat. The lowest was determined in oat, as expected. Crude protein ratios of forage rape increased when it was grown in mixture with the others (except Hungarian vetch) while the same value decreased for others grown in mixture with forage rape (Table 2 and Figure 4). Previous researchers indicated crude protein ratio of forage rape as 19.4% (Luo *et al.* 2014), 20% (Darby, 2011), 10-28% (Altınok and Karakaya, 2003). The results obtained from this research similar to previous researchers' findings.

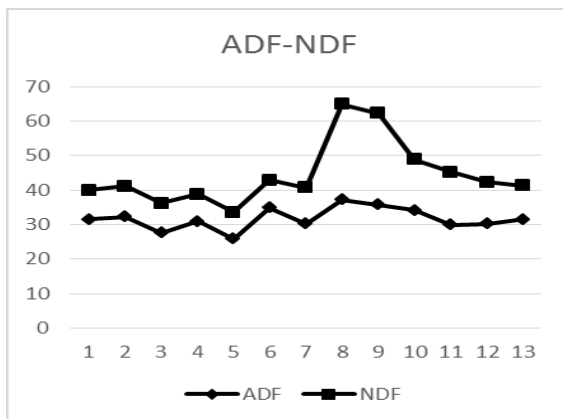

Figure 3. ADF and NDF contents of treatments

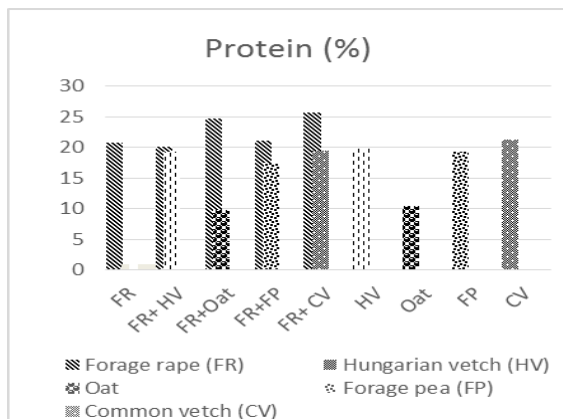

Figure 4. Crude protein contents of treatments

Conclusion

The results indicated that it could be possible to grow forage rape solely and in mixture with some other annual forage crops during the winter period in Samsun conditions. The hay yield of mixtures was higher than their solely treatments. Forage rape mixtures with forage pea and oat gave more than 9 t ha^{-1} highly nutritious and quality hay yield. The species involved in the mixtures increased both hay yield and crude protein ratio of forage rape.

Acknowledgement

Thanks to Ondokuz Mayıs University project Management Office because of financially support the Project (Grant No:PYO.ZRT.1904.15.016).

References

- Agegnehu, G., A. Ghizam and W. Sinebo, 2006. Yield performance and land-use efficiency of barley and faba bean mixed cropping in Ethiopian highlands. *Eur. J. Agron.* 25: 202-207
- Altınok, S. and A. Karakaya, 2002. Forage yield of different alfalfa cultivars under Ankara conditions. *Turkish Journal of Agriculture and Forestry.* Vol. 26, 1:11-16.

- Altinok S., Karakaya A. 2003. Effect of growth season on forage yields of different Brassica cultivars under Ankara conditions. *Turkish Journal of Agriculture and Forestry* 27,85-90.
- Anil, L., J. Park, R.H. Phipps, and F.A. Miller, 1998. Temperate intercropping of cereals for forage: A review of the potential for growth and utilization with particular reference to the UK. *Grass Forage Sci.* 53:301–317.
- Caballero, R., E.L. Goicoechea, and P.J. Hernaiz, 1995. Forage yields and quality of common vetch and oat sown at varying seeding ratios and seeding rates of vetch. *Field Crops Res.* 41:135–140.
- Carr PM, Horsley RD, Poland WW, 2004. Barley oat and cereal–pea mixtures as dryland forages in the northern great plains. *Agron J.* 96:677-684.
- Darby H. 2011. 2011 Forage Brassica Variety Trial. March 2011, University of Vermont Extension
- Dhima KV, Lithourgidis AS, Vasilakoglou IB, Dordas CA, 2007. Competition indices of common vetch and cereal intercrops in two seeding ratio. *Field Crops Res.* 100:249- 256.
- Dordas CA, Vlachostergios DN, Lithourgidis AS, 2012. Growth dynamics and argonomic-economic benefits of pea-oat and pea-barley intercrops. *Crop pasture Sci.* 63:45- 52.
- Hauggaard-Nielsen H, Ambus P, Jensen ES, 2001. Interspecific competition N use and interference with weeds in pea-barley intercropping. *Field Crops Res.* 70:101-109.
- Luo, J., X. Z. Sun, D. Pacheco, S. F. Ledgard, S. B. Lindsey, C. J. Hoogendoorn, B. Wise and N. L. Watkins, 2014. Nitrous oxide emission factors for urine and dung from sheep fed either fresh forage rape (*Brassica napus* L.) or fresh perennial ryegrass (*Lolium perenne* L.). *Animal* (2015), 9:3, pp 534–543. The Animal Consortium 2014. doi:10.1017/S1751731114002742
- Javanmard A., Nasab A.D.M., Javanshir A., Moghaddam M., Janmohammadi H., 2009. Forage yield and quality in intercropping of maize with different legumes as double cropped. *J. Food Agr. Environ.* 7:163-166.
- Karakaya, A and S. Altinok. 2003. Forage yield and quality of different turnip cultivars grown as main and second crop under Ankara conditions. *Turk J Field Crops.* (2): 67.
- Kay M., 1975. Root crops and Brassicae for beef production. *J Br Grassl Soc* 30, 85-86.
- Lithourgidis AS, Dhima KV, Vasilakoglou IB, Dordas CA, Yiakoulaki MD, 2007. Sustainable production of barley and wheat by intercropping common vetch. *A. Sustain D:* 27:95-99.
- Lithourgidis A.S., Dordas C.A. 2010. Forage yield, growth rate, and nitrogen uptake of faba bean intercrops with wheat, barley, and rye in three seeding ratios. *Crop Sci*50:2148-2158.
- Lithourgidis AS, Dordas CA, Damalas CA, Valchostergios DN, 2011a. Annual intercrops: an alternative pathway for sustainable agriculture. *Aust J Crop Sci.* 5:396-410.
- Lithourgidis AS, Valchostergios DN, Dordas CA, Damalas CA, 2011b. Dry matter yield, nitrogen content, and competition in pea-cereal intercropping systems. *Eur J Agron.* 34:287-294.
- Lithourgidis AS, Vasilakoglou IB, Dhima KV, Dordas CA, Yiakoulaki MD, 2006. Forage yield and quality of common vetch mixtures with oat and triticale in two seeding ratios. *Field Crops Res.* 99:106-113.
- Rao, S. C., F.P. Horn, 1986. Planting season and harvest date effects on dry matter production and nutritional value for Brassica ssp. in the southern great plain. *Agronomy Journal* 78:327-333.
- Uzun, A. and F.F. Asik. 2012. The effect of mixture rates and cutting stages on some yield and quality characters of pea (*Pisum sativum* L.) + oat (*Avena sativa* L.) mixture. *Turk J. Field Crops.* 17(1):62-66.

- Vasilakoglou I, Dhima K, 2008. Forage yield and competition indices of berseem clover intercropped with barley. *Agron J.* 100:1749-1756.
- Westwood, C. T., H. Mulcock. 2012 Nutritional evaluation of five species of forage brassica. *Proceedings of New Zealand Grassland Association* 74: 31-38.
- Wiedenhoef M.H., Barton B.A., 1994. Management and environment effects on *Brassica* forage quality. *Agron J* 86, 227-232.

THE EFFECT OF ORGANIC AND MINERAL FERTILIZATION IN DIFFERENT CROPPING SYSTEMS OF MAIZE

Milena SIMIĆ^{1*}, Vesna DRAGIČEVIĆ¹, Nebojša MOMIROVIĆ², Milan BRANKOV¹, Igor SPASOJEVIĆ¹

¹Maize Research Institute „Zemun Polje“, Belgrade, Serbia

²University of Belgrade, Faculty of Agriculture, Belgrade, Serbia

*Corresponding author: smilena@mrizp.rs

Abstract

Cropping systems of maize that are predominant in Serbia include continuous cropping, two crop rotation with winter wheat, and to a smaller extent, three crop rotation with winter wheat and soybean. The application of fertilizers, organic and mineral, is necessary in order to achieve higher yields. The typical sources of farmyard manure (FYM) are farms with the livestock production which are affected by present changes in agricultural owner's structure. Instead of FYM, soybean as a previous crop of maize, could play a role of a natural nitrogen soil supplier. The objective of the study was to evaluate the effects of the organic and mineral fertilizer application in different maize production systems on crop development and yield. The study was initiated in the experimental field of the Maize Research Institute Zemun Polje, Serbia in 2008/2009. The following production systems were evaluated: maize continuous cropping (MC), maize-winter wheat (MW), maize-soybean-winter wheat (MSW) and maize-winter wheat-soybean (MWS). In the autumn of 2008, cattle manure was applied in all production systems and in MC and MSW every third year, in MW each second year and, FYM was not applied in MWS rotation. Additionally, mineral fertilizers were applied in autumn and during early development stages of maize in spring in all cropping systems according to recommendation based on soil analysis. In 2015, after two completed three rotation cycles, the nitrogen content in the soil, leaf area, chlorophyll content, harvest index and the grain yield of maize were analysed. The highest chlorophyll content, harvest index and grain yield of maize were achieved in the rotation with winter wheat and when FYM was applied. Growing of maize in continuous cropping or without the application of organic fertilizers reduces grain yield.

Keywords: *Production system, maize, fertilisers, nitrogen, yield*

Introduction

Maize is the dominant crop in agricultural production in Serbia (Videnović *et al.*, 2013a). The predominant production systems of maize is continuous cropping, two crop rotation with winter wheat, and to a smaller extent, three crop rotation with winter wheat and soybean, (Videnović *et al.*, 2007). Rotation, as cropping system has many advantages, which are reflecting through better crop growth and yield (Videnović *et al.*, 2013b). Its combined application with other cropping measures (tillage, fertilization, sowing, cultivation, etc.) could facilitate maximal growth and photosynthesis efficiency (Spasojević *et al.*, 2014). Crop rotation, combined with application of herbicides or hoeing, had positive impact on maize yielding potential by increasing of leaf area index, chlorophyll and carotenoids content.

Results from the long-lasting study conducted in Zemun Polje, showed that grain yield of maize was the lowest in monoculture in 21 year average (6.75 t ha⁻¹), (Videnović *et al.*, 2007). Adiku *et*

al. (2009) state that the crop rotation and residue management practices can significantly affect maize performances. Studies carried out by Stranger and Lauer (2008) showed that extended rotations involving forage crops, reduce N inputs, increase maize yield and are more sustainable than short-terms rotations or monoculture. For the region of central Serbia, contemporary maize growing systems should include a correctly applied crop rotation with legumes (soybean), conventional tillage with deep autumn ploughing, precisely determined plant density and application of fertilisers in the content and formulation adjusted to the requirements of the cultivated plant (Simić *et al.*, 2016).

Application of fertilizers, organic and mineral, is necessary in order to achieve high, quality yields. The typical sources of farmyard manure (FYM) are farms with the livestock production. This type of agricultural economy is affected by present changes in the structure of land owner's. Instead of FYM, soybean as a previous crop of maize in three maize-winter wheat-soybean crop rotation, could play a role of a natural nitrogen soil supplier. It is known that each crop utilises nutrients from the soil to varying extent. Additionally, the composition and abundance of microbiota differ among various individual crops, which affect the scope of transformation of organic and mineral matters into forms available to plants. According to studies conducted in Zemun Polje, fertilizer application was the most effective in maize monoculture when yield has been increased for 0.76 t ha⁻¹ (12.4%) after the application of 160 kg N ha⁻¹, even though the chernozem as a naturally fertile soil does not require intensive fertilization (Videnović *et al.*, 2007).

The objective of the study was to evaluate the effects of the organic and mineral fertilizer application in different maize production systems on crop development and yield.

Material and Methods

The study was initiated in Maize Research Institute Zemun Polje, Serbia in 2008/2009 with the aim to evaluate effects of organic and mineral fertilizers application on maize growth and productivity in different production systems. The soil type at the experimental field is slightly calcareous chernozem with 53% sand, 30% silt, 17% clay; with good fertility and 3.3% of organic matter content and moderate drainage. The pH is 6.9 and soil structure is silty clay loam. The maize hybrid ZPSC 606 was grown in the following production systems: maize continuous cropping (MC), maize-winter wheat (MW), maize-soybean-winter wheat (MSW) and maize-winter wheat-soybean (MWS). In the autumn of 2008, FYM was applied in all production systems and in MC and MSW every third year, in MW each second year and, FYM was not applied in MWS rotation. Additionally, mineral fertilizers were applied in the autumn and during early phases of maize development in the spring (Table 1). The amounts of mineral fertilizers were determined by the soil analysis. For weed control, herbicides isoxaflutole + acetochlor at the recommended dose of 1536 g a.i. + 105 g a.i. were applied.

In 2015, after completed the second three rotation cycle, nitrogen content in the soil, leaf area, chlorophyll content, harvest index and grain yield of maize were analysed during crop vegetation period.

The nitrogen content in the soil was evaluated at the beginning of growing season, in the spring 2015, in order to crate recommendation for further fertilizer applications. Maize leaf area and chlorophyll content were measured at the end of anthesis phase by sampling of three plants. Leaf area was determined with LI – 3100 area meter (LICor, Lincoln, NE, USA) and chlorophyll content (chlorophyll A+B) was determined with 70% acetone extraction by the method of Sarić *et al.* (1990). The maize grain yield was measured from two inner rows of each subplot and

calculated to 14 % of moisture. The experimental data were statistically processed by analysis of the variance (ANOVA) and analysed by the LSD-test (5%).

Table 1. Application of cattle manure and mineral fertilizers in investigated production systems

Year	Fertilizer/Crop	MC	M-WW	M-S-WW	M-WW-S
2008	Farmyard manure	October, 14			
	NPK (600 kg ha ⁻¹)	October, 17			
2009		Maize	Maize	Maize	Maize
	AN (120 kg N ha ⁻¹) MAP (150 kg ha ⁻¹)	June, 4			
2010		Maize	Winter wheat	Soybean	Winter wheat
	Urea (120 kg N ha ⁻¹) Farmyard manure MAP (150 kg ha ⁻¹)	November, 11	April, 8 November, 11 November, 11	November, 11	November, 11
2011		Maize	Maize	Winter wheat	Soybean
	Urea (120 kg N ha ⁻¹) AN (120 kg N ha ⁻¹) Farmyard manure MAP (150 kg ha ⁻¹)	May, 30 October, 19 October, 28	May, 30 October, 28	March, 16 October, 19 October, 28	October, 28
2012		Maize	Winter wheat	Maize	Maize
	Urea (120 kg N ha ⁻¹) Farmyard manure MAP (150 kg ha ⁻¹)	June, 6 November, 2	March, 19 October, 31 November, 2	November, 2	November, 2
2013		Maize	Maize	Soybean	Winter wheat
	Urea (120 kg N ha ⁻¹) MAP (100 kg ha ⁻¹)	May, 29 October, 30	May, 29 October, 30	October, 30	March, 12 October, 30
2014		Maize	Winter wheat	Winter wheat	Soybean
	Urea (120 kg N ha ⁻¹) Farmyard manure MAP (100 kg ha ⁻¹)	November, 4 November, 14	March, 27 November, 4 November, 14	March, 27 November, 6 November, 14	November, 14
2015		Maize	Maize	Maize	Maize

Meteorological conditions

Meteorological conditions during investigated period were different, (Figure 1). Year 2012 was characterised by the highest average temperature achieved in July and August (27.1 °C and 26.6 °C, respectively). Moreover, the lowest precipitation amount, of only 4 mm was also obtained in August. Present conditions could affect grain filling, what could be also reflected on relative low values of grain yield.

The sum of precipitation was higher in 2009, 2010 and 2014 than in 2008, 2011, 2012 and 2013. The 2012 was extremely dry (June - 30.7 mm; August - 5.8 mm and September - 26.0 mm) and unfavourable for maize production. A dry spell during June-September period in 2012 year was especially important since it coincided with maize pollination and yield formation, Figure 1.

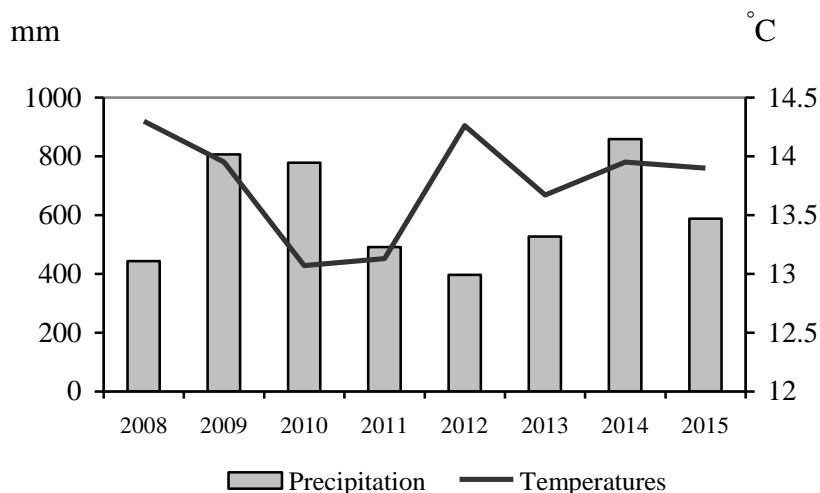

Figure 1. Meteorological conditions 2008-2015

Results and Discussion

Soil analysis showed that nitrogen content had the highest values in first soil layer of 0-30 cm in almost all cropping systems (Table 2). Totally, the highest amount of soil nitrogen was detected in MW rotation ($339.90 \text{ kg ha}^{-1}$), lower and similar values were in MC and MSW (192.86 and $197.80 \text{ kg ha}^{-1}$), while the lowest nitrogen content was in maize-winter wheat-soybean rotation ($159.72 \text{ kg ha}^{-1}$). This is in accordance with farmyard manure frequency of application. The nitrogen content in the soil in MWS cropping system was not lowered significantly in comparison to MSW and MC taking in account the fact that cattle manure was not applied in MWS rotation. Nitrogen content in the first soil layer in this cropping system was even higher than in MC and MSW but in the deepest soil layer (60-90 cm) it was especially low in comparison to other rotations (19.99 kg ha^{-1}). This shows us that growing of soybean in rotation and as preceding crop of maize, can help in soil nitrogen supplying and even could replace application of organic fertilizers as nitrogen source up to the certain level. Additionally, intensive application of organic fertilizer, such FYM, is very important for soil fertility.

Table 2. Nitrogen content (kg ha^{-1}) in the soil of investigated cropping systems, spring 2015

Soil layer	MC	MW	MSW	MWS	Average
0-30	91.85	131.76	56.57	114.33	98.63
30-60	61.82	87.31	50.02	25.40	56.14
60-90	39.19	120.83	91.21	19.99	67.80
Total	192.86	339.90	197.80	159.72	222.57

The chlorophyll content in maize leaves and leaf area had highest values in MW rotation, (Figure 2). Chlorophyll content had almost equal values in both three crop rotations, while its content was the lowest in maize continuous cropping (44.2 SPAD units). Leaf area index, was also the lowest in maize continuous cropping ($13385.2 \text{ cm}^2 \text{ m}^{-2}$) and had the similar value in MW and MSW. In MWS rotation, chlorophyll content and leaf area were higher than in MC, even though fertilizers were not applied in MWS since the beginning of the production. This implicates that organic and mineral fertilizer application, as very important measure for maize production, and could be effective only in combined application with crop rotation especially with those involving legumes as natural nitrogen suppliers (Vári and Pepó, 2014). Leaf area index and relative chlorophyll content have primary roles in the yield forecast of maize in the early season (Vári and Pepó,

2014). Different levels of fertilization and crop rotation have a considerable impact on the maximum values of the leaf area, chlorophyll content and yields of maize.

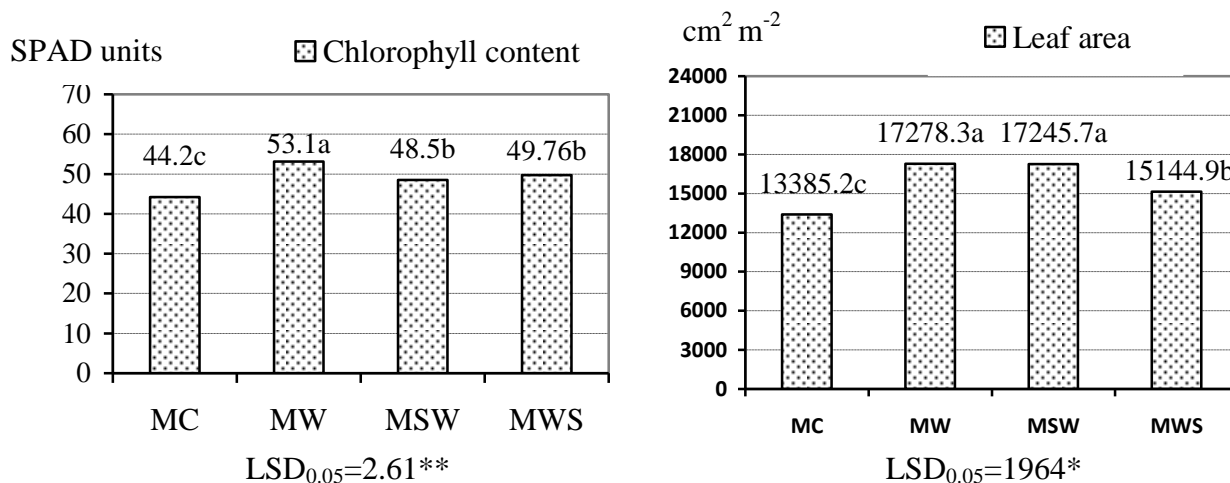

Figure 2. Chlorophyll content and leaf area of maize leaves in dependence of crop production system

Parallel with leaf area and chlorophyll content variations, harvest index and grain yield of maize have been changed within different cropping systems, (Figure 3). Differences in harvest index of maize were not significant between investigated crop rotations, but maize grain yield was noticeable highest in MW rotation. Regimes of mineral and organic fertilizer application, have increased maize grain yield by 30.66% in MW rotation, 20.58% in MSW and 18.10% in MWS in comparison to MC (5.79 t ha⁻¹).

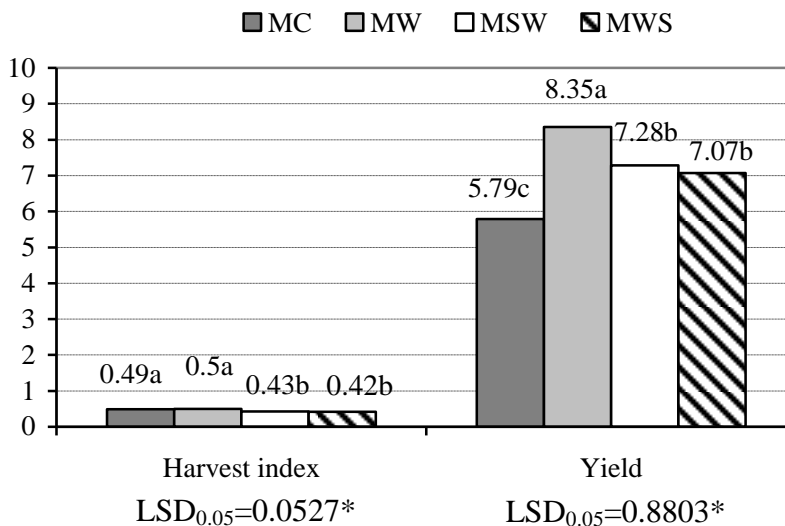

Figure 3. Harvest index and grain yield of maize (t ha⁻¹) in dependence of crop production system

The highest average maize yield (8.35 t ha⁻¹) was achieved with application of cattle manure and N fertiliser at the beginning of growing period when maize was grown in MW rotation. Nevertheless of the late maturing hybrid potential and high level of fertilizer application in the

maize monoculture, the highest yield did not reach more than 5.79 t ha⁻¹. This underlined the importance of all cropping practices and their integrated effects on maize production. In similar investigation conducted in Zemun Polje, the average maize yield was higher by 11.4 % in soybean–maize rotation, despite the amount of applied nitrogen fertiliser being reduced by 50 % (Videnović *et al.*, 2013b). Average maize yields were not the highest in the treatment with the highest amount of fertilisers. It means that the application of greater rates of mineral fertilisers under the Zemun Polje conditions on chernozem soil is not economically justified (Videnović *et al.*, 2007).

Conclusion

The values of all measured parameters were the highest in MW rotation which shows that old and the most present cropping system, based on old type of farm ownership and organisation, has advantage in maize production. But, in present time, with new system of farming land organization, crop rotation with legumes as nitrogen source, could be a good substituent and certainly takes advantage over maize monoculture.

Acknowledgements

This study was supported by the Ministry of Education, Science and Technological Development of the Republic of Serbia.

References

- Alvarez, R., Grigera, S. (2005): Analysis of Soil Fertility and Management Effects on Yields of Wheat and Corn in the Rolling Pampa of Argentina. *Journal of Agronomy and Crop Science*, 191,5, 321-329.
- Jovanović, Ž., M. Vesković, P. Jovin, D. Kovačević (2004): Effect of Different Growing Systems on Maize Yield According to The Concept of Sustainable Agriculture. *Proceedings of the VIIIth ESA Congress, Copenhagen, Denmark*, 611-612.
- Kovačević, D. (2010): *Crop Science*. 1. ed. Faculty of Agriculture, Belgrade, Serbia, 771p. (In Serbian)
- Sarić, M.R., Kastori, R.R., Petrović, M., Stanković, Ž., Krstić, B.Đ. and Petrović, N.M. (1990): *Practical course of plant physiology*. Naučna knjiga, Belgrade, Serbia. (In Serbian)
- Simić M., Dragičević V., Kresović B., Videnović Ž., Dumanović Z. (2016): Advanced cropping technology of maize (*Zea mays* L.) in Serbia. *Agriculture&Forestry*, 62(1): 227-240.
- Spasojević I., Dragičević V., Simić M., Kovačević D., Brankov M. (2014): Effects of different cropping systems and weed management methods on free energy and content of pigments in maize. *Pesticides&Phytomedicine (Belgrade)*, 29 (1): 45-54.
- Stranger, F.T., G.J. Lauer, 2008. Corn grain yield response to crop rotation and nitrogen over 35 years. *Agronomy Journal*, 100: 643-650.
- Todorović J., Božić D. (1995): *Crop Science*. Faculty of Agriculture Banja Luka, Faculty of Agriculture, Belgrade, 395p. (In Serbian)
- Vári E., Pepó P. (2014): The study of changes in the assimilation surface, relative chlorophyll content and maize yield with different agrotechnical factors. *In: Sustainable Irrigation and Drainage, V Management, Technologies and Policies* (ed.) C.A. Brebbia & H. Bjornlund. WIT Press, UK, 143-154.
- Videnović, Ž., Ž. Jovanović, G. Cvijanović, L. Stefanović, M. Simić, 2007. The contribution of science to the development of contemporary maize growing practices in Serbia. *In: Science as sustainable development background. Maize Research Institute „Zemun Polje“*, Belgrade, Serbia, 267 – 285. (In Serbian)

- Videnović Ž., Dumanović Z., Simić M., Srdić J., Babić M., Dragičević V. (2013a): Genetic potential and maize production in Serbia. *Genetika*, Vol. 45(3), 667-678. ISSN 0354-0012
- Videnović Ž., Jovanović Ž., Dumanović Z., Simić M., Srdić J., Dragičević V., Spasojević I. (2013b): Effect of long term crop rotation and fertilizer application on maize productivity. *Turkish Journal of Field Crops*, Vol. 18 (2), 233-237. ISSN 1301-1111

INFLUENCE OF RACHIS POSITION ON PHYSICAL AND COMPOSITIONAL PARAMETERS OF CABERNET SAUVIGNON BERRIES

Tatjana JOVANOVIĆ-CVETKOVIĆ*, Rada GRBIĆ, Borut BOSANČIĆ, Nemanja MIŠIĆ

University of Banjaluka, Faculty of Agriculture, Republic of Srpska, Bosnia and Herzegovina

*Corresponding author: tatjana.j.cvetkovic@agrofabl.org

Abstract

The purpose of this investigation was to determine the characteristics of Cabernet Sauvignon/Kober 5BB berries according to the position of the rachis (bunch). The berries from 5 bunches (a total of 871 berries) were divided according to the position on the rachis (top, middle and bottom) and weight of berries (two classes of weight: 1) less than or equals 1g and 2) between 1.01 and 1.50 g). Each of the berries was used to evaluate physical characteristics (fresh berry weight, fresh weight of skin, seeds and flesh and seed number). Soluble solids content and total titratable acidity was measured on must obtained by crushing berries, taking into account the rachis position. Data analysis of berry percentage distribution showed that there was a difference between each weight category and position. From the top to the bottom rachis position, a decrease in percentage of berry number occurred. With regard to physical characteristics, the analysis of the results indicated a highly significant difference in berry weight between the measured classes and a significant difference between the positions. The analysis of skin, seed weight and seed number also indicated that there was a highly significant difference among the two classes of berry weight. Concerning the compositional parameters, the highest content of soluble solids and total titratable acidity were found in the bottom part of the bunch. Berry variability is a factor influencing the yield and quality of grape and wine. Generally, it is difficult to obtain a uniform size of berries under field conditions.

Key words: *Cabernet Sauvignon, berry position, berry weight, berry composition*

Introduction

Variations are a constituent part of all biological systems, and vineyards do not represent an exception what so ever. According to the quotations of Gray (2002), a variation in vineyard is present in more levels and evident among berries, bunches and vines. The same author claims that two components have the biggest significance in differences among berries: the size of a berry and the content of a berry. Variations in the size of a berry reflect on the yield and the quality, while variations in the content of a berry have influence on the taste and the quality of wine. Variations of physical and chemical characteristics among the berries on a bunch of grapes aren't usually taken seriously by many vine growers and wine producers (Pisciotta et al. 2013). Tarter and Keuter (2005) claim that the use of "traditional technique" of estimation ⁰Brix in grapes, where the condition in the whole vineyard is based on one sample, isn't the best solution. According to these authors, the way of taking samples could be significantly improved if it would be clearly understood which berries in the bunch have ⁰Brix that corresponds of ⁰Brix in the whole bunch. The variation of a berry characteristics in a bunch is under the influence of production, among which irrigation has an important influence (Roby and Mathews 2004; Ferrer et al., 2014) as well as applied pruning (Holt et al., 2008). Mathews and Nuzo (2007) claim that the viticultural practices applied in vineyard (irrigation, pruning, thinning) in the purpose of yield

control can have much bigger significance in the defining of the quality of grapes and wine than yield or characteristics of berries. Berries in a bunch of grapes have different characteristics depending on their position, which has the influence on the grape quality and wine production (Melo et al. 2015).

The aim of this paper represents the Cabernet Sauvignon variety berries' characteristics analysis depending on their position in a bunch.

Material and Methods

Vitis vinifera L. cv. Cabernet Sauvignon grafted onto Kober 5BB samples were obtained from a seven year old vineyard, located in Banja Luka city area, in the *northwestern region* of Bosnia and Herzegovina. Rows were oriented North-South. *The vines were trained* on trellising systems Double Guyot. One typical bunch per vine was selected from five vines according to similar appearance and stored at about 20°C *before processing*. *The total* of 871 berries was sorted according to the position on the rachis by dividing the total rachis axis into thirds (top, middle and bottom) including berries on the wings. After that all the berries were separated from the pedicel, counted, weighed and divided into two classes according to the berry weight: 1) less than or equal to 1 g and 2) between 1.01 and 1.50g. Each of the berries was used to evaluate other physical characteristics: weight of fresh skin, seed, flesh (g) and seed number. The content of soluble solids (Brix %) and titratable acidity (g/l tartaric acid) were analysed in the fresh must by means of standard method immediately after crushing the berries of every subgroup according to the position on the rachis. The berry percentage distribution for each weight class and position as well as the relative proportion of each part of the berry (flesh, skins and seeds) were calculated.

Statistical analysis

Data was analyzed through general linear models with significant difference established at $p < 0.05$ level. Statistical analyses and graphical visualizations were made in R (R Core Team, 2016) and IBM SPSS Statistics 22 (IBM 2013).

Results and Discussion

The results of the berry percentage distribution for each position and weight class showed that the top part of the rachis had the most berries (41.23%), followed by middle (36.51%) and bottom part (22.26 %) (Table 1).

Table 1. The percentage of berry number for each position and weight class (based on total berries, n = 871)

Class of berry weight	1	2	Total
	≤ 1 g	1.01-1.50 g	
Rachis position	% of berry number	% of berry number	%
Top	21.00	20.23	41.23
Middle	18.53	17.98	36.51
Bottom	13.44	8.82	22.26
Sum	52.97	47.03	100.00

The results match those of Piscciota et al. (2013) and confirm the role of wings in determining the number of berries in some parts of the bunch. Also, different percentage distributions were found for each class of berry weight. Class 1 had higher percentage of berry number per position than class 2, consequently in the entire sample (52.97 % and 47.03%, respectively).

According to the results of relative proportion of skin, seed and flesh (Table 2), a different percentage distribution was found for each position and weight class. Approximately, participation of skin, seed and flesh in the fresh weight of the berry was (26%, 5% and 69%) along the rachis.

The found values of proportion of seed were similar to those reported by Roby et al. (2004).

Table 2. The relative proportion (%) of skin, seed and flesh for each position and weight class (based on total berries, n = 871)

Class of berry weight	1			2			Mean		
	≤ 1 g			1.01-1.50 g					
Rachis position	skin %	seeds %	flesh %	skin %	seeds %	flesh %	skin %	seeds %	flesh %
Top	25.16	4.80	70.04	25.13	5.59	69.28	25.15	5.20	69.66
Middle	27.34	4.78	67.88	23.89	5.28	70.83	25.61	5.03	69.36
Bottom	26.26	5.81	67.93	25.16	6.03	68.81	25.71	5.92	68.37
Mean	26.25	5.13	68.88	24.93	5.63	69.64	25.49	5.38	69.13

Berry characteristics

The analysis of berry mass has indicated that there was statistically highly significant difference in mass between the measured classes of berries and significant difference between the positions (Table 3, Figure 1).

Table 3. Berry characteristics in the two weight classes as a function of position on the rachis

Position	Class	Berry mass (g)			Flesh mass (g)			Skin mass (g)			Seed No.			Seed mass (g)		
		mean	±	sd	mean	±	sd	mean	±	sd	mean	±	sd	mean	±	sd
Top	1	0.81	±	0.13	0.57	±	0.11	0.2	±	0.05	1.15	±	0.39	0.04	±	0.01
	2	1.23	±	0.15	0.85	±	0.15	0.31	±	0.07	1.84	±	0.59	0.07	±	0.04
Middle	1	0.78	±	0.15	0.53	±	0.11	0.21	±	0.06	1.08	±	0.29	0.04	±	0.01
	2	1.22	±	0.13	0.87	±	0.11	0.29	±	0.06	1.83	±	0.57	0.06	±	0.02
Bottom	1	0.76	±	0.14	0.52	±	0.12	0.2	±	0.05	1.18	±	0.39	0.04	±	0.03
	2	1.19	±	0.15	0.82	±	0.14	0.3	±	0.07	2.03	±	0.61	0.07	±	0.02
F _{position}		4.72*			5.51**			0.64			5.36**			3.52*		
F _{class}		1518**			1019**			454**			473**			213**		
F _{interaction}		0.46			3.48*			4.61*			1.38			0.33		

(**) and (*) indicates statistically significant (p<0.05*) or highly significant (p<0.01**) difference

The mass of the berries of class 2 is higher than the mass of the berries of class 1. From the top to the bottom rachis position there was a decrease in berry mass but there was no significant difference between the middle and top position.

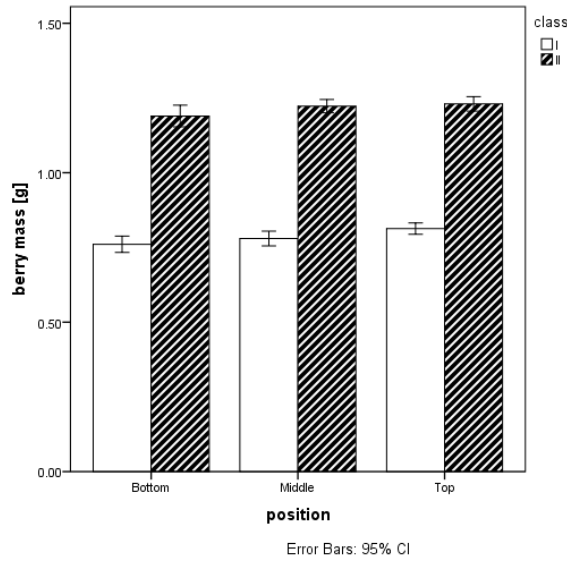

Figure 1. Berry mass (g) of a single berry in the two weight classes as a function of position on the rachis (vertical bars represent standard errors)

The analysis in terms of flesh mass showed a statistically significant influence of interaction between berry position and class on the flesh mass (Table 3, Figure 2). Top position in class 1 differs significantly from bottom and middle positions, between which there was no significant difference. In class 2 bottom position had significantly smaller flesh mass in comparison to middle and top positions, between which there was no statistically significant difference.

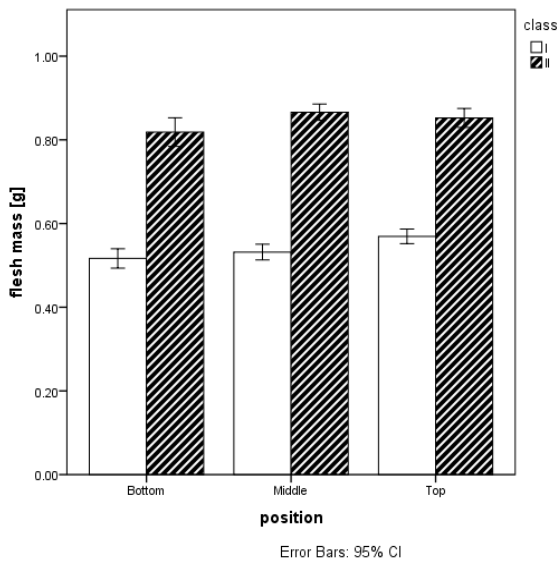

Figure 2. Average flesh mass (g) of a single berry in the two weight classes as function of position on the rachis (vertical bars represent standard errors)

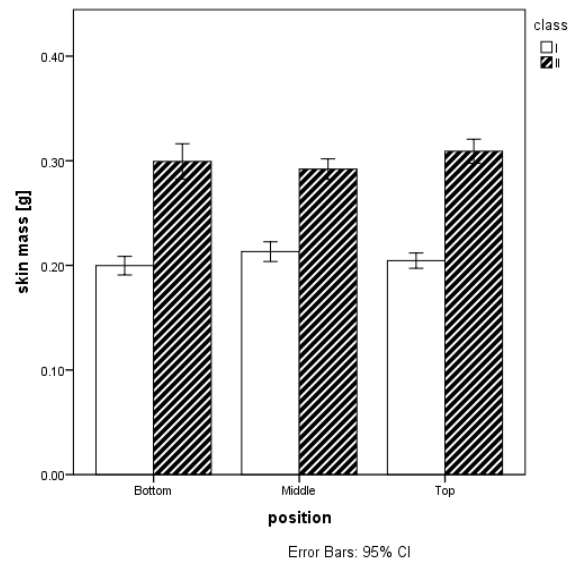

Figure 3. Average skin mass (g) of a single berry in the two weight classes as a function of position on the rachis (vertical bars represent standard errors)

Regarding the skin mass the analysis indicated that there was a significant interaction between positions and classes (Table 3, Figure 3). In class 2 there was statistically significant difference between top and middle position.

In seed number there was a highly significant influence of both position and class (Table 3, Figure 4). The berries of class 2 had more seed than the berries of class 1 and berries from the bottom part of the bunch had more seed than the other two parts.

Seed mass showed significant differences depending on the position and weight class. The results indicated that there was a significant influence of position and highly significant influence of class on seed mass (Table 3, Figure 5). In class 2 berries had bigger seed mass than the berries in class 1. Bottom position had bigger seed mass than the other two analysed positions.

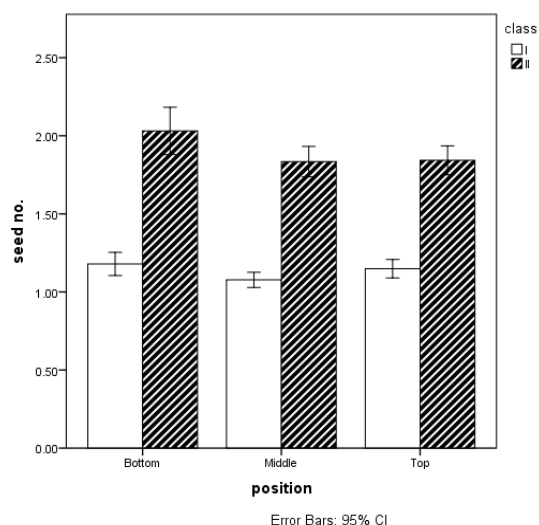

Figure 4. Average seed number of a single berry in two weight classes as a function of position on the rachis (vertical bars represent standard errors)

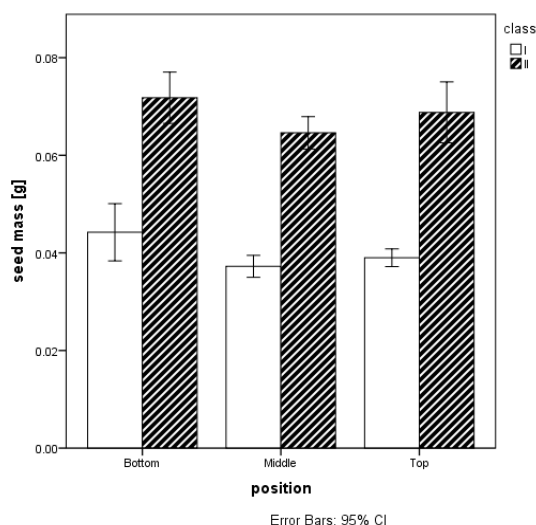

Figure 5. Average seed mass of a single berry in two weight classes as a function of position on the rachis (vertical bars represent standard errors)

Berry must analysis

The analysis of soluble solids content indicated that there was a highly significant influence of the position on the soluble solids content (Brix %) (Table 4, Figure 6).

Table 4. Soluble solids (Brix %) and total titratable acidity (TTA) at different position on the rachis

Position	Brix (%)		TTA (g/l tartaric acid)	
	mean	± sd	mean	± sd
Top	22.08	± 0.77	7.16	± 1.01
Middle	21.70	± 1.16	7.71	± 0.41
Bottom	22.89	± 0.59	8.22	± 0.74
F_{position}	6.93*		5.38*	

(*) indicate statistically significant ($p < 0.05$) difference

Tarter and Keuter (2005) had also indicated that there are differences in the content of soluble solids at Cabernet Sauvignon variety, depending on the position along the bunch. In this study, the berries from the bottom part of the bunch had significantly ($p < 0.05$) higher soluble solids content in comparison to berries from the middle and top part, which differs from the results reported by Kasimatis et al. (1975) and Pisciotta et al. (2013).

The analysis of total titratable acidity (g/l tartaric acid) showed that there was statistically significant difference between different positions on the rachis (Table 4, Figure 7). There was a tendency of significant total titratable acidity decrease ($p=0.04$) from the bottom to the top position.

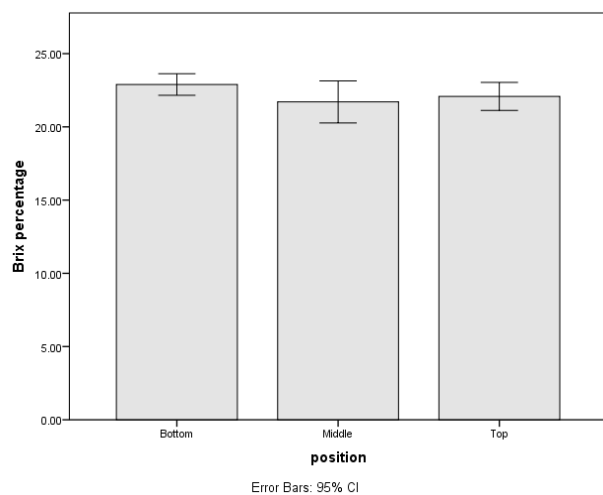

Figure 6. Average soluble solids content of berries (Brix %) at different position on the rachis (vertical bars represent standard errors)

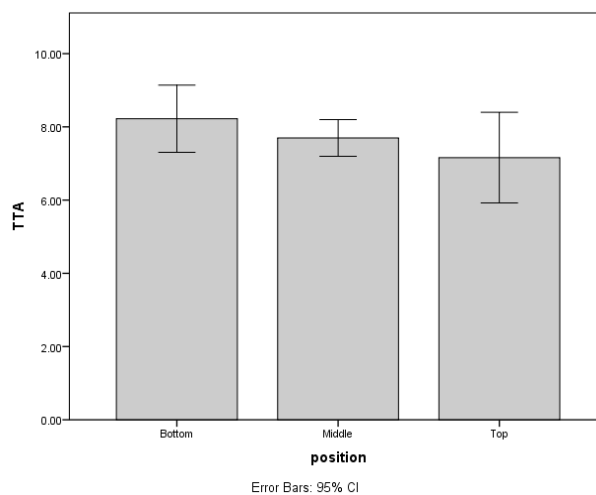

Figure 7. Average total titratable acidity of berries at different position on the rachis (vertical bars represent standard errors)

Conclusions

The analysis results showed that berries on the analysed parts of the rachis (top, middle, bottom) differed both regarding specific physical and chemical characteristics. Division of berries into two classes considering mass, clearly indicates existence of inequality of berries on the entire bunch. Since the appearance of inequality of the berries and bunch, considering size, reflects on yield and the quality of grapes and wine, all further researches of causes and consequences of the phenomenon mentioned above are of multiple significance.

References

- Ferrer M., Echeverría G., Carbonneau A. (2014). Effect of Berry Weight and its Components on the Contents of Sugars and Anthocyanins of Three Varieties of *Vitis vinifera L.* under Different Water Supply Conditions. *S. Afr. J. Enol. Vitic.*, Vol. 35, No. 1, pp.103-113.
- Gray, J.D. (2002). The basis of variation in the size and composition of Shiraz berries. *ASVO PROCEEDINGS • Finishing the job – optimal ripening of Cabernet Sauvignon and Shiraz*, pp. 30-35.
- Holt, H.E., Field, J., Francis, I.L. (2008). Relationships between berry size, berry phenolic composition and wine quality scores for Cabernet Sauvignon (*Vitis vinifera L.*) from different pruning treatments and different vintages. Summary, *Australian Journal of Grape and Wine Research*, Vol. 14., No. 3. pp.191.
- Kasimatis A.N., Vilas E.P., Swanson F. H., Baranek P.P. (1975). A Study of the Variability of 'Thompson Seedless' Berries for Soluble Solids and Weight. Abstract, *American Journal of Enology and Viticulture* January 1975 26: 37-42; published ahead of print January 01, 1975

- Melo M.S., Schultz1 H.R., Volschenk C.G., Hunter J.J. (2015). Berry Size Variation of *Vitis vinifera* L. cv. Syrah: Morphological Dimensions, Berry Composition and Wine Quality. S. Afr. J. Enol. Vitic., Vol. 36, No. 1, pp. 1-10.
- Matthews M.A., Nuzzo V. (2007). Berry Size and Yield Paradigms on Grapes and Wines Quality. Proc. Intl. WS on Grapevine, Eds. V. Nuzzo et al., Acta Hort. 754, ISHS 2007, pp. 423-435.
- Pisciotta A., Lorenzo di R., Barbagallo M.G., Hunter J.J (2013). S. Afr. J. Enol. Vitic., Vol. 34, No. 1, pp. 100-107.
- Roby G., Matthews A.M. (2004). Relative proportions of seed, skin and flesh, in ripe berries from Cabernet Sauvignon grapevines grown in a vineyard either well irrigated or under water deficit. Australian Journal of Grape and Wine Research 10, pp. 74–82.
- Tarter M., Keuter S. (2005). Effect of rachis position on size and maturity of Cabernet Sauvignon berries. Summary 107, American Journal of Enology and Viticulture, 56(1), pp. 86- 89.

DETERMING THE POPULATION DYNAMICS INFESTATION OF TUTA ABSOLUTA MEYRICK (LEPIDOPTERA: GELECHIDAE) BY DIFFERENT TRAPS ON TOMATO IN AYDIN PROVINCE, TURKEY

Muammer DEMIROZ, Ibrahim GENCSOYLU^{1*}

¹Department of Plant Protection, Faculty of Agriculture, Adnan Menderes University, Aydin Turkey

*Corresponding author: igencsoylu@adu.edu.tr

Abstract

The aim of paper was to investigate the population dynamics and infestation of *Tuta absoluta* (Meyrick) by using different traps on tomato field of glasshouse in 2010-2011 in Aydin province, Turkey. The study was conducted at the two growing seasons (Fall and Spring). Three different types of trap (Delta pheromone trap, pheromone+water pan and light trap) were used to evaluate the population dynamics during the experiment. At the end of the study, the highest population of *T. absoluta* was captured with 350 adult/trap in the pheromone+water pan trap in fall season and followed by 95 adult/trap in delta pheromone trap and 23 adult/trap in the light trap. After this time, the population decreased and continued at low amount (no more than 50 adult) in fall season. In spring season, the highest population was observed on two different sampling times. Pheromone+water pan trap captured 33 adults/trap and delta type pheromone trapped zero on 9 March 2011. On the other way, 40 adults/trap was captured in the pheromone+water pan and 18 adult/trap in delta pheromone trap on 14th May 2011. In contrast, the light trap was not efficient and not useful due to catching bees in the glasshouse. Infestation rate on leaves caused by the *T. absoluta* varied %10-66.7 and %5-100 in fall and spring season. On the other hand, the damage rate on the fruit varied %6.7-46.7 and %10-63 in fall and spring season. It is concluded that *T. absoluta* is major economically important pests, had four peaks for each season and gives 7-8 generations in both spring and fall tomato-growing seasons in the glasshouse. Pheromone+water pan trap with olive oil was 2.2-3.6 times more effective than the pheromone trap and 15 times more than the light trap. Therefore, it is more useful in management program against *T. absoluta*.

Keywords: *Tuta absoluta*, tomato, traps, Aydin province in Turkey

Introduction

Tomato is one of the most important vegetables in Aegean, Mediterranean and Marmara region in Turkey. The country is the fourth place on production with 12.516.000 ton after China, India and United States (Anonymous, 2016) and it is produced for fresh consumption under both greenhouse and open field areas in Turkey. There are many pests in tomato field. The tomato moth, *Tuta absoluta* Meyrick, is considered to be one of the most pests causing the damage in tomato fields. It was first recorded in Peru and widespread through South Africa in early 1900s and then has spread to Europa, Africa and Middle East countries (Van Der Straten et al., 2011; Tropea-Garzia et al., 2012) and finally recorded in Turkey (Kılıç, 2010). It has spread rapidly through Southern part (Mamay and Yanık 2012; Bayram et al., 2014) Meditteranean (Erler et al., 2010; Portakaldalı et al., 2012), Eastern (Marmara (Pehlavan and Kovancı, 2013; Çetin et al., 2014; Canbay et al., 2014) and Center Anatolia part of Turkey (Erdoğan et al., 2014).

The larva of *T. absoluta* can damage the plant and mine the leaves and produce large galleries. It overwinters eggs, pupae or adult and gives 10-12 generation. It is known as the most devastating

tomato pest and cause as much as 100% lost of production (Haji et al., 1995). Oztemiz (2013) mentioned that the tomato production decreased with the entry of the pest and the country economy lost 45 million euro due to the damage and caused 100% yield losses in greenhouse and open-field tomato. She also reported that 13 times pesticides were applied and chemical application is limited due to insect's nature of damage in the country.

In order to reduce the excessive use of insecticide various control measures should be applied against the pest due to more generations per year. One of the control technique was pheromone traps (Kılıç, 2010; Tropea-Garzia et al.).

The aim of the study was to evaluate the effect of various traps and infestation rate on plant part in glasshouse in both spring and fall season.

Material and method

The study was conducted in three greenhouses of 800-1300 m² surface. The experiment was located at Kozalaklı Village far from Aydın-Center about 19 km. The tomato was planted on 3rd September 2010 and 20th January 2011. All cultural practices were conducted in according to farmer practices. Insecticides were not applied, but fungicides were conducted.

Three monitoring methods (Pheromone, pheromone+water pan and light trap) were applied to determine the population dynamics of *T. absoluta*. Pheromone traps was placed with 1, 5m above the ground level on 9 September 2010 whereas the pheromone+water pan and light were placed 0 45 cm above the ground level at the same day. The pheromone+water pan consist of pan (9 liter) with water and added olive oil. The pheromone connected with the iron wire into the pan. The traps were monitored weekly by the end of the harvest. The capsules changed monthly whereas the sticky part was replaced weekly. The light traps were removed in spring season due to affect the bees in the greenhouse.

The sampling of infestation rate on the leaves and fruits were observed weekly. 60 leaves and all fruits were visually checked for each greenhouse. It started on 16 October 2010, 29 January 2011 and finished 15 January 2011 and 14 May 2011 for fall and spring season.

Results and Discussion

Seasonal flight activity of *T. absoluta* at different traps in fall season was shown in Figure 1. The first moth was captured on 16 October 2010 in pheromone trap and light trap.

The highest population was captured with 348 adults/trap in pheromone+water pan trap. After the two sampling date the population decreased. It is shown that it had four peaks in spring season. The first peak was noted with 90 adults/trap on 23. 10.2010 in pheromone trap, 348 adults/trap in pheromone+water pan trap and 25 adults/traps in light trap. The second peak was noted with 17, 26 and 24 adults on 4.12.2010 in the traps. The third was noted with 18, 26, and 25 adults on 1.1.2011 and the fourth peak was 10, 16,18 adults on 15.1.2011. in spring season. The flight activity was not observed by 26.2.2011 then increased with low amount. The adult in pheromone+water pan was observed earlier compared with pheromone trap. Four peaks were also recorded during the season. The first peak was observed on 12.2.2011 with 15 adults in pheromone+water pan trap and the second on 19.3.2011 with 33 adult, third on 16.4.2011 with 25 adult and the fourth on 14.5.2011 with 40 adults/trap (Figure 2). Light trap was not used due to catching the bees in the greenhouse

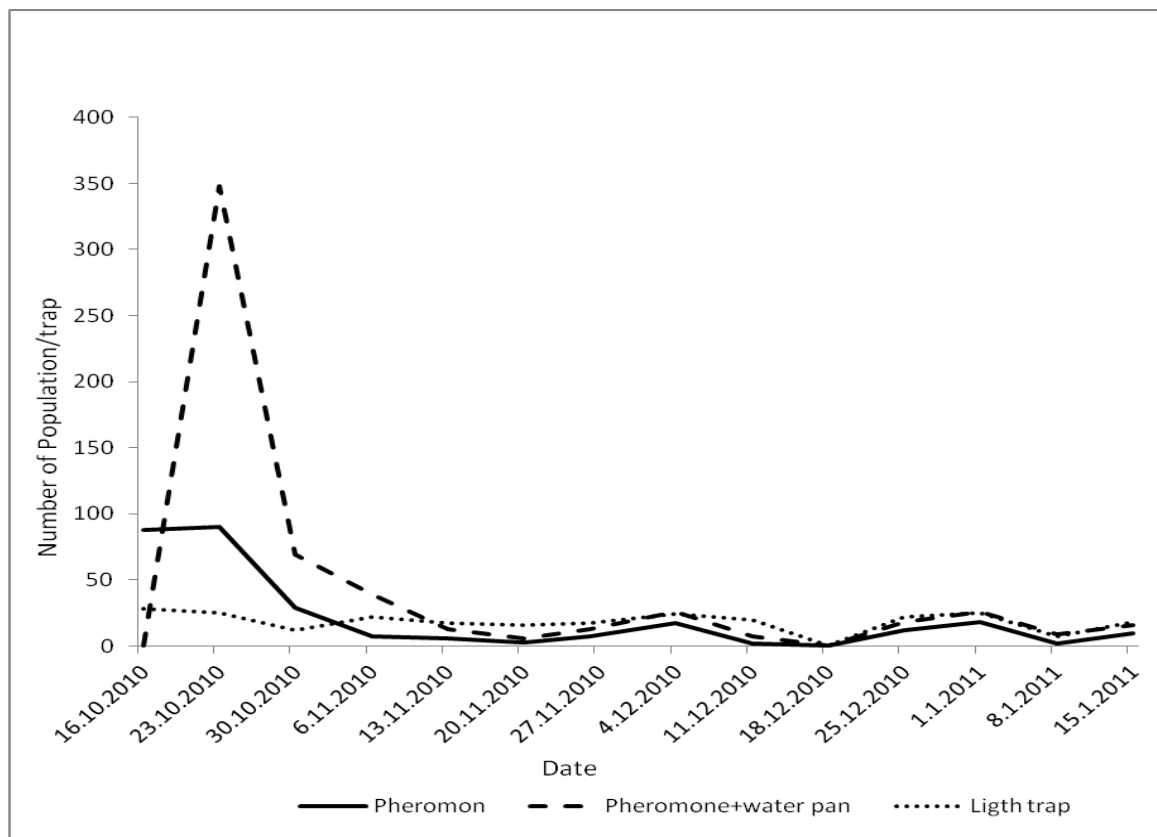

Figure 1. Fluctuation of *Tuta absoluta* at different traps during the fall season.

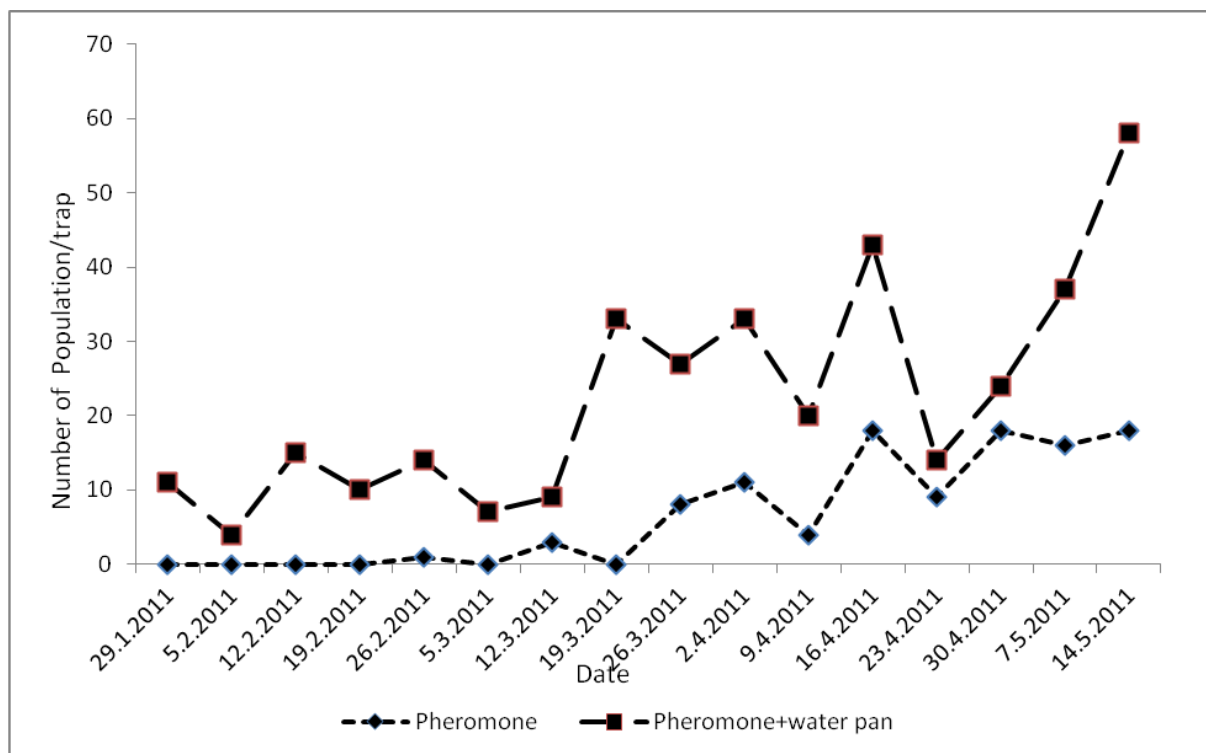

Figure 2. Fluctuation of *Tuta absoluta* at different traps during the spring season.

Table 1. The mean number of infestation rate (%) of *T. absoluta* on leaves and fruits in Greenhouse in fall season

Dates	Leaves			Fruits	
	Greenhouse 1 Greenhouse 3	Greenhouse 2	Greenhouse 3	Greenhouse 1	Greenhouse 2
16.10.2010	33,3	16,7	0	0	0
23.10.2010	13,3	36,7	10	0	0
30.10.2010	10	23,3	23,3	0	0
06.11.2010	23,3	26,7	26,7	3,3	10
13.11.2010	23,3	40	30	0	16,7
20.11.2010	30	20	40	6,7	6,7
26.11.2010	23,3	13,3	20	6,7	6,7
04.12.2010	16,7	56,7	63,3	3,3	3,3
11.12.2010	33,3	46,7	53,3	6,7	6,7
18.12.2010	0	53,3	46,7	0	33,3
25.12.2010	0	66,7	66,7	0	36,7
01.01.2011	0	40	43,3	0	40
08.01.2011	0	37,7	0	0	40
15.01.2011	0	20	0	0	20

Table 2. The mean number of infestation rate (%) of *T. absoluta* on leaves and fruits in Greenhouse in spring season

Dates	Leaves			Fruits	
	Greenhouse 1 Greenhouse 3	Greenhouse 2	Greenhouse 3	Greenhouse 1	Greenhouse 2
29.01.2011	0	13,3	0	0	0
05.02.2011	0	10	0	0	0
12.02.2011	0	3,3	0	0	0
19.02.2011	0	31,7	0	0	0
26.02.2011	0	11,7	0	0	0
05.03.2011	0	21,7	0	0	0
12.03.2011	0	26,7	0	0	0
19.03.2011	0	26,7	0	0	0
26.03.2011	0	73,3	0	0	0
02.04.2011	26,7	70	0	0	16,7
09.04.2011	13,3	83,3	0	0	26,7
16.04.2011	18,3	80	0	0	40
23.04.2011	23,3	68,3	0	3,3	36,7
30.04.2011	36,7	95	5	10	26,7
07.05.2011	40	100	13,3	0	63,3
14.05.2011	50	100	16,7	13,3	20

In this study pheromone+water pan trap captured more trap than the other traps. However, Pehlavan and Barış (2013) combined the water pan with the light source and they found that this kind of trap captured low amount due to evaporation of water in hot days. However, the reason for these differences is that the evaporation is low amount and also the olive oil was added into water in this experiment. 7-9 infestation peaks of infestation on the leaves, fruits and flight activities were occurred in both spring and fall season (from October to May). It means that the pest has 3-4 generations during each planting period in greenhouse. *T. absoluta* gave four generations in Tunisia, up to nine generations in Italy and 13 generations in Spain (Tropea-Garzia et al., 2012), South Africa (Barrientos et al., 1998). The data was also supported by Mamay and Yanık (2012), Pehlavan and Kovancı (2013) and Çetin et al., (2014). They mentioned that four peaks, or generations were occurred in open field tomato growing

The infestation on the leaves and fruits with *T. absoluta* in fall season is shown in Table 1. The first infestation on the leaves was observed with 33.3% on 16.10.2010. Four peaks of infestation were occurred in the greenhouses and infestation rate varied between %10-66.7%. The first fruit damage was observed at the beginning of November in greenhouses and varied 3.3-46.7% and three peaks of fruit damage were occurred. In spring season infestation on the leaves was not observed until 2.4.2011 in greenhouse 1 and 30.4.2011 in greenhouse 3. On the other hand, it was occurred through both seasons in Greenhouse 3. It varied 3.3-100% in greenhouses. Fruit damage rate was not observed on 23.4.2011 and reached to the highest level with 13.3% in greenhouses. However, it was observed with 16.7% on 2.4.2011 and reached to the highest level with 63.3% on 7.5.2011 in greenhouse 2 (Table 2). The rate was found more amounts compared with Pehlavan and Kovancı (2013). They found that infestation damage on the fruit was 1.45%. These differences should be varieties or favorable condition. The study was supported by Bayram et al., (2014). They reported that 3-5 maximum peak point was occurred and 100% tomato plant and fruit in Bismil, 60-90% plants, 20-30% fruits in Ergani County were damaged by the pest. Both fruit and leave damage increased toward the end of the season due to rising in temperature. This result also supported by Leite et al., (2004) Lacordaire and Feuvrier (2010), Allache and Demnati (2012).

Conclusion

It is concluded that *T. absoluta* is major economically important pests, had four peaks for each season and gives 7-8 generations in both spring and fall tomato-growing seasons in the glasshouse. Pheromone+water pan trap with olive oil was 2.2-3.6 times more effective than the pheromone trap and 15 times more than the light trap. Therefore, it is more useful in management program against *T. absoluta*.

References

- Anonymous, 2016. <http://www.tuik.gov.tr/UstMenu.do?metod=temelist>
- Allache, F. and F. Demnati, 2012. Population changes of *Tuta absoluta* (Mey.) (Lepidoptera: Gelechiidae): a new introduced tomato crop pest at Biskra in Algeria. *Jordan Journal of Agricultural Science*, 8: 391-400.
- Barrientos, Z. R., H. J. Apablaza, S. A. Norero, and P. P. Estay, 1998. Threshold temperature and thermal constant for development of the South America Tomato moth *Tuta absoluta* (Meyrick) (Lepidoptera: Gelechiidae). *Ciencia e Investigacion Agraria*, 25: 133-137.
- Bayram, Y., Ö. Bektaş, M. Büyük, N. Bayram, M. Duman, and Ç. Mutlu, 2014. A survey of tomato leafminer [*Tuta absoluta* Meyrick] (Lepidoptera: Gelechiidae) and its natural

- enemies in the South-east Anatolia Region. *Türkiye Biyolojik Mücadele Dergisi*, 5 (2):99-110.(In Turkish).
- Canbay, A., İ. Alaserhat, and Ö. Tohma, 2014. Monitoring population of harmful *Tuta absoluta* (Meyrick) (Lep.: Gelechiidae) and predators in tomato areas in Erzincan and Iğdır provinces. *Atatürk Üniversitesi Ziraat Fakültesi Dergisi*, 45 (1): 79-97. (In Turkish).
- Çetin, G., P. Göksel, O. Dura, and C. Hantaş, 2014. Spreading, infestation and damage rates and adult population monitoring of tomato leaf miner [*Tuta absoluta* (Meyrick) (Lepidoptera: Gelechiidae)] on open field tomato grown in the South Marmara Region of Turkey. *Turkish Journal of Agricultural and Natural Sciences, Special Issue: 2*, 169-1624.
- Erdoğan, P., A. Barış, and Y. N. Alpkent, 2014. Survey and population monitoring of Tomato leaf miner [*Tuta absoluta* Meyrick (Lepidoptera:Gelechiidae)] in the Central Anatolia region. *Bitki Koruma Bülteni* 54(3):255-265.(In Turkish).
- Erler F., M. Can, M. Erdoğan, A. O. Ateş and T. Pradier, 2010. New record of *Tuta absoluta* (Meyrick) (Lepidoptera: Gelechiidae) on greenhouse-grown tomato in Southwestern Turkey (Antalya). *Journal of Entomological Science*, 45 (4): 392-393.
- Haji, F. N. P., L. C. L. Freire, F. G. Roa., C. N. Silva, M. M. Souza J'Unior, and M. I. V. Silva, 1995. Manejo Integrado de *Scrobipalpuloides absoluta* (Povolny) (Lepidoptera: Gelechiidae) no Subm'edio S'ao Francisco. *An. Soc. Entomol. Brasil* 24:587–592.
- Kılıç, T., 2010. First record of *Tuta absoluta* in Turkey, *Phytoparasitica*, 38(3):243-244.
- Leite, G.L.D., M. Piçanço, G.N. Jham and F. Marquini, 2004. Intensity of *Tuta absoluta* (Meyrick, 1917) (Lepidoptera: Gelechiidae) and *Liriomyza* spp. (Diptera: Agromyzidae) attacks on *Lycopersicum esculentum* Mill. leaves. *Ciência Agrotecnologia*, 28(1): 42-48.
- Locardaire, A. I., and E. Feuvrier, 2010. Tomate, traquer *Tuta absoluta*. *Phytoma-La Defense des Vegetaux*, 632: 40-44.
- Mamay, M. and E. Yanık, 2012. Determination of adult population development of Tomato leafminer [*Tuta absoluta* (Meyrick) (Lepidoptera: Gelechiidae)] in tomato growing areas in Şanlıurfa. *Türkiye Entomoloji Bülteni*, 2 (3): 189-198. (In Turkish)
- Portakaldalı, M., S. Öztemiz, H. Kütük, H. D. Büyüköztürk, and A. Ç. Ateş, 2013. Distribution of *Tuta absoluta* (Meyrick) (Lepidoptera: Gelechiidae) in the Eastern Mediterranean and Southeastern Anatolia Regions. *Türkiye Entomoloji Bülteni*, 3 (3): 133-139. (In Turkish).
- Öztemiz, S., 2013. *Tuta absoluta* Povolny (Lepidoptera: Gelechiidae) the exotic pest in Turkey. 4th ESENIAS Workshop: International Workshop on IAS in Agricultural and Non-Agricultural Areas in ESENIAS Region, 16-17 December 2013, Çanakkale, Turkey
- Pehlevan, B., and O. B. Kovanci, 2013. Monitoring adult populations of *Tuta absoluta* in field-grown processing tomatoes in Northwestern Turkey. *Proceedings–24th International Scientific-Expert Conference of Agriculture and Food Industry–Sarajevo*, 396-400.
- Tropea-Garzia, G., G. Iscaro, A. Biondi, and L. Zappala, 2012. Biology, distribution and damage of *Tuta absoluta*, an exotic invasive pest from South America, *OEPP Bulletin*, 42: 205-210.
- Van Der Straten, M.J., R.P.J. Potting and A. Van Der Linden. 2011. Introduction of the tomato leafminer *Tuta absoluta* into Europe. *Proceedings of the Netherlands Entomological Society Meeting. Volume 22*, 23-30.

COVER CROPS EFFECT ON STATUS OF MAIN ANTIOXIDANTS IN SWEET MAIZE

Vesna DRAGIČEVIĆ^{1*}, Željko DOLIJANOVIĆ², Biljana JANOŠEVIĆ², Milena SIMIĆ¹,
Margarita DODEVSKA³, Milan BRANKOV¹, Jelena MESAROVIĆ¹

¹Maize Research Institute “Zemun Polje”, Slobodana Bajica 1, 11185 Zemun Polje, Serbia

²University of Belgrade, Faculty of Agriculture, Nemanjina 6, 11080 Zemun, Serbia

³Center for Food Analysis, Zmaja od Noćaja 11, 11000, Belgrade, Serbia

Abstract

Cover crops has important role in sustainability, owing to protection from soil erosion and soil enrichment with organic matter. Bio-fertilizers are important for increase of soil and crop quality. The aim of experiment was to examine nutritional quality of sweet maize, sown at experimental plots after different cover crops: T1 - common vetch (*Vicia sativa* L.), T2 - winter oats, (*Avena sativa* L.), T3 - fodder kale (*Brassica oleracea* (L.) *convar. acephala*), T4 - field pea (*Pisum sativum* L.) + winter oats, T5 - dead organic mulch, T6 - common vetch + winter oats, T7 - field pea and control - uncovered during the winter, in combination with bio-fertilizer Uniker, during 2013/2014. Content of main antioxidants: phenolics, glutathione, vitamin C, carotenoids and phytic acid were determined in technological maturity. The highest content of carotenoids (2.48 $\mu\text{g g}^{-1}$) was obtained in T1 + Uniker combination, while the highest values of glutathione and phenolics were in T2 treatment (1927 nmol g^{-1} and 716 $\mu\text{g g}^{-1}$, respectively). T3 was characterized with the highest vitamin C content in combinations with and without Uniker (29.92 and 31.09 mg 100g^{-1}) and control had the highest phytic P content (3.69 mg g^{-1}). Correlation consigned that increased kernel yield was followed by carotenoid increase and phenolics decrease in general, while application of Uniker induced increase of P_{phy} and decrease of vitamin C, parallel with grain yield increase.

Key words: *sweet maize grain, nutritional quality, antioxidants*

Introduction

Sustainable agriculture combines various cultural practices with aim to maintain agro-ecosystem stability and high crop productivity. From this point, great responsiveness was given to the cover crops, which protect soil from erosion, maintain balance of nutrients in soil, by increasing organic matter level, together with conservation of nutrients from loosing. This is particularly important for nitrogen, since cover crops hold back nitrogen from leaching through soil profile (Restovich et al., 2012). Dolijanović et al. (2012) underlined significantly higher sweet maize kernel yield achieved from the field with cover crops in relation to kernel yield achieved from the uncovered field. Uchino et al. (2009) and Dolijanović et al. (2012) also emphasized that the highest grain yields of soybean and sweet maize were obtained when they are grown after leguminous cover crops. It is also important to underline that excessive fertilization could decline nutritive value of crops, particularly when nitrogen fertilization, which increases nitrate level and decreases the level of vitamin C, soluble sugars and Mg and Ca in some crops (Wang et al., 2008). Other than that, low input agricultural strategies contribute to increased level of vitamins in vegetables, including sweet maize (Worthington, 2004; Crinnion, 2010). Application of catch crops has advantage to application of mineral and other organic fertilizers in increased vitamin C concentration in sweet maize kernels (Rosa, 2015).

What is more, by incorporation of cover crops residues into soil, microbiological activity is increasing. Microorganisms, present naturally in soil or introduced by application of microbiological fertilizers contribute to maintenance of soil fertility together with increase of crop yields (Mahdi et al., 2010).

Sweet maize, rich in carbohydrates is also good source of fibers, vitamins and minerals and it could have many health benefits, what is important in particular since it is mainly consuming fresh (Arnarson, 2015). It is also high in phenolics, with high antioxidant activity expressed among other maize genotypes (Das et al., 2014).

The aim of experiment was to test the reaction of sweet maize to application of different cover crops from the point of nutritional quality, i.e. variation in concentration of antioxidants like vitamin C, carotenoids, water soluble phenolics, glutathione and phytic acid expressed as phytic phosphorus.

Material and methods

A field experiment was carried out over 2013/14, at the Experimental Field of Maize Research Institute in Zemun Polje (44°52'N 20°20'E). The experiment was established as a block design with four replications with winter cover crops as treatment: T1 - common vetch (*Vicia sativa* L.), T2 - winter oats, (*Avena sativa* L.), T3 - fodder kale (*Brassica oleracea* (L.) *convar. acephala*), T4 - field pea (*Pisum sativum* L.) + winter oats, T5 - dead organic mulch, T6 - common vetch + winter oats, T7 - field pea and control - classical variant, uncovered during the winter.

The cover crops were sown at the end of October or in early November. Green mass of the cover crops were incorporated in the soil in early May. After that bio-fertilizer – Uniker (containing proteolytic and cellulolytic bacteria) was applied to accelerate mineralization of cover crops, which was followed by sweet maize (ZPSC 421*su*) sowing.

The kernels were harvested at the stage of milk maturity (end of August). The content of main antioxidants: phenolics, glutathione, vitamin C, carotenoids and phytic acid were determined. Phytic P (P_{phy}) and total glutathione (GSH) content were determined colorimetrically. Phytic P was determined by the method of Dragičević et al. (2011) and GSH by the method of Sari Gorla et al. (1993). Free soluble phenolics were determined by method of Simić et al. (2004), as well as carotenoids content (mainly containing of β -carotene) was also determined colorimetrically, after extraction with saturated butanol AACC (1995). Vitamin C was determined by iodometric titration (Rikovski et al., 1989). The experimental data were statistically processed by ANOVA (with LSD 5%) and by regression analysis.

Results and discussion

According to results present in Table 1, concentrations of all examined antioxidants in sweet maize kernels varied significantly toward cover crop treatment, as well as interaction cover crop x Uniker treatment. The highest variability was in carotenoid concentration, accordingly to the results of Khalid and Juvik (2009) who find high variability in carotenoid content in sweet maize kernels among various agro-ecological conditions. For GSH, the highest values were obtained at T5 treatment (with Uniker) and T7 (\emptyset); for phenolics, they were obtained in control (with Uniker) and T4 (\emptyset); for vitamin C, the highest values were acquired by T3 treatment (with Uniker) and T6 (\emptyset); for carotenoids, the highest values were obtained at T1 treatment (with Uniker) and T5 (\emptyset), and for P_{phy} , they were obtained by T6 treatment (with Uniker) and control (\emptyset). T1 (common vetch cover crop) was characterised with the lowest values of GSH (with Uniker) and vitamin C (in both, with and without Uniker application), while T2 (winter oats) was treatment with the lowest values of GSH and phenolics concentration (without Uniker) and P_{phy}

concentration (with Uniker) and T3 (fodder kale) is the treatment with the lowest values of carotenoids (in both, with and without Uniker application). Rosa (2015) find that cover crops were positively reflected on increase in vitamin C concentration, what is in this experiment present in treatments with fodder kale, field pea and combination of common vetch + winter oats. The positive impact of microbiological fertilizers is also observed on carotenoid lycopene and vitamin C accumulation in tomato fruits (Verma et al., 2015; Ochoa-Velasco et al., 2016). GSH content was mainly influenced by mulch and field pea, confirming that organic fertilizers, with available N forms are important for accumulation of this protein type (Dragičević et al., 2013). It is well known that fertilizers, together with other measures commonly used in organic farming, as low input agriculture contributes to increased level of vitamins in vegetables, including sweet maize, when compared to conventional farming (Worthington, 2004; Crinnion, 2010).

Table 1. Concentration of glutathione (GSH), phenolics, Vitamin C and phytic P (P_{phy}) in sweet maize grain influenced by different cover crops (T1 – T7) and bio-fertilizer (Uniker; Ø – without Uniker)

Treatment	T1	T2	T3	T4	T5	T6	T7	Cont.	Aver.	LSD 0.05		
GSH (nmol g ⁻¹)	Unik	1363.8	1373.3	1415.7	1538.7	1879.7	1723.1	1487.5	1608.9	1548.8	T	190.8
	Ø	1726.3	1927.6	1374.9	1470.8	1738.3	1410.9	1218.4	1469.2	1542.0	Un.	226.3
	Av.	1545.0	1650.5	1395.3	1504.7	1809.0	1567.0	1353.0	1539.1	1545.4	TXUn.	123.3
Phenol. (µg g ⁻¹)	Unik	536.8	613.2	491.1	657.5	563.9	527.5	471.0	712.5	571.7	T	90.1
	Ø	621.1	716.1	570.4	503.2	666.8	531.8	641.1	699.0	618.7	Un.	101.8
	Av.	578.9	664.7	530.7	580.4	615.4	529.6	556.1	705.7	595.2	TXUn.	76.3
Vit. C (mg 100g ⁻¹)	Unik	21.71	27.57	29.92	28.75	26.40	24.05	22.29	27.57	26.03	T	2.47
	Ø	21.12	21.41	31.09	30.51	29.92	31.09	29.33	29.92	28.05	Un.	3.54
	Av.	21.41	24.49	30.51	29.63	28.16	27.57	25.81	28.75	27.04	TXUn.	0.66
P_{phy} (mg g ⁻¹)	Unik	3.27	2.98	3.55	3.07	3.00	3.50	3.40	3.28	3.25	T	0.24
	Ø	3.54	3.28	3.24	2.94	3.53	3.31	3.16	3.69	3.34	Un.	0.27
	Av.	3.40	3.13	3.39	3.00	3.26	3.40	3.28	3.48	3.29	TXUn.	0.18
Carot. (µg g ⁻¹)	Unik	2.48	1.88	1.58	1.62	1.73	2.03	2.12	1.79	1.90	T	0.21
	Ø	1.76	1.61	1.32	1.94	2.06	1.91	1.92	1.89	1.80	Un.	0.27
	Av.	2.12	1.74	1.45	1.78	1.89	1.97	2.02	1.84	1.85	TXUn.	0.10

Variations in kernel yield were connected to variability in content of main antioxidants in sweet maize kernels, having significant and positive correlation of kernel yield with carotenoids and P_{phy} ($R^2=0.3518$ and $R^2=0.3398$, respectively; Figure 1), as well as significant and negative

correlation with phenolics and vitamin C ($R^2=0.1764$ and $R^2=0.5926$, respectively) in Uniker treatment. In parallel, Verma et al. (2015) find positive impact of effective microorganisms on yield and lycopene content of tomato fruits. Other than that, in treatment without Uniker, significant and positive correlation between kernel yield and carotenoids and vitamin C ($R^2=0.2404$ and $R^2=0.5967$, respectively; Figure 2) was observed, while significant and negative correlation was between kernel yield, phenolics and GSH ($R^2=0.2963$ and $R^2=0.4415$, respectively). In the case of vitamin C, results obtained in the part of experiment without Uniker application indicate that proper nutrition reflects positive on increase of kernel yield and vitamin C concentration in kernels (Wang et al., 2008), as improved quality. This was especially underlined in treatments with fodder kale, field pea and combination of common vetch + winter oats (Table 1).

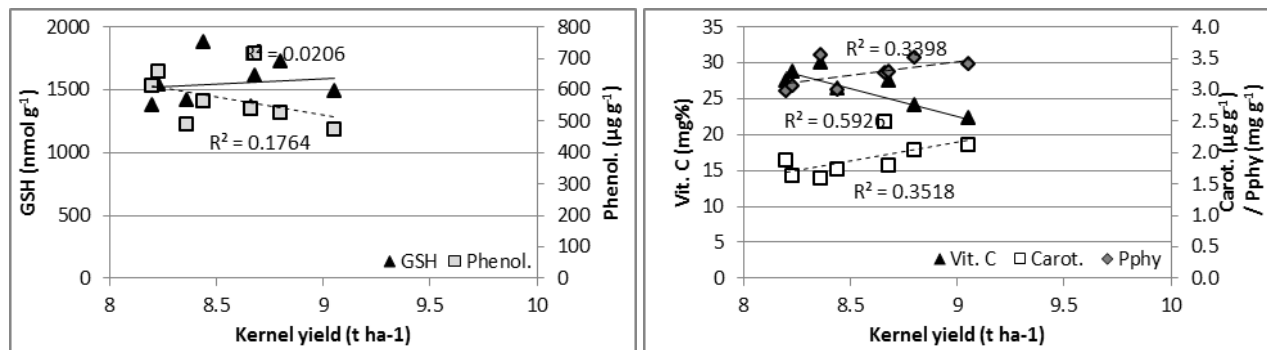

Figure 1. Interdependence between kernel yield and concentration of different antioxidants (GSH, phenolics, vitamin C, carotenoids and P_{phy}) in sweet maize grain in Uniker treatment

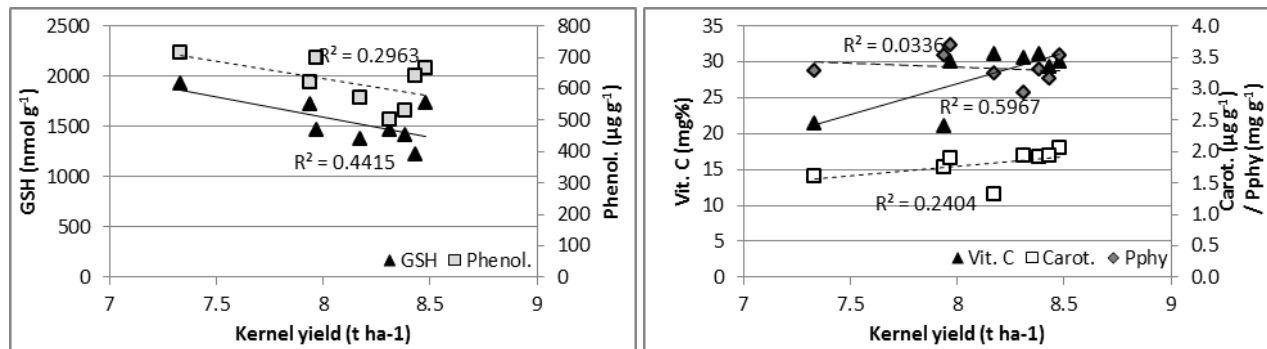

Figure 2. Interdependence between kernel yield and concentration of different antioxidants (GSH, phenolics, vitamin C, carotenoids and P_{phy}) in sweet maize grain in treatment without Uniker

Conclusion

Based on obtained results from research, it could be concluded that the highest variability was present in carotenoid concentration, among parameters examined. Uniker slightly increased carotenoid and GSH content, while it showed decreasing effect on phenolics content. Cover crop treatments expressed various effects, with the highest impact of dead organic mulch on GSH increase, fodder kale and field pea for vitamin C increase and common vetch for carotenoid increase. In general, increased kernel yield was followed by carotenoid increase and phenolics decrease, while application of Uniker showed diverse results, increasing P_{phy} and decreasing vitamin C, parallel with kernel yield increase.

Acknowledgments

This work was supported by the Ministry of Education, Science and Technological Development, Republic of Serbia.

References

- American Association of Cereal Chemists Method (1995). Approved Methods of the AACC. The association: St. Paul, Minnesota, USA, AACC Method, pp. 14-50.
- Arnarson A. (2015). Corn 101: Nutrition Facts and Health Benefits. <https://authoritynutrition.com/foods/corn/>
- Crinnion W.J. (2010). Organic foods contain higher levels of certain nutrients, lower levels of pesticides, and may provide health benefits for the consumer. *Alternative Med. Review* 15, 4-13.
- Das A.K., Sreerama Y.N., Singh V. (2014). Diversity in phytochemical composition and antioxidant capacity of dent, flint, and specialty corns. *Cereal Chem.* 91, 639-645.
- Dolijanovic Z., Momirovic N., Mihajlovic V., Simic M., Oljaca S., Kovacevic D., Kaitovic Z. (2012). Cover crops effects on the yield of sweet corn. III International Symposium "Agrosym 2012", Jahorina, 15-17 November 2012, Bosnia and Herzegovina, Proceedings, pp. 104-110.
- Dragicevic V., Spasojevic I., Oljaca S., Simic M., Dolijanovic Z. (2013). Grain quality in organic and ecological cropping systems. IV International Symposium „Agrosym 2013“, Jahorina 03.-06. October 2013, Bosnia and Herzegovina, Proceedings, pp.700-705.
- Dragičević V., Sredojević S., Perić V., Nišavić A., Srebrić M. (2011). Validation study of a rapid colorimetric method for the determination of phytic acid and inorganic phosphorus from grains. *Acta Period Technol* 42, 11-21.
- Khalid E.I., Juvik J.A. (2009). Feasibility for improving phytonutrient content in vegetable crops using conventional breeding strategies: Case study with carotenoids and tocopherols in sweet corn and broccoli. *J. Agric. Food Chem.* 57, 4636–4644.
- Mahdi S., Hassan G.I., Samoon S.A., Rather H.A., Showkat A.D., Zehra B. (2010). Bio-fertilizers in organic agriculture. *J. Phytol.* 2, 42-54.
- Ochoa-Velasco C.E., Valadez-Blanco R., Salas-Coronado R., Sustaita-Rivera F., Hernández-Carlos B., García-Ortega S., Santos-Sánchez N.F. (2016). Effect of nitrogen fertilization and *Bacillus licheniformis* biofertilizer addition on the antioxidants compounds and antioxidant activity of greenhouse cultivated tomato fruits (*Solanum lycopersicum* L. var. Sheva). *Sci. Hort.* 201, 338–345.
- Restovich S.B., Andriulo A.E., Portela S.I. (2012). Introduction of cover crops in a maize–soybean rotation of the Humid Pampas: Effect on nitrogen and water dynamics. *Field Crops Res.* 128, 62–70.
- Rikovski I., Džamić M., Rajković M. (1989). *Practicum of Analytical Chemistry (In Serbian). Construction book*, Belgrade.
- Rosa R. (2015). Quality of sweet corn yield depending on winter catch crops and weed control method. *HortorumCultus* 14, 59-74.
- Sari Gorla M., Ferrario S., Rossini L., Frova C., Villa M. (1993). Developmental expression of glutathione-S-transferase in maize and its possible connection with herbicide tolerance. *Euphytica* 67, 221-230.
- Simić A., Sredojević S., Todorović M., Đukanović L., Radenović Č. (2004). Studies on the relationship between content of total phenolics in exudates and germination ability of maize seed during accelerated aging. *Seed Sci. Technol.* 32, 213-218.

- Uchino H., Iwama K., Jitsuyama Y., Yodate T., Nakamura S. (2009). Yield losses of soybean and maize by competition with interseeded cover crops and weeds in organic-based cropping systems. *Field Crops Res.* 113, 342–351.
- Verma S., Sharma A., Kumar R., Kaur C., Arora A., Shah R., Nain L. (2015). Improvement of antioxidant and defense properties of Tomato (var. Pusa Rohini) by application of bioaugmented compost. *Saudi J. Biol Sci.* 22, 256–264.
- Wang Z.-H., Li S.-X., Malh S. (2008). Effects of fertilization and other agronomic measures on nutritional quality of crops. *J. Sci. Food Agric.* 88, 7–23.
- Worthington V. (2004). Nutritional quality of organic versus conventional fruits, vegetables, and grains. *J. Alt. Complemen. Med.* 7, 161-173.

THE INFLUENCE OF MINERAL NUTRITION ON WINTER WHEAT YIELD

Vera ĐEKIĆ^{1*}, Jelena MILIVOJEVIĆ¹, Miodrag JELIĆ², Vera POPOVIĆ³,
Snežana BRANKOVIĆ⁴, Mirjana STALETIĆ¹, Dragan TERZIĆ⁵

¹Small Grains Research Centre, Save Kovacevica 31, Kragujevac, Serbia

²University of Priština, Faculty of Agriculture, Kopaonička bb, Lešak 38219, Kosovo and Metohija, Serbia

³Institute of Field and Vegetable Crops, Maxim Gorky St. 30, Novi Sad, Serbia

⁴University of Kragujevac, Faculty of Science, Institute of Biology and Ecology, 34000 Kragujevac, Serbia

⁵Institute for forage crops, Kruševac, Serbia

*Corresponding author: verarajic@yahoo.com

Abstract

Investigations were carried out during the 2008/2009 and 2009/2010 year on stationary field trial, which was established in 1970 on the experimental field of the Center for Small Grains in Kragujevac. The objective of this study was to investigate the influence of mineral nutrition on the yield of winter wheat varieties Ana Morava. Trials were included control and seven fertilization variants with different combinations of NPK fertilizers. Investigation where showed a considerable variation of grain yield which were in dependence from mineral nutrition. The highest grain yields were the highest with mineral fertilizer in the combined 80 kg/ha N and 100 kg/ha P₂O₅ (3.976 t/ha). Over the two-year period, all investigated treatments of wheat achieved the highest average 1000-grain weight in the combined 80 kg/ha N and 100 kg/ha P₂O₅ (41.64 g). Analysis of variance was found highly significant effect of years on grain yield and 1000 grains weight. Different combinations of NPK fertilizers had the most highly significant influence on all characters, except for test weight. Analysis of variance for the impact of years and fertilization variants on investigated traits was found that doses of nitrogen in combination with NPK fertilizers significantly affected only on grain yield. Positive correlations were observed between grain yield and test weight in all treatments. Grain yield were significantly positively correlated with 1000-grain weight only in the 2008/09 ($r=0.44^*$) and 2009/10 ($r=0.55^*$).

Key words: *fertilization, yield, quality, wheat*

Introduction

New perspective wheat lines and varieties has more and better filled grain, higher yield, grain mass and farinaceous content, while proteins and lysine was smaller compared with older varieties (Đekić et al., 2014, 2015). Several factors are decisive in increasing wheat yields: the cultivar, cultural practices, agroecological conditions, local climatic and soil characteristics, mineral nutrition and adequate protection from plant diseases, pests and weeds. Wheat productivity and grain quality in Central Serbia are governed by a range of factors, notably climate, soil, genetics and crop nutrition. Soil acidity in wheat fields in Central Serbia has become a severe problem that leads to a significant decline in grain yield and quality of wheat (Đekić et al., 2013).

Mineral nutrition of wheat grown on acid soil reaction is specific. The crucial importance play equilibrated nutrition by nitrogen and phosphorus with higher impact of phosphorus nutrient. The optimum rate of P application is important in improving yields of most crops (Jelić et al., 2013, 2014). In Serbia, farmers are using only nitrogen fertilizers for fodder crops while the use of P fertilizer is negligible. These crops are often grown on marginal lands. Hence, the production is low

and quality is poor. The absence of record yields indicates that an answer could be sought in soil, the main substrate for field crop production. Additionally, the major previous crops of small grains also suffer from negative nutrient balance. The use of incomplete production technology in previous decades had definitely affected the potential and actual soil fertility.

The objective of this study was to evaluate the effect of different fertilization systems on the grain yield and quality of wheat grown on a vertisol soil. The study was also aimed at optimizing fertilization for maximum profitability in the future wheat production of Central Serbia.

Materials and methods

Experimental design and statistical analysis

The study was carried out in a stationary field trial involving fertilization over a two years period from 2008/09 to 2009/10. Trials were first set up in the experimental fields of the Small Grains Research Centre in Kragujevac in 1970. Plot size was 50 m². The wheat cultivar used in the experiment was Ana Morava, the dominant cultivar in the production region of Serbia. This investigation included an untreated control and seven variants of fertilization: 1-80 kg/ha N, 2-60 kg/ha P₂O₅, 3-80 kg/ha N, 60 kg/ha K₂O, 4-80 kg/ha N, 60 kg/ha P₂O₅, 5-80 kg/ha N, 100 kg/ha P₂O₅, 6-80 kg/ha N, 60 kg/ha P₂O₅, 60 kg/ha K₂O and 7-80 kg/ha N, 100 kg/ha P₂O₅, 60 kg/ha K₂O. A non-fertilized variant served as a control. Total amounts of phosphorus and potassium fertilizers and half the nitrogen rate are regularly applied during pre-sowing cultivation of soil. The trial was set up in a randomized block design with five replications. Fertilization was regular and followed a long-time scheme.

On the basis of achieved research results the usual variational statistical indicators were calculated: average values, standard error and standard deviation. Statistical analysis was made in the module Analyst Program SAS/STAT (SAS Institute, 2000).

Soil conditions

The trial was set up on a vertisol soil in a process of degradation, with heavy texture and very coarse and unstable structure. The humus content in the surface layer of soil was low (2.22%). Soil pH indicates high acidity (pH in H₂O 5.19; pH in KCl 4.27), nitrogen content in soil is medium (0.11-0.15%), while the content of available phosphorus ranges from very low (1.7-2.9 mg/100 g soil) in the 4 variant (80 kg/ha N, 60 kg/ha P₂O₅) to very high (26.9 mg/100 g soil P₂O₅) in the 6 and 7 variants of fertilization. Available potassium contents are high, ranging from 19.5 to 21.0 mg/100 g soil K₂O.

Agroecological conditions

This study was conducted over a three-year period in the Šumadija region, Central Serbia, on a Vertisol soil, at Kragujevac location, 173-220 m a. s. l. (44° 22' N, 20° 56' E), in a temperate continental climate having an average annual temperature of 11.5°C typical of Šumadija districts in Serbia and a rainfall amount of about 550 mm. The data in Table 1 for the investigated period (2008-2010) clearly indicate that the years in which the researches were conducted differed from the typical multi-year average of Kragujevac region regard the meteorological conditions.

The average air temperature in 2008/09 was higher by 1.48°C and 2009/10 was higher by 1.01°C.

The sum of rainfall precipitation in 2008/09 was higher by 13.0 mm, where the sum of rainfall in 2009/10 was 616.2 mm higher than the average of many years and with a very uneven distribution of precipitation per months. Spring months April, May and June in 2009/10 were surplus of precipitation, what affected unfavorable on the crops. During the April in 2009/10 it

was 142.2 mm of rainfall, what was 90.7 mm more compared with the perennial average. During the month of June in 2009/10 it was 196.7 mm of rainfall, what was 117.4 mm more compared with the perennial average.

Table 1. Mean monthly air temperature and precipitation (Kragujevac)

Year	Months										Aver.
	X	XI	XII	I	II	III	IV	V	VI	VII	
Mean monthly air temperature (°C)											
2008-09	13.1	8.5	4.4	2.3	2.0	6.8	13.4	17.8	20.2	22.5	11.1
2009-10	11.7	8.8	2.6	0.9	3.2	7.2	12.1	16.5	20.2	23.1	10.63
Average	11.8	5.6	1.9	0.6	2.0	6.2	11.2	16.2	19.4	21.3	9.62
The amount of rainfall (mm)											
2008-09	31.3	30.6	29.7	57.7	76.9	40.3	16.8	46.0	137.8	25.2	492.3
2009-10	102.6	77.5	194.2	57.0	150.5	43.3	142.2	116.7	196.7	14.8	1095.5
Average	47.5	50.0	49.5	36.8	33.9	43.5	51.5	64.8	79.3	62.5	479.3

Results and discussion

The grain yield of wheat significantly varied across years, from 1.327 t/ha to 5.193 t/ha in 2008/09, from 1.178 t/ha to 3.049 t/ha in 2009/10.

Table 2. Grain yield, 1000-grain weight and test weight of winter wheat

Traits	Fertilization	Years						Average		
		2008/09			2009/10			\bar{x}	S	S_x
		\bar{x}	S	S_x	\bar{x}	S	S_x			
Grain yield, (t ha ⁻¹)	Control	1.327	0.372	0.166	1.178	0.247	0.111	1.252	0.308	0.097
	1	2.980	0.891	0.398	2.371	0.888	0.397	2.675	0.898	0.284
	2	1.938	0.400	0.179	1.922	0.661	0.296	1.930	0.515	0.163
	3	2.275	1.142	0.511	1.960	0.642	0.287	2.117	0.889	0.281
	4	3.940	0.997	0.446	2.200	1.337	0.598	3.070	1.441	0.456
	5	5.193	0.904	0.404	2.759	0.997	0.446	3.976	1.565	0.495
	6	3.833	0.855	0.382	3.049	0.819	0.366	3.441	0.891	0.282
1000-grain weight, (g)	Control	40.20	2.421	1.083	38.62	1.141	0.510	39.41	1.969	0.623
	1	41.32	0.936	0.419	39.96	0.814	0.364	40.64	1.095	0.346
	2	40.34	0.343	0.154	36.84	1.396	0.624	38.59	2.079	0.657
	3	39.52	2.086	0.933	38.62	0.861	0.385	39.07	1.578	0.499
	4	41.46	1.441	0.645	38.54	2.310	1.033	40.00	2.380	0.753
	5	42.78	2.619	1.171	40.50	1.646	0.736	41.64	2.387	0.755
	6	42.64	1.322	0.591	39.98	2.198	0.983	41.31	2.211	0.699
Test	Control	69.92	1.804	0.807	69.95	1.967	0.880	69.93	1.779	0.563

1	71.25	2.757	1.233	71.13	1.906	0.852	71.19	2.235	0.707
2	70.85	1.327	0.593	71.01	1.403	0.627	70.93	1.290	0.408
3	71.33	1.035	0.463	72.37	2.917	1.305	71.85	2.135	0.675
4	70.69	1.539	0.688	72.45	1.296	0.580	71.57	1.631	0.516
5	70.68	3.229	1.444	71.81	2.736	1.224	71.24	2.884	0.912
6	71.33	1.425	0.637	72.73	1.853	0.828	72.03	1.724	0.545
7	71.73	1.927	0.862	72.93	3.025	1.353	72.33	2.473	0.782

Grain yield were the highest in the combined treatment 5 (80 kg/ha N and 100 kg/ha P₂O₅) with mineral fertilizer NP (3.976 t/ha). Results clearly show that yield components were significantly affected by fertilization (Table 2), the lowest values for grain yield and yield components were obtained in the untreated control. During the first year of investigations, the highest average value of 1000-grain weight achieved the 5 (80 kg/ha N, 100 kg/ha P₂O₅), 6 (80 kg/ha N, 60 kg/ha P₂O₅, 60 kg/ha K₂O) and 7 (80 kg/ha N, 100 kg/ha P₂O₅, 60 kg/ha K₂O) treatments (42.78, 42.64 and 42.42 g). During the second year of investigations (2009/10), the highest average value of 1000 grain weight achieved the 5 (80 kg/ha N, 100 kg/ha P₂O₅) and 7 (80 kg/ha N, 100 kg/ha P₂O₅, 60 kg/ha K₂O) treatments (40.50 g and 40.18 g). During the first year achieved the highest test weight at 7 treatment (71.73 kg/hl), while the lowest test weight was the control treatment (69.92 kg/hl). During the second year of investigations, the highest test weight at 7 (80 kg/ha N, 100 kg/ha P₂O₅, 60 kg/ha K₂O) treatment (72.93 kg/hl), followed by 6 treatment (80 kg/ha N, 60 kg/ha P₂O₅, 60 kg/ha K₂O) (72.73 kg/hl) and 4 (80 kg/ha N, 60 kg/ha P₂O₅) treatment (72.45).

The study showed that among investigated fertilization variants the highest grain yields were achieved in variant with 80 kg/ha N and 100 kg/ha. Usage of fertilizers and certain amendments on extremely acid soils in certain years, particularly those less favorable for production, almost certainly had different effects on grain filling, resulting in diverse relationships between productive and qualitative traits. Presented results confirm the opinion of many authors that the traits analyzed are genetically determined, but strongly modified by the nutrient status and weather conditions (Đekić et al., 2014; Jelić et al., 2013). Highly significant differences in grain yield at investigated wheat cultivar were found relative to the fertilization (Table 3).

Table 3. Analysis of variance of the tested parameters (ANOVA)

Effect of year on the traits analyzed				
Traits	Mean sqr Effect	Mean sqr Error	F(1. 78)	p-level
Grain yield (t ha ⁻¹)	16.11102	1.541493	10.45157**	0.001797
1000-grain weight (g)	95.04800	3.415513	27.82833**	0.000001
Test weight (kg hl ⁻¹)	13.61250	4.304160	3.16264	0.079238
Effect of fertilization on the traits analyzed				
Traits	Mean sqr Effect	Mean sqr Error	F(7. 72)	p-level
Grain yield (t ha ⁻¹)	8.64519	1.053211	8.208411**	0.000000
1000-grain weight (g)	13.18029	3.738833	3.525240**	0.002612
Test weight (kg hl ⁻¹)	5.60950	4.306535	1.302555	0.261592
Effect of the year x fertilization interaction on the traits analyzed				
Traits	Mean sqr Effect	Mean sqr Error	F(7. 64)	p-level
Grain yield (t ha ⁻¹)	1.750069	0.741714	2.359493*	0.032931
1000-grain weight (g)	1.858857	2.517750	0.738301	0.640356
Test weight (kg hl ⁻¹)	1.232857	4.497313	0.274132	0.961830

Based on the analysis of variance, it can be concluded that are highly significant differences in grain yield regard the year of investigation ($F_{\text{exp}}=10.452^{**}$) and highly significant differences at 1000-grain weight ($F_{\text{exp}}=27.828^{**}$). Highly significant differences in grain yield and 1000-grain weight regard the fertilization of investigation ($F_{\text{exp}}=8.208^{**}$ and $F_{\text{exp}}=3.525^{**}$). In the dual interaction between the year and fertilization, significant effects were on grain yield.

Positive correlations were observed (Table 4) between grain yield and test weight in all treatments.

Table 4. *Correlation coefficients for the traits analyzed across treatments*

Correlations between the traits analyzed in the unfertilized control			
	Grain yield (t ha ⁻¹)	1000-grain weight (g)	Test weight (kg hl ⁻¹)
Grain yield (t ha ⁻¹)	1.00	0.23 ^{ns}	-0.20 ^{ns}
1000-grain weight (g)		1.00	0.26 ^{ns}
Test weight (kg hl ⁻¹)			1.00
Correlations between the traits analyzed in the 80 kg/ha N			
Grain yield (t ha ⁻¹)	1.00	0.58*	0.06 ^{ns}
1000-grain weight (g)		1.00	-0.17 ^{ns}
Test weight (kg hl ⁻¹)			1.00
Correlations between the traits analyzed in the 60 kg/ha P ₂ O ₅			
Grain yield (t ha ⁻¹)	1.00	0.09 ^{ns}	-0.06 ^{ns}
1000-grain weight (g)		1.00	-0.37 ^{ns}
Test weight (kg hl ⁻¹)			1.00
Correlations between the traits analyzed in the 60 kg/ha K ₂ O			
Grain yield (t ha ⁻¹)	1.00	0.39 ^{ns}	-0.49 ^{ns}
1000-grain weight (g)		1.00	-0.51 ^{ns}
Test weight (kg hl ⁻¹)			1.00
Correlations between the traits analyzed in the 80 kg/ha N, 60 kg/ha P ₂ O ₅			
Grain yield (t ha ⁻¹)	1.00	0.65*	-0.60*
1000-grain weight (g)		1.00	-0.50 ^{ns}
Test weight (kg hl ⁻¹)			1.00
Correlations between the traits analyzed in the 80 kg/ha N, 100 kg/ha P ₂ O ₅			
Grain yield (t ha ⁻¹)	1.00	0.59*	-0.05 ^{ns}
1000-grain weight (g)		1.00	0.14 ^{ns}
Test weight (kg hl ⁻¹)			1.00
Correlations between the traits analyzed in the 80 kg/ha N, 60 kg/ha P ₂ O ₅ , 60 kg/ha K ₂ O			
Grain yield (t ha ⁻¹)	1.00	0.26 ^{ns}	0.02 ^{ns}
1000-grain weight (g)		1.00	-0.42 ^{ns}
Test weight (kg hl ⁻¹)			1.00
Correlations between the traits analyzed in the 80 kg/ha N, 100 kg/ha P ₂ O ₅ , 60 kg/ha K ₂ O			
Grain yield (t ha ⁻¹)	1.00	0.64*	-0.47 ^{ns}
1000-grain weight (g)		1.00	-0.57*
Test weight (kg hl ⁻¹)			1.00

Positive and medium correlations were also found between grain yield and 1000-grain weight in the 1 treatment ($r=0.58^*$) in the 4 treatment ($r=0.65^*$), in the 5 ($r=0.59^*$) and 7 treatment ($r=0.64^*$).

Negative and medium correlations were also found between test weight and 1000-grain weight in the 7 treatment ($r=-0.57^*$).

Table 5. *Correlations between the traits analyzed during 2008-2010*

Traits	Correlations in 2008/09			Correlations in 2009/10		
	Grain yield, t/ha	1000-grain weight, g	Test weight, kg/hl	Grain yield, t/ha	1000-grain weight, g	Test weight, kg/hl
Grain yield (t ha ⁻¹)	1.00	0.44 [*]	0.40 ^{ns}	1.00	0.55 [*]	0.13 ^{ns}
1000-grain weight (g)		1.00	0.27 ^{ns}		1.00	-0.12 ^{ns}
Test weight (kg hl ⁻¹)			1.00			1.00

Testing the correlation coefficients between grain yield and 1000-grain weight of wheat (Table 5) was found positive and were significantly correlated between in 2008/09 and 2009/10. However, 1000-grain weight were significantly positively correlated with grain yield only in the first year ($r=0.44^*$) and second year ($r=0.55^*$). The results suggest that grain yield and quality formation is affected by both genetic and environmental factors (Đekić et al., 2015).

Conclusion

The highest grain yield had mineral nutrition by combination of two mineral elements N and P (80 kg/ha N and 100 kg/ha P₂O₅), as well by application three mineral elements N, P and K in rate 80 kg/ha N, 100 kg/ha P₂O₅ and 60 kg/ha K₂O. Regard the high importance of sufficient rainfall amounts during the spring months, particularly May for small grains production, the distribution and amount of rainfall over the growing season 2008/09 were considerably more favorable, what resulted with increment of yields during that year.

Statistically were highly significantly different between of year on the grain yield and 1000 grain weight were significantly different. Effect of fertilization on the grain yield and 1000 grain weight were highly significantly. Significantly positively correlated with yield and 1000 grain weight both in 2008/09 (0.44^{*}, respectively), and 2009/10 (0.55^{*}, respectively). Significant positive and medium correlations were observed between grain yield and 1000-grain weight in 1, 4, 5 and 7 treatments, and significant negatively medium correlations were observed between 1000 grain weight and test weight in 7 treatment.

References

- Đekić V., Staletić M., Jelić M., Popović V., Branković S. (2013): The stability properties of wheat production on acid soil. Proceedings, 4th International Symposium "Agrosym 2013", 03-06. Oktober, Jahorina, 84-89.
- Đekić V., Milovanović M., Popović V., Milivojević J., Staletić M., Jelić M., Perišić V. (2014): Effects of fertilization on yield and grain quality in winter triticale. Romanian Agricultural Research, No.31, 175-183.
- Đekić V., Milovanović M., Milivojević J., Staletić M., Popović V., Simić D., Mitrović M. (2015): Impact of year and grain quality of winter wheat. Proceedings of research papers, Belgarde, Vol. 21, br. 1-2, 79-86.
- Jelić M., Dugalic G., Milivojevic J., Djikic S., Đekić V., Savic N., Gudzic N. (2013): Influence of perennial application of fertilizers and ameliorative measures on changes of pseudogley soil properties and grain yield of winter wheat. 1st International Congress SOIL-WATER-PLANT, 23-26 September, Belgrade, p. 195-207.

Jelić M., Milivojević J., Đekić V., Paunović A., Tmušić N. (2014): Impact of liming and fertilization on grain yield and utilization of nitrogen and phosphorus in wheat plant grown on soil type pseudogley. Proceedings of research papers, Belgrade, Vol. 20, br. 1-4, 49-56.

SAS/STAT (2000). User's Guide, Version 9.1.3. SAS Institute Inc.

A PLANT (*Bituminaria bituminosa*) SUITABLE TO PRODUCE FORAGE WITH LOW INPUT IN MEDITERRANEAN ENVIRONMENT

Zeki ACAR*, İlknur AYAN, Mehmet CAN

Ondokuz Mayıs University, Agricultural Faculty, Department of Agronomy, Samsun, Turkey

*Corresponding author: zekiacar@omu.edu.tr

Abstract

Bituminaria bituminosa (*Bitbit*) is a perennial species in *Bituminaria* genus. It naturally grows in open fields, road sides, eroded and slide areas and woodlands of soil pH 4.7-8.5. *Bitbit* plays important role in natural vegetation of the coastal areas in Turkey and keeps greenery throughout the summer period in northern and western areas. We have been carrying out studies on *Bitbit* since 2010. We have collected 86 genotypes from Central Black Sea Region of Anatolia. No fertilizer and water were applied throughout the study and hay and seed yields, agronomical, morphological and phenological traits of genotypes were investigated. It was observed that there were significant differences and diversity in terms of all aspects amongst the genotypes. In some genotypes, only one harvest was performed, but in others, two harvests were done in the same season. Hay yield obtained from the second harvest decreased sharply for all genotypes. In the first year, average hay yield per plant of genotypes was 7.81 g, but it reached to 351.6 g in the second year. When we evaluated all genotypes, average hay yield per plant was between 83-994 g in the second year. While average seed yield obtained per plant was 85.22 g, it exceeded 250 grams for some genotypes. Especially leaves of the plant are very rich in terms of Ca, Mg, K and P. At the early growing stages, leaf ratio was 70-80%, crude protein 23%, ADF 20%, NDF 30% and Relative Feed Value (RFV) value more than 150. Even though *Bitbit* plants contain some chemical compounds, they do not cause a detrimental effect on animal health and on quality of animal products. Considering the plant needs, it needs very little input to grow. Therefore, it might be very important for extensive livestock farming at summer and winter periods in Mediterranean Basin.

Keywords: *Bituminaria bituminosa*, genotype, yield, quality, low input.

Introduction

In Turkey, cultivated forage crops and plants existing naturally in pastures are cool season plants. Pasture plants are dormant or dry, because of high temperature and drought in June-September period which is resulting serious forage gap for the animals grazing on pasture. According to global climate changing scenarios, drought and high summer temperatures are expected in Turkey (Anon 2011). *Bitbit* is a perennial legume, improves the quality of pasture in the hot and dry periods while other species and grasses disappear or decrease their hay quality in the Mediterranean basin (Mendez and Fernandez, 1990; Pecetti *et al.* 2007). In northern parts of Turkey, *Bitbit* plants keep their greenery all over the year and livestock graze on this plant (Acar *et al.* 2016). Relative to annuals, perennials regrow more rapidly at the onset of autumn rains and are able to delay senescence in summer by better exploitation of residual soil moisture. In harsh environments, such as in Israel, *Bitbit* has been reported to withstand intensive grazing by cattle, being the only species with green matter in late spring (Gutman *et al.* 2000). In the Canary Islands a local ecotype called ‘tedera’ is traditionally used for feeding goats, either under grazing

or as hay (Ventura *et al.* 2000). *Bituminaria bituminosa* is usually considered of low palatability because of the strong smell that can be emitted by oil glands located on its foliage (whence its botanical name). Nonetheless, the ‘tedera’ population, for example, is reported to be of good palatability (Munoz *et al.* 2000), while high palatability and browse intake of the species throughout the year have also been reported (Otal *et al.* 1991). The nutritive value of *B. bituminosa* in terms of forage composition and digestibility has proved similar to or even better than that of other wild legumes (Viano *et al.* 1995). The presence of some secondary compounds (e.g. phenolic components) may have health-promoting effects due to their antioxidant properties (Pecetti *et al.* 2007).

Material and Methods

This study was carried out at 180 m asl. in Samsun between 2012-2015. Long term precipitation and temperature of experiment site were 830 mm and 13.8 °C. The same figures 2013 and 2014 years were 1019 mm, 15.85 °C and 620 mm, 14.7 °C. In the scope of the Project 86 *Bitbit* genotypes was collected from Samsun, Sinop and Kastamonu provinces. Regarding the altitude, *Bitbit* plants naturally grow from just nearby the sea (3 m) to south-eastern skirts of Mount Dranaz (985 m). After seed cleaning and germination tests, seeds were scarified and sown in small pots. In November of 2012, the seedlings were transplanted to the experimental field with 70 cm*70 cm spaces as 20 plants for each genotype. No fertilizer and water were applied throughout the study and observed hay and seed yields, morphological and phenological traits, crude protein, some minerals, ADF and NDF of genotypes. In 2013 spring stem elongation was observed in 41 genotypes but no stem elongation was observed in 45 of them. Two cuts were performed for 37 genotypes over 41 in 2013. In 2014, two cuts were performed in 55 genotypes and only one cut was done in 31 genotypes. Morphological measurements were realised on 10 plant samples for all genotypes. Then, five plants were randomly harvested in each plot at the 50% flowering stage. Plant samples (leaf and stem) were dried at 60 °C in oven till constant weight, and ground to pass through 1 mm screen. Chemical characters; dry matter, crude protein, ADF, NDF, ADP, Ca, Mg, K, P content of samples were determined by using Near Infrared Reflectance Spectroscopy (NIRS, “Foss 6500”) with software package program “IC-0904F”. Statistical analysis was performed with SPSS 17.0 program.

Results and Discussion

There was statistically significant variation amongst the genotypes in terms of plant height. Although, plant height values increased in 2014, variation level decreased (Table 1). There might be two reasons for the variation in the first year: i) genetic capacity of genotypes ii) no stems elongation. The variation in the second year could be attributed to genetic differences amongst the genotypes. Regarding the agronomical and morphological traits, perennial plants had highest values in the second year (Acar and Ayan, 2012). Increasing of plant height in 2014 might be attributed to the second year effect and climatic conditions that rainfall was higher in 2014 and it was hotter in 2014 compared to 2013. Plant height values obtained from the research were similar those that of some previous researchers 20-140 cm (Davis, 1970); 54-128 cm (Gulumser, 2011); 116.4 cm at blooming stage (Acar *et al.* 2016). While the first year branch number of *Bitbit* genotypes was 8.24, it increased to 17.75 in the second year. Similar to change of the branch number, stem thickness of genotypes increased from 5.42 mm to 7.91 mm in the second year (Table 1). The source of the increasing probably comes from second year effect and favourable climatic conditions in 2014. Branch number and stem thickness changed in the first and second year as 13.7-14.7 and 5.2-6.3 mm, respectively reported by Gulumser and Acar (2012). Opposite

of the first 3 morphological characters, leaflet sizes of *Bitbit* genotypes slightly decreased in the second year. The mean values of leaflet width and length were 23.6 and 50.4 mm in the first year and 23.6 and 49.1 mm respectively, in the second year (Table 1). Gulumser and Acar (2012) explained that leaflet width and length of some *Bitbit* genotypes were 21-24 mm and 45-45 mm in the first and second year, respectively. The results obtained from this study were slightly higher than their findings. The reasons of differences could probably be due to the climatic conditions and genetic variation of genotypes. Leaf numbers of *Bitbit* genotypes varied from 9 to 41 with 23.36 mean in the first year and between 21 and 80 with 48.67 mean in the second year. Increasing of leaf number in the second year was a consequence of plant height and branch number (Table 1). Parallel to increasing of leaf number, leaf ratio also increased. The first and second year average leaf ratio values were 63.31% and 70.04%, respectively (Table 1). Acar *et al.* (2016), reported that leaf ratio of *Bitbit* genotypes alters from 30.8% to 78.5% according to development stage. Leaf ratio values obtained from this research support Acar *et al.* (2016) findings.

Table 1. Some agronomic traits of *Bitbit* genotypes

Traits	2013			2014		
	Mean	SE	Range	Mean	SE	Range
Plant height (cm)	62.03	2.45	34.70 – 114.35	95.31	1.70	65.00 – 147.60
Branch number	8.24	0.50	2.00 – 18.00	17.75	0.65	8.00 – 39.00
Stem thickness (mm)	5.42	0.15	3.39 – 8.21	7.91	0.15	4.50 – 12.27
Leaflet width (mm)	23.62	0.75	15.89 – 36.87	23.58	0.60	10.65 – 37.25
Leaflet length (mm)	50.38	1.39	30.14 – 68.76	49.13	1.10	22.74 – 71.46
Leaf number	23.36	1.42	9.00 – 41.00	48.67	1.39	21.00 – 80.00
Leaf ratio (%)	63.31	1.97	32.23 – 88.08	70.04	0.53	56.15 – 82.16
Head number/plant	28.01	1.94	4.00 – 92.00	370.62	17.54	12.00 – 892.00
Flower number/head	15.01	0.41	7.00 – 24.00	13.37	0.32	7.00 – 20.00
1000 seed weight (g)	30.14	0.44	20.45 – 44.66			
Hard seed ratio (%)	92.20	0.48	97.64 – 76.67			

Head numbers per plant counted at *Bitbit* genotypes were 4-92 in the first year, while it changed from 12 to 892 in the second year. Mean values about head number were 28.01 and 370 the first and second year, respectively (Table 1). The increase of head number in the second year could be attributed to increase of plant height and branch number. Similar increase in the second year was observed by Gulumser and Acar (2012). In the contrary of head number, flower numbers per head decreased in the second year. While mean flower number was 15 in the first year, it declined to 13.4 in the second year. Parallel to average flower number, variation amongst the genotypes also declined (Table 1). The results similar to Gulumser (2011) that he determined the flower numbers as between 4.5 to 19.5 per head and Davis (1970) who indicated flower number 7-30. 1000 seed weight values were found between 20.45 and 46.66 grams with 30.14 gram mean according to genotypes. Average hard seed ratio was 92.20% and it ranged from 76.67% to 97.64% (Table 1). 1000 seed weight of *Bitbit* was reported between 20 and 29 grams by Correal *et al.* (2008) in Spain. The differences in environments and genotypes might affect the the variation in 1000 seed weight. Correal *et al.* (2008) found that hard seed ratios of Spanish *Bitbit* genotypes altered from 39% to 98%. Considering all investigated morphological characters, there were significant differences amongst the genotypes, except for hard seed ratio. These results could be promising to develop high yielding and high quality cultivars.

Table 2. Some chemical traits of *Bitbit* genotypes

Traits	2013			2014		
	Mean	SE	Range	Mean	SE	Range
Crude protein (%)	20.32	0.36	15.22 – 25.95	14.93	0.26	8.42 – 23.11
Ca (%)	1.53	0.02	1.23 – 1.88	1.62	0.01	1.31 – 1.86
K (%)	2.17	0.03	1.55 – 2.66	1.73	0.04	0.66 – 2.62
Mg (%)	0.44	0.01	0.35 – 0.56	0.45	0.01	0.37 – 0.56
P (%)	0.36	0.01	0.32 – 0.40	0.33	0.03	0.25 – 0.39
ADF (%)	33.93	0.99	23.69 – 43.91	32.72	0.35	25.48 – 41.64
NDF (%)	44.11	1.03	39.24 – 51.83	42.76	0.37	34.16 – 52.62

Crude protein ratios of *Bitbit* genotypes varied between 15.22% and 25.95% with 20.32% mean in the first year and it altered from 8.42% to 23.11% with 14.93% mean value in the second year (Table 2). Crude protein ratios of *Bitbit* leaves were higher than those in stems. The leaves and stems had 22.35-25.60% and 11.37-14.06% crude protein, respectively (Gulumser *et al.* 2010). Crude protein ratios of *Bitbit* genotypes varied from 23.41% at pre-elongation stage to 7.28% at seed setting stage (Acar *et al.* 2016). Some previous researchers determined crude protein ratio of *Bitbit* as 10.3-20.4% (Ventura *et al.* 2004; Pecetti *et al.* 2007). Calcium and magnesium contents of *Bitbit* genotypes increased from 1.53% to 1.62% and from 0.44% to 0.45%, in the first and second years respectively, while potassium and phosphorus contents decreased from 2.17% to 1.73% and from 0.36% to 0.33% (Table 2). These results supported to Ventura *et al.* (2004) that they reported calcium, phosphorus, magnesium and potassium ratios of *Bitbit* as 0.86-1.13%, 0.25-0.32%, 0.18-0.26% and 0.26-0.33%, respectively and Acar *et al.* (2016), those findings were 1.30-1.87% as calcium, 0.18-0.40% as phosphorus, 0.35-0.40% as magnesium and 0.51-2.59% as potassium. ADF and NDF ratios slightly reduced from 33.93% to 32.72% and from 44.11% to 42.76%, respectively in the second year (Table 2). These reduce could be attributed to increase of leaf ratio in the second year (Table 1). Gulumser (2011) explained that ADF and NDF ratios of *Bitbit* leaves were lower compared to stems. Similarities were found between these results and some previous researcher findings that they reported ADF and NDF values as 23.8-41.9% and 38.0-56.3%, respectively (Ventura *et al.* 2004; Pecetti *et al.* 2007; Gulumser and Acar, 2012).

Table 3. Some agronomical traits of *Bitbit* genotypes

Traits	2013			2014		
	Mean	SE	Range	Mean	SE	Range
Hay yield (g/plant)						
1. Harvest	5.78	0.45	1.04 – 14.92	295.38	15.89	83.31 – 780.90
2. Harvest	2.18	0.19	0.33 – 5.49	85.38	6.49	24.61 – 283.75
Sum	7.86	0.58	1.04 – 17.27	380.76	19.74	83.31 – 994.86
Seed yield (g/plant)	7.42	0.63	0.52 – 33.28	85.22	5.58	1.77 – 261.94

There was stem elongation on 41 genotypes out of 86 in the first year (2013). But, hay yield of the genotypes was quite low in the first year. While hay yield/plant altered from 1.04 g to 14.92 g at the first harvest, the data decreased to 0.33-5.49 g at the second harvest in 2013 (Table 3; Figure 1). In the second year (2014) all of the genotypes had stem elongation and two cuts were done in 55 genotypes. Hay yield figures significantly increased to 83-780 g at the first harvest of the second year. At the second harvest hay yields of the genotypes sharply decreased and the numbers were between 24.61 and 283.75 g. Considering total hay yield, more or less 1 kg hay

yield per plant was obtained from some genotypes in 2014 (Table 3). Acar *et al.* (2016) have reported that they took 205 g/plant hay yield as the average of 25 *Bitbit* genotypes. Decreasing yield after the first harvest is very common for all perennial forage crops (Acar and Ayan, 2012). Seed harvest was performed only for the first development of the genotypes in both years. Average seed yields were 7.42 g and 85.22 g/plant in the first and second years, respectively. Seed yield of some genotypes exceeded 250 g/plant in 2014 (Table 3; Figure 2). Similar to hay yield, seed yields of the genotypes were increased in the second year. Increasing of the yields in the second year could be attributed to second year effects for perennials and favourable climatic conditions.

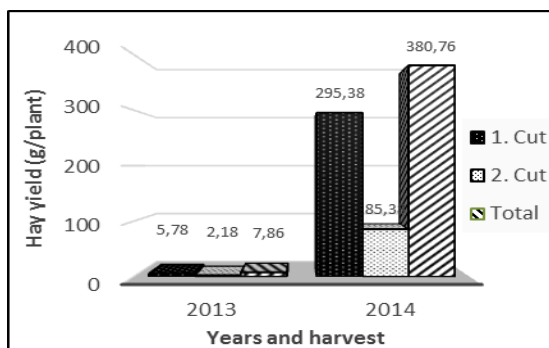

Figure 1. Hay yield of *Bitbit* genotypes

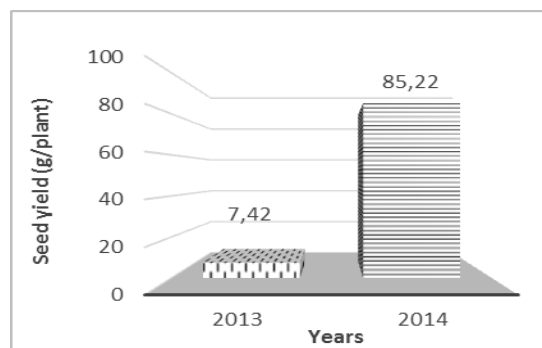

Figure 2. Seed yield of *Bitbit* genotypes

Table 4. Linear correlation amongst hay and seed yields and some other traits

Traits	Hay yield	Seed yield
Plant height	0.728**	0.277*
Stem thickness	0.188	0.249*
Branch number	0.251*	0.021
Leaf number	0.284**	0.242*
Leaf ratio	-0.335**	-0.209
Head number	0.243*	0.591**
Flower number	0.218*	0.369**
1000 seed weight	-0.097	0.248*
Seed yield	0.233*	-

There is a significant positive correlation between hay yield and branch number, head number, flower number, seed yield ($P \leq 0.05$); significant positive correlation between hay yield and plant height, leaf number ($P \leq 0.01$) and significant and negative correlation between hay yield and leaf ratio ($P \leq 0.01$). In terms of seed yield, correlation with plant height, stem thickness, leaf number and 1000 seed weight were positive and significant ($P \leq 0.05$); with head number and flower number, it was positive and significant at $P \leq 0.01$ level (Table 4). As plant height, branch number, leaf number and head number increase, hay yield also increased (Gulumser, 2011).

Conclusion

There was significant variation amongst the genotypes in terms of morphological and agronomical characters. In addition to high nutritious value, some of the genotypes have high forage yield. Although, almost all cool season plants dry, *Bitbit* genotypes kept greenery throughout the summer period. Considering the all results and global warming *Bitbit* could be a promising plant for forage production in Regions that have Mediterranean climate.

Acknowledgement

Thanks to Turkish Scientific Technical Research Council (TUBITAK) because of financially support the Project (Grant No: TOVAG 111 O 651).

References

- Acar, Z. and I. Ayan, 2012. Forage Culture. OMU Zir. Fak Yay. Ders Kitabı No. 2, p.175, Samsun, TURKEY.
- Acar, Z., F. Kumbasar, I. Ayan, M. Can, E. Tuzen, S. Zeybek and G. Kaymak, 2016. Effects of Plant Development Phases on Some Morphological, Agronomical and Chemical Traits of *Bituminaria bituminosa* Genotypes. Options Mediterraneennes No. 114, p.169-172, Orestiada, Greece.
- Antoloji com. <http://www.antoloji.com/iklim-degisikligi-2030-da-tum-siddetiyle-kendisini-hissettirecek-siiri/> (13.07.2011).
- Correal, E., Hoyos, A., Rios, S., Méndez, P., Real, D., Snowball, R., Costa, J., 2008. Seed production of *Bituminaria bituminosa*: size. Production. Retention and germination capacity of the legumes. In 'Options Méditerranéennes'. Elvas, Portugal, p. 379-383.
- Davis, P.H., 1970. Flora of Turkey and the East Aegean Islands. Vol. 3. p. 263-264, Edinburgh.
- Gutman, M., Perevolotsky, A., Sternberg, M., 2000. Grazing effects on a perennial legume. *Bituminaria bituminosa* (L.) Stirton. in a Mediterranean rangeland. In Black Sea Region. Options Mediterraneennes. A no. 92. 299-303.
- Gulumser, E., Başaran, U., Acar, Z., Ayan, I., Mut, H., 2010. Determination of some agronomic traits of *Bituminaria bituminosa* accessions collected from Middle Black Sea Region. Options Mediterraneennes. A no. 92. 105-108.
- Gulumser, E. 2011. Characterization and determination of agricultural characteristics of *Bituminaria bituminosa* L. genotypes naturally at the Central Black Sea Region of Turkey. OMU Sci. Inst. Ms thesis, p.72, Samsun, Turkey.
- Gülümser, E., Acar, Z., 2012. Morphological and chemical characters of *Bituminaria bituminosa* (L.) C.H. (Stirton) grown naturally in the middle Black Sea Region. Turkish Journal of Field Crops, 17(2): 101-104.
- Méndez, P., Fernández, M., 1990. Interés forrajero de las variedades de *Bituminaria bituminosa* (L.) Stirton ("tedera") de Canarias. In 'XXX Reunion científica de la sociedad Espanola para el estudio de los pastos'. Donostia-San Sabastian p.264-272.
- Munoz A, Ortiz-Dorda J and Correal E, 2000. Morphological and molecular characterization of *Bituminaria bituminosa* accessions from South-East Spain and the Canary Islands. Cahiers Options Mediter 45:103–107.
- Otal J, Correal E and Belmonte C, 1991. Variaciones estacionales de la palatabilidad y consumo por el ganado ovino de diversos arbustos forrajeros preseleccionados en el SE espa ~ nol. Actas dela XXXI Reuni'on Cient'ifica de la SEEP, Almer'ia, pp. 353–357.
- Pecetti L.,Tava A., Pagnotta M A., and Russi L., 2007. Variation in forage quality and chemical composition among Italian accessions of *Bituminaria bituminosa* (L.) Stirt. J Sci Food Agric 87:985–991.
- Ventura MR, Mendez P, Flores MP, Rodr'iguez R and Castanon JIR, 2000. Energy and protein content of tedera (*Bituminaria bituminosa*). Cahiers Options Mediter 45:219–221.
- Ventura, M.R., Castanon, J.I.R., Pieltain, M.C., Flores, M.P., 2004. Nutritive value of forage shrubs: *Bituminaria bituminosa*, *Rumex lunaria*, *Acacia salicina*, *Cassia sturtii* and *Adenocarpus foliosus*. Small Rumin. Res. 52, 13-18.

Viano J, Masotti V, Gaydou EM, Bourreil P, Ghiglione C and Giraud M, 1995. Compositional characteristics of 10 wild plant legumes from Med. French past. *J Agric Food Chem* 43:680–683.

VARIABILITY OF COCKSFOOT (*Dactylis glomerata* L.) AUTOCHTHONOUS POPULATIONS COLLECTED IN SERBIA

Snezana BABIC^{1*}, Dejan SOKOLOVIC¹, Jasmina RADOVIC¹, Zoran LUGIC¹, Snezana ANDJELKOVIC¹, Tanja VASIC¹, Aleksandar SIMIC²

¹Institute for forage crops, 37251, Globoder, Krusevac, Serbia

²Faculty of Agriculture, Zemun, University of Belgrade, Serbia

*Corresponding author: snezana.babic@ikbks.com

Abstract

Cocksfoot (*Dactylis glomerata* L.) is one of the most important cool season perennial grasses used for animal feed production on grasslands and pastures. It shows a high yield of quality forage as a component of different grass legume mixtures with more than five years of utilisation. Basic requirement for successful breeding of this species, as well as other, is variability of the initial material. The collection examined consisted of twenty two autochthonous populations of cocksfoot collected in hilly-mountainous areas of Serbia. Trial was conducted as spaced plant nursery with 30 plants per genotype in two years. The aim was to determine genetic variability for the most important phenological (heading date), morphological traits (plant height, length of leaf, width of leaf, the leaf number, panicle length and the number of tillers per plant) and dry matter yield per plant. Investigated material has demonstrated significant variability within the genotypes for all studied parameters. The highest average within population variability was determined for dry matter yield (CV 95%), while the lowest variability was determined for date of heading (CV 24%). The highest dry matter yield per plant was measured in the population of Čestobrodica 1, Grza and Boljevac 3 locality. The data were analysed by ANOVA. Among populations variability was high statistically significant for all investigated traits. Genetic diversity of examined cocksfoot autochthonous populations was illustrated by cluster analysis. High level of genetic variability in this collection indicates that the cocksfoot breeding process can make progress in the further.

Key words: *cocksfoot, variability, autochthonous populations, dry matter yield*

Introduction

Cocksfoot is one of the most important forage perennial grasses in Europe and Serbia also. Forage breeding of this species is very intense recent decades. As component of different sown grass-legume mixtures, it shows high and stable yield of quality forage (Balan et al., 2006; Kyriazopoulos et al., 2008). If it is cut frequently, the quality of cocksfoot dry matter can be compare with the quality of perennial ryegrass (Turner et al., 2005). Cocksfoot is a forage species with great adaptability, which has a good tolerance to frost, shade (Rodriguez-Barreira et al., 2008), heat and drought. It has good regrowth ability. In Serbia, cocksfoot (*Dactylis glomerata* L.) is a characteristic species of grasslands from the alliance *Arrhenatherion elatioris* with a different presence and covering. In natural habitats it occurs on various meadows in moderately moist soils, from lowland to mountain habitats over 1000 m a.s.l. (Sokolović et al., 2003) especially in shady places such as sparse woods, wood edges and abundant orchards.

First step in grass breeding process is the determination of genetic variability of breeding material. The existence of genetic variability in available breeding material influences the choice of breeding material and ensures success of a plant breeding program. Autochthonous populations demonstrate great adaptability to different macro and micro habitats varying in traits of adaptive significance and often can be used for direct phenotypic selection and for cultivars release (Posselt and Willner, 2007). The genetic variability of all the agronomical traits important for breeding represents a basic prerequisite for successful selection (Christie and Krakar, 1980). The primary aim in cocksfoot forage breeding is obtaining cultivars with a high yield and quality for livestock feed (Casler et al., 2000). The aim of this investigation was to define genetic variability of 22 cocksfoot autochthonous populations collected in hilly-mountainous areas of Serbia. The most important breeding criteria in cocksfoot breeding programs, as well as other forage grasses, were increasing of forage yield, disease resistance and drought and frost tolerance. One more objectives in many cocksfoot breeding programs on all continents are improvement of resistance to stem rust (*Puccinia graminis*) (Alderson and Sharp 1995). Since is cocksfoot regular component of grass-legume mixtures in Serbia, dry matter yield and quality, persistency and rust resistance and different maturity time is most important breeding criteria of this species.

Material and methods

A collection consisting of 22 autochthonous populations of cocksfoot was investigated during a two years period (2012 and 2013). Autochthonous populations have collected in hilly-mountainous areas of Serbia (Table 1.).

Table 1. Origin of the cocksfoot autochthonous populations

No	Collecting site	Altitude (m a.s.l)	Geographic latitude	Geographic longitude
1	Neradje	1083	43°28'	19°36'
2	Dupci 2	347	43°21'	21°07'
3	Česma	998	43°27'	20°53'
4	Grza	323	43°53'	21°38'
5	Tripkova	789	43°49'	19°44'
6	Boljevac 2	478	43°50'	22°04'
7	M. Polje 2	695	43°31'	20°53'
8	Čestobrodica 1	568	43°50'	19°30'
9	Crni Vrh 1	759	44°08'	21°57'
10	Čestobrodica 2	590	43°51'	21°40'
11	Crni Vrh 3	812	44°09'	21°59'
12	Boljevac 1	467	43°50'	22°01'
13	Željini 1	433	43°50'	22°00'
14	Crni Vrh 2	843	44°11'	21°59'
15	Balašević	765	43°45'	22°00'
16	Boljevac 3	470	43°50'	22°02'
17	M. Polje 1	558	43°28'	20°56'
18	Draglica	962	43°34'	19°45'
19	Borova Glava	1100	43°40'	19°44'
20	Farma Zlatibor	1005	43°43'	19°43'
21	Šuljagići	1106	43°38'	19°44'
22	Kremna	1018	43°42'	19°41'

Investigation was conducted in an experimental field of the Institute for Forage Crops, on degraded alluvium soil type. The trial was set up in a space plant nursery with plant to plant distance 60x60cm as a randomized block design with 30 plants per population in three replications. Heading date (HD) and morphological traits plant height (PH) (cm), leaf length (LL) (cm), leaf width (LW) (cm), the number of leaves per tiller (NLT), panicle length (PL) (cm), the number of tillers per plant (NTP) and dry matter yield (DMY) (g per plant) were investigated in 2 years; results are shown as two-year mean values. Heading date is presented as number of days from April the first. All morphological traits and dry matter yield per plant were measured at the full heading stage in first cut. All data were analysed by ANOVA. Differences between accessions were tested by the LSD test. Broad sense heritability (h_b^2) was calculated for all traits according to the formula

$$h_b^2 = \frac{\delta_g^2}{\delta_f^2} \cdot 100$$

(δ_g^2 -genetic variance; δ_f^2 - phenotypic variance)

Cluster analysis was performed by the Ward method, using the Euclid distances (Statistica 8.0, Stat Soft.inc).

Results and discussion

Analyses of maturity, morphological traits which influence dry mater yield and quality, as well as biomass production of cocksfoot populations, showed high within population variability (Table 2.). Also, highly significant differences between cocksfoot autochthonous populations were determined for all studied traits (LSD values in Table 2.).

From the point of grass breeding, heading date is a very important trait, because accessions differing in this trait would enable creating of cultivars with diverse maturing time. This is of interest for the composition of mixtures for various terms and duration of utilization (Sokolović et al., 2010). The earliest heading dates were found in population Grza, while heading occurred last in population Neradje.

The average plant height in the first cut was 78.21cm, which is substantially similar to results published by Sokolović et al. (2016), who reported plant heights of 59.13–101.3cm, in average 76.64cm.

Leaf length and width and number of leaves per plant influence the forage quality by increasing the dry matter quality and improving the crude protein content. Populations Neradje, Balašević, Česma, M. Polje 2, Draglica, Kremna and Dupci 2 have a favourable ratio of leaf length and width and number of leaves per plant, which indicated that these populations have the best biomass quality.

In grasses, number of tillers per plant in the first cut (NTP) is the trait which has the highest impact on DMY, but number of tillers per plant also affects other important traits like seed yield. The highest NTP were found in populations Kremna (108.12), Boljevac 3 (107.75), Boljevac 2 (103.87) and Neradje (101.70). These are similar to the NTP reported by Sokolović et al. (2016), but higher than the published Babić et al. (2009) where the average number of tiller per plant was 49.26. Large variations in NTP between studies are expected, since the trait is highly affected by environmental conditions.

Dry matter yield per plant is one of the most important traits in the breeding process. The ultimate goal is to increase the yield of dry matter, or maintain the yield through improving of

other traits. The yield is very variable trait, influenced by a large number of genes, and largely depends on the present agroecological conditions. For the populations Čestobrodica 1, Grza and Boljevac 3 were scored the highest dry matter yield per plant (148.09, 135.84 and 123.49g). Average dry matter yield of collection was 109.33g per plant which is significantly lower compared to the results reported by Sokolović et al. (2016), where the two years average dry matter yield per plant was 142.58g.

Obtained results show a very high variability within populations for the most important traits, as indicated by the high coefficients of variation (Table 2.). Coefficients of variation were especially high in production traits such as number of tillers per plant (90.32%) and dry matter yield (95.03%), while heading date showed the lowest within population variability (23.99%).

Table 2. Average trait values and variability of cocksfoot autochthonous populations

Trait	HD	PH	LL	LW	NLT	PL	NTP	DMY
Population		cm	cm	cm		cm		g/plant
Neradje	36,63	92,00	24,85	0,76	2,89	15,69	101,70	118,74
Dupci 2	31,74	90,38	22,56	0,78	3,00	11,64	93,19	117,71
Česma	32,86	88,83	23,50	0,74	2,72	15,03	91,16	108,00
Grza	30,00	87,62	19,69	0,69	2,73	11,41	98,32	135,84
Tripkova	32,11	81,52	18,30	0,68	2,60	12,03	91,03	107,80
Boljevac 2	29,59	80,00	18,48	0,48	3,13	8,42	103,87	120,56
M. Polje 2	30,34	86,50	22,20	0,63	3,05	11,21	98,03	120,52
Čestobrodica 1	32,57	93,48	21,16	0,65	2,94	12,98	88,87	148,09
Crni Vrh 1	33,44	81,27	20,22	0,66	2,50	13,05	86,53	103,11
Čestobrodica 2	30,97	77,57	19,23	0,64	2,83	8,47	86,11	103,34
Crni Vrh 3	32,57	68,13	18,06	0,52	2,87	10,15	95,85	111,13
Boljevac 1	34,10	66,73	16,69	0,63	2,58	9,83	88,59	102,99
Željini 1	33,89	66,70	19,31	0,59	2,78	10,06	83,70	100,27
Crni Vrh 2	33,06	65,05	19,37	0,63	2,94	9,74	86,33	93,91
Balašević	33,00	83,50	23,82	0,70	2,81	13,72	82,29	102,51
Boljevac 3	30,50	76,32	20,37	0,77	2,79	12,74	107,75	123,49
M. Polje 1	32,50	71,00	23,23	0,79	2,78	12,13	86,13	96,05
Draglica	32,42	69,13	23,02	0,74	3,17	11,99	92,44	95,65
Borova Glava	31,69	80,78	21,67	0,69	2,71	14,91	89,00	99,71
Farma Zlatibor	33,00	67,22	20,80	0,78	3,00	15,35	81,09	96,84
Šuljagići	32,17	60,13	17,74	0,62	2,63	9,72	79,78	91,60
Kremna	32,13	86,89	22,90	0,95	2,58	15,29	108,12	107,48
Average	32,33	78,21	20,78	0,69	2,82	12,07	91,81	109,33
LSD	0,05	5,41	16,15	3,20	0,17	0,41	2,90	12,72
	0,01	7,24	21,61	4,29	0,23	0,55	3,88	17,02
CV%		23,99	25,30	24,76	24,90	25,97	30,13	90,32
$h_b^2\%$		12,33	34,52	55,30	38,75	18,62	56,49	58,77

HD - heading date (number of days from April the first); PH - plant height; LL - leaf length; LW - leaf width; NLT - number of leaves per tiller; PL - panicle length; NTP - number of tillers per plant; DMY - dry matter yield per plant

Broad sense heritability was high for number of tillers per plant (58.77%), panicle length (56.49%), leaf length (55.30%) and dry matter yield (53.51%) which indicates that an improvement of these traits could be possible and predictable in these collections. The lowest

broad sense heritability determined for heading date (12.33%) and number of leaf per tiller (18.62%). Broad sense heritability values was significantly less compared to the results reported by Babić et al. (2009), who found high broad sense heritability (over 70%) for all studied traits, especially for heading date where broad sense heritability was 93.0%.

In order to determine genetic distance between cocksfoot autochthonous populations a cluster analysis was performed. The cluster diagram showed three groups of accessions (Figure 1). The first group was formed by cocksfoot populations with high dry mater yield per plant. In this group, populations with highest dry matter yield per plant, Čestobrodica 1 and Grza make a separate subgroup.

Populations Česma, Tripkova, Crni Vrh 1, Borova Glava, Balašević and Čestobrodica 2 were clearly separated from other accessions by the values for all studied traits in range with average values for collection.

Populations Boljevac 1, Željina 1, Crni Vrh 2, M. Polje 1, Draglica, Farma Zlatibor and Šuljagići were the distant from the rest of the collection, due to minimum height of plants and the lowest dry matter yield per plant.

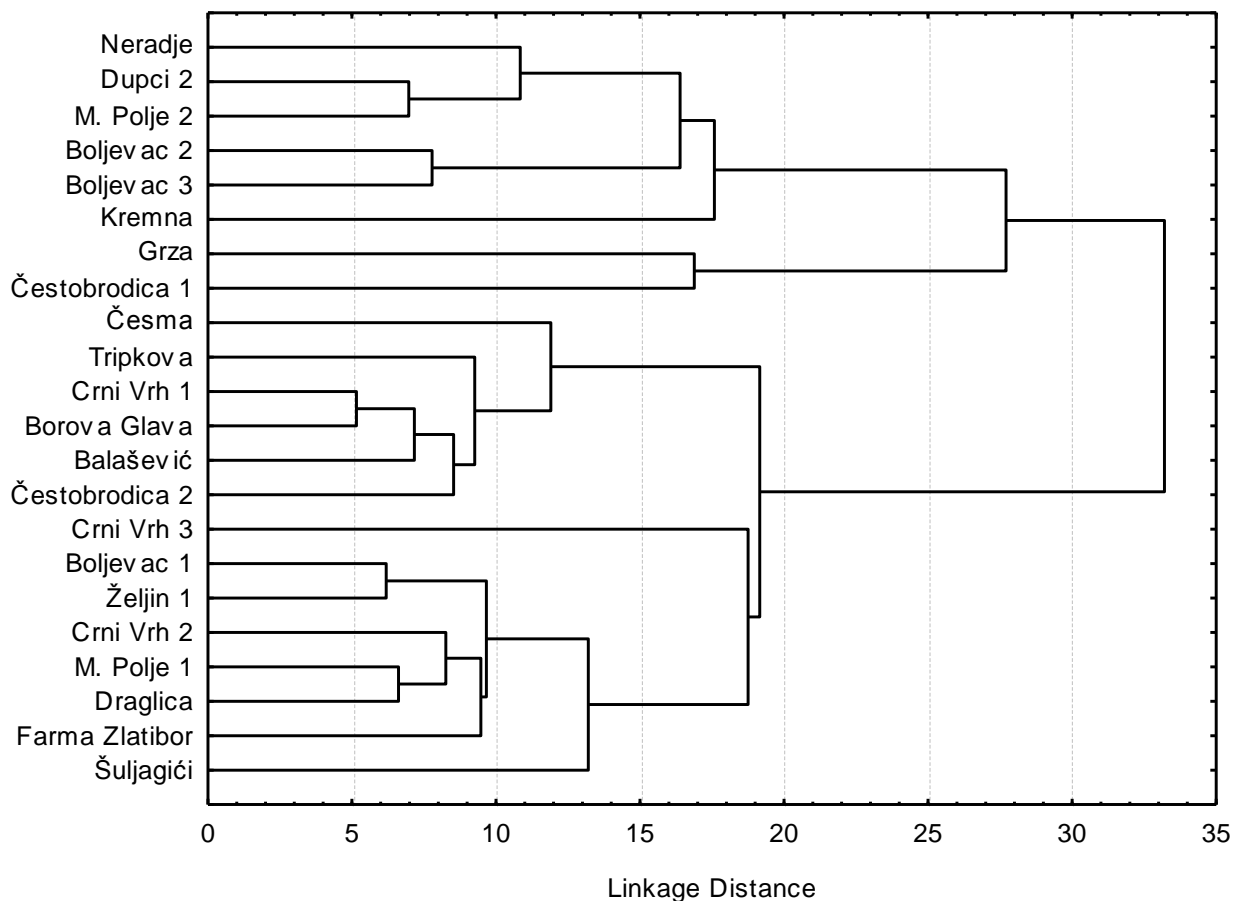

Figure 1. Dendrogram of cluster analysis of cocksfoot autochthonous populations based on eight traits

Conclusion

This study shows significant differences within and between cocksfoot autochthonous populations for studied traits. The highest number of tillers per plant and dry matter yield was obtained for populations Čestobrodica 1, Grza, Boljevac 3, Kremna, Boljevac 2 and Neradje. Populations Neradje, Balašević, Česma, M. Polje 2, Draglica, Kremna and Dupci 2 have the best ratio of leaf length and width, and the number of leaves per tiller, all components of dry matter quality. The average values, coefficients of variation and broad sense heritability for number of tillers per plant and dry matter yield indicate a high breeding potential of investigated autochthonous populations of cocksfoot for these most important traits in cocksfoot breeding process.

Acknowledgment

Research was financed by Ministry of education, science and technological development Republic of Serbia, pr. TR31057.

References

- Alderson J., Sharp W.C. (1995): Grass varieties in the United States. CRC Press, Florida. USA.
- Babić S., Sokolović D., Radović J., Anđelković S., Jevtić G., Simić A. (2009): Breeding of cocksfoot (*Dactylis glomerata* L.) genotypes for orchard land planting. Alternative functions of grassland, Proceedings of the 15th European Grassland Federation Symposium, 7-9 September, Brno, Czech Republic, 345-348.
- Balan M., Breazu I., Oprea G., and Chiper C. (2006): The impact of perennial forage legumes in mixtures with cocksfoot. Grassland Science in Europe 11, 372-374.
- Casler M.D., Fales S.L., McElroy A.R., Hall M.H., Hoffman L.D., and Leath K.T. (2000) Genetic progress from 40 years of orchard grass breeding in N. America measured under hay management. Crop Sci. 40, 1019-1025.
- Christie B.R. and Krakar P.J. (1980): Performance of advanced generation hybrids of orchard grass (*Dactylis glomerata* L.). Canadian Journal Plant Science, 60, 479-483.
- Kyriazopoulos A.P., Abraham E.M., Parissi Z.M., and Nastis A.Z. (2008): Herbage production and nutritive value of *Dactylis glomerata* L. and *Trifolium subterraneum* L. alone and in mixture. Options Mediterraneennes, Series A, No. 79, 211-214.
- Posselt U.K., Willner E. (2007): Performance of *Lolium perenne* ecotypes in comparison with cultivars. Proceedings of Eucarpia fodder crops and amenity grasses section meeting, Perugia, Italia, 56-59.
- Rodriguez-Barreira S., Mosquera-Losada M.R., and Rigueiro-Rodriguez A. (2008): Effect of shading on biodiversity of cocksfoot (*Dactylis glomerata*) established sward. Grassland Science in Europe 13, 1004-1006.
- Sokolović D., Tomić Z., Mrfat-Vukelić S., and Radović J.(2003): Current state of *Lolium perenne* L. and *Dactylis glomerata* L. collections in Serbia. Czech Journal Genetics Plant Breeding, 39, 244-247.
- Sokolović D., Tomić Z., Babić S. (2010): Perennial forage grasses breeding in Serbia: achievements, limits and prospects. XII International Symposium on Forage Crops of Republic of Serbia, 26-28 May, Kruševac-Serbia, Biotechnology in Animal Husbandry, 26 (Spec. issue), Book1, 91-106.
- Sokolović D., Babić S., Radović J., Petrović M., Jevtić G. Lugić Z., Simić A. (2016): Evaluation of orchardgrass (*Dactylis glomerata* L.) autochthonous Serbian germplasm in pre-breeding.

Proceedings of the 31th Eucarpia fodder crops amenity grasses section, 13-17 September, Ghent, Belgium. In: I. Roldán-Ruiz, J. Baert, D. Reheul, (eds.): *Breeding in a World Scarcity*, 89-97.

Turner L.R., Donaghy D.J., and Lane P.A. (2005): The nutritional value of cocksfoot (*Dactylis glomerata* L) and perennial ryegrass (*Lolium perenne* L.) under leaf-stage based defoliation management. Proceedings of the XX International Grassland Congress, 226.

FRUIT CHARACTERISTICS OF THE FIVE MERLOT CLONES IN BELGRADE WINEGROWING REGION, SERBIA

Branislava SIVČEV¹, Zorica RANKOVIĆ-VASIĆ¹, Aleksandar PETROVIĆ², Kristina LEONTIĆ¹

¹Department of Horticulture, University of Belgrade, Faculty of Agriculture, Belgrade-Zemun, Serbia

²Department of Food technology and Biochemistry, University of Belgrade, Faculty of Agriculture, Belgrade-Zemun, Serbia

*Corresponding author: bsivcev@agrif.bg.ac.rs

Abstract

Cultivated the grapevine *Vitis vinifera* subsp. *vinifera* is one of the leading horticultural plants in the world. It was domesticated from wild dioecious species *Vitis vinifera* subsp. *sylvestris*. Today, cultivated grape vines known to manifest a greater diversity and heterozygous in comparing with wild vines. The selection process through further and closer history took place in two directions: spontaneous in nature and with the active participation of men in order to increase productivity grape and berries, sugar content and total acids. Vegetative propagation, expressed hermaphroditism with spontaneous hybridization have contributed significantly to the diversity of varieties. Clonal selection has contributed more variety and adaptability improved quantitative and qualitative characteristics. Merlo is a typical example. In Bordeaux keeps about 300 potential clones, 13 were approved and widely diversity in the world. And in other countries were selected clones of variety Merlo, in our experiment we included clones R12, R5 and I-ISV-F-V4 from Italy, as we include two clones 181 and 348 originated from Bordeaux. In addition to the yield and quality, we were interested indicators supplied the composition of the cluster and berries. The bigger cluster with low seeds in berry and low total acid is clone characteristic of the I-ISV-F-V4, while the per share of sugar in close clones 348 and R-12 chargers.

Key words: *Merlot, clone, yield, quality, composition of grape and berry*

Introduction

Variety Merlo is dominant red grapevine variety in Bordeaux and is grown on an area of 64416 ha or 65 % (van Leeuwen, 2014). Cabernet Sauvignon and Merlot are the two most common red varieties and it is estimated that each of the world cover 240 000 ha. The first description of the variety Merlo gave Oudar (1850) and Rendu (1857) (cited by Boursiquot et al., 2009). Merlo exhibited less sensitivity to powdery mildew and thus explains the rapid expansion of the late nineteenth century, not only in France but also in other wine-growing countries. Quality manifested in a soft and easy recognizable red wine is another important factor. Reviewing Application of DNA with 20 SSR markers was found that a variety Merlo obtained by spontaneous crossing varieties Magdeleine Noire des Charentes (mother) and Cabernet Franc (father) in Bordeaux (Boursiquot et al., 2009). Mother's provenance is not completely confirmed, and therefore further research. The fact is that the ancient-old variety was created from a population where individual can not be identified at the genetic level. Therefore, there is diversity within the varieties manifested in, for example. the size of the berries, sugar accumulation capacity during ripening. Beginning in the sixties of the twentieth century clonal selection was

aimed at creating a virus free planting material, increased productivity, high class and quality (Lacombe et al., 2004; Sivčev et al., 2012). Clonal selection of cultivars of *Vitis vinifera* L. has led to significant improvements in viticulture, especially in terms of quality and quantity of grapes (Sivčev et al., 2011). The variation in phenology are conditioned by Jones and Davis (2000), genotype, climatic conditions and geographical location. To date, these climate changes have had a relatively positive impact on the quality of grapes and wine, which was reflected in earlier maturation of grapes, sugar and richer in polyphenols, with a smaller proportion of "plant" character and the whole high fertility (Ruml et al., 2012). Versatile consideration of viticulture in the world imposes and the fact that the clonal selection was focused primarily on widespread varieties that have led to the impoverishment of the election of new clones. This impoverishment in fact canceled out any possibility of selection of new clones in the future (Roby et al., 2014). Therefore, the preservation of genetic resources of primary task and incorporates institutional clonal selection, mass selection, and private clonal selection (Sivčev et al., 2011). Today a high level of production is not the primary producer requirements, adaptability clone to external factors and / or tolerance to the disease are the new essential requirements (van Leeuwen et al., 2013; Ruehl et al., 2015).

The quality of the grapes at harvest is an essential element of quality wines. Studies have shown that different clones of the variety may show significant differences in the chemical composition of berries. Some clones have the capacity to produce a wine with pronounced color, or the aromatic profile and content of phenol (Ferrandino et al., 2010). Simplified procedure for the introduction of new varieties / clones in Serbia does not negate the research work that includes new and indigenous varieties / clones (Ranković-Vasić et al., 2015).

The aim of this study was to evaluate and determine the basic production features three clones created in Italy (R-12, R-5 and ISV-4) and two originating from France 181 and 348.

Materials and Methods

Studies have been conducted on the experimental field in Belgrade grape growing region (Experimental field 'Radmilovac' - Faculty of Agriculture, University of Belgrade) in the period between 2013 and 2015. So far, vineyard established between 2005 and 2006, with the planting space 3 x 1 m and this grapevine is in the form of asymmetric cordon with trunk of 0.8 m and loaded with 24 buds on average. The investigated clones were grafted at rootstock Kober 5BB. They differ by origin: Clones R12 and R3 come from Viva Cooperativa Raushedo, clone I-ISV-F-4 from Friuli Venezia Giulia both from Italy. Clones 181 and 348 came from France. Among the first admit clones in the year 1975 is clone 181 which it is grown and widely disseminate a total of 15 clones (INRA, 2007). The experiment included ten vines for each clone. In the vineyard were applied standard agricultural practices. The grape harvest was carried out at the stage of full ripening, is determined by the total number of bunches per vine, the yield of grapes per vine, sugar content, total acids in grape juice and weight of berries. The quality of grapes was determined on the basis of sugar content by Oechsle scale and total acid content was measured by titration method with n/4 NaOH in the must. The measured data were statistically analyzed using the software package Statistica (StatSoft, Inc.,Tulsa, OK, USA).

Results and discussion

Variability in crop yield and quality in every situation on the ground and breeders have been trying to understand for centuries. Perhaps one of the most common examples of these problems is the production of wine grape varieties Merlot why was started with clonal selection just in the second half of the twentieth century. The objectives of breeding and selection are to correct

fertility varieties to eliminate negative characteristics of grape bunches and maintain quality (Ruehl et al., 2015). Clonal selection contributes to preserving the biodiversity, where there are two options to choose first the dominant clone and several supporting, time is maintained yield and quality in approximately the same level, without major variations from year to year. Another option is to take on a given plot combines several related by boat feature, or with different characteristics (Zamuz et al., 2007; Sivčev, 2011a).

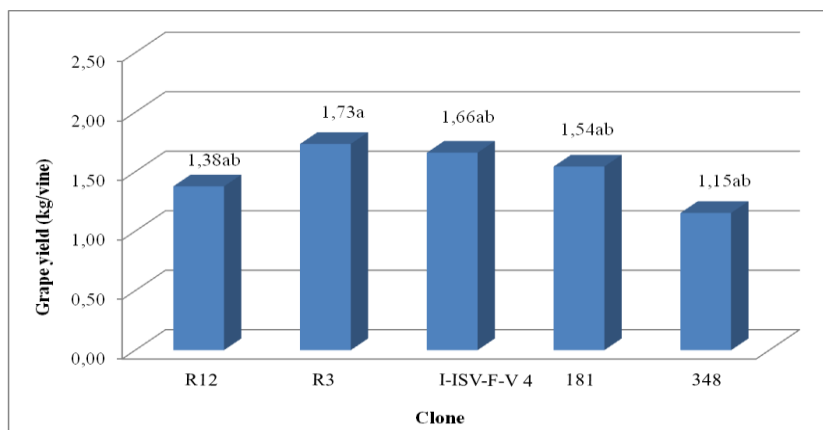

Graf. 1 Mean values of grape yield per vine of the investigated Merlot clones (average 2013-2015)

In the graph. 1 the results shows the tested clones of Merlo. In three years the highest yield is achieved as a clone R3, per unit area of one hectare is 5700 kg. At the same time this clone showed the least variability in the examined period. Close the specified value of the clones I-ISV-F-V4 and 181. After the number of bunches allocated to clone 348 with extremely low values, only 9.73 per vine. The average number of bunches per vine was uniform clones R12, R3 I-ISV-F and 181 and was about 19 bunches per vine.

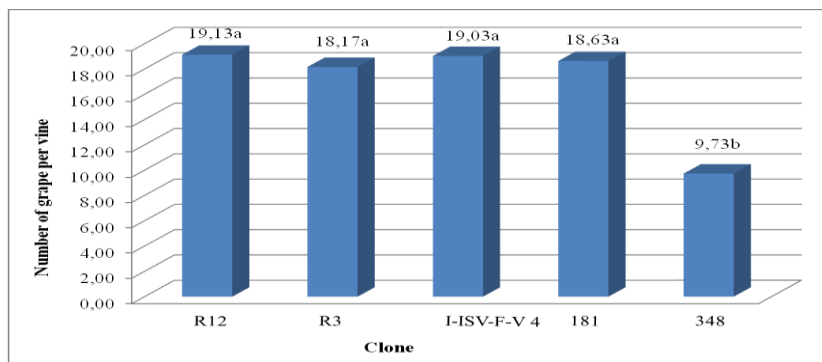

Graf. 2 Mean values of number of grape per vine of the investigated Merlot clones (average 2013-2015)

The results Dimovska et al (2011) realized in the period of full fruting are about the same compared with the clones R12, R3 I-ISV-F-V4 and 181, or clone with the lowest yield of the clone 348.

Comparing bunches noted that no major differences ie that the values in the range from 95-107 g (tab. 1). Merlot variety population as to the scores themselves Banjain and Kulina (2015) has a

small bunch of an average of 95.5 g of Trebinje (Bosnia and Herzegovina). Comparative results Pajović et al. (2011) where they were involved Skopje vineyard and the vineyard of Montenegro indicate that there is no variation in the thickness of the bunch variety Merlot. The larger bunches with larger berries, which is observed in clones 181, while all three clones originating in Italy with regard to this value is very similar. The grape bunches, sometimes winged, are packed with blue-black spherical grapes that have moderately thick skin and juicy, pleasant-tasting pulp (Galet, 2002). Wine from Merlot has a remarkable quality that is expressed after two to three years of aging. This is another reason why this variety with several clones meet in wine-growing region of the Balkans from Slovenia, Istria, Croatian in the continental part, through Bosnia and Herzegovina, Montenegro, Serbia and Macedonia (Žunić and Garić, 2010).

Table. 1 Mean values of yield components and grape quality of the investigated Merlot clones (average 2013-2015)

Characteristic						
Clone	Grape yield (kg·vine ⁻¹)	Number of grape per vine	Bunch weight (g)	Berry weight (g)	Sugar content (%)	Tit. acidity (g·L ⁻¹)
R12	1.38 ab	19.13 a	95.33 b	1.03	22.20	6.40
R3	1.73 a	18.17 a	99.67 ab	1.17	21.47	7.00
I-ISV-F-V 4	1.66 ab	19.03 a	103.00 ab	1.03	21.87	5.77
181	1.54 ab	18.63 a	111.33 a	1.24	21.30	5.87
348	1.15 b	9.73 b	107.00 ab	0.91	21.70	6.17

Mean values followed by the same letter do not differ significantly according to LSD test at P = 0.05

The high sugar content of must was found in all clones and their differences are lower than one percent. Insignificant better quality grape clones which originated in Italy in comparing from France. Van Leeuwen (2014) highlights that in the six-year period in several locations in Bordeaux value of Merlot's quality is 223 g/L. Acidity expressed in tartrate in region from Belgrade the tested clones is within the limits of 5.77 and 7 g/L. Slightly in excess cause the contents of total acids is in clone R3 in comparison with clones I-ISV-F-v4 and 181. In Skopje region (Dimovska et al., 2011) clones of clones 181, 348, R 12, and R 3 are accumulated more sugars as compared with the Belgrade region. Temperature conditions during the ripening grapes have a dominant influence on the quality. In the first and third year of tests achieved better quality grapes compared to another year. Year 2014 was extremely rainy, cold, and caused a lower sugar content in must. By choosing the place at least a two to three clones within each variety in the same locality achieved the continuity in the quality of planting a proven health clones provides the longevity yet.

Conclusion

Our results were given new information on growing clones of Merlo originating from France and Italy in Belgrade vineyard area.

Data show that the clones R3 and I-ISV-F-V4 are the most desirable in terms of the amount yield. The combination of clone R12 with the highest sugar content in expanding and clone R3 with the highest and the clone I-ISV-F-V4 with the lowest share of total acid will significantly contribute to the harmonious relationship between that two features. Clones 181 and 348 differ in size berries and confirm the differences in yield that they should be equal treatment.

Acknowledgement

This paper was realized as a part of the project "Studying climate change and its influence on the environment: impacts, adaptation and mitigation" (43007) and "Application of new genotypes and technological innovation in order to improve fruit and grape production" (31006) financed by the Ministry of Education and Science of the Republic of Serbia within the framework of integrated and interdisciplinary research for the period 2011-2015.

References

- Banjanin, T., Kulina, M. (2015): Technological characteristics of black wine varieties in the conditions of the Trebinje (Bosnia and Herzegovina) vineyard. Sixth International Scientific Symposium „Agrosym 2015“, 119-124.
- Boursiquot, J.M., Lacombe, T., Laucou, V., Julliard, S., Perrin, F.X., Lanier, N., Legrand, D., Meredith, C., This, P. (2009): Parentage of Merlot and related winegrape cultivars of southwestern France: discovery of the missing link. *Australian Journal of Grape and Wine Research* 15: 144-155.
- Dimovska, V., Ivanova, V., Serafimovska, A., Vojnoski, B., Ilieva, F. (2011): Comparison of four Merlot clonal selection from skopjes vineyard region, R. Macedonia. *Food science, engineering and technologies*, LVIII: 43-49.
- Ferrandino, A., Guidoni, S. (2010): Anthocyanins, flavonols and hydroxycinnamates: an attempt to use them to discriminate *Vitis vinifera* L. cv 'Barbera' clones. *European Food Research and Technology*, 230: 417-427.
- Galet, P. (2002): Grapes varieties. Hachette wine library, Paris.
- Institut Français de la Vigne et du Vin, INRA, Montpellier-SupAgro and Viniflor (2007): Catalogue des variétés et clones de vigne cultivés en France (Institut Français de la Vigne et du Vin: Le Grau-du-Roi).
- Jones, G.V., Davis, R.E. (2000): Climate influences on grapevine phenology, grape composition, and wine production and quality for Bordeaux, France. *American Journal of Enology and Viticulture*, 51: 249-261.
- Lacombe, T., Boursiquot, J.-M., Audeguin, L. (2004): Prospection, conservation et evaluation des clones de vigne en France. *Bull. OIV*, 77: 799-809.
- Pajovic, R., Popovic, T., Mijovic, S., Vukoslavljevic, V. (2011): Economic, technological and polyphenolic characteristics of Vranac, Kratosija and Merlot grapes varieties and wines in Montenegro and Macedonia. In: Blesic, M. (ed). Proc. 22nd International Scientific-Expert Conference on Agriculture and Food Industry, 2011, Neum, Bosnia and Herzegovina, 341-345.
- Ranković-Vasić, Z., Nikolić, D., Atanacković, Z., Sivčev, B., Ruml, M. (2015): Characterization and adaptation of some 'Pinot Noir' clones to the environmental conditions of Serbian grape growing regions. *Vitis* 54 (Special Issue), 147-149.
- Roby, J-P., van Leeuwen, C., Elsa Goncalves, E., Antonio Gracã, A., Martins, A. (2014): The preservation of genetic resources of the vine requires cohabitation between institutional clonal selection, mass selection and private clonal selection. *BIO Web of Conferences* 3, 01018: 1-6.
- Ruehl, E., Konrad, H., Lindner, B. (2015): Conserving and utilizing intra-varietal variation in grapevines (*Vitis vinifera* L.) *BIO Web of Conferences* 5, 01007: 1-3.
- Ruml, M., Vuković, A., Vujadinović, M., Đurđević, V., Ranković-Vasić, Z., Atanacković, Z., Sivčev, B., Marković, N., Matijašević, S., Petrović, N. (2012): On the use of regional climate

- models: Implications of climate change for viticulture in Serbia. *Agriculturač and Forest Meteorology*, 158-159: 53-62.
- Sivčev, B., Ranković-Vasić, Z., Radovanović, D. (2011): Clone selection autochthone and introduced grapevine varieties in the old grapevine planted areas of South Eastern and Eastern Serbia and preliminary check of their health status. *Genetika*, 43 (3): 465-475.
- Sivčev, B., Petrović, N., Ranković-Vasić, Z., Radovanović, D., Vuković, A., Vujadinović, M. (2011a): Effect of genotype–environmental interaction on phenotype variation of the bunch weight in white wine varieties. *Archives of Biological Sciences, Belgrade* 63(2): 365-370.
- Sivčev, B., Ranković-Vasić, Z., Nikolić, D, Ivanišević, D, Radojević, I., Atanacković, Z., Korac, N. (2012): Clonal research of black wine grape cultivars in different Serbian localities. *Proceedings . 47th Croatian and 7th International Symposium on Agriculture. Opatija. Croatia, 778–782.*
- Van Leeuwen, C., Roby, J.-P., Alonso-Villaverde, V., Gindro, K. (2013): Impact of clonal variability in *Vitis vinifera* Cabernet franc on grape composition, wine quality, leaf blade stilbene content and downy mildew resistance. *J. Agric. Food Chem.*, 61: 19–24.
- Van Leeuwen, C. (2014): Cabernet franc: experiences from Bordeaux for the Fingerlake wine industry. *Cabernet Franc in Bordeaux.*
- Zamuz, S., Martínez, M.C., Vilanova, M. (2007): Primary study of enological variability of wines from different clones of *Vitis vinifera* L. cv. Albariño grown in Misión Biológica de Galicia (CSIC). *Journal of Food Composition and Analysis*, 20: 591-595.
- Žunić, D., Garić, M. (2010): Special viticulture, *Ampelography II. Faculty of Agriculture, Belgrade.*

SOME PLANT PROPERTIES INTERACTIONS AND L-DOPA CONTENT OF FABA BEAN (*Vicia faba* L.) THAT DIFFERENT SOWING TIME

Nurdoğan TOPAL^{1*}, Hatice BOZOĞLU²

¹Department of Field Crops, Faculty of Agriculture and Natural Sciences, University of Usak, Usak, Turkey

²Department of Field Crops, Faculty of Agriculture, University of Ondokuz Mayıs, Samsun, Turkey *Corresponding author: nurdogan.topal@usak.edu.tr

Abstract

The study was carried out in Turkey's Samsun ecological conditions. The total of 26 genotypes (four of which cultivars) and two different sowing time (winter and early spring) were used in experiment that was conducted in a randomized block design with three replications. Winter sowing was made in November 2010 and spring sowing was made in March 2011. Winter and spring sowings effects was examined for biological yield, pod number, grain yield, protein content of the leaves, flowers and fresh fruit and L-Dopa (it is a metabolite used in the treatment of Parkinson's disease) content of the leaves, flowers and fresh fruit. L-Dopa content was determined by HPLC. The t-test was used for comparison of sowing times. According to t-test biological yield ($t = 23.19^{**}$), pod number ($t = 15.54^{**}$), grain yield ($t = 21.752^{**}$), crude protein content in leaves ($t = 8.052^{**}$) and the L-Dopa content in fruit ($t = 3.801^{**}$) were found with very significant differences regarding the sowing time and winter sowing came to the fore. Protein content of flowers ($t = 7.58^{**}$), protein content of fruit ($t = 2.91^{**}$), L-Dopa content of leaves ($t = 2,831^{**}$) and L-Dopa content of flowers ($t = 5, 54^{**}$) came to the fore for the spring sowing. When the results were evaluated, winter sowing seemed to be more advantageous than spring sowing.

Keywords: *Faba bean, Sowing time, L-Dopa, Yield components.*

Introduction

Faba bean, which is a cool season legume crops, is a multi-faceted plant used in human and animal consumptions (Crépon et al., 2010) and therefore it is a valuable product (Landry et al., 2016). According to Vavilov large grained faba bean origin is Mediterranean region. Turkey also is located in Mediterranean region (Özdemir, 2002). Faba bean cultivation is carried out in more than fifty five countries (Maalouf et al., 2013). The worldwide production is estimated to be approximately 3,398,330 tones, harvest area is estimated to be approximately 2,057,883 ha (FAOSTAT, 2013). And about %47 of these areas are located in Asia and this continent produces about %47.16 of faba bean grains (Kazemi et al., 2016). In Turkey, Faba bean harvest area was 5,911 ha, faba bean yield was 2,525.3 kg/ha and faba bean production was 14,927 tones (FAOSTAT, 2014). Faba bean is also important plant for nutrient value. 100 g dry faba bean has 26-34 g of Nitrogen, 2-4 g of Crude fat, 15-24 of Dietary fibre, 40-50 g of Starch and 2.1-2.3 g of Sucrose (Guillon and Champ, 2002). Faba bean with high protein and dietary fiber content and low fat and sugar content primarily located in protective foods against diseases such as obesity and cancer. Beyond the agricultural and nutritive properties of Faba bean contains L-Dopa active ingredients used Parkinson's disease (Topal and Bozoglu, 2016). L-Dopa naturally located in different plant parts such as seedlings, green pods and beans is the precursor of the neurotransmitter dopamine. The pods are used in the treatment of some disease like Parkinson, hypertension, renal failure and liver (Randhir et al., 2002). The chemical name is (S) -2-amino-3-

(3,4-dihydroxyphenyl) propanoic acid, chemical formula $C_9H_{11}NO_4$ and a molecular weight of 197.19 g/mol. The half-life of L-Dopa is 0.75-1.5 hours. L-Dopa is converted into dopamine in the brain and body. In the absence of dopamine, dopamine found in certain plants such as faba bean and then not pass the blood-brain barrier, which is the precursor of dopamine and L-Dopa can pass this barrier. In the human and animal body, "L-Dopa decarboxylase" where an enzyme called L-Dopa is decarboxylated to dopamine by metabolizing meat has been identified (Wikipedia, 2016).

Parkinson's disease is a universal disease and shows an increase of 5-19 per hundred thousand in a year. In recent years, studies of Parkinson's disease is not unique to the elderly, they have revealed that the 21-40 age group starts seen in humans. Studies show that in the young period Parkinson's disease depends on genetic factors rather than environmental factors. Frequency of a Parkinson's disease varies by country. In Parkinson's disease related studies have demonstrated the important factor is race. The incidence of Parkinson's disease is higher in Europe and North America, in the mid-rate in China and Japan, while the black race in Africa is low (who, 2006). Today the number of Parkinson's disease patients is 5 million and Parkinson's patients will be between 8.7 and 9.3 million by 2030 (Dorsey et al., 2007). The number of patients with Parkinson's disease in Turkey is approximately 100 thousand and 10,000 new patients are diagnosed every year (PHD, 2016). Researchers have investigated motor effects of Faba bean on Parkinson's disease. In study, for the L-Dopa is natural source of faba bean and L-Dopa is a treatment factor of Parkinson's disease six patients were examined in this context. As a result, the broad bean is pharmacologically sufficient amount of L-Dopa and emphasized to be used in the diet of patients with Parkinson's (Kempster et al., 1993). L-Dopa an effective used in drug composition for Parkinson's disease. For example L-Dopa-a-lipoic acid (LD-LA) is a new drug for the treatment of Parkinson's disease. L-Dopa half-life in human plasma is fifty minutes (Aurizio et al., 2011). Protein, fat, carbohydrates, vitamins and minerals on the source of plants can exist also in a protective effect against some diseases and problems. The use of such plants in complementary medicine is increasing day by day. The importance of Faba bean used in the treatment of Parkinson's disease will increase because the incidence of Parkinson's will increase in the elderly population in 25 years (Topal and Bozoglu, 2009). Faba Bean is a cool season legumes and it originate from Turkey. It also could be sown winter or spring. In this study is investigated whether sowing time effects on some plant parts L-Dopa content.

Materials and methods

Trial was carried out at 41°21'50.6"N 36°11'26.6"E locations in Samsun in Turkey. The altitude of the trial area is 197 meters. Soil analysis show that clay structure, neutral pH (6.887), unsalted (EC = 0.523 ds / m), organic matter the medium (%2.681) and rich in phosphorus content (64 333 ppm P). A humid and mild climate-type provision in Samsun is ongoing. Samsun thirty-five-year average shows that lowest temperature of February (approx. 3.7 degrees), the highest temperature in the month of August (approx. 27 degrees), and the least rainfall of the month July.

As materials, in the experiment were used broad bean varieties which are registered in Turkey (Eresen-87, Filiz-99, Kitik1-2003, Lara), 22 genotypes. Experiments were conducted in a randomized block design with three replications. Winter sowing was made in November 2010 and spring sowing was made in March 2011. The samples of leaves were taken before flowering, flowers were taken during the fifty percent flowering and fruits were taken during the fifty percent pod binding were weighed. After this samples were dried (at 45 °C) and milled. Samples were kept at 4 centigrade degrees for chemical composition analysis. Protein analysis was made by Kjeldahl method (Kacar and İnal, 2008). L-Dopa assay method was made by Shivananda et

al.(2003). Analysis was carried out in Thermo Separation with automatic sampling HPLC device (Detector:UV-280nm; Mobile Phase: Sodium dihydrogen orthophosphate; Analytical column: C18, 4.6x 250 nm; Flow rate: 2 ml / min). There was used six L-Dopa Standard (S₁:0,002 g, S₂:0,004 g, S₃:0,008 g, S₄:0,016 g, S₅:0,032 g, S₆:0,064 g.) to get regression curve and formula. Analysis of variance in some plants properties and L-Dopa content of faba bean was used and the t-test was used for comparison of sowing times with SPSS-13 software package.

Results and Discussion

The average number of pods in winter and spring sowing were found respectively 11.81 and 4.60 and this difference was statistically significant ($t=15.54^{**}$). The number of pods of genotypes ranged from 7.42-18.55 for winter sowing. For spring sowing, the number of pods of genotypes ranged from 3.31-7.15 and it was showed decrease of approximately %46. As a demonstrated in several studies carried out in legumes, the number of pods is one of the most important features directly associated with grain yield. Generally, the number of pods per plant affect grain yield positive (Mohamed, 1985; Ricciardi, 1985; Kıtıkı and Açıkğöz 1994; Bozoglu and Gulumser, 1994; Peksen and Gulumser, 2007). The number of pods per plant in Faba bean range from 1-9 (Akçin, 1988; Sehirali, 1988). Bozoglu and Gulumser (1994) reported that sowing time effect on pod number is important ($P<0.01$) and highest pod number derived from winter sowing on November 6 with 28.2 items. For pods numbers they also stated that November sowing was high rather than April. As a result of t-test it was found vary sowing time ($t=23,19^{**}$). While biological yield per plant was 64,3 g at winter sowing and this value was reduced up to 15,91 g/plant at spring sowing. In winter sowing biological yield ranged between 45.42-101.89 g/plant. Differently in spring sowing biological yield ranged between 10.58-24.06 g/plant. Mwanamwenge et al (1999) reported that there was a strong relationship between biological yield and grain yield ($r=0.89^{**}$).

While winter sowing grain yield was 27,92 g in spring sowing this figure reduced up to 5.98 g. Statistical result of the t-test showed that differences between winter and spring sowing ($t=21.752^{**}$). Winter sowing productivity (29.65 g/plant) is high rather than spring productivity (5.97 g/plant). In the same ecology, previous studies reported that grain yield per plant ranged 15-79.7 g. (Bozoglu, 1989), 11.9-19.5 g. (Gulumser and Bozoglu, 1994), 32.3-49.6 g. (Peksen and Gulumser, 2007). These results are similar to our results.

According to the result of t-test there was significant differences among the sowing times for leaves ($t=8.052^{**}$). The leaf protein ratio in winter sowing was found %42.01. For spring sowing leaf protein ratio was found %32.23. Mady (2009) reported that leaf protein rates varying ranges between percent 19-30. In their study Radwan et al (2010) reported that %30 total leaf protein ratio of faba bean. We think that differences in our study caused by cultivars. Significant differences were found between the sowing period in terms of protein content in flowers ($t=7.58^{**}$). Flowers protein ratio was found %45.35 in spring sowing time and %36.26 in winter sowing time. Widely grown broad bean varieties have a strong apical dormancy and indeterminate growth. Therefore, there is a high potential blooming (Sepetoglu, 1994). However, the pods replacement rate of broad bean flowers is low. Bozoglu (2005) demonstrated that fruit binding rate changed between percent 10.2 and 27.1. T-test results about fruit protein ratio showed that there were significant differences among spring and winter sowing ($t= 2.91^{**}$). In terms of fruits protein ratio spring sowing (%36.07) was higher than winter sowing (%32.30). Spring sowing fruit setting period is shorter than winter sowing and this shorter time leads to increased protein ratio proportionally. Because of short time, carbohydrates accumulate is low. Therefore spring sowing fruit protein ratio is higher than winter sowing.

Table1. Relations between the features.

FEATURES	BY	PN	GY	PCL	PCFL	PCFR	LCL	LCFL	LCFR
BY	1	0.991**	0.946**	0.664**	-0.627**	-0.444**	-0.287*	-0.442**	0.716**
PN		1	0.935**	0.645**	-0.627**	-0.452**	-0.282*	-0.417**	0.692**
GY			1	0.681**	-0.667**	-0.436**	-0.292*	-0.471**	0.661**
PCL				1	0.428**	-0.282*	-0.049	-0.370**	0.501**
PCFL					1	0.331*	0.112	0.459**	-0.460**
PCFR						1	0.098	0.113	-0.300*
LCL							1	0.239	-0.147
LCFL								1	-0.169
LCFR									1

BY: Biological Yield, PN: Pod Number, GY: Grain Yield, PLC Protein Content of Leaves, PCFL: Protein Content of Flowers, PCFR: Protein Content of Fruits, LCL: L-Dopa Content of Leaves, LCFL: L-Dopa Content of Flowers, LCFR: L-Dopa Content of Fruits.

When examining relationships between features (table 1) there are positive and significant relationship between L-Dopa content of fruit and biological yield, pod number, grain yield, protein content of leaf. Additionally there are negative and significant relationship between proteins contents of fruit and pod number, biological yield, grain yield and protein content of leaves. Once and for all there are negative and significant relationship between L-Dopa content of fruit and protein content of fruit. In a study conducted by Peksen (2006), Faba bean populations were investigated for relationships among traits of faba bean and there were put forward positive and significant correlation between grain yield and pod number (0.700**) and biological yield (0.648**). In yet another study faba bean, there were found positive and significant relationship among pod number and grain yield (0.760**), biological yield (0.727**) and grain yield (0.896**) but there are negative and insignificant relationship protein content of seeds and other traits (Beser and Adak, 1999).

Leaves L-Dopa content were found 19.48 mg/kg in winter sowing and 22.45 mg/kg in spring sowing and these differences were statically significant ($t=2.831^{**}$). Shetty et al (2003) reported that leaves L-Dopa content changed among 20 and 24 mg/g. When genotypes compared among themselves, B 15 (29.51 mg/kg) genotype is high from others at winter sowing, for spring sowing B 26 (30.32 mg/kg) genotype is high. In figure 1, leaves L-Dopa content of Genotypes are given. This result is higher than our result. It's also the reason why we think that the receipt of the leaves before flowering. This condition may be created difference.

Figure1. Leaf L-Dopa Content of Genotypes (mg/kg)

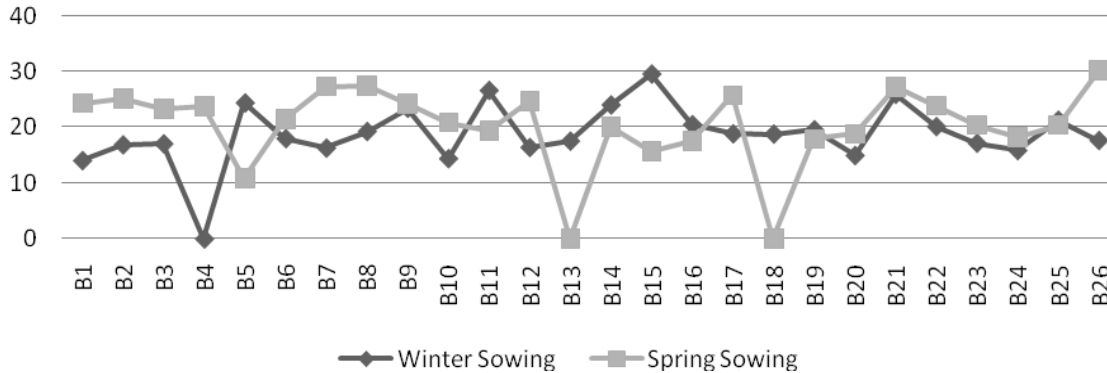

L-Dopa content of flowers was evaluated and it was observed that spring sowing (97.55 mg/kg) results was higher than winter sowing (78.93 mg/kg). According to t-test results this differences is significant ($t=5.54^{**}$). In terms of flowers L-Dopa content, genotypes compared in its genotype B 26 (97.60 mg/kg) is high than others in winter sowing. B 24 (109.95 mg/kg) genotype is also high than others in spring sowing. Flowers L-Dopa content of Genotypes are given at Figure 2. Cenarruzabeitia et al (1978) stated that L-Dopa amount increased parallel with plant growth with it and they reported that the flower's organs with the highest L-Dopa so these flowers may be used for medical purposes.

Figure2. Flowers L-Dopa Content of Genotypes (mg/kg)

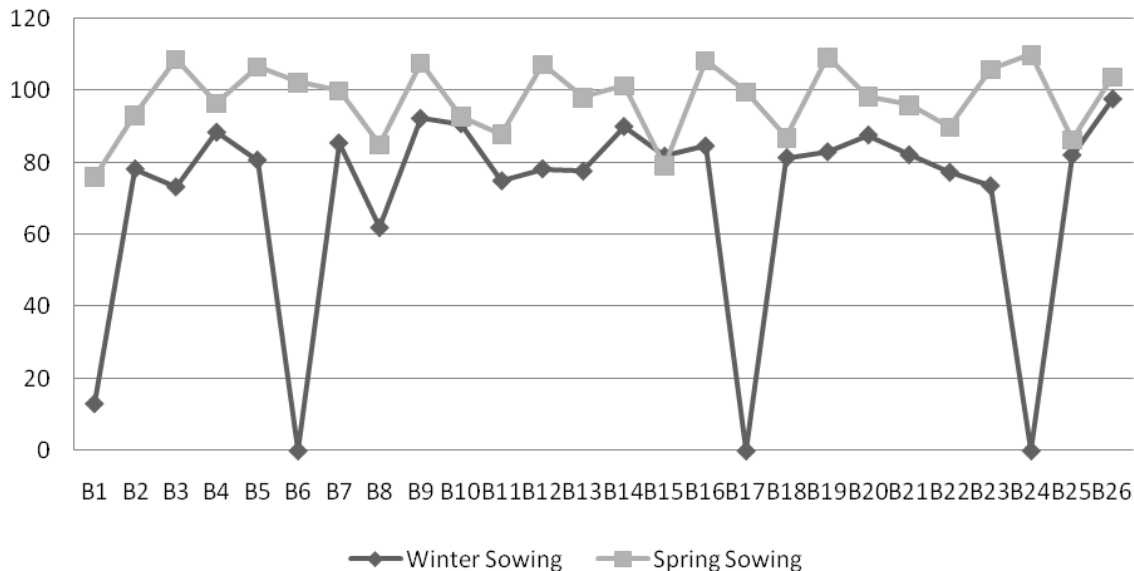

L-Dopa was investigated in fruit used human consumption and it was determined 1.52-79.9 mg/kg in fruit. There was significant differences among sowing times ($t=3.801^{**}$). While winter sowing L-Dopa ratio average was 29.59 mg/kg, spring sowing was 5.94 mg/kg. While B14 (52.73 mg/kg) genotype came to fore in winter sowing B7 (9.84 mg/kg) genotype came to fore in spring sowing. Fruit L-Dopa content of Genotypes are given at Figure 3. Holden (2006) reported that each 85 gram green pod contained 50-100 mg levedopa. Lattanzio et al (1983) found that per

dry matter of fruit contained %4 L-Dopa. We believe that our result differs with literatures due to different green pods harvest time.

Figure3. Fruit L-Dopa Content of Genotypes (mg/kg)

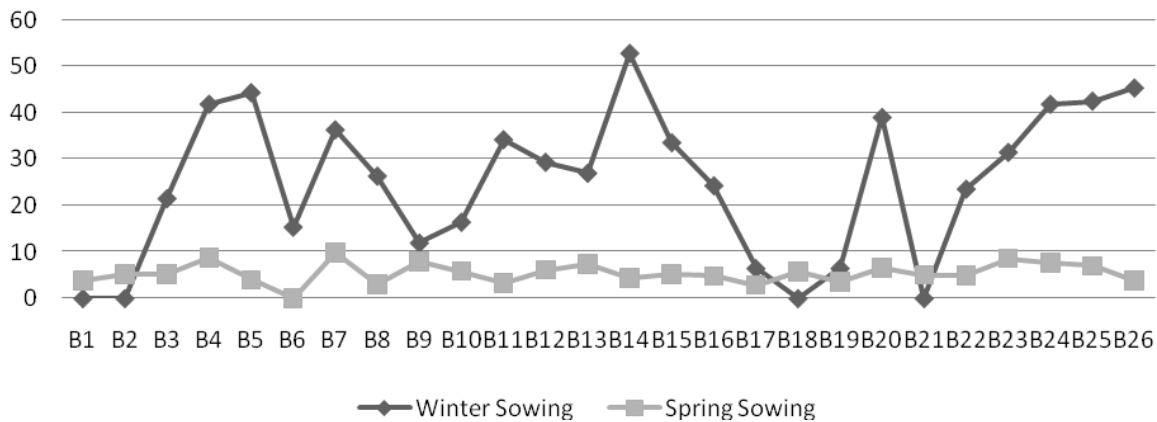

Conclusion

Our results are consistent with these findings. These data show us that L-Dopa content varying depending on the environment and climate conditions. If L-Dopa obtained from leaves and flowers spring sowing should be preferred if used fruit winter sowing should be preferred. Winter sowing is also recommended in terms of yield.

References

- Akcin, A., 1988. Edible Legumes. Selcuk University Publications: 43. Faculty of Agriculture Publications: 8. Konya, Turkey.
- Aurizio, E. D., Nostrum, C. F., Steenbergen, M. J., Sozio, P., Siepmann, F., Siepmann, J., Hennink, W. E., Di Stefano, A., 2011. Preparation and characterization of poly(lactic-co-glycolic acid) microspheres loaded with a labile antiparkinson prodrug. *Int J Pharm.* 16;409 (1-2):289-96.
- Beser, E., Adak, M. S., 1999. Effect Of Different Dose And Application Time Of Cycocel On Yield And Yield Components In Faba Bean (*Vicia faba* L.). *Central Research Institute of Field Crops Journal* (8), 1-2, 1999.
- Bozoglu, H. 1989. A study on growth status of faba bean types were sown in different times and their yield at Samsun's ecological conditions. Natural Sciences Institute of Ondokuz Mayıs University. Master Thesis (Unpublished)Page: 83.
- Bozoglu, H., Gulumser, A., 1994. A study on growth status of some faba bean types were sown in different times and their yield at Samsun's ecological conditions, *Field Crops Congress* 25-29 April, İzmir, Vol:1, Agronomy Papers, 247-249.
- Bozoglu, H., 2005. Determination of faba bean (*Vicia faba* L.) flowering and fruting and relationship with grain yield. Turkey VI. Field Crops Congress, Antalya 5 to 9 September, Vol. II, Page 637-642.
- Cenarruzabeitia, M. N., Soria, A., Larralde, J., 1978. The content of L-DOPA And its precursor L-tyrosine in *Vicia faba* grown in the north of Navarre. *Anales de Edafologia y Agrobiologia* 37(7/8): 677-681.
- Crépon, K., Marget, P., Peyronnet, C., Carrouée, B., Arese, P., Duc. G., 2010. Nutritional value of faba bean (*Vicia faba* L.) seeds for feed and food. *Field Crops Res.*, 115, pp. 329-339.

- Dorsey, E. R., Constantinescu, R., Thompson, J. P., Biglan, K. M., Holloway, R. G., Kieburz, K., Marshall, F. J., Ravina, B. M., Schifitto, G., Siderowf, A., Tanner, C. M., 2007. Projected number of people with Parkinson disease in the most populous nations. *Neurology* 68: 384-386.
- FAOSTAT 2014. Food and Agriculture Organization of the United Nations. Rome, Italy. Available online at: <http://faostat3.fao.org/download/Q/QC/E>. (Accessed 20.06.2016).
- FAOSTAT 2013. Food and Agriculture Organization of the United Nations. Rome, Italy. Available online at: <http://faostat.fao.org/site/567/DesktopDefault.aspx?PageID=567#ancor> (Accessed 20.06.2016).
- Guillon, F., Champ, M. J., 2002. Carbohydrate fractions of legumes: uses in human nutrition and potential for health. *British Journal of Nutrition* (2002), 88, Suppl. 3, S293–S306. DOI: 10.1079/BJN2002720.
- Gulumser, A., Bozoglu, H., 1994. Determination of weed control methods and its effect on faba bean yield at Samsun's ecological conditions., *Field Crops Congress*. 25-29 April İzmir, Vol:1 Agronomy Papers, 117-121.
- Holden, K., 2006. Fava Beans, Levodopa, and Parkinson's Disease; <http://www.scienzavegetariana.it/nutrizione/favabeans.html>.
- Kacar, B., İnal, A., 2008. *Bitki Analizleri*. Nobel Yayın No: 1241. 172-180 s., Nobel Yayın Dağıtım Ltd. Sti., Ostim, Ankara. ISBN:978-605-395-036-3.
- Kazemi, H., , Sadeghi, S., Akinci, H., 2016. Developing a land evaluation model for faba bean cultivation using geographic information system and multi-criteria analysis (A case study: Gonbad-Kavous region, Iran). *Ecological Indicators* Volume 63, April 2016, Pages 37–47.
- Kempster, P.A., Bogetic, Z., Secombe, J.W., Martin, H.D., Balazs, N. D. H., Wahlqvist, M. L., 1993. Motor effects of broad beans (*Vicia faba*) in Parkinson's disease: single dose studies. *Asia Pacific J Clin Nutr* 2, 85-89.
- Kıtıkı, A., Acikgoz, N., 1994. Determining the amount of contributions that features contributing to yield of faba bean..*Field Crops Congress*. 25-29 April. Pages: 112-115. İzmir.
- Landry, E. J., Fuchs, S. J., Hu, J., 2016. Carbohydrate composition of mature and immature faba bean seeds. *Journal of Food Composition and Analysis*. Volume 50, July 2016, Pages 55–60.
- Lattanzio, V., Bianco, V., Crivelli, G., Miccolis, V., 1983. Variability of Amino Acids, Protein, Vicine and Convicine in *Vicia faba* (L) Cultivars. *Journal of Food Science* Volume 48 Issue 3 Page 992-993.
- <http://www.sciencedirect.com/science/article/pii/S1470160X15006536?np=y> - bib0150. Maalouf, M., Nawar, A., Hamwieh, A., Amir, X., Zong, S., Yang, B. T., 2013. *Faba bean. Genetic and Genomic Resources of Grain Legume Improvement*, Newnes Press (2013) 322 pp.
- Mady, M. A., 2009. Effect of foliar application with yeast extract and zinc on fruit setting and yield of faba bean (*vicia faba* l). *J. Biol. Chem. Environ. Sci.*, Vol. 4(2): 109-127.
- Mohamed, A. K., 1985. Effect of sowing date, ridge direction, plant orientation and population on faba bean grain yield. *FABIS Newsletter* (No:12): 11-13, ICARDA.
- Mwanamwenge, J., Loss, S.P, Siddique, K.H.M , Cocks, P.S., 1999. Effect of water stress during floral initiation, flowering and podding on the growth and yield of fababean (**Vicia faba** L.) *European Journal of Agronomy* Volume 11, Issue 1, Pages 1–11.
- Özdemir, S., 2002. *Yemeklik Baklagiller*. Hasat Yayıncılık. ISN:975-8377-13-2. Sf:91-108. İstanbul.

- Peksen, E., 2006. Relationships Among Characters And Determination Of Selection Criteria For Seed Yield In Faba Bean (*Vicia faba* L.). J. of Fac. of Agric., OMU, 2007,22(1):73-78.
- Peksen, E., Gulumser, A., 2007. The comparison in terms of some plant characteristics and grain yield of bean genotypes sown in autumn and spring. Ondokuz Mayıs University Faculty of Agriculture Journal, 22 (1): 79-85.
- PHD(2016). World Parkinson's Day. Parkinson's Disease Society.
<http://www.parkinsonderneği.org.tr/menu/55/dunya-parkinson-gunu>(Accessed 22.06.2016).
- Radwan, D.E.M., Fayez, K. A., Mahmoud, Y. S., Lu, G., 2010. Modifications of antioxidant activity and protein composition of bean leaf due to Bean yellow mosaic virus infection and salicylic acid treatments. Acta Physiol Plant 32:891–904 DOI 10.1007/s11738-010-0477-y.
- Randhir, R., Shetty, P., Shetty, K., 2002. l-dopa and total phenolic stimulation in dark germinated fava bean in response to peptide and phytochemical elicitors. Process-Biochemistry; 37(11): 1247-1256.
- Ricciardi, L., 1985. Variability of biological and agronomic characters in accessions of *Vicia faba* L. Annali della Facolta di Agraria, Universita di Bari 19881/82 rec. No:32 p.119–144.
- Sepetoglu, H., 1994. Yemeklik Dane Baklagiiler. Ege Universitesi Ziraat Fakultesi Yayınları. Ders Notları No: 24
- Sehirali, S., 1988. Yemeklik Tane Baklagiller. A.U Ziraat Fakultesi Yayınları:1089, Ders Kitabı: 314, Ankara, 435 s
- Shetty, P., Atallah, M.T., Shetty, K., 2003. Stimulation of total phenolics, l-dopa and antioxidant activity through proline-linked pentose phosphate pathway in response to proline and its analogue in germinating fava beans (*Vicia faba*). Process-Biochemistry; 38(12): 1707–1717.
- Shivananda, T. N., Haris, G. U., Rao, V., Khanam, S., 2003. A New Method for Estimation of L-Dopa using HPLC.National Academy Science Letters. Vol. 26, No. 1&2, P:36-43.
- Topal, N., Bozoglu, H., 2009. Bakla (*Vicia faba* L.) Parkinsona Çaremi? Turkiye VIII. Tarla Bitkileri Kongresi, 19-22 Ekim 2009, Hatay. 702-706.
- Topal, N., Bozoglu, H., 2016. Determination of L-Dopa (L-3, 4- dihydroxyphenylalanine) Content of Some Faba Bean (*Vicia faba* L.) Genotypes. Journal Of Agricultural Sciences, 22 (2016) 145-151.
- Who, 2006. 3,8 Parkinson's disease, Neurolojical disorders; Public health challenges. Page 140-148.
- Wikipedia, 2016. <https://en.wikipedia.org/wiki/L-DOPA> (access: 08.08.2016)

GENOTYPE AND FERTILIZATION INFLUENCES ON ZINC STATUS IN MAIZE IN TEMPERATE SEMIARID CONDITIONS

Ivica DJALOVIC^{1*}, Goran BEKAVAC¹, Srđan ŠEREMEŠIĆ²,
Dragiša MILOŠEV², Darinka BOGDANOVIĆ²

¹Institute of Field and Vegetable Crops, Department for Maize, Novi Sad, Serbia

²University of Novi Sad, Faculty of Agriculture, Department of Field and Vegetable Crops, Novi Sad, Serbia

*Corresponding author: maizescience@yahoo.com; ivica.djalovic@ifvcns.ns.ac.rs

Abstract

Maize has large requirements for zinc and it is very susceptible to Zn deficiency, especially the inbred lines. The aim of this study was to analyze the response of maize genotypes to different fertilization treatments, as well as the zinc concentration in leaves and grain. The study included the following systems of fertilization: T₁: control – P₆₀K₆₀const; T₂: P₆₀K₆₀ + N_{min} spring; T₃: P₆₀K₆₀ + N₄₀ autumn + N_{min} spring; T₄: P₆₀K₆₀ + N₆₀ spring; T₅: P₆₀K₆₀ + N₁₀₀ spring; T₆: P₆₀K₆₀ + N₄₀ autumn + N₆₀ spring + Zn; T₇: P₆₀K₆₀ + N₄₀ autumn + N₈₀ spring + Zn; T₈: P₆₀K₆₀ + N₁₆₀ spring + Zn. Zn was applied as zinc sulphate (ZnSO₄), in the amount of 1.0 kg ha⁻¹ with foliar spraying, in the fourth and sixth week after sowing. Average Zn content in maize leaves, across the treatments ranged from 44.4 mg kg⁻¹ dry weight (DW) in 2011 to 41.2 mg kg⁻¹ DW in 2012. Depending on the applied fertilization system, lower content of Zn in maize leaves (36.4 mg kg⁻¹ DW), was found with application of P₆₀K₆₀ + N₆₀ spring, and the highest (57.8 mg kg⁻¹ DW) in the treatment P₆₀K₆₀ + N₄₀ fall + N₈₀ spring + Zn. Higher Zn content in grain was found in the NS 6030 hybrid (26.3 mg kg⁻¹ DW) and NS 6010 (26.1 mg kg⁻¹ DW) compared to NS 4023 (24.1 mg kg⁻¹ DW) and NS 640 (25.3 mg kg⁻¹ DW). On average, Zn concentration in the grain differed in 2011 (27.6 mg kg⁻¹) compared to 2012 (23.3 mg kg⁻¹). The lower Zn content in the grain was observed in T₁ (23.4 mg kg⁻¹) and the highest in T₇ (31.0 mg kg⁻¹). Future breeding programs should be focused on developing new genotypes suitable for mineral bio-fortification and with increased mineral bioavailability in grains.

Key words: *fertilization, maize hybrids, zinc, leaves, grain.*

Introduction

Maize has large requirements for zinc and it is very susceptible to Zn deficiency, especially the inbred lines. Zinc is a basic component for all plants, playing a key role as a structural constituent or regulatory co-factor of a wide range of different enzymes and proteins, maintaining the integrity of biological membranes and plant resistance (Rengel et al., 1999; Mengel & Kirkby, 2001; Cakmak, 2008). Zinc concentration is affected by a range of factors, including soil type, fertility, and moisture, environmental factors, soil pH (Zhao et al., 2011), genotype and interactions among the nutrients (Feila et al., 2005). Zn nutrition of plants is considered one of the major problems in the arid and semi-arid regions (Cakmak, 2008).

Understanding the dynamics of zinc uptake by maize is the basis for indicating the critical stages for accumulation of this micronutrient in the plant. However, most studies are usually focused only on the nutrient content in certain developmental stages and/or certain organs of the cultivated plants (Hossain et al., 2008; Izsaki, 2009).

Zinc fertilizer is widely used to increase yield (Potarzycki & Grzebisz, 2009) and to improve crop nutritional values (Jin et al. 2013). Most research on soil and foliar application of zinc focused on

alleviating its deficiencies, particularly on maize, wheat and rice cultivated in semiarid or arid regions (Cakmak, 2008). Crops can be supplied with Zn through direct application, via foliar fertilization or seed treatments (Gonçalves Júnior et al., 2007). Foliar application is one of the primary methods of applying Zn fertilizer and according to Cakmak et al. (2010) it improves Zn concentrations in cereals grain. Zhang et al. (2012) indicate that foliar Zn application for improving Zn concentration in grain is better than soil application. Knowledge of the different forms of zinc fertilizer and timing of foliar application is crucial for enhancing zinc in grain (Velu et al., 2014). Application of Zn in combination with NPK fertilizers increased Zn uptake from the soil to the grain, resulting in an increase in maize grain nutritional quality. Malakouti (2008) concluded that application of Zn with mixed fertilizers, particularly N-based fertilizers, could enhance Zn uptake. In studies with maize hybrids grown at different nitrogen (N) and water levels, Feila et al. (2005) found that N fertilization reduced grain concentrations of Zn and Mn, which was attributed to higher grain yield as a result of N application.

The aim of this study was to analyze the response of maize genotypes to different fertilization treatments, as well as the zinc concentration in leaves and grain.

Material and Methods

Site characterization, experimental design and plant analysis

Field experiments were conducted in 2011 and 2012 at the research experimental station of Institute of Field and Vegetable Crops, Novi Sad, Serbia (N 45° 19', E 19° 50'). The soil at the study site is a typical calcareous chernozem. Soil sampling prior the trial establishment resulted with the following soil chemical properties in the 0–30 cm soil depth: pH 7.21, humus 2.90%, total N 0.260 g kg⁻¹, P₂O₅ 17.8 mg kg⁻¹, and K₂O 24.0 mg kg⁻¹.

The experiment consisted of 8 treatment combinations in each of the two years: T₁: control – P₆₀K₆₀const; T₂: P₆₀K₆₀ + N_{min} spring; T₃: P₆₀K₆₀ + N₄₀ autumn + N_{min} spring; T₄: P₆₀K₆₀ + N₆₀ spring; T₅: P₆₀K₆₀ + N₁₀₀ spring; T₆: P₆₀K₆₀ + N₄₀ autumn + N₆₀ spring + Zn; T₇: P₆₀K₆₀ + N₄₀ autumn + N₈₀ spring + Zn; T₈: P₆₀K₆₀ + N₁₆₀ spring + Zn. Zn was applied as zinc sulphate (ZnSO₄), in the amount of 1.0 kg ha⁻¹ with foliar spraying, in the fourth and sixth week after sowing. Maize seeds (*Zea mays* L. cv. NS 4023, NS 640, NS 6010 and NS 6030) were sown on 10 April, 2011 and 18 April, 2012. The distance between rows and plants was 75 cm and 24 cm, respectively. The experiment was set up in a completely randomized block design (RCBD) with four replicates. Maize was sown and harvested in the optimal agrotechnical terms. Plant tissue analyses included total Zn concentrations in leaves and grain samples. The ear–leaf of maize (25 leaves in the mean sample) was collected for chemical analysis at flowering stage (the second half of July). Zn concentrations were determined by inductively coupled plasma atomic emission spectroscopy after digesting the grain samples in a closed microwave digestion system in the presence of concentrated HNO₃ and H₂O₂ (HNO₃:H₂O₂ = 5:2, v/v).

Statistical analysis

The data were statistically processed by using the program STATISTICA series 12.6. A three–factor completely random design with a factorial combination was employed for analysis of variance (ANOVA). Assumptions for ANOVA were satisfied and the least significant difference (LSD) was calculated at $P \leq 0.05$. This allowed for treatment means to be compared using the Tukey's multiple comparison test.

Results and Discussion

Zinc (Zn) deficiency in plant tissues is a reflection of both genetic and environmental-related factors and is the most widespread problem in cereal crops worldwide. Response of maize genotypes to different fertilization treatments, and zinc concentration in the leaves and grain are given in Tab. 1, and Figures 1 and 2. Analysis of variance for Zn content in the maize leaves showed statistically significant effect of treatment (B) and hybrid (C) ($P < 0.01$) while the effects of the year (A) did not show statistical significance. By testing analysis of variance, statistically significant interaction effect between treatment and hybrids (B \times C) ($P < 0.01$) was observed, while other interactions (A \times B, A \times C, and A \times B \times C) have not demonstrated statistical significance. Average Zn content in maize leaves, across the treatments for the study years, ranged from 44.4 mg kg⁻¹ dry weight (DW) in 2011, to 41.2 mg kg⁻¹ DW in 2012. Depending on the applied fertilization system, the lowest content of Zn in maize leaves (36.4 mg kg⁻¹ DW), was found with application of P₆₀K₆₀ + N₆₀ spring, and the highest (57.8 mg kg⁻¹ DW) in the treatment P₆₀K₆₀ + N₄₀ fall + N₈₀ spring + Zn.

Table 1. The content of Zn in the maize leaves and grain (mg kg⁻¹)

Factors	Zn in leaves (mg kg ⁻¹)	Zn in grain (mg kg ⁻¹)
Year (A)		
2011	44.4 ± 10.5 a	27.6 ± 7.3 a
2012	41.2 ± 9.9 a	23.3 ± 1.4 a
Treatment (B)		
Control – P ₆₀ K ₆₀ const	40.2 ± 10.5 bc	23.4 ± 1.3 b
P ₆₀ K ₆₀ const. + N _{min} spring	39.1 ± 3.0 c	26.7 ± 5.8 ab
P ₆₀ K ₆₀ const. + N ₄₀ autumn + N _{min} spring	42.9 ± 6.1 bc	23.6 ± 2.8 b
P ₆₀ K ₆₀ const. + N ₆₀ spring	36.4 ± 5.5 c	25.2 ± 3.7 ab
P ₆₀ K ₆₀ const. + N ₁₀₀ spring	41.4 ± 7.5 bc	24.6 ± 3.7 ab
P ₆₀ K ₆₀ const. + N ₄₀ autumn + N ₆₀ spring + Zn	47.7 ± 10.5 b	24.6 ± 3.2 ab
P ₆₀ K ₆₀ const. + N ₄₀ autumn + N ₈₀ spring + Zn	57.8 ± 11.1 a	31.0 ± 11.8 a
P ₆₀ K ₆₀ const. + N ₁₆₀ spring + Zn	37.3 ± 8.6 c	24.2 ± 4.0 ab
Hybrid (C)		
NS 4023	39.4 ± 9.5 b	24.1 ± 3.0 a
NS 640	46.7 ± 8.9 a	25.3 ± 4.9 a
NS 6010	38.2 ± 6.4 b	26.1 ± 7.4 a
NS 6030	47.1 ± 12.6 a	26.3 ± 6.4 a
ANOVA		
Year (A)	ns	ns
Treatment (B)	**	ns
Hybrid (C)	**	ns
A \times B	ns	ns
A \times C	ns	ns
B \times C	**	ns
A \times B \times C	ns	ns

* $P < 0.05$; ** $P < 0.01$; NS – not significant; † – all sources of variation are tested in relation to the proper environment square error from the ANOVA model

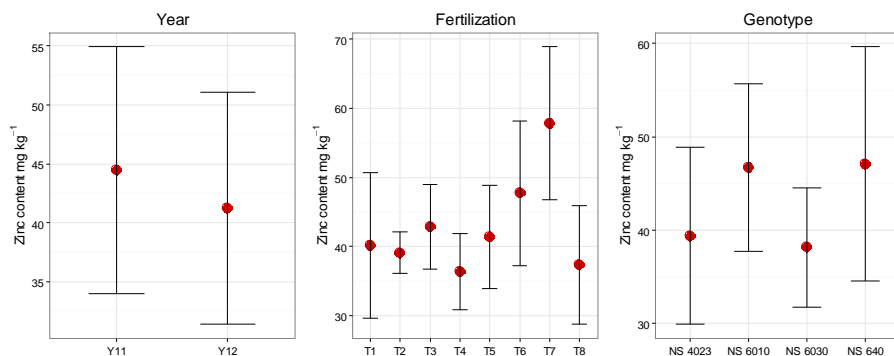

Figure 1. Variation of zinc content in maize leaves as influenced by individual factors

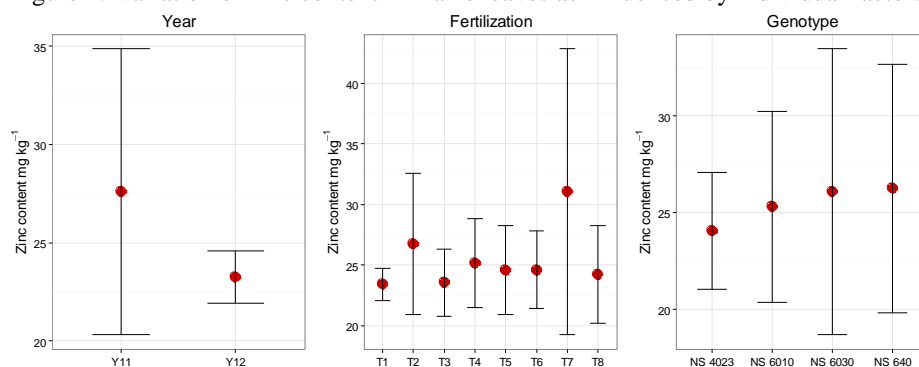

Figure 2. Variation of zinc content in maize grain as influenced by individual factors

The effect of fertilizers application rate on zinc concentration in the maize plants showed significant differences ($P < 0.01$), which is in agreement with Hosseini et al. (2007) who reported that foliar application of zinc fertilizer significantly affected nutrient concentration in maize plants. Maftoun and Karimian (1989) found that the uptake of zinc generally increased with increasing zinc rates, and was mainly due to an increase in either dry matter yield or zinc concentration in various plant parts. Thus, maize plants with a high zinc uptake capacity do not necessarily have a high zinc concentration in their leaf or shoot tissue (Banziger & Long, 2000). Cakmak et al. (1996) showed that Zn efficiency of cereals is mainly related to difference in acquisition of Zn by the roots. Korndörfer et al. (1995) also observed that Zn content in the maize leaf increased with doses of Zn applied to soil and the average content of Zn in the leaf varied from 13 mg kg^{-1} in the control to 23 mg kg^{-1} in the micronutrient treatment ($4 \text{ kg of Zn ha}^{-1}$), and in the present study, Zn content varied between 15 mg kg^{-1} and 22 mg kg^{-1} .

Estimating variation of genotype in grain mineral concentration and bioavailability in relation to grain yield, according to the year, is important for maize production. Higher Zn content in grain was found in the NS 6030 hybrid ($26.3 \text{ mg kg}^{-1} \text{ DW}$) and NS 6010 ($26.1 \text{ mg kg}^{-1} \text{ DW}$) compared to NS 4023 ($24.1 \text{ mg kg}^{-1} \text{ DW}$) and NS 640 ($25.3 \text{ mg kg}^{-1} \text{ DW}$). In our trial, grain Zn concentration ranged from 27.6 mg kg^{-1} in 2011 to 23.3 mg kg^{-1} in 2012. The lowest Zn content in the grain was observed in T₁ (23.4 mg kg^{-1}) and the highest in T₇ (31.0 mg kg^{-1}) (Table 1, Figures 1 and 2).

The effect of soil Zn application on the grain Zn concentration is related to the soil characteristics that affect Zn availability, including pH and Ca concentration (Alloway, 2009). Zhang et al. (2012) indicated that the foliar application of 0.2%, 0.4%, and 0.5% $\text{ZnSO}_4 \cdot 7\text{H}_2\text{O}$ increased Zn concentration in grain flour by 60%, and 76%, respectively, compared with the control treatment.

Studies on maize also show increased zinc in grain between 4% and 16% with soil applied zinc (Wang et al., 2012). Potarzycki & Grzebisz (2009) reported that optimal maize grain yield was recorded with high Zn foliar spray concentration ranging between 0.25% and 0.37% of Zn. In a study with doses of Zn applied to soil in maize crop, Kanwal et al. (2010) verified a significant increase in the content of this micronutrient in maize grains (21.8 to 30.7 mg kg⁻¹). Brkić et al. (2003) also found the highest Zn concentration in grain of genotypes that included this line as a parent, indicating importance of inheritance for grain nutrient contents.

Conclusion

Maize is sensitive to Zn deficiency. Zinc is mostly deficient in soils and application of zinc fertilizer is required to explore its full potential. Application of zinc sources at different rates usually affects plant available zinc content of soil as well as the concentration and uptake of zinc by maize. Considerable influences of the factors: year and fertilization on maize leaves and grain Zn concentration were found. Foliar applied Zn products are effective for increasing Zn uptake in maize. Future breeding should be focused on developing new genotypes suitable for mineral biofortification and with increased mineral bioavailability in grains.

Acknowledgements

*This study is part of the TR031073 project supported by the Ministry Education, Science and Technological Development of the Republic of Serbia.

References

- Alloway, B. J. (2009): Soil factors associated with zinc deficiency in crops and humans. *Environ. Geochem. Health* 31: 537–548.
- Banziger, M., Long, J. (2000): The potential for increasing the iron and zinc density of maize through plant-breeding. *Food and Nutrition Bulletin* 21: 397–400.
- Brkić, I., Šimić, D., Zdunić, Z., Jambrović, A., Ledенčan, T., Kovačević, V., Kadar, I. (2003): Combining abilities of corn-belt inbred lines of maize for mineral content in grain. *Maydica*, 48: 293–297.
- Cakmak, I., Yilmaz, A., Kalayci, M., Ekiz, H., Torun, B., Erenoglu, B., Brown, H.J. (1996): Zinc deficiency as a critical problem in wheat production in central Anatolia. *Plant Soil*, 180: 165–172.
- Cakmak, I. (2008): Enrichment of cereal grains with zinc: agronomic or genetic biofortification? *Plant and Soil*, 302: 1–17.
- Cakmak, I., Kalayci, M., Kaya, Y., Torun, A.A., Aydin, N., Wang, Y., Arisoy, Z., Erdem, H., Gokmen, O., Ozturk, L., Horst, W.J. (2010): Biofortification and localization of zinc in wheat grain. *Journal of Agriculture and Food Chemistry* 58: 9092–9102.
- Feila, S., Mosera, B., Jampatongb, S., Stampa, P. (2005): Mineral composition of the grains of tropical maize varieties as affected by pre-anthesis drought and rate of nitrogen fertilization. *Crop Science* 45: 516–523.
- Gonçalves Jr.A.C., Trautmann, R.R., Marengoni, N.G., Ribeiro, O.L., Santos, A.L. (2007): Produtividade do milho em resposta a adubação com NPK e Zn em Argissolo Vermelho-Amarelo Eutrófico e Latossolo Vermelho Eutroférico. *Ciência e Agrotecnologia* 31: 1231–1236.
- Hosseini, S.M., Maftoun, M., Karimian, N., RonaghI, A. & Emam, Y. (2007): Effect of zinc × boron interaction on plant growth and tissue nutrient concentration of corn. *J. Plant Nutr.* 30 (5): 773–781.

- Hossain, M.A., Jahiruddin, M., Islam, M.R., Mian, M.H. (2008): The requirement of zinc for improvement of crop yield and mineral nutrition in the maize–mungbean–rice system. *Plant Soil* 306: 13–22.
- Izsaki, Z. (2009): Effect of Nitrogen Supply on Nutritional Status of Maize. *Commun. Soil Sci. Plant Anal.* 40: 960–973.
- Jin, T., Zhou, J., Chen, J., Zhu, L., Zhao, Y., Huang, Y. (2013): The genetic architecture of zinc and iron content in maize grains as revealed by QTL mapping and meta-analysis. *Breeding Science* 63: 317–324.
- Kanwal, S., Rahmatullah, A.M.R., Rashid, A.R. (2010): Zinc partitioning in maize grain after soil fertilization with zinc sulfate. *International Journal of Agriculture & Biology* 12: 299–302.
- Korndörfer, G.H., Alcântara, C.B., Horowitz, N., Lana, R.M.Q. (1995): Formas de adição de zinco a um formulado NPK e seu efeito sobre a produção de milho. *Scientia Agricola* 52: 555–560.
- Malakouti, M.J. (2008): The effect of micronutrients in ensuring efficient use of macronutrients. *Turkish Journal for Agriculture* 32: 215–220.
- Maftoum, M., Karimian, N. (1989): Relative efficiency of two zinc sources for maize (*Zea mays* L.) in two calcareous soils from an arid area of Iran. *Agronomie*, 9: 771–775.
- Mengel, K., Kirkby, E.A. (2001): *Principles of Plant Nutrition*. 5th Edition, Kluwer Academic Publishers, Dordrecht / Boston / London. 849 p.
- Potarzycki, J., Grzebisz, W. (2009): Effect of zinc foliar application on grain yield of maize and its yielding components. *Plant Soil Environ.* 55 (12): 519–527.
- Rengel, Z., Batten, G.D., Crowley, D.E. (1999): Agronomic approaches for improving the micronutrient density in edible portions of field crops. *Field Crops Res* 60: 27–40.
- Wang, J., Mao, H., Zhao, H., Huang, D., Wang, Z. (2012): Different increases in maize and wheat grain zinc concentration caused by soil and foliar applications of zinc in Loess Plateau, China. *Field Crop Res.* 135: 89–96.
- Velu, G., Ortiz–Monasterio, I., Cakmak, I., Hao, Y., Singh, R.P. (2014): Biofortification strategies to increase grain zinc and iron concentration in wheat. *J. Cereal Sci.* 59: 365–372.
- Zhang, Y.Q., Sun, Y.X., Ye, Y.L., Rezaul, K.M., Xue, Y.F., Yan, P., Meng, Q.F., Cui, Z.L., Cakmak, I., Zhang, F.S., Zou, C.Q. (2012): Zinc biofortification of wheat through fertilizer applications in different locations of china. *Field Crop Res.* 125: 1–7.
- Zhao, A.Q., Lu, X.C., Chen, Z.H., Tian, X.H., Yang, X.W. (2011): Zinc fertilization methods on zinc absorption and translocation in wheat. *J. Agric. Sci.* 3: 28–36.

EFFECTS OF FERTILIZATION ON PRODUCTION TRAITS OF TRIJUMF CULTIVAR OF TRITICALE

Vera ĐEKIĆ¹, Jelena MILIVOJEVIĆ¹, Mirjana STALETIĆ¹, Milivoje MILOVANOVIĆ¹,
Dragan TERZIĆ², Vera POPOVIĆ³, Ivica ĐALOVIĆ³

¹Small Grains Research Centre, Save Kovacevica 31, Kragujevac, Serbia

²Institute for forage crops, Kruševac, Serbia

³Institute of Field and Vegetable Crops, Maxim Gorky St. 30, Novi Sad, Serbia

*Corresponding author: verarajic@yahoo.com

Abstract

Studies of fertilization effects were conducted in a stationary field trial on a degrading vertisol soil with low pH. Eight variants of mineral nutrition (N, P, K, NK1, NP1, NP2, NP1K1 and NP2K1) and untreated control (without nutrition) were tested in the experiment. The rates of nitrogen application were 80 kg N/ha, and they were applied either individually or in combination with two phosphorus rates and a potassium fertilizer. The wheat triticale cultivar used in the experiment was Trijumf. The highest grain yields under mineral nutrition involving a combination of three mineral elements NP2K1 (4.755 t/ha), NP2 (4.519 t/ha), NP1 (4.143 t/ha) and treatment NP1K1 (4.028 t/ha) have achieved satisfactory results, while the poorest results were achieved by the control and N treatments.

Key words: *fertilization, yield, quality, triticale*

Introduction

Triticale is cereal species gained by cross-breeding of wheat and rye. Thanks to its nutritive values higher than maize, electioneers and scientists for animal nutrition where recommended it for all animal species nutrition. Also, it could replace wheat very successfully in portions for animal nutrition (Đekić et al., 2012), regard the fact that food demands in the world are all the larger and more, and wheat yields and soils area less and less. Triticale is especially characteristic regard the high protein content in the grain and beneficial content of important amino acids regard the other cereals.

Triticale potential, grown under optimal conditions, regard the yield was approximately similar to wheat potential, and was much higher than wheat potential under unfavorable growing conditions (Browne et al., 2006). Wheat and triticale comparing presents that triticale accumulate more nitrogen than wheat in corn period and grain physiological maturation, what indicates that triticale is much appropriate culture for growing on nitrogen poor soils (Đekić, 2010). As species, it has important value on soils with marginal characteristics as dry or acid soils, and is also less demanded regard the fertilizers and other preparations which take place in agronomy.

Triticale presented high tolerance regard the acid soils, as well as good productive results on sandy soils (Đekić et al., 2010a; 2014). Soil acidity frequently affects agricultural production in Serbia. Triticale was planting where corn did not prosper, as well in the areas with moderate climate (Djekic et al., 2011b). It could be said that it inherited very good up to excellent tolerance regard the most important pathogens and small grains pests. Triticale presented high adaptability on local agro-ecological conditions, and it was influenced on stable yield reaching.

New perspective triticale lines and varieties has more and better filled grain, higher yield, grain mass and farinaceous content, while proteins and lysine was smaller compared with older varieties (Đekić, 2010; Đekić et al., 2010b, 2011a).

Mineral fertilizers play a vital role towards improving crop yields but one of the main constraints in achieving proven crop potential is imbalanced use of nutrients, particularly low use of P as compared to N. The optimum rate of P application is important in improving yields of most crops (Đekić et al., 2014). In Serbia, farmers are using only nitrogen fertilizers for fodder crops while the use of P fertilizer is negligible. These crops are often grown on marginal lands. Hence, the production is low and quality is poor.

The objective of this study was to evaluate the effect of different fertilization systems on the grain yield and quality of triticale grown on a vertisol soil. The study was also aimed at optimizing fertilization for maximum profitability in the future triticale production of Central Serbia.

Materials and methods

Materials and field trials

The study was carried out in a stationary field trial involving fertilization over a two years period from 2007/08 to 2008/09. Trials were first set up in the experimental fields of the Small Grains Research Centre in Kragujevac in 1970. Plot size was 50 m². The wheat triticale cultivar used in the experiment was Trijumf, the dominant cultivar in the production region of Serbia. This investigation included an untreated control and eight variants of fertilization: N (80 kg N/ha), P (60 kg P₂O₅/ha), K (60 kg K₂O/ha), NK1 (80 kg N/ha, 60 kg K₂O/ha), NP1 (80 kg N/ha, 60 kg P₂O₅/ha), NP2 (80 kg N/ha, 100 kg P₂O₅/ha), NP1K1 (80 kg N/ha, 60 kg P₂O₅/ha, 60 kg K₂O/ha) and NP2K1 (80 kg N/ha, 100 kg P₂O₅/ha, 60 kg K₂O/ha). The trial was set up in a randomized block design with five replications. Fertilization was regular and followed a long-time scheme. Total amounts of phosphorus and potassium fertilizers and half the nitrogen rate are regularly applied during pre-sowing cultivation of soil. The remaining amount of nitrogen fertilizer is applied in a single treatment at the height of tilling towards the end of winter.

The crop was harvested at full maturity. Grain yield (t/ha) was harvested and reported at 14% moisture. Three parameters of grain quality, namely test weight (kg/hl) and 1000-grain weight (g) were analyzed. Thousand grain weight was determined using an automatic seed counter. Test weight is the weight of a measured volume of grain expressed in kilograms per hectoliter.

On the basis of achieved research results the usual variational statistical indicators were calculated: average values, error of the mean and standard deviation. Statistical analysis was made in the module Analyst Program SAS/STAT (SAS Institute, 2000).

Soil and weather conditions

This study was conducted over a two-year period in the Šumadija region, Central Serbia, on a vertisol soil, at Kragujevac location, in a rainfall amount of about 500 mm.

The trial was set up on a vertisol soil in a process of degradation, with heavy texture and very coarse and unstable structure. The humus content in the surface layer of soil was low (2.22%). The reduced humus content in field vertisols profiles suggests the necessity of using humification when planning fertilization systems and soil ameliorative operations to be used to maintain and improve the soil adsorption complex. Soil pH indicates high acidity (pH_(H₂O)=5.19; pH_(KCl)=4.27), nitrogen content in soil is medium (0.11-0.15%), while the content of available phosphorus ranges from very low (1.7-2.9 mg/100 g soil) in the N and NK trial variants to very

high (26.9 mg P₂O₅/100 g soil) in the NPK variants of fertilization. Available potassium contents are high, ranging from 19.5 to 21.0 mg K₂O/100 g soil.

Table 1. *Middle monthly air temperature and precipitation amount (Kragujevac)*

Year	Months										Aver.
	X	XI	XII	I	II	III	IV	V	VI	VII	
Mean monthly air temperature (°C)											
2007-08	10.8	4.5	0.6	2.5	4.5	8.1	12.6	17.3	21.8	22.4	10.51
2008-09	13.1	8.5	4.4	2.3	2.0	6.8	13.4	17.8	20.2	22.5	11.10
Average	12.5	6.9	1.9	0.5	2.4	7.1	11.6	16.9	20.0	22.0	10.18
The amount of rainfall (mm)											
2007-08	36.6	13.0	53.2	30.1	13.1	65.7	51.5	92.8	110.4	28.1	494.5
2008-09	57.7	76.9	40.3	16.8	46.0	137.8	25.2	31.3	30.6	29.7	492.3
Average	47.5	50.0	49.5	36.8	33.9	43.5	51.5	64.8	79.3	62.5	519.3

The average air temperature in 2007/08 was higher by 0.33°C and 2008/09 was higher by 0.92°C in relation to a multi-year average. The sum of rainfall precipitation in 2007/08 was lower by 24.8 mm, where the sum of rainfall in 2008/09 was 27.0 mm lower than the average of many years and with a very uneven distribution of precipitation per months. Spring months were surplus of precipitation, what affected unfavorable on the crops. During the Mart in 2008/09 it was 137.8 mm of rainfall, what was 94.3 mm more compared with the perennial average. During the month of June in 2007/08 it was 110.4 mm of rainfall, what was 31.1 mm more compared with the perennial average. Regard the high importance of sufficient rainfall amounts during the spring months, the distribution and amount of rainfall over the growing season 2007/08 were considerably more favorable, what resulted with increment of yields during that year. Apart from the rainfall deficiency during the spring months and the non-uniform distribution of rainfall across months, an increasing in average air temperatures was also observed.

Results and discussion

Fertilization had a significant effect on grain yield (Table 2). The average grain yield of triticale significantly varied across treatments and years, from 5.160 t/ha in 2007/08 to 4.198 t/ha in 2008/09 in treatment NP2. In the two-year period, was lowest in the unfertilized control (0.974 t/ha) and significantly higher in fertilized treatments, ranging the highest average grain yield of all treatments investigated was achieved in the NP2K1 variant with the higher phosphorus rate (4.755 t/ha) and NP2 (4.519 t/ha).

The average grain yield in 2007/08 year was lowest in the unfertilized control (1.190 t/ha) and significantly higher in fertilized treatments to 5.160 t/ha (NP2) and 5.130 t/ha (NP2K1). During the second year of investigations (2008/09), the highest average value of grain yield achieved the NP2K1 treatments (4.380 t/ha) and 4.198 t/ha in NP2 treatment. NP2K1 fertilization induced a significant increase in grain yield as compared to the control for 3.781 t/ha.

The study showed that most investigated triticale cultivar achieved their highest grain yields less than 80 kg/ha nitrogen rate, phosphorus rate of 100 kg/ha P₂O₅ and potassium rate of 60 kg/ha K₂O (NP2K1) and NP2 treatment (80 kg N/ha, 100 kg P₂O₅/ha). Nitrogen, phosphorus and potassium application, particularly on acid soils poorly supplied with these nutrients, has a high effect on the grain yield of triticale and other cereal crops (Đekić et al., 2014; Jelić et al., 2013).

The sufficient amounts of rainfall during the spring months (Table 1), which are vital to successful triticale production, suggest that the distribution and total amount of rainfall during the growing season 2007/08 were considerably more favorable, resulting in an increased yield in this year as compared to the first year. The significantly lower yield in 2008/09 was due to a decline in total rainfall in the spring and its non-uniform distribution across months, accompanied by higher average air temperatures in these years. According to Đekić et al. (2010a; 2014), the best triticale yields with high quality grain are generated by warm, bright (high solar radiation) spring weather and cooler summer weather without excessive rains during grain filling.

Table 2. Grain yield, test weight and 1000-grain weight content of winter triticale

Traits	Fertiliz.	Years				Average	
		2007/08		2008/09		\bar{x}	S
		\bar{x}	S	\bar{x}	S		
Grain yield, (t ha ⁻¹)	Control	1.190	0.236	0.866	0.253	0.974	0.286
	N	2.306	0.454	2.304	0.155	2.305	0.272
	P	2.256	0.203	2.206	0.359	2.239	0.308
	K	2.888	0.513	2.512	0.408	2.637	0.464
	NK1	4.228	0.580	3.506	0.491	3.747	0.612
	NP1	4.490	1.071	3.970	0.832	4.143	0.915
	NP2	5.160	0.261	4.198	1.011	4.519	0.947
	NP1K1	4.520	0.653	3.782	0.547	4.028	0.666
	NP2K1	5.130	0.360	4.380	0.149	4.755	0.429
1000 grain weight, (g)	Control	42.80	1.304	37.16	0.552	39.04	2.873
	N	47.36	3.788	42.26	0.793	43.96	3.271
	P	45.48	1.006	39.50	0.499	41.49	2.994
	K	45.54	3.678	39.50	0.926	41.51	3.620
	NK1	46.66	3.735	41.30	1.327	43.09	3.458
	NP1	47.24	1.479	42.30	0.653	43.95	2.590
	NP2	47.62	1.524	40.78	0.784	43.06	3.493
	NP1K1	47.64	1.203	42.86	0.409	44.45	2.442
	NP2K1	46.28	1.062	42.24	1.399	43.59	2.338
Test weight (kg/hl)	Control	63.76	0.793	67.20	1.568	66.05	2.139
	N	65.88	1.741	69.68	2.902	68.41	3.117
	P	65.52	2.540	69.99	1.984	68.50	3.022
	K	63.84	1.889	69.24	1.921	67.44	3.215
	NK1	64.84	1.403	68.77	1.470	67.46	2.373
	NP1	65.68	1.706	68.29	0.956	67.42	1.744
	NP2	65.72	0.976	69.37	1.138	68.15	2.068
	NP1K1	65.20	1.180	69.80	1.283	67.50	2.591
	NP2K1	65.28	1.863	69.97	1.947	68.41	2.944

Thousand grain weight of triticale significantly varied across years, from 42.80 g to 47.64 g in 2007/08, from 37.16 g to 42.86 g in 2008/09. The control and P-treatment achieved the lowest average 1000 grain weight during the both years of investigation compared with other tested

treatments. During the both years of investigation the highest average value of 1000 grain weight achieved the NP1K1 treatment (47.64 g and 42.86 g). A number of authors (Browne et al. 2006; Đekić, 2010; Đekić et al., 2010b, 2014; Đurić et al., 2012) underline that 1000-grain weight is a cultivar-specific trait, with considerably higher variations being observed among genotypes than among treatments or environmental factors.

Table 2. presents average values for grain test weight across years and treatments. All testing fertilization variants had test weight greater than 65 kg/hl, except control, K and NK1 variants. During the first year achieved the highest test weight at N-treatment (65.88 kg/hl), followed by NP1 and NP2 (65.68 kg/hl and 65.72 kg/hl), while the lowest test weight was the control (63.76 kg/hl). During the second year of investigations, the test weight of P was the highest with 69.99 kg/hl, while the slightly lower test weight was realized by NP2K1 (69.97 kg/hl) and NP1K1 (69.90 kg/hl). The average two-year value of test weight the highest at P (68.50 kg/hl), while the lowest average two-year value was at control treatment (66.05 kg/hl). Grain test weight showed a very significant dependence on year (Table 3). In all years, the use of different treatments induced a significant increase in grain test weight. Test weight is an indicator of grain quality, particularly grain monetary value (Đekić et al., 2014).

Table 3. Analysis of variance of the tested parameters (ANOVA)

Effect of year on the traits analyzed				
Traits	Mean sq Effect	Mean sq Error	F(df1.2) 1.88	p-level
Grain yield (t/ha)	4.8674	1.750393	2.7807	0.098959
1000 grain weight (g)	659.3440	5.356071	123.1022**	0.000000
Test weight (kg/hl)	373.9323	3.243677	115.2804**	0.000000
Effect of fertilization on the traits analyzed				
Traits	Mean sq Effect	Mean sq Error	F(df1.2) 8.81	p-level
Grain yield (t/ha)	15.74848	0.40635	38.75622**	0.000000
1000 grain weight (g)	27.49528	11.24341	2.44546*	0.020097
Test weight (kg/hl)	5.84694	7.56297	0.77310	0.627383
Effect of the year x fertilization interaction on the traits analyzed				
Traits	Mean sq Effect	Mean sq Error	F(df1.2) 8.72	p-level
Grain yield (t/ha)	4.8674	0.349590	13.9231**	0.000377
1000 grain weight (g)	659.3440	3.303333	199.5996**	0.000000
Test weight (kg/hl)	373.9323	3.123611	119.7115**	0.000000

Based on the analysis of variance, it can be concluded that there are very significant differences in 1000 grain weight regard the year of investigation ($F_{exp}=123.102^{**}$) and highly significant differences at grain test weight ($F_{exp}=115.280^{**}$). Highly significant differences in grain yield and significant differences in 1000 grain weight at investigated triticale cultivar were found relative to the fertilization. In the dual interaction between the year and fertilization, highly significant effects were in grain grain yield, 1000 grain weight and test weight (Table 3). The use of fertilizers and certain amendments on extremely acid soils in certain years, particularly those less favorable for production, almost certainly has different effects on grain filling, resulting in diverse relationships between productive and qualitative traits. The present results confirm the

opinion of many authors that the traits analyzed are genetically determined but are strongly modified by the nutrient status of the environment and weather conditions (Đekić et al., 2010a, 2014; Jelić et al., 2013).

Conclusion

Environmental conditions (weather and soil) and fertilization have a significant effect on grain yield and quality in triticale. Grain yield shows a tendency to increase in the years having a higher total amount and better distribution of rainfall during critical plant development stages.

Based on the gain results during two-year investigation on eight treatments fertilization, it can be concluded that the highest yield achieved the treatments NP2K1 (4.755 t/ha), NP2 (4.519 t/ha), NP1 (4.143 t/ha) and treatment NP1K1 (4.028 t/ha) have achieved satisfactory results, while the poorest results were achieved by the control and N treatments.

Considering the average yields value and test weight and 1000 grain weight in 2007/08 and 2008/09., it was evidently that the yields and test weight were highly statistically significantly different between the year ($p < 0.001$). The effect of environmental factors on grain quality was clearly evident. The physical quality of the grain declined in the years that were less favorable for triticale production. Effect of fertilization on the grain yield were highly statistically significantly and 1000 grain weight were statistically significantly. Interaction of the year and fertilization on the grain yield, 1000 grain weight and test weight were statistically significantly.

References

- Browne R. A., White E. M., Burke J. I. (2006): Responses of developmental yield formation processes in oats to variety, nitrogen, seed rate and plant growth regulator and their relationship to quality. *J. Agric. Sci. (Camb.)* 144: 533-545.
- Đekić V. (2010): Effect of triticale production modality on efficiency of feeding mixtures nutrition in broiler chickens. Dissertation. Agricultural faculty, Belgrade, 1-90.
- Đekić V., Milovanović M., Glamočlija Đ., Staletić M. (2010a): Influence of variety and year on grain yield and quality of triticale varieties of Kragujevac. Proceedings of 45th Croatian and 5th International Symposium on Agriculture, 15.-19. February, Opatija, Croatia, 707-711.
- Đekić V., Milovanović M., Staletić M., Perišić V. (2010b): Investigation of yield components Kragujevac varieties winter triticale. Proceedings of research papers, Vol. 16, No. 1-2, 35-41.
- Đekić V., Mitrović S., Radović V., Đermanović V., Pandurević T. (2012): Applicability of triticale in the diet of broiler chickens. Proceedings. 47th Croatian and 7th International Symposium on Agriculture, 13.-17. Februar, Opatija, Croatia, 664-668.
- Đekić V., Milovanović Milivoje, Vera Popović, Jelena Milivojević, Mirjana Staletić, Jelić Miodrag, Vesna Perišić (2014): Effects of fertilization on yield and grain quality in winter triticale. *Romanian Agricultural Research*, No.31, p. 175-183.
- Djekic V., Mitrovic S., Milovanovic M., Djuric N., Kresovic B., Tapanarova A., Djermanovic V., Mitrovic M. (2011a): Implementation of triticale in nutrition of non-ruminant animals. *African Journal of Biotechnology*, Nigeria, Afrika, Vol. 10 (30), 5697-5704.
- Djekic V., Milovanovic M., Staletic M., Milivojevic J., Djuric N. (2011b): Chemical composition of different varieties of grain triticale. International Scientific Symposium of Agriculture "Agrosym Jahorina 2011", 10-12. November, Jahorina, 351-355.
- Đurić N., Trkulja V., Simić D., Prodanović S., Đekić V., Dolijanović Ž. (2013): Analysis grain yield and quality of some cultivars of winter wheat in 2011-2012. year. Proceedings of Research papers of Institut PKB Agroekonomik, Vol. 19, No. 1-2, pp. 15-21.

- Jelić M., Dugalić G., Milivojević J., Đekić V. (2013): Effect of liming and fertilization on yield and quality of oat (*Avena sativa* L.) on an acid luvisol soil. *Romanian Agricultural Research*, 2013, No 30, p. 239-248.
- Mohr R. M., Grant C. A., May W. E., Stevenson F. C. (2007): The influence of nitrogen, phosphorus and potash fertilizer application on oat yield and quality. *Can. J. Soil Sci.* 87: 459-468.

KARYOLOGICAL INVESTIGATIONS ON SOME NIGELLA L. SPECIES

Osman GEDİK*, Ömer Süha USLU, Ali Rahmi KAYA, Adem EROL

Department Of Field Crops, Faculty of Agriculture, University of Sütçü İmam, Kahramanmaraş, Turkey

*Corresponding author: ogedik@ksu.edu.tr

Abstract

This study was performed in the laboratory of the Kahramanmaraş Sütçü İmam University Faculty of Agriculture Department of Field Crops in Turkey. In this research were investigated karyological properties of some *Nigella* species and used three nigella species. These species were *Nigella damascene*, *Nigella sativa* species and *Nigella Çameli* registered varieties. The scope of karyological analysis examined the number of chromosome, the length of chromosome, relative length of chromosome, chromosome arm ratio, centromere index, centromere situation and idiograms of these species were performed. The somatic chromosome numbers were determined as $2n = 2x = 12$ in all species. Karyotype analysis indicated that chromosomes of *Nigella* species generally have median region (m), subterminal region (st) and terminal point (T) karyotypes. Karyotype formula was observed as $5m+T$ in *Nigella damascene*, $5m+1st$ in *Nigella sativa* and $5m+1st$ in Çameli. Relative length was changed 9.60-19.40 in *Nigella damascene*, 9.45-20.26 in *Nigella sativa* 8.48-22.55 in Çameli. Karyological properties and the number of chromosome of three species were almost observed similar.

Keywords: *Nigella*, chromosome, karyotype, black sesame.

Introduction

The genus *Nigella* L. belong to the Ranunculaceae family and includes about 20 species distributed from the Mediterranean regions to West Asia (Hegnauer, 1973). The genus *Nigella* comprises about 13 species in Turkey (Davis, 1978, 1988). It is known as “çörek otu” in Turkish. *N.sativa* a seasoned plant is cultivated in several parts of the world. The seeds also known as black cummin or black caraway, have been use in Far Eastern Countries and many Middle Eastern as a natural remedy for over 2000 years (Kökdil *et al.*, 2006). The seeds have antimalarial, insecticidal, antifungal antibacterial, and antitumor activates. The seeds are also reported to have carminative, antispasmodic, digestive, diuretic and antiseptic properties (Burits and Burcar, 2000; Morsi, 2000; Teicher, 2002; Ali and Blunden, 2003; Marsik *et al.*, 2005; Saleh, 2006; Abdulelah and Abidin, 2007). *Nigella* is annual aromatic plant and its cultivation traced back more than 3000 to the kingdom of the ancient Egyptians and Assyrians (Jabeen *et al.*, 2012). The seeds include 20.85% protein, 38.20% fats, 4.64%, moisture 4.37%, ash 7.94%, crude fiber 31.94% carbohydrate. It also contains campesterol, cholesterol, betasitosterol, stigmastrol (Riaz *et al.*, 1996; Salma *et al.*, 2007; Jabeen *et al.*, 2012). The karyotype concept originated by the Russian school of cytogenetics. Karyotype provides basic information about morphology of an individual chromosome number, chromosomal homology and ploidy level in plants (Jabeen *et al.*, 2012).

Materials and Methods

N. damascena and *N. sativa* (Çameli registered varieties) seeds samples were obtained Eskişehir Transitional Zone Agricultural Research Institute and *N. sativa* seeds were obtained GAP Agricultural Research Institute. The karyological studies are conducted on the root tips

meristematic cells. The seeds were germinated on moist filter paper in petri dishes at 22°C. The actively growing root tips were pretreated with aqueous colchicine (0.05%) for 3 h at room temperature. Afterwards the root tips were fixed with Farmer (1:3 glacial acetic acid-absolute ethanol) for at least 24 h at 4°C, hydrolysed in 1 N HCl at 60°C for 8 min, then rinsed in tap water for 3-5 min. Finally they were stained in Feulgen for 1 h and mounted in 45% acetic acid (Elçi 1982; Gedik *et al.*, 2016). Digital microphotographs from at least 5 well-spread metaphase plates were taken using Nikon E200 microscope, and were recorded with Nikon digital sight DS-Fi2 camera. The short arm (s), long arm (l) and total lengths (TKL) of each chromosome was measured and the relative lengths, arm ratios, and centromeric indices were determined from images of selected cells. Chromosomes were classified according to the nomenclature of Levan *et al.* (1964). The intrachromosomal asymmetry index (A1) and the interchromosomal asymmetry index (A2) are followed by Romero Zarco (1986).

Results and Discussion

The number of somatic chromosomes, ploidy level, karyotype formula, morphometric parameters, A1 and A2 values were determined for each taxa (Table 1). Idiograms of haploid chromosomes were drawn (Figure 2). The examined taxa and characteristics of somatic chromosomes are given below.

Nigella damascena L.

In previous studies conducted on this species the chromosome number was recorded as $2n=12$ (Ghosh and Datta, 2006; Marks, 1975) and according to Hizume *et al.*, (2013) the *Nigella* species are diploid and its genome ($2n=12$) has five pairs of long metacentric chromosomes and a short telocentric pair. In our study, the chromosome number was determined to be $2n=12$. Chromosomes of the species had 5 median region (m) and 1 terminal point (T) centromeres. Metaphase chromosome length ranged from 9.15 to 18.47 μm and the ratio of the longest to shortest chromosome is 1.9:1. Chromosome arm ratios are measured as 1.13-7.32 μm . Centromeric index varies between 12.01 μm and 45.75 μm and relative lengths vary from 9.60 μm to 19.40 μm . The haploid chromosome length is 95.24 μm . (Tables 1-2, Figures 1-2).

Nigella sativa L.

Its chromosome number is $2n=12$ and it consists of 5 median region (m), 1 subterminal (st) (Table 2). The shortest chromosome length is 9.42 μm and the longest chromosome is 20.18 μm . Total karyotype length is 99.62 μm . chromosome arm ratios are between 1.12 μm and 4.21 μm while relative lengths are between 9.45 μm and 20.26 μm . Centromeric index is between 19.18 μm and 46.96 μm (Table 2). Similarly, Ghosh and Datta (2006), Jabeen *et al.* (2012) found that *N. sativa* has $2n=12$ chromosomes. According to Jabeen *et al.*, (2012) three cultivars of *Nigella sativa* L., has been carried out to determine chromosomal position by using "Feulgen stain". The basic chromosomes number of $x=6$ have been found in all cultivars of *Nigella sativa*. The total length of chromosomes among the land races of Kohat, 10.84 μm to 4.50 μm , Faisalabad 10.00 μm to 4.50 μm and Kashmir 4.66 μm to 8.16 μm . The mean relative lengths of the chromosomes of this variety ranged from 19.82 μm to 8.92 μm .

Nigella sativa L. (Çameli registered variety)

The chromosome number was determined to be $2n=12$. Chromosomes of the species had 5 median region (m) and 1 subterminal (st) centromeres. Metaphase chromosome length ranged from 8.55 to 22.74 μm and the ratio of the longest to shortest chromosome is 2.6:1. Chromosome

arm ratios are measured as 1.22- 4.61 μm . Centromeric index varies between 21.66 μm and 44.94 μm and relative lengths vary from 8.48 μm to 22.55 μm . The haploid chromosome length is 100.82 μm . *N. sativa* Çameli registered variety is the same karyotype formula with *N. sativa* (Tables 1-2, Figures 1-2).

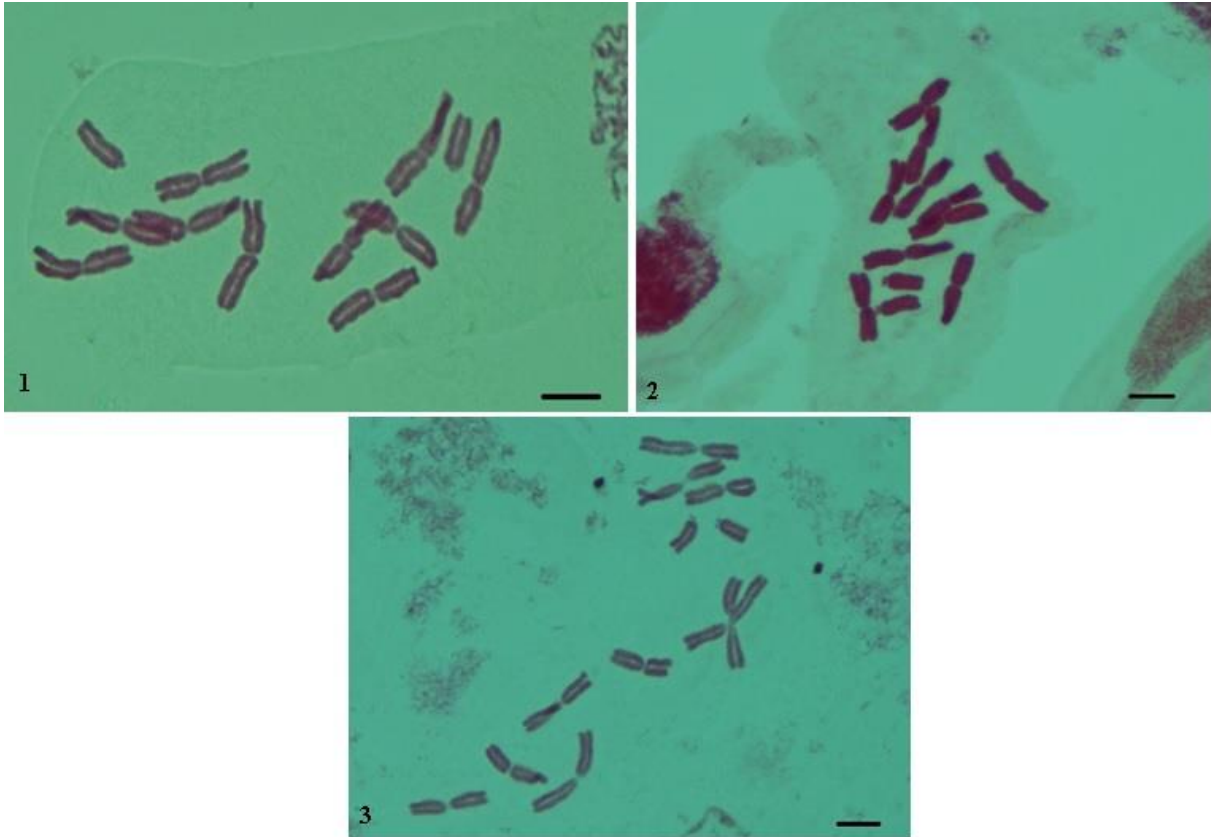

Figure 1. Somatic metaphases in *Nigella* taxa. 1- *N. damascena*, 2- *N. sativa*, 3- *N. sativa* (Çameli) (Scale bar 10 μm).

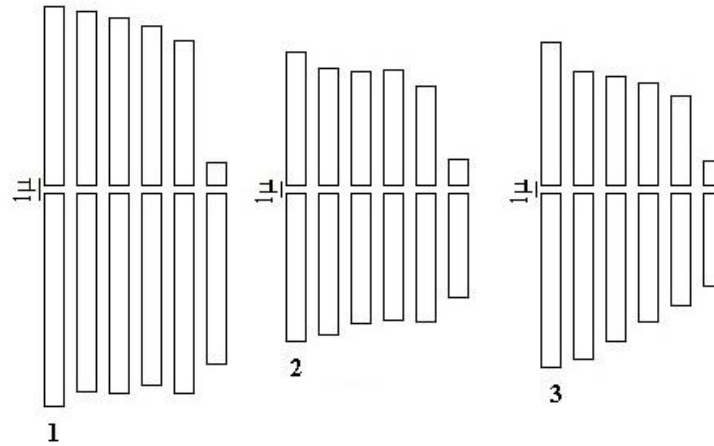

Figure 2. Haploid idiograms: 1- *N. damascena*, 2- *N. sativa*, 3- *N. sativa* (Çameli)

Table 1. Somatic chromosome number (2n), ploidy level, karyotype formula, ranges of chromosome length, total karyotype length (TKL), and asymmetry indexes (A₁, A₂) of Romero Zarco (1986) for the studied *Nigella* taxa.

Taxa	2n	Ploidy level	Karyotype formula	Chromosome length range (µm)	TKL (µm)	A ₁	A ₂
<i>N.damascena</i>	12	2x	5m+T	9.15-18.47	95.24	0.28	0.21
<i>N. sativa</i>	12	2x	5m+st	9.42-20.18	99.62	0.26	0.22
<i>N. sativa</i> (Çameli)	12	2x	5m+st	8.55-22.74	100.82	0.31	0.29

Table 2. Karyomorphological parameters of *Nigella* taxa.

<i>N. damascena</i>					<i>N. sativa</i>				
Pair No.	RL	AR	CI	Type	Pair No.	RL	AR	CI	Type
I	19.40	1.18	45.75	m	I	20.26	1.13	46.94	m
II	18.35	1.13	46.83	m	II	18.65	1.23	44.82	m
III	18.22	1.18	45.71	m	III	17.64	1.17	45.94	m
IV	17.36	1.20	45.34	m	IV	17.54	1.12	46.96	m
V	17.04	1.37	42.17	m	V	16.43	1.34	42.66	m
VI	9.60	7.32	12.01	T	VI	9.45	4.21	19.18	st

<i>N. sativa</i> (Çameli)				
Pair No.	RL	AR	CI	Type
I	22.55	1.22	44.94	m
II	19.90	1.45	40.75	m
III	18.23	1.36	42.32	m
IV	16.42	1.24	44.52	m
V	14.39	1.24	44.49	m
VI	8.48	3.61	21.66	st

Abbreviations: RL, relative length; AR, arm ratio; CI, centromeric index; m, median region; sm, submedian region; M, median point. Chromosome pairs are assigned roman numerals.

Conclusion

Present study represent detailed karyological results about the *N. damascena*, *N. sativa* and *N. sativa* Çameli registered variety. In this study it was found that the studied species $2n=12$ chromosome numbers. While chromosome numbers the same as three species, the karyotype formula different from in *N. damascena* and the intrachromosomal asymmetry index (A1) and the interchromosomal asymmetry index (A2) are different in three species.

References

- Abdulelah, H.A.A. and Abidin B.A.H.Z. (2007). In vivo antimalarial tests of *Nigella sativa* (black seed) different extracts. Am. J. Pharm. Toxic., 2, 46-50.
- Ali, B.H. and Blunnden, G. (2003). Pharmacological and toxicological properties of *Nigella sativa*, Phytother Res., 17, 299-305.
- Burits, M. and Burcar, F. (2000). Antioxidant activity of *Nigella sativa* essential oil phytother Res., 14(5), 323-328.
- Davis, P.H. (1978). Flora of Turkey and the East Aegean Islands, Vol.6, The Edinburgh University, p.98-105.
- Davis, P.H. (1988). Flora of Turkey and the East Aegean Islands, Vol.10, The Edinburgh University, p. 294, 405-406.
- Elçi, S. 1982. Sitogenetikte Gözlemler ve Araştırma Yöntemleri. Elazığ: Fırat University Press (in Turkish).
- Gedik, O., Kıran, Y., Arabacı, T. and Köstekci, S. (2016). Karyological studies of eight *Carduus* L.(Asteraceae, Cardueae) taxa from Turkey. Caryologia: International Journal of Cytology, Cytosystematics and Cytogenetics. 69(2), 121-127.
- Ghosh, A. and Datta, A. K. (2006). Karyotyping of *Nigella sativa* L. (Black Cumin) and *Nigella damascena* L. (Love-in-a-mist)by Image Analyzing System. Cytologia, 71(1), 1–4.
- Hegnauer, R. (1973). Chemotaxonomy of plants, Birkhauser verlag, Basel and Stuttgart, p.43.
- Hizume, M., Shiraishi, H., Matsusaki, Y. and Shibata, F. (2013). Localization of 45S and 5S rDNA on Chromosomes of *Nigella damascena*, Ranunculaceae. Cytologia 78(4), 379–381.
- Jabeen, R., Iftikhar, T., Mengal, T. and Khattak, M. I. (2012). A Comparative Chromosomal Count and Morphological Karyotyping of Three Indigenous Cultivars of Kalongı (*Nigella sativa* L.). Pak. J. Bot., 44(3), 1007-1012.
- Kökdil, G., İlçim, A., Özbilgin, B., Uygun, C. (2006). Morphology and Stem Anatomy of Some Species Of Genus *Nigella* L. in Turkey. J. Fac. Pharm, Ankara, 35 (1), 19 - 41.
- Levan, A., Fredga, K. and Sanberg, A.A. (1964). Nomenclature for centromeric position on chromosomes. Hered. 52, 201-220.
- Marks, G.E. 1975. The Giemsa-Staining Centromeres of *Nigella damascena*. J. Cell Sci. 18, 19-25.
- Marsik, P., Kokoska, L., Landa, P., Nepovim, A., Soudek, P. and Vanek, T. (2005). In vitro inhibitory effects of thymol and quinones of *Nigella sativa* seeds on cyclooxygenase-1- and-2-catalyxed prostaglandin E2 biosyntheses. Planta Medica, 71, 739-742.
- Morsi, N.M. (2000). Antimicrobial effect of crude extracts of *Nigella sativa* on multiple antibiotic resistant bacteria Acta Microbial Pol., 49(1), 63-74.
- Riaz, M., Syed, M. and Chaudhary, F.M. 1996. Chemistry of the medicinal plants of the Genue *Nigella* (Family- Ranunculaceae). Hamdard Medicus, 39(2), 40-44.
- Romero, Z.C. (1986). A new method for estimating karyotype asymmetry. Taxon, 35, 26-530.
- Saleh, S. 2006. Protection by *Nigella sativa* (Black seed) against hyperhomo-cysteinemia in rats vascular disease. Preventia, 3, 73-78.

Salma, C.R., Hentati, B., Chris, T.B, Claude, P. and Hamadi, A. 2007. *Nigella sativa* L., chemical composition and physio-chemical characteristic of lipid fraction. 101(2), 673-681.

Teicher, B.A. (2002). In vivo tumor response end point. In: *Tumor Models in Cancer Research*. (Ed.): B.A. Ticher. Humana Press Inc. Totowa, New Jersey, 593-616.

PROHEXADIONE-CALCIUM AFFECTS VEGETATIVE GROWTH AND YIELD OF PEPPER

Nusret ÖZBAY^{1*}, Recai METİN²

¹University of Bingöl, Agricultural Faculty, Department of Horticulture, 12000, Bingöl, Turkey

²Nizip Gıda Tarım ve Hayvancılık İlçe Müdürlüğü, Nizip, Gaziantep, Turkey

*Corresponding author: oznusret@yahoo.com

Abstract

Some crops like red pepper (*Capsicum annuum* L.) tend to stretch very early after germination especially if it is grown in low light environments. Therefore, the height of vegetable crop seedlings must be controlled by any possible way. The most common way to control plant height is to apply a plant growth retardant that inhibits stem elongation. This study was conducted to compare the effects of Prohexadione-Calcium (Pro-Ca) concentrations (0, 25, 50, 75, and 100 mg.L⁻¹) and application methods (seed soaking, foliar spray, and soil drench), on growth and quality of pepper seedlings and to determine any subsequent effects in the field on vegetative growth, flowering and yield. At field transplanting (42 days after planting), Pro-Ca concentrations higher than 25 mg.L⁻¹ and application methods except for seed soaking reduced seedling heights by 25-31%, leaf area size by 7-16 %, shoot fresh weight by 23-32%, shoot dry weight by 19-29%, root fresh weight by 10-22%, and root dry weight by 20-24%. No delay in flowering and fruit set time were found in pepper plants grown from Pro-Ca treatments. However, the 100 mg.L⁻¹ Pro-Ca treatment was found to decrease yield by 22%. These results indicate that lower Pro-Ca concentrations (25 and 50 mg.L⁻¹) can be used to control excessive elongation growth of pepper seedlings without yield loss.

Key words: *growth retardant, height control, application method, Capsicum annuum* L.

Introduction

Production of quality crops from transplants requires the use of uniform high quality transplants. Ideally, the acceptable transplants should be short and stocky with thick, strong stems and deep green color (Latimer, 1998). Some vegetable crops like peppers have the same tendency to early stretching as some bedding plant species do. Stretching and legginess in pepper transplants becomes a problem when field planting in the spring is delayed due to weather conditions. High light intensities at which the seedlings are grown, together with either low natural radiation levels during the rainy season and winter or high greenhouse temperature in summer, often result in batches of badly stretched seedlings being produced (Kim et al., 2008). In the field, lodging plants due to excessive vegetative growth results in yield losses. Tall vegetable transplants are also more difficult to transplant, more likely to break and are less compatible with transplanting machinery, than more moderately sized plants. In the greenhouse, plant stretching is an unwanted effect in plug production reducing plug quality and making it difficult to handle and perform mechanized transplanting (Magnitskiy et al., 2006). Plant height reduction is playing an important role in promoting yield and quality and decreasing the cost, space and labor (Kim et al., 2010). Therefore, managing transplant height is vital to the vegetable transplant production in both greenhouse and field plant production.

Commercial and experimental methods to control pepper transplant growth include applying plant growth regulators, regulating temperature during hardening or by controlling day and night

temperatures, and inducing mechanical (seismic) stress (Hatt Graham and Decoteau, 1995). Although various cultural practices can contribute to the production of acceptable transplants, chemical plant growth regulators provided one of the most convenient and consistent management methods. Pro-Ca is a novel plant growth regulator that inhibits the late stages of gibberellins (GAs) biosynthesis in plants, thus reducing the vegetative growth of the plant (Kim et al., 2007). Pro-Ca has low toxicity and persistence in the plant (Ilias and Rajapakse, 2005). Greene and Schloemann (2010) reported that inhibitory effects from an application of Pro-Ca lasted for about 28 days. Pro-Ca is very effective in controlling the growth of many fruit crops (Palonen and Mouhu, 2009) and may offer an alternative for use in vegetable transplant production.

This study was conducted to compare the effects of various Pro-Ca concentrations (0, 25, 50, 75, and 100 mg·L⁻¹) and different application methods (seed soaking, foliar spray and soil drench), on the characteristics and quality of pepper transplants and to determine any subsequent effects in the field on vegetative growth and yield.

Material and Methods

Greenhouse and field experiments were conducted at the Horticultural Sciences Department Research Units, Kahramanmaraş Sutcu Imam University, Turkey. Seeds of ‘Sena’ red hot pepper (*Capsicum annuum* L.) were obtained from Agricultural Research Institute, Kahramanmaraş, Turkey (latitude: 37°35'N, longitude: 36°49'E, elevation: 502 m).

Seed soaking treatment

The seeds were surface disinfected in 1% NaClO solution for 10 min to eliminate possible seed-borne microorganisms, rinsed for 1 min under running tap water and dried for 30 min at room temperature. Pepper seeds were placed in covered transparent polystyrene boxes (10 cm x 10 cm x 4 cm) on double layers of filter paper (Whatman #1). Seeds were soaked for twenty four hours in an aqueous solution of Prohexadione-Ca (Regalis, BASF 125 10W containing 10% Prohexadione-Ca as the active ingredient) at 25, 50, 75 or 100 mg·L⁻¹. Control seeds were similarly treated with the same amount of distilled water. After soaking, seeds were transferred to a sieve and then dried on filter paper at 20°C for 2 h to make the singulation of the seeds easier.

Greenhouse experiment

The greenhouse experiment investigated the effects Pro-Ca application methods and the concentrations on seedling growth parameters. Seedlings were grown in an unheated greenhouse at average day/night temperature of 29.5/19.8°C and relative humidity of 58%. Pro-Ca treated seeds (for seed treatment) and untreated pepper seeds (for foliar spray and soil drench application methods) were sown into 45-cell plastic trays (cell volume 75 cm³) filled with a media consisting of peat and perlite in the ratio of 4:1 and grown on a greenhouse bench. Seedlings were watered regularly and fertilized with 20-20-20 N-P-K soluble fertilizer at a rate of 200 mg·L⁻¹N once a week. As second application method, at emergence of the third true leaf (21 day after sowing), pepper seedlings from Pro-Ca untreated seeds were one-time sprayed with 0, 25, 50, 75, or 100 mg·L⁻¹ Pro-Ca solutions containing of 0.1% Tween 20 (Sigma Chemical Co., St. Louis, Mo.) as a wetting agent. Water containing Tween 20 was applied to control plants. Pepper seedlings were sprayed on the foliage with Prohexadione-Ca solution at five concentrations (0, 25, 50, 75 or 100 mg·L⁻¹) to run-off, using a hand-held sprayer. At the time of spraying, plastic tray was covered with aluminum foil to protect growth regulator solutions with the substrate. As third application

method, Pro-Ca (20 mL per cell) was applied as a soil drench to the growing medium at emergence of the third true leaf. At 42 day after planting (DAP), the greenhouse experiment was discontinued and final seedling growth measurements were taken. Ten plants per treatment were randomly chosen from each replication to determine seedling height, internodes length, stem diameter, number of true leaves, leaf area (with a LI-3100C leaf area meter, LICOR, Lincoln, Nebraska, USA), shoot fresh and dry weights, and root fresh and dry weights (after drying samples in the oven set at 80°C until constant weight was reached).

Field experiment

Pro-Ca treated and untreated seedlings were transplanted into the field to investigate effects Pro-Ca on growth and yield parameters. The experimental plots were consisting of two rows of 10 plants each, with 20 plants per treatment with a drip irrigation tube down the center. Plant rows were spaced 50 cm apart on beds with 120 cm center and plants within each row were 50 cm apart (120 x 50 x 50 cm). Plants were grown to maturity with standard local field production practices (irrigation, disease/insect management, fertilizer rates, weed control, etc.). During field experiment, the effects of Pro-Ca were observed on plant heights (measured at 60, 90 and 120 DAP), number of fruits per plant, average fruit weight, and fruit yield in pepper. During field experiments average day/night temperature of 33.5/20.8°C and relative humidity of 45%.

Experimental design and statistical analysis

The experiment was a 5 x 3 factorial in a completely randomized design or randomized block design with three replications per treatment. Each experiment was repeated twice and yielded similar data. Therefore, the data from two experiments were combined and subjected to analysis of variance performed with SAS 9.1. (SAS Institute Cary, NC, USA) and mean separation was performed by Fisher's least significant difference (LSD) test when *F*-test was significant at $P \leq 0.05$.

Results and Discussion

Greenhouse experiment

With application of 50, 75 and 100 mg·L⁻¹ Pro-Ca, seedling height was suppressed by 25%, 28% and 31%, respectively, compared to the control. There were significant differences in seedling height among Pro-Ca application methods, soil drench treatment having the highest reduction (37%). 100 mg·L⁻¹ Pro-Ca also effectively reduced internode length by 27% as compared to control (Table 1). The Highest concentration of Pro-Ca (100 mg·L⁻¹) resulted in reduction in shoot fresh weight and dry weight of pepper seedlings (by 32.14% and 27.72%, respectively) (Table 2). It was found that all Pro-Ca doses resulted in reduction in leaf area by up to 14% compared to control plants although there was a slight difference in the leaf number between Pro-Ca treatments and control plants (Table 3). Root fresh and dry weights were significantly decreased by all the Pro-Ca doses with the exception of 25 mg·L⁻¹ (Table 3).

Field experiment

Pro-Ca treatments resulted in 17% reduction in plant height at 60 DAP, 14% reduction in plant height at 90 DAP, and 12% reduction in plant height at 120 DAP (Table 4). There were significant differences in plant height among Pro-Ca application methods, soil drench treatment having the highest reduction at 60, 90, and 120 DAP (26, 23.5 and 15% respectively). Low concentrations of Pro-Ca (25-50 mg·L⁻¹) did not significantly affect number of fruits per plant

and total fruit yield. However, Pro-Ca at 100 mg·L⁻¹ reduced number of fruits per plant by 17% and total yield by 21% (Table 5). No significant differences in mean fruit weight among Pro-Ca dosage treatments were found. Pro-Ca doses (75 and 100 mg·L⁻¹) reduced yield in pepper by 17% and 21%, respectively, whereas 25 and 50 mg·L⁻¹ did not cause any change in yield in comparison with control.

Table 1. Effects of Pro-Ca doses and application methods on seedling height, internode length, and stem diameter of six-week old pepper seedlings in the greenhouse.

Pro-Ca mg·L ⁻¹	Seedling height (cm)				Internode length (cm)				Stem diameter (mm)			
	Application methods			Mean	Application methods			Mean	Application methods			Mean
SS	FS	SD	SS		FS	SD	SS		FS	SD		
0	11.05	9.36	9.10	9.84 a	2.65	2.24	2.23	2.37 a	2.74	2.65	2.50	2.63 ab
25	10.50	10.75	7.36	9.54 a	2.44	2.95	1.70	2.36 a	2.66	2.59	2.80	2.68 a
50	9.38	8.21	5.63	7.41 b	2.43	2.17	1.53	1.91 b	2.37	2.58	2.72	2.56 abc
75	9.30	7.60	4.47	7.12 b	2.67	1.97	0.95	1.86 bc	2.37	2.48	2.75	2.53 bc
100	9.20	7.41	3.92	6.84 b	2.37	2.10	0.74	1.74 c	2.49	2.30	2.56	2.45 c
Mean	9.69 a	8.67 b	6.10 c		2.51 a	2.29 b	1.43 c		2.53 b	2.52 b	2.67 a	
LSD _{0.05}	Pro-Ca = 0.568***				Pro-Ca = 0.166***				Pro-Ca = 0.127**			
	Method = 0.44***				Method = 0.128***				Method = 0.098***			
	Pro-Ca x Method = 0.98***				Pro-Ca x Method = 0.29***				Pro-Ca x Method = 0.22**			

** Significant at P<0.01, *** Significant at P<0.001, SS: Seed soaking, FS: Foliar spray, SD: Soil drench, Means followed by the same letter are not significantly different at the 0.05 level, using Fisher's LSD.

Table 2. Effects of Pro-Ca doses and application methods on number of true leaves, shoot fresh and dry weights of six-week old pepper seedlings in the greenhouse.

Pro-Ca mg·L ⁻¹	Number of true leaves				Shoot fresh weight (mg)				Shoot dry weight (mg)			
	Application methods			Mean	Application methods			Mean	Application methods			Mean
SS	FS	SD	SS		FS	SD	SS		FS	SD		
0	7.00	6.33	6.70	6.68 a	1791	1682	1615	1696 a	297	245	259	267 a
25	6.90	6.77	6.63	6.77 a	1644	1655	1519	1606 a	275	250	250	258 a
50	6.13	6.33	6.00	6.15 b	1237	1444	1243	1308 b	207	210	229	215 b
75	6.40	6.03	5.90	6.11 b	1274	1209	1233	1239 bc	208	190	240	213 b
100	6.20	5.90	5.80	5.97 b	1379	1050	1031	1153 c	235	159	187	194 b
Mean	6.53 a	6.27 ab	6.21 b		1465 a	1408 ab	1328 b		244 a	211 ab	233 b	
LSD _{0.05}	Pro-Ca = 0.348***				Pro-Ca = 104***				Pro-Ca = 29.35***			
	Method = NS				Method = 80.78**				Method = 22.74*			
	Pro-Ca x Method = NS				Pro-Ca x Method = 181*				Pro-Ca x Method = NS			

^{NS} Non significant, * Significant at P<0.05, ** Significant at P<0.01, *** Significant at P<0.001, SS: Seed soak, FS: Foliar spray, SD: Soil drench. Means followed by the same letter are not significantly different at the 0.05 level, using Fisher's LSD.

In the present study, the application of Pro-Ca caused an immediate vegetative growth reduction, most dramatically demonstrated by a reduction in plant height and internodes length, compared with control treatment. This inhibitory effect of Pro-Ca diminished over time, and the difference in plant height and internode length between treated and control plants gradually decreased.

These results are in agreement with some previous studies (Rayirath et al., 2009; Kim et al., 2010; Guak, 2013). These findings also confirm Grossmann et al. (1994), who reported that the treatment of wheat seedlings with increasing Pro-Ca concentrations in hydroponics reduced plant height and fresh weight of shoots by up to 40%.

Table 3. Effects of Pro-Ca doses and application methods on leaf area, root fresh and dry weights of six-week old pepper seedlings in the greenhouse.

Pro-Ca mg·L ⁻¹	Leaf area (cm ² /plant)				Root fresh weight (mg)				Root dry weight (mg)			
	Application methods				Application methods				Application methods			
	SS	FS	SD	Mean	SS	FS	SD	Mean	SS	FS	SD	Mean
0	77.45	72.34	73.72	74.50 a	1185	1023	939	1049 a	93	82	71	82 a
25	76.75	65.86	66.54	69.72 b	991	1072	788	950 b	81	87	64	77 a
50	74.33	65.13	52.80	64.09 c	909	851	749	836 c	61	70	66	66 b
75	75.81	64.12	50.77	63.57 c	850	715	919	828 c	67	59	69	65 b
100	75.63	60.42	53.17	63.07 c	960	681	839	827 c	73	44	70	62 b
Mean	75.99 a	65.57 a	59.40 b		979 a	868 b	847 b		75 a	68 ab	68 b	
LSD _{0.05}	Pro-Ca = 4.21*** Method = 3.21*** Pro-Ca x Method = 7.29**				Pro-Ca = 87.82*** Method = 2.04*** Pro-Ca x Method = 152**				Pro-Ca = 8.69*** Method = NS Pro-Ca x Method = 15.06**			

^{NS} Not significant, ** Significant at P<0.01. *** Significant at P<0.001, SS: Seed soak, FS: Foliar spray, SD: Soil drench. Means followed by the same letter are not significantly different at the 0.05 level, using Fisher's LSD.

Table 4. Effects of Pro-Ca doses and application methods on plant height 60, 90, and 120 days after planting (DAP) in the field.

Pro-Ca mg·L ⁻¹	Plant height 60 DAP (cm)				Plant height 90 DAP (cm)				Plant height 120 DAP (cm)			
	Application methods				Application methods				Application methods			
	SS	FS	SD	Mean	SS	FS	SD	Mean	SS	FS	SD	Mean
0	26.64	26.76	25.44	26.28 a	39.17	39.14	37.05	38.45 a	54.46	54.03	52.08	53.52 a
25	27.16	27.38	21.02	25.19 a	39.64	39.57	32.81	37.34 ab	55.54	54.68	50.78	53.67 a
50	25.97	24.78	19.81	25.38 b	37.64	37.78	29.85	35.09 bc	53.77	51.28	44.36	49.80 b
75	25.63	24.30	17.23	22.39 bc	37.78	36.70	24.70	33.06 c	50.05	52.14	39.16	47.12 c
100	26.19	24.85	14.39	21.81 c	39.05	36.32	23.49	32.95 c	49.52	52.94	38.32	46.93 c
Mean	26.32 a	25.61 a	19.52 b		38.66 a	37.90 a	29.58 b		52.67 a	53.01 ab	44.94 b	
LSD _{0.05}	Pro-Ca = 1.23*** Method = 0.95*** Pro-Ca x Method = 2.12***				Pro-Ca = 2.83*** Method = 2.19*** Pro-Ca x Method = 4.90*				Pro-Ca = 2.35*** Method = 1.82*** Pro-Ca x Method = 4.07**			

*=Significant at P<0.05, **=Significant at P<0.01, ***=Significant at P<0.001, SS: Seed soak, FS: Foliar spray, SD: Soil drench. Means followed by the same letter are not significantly different at the 0.05 level, using Fisher's LSD.

Soaking of faba bean seeds in solutions of Pro-Ca caused significant reduction in shoot height and shoot fresh weight. The reduction corresponded with increasing Pro-Ca concentration (Bekheta et al., 2009). The inhibitory effect of Pro-Ca on seedling height is further supported by other researchers for some other species, such as cabbage (Hamano et al., 2002), petunia and impatient (Ilias and Rajapakse, 2005), okra (Ilias et al., 2007), onion and garlic (Ouzounidou et

al., 2011). Pro-Ca inhibits gibberellin biosynthesis by blocking the 3 β -hydroxylation of GA₂₀ to GA₁, resulting in reduced stem elongation (Rademacher, 2000). Application of Pro-Ca decreased the levels of GA₃ and IAA but increased the levels of ABA and cytokinins in faba bean seedlings, compared with their respective controls (Bekhetta et al., 2009).

Table 5. Effects of Pro-Ca doses and application methods on number of fruits per plant, mean fruit weight, and fruit yield in pepper.

Pro-Ca mg·L ⁻¹	Number of fruits per plant				Mean fruit weight (g)				Fruit yield (ton/ha)			
	Application methods				Application methods				Application methods			
	SS	FS	SD	Mean	SS	FS	SD	Mean	SS	FS	SD	Mean
0	49.53	53.70	48.14	50.46 ab	9.47	9.25	8.77	9.16	16.36	17.72	15.54	16.54 a
25	50.58	58.93	47.79	52.43 a	9.55	9.11	8.64	9.10	17.37	19.18	14.44	17.00 a
50	54.46	59.75	42.67	52.29 a	8.84	8.62	8.20	8.55	17.09	18.22	12.50	15.94 ab
75	47.69	59.16	25.31	44.05 ab	9.73	8.28	8.15	8.72	16.38	17.52	7.180	13.69 bc
100	47.32	55.03	23.05	41.80 b	9.04	8.32	9.49	8.95	15.10	16.22	7.670	13.00 c
Mean	49.92 b	57.31 a	37.39 c		9.33 a	8.72 b	8.65 b		16.46 a	17.77 a	11.47 b	
LSD _{0.05}	Pro-Ca = 8.52*				Pro-Ca = NS				Pro-Ca = 2.35**			
	Method = 6.60***				Method = 0.59*				Method = 1.82***			
	Pro-Ca x Method = NS				Pro-Ca x Method = NS				Pro-Ca x Method = NS			

^{NS} Not significant, * Significant at P<0.05, ** Significant at P<0.01, *** Significant at P<0.001, SS: Seed soak, FS: Foliar spray, SD: Soil drench. Means followed by the same letter are not significantly different at the 0.05 level, using Fisher's LSD.

Stem and leaf dry masses and stem length of okra were significantly enhanced by the application of exogenous GA₃, but Pro-Ca inhibited growth (Ilias et al., 2007). Prohexadione-Ca has a potential for effective control of vegetative growth in several plant species however, timing seems to be very important (Ilias and Rajapakse, 2005).

Pro-Ca treatments (higher doses) resulted in reduction in leaf number and leaf area compared to the control plants, which agrees with previous studies on Pro-Ca and some triazole group regulators (Glen and Miller, 2005; Medjdoub et al., 2007). It has been reported that Pro-Ca application decreased leaf number and leaf area of tomato plants compared to the control (Altintas, 2011). Reduced leaf area with increasing treatments is most likely due to the inhibition of gibberellin biosynthesis. Kang et al. (2010) reported that the endogenous bioactive GA₁ and GA₄ contents of Chinese cabbage drastically decreased with elevated Pro-Ca.

No delaying in flowering and fruit set time were found in pepper plants grown from Pro-Ca treatments (data not presented). These findings on pepper flowering and fruit set time are in line with Ilias et al. (2007), who reported that control and Pro-Ca treated okra plants took same time to bloom. In contrast, application of Pro-Ca (200 mg·L⁻¹), 45 days after planting, delayed anthesis up to 11 days in petunia (Cerny-Koenig et al., 2005). This may be because of late application of retardant. Some yield parameters of pepper such as mean fruit weight and fruit yield were also reduced by the application of higher Pro-Ca treatments (especially with 100 mg·L⁻¹) but not with the lower concentrations as mentioned previously.

These findings are consistent with those reported for apple plants by Miller (2002). Pro-Ca may be reducing fruit size primarily by slowing cell division during this active period of cell division in the pepper fruits. An alternative or contributing factor reducing fruit size could be reduced leaf area, which is true in our case. On the other hand, our results are contrary to some other studies.

Hytönen et al. (2009) reported that Pro-Ca treatment during the planting year resulting in a significant yield increases in strawberry during the following season. Similarly, Greene and Schloemann (2010) found that Pro-Ca increased total marketable yield without affecting mean fruit size. Asín et al. (2007) determined that Pro-Ca did not have any significant negative effect on yield of pear. It may be thought that the improving or negative effect of Pro-Ca depends on application time, doses, environmental conditions, species, cultivar, and even on individual plant.

Conclusion

Low concentrations of Pro-Ca appear to be effective at controlling vegetative growth yet appear to have minimal side effects. Based on our results it can be stated that lower Pro-Ca concentrations can be used to control excessive elongation growth of pepper seedlings without any major yield loss. Concentration ranging from 50 to 75 mg·L⁻¹ can be used to achieve a 28 % height reduction. Several growth regulators are available to control plant height by controlling GA biosynthesis, but most of them have a long half-life. In contrast, Pro-Ca is a non-toxic growth regulator with a short half-life.

References

- Altintas, S. (2011). Effects of prohexadione-calcium with three rates of phosphorus and chlormequat chloride on vegetative and generative growth of tomato. *African Journal of Biotechnology*, 10(75):17142-17151.
- Asín, L., Alegre, S. Montserrat, R. (2007). Effects of paclobutrazol, prohexadione-Ca, deficit irrigation, summer pruning and root pruning on shoot growth, yield and return bloom, in a 'Blanquilla' pear orchard. *Scientia Horticulturae*, 113(2):142-148.
- Bekheta M.A., Abdelhamid, M.T. El-Morsi, A.A. (2009). Physiological response of *Vicia faba* to prohexadione-calcium under saline conditions. *Planta Daninha*, 27(4): 769-779.
- Cerny-Koenig, T.A., Faust, J.E. Rajapakse, N.C. (2005). Role of gibberellin A(4) and gibberellin biosynthesis inhibitors on flowering and stem elongation in petunia under modified light environments. *HortScience*, 40 (1):134-137.
- Glen, D.M., Miller, S.S. (2005). Effects of Apogee on growth and whole-canopy photosynthesis in spur delicious apple trees. *HortScience*, 40:397-400.
- Greene, D.W., Schloemann, S.G. (2010). Prohexadione-calcium inhibits runner formation and enhances yield of strawberry. *Journal of the American Pomological Society*, 64:125-139.
- Grossmann, K., Ko-Nig-Kranz, S. Kwiatkowski, J. (1994). Phytohormonal changes in intact shoots of wheat and oilseed rape treated with the acylcyclohexanedione growth retardant prohexadione calcium. *Physiologia Plantarum*, 90:139-143.
- Guak, S. (2013). Effects of prohexadione-ca, ethephon, and water stress on growth and productivity of 'Golden Delicious'/M.9 Apple. *Korean Journal of Horticultural Science & Technology*, 31(1):38-49.
- Hamano, M., Yamato, Amazaki, Y.H., Miura, H. (2002). Endogenous gibberellins and their effects on flowering and stem elongation in cabbage (*Brassica oleracea* var. *capitata*). *Journal of Horticultural Science & Biotechnology*, 77(2):220-225.
- Hatt Graham, H.A., Decoteau, D.R. (1995). Regulation of pepper transplant growth with light and subsequent effects on fruit production. *HortScience*, 30:487-489.
- Hytönen, T., Mouhu, K., Koivu, I. Elomaa, P., Junttila, O. (2009). Planting year prohexadione-calcium treatment increases the cropping potential and yield of strawberry. *ISHS Acta Horticulturae*, 842:741-744.

- Ilias, I., Ouzounidou, G., Giannakoula, A. Papadopoulou, P. (2007). Effects of gibberellic acid and prohexadione-calcium on growth, chlorophyll fluorescence and quality of okra plant. *Biologia Plantarum*, 51(3):575-578.
- Ilias, I.F., Rajapakse, N. (2005). Prohexadione-calcium affects growth and flowering of petunia and impatiens grown under photoselective films. *Scientia Horticulturae*, 106:190-202.
- Kang, S.M., Kim, J.T. Hamayun, M., Hwang, I.C., Khan, A.L. Kim, Y.H. Lee, J.C. Lee, I.J. (2010). Influence of prohexadione-calcium on growth and gibberellins content of Chinese cabbage grown in alpine region of South Korea, *Scientia Horticulturae*, 125(2):88-92.
- Kim, I.S., Zhang, C., Kang, H.M., Mackay, B. (2008). Control of Stretching of cucumber and tomato plug seedlings using supplement light. *Horticulture, Environment, and Biotechnology*, 49:287-292.
- Kim, H.Y., Lee, I.J., Hamayun, M., Kim, J.T., Won, J.G., Hwang, I.C., Kim, K.U. (2007). Effect of prohexadione calcium on growth components and endogenous gibberellins contents of rice (*Oryza sativa* L.). *Journal of Agronomy and Crop Science*, 193:445–451.
- Kim, Y.H., Khan, A.L., Hamayun, M., Kim, J.T., Lee, J.H., Hwang, I.C. Yoon, C.S. Lee, I.J. (2010). Effects of prohexadione calcium on growth and gibberellins contents of *Chrysanthemum morifolium* R. cv. 'Monalisa White'. *Scientia Horticulturae*, 123:423-427.
- Latimer, J.G. (1998). Mechanical conditioning to control height. *HortTechnology*, October-December, 8(4).
- Magnitskiy S.V., Pasian, C.C., Bennett, M.A., Metzger, J.D. (2006). Effects of soaking cucumber and tomato seeds in paclobutrazol solutions on fruit weight, fruit size, and paclobutrazol level in fruits. *HortScience*, 41(6):1446-1448.
- Medjdoub, R., Val Falcón, J. , Blanco Braña, A. (2007). Physiological effects of prohexadione-calcium in apple trees: Effects on parameters related to photoproductivity. *Journal of Horticultural Science and Biotechnology*, 82(1):126-132.
- Miller, S.S. (2002). Prohexadione-calcium controls vegetative growth in apple. *Journal of Tree Fruit Production*, 3:11-28.
- Ouzounidou, G., Giannakoula, A., Asfi, M., Ilias, I. (2011). Differential response of onion and garlic agenest plant growth regulator. *Pakistan Journal of Botany*, 43(4):2051-2057.
- Palonen, P., Mouhu, K. (2009). Vegetative growth and flowering of primocane raspberry 'Ariadne' as affected by prohexadione-calcium treatments. *HortScience*, 44(2):529–531.
- Rademacher, W. (2000). Growth retardants: Effects on gibberellin biosynthesis and other metabolic pathways. *Annual Review of Plant Physiology and Plant Molecular Biology*, 51:501-531.
- Rayirath, U.P., Lada, R.R., Caldwell, C.D., Asiedu, S.K., Sibley, K.J., Adams, A.D. (2009). CCC and prohexadione-ca enhance rhizome growth and lateral bud production in rhubarb (*Rheum rhubarbarum* L.) *Journal of Plant Growth Regulation*, 28(2):137-146.

THE EFFECTS OF SOME ROOTSTOCKS ON BIOLOGICAL AND PHENOLOGICAL PROPERTIES OF NAVEL ORANGE TYPES IN TURKEY

Ertugrul TURGUTOGLU¹, Sadiye GOZLEKCI²

¹West Akdeniz Agricultural Research Institute, Antalya, Turkey

²Akdeniz University, Faculty of Agriculture, Department of Horticulture, 07058, Antalya, Turkey

*Corresponding author: sgozlekci@akdeniz.edu.tr

Abstract

Citrus fruits export is ranked as the 1st in fresh fruits and vegetable export in Turkey. In Turkey, the total citrus fruit production is 3.975.873 tons in 2015. About 86.64% of the total citrus production in Turkey is in the Mediterranean Region. Orange production constitutes 45.70% with 1.816.798 tons of this production. Approximately 27.33% of orange production in Turkey is cultivated in Antalya province. In this study, four navel orange clones (numbers 3, 38, 39 and 86) and three navel orange varieties ('Gillette', 'Navelina' and 'Tule Gold') grafted onto common Sour orange and Troyer citrange rootstocks were used. Blooming dates (The first blooming, full blooming and the last blooming dates); flower and June drop (fruitlets) rates were examined by using Navel orange clones and varieties. Furthermore, some development parameters of the trees (canopy volume, stem diameter and canopy area) were also studied. The blooming period of Navel orange clone and varieties under Antalya seasonal conditions has been determined and has ranged between the periods of April 7 to May 2. Although, flower and June fruit drop rates were not fundamentally affected by the rootstock, clones and varieties have influenced the flower and fruit drop rates. There wasn't any statistical effect on the rootstock of flower drop and June fruit drop rates. However, significant positive correlations were observed regarding development parameters of the orange clones and varieties.

Keywords: *Citrus, blooming, June drop, Sour orange, Troyer*

Introduction

Citrus is one of the most important fruit tree crop in the world. Navel varieties, especially 'Parent Washington Navel' oranges are among the most popular citrus cultivar grown in Turkey. Navel orange production constitutes 74.33% of the 1.350.600 tons of total orange production in Turkey. Because of high soil pH problems, the most popular rootstock use in citrus cultivation is sour orange. Besides, Troyer and Carrizo citranges which are hybrids between the trifoliolate orange and the Washington navel orange have also been used for orange production. Rootstocks may influence citrus growth and development, including yield, fruit quality, and tolerance to stress caused by biotic and abiotic factors (Filho *et al.*, 2007). While 'trifoliolate orange', 'Troyer' and 'Carrizo citranges' are also used, the main source of rootstock for Turkish citrus production is 'Sour orange'. The 'Sour orange' has been most desirable citrus rootstock in the world because of its adaptability to a range of soil conditions and excellent fruit quality production. However, the appearance of *Citrus tristeza virus* in the Mediterranean region (Kyriakou and Polykarpou, 1989) has necessitated a research program to replace 'sour orange' with rootstocks tolerant to *tristeza* for almost all the commercial cultivars (Tuzcu *et al.*, 1998; Kaplankiran *et al.*, 2005; Demirkiser *et al.*, 2009). Rootstocks have had a substantial role in the development of the citrus industry in the world. The effect of rootstocks on citrus fruit production and fruit quality has been studied in many citrus producing areas (Continella *et al.*, 1988; Economides and Gregoriou,

1993;GeorgiouandGregoriou, 1999;Georgiou, 2002; Roose *et al.*, 1989; Rouse and Maxwell, 1970; Zekri, 1996, 1997, 1999, 2000; Salibe andMoreira, 1973; Crescimanno *et al.*, 1981; Perez *et al.*, 2005; Temiz, 2005; Turgutoglu *et al.*, 2015; Kurt *et al.*, 2014). Findings from their studies have revealed different and inconsistent conclusions. Therefore, it is reasonable to adopt rootstock recommendations from one part of the world to another without a thorough evaluation locally. Since environmental conditions and cultural practice are unique to each geographical location.

The aim of this study is to determine the blooming dates, flower and the June drop rates and development parameters of 4 navel orange clones(no's. 3, 38, 39 and 86) and 3 navel orange varieties('Gillette', 'Navelina' and 'Tule Gold') grafted onto common sour orange and Troyer citrange rootstock atAntalya, Western Mediterranean region of Turkey.

Materials and Methods

This study was carried out at BatıAkdeniz Agricultural Research Institute, Antalya (Turkey) during 2006-2007 seasons.Four navel orange clones (no's. 3, 38, 39 and 86) and three navel orange varieties ('Gillette', 'Navelina' and 'Tule Gold') were budded on the rootstocksof'sour orange' (*Citrus aurantium*L. var. 'Yerli') and 'Troyer citranges' (*Citrus sinensis*Osb.×*Poncirus trifoliata* Raf). The experimental design was completely randomized with four replications and a single tree per plot. The budded trees were planted in 1999 with 7×7 m spacing at the Fruit Research Station of West AkdenizAgricultural Research Institute,Antalya.The soil texture of the plot located in Antalya was sandy-clay. The soil was coarse textured (39% sand, 38% silt, 23% clay) and alkaline in the soil profile (pH 8.40 in 1:2.5 soil: water suspension).

The first and full blooming dates were recorded when 5-10% and 90-95% of the flowers have opened respectively. The last blooming date was recorded when 80-90% of the petal had dropped.Data collected from each branch included total number of flower and fruitlet per branch. Percentage flower drop rate was calculated as; number of the fallen flower / number of total flower x 100.The Percentage June drop rate was found as; number of the fallen fruitlet / number of total fruit set after blooming x 100.

In January (2006 and 2007), canopy height and canopy diameter in the two, three directions were measured after harvesting to obtain the mean diameter. The canopy volume was calculated from canopy height and spread and applying the formula: $CV = \frac{4}{3}\pi ab^2$, where a is the major axis length/2, and b is the minor axis length/2 (Westwood, 1993). Additionally, stem diameterswere measured 10 cm above the bud union by scion trunk circumferences.

A completely randomized design with four replications was used. The data were recorded were subjected to ANOVA using SAS program (SAS, 2005) and means were compared with Duncan test at the 5% level of significance.

Results and Discussion

In most species under subtropical conditions, flowering takes place in spring and the subsequent formation of fruit extends until Midwinter (Iglesias *et al.* 2007).In Antalya, citrus bloom varies by year, typically occurring in 2-3 waves of flowering any time from the end of March through the beginning of April. In this study, blooming dates (The first blooming, full blooming and the last blooming dates) of Navel orange clones and varieties were found to be consistent with the above mentioned dates. In addition, blooming dates were not affected by rootstocks (Table 1).

Table 1. Blooming dates (The first blooming, full blooming and the last blooming dates) of navel orange clones and varieties

Types	Rootstocks	First bloomingdate	Full blooming date	LastBlooming date
3	Sourorange	9 April	24 April	28 April
	Troyercitrance	9 April	24 April	28 April
38	Sourorange	8 April	24 April	2 May
	Troyercitrance	8 April	24 April	2 May
39	Sourorange	9 April	24 April	2 May
	Troyercitrance	9 April	24 April	1 May
86	Sourorange	7 April	24 April	29 April
	Troyercitrance	7 April	24 April	29 April
Gillette	Sourorange	9 April	24 April	2 May
	Troyercitrance	9 April	24 April	2 May
Tule Gold	Sourorange	9 April	23 April	30 April
	Troyercitrance	9 April	23 April	30 April
Navelina	Sourorange	7 April	23 April	28 April
	Troyercitrance	7 April	23 April	28 April

The Navel orange clones and varieties significantly affected the flower drop and June drop rates, but not the rootstocks. The flower drop rate of clone 38 and Navelina variety has lower than those of the other clones and varieties (Table 2). Similar results were reported by Yıldırım (2003) on 'Washington Navel' orange. The June drop rate of Tule Gold variety has the lowest compared to the others (Table 3). Fruit set rather than flowering is the step that limits yield in most citrus cultivars (Ruiz et al., 2001). The number of fruits finally harvested was less than 2% of the number of flowers formed, and values as low as 0.1% have been reported (Monselise, 1986). Bud, flower and ovary abscission occur mostly at the beginning of the cell division phase, whereas the fall of fruitlets and developing fruits is higher during the June drop. Generally, a small percentage of fruits overcome the June drop and less than 1% reached ripening (Iglesias et al. 2007).

Table 2. The flower drop rate of navel orange clones and varieties (%)

Types	Rootstocks		Average of Types
	Sourorange	Troyercitrance	
3	64,41 ± 14,72 ^x	53,24 ± 11,13	58,82 ± 13,48 ab ^y
38	45,51 ± 5,08	50,21 ± 11,49	47,86 ± 8,60 b
39	64,00 ± 9,28	65,65 ± 10,15	64,83 ± 9,05 a
86	66,85 ± 12,88	62,63 ± 19,69	64,74 ± 15,57 a
Gillette	49,87 ± 13,58	52,29 ± 5,41	51,08 ± 9,66 ab
Tule Gold	50,41 ± 24,14	65,17 ± 10,15	57,79 ± 18,87 ab
Navelina	48,45 ± 9,79	40,80 ± 2,72	44,62 ± 7,34 b
Average of Rootstocks	55,64 ± 15,13 ^{ns}	55,71 ± 12,95	

^xMean of four replications for two years.

^ySuperscripts indicate mean separation within last column (among types) by Duncan's multiple range test, 0.05 level. ns; nonsignificant.

Table 3. The Junedrop rate of navel orange clones and varieties (%)

Types	Rootstocks		Average of Types
	Sourorange	Troyercitrance	
3	98,09 ± 0,74 ^x	91,23 ± 5,66	94,66 ± 5,24 a ^y
38	88,80 ± 7,35	86,00 ± 11,34	87,40 ± 8,97 ab
39	88,60 ± 4,31	91,04 ± 2,81	89,82 ± 3,61 ab
86	96,46 ± 3,65	93,09 ± 2,08	94,78 ± 3,29 a
Gillette	92,81 ± 7,10	96,45 ± 1,29	94,63 ± 5,11 a
Tule Gold	73,38 ± 25,86	86,07 ± 12,23	79,73 ± 19,92 b
Navelina	99,26 ± 1,05	98,33 ± 0,74	98,80 ± 0,91 a
Average of Rootstocks	91,06 ± 12,91 ^{ns}	91,74 ± 7,52	

^xMean of four replications for two years.

^ySuperscripts indicate mean separation within last column (among types) by Duncan's multiple range test, 0.05 level. ns; nonsignificant.

According to our results, stem diameter, canopy volume and canopy area were not fundamentally affected by rootstock. Our findings are in agreement with Tuzcuet *al.* (1999) who reported similar results on 'Valencia late' and 'Shaomuti' orange. However, our result is in disagreement with others (Yildirim, 2003; Georgiou, 2002) who reported opposite result in their studies. Clones 38 and 39 were similar and higher than others in terms of all three parameters (Table 4; 5; and 6).

Table 4. The stem diameter of navel orange clones and varieties (mm)

Types	Rootstocks		Average of Types
	Sourorange	Troyercitrance	
3	105,34 ± 9,23 ^x	108,77 ± 14,77	107,30 ± 11,87 bc ^y
38	149,00 ± 26,04	142,50 ± 13,63	145,75 ± 19,55 a
39	139,00 ± 12,11	138,00 ± 23,37	138,50 ± 17,24 a
86	121,32 ± 4,73	113,43 ± 10,81	117,38 ± 8,80 b
Gillette	94,05 ± 6,18	96,09 ± 16,29	95,07 ± 11,46 cd
Tule Gold	110,29 ± 8,40	97,45 ± 7,63	103,87 ± 10,11 bc
Navelina	81,80 ± 12,49	91,33 ± 2,79	86,56 ± 9,21 d
Average of Rootstocks	114,40 ± 29,43 ^{ns}	112,51 ± 22,53	

^xMean of four replications for two years.

^ySuperscripts indicate mean separation within last column (among types) by Duncan's multiple range test, 0.05 level. ns; nonsignificant.

Table 5. The canopy volume of navel orange clones and varieties (m³)

Types	Rootstocks		Average of Types
	Sourorange	Troyercitrange	
3	10,09 ± 2,51 ^x	12,22 ± 3,45	11,31 ± 3,06 ^{c^y}
38	27,26 ± 6,69	25,15 ± 7,87	26,21 ± 6,86 a
39	30,77 ± 6,35	25,88 ± 6,14	28,32 ± 6,35 a
86	16,77 ± 4,83	18,28 ± 5,67	17,52 ± 4,94 b
Gillette	8,58 ± 2,00	6,91 ± 0,90	7,75 ± 1,69 c
Tule Gold	8,69 ± 1,86	7,00 ± 2,57	7,85 ± 2,27 c
Navelina	5,08 ± 0,33	9,92 ± 3,39	7,50 ± 3,42 c
Average of Rootstocks	15,32 ± 10,24 ^{ns}	15,05 ± 8,92	

^xMean of four replications for two years.

^ySuperscripts indicate mean separation within last column (among types) by Duncan's multiple range test, 0.05 level. ns; nonsignificant.

Table 6. The canopy area of navel orange clones and varieties (m²)

Types	Rootstocks		Average of Types
	Sourorange	Troyercitrange	
3	6,20 ± 0,97 ^x	7,06 ± 1,64	6,69 ± 1,37 ^{c^y}
38	11,25 ± 1,91	10,60 ± 1,64	10,93 ± 1,68 a
39	12,11 ± 0,88	10,26 ± 1,41	11,18 ± 1,47 a
86	8,72 ± 1,37	8,79 ± 1,53	8,75 ± 1,34 b
Gillette	5,10 ± 0,85	4,33 ± 0,68	4,71 ± 0,82 d
Tule Gold	5,53 ± 0,82	4,33 ± 1,20	4,93 ± 1,15 d
Navelina	3,63 ± 0,08	5,32 ± 0,77	4,48 ± 1,07 d
Average of Rootstocks	7,51 ± 3,18 ^{ns}	7,24 ± 2,84	

^xMean of four replications for two years.

^ySuperscripts indicate mean separation within last column (among types) by Duncan's multiple range test, 0.05 level. ns; nonsignificant.

Conclusions

Generally, there is no perfect rootstock even for specific situations. Both rootstocks had similar features for investigated characteristics. Based on the present results, Troyercitrange appeared to be promising along with sourorange. However, the most citrus producing areas in Antalya province are highly calcareous. Since Troyer citrange is sensitive to highly calcareous soils, Sourorange even though susceptible to the *citrus tristeza virus*, it might be preferred because of its high calcareous tolerance and adaptability to a wide range of soil conditions and excellent fruit quality production. Additionally, the navel clones and varieties used in this study could also be recommended for both local and commercial orange productions.

References

- Continella, G., Germana, C., La Rosa, G. and Tribulati, E. 1988. Performance and physiological parameters of 'comune' clementine influenced by four rootstocks, p.91-100. In Proc. Sixth Inter. Citrus Congress.
- Crescimanno, F.G., Deirra, P. and Frau, A.M. 1981. Citrus rootstocks trials in sardinia preliminary results on the performance of ten rootstocks for navel and valencia oranges. Proc. Int. Soc. Citriculture 1: 119-123.
- Demirkeser, T. H., Kaplankiran, M., Toplu, C. and Yildiz, E. 2009. Yield and fruit quality performance of nova and robinson mandarins on three rootstocks in Eastern Mediterranean. African J. Agric. Research, 4: 262–268.
- Economides, C. V. and Gregoriou, C. 1993. Growth, yield and fruit quality of nucellar frost 'marsh' grapefruit on fifteen rootstocks in Cyprus. J. Amer. Soc. Hort. Sci., 118: 326–329.
- Filho, F. A. A. M., Espinoza-Núñez, E., Stuchi, E. S. and Ortega, E. M. M. 2007. plant growth, yield, and fruit quality of 'fallglo' and 'sunburst' mandarins on four rootstocks. Scientia Hort., 114: 45–49.
- Georgiou, A. and Gregoriou, C. 1999. Growth, yield and fruit quality of 'shamouti' orange on fourteen rootstocks in Cyprus. Scientia Hort., 80: 113–121.
- Georgiou, A. 2002. Evaluation of rootstocks for 'clementine' mandarin in Cyprus. Scientia Hort., 93: 29–38.
- Iglesias D.J., Tadeo, F.R., Primo-Millo, E. and Talon, M. 2006. Carbohydrate and ethylene levels regulate citrus fruitlet drop through the abscission zone during early development. Trees 20: 348-355.
- Kaplankiran, M., Demirkeser, T. H. and Yildiz, E. 2005. The effects of some citrus root stocks on fruit yield and quality for okitsu satsuma during the Juvenility Period in Dörtyol (Hatay, Turkey) Conditions. 7th International Congress of Citrus Nurserymen. (Abstracts:49), 17-21 September 2005, Cairo, Egypt.
- Kurt, S., Turgutoglu, E. and Demir, G. 2014. Fruit quality properties of some virus-free grapefruit varieties grafted on different rootstocks. Derim, 31(2): 51-62.
- Kyriakou, A. and Polycarpou, D. 1989. Defection of citrus tristeza in Cyprus. Mediterranean Crop Improvement Council, News, 12: 3–4.
- Monselise S.P. 1986. Citrus. In: Monselise S.P. (ed), Handbook of fruit set and development, pp.87-108. CRC Press, Boca Raton.
- Perez, J.G.P., Castillo, I.P., Lidon, A.G., Botia P. and Sanchez, F.G. 2005. Finolemon clones compared with the lemon varieties eureka and lisbonon two rootstocks in murcia (Spain). Scientia Horticulturae. 106 (4): 530-538.
- Rouse, R.E. and Maxwell, N.P. 1979. Performance of mature nucellar 'redblush' grapefruit on 22 rootstocks in Texas. Journal of American Society Horticulture Science, 114: 678-684.
- Roose, M.L., Cole, P.A., Atkin, D. and Kupper, R.S. 1989. Yield and tree size of four citrus cultivars on 21 rootstocks in California. J. Am. Soc. Hort. Sci. 114 (4): 678-684.
- Ruiz, R., Garcia A-Luis, Monerri, C. and Guardiola, J.L. 2001. Carbohydrate Availability in Relation to Fruitlet Abscission in Citrus. Annals of Botany, 87: 805-812.
- SAS Institute. 1999. SAS/STAT User's guide. SAS Institute, Cary, North Carolina, USA.

- Salibe, A. AndMoreira, S. 1973. Performance of eight rootstocks with nucellar ‘baininha’ navel orange scion in a sandy soil. *Int. CitrusCongress*2: 149-152.
- Temiz, S.AndKaplankiran, M. 2007. Morphological and pomological characteristics and fruit sets of some grapefruit varieties on different rootstocks in Kırıkhan (Hatay) conditions. *Proceedings of 5th National Horticultural Congress*, 4-7 September, Erzurum, Turkey.
- TUİK 2015. Turkish Statistical Institute. www.turksat.gov.tr. (Accessed June 2016).
- Turgutoglu, E., Kurt, S. and Demir, G. 2015. The effects of different rootstocks on fruit quality of some clementine mandarin varieties and types. *Derim*, 32 (2): 119-128. DOI:10.16882/derim.2015.52357.
- Tuzcu, O.,Kaplankiran, M. and Seker, M. 1998. The effects of some citrus rootstocks on fruit productivity of some important orange, grapefruit, lemon and mandarin cultivars in Çukurova Region. *Turkish J. Agric. Forestry*, 22: 17–126.
- Westwood, M. N. 1993. *Temperate-zone pomology, physiology and culture*. 3rd Edition, Timber Press Inc., Portland, Oregon, 535 pp.
- Yildirim, B. 2003. Relationship between productivity and carbohydrate levels on ‘Washington navel’ which grafted on different rootstock. Cukurova university, Institute of Natural and Applied Sciences. Department of Horticulture. Ph.D Thesis (Unpublished) 461 p. Adana.
- Yildirim, B., Yesiloglu, T., Kamiloglu, M. U., Incesu, M., Tuzcu, O. And Cimen, B. 2010. Fruit yield and quality of ‘santateresa’ lemon on seven rootstocks in Adana (Turkey). *African J. Agric. Research*, 5: 1077–108.
- Zekri, M. 1996. Leaf mineral concentration, growth, yield, fruit quality and economics of ‘ambersweet’ orangetrees on two rootstocks. *Proc. Fla. State Hort. Soc.* 109: 92-96.
- Zekri, M. 1997. Performance of ambersweet, a new citrus hybrid cultivar, on two rootstocks in Florida. *Fruits*, 52: 141-148.
- Zekri, M. 1999. Performance of ‘valencia’ orangetrees on four rootstocks in a high-density planting. *Proc. Interamerican Soc. For Tropical Hort.* 43: 108-115.
- Zekri, M. 2000. citrus root stocks affect scion nutrition, fruit quality, growth, yield and economical return. *Fruits*, 55: 231-239.

THE NEW WALNUT VARIETY BREEDING PROGRAM IN TURKEY

Yaşar AKÇA^{1*}, Mehmet SÜTYEMEZ², Sebahattin YILMAZ³, Hakan KARADAĞ¹

¹Horticulture Department, Agriculture Faculty of Gaziosmanpaşa University, Tokat, Turkey

²Horticulture Department, Agriculture Faculty of Sütçü İmam University, Kahramanmaraş, Turkey

³Horticulture Department, Agriculture Faculty of Ahi Evran University, Kırşehir, Turkey

*Corresponding author: akca66@gmail.com

Abstract

Turkish walnut cultivars are considerably early leafing and they are bear fruit on terminal buds. The most widely used breeding method in walnut variety breeding programs in Turkey was selection. Cross breeding method was used in only three studies. The new walnut variety breeding program was started in 2008. The aim of this breeding program is to provide new walnut cultivars by crossing for the Turkey walnut industry. The primary goal is to develop cultivars with late leafing, lateral fruit bearing, early harvest dates, and good nut quality. Thirteen crosses have been carried out in different three ecological conditions. The varieties with late leafing and good nut quality chosen as female parents were pollinated by varieties with lateral fruit bearing and high yielding. To ensure the highest possible germination, seed are stratified in cold room (4 °C). After stratification, germinated seeds were sowed in to plastic containers containing peat, perlite and soil for growth in the greenhouse. We have 1340 seedlings under evaluation in the breeding program. Leafing time of seedlings was observed in greenhouse at second year; and late leafing seedling were selected and planted in a breeding orchard. Leafing time of seedlings are determined and compared by ‘Franquette’, ‘Serr’ and ‘Chandler’ cv. during three years in breeding orchard. If no nuts have been produced by age four they are painted by red. The results showed that 189 genotypes were selected according to late leafing, and six genotypes early fruiting and late leafing. In 1340 hybrids observed, 33.52 % of seedling varied from medium late to late leafing. The data showed that there are correlation between the leafing time of first and third year.

Keywords: *Walnut, crossing breeding, cultivar*

Introduction

The Anatolia, English or Persian walnut (*Juglans regia* L.) is the most horticultural developed and widely cultivated of all the walnut species (*Juglans* L.) in the world. Turkey is reported to be the genetic origin of *Juglans regia* and wild trees of walnut are found in every parts of the country and trees exhibit considerable variation in respect of vegetative growth and fruit characters. Although there are many walnut variety breeding program in the world, the new walnut variety program begun in 1999 in Turkey. A lot of walnut variety breeding programs have been carried out in USA, France, Hungary, Italy and Spain; a few of these programs are still ongoing (Germain *et al.*, 1985; Tulecke and McGranahan, 1994; Tamponi *et al.* 1997; Szentiványi and Szücs (2001); Anonymous, 2016).

Breeding of new walnut varieties is characterized by earlier fruiting, higher yield, lateral bearing, late leafing, good adaptability to different ecological conditions, good fruit quality and tolerant to pests and diseases. The ideal walnut cultivar should be relatively late leafing to escape spring frosts and the rains that spread walnut blight (*Xanthomonas campestris* pv. *juglandis*), precocious (yielding more than 500 kg/hectare in the fourth year), and vegetative vigorous with bearing on

both terminal and lateral shoots. The nut shell should be relatively smooth, well sealed, and make up no more than 50% of the nut weight. The nuts would fit the category of large or jumbo. The kernel would be plump and light colored, weighing about 8–9 g, and come out easily in halves. The tree would be at least moderately resistant to pests and diseases.

Turkish walnut cultivars have too early leafing out and most of them are susceptible to bacterial blight, and they bear fruit on terminal buds. The most widely used breeding method in walnut variety breeding programs in Turkey is by selection. The first breeding program was started in 1970 in Turkey (Ölez, 1971). At the first stage of the walnut breeding in Turkey, during 1970 to 2011 years, selection works have been made in populations that has been generated from seed. More than 200 promising types were selected among these trees [(Akça and Şen, 2001; Akca and Ozongun, 2004; Asma, 2012; Karadağ and Akça, 2011; Simsek et al., 2011; Kırca, et al., 2014; Akça *et al.*, 2015; Yarılgaç and Yılmaz, 2016)]. These selection works aimed to find new walnut types with high nut quality and yield. Also, the aim of this walnut variety breeding program was to obtain new selections combining lateral fruitfulness, late leaf break, resistance to pathogens (*Xanthomonas juglandis* and *Gnomonia juglandis*), regular yield, and high fruit quality. During the last 45 years, selection works carried out to find new walnut cultivars in Turkey. The selected types have a too early leafing out (Except Niksar1) and most of them are susceptible to bacterial blight and low yield. Therefore, this variety breeding program was started in 2008, in order to obtain new more productive cultivars with late leafing, higher nut quality and resistance to bacterial blight, early bearing. This paper reports the results gathered on leafing time characteristics.

Material and Methods

Twelve crosses have been done. The female parents consisted of Turkish, French and Californian varieties with late leafing (LL) and good nut and kernel quality. The male parents were lateral bud fruitfulness (LBF), early to medium late bud break and high fruit quality (Table 1). The female flowers were carefully bagged before receptive stage. After, the pollen of chosen parents was applied to receptive flowers. Pollen applied flowers marked with different colored threads. Seed from these crosses is collected in the fall before nut drop, air dried before storing. To ensure the highest possible germination, after soaking 24 hours in a GA₃ solutions at 50 ppm, seed are stratified in cold room (4-5 °C). After stratification, germinated seed are planted in large tubes in containing peat, perlite and soil for growth in the greenhouse. The leafing time of each hybrid was noted and the seedlings which leafed out two-three weeks earlier than 'Franquette' were discarded. The selected selections were planted in the breeding orchard 4 x 4 m, on their own roots. By age 6, trees with low yield or other problems are cut down. Date of bud break is reach a length of about 2.5 cm of the terminal bud and pronounced leaflets and observing least 7-8 cm of shoot growth has been recognized as the date of the foliation (Ölez, 1971). Leafing times were grouped according to UPOV standards (Table 2) (Anonymous, 1999).

Treatments / Parents	60 NF 81 ♂	‘Akça1’’ ♀	‘Akça 2’ ♂	‘Şebin’ ♀ ♂	‘Sütyemez 1’ ♂	‘Sütyemez 2’ ♂	‘Maraş12’ ♂	‘Oğuzlar77’ ♂	‘Franquette’ ♀	‘Hartley’ ♀
Leafing time	Early	Late	Early	Medium	Early	Medium	Medium	Early	Late	Medium
Lateral bud fruitfulness (%)	70-75	30	60	30-50	50-60	40-50	90	60-70	0-5	5-10
The number nut per cluster	6-8	2-4	3-8	2 4	2-3	6-8	3-20	4-6	1-2	1-2
Dichogamous	Protandrous	Protogynous	Protandrous	Protandrous	Protandrous	Protogynous	Homogenous	Protogynous	Protandrous	Protandrous
Kernel weight (g)	6,5	5.67	5.23	7 44	13	8.5	6,3	4.5	5,3	6,1
Kernel color	Light	Light	Light	Light	Light	Light	Light	Light	Light	Light
Shell thickness	Medium	Thin	Medium	Thin	Medium	Medium	Thin	Thin	Thick	Medium
Shell color	Light	Dark	Light	Dark	Light	Light	Light	Light	Light	Light

Table 1. Properties of parents used in the crosses

Leafing group	Difference of leafing time according to ‘Franquette’ cv at breeding orchard
Very-Early (1)	>(-26)
Early (2)	(-21) - (-26)
Medium- Early (3)	(-15) - (-20)
Medium (4)	(-09) - (-14)
Medium – Late (5)	(-03) - (-08)
Late (6)	(-02)- (+03)
Very – Late (7)	>(+03)

Table 2. Leafing groups according to ‘Franquette

Results and Discussion

The Turkish walnut cultivars have low yield potential. The yield is limited for the apical type of their bearing. Most of the Turkish cultivars are early leafing and very sensitive to spring frosts, when they grow under the continental climatic conditions. Therefore it is necessary to carry out a variety breeding program for developing new cultivars with lateral bearing, late bud-break, disease resistance and valuable economic traits of fruits.

During the first stage of the variety breeding program in Turkey (1998-2000), was used the national walnut genetic resources, in result of this research was not found walnut variety with late leafing according to 'Franquette' and 'Chandler' (Akça, 2001). But, during the last 10 years, the Californian and French walnut cultivars were used in crossing program. At the end of this new variety walnut breeding program are found excellent new walnut F₁ hybrids (Anonymous, 2012). Twelve crosses have been made so far and 1340 seedlings obtained in the new variety breeding program (Table 3).

Parents	Number of seedlings
'Şebin' x 'Akça 2'	75
'Şebin' x 60 NF 81	85
'Akça1' x 'Akça 2'	281
'Akça1' x 'Maraş12'	168
'Akça1' x 'Sütyemez2'	128
'Franquette' x 'Maraş12'	61
'Franquette' x 'Sütyemez1'	34
'Franquette' x 'Sütyemez2'	28
'Hartley' x 'Maraş12'	98
'Hartley' x 'Sütyemez1'	73
'Hartley' x 'Sütyemez2'	56
'Hartley' x 'Oğuzlar 77'	134
'Hartley' x 'Akça 2'	119
Total seedlings	1340

Table 3. Number of seedlings obtained from crosses

Distribution of walnut F₁ population's leafing time by parents (frequency %) were presented in Table 4. The percentage of medium, medium late and late leafing group of F₁ seedlings was observed as %50.72. The very early group (11.11%) of F₁ populations was only obtained in Hartley x Oğuzlar77 crossing. The distribution of F₁ population's leafing that is obtained from crossing late and very early parents was changed to used parent. For example medium, medium-late and late leafing percentage of F₁ population from crossing 'Franquette' x 'Maraş' 12 were determined as 20%, 14.29% and 28.58% respectively, but 38.00%, 32.00%, 6.00%, respectively male parent as 'Akça 1' was used.

Female Parents	Male Parents	Very Early (1)	Early (2)	Medium – Early (3)	Medium (4)	Medium –Late (5)	Late (6)
‘Akça1’ (6)	‘Sütyemez2’ (2)	-	7.69	38.46	26.92	11.54	15.38
‘Akça1’ (6)	‘Akça2’ (3)	-	10.06	32.08	34.59	10.06	13.21
‘Akça1’ (6)	‘Maraş12’ (1)	-	18.00	38.00	32.00	6.00	6.00
‘Franquette’ (6)	‘Maraş12’ (1)	-	2.86	34.28	20.00	14.29	28.58
‘Hartley’ (4)	‘Sütyemez1’ (2)	-	15.38	53.85	23.08	0	7.69
‘Hartley’ (4)	‘Akça2’ (3)	-	15.38	15.38	23.08	30.77	15.38
‘Hartley’ (4)	‘Oğuzlar77’ (2)	11.11	14.81	44.44	18.51	7.40	3.70
‘Hartley’ (4)	‘Maraş12’ (1)	-	12.12	30.30	39.39	12.12	6.06
Mean		1.39	12.04	35.85	27.20	11.52	12.00

Table 4. Distribution of walnut F₁ population’s leafing time according to parents (frequency %)

Germain (1990) was obtained 2500 F₁ plant from used different French and Californian walnut parents. The percentage of medium late to very-very late leafing group was reported as 37.2% in this breeding program. Germain (1990), reported that used parent effected to the distribution of walnut F₁ population’s leafing time.

Also, Szentiványi and Szücs (2001), examined to the inheritance of blooming time characteristics in 122 F₁ progenies from the cross A117 x Pedro, 125 ones from Pedro x A117, 34 ones from M10 x Pedro and 17 ones from T2 x Pedro. It was not observed the very late group of female blooming in F₁ population. Late female blooming group was changed between 6.25% to 21.43.

Conclusion

Among the 1340 hybrids, 198 F₁ hybrids have been preselected for the desired characters. They have been examined for further observations. The nut quality of preselected F₁ hybrid was observed much more than Chandler, Fernor, Hartley, Midland and Pedro (size, shell hardness, kernel percentage, color of kernel, proportion of waste, etc.). Superior pre-selections will be licensed before 2020. The early bore nuts was determined ‘Hartley’ x ‘Oğuzlar 77’, ‘Hartley’ x ‘Maraş12’ and ‘Hartley’ x ‘Akça 2’ combinations in 3th year after planting, the catkins has seen in their 4th-6th year.

Acknowledgment

This research was supported by TÜBİTAK (KAMAG -106 G 152)

References

- Akca Y. (2001). Breeding of walnut varieties by cross breeding, In: National Walnut Symposium, 5–8 September, Tokat-Turkey, pp. 53–63.
- Akca Y., Sen S.M., (2001). Study on the selection of superior walnut trees in Hizan (Bitlis) populations, *Acta Hort.* 544, pp. 115:119
- Akca Y., Ozongun S. (2004). Selection of late leafing, late flowering, laterally fruitful walnut (*Juglans regia* L.) types in turkey. *New Zealand J. Crop Hort. Sci.* No 32, pp.337–342.
- Akca Y., Bilgen Y., and Ercisli S. (2015). Selection of superior Persian Walnut (*Juglans regia* L.) from seedling origin in Turkey, *Acta Sci. Pol. Hortorum Cultus*, Vol. 14, No 3 , pp. 103-114

- Anonymus (1999). Gridlines for the conduct of tests for distinctness uniformity and stability 'Walnut' *Juglans regia* L, Geneva.
- Anonymous (2012). Studies on the development of walnut industry in Turkey, Project report of TÜBİTAK KAMAG 106-G 152.
- Anonymous (2016). http://fruitandnuteducation.ucdavis.edu/education/fruit_nut_production/Walnut/Walnut_Cultivar_Table/
- Asma, B.M., (2012). Pomological and phenological characterization of promising walnut (*Juglans regia* L.) genotypes from Malatya, Turkey, Acta Sci. Pol., Hortorum Cultus Vol. 11, No 4, pp. 169-178.
- Karadağ H, and Y Akça Y. (2011). Phenological and pomological properties of promising walnut (*Juglans regia* L.) genotypes from selected native population in Amasya Province African Journal of Biotechnology Vol. 10, No 74, pp. 16763-16768.
- Kırca, S., Yarılgaç, T., Kırca L., Bak T. (2014). Study on the selection of walnut (*Juglans regia* L.) in Trabzon, Turkish Journal of Agricultural and Natural Sciences Special Issue No 1, pp. 835:841
- Ölez H. (1971). Studies on the selection of walnut (*Juglans regia* L.) in the Marmara Region, PhD Thesis, (In Turkish.).
- Germain E., Leglise P., Bayol M. (1985). Creation, par hybridation de varietes de noyer (*Juglans regia* L.) associant floraison tardive, mise a fruit rapide et productivite elevee: premiers resultats, 5 Colloque sur les recherches fruitiers –Bordeaux, pp. 13-14 .
- Germain E. (1990). Inheritance of late leafing and lateral bud fruitfulness in Walnut (*Juglans regia* L.), Phenotypic correlations among some traits of the trees, Acta 284, pp. 125:134
- Szentiványi P., and Szücs, E. (2001). Inheritance of blooming time of walnut, with regard to the property of reproductional autoregulation of species, Acta Hort. No 544, pp. 83-88.
- Simsek M., Uguz M.U., Erdogan M.K., Gul A., Karakoc S., and Digrak M. (2011). Selection studies on high quality walnut types and their antibacterial properties, Journal of Medicinal Plants Research Vol. 5, No 14, pp. 3269-3276.
- Tamponi G., Monastra F., Fanigliulo R. (1997). Walnut Breeding Update to 1995, Proc. III. Int. Walnut Congress, Acta Hort. 442, pp:77-82.
- Tulecke W., and McGranahan G. (1994). The walnut germplasm collection of the University of California, Davis: A description of the collection and a history of the breeding program Of E.F. Serr And H.I. Forde. Rept 13. University Of California Genetic Resources.
- Yarılgaç T., Yılmaz K. (2016). Physical and biochemical characteristics of some walnut genotypes selected from Çal (Denizli) region. Anadolu Tarım Bilimleri Dergisi Vol. 31, No. 1, pp. 9-15.

GRAIN YIELD AND YIELD COMPONENTS IN SPRING MALTING BARLEY

Milomirka MADIĆ^{1*}, Dragan ĐUROVIĆ¹, Aleksandar PAUNOVIĆ¹, Desimir KNEŽEVIĆ²,
Miodrag JELIĆ²

¹University of Kragujevac, Faculty of Agronomy Čačak, Cara Dušana 34, Čačak, Serbia

²Faculty of Agriculture, Lešak, University of Priština, (Kosovska Mitrovica) Serbia

*Corresponding author: mmadic@kg.ac.rs

Abstract

Malting barley thrives in temperate climates that exhibit small temperature fluctuations, especially during grain maturation, when the crop is particularly sensitive to heat stress. A field trial involving four two-rowed spring barley cultivars was conducted at the experimental field of the Secondary School of Agriculture and Chemistry, Kraljevo (Serbia) over a period of three years (2012-2014) to evaluate the variability of yield components (plant height, number of kernels per spike, kernel weight per spike and thousand-kernel weight) and grain yield in different growing seasons. The experiment was laid out in a randomized block design with three replications on a pseudogley soil acidic in reaction. Seeding rate was 450 germinable seeds m⁻². At tillering, 50 kg ha⁻¹ nitrogen was applied. Calcium ammonium nitrate (CAN) with a nitrogen content of 27% was used for top dressing. The studied traits were significantly affected by weather conditions during the growing season. The effect of weather differed across cultivars. Grain yield, thousand-kernel weight, kernel weight per spike, number of kernels per spike and plant height were highest in all cultivars in the year characterized by moderate temperatures during grain filling and a high rainfall total in the second part of the growing season. The highest values for grain yield, number of kernels per spike and kernel weight per spike were obtained in 'Novosadski 448'.

Key words: *malting barley, climate, grain yield, yield components.*

Introduction

In Serbia spring barley goes through growth and development stages mostly under high temperature and water deficit conditions, especially during grain filling, which leads to a reduction in grain filling period, kernel size, kernel weight and, hence, grain yield and quality (Pržulj and Momčilović, 2002). Temperature and rainfall are not necessarily the most important factors that govern the level of production and grain quality in malting barley, since the harvested grain is often of poor quality when these factors are close to optimal (Pržulj et al., 2014). Therefore, the market is often lacking in barley that satisfies quality requirements of the malting and brewing industry (O'Donovan et al., 2011). In contrast, different soil and climatic conditions, especially temperature and moisture content during grain filling (Passarella et al., 2005) can cause a high variation in major grain yield components and, hence, total grain yield and quality of malting barley (Atlin et al., 2000; Paunović et al., 2007; Madić et al., 2009). Environmental conditions in Serbia and Southeastern Europe are considerably different from those in the barley belt of Western and Central Europe (Malešević and Starčević, 1992). Due to frequent heat waves during the growing season and considerable fluctuations in the amount and distribution of rainfall, there has been a tendency in Serbia for protein to accumulate in the barley grain and for kernel size to decrease (Malešević et al., 2010).

The objective of this study was to assess the effect of genotype and production conditions (year) on yield components and grain yield in spring malting barley grown on poorly productive soil.

Material and methods

Research was conducted in 2012-2014 at the experimental field of the Secondary School of Agriculture and Chemistry, Kraljevo in Serbia (experimental field of the Faculty of Agronomy, Čačak) on an acidic soil ($\text{pH}_{\text{H}_2\text{O}}$ 4.5, humus 2.18%, P_2O_5 7.50 mg 100^{-1} g and K_2O 15.5 mg 100^{-1} g soil). Four cultivars of two-rowed spring malting barley were used: 'Novosadski 448', 'Dinarac', 'Dunavac' and 'Lider'. The field trial was laid out in a randomized block design with three replications and a plot size of 5x1m. The total amount of the complex mineral fertilizer N:P:K (15:15:15) i.e. 300 kg ha^{-1} was manually broadcast before seedbed preparation. Seeding was performed by a seed drill designed for micro-trials at a rate of 500 germinable seeds m^{-2} and a spacing of 10 cm between rows and 3 cm in the row. Plants were fertilized at tillering by calcium ammonium nitrate (CAN - 27% N) at 50 kg N ha^{-1} . At full grain maturity, 30 plants were sampled from each plot for analysis of plant height, number of kernels per spike, kernel weight per spike and 1000 kernel weight. Prior to harvest, the number of spikes m^{-2} was determined. After harvest, grain yield from each plot was weighed and calculated as yield in kg ha^{-1} . Results were subjected to a two-way analysis of variance (cultivar, year). The significance of differences in means was assessed by Duncan's test (SPSS 1995).

Total rainfall was 263.5 mm, 322.6 mm and 653.5 mm in 2012, 2013 and 2014, respectively. Substantial amounts of rainfall in April and May 2012 caused lodging in the barley crop, whereas drought and high temperatures occurred during grain filling and maturation. The year 2013 was characterized by humid and cold weather accompanied by a thick cover of snow in February and March, and high temperatures from mid April until harvest. Weather conditions in the 2014 growing season included high rainfall totals during the second part of the season and almost daily rainfall during grain filling. Extreme rainfall events with an average of 700 mm rainfall were recorded in most of Serbia during 2014 as the rainiest season in the last 45 years.

Results and discussion

The optimum plant height in breeding malting barley has not been precisely defined. There has been a tendency in selection work to create short-stem cultivars to eliminate plant lodging and its negative effects, given the weak mechanical tissue of the barley stem (Pržulj et al. 2010). The analysis of variance for plant height showed significant differences across cultivars and production conditions during the experimental years. Plant height was greatest in 2014, significantly lower in 2012, and lowest in 2013 (Table 1). Over the three-year period, the greatest average plant height was obtained in 'Lider', and the smallest in 'Novosadski 448'. The significant dependence of plant height upon year was confirmed by Gozdowski et al. (2012), who obtained the shortest stem in the year of deficient rainfall, whereas Knežević et al. (2014) stressed that plant height is primarily a cultivar-specific trait, with cultivars showing great differences as the result of differences in their genetic constitution.

Number of spikes is the most important yield component in all cereal crops; at the same time, it is the most unstable yield component under semiarid conditions in Southeastern Europe (Pržulj and Momčilović, 2004). Moderate air temperatures and favourable soil moisture in May and April 2012 enabled good tillering and led to the formation of a large number of spikes (812.3 m^{-2}). In 2013 and 2014, the number of spikes per unit area in 'Dinarac' was significantly higher than in the other cultivars. In 2012, 'Dinarac' exhibited higher values of this trait only when compared to 'Lider'.

Number of kernels per spike varied across years from 16.4 in 2013 to 21.5 in 2014 (Table 1). In all three years, 'Novosadski 448' had significantly more kernels compared to the other cultivars. The

significant effect of weather and cultivar on the number of kernels per spike was also reported by Gozdowski et al. (2012). Due to the high number of kernels per spike, 'Novosadski 448' exhibited the highest kernel weight per spike (Table 1). Kernel weight per spike in 'Novosadski 448' was significantly higher than in the other cultivars in all years except 2014, when it showed no significant difference from 'Lider'. 'Dunavac' had a significantly lower kernel weight compared to the other cultivars in all years.

Table 1. Means for plant height (PH), number of spikes m^{-2} (NS m^{-2}), number of kernels per spike (NKS), kernel weight per spike (KWS), 1000 kernel weight (TKW) and grain yield (GY) in spring barley cultivars in 2012, 2013 and 2014

		PH	NS m^{-2}	NKS	KWS	TKW	GY
Cultivar A	'NS448'	74.1	760.5	20.1	0.80	38.3	5.44
	'Dinarac'	79.3	796.6	16.7	0.74	42.8	5.56
	'Dunavac'	78.5	763.3	18.7	0.67	38.4	5.35
	'Lider'	86.7	708.2	17.5	0.70	39.2	5.10
Year B	2012	85.5b	812.3a	17.9b	0.70b	38.8b	5.55b
	2013	65.3c	715.4c	16.4c	0.65b	39.7b	4.48c
	2014	88.2a	760.6b	21.5a	0.8a	41.1a	5.90a
'NS 448'	2012	79.9c	820.5a	19.7a	0.82a	38.4b	5.85a
	2013	62.3c	700.4b	17.1b	0.65a	36.1d	4.51a
	2014	81.1c	755.8b	23.1a	0.89a	38.4c	5.94
'Dinarac'	2012	85.2b	840.4a	16.4c	0.75b	42.1a	5.52a
	2013	63.4b	736.7a	14.1d	0.60b	44.5a	4.72a
	2014	89.4b	796.6a	18.8c	0.76b	41.3a	5.70
'Dunavac'	2012	85.9b	831.4a	17.3b	0.69b	38.2b	5.49
	2013	67.1a	720.8b	16.1b	0.60b	37.8b	4.47
	2014	84.6b	738.4b	20.1b	0.68c	39.4b	5.78
'Lider'	2012	96.5a	753.6b	17.5b	0.66b	37.5	5.12a
	2013	67.1a	640.5c	15.6c	0.70b	39.7	3.95b
	2014	96.7a	729.9b	20.2b	0.84a	41.5	6.20
	A	***	***	***	***	***	***
	B	***	***	***	***	***	**
	AxB	***	***	***	***	***	***

Means followed by different lowercase letters for cultivars and years are significantly different at the 95% level according to Duncan's multiple range test

*** F-test significant at 0.001

Thousand kernel weight is a kernel size trait expressing kernel suitability for malting. The analysis of variance indicated significant differences among cultivars (Table 1). Across years, 1000-kernel weight was significantly higher in 2014 than in 2012 and 2013. The 2012 and 2013 growing seasons were characterized by dry and hot weather during grain filling. Plant lodging in 2012 did not lead to reduced 1000-kernel weight compared to the unfavourable year 2013, most likely due to higher soil water reserves from April and May. Thousand-kernel weight in 'Dinarac' was significantly higher than in the other cultivars, except 'Lider' in 2014. Climatic conditions are of particular importance during grain filling, since moisture deficiency and high temperatures during this period (Pržulj et al., 2014) result in reduced thousand-kernel weight. Weather conditions during the growing season had a significant effect on the traits analyzed in all barley cultivars. Yield and yield components as a function of weather conditions during the growing season were also reported by Malešević et al. (2010) and Glamočlija et al. (2011).

Grain yield was lowest in 2013, significantly higher in 2012 and highest in 2014 (Table 1). In the first two years, 'Lider' gave a significantly lower grain yield compared to the other cultivars. Garcia del Moral et al. (2003) observed that yield stability as affected by different environmental conditions is closely associated with kernel number per spike since a large number of kernels per spike ensures a large number of kernels per unit area even when the number of spikes is low. Upon formation of the number of spikes and number of kernels per spike during vegetative growth, yield is mostly determined by kernel weight (Wiegand and Cuellar, 1981).

Conclusion

The analysis of variance of spring malting barley genotypes showed significant differences in the studied traits among cultivars. Weather conditions during the growing season had a significant effect on these traits in all barley cultivars. Grain yield, thousand-kernel weight, kernel weight per spike, number of kernels per spike and plant height were highest in the year with moderate air temperatures during grain filling and a high rainfall total in the second part of the growing season. 'Novosadski 448' outperformed the other cultivars in terms of grain yield, number of kernels per spike and kernel weight per spike, but it had the lowest values for 1000-kernel weight and plant height. 'Dinarac' gave the highest number of spikes, highest 1000-kernel weight, and the lowest number of kernels per spike.

Acknowledgements

This study is part of Projects Ref. Nos. TR 031054 and TR 031092 funded by the Ministry of Education and Science, Republic of Serbia.

References

- Atlin, N. G., McRae, B. K., Lu, X. (2000): Genotype x Region Interaction for Two-Row Barley Yield in Canada. *Crop Science*, 40(1): 1-6.
- García del Moral, L.F., García del Moral, M.B., Molina-Cano, J.L., Slafer, G.A. (2003): Yield stability and development in two- and six-rowed winter barleys under Mediterranean conditions. *Field Crops Research*, 81: 109-119.
- Glamočlija, Đ., Dražić, G., Ikanović, J., Popović, V., Stanković, S., Spasić, M., Rakić, S., Milutinović, M. (2011): Uticaj sorte i povećanih količina azota na morfološke i tehnološke osobine pivarskog ječma. *Zbornik naučnih radova Instituta PKB Agroekonomik*, 17(1-2): 55-66.
- Gozdowski, D., Wszyński, Z., Kalinowska-Zdun, M., Pałowski, K., Pietkiewicz, S. (2012): Zmienność budowy przestrzennej łanu jęczmienia jarego w zróżnicowanych warunkach Środowiskowo-Agrotechnicznych. Część II. Architektura łanu. *Fragm. Agron.* 29(3): 20–30.
- Knežević, B. J., Aksić, M., Ćirić, S.S., Gudžić, N., Tmušić, N. (2014): Effect of rates of nitrogen on the productive elements of spring malting barley. *Journal of Agricultural Sciences*, 59(1): 15-24.
- Madić, M., Paunović, A., Knežević, D., Zečević, V. (2009): Grain Yield And Yield Components Of Two-Row Winter Barley Cultivars And Lines. *Acta Agriculturae Serbica*, XIV(27): 17-23.
- Malešević, M., Glamočlija, Đ., Pržulj, N., Popović, V., Stanković, S., Tapanarova, A. (2010): Production characteristics of different malting barley genotypes in intensive nitrogen fertilization. *Genetika*, 42(2): 323-330.
- Malešević, M., Starčević, Lj. (1992): Proizvodnja pivskog ječma. Pivski ječam i slad. V monografija, DP „20 oktobar“ Sladara Bačka Palanka, Čelarevo, 14-52.

- O'Donovan, J.T., Turkington, T.K., Edney, M.J., Clayton, G.W., McKenzie, R.H., Juskiw, P.E., Lafond, G.P., Grant, C.A., Brandt, S.A., Harker, K.N., Johnson, E.N., May, W.E. (2011): Seeding Rate, Nitrogen Rate, and Cultivar Effects on Malting Barley Production. *Agronomy Journal*, 103(3): 709-716.
- Passarella, V.S., Savin, R., Slafer, G.A. (2005): Breeding effects on sensitivity of barley grain weight and quality to events of high temperature during grain filling, *Euphytica*, 141:41-48.
- Paunović, A., Madić, M., Knežević, D., Bokan, N. (2007): Sowing density and nitrogen fertilization influences on yield components of barley. *Cereal Research Communications*, 35(2): 901-904.
- Pržulj, N., Momčilović, V. (2004): Physiological basis of barley yield under near optimal and stress conditions. *Plant breeding and seed production*, X(1-4): 15-26.
- Pržulj, N., Momčilović, V., Nožinić, M., Jestrović, Z., Pavlović, M., Obrović, B. (2010): Importance and breeding of barley and oats. *Ratarstvo i povrtarstvo*, 47(1): 33-42.
- Pržulj, N., Momčilović, V., Simić, J., Mirosavljević, M. (2014): Effect of Year and Variety on Barley Quality. *Genetika*, 46(1): 59-73.
- Pržulj, N., Momčilović, V. (2002): NS sorte ječma za agroekološke uslove jugoistočne Evrope. *Zbornik radova Instituta za ratarstvo i povrtarstvo*, 36: 271-282.
- Wiegand, C.L., Cuellar, J.A. (1981): Duration of grain filling and kernel weight of wheat as affected by temperature. *Crop Sci.*, 21: 95-101.

CHERRY BREEDING WORK AT FRUIT RESEARCH INSTITUTE – ČAČAK (REPUBLIC OF SERBIA)

Sanja RADIČEVIĆ^{1*}, Radosav CEROVIĆ², Slađana MARIĆ¹, Milena ĐORĐEVIĆ¹

¹Fruit Research Institute, Čačak, Republic of Serbia

²University of Belgrade, Innovation Centre at Faculty of Technology and Metallurgy, Belgrade, Republic of Serbia

*Corresponding author: saniaradicevic@gmail.com

Abstract

Cherry breeding programme at Fruit Research Institute (FRI) – Čačak (Republic of Serbia) has had a long tradition since its initiation in 1960. The main method is the planned hybridisation within *Prunus avium* L. and *Prunus cerasus* L. Two sweet cherry ('Asenova Rana' and 'Čarna') and two sour cherry cultivars ('Šumadinka' and 'Čačanski Rubin') have been released in the previous period. Three new sour cherry cultivars ('Sofija', 'Nevena' and 'Iskra') were named and released in 2015, whereas a large number of hybrids are being intensively studied. Current sour cherry breeding work is based on the use of domestic genotypes, well adapted to the environmental conditions of the area (either obtained by planned hybridisation or autochthonous), and introduced genotypes – known sources of resistance, with a high cropping potential and good fruit quality. The investigations are also focused on different aspects of floral biology of these fruit species – flowering phenology, pollen quality, monitoring the pollen tubes growth in the pistil and cytoembryology. Cultivars' specificities in reproductive behaviour as pollen donors/recipients were considered in order to find solutions for adequate choice of cultivars combinations that yield the best performance in terms of good fruit set and satisfactory yields. Decades-long research work on self- and cross-(in)compatibility in cherries was started by monitoring fruit set percentage under field conditions, and was later considerably advanced by observing pollen tubes growth in the pistil using fluorescence microscopy. In recent years, *S*-genotyping of domestic and foreign sweet cherry cultivars has also been involved, using consensus primers that amplify the two introns of *S-RNase* and allele-specific primers.

Keywords: *Sweet and sour cherry, breeding, new cultivars, floral biology, S-incompatibility*

Introduction

Sweet cherry (*Prunus avium* L.) and sour cherry (*Prunus cerasus* L.) belong to the *Rosaceae* family, *Prunus* genus and *Cerasus* subgenus. *P. avium* has a diploid genome, whereas *P. cerasus* is an allotetraploid species, originating as a result of natural hybridisation involving *P. avium* (producing unreduced gametes) and tetraploid *P. fruticosa* (ground cherry) (Dirlewanger *et al.*, 2007).

Cherries are among the most popular temperate fruit crops, due to their attractiveness in appearance, high nutritive value and suitability for both fresh consumption and different kinds of industrial and domestic processing. Compared to other temperate fruits, breeding improvements have been relatively slow, in particular in sour cherry. In recent time, the integration of the molecular markers in breeding programmes has had a strong impact on breeding achievements.

In the structure of fruit growing in the Republic of Serbia, cherry has an important place, especially in sour cherry production which, together with raspberry, represents the country's most important exporting fruit (Cerović and Radičević, 2008; Budan *et al.*, 2013; Lukić *et al.*, 2016). The work on developing new cherry genotypes at Fruit Research Institute (FRI), Čačak resulted

in realization of two sweet cherry and five sour cherry cultivars, as well as numerous promising hybrids which are under the evaluation process. Using modern methods in investigation of fertilization biology and determination of *S*-genotype are important parts of cherry breeding work at FRI, Čačak.

In this paper, we referred to the most important achievements at FRI, Čačak in the field of cherry breeding, floral biology and identification of incompatibility alleles.

Planned hybridisation within *Prunus avium* L.

The work on breeding sweet cherries at FRI, Čačak has been in progress since 1960. The objectives were developing cultivars of differing ripening time, with large, high-quality fruits resistant to cracking, with early, abundant and regular bearing, moderate vigour and compact growth habit. Cultivars should have crisp flesh and deep red or yellow ground colour, high flesh/stone ratio, improved resistance to pests and diseases, and hardiness to winter and late spring frosts (Milenković *et al.*, 2006). In 254 crosses, 40 cultivars were used as female parents (acceptors) and 56 as male parents (donors). The best progenies were originated from the crosses ‘Majova Rana’ × ‘Drogan’s Yellow’, ‘Emperor Francis’ × ‘Cassin’s Early’, ‘Majova Rana’ × ‘Schrecken Bigarreau’, ‘Stella’ × ‘Van’, ‘Van’ × ‘Stella’, ‘Stella’ × ‘Bing’ (Budan *et al.*, 2013). More than 5,000 hybrid seedlings were obtained, out of which 60 were designated as promising. Only 14 were singled out as elite, and certain number of them was tested in several localities in comparative cultivar trials. Two genotypes were released as cultivars – ‘Asenova Rana’ (‘Drogan's Yellow’ × ‘Majova Rana’) and ‘Čarna’ (‘Majova’ × ‘Schrecken Bigarreau’).

Planned hybridisation within *Prunus cerasus* L.

The work on the improvement sour cherry genotypes at FRI, Čačak, started concurrently with sweet cherry (1960). The breeding goals were to obtain self-fertile, highly cropping cultivars, with different ripening time, large and good quality fruits, suitable for freezing, industrial processing and fresh consumption, with favourable flesh/stone ratio, dark red or colourless juice that does not bleed at separation from the stalk (Milenković *et al.*, 2006). A special attention has been paid to obtaining genotypes tolerant/resistant to cherry leaf spot (*Blumeriella jaapii* (Rehm.) v. Arx.), brown rot (*Monilinia laxa* /Ader et Ruhl./ Honey ex Whetz.) and shot-hole (*Clasterosporium carpophilum* (Lév.) Aderh.) (Lukić *et al.*, 2012). In the first phase, planned hybridisation included 33 cultivars used as female parents and 52 as male parents, in 125 crosses. The best progenies were derived from the crosses ‘Köröser Weichsel’ × ‘Heimanns Konserven Weichsel’, ‘Köröser Weichsel’ × ‘Richmorency’, ‘May Sour Cherry’ × ‘Heimanns Konserven Weichsel’, ‘Köröser’ × ‘Heimanns Rubin’, ‘Heimanns Konserven Weichsel’ × ‘May Sour Cherry’ and ‘Čačanski Rubin’ × ‘Heimanns Konserven Weichsel’. More than 20,000 hybrid seedlings were obtained, 80 of which were singled out as promising; 25 were designated as elite and evaluated in comparative varietal trials. Two of them are registered as cultivars – ‘Čačanski Rubin’ (‘Shasse Morello’ × ‘Köröser Weichsel’), and ‘Šumadinka’ (‘Köröser Weichsel’ × ‘Heimanns Konserven Weichsel’).

In the second phase, 11 sour cherry genotypes were selected from the population of 3,000 hybrid seedlings (Cerović *et al.*, 1998; Nikolić *et al.*, 1999), and four of which have been singled out as elite, due to high quality fruits and a significant level of field resistance to economically most serious pests and causal agents of diseases (Radičević *et al.*, 2010). In 2015, three of them were released as new sour cherry cultivars (Radičević and Cerović, 2015):

‘Sofija’ (‘Čačanski Rubin’ × ‘Heimanns Konserven Weichsel’) – It is a mid-early ripening cultivar (the second decade of June under the West Serbia condition), with large to very large fruits (7.0 g on average), roundish in shape. The skin is ruby-red coloured, and the flesh is red,

sweet-subacid, of pleasant aroma and excellent quality. The juice is red. The stone is medium large, and stalk is very long, easily separating from the fruit, without leakage of juice. It is a regular and heavy cropper, showing a high level of field resistance to *Blumeriella jaapii*.

‘Nevena’ (‘Köröser Weichsel’ × ‘Heimanns Konserven Weichsel’) – The ripening time is mid-late (the beginning of third decade of June under the West Serbia condition). The fruit is large to very large (7.0 g on average), with dark red skin and flesh, of a pleasant aroma and high quality. The juice is intensely coloured. The stone is small to medium large, and the stalk is short to medium long. It is tolerant to *Blumeriella jaapii*. The fruits are of the excellent quality, good transportability, suitable both for fresh consumption and different kinds of processing.

‘Iskra’ (‘Köröser Weichsel’ × ‘Heimanns Rubin’) – The ripening time is mid-late (third decade of June under the West Serbia condition). The fruit is large to very large (7.5 g on average), of flattened-spherical shape, with light red skin colour, and whitish mesocarp of a pleasant aroma and excellent quality. The juice is light red, the stone is small, and the stalk is medium long. With the presence of adequate pollenisers, it is a regular and heavy cropper. It is tolerant to *Blumeriella jaapii*. The fruits are of a high quality, suitable both for fresh consumption and different kinds of processing.

The new breeding programme within *P. cerasus* at FRI started in 2011, and is in accordance with the requirements of the modern sour cherry production, both regarding the breeding objectives and the proper choice of parental genotypes. New sour cherry cultivars ought to possess a high cropping potential, and a fruit quality to suit the needs of industrial processing and fresh consumption (fruit size, low share of stone in the total fruit weight and easily detachable stone, as well as a high soluble solids content with a good balance of sugars and acids). Tolerance to *Blumeriella jaapii* is one of the major breeding goals. The relatively short span in the ripening time among the commercially important cultivars imposes a need to prolong the harvesting season, especially with earlier-ripening cultivars. Important goals are also self-fertility, and suitability for mechanical harvesting (medium vigour and upright growth of branches, even ripening time, fruit firmness and resistance to bruises, as well as easy detachment of stone and absence of juice leakage at separation of fruit from the stalk). The concept was significantly influenced by the fact that the pedigree of the commercially significant cultivars is dominated by a relatively small number of genotypes. Due to modern breeding trends imply the use of genetic potential from indigenous genotypes (predominantly from the South-Eastern Europe, which is characterised by a significant diversity within *P. cerasus*), the programme aims to unify the desired characteristics of the genotypes obtained from the planned hybrids population (domestic and introduced cultivars, promising hybrids) and from the natural populations (indigenous genotypes).

Floral biology investigation

In addition to conventional breeding method, the investigations at FRI, Čačak are also focused on the different aspects of fertilization biology in cherries.

Due to the fact that cherry genotypes are mostly self-incompatible, the knowledge of possibilities for cross-pollination and fertilization is essential for an adequate choice of cultivar combination that ensures abundant fruit set. Effective pollination among compatible cultivars is related to their flowering time (early, mid-early, mid-late and late flowering cultivars), which is an important part of floral biology investigation at FRI (Radičević *et al.*, 2008, 2012). Perennial overlap during the phenophase of full flowering for a period of 5–8 days is the crucial for a successful cross-pollination in commercial orchards (Cerović *et al.*, 2005); the overlap should be accompanied by a short span in the beginning of full flowering among the cultivars (2–3 days). On the basis of the average full flowering overlap in sweet cherry cultivars in West Serbia conditions and

classification of the cultivars among different incompatibility groups, recommendations for their effective cross-pollination and fertilization in sweet cherry orchards have been offered (Radičević *et al.*, 2011, 2015).

Pollen quality in cherries is one of the key aspects of reproduction process which to a great extent influences its efficacy and consequently the realization of the cropping potential. Pollen vitality and *in vitro* germination is directly related to the regularity of the microsporogenesis process (Cerović, 1991a). Special attention has been paid to investigation of temperature influence on pollen *in vitro* germination (Cerović and Ružić, 1992a). In different introduced sweet cherry cultivars, pollen germination *in vitro* can be the first indicator of their adaptability to agro-environmental conditions (Radičević *et al.*, 2012, 2013b), from the standpoint of regularity of phases within the fertilization process. On the other hand, the importance of pollen morphology in clarifying the classification of many plants has been recognized from taxonomists, paleobotanists and breeders. Examination of sweet cherry pollen grains by scanning electron microscope (SEM) has not only revealed differences in pollen size, coarseness, depth of ridges, striation of exine among the cultivars, but it could also be of a great importance for identification studies (plant breeders, gene banks) and helpful in studying the gene flow (Radičević *et al.*, 2013b).

Pollination experiments followed by monitoring the pollen tubes growth in the pistil by fluorescent microscopy and monitoring the fruit set are important parts of floral biology investigation at FRI, Čačak. Pollen tube growth *in vivo* shows the dependence with respect to pollen germination *in vitro* in sour cherry (Cerović and Ružić, 1992a) and sweet cherry (Radičević *et al.*, 2016). Our investigation showed that in cherries, the pollen-pistil interaction manifests through the gametophytic self-incompatibility system (Cerović, 1997; Bošković *et al.*, 2006; Radičević *et al.*, 2013a), but it occurs in compatible crosses too, so the pollen performance and final outcome of the fertilization represents overlapping effect of several factors – polleniser genotype, behaviour of pollenisers at different temperatures, the influence of pollinated cultivar on pollen performance, the influence of temperature on male-female relations (Radičević *et al.*, 2016).

Investigation of functionality of female flower elements conducted using fluorescent-microscopy and histological methods pointed to its dependence of genotypic factors and the temperature during the full flowering phenophase (Cerović, 1991b; Cerović and Ružić, 1992b; Cerović *et al.*, 1999, 2014; Radičević *et al.*, 2016). The aforementioned factors were considered in the context of temperature conditions, bearing in mind the effects of global warming, and incidence of seasons with higher temperatures during the flowering in main cherry regions in the Republic of Serbia.

The study of S-allelic constitution in cherry genotypes

Cherries exhibit a S-RNase-based gametophytic self-incompatibility system, in which self-pollen rejection is controlled by alleles of the stylar (*S-RNase*) and pollen (*SFB*) specific genes. Diploid sweet cherry is generally self-incompatible, while tetraploid natural sour cherry genotypes include both self-incompatible and self-compatible types, although polyploidy per se does not result in self-compatibility. The S-genotype of cherry cultivar is an agronomically important trait, which provides useful information for breeders using it in crossing programmes and as genetic marker, and indeed for growers in order to achieve an effective pollination. In the recent period, determination of S-genotype of domestic and foreign sweet cherry cultivars using the consensus primers that amplify the first and the second introns of *S-RNase* (PaConsI-F + -R and PaConsII-F + -R, respectively) and allele-specific primers has been applied in the laboratory of Department of Pomology and Fruit Breeding at FRI, Čačak (Radičević *et al.*, 2013a, 2015; Marić *et al.*, 2014, 2015). The high polymorphism of *S-RNase* (25 alleles have been identified so far) has been used for cultivar identification and discrimination (Radičević *et al.*, 2015; Marić *et*

al., 2015), determination of *S*-genotype and incompatibility group in some old cultivars which have not been published earlier, i.e. 'Majova Rana' (S_7S_4 ; incompatibility group IX), 'Junska Rana' (S_3S_9 ; incompatibility group XVI) (Marić *et al.*, 2014, 2015) and assessment of self-(in)compatibility in some sweet cherry cultivars (Radičević *et al.*, 2013a). Current work is focused on the analysis of segregating progenies in order to elucidate the nature of self-compatible behaviour in some sweet cherry genotypes, as well as on determination of *S*-allelic constitution in autochthonous genotypes and newly released sweet cherry cultivars and hybrids within breeding programmes in the Balkan region.

Conclusion

The new cherry genotypes, together with the ones that were released previously at FRI, Čačak, will represent an important base for the production of cherry fruits, as well as a base for further breeding programmes within *P. avium* and *P. cerasus*. The application of methods of reproductive and molecular biology within the conventional cherry breeding programme will improve efficiency in developing new cultivars by enabling proper choice of parental genotypes and early selection for adult traits.

Acknowledgement

This work was conducted under Research Project *TR-31064: Development and preservation of genetic potential of temperate zone fruits*, supported by the Ministry of Education, Science and Technological Development of the Republic of Serbia.

References

- Bošković, R.I., Wolfram, B., Tobutt, K.R., Cerović, R., Sonnenveld, T. (2006). Inheritance and interactions of incompatibility alleles in the tetraploid sour cherry. *Theoretical and Applied Genetics*, 112 (2), 315–326.
- Budan, S., Zhivondov, A., Radicevic, S. (2013). Recent achievements in cherries breeding in some Balkan countries. *Acta Horticulturae*, 981 (1), 83–90.
- Cerović, R. (1991a). Cytogenetic properties of sour cherry in relation to pollen. *Genetika*, 23 (3), 247–258.
- Cerović, R. (1991b). Comparative use of the paraffin and fluorescence-microscopic methods for estimating the ovule viability in sour cherry. *Journal of Yugoslav Pomology*, 25, 9–17.
- Cerović, R. (1997). Sour cherry fertilization biology. Endowment Andrejević, Belgrade, Republic of Serbia.
- Cerović, R., Nikolić, M., Milenković, S. (1998). Breeding of sour cherries for quality and resistance to *Blumeriella jaapii* (Rehm.) V. Arh and *Rhagoletis cerasi* L. *Genetika*, 30 (1), 51–58.
- Cerović, R., Radičević, S. (2008). Sour cherry research and production in Serbia and Montenegro. *Acta Horticulturae*, 795 (2), 493–496.
- Cerović, R., Radičević, S., Ružić, Đ., Đorđević, M., Vujović, T. (2014). Functionality of embryo sacs as related to their vitality and fertilization success in 'Asenova Rana' sweet cherry. *Journal of Pomology*, 48 (187/188), 97–104.
- Cerović, R., Ružić, Đ. (1992a). Pollen tube growth in sour cherry (*Prunus cerasus* L.) at different temperatures. *The Journal of Horticultural Science & Biotechnology*, 67 (3), 333–340.
- Cerović, R., Ružić, Đ. (1992b). Senescence of ovules at different temperatures and their effect on the behaviour of pollen tubes in sour cherry. *Scientia Horticulturae*, 51 (3/4), 321–327.

- Cerović, R., Ružić, Đ., Radičević, S., Kuzmanović, M. (2005). Determination of the cultivar composition of pollinators for sweet cherry cv Čarna. *Journal of Pomology*, 39, 347–355.
- Cerović, R., Vujičić, R., Mičić, N. (1999). Localization of polysaccharides in the ovary of sour cherry. *Gartenbauwissenschaft*, 64 (1), 40–46.
- Dirlewanger, E., J. Claverie, A. Wunsch, Iezzoni, A.F. (2007). Cherry. In Kole, C. (ed), “Genome Mapping and Molecular Breeding in Plants, Vol. 4: Fruits and Nuts”, Springer Verlag Berlin Heidelberg, pp. 103–118.
- Lukić, M., Marić, S., Radičević, S., Milošević, N., Đorđević, M., Laposavić, A. (2015). Current condition and prospects of fruit growing in the Republic of Serbia. *Journal of Mountain Agriculture on the Balkans*, 18 (3), 541–573.
- Lukic, M., Maric, S., Radicevic, S., Mitrovic, M., Milosevic, N., Đorđević, M. (2012). Importance of resistant/tolerant fruit genotypes for environmental protection. *Journal of Environmental Protection and Ecology*, 13 (1), 120–127.
- Marić, S., Radičević, S. (2014). Application of PCR method in determination of *S*-genotype in sweet cherry (*Prunus avium* L.) at Fruit Research Institute – Čačak. *Journal of Pomology*, 48 (185/186), 29–37.
- Marić, S., Radičević, S., Cerović, R., Vranić, D. (2015). Determination of *S*-allelic constitution in some sweet cherry cultivars (*Prunus avium* L.). *Journal of Pomology*, 49 (189/190), 43–48.
- Milenković, S., Ružić, Đ., Cerović, R., Ogašanović, D., Tešović, Ž., Mitrović, M., Paunović, S., Plazinić, R., Marić, S., Lukić, M., Radičević, S., Laposavić, A., Milinković, V., Weber, C. (2006). Fruit cultivars developed at the Fruit Research Institute, Čačak and New varieties of raspberry and blackberry for fresh consumption and processing markets. Agricultural Research Institute SRBIJA, Belgrade, Republic of Serbia.
- Nikolić, M., Cerović, R., Mitrović, M. (1999). Biological-pomological studies of the promising sour cherry hybrids. *Journal of Yugoslav Pomology*, 33 (127/128), 99–106.
- Radičević, S., Cerović, R. (2015). New sour cherry (*Prunus cerasus* L.) cultivars developed at Fruit Research Institute, Čačak. *Journal of Pomology*, 49 (191/192), 115–121.
- Radičević, S., Cerović, M., Đorđević, M. (2012). Study of correlations among some parameters of flowering biology in sweet cherry cultivars (*Prunus avium* L.). *Journal of Pomology*, 46 (179/180), 121–128.
- Radičević, S., Cerović, R., Glišić, I., Karaklajić-Stajić, Ž. (2010). Promising sour cherry hybrids (*Prunus cerasus* L.) developed at Fruit Research Institute – Čačak. *Genetika*, 42, 299–306.
- Radičević, S., Cerović, R., Kuzmanović, M., Marić, S. (2008). The study of the flowering phenophase and pollen germination in newly developed sweet cherry cultivars. *Journal of Pomology*, 42 (163/164), 89–95.
- Radičević, S., Cerović, R., Marić, S., Đorđević, M. (2011). Flowering time and incompatibility groups – cultivar combination in commercial sweet cherry (*Prunus avium* L.) orchards. *Genetika*, 43 (2), 397–406.
- Radičević, S., Cerović, R., Nikolić, D., Đorđević, M. (2016). The effect of genotype and temperature on pollen tube growth and fertilization in sweet cherry (*Prunus avium* L.). *Euphytica*, 209 (1), 121–136.
- Radičević, S., Marić, S., Cerović, R. (2015). *S*-allele constitution and flowering time synchronization – preconditions for effective fertilization in sweet cherry (*Prunus avium* L.) orchards. *Romanian Biotechnological Letters*, 20 (6), 10977–11006.
- Radičević, S., Marić, S., Cerović, R., Đorđević, M. (2013a). Assessment of self-(in)compatibility in some sweet cherry (*Prunus avium* L.) genotypes. *Genetika*, 45 (3), 939–952.

Radičević, S., Nikolić, D., Cerović, R., Đorđević, M. (2013b). *In vitro* pollen germination and pollen grain morphology in some sweet cherry (*Prunus avium* L.) cultivars. Romanian Biotechnological Letters, 18 (3), 8341–8349.

SIGNIFICANCE OF AGRO-ECOLOGICAL CONDITIONS ON TRAIT FORMATION OF MAIZE HYBRID SEED

Marijenka TABAKOVIĆ^{1*}, Snežana JOVANOVIĆ¹, Rade STANISAVLJEVIĆ², Ratibor ŠTRBANOVIĆ², Miloš CREVAR¹, Dobrivoj POŠTIĆ², Jasna KOJIĆ¹

¹Maize Research Institute, Zemun Polje, Slobodana Bajića 1, 11185 Belgrade, Serbia

²Institute for Plant Protection and Environment, Teodora Drajzera 9, 11040 Belgrade, Serbia

*Corresponding author: mtabakovic@mrizp.rs

Abstract

Traits of the F₁ generation of maize hybrid seed were observed in four SC combinations produced in two locations. Agro-ecological conditions for the production of hybrid seed in these locations during three years differed. The coefficient of variation for germination energy and seed germination was 0.71% in ZP 341 during the first year. Produced seed of all observed hybrids was of satisfactory quality. The analysis of data shows that seed germination and energy (2.56% CV) varied the most in the hybrid combination ZP 434 in the three-year experiment. According to the location assessment, established differences in traits were greater, and the coefficient of variation for both locations amounted to $0.9 \leq 3.21$. The effect of agro-ecological conditions differed over locations during the same production season. According to obtained results, agro-ecological conditions have an essential role on the formation of traits of hybrid seed. Based on gained results, the level of expression of the two observed traits in all four hybrids was high under all agro-ecological conditions. Moreover, effects of the factors (hybrid and location) on germination energy and seed germination were high.

Key words: *maize, location, germination, variability.*

Introduction

The necessary and appropriate number and arrangement of plants in a commercial maize hybrid crop can be provided primarily by sowing seeds of good physiological and physico-mechanical traits.

With regard to both scientific and technological research, germination represents a physiological trait of maize hybrid seed that depends on remaining physiological traits of embryos and seeds, but also on the environmental conditions under which the research is carried out. Seed germination is a complex biochemical, physiological and morphological process in the formation of a new plant. According to Ujević and Kovačević (1972), the process of seed germination is proceeded through three stages. Germination is a process encompassing enzyme activation, degradation of insoluble reserve materials, translocation and mobilisation of soluble substances and growth-inducing reactions. The studies performed by McDonald et al. (1994) point out that the most active water intake by seeds occur during the first six hours of imbibition and that is more pronounced in the embryo than in the endosperm. Physico-mechanical and physiological traits of maize hybrid seed depend on agro-ecological conditions during the seed formation and maturation. Shien and Mc Donald (1982) observed the influence of a seed size and shape in two maize inbred lines on seed quality and established that there is no dependence on a seed size. There are numerous studies published in our country relating to the significance of the seed size and shape and their effects on germination (Đukanović et al. 2003; Pajić et al. 1997). According

to results obtained by Chassot (2000), in the no-tillage system, the air and soil temperatures are probably the main physiological stress factor during the early maize plant development. Stone et al. (1999) determined that the soil temperature directly affected meristematic tissues of radicles and shoots.

All traits of maize hybrid seeds depend on a genotypic combination and the interaction of this combination and agro-ecological conditions during the growing season of the seed crop. Lee et al. (2002) showed significant differences in tolerance of genotypes to low temperatures; these differences were manifested during various developmental stages of roots and above-ground plant parts.

The research programme encompassed experimental studies of traits of the F₁ generation of maize hybrid seed, mathematical and statistical processing, evaluation and the analysis of obtained experimental data.

Material and Methods

Seed of the following hybrid combinations, produced in two locations, Banat1 (L1) and Banat2 (L2), was used as a material in this study: ZP 341, ZP 434, ZP 684 and ZP 704. The material was produced by the application of similar cropping practices. Production locations differed in ecological and agro-ecological conditions.

Production trials were established for each hybrid combination according to standards prescribed in the *Regulation on control of the seed production of agricultural crops* (Official Gazette of RS, issue 60/2006).

Agro-ecological conditions were monitored during the production process, while data were obtained from the nearest hydrometeorological stations.

Working samples of 1000 g each were drawn from the natural seed material (25-30 kg) and used for the analysis of germination energy and seed germination.

The determination of seed physiological traits (germination energy and germination) was done at the standard temperature regime and filter paper: t=20/30°C ((16:8) light : dark (L:D) photoperiod, white light at higher temperatures), germination energy for 4 days and germination for 7 days.

Each of obtained parameters was processed by the statistical analysis by the application of the descriptive statistics for parameters at the annual level (the period from 2006 to 2010). Differences among four observed maize hybrids in two locations in Bačka were established by the analysis of variance for the factorial trial set up according to the randomised block design and by the LSD test at the probability levels of 5% and 1% (Hadživuković, 1973). In order to draw objective conclusions on effects of observed parameters on tested maize seed traits and the possibility to apply parametric tests (ANOVA and LSD-test), homogeneity of variance was tested by the Levene's test.

Results and Discussion

Results of the three-year study on the impact of a location and a year of production on physiological traits, energy and germination, point out to the minor variability of observed traits. Germination and energy values were above 90%, while the coefficient of variation (CV) did not exceed 4%. The influence of the production location was higher than the effect of the production year. Furthermore, the differences among hybrid combinations were also determined. The least variation was in the hybrid combination ZP 704 during the first year of production (G1, Table 1).

Table 1. Average values and variations for germination energy and seed germination over years of production

Year		Germination energy (ek)				Seed germination (uk)			
		ZP341	ZP434	ZP684	ZP704	ZP341	ZP434	ZP684	ZP704
G1	Average	97.51	97.41	96.55	95.32	97.5	97.46	96.50	95.31
	CV	0.71	1.13	0.42	0.14	0.71	1.13	0.43	0.14
G2	Average	96.50	95.23	95.35	96.74	96.5	95.25	96.23	98.00
	CV	0.71	2.56	0.14	0.14	0.71	2.56	1.13	0.01
G3	Average	92.22	94.25	94.71	94.57	91.7	94.71	94.74	94.85
	CV	0.28	0.84	0.42	1.55	0.42	0.14	0.42	1.98

The production location L2 caused the greatest variation in the hybrid combination ZP 341, while the combination ZP 684 with the coefficient of variation of 0.9% in the location L1 had the least differences in values of traits presented in Table 2.

Table 2. Average values and variations for germination energy and seed germination over locations of production

Location		Germination energy (ek)				Seed germination (uk)			
		ZP341	ZP434	ZP684	ZP704	ZP341	ZP434	ZP684	ZP704
L1	Average	94,80	95,47	95,33	95,07	94,80	95,47	95,33	95,53
	CV	2,99	2,47	0,90	1,60	2,99	2,47	0,90	2,32
L2	Average	95,67	95,73	95,67	95,93	95,67	96,07	96,27	96,53
	CV	3,21	1,86	0,99	0,76	3,21	1,29	1,10	1,33

Observed factors have a smaller or a greater statistically significant effect on germination energy and seed germination, as well as on their partial effect of action. Hence, both factors and their interaction too affect changes in germination energy and seed germination. It was determined that many factors affected the process of maize seed germination either individually and or in interactions, while the obtained results referred to the seed as a whole (Dačić et al. 1997, Sabovljević et al. 1997, Tabaković et al. 2015.).

The year of production is a factor that affected both energy and germination in all hybrid combinations. Moreover, the interaction of the two factors was significant. The significance of the location on the expression of seed germination was observed in the hybrid combinations ZP 434, ZP 684 and ZP 704, while energy varied under the effect of this factor only in the hybrid combination ZP 704 (Table 3).

The partial effect of the year on the physiological traits was the highest in ZP 341 ($\eta^2= 0.817$, $\eta^2=0.779$). On the other hand, this effect of the location was small in all hybrid combinations and ranged from $\eta^2= 0.001$ to $\eta^2=0.4639$, while the interaction of factors with its partial effect caused the greatest variation in seed germination in ZP 434 ($\eta^2=0.480$) (Table 3).

The year of production as a factor had a significant effect on energy and germination in all hybrid combinations. Furthermore, the interaction of two factors was significant. Effects of the location on seed germination were significant in the following three hybrid combinations ZP 434, ZP 684 and ZP 704, while energy varied under the influence of this factor only the hybrid combination ZP 704 (Table 3).

The partial effect of the year on physiological traits was the greatest in ZP 341 ($\eta^2= 0.817$, $\eta^2=0.779$), while it was small in remaining hybrid combinations ranging from $\eta^2= 0.001$ to

$\eta^2=0.4639$. In addition, the partial effect of the interaction of factors was greatest on seed germination in ZP 434 ($\eta^2=0.480$) (Table 3).

Table 3. Statistical significance of differences for energy and seed germination (F and LSD test)

Hybrids	Germination energy			Seed germination			
	Year	Location	Interaction	Year	Location	Interaction	
ZP 341	F-test	53.75*	0.02	2.69	42.39*	0.02	2.35
	LSD 0,01	1.456	1.629	3.256	0.976	1.091	2.182
	LSD 0,05	1.917	2.146	4.286	1.185	1.236	2.873
	Partial Eta Squared of value	0.817	0.001	0.183	0.779	0.001	0.164
	Levene's test	F	2.542			1.520	
	p-level	0,0000			0,0000		
ZP 434	F-test	13.07**	0.260	10.21**	12.63**	1.653**	11.08**
	LSD 0,01	0.876	0.980	1.960	0.784	0.876	1.756
	LSD 0,05	1.154	1.290	2.580	1.032	1.154	2.308
	Partial Eta Squared of value	0.521	0.011	0.460	0.513	0.064	0.480
	Levene's test	F	1.959			0.893	
	p-level	0,0001			0,0643		
ZP 684	F-test	5.478**	0.543	0.348	12.40**	8.71**	1.111
	LSD 0,01	1.735	1.940	3.881	0.876	0.980	1.960
	LSD 0,05	2.284	2.554	5.108	1.154	1.290	2.580
	Partial Eta Squared of value	0.4706	0.0798	0.4491	0.6362	0.4639	0.7237
	Levene's test	F	3.680			1.199	
	p-level	0,0005			0,0006		
ZP 704	F-test	2.851**	1.295**	0.766	14.817*	3.750**	3.050**
	LSD 0,01	1.095	1.224	2.448	0.803	0.898	1.796
	LSD 0,05	1.441	1.611	3.222	1.057	1.182	2.365
	Partial Eta Squared of value	0.192	0.051	0.060	0.553	0.135	0.203
	Levene's test	F	1.531			3.797	
	p-level	0,052			0,053		

Conclusion

All stated factors affect expression of traits of maize hybrid seeds to a different extent and in different ways: directly; more or less indirectly, through greater or smaller interactions and in altering ways;

Average values and variations of traits of maize hybrid seed represent a resultant of actions of all mentioned factors in all stated ways of their actions.

Results of the analysis of variance, i.e. values of the F-test and probabilities of these values, point out that the effect of certain factors is not the same for the expression of all seed traits and all hybrid combinations.

References

- Chassot A. (2000). Early growth of roots and shoots of maize as affected by tillage-induced changes in soil physical properties. Diss. ETH No. 13907, Zurich.
- Dačić V., Mirić M., Sabovljević R., Mišić-Stanković Z., (1997). Uticaj mehaničke ujednačenosti i uslova proizvodnje na klijavost hibridnog semena kukuruza. Zbornik izvoda, II JUSEUM, 30. (The influence of mechanical uniformity and production conditions on germination of hybrid maize seed).

- Đukanović L., Sabovljević R., Rošulj M. (2003). Promene morfo-fizioloških osobina semena roditeljskih linija i F1 hibridnih kombinacija kukuruza usled starenja. II simpozijum za oplemenjivanje organizama, Zbornik apstrakta, Vrnjačka banja, vol.17. (Changes of morpho-physiological characteristics of parental lines seeds and F1 maize hybrid combinations due to aging).
- Hadživuković S.(1973). Statistički metodi, Novi Sad.
- Lee E.A., Staebler M.A., Tollenaar M. (2002). Genetic variation and physiological discrimination for cold tolerance in maize (*Zea Mays* L.) during an early autotrophic phase of development. *Crop Sci.* 42, 1919–1929.
- McDonald M.B., Sullivan J. and Laver M.J. (1994). The pathway of water uptake in maize seeds. *Seed Science and Technology*, vol. 22, 79-90.
- Pajić Z., Popović R., Babić M. (1997). Uticaj tipa endosperma na klijavost semena kukuruza. Zbornik izvoda, II JUSEUM, 29. (Influence of endosperm type on maize seed germination)
- Pravilnik o kontroli proizvodnje semena poljoprivrednog bilja (2006). Sl. Glasnik RS, Beograd, br.60/2006. (Control regulation of agricultural plants' seed production).
- Tabaković M., Jovnović S.V., Stanisavljević R., Štrbanović R., Popović V. (2015). Variation of morphological and physiological traits of maize hybrid seed over growing locations. Sixth International Scientific Agricultural Symposium „Agrosym 2015“ of Republic of Srpska, Book of proceedings, October 15st-18th, 2015. Jahorina, Bosnia and Hercegovina, 456-460.
- Sabovljević R., Stevanović S., Mišić-Stanković Z., Popović R. Marković, D. (1997). Varijabilnost i klijavost hibridnog semena kukuruza u odnosu na poreklo i temperaturu ispitivanja. Zbornik izvoda, II JUSEUM: 31.(Variability and maize hybrid seed germination compared to origin and temperature of examination).
- Shien W.J. and McDonald B.M. (1982). The influence of seed size, shape and treatment on inbred seed corn quallitz. *Seed Sci Techno.*,vol.10, 307-313.
- Stone P.J., Sorensen I B., Jamieson P.D. (1999). Effect of soil temperature on phenology, canopy development, biomass and yield of maize in a cooltemperature climate. *Field Crop. Res.*, vol.63, 169–178.
- Ujević A.I., J. Kovačević J. (1972). Ispitivanje semena. Zavod za ispitivanje semena, Zagreb. (Seed examination).

DETERMINATION OF SOME EAR CHARACTERISTICS OF LOCAL POP CORN (*Zea mays L. everta*) GENOTYPES IN KAHRAMANMARAS CONDITIONS (TURKEY)

Gülay ZULKADİR*, Leyla İDİKUT, Mustafa ÇÖLKESEN

Kahramanmaraş Sutcu Imam University, Faculty of Agriculture, Department of field crop, Onikisubat,
Kahramanmaraş, Turkey

*Corresponding author: gulayzulkadir@ksu.edu.tr

Abstract

In this study, 8 pop corn (*Zea mays L. Everta*) genotypes were used. Five ear characteristics of 8 pop corn genotypes (6 local pop corn genotypes and 2 local pop corn varieties) were examined. Local corn genotypes were collected from Tokat -Erbaa district, Samsun-Bafra district, Ordu-Çamaş district, Ordu-Perşembe district, Ordu-Ulubey district and Konya in the Turkey in 2014. And also, local corn varieties were used such as Ant-Cin 98 and Nermin-Cin as proprietary in kinds. At this study, field and laboratory studies were completed in 2015. The experiment was conducted in 3 replicates according to a randomized block design. At this study, ear length, ear diameter, number of row per ear, number of kernel rows per ear, 1000-grain weight and popping volume were investigated. The ear length, ear diameter, number of row per ear, number of kernel rows per ear, 1000-grain weight and popping volume characters were determined ranging 16.87-18.40 cm, 32.67-36.33 mm, 11.60-20.13 units, 40.47-47.07 units, 94.33-224.40 g and 6.63-20.93 cm³ g⁻¹ respectively. Research results showed that there were not high variations in ear length, ear diameter, number of row per ear, number of kernel rows per ear from examination characteristics. However, number of row per ear, 1000-grain weight and explosion volume were determined statistically significant (P<0.001). The most number of row per ear value was obtained in Tokat-Erbaa district, 1000-grain weight's highest value was obtained in Ordu-Çamaş district and also highest popping volume value was obtained in Samsun-Bafra district. According to these results, the ear features of local corn genotypes have equivalent Ant-cin 98 and Nermin-cin varieties without number of row per ear, 1000-grain weight and popping volume features.

Keywords: *local pop corn, ear characteristics.*

Introduction

Maize (*Zea mays L.*) is one of the important cereals grown in all over the world and also maize is the third most widely circulated crop of the world, being grown in diverse seasons and ecologies with highest production and productivity among food cereals. Popcorn is different from other maize types with its popping ability. Popcorn has a special place in human nutrition of nutrient content as high fibre, vitamins and minerals it contains (Öztürk et al., 2016). It is also healthy and nutritious snack product with the stomach acid absorption, reducing the feeling of hunger, giving the feeling of satiety and being low in calories as a whole grain (Jele et al., 2014; Soni et al., 2014; Öztürk et al., 2016). Nutritional composition of popcorn showed that it contained 3.8 to 4.6% oil, 8.1 to 10.5% protein, and 61.0 to 67.9% starch (Soni et al., 2014). Popcorn explodes when exposed to heat treatment and produce flakes. Therefore, the use of popcorn (*Zea mays everta* Sturt.) as a snack food has been increasing continuously throughout the world.

Grain yield and popping volume are very important agronomic traits in popcorn as in other corn types. The most important factor effecting grain yield and popping volume in popcorn are

genotype (Sakin et al., 2005). Popping properties were mostly effected by physical properties of the popcorn kernels. Ear traits, kernel type, moisture level, kernel size, 1000 kernel weight, test weight, flake size and popping method are effective on popcorn quality parameters (Allred Coyle et al., 2000). Generally, popcorn germplasm has a narrow genetic basis. So that the higher yield and popping volume, new popcorn hybrids have almost completely replaced local varieties. It is provided by effectively a breeding programme. Landraces of maize represent a valuable genetic resource for breeding and genetics studies. Therefore, at the breeding programs is preferred local genotypes that maize populations are rich source of genetic variability, providing the necessary raw materials for maize breeding programs.

In this study, we aimed that 8 different local popcorn genotypes determined of some ear characteristics and popping traits. And also, these traits were examined of availability.

Materials and Methods

The study was conducted in the research fields of the Eastern Mediterranean Gateway Zone Agricultural Research Institute in Kahramanmaraş, Turkey in 2015. During flowering in maize, relative humidity is below 50%, maximum temperature is over 40 °C and it seems to have little or no rainfall in Kahramanmaraş. Long-term average precipitation for this region was 25.3 mm/year. The amounts of total downfall in the vegetation periods of 166.5 mm/year was less than the long-term average. Plants were irrigated eight times until sowing to harvest. The average temperatures of the growing season was 24 °C. Soils of the research area had a texture classification of Sandy clay loam. The soils were slightly alkaline, medium in lime content, and very low in salt content. The soils were rich in available phosphorus (P) and potassium (K) (Anonymous, 2015). Thus, fertilizer of 25 kg N, and 10 kg P₂O₅ ha⁻¹ was applied. To be used in the experiment 8 popcorn genotypes, (6 local popcorn genotypes and 2 local popcorn varieties) were obtained from Tokat -Erbaa district, Samsun-Bafra district, Ordu-Çamaş district, Ordu-Perşembe district, Ordu-Ulubey district and Konya in the Turkey in 2014 (Table 1). These genotypes were tested to determine grain yield and some ear characteristic in growing seasons of 2015. The experimental design was a randomized complete block with three replications. Seeds were sown in the first week of May in four-row plots, 5 m long, with 70 cm between rows. The standard maize growing technique was practiced. In this study, ear length, ear diameter, number of row per ear, number of kernel rows per ear, 100-grain weight and popping volume were investigated for genotypes. Harvest was made the first week of September. Ear length, ear diameter, number of row per ear, number of kernel rows per ear, 100-grain weight and popping volume were investigated. Popping expansion was measured in sample of 50.0 g of seeds. Popping tests were performed by using a hot air popping machine (Premier PPM 2021 900W). The moisture content of samples was 14±0.5% before popping. Popped samples were poured into a 2000 mL glass beaker, and volume recorded (Sakin et al., 2005). According to the analysis carried out in the investigation of properties, SAS program used for analyzing and Tukey test was used for grouping.

Results and Discussion

Ear length: There were not statistically significant ($p>0.05$) differences among the all of the genotypes the terms of ear length. The longest ear (18.40 cm) was obtained from Ordu-Perşembe district genotype and the lowest one (16.87 cm) was obtained from Konya Pop (Table 1).

Variations in ear characteristics of maize depend on genotype, environmental conditional and genotype x environmental interaction (Şener et al., 2004). Also, ear length trait affected by plant densities (Gökmen et al., 2001; Şener et al., 2004). According to previously studies were reported

that ear diameter have measured as 16.19-18.1 cm (Şener et al., 2004), 12.92-17.50 cm (İdikut et al., 2015), 17-20 cm (Tekkanat and Soylu, 2005), 15.7-16.9 cm (Gökmen et al., 2001), 13-17 cm (Sezer and Yanbeyi, 1997), 11-17 (Özkaynak and Samancı, 2003), 19-21 cm (Eşiyok et al., 2004), 17-19 cm (Öktem et al., 2004), 12-18 cm for dent corn (Saruhan and Sireli, 2005), 21-23 cm (Çetinkaya and Dura, 2010), 13.0-15.1 cm (İdikut et al., 2012) and averaged 19 cm for first crop, 18 cm for second crop on popcorn genotypes (Koca et al., 2010). In the previously studies were supported that our findings and difference the length of ear depends varieties, the environment and the process.

Ear diameter: There were not statistically significant ($p>0.05$) differences among the all of the genotypes to ear diameter. The thickest ear (36.33 mm) was obtained from Ordu-Ulubey district genotype and the thinnest one (32.67 cm) from Samsun-Bafra district (Table 1). Variations in ear diameter depend on genotype and environmental conditions as in ear length. According to previously studies were reported that ear diameter were measured at 24-29 mm in popcorn genotypes and 26-30 in hibrids (Özkaynak and Samancı, 2003), 42-43 mm (Eşiyok et al., 2004), 36-39 mm in dent corn (Saruhan and Sireli, 2005), 33-44 mm (Tekkanat and Soylu, 2005), 52-55 mm (Çetinkaya and Dura, 2010), 30.2-40.1 mm (Farsiani et al. 2011), 28.3-30.7 mm (İdikut et al., 2012), 40.2-50.2 mm (Peykarestan and Seify, 2012), 27-33 mm (İdikut et al., 2015). Mani and Dadari (2003) has announced the features that make the greatest contribution to the efficiency that one ear diameter. In the previously studies were supported that our results.

Table 1. Genotypes and kernel colour, ear length, ear diameter, number of row per ear, number of kernel rows per ear, 100- grain weight and popping volume values belonging to genotype.

Genotype No	Genotypes Sources	Kernel Colour	Ear Length	Ear Diameter	Number of Row Per Ear	Number of Kernel Rows Per Ear	1000- Grain Weight	Popping Volume
1	Ordu-Ulubey district	Yellow	17.87 ^A	36.33 ^A	16.37 ^B	47.07 ^A	185.50 ^B	6.63 ^C
2	Ant-Cin	Yellow	16.93 ^A	32.77 ^A	16.40 ^B	42.47 ^A	137.03 ^C	20.11 ^A
3	Konya	Yellow	16.87 ^A	33.60 ^A	15.87 ^B	40.47 ^A	143.87 ^C	16.17 ^A
4	Nermin-Cin	Dark yellow (Orange)	18.03 ^A	33.33 ^A	15.47 ^B	42.87 ^A	123.25 ^C	19.25 ^A
5	Tokat-Erbaa district	Light yellow	17.93 ^A	35.33 ^A	20.13 ^A	43.93 ^A	132.60 ^C	19.50 ^A
6	Samsun-Bafra district	Yellow	17.83 ^A	32.67 ^A	14.93 ^{BC}	43.40 ^A	94.33 ^D	20.93 ^A
7	Ordu-Çamaş district	Red	18.00 ^A	33.97 ^A	12.93 ^{BC}	43.87 ^A	224.40 ^A	9.05 ^C
8	Ordu-Perşembe district	Red	18.40 ^A	33.03 ^A	11.60 ^C	44.60 ^A	195.97 ^B	7.29 ^C
F and P values			F=0.93 P=0.5117	F=1.60 P=0.2047	F=12.73 P<.0001	F=1.78 P=0.1613	F=95.63 P<.0001	F=99.19 P<.0001

Number of row per ear: There were statistically significant ($p>0.01$) differences among the all of the genotypes to number of row per ear. The most number of row per ear (20.13 units) was

obtained from Tokat-Erbaa district genotype and the least one (11.60 units) from Ordu-Perşembe district genotype (Table 1). In the other studies have announced that the number of row per ear were 11-17 units in inbred popcorns and 13-15 units in hybrids (Todorovic et al., 2012), 12-16 units (İdikut et al., 2015), 12-14 units in popcorn genotypes and 13-15 units in hibrids (Özkaynak and Samancı, 2003), 15-17 units (Eşiyok et al., 2004), 13-17 units (Tekkanat and Soylu, 2005), 14.66-17.5 units (İdikut et al., 2012). Earlier studies on the number of ear rows were saved between 13-17 units. The genetic characteristics of corn varieties are affect on the number of ear rows. Therefore, our results were in agreement with earlier studies.

Number of kernel rows per ear: There were not statistically significant differences among the genotypes for number of kernel rows per ear. The most number of kernel rows per ear (47.07 units) was obtained from Ordu-Ulubey district genotype and the least one (40.47 units) from Konya popcorn genotype (Table 1). In the previously studies, the number of kernel row pere ar changed between 20-33 units for genotypes and 30-42 units in hibrids (Özkaynak and Samancı, 2003), 36-41 units (Eşiyok et al., 2004), 36-46 units (Tekkanat and Soylu, 2005), 22.7 - 51.0 units (Cengiz, 2006), 28.56-37.66 units (İdikut et al., 2012) and 29.32-40.86 units (İdikut et al., 2015). Our study results were consistent with earlier studies. Environmental conditions (temperature, water, nutrients) effects may be dominant genetic structure on number of kernel rows per ear. Therefore, the number of kernel rows per ear can be very variable.

1000-grains weight: There were statistically significant ($p<0.01$) differences among of the genotypes to 1000-grains weight. The highest 1000-grains weight (224.40 g) was obtained from Ordu-Çamaş district genotype and the lowest one (94.33 g) from Samsun-Bafra district genotype (Table 1). The weight of 1000- kernels was affected with genotype and environment condition. In the previously studies have reported that the weight of 1000- kernels was 132 g (Ulloa et al., 2010), 163.5-173.5 g (Peykarestan and Seify, 2012), 114-123 g (İdikut et al., 2012), 86-140 g in genotypes and 83-115 g in hibrids (Özkaynak and Samancı, 2003), 291-342 g in hibrids varieties (Öktem et al., 2004), 129-213 g in hibrid popcorn (Gökmen et al., 2007), 390-407 g in hibrids verieties (Çetinkaya and Dura, 2010), 309 g in first crop popcorn and 296 g in second crop popcorn (Koca et al., 2010) and 209-368 g in hibrids verieties (Kuşaksız, 2010). At the earlier studies were observed that the weight of 1000- grains on maize plant is change as variety, environmental condition and applied the method.

The our finding were consistent with some earlier studies. But it were not consistent with others, because used varieties at these studies were dent corn or flint corn.

Popping volume: There were statistically significant ($p<0.01$) differences among the all of the genotypes to popping volume. The highest popping volume ($20.93 \text{ cm}^3 \text{ g}^{-1}$) was obtained from Samsun-Bafra district and the lowest one ($6.63 \text{ cm}^3 \text{ g}^{-1}$) from Ordu-Ulubey district genotype (Table 1). Ant-Cin ($20.11 \text{ cm}^3 \text{ g}^{-1}$), Tokat-Erbaa ($19.50 \text{ cm}^3 \text{ g}^{-1}$), Nermin-Cin ($19.25 \text{ cm}^3 \text{ g}^{-1}$) and Konya genotype ($16.17 \text{ cm}^3 \text{ g}^{-1}$) have a high popping volume and these genotypes were determined that statistically same group with Samsun-Bafra district. İdikut et al. (2015) were reported that popping volume values were changed between $10\text{-}23 \text{ cm}^3 \text{ g}^{-1}$ on different local popcorn lines. At the other some searcher were announced that popping volume values were determinated as change between $38\text{-}48 \text{ cm}^3 \text{ g}^{-1}$ in hibrid genotypes (Öz and Kapar, 2011), $44.7\text{-}47.3 \text{ cm}^3 \text{ g}^{-1}$ (Sweley et al., 2012), $1288\text{-}25.75 \text{ cm}^3 \text{ g}^{-1}$ (Jele et al., 2014), $10\text{-}23 \text{ cm}^3 \text{ g}^{-1}$ (İdikut et al., 2015), $16\text{-}47 \text{ cm}^3 \text{ g}^{-1}$ in some single, three way and double cross popcorn hybrids (Sakin et al., 2005).

The factors affected popping volume are moisture content, popping temperature, popping method, kernel size, shape and weight, variety or genotype, kernel density, drying condition, and kernel damage (Ertaş et al., 2009; Ceylan and Karababa, 2001; Allred Coyle et al., 2000).

Ertas et al. (2008) were reported that popping volume is evolves at %12 moisture in popcorn and kernel size, shape and colour values are effects popping volume. We have obtained in our study results were very high. The reason of this may be that kernel weight will be popped kernels or popping method.

Conclusion

Overall, the study found significant variability among local popcorn genotypes for number of row per ear, 1000-grain weight and popping volume traits. The most number of row per ear was Tokat-Erbaa district genotype, the highest 1000-grain weight was Ordu-Çamaş district genotype, while the highest popping volume was Samsun-Bafra district. Among the genotypes don't found statistically significant variability to other traits. Therefore, the ear features of local corn genotypes have equivalent Ant-cin 98 and Nermin-cin varieties without number of row per ear, 1000-grain weight and popping volume features.

References

- Allred Coyle T.A., Toma R.B., Reiboldt W., Thakur M. (2000). Effects of moisture content, hybrid variety, kernel size, and microwave wattage on the expansion volume of microwave popcorn. *Int. J. Food Sci. Nutr.* 51: 389–394.
- Anonymous, (2015). Soil laboratory of the Eastern Mediterranean Gateway Zone Agricultural Research Institute in Kahramanmaraş, Turkey.
- Cengiz R. (2006). The research on inheritance of yield and yield components of 8x8 half diallel corn hybrids among corn inbred lines. Trakya University Institute of Science & Technology Basic Science of Field Plants. Master Thesis, 160p.
- Cetinkaya N., Dura S. (2010). The effects of a endomycorrhizal preparate on yield and vegetative development of corn. *Ege University, Journal of Agricultural Faculty*, 47 (1) : 53 -59.
- Ceylan M., Karababa E. (2001). Comparison of sensory properties of popcorn from various types and sizes of kernel. *Journal of the Science of Food and Agriculture* 82, 127–133.
- Ertaş N., Soylu S., Bilgicli N. (2009). Effect of kernel properties and popping methods on popcorn quality of different corn cultivars. *J. of Food Engin.* 32: 478-496.
- Ertas N., Soylu S., Bilgicli N. (2008). A research on the determination of relations between the physical properties of the quality and explosion on popcorn. Turkey 10. Food Congress, 21-23 May Erzurum, 467-470.
- Esiyok D., Bozokalfa M.K., Ugur A. (2004). Determination of yield quality and some plant characteristic of some sweet corn (*Zea mays* L. var. *saccharata*) varieties in different locations *Ege University, Journal of Agricultural Faculty*, 41(1): 1-9.
- Farsiani A., Ghobadi M.E., Honarmand S.J. (2011). The effect of water deficit and sowing date on yield components and seed sugar contents of sweet corn (*Zea mays* L.). *African Journal of Agricultural Research* Vol. 6(26), pp. 5769-5774.
- Gokmen S., Sakin M.A., Yildirim A. (2007). yield, yield components and quality characteristics of some popcorn varieties grown in Tokat-Kazova conditions. Turkey VIII. Field Crops Congress. Vol (1) : 330 -333.
- Gokmen S., Sencar O., Sakin M.A. (2001). Response of popcorn (*Zea mays* everta) to nitrogen rates and plant densities. *Turkish J. of Agric. and Forestry* 25: 15-23.
- Idikut L., Yılmaz A., Yururdurmaz C., Colkesen M. (2012). Determination of morphological and agronomical properties of local popcorn genotypes. *Research Journal of Biological Sciences* 5 (2): 63-69.

- Idikut L., Zulkadir G., Yururdurmaz C., Colkesen M. (2015). Investigation of Agricultural Characteristics of Local Popcorn Genotypes in Kahramanmaras Conditions. *KSU J. Nat. Sci.*, 18(3).
- Jele P., Derera J., Siwela M. (2014). Assessment of popping ability of new tropical popcorn hybrids. *Australian Journal of Crop Science* 8(6):831-839.
- Koca Y.O., Turgut I., Ereku O. (2010). The determination of performance at the first and second crop productions in maize grain cultivation. *Ege University, Journal of Agricultural Faculty*, 47(2): 181 -190.
- Kuşaksız T. (2010). Adaptability of some new maize (*Zea mays* L.) cultivars for silage production as main crop in Mediterranean environment. *Turkish Journal of Field Crops*, 15 (2): 193-197.
- Mani H., Dadari A. (2003). Growth and yield analysis of irrigated popcorn (*Zea mays* evarta) grown in kadawa as affected by sowing date and intra-row spacing. using correlation coefficient. *Asset Series A*, 3 (4):63-70.
- Oktem A., Ulger A.C., Coskun Y. (2004). The effect of grain yield and yield components on corn plants (*Zea mays* L.) of some weed control methods in Harran plain conditions. *HR.U. Journal of Agricultural Faculty*, 8(1): 51-57.
- Oz A., Kapar H. (2011). Determination of grain yield, some yield and quality traits of promising hybrid popcorn genotypes. *Turkish Journal of Field Crops*, 16(2): 233-238.
- Ozkaynak E., Samanci B. (2003). Comparison of Popcorn (*Zea mays* everta Sturt.) Lines and Their Testcrosses for Yield and Yield-Related Traits. *Akdeniz Univ., Journal of Agricultural Faculty*, 16(1): 35-42.
- Ozturk A., Erdal S., Pamukcu M., Boyaci H.F., Sade B. (2016). Determination of some quality traits and relationships among traits in popcorn inbred lines. *Derim*, 2016, 33 (1):119-130.
- Peykarestan B., Seify M. (2012). Impact of sowing date on growth and yield attributes of pop corn grown under different densities. *International Research Journal of Applied and Basic Sciences*, 3 (1): 85-91.
- Sakin M.A., Gökmen S., Yıldırım A., Belen S., Kandemir N. (2005). Effects of cultivar type on yield and quality of popcorn (*Zea mays* everta). *New Zealand J. of Crop and Horticultural Sci.* 33:17-23.
- Saruhan V., Sireli H.D., (2005). An investigation on the effect of plant densities and nitrogen doses on ear, stem and leaf yields of maize (*Zea mays* L.). *Harran University, Journal of Agricultural Faculty*, 9 (2): 45 -53.
- Sezer I., Yanbeyi S. (1997). The effects of plant densities and fertilizer with nitrogenous on grain yield, yield components and some plant characters of popcorn (*Zea mays* L. everta) grown in Carsamba plain. *Turkey II. Field Crops Congress.*, 128-133. 22-25 September, Samsun.
- Soni N.V., Khanorkar S.M., Shah A.K., Talati J.G. (2014). Hybrid vigour and combining ability for yield and quality traits in popcorn (*Zea mays* var. everta). *Indian Journal of Agricultural Biochemistry* 27 (2), 188-192.
- Sweley J.C., Rose D.J., Jackson D.S. (2012). Hybrid and environment effects on popcorn kernel physiochemical properties and their relationship to microwave popping performance. *Faculty Publications in Food Science and Technology*. Paper 115. <http://digitalcommons.unl.edu/foodsciefacpub/115>.
- Şener O., Gözübenli H., Konuşkan O., Kılınc M. (2004). The effects of intra-row spacings on the grain yield and some agronomic characteristics of maize (*Zea mays* L.) Hybrids. *Asian Journal of Plant Sciences* 3 (4): 429-432.
- Tekkanat A., Soylu S. (2005). Determination of important agronomical characters in popcorn cultivars. *S.U. Journal of Agricultural Faculty Ziraat*, 19 (37): 41-50.

- Todorovic G., Secanski M., Zivanovic T., Protic R., Kostic.M., Jovanovic S., Bozovic D. (2012). Inbred genotypes of different cycles of selection - donors of favourable alleles for the improvement of the kernel row number of F1 maize hybrids. *Turkish Journal of Field Crops*, 17(2):198-202.
- Ulloa S.M., Datta A., Cavalieri S.D., Lesnik M., Knezevic S.Z. (2010). Popcorn (*Zea mays* L. var. everta) yield and yield components as influenced by the timing of broadcast flaming. *Crop Protection* 29:1496–1501.

FIELD PEA AS A PROTEIN SOURCE IN CROP ROTATIONS UNDER MODERN PRODUCTION SYSTEMS

Nikola BOKAN^{1*}, Đura KARAGIĆ², Voja MIHAILOVIĆ², Dalibor TOMIĆ¹, Vladeta STEVOVIĆ¹, Branko MILOŠEVIĆ²

¹Faculty of Agronomy, Čačak, University of Kragujevac, Serbia

²Institute of Field and Vegetable Crops, Novi Sad Serbia

*Corresponding author: nikola@kg.ac.rs

Abstract

Field pea grown for grain and forage is an important protein source which can improve milk and meat production. Along with common vetch, field pea is the most important annual forage legume in Central Serbia, and can substitute alfalfa, whose potential for expansion has been constrained by large areas of acidic soils. As a legume, field pea also plays a major role in field crop rotations, and has been increasingly used in conventional, integrated, organic and sustainable farming systems. Under dryland conditions, grain yield of spring pea cultivars 'NS-Junior' and 'Javor' was analyzed in 2011, 2012 and 2014 on an acidic soil receiving amendments. The field trial was established in Čačak (43°54'39.06" N, 20°19'10.21" E, 246m a.s.l.) on an alluvial soil acid in reaction (pH_{H2O} 4.8). The entire experimental field was fertilized with 300 kg ha⁻¹ N₁₅P₁₅K₁₅. In addition to an untreated control, two liming treatments were applied, at rates of 3t ha⁻¹ and 6t ha⁻¹. The experiment was laid out in a randomized complete block design with four replications. Plot size was 5m² (1x5m). 'Javor' gave a significantly higher average grain yield compared to 'NS-Junior'. There was no significant difference between the control and lime treatments. In all three years, grain yield was significantly below the genetic potential of the cultivars, largely due to rainfall deficiency, delayed sowing dates, and very dry soil and air conditions during critical stages of plant growth and development.

Key words: *pea, protein, grain, production systems, yield*

Introduction

Growing field pea for grain and forage is part of the livestock development strategy, given the potential of field pea as a good source of protein to increase milk and meat production. This is of particular importance for livestock farmers in Central Serbia, as well as in other regions of the Balkans, who are facing problems associated with alfalfa production on acid soils. Along with common vetch, field pea is the most important annual forage legume on arable land in Serbia (Mihajlović et al., 2004). A major goal of selection programs on annual forage legumes is to create cultivars adaptable to diverse agroenvironmental conditions (Mihajlović and Mikić, 2010), given their significant effect on the percentage of seeds formed in different years and at different seeding dates (Erić et al., 2007).

The advantage of field pea over soybean is that its grain does not require heat treatment prior to feeding. All feed pea cultivars created in Novi Sad (Serbia) have low or very low trypsin inhibitor levels, which is in accordance with current European Union regulatory requirements (Mikić et al., 2009). Moreover, field pea is an important component of crop rotations as it contributes to soil fertility regeneration through its symbiotic relationship with nitrogen-fixing bacteria (Stoddard et al. 2009). The frequent occurrence of arid events has led to the need to use appropriate crop

rotations in dryland farming, along with other cultural practices, in an attempt to reduce the adverse effect of water deficiency during the growing season of the crop. Field pea is of great significance in organic and sustainable farming systems as it provides a rich source of protein and mineral elements (Ćupina et al., 2004, Corre-Hellou & Crozat, 2005, Lauk & Lauk, 2008). As other legumes, field pea plays an important role in organic farming since it reduces weed infestation, improves soil quality and acts as an excellent crop for companion planting, green manuring and environmental corridors (Bokan et al., 2016). Acid soils require amelioration for improvement of their productivity (Dugalić, 1997, Bročić, 1997, Bošković Rakočević, 2003, Bošković Rakočević and Bokan, 2005, Bokan et al., 2010).

Material and methods

A field trial was established in city of Čačak area (43°54'39.06" N, 20°19'10.21" E, 246 m a.s.l.) in Serbia) on an alluvial soil acid in reaction ($\text{pH}_{\text{H}_2\text{O}}$ 4.8), containing 3.18% organic matter, 0% CaCO_3 , 22.08 mg P_2O_5 , 30.0 mg K_2O 100 g^{-1} soil. The entire experimental field was fertilized with 300 kg ha^{-1} ^{15}N ^{15}P ^{15}K . In addition to an untreated control, the experiment included treatments with 3t ha^{-1} and 6t ha^{-1} lime worked into the soil through secondary tillage using a disk harrow. The experiment was set up in a randomized complete block design with four replications. Plot size was 5m² (1x5m). Manual weed control was carried out twice. The crop was not irrigated during the growing season.

Two cultivars of spring field pea 'NS Junior' and 'NS Javor' were used. 'NS Junior' is of excellent quality, with a crude protein content of 25-28% in the grain. The cultivar is also intended for combined use (green forage and grain). It is the most common field pea cultivar in Serbia, since it produces grain yields of more than 5t/ha under favorable conditions. 'Javor' is grown for grain, and has an average crude protein content of 24.4 %. In three-year VCU trials, this cultivar gave an average grain yield of 5.41 t/ha (Erić et al., 2007).

Results were subjected to a two-way analysis of variance (ANOVA) using SPSS 4.5 software. The significance of differences between treatment means was assessed by the LSD test.

Climatic conditions

The average temperature in the experimental years was above the long-term average (Table 1). April, June and July in all three years were also warmer than average. Annual rainfall totals decreased by 222.6 mm in the first year and by 120.4mm in the second year, and increased by 201.8 mm in the third year compared to the long-term average. In the Republic of Serbia, 2011 was an extremely dry year. In the following year 2012, rainfall total increased by 107.2 mm in the region of Čačak, and this year seemed to be more favorable for the crop. However, only the rainfall total during April and May was higher than the long-term average, whereas only 56.9 mm of rain was received in the following three months. This indicates that 2012 also had an unfavorable distribution of rainfall. In 2014, rainfall total was 892 mm on an annual basis and 653 mm during the April-September growing season, with only August being close to the long-term average, whereas the rainfall total for the other months was higher than the long-term average. These values suggest that rainfall totals and rainfall distribution were the most favorable in the third year.

Table 1. Monthly precipitation, growing season precipitation and temperature in Čačak

Month	Air temperature (°C)				Precipitation (mm)			
	2011	2012	2014	Normal	2011	2012	2014	Normal
January	0.7	0.5	4.1	0	18.5	99.4	21.5	44.1
February	1.2	□3.9	6.6	2.3	50.4	52.9	6.0	38.9
March	6.9	8.8	10.2	6.8	45.9	25.4	52.5	46.2
April	12.2	12.6	12.8	11.5	23.5	70.3	104.5	51.6
May	15.5	15.9	16.1	16.8	83.2	106.8	125.0	72.7
June	20.7	22.3	21.1	20.0	64.8	11.8	103.5	87.3
July	22.3	25.5	22.7	21.5	36.0	45.1	163.0	79.1
August	23.4	24.5	22.1	21.2	14.7	0.0	56.0	58.0
September	21.3	21.0	20.1	16.7	32.4	7.8	101.0	56.2
October	11.3	14.6	15.1	11.4	30.9	54.9	50.0	51.1
November	3.8	9.5	8.9	6.0	1.3	10.8	19.0	55.9
December	3.3	0.8	3.1	1.4	66.0	94.6	90.0	50.4
Mean or total	11.9	12.7	13.6	11.3	467.6	579.8	892.0	690.2

Results and discussion

The average grain yield in 2011 was 2.66 t/ha (Table 2). 'Javor' had a significantly higher yield (2.78 t/ha) compared to 'Junior' (2.54 t/ha).

Table 2. Effect of soil liming on grain yield ($t\ ha^{-1}$) of pea cultivars 'NS-Junior' and 'Javor' in 2011

Treatments	'Junior'	'Javor'	\bar{x}
Ø	2.55	2.84	2.70
3t	2.51	2.70	2.60
6t	2.57	2.79	2.68
\bar{x}	2.54	2.78	2.66
		Cultivar (A)	0.234
LSD 0.05		Liming (B)	0.286
		A x B	0.485

In 2012, the average grain yield was 1.65 t/ha (Table 3). 'Javor' gave a significantly higher yield (1.93 t/ha) compared to 'Junior'(1.37 t/ha).

Table 3. Effect of soil liming on grain yield ($t\ ha^{-1}$) of pea cultivars 'NS-Junior' and 'Javor' in 2012

Treatments	'Junior'	'Javor'	\bar{x}
Ø	1.30	1.82	1.56
3t	1.41	2.16	1.78
6t	1.40	1.81	1.61
\bar{x}	1.37	1.93	1.65
		Cultivar (A)	0.247
LSD 0.05		Liming (B)	0.303
		A x B	0.428

In the third experimental year (2014), the cultivars produced the highest average grain yield in all three years i.e. 2.85 t ha⁻¹ in both cultivars (Tab. 4). The grain yield of 'Javor' was significantly higher (3.07 t ha⁻¹) than that of 'Junior' (2.63 t ha⁻¹).

Table 4. Effect of soil liming on grain yield (t ha⁻¹) of pea cultivars 'NS-Junior' and 'Javor' in 2014

Treatments	'Junior'	'Javor'	\bar{x}
Ø	2.63	3.03	2.83
3t	2.60	3.08	2.84
6t	2.67	3.11	2.89
\bar{x}	2.63	3.07	2.85
		Cultivar (A)	0.199
LSD 0.05		Liming (B)	0.244
		A x B	0.345

Climatic conditions during the experimental years (Table 1) indicate that 2011 was generally more unfavorable for the crop than 2012. Nevertheless, grain yield was higher in this less favorable year, one of the reasons being the decrease in rainfall by 53 mm in June 2012, which is a critical period for the supply of water required for intensive grain filling in field pea. Moreover, the soil water deficit in June was accompanied by high mean daily air temperatures. The mean monthly air temperature for June increased by 2.3°C compared to the long-term average, and by 1.6°C compared to 2011. The highest average grain yield of field pea was obtained in 2014 which had the most favorable climatic conditions (2.85 t ha⁻¹). This finding is in agreement with the production potential and properties of the studied cultivars (Erić et al., 2007).

In all three years, lime applied at 3t/ha and 6 t/ha to ameliorate the acid soil did not affect the grain yield of field pea compared to the control. This suggests the potential for growing field pea under such soil conditions. Liming has a long-term effect in improving soil chemical properties; therefore, its short presence in the soil had no effect on grain yield (Bokan et al., 2013). Low grain yields indicate that field pea development is significantly affected not only by soil but also by climatic factors during the growing season. As in other annual forage legumes, rainfall distribution is an important contributor to consistently high yields. Given the variable distribution of rainfall across months in the experimental years, grain yield stability can be achieved by irrigation as a regular cultural practice.

Conclusion

In all three years, grain yield was significantly higher in 'NS Javor' than in 'NS Junior'.

Ameliorative liming did not have a significant effect on the grain yield of the tested cultivars. This result confirms the potential for growing field pea on acid soils.

Grain yield increases for this annual forage legume can be expected to come from improved production technology. As a legume, field pea plays an important role in field crop rotations, and has been increasingly used in conventional, integrated, organic and sustainable farming systems. In the long run, amelioration of acid soils as an integral part of the agricultural development strategy should be consistently practiced through appropriate organic fertilization and lime application dynamics.

Acknowledgements

This study is part of the TR 31024 project "Increasing the Importance of Forage Crops on the Market through Breeding and Seed Technology Optimization" financially supported by the Ministry of Education, Science and Technological Development, Republic of Serbia.

References

- Bokan, N., Dugalić, G., Katić, S., Milić, D., Vasiljević, S. (2010). Effect of fertilization of Pseudogley on alfalfa yield in the year of establishment. XV Conference of Biotechnology, Proceedings, Faculty of Agronomy, Čačak, 26-27 March 2010, 15(16), 301-306, [In Serbian].
- Bokan N., Karagić Đ., Mihailović V., Tomić D., Stevović V., Milošević B. (2013). Effect of liming on grain yield of field peas, *Agro-knowledge Journal*, 14(4), 631-638. University of Banja Luka, Faculty of Agriculture.
- Bokan, N., Dugalić, G., Tomić, D., Vasiljević, S., Karagić, Đ., Milić, D., Milošević B, Katanski, S. (2016). The importance of legumes in organic agriculture. XV Conference on Biotechnology, Proceedings, Faculty of Agronomy, Čačak, 11 to 12 March 2016, 21(23), 123-128, [In Serbian].
- Bošković – Rakočević, Ljiljana (2003). The effect of amelioration on the changes of some properties of acid soil adsorption complex, *Archive for Agricultural Sciences*, 64(3-4), 61-69, [In Serbian].
- Bošković – Rakočević, Ljiljana, Bokan, N. (2005). Neutralising Acid Soils for the Indispensable Microelements Mobility. *Acta agriculturae Serbica*, Čačak, 10(20), 23-28.
- Bročić, Z. (1997). The effect of lime, organic and mineral fertilizers on chemical changes pseudogley and maize yield in Dragačevo. Proceedings of the IX Congress JDPZ "Arranging, use and conservation of soil," edited by S. Dragović, Novi Sad, 23-27. jun 1997, 157-165, [In Serbian].
- Corre-Hellou, G., Crozat, Y. (2005). N₂ fixation and N supply in organic pea (*Pisum sativum* L.) cropping systems as affected by weeds and pea weevil (*Sitona Lineatus* L.), *Eur. J. Agron.*, 22, 449-458.
- Ćupina, B., Erić, P., Krstić, Đ., Vučković, S. (2004). Winter forage intercrops in sustainable agriculture and organic farming, *Acta agriculturae Serbica*, Čačak, 9(17) Special issue, 451-459, [In Serbian].
- Dugalić, G. (1997). Characteristics of pseudogley in Kraljevo and finding opportunities to increase its productive capable. Doctoral dissertation, Faculty of Agriculture, Zemun. University of Belgrade.
- Erić, P., Mihailović, V., Ćupina, B., Mikić, A. (2007). Annual forage legumes. Institute of Field and Vegetable Crops, Novi Sad, 256, [In Serbian].
- Lauk, R., Lauk., E. (2008). Pea-oat intercrops are superior to pea-wheat and pea barley intercrops, *Acta. Agric. Scand. Section B: Plant Soil Sci.*, 58, 139-144.
- Mihailović, V., Erić, P., Katić, S., Karagić, Đ., Mikić, A., Pataki, I. (2004). Seed production of field pea. *Seed Science II*, editors: Milošević, M., Malešević, M. Institute of Field and Vegetable Crops, Novi Sad, 635-673, [In Serbian].
- Mihailović, V., Mikić, A. (2010). Novel Directions of Breeding Annual Feed Legumes in Serbia. *Biotechnology in Animal Husbandry. XII international Symposium on Forage Crops of Republic of Serbia. INSTITUTE FOR ANIMAL HUSBANDRY*, 26-28, May, Kruševac, 26(1) spec. Issue, 81-90.

- Mikić, A., Perić, V., Đorđević, V., Srebrić, M., Mihailović, V. (2009). Anti-nutritional factors in some grain legumes, *Biotechnol. in Anim. Husb.*, 25, 1181-1188.
- Stoddard, F. L., Hovinen, S., Kontturi, M., Lindstrom, K., Nykanen, A. (2009). Legumes in Finnish Agriculture: history, present status end future prospects, *Agric. Food. Sci.*, 18: 191-205.

EFFECTS OF FERTILIZERS ON YIELD OF MAIZE HYBRIDS WITH DIFFERENT KERNEL COLOUR

Snežana OLJAČA*¹, Milena SIMIĆ², Vesna DRAGIČEVIĆ², Željko DOLIJANOVIĆ¹, Jasmina OLJAČA¹

¹University of Belgrade, Faculty of Agriculture, Nemanjina 6, 11080 Belgrade, Serbia

²Maize Research institute Zemun Polje, S. Bajića 1, 11080 Belgrade, Serbia

*Corresponding author: [soljaca@agrif.bg.ac.rs](mailto:soljača@agrif.bg.ac.rs)

Abstract

White, red and yellow are the most common basic colours of maize, but other colour varieties exist, like blue, purple, brown and orange. Maize kernels with diverse colours have pigments and other substances with antioxidant capacity that can be highly beneficial for human health. This paper deals with results of the effects of different fertilizers on yield of maize hybrids with different kernel colour in two-year period (2014-2015). Trial was set up on chernozem soil type in the experimental field of Maize Research Institute in Zemun Polje, Serbia. Maize hybrids differing in the kernel colour developed at the Maize Research Institute, Zemun Polje, Belgrade, Serbia, were selected for these study: red maize ZP Rumenka, white maize ZP 655b and yellow maize ZP 633. The treatments of fertilization consisted of following variants: control, mineral fertilizer AN, microbiological fertilizer Uniker and organic fertilizer under the trade name „Humus Vita Stallatico". On the basis of two-year results it is obvious that meteorological conditions have very significant influence on maize yield. The second season had weather pattern less favourable for the maize production due to severe drought and very high temperature during flowering. According to results the yield of different maize hybrids was significantly different depend on varieties too. Fertilization showed no significant influence on maize yield in this experiment. All maize hybrids have greater yield in 2014 growing season compared with 2015. Red coloured hybrid ZP Rumenka had very significant lower yield then white and yellow hybrid in both years. The highest yields were recorded on treatments with the organic fertilizer in maize with red and yellow kernels.

Key words: *maize, different coloured kernel, fertilizer, yield.*

Introduction

Coloured maize has different pigments and other substances with antioxidant capacity that can be highly beneficial for human health. There is a clear relationship between pigment content and antioxidant capacity and several authors have reported that a higher content of pigment compounds in maize kernels is associated to higher antioxidant capacity (Lopez-Martinez et al. 2011; Žilić et al. 2012). Differences in pigment content are directly related to antioxidant capacity in maize kernels (Rodriguez et al. 2013). For example, red maize provides 20% more protein than white or yellow maize. It is rich in anthocyanins and flavonoids and contains 350% more antioxidants than common white or yellow maize (Žilić et al 2011). Red maize can be used in place of white and yellow sweet corn, though it does mature more quickly and can have a tendency to contain more starch than yellow and white varieties. Harvested immature and used soon thereafter, it can be hulled fresh for salads and soups.

Cropping systems aimed for high quality food production include all available measures that increase nutrients favorable for human health and growing of improved genotypes (Dragičević et al 2014). Menkir and Mazya-Dixon (2004) noticed low variations in β -carotene content in grain under the influence of environment, while the genotype was main source of variation. Lower level of phytate and higher level of β -carotene achieved in crops from organic production indicated higher nutritional quality of crops produced in this system (Dragičević et al 2013a). The aim of experiment was to compare conventional and organic production from the point of potential to improve yield of maize with different coloured kernel.

Materials and methods

A two year (2014-2015) field experiment was conducted at the Maize Research Institute in Zemun Polje, Belgrade, Serbia. Trial was set up on chernozem soil type in the experimental field. Maize hybrids differing in the kernel colour developed at the Maize Research Institute Zemun Polje were selected for this study: red maize ZP Rumenka, white maize ZP 655b and yellow maize ZP 633. The treatments of fertilization consisted of following variants: control (with no fertilizer), mineral fertilizer AN (ammonium-nitrate 34.4% N) in amount of 75 kg ha⁻¹ N, microbiological fertilizer Uniker in amount of 10 l/ha and organic fertilizer under the trade name „Humus Vita Stallatico" in amount of 1.5 t ha⁻¹. Uniker is microbiological fertilizer witch consisted of following strains of bacteria: *Bacillus megaterium*, *Bacillus lichenioirmis* and *Bacillus subtilis*. It is applied by incorporation into soil prior to sowing, in order to improve soil microbiological activity and increase mineralization of organic matter. „Humus Vita Stallatico" is composted organic fertilizer made from cattle and poultry manure with high content of humified organic matter (48%) and fulvo (9%) and humic acid (10%). Content of nitrogen, phosphorus and potassium is nearly equal with over 3% for each macroelement. Grain yield of maize (t ha⁻¹) were determined after harvest.

Data was analyzed statistically using analysis of variance and LSD_{0.05} were used for comparison, when main effects or interactions were statistically significant.

Results and discussion

Meteorological data on the experimental field during two years of trial are shown in table 1. The data shows better meteorological conditions for crops in the first year of this experiment. This year is characterized by big amounts of rainfall (annual sum was 858.4 mm) specially in May and July. Annual temperature mean 13.9 °C was significantly higher than long term temperature mean for Zemun Polje. Relatively high average monthly air temperature was in July and August 23.2°C and 22.6 °C, respectively. The second year of experiment 2015 had significantly small amount and bad rainfall distribution compared with first year. Severe drought is appeared from June to August and caused very significant decrease of maize yield. Regarding temperature conditions in this period, extremely high temperature means is recorded in July (26.4 °C) and August, (25.7 °C).

The results of the effect of maize varieties with different coloured kernel and fertilizers on grain yield of these varieties are shown in table 2. On the basis of two-year results it is obvious that meteorological conditions have very significant influence on maize yield. The second season had weather pattern less favourable for the maze production due to severe drought and very high temperature during flowering. All maize hybrids have greater yield in 2014 growing season compared with 2015. According to results the yield of different maize hybrids was significantly different depend on varieties to.

Table 1. Meteorological conditions in Zemun Polje for 2014 and 2015 seasons

Year/Month	2014		2015	
	Temperature (°C)	Precipitation (mm)	Temperature (°C)	Precipitation (mm)
January	5.3	30.7	3.3	46.7
February	7.8	19.9	4.2	44.0
March	10.8	46.9	8.1	99.1
April	13.7	84.8	12.9	19.7
May	17.4	192.5	17.6	97.8
June	21.1	71.2	22.1	31.1
July	23.2	187.4	26.4	7.2
August	22.6	41.0	25.7	56.0
September	18.0	75.6	20.2	73.6
October	14.1	56.6	12.4	65.1
November	9.7	10.5	8.1	44.1
December	3.8	41.3	4.3	3.3
Average	13.9		13.8	
Sum		858.4		587.7

Table 2. The effect of maize varieties and fertilizer on yield of maize with different coloured kernel (t ha⁻¹)

Maize varieties	2014				
	B ₁	B ₂	B ₃	B ₄	Aver.
Rumenka (red maize)	6.20a	6.70a	5.99a	6.80a	6.42a
ZP 655b (white maize)	10.18b	10.77b	10.84b	10.12b	10.48b
ZP 633 (yellow maize)	10.87c	10.97c	11.28c	11.17c	11.07b
Average	9.08a	9.48a	9.37a	9.36a	9.32
	2015				
Rumenka (red maize)	1.47a	1.59a	1.56a	1.58a	1.03a
ZP 655b (white maize)	2.42a	5.13b	4.66b	1.21a	3.35b
ZP 633 (yellow maize)	3.32b	1.64a	2.73a	5.08b	3.19b
Average	2.40a	2.79a	2.98a	2.62a	2.52

B₁-control, B₂-mineral fertilizer, B₃-microbiological fertilizer, B₄- organic fertilizer

Means in columns followed by the same letter are not significantly different according to *LSD* values ($P = 0.05$)

Fertilization showed no significant influence on maize yield in this experiment. Red coloured hybrid ZP Rumenka had very significant lower yield than white and yellow hybrid in both years. In 2014 fertilization treatments have no significant influence on red maize yield, but there were significant differences in yield on plots with white and yellow hybrids. Individually observed the highest yield was achieved in the yellow maize with microbiological 11.28 and organic fertilizer 11.17 t ha⁻¹. Also the highest grain yields were observed in the experiment on these treatments in both seasons. These results are similar to the results demonstrated by Dragičević et al (2013b) who concluded that in ecological production the highest yields and 1000 grain weight were obtained in Uniker treatment (microbiological fertilizer) with two times higher values in soybean, in relation to control. Oljača et al (2012) emphasized also that significantly higher yields of red maize Rumenka were obtained in combinations intercrop alternated rows with organic and microbiological fertilizers 3.38 and 3.25 t ha⁻¹ respectively.

In 2015 fertilization treatments have no significant influence on maize yield in all maize varieties but it is evident significant influence of maize hybrid. If we compare the interaction between two factors there were some significant differences. White maize gave significantly lower yield on control (2.42 t ha⁻¹) and organic fertilizer treatment (1.21 t ha⁻¹). While yellow one showed significant decrease of yield on mineral (1.64 t ha⁻¹) and microbiological fertilizer treatment (2.73 t ha⁻¹). On the plot with mineral fertilizer AN we obtain the lowest yield of yellow maize. This is the evidence that plants can not use mineral nutrients in extremely dry conditions. It is evident from the results that maize yield in all variant of hybrid and fertilization was at least two-fold lower in 2015 compare with 2014.

Drought is one of the major hazards affecting Serbia and drought is a normal part of the climate. This region will suffer from increased incidents of heat waves and droughts without possibilities for effectively shifting crop cultivation to other parts of the years. The results from the investigation performed by Kovačević et al (2012) shows the noticeable trend of decreasing moisture indices for the first twelve years of the new millennium compared to the last decade of the old one. This trend is particularly evident in the vegetative period of maize.

Conclusion

According to the obtained results during investigations of effects of fertilization and maize hybrids with different kernel colour on the grain yield the following conclusions can be made: meteorological conditions have very significant influence on maize yield. The second season 2015 had weather pattern less favourable for the maize production due to severe drought and very high temperature. It is evident from the results that maize yield in all variant of hybrid and fertilization was at least two-fold lower in 2015 compare with 2014. Fertilization showed no significant influence on maize yield in this experiment. If we compare the interaction between two factors there were some significant differences. The highest grain yields were observed in the yellow maize with organic fertilizer in both seasons. On the plot with mineral fertilizer AN we obtain the lowest yield of yellow maize. This is the evidence that plants can not use mineral nutrients in extremely dry conditions. In the fight against drought, regular and specific cultivation practices should be used along with an adequate assortment of plants with more tolerance to drought including soil tillage, particularly conservation tillage, proper fertilization and crop rotation.

Acknowledgement

This experiment has been carried out with funding from the Serbian Ministry of Education and Science in the frame of the project TR - 31037.

References

- Dragičević V., Spasojević I., Oljača S., Simić M., Dolijanović Ž. (2013a). Grain quality in organic and ecological cropping systems. Book of Proceedings IV International Scientific Symposium "Agrosym 2013", Jahorina, 700-705.
- Dragičević V., Oljača S., Dolijanović Ž., Stojiljković M., Spasojević I., Nišavić M. (2013b). Effect of intercropping systems and fertilizers on maize and soybean grain composition. 4th Annual Conference of Cost action FA 0905, Mineral improved crop production for healthy food and feed. Norwegian University of Life Sciences, UMB, 31.
- Dragičević V., Stojiljković M., Simić M., Nikolić B., Oljača S., Drinić-Mladenović S., Kravić, N. (2014). Determination of mineral nutrients availability and antioxidants content from grain in different crops. Proceedings 4th Workshop "Specific methods for Food Safety and Quality", Belgrade, pp. 10-12.
- Lopez-Martinez L.X., Parkin K.L, Garcia H.S (2011). Phase II-Inducing, Polyphenols content and antioxidant capacity of corn (*Zea mays* L.) from phenotypes of white, blue, red and purple colors processed into Masa and Tortillas. *Plant Food Hum Nutr* 66 (1), 41–47.
- Kovačević D., Oljača S., Dolijanović Ž., Milić V. (2012). Climate changes: ecological and agronomic options for mitigating the consequences of drought in Serbia. Book of Proceedings III International Scientific Symposium "Agrosym 2012", Jahorina, 17-35.
- Menkir A., Maziya-Dixon B. (2004). Influence of genotype and environment on β -carotene content in tropical yellow-endosperm maize genotypes. *Maydica*, 49, 313-318.
- Oljača S., Dolijanović Ž., Simić M., Oljača M. (2012). Yield of red maize intercropped with black soyabean in organic cropping system. Book of Proceedings, III International Scientific Symposium "Agrosym 2012", Jahorina, 301-315.
- Rodriguez V. M., Soengas P., Landa A., Ordas A., Revilla P. (2013). Effects of selection for color intensity on antioxidant capacity in maize (*Zea mays* L.) *Euphytica*, 193, 339–345.
- Žilić S., Milašinović M., Terzić D., Barać M., Ignjatović-Mičić D. (2011). Grain characteristics and composition of maize specialty hybrids. *Spanish Journal of Agricultural Research*, 9(1), 230-241.
- Žilić S., Serpen A., Akililoglu G., Gokmen V., Vančetović J. (2012). Phenolic compounds, carotenoids, anthocyanins, and antioxidant capacity of colored maize (*Zea mays* L.) kernels, *Journal of Agricultural and Food Chemistry*, 60, 1224-1231.
- http://www.specialtyproduce.com/produce/Red_Corn_2852.php Accessed on 30.05.2016.

STUDY OF THE LEAF AREA AND DRY MATTER IN NEW WHEAT VARIETIES DEPENDING ON THE APPLIED NITROGEN FERTILIZATION

Ivan YANCHEV*, Dafinka IVANOVA

Faculty of Agronomy, Agricultural University, Plovdiv, Bulgaria

*Corresponding author: ivan.yanchev@abv.bg

Abstract

The study discusses the influence of the empty area in the spring before sunflowers reach third-fourth leaf, and later on when the sunflowers surpass the wheat in height and serve as a green screen during its most important phases, i.e. from the end of shooting-up to the milk and wax ripeness. This study focuses on the formed leaf area during these phases throughout the years of the experiment, the influence of the strips, the effect of nitrogen fertilization, and the performance of the varieties as quality factors. The photosynthetic potential is characterized by the Leaf Area Index (LAI), and by the formation of dry matter relevant to the biological output of the respective growth and developmental phases. During the period 2013-2015 a field experiment is carried out on the research field of the Agricultural University-Plovdiv with two experimental crops – the first one consisting of ordinary sown common wheat, while the second one consisting of alternating strips of wheat and sunflower. The fertilization effect of four rates of nitrogen fertilization is studied, namely N_0 , N_8 , N_{16} , N_{24} , on the crops, while using three wheat varieties: Sadovo 1, Gea 1 and Sadovo 772. With the increase of the nitrogen fertilization rate, the leaf area and the dry matter increase too, more significantly at the third and fourth fertilization rate for both crops.

Keywords: *wheat, varieties, leaf area, fertilization.*

Introduction

The cultivar composition, representing various but consolidated agricultural properties, is intended to meet the equally various requirements of the market, the conditions of growth, the applied technological decisions, etc. (Akbar and Silva, 2012; Delibaltova and Kirchev, 2010; Ilievski et al., 2012; Man et al., 2012; Negassa et al., 2012). Throughout the whole country the most frequent crops preceding wheat are both, sunflower and corn. The droughts over the last years have led to the increase of the sunflower fields which is also, the better wheat preceding crop for a number of reasons (Delibaltova et al., 2014; Ivanova et al., 2010; Kirchev and Delibaltova, 2016; Tsenov et al., 2004; Tsenov and Kostov, 1999). The purpose, was to find out the productivity of new cultivars of common wheat grown in two different way– the first one consisting of ordinary sown common wheat, while the second one consisting of alternating strips of wheat and sunflower.

The aim of investigation was to determine the influence of nitrogen levels and methods of sowing in the formation of leaf area and dry biomass in the vegetation.

Material and methods

The study is implemented during the period 2013-2015 at the Research Center of the Agricultural University – Plovdiv, Bulgaria. The first part of the experiment consists of a customary sown wheat, which is taken as a standard in the second stage of the experiment, where alternating strips

of sunflower and wheat are positioned perpendicularly to the most prevailing hot winds. Three-factor field experiment was carried out in order to find out the nitrogen mineral nutrition effect on the formed leaf area, on area of $1.0\text{m}^2 \text{LAI}^{-1}$ /LAI -Leaf Area Index/, and the formed dry biomass for three varieties of common wheat. The experiment is performed pursuant to the method of the fractional land plots, repeated four times, with dimensions of the land plot of 10.0m^2 . The researched factors are: Factor A – method of sowing, i.e. ordinary and broad-strip sowing; Factor B – rates of nitrogen fertilization / N_0, N_8, N_{16}, N_{24} /; and Factor C – varieties, namely Sadovo 1, Gea 1 and Sadovo 772. The following characteristics are studied: number of plants on a unit of land, overall and productive bushiness, leaf area and dry biomass, expressed as biological output in the course of the different growth phases.

Results and discussion

On the basis of the leaf area formed by the varieties as a result of the interaction between the factors, as well as on the average number of plants per variants and years, we found out the Leaf Area Index (LAI).

Table 1. Surface of leaf (m m^{-2}) in analyzed varieties grown under different N rate nutrition in different years conditions.

Varieties	N, kg da^{-1}	Broad-strip sowing						Ordinary sowing					
		2013		2014		2015		2013		2014		2015	
		Stem elongation	Spike emergence	Stem elongation	Spike emergence	Stem elongation	Spike emergence	Stem elongation	Spike emergence	Stem elongation	Spike emergence	Stem elongation	Spike emergence
Sadovo1	0	3,5	3,3	3,1	2,7	3,2	3,0	3,3	3,2	3,0	3,0	3,0	2,7
	8	4,8	4,0	4,1	3,8	4,0	3,8	4,5	3,9	3,7	3,6	3,5	3,6
	16	6,4	4,8	6,3	5,4	6,6	5,7	6,1	4,7	5,3	5,1	6,5	5,3
	24	6,6	5,1	6,4	5,5	6,5	5,5	6,2	4,9	5,3	5,1	6,1	5,6
Gea1	0	3,3	3,2	3,2	3,1	3,4	3,2	3,4	3,3	2,9	2,9	3,1	3,0
	8	4,6	4,0	4,2	3,8	4,4	3,9	4,4	4,0	3,7	3,7	4,1	3,4
	16	7,2	5,5	6,3	5,8	6,8	6,0	5,8	5,3	5,8	4,9	6,0	4,8
	24	6,6	5,0	6,1	5,6	6,8	5,6	5,7	5,1	5,8	5,0	6,2	5,1
Sadovo 772	0	3,7	3,4	3,1	2,9	3,4	3,3	3,7	3,3	2,7	2,7	3,3	3,1
	8	4,3	3,9	4,0	3,7	4,4	3,8	4,4	3,9	3,6	3,7	4,2	3,5
	16	6,2	5,3	5,5	5,4	6,4	6,0	5,3	5,3	5,5	4,9	5,6	5,4
	24	6,6	5,7	5,9	5,6	6,8	5,7	5,5	5,7	5,4	5,0	5,5	4,8
<i>LSD 5%</i>			2.28	2.23	2.11	2.09	2.19	2.13	2.21	2.18	2.09	2.00	2.08

The results for this characteristic in all varieties without applied nitrogen and with N_8 are under the minimal basic value of LAI of 5m^2 . Values closest to it are achieved by the variety Sadovo, in broad-strip sowing, with N_8 , namely LAI - 4.8m^2 . At this norm of supply, the indicators of the broad-strip sown crops have better results, with the exception of the variety Sadovo 772, where the difference is insignificant, i.e. 4.3m^2 for the broad-strip sown crops and 4.4m^2 for the ordinary sown crops. In all varieties the differences in LAI are insignificant when nitrogen is not applied. Only on the basis of the soil fertility the achieved results are under 4.0m^2 on 1.0m^2 of soil, which is under the accepted criterion for optical dynamic system. With the nitrogen rate increase

from N_8 to N_{16} , LAI sharply increases in all varieties in both methods of sowing. The differences remain insignificant with the increase of the fertilization rate to N_{24} , in which LAI is larger with $0.2-0.4\text{m}^2$, however in some of the variants it is the same or lower. The comparison between the two types of sowing and the fertilization rates exhibit more significant differences, reaching most often to 1.0m^2 , especially in the varieties Gea 1 and Sadovo 772. In the broad-strip sowing method, LAI for the variety Gea is 7.2 and it lowers to 6.6m^2 with the fertilization rate increase from N_{16} to N_{24} , while for the variety Sadovo 772 they are respectively 6.2 and 6.6m^2 , whereas for the ordinary sowing method they are quite lower. For the variety Sadovo 1, regardless of the sowing organization, the values are $6.4-6.1\text{m}^2$ at N_{16} and $6.6-6.2\text{m}^2$ at N_{24} , which definitely demonstrates higher degree of plasticity.

Table 2. Variation of dry biomass (kg m^{-2}) in analyzed varieties grown under different N rate nutrition in different years conditions.

Varieties	N, kg da^{-1}	Broad-strip sowing						Ordinary sowing					
		2013		2014		2015		2013		2014		2015	
		Stem elongation	Spike emergence	Stem elongation	Spike emergence	Stem elongation	Spike emergence	Stem elongation	Spike emergence	Stem elongation	Spike emergence	Stem elongation	Spike emergence
Sadovo1	0	0,7	1,5	0,6	1,4	0,5	1,3	0,6	1,2	0,4	1,5	0,5	1,1
	8	0,9	2,2	0,8	2,2	0,8	1,9	0,9	1,7	0,7	1,9	0,7	1,9
	16	1,6	2,8	1,5	3,7	1,3	3,0	1,4	2,5	1,4	3,4	1,2	3,0
	24	1,6	2,8	1,4	3,7	1,4	2,9	1,6	2,6	1,4	3,5	1,3	3,0
Gea1	0	0,6	1,9	0,6	1,3	0,6	1,4	0,6	1,3	0,5	1,2	0,4	1,3
	8	0,9	2,6	0,8	2,0	0,8	2,0	0,9	1,9	0,8	1,6	0,8	1,9
	16	1,8	3,7	1,6	3,7	1,5	3,0	1,4	2,8	1,4	3,3	1,4	2,8
	24	1,6	3,4	1,2	3,1	1,5	3,2	1,5	2,9	1,4	3,2	1,4	3,1
Sadovo 772	0	0,6	2,0	0,5	1,3	0,4	1,2	0,6	1,7	0,4	1,1	0,4	1,1
	8	0,8	2,3	0,7	1,7	0,6	1,9	0,9	2,3	0,7	1,8	0,6	1,8
	16	1,7	3,1	1,6	3,1	1,6	3,2	1,4	2,7	1,6	2,4	1,3	2,9
	24	1,5	3,3	1,5	3,3	1,5	3,4	1,5	3,1	1,5	2,6	1,4	2,9
<i>LSD 5%</i>			<i>0.25</i>	<i>0.82</i>	<i>0.16</i>	<i>0.66</i>	<i>0.18</i>	<i>0.76</i>	<i>0.22</i>	<i>0.78</i>	<i>0.14</i>	<i>0.62</i>	<i>0.16</i>

When studying the fertilization effect at N_0 and N_{24} , as a difference between the maximum and minimum values of the formed LAI, we found out that the differences are more substantial in the broad-strip sowing method, namely: Sadovo 1 – 3.1m^2 , Gea 1 – 3.9m^2 , and variety Sadovo 772 – 2.9m^2 , versus 2.9m^2 , 2.4m^2 and 1.8m^2 for the varieties in the case of the ordinary sowing method. The difference is again minimal between the data for the two types of sowing, i.e. for the variety Sadovo 1- from 3.1 to 2.9m^2 , while for the new varieties it is more than 1, expressed at a less extent in the variety Sadovo 772 – from 2.9 to 1.8m^2 , and at a greater extent in the variety Gea 1, with values 3.9 and 2.4m^2 .

The results obtained demonstrate the influence of the larger nutritional area in the case of the broad-strip sowing method, as well as the influence of the warming of the ground air as a result of the warming of the empty strips that will be sown with sunflower. In the end of March and in the beginning of April, the values of the temperature on the leaves during midday hours is about

17⁰C, while on the soil adjacent to the strips, the temperature reaches 32⁰C. In the first year of the research, in the broad-strip sowing method, in the shooting-up phase, the variety Gea 1 accumulates greatest quantities of dry biomass, followed by the variety Sadovo 1 and variety Sadovo 772, while in the ordinary sowing method, the same varieties grown without fertilization, and at N₈ and N₁₆ form the same quantity of dry substance. Only, with fertilization at N₂₄, the leading place for this indicator belongs to variety Sadovo 1 with 1 to 1.6 kg m⁻². With the increase of the fertilization rate from N₀ to N₂₄ the accumulation of dry biomass increases in the both variants of sowing. During the shooting-up phase, the increase of the dry substance from N₀ to N₁₆, in the broad-strip sowing method is with 0.9 , 1.2 and 1.1 kg m⁻², respectively for the varieties Sadovo 1, Gea 1 and Sadovo 772, where the most significant difference is reported in the instance of the variety Gea 1. In the ordinary sowing method the results are similar. During the ear formation phase the largest dry substance is reported for the variety Gea 1, in the broad-strip sowing method and for variety Sadovo 772 in the ordinary sowing method, where for the first variety the effect of fertilization is expressed by 1.8 kg m⁻² dry substance, while for the second variety it is expressed by 1.4 kg m⁻². The studied varieties increase their biomass while passing into the phase of ear formation. The values of this increase vary from 0.6 to 1.4 kg m⁻² at the main background, and from 1.0 to 1.9 kg m⁻² at the high fertilization rate, regardless of the sowing organization. Comparing the difference between the phases of the two varieties, a trend is discerned for bigger values in the broad-strip sowing method, where the dry substance formed during the period reaches 1.9 kg m⁻², while for the ordinary sowing method it is 1.6 kg m⁻².

During the second year of the experiment, in the broad-strip sowing method, in the phase of shooting-up, the largest quantities of dry biomass are formed at the high fertilization rates with preponderance for N₁₆, equal for the varieties Gea 1 and Sadovo 772 reaching 1.6kg m⁻², while for the variety Sadovo 1, it is 1.5 kg m⁻². During the same phase in the ordinary sowing method the values are highest for the variety Sadovo 772 reaching up to 1.6 kg m⁻² at N₁₆, while for the standard and variety Gea 1, they are 1.4 kg m⁻². With the transition to the phase of ear formation, the dry biomass increases significantly, and the values are higher both versus the previous year, as well as versus the shooting-up phase. This is best presented by the differences in the effectiveness of the fertilization rates, which in 2013 formed over 2.0 kg m⁻² of dry substance, while in 2014 it is from 1.3 to 1.8 kg m⁻². In 2015, again variety Gea 1 exhibits best responsiveness and the formed dry biomass versus the low fertilization rates is 2.4 kg m⁻² for the broad-strip sowing method, and 2.1 kg m⁻² for the ordinary sowing method. With regards to the difference between the phases, we found out that the achieved biomass is within the limits from 0.7 to 1.4 kg m⁻² for the low fertilization rates, and from 0.8 to 2.3 kg m⁻² for the high, whereas most often varies within the boundaries from 1.8 to 2.0 kg m⁻².

During the third year, both for the broad-strip and for the ordinary sowing method, the high fertilization rates influence significantly the formed quantity of dry biomass. At the main background and at second fertilization rate, the values do not reach 1.0 kg m⁻² and they vary within the limits from 0.4 to 0.8 kg m⁻², while at third and fourth rate they exceed 1.0 kg m⁻² within the limits from 1.3 to 1.6 kg m⁻². The varieties Gea 1 and Sadovo 772 most often outperform the standard in the broad-strip sowing method. The dry substance is constantly higher with several tenths, for the three varieties.

For the fertilization effect we judge on the basis of the difference between basic and maximal fertilization rate. The formed dry biomass most often moves around 1.0 kg m⁻² in the two types of sowing, in the shooting-up phase, with values from 0.9 to 1.2 kg m⁻²

With the setting in of the ear formation phase, the dry biomass increases more than twice. In the broad-strip sowing method a trend is forming towards more intensive absorption of the nutrients and the differences in the biomass reach 500 g m^{-2} versus the ordinary sowing method.

Variety Sadovo 772 forms most biomass, followed by Gea 1 and Sadovo 1, in the broad-strip sowing method, with maximal values from 3.2 to 3.4 kg m^{-2} , while in the ordinary sowing method no difference is observed between the varieties.

The fertilization effect on the varieties during the ear formation phase reaches up to 2.2 kg m^{-2} , where most often it is from 1.8 to 2.0 kg m^{-2} of dry biomass for the two types of sowing. The difference between the phases and the productivity with the increase of the fertilization rate follows the established trend. In the broad-strip sowing method they are within the limits of 0.8 and 1.9 kg m^{-2} , while in the ordinary sowing, they are lower, with values from 0.5 to 1.7 kg m^{-2} . The varieties Gea 1 and Sadovo 772 most often surpass the standard or are equal to it only in some of the fertilization rates. Fertilization increases the dry biomass during the shooting-up phase with values varying from 0.8 to 1.2 kg m^{-2} for the entire period, the same positive effect is maintained also during the phase of ear formation within the limits from 1.3 to 2.4 kg m^{-2} . In the different years the formed quantity of biomass in the shooting-up phase as a result of the increased fertilization rates, is relatively similar, due to the same influence of the climatic conditions on the foliar and stem mass, which is not so dynamic in the beginning of the phase. Setting in the ear formation phase, the growth and developmental rate is expressed by the fast increase of the dry biomass up to twice, but the values for the separate years are not the same. The highest fertilization effect is observed in 2014, in the broad-strip sowing method, followed by 2015 and 2013; the effect is similar for the ordinary sowing method, however with lower values of the formed dry biomass.

Conclusions

The fertilization effect for the basic rate and when applying $\text{N}_8 \text{ kg m}^{-2}$, with regards to the formed leaf area expressed in m^2 per 1.0m^2 is under the accepted criterion for optical and dynamic system, equal at least to 5.0m^2 leaves per 1.0m^2 of sown area, while in N_{16} and $\text{N}_{24} \text{ kg m}^{-2}$ the leaf area is within the limits from 5.0 to 7.2 m^2 thus providing a more intensive synthesis of dry biomass during the two phases for the studied period.

Fertilization increases the dry biomass during the shooting-up phase, with values varying from 0.8 to 1.2 kg m^{-2} for the entire period, the same positive effect is maintained also during the ear formation phase, within the limits from 1.3 to 2.4 kg m^{-2} .

The highest fertilization effect is observed in the broad-strip sown crops, though this effect is similar in the ordinary sown crops, it shows lower values for the formed leaf area and the dry biomass.

References

- Akbar, H., Silva, J. (2012). Phenology, growth and yield of three wheat (*Triticum aestivum* L.) varieties as affected by high temperature stress. *Notulae Scientia Biologicae*, 4(3), 97-109.
- Delibaltova, V., Kirchev, H. (2010). Grain yield and quality of bread wheat varieties under the agroecological conditions of Dobroudja region. *Bulgarian Journal of Agricultural Science*, 16, 1, 17-21.
- Delibaltova, V., Kirchev, H., Zheliazkov, I., Dyulganski, Y. (2014). Investigation on the yield and grain quality of bread wheat varieties in Southeast Bulgaria. *Bulgarian Journal of Agricultural Science*, 20, 1, 106-110.

- Ilievski, M. M., Spasova, D. D., Georgievski, M. M., Atanasova B. B., Jovanov D. D. (2012). Quality of the grain of Macedonian wheat genotype in different production systems. *Journal Of Hygienic Engineering And Design*, 1231-233.
- Ivanova, A., Tsenov, N., Kirchev, H. (2010). Impact of environment and some agronomy practices on the productivity of the new wheat variety Bolyarka in South Dobrudzha region. *BALWOIS 2010 - Ohrid, Republic of Macedonia, Vol. II*.
- Kirchev, H., Delibaltova, V. (2016). Genotypic specific features of common wheat varieties (*Triticum aestivum* L.). Yield and quality of grain. *International Journal for Research in Agricultural Research*, 2, 2, 48-58.
- Man, S. S., Muste, S. S., Paucean A. A., Pop, A. A. (2012). The behavior of some autumn wheat varieties in the conditions of the Transylvania central area. *Bulletin Of University Of Agricultural Sciences And Veterinary Medicine Cluj-Napoca. Agriculture*, 69(2), 281-289.
- Negassa, A. A., Hellin J. J., Shiferaw B. B. (2012). Determinants of adoption and spatial diversity of wheat varieties on household farms in Turkey. *Socio-Economics Working Paper - CIMMYT*, (2),
- Tsenov, N., Kostov, K., Gubatov, T., Peeva, V. (2004). Study on the genotype * environment interaction in winter wheat varieties. I. Grain quality. *Field Crop Studies*, I, 1, 20-29.
- Tsenov, N., K. Kostov, 1999. Galatea - a new variety of bread wheat, *Plant Science*, 36, 251-257.

EFFECT OF HEADING CUT POSITION AND DATE OF HEADING DURING EARLY SUMMER PRUNING ON THE OCCURRENCE AND PROPERTIES OF SYLLEPTIC SHOOTS IN APRICOT

Ivan GLIŠIĆ*, Dušan MIKIĆ, Tomo MILOŠEVIĆ, Gorica PAUNOVIĆ, Radmila ILIĆ

Faculty of Agronomy, Čačak, University of Kragujevac, Serbia

*Corresponding author: glishoo@yahoo.com

Abstract

This paper presents two-year results (2014 and 2015) of a trial on the effect of heading cut position and heading date on the occurrence and properties of sylleptic shoots in apricot. The research included cv. 'Hungarian Best' grafted on Myrobalan (*P. cerasifera*, Ehrh) seedling rootstock, and grown near Čačak (43°53'N latitude; 20°21'E longitude; 390 m a.s.l.), Western Serbia. Heading is aimed at reducing tree vigour and inducing the formation of sylleptic shoots that will develop into fruiting branches possibly by the end of the growing season. Shoots were cut back at three dates (D₁ - 5 June; D₂ - 20 June and D₃ - 5 July) and under two treatments i.e. treatment 1 (T₁) - just above the bud, and treatment 2 (T₂) - between buds. Inter alia, results showed a much greater % positive response in T₁ (82.21%) than in T₂ (52.88%), and the best performance at D₂. Number of sylleptic shoots was not significantly different across heading dates, but significant differences were found between the two heading cut positions. On average, T₁ and T₂ gave 2.12±0.24 and 1.17±0.13 sylleptic shoots, respectively. Significant differences were observed in sylleptic shoot length across heading dates; with the longest sylleptic shoots at D₁ - 9.39±0.91 cm, and the shortest at D₃ - 5.99±0.62 cm. Heading cut position had no significant effect on sylleptic shoot length. As regards the number of flower and vegetative buds per sylleptic shoot, results showed that early cutback dates (D₁ and D₂) mostly led to the formation of vegetative sylleptic shoots. A similar event was induced by heading treatment T₁.

Keywords: *Apricot, early summer pruning, sylleptic shoots*

Introduction

Pruning is one of the most important tree management practices, which ensures that trees are strong enough to support their load of fruit and that branches are properly angled to allow in sufficient sunlight for flower buds to form and for fruit to develop and ripen (Demirtas *et al.*, 2010). Pruning enhances fruit external and internal quality properties such as skin colour, total soluble solids/acidity balance, sugar accumulation etc. (Lord and Greene, 1982).

Summer pruning of apricot trees has been practiced for a long time in major apricot producing countries in Europe (Krška *et al.*, 2012). Šit (1958) was among the first researchers to stress the importance of summer pruning in apricots, and explained that heading at the end of May and in the first half of June stimulates the formation of sylleptic branches with flower buds flowering much later compared to those on unpruned shoots. Previous studies also showed that summer pruning has a positive effect on flower bud formation, improves fruit quality, controls tree development etc. (Kuden and Kaska, 1995; Demirtas *et al.*, 2010). Generally, summer pruning can be applied before and after harvest taking into account the development stage of flower buds. If shoots are cut back early before harvest, summer buds commonly develop into sylleptic shoots which produce flower buds (Šit, 1958; Demirtas *et al.*, 2010). Moreover, summer pruning

reduces tree vigour, stimulates the tree to come into bearing at an early age, and improves fruit quality (Son and Küden, 2002; Szklarz *et al.*, 2011).

However, in Serbia, summer pruning has only recently gained acceptance in apricot plantings, and is normally carried out after harvest until the last ten days in August i.e. during paradormancy (Milošević *et al.*, 2008; Jovanović *et al.*, 2010). The need to prune (especially summer prune) apricot trees has increased due to the fact that the highly vigorous Myrobalan seedling has become the dominant rootstock in Serbian plantings. Pre-harvest pruning which mostly involves shoots and inhibits their growth is practically not used or is scarcely used. Furthermore, timing of this pruning treatment has not been precisely defined. Therefore, the main objective of this study was to determine the optimum date of summer pruning, and the optimum heading cut position to stimulate the development of quality sylleptic shoots with flower buds.

Material and Methods

Research was conducted in an apricot planting at Miokovci during 2014 and 2015. The cultivar 'Hungarian Best' was used in the experiment. Trees were grafted on Myrobalan (*Prunus cerasifera* Ehrh.) rootstock and planted at a spacing of 6.0 × 4.0 m (416 trees ha⁻¹). Training system was the open centre with 3-4 primary scaffold branches.

In the open centre system, there is a tendency for main structural branches to become bare of shoots and for the fruit-bearing area to shift to the canopy periphery. To avoid this, summer pruning was applied as early as the second year after planting, and involved heading back shoots to 4-6 buds. Shoots were cut back at three dates (D) and under two treatments (T). Heading dates included D₁ on 5 June, D₂ on 20 June and D₃ on 5 July. Heading treatment involved heading back shoots just above the bud (T₁), and heading back shoots between two adjacent buds (T₂) (Fig. 1). At each heading date and in each treatment, 30 shoots were cut back in 3 replications, with 10 shoots per replication. Upon heading, sylleptic shoot formation was assessed.



Fig. 1. Heading treatments during early summer pruning

At the end of March of the following year, shoots were evaluated for their response to the heading treatment performed in June and July of the previous growing season (0 = no sylleptic branching on the headed shoot, 1 = one sylleptic shoot developed on the headed shoot, 2 = two sylleptic shoots developed on the headed shoot, etc.). Then, positive responses to heading were counted and expressed as % across heading dates and heading cut positions. The following morphological properties of sylleptic shoots were analyzed: sylleptic shoot length (cm), number of vegetative buds per sylleptic shoot and number of flower buds per sylleptic shoot.

Data were statistically averaged, and the mean absolute deviation was defined using the standard error of the mean (\pm SE). Statistical analysis and testing of the significance of differences were

performed by the analysis of variance and LSD test at the significance level $P \leq 0.05$ using the ANOVA statistical software (SPS Statistica, Software 5.0).

Results and Discussion

Results on the response of shoots to heading and the number and length of sylleptic shoots are presented in Table 1.

Table 1. Response of shoots to heading; number and length of sylleptic shoots	Positive response of shoots to heading (%)	Number of sylleptic shoots	Length of sylleptic shoot (cm)
Heading date (A)			
D ₁	59.91±8.14 b	1.67±0.15 ab	9.39±0.91 a
D ₂	78.56±8.09 a	1.84±0.20 a	6.13±0.55 b
D ₃	64.16±8.77 b	1.43±0.20 b	5.99±0.62 b
Heading cut position (B)			
T ₁	82.21±8.11 a	2.12±0.24 a	7.10±0.70
T ₂	52.88±7.94 b	1.17±0.13 b	7.24±0.59
ANOVA			
A	**	*	*
B	**	**	ns
A × B	ns	ns	*

Different lowercase letters within columns indicate the significance of differences between means at $P \leq 0.05$ according to LSD test

Results revealed a significant effect of heading date and heading cut position on percent positive response to heading (Table 1). Across heading dates, the highest percent positive response was obtained at D₂ – 78.56±8.09%, whereas the values at D₁ and D₃ were lower and exhibited no statistical difference. Overall, the percent positive response to heading at all dates was satisfactory (>50%), suggesting that early-summer pruning during June delivered positive results. These results are better if this operation is conducted until 20 June, which is in agreement with previous findings (Glisic *et al.*, 2015). As for the heading cut position, the response to heading was much better in T₁, i.e. when the shoots were headed back just above the bud (82.21±8.11% positive response). Milatović *et al.* (2015) reported that shoots in sweet cherry trees should preferably be cut back just above the bud during early-summer pruning to stimulate sylleptic branching. The results of the present study are consistent with this report.

In terms of the number of sylleptic shoots induced by heading, the best performance was achieved at D₂ – 1.84±0.20 and in T₁ – 2.12±0.24 sylleptic shoots per headed shoot. Length of sylleptic shoots showed significant differences across heading dates, ranging from the longest sylleptic shoots at D₁ – 9.39±0.91 cm to smaller lengths at D₂ and D₃ 6.13±0.55 and 5.99±0.62

cm, respectively. Heading cut position had no significant effect on sylleptic shoot length. Milošević *et al.* (2011b) obtained significantly longer sylleptic shoots in apricot at early heading dates during early-summer pruning. A similar pattern was observed in the present experiment. Number of flower and vegetative buds and their ratio per sylleptic shoot in apricot trees are given in Table 2.

Table 2: Number of flower and vegetative buds and their ratio

	Number of flower buds	Number of vegetative buds	Ratio of flower buds to vegetative buds
Heading date (A)			
D ₁	1.73±0.19 a	3.81±0.31 a	1 : 2.27
D ₂	1.00±0.10 c	3.58±0.40 a	1 : 3.70
D ₃	1.42±0.12 b	2.95±0.21 b	1 : 1.75
Heading cut position (B)			
T ₁	1.38±0.15	3.82±0.29 a	1 : 2.94
T ₂	1.39±0.19	3.07±0.32 b	1 : 1.96
ANOVA			
A	**	*	
B	ns	*	
A × B	*	**	

Different lowercase letters within columns indicate the significance of differences between means at $P \leq 0.05$ according to LSD test

Results showed that heading date had a highly significant effect on the number of flower buds per sylleptic shoot, as opposed to the non-significant effect of heading cut position. Moreover, the effect of the heading date x heading cut position interaction as a variability factor was significant. Results ranged from 1.00±0.10 flower buds per sylleptic shoot at D₂ to 1.73±0.19 at D₁. Similarly, the number of vegetative buds per sylleptic shoot was significantly affected by heading date and heading cut position, and highly significantly affected by their interaction, and ranged between 2.95±0.21 at D₃ and 3.81±0.31 at D₁. The best ratio of flower buds to vegetative buds was at D₃ – 1:1.75 and under heading treatment T₂ - 1:1.96.

Milošević *et al.* (2011b) found that late heading dates generally result in short sylleptic shoots that exhibit a better ratio of flower to vegetative buds, which was confirmed by the present findings. Glisić *et al.* (2015) obtained similar results in cv. 'Roxana' and even more favourable values for the number of flower buds and the flower to vegetative bud ratio. This can be explained by the high yield potential of 'Roxana' (Milošević *et al.*, 2010). As for heading cut position, Guimond and Andrews (1998) reported that greater length of shoot left after pruning (corresponding to T₂ in this experiment) inhibited the growth and vegetative development of sylleptic shoots, as confirmed by the present results.

Conclusions

Heading the shoots of apricot cv. 'Hungarian Best' at early dates (1-20 June) led to a positive response, more sylleptic shoots and greater length of sylleptic shoots than at the later date (beginning of July). Heading just above the bud gave much better results compared to the heading cut between buds. In contrast, later heading and the treatment with a greater length of the shoot left above the bud had an inhibitory effect on vegetative growth, and led to the formation of a small number of mostly sylleptic shoots mainly of generative character.

Generally, the apricot cv. 'Hungarian Best' grafted on Myrobalan seedling exhibits a positive response to heading as part of early-summer pruning, especially if heading cuts are made in the first half of June and if shoots are cut back just above the bud.

Acknowledgement:

This study is part of Project Ref. No. TR 31064 ("Creation and Maintenance of the Genetic Potential of Continental Fruit Crops") financially supported by the Ministry of Education, Science and Technological Development of the Republic of Serbia. We acknowledge the financial support and all other types of support and assistance provided by the Ministry in implementing project activities.

References

- Demirtas N.M., Bolat I., Ercisli S., İkinci A., Olmez H.A., Sahin M., Altindag M., Celik B. (2010). The effects of different pruning treatments on the growth, fruit quality and yield of 'Hacihaliloglu' apricot. *Acta Scientiarum Polonorum, Hortorum Cultus*, 9: 183-192.
- Glišić I., Milošević T., Paunović G., Ilić R. (2015): Effect of heading date on the properties and development of sylleptic shoots in apricot. *Proceedings of the XX Symposium on Biotechnology; Faculty of Agronomy Čačak*, 13 – 14 March 2015, 20 (22): 211-219. (in Serbian)
- Guimond C.M., Andrews P.K. (1998): Timing and severity of summer pruning affects flower initiation and shoot regrowth in sweet cherry. *Hort Science*, 33, 647-649.
- Jovanović, S., Milošević, T., Glišić, I. (2010): Effect of late summer pruning on fruiting shoot characteristics of apricot cv. Hungarian Best. In: *Conference Proceedings 2nd International Conference on Horticulture Post-Graduate Study: 54-59, Lednice, Czech Republic, 30-31th August 2010.*
- Krška B., Gogolková K., Ondrášek I., Dokoupil L. (2012): Preliminary evaluation of basic biological traits of apricots on selected rootstocks. *Acta Horticulturae*, 966: 183-188.
- Küden, A, Kaska, N. (1995): Effects of winter and summer pruning on the yield and fruit quality of Priana and Beliana apricot cultivars. *Acta Horticulturae*, 384, 455–459.
- Lord, W.J., Greene, D.W., (1982). Effect of summer pruning on the quality of McIntosh apples. *HortScience*, 17: 372–373.
- Milatović D., Nikolić M., Miletić N. (2015): Sweet and sour cherries. *Serbian Scientific Pomological Society, Čačak*, 1-540. (in Serbian)
- Milošević T., Glišić I., Veljković Biljana, Glišić Ivana, Paunović Gorica, Milošević N. (2008): Main causes of variation in apricot production. *Proceedings of scientific papers of the XXIII Symposium on Improvement in Fruit and Grape Production, Grocka*, 14, 5: 21-31. (in Serbian)
- Milošević T., Milošević N., Glišić I. (2011a): Influence of Stock on the Early Tree Growth, Yield and Fruit Quality Traits of Apricot (*Prunus Armeniaca*, L.). *Journal of Agricultural Sciences*, 17, 3: 167-176.

- Milošević T., Milošević N., Glišić I., Paunović Gorica (2011b): Effect of summer pruning on the properties of sylleptic shoots in apricot. Proceedings of scientific papers of the XXVIII Symposium on Improvement in Fruit and Grape Production, Grocka, 17(5): 27-36. (in Serbian)
- Milošević, T., Glišić, I., Paunović Gorica, Milošević, N., Glišić Ivana (2010): Effect of rootstock and plant spacing on the vegetative growth and initial cropping in apricot. Proceedings of Abstracts of the XV International Scientific Symposium of Agronomists of the Republika Srpska, 102, Trebinje. (in Serbian)
- Šit, P.G. (1958): Study on the Growth and Development of Fruits and Berries. Moscow. (in Russian)
- Son, L., Küden, A. (2002): Effects of Pruning Treatments on the Yield and Fruit Quality of Precoce de Tyrinthe Apricot Cultivar. Turkish Journal of Agriculture and Forestry, 26: 79-86.
- Szklarz, M., Radajewska, B., Klak T. (2011): Effect of tree pruning and crown formation in young apricot (*Armeniaca vulgaris* Lam) trees on their growth and yielding. Acta Scientarum Polonorum, Hortorum Cultus, 10(3): 63-73.

WALNUT VARIETY BREEDING UPDATE TO 2015

Yaşar AKÇA^{1*}, Sebahattin YILMAZ², Mehmet SÜTYEMEZ³, Hakan KARADAĞ¹, Serpil ArslanYILDIZ¹

¹Horticulture Department, Agricultural Faculty of Gaziosmanpaşa University, Tokat, Turkey

²Horticulture Department, Agriculture Faculty of Ahi Evran University, Kırşehir, Turkey

³Horticulture Department, Agriculture Faculty of Kahramanmaraş Sütçü İmam, Kahramanmaraş, Turkey

*Corresponding author: akca66@gmail.com

Abstract

During 1998-2000, 2008-2012 and 2012-2015, the following controlled crosses were made to found new walnut genotypes with late leafing, lateral bud fruitfulness and high nut quality. In first variety breeding program, Turkish walnut selections were crossed with Payne and between their in 1998-1999: ‘Niksar 1’ × ‘Niksar 2’, ‘Niksar 1’ × ‘Payne’, ‘Niksar 1’ × ‘Şebin’, ‘Turhal 1’ × ‘Niksar 2’, ‘Şebin’ × ‘Niksar 2’. 757 seedlings from controlled crosses were obtained in 1998 and 624 seedlings were obtained in 2000. In second variety breeding program, ‘Niksar 1’, ‘Şebin’, ‘Hartley’, ‘Topak’, ‘Chandler’, ‘Akça 2’, ‘Oğuzlar 77’, ‘Franquette’, ‘Sütyemez 1’, ‘Sütyemez 2’ and ‘Maraş 12’ walnut standard cultivars and selections were used in variety breeding program in between 2008-2012. We have 1340 seedlings under evaluation in this breeding program. In third variety breeding program, during 2012-2015, the following controlled crosses were made to found the new walnut genotypes with tolerant to bacterial blight, late leafing and lateral bud fruitfulness, high nut quality: ‘Pedro’ × ‘Chandler’, ‘Pedro’ × ‘Fernette’, ‘Pedro’ × ‘Midland’, ‘Fernor’ × ‘Pedro’, ‘Fernor’ × ‘Chandler’, ‘Fernor’ × ‘Fernette’, ‘Fernor’ × ‘Howard’, ‘Fernor’ × ‘KZK1’, ‘Howard’ × ‘Fernor’, ‘Howard’ × ‘Chandler’, ‘Fernette’ × ‘Howard’, ‘Fernette’ × ‘Chandler’, ‘Fernette’ × ‘KZK 1’, ‘Chandler’ × ‘Kaman 1’, ‘Chandler’ × ‘KZK1’. A total number 1633 F1 seedling were obtained. The selected F1 seedlings were planted in the breeding orchard with a distance of 4 × 4 m on their own roots. The results of only phenological and pomological characteristics of controlled crosses ‘Hartley’ × ‘Niksar 1’ and ‘Hartley’ × ‘Oğuzlar 77’ will be presented in this paper. The kernel weight ranged between 8.2 g (55-60-89) to 11.80 g (55-60-) and kernel ratio (%) was changed between 50.0 (55-77-81) to 61.0 (55-60-37). The leafing time of selected genotypes is same with ‘Chandler’ and later than.

Keywords: *Walnut, crossing breeding, late leafing, nut quality*

Introduction

The important problem of walnut production is damage of spring frosts in Turkey. Turkish walnut cultivars are considerably early leafing and they bear fruits on terminal buds. The selection breeding method was the most widely used in walnut variety breeding of Turkey. A lot of selection study has been done among the rich native populations (Akça and Şen, 2001; Akca and Ozogun, 2004; Karadağ and Akça, 2011; Simsek *et al.*, 2011; Asma, 2012; Kırca *et al.*, 2014; Akça *et al.*, 2015; Yarılgaç and Yılmaz, 2016).

It was not possible to found that is late leafing and lateral bud fruitfulness variety in seedling walnut population by selection breeding method due to the degree of heritability and contraindications of these two characteristics. The walnut varieties with lateral fruiting and late leafing walnut types same as Californian cultivars are not found from seedling population in

Turkey. ‘Şebin’, ‘Bilecik’, ‘Niksar 1’, ‘Şen 1’ and ‘Maraş 18’ walnut cultivars were important cultivars that were selected from seedling populations.

Cross breeding method was used in only three studies until today (Akça, 2001; Anonymous, 2012). The aim of this breeding program is to provide new walnut cultivars by crossing for the Turkey walnut industry. The primary goal is to develop cultivars with late leafing, lateral fruit bearing, early harvest dates, and good nut quality.

Most of the walnut production of Turkey comes from seedling trees, which give less and in homogeneity crop that cause low commercial value. However, in recent 15 years some regular orchards have been established by Californian and French cultivars. With respect to national varieties, main Californian (‘Chandler’) and French (‘Fernor’ and ‘Fernette’) cultivars are being used in these new orchards.

The primary objective of Turkish walnut scion breeding program is generation of new cultivars with late leafing, lateral bud fruitfulness, disease resistance, yield, and good kernel quality. In our walnut breeding program, late leafing parents were crossed with lateral bearing parents. In regions with late spring frosts in Turkey, late fruiting walnut varieties can be used economically. Therefore, the breeding of new varieties with high fruit quality that will not effected by spring frosts are required.

Material and Methods

During 1998-2000, 2008-2012 and 2012- 2015, the following controlled crosses were made to found new walnut genotypes with late leafing and lateral bud fruitfulness, high nut quality. In first variety program, Turkish walnut selections were crossed with Payne and between their in 1998 -1999: ‘Niksar 1’ x ‘Niksar 2’, ‘Niksar 1’ x Payne, ‘Niksar 1’x ‘Şebin’, ‘Turhal 1’ x ‘Niksar 2’, ‘Şebin’ x ‘Niksar 2’. In second variety program, ‘Niksar 1’, ‘Şebin’, ‘Hartley’, ‘Topak’, ‘Chandler’, ‘Akça 2’, ‘Oğuzlar 77’, ‘Franquette’, ‘Sütyemez 1’, ‘Sütyemez 2’ and ‘Maraş 12’ walnut standard cultivars and selections were used in second variety breeding program in between 2008 - 2012. In third variety program, during 2012-2015, the following controlled crosses were made to found the new walnut genotypes with tolerant to bacterial blight, late leafing and lateral bud fruitfulness, high nut quality: ‘Pedro’ × ‘Chandler’, ‘Pedro’ × ‘Fernette’, ‘Pedro’ × ‘Midland’, ‘Fernor’ × ‘Pedro’, ‘Fernor’ × ‘Chandler’, ‘Fernor’ × ‘Fernette’, ‘Fernor’ × ‘Howard’, ‘Fernor’ × KZK1, ‘Howard’ × ‘Fernor’, ‘Howard’ × ‘Chandler’, ‘Fernette’ × ‘Howard’, ‘Fernette’ × ‘Chandler’, ‘Fernette’ × ‘KZK 1’, ‘Chandler’ × ‘Kaman 1’, ‘Chandler’ × ‘KZK1’. Based on the status of the bacterial blight diseases and leafing time will be determine in greenhouse in between 2016-2017. In order to inoculate plant, it will be use *Xaj* isolates that the value of virulence is high and precise identification is right. The symptoms of bacteria on the leaf will be examined after than inoculations 14, 21 and 30 days and the disease symptoms will be scored according to 0-4 scale values.

The female flowers were carefully bagged before receptive stage. After, the pollen of chosen parents was squirted to receptive flowers. Pollen applied flowers marked with different colored threads. Seed from these crosses is collected in the fall before nut drop, air dried before storing. To ensure the highest possible germination, after soaking 24 hours in GA₃ solutions at 50 ppm, seed are stratified in cold room (4-5 °C). To ensure the highest possible germination, seed are stratified in cold room (4 °C). After stratification, germinated seeds were sowed in to plastic containers containing peat, perlite and soil for growth in the greenhouse. The leafing time of each hybrid was noted and the seedlings which leafed out two-three weeks earlier than Franquette were discarded. The selected selections were planted in the breeding orchard 4 × 4 m, on their own roots. By age 6, trees with low yield or other problems are cut down.

Nut and kernel weight, kernel percentage, nut dimension, shell thickness, kernel color and ease of kernel removal were evaluated using 25 nuts chosen randomly. The evaluation of selected superior genotypes was made according to UPOV (Anonymous, 1999). The results of only phenological and pomological characteristics of controlled crosses ‘Hartley’ × ‘Akça’, ‘Hartley’ × ‘Oğuzlar 77’ will be presented in paper.

Results and Discussion

Among the important goal of walnut breeding programs are late leafing, lateral bud fruitfulness, early yielding, shortness of vegetation period, early harvesting time, good fruit quality, high yield and resistance to bacterial blight. Similar walnut breeding programs have been carried out in USA, France, Hungary, Italy and Spain; a few of these programs are still ongoing (Germain *et al.*, 1985; Szentivanyi 1990; Tulecke and McGranahan, 1994; Tamponi *et al.* 1997, Anonymous, 2013).

Leafing time of F₁ selections were classified as early, medium-early, medium and, medium-late, group according to ‘Franquette’ cultivar in breeding orchard (Table 1). ‘Chandler’ walnut cultivar was classified medium early group in breeding orchard. The genotypes with medium, medium-early and medium –late are tolerant to late spring frost in Turkey walnut production.

Symptoms of bacterial blight (*Xanthomonas juglandis*) and anthracnose (*Gnomonia leptostila*) were examined in the breeding orchard. We have not observed bacterial blight and anthracnose symptoms on selected F₁ seedlings obtained from the first and second breeding programs.

Kernel weight, kernel percentage and shell thickness should be 6.0 to 8.0 g, 50 to 55%, and 0.7 to 1.5 mm respectively in promising new walnut cultivars according to Akça and Ozogun (2004).

In the selected F₁ genotypes, kernel ratio, kernel weight and nut weight changed from 50.0 – 61.0 %, 8.2 g – 11.8g, 13.9 g to 23.4 g, respectively. There is not very low (< 40%) and low (40–44%) kernel ratio among selected F₁ genotypes. Generally, kernel percentage of selected genotypes to be found high rather than 55%. Kernel color of all the selected F₁ were observed extra light and kernel ease of removal were determined very easy (Table 1).

Table 1. Pomological and phenological characteristics of F₁ selections

F ₁ genotypes	Nut length (mm)	Nut width (mm)	Nut thickness (mm)	Nut weight (g)	Kernel weight (g)	Shell thickness (mm)	Kernel ratio(%)	Kernel color	Empty kernel percent (%)	Kernel ease of removal	Leafing time in breeding orchard	Leafing group according to 'Franquette'
55-60- 89	39.7	36.7	36.0	13.9	8.2	0.9	59.7	Extra Light	0	Very Easy	17.April	Medium Early
55-77- 79	51.8	35.1	35.8	14.4	8.3	1.3	57.6	Extra Light	0	Very Easy	17.April	Medium Early
55-77- 81	48.8	36.7	34.5	16.6	8.3	1.5	50.0	Extra Light	0	Very Easy	17.April	Medium Early
55-60- 77	40.3	36.3	32.8	15.7	8.5	1.6	54.1	Extra Light	0	Very Easy	20.April	Medium Early
55-60- 37	46.1	37.5	36.2	14.4	8.7	0.9	61.0	Extra Light	0	Very Easy	27.April	Medium Late
55-60- 90	45.1	36.7	36.0	15.4	8.7	1.2	56.7	Extra Light	0	Very Easy	20.April	Medium Early
55-60- 78	47.4	38.9	36.4	18.1	10.0	1.4	55.3	Extra Light	0	Very Easy	22.April	Medium
55-60- 24	43.3	37.1	35.4	17.0	10.1	0.8	59.6	Extra Light	0	Very Easy	25.April	Medium
55-77- 76	45.2	36.4	34.2	22.4	11.4	1.7	50.9	Extra Light	0	Very Easy	20.April	Medium Early
55-60- 83	44.6	39.5	38.7	20.1	11.7	1.1	58.2	Extra Light	0	Very Easy	20.April	Medium Early
55-60- 12	53.6	48.8	41.7	23.4	11.8	1.3	50.5	Extra Light	0	Very Easy	14.April	Early

Temponi *et al.* (1997), used ‘Sorrento’, ‘Serr’, ‘Payne’, ‘Chico’, ‘Pedro’, ‘Midland’, ‘Hartley’ ‘Gustine’ walnut cultivars in the new walnut crossing breeding program. A total number of 2500 seedlings were obtained in this walnut breeding program. In this study, kernel weight was ranged 4ç8 g (‘A1-1-33’ (‘Sorrento’ × ‘Serr’) to 7.2 g, (‘B1-8-4’ (‘Sorrento’ × ‘Chico’), kernel ratio changed from 43% (‘F-1-35’ (‘Sorrento’ × ‘Pedro’) to 60% (‘B1-7-4’ (‘Sorrento’ × ‘Chico’).

Szentivanyi (1990) reported that, a cross walnut breeding program was begun in the late 60’s with the Californian walnut cultivars (‘Pedro’, ‘Payne’ and ‘Tehama’) and Hungarian cv (‘Milota 10’, ‘Tiszasecsi’, ‘Alsoszentivani’). The new hybrids walnuts with late leafing are found in this program. Kernel weight changed to 5.10 g (‘T34-101’) to 9.80 g (‘A117-12’) g.

There has been an active walnut breeding program at UC Davis since 1948 ‘Chandler’, ‘Howard’, ‘Vina’, ‘Tulare’ and ‘Serr’ were selected by this program. Recently, ‘Sexton’, ‘Gillet’ and ‘Forde’ were released. According to report of walnut improvement 2013 of UC Davis, 86 scion selections are evaluated and propagated and over 4300 seedling are completed early evaluations. ‘Solano’ ‘Gillet’, ‘Sexton’ and ‘Forde’ walnut cultivars were obtained from this program. Kernel weight and kernel ratio of ‘Solano’ was reported as 8.0 g and 54% respectively. Also, kernel weight and kernel ratio of ‘Gillet’, ‘Sexton’ and ‘Forde’ was ranged, 8.5 g, 8.2 g and 9.0 g, 50%, 50% and 54% respectively (Anonymous, 2016a).

Germain (2004), reported that French walnut cultivars ‘Fernor’ and ‘Fernette’ were obtained from ‘Franquette’ × ‘Lara[®]’ crossing. The new walnut cultivars ‘Feradam’, ‘Ferouette’ and ‘Ferbelle’ were obtained from France walnut breeding program. Also, H113/1, H113/4, H113/20, H107/23, HP 39 F1 selections are evaluated. ‘Feradam’ has very big nuts rather than ‘Ferbelle’, ‘Ferouette’ (Anonymous, 2016b). Our promising walnut F₁ hybrids have high kernel weight, kernel ratio and kernel dimension better than the results of another walnut program.

Conclusion

The new international variety walnut breeding program can be started in EU countries. We have a lot of the new selections obtained variety walnut breeding program in Turkey. The new selections late leafing, lateral bud fruitfulness, high nut quality and tolerance to bacterial blight, it will enable to development of walnut production of Turkey.

Acknowledgment

This research was partially supported by TÜBİTAK (KAMAG -106 G 152)

References

- Akca Y. (2001). Breeding of walnut varieties by cross breeding, In: National Walnut Symposium, 5–8 September, Tokat-Turkey, pp. 53–63.
- Akca Y, Sen S.M. (2001). Study on the selection of superior walnut trees in Hizan (Bitlis) populations, *Acta Hort.*544.pp. 115:119
- Akca Y., Ozongun S. (2004). Selection of late leafing, late flowering, laterally fruitful walnut (*Juglans regia* L.) types in turkey. *New Zealand J. Crop Hort. Sci.* No 32, pp. 337–342.
- Akca Y., Bilgen Y., and Ercisli S. (2015). Selection of Superior Persian Walnut (*Juglans regia* L.) From Seedling Origin in Turkey, *Acta Sci. Pol. Hortorum Cultus*, Vol. 14, No3,, pp. 103-114.
- Anonymous (1999). Gridlines for the conduct of tests for distinctness uniformity and stability ‘Walnut’ *Juglans regia* L, Geneva.

- Anonymous (2012). Studies on the development of walnut industry in turkey, Project report of TÜBİTAK KAMAG 106-G 152.
- Anonymous (2016a). <http://www.noixsudouest.fr/immaj/104/02-alm-fiche-cr-3fer-2014.pdf>.
- Anonymous (2016b). http://fruitandnuteducation.ucdavis.edu/education/fruit_nut_production/Walnut/Walnut_Cultivar_Table/.
- Asma, B.M. (2012). Pomological and phenological characterization of promising walnut (*Juglans regia* L.) genotypes from Malatya, Turkey, Acta Sci. Pol., Hortorum Cultus Vol.11, No 4 pp.169-178-
- Karadağ H, Akça Y.,(2011). Phenological and pomological properties of promising walnut (*Juglans regia* L.) genotypes from selected native population in Amasya Province African Journal of Biotechnology Vol. 10, No 74, pp. 16763-16768.
- Kırca, S., Yarılgaç T., Kırca L., Bak T. (2014). Study on The Selection of Walnut (*Juglans regia*L.) In Trabzon, Turkish Journal of Agricultural and Natural Sciences Special Issue No 1, pp. 835:841
- Germain, E, Leglise P., Bayol M.(1985). Creation, par hybridation de varietes de noyer (*Juglans regia* L.) associant floraison tardive, mise a fruit rapide et productivite elevee: premiers resultats, 5 Colloque sur les recherche fruitiers –Bordeaux, 1985, pp. 13-14.
- Germain E. (1999). Le Noyer; CTIFL, ISBN, 2879111048.
- Simsek M., Uguz M.U., Erdogan M.K., Gul A., Karakoc S., and Digrak M. (2011). Selection studies on high quality walnut types and their antibacterial properties, Journal of Medicinal Plants Research Vol. 5, No 14, pp. 3269-3276.
- Szentivanyi, P., (1990). Breeding early fruiting, high producing walnut cultivars leafing after late spring frosts, First Intern. Symp. On Walnut Production , Budapest, Acta Hort., No 284, pp.175-182.
- Tamponi, G., Monastra, F., Fanigliulo R. (1997). Walnut Breeding Update to 1995, Proc. III. Int. Walnut Congress, Acta Hort. 442.pp:77-82.
- Tulecke, W., and McGranahan, G., (1994). The walnut germplasm collection of the University of California, Davis: A description of the collection and a history of the breeding program Of E.F. SerrAnd H.I. Forde. Rept 13. University Of California Genetic Resources.
- Yarılgaç,T., Yılmaz, K. (2016). Physical and biochemical characteristics of some walnut genotypes selected from Çal (Denizli) region. Anadolu Tarım Bilimleri Dergisi Vol. 31 No 1, pp. 9-15.

PRODUCTIVITY OF SOME DUTCH POTATO VARIETIES IN THE MOUNTAIN REGION OF MONTENEGRO

Zoran JOVOVIĆ¹, Andrey SKRYABIN², Ana VELIMIROVIĆ¹, Željko DOLIJANOVIĆ³,
Milica BUČKOVIĆ¹

¹University of Montenegro, Biotechnical Faculty Podgorica, Montenegro

²Plant Growing Department, Perm State Agricultural Academy, Russia

³University of Belgrade, Agricultural Faculty, Serbia

Abstract

This paper presents the results of a two-year study of six Dutch potato varieties in agroecological conditions of northern Montenegro. The two-year average of the highest number of tubers were found in the variety Arnova (8.4), while the lowest tuber number was obtained in varieties Arrow (6.8), Rudolph (6.8) and Riviera (6.9). Increasing the number of tubers in the variety Arnova compared to other varieties was statistically significant. Varieties Rudolph (116.5 g) and Kuroda (100.5 g) gave averagely biggest tubers. The average weight of tuber of other varieties studied was approximately at the same level, and ranged from 80.4 g, for the cultivar Arrow to 88.6, for the Arnova. Rudolph and Kuroda were, compared with all other varieties, had significantly larger tubers. The highest yield in trials was on plots planted with varieties Rudolph - 33.7, Kuroda - 32.0 and Arnova - 31.5 tha^{-1} . The lowest yield was measured at variety Arrow - 23.2 tha^{-1} . Yields of varieties Rudolph, Kuroda and Arnova were compared to all other investigated varieties statistically significant. This research showed that the highest yields of tubers in agroecological conditions of mountain climates are achieved by growing medium late and middle early varieties of potatoes.

Keywords: *potato, tuber number, tuber weight, yield*

Introduction

Potato is among the most important and most profitable crops in many countries of the world. On a global scale, after rice, wheat and maize, potato is the fourth largest source of food. The economic importance of potato in Montenegro is very significant, especially for the mountainous area where it is predominantly grown.

Potato is a plant of temperate climate and is grown in almost all latitudes. However, the best zone for potato growing is considered the area of temperate zone (40-60° north latitude), as well as areas under 40° of north latitude at high altitudes (Muminović et al., 2014). Due to the very pronounced polymorphism, potatoes easily adapt to different environmental conditions. Thanks to this feature, potato is now grown even in poor production conditions and high altitudes, even where the cultivation of other agricultural crops is not possible (Jovović et al., 2015).

Potatoes prefer chilly nights, but nights like that are less and less. The increasing climate variability poses a serious threat to its further cultivation. Climate change has increasingly negative impact on potato crop production leading to large seasonal fluctuations in the amount and quality of yields. Therefore, in the future potato production is gradually moving from the warmer south to colder northern areas and higher mountain regions (Jovović et al., 2016).

The systematic study of the different genotypes in different environmental conditions is of great importance resulting with wider selection of varieties adapted to the specific conditions (Yang,

2002). Yields of potatoes, in addition to the variety, greatly depend on the agro-ecological conditions, but also on nature of interaction between genotype and environment. The reaction of individual varieties to different environmental conditions is conditioned by their genetic predisposition. Knowing very complex relations existing between genotype and environment is of paramount importance when selecting varieties (Jovović et al., 2012).

As different production areas are governed by very different environmental conditions, variety performance is different as well. Therefore, knowledge on the productivity of potato varieties and their reactions to the specific conditions of production regions is one of the most important preconditions for achieving high and stable yields (Momirović et al., 2000). Consequently, the study of the productivity of different potato varieties in different agro-ecological conditions has outstanding practical significance. In this way, there is very reliable information about the cultivated varieties that will allow maximum utilization of genetic resources and thus achievement of high and stable yields (Yang, 2002).

The aim of this study was examination of yield and other indicators of productivity for six Dutch potato varieties in mountain areas of Montenegro.

Materials and methods

The study of the productivity of six promising Dutch potato varieties was carried out during 2013 and 2014 in Kolašin, on the alluvial-deluvial soil at an altitude of 900 m. Varieties with different length of vegetation and skin colour were tested - early varieties: Riviera (1) and Arrow (2); medium early: Tresor (3) and Arnova (4) and medium-late varieties of red epidermis: Kuroda (5) and Rudolph (6).

The experiments were conducted in a completely randomized block design, with 4 replicates and the surface of the single experimental plot of 15 m². Planting of potatoes was carried out on May 20 2013 and 15 May 2014, by hand, at a distance of 70 x 33 cm, with the resulting density of 43300 plants per hectare. The basic tillage, pre-sowing preparation and fertilization were conducted as standard agricultural practices for potato crop. The protection of crops from weeds, pests and disease-causing agents was conducted timely. Potato harvesting was carried out on 15 September in both years.

Table 1. Chemical characteristics of soil in the experimental field

Depth (cm)	pH		CaCO ₃ %	Humus %	Soluble mg/100 g	
	H ₂ O	nKCl			P ₂ O ₅	K ₂ O
40	6,29	5,55	1,1	4,53	2,4	16,0

Table 2. Meteorological condition during the experiment

Year	Month					Average
	May	June	July	August	September	
Air temperature (°C)						
2013.	12,4	15,7	18,1	18,4	12,7	15,5
2014.	11,3	15,3	17,3	17,5	12,8	14,8
Precipitation sum (mm)						
2013.	301,3	125,0	32,9	67,8	118,3	645,3
2014.	96,6	150,3	114,7	69,1	233,2	663,9

Determination of the number of tubers and their mass was performed after complete maturation on average sample of 10 potato plants from a row in each repetition. Total yield per hectare was calculated according to the theoretical categories of crop density.

Soil in experimental plots has favourable water and air properties, high humus content, low phosphorus and calcium and moderate potassium content (table 1). Meteorological data for the experimental period are given in table 2. Statistical analysis was performed by the method of factorial analysis of variance (ANOVA), and the score difference between the mean values using LSD test.

Results and discussion

The measurement results given in Table 3 show that the largest number of tubers in the experiment was found in variety Arnova - 8.4 (7 in 2013 and 9.8 in 2014), while the lowest tuber number was measured in Arrow - 6.8 (6.2 and 7.3), Rudolph - 6.8 (7.2 and 6.3) and Riviera - 6.9 (6.3 and 7.4). In two-year average, variety Arnova had significantly higher number of tubers compared with other varieties. The significant increase in the number of tubers was determined in varieties Kuroda (7.5) and Tresor (7.3) compared to Errow (6.8), Rudolph (6.8) and Riviera (6.9).

Table 3. Results of studies for Dutch varieties

Parameter	Year	Variety						Average
		Riviera	Arrow	Tresor	Arnova	Kuroda	Rudolph	
Average number of tubers	2013.	6,3	6,2	6,6	7,0	7,8	7,2	6,9
	2014.	7,4	7,3	8	9,8	7,1	6,3	7,7
	Average	6,9	6,8	7,3	8,4	7,5	6,8	7,3
Average tuber weight (g)	2013.	82	87	86	96	85	108	90,7
	2014.	84	74	76	81	116	125	92,7
	Average	83,0	80,5	81,0	88,5	100,5	116,5	91,7
Yield (t.ha ⁻¹)	2013.	22,0	23,1	24,5	28,7	28,5	33,4	26,7
	2014.	26,6	23,2	26,0	34,2	35,4	33,9	29,9
	Average	24,3	23,2	25,3	31,5	32,0	33,7	28,3

	Year	lsd 0,05	lsd 0,01
Average number of tubers	2013.	0,463	0,629
	2014.	0,670	0,909
	2013-14.	0,327	0,444
Average tuber weight (g)	2013.	5,921	8,034
	2014.	14,415	19,556
	2013-14.	6,765	9,179
Yield (t.ha ⁻¹)	2013.	1,833	2,487
	2014.	3,956	5,367
	2013-14.	2,021	2,742

The average number of tubers is a very important parameter of productivity on which depends the production per plant of potatoes, and finally the total yield per unit area (Bugarčić et al., 2000). The variability of the number of tubers, except genetic differences between the varieties of potato, largely depends on the interaction between genotype and environmental factors (Nacheva, 2006). In compared studied years, slightly higher average number of tubers was found in 2014 as a result of higher rainfall in June, when potato plant tuberisation is occurring.

Tuber size is an important parameter of productivity and is basically a varietal characteristic, but above all it depends on the level of agricultural practices, soil type and weather conditions during the vegetation period (Jovović et al., 2011). In two-year studies, plots with the highest average tuber weight measured, were planted with varieties Rudolph (116.5 g) and Kuroda (100.5 g). The smallest tubers were measured in varieties Arrow, Tresor and the Riviera (80.5, 81 and 83 g). Analysis of variance of the average tuber weight showed a highly significant increase in tuber

weight of varieties Kuroda and Rudolph as compared to other varieties. Differences in tuber weight between Rudolph and Kuroda are also statistically significant. Increase in number of tubers in the variety Arnova compared with varieties Arrow and Tresor was statistically significant.

Number and size of tubers depend on the number of primary shoots formed on single plant. Bigger number of primary shoots, bigger number of tubers formed, but not their weight too (Butorac and Bolf, 2000). The results of this study are correlated with this statement.

The highest yields were obtained in experiments on plots cultivated with varieties Rudolph - 33.7, Kuroda - 32.0 and Arnova - 31.5 tha^{-1} , while the lowest yielding varieties were Arrow - 23.2, Riviera - 24.3 and Tresor - 25.3 tha^{-1} . Rudolph, Kuroda and Arnova as compared to other varieties yielded a significantly higher tuber yield. Arrow, Riviera and Tresor yields were statistically highly significant. The significant increase in yield was found in the variety Tresor compared with Arrow, as well as between varieties Rudolph and Arnova. As 2014 had a slightly greater quantity and a better distribution of rainfall during the growing season of potato, and lower average air temperatures, it resulted with higher yields in this year (29.9 in 2014 and 26.7 tha^{-1} 2013).

Proper selection of varieties could significantly reduce adverse environmental effects. For these reasons, the study of potato varieties in the mountain area of Montenegro should continue.

Conclusion

Based on said above it can be concluded:

- With proper variety selection, high potato yields can be achieved even in mountainous areas of Montenegro.
- In two-year studies, the highest yielding varieties were Rudolph - 33.7, Kuroda - 32.0 and Arnova - 31.5 tha^{-1} , while the lowest yields were measured in plots planted with varieties Arrow - 23.2, Riviera - 24.3 and Tresor and - 25.3 tha^{-1} .
- The largest number of tubers per plant was determined in cultivar Arnova (8.4), while the lowest tuber number was found in varieties Arrow and Rudolph (6.8). The number of tubers in the variety Arnova compared to other varieties was statistically significant.
- Tubers with the highest average weight were obtained from varieties Rudolph (116.5 g) and Kuroda (100.5 g), while the smallest tubers were measured in the varieties Arrow and Tresor (80.5 and 81.0 g).
- The highest yields are achieved growing medium late and medium early potato varieties in mountainous area of Montenegro.

Literature

- Bugarčić, Ž., Rose Aboth Bugarčić, Đekić, R., Jelena Ivan (2000): Testing productivity of Dutch potato varieties in different agro-ecological conditions of Serbia. *Archive of Agricultural Sciences* 61, 215 (vanr. sv.), 143–150.
- Butorac, J., Bolf, M. (2000): Production of potatoes, Library "Cooperative enterprise adviser ' Zagreb.
- Jovovic, Z., Micev, B., Velimirovic, A. (2016): Impact of climate change on potato production in Montenegro and options to mitigate the adverse effects. *Acad. J. Environ. Sci.* 4(3): 047-054, West Yorkshire, England.
- Jovović, Z., Dolijanović, Ž., Velimirović, Ana, Poštić, D., Milošević, D. (2015): Examination of some Dutch white flesh potato varieties in mountainous region of Montenegro. VI

International Symposium „Agrosym 2015“, Jahorina, October 15-18, 2015, Bosnia and Herzegovina, Book of abstracts, 681-684.

Jovović, Z., Dolijanović, Ž., Kovačević, D., Velimirović, Ana, Biberdžić, M. (2012): The productive traits of different potato genotypes in mountainous region of Montenegro. *Genetika*, Vol. 44, No 2, 389-397, Belgrade.

Jovović, Z., Kovačević, D., Milošević, D. (2011): Effect of weed control on photosynthetic activity and size of biological potato production. XVI conference on biotechnology. Proceedings, 391-396, Čačak.

Momirović, N., Mišović, M., Bročić, Z. (2000): Modern technology of growing multi-purpose potato. *Journal of Scientific agricultural research*. Vol. 61, No 215, 45–70, Belgrade.

Muminović, Š., Karić, Lutvija, Jovović, Z., Žurovec, Jasminka (2014): Potato. Monograph, University of Sarajevo, Faculty of Agriculture Sarajevo.

Nacheva, E. (2006): Testing of yield components in the selected material of potatoes. *Plant breeding and Seed production*, Vol. 12, No. 3-4, pp 9-13, Belgrade.

Yang, C. (2002): Analysis of genotype and environment (GxA) interaction in grain yield and leaf blast reaction of rice varieties through multi-location trials. Dissertation, Kangwon National University. Korea, pp. 34-50.

EFFECTS OF DIFFERENT TYPES OF CYTOPLASM ON PLANT HEIGHT OF MAIZE INBRED LINES

Snežana V. JOVANOVIĆ^{1*}, Marijenka TABAKOVIĆ¹, Goran TODOROVIĆ¹, Jasna KOJIĆ¹, Ratibor ŠTRBANOVIĆ², Rade STANISAVLJEVIĆ², Svetlana TURUDIJA ŽIVANOVIĆ³

^{1*} Maize Research Institute, Zemun Polje, Belgrade, Serbia

² Institute for Plant Protection and Environment, Belgrade, Serbia

³ Institute for Medicinal Plant Research, Dr Josif Pančić, Belgrade, Serbia

*Corresponding author: jsnezana@mrizp.rs

Abstract

The aim of the study was to determine effects of both, different types of cytoplasm (*cms-C*, *cms-S* and fertile) and environmental factors, on the plant height of 12 maize inbred lines. The trial with inbred lines was set up in two locations (Zemun Polje - Selection field and Zemun Polje - Školsko dobro) in 2008 and 2009. Very significant differences in the plant height among inbred lines in dependence on the type of cytoplasm and the location were established by the analysis of variance. The average plant height varied from 161.8cm (L₁₁) to 220.5cm (L₁). In relation to the type of cytoplasm (*cms-C*, *cms-S* and fertile), the average values of the plant height very significantly varied ($P \leq 1\%$). The plant height in inbred lines with fertile cytoplasm was very significantly higher ($Lsd_{0,01}$) (187.6cm) than in inbred lines with sterile *cms-C* (181.1cm) and *cms-S* (180.2cm) types of cytoplasm. Varying of average values of the plant height was very significant ($P \leq 1\%$) in both years of investigation and locations. In 2008, the average plant height of inbred lines (173.98cm) was significantly lower than the average values recorded in 2009 (191.94cm). Very significantly higher values of the plant height were determined in the first location, Selection field (189.25cm) than in the second location, Školsko dobro (176.67cm).

Key words: *Cytoplasmic male sterility, inbred lines, plant height*

Introduction

Maize hybrids are the product of the cross between inbred lines derived in the process of selection by controlled self-pollination of selected genotypes until homogeneity is reached. In the hybrid maize seed production it is necessary to perform detasseling on the female component in order to avoid self-pollination and reduction in heterosis of F₁ generation hybrids.

It is necessary that complete hybridisation between parental components is achieved otherwise heterosis will not be expressed in the F₁ generation. If complete hybridisation is not achieved self-pollinated female component will occur in produced seed and heterosis will not be fully used, while total yield per area unit will be reduced.

In the production of hybrid maize seed, it very often happens that complete hybridisation between parental components cannot be achieved during detasseling even by the best producers. In order to achieve complete hybridisation it is necessary to remove all tassels in female component rows prior to pollen release. This job requires a great number of workers who should be engaged in a relatively short period of time (10-30 days). In addition to these workers, it is necessary to provide appropriate control and super control of quality of the job done, which means engagement of a large number of skilled workers.

Mechanical topping in the production of hybrid maize seed has been imposing from the beginning of this production. Experiments with mechanical topping had been performed by numerous researches (Dungan and Wudworth, 1939; Borgeson, 1943; Kiesslbach, 1945; Bauman, 1959; Hunter *et al.*, 1973 and many others), while results of their studies were summarised by Huey (1971) and Trifunović (1975). Huey (1971) stated that mechanical tappers were not usable under poor weather conditions, and that they did not solve the problem of detasseling on tillers and under developed plants, while leaf loss could not be lower than 2-3 even with the most attentive operation.

The possibility of successful solving problem of detasseling in the hybrid maize seed production occurred when cytoplasmic male sterility in maize was discovered. The use of male sterile versions of the female component thoroughly eliminates the need to perform detasseling, reduces the number of workers necessary for control, effectively improves production quality and significantly reduces costs and accompanying risks, and ultimately, in this way, the seed production becomes very attractive for producers.

The first description of male sterility was provided by Rhoades (1931). Further researches showed that cytoplasmic factors were responsible for sterility.

Cytoplasmic male sterile plants of the female component do not consume nutrients and energy to form and shed pollen, but to form the grain. Fertile pollen is a great recipient of mineral nitrogen, much more than any other part of the plant. It was estimated that sterile plants may save approximately 10-30 kg ha⁻¹ of nitrogen, which is, instead of being used to form pollen, directed into female reproductive organs, thus resulting in the grain yield increase.

Kaesler *et al.* (2003) considers cytoplasmic male sterility (*cms*) a trait interesting for the maize seed industry, because it leads to lower costs of the hybrid seed production by eliminating the labour-intensive mechanical emasculation of parental lines.

In recent years, many hybrid seeds based on male sterile inbred lines have been produced with major *cms* types, *cms*-C and *cms*-S, replacing *cms*-T, which is susceptible to maize leaf pathogens.

The main goal in the commercial maize production is the highest possible grain yield, along with other favourable agronomic traits. Increasingly strong competition in the market of maize seed requires studies on the effect of the type of cytoplasm and its interaction with a genotype on yield and some morphological traits for the purpose of the production.

Material and Methods

Material and methods in performing field trials

Total of 12 maize inbred lines with three different types of cytoplasm was observed: 1) inbreds with the *cms*-C type, 2) inbreds with the *cms*-s type and 3) inbreds with fertile cytoplasm.

Two trials were set up in two locations (Zemun Polje - Selection field and Zemun Polje - Školsko dobro) in 2008 and 2009. The tree-replication trials were set up according to randomised block design. Each plot within the replication consisted of 4 rows. Fertile versions of inbred lines were sown in two border rows and these inbreds had a role of a pollinator for their sterile counterparts. Each row consisted of 12 hills with 4 seeds each. The within-row hill distance amounted to 40 cm, while the inter-row distance amounted to 70 cm. The elementary plot size was 5.6m².

The trial was set up under rainfed conditions. Cropping practices common for maize were applied during the growing season.

Thinning to two plants per hill was done in the 5-leaf stage. In order to avoid the effect of border plants, only plants from 10 inner hills were used in the analysis of agronomic traits.

The 12 observed inbred lines encompass the majority of maize germplasm that is used in the seed production of the Maize Research Institute. The comparison of probable pollen restoration into two observed *cms* types can point out to more suitable *cms* type for the seed production under conditions of our country.

Immediately prior to harvest, a total number of both, plants and lodged and broken plants, was great in all replications. Broken plants were all those plants that were broken below the upper-ear bearing node, while lodged plants were those in which the angle between the stalk and the ground was less than 45°.

Harvest was done at full ripeness.

Methods of experimental data processing

Statistical-biometrical data processing is based on means per replication. Differences among analysed maize inbred lines with various sources of cytoplasm (C, S and fertile), in two locations and during two years as well as their interactions were determined by the analysis of variance for the factorial trial set up according to the randomised block design, as well as by the LSD test at the probability levels of 5% and 1% (Hadživuković 1991). In order to draw objective conclusions on effects of observed factors on tested traits of maize inbred lines and the possibility to apply parametric tests (ANOVA and LSD-test), homogeneity of variance was tested.

Results and Discussion

The average plant height of inbred lines ranged from 161.8cm (L_{11}) to 220.5cm (L_1) (Table 1). In dependence on the type of cytoplasm (*cms*-C, *cms*-S and fertile) these values very significantly ($P \leq 1\%$) varied. Inbred lines with fertile cytoplasm were on the average very significantly ($Lsd_{0,01}$) higher (187.6cm) than inbreds with sterile *cms*-C type (181.1cm) and *cms*-S type (180.2cm). Variation of average plant heights of all inbred lines was very significant ($P \leq 1\%$) in both years of investigations and both locations. The average plant height (173.98cm) was very significantly lower in 2008 than in 2009 (191.94cm). Furthermore, a very significantly greater plant height was obtained in the first location, Selection field (189.25cm) than in the second location, Školsko dobro (176.67cm), (Table 1).

Table 1. Average plant heights over inbred lines, years, type of cytoplasm and locations

Year (G)	Location (L)	Cytoplasm (C)	Inbred lines (I)												LSD test	
			1	2	3	4	5	6	7	8	9	10	11	12	5%	1%
G ₁	L ₁	C ₁	219.6	182.6	188.6	190.3	184.7	163.1	162.6	164.9	182.0	170.0	149.2	176.6	14.833	20.161
		C ₂	224.5	176.5	191.3	188.7	200.0	178.5	163.9	172.7	197.4	166.2	145.4	167.2		
		C ₃	231.1	198.5	194.7	201.6	196.7	182.1	173.0	180.7	209.2	181.8	165.9	195.8		
	L ₂	C ₁	215.2	158.5	154.3	171.7	177.3	154.2	146.9	156.2	175.9	155.6	144.1	174.2		
		C ₂	202.1	156.2	153.6	170.9	168.1	155.8	140.2	147.4	182.2	155.5	146.5	167.2		
		C ₃	212.5	164.3	151.2	177.9	172.2	161.1	145.6	152.2	213.9	153.2	156.3	173.2		
G ₂	L ₁	C ₁	227.7	199.4	194.4	197.2	207.4	190.4	177.7	180.0	212.2	191.5	168.7	192.6		
		C ₂	221.9	191.7	193.3	199.8	196.6	185.6	178.7	180.0	171.7	187.5	173.4	186.2		
		C ₃	232.7	204.0	206.6	207.0	205.0	194.4	180.1	173.5	180.1	183.6	179.2	196.2		
	L ₂	C ₁	222.2	189.2	193.9	206.2	203.7	149.7	167.5	176.5	197.4	183.1	162.1	182.4		
		C ₂	211.6	177.8	181.8	197.7	190.0	181.5	166.3	176.0	207.8	187.6	177.0	196.6		
		C ₃	225.2	189.7	185.9	214.9	203.8	194.1	168.6	178.0	214.7	185.2	173.5	194.7		
Average for years			220.5	182.4	182.5	193.7	192.1	174.2	164.3	169.8	195.6	175.1	161.8	183.6	3.22	4.25
Average for cytoplasm			C ₁			181.1	C ₂			180.2	C ₃			187.6	1.61	2.13
F test																
Mean for years			G ₁			173.98	G ₂			191.94**	** P _≤ 1%					
Mean for locations			L ₁			189.25**	L ₂			176.67						

C₁ -cms-C cytoplasm
 C₂ -cms-S cytoplasm
 C₃ -fertile (N) cytoplasm
 * ≤0,05
 **≤ 0,01

If obtained values are compared with ones achieved by Sečanski (1999), it can be concluded that the heights were approximately equal ranging from 169 cm to 185 cm.

The plant height does not depend only on genetic background of the trait, but also on many environmental factors and cropping practices (sowing density, soil type, presence of diseases and pest, meteorological conditions...).

According to two-year studies Todorović (1995), stated that the plant height was greater in observed hybrids than in observed inbreds, ranging from 194.30 cm to 253.50 cm vs. 165.60 cm to 189.50 cm.

Similar results were obtained in the study carried out by Radanović *et al.* (2015), which means that heterosis for this trait was very pronounced.

According to everything stated it can be concluded that the plant height is a very important trait that indirectly affects yield and is related to the duration of the growing season.

Conclusion

Based on two year studies of maize inbred lines with different types of cytoplasm the following conclusions may be drawn:

1. An inbred line, type of cytoplasm, year and location significantly affect the plant height.
2. The highest plant height was recorded in the inbred line L₁ (220.5 cm).
3. The lowest plant height was recorded in the inbred line L₁₁ (161.8 cm).
4. The highest, i.e. lowest average plant height was detected in inbreds with fertile cytoplasm (187.6 cm), i.e. cytoplasm S type (180.2 cm), respectively.
5. The average plant height was significantly lower in the first year (173.98 cm) than in the second year (191.94 cm).
6. The average plant height was higher in the first location (189.25 cm) than in the second location (176.67 cm).

References

- Bauman, L. F. (1959). Progress report on genetic control of male sterility. Proc of 6th Ann. Hybrid corn Industry-Res. Conf., pp. 13-18.
- Borgeson, C., (1943). Methods of detasseling and yield of hybrid seed corn. Jour. Amer. Soc. Agron., 35: 919-922.
- Dungan, G. H. and Woodworth, C. M. (1939). Loss resulting from pulling leaves with tassels in detasseling corn. Ag J., 31: 872-875.
- Hadživuković, S. (1991). The application of statistical methods in agricultural and biological research. Second edition. Faculty of Agriculture, Novi Sad.
- Huey, J. R. (1971). Experiences and results of mechanical topping versus detasseling in 1971. Proc. of 26th Corn. Res. Conf. pp. 144-147. Amer. Seed Trade Assoc.
- Hunter, R. B., Mortimore, C. G., and Kannenberg, L. W. (1973). Inbred maize performance following tassel and leaf removal. Agronomy Journal 65: 471-472.
- Kaesar, O., Weingartner, U., Camp, K.-H., Chowchong, S., Stamp, P. (2003). Impact of different cms types on grain yield of dent x flint hybrids of maize (*Zea mays* L.). Maydica 48: 15-20.
- Kiesselbach, T. A. (1945). The detasseling hazard of hybrid seed corn production. Jour. Amer. Soc. Agron. 37: 806-811.
- Radanović S., Živanović, T., Sečanski, M., S. Jovanović, S., Prodanović, S., Šurlan Momirović, G. (2015). The genetic basis of inheritance of plant height in maize. Journal of Agricultural Sciences. Vol. 60, No.2, str. 97-107.

- Rhoades, M. M., (1931). The cytoplasmic inheritance of male sterility in *Zea mays*. *J. Genet.* 27: 71-93.
- Sečanski M. (1999). Combining abilities of inbred lines for dry matter yield and grain yield of maize hybrids (*Zea mays* L.), Master degree. University of Belgrade, Faculty of Agriculture.
- Todorović G. (1995). Genetic effect of heterosis in diallel maize (*Zea mays* L.) hybrids of F1 generation, Master degree. University of Belgrade, Faculty of Agriculture.
- Trifunović, V. (1975). Study of pollen sterility of mother lines of maize with regard to obtaining hybrid seeds. *Archive for Agricultural Sciences* 28 (104): 59-107.

SOME EARLINESS ENHANCING METHODS IN SWEET CORN PRODUCTION

Ferenc OROSZ

Sapientia University, Department of Horticulture, 540485 Targu Mureş, Şoseaua Sighişoarei 1C, Romania
(Corresponding author: oroszferenc67@gmail.com)

Abstract

Aim of experiment, set up in 2014, was to study evolution of sweet corn growing period with application of some technological elements such as: propagation time, propagation method, floating row cover. The chosen variety was a conventional sweet corn hybrid, very early ripening 'Spirit'. The following growing technologies were compared: 1. direct sowing of plants with floating row cover, early period 2. direct sowing of plants without row cover, early period 3. plants transplantation with floating row cover, earlier period and 4. direct sowing of plants without row cover, normal period (regarded as control). The transplanted plants had shorter growing period by 9 days, compared to direct sowed covered treatment and were 26 days earlier harvested than control. The influence of above mentioned technological elements on some important morphological properties of sweet corn ears regarding: husked and unhusked ear weight, ear length, length of seeds and ear diameter was studied.

Key words: *earliness, sweet corn, transplantation, fleece covering.*

Introduction

Currently, Hungary is not considered as an influential country of the market considering the majority of the vegetables. The only exception is the sweet corn. Although the yield fluctuated, the growing area have grown continuously, in 2002 we gone before French and Hungary became the European leader in sweet corn growing. The impulsive force of great growth, was the canning and freezing industry. Based on its present growing area, the sweet corn is the vegetable which is grown on the greatest area in Hungary and after the sudden and sharp decline in 2003 this plant returned in a rise after 2006. According to the Hungarian Interprofessional Organization for Fruit and Vegetables and Product Board, with a growing area of over 30,000 hectares Hungary is presently the first in the EU. In the case of the former, however, the increase in fresh consumption partly counterbalanced the rate of decrease. In order to promote fresh consumption, as well as to maintain and increase the sweet corn exports, it is necessary to promote investigations able to ensure a further increase in the growing area and yields of sweet corn with the help of the experiences. Of the production technology elements, a number of researchers studied or are currently studying the sowing time of sweet corn. Early sowing is also recommended by Aldrich (1970) for the reason that the roots will penetrate deeper this way, from where they can get water even in periods of drought. The more intensive vegetative growth also takes place during the period of shorter daytime and this way the plants will be smaller and will be less prone to lodge. Several techniques are known in the art for the purpose of early fresh market shipments: seedling growing or direct sowing with temporary plant cover (Kurucz 1998; Hodossi 2004). Direct sowed sweet corn under fleece cover showed earlier ripening and gave better yields in the experiments of Kassel (1990). The plots under fleece cover reached harvest maturity 12 days earlier as compared to the plots with no cover. Besides, a greater number of missing plants was observed in the plots with no cover. As a result of the greater plant number

and the better ear set per plant yields were much higher in the plots with fleece cover. The most widespread method of seedling production is the use of soil blocks (Pereczes, 1999) which can also significantly increase earliness. According to the trials of Kurucz (1998) seedling growing advanced harvest by 2 weeks. According to Hodossi (2004) 10 to 12 day earliness can be achieved by planting seedlings grown in soil blocks and 6 to 8 day earliness by seedlings grown in trays. The measurements of Kassel (1990) revealed that the ears of direct sowed corn plants under floating row cover could be harvested 10 days earlier as compared to the plots planted with seedlings and having no cover. The combined application of seedling growing and floating row cover of plants can advance harvest by three weeks as compared to the traditional technology (Kurucz, 1998).

Materials and methods

The experiment was set up on an area equipped for irrigation at Tg. Mures, Mures County, situated in central part of Romania. Conventional, reliable and sufficiently known among growers sweet corn variety, Spirit, was used as a reference variety in the variety comparison trials of the Central Agricultural Office. Hybrid has short growing period of 85 days and yellow kernels. Average height of plants is 159 cm, average ear height is 37 cm, ear length 19.6 cm and average ear weight is 245 g. The variety was granted official recognitions in 1988 and has been the dominant variety of the early ripening category till now. In the year prior to the experiment the area was under wheat.

The following treatments, each with four replications, were applied during the experiment:

P1 = direct sowing of plants with floating row cover, early period (8th April)

P2 = direct sowing of plants without row cover, early period (8th April)

P3 = plants transplantation with floating row cover, early period (8th April)

P4 = direct sowing of plants without row cover, normal period, regarded as control (25th April).

For the frame structure of the treatments with cover we used \varnothing 4.2 mm zinc coated wire coils. The fleece, 60 cm in width, was stretched over a small tunnel of 40 cm in height and then its edges (25-25 cm, respectively) were covered with soil using a hoe and the its ends were tied to the stakes hammered down. The construction of the frame structure and the setting out of the fleece cover were carried out at the same day as direct seeding and out planting.

For the purpose of seedling growing, the seeds were sown on 16th March 2014, in trays with rigid walls having 3,7x4x5,4 cm size. For growing the seedlings, commercial mix made of white peat 10-20 mm, PG Mix 1 kg/m³ + micro nutrients, bentonite 40 kg/m³, pH 5,5-6,5 was used. The seedlings were planted out at the 3 to 4 leaf phenological stage. At the two propagation times the treatments P1 and P3 were covered with Novagryl floating row cover, having a weight of 19 g/m², (using the small tunnel technique) in order to enhance earliness. The stand was created to contain 60,607 plants per hectare, according to the recommendations of the owner of the variety, at a spacing of 110+40x22 cm in twin rows. Each plot had an area of 6x3,5m (8 parallel rows and 16 seeds sown in each row). Sowing depth was 3 cm. The edge was the respective outer rows of the 4 twin rows of the plot.

In October 2013, 35 t/ha of farmyard manure was worked into the soil with ploughing on area. Nitrogen fertilizer (120 kg/ha) was applied at the 6-7 leaf stage, the form of top dressing. The fertilizer application was worked into the soil with a rotary hoe.

Ears were harvested together with the husks, from the two central twin rows. Twenty ears were selected from each row and the following measurements were carried out:

weight of unhusked and husked ears (g),

total ear length (cm),
length of seeds (mm),
ear diameter (mm).

The statistical analysis of the results was carried out by using the programme *RopStat 1.1*. When the standard deviations were identical the mean values were compared by pairs using the *Tukey-Kramer* test, while in the case of the non identical standard deviations the means were compared using the *Games-Howell* test (Vargha, 2007).

Results and discussion

According to obtained results, harvesting time (measured in days) was the shortest in the treatment P3 and P2, merely 76, respectively 85 days, i.e. the corns became ready for harvest 26, respectively 17 days earlier compared to P4 (control). In case of P1 treatment, harvesting began 12 days earlier compared to P4 (control).

Results of the one of the major characteristics in connection with yield rating, unhusked and husked ear weight, are summarised in Figure 1.

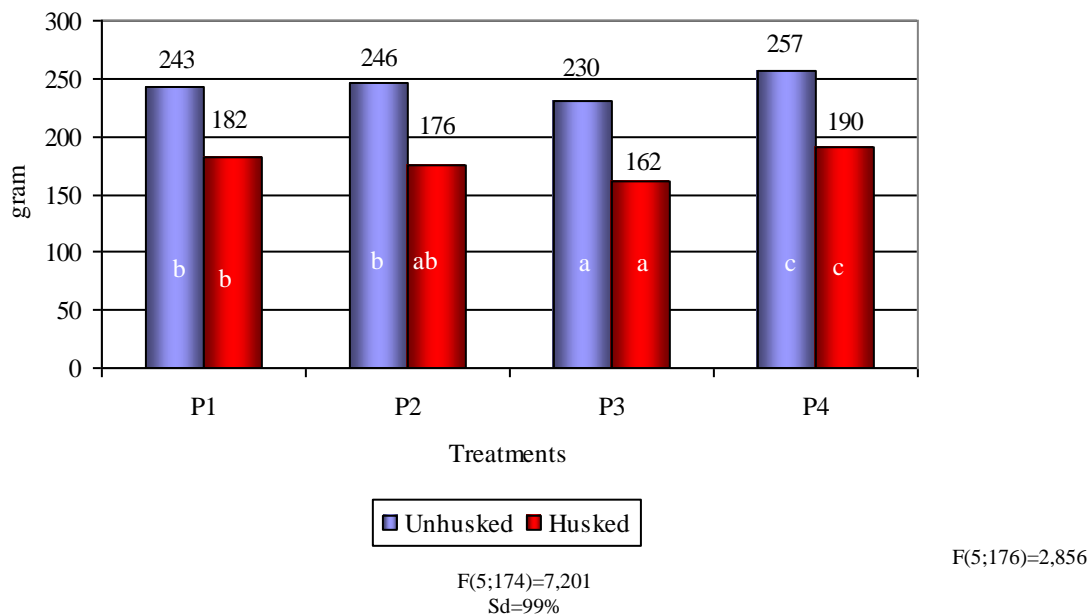
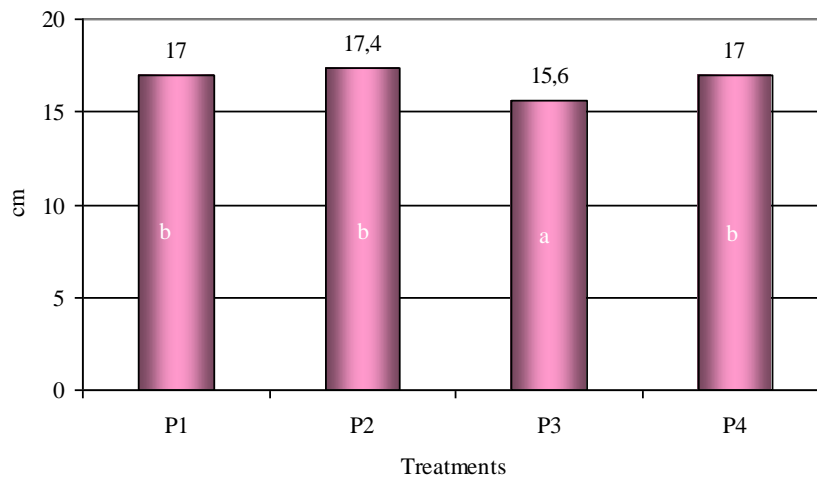

Fig. 1. Unhusked and husked ear weight (g).

Analysing the data measured for unhusked ear yield, it is noticeable that the average weight of the ears of the earlier transplanted, covered treatment P3 was significantly (at $p<0.01$ level) lower as compared to earlier and later sowed, covered and uncovered treatments P1, P2 and P4 (control). Though there was some difference between the plants of the treatments P1 and uncovered, sowed, treatment P2 in unhusked ear weight, statistically this was not significant. Significantly highest value, supported statistically (at $p<0.01$ level), of unhusked ear weight was produced by ears of control treatment (P4). In case of husked ear weight the same tendencies were observed as in case of unhusked ear weight.

The data concerning, an important characteristics for market appeal (total ear length) are contained in Figure 2.



F(5;174)=11,000

Sd=99%

Fig. 2. Total ear length (cm).

The length of the covered, earlier transplanted treatment P3 was significantly (at $p < 0.01$ level) shorter compared to the ear length of all treatments. No statistically demonstrable difference was found between ear lengths of covered, direct sowed P1, uncovered direct sowed P2 and P4 (control) treatments.

Total ear length, average ear length 19.6 cm as measured in the variety comparison trials, had been not achieved by the above mentioned treatments.

Other important characteristics for market appeal (total ear diameter), is presented in Figure 3.

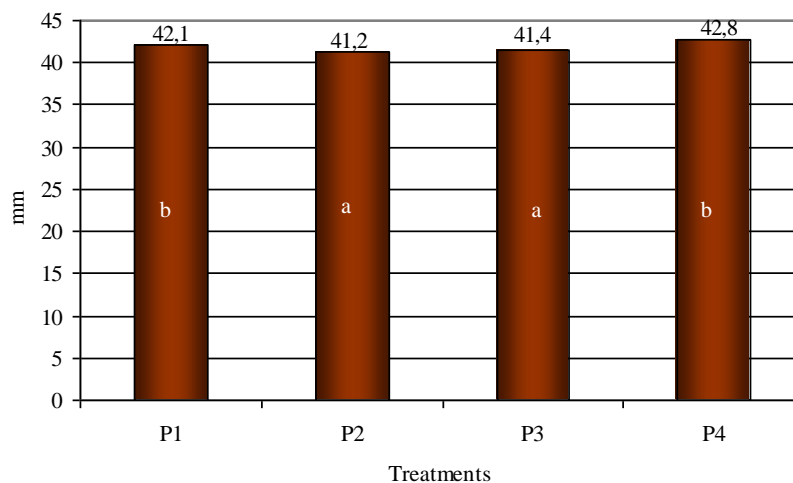

F(5;174)=4,440

Sd=99%

Fig. 3. Total ear diameter (mm).

The measured values were significantly (at $p < 0.01$ level) higher in case of covered treatment P1 and P4 (control) treatment compared to uncovered sowed treatment P2 and covered transplanted treatment P3. The total ear diameter of transplanted, covered treatment P3 and uncovered earlier sowed treatments P2, have had no significantly differences..

Length of seeds is an important characteristic for yield quantity is presented on Figure 4.

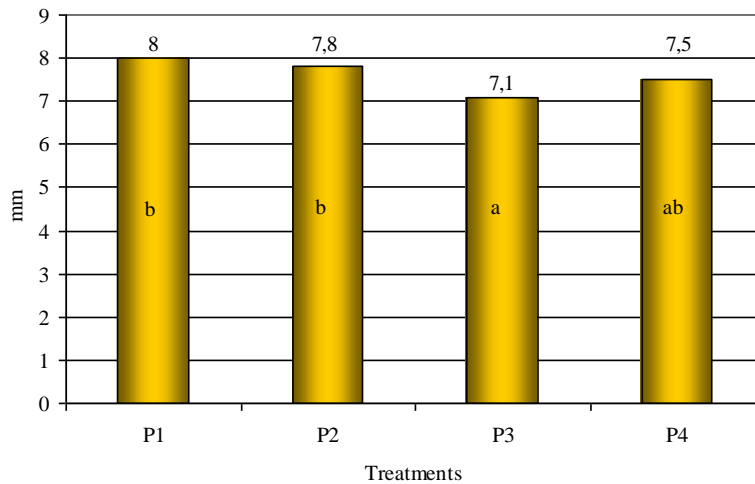

F(3;174)=1,248

Sd=99%

Fig. 4. Length of seeds (mm).

The measured values were significantly (at $p < 0.01$ level) higher in case of covered and uncovered, earlier sowed treatments P1 and P2 compared to covered, earlier transplanted P3 treatment. Length of seeds of transplanted, covered treatment P3 and P4 (control) treatment was not found significantly differences.

Conclusions

Based on the results of the 2013 year experiment, the following conclusions can be made: The growing period was significantly shortened with transplantation of sweet corn plants compared to direct seeded.

Harvest time occurred 26 days earlier in the case of earlier time transplanted and floating row covered (P3) application compared to normal time, direct sowed, uncovered, control (P4) treatment, and 9 days earlier compared to earlier time, direct sowed, covered P1 treatment. At the same time the floating row cover produce 6 days shortening in the growing season between P1 (direct sowing of plants with floating row cover) and P2 (direct sowing of plants with no row cover) treatments.

The fleece covering had favourable effect on studied morphological characteristics of plants that are transplanted and floated with row cover.

In case of direct sowed treatment (P2) the effect of covering had positive effect on unhusked and husked ear weight, length of ears, total diameter of ears, and length of seeds.

References

- Aldrich S. R. (1970): In: Inglett, G. E. (ed.): Corn culture, processing, products. The AVI Publishing Co. Inc., Westport, Connecticut.
- Hodossi S. (2004): Csemegekukorica (Sweet corn). In: Hodossi S.–Kovács A.–Terbe I. (ed.): Zöldségtermesztés szabadföldön (Open field vegetable growing). Mezőgazda Kiadó, Budapest, 340-348.
- Kassel LVG. (1990): Direktaussaat von Zuckermals unter Vlies. Gemüse, 26 (7), 350.

- Kurucz M. (1998): Palántázott és takart csemegekukorica (Planted and covered sweet corn). *Kertészet és szőlészet*, 47 (11), 7.
- Perczes J. (1999): Csemegekukorica. In: Nagymagvú zöldségfélék (Big seeded vegetables). (Ed. Mártonffy B., Rimóczi I.). Mezőgazda Kiadó. Budapest, 50-72.
- Vargha A. (2007): Matematikai statisztika pszichológiai, nyelvészeti és biológiai alkalmazásokkal (Mathematical statistics with psychological, lingvistical and biological applications). Pólya Kiadó. Budapest, 213-237.

APPLICATION OF LIQUID ORGANIC FERTILIZER ON RED CLOVER PRODUCTION ON ACID SOIL

Dalibor TOMIĆ^{1*}, Vladeta STEVOVIĆ¹, Dragan ĐUROVIĆ¹, Đorđe LAZAREVIĆ¹, Nikola BOKAN¹, Jasmina KNEŽEVIĆ²

¹University of Kragujevac, Faculty of Agronomy, Čačak, Serbia

²University of Priština, Faculty of Agriculture, Lešak, Serbia

*Corresponding author: dalibort@kg.ac.rs

Abstract

The aim was to analyze the impact of foliar application of liquid organic fertilizer on the forage and seed yield of red clover (*Trifolium pratense* L.) in conditions of dense sowing on acid soil. The field experiment with varieties of red clover (K-39 – diploid, Amos - tetraploid) and fertilizing treatments (control, Bioplant flora) was set up in Čačak (Serbia) on the alluvium soil type, with acid reaction ($\text{pH}_{\text{H}_2\text{O}}=4.8$). The experiment was designed using a randomized block design with three replications, with the plot size of 5x1m, row spacing of 20 cm and the amount of seed of 18 kg ha⁻¹. The foliar application of fertilizers (Bioplant flora, Plant DOO, Russia at a concentration of 0.4%, with the implementation of 250 l ha⁻¹ of water) was carried out in the first and second growth in the second year of cultivation, once at the beginning of intensive growth and the second time two weeks after that. The first growth was used for forage production and the regrowth for seed production. The foliar application of liquid fertilizer influenced the significant increase in forage yield at tetraploid variety Amos. Irrespective of foliar application of liquid fertilizer, cultivar K-39 had a significantly higher number of inflorescences per stem, number of inflorescences m⁻², number of seeds per inflorescence, fertility of flowers and seed yield than variety Amos. Foliar application of liquid manure has affected a significant increase in the value of yield components, primarily fertility of flowers and seed number per inflorescence in cultivar K-39.

Key words: red clover, Bioplant flora, yield, variety

Introduction

Thanks to the high and stable yield, diverse use, relatively modest requirements for cultivation and good forage quality, red clover (*Trifolium pratense* L.) is an important plant species in the production of forage for livestock feed rich in proteins. In the Republic of Serbia as the most rational proved to be combined production of forage and seeds of red clover (Lugić et al., 1996), where for the production of seeds is used the second growth in the second year and sometime the second growth in the third year. Seed yield of red clover is mainly determined by the genetic base of the cultivar, environmental conditions of the area, time of cut the first growth, presence of insects pollinators as well as the interaction of genotype/environment (Steiner et al., 1995). Proper mineral nutrition, and the content of some macro and micronutrients in plants can also be a limiting factor for achieving high yield of red clover, especially when production takes place on acid soils, where certain macro and micro-elements are heavily accessible to the plants. According to Taylor and Quesenberry (1996) acid soils are characterized by a high prevalence of easily accessible form of aluminium, iron and manganese and reduced content of readily available phosphorus, calcium and molybdenum.

The aim of the research was to assess the impact of foliar application of liquid fertilizer Bioplant flora to forage and hay yield, seed yield and seed yield components of red clover in the second year of growing in one diploid and one tetraploid variety, on an acid soil near Čačak city (Serbia).

Materials and methods

The experiment was set up in 2012 on the estate of veterinary stations in Čačak (43°54'39.06"N, 20°19'10.21"E, 246m above sea level), on the alluvial soil type, acid reaction (pH H₂O 4.8), which contains 3.18% of organic matter, 0% CaCO₃, 22.08 mg P₂O₅, 30.0 mg K₂O 100 g⁻¹ soil. Together with the basic treatment and after the first growing season, the land was fertilized with 300 kg ha⁻¹ of N₁₅P₁₅K₁₅. Factorial experiment was designed using a randomized block design with three replications with plot size of 5m² (5x1m). These cultivars of red clover were chosen for the trial: K-39 – diploid and Amos – tetraploid. Sowing was done in rows of 20 cm width and the amount of seeds of 18 kg ha⁻¹, which is according to Lugić et al. (1996) recommended in combined production. The crop is grown without irrigation. Foliar application of fertilizers (Bioplant flora, Plant DOO, Russia at 0.4%, with the implementation of 250 l ha⁻¹ water) was carried out in the first and second growth in the second year of cultivation, once at the beginning of intensive growth and the second time after two weeks.

The analyses were carried out in the second year (2013). The first growth was cutting in the bud stage. Green forage yield was determined by measuring the total mass of the plots immediately after cutting and converted to forage yield in t ha⁻¹. After drying the metered sample to room temperature, the hay yield was recalculated (t ha⁻¹). The second growth was used for the production of seeds. In the field were determined following yield components: number of stems m⁻² and number of inflorescences m⁻² (counting the area of 0.2 m² per elementary plot), number of inflorescences per stem (counting on ten randomly selected strips from elementary plot). In the laboratory is determined by: flower number per inflorescence and seed number per inflorescence (on a sample of ten inflorescences per elementary plot) and thousand grains weight (based on weight 5x100 seeds separated from the same sample as the pods were). Fertility of the flowers was recalculated on the base of number of flowers and the number of seeds per inflorescence. The actual seed yield was determined on the basis of yield components (number of inflorescences per unit area, number of seeds per inflorescence, thousand grains weight) and recalculated on the seed yield in kg ha⁻¹.

The mean annual air temperature in 2013 was 13.0°C, and the amount of annual rainfall 582.7mm. The average annual air temperature for the multi-year period (1992-2002) was 11.97°C, and the average sum of annual rainfall 680.3mm.

The results were analyzed using analysis of variance of two-factor experiment (ANOVA) using SPSS 4.5 software. The significance of differences of the mean values of the varieties, foliar nutritions as well as interaction middles were tested with LSD test.

Results and discussion

The most of the European and Japanese manufacturers stand out the advantage of tetraploid varieties of red clover for forage production, which are characterized by higher and more stable yield as compared to the diploid (Tomaszewski, 1989; Jonsson, 1985). However, the obstacles to the wider introduction of tetraploid red clover cultivars into the production are a low yield and high cost of the seed (Vasiljević et al., 1999). In our experiment, in the first cutting in the second year of growing, regardless of foliar nutrition, the diploid cultivar K-39 had a significantly greater height of stem in relation to the tetraploid variety Amos (Table 1.). However, in terms of green forage yield, hay yield and content of hay compared to the green forage yield, the cultivars

had not any significant differences between themselves. Due to a very expressed drought in 2012 the crop was badly prepared, so in the first cutting in 2013 a very low forage yield was achieved. A proper mineral nutrition of red clover, especially on acid soils, is one of the preconditions for the realization of a better yield potential. Foliar application of liquid fertilizer, has positively influenced the increase in the yield of green forage only in varieties of Amos, which usually has a higher potential for yield of forage.

In the second growth in the second year of cultivation, in our experiment, in terms of the number of stems m^{-2} , there were not any significant differences between the cultivars of red clover, as well as between the treatments (Table 2.). Irrespective of foliar application of liquid fertilizer, a significantly higher number of inflorescences per stem and number of inflorescences m^{-2} , had the diploid variety K-39 as compared to the tetraploid variety Amos.

Wilczek and Cwintal (2008) indicate that foliar fertilization of red clover with microelements can have a positive effect on the components of yield, and seed yield. The foliar fertilization in our experiment, had not any significant effect on the increase of inflorescences number per stem and inflorescences number m^{-2} in any of the varieties.

Table 1. Plant height, forage yield, the share of hay in relation to the total weight of forage and hay yield of red clover cultivars (K-39, Amos) as affected by foliar treatment (control – Ø, Bioplant).

		Plant height (cm)	Forage yield (kg ha ⁻¹)	Share of hay (%)	Hay yield (kg ha ⁻¹)
Cultivar	K-39	72,9 a	6,94	22,53	1,569
	Amos	55,5 b	6,38	20,72	1,301
Fertilization	Ø	64,2	5,63 b	22,84	1,292
	Bioplant	64,3	7,68 a	20,42	1,578
K-39	Ø	72,9	6,33 ab	23,79	1,503
	Bioplant	72,9	7,55 ab	21,27	1,634
Amos	Ø	55,5	4,94 b	21,88	1,08
	Bioplant	55,6	7,82 a	19,57	1,527

The values denoted with different small letters within columns for genotypes, foliar treatment and interaction are significantly different ($p < 0,05$) in accordance with the LSD test.

Table 2. Seed yield components: stems number m^{-2} – SNM, inflorescence number per stem – INS, inflorescence number m^{-2} – INM, flower number per inflorescence – FNI, seed number per inflorescence – SNI, fertility – F (%), thousand seed weight – TSW (g) and seed yield – SY (kg ha⁻¹) in red clover cultivars (K-39, Amos) as affected by foliar treatment (control – Ø, Bioplant).

		SNM	INS	INM	FNI	SNI	F	TSW	SY
Cultivars	K-39	258	4,10 a	1111 a	83	35,5a	43,5 a	1,696 b	672 a
	Amos	254	2,23 b	562 b	80,9	11,7b	14,4 b	2,006 a	198 b
Foliar treatment	Ø	282	2,83	769	82,6	20	24,4	1,962	315
	Bioplant	230	3,5	876	81,3	27,2	33,5	1,777	555
K-39	Ø	297	3,57 ab	1041	84,5	26b	31,7 b	1,807 ab	475 b
	Bioplant	219	4,63 a	1181	81,5	45 a	55,4 a	1,586 b	870 a
Amos	Ø	267	2,10 b	552	80,7	14 c	17,2 bc	2,045 a	156 b
	Bioplant	242	2,37 b	571	81,1	9,4 c	11,6 c	1,967a	241 b

The values denoted with different small letters within columns for genotypes, foliar treatment and interaction are significantly different ($p < 0,05$) in accordance with the LSD test.

In terms of the number of flowers per inflorescence, there also were not any significant differences between the varieties of red clover, or between the treatments. According to Julien (1956) and Miladinović (1978) between the genotypes of red clover there were large differences in the number of flowers per inflorescence.

Regardless of foliar nutrition, a significantly higher number of seeds per inflorescence was recorded in cultivar K-39 in relation to the variety Amos. This is due to significantly higher fertility of flowers in the variety K-39, which was expected, given that it is a diploid variety, as compared to Amos, the tetraploid one. Reduced fertility of tetraploid cultivars of red clover causes a composite complex of factors: genetic, cytogenetic, embryogenic, flower morphology, climate and other factors. The most common causes of low seed yield are: reduce of number of productive stems, inflorescence number, and the number of flowers, as well as unfavorable conditions for fertilization by insects pollinators (Vasiljević et al., 1999). Tube of coronal sheet (corolla) in tetraploid red clover is longer, which makes it difficult to pollinate with honey bees (Nikovitz, 1985). That is why tetraploid flowers are usually pollinated through large bumble bees (Alekseyev, 1981). Wilczek and Cwintal (2008) reported that the number of seeds per inflorescence and fertility of flowers are the most important components of seed yield of red clover. Jevtić et al. (2007) i Wilczek and Cwintal (2008) indicate that a major impact on fertility of the flowers and the number of flowers per inflorescence has the presence of insects pollinators. Wilczek and Cwintal (2008) state that in different years fertility of red clover flowers ranged from 51.2 to 69.8% and that a large amount of rainfall during flowering can significantly reduce fertility and harvested seed yield in relation to the potential seed yield.

Foliar application of liquid fertilizer influenced the significant increase of the number of seeds per inflorescence and fertility of flowers only in the variety K-39. The availability of trace elements is one of the factors that can greatly affect the seed yield of clovers (Stoltz and Wallenhammar, 2014). Foliar fertilization is an efficient way to supply plant with micronutrients, especially when their adoption through the root system is limited due to the drought and low soil pH (Mortvedt, 1994; Donald et al., 1998; Dordas, 2006). Since the flowers and seeds of perennial legumes don't transpire, they are not able to supply themselves with mineral nutrients directly from the soil (Wilczek and Cwintal, 2011). This is a possible reason why in many studies there is a positive effect of foliar use of certain elements, just on the development of flowers and fruit. The reason for better reaction of the cultivar K-39 on the foliar nutrition is generally higher fertility of flowers (29.1%) and higher number of seeds per inflorescence (23.8%) as compared to the variety Amos, so the effect of foliar nutrition in this cultivar had a better expression.

Irrespective of foliar treatment, a significantly higher thousand grain weight had the cultivar Amos (2.0 g) as compared to the cultivar K-39 (1.7 g). The foliar application of liquid organic fertilizer did not significantly influence on the thousand grain weight in any of the cultivars.

Regardless of foliar nutrition, diploid cultivar K-39 had a significantly higher seed yield (672 kg ha^{-1}) in relation to the tetraploid cultivar Amos (198 kg ha^{-1}) as a result of primarily higher fertility of flowers and higher inflorescences number per unit area, and a higher number of inflorescences per stem. Obtained results are in accordance with the results (Vojin, 2007) according to which the diploid genotypes of red clover gave a significantly higher seed yield as compared to the tetraploid varieties. According to Montardo et al. (2003) and Herrman et al. (2006), the seed yield is in a positive correlation with the number of inflorescences per plant of red clover. The basis for increasing the seed yield potential according to the same authors is the increase of the number of inflorescence per plant. Herrman et al. (2006) have found a positive correlation between seed yield per plant and seeds number per plant, seed yield per plant and flower fertility, as well as the seeds number per inflorescence and fertility of flowers.

Foliar application of liquid organic fertilizer influenced the significant increase in actual seed yield only in cultivar K-39. It can be associated with better supply of plant with mineral nutrients, given that the soil with acid reaction and a positive effect of biostimulators, which the fertilizer contains on growth, elongation of stem and inflorescence development, as well as greater

fertility of the flowers of this variety, which normally has a higher potential for seed yield. Numerous other studies also point out the importance and role of foliar application of fertilizers on productivity of various species of plants (Nyomora et al., 1997; Perica et al., 2001; Asad et al., 2003; Donald et al., 1998).

Conclusion

Irrespective of foliar application of liquid organic fertilizer, cultivar K-39 had a significantly greater height of the stem, greater number of inflorescences per stem, number of inflorescences m⁻², number of seeds per inflorescence and significantly higher fertility of flowers than variety Amos. All this has resulted in significantly higher seed yield in cultivar K-39, regardless of foliar nutrition.

Foliar application of liquid organic fertilizer in the first growth in the second year of cultivation caused the significant increase in the forage yield in the tetraploid variety Amos. Also, foliar application of liquid fertilizer Bioplant flora in the second growth, influenced the significant increase in the value of yield components, primarily fertility of flowers and seed number per inflorescence in cultivar K-39, which normally has a greater potential for seed yield. This is the result of positive action of biostimulants and nutrients which the fertilizer contains on the growth and development of vegetative and generative organs.

Acknowledgement

This work is part of the research project Ref. No. TR-31016, funded by the Ministry of Education, Science and Technological Development, Republic of Serbia.

References

- Alekseev A. (1981). Pollination of tetraploid clover, Pchelovodstvo, Moskva, 6, 19-20.
- Asad A., Blamey C.P.F., Edwards G.D. (2003). Effects of boron foliar applications on vegetative and reproductive growth of sun-flower, Anal. Bot., 92, 565–570.
- Donald D.H., Gwathmey C.O., Carl E.S. (1998). Foliar feeding of cotton: Evaluating potassium sources, potassium solution buffering and boron, Agronomy Journal, 90, 740-746.
- Dordas C. (2006). Foliar boron application improves seed set, seed yield, and seed quality of alfalfa, Agronomy Journal, 98, 907-913.
- Herrmann D., Boller B., Studer B., Widmer F., Kolliker R. (2006). QTL analysis of seed yield components in red clover (*Trifolium pratense* L.), Theoretical and applied genetics, 112(3): 536-545.
- Jevtić G., Radović J., Lugić Z., Sokolović D., Vasić T. (2007). Uticaj medonosne pčele (*Aphis mellifera* L.) i šećernog sirupa na prinos semena lucerke i crvene deteline [The effect of the honey bee (*Apis mellifera* L.) and sugar syrup on seed yield of alfalfa and red clover], Zbornik radova, IX Simpozijum o krmnom bilju Republike Srbije, 44(1), 99-106.
- Jonsson H.A. (1985). Red clover (*Trifolium pratense*) Sara, Agri Hortique Genetica, 43, 43-51.
- Julen G. (1956). Practical aspects of tetraploid clover. Proceedings of the 7th international grasslands kongress, 471-478.
- Lugić Z., Krstić O., Tomić Z., Radović J. (1996). Uticaj načina setve na produkciju suve mase i semena crvene deteline (*Trifolium pratense* L.) [Influence of sowing on dry mass and seeds production of red clover (*Trifolium pratense* L.)], Zbornik radova Instituta za ratarstvo i povrtarstvo, 26, 259-264.

- Miladinović M. (1978). Uticaj načina setve na prinos semena i vegetativne mase crvene deteline [Influence of sowing on the seed yield and vegetative mass of red clover], *Savremena poljoprivreda*, 7(8): 69-74.
- Montardo P.D., Agnol D.M., Crusius F.A., Paim R.N. (2003). Path Analysis for Seed Production in Red Clover (*Trifolium pratense*), *Revista Brasileira de Zootecnia*, 32: 1076-1082.
- Mortvedt J.J. (1994). Boron diet essential for crops, *Farm Chemicals*, February, pp. 2.
- Nikovitz A. (1985). Bee pasture value of red clover varieties, *Meheszeti*, 33(1), 7.
- Nyomora A.M.S., Brown H.P., Freeman M. (1997). Fall foliar-applied boron increases tissue boron concentration and nut set of almonds, *J. Am. Soc. Hortic. Sci.*, 122, 405–409.
- Perica S., Brown H.P., Connell H.J., Nyomora S.M.A., Dordas C., Hu H., Stangoulis C.J. (2001). Foliar boron application improves flower fertility and fruit set of olive, *Hort. Science*, 36, 714–716.
- SPSS 4.5 Inc. (1993). *STATISTICA for Windows (Computer program manual)*. Tulsa. OK
- Steiner J.J., Leffel J.A., Gingrich G., Aldrich-Markham S. (1995). Red clover seed production: III Effect of herbage removal time under varied environments. *Crop Science*, 35, 1667-1675.
- Stoltz E., Wallenhammar A. (2014). Influence of boron on seed yield and seed quality of organic white clover (*Trifolium repens* L.), *Grass and Forage Science*, doi: 10.1111/gfs.12141.
- Taylor N.L., Quesberry K.H. (1996). Red clover Science. *Curent Plant Sciences and Biology in Agriculture*, 28, 44-57.
- Tomaszewski Z. (1989). Comparison of seed production in diploid and tetraploid varieties and lines of red clover (*Trifolium pratense* L.), *Biuletyn Instytutu Hodowli i Aklimatyzacji Roslin*, 169, 3-11.
- Vasiljević S., Šurlan-Momirović G., Mihajlović V., Pataki I., Karagić Đ., Trifunović T. (1999). Selekcija crvene deteline (*Trifolium pratense* L.) na viši prinos semena [Selection of red clover (*Trifolium pratense* L.) at a higher seed yield], *Selekcija i semenarstvo [Plant breeding and seed production]*, 6(3-4), 39-43.
- Vojin S. (2007). Uticaj načina setve i bakterizacije na prinos semena crvene deteline [Influence of sowing and inoculation on seed yield of red clover], *Zbornik radova, IX Simpozijum o krmnom bilju Republike Srbije*, 44(1), 223-228.
- Wilczek M., Ćwintal M. (2008). Effect of the methods of additional feeding with microelements (B,Mo) on the yield structure and seed yield of red clover, *Electronic Journal of Polish Agricultural Universities*, <http://www.ejpau.media.pl/volume11/issue4/abs-05.html>.
- Wilczek M., Ćwintal M. (2011). Effect of pre-sowing laser stimulation of seeds and feeding with microelements (B, Mo) on yielding of seed tetraploid red clover in four-year use (in Polish). *Acta Agrophysica*, 17(1), 207-217.

COMPARATIVE TESTING OF MAIZE HYBRIDS (ZEA MAYS L.), CULTIVATED FOR GRAIN, UNDER NON-IRRIGATION IN CENTRAL NORTH BULGARIA

Vanya DELIBALTOVA

Department of Crop Science, Faculty of Agronomy, Agricultural University, Plovdiv, Bulgaria

*Corresponding author: vdelibaltova@abv.bg

Abstract

The experimental work was performed in the Central North Bulgaria region – city of Pavlikeni in the period 2012 - 2014. The experiment was performed on carbonate chernozem soil type by means of a block method with four repetitions; experimental field area - 15 m², after the predecessor winter wheat. The following hybrids were tested; P8523, P9606, P9721, P0412 and P1114. The aim of the investigation was to establish the productivity of five maize hybrids for grain, grown under the conditions of central north Bulgaria. All the stages of the established technology for maize growing under non-irrigation conditions were followed. The experimental data was processed according to the method of dispersion analysis. The analysis of the results showed, that the highest values of elements of productivity - length of the cob, number of the row per cob, number of the grains per row, mass of the cob, mass of the grains per cob and mass of 1000 grains were reported in the hybrid P0412 and the lowest in P8523 hybrid. Under the conditions of North Central Bulgaria the highest yield was obtained in P0412 hybrid – 8163 kg/ha, and the lowest one – in P8523 hybrid – 6821 kg/ha. The percentage content of protein in grain was the highest in P1114 hybrid (10.8 %) and that of fats – in P0412 (5.19 %). The highest starch content was established in P8523 hybrid (77.05 %).

Keywords: *maize, elements of productivity, yield of grain, protein, fats, starch.*

Introduction

The production potential of hybrid maize is determined by the environmental factors as well as by the technology of growing (Calvino et al., 2003; Delibaltova, 2014; Niaz et al., 2014).

The agroecological and the climatic conditions in the separate regions of Bulgaria influence the development and productivity of plants (Liu et al., 2012; Stoyanova and Mihova, 2008; Zivkov and Matev, 2005). The right choice of the maize hybrids and the proper regional distribution, as well as their growing by strictly following the agrotechnical practices, are of vital importance for the yield amounts and the quality of the produce obtained (Chen et al., 2013; Dong et al., 2016; Kandil, 2013). That necessitates the constant introduction of new hybrids that are the most suitable and efficient for the separate microregions of Bulgaria (Delibaltova, 2009; Delibaltova and Ivanova, 2009). The aim of the investigation was to establish the productivity of five maize hybrids for grain, grown under the conditions of central north Bulgaria.

Material and methods

Field trials

The experimental work was performed in the Central North Bulgaria region – city of Pavlikeni in the period 2012-2014. The experiment was performed on carbonate chernozem soil type by means of a block method with four repetitions; experimental field area - 15 m², after the

predecessor winter wheat. The following hybrids were tested; P8523, P9606, P9721, P0412 and P1114.

Ploughing-in of the stubble was performed in August after the forecrop was gathered, and deep ploughing at 25 - 28 cm was performed in October; pre-sowing cultivation with harrowing was performed twice in March and April. Fertilization was performed in autumn before deep ploughing, with 8 kg active substance phosphorus and 10 kg active substance potassium and before sowing with 18 kg active substance nitrogen. The sowing was performed in the second decade of April as the seeds were pre-processed against diseases and pests (by Vitavax – 250 ml / 100 kg seeds and by Diafuran 2.5 l / 100 kg seeds respectively), at crop density of 65000, 63000, 63000, 59000 и 59000 plants per ha for - P8523, P9606, P9721, P0412 and P1114 respectively. Herbicide Gardian3000 ml/ ha was applied before sowing and Merlin duo – 1500 ml/ha was applied during vegetation of maize for weed control. All the stages of the established technology for maize growing under non-irrigation conditions were followed. The indices height of the plants, height of the cob, length of the cob, number of the row per cob, number of the grains per row, mass of the cob, mass of the grains per cob, mass of 1000 grains, grain yield and protein, fats, starch content in grain were determined.

Statistical analysis

For the purpose of determining the quantity dependence between the studied indicators, the experimental data were processed according to the Anova Method of dispersion analysis, and the differences between the variants were determined by means of the Duncan's Multiple Range Test (Duncan, 1995).

Results and discussion

The period of study (2012-2014) comprised years, which differed significantly concerning the major meteorological factors (air temperature and precipitation sum) having an effect on maize productivity. The most favourable for the growth and development of the plants was reported to be 2014, followed by 2013 and the most unfavourable was 2012. The last experimental year (2014) was characterized by temperature values close to those established for many years and by enough and evenly distributed precipitations fully meeting the requirements of the hybrids for moisture from emergence till ripening. In the first year of the experiment (2012) the rainfalls were insufficient and unevenly distributed. The dryness during the critical stages of maize development had on the production possibilities of the plants.

The values of the morphological characteristics and the structural elements of the yield were presented in Table 1 in average for the three years. The studied hybrids differed significantly in the height of the plants. The lowest height was reported for the plants of hybrid P8523 (193.3 cm) and the highest were the plants of hybrid P1114– 241.7 cm. Referring to that characteristic P0412 hybrid fell behind P1114 by 2.6 % and P9721 surpassed P9606 by 4.3 %. The height of the first cob initiation as a characteristic determining the suitability level for mechanized maize grain harvesting varied from 63.2 cm in P8523 hybrid to 116.7 cm in P1114. Due to the lower height of the first cob initiation in P8523 and P9606, the regulation of the combine harvester is necessary for the better quality harvesting.

The analysis of the cobs showed that the late hybrid P0412 had the longest cobs – 23.7 cm and it surpassed P1114 by 7.7 %, the difference being statistically significant, while the medium lates P9721 and P9606 were surpassed by 11.8 and 20.3 %, respectively. The early hybrid P8523 formed cobs of the smallest length – 18.1 cm. The highest values of the characteristic number of rows in the cob were reported in P0412 hybrid – 16.5 rows and in the rest hybrids the number

varied from 13.1 (P8523) to 14.3 rows (P9721). It was statistically proven that P0412 hybrid surpassed by 15.9 % in average all the other studied hybrids.

Out of all the investigated hybrids the smallest number of grains in the row, in average for the three years, was established in hybrid P8523 – 38.2 and it fell behind the hybrids P9606, P9721 and P1114 by 7.3, 18.8 and 27.2 %, respectively, the biggest number of grains in the row being formed by hybrid P0412.

Table 1. Morphologic characteristics and structural elements of the yield of maize hybrids mean for the period 2012 – 2014

Hybrids	Height of the plants, cm	Height of the cob, cm	Length of the cob, cm	Number of the row per cob	Number of the grains per row	Mass of the cob, g	Mass of the grains per cob, g	Mass of 1000 grains, g
P8523	193.3 ^a	63.2 ^a	18.1 ^a	13.1 ^a	38.2 ^a	166.5 ^a	150.4 ^a	265.0 ^a
P9606	219.1 ^b	74.5 ^b	19.7 ^b	14.0 ^a	41.0 ^b	177.3 ^b	162.0 ^b	278.6 ^b
P9721	228.5 ^c	101.0 ^c	21.2 ^c	14.3 ^a	45.4 ^c	209.6 ^c	167.0 ^b	297.9 ^c
P0412	235.6 ^d	108.5 ^c	23.7 ^d	16.5 ^c	50.3 ^e	235.8 ^e	250.2 ^d	367.2 ^e
P1114	241.7 ^e	116.7 ^d	22.0 ^c	15.5 ^b	48.6 ^d	223.4 ^d	223.0 ^c	326.7 ^d
<i>LSD 5 %</i>	<i>5.38</i>	<i>8.01</i>	<i>1.52</i>	<i>1.42</i>	<i>2.77</i>	<i>10.2</i>	<i>7.80</i>	<i>11.5</i>

Cob weight in the late hybrids was from 223.4 to 235.8 g. P1114 hybrid fell behind P0412 by 5.5 % and the P9606 fell behind the hybrid P9724 by 18.2 %. The lowest values of that characteristic were reported in the early hybrid P8523 – 166.5 g. The differences between the hybrids were statistically significant.

The grain weight per cob in average for the period varied from 150.4 g in P8523 to 250.2 g in P0412. P1114 hybrid fell behind P0412 by 11.2 % (with statistical significance), however, both of them had higher grain weight per cob compared to P8523 – by 14.8 % and 16.6 %, respectively, as well as to P9606 and P9721 – by 13.6 % and 15.2 % in average. Grain weight per cob in P0412 was bigger compared to all the hybrids, the differences varied from 11.2 % to 16.6 % and they were statistically very significant. Like the other structural elements of the yield, 1000 grain weight characteristic also had the highest values established in hybrid P0412, i.e. 367.2 g. In the rest of the hybrids the values of that characteristic varied within the limits from 265.0 g (P8523) to 326.7 g (P1114). Data statistical processing showed that the differences between all the studied hybrids were significant.

The results obtained were presented in Table 2 and they showed that both by years and in average for the experimental period hybrid, P0412 surpassed in grain yield all the other hybrids included in the study. The higher grain yield of the hybrid was due to the higher values of its structural elements. The highest grain yields were obtained in the favourable for maize 2014 year when the temperature values and the precipitation sum fully met the plant requirements for warmth and moisture throughout the whole vegetation period. The yields obtained reached up to 11125 kg/ha in hybrid P0412. Referring to grain yield that hybrid surpassed the hybrids P1114, P9721, P9606 and P8523 by 17.4 %, 20.0 %, 21.9 % and 30.8 %, respectively, the differences being statistically significant.

In the second experimental year (2013) the grain yields obtained varied from 7240 kg/ha in the early hybrid to 8265 kg/ha in the late hybrid P0412, i.e. they were by 25.6 % lower in average in comparison with the previous year. Mathematical processing of data showed that hybrid P1114

significantly fell behind P0412 by 95 kg/ha, while hybrid P9606 fell behind P9721 by 118 kg/ha. The lowest yields were realized by hybrid P8523 – 7240 kg/ha.

In the first year of the study (2012) the meteorological conditions during the hybrid vegetation were extremely unfavourable and the plants were not able to attain their biological potential. The grain yields obtained were within the limits of 4720 to 5100 kg/ha. Statistically proven, the lowest ones were those of hybrid P8523 and the highest – of P0412.

Table 2. Grain yield – kg/ha

Hybrids	Stand density Plants/ha	Years of <u>study</u>			Average for the period kg/ha
		2012 kg/ha	2013 kg/ha	2014 kg/ha	
P8523	65000	4720 ^a	7240 ^a	8503 ^a	6821
P9606	63000	4887 ^b	7564 ^b	9130 ^b	7194
P9721	63000	5000 ^c	7682 ^c	9270 ^c	7317
P0412	59000	5100 ^d	8265 ^e	11125 ^e	8163
P1114	59000	4974 ^c	8170 ^d	9472 ^d	7539
<i>LSD 5 %</i>		<i>43.2</i>	<i>66.1</i>	<i>51.4</i>	

The results of the hybrids P1114, P9721 and P9606 had quite close values and they were statistically insignificant.

During the period of study (2012-2014) P0412 hybrid realized the yield of 8163 kg/ha in average and it surpassed the hybrids P1114, P9721 and P9606 by 2.5, 2.0 and 4.3%, respectively. The grain yield obtained from P8523 hybrid was 4720 kg/ha and it was less than the yields from all the other hybrids included in the experiment by 3.5 to 8.1 %.

The results from analyses of variance over three years for the grain yield are presented in Table 3. It was found that the effects of Hybrids and Year on the yield grain were significant. The Interaction was also statistically significant.

Table 3. Analysis of variance.

<i>Source of Variation</i>	<i>SS</i>	<i>df</i>	<i>MS</i>	<i>F</i>	<i>P-value</i>	<i>η²</i>
Hybrids	11823911,9	4	2955978,0	4834,07	0,000	34,7
Years	212822420,6	2	1064112101,0	174019,0	0,000	33,5
Interaction	6701336,2	8	837667,03	1369,88	0,000	31,8
Residual	27517,0	45	611,49			

The nutritional and forage value of maize grain is determined to a great degree by the content of proteins, fats and starch. Data of the chemical analyses (Table 4) showed that the highest protein content in grain was established in hybrid P1114 – 10.8 %. It exceeded the hybrids P0412, P9721, P9606 and P8523 by 12.5 %, 16.1 %, 36.7 % and 29.3 %, respectively.

Table 4. Chemical composition of grain, mean of the period 2012-2014

Hybrids	%		
	protein	fats	starch
P8523	8.35 ^a	4.15 ^b	77.05 ^c
P9606	7.90 ^a	4.05 ^b	75.52 ^b
P9721	9.30 ^b	3.49 ^a	74.09 ^b
P0412	9.60 ^b	5.19 ^c	71.80 ^a
P1114	10.80 ^c	4.67 ^b	70.50 ^a
<i>LSD 5 %</i>	<i>0,89</i>	<i>0,48</i>	<i>1,51</i>

The fat content varied from 3.49 % in P9721 to 5.19 % in P0412.

The medium early hybrid P9606 fell behind P8523 by 23.4 %, while the medium early hybrid P9721 fell behind the two late ones (P1114 and P0412) by 33.8 and 48.7 %, respectively.

The starch percentage was lowest in P1114 – 70.5 % and highest in P8523 – 77.05 %. The early hybrid exceeded the values of that characteristic established in the hybrids P9606, P9721 and P0412 by 2.0 %, 4.0 % and 7.3 %, respectively.

Conclusions

The characteristics plant height and height of the first cob initiation had the highest values in hybrid P1114 (241.7 and 116.7 cm) and the lowest in P8523 (193.3 and 63.2 cm).

The structural elements of yield – cob length, number of rows per cob, number of grains per row, cob weight, weight of the grains per cob and 1000 grain weight varied within a broad range, the highest values being reported in hybrid P0412. There was an obvious tendency of increase of those values in the direction of early to late hybrids.

Under the conditions of North Central Bulgaria the highest yield was obtained from P0412 hybrid – 8163 kg/ha, followed by P1114 – 7539 kg/ha and the lowest one – from P8523 hybrid – 6821 kg/ha.

The percentage content of protein in grain was the highest in P1114 hybrid (10.8 %) and that of fats – in P0412 (5.19 %). The highest starch content was established in P8523 hybrid (77.05 %).

References

- Calvino P., F. Andrade, V. Sadras, 2003. Maize yield as affected by water availability, soil depth and crop management. *Agronomy Journal* 95, 275-281.
- Chen, X., Chen, F., Chen, Y., Gao, Q., Yang, X., Yuan, L., 2013. Modern maize hybrids in Northeast China exhibit increased yield potential and resource use efficiency despite adverse climate change. *Global Change Biology*, 19(3), 923-936.
- Delibaltova V., 2009. Investigation on the productive potential of mid-early maize hybrids, cultivated for grain under non-irrigation in North-East Bulgaria. *Plant science*, 46, 488 -492.
- Delibaltova V.,R. Ivanova, 2009. Production possibility of maize hybrids cultivated for grain under irrigation in Plovdiv region. *Plant science*, 46, 493 - 496.
- Delibaltova, V., 2014. Response of Maize Hybrids to Different Nitrogen Applications Under Climatic Conditions of Plovdiv Region *Intl J Farm & Alli Sci. Vol.*, 3 (4): 408-412.
- Dong, X., Xu, W., Zhang, Y., & Leskovar, D. I., 2016. Effect of Irrigation Timing on Root Zone Soil Temperature, Root Growth and Grain Yield and Chemical Composition in Corn. *Agronomy*, 6(2), 34.
- Duncan V., 1995. Multiple – range and multiple F – test *Biometrics* 11; 1-42.

- Kandil, E., 2013. Response of some maize hybrids (*Zea mays*) to different levels of nitrogenous fertilization. *Journal of Applied Sciences research*, 9, (3), 1902-1908.
- Liu, Z., Yang, X., Hubbard, K. G., & Lin, X., 2012. Maize potential yields and yield gaps in the changing climate of northeast China. *Global Change Biology*, 18(11), 3441-3454.
- Niaz, A., Yaseen, M., Arshad, M., & Ahmad, R., 2014. Variable nitrogen rates and timing effect on yield, nitrogen uptake and economic feasibility of maize production. *J. Agric. Res*, 52(1).
- Stoyanova A., R. Muhova, 2008. Productivity of irrigation water in maize for grain, irrigated through furrows. *Plant science*, 5, 426-428.
- Zivkov Z., A. Matev, 2005. Possibilities for decrease of nitrogen fertilization rate by grain corn, cultivated in conditions of the Sofia by different water regime. *Agricultural University – Plovdiv, Scientific Works*, vol. L, book 1, 59-64.

NUTRITIVE VALUE OF OYSTER MUSHROOM DEPENDING ON THE SUBSTRATE

Dušanka BUGARSKI^{1*}, Maja KARAMAN², Jelica GVOZDANOVIĆ-VARGA¹, Janko ČERVENSKI¹, Lutvija KARIĆ³

¹Institute of Field and Vegetables Crops, Novi Sad, Republic of Serbia

²Department of Biology and Ecology, Faculty of Sciences, University of Novi Sad, Republic of Serbia

³University of Sarajevo, Faculty of Agriculture and Food Science, Sarajevo, Bosnia and Herzegovina

*Corresponding author: dusanka.bugarski@ifvcns.ns.ac.rs

Abstract

Oyster mushroom has lately been more produced worldwide due to its shorter growing season and fruiting, high resistance to diseases and pests, and low requirements for growing conditions. Growing oyster mushrooms is simple and many different substrates are used which contain cellulose, hemicellulose and lignine. The degradation of these components provides fruiting bodies of mushrooms and they are important for human nutrition. The process of growing mushrooms uses agricultural residues, so oyster mushroom cultivation directly helps the management of organic waste. Storing and burning organic waste have become a significant environmental issue and large quantities of biomass are unnecessarily being destroyed. The aim of this study was to grow oyster mushrooms on agricultural waste most abundant in Vojvodina Province – wheat and soybean straw and maize and sunflower stalks, used as individual substrates and in combination with wheat straw, which is most often used as oyster mushroom substrate. Isolated and determined oyster mushroom (*P. ostreatus*) strain was used (NS 77). The effect of substrate on the nutritive content of mushrooms was analyzed, as well as the content of water, proteins, fats, cellulose, ash and mineral elements. Determination of the effect of substrate on the content of nutrients in the oyster mushroom enabled control of the quality of mushrooms depending on the market demands.

Key words: *oyster mushroom, strain NS 77, substrate, nutritive value,.*

Introduction

Wide distribution of *Pleurotus* sp. use is mostly based on its growing on a wide array of substrates from unused lignocellulosic biomass waste from plant growing. In India it is grown on false banana tree and cut rice straw (Jandaik, 1974), cotton waste in Malesia (Tan, 1981) while Danai *et al.* (1989) report on mix from cotton straw and wheat straw in Israel. Sawdust supplemented with wheat bran or rice bran is used in the commercial cultivation in Japan (Wang *et al.*, 2001). In Portugal it is grown on oat straw (Fernandes *et al.*, 2015), in Taiwan on sawdust, corncob, sugarcane bagasse (Hoa *et al.*, 2015). Manzi *et al.* (1999) added 15% of sugar beet waste to wheat straw in Italy. The prospects of wide use of oyster mushroom in the future is based on the easily-accessible and affordable substrates, its nutritive value and content of medicinally active compounds which benefit human health, while at the same time the unique taste (Bugarski *et al.*, 2012). Nutritive value is similar to other plant species, with the addition of much higher protein content in oyster mushroom. According to Akyuz and Kirbag (2010) and Wani *et al.* (2010), protein content ranges between 17 g and 42 g per 100 g dried mushroom, while in fresh mushroom it is around 4% (Lin, 1999). The difference resulting from high water content which ranges from 87.5% to 92,5% depending on the strain, substrate and cultivation practices (Bugarski *et al.*, 2012). Regarding mineral elements, oyster mushroom contains significant

quantities of P, K, Na, Se and Mg (Lin, 1999). Wang et al., (2001) reported similar nutrient contents in commercially grown mushrooms and wild mushroom species, but also quantitative and qualitative differences between different *P. ostreatus* strains and growing methods and conditions. Mshandete and Cuff (2007) state that, apart from the strain and substrate, the chemical composition depends on the growing stage and part of the mushroom as well. Inspired by these data, this study aimed to separately analyse the chemical composition in the cap and stalk. This study supposed that if the chemical composition of the mushroom stalk does not differ significantly from the chemical composition of the mushroom cap, the stalk could be dried, milled and used for cookery.

Material and Methods

In this three-year trial (2006-2009), strain of *Pleurotus ostreatus* NS 77 was grown on different substrates under production conditions, and the effect of chemical composition of the cap and the stalk was analysed. The strain NS 77 comes from the collection of the Institute of Field and Vegetable Crops in Novi Sad, Serbia. The mushroom is of standard shape, light grey, with a large number of small fleshy fruits on long stalks growing in clusters. The substrates were prepared individually or in the in the following combinations with wheat straw which is the substrate most often used in oyster mushroom cultivation in Serbia: 1. Wheat straw (S1) 2. Wheat straw 50% + Soybean straw 50% (S2) 3. Wheat straw 50% + Corn stalks 50% (S3) 4. Wheat straw 50% + Sunflower stalks 50% (S4) 5. Soybean straw (S5) 6. Corn stalks (S6) 7. Sunflower stalks (S7). Average mushroom samples were collected from each replication for chemical composition of caps and stalks were determined separately. Moisture percentage was determined according to Roy (1993). Cellulose was determined by the standard AOAC method and crude fats by the conventional Soxhlet method. N was determined on CNSH Elementar Vario III Analyser (KONIG, 1991) and multiplying by a conversion factor 4.375 was obtained a protein content. The plant material was mineralised according to the standard method ISO 551:1979. In order to test the differences between the treatments for chemical characteristics, the null hypothesis $H_0: \mu_i = \mu_j$ was tested for all values of chemical characteristics $i \neq j$ using the Tukey's test, at 95% level of significance. The interpretation of the graphics follows the geometrical principles of biplot (Kroonenberg, 1995). The data were assessed and visualized in R program (R Core Team, 2015).

Results and Discussion

Analysis of variance showed significant differences in water content depending on the substrate used for growing oyster mushroom (*P. ostreatus*) strain NS 77. The highest water content (Tab. 1) was found in oyster mushroom grown on S6 (92.11%), and the lowest in oyster mushroom grown on S4 (91.19%), which is in accordance with the results of Manzi *et al.* (1999) who reported the range between 85.2% and 94.7%, Akyuz and Kirbag (2010) (89.7%-90.3%) and Pardo-Gimnez *et al.* (2015) (91.9%- 92.4%).

Table 1. Content of nutrients (%) in the cap and the stalk of the strain NS 77

Sub	Content of nutrients in the cap					Content of nutrients in the stalk				
	Moisture	Protein	Fat	Cellu.	Ash	Moisture	Protein	Fat	Cellu.	Ash
S1	91.34 ^{ab}	21.52 ^{ab}	2.32 ^a	3.56 ^a	8.27 ^a	91.34 ^{ab}	6.93 ^a	0.99 ^{abc}	2.77 ^a	5.61 ^a
S2	91.56 ^{ab}	22.85 ^{ab}	2.20 ^a	3.61 ^a	9.47 ^a	91.56 ^{ab}	7.77 ^{ab}	0.85 ^{ab}	3.63 ^a	7.97 ^{ab}
S3	91.72 ^a	26.23 ^a	1.71 ^a	3.32 ^a	8.77 ^a	91.72 ^a	9.27 ^{ac}	1.60 ^c	3.97 ^a	7.24 ^{ab}
S4	91.19 ^b	19.80 ^b	1.97 ^a	2.77 ^a	8.31 ^a	91.19 ^b	6.73 ^a	0.61 ^a	2.54 ^a	5.52 ^a
S5	91.43 ^b	18.53 ^b	1.58 ^a	2.67 ^a	8.74 ^a	91.43 ^b	6.53 ^a	1.20 ^{abc}	3.60 ^a	7.24 ^{ab}
S6	92.11 ^a	25.89 ^a	1.28 ^a	3.25 ^a	9.30 ^a	92.11 ^a	10.87 ^c	1.16 ^{abc}	3.55 ^a	9.08 ^b
S7	91.18 ^{ab}	22.39 ^{ab}	1.96 ^a	2.74 ^a	8.76 ^a	91.18 ^{ab}	7.37 ^{ab}	1.53 ^{bc}	3.74 ^a	6.29 ^a

Note: a, b, c, - values designated with the same alphabetic lettering in a column are not statistically significant (Tukey's test of multiple comparisons)

Ash content in mushroom cap showed no significant difference in relation to different substrates and ranged between 9.47% in mushroom grown on S2, and 8.27% in mushroom grown on S1. Ash content in mushroom stalk showed significant differences in relation to different substrates and ranged between 9.08% in mushroom grown on S6 and 5.52% in mushroom grown on S4 or 5.61% in mushroom grown on S1 or 6.29% in mushroom grown on S1 (Tab. 1). This is in accordance with the reported 13.7-6.0% in Akyuz and Kirbag (2010), 6.7-8.4% in Wang *et al.* (2001), 5.9-6.42% in Patil *et al.* (2010), and 7.32-7.83% in Kortei *et al.* (2014).

Protein content showed significant differences in the cap and the stalk in relation to the substrate used. The mushroom cap showed significant differences regarding protein content in mushrooms grown on the S3 (26.23%) and S6 (25.89%) in relation to S5 (18.53%) and S1 and S7 (19.80%) as shown in Table 1. The mushroom stalk showed significant differences regarding protein content in mushrooms grown on S6 (10.85%) and S3 (9.24%) in relation to other substrates, especially S5 (6.52%), which had the lowest protein content. The results from the cap are somewhat lower than Deepalakshmi and Mirunalini (2014) who reported 17-42%, and higher than Kortei *et al.* (2014) who reported 10.48-10.80%. Cellulose was uniform in mushrooms grown on all substrates. Its content in the mushroom cap ranged from 2.67% in S5 to 3.61% in S2. Cellulose content in the mushroom stalk ranged from 2.54% in S4 to 3.97% in S3.

Depending on the substrate on which oyster mushroom was grown, there were no significant differences in fat content in the cap, and it ranged from 1.28% in S6 to 2.32% in S1. On the other hand, there were significant differences in fat content in the stalk, and it ranged from 1.60% in S1 or 1.53% in S7 and 0.61% in mix of S4 (Tab. 1). Fat content results in the stalk are similar to the results of Akyuz and Kirbag (2010) (0.5-1.3%).

There were significant differences in P content in mushroom cap and stalk in relation to the substrate used. P content in the cap showed significant differences in mushrooms grown on S6 (123 mg) in relation to S1 (85 mg), as shown in Table 2. P content in the stalk showed significant differences in mushrooms grown on S2 (68 mg) or S6 (67 mg) and S1 (26 mg), as shown in Table 3. The results are lower than reported in Wang *et al.* (2001), and Manzi *et al.* (1999). There were no significant differences in Na content in the mushroom cap regarding different substrates, and it ranged from 6.15 mg in mushrooms grown on S3 to 31.02 mg in S1 (Tab. 2). However, there were significant differences in Na content in the mushroom stalk which ranged from 17.22 mg in S3 to 56.94 mg in S5 (Tab. 3). Wang *et al.* (2001) reported Na content of 21.9 mg, and Manzi *et al.* (1999) reported Na content of 25.2-136.0 mg.

Similar results were found for Ca content in mushroom cap, which ranged from 2.23 mg in mushrooms grown on S7 to 3.19 mg in S2. There were significant differences in Ca content in mushroom stalk and it ranged from 1.97 mg in S4 to 2.99 mg in mushrooms grown on S6 (Tab. 2). The results are similar to lower values (2-36 mg) reported by Deepalakshmi and Mirunalini (2014), but are tenfold lower than 23.5-48.6 mg reported by Manzi *et al.* (1999).

Table 2. Content of minerals (mg/100 g dry matter) in the cap of the strain NS 77

Substrates	Ca	Cu	Fe	Mg	Mn	Na	P	Zn
S1	2.76 ^a	1.84 ^a	12.31 ^a	171.44 ^a	1.23 ^a	31.02 ^a	85.0 ^a	8.72 ^a
S2	3.19 ^a	2.02 ^a	8.08 ^a	175.83 ^a	1.32 ^a	11.41 ^b	121.0 ^{ab}	8.36 ^a
S3	2.83 ^a	2.18 ^a	10.08 ^a	153.43 ^a	2.07 ^a	6.15 ^b	108.0 ^{ab}	9.10 ^a
S4	2.67 ^a	2.07 ^a	13.66 ^a	161.89 ^a	1.31 ^a	10.98 ^b	96.0 ^{ab}	9.21 ^a
S5	2.80 ^a	2.03 ^a	7.62 ^a	164.52 ^a	1.33 ^a	15.85 ^b	119.0 ^{ab}	7.97 ^a
S6	3.07 ^a	2.42 ^a	9.91 ^a	178.41 ^a	1.38 ^a	9.56 ^b	123.0 ^b	9.51 ^a
S7	2.23 ^a	2.05 ^a	8.11 ^a	162.60 ^a	1.35 ^a	8.79	113.0 ^{ab}	9.22 ^a

Table 3. Content of minerals (mg/100 g dry matter) in the stalk of the strain NS 77

Substrates	Ca	Cu	Fe	Mg	Mn	Na	P	Zn
S1	2.09 ^a	1.14 ^a	5.29 ^a	90.44 ^a	0.54 ^a	28.5 ^a	26.0 ^a	1.86 ^a
S2	2.75 ^{ab}	1.34 ^a	4.24 ^a	121.90 ^{bc}	0.56 ^a	33.3 ^{ab}	68.0 ^b	1.75 ^a
S3	2.58 ^{ab}	1.68 ^a	4.31 ^a	96.08 ^{ab}	0.59 ^a	17.2 ^a	43.0 ^{acd}	3.66 ^a
S4	1.97 ^a	1.24 ^a	4.36 ^a	70.58 ^{ab}	0.50 ^a	28.3 ^{ab}	38.0 ^{ac}	1.30 ^a
S5	2.36 ^{ab}	1.78 ^a	4.68 ^a	98.92 ^{abc}	0.70 ^a	56.9 ^b	54.0 ^{bcd}	2.55 ^a
S6	2.99 ^b	1.83 ^a	5.58 ^a	121.73 ^{bc}	0.68 ^a	21.4 ^a	67.0 ^b	3.67 ^a
S7	2.07 ^a	1.38 ^a	3.46 ^a	125.82 ^c	0.65 ^a	26.0 ^{ab}	57.0 ^{bd}	2.20 ^a

There were no significant differences in Mg content in the mushroom cap regarding different substrates, and it ranged from 153.43 mg in S3 to 178.41 mg in S6. However, there were significant differences in Mg content in the mushroom stalk which ranged from 90.44 mg in S1 to 125.82 mg in S7. The highest Mg content was found in the cap, which is similar to 181.9 mg reported by Wang *et al.* (2001) and 161.4-203.2 mg reported by Manzi *et al.* (1999). The contents of Fe, Mn, Cu, and Zn did not show significant differences in relation to the substrates on which oyster mushrooms were grown. Fe content in the cap ranged from 7.62 mg in S5 to 13.66 mg in S4, and Fe content in the stalk ranged from 3.46 mg in S7 to 5.58 mg in S6 (Tab. 3). Mean values of the results are similar to 7.1 mg which was reported by Wang *et al.* (2001), and 13.13-15.62% as reported by Patil *et al.* (2010). According to Vetter (1994), Fe content in the cap was 15.1 mg and in the stalk it was 13.7 mg. Mg content in the cap ranged from 1.23 mg in S1 to 2.07 mg in S3, and in the stalk it ranged from 0.5 mg in S4 to 0.7 mg in S5. The results are similar to 1.6 mg reported by Wang *et al.* (2001), higher than 1.13 mg in the cap and almost identical to 0.71 mg in the stalk as reported by Vetter (1994). Cu content in the cap ranged from 1.84 mg in S1 to 2.42 mg in S6, and in the stalk the results were uniform among different substrates but lower, and ranged from 1.14 mg in S1 to 1.83 mg in S6. The results in the cap are similar to 2.5 mg as reported by Wang *et al.* (2001), and 2.19 mg in the cap and 1.62 mg in the stalk as reported by Vetter (1994). Zn content in the cap ranged from 7.97 mg in S5 to 9.51 mg in S7, and in the stalk

it ranged from 1.30 mg in S7 to 3.68 mg in S6. The results are similar to 7.61-11.45% reported by Hoa *et al.* (2015) and somewhat lower than 13.7 mg as reported by Wang *et al.* (2001).

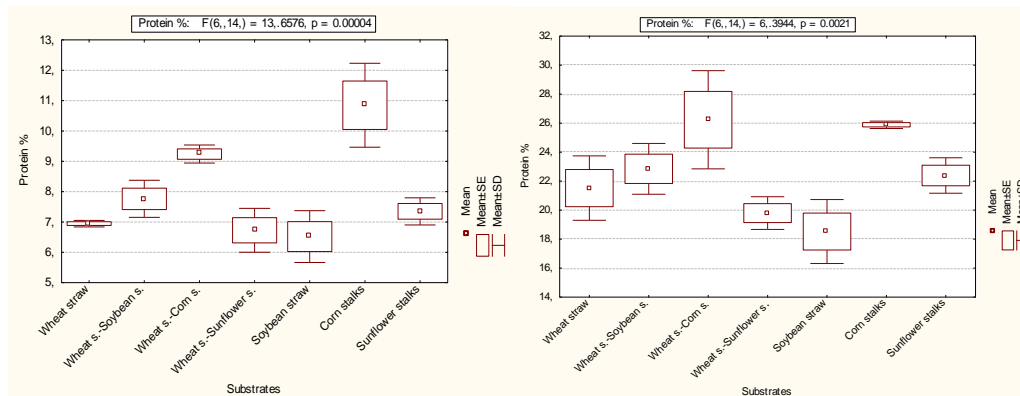

Figure 1. Protein content in stalk (%) Figure 2. Protein content in cap (%)

Cellulose content was similar in the cap and the stalk depending on the substrate, while the contents of protein, fat and mineral elements were mostly higher in the cap than in the stalk, with the exceptions of Zn and Na content. Zn content in the cap was 2.5 times higher in S3, and as much as 7 times higher in S4. Na content ranged from similar value in S1 to 3.6 times lower in S5, as shown in Tables 2 and 3. Higher content of mineral elements in the cap than in the stalk, with the exception of Na, was reported by Vetter (1994).

The highest and the lowest mean values of nutrients and minerals content, except Zn, are lower in the stalks than in the cap. Protein content is also lower in the stalks (Fig. 1) than in the cap (Fig. 2), but is identically distributed throughout the substrates.

The biplot shows that the first dimension explained 54.3% of the variability of samples, while the second dimension explained 17.6% (Fig. 3). Substrates with profiles similar to „the average substrate“, i.e. with higher number of characteristics that respond to the most common category, are distributed near the coordinate origin. Among them, S2 stands out, in the vicinity of coordinate origin. Distances between the points for chemical elements and nutrients depend on the similarity of their profiles. Ideally, the parameters that belong to the same substrate are grouped at smaller distances, such as water, proteins, Ca, Zn, ash, and Cu, which form together a group of positive variables with high values for S6 and S3, while fat and cellulose have high values for S3 and S7. The substrate S6 contains only corn stalks, and S3 is the combination wheat straw + corn stalks. These two substrates had high quality and high yields of oyster mushroom.

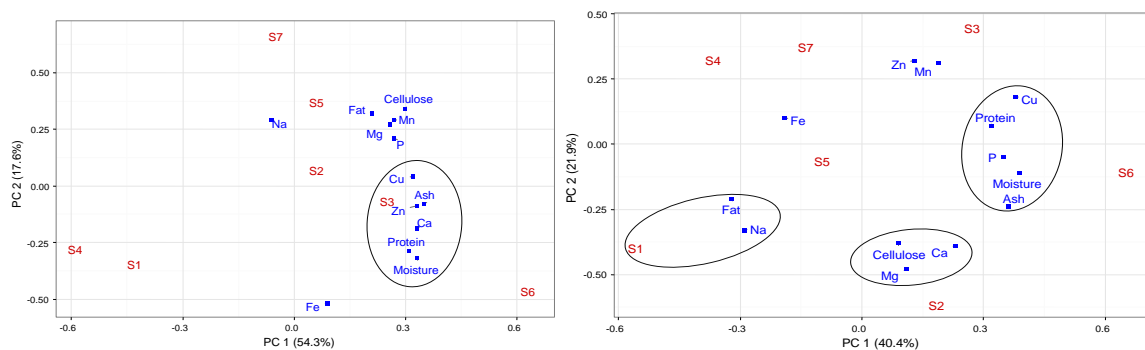

Figure 3 and 4. Biplot of nutrients and minerals content in the stalk and in the cap. The biplot (Fig. 4), shows that the first dimension explained 40.4% of the variability of the samples, while the second dimension explained 21.9%. Along both axes, S5 is situated in the coordinate origin of the biplot, being the substrate with the least variations of the assessed nutrients and minerals. Mg, Ca and cellulose comprise a group of positive variables with highest values for S2, while ash, water, P, proteins and Cu comprise a group of positive variables with high values for S6. S1 had the highest values of Na and fat, while S4 had the highest Fe content.

Conclusions

This study confirmed the initial assumption that chemical composition of oyster mushroom depends on the substrate it is grown on. The study found significant differences in the water content, protein content, P and Na content both in the cap and the stalk, depending on the substrate. Quantity of cellulose, Fe, Mn, Cu and Zn showed no significant differences in relation to the substrate on which they were grown. The contents of ash, fat, Mg, and Ca in the cap were uniform, while in the stalk the difference was significant in relation to the growing substrate. Content of nutrients and minerals in the fruiting body of the strain NS 77 was the lowest in S1, followed by S7 and S4, and it was the highest in S6 and S3 and S2. Corn stalk (S6) was the best substrate regarding water regime, protein content, ash content, P, Ca, Cu, Mn, Zn, and Mg. Therefore, it can be concluded that wheat straw can be used as a substrate only in combination with other crops, such as corn or soybean.

References

- AOAC, (1990). Official Methods of Analysis (Method 945.16) 15th ed.: Association of Official Analytical Chemists: Washington DC.
- Akyuz, M., Kirbag S. (2010). Nutritive value of wild edible and cultured mushrooms. *Turk J Biol.*, 34: 97-102.
- Bugarski, D., Gvozdanović-Varga, J., Takač, A., Jovičević, D. (2012). Production method as an oyster mushroom quality determinant. *Savremena poljoprivreda*, 61: 138-146.
- Danai, O., Levanon, D., Silanikove, N. (1989). Cotton straw silage as a substrate for *Pleurotus* sp. Cultivation. *Mushroom Science*, XII, 2: 81-90.
- Deepalakshmi, K., Mirunalini, S. (2014). *Pleurotus ostreatus* an oyster mushroom with nutritional and medicinal properties. *J Biochem Tech*, 5 (2):718-726.
- Fernandes, A., Barros, L., Martins, A., Herbert ,P., Ferreir, I. C. F. R. (2015). Nutritional characterisation of *Pleurotus ostreatus* (Jacq. ex Fr.) P. Kumm. produced using paper scraps as substrate. *Food Chem*, 169, 396–400.
- Hoa, H. T., Chun-Li Wang, C. L., Wang, C. H. (2015). The effects of different substrates on the growth, yield, and nutritional composition of two oyster mushrooms (*Pleurotus ostreatus* and *Pleurotus cystidiosus*). *Mycobiology*, 43(4), 423-434.
- ISO 551:1979 Fruits,vegetables and derived products- Decomposition of organic matter prior to analysis-Wet Method.
- Jandaik, C. L. (1974). Artificial cultivation of *P. sajor-caju*. *Mushroom J.*, 22.10: 405.
- Konig, E. (1991). Nitrogen and Protein Concentration in Foodstuffs and Animal Feeds. *Biotech Forum Europe, International Journal of Biotechnology*, 8(1-2): 25-29.
- Kortei, N. K., Dzogbefia, V. P., Obodai, M. (2014). Assessing the Effect of Composting Cassava Peel Based Substrates on the Yield Nutritional Quality, and Physical Characteristics of *Pleurotus ostreatus* (Jacq.ex Fr.) Kummer. *Biotechnol Res Int*, 571-520.

- Kroonenberg, P.M (1995). Introduction to biplots for G×E tables, University of Queensland, Brisbane, Australia.
- Lin, Z. (1999). JUNCAO Technology, Fujian Agricultural University, China.
- Manzi, P., Gambelli, L., Marconi, S., Vivanti, V., Pizzoferrato, L. (1999). Nutrients in edible mushrooms: an inter-species comparative study. *Food Chemistry*, 65: 477-482.
- Mshandete, A. M., Cuff, J. (2007). Proximate and nutrient composition of three types of indigenous edible wild mushrooms grown in Tanzania and their utilization prospects. *African Journal of Food Agriculture Nutrition and Development*, 7, 6, nd 07054.
- Pardo-Giménez, A., Catalán, L., Carrasco, J., Álvarez-Ortí, M., Ziedc D., Pardob, J. (2015). Effect of supplementing crop substrate with defatted pistachio meal on *Agaricus bisporus* and *Pleurotus ostreatus* production. [wileyonlinelibrary.com DOI 10.1002/jsfa.7579](https://doi.org/10.1002/jsfa.7579).
- Patil, S. S., Ahmed, S. A., Telang, S. M., Baig, M. M. (2010). The nutritional value of *Pleurotus ostreatus* (Jacq.:Fr) Kumm cultivated on diferent lignocellulosic agrowastes. *Innovative Romanian Food Biotechnology*, 7: 66-75.
- R Core Team (2015). A language and environment for statistical computing. R Foundation for Statistical Computing, Vienna, Austria.
- Roy, S. (1993). Determination of moisture of mushrooms by Vis-NIR spectroscopy, *J.Sci. Food Agriculture*, 63(3): 355-360.
- Tan, K.K. (1981). Cultivation of the oyster mushroom, *Pleurotus ostreatus*, on cotton waste. *Mushroom Science*, XI: 697-703.
- Vetter, J. (1994). Mineral elements in the important cultivated mushrooms *Agaricus bisporus* and *Pleurotus ostreatus*. *Food Chemistry*, 50: 277-279.
- Wang, D., Sakoda, A., Motoyuki, S. (2001). Biological efficiency and nutritional value of *Pleurotus ostreatus* cultivated on spent beer grain, 78: 293-300.

CHANGE NUMBER OF MICROORGANISMS IN THE RHIZOSPHERE OF ALFALFA AS RESULT OF INOCULATION RHIZOBIA AND AZOTOBACTER

Snežana ANĐELKOVIĆ^{1*}, Tanja VASIĆ¹, Jasmina RADOVIĆ¹, Snežana BABIĆ¹, Jasmina MILENKOVIĆ¹, Goran JEVTIĆ¹, Simonida ĐURIĆ²

¹Institute for Forage Crops Kruševac, Republic of Serbia

²Faculty of Agriculture, University of Novi Sad, Republic of Serbia

*Corresponding author: snezana.andjelkovic@ikbks.com

Abstract

Microorganisms present the biotic component of soil and their abundance is an indicator of soil quality. Content of organic matter, as an energy source for microbial metabolism, and chemical properties, especially pH value of the soil, are limiting factors that influence the activity of microbial populations. In order to find solutions of growing alfalfa and other crops on acid soils different agricultural measures are used, and biological measures such as the use of microbial inoculants for better utilization of resources for the development of plants and microorganisms are increasingly introduced. In this paper, the effects of microbial inoculants on the abundance of microorganisms in the rhizosphere soil of alfalfa (*Medicago sativa* L.) were studied. Alfalfa seed of cultivar Syntéza 1 inoculated with two nitrogen-fixing bacteria: rhizobium (*Sinorhizobim meliloti*) and azotobacter (*Azotobacter chroococcum*). The above listed microorganisms were used individually and in joined cultures. After inoculation seed from each inoculum variant were planted in the pots filled with corresponding soil. The control variant was without inoculation. For the purposes of research two types of soil with different pH were used (the soil with increased acidity and with neutral reaction). The results Fishers LSD test show that the total number of microorganisms in the rhizosphere of alfalfa after inoculation in comparison with the control varied depending on the variant of inoculation and soil type.

Keywords: *microorganisms, alfalfa, inoculation*

Introduction

Soil is a system which is characterized by complex ecological interactions of organisms (Zaccardelli et al., 2013). In this system microorganisms play a significant role, they with their enzymatic systems, participate in 60-90% of the total metabolic activity in soil (Lee et al., 1994). Abundance, activity and diversity microorganisms in the soil are factors that determine its fertility (Milošević et al., 1999). The abundance of microorganisms ranges from tens to hundreds of billions in one gram of absolutely dry soil (Govedarica and Jarak, 1995). Stable composition of soil microbiocenoses is important for a correct functioning of this environment (Hawrot-Paw et al., 2016). The abundance of microorganisms in soil is influenced by many abiotic and biotic factors, primarily by soil type, content of organic matter (as an energy source for microbial metabolism), plant species, temperature, water, etc. (Milić et al., 2004).

In relation to the pH, micro-organisms dwell in environments with a wide range of pH from 1.7 to 9.0. The high abundance and activity of microorganisms is characteristic for the soils of neutral and slightly alkaline reaction and with a high content of organic matter. However, acid soils are characterized by low microbial activity (Diaz-Ravina et al, 1998).

In order to find solutions of growing alfalfa and other crops on acid soils different agricultural measures are used, and biological measures such as the use of microbial inoculants for better utilization of resources for the development of plants and microorganisms are increasingly introduced (Jarak et al., 2005). The successful introduction of inoculum strains in the soil depends on the number of indigenous populations, the activities of host plant, and other traits of the soil (Brockwell et al., 1995).

Soils with high acidity have negative effects on the abundance and activity of rhizobium and on the intensity of nitrogen fixation (Soto et al. 2004). To ensure the successful production of alfalfa on soils of high acidity, pre-sowing inoculation using *S. meliloti* strains results in satisfactory nitrogen-fixing activity in such soils. Rhizobium provide macrosymbionts with nitrogen and also synthesize polysaccharides, vitamins B₁₂, B₁, B₂ (Denison and Kiers 2004). In addition to the symbiotic nitrogen-fixers, the increase of nitrogen balance is achieved by the application of free nitrogen-fixers, primarily azotobacter which synthesize gibberellins, auxins, pyridoxine and nicotinic acid (Dobbelaere et al., 2003).

The aim of this study was to examine the effect of inoculation with rhizobium (*Sinorhizobium meliloti*) and azotobacter (*Azotobacter chroococcum*) as individually culture and combined cultures on the number of microorganisms in the rhizosphere of alfalfa grown in different soil types.

Material and Methods

The experiment was a two-factorial, where the first factor was the soil of different pH values and the second factor was the variant of microbial inoculation. For the purposes of research, were used two types of soil with different pH: the soil with neutral reaction pH 6.58 (KCl) - A and the soil with increased acidity pH 4.77 (KCl) – B (Tab. 1). Soil A is of alluvium type, and soil B is a cambisol. Chemical composition of the soil was determined by standard methods in the chemical laboratory of the Institute for Forage Crops in Kruševac.

Table 1. The chemical composition of the soil

Soil \ Parameter	Total nitrogen, %	P ₂ O ₅ mg/100g	K ₂ O mg/100g	Humus, %	pH/KCl
A	0.138	6.60	24.05	2.62	5.58
B	0.204	10.20	51.0	4.30	4.77

Research was conducted on alfalfa cultivar Syntéza 1, bred in the Plant Production Research Center (PPRC) in Pieštany.

The inoculation was done using the following inocula:

1. *Sinorhizobium meliloti* (10.8×10^{11} per ml);
2. *Azotobacter chroococcum* (28×10^{11} per ml);
3. *S.meliloti* + *A.chroococcum*;
4. Control – no inoculation.

These microorganisms were from the collections of the Department of Microbiology of the Faculty of Agriculture in Novi Sad. The *S. meliloti* cultures were grown on YM substrate by Vincent, *A. chroococcum* cultures were grown on the liquid substrate by Feodorov (Jarak and Djurić, 2006).

The alfalfa seed was sterilized using the 0.2 % HgCl₂ solution and 70 % alcohol and rinsed several times with sterile tap water and afterwards submerged in the correct inoculum. After this, the seed of each inoculum variant was planted in the pots containing correct soil type. In each pot, 10 ml of the appropriate inoculum was added. After each alfalfa cut, three times during the

growing seasons, the total number of microorganisms in the rhizosphere was determined for each inoculation variant. This was done by streaking 10^{-6} dilution of soil suspension on soil agar - method of agar panels (Pochon and Tardieux, 1962). The incubation lasted for five days on 28° c. The number of grown colonies was calculated per 1g of absolutely dry soil.

The results were processed using the statistical package STATISTICA 8.0. The significance of the difference between the investigated treatments was determined by analysis of variance i.e. LSD test.

Results and Discussion

The total number of microorganisms, where bacteria were the most abundant, can be used as a general indicator of the biological activity in the soil and is extremely important for the creation and maintenance of soil fertility (Milošević et al., 2000). Alfalfa was grown on soils of different pH values: the soil with neutral reaction (A) and the soil with increased acidity (B). Each type of soil has the characteristic features of microbial processes that can be affected by different measures (Govedarica et al. 1997). The results of statistical analysis by Fishers LSD test show that the total number of microorganisms in the rhizosphere of alfalfa after inoculation varied depending on the inoculation and soil type (Tab. 2). The abundance and diversity of microorganisms in the soil influenced by physical and chemical properties - acidity, amount and type of organic matter, water, air and heat regime, structure and mechanical traits of soil, etc. (Jarak and Čolo, 2007).

After first cut of alfalfa, the total number of microorganisms was statistically different on all variants. Compared to control variants the number of microorganisms was higher on all treatments, except variant of application of combined cultures *S. meliloti* + *A.chroococcum*. The highest number of microorganisms recorded on treatment of inoculation with *A.chroococcum* in soil A. Examining the impact of the application of inoculation in soybean Cvijanović et al. (2012) have found that the total bacterial number was higher in the inoculated soil. Also, by bacterization of alfalfa on pseudogley the total number of bacteria can be increased (Jarak et al., 2002).

Table 2. The total number of microorganisms (log number) in the rhizosphere of alfalfa

Soil	Variant	I cut	II cut	III cut
A	<i>S. meliloti</i>	1,866 ^c	1,532 ^b	1,394 ^g
	<i>A.chroococcum</i>	2,297 ^a	1,298 ^d	1,406 ^g
	<i>S. meliloti</i> + <i>A.chroococcum</i>	1,374 ^g	1,430 ^c	1,650 ^e
	Control	1,529 ^e	1,562 ^b	1,566 ^f
B	<i>S. meliloti</i>	1,921 ^b	1,634 ^a	1,959 ^b
	<i>A.chroococcum</i>	1,603 ^d	1,164 ^e	1,768 ^c
	<i>S. meliloti</i> + <i>A.chroococcum</i>	0,999 ^h	1,667 ^a	1,685 ^d
	Control	1,435 ^f	1,463 ^c	2,226 ^a

Note: Mean values with the same superscript(s) are not significantly different according to Fisher's LSD test (p < 0.05)

After second cut of alfalfa, the highest number of microorganisms recorded in soil B applied of monovalent inoculum *S. meliloti* and combined cultures *S. meliloti* + *A.chroococcum*, but in comparison with the control, number of microorganisms in soil A was lower by applying

A.chroococcum. Comparing to the control, the number of microorganisms in the soil A was statistically significant different in a negative sense on treatments inoculated *A.chroococcum* and *S. meliloti* + *A.chroococcum*. The treatment with inoculation with *S. meliloti* and control variant make homogeneous group (absence of a statistically significant difference). Large number of microorganisms is introduced into the soil by application of microbial inoculation that brings changes in the abundance and composition of the indigenous population (Andjelković et al., 2013).

In third term, only in the treatment of soil A, where the mixture of rhizobium and azotobacter was applied, the total number of microorganisms was significantly increased compared to the control. In all other of the inoculation variants achieved statistically significant reduction in number compared to the control. Treatment with inoculation with *S. meliloti* and treatment with *A. chroococcum* in the soil A make homogeneous group (absence of a statistically significant difference). Microorganisms, from those applied inoculums, that can adapt to the conditions prevailing in the soil can help in the intensification of microbiological processes. As noted by Revellin et al. (2000), after application, microorganisms in the soil encounter whole new environmental conditions that may inhibit their activity.

Conclusion

The obtained results showed that the application of microorganisms can provide the different effects in two soils with different pH values collected from agricultural fields at different locations. As a result of the effect of various abiotic and biotic factors that exist in these soils, survival of introduced microorganisms was varied. In the rhizosphere of alfalfa cultivar Syntéza 1 the number of microorganisms varied depending of the variant of inoculation and the type of soil within one term of analysis. Also, the abundance of microorganisms on the same treatment at different time periods was different compared to the control during the growing season. There is no clear trend influence neither one of the factors applied. Application of microbial inoculation, as a biological measure, in order to improve soil and increase its productivity and production potential of crops is justified from environmental and economic aspects.

Acknowledgment

Research was financed by the Ministry of Education, Science and Tehnological Development, Republic of Serbia, project TR 31057.

References

- Andjelković S., Vasić T., Radović J., Babić S., Jarak M., Djurić S., Ćirić S. (2013). Effect of inoculates on abundance of fungi and actinomycetes in alfalfa rhizosphere. Proceedings of the 1st International Congress on Soil Science, 23-26 September, Belgrade, Serbia, pp.232-238.
- Brockwell J., Bottomley P.J., Thies J.E. (1995). Manipulation of rhizobia microflora for improving legume productivity and soil fertility: a critical assessment. *Plant and Soil* 174, pp. 143-180.
- Cvijanović G, Dozet G, Djukić V, Đorđević S, Puzić G (2012). Microbial activity of soil during the inoculation of soya bean with symbiotic and free-living nitrogen-fixing bacteria. *African Journal of Biotechnology* 11(3), pp. 590-597.
- Denison R.F., Kiers E.T. (2004). Why are most rhizobia beneficial to their host plants, rather than parasitic, *Microbes & Infection*, 6, pp. 1235-1239.
- Diaz-Ravina M., Carballas T., Acea M. J.(1998). Microbial biomass and metabolic activity in four acid soil. *Soil Bio. Biochem.*, 20(6), pp. 817-823.

- Dobbelaere S., Vanderleyden J., Okon Y. (2003). Plant growth-promoting effects of diazotrophs in the rhizosphere, *Crit. Rev. Plant Sci.* 22, pp. 107-149.
- Frame J. (2005). Forage legumes for temperate grassland. Science Publishers, Inc., Enfield (NH), USA-Plymouth, UK, 13-17.
- Govedarica M., Milošević N., Jarak M. (1997). Teški metali i mikroorganizmi u zemljištu. Teški metali u životnoj sredini. (Heavy metals and microorganisms in the soil. Heavy metals in the environment). Ed. R.Kastori, Poljoprivredni fakultet, Novi Sad, 155-193.
- Govedarica M., Jarak M. (1995). Mikrobiologija zemljišta. (Microbiology of soil). Poljoprivredni fakultet. Novi Sad.
- Hawrot-Paw M., Mikiciuk G., Mikiciuk M., Izwikow M., Kiniorska J. (2016). Number and activity of microorganisms in soil inoculated with the Rhizocell C biopreparation in strawberry cultivation (*Fragaria* × *Ananasa Duch.*). *Journal of Ecological Engineering* Volume 17(2), pp.135–140.
- Jarak M., Čolo J (2007). Mikrobiologija zemljišta. (Microbiology of soil). Univerzitet u Novom Sadu, Poljoprivredni fakultet, Novi Sad.
- Jarak M., Đurić S. (2006). Praktikum iz mikrobiologije. (Microbiology practicum). Univerzitet u Novom Sadu, Poljoprivredni fakultet, Novi Sad.
- Jarak M., Hajnal T., Djurić S., Žurkić J. (2005). Preživljvanje rizobiuma, azotobaktera i aktinomiceta u zemljištima različite kiselosti (Survival of rhizobia, azotobacter and actinomycetes in soils of different pH values). *Letopis naučnih radova*, 29(1), pp.41-49.
- Jarak M, Govedarica, M, Milošević N, Đurić S, Petrov S (2002). Efekat bakterizacije lucerke gajene na černozeu i pseudogleju (Effect of inoculation of alfalfa growing on chernozem and pseudogley). *Zbornik radova Instituta za ratarstvo i povrtarstvo*, Novi Sad, Sv. 37, pp. 97-103.
- Lee K.E. (1994). The functional significance of biodiversity in soils, 15th World Congress of Soil Science, Acapulco, Mexico, 10-16.07.1994., 4a, pp.168-182.
- Miličić D., Jarak M. (2008). Popravka kiselih zemljišta primenom mikrobnih inokulanata i kalcifikacije. *Letopis naučnih radova*, 32(1), pp. 51-56.
- Milić M.V., Jarak, N.M., Mrkovački B.N., Milošević A.N., Govedarica M.M., Đurić S., Marinković J. (2004). Primena mikrobioloških đubriva i ispitivanje biološke aktivnosti u cilju zaštite zemljišta. (Microbiological fertilizer use and study of biological activity for soil protection purposes). *Zbornik radova Instituta za ratarstvo i povrtarstvo*, Novi Sad, br. 40, pp.153-169.
- Milošević N, Govedarica M, Jarak M (2000). Mikrobiološka svojstva zemljišta oglednog polja Rimski Šančevi (Microbiological properties of the soil experimental field Rimski Šančevi). *Zbornik radova Instituta za ratarstvo i povrtarstvo*, Novi Sad, Vol. 33, pp. 13-20.
- Milošević, N., Govedarica, M., Jarak, M. (1999): Mikrobiološki preparati – značaj i mogućnosti njihove primene u ratarskoj proizvodnji (Microbiological preparations - their importance and applicability on field crop production). *Zbornik radova Instituta za ratarstvo i povrtarstvo*, Novi Sad, Sv. 31, pp. 49-61.
- Nannipieri P., Ascher, J., Ceccherini M.T., Landi L., Pietramellara G., Renella G. (2003). Microbial diversity and soil functions. *Eur.J.Soil Sci.* 54, pp .665-670.
- Pochon J., Tardieux, P. (1962). *Technique d'analyse en microbiologie du sol*, Paris.
- Revellin C., Meunier G., Giraud J.J., Sommer G., Wadoux P., Catroux G. (2000). Changes in the physiological and agricultural characteristics of peat-based *Bradyrhizobium japonicum* inoculants after long term storage, *Applied Microbiology and Biotechnology*, 54, pp. 206-211.

- Soto M. D., Van D., Martinez-Arabaca F., Jimenez-Zurdo J., Toro N. (2004). Attachment to plant roots and nod gene expression are not affected by pH or calcium in the acid-tolerant alfalfa-nodulating bacteria *Rhizobium* sp. LPU83, FEMS Microbiol. Ecol. 48, pp. 71-77
- Zaccardelli M., De Nicola F., Vилlecco D., Scotti, R.(2013). The development and suppressive activity of soil microbial communities under compost amendment . J. Soil Sci. Plant Nutr. Vol.13 (3), pp. 730-742.

EFFECTS OF BRASSINOSTEROIDS AND GIBBERELIC ACIDS APPLIED *IN VITRO* CONDITIONS ON POLLEN VIABILITY AND GERMINATION OF SOME GRAPE CULTIVARS

Zeliha GÖKBAYRAK*, Hakan ENGİN

Department of Horticulture, Faculty of Agriculture, Çanakkale Onsekiz Mart University, Çanakkale, Turkey

*Corresponding author: zgokbayrak@comu.edu.tr

Abstract

There are numerous factors affecting pollen germination in plants. Plant growth regulators have produced different results on pollen germination both *in vivo* and *in vitro*. In this research, pollen viability using IKI test and effects of three different growth regulators (epibrassinolide, homobrassinolide and gibberellic acid) added into growth medium on the *in vitro* pollen germination of two wine grape cultivars (Cabernet Sauvignon and Merlot) were investigated. Pollen viability results showed that Cabernet Sauvignon contained more viable pollens (63.12% that Merlot (59.06%). Pollens collected from fresh flowers were sown on medium containing 1% agar and 20% sucrose using ‘agar in petri dish’ method. Results revealed that growth regulators did not affect germination in the cultivars, but the treatments had an overall increasing influence (about 25%). Although, in general, treatments produced similar ratios with the control group, 100 mgL⁻¹ GA₃, alone, and in combination with 0.01 and 0.001 mgL⁻¹ epibrassinolide were found to cause significant increase. In addition, applying the lowest GA₃ concentration (25 mgL⁻¹) with 0.1 mgL⁻¹ epibrassinolide provided the highest germination (23.54%). Only 0.001 mgL⁻¹ homobrassinolide resulted in the almost the same ratio with the control group. Information obtained here show that effects of growth regulators change with the genotype, type of the hormones and composition of the basal growth medium.

Key words: *Vitis vinifera* L., Pollen Germination, Gibberellin, Epibrassinolide, Homobrassinolide

Introduction

For plant species in different families, *in vitro* germination of pollen has been investigated at genetical, physiological and biochemical levels. Pollen germination evaluated *in vitro* might validate germination *in vivo* (Hormoza and Herrero, 1999; Tunistra and Wedel, 2000).

In vitro germination introduces a way for pollens to germinate under specific nutrient medium and temperature conditions (Heslop-Harrison, 1979). Some studies also show effects of plant growth regulators added to the medium. Some researchers showed that auxins and gibberellins generally promote *in vitro* pollen germination and growth (Viti et al., 1990; Qi et al., 2010; Ruijin and Chuanlai, 2010), whereas inhibition occurred when cytokinins and abscisic acid were utilized (Hewitt et al., 1985; Tosun and Koyuncu, 2007).

Brassinosteroids are the least investigated growth regulators in terms of their effects of pollen germination and pollen tube growth. Kang and Guo (2011) through their extensive works in *Arabidopsis* showed that brassinosteroids are important in the regulation of reproductive growth. In addition, they were shown to improve pollen tube growth in *Camelia japonica* (Hewitt et al., 1985) and tomato (Singh and Shono, 2003). Gökbayrak and Engin (2015) indicated that epibrassinolide, an active form of brassinosteroid, were effective more than naphthalene acetic acid and less than gibberellic acid on increasing pollen germination in table grapes. On the other

hand, Ylstra et al (1995) reported in tobacco that 28-homobrassinolide completely inhibited pollen germination while 24-epibrassinolide did not stimulate it. There is both lack of information and contradicting results about effects of brassinosteroids on pollen germination. This study was conducted to determine the effects of two brassinosteroid compounds, epibrassinolide and 22S, 23S-homobrassinolide, along with the other group growth regulator, gibberellins, on *in vitro* pollen germination and growth of wine grape cultivars.

Material and Methods

Pollens of the wine grape cultivars, 'Cabernet Sauvignon' and 'Merlot' (*Vitis vinifera* L.) were utilized as plant materials. All the cultivars are dark colored and late maturing, known to exhibit low fruit set under vineyard conditions. The vines were located at the experimental vineyard in the Dardanos Campus of Canakkale Onsekiz Mart University. Inflorescences were collected in the morning hours at the 23rd stage (full bloom) of Eichorn ve Lorenz (1977) classification. Inflorescences were brought into lab and all unopened flowers were emasculated and later, anthers were collected in petri dishes. Anthers were allowed to burst for 24 hours at room temperature.

Iodized potassium iodide staining was employed to test the viability of pollens. Potassium iodide (1 g) and iodine (0.5 g) were added to 10 ml distilled water. After completion of the staining, pollens stained dark brown or yellow/transparent were considered viable and non-viable, respectively.

The pollen germination capability was determined using epibrassinolide (EBR, Sigma E-1641), 22S, 23S-homobrassinolide (HBR, Sigma H-1267) and gibberellic acid (GA₃, commercial grade) at three concentrations with basic 1% agar + 20% sucrose medium. Concentrations applied were GA₃; 25, 50, 100 mgL⁻¹, EBR; 0.001, 0.01 and 0.1 mgL⁻¹, and HBR; 0.001, 0.01 and 0.1 mgL⁻¹. A total of 28 different treatments were carried out including the control, which included nothing but the basic medium. Appropriate amounts of freshly prepared solutions of growth regulators singly and in combinations of brassinosteroids with gibberellic acid were thoroughly mixed with the basal germination medium during cooling but before attaining a semisolid condition. Pollen was dusted on the media using a fine camel hair brush so as to provide a nearly uniform layer. Petri dishes after inoculation were incubated for 24 h at 26±1°C under room conditions. After the incubation period, the surface of the media was flooded with a fixative solution. This solution contained 20 parts glycerin, 5 parts formaldehyde, 3 parts glacial acetic acid and 72 parts water (Pfahler, 1967). Petri dishes were stored at room temperature and observations on percent germination were recorded from four different areas under a light microscope (Olympus CX41) at 10x magnification.

Statistical analysis was performed using MINITAB statistics package program (ver. 16) for one-way analysis of variance. Data was divided in two groups, one including sole applications of the three hormones and the other including combinations of the hormones. Control group was the same in the both groups. Differences among the meaningful treatments were tested using Duncan's multiple comparison analysis.

Results and Discussion

Pollen viability of the cultivars were tested with IKI staining and results showed that ‘Cabernet Sauvignon’ contained more viable pollens (63.12% that ‘Merlot’ (59.06%).

Results of testing effects of the plant growth regulators belonging to two distinct classes, gibberellins and brassinosteroids, on ‘Cabernet Sauvignon’ and ‘Merlot’ wine grape cultivars were evaluated in two groups for ease of interpretation of the results of the statistical analyses.

Statistical analysis of the sole applications of the hormones and the control showed that effects of the hormones affected *in vitro* pollen germination ratios of the cultivars (Table 1). However, in the pollens of ‘Cabernet Sauvignon’, there were no clear cut differences between the hormones and the control, except for 100 mgL⁻¹ GA₃ treatment. 0.1 mgL⁻¹ HBR showed the greatest effect among the brassinosteroids. In general, type of the brassinosteroid compound did not cause a marked effect on the pollen germination. One interesting result is that HBR caused less germination ratio than the control. This might be the result of totally random observations of the field views.

In ‘Merlot’ pollens, on the other hand, influence of the hormones compared to the control was more apparent and this effect was mostly dependent on the concentration of the hormone to which the pollens were exposed. The greatest germination was obtained from the 100 mgL⁻¹ GA₃ application. 50 mgL⁻¹ GA₃, 0.001 mgL⁻¹ EBR and 0.01 and 0.001 mgL⁻¹ HBR yielded similar ratios with the control.

Table 1. *In vitro* pollen germination ratios (%) of the wine grape cultivars (*Vitis vinifera* L.) exposed to different plant growth regulators

Growth regulators (mgL ⁻¹)	Cabernet Sauvignon	Merlot
GA ₃ 25	17.78 abc	20.85 ab
GA ₃ 50	20.20 ab	12.20 bcd
GA ₃ 100	22.42 a	23.63 a
EBR 0.1	11.85 abc	16.69 abc
EBR 0.01	11.01 bc	17.25 abc
EBR 0.001	13.47 abc	12.06 bcd
HBR 0.1	17.96 ab	16.32 abc
HBR 0.01	7.41 c	10.58 cd
HBR 0.001	9.95 bc	14.05 abcd
Control	10.75 bc	5.55 d

The second group of statistical analysis was done to possibly show any interactions of brassinosteroids in the presence of gibberellic acid at different concentrations (Table 2). ‘Cabernet Sauvignon’ pollens did not react to combination treatments and resulted in 10-35% germination ratios. ‘Merlot’ pollens were affected by the combination applications, although not to a great extent. Most of the hormone combinations did not yield great differences compared with the control group. However, it seemed that effects of epibrassinolide concentrations were more dependent on the GA₃ concentration. For instance, germination was more prominent with 25 mgL⁻¹ GA₃ than with 50 or 100 mgL⁻¹ GA₃. Effects of HBR were somewhat similar to the EBR concentrations, being higher at 25 mgL⁻¹ GA₃ compared to the higher concentrations.

Table 2. *In vitro* pollen germination ratios (%) of the wine grape cultivars (*Vitis vinifera* L.) exposed to combination of different plant growth regulators

Growth regulators (mgL ⁻¹)	Cabernet Sauvignon	Merlot
GA ₃ 25 + EBR 0.1	35.30	11.81 bcd
GA ₃ 25 + EBR 0.01	23.06	15.70 bcd
GA ₃ 25 + EBR 0.001	14.72	11.17 bcd
GA ₃ 50 + EBR 0.1	12.43	17.44 ab
GA ₃ 50 + EBR 0.01	12.22	14.29 abc
GA ₃ 50 + EBR 0.001	16.57	17.32 ab
GA ₃ 100 + EBR 0.1	11.26	11.52 abc
GA ₃ 100 + EBR 0.01	23.25	19.41 a
GA ₃ 100 + EBR 0.001	28.01	16.15 abc
GA ₃ 25 + HBR 0.1	13.13	17.25 ab
GA ₃ 25 + HBR 0.01	12.77	15.10 bcd
GA ₃ 25 + HBR 0.001	12.51	8.26 bc
GA ₃ 50 + HBR 0.1	16.36	13.58 abc
GA ₃ 50 + HBR 0.01	15.77	9.27 abc
GA ₃ 50 + HBR 0.001	20.29	11.61 abc
GA ₃ 100 + HBR 0.1	18.96	9.10 abc
GA ₃ 100 + HBR 0.01	13.02	11.68 abc
GA ₃ 100 + HBR 0.001	10.79	12.56 abc
Control	10.75	5.55 c
mean	16.19	14.01

These cultivars are known for their poor fruit set and tendency to millendrage because of high pollination deficiencies (Kidman et al., 2013). Baby et al. (2016) report that *in vitro* pollen germination of these cultivars had similarities with their *in vivo* conditions and that pollens were less functional. Alva et al. (2015) indicated ‘Cabernet Sauvignon’ germination around 35% in 15% sucrose and calcium chloride containing medium that was kept in the dark. The difference (10.75% vs. 35%) might be due to the constituents of the medium. Sucrose is important for balancing internal and external pressure in organelles and different concentrations were found related to osmotic potential (Alcaraz et al., 2011).

Different studies on grape cultivars stated that high gibbrellins found on anthers and pollens affected pollen germination (Izhaki et al., 2002; Singh et al., 2002). Kimura et al. (1996) showed that pollen germination of cultivar ‘Muscat Bailey A’ was restricted with increasing gibberellin. Similar tendency was also observed for ‘Kozak Beyazı’ and ‘Amasya Beyazı’ grape cultivars, in addition effects of epibrassinolide were cultivar-dependent (Gökbayrak and Engin, 2015).

Conclusion

‘Cabernet Sauvignon’ and ‘Merlot’ are cultivars with generally low viability and germination ability. Information obtained here show that effects of growth regulators change with the

genotype, type of the hormones and composition of the basal growth medium. Brassinosteroids generally enhance *in vitro* pollen germination, but the effect is cultivar and type dependent.

Acknowledgement

This research was funded by the Scientific Research Projects Coordination Unit of Canakkale Onsekiz Mart University. Project code: FBA-2014-343

References

- Alcaraz M.L., Montserrat M., Hormaza J.I. (2011). *In vitro* pollen germination in avocado (*Persea americana* Mill.): Optimization of the method and effect of temperature. *Sci. Hort.*, 130, 152-156.
- Alva, O., Roa-Roco, R.N., Pérez-Díaz, R., Yáñez, M., Tapia, J., Moreno, Y., Ruiz-Lara, S., González, E. (2015). Pollen morphology and boron concentration in floral tissues as factors triggering natural and GA induced parthenocarpic fruit development in grapevine. *PLoS ONE* 10(10): e0139503.doi:10.1371/journal.pone.0139503
- Baby, T., Gilliam, M., Tyerman, S.D., Collins, C. (2016). Differential fruitset between grapevine cultivars is related to differences in pollen viability and amine concentration in flowers. *Australian Journal of Grape and Wine Research*. 22, 149-158.
- Eichhorn, K.W., Lorenz, H. (1977). Phaenologische entwicklungsstadien der rebe. *Nachrichtenblatt des deutschen pflanzenschutzdienstes (Braunschweig)*, 29, 119-120. THIS REFERENCE DOES NOT HAVE AN ENGLISH TITLE AND BEEN CITED THIS WAS IN MANY JOURNALS AND BOOKS.
- Gökbayrak, Z, Engin, H. (2015). Effect of plant growth regulators on enhancing *in vitro* pollen germination in grapevine cultivars. 3rd Balkan Symposium on Fruit Growing, September 16-18, Belgrade, Serbia. (in press)
- Heslop-Harrison, J. (1979). An interpretation of the hydrodynamics of pollen. *Amer. J. Bot.*, 66: 737- 743.
- Hewitt, F.R., Hough, T., O'Neill, P., Sasse, J.M., Williams, E.G., Rowon, K.S. (1985). Effect of brassinolide and other growth regulators on the germination and growth of pollen tubes of *Prunus avium* using a multiple hanging-drop assay. *Aust. J. Plant Physiol.*, 12, 201–211.
- Hormoza, J.I., Herrero, M. (1999). Pollen performance as affected by the pistilar genotype in sweet cherry (*Prunus avium* L.). *Protoplasma*, 208, 129-135.
- Izhaki, A., Borochoy, A., Zamski, E., Weiss, D. (2002). Giberellin regulares post-microsporogenesis processes in petunia anthers. *Physiologia Plantarum*, 115, 442-447.
- Kang, Y.Y., Guo, SSR. (2011). Role of brassinosteroids on horticultural crops. In: *Brassinosteroids: A Class of Plant Hormone*, Springer Science+Business Media, New York. p. 143-192.
- Kidman, C.M., Dry, P.R., McCarthy, M.G., Collins, C. (2013). Reproductive performance of ‘Cabernet Sauvignon’ and ‘Merlot’ (*Vitis vinifera* L.) is affected when grafted to rootstocks. *Australian Journal of Grape and Wine Research* 19, 409–421.
- Kimura, P.H., Okamoto, G., Hirano, K. (1996). Effects of gibberellic acid and streptomycin on pollen germination and ovule and seed development in Muscat Bailey A. *Am. J. Enol. Vitic.*, 47, 152-156.
- Pfahler, P.L. (1967). *In vitro* germination and pollen tube growth of maize (*Zea mays* L.) pollen. Calcium and boron effects. *Canadian Journal of Botany*, 45, 839-845.
- Qi, X.L., Zhang, S.L., Fang, J.B. (2010). Effects of plant growth regulators on pollen germination in kiwifruit. *Nonwood Forest Research* 3, 010.

- Ruijin, Z., Chuanlai, Z. (2010). Effect of gibbereliin and paclobutrazol on pollen germination and tube growth in pear. *Journal of Henan Institute of Science and Technology (Natural Science Edition)* 2, 013.
- Singh, I., Shono, M. (2003). Effect of 24-epibrassinolide on pollen viability during heat-stress in tomato. *Indian J. Exp. Bot.* 41, 174-176.
- Tunistra, M.R., Wedel, J. (2000). Estimation of pollen viability in grain sorghum. *Crop Sci.*, 40, 968-970.
- Singh D.P., Jermakov A.M., Swain S.M. (2002). Gibberellins are required for seed development and pollen tube growth in *Arabidopsis*. *The Plant Cell*, 14, 1-5.
- Viti, R., Bartolini, S., Vitagliano, C. (1990). Growth regulators on pollen germination in olive. *Acta Hort.* 286, 227-230.
- Ylstra, B., Touraev, A., Brinkmann, A.O., Heberle-Bors, E., van Tunen, A.J. (1995). Steroid hormones stimulate germination and tube growth of in vitro matured tobacco pollen. *Plant Physiol.*, 107, 639-643.

THE EFFECTS OF OMEGA FATTY ACIDS ON HUMAN HEALTH

Merve GÖRE, M. Safa HACIKAMILOĞLU, Orhan KURT

1Ondokuz Mayıs University, Faculty of Agriculture, Field Crop of Department, Samsun, Turkey

*Corresponding author: merve.gore@omu.edu.tr

Abstract

Oil is one of the most important organic substances required for human nutrition. Omega fatty acids play an important role in the body's physiological and biochemical activity of constructive and restorative functions and they are effective in the development of healthy tissue. Omega fatty acids consist of Omega-3, Omega-6 and Omega-9 and they have important function in the treatment of obesity, strengthening the immune system and the prevention of cholesterol and heart disease. Poly-unsaturated fatty acid/Saturated fatty acid rate (P / S) is an important quality factor. Higher P/S ratios increases the quality of oil. The most important plant sources for linoleic acid are; sunflower, safflower, soybean, corn, sesame, peanut, cotton and linolenic acid major sources are rapeseed and flax. The lack of omega fatty acids causes many diseases. Saturated fatty acids cause cardiovascular diseases and weight gaining due to fat accumulation. Omega fatty acids such as Omega-3, Omega-6 and Omega-9 have positive effect on health. For adequate and balanced consumption of oil fatty acids, consumers should have minimum and maximum limits. In this paper; the effects of omega fatty acids on human health will be discussed.

Keywords: *Fatty acid, Omega fatty acids, Omega-3, Human Health.*

Introduction

Oil is one of the most significant organic substances required for human nutrition. Oil is derived from plant or animal sources as a natural or refined product. The human body produces fat with the help of special enzymes for metabolic activity (Bayizit, 2003).

The main structural components of fats are called fatty acids. The physical, chemical and physiological properties of oil depend mainly on the type and amount of fatty acids (Kayahan, 2009). The importance of oil in terms of nutrition depends on the number of atoms, saturation degree, number of double bonds between carbon atoms and the position of hydrogen atoms in the molecule (Karabulut and Yandı,2006; Samur, 2006). Fatty acids are divided into five groups; i) Saturated fatty acids, ii) Unsaturated fatty acids, iii) Oxidized fatty acids, iv) Cyclic fatty acids and v) Acetylenic fatty acids.

The Effects of Omega 3 Fatty Acids on Human Health

In recent years, due to increased awareness of health and nutrition, and increased risk of disease, consumers have begun to prefer natural methods rather than synthetic chemical drugs. Several clinical trials indicate that vegetable nutrition reduces chronic diseases, obesity and risk of cancer. Researchers recommend more cereals, fresh fruit and vegetables as opposed to less fat content and animal meat in the diet. The quality of edible vegetable oils depends on the composition and iodine value of the fatty acids (Culbertson, 1954). The ratio of Poly-unsaturated fatty acid/Saturated fatty acid rate (P / S)is a known significant quality factor. Higher ratio presents higher oil quality (Figure 1).

Figure 1. Some vegetable and animal fats of some vegetable and animal fats and rates of P/S.

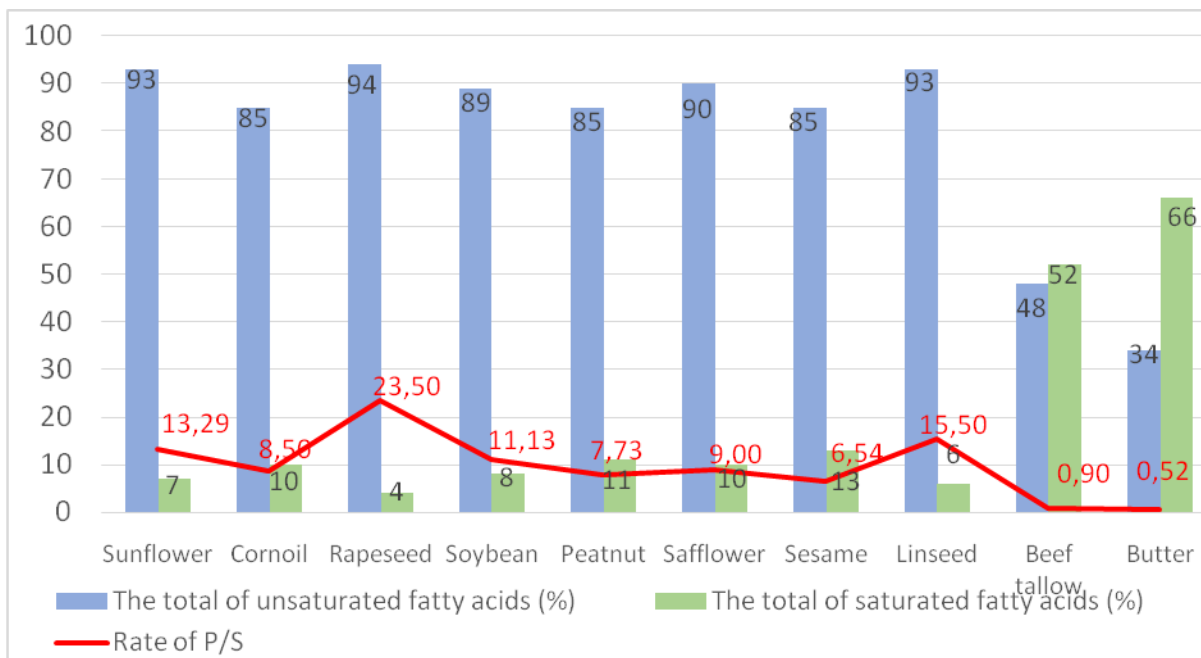

In the last century, the development of food industry affected food consumption and accordingly the fatty acid ratio in food has changed. The Omega-6 consumption trend increases, however the Omega-3 consumption trend decreases (Gómez Candela et al., 2011). The lack of omega fatty acids cause dry skin, asthma, growth retardation, diabetes, certain types of cancer and also learning deficiency (Lewis, 2000).

Omega fatty acids involve in the body's physiological and biochemical activity of constructive and restorative functions and they are effective for development of healthy tissue (Gogus and Smith, 2010).

Omega fatty acids have direct and indirect effects on the body. They indirectly improve the strength of the red blood cells, decrease the blood viscosity, increase the capillary oxygen use, heal heterogenic illnesses, remediate metabolic disorders, strengthen the immune system, decrease the risk of the heart attack and hypertension, and decrease neurotic disorders (Kaya et al, 2004; Leaf and Weber, 1988; Sarica, 2003).

These fatty acids increase birth weight as well as preventing premature birth. Also, the last three months of pregnancy, during which the development of the fetal nervous system and angiogenesis is at its peak and is known to need a lot of Omega-3 (Gordon and Ratliff 1992). Moreover, a small increase in the consumption of Omega-3 fatty acids, reduces the risk of fatal coronary heart disease by 40-50%.

Vegetable Sources of Omega Fatty Acids

Many plants are used as a source of omega fatty acids. Certain plants are very popular across the world. These plants are sunflower, cotton, soybean, rapeseed, safflower, flax, sesame, peanut and corn.

Sunflower

The nutritional value of the sunflower oil is relatively higher than other oilseeds, because of the low saturated fatty acid rate due to high unsaturated fatty acids rate (Figure 1). For that reason, liquid sunflower oil is used in cooking and frying (Harris et al. 1978; Miller et al. 1987). High Omega-9 contained sunflower oil protects metabolic balance and decreases cholesterol. The poly-unsaturated fatty acid in sunflower oil plays an important role in brain functions, body growth and development. It is good for skin and hair health. Also, clinical studies have shown that hyperactive children with attention deficit hyperactivity disorder have low poly-unsaturated fatty acid levels. Researchers recommend sunflower oil for the hyperactivity disorder treatment.

Rapeseed

Rapeseed oil contains 65% oleic, 20% linoleic, 9% linolenic, 4% palmitic and 2% stearic acid. Rapeseed oil has an important role for the central nervous system, eye functions and thrombocyte metabolism. It lowers cholesterol levels and triglyceride levels and increases the viscosity of blood. Moreover, it strengthens the immune system and prevents the formation of atherosclerosis. Rapeseed oil is also preferred as the cooking oil due to less effect on taste.

Cottonseed

Cotton seedoil belongs to the oleic-linoleic acid group of oils due to its 13-44% oleic and 33-58% linoleic acid. The most important saturated fatty acid in this oil is palmitic acid and its rate is 17-29%. One of the most important unsaponifiable matter of vegetable-based oils is tocopherol due to the antioxidant effect. Crude cotton oil is oil rich in natural tocopherols. Heat resistance of cotton oil is higher than other oils; therefore it is an ideal fat for frying. Cottonseed oil regulates bowel movements by softening the digestive system and resolves constipation problems. It enables the rapid repair of wounds in the skin. This oil has muscle relaxant properties. It is effective in reducing pain by stimulating blood circulation, so it is a good antipyretic.

Linseed

Linseed oil contains approximately 9-11% of saturated fatty acids (5-6% palmitic acid and stearic acid 4-5%) and 75-90% of unsaturated fatty acids (50-55% linoleic acid, 15-20% oleic acid, 10-15% linoleic acid) (Robbelen et al., 1989; Carter, 1993). Linseed oil is rich in Omega-3 fatty acids (alpha-linolenic acid) and has many positive effects on human health. Indeed, it has been determined that linseed oil reduces heart diseases and inhibits blood clotting. Omega-3 in flaxseed oil balances high blood pressure and raises good cholesterol. Especially, it has been scientifically proven that alpha-linolenic acid decreases the occurrence of chronic heart diseases. Besides; researchers recommend linseed for forgetfulness, stroke and cancer by consuming linseed oil over the salad or one spoon of seeds per day. In addition, it is a good source of protein, flavonoid, lignan and phenolic acid (Bernera and O' Donnell, 1998; Mazza, 1998; Korthals, 2002).

Safflower

Safflower seed contains 90% unsaturated fatty acids (oleic and linoleic acid). Safflower oil with high linoleic acid (over 70%) is one of vegetable oils that can be used for lowering high blood cholesterol and particularly treats the hardening of the arteries. It also strengthens the immune system. It protects against breast and prostate cancers. Safflower oil improves heart and cardiovascular health, increases muscle tissue, raises the good cholesterol (HDL), and regulates blood sugar levels. It has been determined that it regulates respiratory disorders and bloodstream. Safflower oil decreases the rheumatism pain if applied on to the affected area. Also, it is

preferred for the treatment of obesity due to its fat burning feature and fat storage blocker property of Omega-6.

Sesame

Sesame oil includes 47% oleic (Omega-3) and 39% linoleic (Omega-6). Sesame oil is heart-friendly cooking oil that lowers cholesterol levels. It inhibits some diseases by its secondary metabolites (such as sesamin, sesamol etc.). Sesame oil is a good essential fatty acid which is not produced by the body. Accordingly, sesame oil protects the skin from the harmful effects of the sun and it has an important role in aging. The zinc in sesame oil increases the collagen production of skin and it provides more elastic and softer skin. Sesame oil reduces the plaque formation on teeth and prevents dental problems. Sesame oil sterilizes the mouth when used as a mouth wash.

Soybean

The composition of soybean oil is 20-34% oleic acid (Omega-9), a rate of 49-55% linoleic acid (Omega-6) and the rate of 4-12% linolenic acid (Omega-3). It has considerable benefits for the heart. Soybean oil is used for making mayonnaise, coffee cream, margarine as well as salad dressings in several products in the food industry. Soybean oil cause stronger food taste when fried because of the zero flavor. Fatty acids in soybean oil regulate fat and lipid metabolism in the human body, so it is recommended to people with diabetes, arteriosclerosis or coronary heart disease. It contains many essential amino acids and reduces the risk of breast cancer, colon cancer, prostate cancer and stomach cancer. The use of soybean oil externally causes brighter skin and nails. It prevents hair loss and promotes hair growth. Soybean oil strengthens the immune system. Soybean oil contains A, E, D, K, B vitamins, as well as iron, zinc, phosphorus, magnesium. It regulates bone resorption (osteoporosis).

Corn

Corn oil has 19-49% oleic acid and 34-62% linoleic acid. Corn oil is preferred for frying because of its high burning durability. Corn oil is a rich source of linoleic acid which is good for growth. Corn oil contains tocopherols. This substance with antioxidant effects is an important resource of vitamin E. Corn oil contains vitamins and minerals which are beneficial for health. It is recommended for the prevention of heart disease, diuretic properties and also to reduce kidney stones. According to the studies, phytosterols which inhibit the absorption of cholesterol from the gut have a large effect in reducing blood cholesterol levels. 100 grams of corn oil contains 968 mg of phytosterols. This is the biggest proportion in any vegetable oil.

Peanut

eanut oil contains 47% oleic and 38% linoleic acid. Liquid peanut oil has a clear appearance and very popular for its unique taste and smell. Due to the high content of oleic acid, peanut oil is very nutritional and has desirable physical properties. It is extremely resistant to high temperatures, and particularly preferred for foodstuffs to be stored for some time after frying. In this way, it helps to protect the antioxidant value of packaged products. Resveratrol content of peanut oil inhibits the development of cancer cells. Peanut oil is an alternative product for diabetics because of its sugar balance properties. Peanut oil can be used as a dietary supplement. For this purpose, one or two teaspoons of peanut oil consumption per day, depending on the body needs is recommended. Recent studies have shown that peanut oil accelerates the metabolism and provides appetite control. Dieticians recommended peanut oil to treat obesity and control weight.

Conclusion

In recent years, consumers have come to realize that food is not only basic nutrition to survive, but also for leading a healthy life. Fatty acids are very important for human nutrition. Saturated fatty acids cause fat accumulation and cardiovascular diseases. On the other hand, Omega-3, Omega-6 and Omega-9 fatty acids have positive effects on health. For adequate and balanced consumption of fat, fatty acids should be taken with defined limits and proportions. For a balanced diet, consumers should be educated about fatty acids.

References

- Bayazit A. A. 2003. The Importance of Polyunsaturated Fatty Acid in Diet and Health, *Food and Feed Science Technology*, 3:28-31.
- Berner, L. A., O'Donnell, J. A. 1998. Functional Foods And Health Claims Legislation: Applications To Dairy Foods. *International Dairy Journal*, 8, 355-362.
- Brown A. 2000. Understanding Food. Fish and Shellfish. *Wadsworth /Thomson Learning*, USA; 299 pp.
- Carter, J. F. 1993. Potential of flaxseed and flaxseed oil in baked goods and other products in human nutrition. *American Association of Cereal Chemists Inc.*
- Culbertson, J. O. 1954. Seed Flax Improvement. *Advanced in Agronomy* Vol. 6, 144-182.
- Gogus, U., Smith, C. 2010. Omega-3 Omega fatty acids: a review of current knowledge. *Int. J. Food Sci. Technol.*, 45: 417-436.
- Gómez Candela, C., Bermejo López, L.M., Loria Kohen, V. 2011. Importance of a balanced omega 6/omega 3 ratio for the maintenance of health. *Nutritional recommendations*. *Nutrición Hospitalaria*, 26(2):323-329.
- Gordon, D. T. 1992. Ratliff V. The implications of omega-3 fatty acids in human health, *Advances in Seafood Biochemistry Composition and Quality*, Ed. By George L. Flick; 406 pp.
- Harris, H. C., McWilliam J. R., Mason, W. K. 1978. Influence of temperature on oil content and composition of sunflower seed. *Australian Journal of Agricultural Research*, 29, 203-212.
- Hasler, C. M. 2002. Functional foods: Benefits, concerns and challenges. A position paper from the American Council on Science and Health. *J. Nutr.* 132: 3772-3781.
- Karabulut, H. A., Yandı, İ. 2006 Effects on health and importance of omega-3 fatty acids in seafood. *Ege Journal of Fisheries and Aquatic Sciences* ., 23(1/3): 339-342.
- Kayahan, M. 2009. Trans Fatty Acids for Healthy Nutrition. s. 7-11. II. Traditional Food Symposium. 27-29 Mayıs 2009, Van.
- Kaya Y, Duyar H. A., Erdem, M. E. 2004. The importance of fish fatty acids on human health. *Ege Journal of Fisheries and Aquatic Sciences*; 21 (3/4): 365-370.
- Kolanowski, W., Laufenberg, G. 2006. Enrichment of food products with polyunsaturated fatty acids by fish oil addition. *Eur. Food Res. Technol.*; 222: 472 - 477.
- Korthals, M. 2002. The Struggle Over Functional Foods: Justice And The Social Meaning of Functional Foods. *Journal of Agricultural and Environmental Ethics*, 15, 315-324.
- Leaf, A., Weber, P. C. 1988. Cardiovascular effects of w-3 fatty acids. *The New Engl. J. of Med.*, 318:549-557.
- Lewis N. M., Seburg, S., Flanagan, N. L. 2000. Enriched eggs as a sourced of Omega-3 polyunsaturated fatty acids for humans. *Poult. Sci.*, 79: 971-974.
- Mazza, G. 1998. Flaxseed Products For Disease Prevention. In: *Functional Foods, Biochemical and Processing Aspects*, Lancaster, Pennsylvania: Technomic Publishing Company, 91-127.
- Röbbelen, G., Downey, R. K., Ashi, A. 1989. *Oil Crops of the World*. McGraw-Hill Inc.

- Samur, G. 2006. Nutrition in Cardiovascular Disease. ISBN: 975-590-181-7, Sinem Typography, Ankara.
- Sarıca, Ş. 2003. Effects of Omega-3 Fatty Acids on Human Health and Enrichment of Poultry Meat in Omega-3 Fatty Acids. *Animal Production*; 44(2): 1-9.

POPULATION DYNAMICS OF APHIDS AND NATURAL ENEMIES ON DIFFERENT WHEAT CULTIVARS IN AYDIN PROVINCE, TURKEY

Yunus CAVDIR, Ibrahim GENCSOYLU^{1*}

¹Department of Plant Protection, Faculty of Agriculture, Adnan Menderes University, Aydın, Turkey

*Corresponding author: igencsoylu@adu.edu.tr

Abstract

The study was conducted to determine the population dynamics of aphids and natural enemies on different wheat varieties in Aydın Province, Turkey. Nine wheat varieties (Kiziltan, Atalay, Yaren, GAP, C1252, Tuten 2000, Ege, Turabi and Solen 2000) were used in the study. The experimental plot consisted of 8 m in length and 5 rows with three replicates. The sampling was begun on March 11, 2015 and finished at the end of harvest. The population densities of nymphs and adults of aphids were recorded at weekly intervals. Ten plants were randomly selected for each replicate and totally thirty plants for each variety was checked visually. Natural enemies were also recorded during the sampling of aphids. At the end of the study, three aphid species, *Sitobion avenae* (Fabricius), *Metopolophium dirhodum* (Walker) and *Rhopalosiphum padi* (L.), were recorded. *Coccinellie septempunctata* L. and *Chrysoperla carnea* (Stephens) as predators and *Aphidius rhopalosiphii* De Stefani Perez as a parasitoid were also recorded during the study. Population of aphids were reached to the highest population on May 6th 2015 with 4.2 ± 2.2 on Turabi and followed with 3.7 ± 0.5 on Solen 2000 variety. The population was not observed after the end of May. The mean number of aphids per year was statistically important and lowest on GAP, Tuten 2000, Ege (0.7 ± 0.5), and followed by Yaren (0.8 ± 0.5), Kiziltan (0.9 ± 0.5), Atalay (0.9 ± 0.8), Turabi (1.1 ± 1.0), Solen 2000 (1.2 ± 1.0) and C1252 (1.4 ± 0.7). Natural enemies were observed from the first week of April to the end of May and more predators were recorded on Ege, Tuten 2000 and C1252 varieties. Parasitic rate was higher on Tuten 2000, Turabi and C1252. As a result, the population of aphids in the region was observed under the economic injury level. However, it seems to be a potential pest for the wheat and the three wheat varieties could be effective in managing against the aphids and important tool for IPM program.

Keywords: *Wheat varieties, Aphids, Natural enemies, Parasitoids, Predators, Turkey*

Introduction

Wheat (*Triticum aestivum* L.) is a main cereal crop of Turkey and cultivated over 78 668 874 decare with annual production of 22 600 000 tone in 2015 (Anonymous, 2015) and plays important role as a field crop in country economy. Aydın which is the western city of Turkey has important place in this production with this 220.996 decare. Wheat is attacked by aphids that are small insect and causes serious damage by sucking cell sap, young shoots, injecting toxic salina into the tissues, distortion, leaf curling, twisting, wilting and also transmit the plant viruses and finally reduce the yield. They also result in glutenin and gladin content (Gianoli, 1999; Basky and Fonagy, 2003). Elmalı and Toros (1997) reported that *S. avenae* caused 2.25 % loose of crude protein, and average loss of 1000-grain weight for all varieties was 10.16%. *Sitobion avenae* (Fabricius), *Rhopalosiphum padi*, Linnaeus, *Metopolophium dirhodum* (Walker), *Rhopalosiphum maidis* (Fitch), *Schizaphis graminum* (Rondani), *Sipha maydis* (Passerini), *Sipha elegans* Del Guercio are the main aphids species in Turkey (Özder and Toros 1999; Toros et al., 2002; Yiğit et al., 2007;

Aslan, 2002). However, the aphid species varied according the regions in the country. Sertkaya and Yiğit (2002) reported that *R. padi* and *S. avenae* were recorded in Antakya. In addition to the two aphids, Bilgin (2006) also mentioned that *S. gaminum* and *M. dirhodum* was found in Kahramanmaraş. On the other hand, *D. noxia* was found in Konya (Elmalı 1998) and Tekirdağ (Özder and Toros, 1999). *S. avenae* infests ont only upper leaves but also head, whereas *R. padi* prefers to colonize the leaf sheats and lower leaves of wheat plants (Gianoli, 2000).

Cereal aphid infestation may be limited by some management strategies. One of them is host plant resistance due to economical and environmentally effect (Webster and Inayatullah, 1984; Tyler et al., 1987). Aphid population density affected by abiotic and biotic factors such as both predator and parasitoits (Naeem et al., 2002). As natural enemies *Coccinella septempunctata* (L.), *C. undecimpunctata*, *Synharmonia conglobata* (L.), *Adonia variegata* (Goeze), *Episyrphus baleatus* (DeGeer), *Metasyrphus corollae* (F.), *Melanostoma mellinum* (L.), *Meliscaeva auricollis* (Megeu), *Sphaerophoria scripta* (L.), *Chrysoperla carnea* (Stephens) *Lysiphlepus faborum* (Marchall) and *Ephedrus plagiator* and parasitoid, *Aphidius uzbektanicus* Luthetzki were found in wheat fields (Kıran, 1994; Yiğit et al., 2007). Also, Elmalı and Toros (1994) reported that 14 *Coccinellidae*, three Syrphidae, one Chamaemyiidae, one Miridae, two Nabidae species, were found as predators and 4 aphidiid and 1 aphelinid were determined as parasitoids. The also mentioned that the most common species was Coccinellidae species. In the region no study was conducted on aphids and their natural enemies. Therefore, the aim of the study was determine the aphid species and natural enemies on different varieties in Aydın province, Turkey.

Material and Methods

The study was conducted at Research Farm of Faculty of Agriculture, Adnan Menderes University, during 2014-2015 wheat growing season. The study site was located in the city of Aydın. Nine wheat varieties (Kiziltan, Atalay, Yaren, Tuten 2000, C1252, Turabi, Solen 2000) were sown on 19 November 2014. The experiment was 8 m in long with five rows and three replacates. Population of aphids and natural enemies were recorded from ten randomly selected tillers from each replication at the each week and 2 m space left to reduce the edge effect. The sampling was started on 11 March 2015 and lasted till the breakdown of the population in the field. The insect samples collected were transferred into the bottle. 70% ethanol was added to kill and preserve all insects for identification. Parasitoids in the experiment live through their larval stage mainly in the mummies of the aphids. The mummies were collected and transferred into the lab and reared for 20 day to lay and then send to specialist for identification. The wheat was cultivated in accordance with recommended agriculture practices and no insecticides were applied during the study. All data were analyzed by SPSS programme ($p < 0.05$)

Results and Discussion

Three aphid species, *R. padi*, *S. avenae* and *M. dirhodum* were recorded in this study. The population of aphids species remained very low in March, started increasing in the first week of April and reached to the highest level on the first week of May. They were reached to the highest population on May 6th 2015 with 4.2 ± 21.7 on Turabi and followed with 3.7 ± 0.5 on Solen 2000 variety. The population was not observed after the end of May (Table 1). The mean number of aphids per year was statistically important and lowest on GAP, Tuten 2000, Ege (0.7 ± 0.5) whereas it is more with 1.4 ± 0.7 on C1252 (Table 3). The reason for this differences that C1252 and Turabi varieties have got late maturing wheat species and aphids feeds more time on this variety. Marek (2007) reported that 8.2 aphid/tiller did not affected head length, plant height and 1000-grain weight on Kyber 87 varieties.

Table 1. Mean number of aphids per tiller on different wheat varieties in 2015

Dates	Kiziltan	Atalay	Yaren	Gap	Tuten 2000	C1252	Ege	Turabi	Solen 2000
11.03.15	0.6 ±0.4BC	0.6.0±0.1AB	0.6±0.1 AB	0.3±0.2C	0.6±0.1B	1.2±0.1BCDE	0.7±0.3B	0.8±2.6CD	1.1±0.5ABC
18.03.15	0.7±0.4BC	1.3.±0.7AB	0.6±0.4AB	0.6±0.4ABC	0.8±0.3 AB	1.1±0.3BCDE	1.1±0.1AB	1.0±1.8BCD	0.8±0.2BC
24.03.15	0.8±0.3BC	1.3±0.4 AB	0.9±0.5 AB	0.8±0.1ABC	1.0±0.5AB	1.8±0.3ABC	0.5±0.2B	0.5±2.4CD	1.4±0.1ABC
01.04.15	1.6±0.4AB	1.6±1.5 AB	1.6±0.7 AB	1.6±0.6A	0.8±0.4AB	2.7±0.6AB	1.2±0.2AB	0.5±1.2CD	2.1±0.8ABC
08.04.15	1.1±0.6ABC	1.2±0.3 AB	0.6±0.1 AB	1.5±0.2AB	0.7±0.2B	1.6±0.4ABCD	0.7±0.4B	2.5±9.0ABC	1.5±0.2ABC
15.04.15	0.5±0.2BC	0.7±0.2 AB	0.9±0.5 AB	0.7±0.4ABC	1.1±0.4AB	1.1 ±0.5BCDE	0.3±0.1B	0.2±0.6CD	0.8±0.5BC
22.04.15	0.6±2.6BC	0.8±0.7 AB	1.2±1.0AB	0.4±0.1 BC	0.4±0.2B	0.5±0.1CDE	1.3±0.6AB	0.4±3.2CD	0.6±0.3BC
29.04.15	1.1±0.5ABC	0.6±0.4AB	1.4±0.9AB	1.0±0.1ABC	2.3±1.5A	0.8±0.4CDE	0.6±0.4B	3.0±8.3AB	3.3±1.7AB
06.05.15	2.1±0.2A	2.9±2.0A	1.9±0.5 A	0.9±0.1ABC	1.2±0.3AB	3.0±0.3A	2.2±1.0 A	4.2±2.2A	3.7±0.5A
13.05.15	1.4±0.7AB	0.8±0.3AB	0.7±0.2 AB	0.6±0.3ABC	0.2±0.1B	2.0±0.5ABC	0.3±0.2B	0.6±3.2CD	0.6±0.3BC
20.05.15	1.4.0±0.4AB	0±0B	0.1±0.1B	0±0C	0.1±0.1B	2.7±1.2AB	0.3±0.3B	0±0D	0.01±0.1C
29.05.15	0.7±0.3C	0±0B	0±0B	0±0C	0±0B	0.2±0.1DE	0±0B	0±0D	0±0C
03.06.15	0±0C	0±0B	0±0B	0±0C	0±0B	0±0E	0±0B	0±0D	0±0C

Table 2. Number of main predators on different wheat varieties in 2015

Dates	Kiziltan		Atalay		Yaren		Gap		Tuten 2000		C1252		Ege		Turabi		Solen 2000		
	CS	CC	CS	CC	CS	CC	CS	CC	CS	CC	CS	CC	CS	CC	CS	CC	CS	CC	
08.04.15	0	0	0	0	0	0	0	1	1	0	1	1	1	0	0	0	0	0	0
15.04.15	0	0	0	0	0	0	0	0	0	1	0	0	0	0	3	0	0	0	0
22.04.15	1	0	0	0	1	0	2	0	0	0	0	0	3	0	0	0	0	0	0
29.04.15	0	0	0	0	2	0	0	0	0	0	2	0	1	0	1	0	1	0	0
06.05.15	1	0	4	0	3	0	2	0	4	0	3	2	5	1	2	0	5	0	0
13.05.15	2	0	2	0	3	0	4	0	7	0	1	0	3	0	10	0	0	0	0
20.05.15	4	0	0	0	0	0	1	0	0	0	1	0	0	0	0	0	1	0	0
29.05.15	0	0	0	0	0	0	0	0	0	0	0	0	0	0	0	0	0	0	0
03.06.15	0	0	0	0	0	0	0	0	0	0	1	0	0	0	0	0	0	0	0
Total	8	0	6	0	9	0	9	1	12	1	9	3	13	1	7	0	7	0	0

CS: *Coccinella septempunctata*, CC: *Chrysoperla carnea*

Akhtar (2010) also reported that 12.6 and 14.4 aphid/tiller on Punjab-96 and Inqlab-91 reduced 3.96-7.36% yield. In the study the population has not reached to economic injury level. Therefore it seems to be present insect, but not harmful in the region. *D. noxia* was not found in the region and other region except middle part of Turkey (Altınayar, 1981; Elmalı, 1996). The reason is probably climatic condition.

Table 3. Mean number of aphid populations per year on wheat varieties during the 2015-2016 wheat- growing season.

Varieties	Mean number
Kiziltan	0.9 ±0.5BC
Atalay	0.9 ±0.8BC
Yaren	0.8 ±0.5 BC
Gap	0.7 ±0.4C
Tuten 2000	0.7 ±0.5C
C1252	1.4 ±0.7 A
Ege	0.7 ±0.5C
Turabi	1.1 ±1.0ABC
Solen 2000	1.2 ± 1.0AB

*The capital letters shows significant differences (p<0.05)

Table 4. Parasitism rate (%) with aphids during the 2015-2016 wheat growing season

Date	Kıziltan	Atalay	Yaren	Gap	Tuten 2000	Ç1252	Ege	Turabi	Şölen 2000
11.03.15	5,3	0	0	0	5,0	5,1	0	4,2	0
18.03.15	4,4	0	0	0	0	2,9	0	6,5	0
24.03.15	4	0	3,7	0	9,1	3,5	12,5	0	2,4
01.04.15	4	2,1	4,0	5,8	7,4	11,1	2,8	6,7	0
08.04.15	5,9	2,9	5,6	8,3	16,0	3,9	8,3	2,6	8,3
15.04.15	6,8	0	10,0	4,8	3,0	5,3	9,1	0	2,2
22.04.15	5,3	0	2,6	7,7	15,4	7,2	2,5	21,4	7,7
29.04.15	3,1	2,4	3,2	1,4	0	0	3,2	0	0
06.05.15	1,6	2,2	1,8	0	5,1	0	0	0,8	0
13.05.15	0	0	0	0	0	0	0	0	0
20.05.15	0	0	0	0	0	0	0	0	0
29.05.15	0	0	0	0	0	0	0	0	0
03.06.15	0	0	0	0	0	0	0	0	0

Coccinellie septempunctata L. and *Chrysoperla carnea* (Stephens) as predators and natural enemies were observed from first week of April to the end of May and more predators were recorded on Ege, Tuten 2000 and C1252 varieties (Table 2). It seems that the most important predators is *C. septempunctata*. Krotova (1994) supported the study that he mentioned 17 species of coccinellids as predators of which *C. septempunctata* was the most important. As a

parasitoid *Aphidius rhopalosiphi* De Stefani Perez was recorded during the study. Parasitism percentage was not seen till middle of March then observed and reached different level on the varieties. The highest parasitism percentage was observed on Turabi variety with 21,4 % on late April and followed by Tuten 2000 (16%), Ege (12,5%), C1252 (11.1%), Yaren (10%), GAP and Solen (8.3%), Kiziltan (6.8%) and Atalay (2.9%) (Table 4). In contrary *A. uzbekistanicus* was recorded in other wheat field of the country (Aslan et al ., 2004; Yiğit el al., 2007; Yiğit and Sertkaya, 2007). Bilgin et al. (2008) mentioned that the highest parasitism percentage was 17.9-18.4% in Golia and Zenit cultivars and had important role on the suppression of *R. padi* in wheat. The study was supported by the references.

Conclusion

The observed population of aphids in the region was under the economic injury level. However, it seems to be a potential pest for the wheat. Natural enemies were also low, but if we increase the natural enemy population through its rearing in the laboratory at the peak level, we reduce the infestation and improve the wheat quality and yield. It can be concluded that the three wheat varieties could be effective in managing against the aphids and important tool for IPM program.

Acknowledgment

Thanks to Dr. Işıl Özdemir for identification of aphid species and Prof. Dr. Zeljko Tomanovic for identification of parasitoids.

References

- Ananonym, 2015. <http://www.tuik.gov.tr/UstMenu.do?metod=temelist>
- Aslan, M. M., 2002. Determination of Aphdiodidae (Homoptera) species and their parasitoids and predators in Kahramanmaraş. Ç. U. Graduate School, Ph.D. Thesis, No: 672,136. (In Turkish).
- Altınyar, G., 1981. Research on determining insect faunas in the wheat field of Central Anatolia. Bitki Koruma Bülteni, 21:53-89. (In Turkish).
- Akhtar, N., R.T. Hashmat, G. Jilani, S.U.R. Chughtai,, Ehsan-UI-Haq, M. Irshad, Ata-UL Mohsin., and S. Yasmin, 2007. Resistance of different wheat lines to *Rhopalosiphum padi* (L.) (Aphididae : Homoptera) in Pakistan. Pakistan Journal of Zoology, 39: 191-194.
- Basky Z., and A. Fonagy. 2003. Glutenin and gliadin contents of flour derived from wheat infested with aphid species. Pest Management Science, 59:426-430.
- Bilgin, M. G., 2006. Population dynamics of aphids and their natural enemies in the wheat field of Kahramanmaraş province, Kahramanmaraş Sütçü İmam University, Graduate School Master Thesis, 51s.(In Turkish).
- Bilgin, M.G., T.Ç. Özsisli, and A.A. Işıkber, 2008. Population density and natural enemies of aphids in the wheat fields in Kahramanmaraş province (Turkey). KSÜ Fen ve Mühendislik Dergisi, 11:97-107. (In Turkish).
- Elmalı, M., and S. Toros, 1994. Research on determining aphids and natural enemies in the wheat field of Konya province. Türkiye III. Biyolojik Mücadele Kongresi, 13-18.(In Turkish).
- Elmalı, M., and S. Toros, 1997. Effect of *Sitobion avenae* (F.) (Homoptera: Aphididae) on wheat yield and quality. Türk Entomoloji Dergisi, 21:109-118. (In Turkish).
- Elmalı, M., 1998. Russian wheat aphid in Konya province. Euphytica, 100: 69-76.
- Dong, H., K. K. Nkongolo and J. S. Quick, 1994. Progress and problems in transfer of Russian wheat aphid resistance from Russian triticale to wheat. Proc. Ann. Russ. Wheat Aphid, 6: 133-138.

- Gianoli, E., 2000. Competition in cereal aphids (Homoptera: Aphididae) on wheat plants. *Environmental Entomology*, 29: 213-219.
- Kıran, E., 1994. Investigation on aphid species and their natural enemies in Southeast Anatolia Region. *Türkiye III. Biyolojik Mücadele Kongresi Bildirileri*, (25-28 Ocak 1994) İzmir: 29-37. (In Turkish).
- Krotova, I.G. 1994. Coccinellids (Coleoptera: Coccinellidae) entomophages of cereal aphids in the Priob Forest Steppe. *Siberian Scienti. Res. Ins. Agri. and Farm. Siberia*, 5: 43-50
- Naeem, M., S.G. Compton and L.D. Incoll, 2002. Population trends of barley feeding aphids and their parasitoids to an agro forestry environment system. *Pakistan Journal of Agricultural Research*, 5: 43-52.
- Özder, N., and S. Toros, 1999. Investigation on the wheat aphids (Homoptera: Aphidiade in Tekirdağ province. *Türkiye Entomoloji Dergisi*, 23:101-110. (In Turkish).
- Sertkaya, E., and A. Yiğit, 2002. Aphid species, injurious on wheat and their natural enemies in Antakya province. *Türkiye 5. Biyolojik Mücadele Kongresi*,:265-274.(In Turkish).
- Yiğit, A., E. Sertkaya, and M. Tiryakioğlu, 2007. Population fluctuations of cereal aphids *Rhopalosiphum padi* (L.) and *Sitobion avenae* (F.) (Homoptera: Aphididae) and their impact on crop loss parameters of wheat. *Türkiye Entomoloji Dergisi*, 31:21-34. (In Turkish).
- Toros, S., N. Uygun, R. Ulusoy, S. Satar and I. Özdemir, 2002. Aphidoidea species in East Mediterrean Region. Ministry of Agricultural and Rural Affairs, Ankara, 108s.(In Turkish).
- Tyler, J. M., J. A. Webster and O. G. Merkle, 1987. Designations for genes in wheat germplasm conferring greenbug resistance. *Journal of Crop Science*, 27: 526-527.
- Webster, J. A. and C. Inayatullah, 1984. Greenbug (Homoptera: Aphididae) resistance in triticale. *Journal of Environmental Entomology*, 13:444-447.

RESULTS OF INVESTIGATION ON SOME BIO -MORPHOLOGICAL TRAITS OF BURLEY TOBACCO VARIETIES

Karolina KOCOSKA*, Ilija RISTESKI

University "St. Kliment Ohridski" - Bitola - Scientific Tobacco institute - Prilep,
Republic of Macedonia

*Corresponding author: karolina_kocoska@yahoo.com

Abstract

During 2009, 2010 and 2011 field trials were carried out in Scientific Tobacco Institute – Prilep (Republic of Macedonia) with three varieties of Burley tobacco (American fertile variety B-21 (used as a check) and domestic varieties B-2/93 and Pelagonec CMS F₁). Investigations were made on diluvial soil, using randomized block design with 8 replications at 90 x 50 cm spacing. The obtained results were statistically processed by the method of analysis of variance and tested with LSD test. During the growing season, morphological measurements were made on 20 stalks of each variety. The following traits were included in the analyzes: time of flowering, length and width of the 5th, 10th and 15th leaf, stalk height and number of leaves. In most of these traits domestic varieties proved to be superior to the fertile variety B-21 Ø, with some advantage of the variety Pelagonec CMS F₁. Typical Burley characteristics make this variety attractive both for farmers and manufacturers. In present conditions, it can be used as initial variety for restarting the production of Burley tobacco in R. Macedonia, but it can be also interesting for neighboring countries and wider. The obtained results can help producers to make decision which genotype to use in the start of the production cycle.

Keywords: *tobacco, variety, Burley tobacco, leaves, stalks.*

Introduction

The share of Burley tobacco raw in technological blends ranges between 25 and 30%. Cigarette factories find this raw material attractive due to its flexible use. Burley leaves are characterized by high combustibility and filling capacity and good absorption of casings that improve the taste of tobacco blends. The production of Burley tobacco in Republic of- Macedonia started in the 60s of the last century on small areas intended for experimental purposes in Scientific Tobacco Institute-Prilep. Since then, the Department of genetics, selection and seed control together with the departments of Chemistry, Agrotechnics and Technology is working on creation of new varieties of Burley tobacco and finding the appropriate cultural practices in order to obtain raw material with higher use value. Analyzis of length: width ratio in the 5th, 10th and 15th leaf shows a tendency of increase from the lower to the upper insertions and that Macedonian varieties are characterized by larger leaf size.

Material and Methods

During 2009, 2010 and 2011 investigations were conducted in the field of Scientific Tobacco Institute – Prilep (Republic of Macedonia) with three varieties of Burley tobacco (American variety B-21 and domestic male-sterile varieties B-2/93 and Pelagonec CMS F₁). Investigations were set up in randomized block design with 8 replications at 90 x 50 cm spacing on 657 m², with dimensions 5 m x 131.4 m. In each replication the 3 tested varieties were sown in 6 rows,

five of which were harvested and one was used for morphological investigations. The number of stalks of each variety per harvest was 45, and total number of stalks in the whole trial was 360. During the growing season, 10 stalks of each variety were used for morphological measurements of the 5th, 10th and 15th leaf, stalk height with inflorescence and total leaf number per stalk.

Results and Discussion

Plant height (cm) and leaf number per plant

Burley tobacco belongs to the group of high tobaccos, but this morphological trait depends on agro-ecological conditions, cultural practices, soil composition and the available moisture. The variety B-21 in 2009 (Table 1) was characterized by minimum height (124.9 ± 0.21), with d 1.30 standard deviation and variability coefficient of 1.04% (2009), 1.40% (2010) and 1.08% (2011). Macedonian variety Pelagonec was the highest and had the lowest variation coefficient compared to other two varieties, ranging from 0.27% in 2009, 0.45% in and 0.63% in 2011.

Table 1. Plant height with inflorescence, in cm

VARIETY	2009			2010			2011			Average	Relative difference	
	$\bar{x} \pm s$	σ	cV %	$\bar{x} \pm s$	σ	cV %	$\bar{x} \pm s$	σ	cV %			
B-21 \emptyset	124.9±0.21	1.30	1.04	131.2±0.29	1.83	1.40	125.8±1.12	1.36	1.08	127.3	100.00	
B-2/93	167.6±0.15 ⁺⁺	0.97	0.58	177.0±0.22 ⁺⁺	1.39	0.79	178.0±1.27	2.13	1.20	174.2	136.84	
Pelagonec	179.4±0.08 ⁺⁺	0.49	0.27	193.5±0.14 ⁺⁺	0.88	0.45	191.5±1.15	1.22	0.63	188.1	147.76	
2009	LSD Stalk height 5% = 1.18 cm ⁺ 1% = 1.63 cm ⁺⁺			2010	LSD Stalk height 5% = 1.65 cm ⁺ 1% = 2.29 cm ⁺⁺			2011	LSD Stalk height 5% = 2.06 cm ⁺ 1% = 2.85 cm ⁺⁺			

According to the presented data, the average height ranges from 127.3 cm in the check variety B-21 to 188,1 cm in Pelagonec (47.76% higher compared to the check). Plants of B-2/93 variety were 174.2 cm high, i.e.36.84% higher than the check.

Stojanov, and Apostolova (1999), in their research of newly created Burley tobacco varieties reported that the average stalk height in variety B 1317 was 158 cm while in B-1351 it ranged between 165 and 170 cm.

Ristevski (2006) reported that average stalk height in several varieties of Burley tobacco ranged from 156 cm to 189 cm and the average number of leaves varies from 25.7 to 29.

Table 2. Leaf number

VARIETY	2009			2010			2011			Average	Relative difference	
	$\bar{x} \pm s$	σ	cV %	$\bar{x} \pm s$	σ	cV %	$\bar{x} \pm s$	σ	cV %			
Ø	26.6±0.15	0.92	3.45	27.0±0.11	0.70	2.59	27.0±0.10	0.65	2.42	26.87	100.00	
B-21	30.0±0.15 ⁺⁺	0.99	3.31	31.3±0.09 ⁺⁺	0.59	1.90	31.2±0.10	0.63	2.02	30.83	114.74	
Pelagonec	31.7±0.12 ⁺⁺	0.75	2.35	33.3±0.09 ⁺⁺	0.59	1.76	33.0±0.12	0.75	2.28	32.67	121.59	
2009	LSD Leaf number 5%= 1.82 ⁺ 1%= 1.14 ⁺⁺			2010	LSD Leaf number 5%= 0.75 ⁺ 1%= 1.04 ⁺⁺			2011	LSD Leaf number 5%= 0.97 ⁺ 1%= 1.34 ⁺⁺			

Data in Table 2 reveal correlation between number of leaves and height of the stalk. The highest leaf number of 32,67 was observed in variety Pelagonec, i.e. 21.59% more than the check. Leaf number of B 2/93 averaged 30.83, or 14.74% more than the check variety.

According to Uzunoski (1985), the introduced American variety Burley B-21 has variable height, ranging from 140 to 230 cm, and the average number of leaves is 24.

According to the results of two-year investigations it can be stated that the obtained data on stalk height and leaf number are typical of Burley tobacco. Climate conditions in 2010, characterized by higher humidity, directly influenced the increased stalk height and leaf number of the varieties included in the trial. In all three years, the investigated varieties showed 5 % significance and lower coefficient of variation compared to the check.

-Characteristics of the 5th leaf

According to its position, the 5th leaf belongs to the lower part of the plant. With different varieties of Burley tobacco it differs in several morpho-technological, chemical and tasting characteristics. Data presented in Table 3 reveal that leaf length in the first year of investigation (2009) was lower compared to 2010.

The average length of the 5th leaf was the lowest (43.80 cm) in the check variety B-21 and the highest (55.00 cm) in Pelagonec (25.57% more compared to the check).

Width of the 5th leaf was the lowest in the check B-21 (28.4 cm) and the maximum width was measured in the variety Pelagonec (38.4 cm, i.e. 33.80% more compared to the check). The average length:width ratio was the lowest in B 2/93 and Pelagonec (1.43) and highest in the check B-21. These data indicate that the check variety has slightly elongated form of the 5th leaf compared to other two varieties.

Ristevski (2006) in his investigation on six varieties of Burley tobacco in the region of Prilep during 1999-2001 reported that the average length of the 5th leaf was 43-52 cm and the average width 27 - 34 cm.

Table 3. Morphological measurement of the 5th leaf

Varieties	Length of the 5th leaf				Width of the 5th leaf			Length : Width ratio		
	Year	Length	Average 2009/11	Index	Width (cm)	Average 2009/11	Index	L:W ratio	Average 2009/11	Index
B-21	2009	42.5			28.8			1.48		
	2010	45.5	43.8	100.00	28.6	28.4	100.0	1.59	1.54	100.00
	2011	43.4			27.8			1.56		
B-2/93	2009	48.3			34.9			1.38		
	2010	50.9	50.0	114.16	34.3	34.4	121.12	1.48	1.45	95.00
	2011	50.8			34.0			1.49		
Pelagonec	2009	53.7			38.7			1.39		
	2010	55.2			37.1	38.0	133.80	1.49	1.45	95.00
	2011	56.1	55.0	125.57	38.2			1.46		

Characteristics of the 10th leaf

Tenth leaf is positioned in the middle part of the stalk, where tobacco leaves are the largest in size. Characteristics of this leaf are presented in Table 4.

The lowest 10th leaf length (53.53 cm) was measured in the check variety B-21 and the highest (66.60 cm) was recorded in Pelagonec (24.41% higher index compared to the check). In respect of this trait, B 2/93 showed better results compared to the check, having a leaf length of 60.78 cm, i.e. 13.54% more than the check variety. In 2009 the lowest leaf width was measured in B-21 variety (29.5 cm) and the highest in varieties B 2/93 and Pelagonec (33.4 cm and 34.5 cm). In 2010 and 2011, the width of the leaves was higher and ranged from 36,8 cm in the check to 39,1 cm in varieties B 2/93 and Pelagonec.

The lowest average width of the 10th leaf (32.43 cm) was observed in the variety B-21 and the highest (37.27 cm) in Pelagonec (14.92% higher index compared to the check variety). In B 2/93, the average width of the 10 th leaf was 35.50 cm, i.e. 9.47% higher index compared to the check variety. Cavkaroski et al. (1991), in their trials with 10 varieties of Burley tobacco set up in the regions of Prilep and Bitola in 1988 and 1989, reported great variations in leaf size and height of the stalk under the influence of agro-ecological conditions and smaller variations in number of leaves per stalk.

Table 4. Morphological measurements of the 10th leaf

Varieties	Length of the 10th leaf			Width of the 10th leaf			Length : Width ratio			
	Year	Length	Average 2009/11	Index	Width (cm)	Average 2009/11	Index	L:W ratio	Average 2009/11	Index
B21	2009	50.4			29.5			1.77		
	2010	56.2	53.53	100.00	36.8	32.43	100.00	1.53	1.68	100.00
	2011	54.0			31.0			1.74		
B-2/93	2009	58.3			33.4			1.75		
	2010	62.8	60.78	113.54	39.1	35.50	109.47	1.60	1.71	101.79
	2011	61.1			34.0			1.79		
Pelagonec	2009	63.2			34.5			1.83		
	2010	68.8	66.60	124.41	39.1	37.27	114.92	1.76	1.79	106.55
	2011	67.8			38.2			1.77		

Characteristics of the 15th leaf

The lowest average length of the 15th leaf was recorded in the check variety B-21 (53.97 cm) and maximum length (60.27 cm) in variety Pelagonec (i.e. 11.67% higher index compared to the check).

Also the variety B 2/93 showed better results, achieving 56.63 cm length of the 10th leaf and 4.93% higher index compared to the check.

The lowest leaf width was measured in 2011 in B-21 variety (22.5 cm) and maximum (29.8 cm) in variety Pelagonec (2010). The lowest average width of the 15th leaf (22.83 cm) was measured asgain in the check variety B-21 and the maximum width was observed in Pelagonec (28.60 cm, i.e. 25.27% more than the check variety.)

Ristevski I. (2006) reported that average leaf length of the six varieties included in the trial was 51 - 62 cm and the average width 24 - 33 cm.

Table 4. Morphological measurements of the 15th leaf

Varieties	Length of the 15th leaf			Width of the 15th leaf			Length : Width ratio			
	Year	Length	Average 2009/11	Year	Length	Average 2009/11	Year	Length	Average 2009/11	Year
B-21	2009	54.3			23.7			2.29		
	2010	53.4	53.97	100.00	22.3	22.83	100.00	2.34	2.35	100.00
	2011	54.2			22.5			2.41		
B-2/93	2009	55.5			25.8			2.14		
	2010	57.6	56.63	104.93	27.9	26.90	117.83	2.06	2.10	0.89
	2011	56.8			27.0			2.10		
Pelagonec	2009	58.7			26.8			2.19		
	2010	61.3	60.27	111.67	29.8	28.60	125.27	2.06	2.11	0.89
	2011	60.8			29.2			2.08		

The lowest average L : W ratio was recorded in the leaves of B 2/93 (2.10) and the highest in the check variety B-21, which has slightly elongated form compared to the other two varieties.

The analyses shows that L : W ratio of the 5th, 10th and 15th has a tendency to increase from the lower to the upper insertions, i.e. the leaves of upper insertions are characterized by slightly elongated form.

Climate conditions in 2010 were favorable for plants to form larger and wider leaves and thereby to give a better expressed length: width ratio in investigated varieties. The results obtained for L : W ratio in the 5th, 10th and 15th leaf are in accordance with our expectations and literature data.

Conclusions

The average height of varieties included in the trial ranged from 127.3 cm in the check variety B-21 to 188.1 cm in variety Pelagonec, which is 47.76% more compared to the check. The highest leaf number was recorded in Pelagonec (32.57) and the lowest in variety B-21 (26.87). Macedonian varieties are characterized by slightly higher leaf number.

The lowest average length (43.80 cm) and width (28.4 cm) of the 5th leaf was measured in the check B-21, and the highest length (55.00 cm) and width (38.0 cm) was recorded in variety Pelagonec (increase of 25.57 % compared to the check variety).

The lowest average length (53.53 cm) and width (32.43 cm) of the 10th leaf was measured in the check variety B-21 and the highest length (66.60 cm) and width (37.27 cm) was observed in Pelagonec, which is 14.27% higher index compared to the check.

The lowest average length (53.97 cm) and width (22.83 cm) of the 15th leaf was recorded in the check variety B-21 and the highest length (60.27 cm) and width (28.6 cm) was observed in Pelagonec, which is 25.27% higher index compared to the check variety.

Analyzis of length: width ratio in the 5th, 10th and 15th leaf shows a tendency of increase from the lower to the upper insertions and that Macedonian varieties are characterized by larger leaf size.

References

- Risteski I. (2006). Variety structure, method of harvesting and during – essential factors improved quality and increased production of the tupe Burley in Republic of Macedonia . Doctoral disertacion. University "St. Kliment Ohridski "- Bitola - Scientific Tobacco institute - Prilep,
- Risteski I., Kocoska K., Hristoski Ž., (2010). Morphological properties of some domestic and introduced burley tobacco varieties (lines) in agroecological conditions of Prilep. Tutun/Tobacco. Vol. 60, No. 7-12,71-78.
- Stoyanov B. Apostolova E. (1999). New variety Burley. 1317. Bulgarian tobacco 6/1999-Пловдив.
- Uzunoski M.(1985). Tobacco production. Economic jurnal – Skopje
- Cavkaroski D., Risteski I., Aceska N., Kocoska K. (1995). Results from the creation Burley varieties tobacco. XVII Simpozium of tobacco,27-29 september, 1995 год. Ohrid.

STABILITY OF SPIKE WEIGHT AND GRAIN WEIGHT PER SPIKE OF DIFFERENT WHEAT GENOTYPES

Veselinka ZEČEVIĆ^{1*}, Mirela MATKOVIĆ¹, Sofija PETROVIĆ², Miodrag DIMITRIJEVIĆ²,
Desimir KNEŽEVIĆ³

¹University “John Naisbitt“ Belgrade, Faculty of Biofarming, Backa Topola, Serbia

²University of Novi Sad, Faculty of Agriculture, Novi Sad, Serbia

³University of Pristina, Faculty of Agriculture, Kosovska Mitrovica-Lesak, Serbia

*Corresponding author: joca@kg.ac.rs

Abstract

In this paper, the stability of ten divergent wheat varieties was investigated, where two traits were analyzed: spike weight and grain weight per spike. The trial was conducted on the experimental field of the Center for Small Grains in Kragujevac during three growing seasons. The expressions of the analyzed traits were statistically significant and showed additive and non-additive sources of variation. The AMMI analysis showed significant effect of the genotype x environment interaction, where two main components were significant (PCA1 and PCA2). The first principal component (PCA1) expressed the largest share of the genotype x environment interaction. The genotypes reacted differently to different environmental conditions. Genotype Szegedi 765 had the highest value of analyzed traits, but moderate to low stability. Genotypes Sterna and Gruza expressed the highest stability, while genotype Mironovskaya 808 showed the highest instability in terms of both traits. The investigated genotypes had the highest stability in the second year of investigation, and the lowest stability in the first year. In terms of stability, these genotypes can be used in wheat breeding programs.

Key words: *Stability, AMMI, wheat, interaction, PCA*

Introduction

Wheat, as one of basic grains in the human diet, has always taken a central role in agricultural production. Wheat is mainly used in human nutrition as shown by the fact that it takes about 53% of total production in developed, and 85% in developing countries (Peña, 2007).

The main goal in a crop breeding program is the development of genotypes which are stable or adapted to a wide range of diversified environments (Farshadfar *et al.*, 2011). Stability is important for breeders in terms of changing ranks of genotypes under the influences of different environments, which can influence selection's efficiency. On the other hand, for farmers, high yielding characteristics of genotypes are most important, regardless of the change ranks of genotypes (Crossa *et al.*, 2002). In wheat breeding programme it is important to identify genotypes which are adapted or stable to different environmental conditions (Hagos and Abay, 2013).

The genotype x environment (GE) interaction is major problem especially in the study of quantitative characteristics, which are influenced with few genes. Because of it, predictions and interpretation of genetic experiments are very complicated (Amiri *et al.*, 2013). The additive main effect and multiplicative interaction (AMMI) method proposed by Gauch (1992) was a significant advance in the analysis of genotype x environment interpretation. The AMMI model separates the additive variance from non-additive, multiplicative, variance, and includes the principal component analysis (PCA) to the interaction. This model explains in more detail the interaction pattern (Thillainathan and Fernandez, 2001).

The main objectives of this study are investigating stability of spike weight and grain weight per spike in different wheat genotypes and identifying stable genotypes by evaluating GE interaction using AMMI model and biplot analyses.

Material and Methods

The experiment was conducted in the experimental field of the Center for Small Grains in Kragujevac (Serbia) during three different vegetation seasons. Ten wheat genotypes (Arsenal, KG-56, Gruza, Mironovskaya 808, Norin 10, Rana Niska, Spartanka, Sterna, Osjecanka, and Szegedi 765) were evaluated in a randomized complete block design with three replications. Rare sowing was performed where seeds were sown in 1 m long rows, with 20 cm space between the rows and 10 cm distance between each seed in a row. Because of this rare sowing method, genotypes could express their maximal genetic potential for tillering and other spike characteristics. Genotype and environment interaction was tested using AMMI (Additive Main Effects and Multiplicative Interaction) proposed by Gauch (1992) and Zobel (1988). Biplot analyses were, also, created due to graphical visualization in the relationship between genotype and environment. AMMI and biplot analysis were performed using GenStat Trial Version 18.1.0.17005 (<https://www.vsni.co.uk/>).

Results and Discussion

Spike weight and grain weight per spike could be of the importance for grain yield formation. Saed-Moucheshi *et al.* (2013) established that spike weight had the highest correlation with yield in wheat. Results of AMMI analysis of mean spike weight and grain weight per spike showed significant differences ($p < 0.01$) among the genotypes, the environments and GE interaction. The significance of GE interaction effects demonstrated that genotypes responded differently to variations in environmental conditions. AMMI analysis of spike weight showed that 20.98% of the total sum of squares was attributable to genotype effect, only 5.77% to environmental effects, and 11.65% to GE interaction.

Table 1. AMMI ANOVA for spike weight and grain weight per spike of ten wheat genotypes in three years

Source of variation	Spike weight				Grain weight per spike			
	df	SS	MS	F-value	df	SS	MS	F-value
Total	899	600.289			899	402.989		
Genotypes	9	125.93	13.998	32.92**	9	47.74	5.304	17.86**
Environments	2	34.63	17.317		2	34.84	17.418	
Interactions	18	69.96	3.886	9.14**	18	62.02	3.446	11.60**
IPCA1	10	50.54	5.054	11.89**	10	35.06	3.506	11.80**
IPCA2	8	19.42	2.428	5.71**	8	26.96	3.370	11.35**
Error	870	369.77	0.425		870	258.39	0.297	

** $p < 0,01$

The AMMI analysis of variation for grain weight per spike showed that genotype accounted for 11.84% and environment for 8.64% of the total experiment variation. The GE interaction had the largest share in the total variation (15.39%) for grain weight per spike. Petrović *et al.* (2013) and Dimitrijević *et al.* (2005) also found a significant effect of GE interaction on grain weight per spike (Table 1).

In both analyzed traits, the first two main components (IPCA1 and IPCA2) were highly significant, which indicate that interaction was agronomically significant. The greatest contribution to genotype and environment interaction gave IPCA1, with participation of 72.24% for spike weight, and 56.53% for grain weight per spike of the interaction sum of squares (Table 1). The prediction assessment indicated that AMMI with only two interaction principal component axes was the best predictive model (Motamedi *et al.*, 2013).

The GE interaction is considered in detail using AMMI 1 biplot. The genotypes that are located close to the origin, Rana Niska, Sterna, Gruža and KG-56, considered to be stable genotypes. These stable genotypes have good adaptation to a wide range of environments. In relation to all stable genotypes, genotype Gruža had the highest value of spike weight. Genotype Szegedi 765, with the highest value of spike weigh was middle stable genotype, which indicates that it is harder to achieve stability in genotypes with high value of certain trait. Saleem *et al.* (2015) reported that genotypes which showed yield above the grand mean yield were less stable than genotype which was close to the zero of PCA score with low yield. Also, middle stable genotypes are Norin 10, Osječanka, Spartanka, Szegedi 765 and Arsenal. Genotype Mironovskaja 808 is unstable and expresses the greatest interaction with the environment. Analysed genotypes had the highest stability in the conditions that prevailed in the second year (Graph 1).

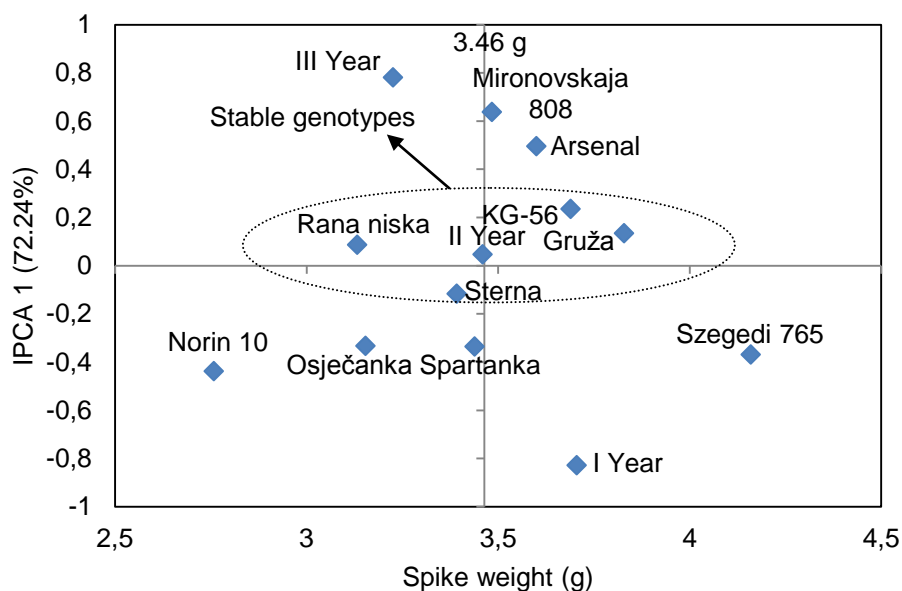

Graph 1. AMMI 1 biplot for the spike weight of 10 wheat genotypes in three years

In order to obtain a more precise analysis of the GE interaction, the AMMI 2 biplot (IPCA1 vs. IPCA2) is created. Genotypes with large IPCA1 or IPCA2, or both, have high interactions, whereas genotypes with IPCA1 or IPCA2 scores near zero have low interactions for the corresponding axis (Motamedi *et al.*, 2013). Genotype Sterna is located the nearest to the biplot origin, which indicates that this genotype is the most stable. Stable genotypes are Rana niska, Spartanka, KG-56 and Gruža, as well. Genotype Mironovskaja 808 has the longest IPCA1 vector and thus expresses the greatest interaction with the environment. The distance from the origin to the points of environmental conditions indicate that no genotype has superior performance of spike weight in all environments. However, the genotypes that are close to a vector of specific environment considered to be stable for the given conditions. Therefore, genotypes Rana niska,

Sterna and KG-56 are close to a vector of environmental conditions in the second year. Genotypes Arsenal, Mironovskaja 808 and Gruža are close to a vector of the third year and considered to be stable in this year, while genotypes Szegedi 765, Spartanka, Norin 10 and Osječanka may be characterised by specific stability in environment of the first year (Graph 2).

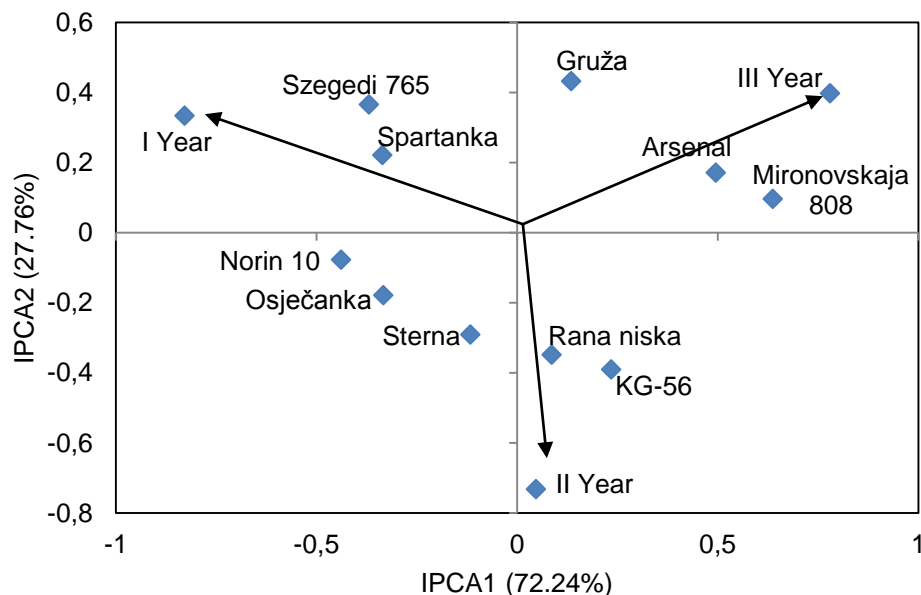

Graph 2. AMMI 2 biplot for the spike weight of 10 wheat genotypes in three years

Genotypes that are stable or less sensitive to environmental influences are found near the biplot origin, and in this case, these genotypes are Sterna, Gruža, Osječanka, Arsenal and Norin 10. Genotype Norin 10, in addition to being stable, is characterized by the lowest value of grain weight per spike, while the genotype Gruža has the highest value of this trait in relation to all stable genotypes. The middle stable genotypes are Rana niska and KG-56, while unstable genotypes are Mironovskaja 808, Szegedi 765 and Spartanka. Genotype Szegedi 765, with the highest value of grain weight per spike, is the most unstable genotype. Genotypes showed the greatest stability in the second year of investigation and the lowest one in the first year (Graph 3).

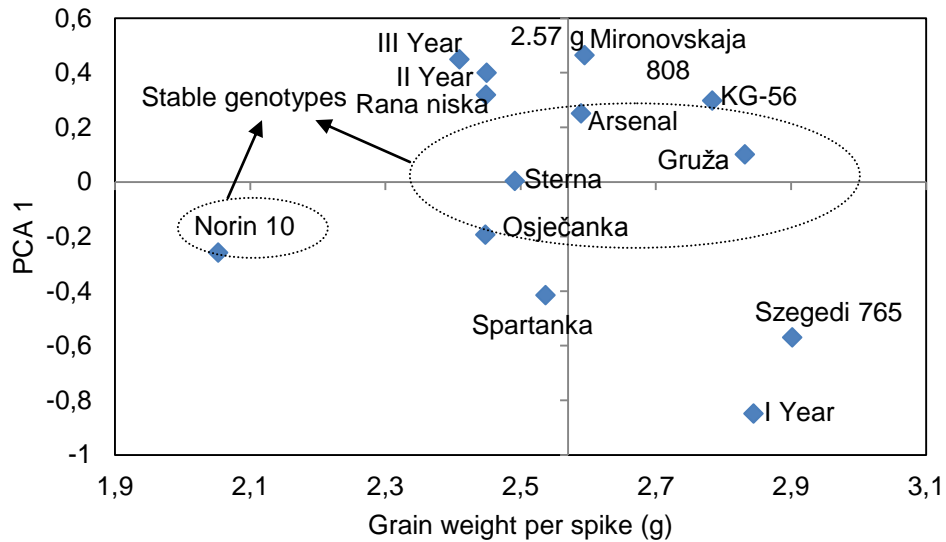

Graph 3. AMMI 1 biplot for the grain weight per spike of 10 wheat genotypes in three years

Genotypes Sterna, Arsenal, Norin 10, Gruža and Osječanka are located near biplot origin and are considered to be more stable in relation to other genotypes. According to Motamedi *et al.* (2013), the greater the PCA scores, either negative or positive, indicates that genotypes are more specifically adapted to certain environmental conditions. Therefore, genotype Mironovskaja 808, with high positive IPCA1 and IPCA2 values, is well adapted to the conditions in the third year, while genotype Szegedi 765 with high positive IPCA2 and high negative IPCA1 value is well adapted to specific conditions in the first year. Genotypes Arsenal and Gruža are close to a vector of the third year, while genotypes, Spartanka and Norin 10 are well adapted to conditions of the first year. The genotypes that are adapted to environment of the second year are Rana niska, KG-56 and Sterna (Graph 4).

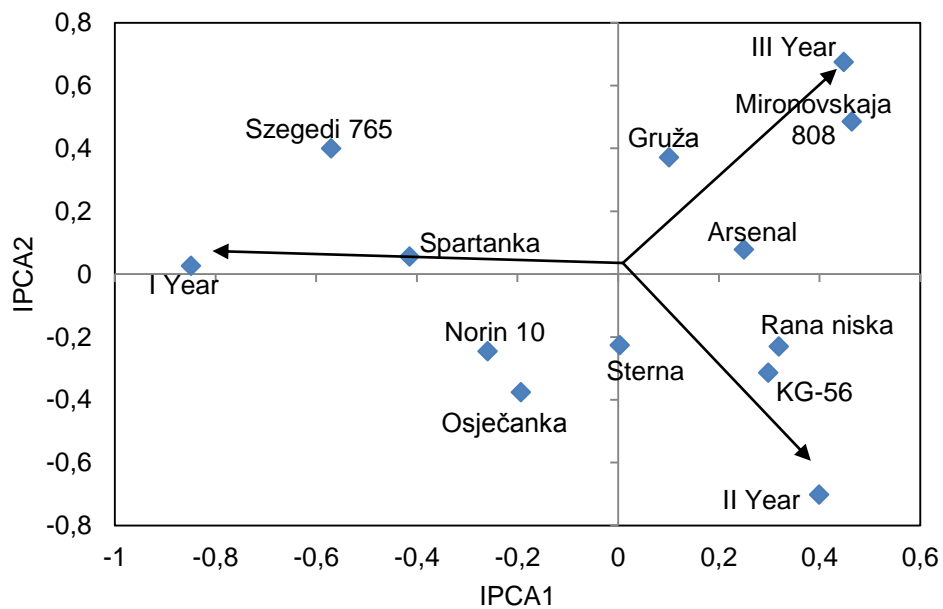

Graph 4. AMMI 2 biplot for the grain weight per spike of 10 wheat genotypes in three years

Conclusion

The AMMI analysis showed significant effect of the additive and non-additive sources of variation on the expressions of the spike weight and grain weight per spike. No genotype has superior performance in all environments, but genotypes Gruža and Sterna are the most stable in wide range of environment. On the other hand, genotypes Mironovskaya 808, Szegedi 765 and Spartanka were located away from biplot origin and are considered specifically adapted genotypes to certain environments. Genotype Mironovskaya 808 expresses high instability for both analyzed traits. Genotype Szegedi 765 had the highest value, but moderate to low stability for both investigated traits. This indicates that it is very difficult to achieve stability in genotypes which are characterized by high values of the certain trait. Stable genotypes, which are adapted to wide range of environments can be used in plant breeding programs.

Acknowledgements

This investigation supported by Ministry of Education, Science and Technology Development of Republic of Serbia, Project TR 31092.

References

- Amiri, E., Farshadfar, E., Jowkar, M.M. (2013). AMMI analysis of wheat substitution lines for detecting genes controlling adaptability, *International journal of Advances Biological and Biomedical Research*, 1(9), 1112-1123.
- Crossa, J., Cornelius, P.L., Yan, W. (2002). Biplots of linear-bilinear models for studying cross-over genotype x environment interaction, *Crops Science*, 42, 612-633.
- Dimitrijević, M., Petrović, S., Belić, M., Hadžić, V., Kraljčić-Balalić, M., Nešić, Lj., Kapor, Z., Beljanski, N., Vuković, N. (2005). Genetička varijabilnost sorti pšenice na solonjecu u uslovima popravke zemljišta (Genetic variability of wheat cultivars on solonetz in conditions of soil repairs). *Letopis naučnih radova Poljoprivrednog fakulteta* 29(1): 100-112.
- Farshadfar, E., Mahmodi, N., Yaghotipoor, A. (2011). AMMI stability value and simultaneous estimation of yield and yield stability in bread wheat (*Triticum aestivum* L.), *Australian Journal of Crop Science*, 5(13), 1837–1844.
- Gauch, H. G. (1992). *Statistical analysis of regional yield trials: AMMI analysis of factorial designs*. Elsevier, Amsterdam, Netherlands.
- Hagos, H., Abay, F. (2013). AMMI and GGE biplot analysis of bread wheat genotypes in the northern part of Ethiopia, *Journal of Plant Breeding and Genetics*, 1, 12-13.
- Motamedi, M., Safari, P., Mohammadi, G. (2013). Additive main effect and multiplication interaction analysis of grain yield in bread wheat genotypes across environments, *International Journal of Biosciences* 3(8), 218-225.
- Peña, R. J. (2007). Current and future of wheat quality needs, In: Buck, H. T., Nisi, J. E., Salomon, N. (Eds.), *Wheat protection in stressed environments, Developments in Plant Breeding*, 12, 411-424
- Petrović, S., Dimitrijević, M., Banjac, B. (2013). Spike traits variability in wheat grown on solonetz and humogley. Fourth International Scientific Agricultural Symposium “Agrosym 2013”, Faculty of Agriculture, East Sarajevo, Jahorina, 178-183.
- Saed-Moucheshi, A., Pessarakli, M., Heidari, B. (2013). Comparing relationships among yield and its related traits in mycorrhizal and nonmycorrhizal inoculated heat cultivars under different water regimes using multivariate statistics, *International Journal of Agronomy*, 1-14.

- Saleem, N., Ahmad, M., Vashnavi, R., Bukhari, A., Ahmad, Dar, Z. (2015). Stability analysis in wheat: An application of additive main effects and multiplicative interaction. *African Journal of Agricultural Research* 10(4): 295-300
- Thillainathan, M., Fernandez, G.C.J. (2001). SAS applications for Tai's stability analysis and AMMI model in genotype x environmental interaction (GEI) effects, *Journal of Heredity* 92(4), 367-371.
- Zobel, R. W., Wright, M. J., Gauch, H. G. (1988). Statistical analysis of a yield trial, *Agronomy Journal*, 80, 388–39.
- <https://www.vsni.co.uk/> Accessed on the 15th of May 2016.

EFFECT OF ESSENTIAL OIL AND EXTRACTS OF ROSEMARY ON THE STABILITY OF FRYING OIL

Ebru Sandal TANRIVERDI¹, Mehmet Musa ÖZCAN^{*2}, Fahad AL-JUHAIMI³

¹Food Engineering, Giresun, Turkey.

²Department of Food Engineering, Faculty of Agriculture, University of Selçuk, 42031 Konya, Turkey

³Department of Food Science & Nutrition, College of Food and Agricultural Sciences, King Saud University, Riyadh-Saudi Arabia

*Corresponding author: mozcan@selcuk.edu.tr

Abstract

Antioxidant activity of essential oil and extracts of rosemary on the oxidative stability of sunflower oil were determined. The essential oil and extracts of rosemary at the concentrations of 0.1%, 0.3% and 0.5% into sunflower oil were added separately. Antioxidant effect of essential oil and extracts of rosemary on the oxidative stability of sunflower oil were evaluated as connected with colour (Hunter *L*, *a* and *b*) and peroxide values. *L* value of the frying oil in which 0.5 % extract of rosemary was added is very close to *L* value of the raw oil. The value of *L* of the frying oil in which extract was added is less than the frying oil that essential oil added. Peroxide value of frying made with 0.3 % concentration of the rosemary essential oil increased less than that of made with the raw sunflower oil. Peroxide value of frying made with 0.5% the rosemary extract decreased, too. In addition, viscosity and free fatty acid (FFA%) values of frying sunflower oil were determined. FFA% of the frying oils of 1. and 2. frying made with the sunflower oil in which 0.5 % essential oil of rosemary added increased less than that of 1. and 2. frying made with the raw sunflower oil. The essential oil of rosemary have been effected more from the extracts of rosemary on the oxidative stability of sunflower oil.

Keywords: *Rosemary, antioxidant activity, frying, sunflower oil*

Introduction

During the frying process, oils and fats are exposed to heat, air and moisture. These factors contribute to diminishing oil quality and changing the triacylglyceride structure (Ramalho & Jorge, 2008). During the deep fat frying process, oils and fats in the presence of atmospheric oxygen and high temperatures are used over and over again and are subjected to the maximum oxidative and thermal effect (Ulusoy & Ergin, 2006). The oxygen in deep-fat frying reacts with oil. The rate of oxidative degradation reactions increases as the concentration of oxygen and free radicals increases (Choe & Min, 1992).

Oxidative degradation occurring fats and oils leads to the formation of unwanted taste and odor, the emergence of a large number of compounds harmful to human health, a decrease in nutritional value (Akgül & Ayar, 1992; Quaglia, Comendador & Finotti, 1998).

Synthetic antioxidants have been used for over 50 years in manufacturing, packaging and storage of fats and fatty foods (Anwar, Ali, Hussain, Shahid, 2009). The use of synthetic antioxidants, such as butylated hydroxytoluene (BHT), butylated hydroxyanisole (BHA) and tertiary butylhydroquinone (TBHQ), in foods is discouraged due to their perceived carcinogenic and teratogenic potential and safety concerns. (Çoban & Patır, 2010). Generally consumers prefer natural antioxidants to synthetic ones. Therefore, for a long time to improve the properties of

foods, such as smell and taste, used as contribution spices, and natural aromatic plants has gained increasing importance (Criado, Motilva, Goni, Romero, 2005).

Within the spices, rosemary (*Rosmarinus officinalis L.*) is the one that presents the highest antioxidant ability. The compounds responsible for rosemary antioxidant activity are mainly phenolic diterpenes such as carnosol, carnosic acid, rosmanol, epirosmanol and isorosmanol (Ramalho & Jorge, 2008). 0,02 % rosemary methanolic extract was established that increased the oxidative stability of sunflower oil at 63° and 120 °C (Criado, Motilva, Goni, Romero, 2005).

The objective of this work was to study the antioxidant action of essential oil and extracts of rosemary on the stability of sunflower oil during deep-frying.

Material and methods

Material

Rosemary was obtained from the local spice seller in Konya (Turkey) As oil, refined sunflower oil was provided from market. Potatoes were obtained from the local market. All solvents were of analytical grade.

Methods

Isolation of essential oils of rosemary and extraction of extracts of rosemary

In the wake of rosemary was developed into a flour with blender 10 g ($\pm 0,5$ g) sample weighed and was put into 2x 250 mL erlenmeyers and their mouths closed. With an interval of 20-30 minutes they are shaken, were stored in a night. Then, each one of all filtered from filter papers and ethanol extractions of spices were extracted with soxhlet device that tuned to 40 C. Dried and ground rosemary plant (about 100 g for each) were subjected to hydrodistillation for 3 h using a Clevenger-type apparatus and the oils obtained were dried over anhydrous sodium sulfate.

Deep fat frying process

The fry-pan (19x3,5 cm in size, no cover) was used for frying process. Oil sample was taken for comparison from the fry-pan. essential oil (0,1%, %0,3 and %0,5) and extract (0,1%, %0,3 and %0,5) of rosemary were used in the frying process. The fry-pan was put for frying process on the electric heater. Oil (220 mL) was introduced into a fry-pan before adding extract or essential oil. The potatoes were peeled, washed, cut as uniformly as possible, wiped, weighed (~53,5 g) and introduced into frying oil immediately. Deep-fat frying was carried out for both extract and essential oil of 0,1%, 0,3% and 0,5%, respectively, twice in same oil. Before each frying, fry-pan was cleaned. At the end of the frying process (the frying process takes 5-6 minutes), frying oil was filtered with filter paper and samples were taken for analysis. Oil samples were stored in the refrigerator until analysis.

Assessment of Instrumental Color

Chromameter was used for colour analysis. A little oil was put into a clean petri and the colour value of three different regions was read. A colorimeter (Minolta Chroma meter CR 400 (Minolta Co., Osaka, Japan)) was used to assess the oil color and the CIELAB colorimetric system was applied. Each time 20 ml of samples put into a glass Petri dish, and the liquid probe of the instrument was immersed into the dish sitting on the white tile, and readings of the CIE lab coordinates are recorded. The L^* , a^* , b^* values are average of ten readings. The colour brightness coordinate L^* measures the whiteness value of a colour and ranges from black at 0 to white at 100. The chromaticity coordinate a^* measures red when positive and green when negative, and

chromaticity coordinate b^* measures yellow when positive and blue when negative (Pagliarini, 1994).

Determination of viscosity of frying oil

35-45 mL sample of oil was put into the viscometer device. Value was recorded as mPas.

Determination of % free fatty acid of frying oil

The oil samples were weighed to 5 g fat \pm 0.01 for determination of % free fatty acid of frying oil, thawed in 100 mL ether. a few drops of phenolphthalein were added and were shaken. Finally, it titrated with 0,1 N KOH (potassium hydroxide) solution, consumption was recorded. % FFA were calculated according to the following formula.

% FFA: $(V/m) \times 2.8$

V: consumed KOH solution, ml

m: sample weight, g

Determination of peroxide value of frying oil

2-3 g oil sample was weighed in the erlenmayer. 10 mL chloroform, 15 mL acetic acid and 1 mL potassium iodide solution were added upon its and were shaken. Then, closing the mouth of it was kept in a dark environment for ~5 min. At the end of this period, 75 ml distilled water and a few drops of starch solution were added upon its and sample was titrated with 0,02 N sodium thiosulfate. Peroxide value were calculated according to the following Formula (Paul and Mittal,1997).:

Peroxide value: $(V/m) \times 2$

V: used in titration sodium thiosulfate, ml

m: sample weight, g

Results and discussion

Physico-chemical properties of raw and frying oils are given in Table 1. Frying oils have been evaluated according to the Hunter color system (Ulusoy & Ergin, 2006). The colour values were expressed as L (brightness/darkness), a (redness/greenness) and b (yellowness/blueness) (Bansal, Zhou, Barlow, Lo, Neo, 2010). As shown in Figure 1(b), L value of the frying oil in which 0.5 % extract of rosemary was added is very close to L value of the raw oil. The value of L of the frying oil in which extract was added is less than the frying oil that essential oil added. While a -value of the frying oil that extract added highly significant decrease as shown in Figure 1(b), increase in the value of a of the frying oil that essential oil added less decreased as shown in Figure 2 (a). Increase in the value of b of 1. and 2. frying made with the sunflower oil in which 0.5 % essential oil of rosemary added is less (Figure 3 (a)). As for that b -value of the frying oils that extract of rosemary added has been an increase rather than (Figure 3 (b)). This increase is due to the color of dark green rosemary extract. b -value of the frying oil that the essential oil of rosemary added showed less increase than b -value of the frying oil that extract of rosemary. Peroxide value of frying made with 0.3 % the rosemary essential oil increased less than that of made with the raw sunflower oil (Figure 6 (a)). Peroxide value of frying made with 0.5% the rosemary extract decreased, too (Şekil 6(b)). Whenever rosemary essential oil and rosemary extract compare, the essential oil seems to be more effective on the peroxide value of the frying oil.

Table 1. Physico-chemical properties of sunflower oil

	Colour	Viscosity (mPas)	FFA%	Peroxide value Meq/Kg oil
Raw oil	L: 47,06 a^{oe} : -0,13 b^{oe} : 1,83	36,9	0,336	6,78
Raw oil 1.frying	L: 56,94 a^{oe} : -0,54 b^{oe} : 2,41	33,7	0,223	16,8
Raw oil 2. frying	L: 51,68 a^{oe} : -0,56 b^{oe} : 2,98	32,9	0,214	24,75
0,1 % VO* added 1. frying	L: 48,78 a^{oe} : -0,34 b^{oe} : 2,18	36,0	0,163	13,6
0,1 % VO added 2. frying	L: 52,66 a^{oe} : -0,74 b^{oe} : 4,13	35,8	0,278	24,24
0,3 % VO added 1. frying	L: 55,20 a^{oe} : -0,38 b^{oe} : 2,46	32,9	0,320	14,0
0,3 % VO added 2. frying	L: 51,72 a^{oe} : -0,03 b^{oe} : 2,54	34,7	0,221	28,13
0,5 % VO added 1. frying	L: 51,07 a^{oe} : -0,19 b^{oe} : 2,02	34,2	0,160	14,15
0,5 % VO added 2. frying	L: 51,72 a^{oe} : -0,03 b^{oe} : 2,54	34,7	0,221	28,13
0,1 % extract added 1. frying	L: 54,74 a^{oe} : -0,67 b^{oe} : 5,04	31,9	0,278	12,84
0,1 % extract added 2. frying	L: 51,00 a^{oe} : -1,39 b^{oe} : 5,82	34,8	0,273	28,98
0,3 % extract added 1. frying	L: 52,41 a^{oe} : -3,62 b^{oe} : 13,11	33,2	0,334	16,73
0,3 % extract added 2. frying	L: 54,11 a^{oe} : -4,03 b^{oe} : 15,77	30,5	0,325	25,0
0,5 % extract added 1. frying	L: 46,11 a^{oe} : -3,91 b^{oe} : 16,28	30,3	0,441	13,93
0,5 % extract added 2. frying	L: 47,98 a^{oe} : -2,96 b^{oe} : 14,51	35,5	0,380	22,15

* essential oil

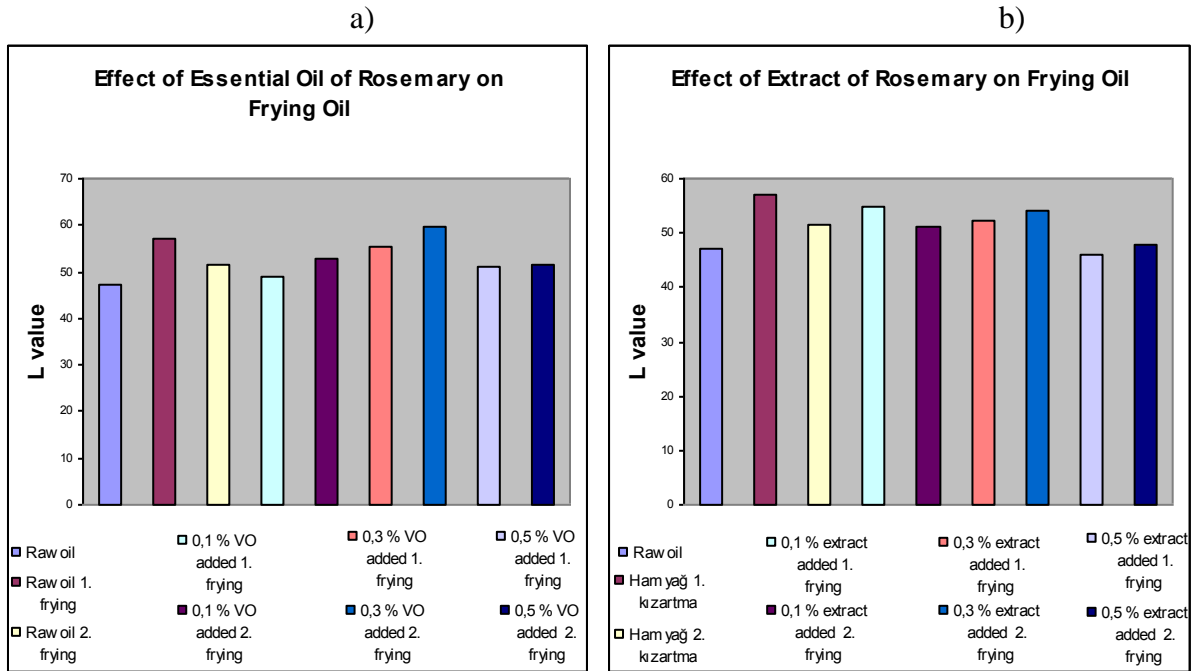

Figure 1: (a) Action of essential oil of rosemary on *L* value of frying oil. **(b)** Action of extract of rosemary on *L* value of frying oil.

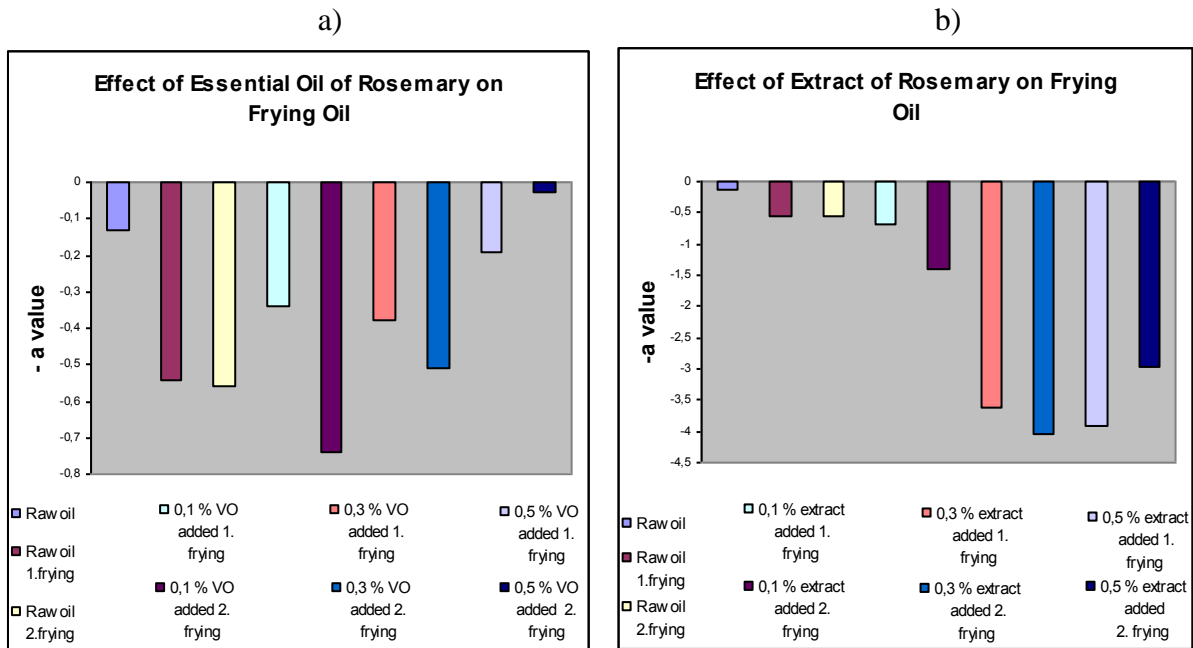

Figure 2 : (a) Action of essential oil of rosemary on *a* value of frying oil. **(b)** Action of extract of rosemary on *a* value of frying oil.

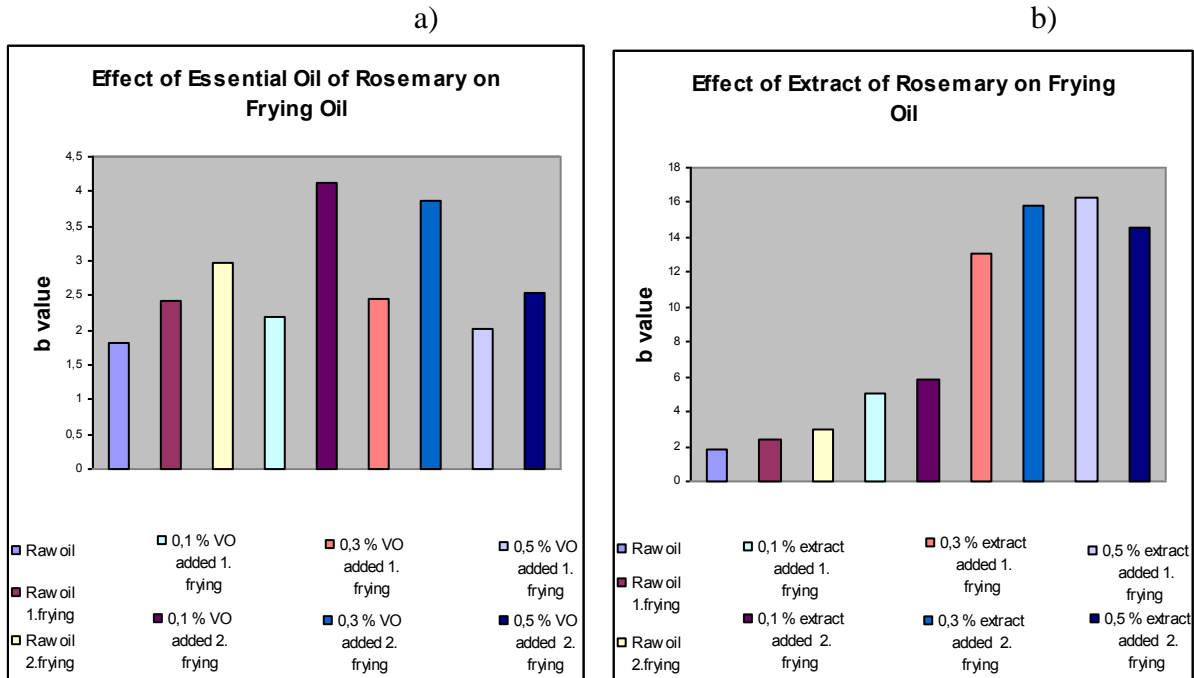

Figure 3 : (a) Action of essential oil of rosemary on *b* value of frying oil. (b) Action of extract of rosemary on *b* value of frying oil.

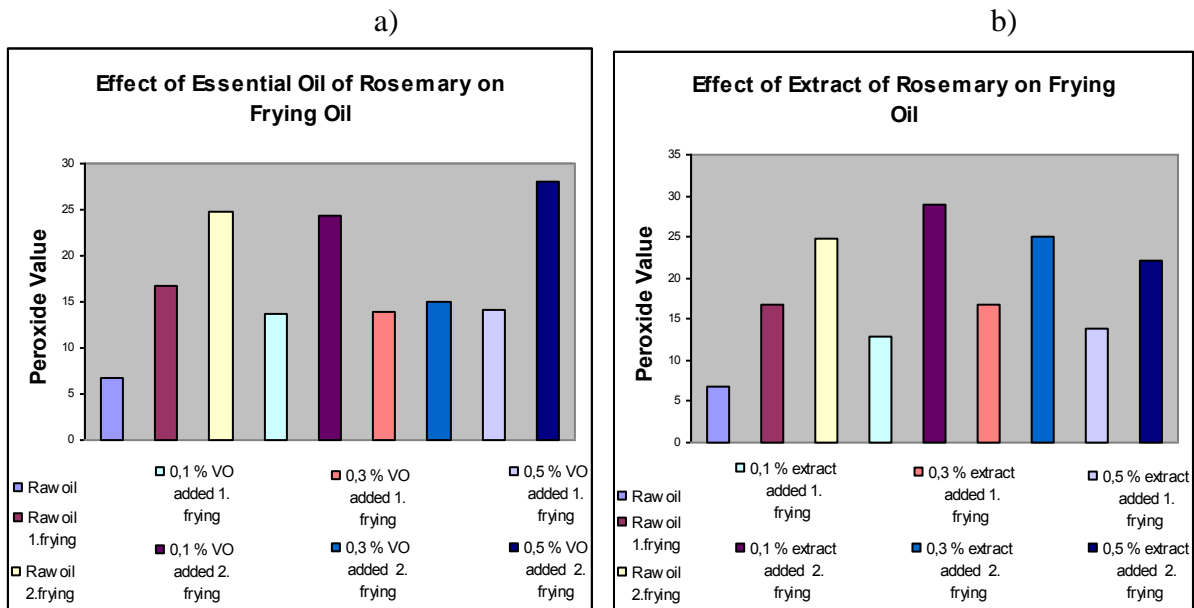

Figure 4 : (a) Action of essential oil of rosemary on viscosity of frying oil. (b) Action of extract of rosemary on viscosity of frying oil.

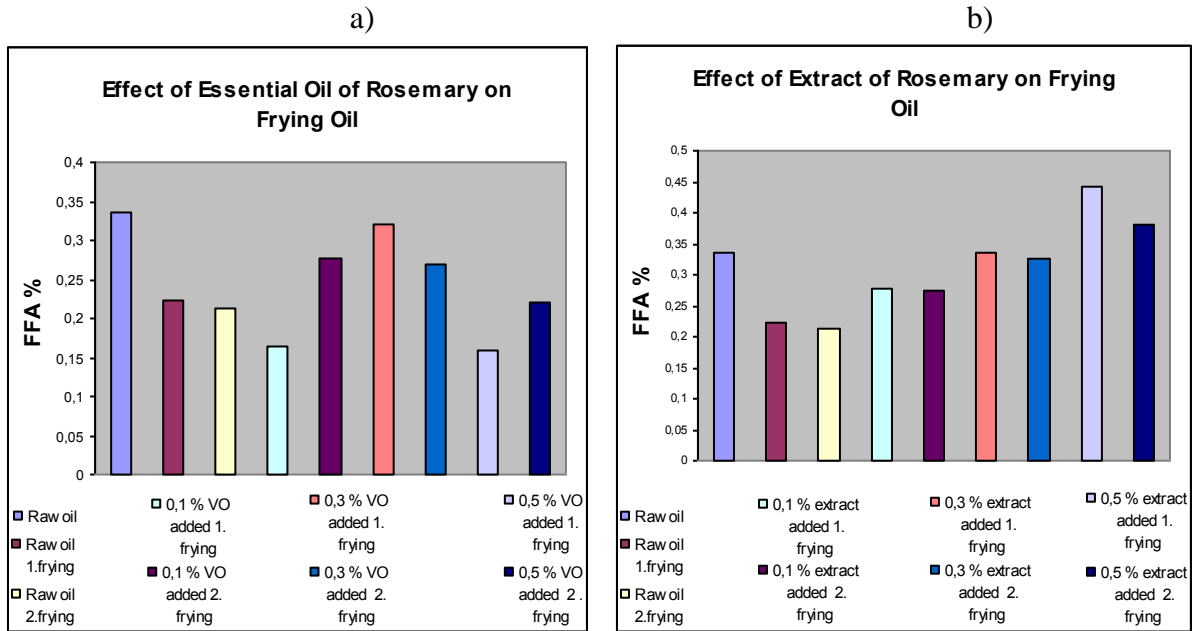

Figure 5 : (a) Action of essential oil of rosemary on % FFA of frying oil. (b) Action of extract of rosemary on % FFA of frying oil.

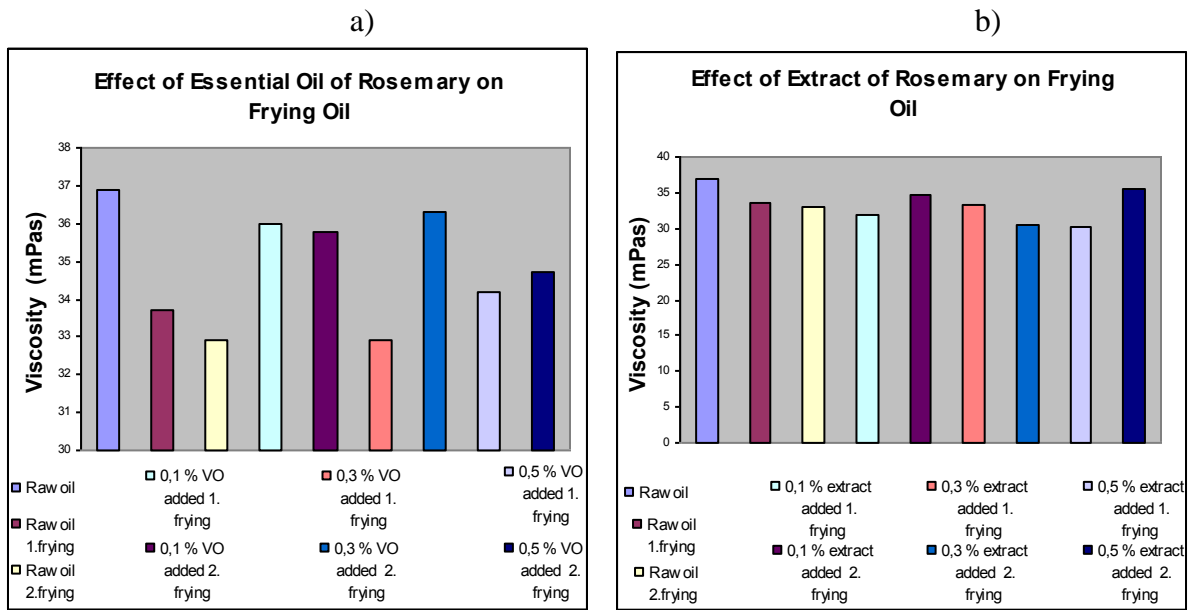

Figure 6: (a) Action of essential oil of rosemary on peroxide value of frying oil. (b) Action of extract of rosemary on peroxide value of frying oil.

The viscosity of the raw sunflower decreased as a result of frying. The viscosity of 1. and 2. frying made by adding 0,1 % essential oil of rosemary didn't far too decrease (Şekil 4 (a)). The frying made by adding extract, almost all concentrations, the viscosity of 1 and 2 frying oils are close to each other (Şekil 4 (b)).

The acid value is the number of milligrams of potassium hydroxide necessary to neutralize the free acids in 1 g of sample. The acid value can be estimated by multiplying the percent free fatty acid content expressed as oleic acid (Paul & Mittal, 1997).

As shown in Figure 5 (a), FFA% of the frying oils of 1. and 2. frying made with the sunflower oil in which 0.5 % essential oil of rosemary added increased less than that of 1. and 2. frying made with the raw sunflower oil. The fact that 0.1%, 0.2% and 0.3% rosemary extract had no effect on the FFA% are show in Figure 5 (b).

Conclusion

Peroxide value of frying made with 0.3 % the rosemary essential oil increased less than that of made with the raw sunflower oil. Peroxide value of frying made with 0.5% the rosemary extract decreased, too. In addition, viscosity and free fatty acid (FFA%) values of frying sunflower oil were determined. FFA% of the frying oils of 1. and 2. frying made with the sunflower oil in which 0.5 % essential oil of rosemary added increased less than that of 1. and 2. frying made with the raw sunflower oil. The essential oil of rosemary have been effected more from the extracts of rosemary on the oxidative stability of sunflower oil.

References

- Akgül, A., & Ayar, A. (1992). Yerli baharatların antioksidan etkileri (Antioxidant effects of ukish spices). Selçuk Üniversitesi Araştırma Fonu ZF 91/067, Konya, 1-10.
- Bansal, G., Zhou, W., Barlow, P. J., Lo, H., & Neo, F. (2010). Performance of palm olein in repeated deep frying and controlled heating processes. *Food Chem.* 121, 338–347.
- Choe, E., & Min, D. B. (2007). Chemistry of deep-fat frying oils. *Journal of Food Science* 72 (5),77-84.
- Criado, M.N., Motilva, M.J., Goni, M. & Romero, M.P. (2005). Comparative study of the effect of the maturation process of the olive fruit on the chlorophyll and carotenoid fractions of drupes and virgin oils from Arbequina and Fraga cultivars. *Food Chemistry* 2,748-755.
- Çoban, Ö. E., & Patır, B., (2010). Antioksidan etkili bazı bitki ve baharatların gıdalarda kullanımı (Using in food of some plant and herbs with antioxidant affective) . *Food Technology Electronic Journal* 5(2), 7-19.
- Mariod, A. A., Matthäus, B., Elchner, K., & Hussein, İ. H. (2006). Antioxidant activity of extracts from *Sclerocarya birrea* kernel oil cake. *Grasas y Aceites*, 57 (4), 361-366.
- Quaglia, G., Comendador, J. & Finotti, E., (1998). Optimization of frying process in food safety. *Grasas y Aceites*, 49 (3-4), 275-281.
- Pagliarini, E. & Rastelli, C. (1994). Sensory and instrumental assessment of olive oil appearance. *Grasas y Aceites* 45, 62–64.
- Paul, S., & Mittal, G. S. (1997). Regulating the use of degraded oil/fat in deep-fat/oil food frying. *Critical Reviews in Food Science and Nutrition* 37 (7), 635- 662.
- Ramalho, V. C. & Jorge, N. (2008). Antioxidant action of rosemary extract in soybean oil submitted to thermoxidation. *Grasas y Aceites* 59 (2), 128-131.
- Ulusoy, B. Ö. & Ergin, G., (2006). Yüksek linolenik asitli kanola yağının derin kızartma sırasındaki oksidatif stabilitesi, Türkiye 9. Gıda Kongresi, Bolu, 439-442.

EFFECTS OF DEFICIT IRRIGATION ON YIELD AND YIELD COMPONENTS OF GRAIN CORN (*Zea mays* L.)

Hakkı AKDENİZ*, Bilal KESKİN, İbrahim Hakkı YILMAZ

Iğdır University, Department of Field Crops, Agricultural Faculty, Turkey

*Corresponding author: hakki_akdeniz@hotmail.com

Abstract

This research was conducted to assess the effect of two irrigation methods (drip and furrow irrigation) and irrigation levels (25 %, 50 %, 75 % and 90 % of the water-holding capacity of the soil) on yield and yield components of grain corn (*Zea mays* L.) at the Agricultural Research and Extension Center, Iğdır University from North East Turkey, in 2014. The experimental design was a split-plot arrangement with three replications on the soils of a clay silt loam. Plant height (185.0-253.3 cm), plant weight (583.3-930.0 g), stem ratio (47.2-57.4%), ear ratio (42.6-52.8%), ear weight (290.0-403.7 g), grain number in ear (350.7-640.0), ear length (24.0-28.7 cm), 1000-grain weight (359.5-450.6 g), crude protein ratio in grain (6.0-9.0%), and grain yield (10.0–25.2t ha⁻¹) were varied between. While the highest plant height, grain yield, 1000-grain weight, stem ratio, grain number in ear was obtained from drip irrigation method, ear ratio and crude protein ratio were obtained from furrow irrigation method. Grain yield and yields components except for ear and stem ratio in corn production were significantly decreased according to decreasing of the water-holding capacity of the soil. Furthermore, the highest and lowest yield and yield parameters were obtained at 25% and 90%, respectively in both irrigation methods. In an arid region where rain never falls during the growing season, the question when to irrigate is rather crucial. According to the results of the study, irrigation should start when available water fallen to 25or 50 percent.

Keywords: *Corn, Deficit Irrigation, Yield, Yield Components*

Introduction

Maize (*Zea mays* L.) ranks as the most important crop worldwide in terms of grain production; although wheat and rice are the most important for direct human consumption. Maize seeds are consumed by humans directly or after processing, and are often the main component of animal feed. Vegetable oil, sugar syrup, alcohol as biofuel, and feedstock for the manufacturing of plastic are commonly derived from maize seeds (Anonymous, 2016).

The total amount of water that a corn crop needs during the growing season may vary from 500-750 mm depending on factors such as weather conditions, plant density, fertility, soil type and days to maturity. Farm planners should have a basic understanding of the relationship between soil and water. Otherwise, they will have difficulty in evaluating the importance of such water-control practices as drainage, mulching, and irrigation. The most widely used form of irrigation scheduling is based on crop water use and soil water evaporation how two these processes, combined with precipitation and stored soil moisture, are used to determine irrigation needs. Magar (1995) reported that semi-arid and arid regions, drip irrigation is particularly well as plants increase in water consumption, 60% water saving compared to surface irrigation, the yield has been provide 30% increase. Water is usually the cruelest natural factors limiting expansion and development of agriculture in this region of Turkey. Iğdır has approximately 256 mm

(Anonymous, 2015), amount of precipitation does not to meet the needs of corn. Moisture stress anytime after planting can affect plant development and reduce yield potential. The any amount of yield loss is dependent on the growth stage of the corn when moisture stress occurs. Öner at al. (2012) found that grain yield per unit area $t\ h^{-1}$ were between 9.3-15.1 $t\ h^{-1}$ in Adapazarı, 7.8-12.9 $t\ h^{-1}$ in Adana and 9.1-12.2 $t\ h^{-1}$ in Samsun, Turkey.

Karasu at al. (2015) stated that deficient irrigation decreased grain yield and yield components except for the percentage of crude oil and crude protein of the grain, but improved the efficient use of irrigation water. Also, they stated that relationship of the grain yield and its components were positively significant.

The goal of study was to evaluate the impacts of irrigation methods and irrigation levels on yield and its components on *Zea mays* L. (71MAY69) in order to recognize and optimize water irrigation regimen when having limited water resources.

Material and methods

A field experiment by drip and furrow irrigated grain corn (*Zea mays indendata* 71MAY69) was conducted on the at the Agricultural Research and Extension Center of Iğdır University, lies at latitude, 44° 48 E, longitude 40° and altitude 800-900 m above sea level, in Eastern Anatolia, Turkey. The effect of various consumptive water level on corn yield of maize was studied. The experimental design was split plot with three replications. The main plots of irrigation methods (drip irrigation and furrow irrigation), the levels of irrigation water included 25%, 50%, 75% and, 90% of the water-holding capacity of the soil. The grain cultivar was sown at a seeding rate of approximately 92,500 seeds ha^{-1} by hand at 5-6 cm depth by hand after barley harvesting on 9 July 2014. The plot size was 5 x 3.5 m, row spacing of 70 cm and crop distances on each row, 1.5 m apart from each other plot, three meters wide left between blocks as buffer zone, and total plot area was 17.5 m^2 . Soil samples were taken before the set up the experiment from the soil layers 0 to 30 and 30 to 60 cm to determine selected physical and chemical properties of the experimental field at the beginning of the experiment (Table 1). Soil lime, soil pH, soil electrical conductivity, potassium, phosphorus, organic matter at 30 cm soil depth was % 6.53, 7.98, 1.8 $dS\ m^{-1}$, 0.3 $t\ ha^{-1}$, 0.008 $t\ ha^{-1}$, 1.6% and experimental soil texture was clay-loam. Irrigation treatments included: drip and furrow was set up in main plot and irrigation level 25%, 50%, 75% and 90 %) in subplot as pointed at Table 3. The irrigation water amount treatments were distributed randomly in the subplots of each main plots. First irrigation was applied to all plots using a sprinkler irrigation system to bring the soil water content in 0-90 cm soil depth up to field capacity. Water content in the soil profile at 0.3 m depth increments were directly measured several times during the growing season. The common dripline design was one lateral for two rows of crop, dripper spacing was 70 cm with dripper flow rate 4 l/h in drip irrigation method. Water was filtered using 150 mm diameter screen filter. Soil moisture accounting is used to calculate the soil-water balance in the root zone throughout the growing season. The water-tensiometer equipment was used for calculating the amount of irrigation water of all treatments. Irrigation was applied when the soil moisture content decreased to 25% (a total of 1380 mm with 13 applications), 50% (a total of 1025 mm with 10 applications), 75% (a total of 812 mm with 6 applications) and 90% (a total of 614 mm with 4 applications). The amount of nitrogen (N) application 250 $kg\ ha^{-1}$ N (ammonium sulphate with 21% N) which has divided into two applications (before planting) and (the plants were reached to 40-50 cm with anchor). The all of the phosphorus, triple super phosphate, 100 $kg\ ha^{-1}$ P were given all plots before planting and weeds were cleared out during the growing season, by hand and hoe.

Some yield and yield component parameters were determined; those include: plant height (cm), plant weight (g), ear length (cm), ear weight (g), ear ratio (%), stem ratio (%), 1000-grain weight (g), grain number in ear, crude protein ratio (%) and grain yield (t/ha⁻¹). Plant height values were measured on randomly selected 20 plants in the centre of every plot before harvest. Randomly selected plants were cut at ground level, the ears were separated from the stem. The ears of plants without husk were used for determining of ear length and weight and grain number per ear and thousand-grain weight.

Statistical analysis

Variance analysis of data obtained in the experiment, Duncan Multiple Comparison Tests SPSS (17.0) was made according to the package.

Table 1. Physical and chemical soil properties of the research location at Iğdir, Turkey

Soil depth (cm)	Saturation (%)	Texture Class	CaCO ₃ (%)	Electrical conductivity (dS m ⁻¹)	pH	P ₂ O ₅ (t ha ⁻¹)	K ₂ O (t ha ⁻¹)	Organic matter (%)
0-30	83	Clay-loam	6.53	1.8	7.98	8.0	343	1.6
30-60	68	Caly-loam	6.53	1.8	8.03	3.7	248	1.3

Table 2. Some climatic parameters of the research location in 2015

Months	Mean Temperature (°C)	Relatively moisture (%)	Mean Precipitation (mm)	The highest temperature (°C)	The lowest temperature (°C)
April	15.7	46.6	30.5	22.9	3.4
May	19.6	52.3	49.9	25.1	14.5
June	23.5	42.3	34.6	30.1	18.0
July	27.7	38.2	7.7	31.6	22.8
August	28.1	36.0	5.0	30.2	22.3
September	22.4	42.6	15.2	28.2	16.0

(Iğdir Regional Directorate of Meteorology Datas, 2015)

Results and discussion

Evaluation of Yield components

Plant height and plant weight

Yield components of grain corn such as plant height, plant weight, ear length, ear weight, ear ratio of maize grown under different irrigation methods and levels of irrigation are presented and stem ratio, 1000-grain weight, grain number in ear, crude protein ratio and grain yield are shown in Table 3 and Table 4, respectively.

Table 3. Different irrigations and their levels on grain corn yield and components in 2014

Irrigation method	Irrigation Levels				Irrigation methods Means
	% 25	% 50	% 75	% 90	
Plant height, cm					
Furrow	253.3 a	245.0 ab	191.7cd	185.0 d	218.7 B
Drip	251.7 a	226.7 ab	233.3 ab	220.0 bc	232.9 A
Irrigation Level Mean	252.5 a	235.8 a	212.5 b	202.5 b	
Plant weight, g					
Furrow	930.0	830.0	683.3	583.3	756.7
Drip	850.0	783.3	783.3	773.3	797.5
Irrigation Level Mean	890.0 a	806.7 ab	733.3 bc	478.3 c	
Ear length, cm					
Furrow	28.7	28.0	26.3	24.0	26.8
Drip	27.7	28.3	28.0	26.3	27.6
Irrigation Level Mean	28.2 a	28.2 a	27.2 a	25.2 b	
Ear weight, g					
Furrow	403.7	390.1	359.7	290.0	361.0
Drip	388.7	376.3	333.3	340.7	359.8
Irrigation Level Mean	396.2 a	383.5 ab	346.5 bc	315.3 c	
Ear ratio, %					
Furrow	43.5	47.7	52.8	50.3	48.6 A
Drip	45.7	48.1	42.6	43.7	45.1 B
Irrigation level Mean	44.6	47.9	47.7	47.1	

Note: Means followed by the same letter are not significantly different at the $p = 0.05$ level using Duncan test

The effect of irrigation methods and irrigation levels were statistically significant at plant height of grain maize. Effect of drip irrigation on plant height (232.9 cm) has been more than furrow irrigation method (218.7 cm) at the end of trial. On the other hand, the effect of different irrigation water amounts was significant and plant height reduced also showed parallel as means of watering scarcity of irrigation levels has also decreased (Table 3). In addition this according to interaction of irrigation method x water levels, the lowest plant height was found from the furrow irrigation at 90% of water deficit (Table 3).

Variance analysis indicates that the weight of the plant according to irrigation methods have not been statistically significant, while levels of irrigation water affected plant weight owing to the fact that the increased plant weight. The lower water application during the vegetative growth stage for furrow irrigated method contributed to shorter plant height and plant weight but in no

significant difference in plant weight compared to irrigation methods. Our results are in close agreement with those of Dagdelen et al. (2008) and also these were similar to those of Bozkurt et al. 2006; Kang et al., 2000; Yazar et al. 2002; Kirnak et al., 2002; Vartanlı and Emekliler 2007; Vural and Dagdelen, 2008; Karasu et al. 2015).

Ear length, weight and ratio

As shown in Table 3, data obtained from the investigation showed that both ear length and ear weight were not significantly affected by furrow and drip irrigation method. Ear lengths were 28.2, 28.2, 27.2 and 25.2 cm in the levels of irrigation water 25%, 50%, 75% and, 90% of water deficit, respectively. Significant differences between irrigation methods were found in term of the ear ratio for combined data of irrigation levels. The ear rate, 48.6% in furrow irrigation was significantly higher than 45.1%, drip irrigation system. However, variance analysis demonstrates that levels of watering in the end of the experiment could not significantly leads to ear ratio of plant (Table 3). Our findings showed that when the irrigation levels decreased, the ear length, weight and ratio decreased. In similar study, Bolanos and Edemedes (1996) indicated that any decrease in irrigation intervals may directly alters factors such as ear width, ear length, leaf surface area, plant height and seed yield.

In maize plant, due to decrease watering during the growing period, lesser biomass is produced and ultimately yield is reduced. These results were consistent with the results of Ertek and Kara (2013); Oktem et al. (2003); reported that the highest fresh ear yield of sweet corn was 13.66 t ha⁻¹ for the 2-day irrigation frequency with 100% evapotranspiration (ET) water application by a drip system. However, corn has been reported to be very sensitive to drought. Water stress can affect growth, development, and physiological processes of corn plants, which can reduce biomass and, ultimately, grain yield due to reduction in the number of kernel per ear (cob) or the kernel weight (Payero et al., 2009; Aslam et al. 2012). Koca. Y. O and Ereku (2011b) indicated that length among of 18.9-24.8 cm, the number of grain per cob among of 514-812, a thousand of grain weight among of 243-330 g.

Stem ratio, %

Results of the experiment showed that, stem ratio in drip irrigated method was higher than the furrow irrigation method and statistically was significant. As average of the irrigation methods, had no effect on stem ratio of the irrigation levels. In addition to, irrigation treatments also results in differences between methods. At the applications of deficit irrigation, the values considerable decreased (Table 4). Kiziloglu et al. (2009) reported that water deficit (20% field capacity) resulted in lower cob, leaf, stem and total fresh yields. Moosavi, S.G. (2012) showed that water deficit stress and N fertilizer level significantly affected leaf area index at silking stage, ear length, grain number per ear, 1000-grain weight and grain yield. Stem diameter, ear diameter and harvest index were only affected by irrigation treatments.

1000-grain weight

Results of the experiment, Table 4 show that 1000-grain weight was higher 416.3 g in drip irrigation method compared to furrow irrigation method with 393.9 g as average of irrigation treatments. In both furrow irrigation and drip irrigation, as the field capacity decreases, 1000-grain weight decreased depending on the irrigation levels. 1000-grain weight significantly interacts with irrigation treatments. Maximum 1000-grain weight was reported at 75% water treatment of drip irrigation while there was 375.5 the same point of furrow. However, when the lowest grain weight was obtained from irrigation of falls to 90% of water-holding capacity of the soil. It is important to keep moisture adequate, but not excessive, even in the late stages of corn development because kernel weight continues to increase. Similarly, Bozkurt et al. (2006)

pointed out that the grain yield per cob varied from 153.3 g for deficit irrigation to 194.9 g for full irrigation treatments and 1000-kernel weight varied from 178.0 to 306.2 g among treatments. Some experiments have shown that drip irrigation does not increase 1000 seed weight to well management surface irrigation (Harde at al. 1982; Kirtok, 1998). Kebede at al. (2014) showed that reducing soil moisture from 100% FC (fully irrigated) to 75% FC of a silt loam soil starting at the silking growth stage in corn did not reduce yield significantly compared to yield from the 100 % FC, while saving a significant amount of water. Moosavi, S. G.(2012) found that the highest grain number per ear, 1000-grain weight and grain yield were obtained under optimum irrigation treatment, and irrigation stop at 10-leaf, tasselling and grain-filling stages decreased grain yield by 52.8, 66.4 and 44.9%, respectively; and it decreased grain number/ear by 45.9, 59.3 and 30.1%, respectively.

Table 4. Different irrigations and their leveles on grain corn yield and components in 2014

Irrigation methods	Irrigation Levels				Irrigation methods Means
	% 25	% 50	% 75	% 90	
Stem ratio, %					
Furrow	56.5	52.3	47.2	49.7	51.4 B
Drip	54.3	51.9	57.4	56.1	54.9 A
Irrigation Level Mean	55.4	52.1	52.3	52.9	
1000-grain weight, g					
Furrow	430.0 ab	410.7 bcd	375.5 de	359.5 e	393.9 B
Drip	419.2 abc	404.2 bcd	450.6 a	391.3 cde	416.3 A
Irrigation Level Mean	424.6 a	407.4 a	413.0 a	375.4 b	
Grain number in ear					
Furrow	626.7 ab	574.0 b	572.0 b	350.7 c	530.8 B
Drip	640.0 a	611.3 ab	591.3 ab	593.0 ab	608.9 A
Irrigation Level Mean	633.3 a	592.7 ab	581.7 b	471.8 c	
Crude protein ratio, %					
Furrow	8.7	8.7	8.3	6.6	8.1 A
Drip	8.0	9.0	7.3	6.0	7.6 B
Irrigation Level Mean	8.4 ab	8.9 a	7.8 b	6.3 c	
Grain yield, t/ha ⁻¹					
Furrow	25.2 a	21.4 bc	17.3 d	10.0 e	18.5 B
Drip	24.9 ab	23.2 abc	23.4ab	19.8 cd	22.8 A
Irrigation Level Mean	25.0 a	22.3 b	20.3 b	14.9 c	

Note: Means followed by the same letter are not significantly different at the p = 0.05 level using Duncan test

Grain number in ear

Grain number is considered as an important factor in production of grain corn. Experiments show that main effects of the furrow irrigation and drip irrigation methods and irrigation levels were significant on grain number in ear as shown in Table 4. In present study, number of grain decreased depends on deficit of water-holding capacity of the soil. In addition, Variance analysis illustrates that grain number was affected irrigation methods and deficit of water levels interaction. The highest number of grain per ear were obtained from drip irrigation system. Number of kernels per ear decreased with increasing deficiency in irrigation water (Table 4). This could be due to stress that affected grain formation as reported by Ahmad et al. (2002). However, we should keep in mind that grain number in corn plant is not stable and mainly changes with factors such as, planting season, climate, region, soil properties and cultivar. The findings obtained in our research provided similar results were reported by Pandery et al. (2000a); number of kernels is closely associated with yield of maize and the number of kernels per ear is a yield component that varies markedly with stress (Fischer, K.S. and F.E. Palmer. 1984); Harder et al. (1982) mentioned that water stress caused failure of kernel development, its number, size and weight. Pandery et al. (2000), also stated that kernels per ear were reduced from 20% to nearly 50% due to water stress. Yazar et al. (1999) concluded that kernel number decrease is the primary effect of water deficit on corn grain yield. Tabatabaei and Dadashi (2013) indicated that the effect of drought stress on grain and biological yields was significant at 1% probability level and the maximum grain yield of about 10.1 ton per hectare was obtained in 100% water requirement. Also, they indicated that about 88% of grain yield variation was related to the grain number per ear.

Crude protein ratio,

%Statistical analysis results for crude protein ratio were significant between furrow and drip irrigation methods and crude protein ratio in grain (8.1%) for furrow method was higher than crude protein ratio (7.6%) for drip method (Table 4). Similarly, both crude protein rate in furrow and drip irrigation decreased as shown the number of grains per ear and 1000 grain weight due to reduced irrigation treatments. These results suggest that soil moisture in both irrigation methods can be depleted to 75% irrigation is applied without significantly decreasing crude ratio of per ear. According to the results of the research by Vartanlı ve Emeklileler (2007) changed between 6.21-8.65 % for the crude protein ratio. Our results were closely to results of grain protein rate 8.28% –10.87% by (Ayrancı and Sade, 2004) but were not similar with findings by Koca and Ereku (2011) grain yield among of 11.3-16.8 t ha⁻¹ and protein rate among of 9.8 %-13.5. Deficit irrigation decreased grain yield and yield components except the percentage of crude oil and crude protein of grain, relationships between the grain yield and each yield component were positively significant.

Grain yield, t/ha⁻¹

The results of analysis of variance showed that the irrigation significantly affected the grain yield of corn (Table 4). Drip irrigation method did increase yield of corn grain higher than the furrow irrigation system and was obtained 22.8 kg/ha⁻¹ grain yield from drip system in this investigation. However, irrigation levels (25%, 50 %, 75 % and 90 % of the water-holding capacity of the soil) affected on yield of grain corn (*Zea mays* L. 71MAY69) and grain yield were 25.0, 22.3, 20.3 and 14.9 kg/ha⁻¹, respectively. The highest grain yield about 25 ton per hectare was obtained 25% of field capacity in both irrigation method. However, a slightly interaction was observed between in both irrigation method at 25% water treatment. Furthermore, grain yield has declined to about 40% when the irrigation level decrease from 25% to 90% of the water-holding capacity of the soil. On

the other hand, 17 % more grain yield was obtained from drip method according to the furrow irrigation. Drought severe stress reduced grain yield by compared to the optimum irrigation condition, this reduction was mainly due to reduction in grain number per ear and average grain weight (Table 4). Hammad at al. (2011) assert that water stress at six and twelve leaves stage simultaneously decreased grain yield 30% while water stress at grain filling stage decreased 20% yield. Our results are quite consistent with the results of the researchers by Kuşcu et al. (2012) concluded that the average grain yields varied from 5.5 to 16.5 t ha⁻¹ and 25% deficit. According to Vartanlı and Emekliler (2007) found that grain yield were 15.8-19.0 t ha⁻¹ and 288.5-320.0 cm for the plant height. Bozkurt at al. (2011) stated that average corn grain yields varied from 1.93 to 10.4 t ha⁻¹ related to amount of irrigation water and irrigation levels had statistically effect on fresh and dry ground biomass production of corn. Koca at al. (2010) stated that means of grain yield components, agricultural and quality characteristics of first crop product were higher than those of second crop product. Also, differences are present among grain yield, the number of grain per. Dagdelen at al. (2008) cited that the grain yield increased with irrigation water amount, and the highest average grain yield (11.1 t ha⁻¹) were obtained from the well irrigated treatment. Karasu at al. (2015) conducted that the highest value of grain yield was found to be 18.3 t ha⁻¹ in the I 125 treatment, which represents excessive water.

Conclusion

Grain yield and yields components decreased according to decreasing of the water-holding capacity of the soil. Irrigation levels significantly affected the grain yield, all some morphological and quality characters studied in present study except for ear and stem ratio of grain corn plant. Drip irrigation method provided highest plant height, grain yield, 1000-grain weight, stem ratio, grain number in ear. Irrigation of grain corn in Iğdır ecological conditions should start when available water fall 25% or 50 percent. In particular, owing to fact that problems drainage and salinity of soils in this region, drip irrigation should be further explored as an effective means to control quantity of irrigation water.

References

- Ahmad, R., A. Mahmood, M. İkraam and B. Hassan. 2002. Influence of different irrigation methods and band placement of nitrogen on maize productivity. *Int. J. Agric. Biol.*, 4(4): 540-543.
- Anonymous (2015). Iğdır Regional Directorate of Meteorology Data.
- Anonymous, 2016. <http://www.fao.org/>
- Aslam, M., Zamir, M.S.I., Afzal, I., Yaseen, M., Mubeen, M., Shoab, A. 2012. Drought Stress, Its effect on Maize Production and development of Drought Tolerance through Potassium Application. *Cercetări Agronomice în Moldova*. Vol. XLVI, No. 2 (154)/ 2013.
- Ayrancı, R., Sade, B. 2004. The determination of dent hybrid corn cultivars (*Zea mays* L. *indentata* Sturt.) grown under Konya ecological conditions. *Bitkisel Araştırma Dergisi* (2004) 2: 6-14.
- Bolanos J, Edemedes GO.1996. The importance of the anthesis-silking interval inbreeding for drought. *Tolerance in tropical maize*. *Field Crops Res*, 48:65-80.
- Bozkurt, S., Yazar, A, and Sayılıkan. M. G. 2011. Effects of different drip irrigation levels on yield and some agronomic characteristics of raised bed planted corn. *African Journal of Agricultural Research* Vol. 6(23), pp. 5291-5300, 19 October, 2011.

- Bozkurt, Y., A. Yazar, B. Gencel, M.S. Sezen, 2006. Optimum lateral spacing for drip-irrigated corn in the Mediterranean Region of Turkey. *Agric. Water Manage.* 85: 113–120.
- Dağdelen, N., Gürbüz, T., Sezgin, T., Yılmaz, E., Yeşilirmak, E., Akçay, S., 2008. Effect of Different Water Stress on the Yield and Yield Components of Second Crop Corn in Semiarid Climate. *International Meeting on Soil Fertility Land Management and Agroclimatology*. Turkey, p: 815-826.
- Fischer, K.S. and F.E. Palmer. 1984. Tropical Maize. In: *The Physiology of Tropical Field Crops*. Goldsworthy, P.R., N.M. Fischer, (Eds.), Wiley, New York. pp. 213-248.
- Hammad, H. M, A. Ahmad, F. Azhar, T. Khaliq, A. Wajid, W. Nasim, and W. Farhad,. 2011. Optimizing water and Nitrogen requirement in Maize (*Zea mays* L.) under Semi arid conditions of Pakistan. *Pak. J. Bot.*, 43(6): 2919-2923.
- Harder, D., R.E. Carlson and R.H. Shaw. 1982. Yield and yield components and nutrient content of corn grain as influenced by post-silking moisture stress. *Agron. J.* 174: 275-278.
- Karasu, A., Kuşcu, H., Öz, M., Bayram, G. 2015. The Effect of Different Irrigation Water Levels on Grain Yield, Yield Components and Some Quality Parameters of Silage Maize (*Zea mays indentata* Sturt.) in Marmara Region of Turkey. *Not Bot Horti Agrobo*, 43(1):138-145.
- Kebede, H., Sui, R.X., Fisher, D.K., Reddy, K.N., Bellaloui, N. and Molin, W.T. 2014. Corn Yield Response to Reduced Water Use at Different Growth Stages. *Agricultural Sciences*. *Agricultural Sciences*, 5, 1305-1315
- Kırnak, H., Gençoğlu, C. ve Değirmenci, V. 2002. Harran Ovası koşullarında kısıntılı sulamanın II. ürün mısır verimine ve bitki gelişimine etkisi. *Atatürk Üniv. Ziraat Fak. Derg.* 34 (2): 117-123.
- Kirtok, Y. 1998. Corn production and use. Kocaoluk Press, Istanbul, Turkey pp. 445
- Kızıloğlu, F. M. Ustun, Ş, Kuslu, Y, Tunc, T. 2009. Determining water–yield relationship, water use efficiency, crop and pan coefficients for silage maize in a semiarid region. *Irrigation Science*, January, 27 (2): 129–137.
- Koca. Y. O and Erekul, O. 2011. The Determination of Performance of Some Hybrid Corn Varieties. *ADÜ Ziraat Fakültesi Dergisi*, 8(2) : 41 - 45
- Magar, S. S. 1995. Adaption of micro irrigation technology in sugarcane on vertisols semi arid climate. micro irrigation for a Changing World. Conserving resources/Preserving the Environment Proceedings of the International Micro irrigation Congress. Edited by Freddie R. Lamm. April 2-6, 1995, Hyatt Regency Orlando, Florida. Published by Am. Soc. of Agri. Eng. p.735-739.
- Moosavi, S.G. 2012. The Effect of Water Deficit Stress And Nitrogen Fertilizer Levels on Morphology Traits, Yield and Leaf Area Index in Maize. *Pak. J. Bot.*, 44(4): 1351-1355, 2012.
- Oktem A, Simsek M, Oktem AG. 2003. Deficit irrigation effects on sweet corn (*Zea mays* var. *saccharata* Sturt) with drip irrigation system in a semi-arid region. I. Water–yield relationship. *Agr. Water Manage.*, 61: 63-74.
- Öner, F., Sezer, I., Gülümser, A. 2012. Comparison of dent corn (*Zea mays* L. *indentata*) varieties and lines growth in different locations in terms of agronomic traits. *Journal of Tekirdag Agricultural Faculty*, Vol. 9 No. 2 pp. 1-6.
- Pandey RK, Maranville JW, Chetima MM. 2000a. Deficit irrigation and nitrogen effects on maize in a Sahelian environment. II. Shoot growth. *Agric. Water Manage.* 46: 15–27.
- Pandey, R.K., J.W. Maranville and A. Admou. 2000a. Deficit irrigation and nitrogen effects on maize in a Sahelian environment I. Grain yield and yield components. *Agric. Water Management* 46: 1-13.

- Pandey, R.K., Maranville, J.W., Admou, A., 2000. Deficit irrigation and nitrogen effects on maize in a Sahelian environment. *Ag. Water Manag.*, 46: 1-13.
- Payero JO, Tarkalson DD, Irmak S, Davison D, Petersen JL. 2009. Effect of timing of a deficit irrigation allocation on corn evapotranspiration, yield, water use efficiency and dry mass. *Agr. Water Manage.*, 96: 1387-1397.
- SPSS, Inc., 1991. Statistical package for the social sciences (SPSS/PC+). Chicago, IL.
- Tabatabaei, S.M. and Dadashi, M. 2013. Effect of different water levels on the yield of Corn with trickle irrigation method (t-tape) in Moghan. *International Journal of Scientific & Engineering Research*, Volume 4, Issue 10, October-2013 1275 .
- Vartanlı, S., and Emeklier, H. Y. 2007. Determination of the Yield and Quality Characteristics of Hybrid Maize Varieties under Ankara Conditions. *Journal Of Agricultural Sciences*, 2007, 13 (3) 195-202 .
- Vural C, Dağdelen N (2008). Determination of irrigation scheduling of drip irrigated corn (*Zea mays var. everta* Sturt) in the Aydın region. *Adnan Menderes Unvi. J. Agr. Fac.*, 5(2): 105-113.
- Yazar, A., Sezen, S.M., Gencel, B., 2002. Drip irrigation of corn in the Southeast Anatolia Project (GAP) area in Turkey. *Irrig. Drain.* 51: 293-300.

AGRICULTURAL MECHANIZATION IN FIELD CROPS IN THRACE REGION OF TURKEY

Bahattin AKDEMIR

Namik Kemal University Faculty of Agriculture Department of Biosystems Engineering, Tekirdag, Turkey

*Corresponding author: bakdemir@nku.edu.tr

Abstract

Instead of one of the well- developed industrial area of Turkey, Thrace Region has important agricultural production. Objective of this research is to determine mechanization chain for field crops in Thrace Region of Turkey. Agricultural machinery type, size, specifications application time of agricultural practices and amount of agricultural inputs were determined for wheat, sunflower, canola, maize, sugar beet and rice. Fuel consumption of each procedure and time requirements of field operations were determined from survey, research studies and articles. In addition, production costs were calculated. As an example: fuel consumption and time requirement of machinery operations were 107.5 l/ha and 3 h/ha for sunflower. In addition, human labour and requirements were determined 3.2 h/ha for field operations of sunflower production. From tillage to harvest of the sunflower, there are 13 field operations. These are plough, cultivator, harrow, centrifugal fertiliser spreader, planting, roller, fertilisation with centrifugal fertiliser spreader, hoeing, 2 times herbicide application, and harvesting. The results can be used to manage next year growing strategies such as field traffic, agricultural input requirements.

Keywords: *Mechanization, field crops, Thrace Region, Turkey*

Introduction

European part of Turkey is gradually well developed region of Turkey (Figure 1). Instead of one of the well- developed industrial area of Turkey, Thrace Region has important agricultural production. Thrace Region has important agricultural production. A large portion of Thracian land is used as cultivation land. The most important means of livelihood in Edirne and Kırklareli provinces are agriculture and the agriculture industry. In Tekirdag province, which has an intense industrial production, a great part of the people living especially in the inland and western parts deal with work based on agriculture (Trakya Kalkinma Ajansi, 2016).



Figure 1. Thrace Region of Turkey (FAO, 2016)

Agriculture is the one of the important income sources in Edirne, Kirklareli and Tekirdag Cities in Thrace Region. Agricultural production value of the Region was obtained from plant production in 79.13% and animal production 20.87%. Wheat, sunflower and rice are the most important crops in this Region. In addition, canola, sugar beet, grape, apple have been growing. Mean size of farm area is approximately 7 ha. Instead of the mean size is higher than Turkey's average farm size 5 ha, 37% of farms are lower than 5 ha. in Thrace Region. Economic income of the farmers is small because of small scale farms and non irrigated agricultural crop production (TUIK, 2016)

Mechanization chain is important for machinery selection and determines problems in crop production. Objective of this research is to determine mechanization chain for field crops in Thrace Region of Turkey. Field operations, agricultural machinery type, size, specifications application time of agricultural practices and amount of agricultural inputs were determined for wheat, sunflower, canola, maize, sugar beet and rice. Fuel consumption of each procedure and time requirements of field operations were determined from survey, research studies and articles. In addition, production costs were calculated.

Materials and methods

Wheat, sunflower, rice, canola, maize for silage, and sugar beet widely produced in Thrace region were selected for determining of agricultural mechanization. Agricultural machinery type, size, application time of agricultural practices and amount of agricultural inputs were determined for wheat, sunflower, canola, maize, and rice. Field operations, machine type, time, speed, effective machine capacity, fuel consumption and human labour requirement were determined by using question with farmers in Thrace Region. Fuel consumption of each procedure and time requirements of field operations were determined from research studies, articles and surveys. Machine size and type, field size, soil type and working conditions etc. affect fuels consumption, effective machine capacity and labour requirement. In this research a sample data were given for an average size farm in Thrace Region. Daily working hour accepted as 10 hour per day. Field efficiency data of the agricultural machines were taken from Canakci (1999), Resim (2005) and ASABE (2016). Collected data were used to calculate effective field capacity (h/ha), total fuel consumption (l/ha) and total man labour requirement as (h/ha).

Results and discussions

Results of the study are given in Table 1 for wheat, in Table 2 for sunflower, table 4 for paddy, Table 4 for maize, and Table 5 for canola. Field operations of the crops investigated in this article have been made by agricultural machineries. Total fuel consumption was determined as 118 l/ha for wheat, 107.5 l/ha for sunflower, 110 l/ha for paddy, 144l/ha for maize, 145.5 l/ha for canola and 116.50 for sugar beet. Total man labour requirement 3.93 h/ha for wheat, 3.72 h/ha for sunflower, 4.78 h/ha for paddy, 3.13 h/ha for maize, 4.08 h/ha for canola, 7.44 h/ha for sugarbeet.

Table 1. Wheat mechanization

Field operations / Machine Type	Working Time	Machine Width (m)	Working Speed (km/h)	Efficiency (%)	Effective Field Capacity (ha/h)	Fuel Consumption (l/ha)	Man labour (h/ha)
Plough	August- September	1.4	6	0.80	0.67	30.0	1.190
Disc harrow	September	3.0	10	0.85	2.55	12.0	0.333
Cultivator	September October	4.0	13	0.80	4.16	7.0	0.192
Centrifugal fertiliser spreader	October	16.0	14	0.70	15.68	3.5	0.045
Toothed roller	October	4.0	17	0.80	5.44	4.5	0.147
Sowing machine	October	4.0	12	0.70	2.24	12.0	0.208
Roller	October	5.0	13	0.85	5.53	4.5	0.308
Fertiliser spreader	January-February	16.0	14	0.70	15.68	3.5	0.045
Sprayer	February	16.0	14	0.65	14.56	3.5	0.045
Sprayer	March	16.0	14	0.65	14.56	3.5	0.089
Fertiliser spreader	March-April	16.0	14	0.70	15.68	3.5	0.089
Sprayer	April	16.0	14	0.65	14.56	3.5	0.089
Sprayer	May	16.0	14	0.65	14.56	3.5	0.089
Sprayer	May-June	16.0	14	0.65	14.56	3.5	0.089
Combine	June-July	5.2	4	0.70	1.46	20.0	0.962
TOTAL						118.0	3.920

Table 2. Sunflower mechanization

Field operations / Machine Type	Workng Time	Machine Width (m)	Working Speed (km/h)	Efficiency (%)	Effective Capacity (ha/h)	Fuel Consumption (l/ha)	Man labour requirement (h/ha)
Plough	September-November	1.40	6	0.8	0.67	30.00	1.190
Cultivator	March	3.40	9	0.85	2.60	10.00	0.327
Cultivator	April	3.50	10	0.8	2.80	8.00	0.286
Toothed harrow	April	4.00	15	0.8	4.80	4.00	0.167
Fertiliser spreader	April	16.00	14	0.7	15.68	3.50	0.089
Sprayer	April	16.00	14	0.65	14.56	3.50	0.089
Sowing machine	April-May	4.20	7	0.7	2.06	8.00	0.340
Roller	April-May	5.00	12	0.85	5.10	4.50	0.167
Fertiliser spreader	June	16.00	14	0.7	15.68	3.50	0.089
Hoeing	June	4.20	7	0.8	2.35	9.00	0.340
Sprayer	June	16.00	14	0.65	14.56	3.50	0.089
Combine	September	5.20	7	0.7	2.55	20.00	0.549
TOTAL						107.50	3.723

Table 3. Paddy mechanization

Field operations / Machine Type	Working Time	Machine Width (m)	Working Speed (km/h)	Efficiency (%)	Effective Capacity (ha/h)	Fuel Consumption (l/ha)	Man labour requirement (h/ha)
Plough	September-October	1.4	6	0.80	0.672	30,0	1.190
Goble disc harrow	March-April	3.0	10	0.85	2.550	12,0	0.333
Levelling	March-April	4.0	7	0.70	1.960	12,0	0.714
Combine harrow	April	4.0	13	0.80	4.160	8,0	0.192
Spring tooth harrow	April	4.0	15	0.80	4.800	4,0	0.167
Centrifugal fertiliser spreader	May (before sowing)	16.0	14	0.70	15.680	3,5	0.089
Centrifugal fertiliser spreader for sowing	May	3.0	7	0.70	1.470	10,0	0.952
Fertiliser application	July	16.0	10	0.70	11.200	3,5	0.125
Spraying-1	May-June	16.0	10	0.65	10.400	3,5	0.125
Spraying-2	July	16.0	10	0.65	10.400	3,5	0.125
Combine	September	5.2	5	0.70	1.820	20,0	0.769
TOTAL						110,0	4.783

Table 4. Maize mechanization

Field operations / Machine Type	Working Time	Machine Width (m)	Working Speed (km/h)	Efficiency (%)	Effective Capacity (ha/h)	Fuel Consumption (l/ha)	Man labour requirement (h/ha)
Plough	September-October	1.4	6	0.80	0.672	30.0	1.190
Cultivator	March-April	3.5	10	0.85	2.975	10.0	0.286
Fertiliser Spreader	April-May	16.0	14	0.70	15.680	3.5	0.089
Sowing	April-May	4.2	7	0.70	2.058	8.0	0.340
Sprayer	May	16.0	14	0.65	14.560	3.5	0.089
Fertiliser Spreader	June	16.0	14	0.70	15.680	3.5	0.089
Hoeing	June	4.2	7	0.80	2.352	9.0	0.340
Sprayer	June	16.0	14	0.65	14.560	3.5	0.089
Lister	June-July	4.2	7	0.80	2.352	7.0	0.340
Combine	September-October	5.2	7	0.70	2.450	66.0	0.286
TOTAL						144.0	3.139

Table 5. Canola mechanization

Field operations / Machine Type	Working Time	Machine Width (m)	Working Speed (km/h)	Efficiency (%)	Effective Capacity (ha/h)	Fuel Consumption (l/ha)	Man labour requirement (h/ha)
Plough	July	1.40	6	0.80	0.67	30.00	1.190
Disc Harrow	August	3.00	9	0.85	2.30	12.00	0.370
Sprayer	August- September	16.00	14	0.65	14.56	3.50	0.045
Disc Harrow	September	3.00	9	0.85	2.30	12.00	0.370
Rotary tiller	September	3.00	5	0.85	1.28	25.00	0.667
Fertiliser spreader	September	16.00	14	0.70	15.68	3.50	0.045
Harrow	September	4.00	15	0.85	5.10	4.50	0.167
Roller-packer	September	5.00	12	0.85	5.10	4.50	0.167
Sowing machine	October	3.00	7	0.65	1.37	12.00	0.476
Roller-packer	October	5.00	12	0.85	5.10	4.50	0.167
Fertiliser spreader	December	16.00	14	0.70	15.68	3.50	0.045
Sprayer	February	16.00	14	0.65	14.56	3.50	0.045
Fertiliser spreader	March	16.00	14	0.70	15.68	3.50	0.045
Sprayer	March	16.00	14	0.65	14.56	3.50	0.045
Harvesting	May-June	5.20	8	0.70	2.91	20.00	0.240
TOTAL						145.50	4.082

Farm mechanization and agricultural input usage time and amount of the main field crops were determined in this study. The results were summarized in Table 6.

Table. 6. General evaluation for fuel

		FIELD OPERATIONS					TOTAL
		TILLAGE	SPRAYER	SOWING	FERTILISER	HARVESTING	
WHEAT	FUEL (l/ha)	58.00	17.50	12.00	10.50	20.00	118.00
	FUEL (%)	49.15	14.83	10.17	8.90	16.95	100.00
	MAN LABOUR (h/ha)	2.17	0.40	0.21	0.18	0.96	3.92
	MAN LABOUR (%)	55.36	10.23	5.31	4.57	24.54	100.00
CANOLA	FUEL (l/ha)	92.50	10.50	12.00	10.50	20.00	145.50
	FUEL (%)	63.57	7.22	8.25	7.22	13.75	100.00
	MAN LABOUR (h/ha)	3.10	0.14	0.48	0.14	0.24	4.08
	MAN LABOUR (%)	75.86	3.31	11.66	3.31	5.88	100.00
PADDY	FUEL (l/ha)	66.00	7.00	10.00	7.00	20.00	110.00
	FUEL (%)	60.00	6.36	9.09	6.36	18.18	100.00
	MAN LABOUR (h/ha)	2.60	0.25	0.95	0.21	0.77	4.78
	MAN LABOUR (%)	54.30	5.23	19.91	4.48	16.08	100.00
SUNFLOWER	FUEL (l/ha)	65.50	7.00	8.00	7.00	20.00	107.50
	FUEL (%)	60.93	6.51	7.44	6.51	18.60	100.00
	MAN LABOUR (h/ha)	2.48	0.18	0.34	0.18	0.55	3.72
	MAN LABOUR (%)	66.55	4.78	9.13	4.78	14.75	100.00
MAIZE-SILAGE	FUEL (l/ha)	56.00	7.00	8.00	7.00	66.00	144.00
	FUEL (%)	38.89	4.86	5.56	4.86	45.83	100.00
	MAN LABOUR (h/ha)	2.16	0.18	0.34	0.18	0.29	3.14
	MAN LABOUR (%)	68.71	5.67	10.83	5.67	9.11	100.00

According to the fuel consumption and man labour requirement; soil preparation is the first field operations for all selected field crops. Percentages of the soil tillage operations in all field operations are higher than 50% for all crops. If farmers want to energy consumption should focus on soil preparations.

Conclusions

Agricultural mechanization is an indicator of agricultural input use in crop production. In addition, it is very important for production cost and energy balance analyses in farm management. From these results; it can be seen that agricultural machineries use for most field operations of field crops in Thrace Region, Turkey. Agricultural machinery usage is necessary to realise crop production in large areas but machinery usage should be good managed otherwise increases production cost and decrease profitability. Big percentage of fuel has been using for soil preparation including hoeing (Table 6). Farmers generally use conventional agricultural practices for soil tillage. Reduced tillage method and/or direct drilling method should be used to decrease machinery use consequently decreasing soil compaction and fuel consumption.

In Turkey, more than 65 % of the farmers are small farmers. As an example mean size of the land is 6.8 hectares and mean numbers of parcels are 6.9 (Ministry of Development, 2014). This is not good for sustainable crop production even most of field operations have been done by agricultural machineries. One of problem is right machinery use. If farmers don't arrange agricultural machinery right, it is create environmental and health problems. Last 10 years farmers get 50% support from Government for some selected agricultural machineries. This support caused increasing agricultural mechanization level for all farmers in Turkey. The problems are small scale farm, small field plots, and young people don't want to work in agricultural (Ministry of Food, Agriculture and Livestock, 2016). Education level of farmers is lower than general mean education level in Turkey and they are using more developed machines. In the contrary, there are many agricultural engineers in Turkey and they are waiting to work in agricultural production. In a survey, mean age determined as 51 for Thrace Region and percentage of primary school education was 66% (Trakya Development Agency, 2013). Government started to put into practice a National Financial Programme to encourage young people to be farmer.

References

- ASABE. (2016). ASAE D497.4.Agricultural Machinery Management Data. <http://elibrary.asabe.org/> (access date: 08/07/2016)
- Canakci M. (1999). A research on the determination of the optimum mechanization implements for farms cultivating wheat, cotton and corn in the Antalya region MSc Thesis. Akdeniz University, Antalya. P:92
- FAO. 2016. Peste Des Petits Ruminants <http://www.fao.org/docrep/008/y5932e/y5932e03.htm> (Access date: 03/07/2016)
- Ministry of Food Agriculture and Livestock. (2016). TR21 West Marmara Agriculture Master Plan. Turkish Food, Agriculture and Livestock. <http://www.tarim.gov.tr/SGB/Belgeler/B%C3%B6lge%20Master%20Planlar%C4%B1/TR21batimarmaraMP.pdf> (Access date: 03/07/2016)
- Ministry of Development. (2014). Working Groupe Report on Sustainable Use of Farm Land, http://tarim.kalkinma.gov.tr/wp-content/uploads/2014/12/Tarim_Arazilerinin_Surdurulebilir_Kullanimi_Calisma_Grubu_Raporu.pdf (Access date: 11/08/2016)
- Resim M. (2005). Sizing agricultural machinery for Kahramanmaras farms. Kahramanmaras Sutcu Imam University, P:53
- Trakya Development Agency. (2013). Farmer perception analysis, <http://www.trakya2023.com/uploads/docs/0909201337QcdT.pdf> (Access date: 11/08/2016)

Trakya Kalkınma Ajansı. (2016). TR21 2014-2023 Regional Plan: <http://trakyaka.org.tr/uploads/docs/862016kqfRQq.pdf> (Access date: 21/06/2016)

TUIK. 2016. Agricultural production statistics. http://www.tuik.gov.tr/PreTablo.do?alt_id=1001 (Access date: 03/07/2016)

VARIATION IN FINAL LEAF NUMBER IN WINTER BARLEY (*Hordeum vulgare* L.)

Vojislava MOMČILOVIĆ¹, Milan MIROSAVLJEVIĆ¹, Vesna MILIĆ², Miloš NOŽINIĆ³,
Novo PRŽULJ^{4,2*}

¹Institute of Field and Vegetable Crops, Novi Sad, Serbia

²University of East Sarajevo, Faculty of Agriculture, Republic of Srpska, Bosnia and Herzegovina

³Agricultural Institute of Republic of Srpska, Banja Luka, Republic of Srpska, Bosnia and Herzegovina

⁴University of Banja Luka, Faculty of Agriculture, Republic of Srpska, Bosnia and Herzegovina

*Corresponding author: novo.przulj@gmail.com

Abstract

Leaf emergence represents externally visible trait that is results of externally not visible leaf primordial initiation. Final leaf number initiated in the apex and the rate of leaf emergence determine of pre-anthesis phases. The aim of this study was to determine the effect of year and cultivars on final leaf number (FLN) in winter barley. In the present study no consistent differences were found in the FLN between 6-rowed and 2-rowed cultivars. FLN differs among barley varieties sown in the field at different years and was controlled by all three factors; cultivar, year and their interaction. Contribution of year in FLN variation was highest, about 74%. This can be explained as a direct effect of the year on the rate of leaf appearance or as an indirect effect of an ontogenetic decline in the rate of appearance. Low value of interaction showed stability of leaf number from year to year. Considered across the growing seasons (GSs), the early cultivar Novosadski 581 had the lowest (11.3) and the late cultivar Kredit the highest (14.7) FLN. In average the early cultivars had one leaf less than the late ones. Earliness is rather the result of leaf number reduction than grain filling reduction. FLN across cultivars and GSs was 13.5. Quadratic equation fitted best the relationship between GDD requirement and FLN per main stem, with $R^2 > 0.99$. In our investigation, the FLN was positively correlated with GDD accumulated till flag leaf completion, while the effect of precipitation was less important. The tested cultivars showed significant variability in FLN, which can be used for selecting most adaptable genotypes.

Keywords: *Barley (Hordeum vulgare L.), final leaf number, phenology, polynomial regression, correlation*

Introduction

The rate of organ emergence and the duration of developmental phases are key components of plant fitness to its environment. An understanding of the effect of environment on leaf emergence is necessary for modeling crop growth (Pržulj and Momčilović, 2011). Leaf production phase from crop emergence to flag leaf appearance integrates the effects of vernalization and photoperiod. Leaf appearance in small cereals is result of leaf primordium initiation and leaf primordium extension and both processes in normal growing conditions are controlled mainly by temperature (Slafer and Whitechurch, 2001; McMaster, 2005). The final number of initiated leaf primordium is proportional to the time from sowing to double ridge (Robertson *et al.*, 1996; Pržulj *et al.*, 2013). At the time of seedling emergence, the shoot apex has five to seven leaf primordia and this is considered to be the range in minimum final leaf number per wheat plant (Robertson *et al.*, 1996).

Kirby (1992) showed that variation in the final leaf number (FLN) produced by winter wheat in the field in response to sowing date and location could be explained, in part, by differences in

exposure to low temperature during the phase when leaf primordia were being initiated. FLN depends upon the rate and duration of leaf initiation. The vernalization response is important for fitting the plant life cycle to the environment in which it is grown, so that it can make the best use of the seasonal opportunities for growth and avoid adverse climatic factors. The major effect of vernalization is to shorten the duration of the phase of leaf primordia production (Griffiths *et al.*, 1985). Air temperature is the main factor affecting the leaf number and phyllochron (Rickman and Klepper, 1991).

Researchers have concentrated on understanding how environmental factors, first of all temperature and photoperiod and then water and nutrition, affect the FLN. Only a few studies have evaluated cultivar effect on the FLN. In this research, we studied the effect of cultivar and year on FLN of winter barley.

Materials and Methods

Cultivars and crop management. Twelve barley cultivars which differed in origin, pedigree and agronomic traits were used in this study. A 6-year experiment was conducted from 2002/03 to 2007/08 growing seasons (GS) at the experimental field of Institute of Field and Vegetable Crops in Novi Sad (45°20'N, 15°51'E, altitude 86 m) on a chernozem soil and under rainfed conditions. The experiment was conducted in a randomized complete block design with 3 replications in each year. The plots were 1.2m wide and 10m long, with 0.20m spacing between rows. Planting density in all GSs was 300 viable seeds per m² for six-rowed barley and 350 viable seeds per m² for two-rowed barley. To avoid negative effects of diseases and pests, the experiments were sprayed with the fungicide Tilt 250 EC in Zadoks phase 64 and the insecticide Karate zeon applied when needed. Weed control was performed by hand. To determine the FLN on the main stem, including the flag leaf, recording was done according to the Haun scale on three tagged plants in each replication. GDD was calculated for each of the phases as $T_n = [(T_7 + T_{14} + 2T_{21})]/4$, where T_7 , T_{14} , and T_{21} are temperatures at 7 AM, 2PM and 9 PM, respectively (Pržulj, 2001). Base temperature was 0° C.

Statistical analysis. All data were subjected to the analysis of variance using Statistica 9.0 program (StatSoft, Tulsa, OK, USA). When differences among earliness groups, duration of developmental phases and agronomic traits were tested, four cultivars from each group were considered as replication as samples for detection of developmental phases.

Weather conditions. The average temperatures at the level of the long-term average and abundant rainfall in October 2002 allowed a rapid crop development and fast progression through vegetative phase. The early reproductive phase continued in the spring under conditions of extreme drought and low temperatures. Excessive rainfall, several-fold above the annual average, and average temperatures accompanied the emergence stage in the 2003/04 GS. The completion of the generative phase next spring unfolded under normal conditions. In the 2004/05 GS, both temperature and rainfall conditions were favorable during the vegetative phase. The remainder of the GS continued under favorable conditions. In the 2005/06 GS, barley germination and the vegetative stage took place under a drought, while the generative phase in November and December unfolded under favorable conditions. The generative phase that continued next spring took place under conditions of high temperature fluctuations, while high temperatures and water deficit coincided with the jointing stage. Drought and high temperatures in October and November 2006 obstructed winter barley emergence and the development of the vegetative phase. Favorable rainfall and temperatures during December and the subsequent winter months enabled the plants to accumulate the necessary amounts of effective temperatures and compensate for the previous delay in development. The end of the generative phase took place under high temperatures and excess rainfall. In the 2007/08 GS, the germination, vegetative

phase and the beginning of the generative phase unfolded under somewhat low temperatures and a large surplus of water.

Results and Discussion

Duration of developmental phases in barley includes a chain of coordinated interdependent processes. Leaf emergence represents externally visible trait that is results of externally not visible leaf primordial initiation. Final leaf number initiated in the apex and the rate of leaf

Table 1. Mean squares of FLN per main stem of winter barley

Source	df	FLN
Cultivar	11	13.98**
Year	5	10.17**
C xY	55	0.98**
% components of variance		
Cultivar		17.20
Year		73.96
C xY		7.19
Heritability		0.93

**-significant at the 0.01 level

emergence determine of pre-anthesis phases. Phenological development and phyllochron is result of genetics and many environmental factors (McMaster, 2005). FLN was controlled by all three factors, cultivar, year and their interaction (Table 1). Contribution of year in FLN variation was highest, about 74%. It means that the tested cultivars were genetically similar in leaf number. Low value of interaction showed stability of leaf number from year to year. Considered across the GSs, the early cultivar Novosadski 581 had the lowest and the late cultivar Kredit the highest FLN (Table 2). In the cultivar Novosadski 581, early maturity was due to a reduction in FLN (Table 2) and a short phyllochron (Table 3). Juskiew *et al.* (2003) found that earliness was due

to accelerated postanthesis growth rather than reduction in leaf number and phyllochron.

Table 2. Final leaf number (FLN) per main stem of twelve winter barley cultivars during six growing seasons (GS)

Cultivar	GS						Average
	2002/03	2003/04	2004/05	2005/06	2006/07	2007/08	
Kompolti-4 (E, 6R)	14	15	13	13	15	14	14.0
Skorohod (E, 6R)	13	14	12	13	14	14	13.3
Novosadski 525 (E, 2R)	13	13	12	13	13	13	12.8
Novosadski 581 (E, 2R)	10	12	10	12	12	12	11.3
Plaisant (M, 6R)	15	13	13	13	15	14	13.8
Gotic (M, 6R)	15	13	14	13	15	14	14.0
Sonate (M, 2R)	13	13	12	13	14	13	13.0
Boreale (M, 2R)	13	13	12	13	14	13	13.0
Novator (L, 2R)	15	15	13	14	15	14	14.3
Kredit (L, 2R)	15	15	14	15	15	14	14.7
Monaco (L, 6R)	13	13	13	13	14	14	13.3
Cordoba (L, 6R)	14	14	13	14	14	15	14.0
Average	13.6	13.6	12.6	13.2	14.2	13.7	13.5
	<i>LSD</i>	0.05	<i>Cultivar</i>	<i>Year</i>	<i>CxY</i>		<i>CV 1.9%</i>
		0.01	0.17	0.12	0.42		
			0.23	0.16	0.56		

E-early, M-medium, L-late, 2R- two-rowed, 6R- six-rowed

Even though the cultivar x year effect for FLN was significant and participated in total variation with 7.2% (Table 1), the FLN variability within a cultivar-year was rather small (Table 2). Although differences in FLN was observed among the cultivars (Table 1, 2), no relationship could be established in the rank of the cultivars for the FLN. For example, the early cultivar Kompolti-4 had one of the highest FLN in 2002/03 GS and one of the lowest in 2005/06 GS (Table 2). The average FLN for the barley main stem was 13.5. In the present study no consistent differences were found in the FLN between 6-rowed and 2- rowed cultivars, although García del Moral and García del Moral (1995) had showed that 6-rowed barley cultivars have less tillers per plant because they have less leaves per main stem. Arisnabarreta and Miralles (2004) also didn't found differences in the FLN between 6-rowed and 2- rowed barley cultivars.

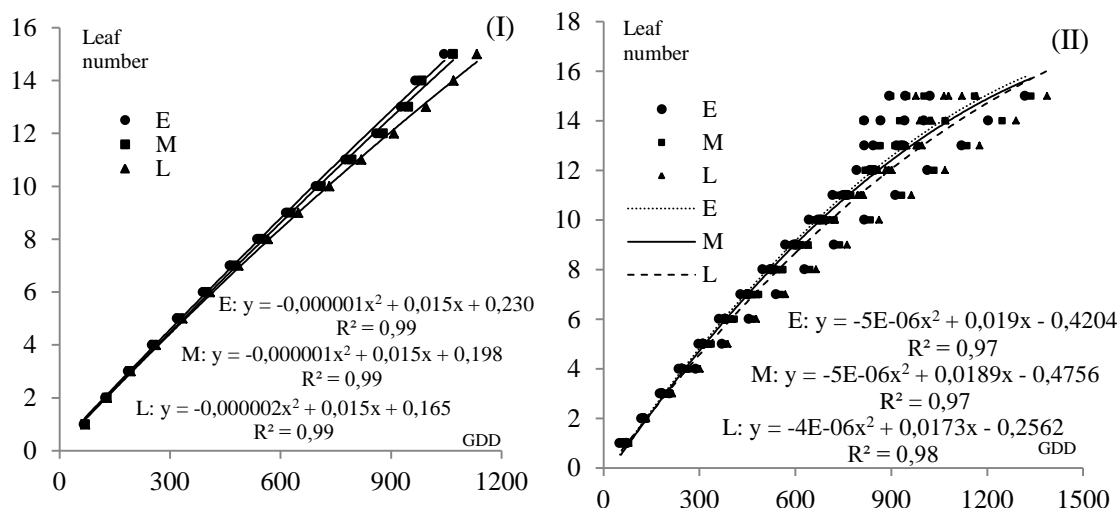

Figure 1. (I) Leaf number development in four early (E), four medium (M) and for late (L) winter barley cultivars across six GSs

(II) Leaf number development of three winter barley maturity classes (E-early, M-medium, L-late) in different GSs. Each point represents the average of four cultivars belonging to a maturity group in individual GS. There are six points for each leaf per maturity group

Table 3. Mean squares of FLN per main stem for three maturity classes (early, medium, late) of winter barley

Source	df	FLN
Maturity class	2	8.56**
Year	5	3.39**
Maturity class x year	10	0.58 ^{ns}
% components of variance		
Maturity class		14.90
Year		20.82
Maturity class x year		25.91
Heritability		0.71

** - significant at the 0.01 level, ns - non significant

Across GSs and maturity classes, the early maturity group completed the FLN fastest (Figure 1I). Quadratic equation fitted best the relationship between GDD requirement and FLN per main stem, with $R^2 > 0.99$. Also, quadratic equation fitted best the relationship between leaf number development across cultivars in the same maturity group and GS, with $R^2 > 0.97$ (Figure 1, II). In our investigation, the FLN was positively correlated with GDD accumulated till flag leaf completion, while the effect of precipitation was less important (data not

shown). When the cultivars were sorted according to earliness, each cultivar representing a replication, then maturity classes and years determined FLN (Table 3). The interaction maturity class x year was not significant for FLN, i.e., the early cultivars always had lowest FLN and the late ones always had highest FLN and longest PHY regardless of the year (Table 3, 4). Across the studied GSs, the early cultivars had 12.9, medium early 13.5, and late 13.9 main stem leaves (Table 4).

In our investigation, the FLN was positively correlated with GDD accumulated till flag leaf completion (Table 5), while the effect of precipitation was less important. The identification of genetic variability on leaf area is a crucial step on plant breeding. (Royo *et al.*, 2004). This is particularly important in species with a narrow genetic background, which may be a result of the selection pressure applied in breeding programs. Understanding of how changes in photosynthetic area may be affected by environmental conditions, particularly drought stress under field conditions, could provide a basis for evolving superior high yielding varieties. Some studies have been conducted to understand the growth of leaves as affected by factors such as temperature, photoperiod, available water, nitrogen etc. Genotype by environment interactions should be taken into account to determine the optimum breeding strategy in a target environment.

Table 4. FLN per main stem for three maturity classes (E-early, M-medium, L-late) across six GS

Maturity class	GS						Average
	2002/03	2003/04	2004/05	2005/06	2006/07	2007/08	
E	12.5	13.5	11.8	12.8	13.5	13.2	12.9
M	14.0	13.5	12.7	13.0	14.5	13.5	13.5
L	14.2	13.8	13.2	14.0	14.5	14.2	13.9
Average	13.6	13.6	12.6	13.2	14.2	13.7	13.5
		<i>Year</i>	<i>Maturity cl.</i>	<i>Y x G</i>			
	0.05	0.76	0.54	1.31	CV 6.9%		
<i>LSD</i>	0.01	1.01	0.71	1.75			

Increases in the potential yield of barley requires an increase in the photosynthetic area in early growth stages, in order to increase the incident radiation intercepted by the crop and the total biomass produced. In barley higher grain yields under drought stress conditions is associated with higher leaf area index at the end of tillering. However, since leaf area is determined by factors such as phenology, leaf number, potential leaf size and stem morphology, any effect of drought on these factors would modify leaf area. In fact, the earliest response of plants to drought is adaptation of the expansion rate of the leaves, which is important through its control of radiation interception and water use during the grain filling period. Before anthesis, the reduction in leaf area index and intercepted radiation under stress is a consequence of decreased leaf expansion and changes in leaf display, whereas after anthesis this reduction is mainly a result of progressive leaf senescence.

Table 5. Simple correlations between final leaf number (FLN) and temperature and precipitation during some phenological growth stages (PGS)

PGS	GDD from E till DR	Precipitation from E till DR	GDD during DR	Precipitation during DR	GDD during J	Precipitation during J
FLN	0.35**	-0.25*	0.34**	-0.27*	0.79*	-0.16

E-emergence, DR- double ridge, J- jointing

Conclusion

The average final number of leaves on the main stem of winter barley under the conditions of the Pannonian Plain was 13.5. The early cultivars had one leaf less than the late cultivars. Earliness is rather the result of leaf number reduction than grain filling reduction.

References

- Arisnabarreta S., Miralles D. (2004). The influence of fertilizer nitrogen application on development and number of productive primordia in field-grown two- and six-rowed barleys. *Australian Journal of Agricultural Research*, 55: 357-366.
- García del Moral M.B., García del Moral L.F. (1995). Tiller production and survival in relation to grain yield in winter and spring barley. *Field Crop Research*, 44: 85-93.
- Griffiths F., Lyndon R.F., Bennett M.D. (1985). The effects of vernalization on the growth of the wheat shoot apex. *Annals of Botany*, 56: 501-511.
- Juskiew P.E., Helm J.H. (2003). Barley response to seeding date in central Alberta. *Canadian Journal of Plant Science*, 83: 275-281.
- Kirby E.J.M. (1992). A field study of the number of main shoot leaves in wheat in relation to vernalization and photoperiod. *Journal of Agricultural Sciences*, 118: 271-278.
- McMaster G.S. (2005). Phytomers, phyllochrons, phenology and temperate cereal development. *Journal of Agricultural Science*, 143: 137-150.
- Pržulj N. (2001). Cultivar and year effect on grain filling of winter barley. *Plant Breeding and Seed Science*, 45: 45-58.
- Pržulj N., Momčilović V. (2011). Importance of spikelet formation phase in the yield biology of winter barley. *Field and Vegetable Crops Research*, 48: 37-48.
- Pržulj N., Momčilović V., Nožinić M., Perović D. (2013). Variation in Phenological Development of Winter Barley. In: Zhang, G., Li, C., Liu, X. (Eds) *Advances in Barley Sciences*, Chapter 34. Springer, pp. 401-412.
- Rickman R.W., Klepper B.L. (1991). Tillering in wheat. In: Hodges, T. (Ed), *Predicting crop phenology*, pp. 3-83. CRC, Boston.
- Robertson M.J., Brooking I.R., Ritchie J.T. (1996). Temperature Response of Vernalization in Wheat: Modelling the Effect on the Final Number of Mainstem Leaves. *Annals of Botany*, 78: 371-381.
- Royo C., Aparicio N., Blanco R., Villegas D. (2004). Leaf and green area development of durum wheat genotypes grown under Mediterranean conditions. *European Journal of Agronomy*, 20: 419-430.
- Slafer G.A., Whitechurch E.M. (2001). Manipulating wheat development to improve adaptation and to search for alternative opportunities to increase yield potential, In: Reynolds M.P., Ortiz-Monasterio J.I., McNab A. (Eds.) *Application of Physiology in Wheat Breeding*, pp. 160-170. CIMMYT. Mexico DF.

**DETERMINATION OF PHENOLOGICAL, POMOLOGICAL AND YIELD
CHARACTERISTICS OF LOW CHILLING APPLE CULTIVARS
BUDED ON M9 AND MM 106 ROOTSTOCKS**

Ali IKINCI*, Ibrahim BOLAT

Department of Horticulture, Faculty of Agriculture, University of Harran, Sanliurfa, Turkey

*Corresponding author: aliikinci@harran.edu.tr

Abstract

The purpose of this study is to determine the vegetative growth, yield, phenological, pomological and morphological characteristics of six apple cultivars grafted on M9 and MM 106 rootstocks under ecological conditions of Sanliurfa in 2007-2012. According to the findings of the study, full blooming occurred between March 25th (Anna/M9) and April 07th (William's Pride/MM 106). The fruits were harvested between July 10th (Vista Bella/M9) and August 12th (Mondial Gala/MM 106). The average fruit weights of the cultivars were determined as 140.9 g (Summer Red/MM 106) and 193.4 g (Anna/M9). Average total soluble solid content ranged between 12.7% (in Jersey Mac/MM 106) and 17.2% (in Mondial Gala/MM 106), while the highest of titratable acidity was observed as 0.76% in Vista Bella/MM 106. Trunk cross-sectional area of six apple cultivars at the end of the 9th year ranged between 54.4 cm²/tree (Anna/M9) and 102.5 cm²/tree (William's Pride/MM 106). Anna/M9 has taken the first row with respect of cumulative yield (167.34 kg/tree) and the yield of fruits per cm² of trunk cross-sectional area (3.08 kg/cm²) in the first nine cropping years.

Keywords: *Apple rootstock, pomology, phenology, trunk cross-sectional area, cumulative yield, yield efficiency.*

Introduction

Apple, growing especially in cold temperate climates, is the most commonly relished species among temperate climate fruits (Ozcagiran et al., 2005). Anatolia is one of the native lands of apple. It was taken to Greece and Italy from the Anatolian region by the Greeks and Romans and therefrom spread out to the rest of Europe.

Cultivation of apple is widespread in the areas within cold temperate climates between latitudes 30° and 50° in the North and South of the Equator (Soylu, 2003). In Turkey, apple is cultivated in areas of altitude over 500 m in the Aegean Region and over 800 m in the Mediterranean and the Southeastern Anatolia Regions (Ozcagiran et al., 2005).

Apple is the most commonly produced kind among the temperate climate fruits in the world. According to FAO (2013) data, Turkey is the third largest apple producer after China (39.7 million tons) and the USA (4.1 million tons) within an estimated global production level of approximately 80.1 million tons. Turkey has a 3% share in the world's apple production with 2.5 million tons. Yet, Turkey lags far behind by exporting 126.000 tons of apple (1.48%) (FAO, 2013) considering the global apple exports of 8.5 million tons exports. Among the reasons why Turkey takes a back seat in apple exports are insufficient technical infrastructure and lack of high-grade apple varieties preferred by the global market (Ozongun et al., 2014). Despite the adaptation and introduction studies on apple varieties in certain periods, more persistent studies in relation to apple varieties, including the varieties demanded in foreign trade, are necessary

considering the numerous varieties of apple introduced to the market every year (Ozongun et al., 2014).

Apple production has been continuously increasing in Turkey, which has productive areas for apple cultivation. In fact, the number of apples cultivated increased from 2,400,000 tons to 3.128.450 between 2000 and 2013. However, due to the adverse climate conditions in 2014, this number fell back to 2.480.444 ton indicating a decline of 20.8%. In Turkey, 26% of the apple production is made in Isparta, 13% is made in Karaman; 9% is made in Antalya; 7% is made in Denizli, and 5% is made in Nigde (Anonymous, 2016a). In Turkey, apple cultivation was practiced using strong-growing apple varieties that were budded on seedling rootstocks until the 1970s. In the later years, it was maintained using modern fruit growing techniques, in which weak-growing apple varieties known as spurs are grafted on various weak-growing rootstocks. As of the 2000s, there has been a significant increase in garden facilities with varieties grafted on the M9 rootstock and new garden facilities using apple varieties grafted on the M9 and MM 106 rootstocks are still being established. From the early years of planting, increasingly more abundant and high-grade products have been harvested; cultural procedures such as pruning, thinning, pest and disease control, as well as harvesting have been implemented more easily and affordably, and higher-grade products in terms of fruit size and color have been obtained by means of clonal rootstocks that are weak or slow-growing (Oz et al., 1994). Consequently, clonal rootstocks have become widespread in place of seedlings. Nowadays, highly dwarf, dwarf and semi-dwarf clonal rootstocks such as M27, M9, M7, M26, and MM 106 are increasingly used in modern fruit growing.

Today, M9 is the most commonly used dwarf rootstock in the world. Apple saplings grafted on M9 rootstocks need support beginning from their planting and they start yielding fruit the following year. The size of the saplings grafted on these rootstocks is 20-40% of what is grafted on seedlings (Ozcagiran et al., 2005). MM 106, which is an M9 and Northern Spy hybrid, has a solid root system that can hold the soil and shorten 25-40% of the apple varieties grafted on it. It is the second most commonly used rootstock in apple cultivation after M9 (Jackson, 2003; Ozcagiran et al., 2005). In Sanliurfa, apple production varies year by year, but it is around 400-500 tons a year. In order to improve and increase apple cultivation in Sanliurfa, which lags behind in apple production compared to the rest of Turkey, rootstocks and apple varieties appropriate for the ecology of the city should be determined. This study aims to identify the phenological and pomological features of certain apple varieties grafted on M9 and MM 106 rootstocks, as well as their yield performance in Sanliurfa, which has a rich potential for apple cultivation in Turkey.

Material and Methods

The present study was implemented on four-year-old Anna, Jersey Mac, Mondial Gala, Summer Red, Vista Bella and William's Pride apple varieties grafted on M9 and MM 106 in the Research and Application Orchard of the Department of Horticulture at the Faculty of Agriculture at Harran University (37°10' N and 38°59' E; 535 m. a.s.l.) between 2007 and 2012. Varieties budded on M9 were planted in 5x2.5 m distances and varieties budded on MM 106 were planted in 5x5 m distances. The garden, where the study took place, was irrigated using drip irrigation. As from their planting, the trees were trained in accordance with the central leader training system. Technical and cultural procedures such as fertilizer application and pest and disease control were regularly implemented and fruit thinning was not performed. According to the climate data (Table 1), the average temperature in Sanliurfa was 19.1 °C, while the highest temperature was 45.2 °C, and lowest temperature was -4.7 °C. Additionally, the areal

precipitation was 389 mm, while the average daily evaporation amount was 14.74 mm between April and October, where the average relative humidity value was 49.1% (Anonymous, 2016b). The soil in the experiment garden (0-40 cm) was generally heavy textured. It had 58.5% clay, 18.5% silt, 1.27% organic matter and a pH of 8.12. The level of potassium in the soil was high, whereas the levels of nitrogen and phosphorus were low (Anonymous, 2012).

Table 1. Mean monthly climate data of Sanliurfa, 2007-2012 (Anonymous, 2016)

Months	Temperature (°C)			Relative Humidity (%)	Precipitation (mm)
	Max.	Min.	Average		
Jan.	17.5	-4.7	4.5	71.1	99.4
Feb.	20.0	-4.0	7.9	72.2	58.5
March	23.6	1.8	12.2	65.6	6.2
April	28.5	4.0	17.8	53.0	81.1
May	39.1	11.0	23.8	33.6	17.4
June	44.0	17.8	30.8	29.2	0.3
July	43.7	20.3	32.2	31.7	0.3
Aug.	45.2	20.0	33.4	29.8	
Sep.	42.0	12.0	27.2	38.9	
Oct.	34.2	9.8	21.0	40.1	42.5
Nov.	26.8	2.2	11.4	58.2	26.2
Dec.	18.5	-4.3	6.8	65.6	23.3

The following sections include observations and measurements conducted, and methods implemented on the apple varieties discussed in this study:

Phenological observations: Phenological stages and morphological characteristics were recorded as per BBCH scale (Meier et al., 1994). Bud swelling (BBCH stage code 01), bud breaking (BBCH 07), first blooming (BBCH 60), full blooming (BBCH 65), post blooming (BBCH 69) and fruit harvest dates (BBCH 07) were separately specified for each variety/rootstock combination.

Pomological traits: Twenty fruits were collected from each variety/rootstock combination in order to measure width (mm), length (mm), weight (g), flesh firmness (Effegi penetrometer FT-011; Effegi-Italy) (with the 11.1 mm tip of the penetrometer), the amount of soluble solids content (SSC) (%) (Atago Palette Series Model PR-101a digital refractometer; Atago Co. Ltd., Tokyo, Japan), pH of the fruit juice and titratable acidity (%), and calculate volume (cm³) of the fruit.

Yield and vegetative traits of the tree: The yearly yield average per tree (kg/tree), the cumulative yield per tree (kg/tree) and yield of fruits per 1 cm² of the trunk cross-sectional area (TCSA) were recorded during the dormant season of 2007 (mainly in March). In the last year of the trial (2012), in order to calculate the trunk cross sectional area (TCSA), trunk circumference was measured from about 15 cm above the graft union with a hand caliper at the end of the growing season and the measurement was converted to TCSA in cm². Finally, yield efficiency (yield per tree/TCSA) was measured as yield per tree divided to TCSA in late growing season.

Statistical Analysis: According to the randomized blocks experimental design, the study was organized in three repetitions, one tree for each repetition. JMP 8.0 package program was used to compare the results obtained from the study. “Duncan’s Multiple Range Test” (p<0.05) was used in comparing the differences between the averages.

Results and Discussion

Table 2 shows conditions the phenological observation results regarding Anna, Jersey Mac, Mondial Gala, Summer Red, Vista Bella, and William's Pride apple varieties grafted on M9 and MM 106 in Sanliurfa conditions.

During the study, spring frost damage was not encountered often on the flowers under Sanliurfa conditions. However, in some regions of Turkey, late frosts in spring can cause significant damage. For this reason, it is crucial to know the exact blooming dates of the varieties in garden facilities.

In the trial, the earliest bud swelling was encountered in the Anna variety (March 6th) grafted on M9 and MM 106 and the latest bud swelling was encountered in Vista Bella/M9, Jersey Mac/M9, and Jersey Mac/MM 106 (March 11th). The earliest bud breaking was observed in the Anna/M9 variety (March 11th) and the latest bud breaking was observed in William's Pride/M9, William's Pride/MM 106, and Jersey Mac/MM 106 (March 17th). The earliest variety to bloom was Anna/M9 (March 20th), while the latest blooming was observed in William's Pride/MM 106 (March 31st). Anna/M9 and Anna/MM 106 were the first completely blooming varieties (March 25th and 27th). They were followed by Mondial Gala/M9 and Summer Red/M9 (April 02nd). The latest to bloom completely was William's Pride/MM 106 (April 07th) (Table 2).

Table 2. Phenological data of the apple cultivars (average of 2008-2012).

Cultivars	Rootstocks	Bud swelling	Bud breaking	First Bloom	Full bloom	End of flowering	Fruit maturation
Anna	M9	6 Mar.	11 Mar.	20 Mar.	25 Mar.	2 Apr.	13 Jul.
	MM 106	6 Mar.	12 Mar.	22 Mar.	27 Apr.	3 Apr.	15 Jul.
Mondial Gala	M9	10 Mar.	15 Mar.	27 Mar.	2 Apr.	9 Apr.	08 Aug.
	MM 106	10 Mar.	16 Mar.	28 Mar.	3 Apr.	10 Apr.	12 Aug.
Vista Bella	M9	11 Mar.	16 Mar.	28 Mar.	3 Apr.	10 Apr.	10 Jul.
	MM 106	8 Mar.	14 Mar.	28 Mar.	4 Apr.	13 Apr.	13 Jul.
William's Pride	M9	10 Mar.	17 Mar.	30 Mar.	5 Apr.	13 Apr.	17 Jul.
	MM 106	10 Mar.	17 Mar.	31 Mar.	7 Apr.	15 Apr.	20 Jul.
Jersey Mac	M9	11 Mar.	16 Mar.	28 Mar.	3 Apr.	10 Apr.	15 Jul.
	MM 106	11 Mar.	17 Mar.	29 Mar.	4 Apr.	12 Apr.	17 Jul.
Summer Red	M9	10 Mar.	15 Mar.	27 Mar.	2 Apr.	9 Apr.	17 Jul.
	MM 106	10 Mar.	16 Mar.	28 Mar.	5 Apr.	12 Apr.	20 Jul.

When Table 2 is examined, it may be seen that the varieties in the Sanliurfa city center were in the harvest phase between the second week of July and the second week of August. The Vista Bella/M9 variety (July 10th) was the first variety to reach harvesting maturity while the Mondial Gala/MM 106 variety (August 12th) was the last one.

Burak et al. (1994) reported the bud swelling, bud breaking, first blooming, full blooming, post blooming dates for the Jersey Mac variety grafted on seedling rootstock between 1990 and 1994 in Yalova conditions as 15/3, 29/3, 16/4, 19/4 and 30/4 respectively. The apple adaptation study conducted in the research garden of Kentucky University (USA) pointed out that the William's Pride variety was in the green tip phase between March 10th and 29th, in the pink flower phase between March 31st and April 04th, in the initial blooming phase between March 31th and April

11th, in the post blooming phase between April 14th and 18th, and in initial fruit set phase between April 19th and 22nd April (Masabni and Wolfe, 2007).

Atay et al. (2010) reported that Jersey Mac, Galaxy Gala and Braeburn varieties grafted on MM 106 rootstock under the conditions of Egirdir were in the full blooming phase in 20, 22 and 20 April in 2006 and reached the full blooming phase on 28 April, 1 May, and 28 April in 2007. Researchers stated that Jersey Mac, Galaxy Gala and Braeburn varieties were in the harvest phase in periods of July 30th – August 03rd; August 27th – August 31st and October 22nd in 2007. In Apple Variety Adaptation Trial carried out between 2003 and 2009 in Egirdir Directorate of Research Station for Fruit Growing, the performances of ten apple varieties grafted on MM 106 were investigated. For the varieties studied, bud swelling occurred between March 21st and 25th, bud breaking occurred between March 29th and April 01st, first flowering occurred between April 19th and 25th, full blooming occurred between 24th-27th April, post blooming occurred between May 01st and 05th, and the harvest stage occurred between August 23th (Rubinstein) and November 14th (Cripps Pink (Pink LadyTM)) (Ozongun et al., 2014).

According to the results of phenological observations conducted between 2003-2009 on Mondial Gala apple variety grafted on M9, M26, MM 106, and MM 111 rootstocks, the bud swelling occurred between 20th-25th March; the bud breaking occurred between March 29th and April 05th; the initial blooming occurred between April 17th and 21st; the full blooming occurred between April 23rd and 29th April; the post blooming occurred between May 01st and 07th; and the harvest occurred between August 25th and September 01st (Ozongun et al., 2016). The initial blooming, full blooming and harvest periods of Jersey Mac apple variety grafted on MM 106 under Samsun's ecological conditions were March 27th – April 08th, April 10th - 22th, and July 07th - 08th respectively (Ozturk and Ozturk, 2016).

Both in Turkey and in other countries, phenological observations on apple varieties yielded varying results. This shows that blooming in apple varieties differs depending on the ecological conditions of fruit growing regions. In the fruit-growing region, annually varying climatic factors are the most important reason behind the changes in blooming time and period of fruit trees. In fruit growing, blooming (full blooming) time and period differs based on the variety, rootstock, ecology and cultural procedures, while high temperatures, especially during the blooming period, shorten the blooming period (Jackson, 2003). The latitudes, longitudes and the altitude of the fruit growing region, hot and cold winds, rootstocks and cultural procedures considerably affect the blooming period (Karacali, 2004).

The average yield value of variety/rootstock combinations per tree by years during the trial period is provided in Table 3. According to the data, the highest cumulative yield value belonged to the Anna/M9 combination (167.34 kg) between 2007 and 2012. It was followed by the Anna/MM 106 (131.07 kg) and William's Pride/MM 106 combinations (122.01 kg). The lowest value belonged to the Mondial Gala/M9 variety (92.17 kg). At the trial, the trunk cross-sectional area values were established between 54.35 cm² (Anna/M9) and 112.73 cm² (Mondial Gala/MM 106). Considering the yield amounts (yield effect) per trunk cross-sectional area unit, the highest value was obtained once again from the Anna/M9 variety (3.08 kg/cm²) as in the cumulative yield. It was followed by the Anna/MM 106 variety (2.12 kg/cm²), the Vista Bella/M9 variety (1.73 kg/cm²) and the William's Pride/M9 variety (1.62 kg/cm²). The lowest value belonged to the Mondial Gala/MM 106 variety (0.87 kg/cm²). According to the decare yield value calculated based on the six-year cumulative yields of different apple varieties grafted on M9 and MM 106 rootstocks, the Anna/M9 (13.39 ton) combination ranked first. It was followed by the Anna/MM 106 (10.49 ton) combination. The lowest value belonged to the Mondial Gala/M9 (7.37 ton) combination.

Crassweller and Smith (2011) reported that until the 10th fruit growing season, the cumulative yield ranged between 85.5 (Ginger Gold - Trellis) and 152.5 kg/tree (Fuji - offset V-axis); the cumulative yield effect changed between 2.00 (Gala-Slender Spindle) and 2.92 kg/cm² (Ginger Gold – Vertical Axis); and the decare cumulative yield changed between 13.23 ton/da (Ginger Gold-Trellis) and 21.76 ton/da (Ginger Gold – Vertical Axis) in Crimson Gala, Ginger Gold and Fuji apple varieties, which were grafted on M9 rootstock, where four different training systems were tried in Pennsylvania (USA) conditions. A cumulative yield changing between 48.40 (Budagowski 9) and 67.00 kg/tree (M.9 EMLA), TCSA changing between 19.29 (Budagowski 9) and 35.15 cm² (Supporter 4) (at the end of the 7th season) and the yield value per trunk cross-sectional area (yield effect) changing between 0.71 (Supporter 4) and 1.02 kg/cm² (Pajam 1) were obtained between 2008 and 2010 from the Granny Smith apple variety grafted on rootstocks of nine varying strengths (M.9 T 984, M.9 T 337, Jork 9, Mark 9, Budagowski 9, M.9 EMLA, Pajam 1, Pajam 2 and Supporter 4) in Macedonia in 2004 (Gjamovski and Kiprijanovski, 2011).

Table 3. Cumulative yield, cumulative yield efficiency and trunk cross-sectional area of apple cultivars budded on M9 and MM 106 rootstocks.

Cultivars	Rootstocks	Cumulative yield (kg tree ⁻¹) (2007-2012)	Trunk cross-sectional area in 2012 (cm ²)	Cumulative yield efficiency (kg cm ⁻²)	Cumulative yield (ton da ⁻¹)
Anna	M9	167.3 a	54.4 g	3.1 a	13.4 a
	MM 106	131.1 b	61.9 fg	2.112 ab	10.5 b
Mondial Gala	M9	92.2 d	90.6 bc	1.0 c	7.8 i
	MM 106	97.9 cd	112.7 a	0.9 c	7.8 g
Vista Bella	M9	111.3 bcd	64.9 efg	1.7 bc	8.9 e
	MM 106	100.1 cd	96.1 b	1.0 bc	8.0 fg
William's Pride	M9	116.6 bcd	72.5 def	1.6 bc	9.3 d
	MM 106	122.0 bc	102.5 ab	1.2 bc	9.8 c
Jersey Mac	M9	96.9 cd	74.7 de	1.3 bc	7.9 gh
	MM 106	102.8 bcd	81.6 cd	1.3 bc	8.2 f
Summer Red	M9	100.7 bcd	74.9 de	1.4 bc	8.1 fg
	MM 106	93.5 d	89.1 bc	1.1 bc	7.5 hi
<i>Significance</i>		**	**	***	*

In Egirdir (Isparta) Fruit Research Institute, ten apple varieties grafted on MM 106 rootstock produced decare cumulative yield values between 8.3 tons/da (Top Red) and 19.40 tons/da (Cripps Pink (Pink Lady™)) at the end of a seven-year variety adaptation trial. The same study showed that the cumulative yield value per tree was between 87.92 kg/tree (Rewana) and 233.78 kg/tree (Cripps Pink (Pink Lady™)), while the yield value per trunk cross-sectional area was between 0.97 kg/cm² (Rewana) and 3.69 kg/cm² (Scarlet Spur) (Ozongun et al., 2014). On ten-year-old Mondial Gala varieties grafted on M9 and MM 106 rootstocks under Egirdir conditions, the trunk cross-sectional area between 67.75 cm² and 109.12 cm², the yield per tree between 37.44 and 95.5 kg and the yield value per trunk cross-sectional area between 5.25 and 3.25 kg/cm² were obtained (Ozongun et al., 2016). In the same study, the tenth-year cumulative decare

yield values of Mondial Gala/M9 and Mondial Gala MM 106 rootstock/variety combinations ranged between 35.17 tons/da and 31.88 tons/da.

Fruit characteristics regarding six apple varieties on trial are given in Table 4. In terms of the features examined, significant statistical differences were detected among the varieties. The varieties examined during the study had an average fruit weight between 140.94 (Summer Red/MM 106) and 193.42 g (Anna/M9), fruit width between 67.87 (Anna/MM 106) and 77.86 mm (William's Pride/MM 106), fruit height between 57.35 (Mondial Gala/MM 106) and 81.98 mm (Anna/M9) and fruit volume between 150.45 (Summer Red/MM 106) and 234.58 cm³ (Anna/M9).

In terms of fruit flesh firmness, the Mondial Gala/M9 variety (25.65 lbre) had the highest value and the Vista Bella/M9 variety (14.86 lbre) had the lowest value. In terms of water-soluble solid matter, the Mondial Gala/MM 106 variety (17.2%) had the highest value. It was followed by Mondial Gala/M9 (17.1%). The lowest value belonged to the Jersey Mac/MM 106 (12.7%) variety (Table 4). In terms of pH, Anna/MM 106 had the highest value with 4.81, while William's Pride/M9 had the lowest value with 2.70. The titratable acidity of the examined apple varieties ranged between 0.21% (Mondial Gala/MM 106) and 0.76% (Vista Bella/MM 106).

Atay et al. (2010) reported that in Galaxy Gala and Jersey Mac apple varieties grafted on MM 106 under Egirdir conditions, the fruit weight was between 150.14 and 135.71 g; the fruit flesh firmness was between 6.01 and 8.90 kg/cm²; water soluble solid matter was between 13.19% and 12.36%; pH was between 3.41 and 3.09, and titratable acidity was between 0.38% and 0.55%. In a variety adaptation trial on ten apple varieties grafted on MM 106 rootstock under Egirdir (Isparta) conditions, the weights of the varieties were between 162 g (Rubinstein) and 287 g (Crown Gold); their width was between 69 mm (Early Red One) and 84 mm (Novaja); their length was between 57 mm (Gala Selecta) and 77 mm (Topred); their flesh stiffness was between 6.94 kg/cm² (Crown Gold) and 9.55 kg/cm² (Cripps Pink (Pink LadyTM)); their pH was between 2.48 (Cripps Pink (Pink LadyTM)) and 4.14 (Topred); their titratable acidity was between 0.31% (Topred) and 1.12% (Cripps Pink (Pink LadyTM)), and their water soluble dry matter was between 12.20% (Scarlet spur) and 16.40% (Cripps Pink (Pink LadyTM)) (Ozongun et al., 2014). In Celarevo (Serbia), the average weight (g), width (mm), water soluble dry matter (%) and titratable acidity (%) values of Gala apple variety grafted on M9 rootstock were 174.4 g, 75.0 mm, 12.4% and 0.16%, respectively (Radiojevic et al., 2014).

Table 4: Fruit quality characteristics of apple cultivars on M9 and MM 106 rootstocks. Values show the average between 2010-2012.

Cultivars	Rootstocks	Fruit width (mm)	Fruit length (mm)	Fruit weight (g)	Fruit volume (cm ³)	Fruit firmness (lb cm ⁻²)	SSC (%)	pH	TA (%)
Anna	M9	71.1	81.9	193.4	234.6	18.6	14.4	3.5	0.5
	MM 106	67.8	75.9	181.1	190.5	19.6	15.0	4.8	0.5
Mondial Gala	M9	70.5	62.3	154.4	167.1	25.7	17.1	3.6	0.3
	MM 106	68.7	57.4	147.0	162.7	24.9	17.2	4.4	0.2
Vista Bella	M9	74.8	60.4	165.9	206.3	16.9	13.5	3.0	0.5
	MM 106	75.1	64.3	166.6	217.5	21.7	13.7	3.1	0.7
Williams' Pride	M9	75.6	65.2	171.2	216.5	21.7	14.0	2.7	0.4
	MM 106	77.9	65.8	183.7	223.1	21.3	14.6	3.6	0.3
Jersey Mac	M9	77.9	61.4	162.7	206.0	18.3	13.3	2.9	0.6
	MM 106	76.6	64.9	178.4	214.4	18.2	12.7	3.5	0.4
Summer Red	M9	69.2	65.4	145.7	160.5	20.2	14.3	3.7	0.6
	MM 106	70.1	62.7	140.9	150.5	22.6	15.0	2.8	0.5

Edizer and Bekar (2007) indicated that the average fruit volume of ten local apple varieties (Tavar, Yağlıkızıl, Arapkızı, Elifli, Demir, Yer Elması, Ekşi Elma, Gelin Elma, Alyanak, and Pehrizoğlu) bred in the central district of Tokat were between 48.00 cm³ (Yer Elması) and 309.50 cm³ (Alyanak).

The weight, width, length, flesh firmness, soluble solids content, juice pH and titratable acidity (TA) levels of the Mondial Gala apple variety grafted on M9 and MM 106 under Egirdir conditions were between 147 and 148 g, 69.04 and 67.65 mm, 61.73 and 60.86 mm, 9.25 and 9.64 kg/cm², 13.03% and 12.48%, 3.70 and 3.66, and 0.30% and 0.35%, respectively (Ozongun et al., 2016). On some apple varieties bred under Samsun conditions, the fruit weight ranged between 112.3 (Jersey Mac) and 173.9 g (Starkrimson Delicious); the fruit width changed between 64.83 (Golden Delicious) and 74.27 mm (Granny Smith); the fruit length changed between 54.55 (Jersey Mac) and 63.74 mm (Red Chief); the fruit flesh firmness changed between 10.90 lb (Jersey Mac) and 17.60 lb (Granny Smith); soluble solids content (SSC) changed between 10.46% (Starkrimson Delicious) and 13.45% (Cooper 7 SB2 and Golden Delicious); juice pH changed between 3.43 (Jersey Mac) and 4.34 (Cooper 7 SB2), and titratable acidity changed between 0.39% (Super Chief) and 0.90% (Granny Smith) (Ozturk and Ozturk, 2016). In the same study, it was stated that the Jersey Mac variety had a fruit weight of 112.3 g, a width of 67.07 mm, a height of 54.55 mm, a fruit flesh firmness of 10.90 lb, a soluble solids content of 12.80%, a pH of 3.43, and a titratable acidity of 0.74% (Ozturk and Ozturk, 2016).

In studies conducted in different regions of Turkey and abroad, fruit quality shows differences. It is expected that the changes in the harvest season, as well as climate and soil characteristics affect the differences in literature findings regarding the values from pomological analysis results obtained during the study and the differences in varieties, cultural procedures and fruit set percentages.

Conclusions

Regarding apple, variety of which has been consistently increasing due to an increasingly broadrange introduced to the market, adaptation studies should be conducted in cultivation regions that have different ecological characteristics, and varieties suitable for these regions should be recommended based on the result of these studies. This would be beneficial for successful and profitable cultivation before new apple varieties are produced. Besides adaptation studies that should be conducted in different ecologies for new varieties, clonal rootstocks which have been recently cultivated in different countries, and tests conducted in the climate and on the soil of these countries should be immediately tried in Turkey. Thus, the rootstocks on which new apple varieties perform better will be determined using future studies on apple varieties and rootstocks.

This study examined the phenological, pomological and yield features of some apple varieties grafted on M9 and MM 106 in Sanliurfa's ecological conditions. Late frost in spring, which harmed other fruit kinds significantly in some years in Sanliurfa, caused comparatively less damage to apple trees.

It has been concluded that summer varieties, which ripen especially in July can be successfully cultivated under Sanliurfa conditions and the varieties which ripen in August can be cultivated in regions with altitude of over 650 m.

The effects of rootstocks on the yield and some fruit quality characteristics differed based on apple varieties. According to the yield values gathered for many years, the Anna variety grafted on M9 and MM 106 had a higher performance compared to other varieties.

In fruit growing, good agricultural practices should be implemented province-wide in Sanliurfa and modern cold storage, especially controlled atmosphere storage, should be installed within sufficient capacity.

References

- Anonymous (2012). Egirdir Fruit Research Institute, Soil Analysis Report.
- Anonymous (2016a). Turkish Statistical Institute, Crop Production Statistics. Available at: <https://biruni.tuik.gov.tr/bitkiselapp/bitkisel.zul> (Accessed: 25 May 2016).
- Anonymous (2016b). Sanliurfa Provincial Directorate of Meteorology climate data. Available at: <http://www.mgm.gov.tr/> (Accessed: 20 May 2016).
- Atay E., Pirlak L., Atay A.N. (2010). Determination of fruit growth in some apple varieties. *Journal of Agricultural Sciences*, 16: 1-8.
- Burak M., Oz F., Bulagay A.N. (1994). The selection of local and foreign apple varieties - III. Atatürk Central Horticultural Research Institute, Scientific Research and Reviews, Issue no: 38, Yalova.
- Crassweller R.M., Smith D.E. (2011). Influence of training system on production of three apple cultivars. *Proceedings of the IXth International Symposium on Integrating Canopy, Rootstock and Environmental Physiology in Orchard Systems*. Ed.: T.L. Robinson. *Acta Horticulture*, 903: 619-626.
- Edizer Y., Bekar T. (2007). Determination of phenological and pomological characteristics of some local apple (*Malus communis* L.) cultivars grown in Tokat province. *Journal of Agricultural Faculty of Gaziosmanpasa University*, 24(1): 1-8.
- FAO (2013). Food and Agriculture Organization of The United Nations (FAO). Available at: <http://faostat3.fao.org/download/Q/QC/E> (Accessed: 20 June 2016).
- Gjamovski V., Kiprijanovski M. (2011). Influence of nine dwarfing apple rootstocks on vigour and productivity of apple cultivar 'Granny Smith'. *Scientia Horticulturae*, 129: 742-746.

- Jackson J.E. (2003). *Biology of apples and pears*. Cambridge University Press. Cambridge, UK., 488 pp.
- Karacali I. (2004). *Storage and marketing of horticultural crops* (4. print). Ege University Agricultural Faculty Publications No: 494, Izmir, Turkey.
- Masabni J., Wolfe D. (2007). *Apple cultivar performance*. Cooperative Extension Service. HortFact-3006. University of Kentucky Research and Education Center, Princeton, KY.
- Meier U., Graf H., Hess M., Kennel W., Klose R., Mappes D., Seipp D., Stauss R., Streif J., Boom van den T. (1994). *Phenological growth stages and identification keys of pome fruit*. *Growth stages of mono- and dicotyledonous plants*, p:52-54.
- Ozongun S., Dolunay E.M., Pektas M., Ozturk G., Calhan O., Atay E. (2016). *Yield and quality alterations of some apple cultivars on different rootstock*. *Journal of Agriculture Faculty of Ege University*, 53(1): 35-42.
- Oz F., Burak M., Buyukyilmaz M., Ozelkok S., Ergun M.E. (1994). *Apple planting density trial*. *Orchard*, 23(1-2): 93-103.
- Ozbek S. (1978). *Apple cultivation*. *Special fruit (Deciduous fruit species)*. Cukurova University Agricultural Faculty Publication, Publication No: 128, Text Book: 11, Adana, pp. 15-94.
- Ozcagiran R., Unalan A., Ozek E., İsfendiyaroğlu M. (2005). *Apple. Temperate fruit species, Pome Fruits. Volume II*, Ege University Faculty of Agriculture, Publication No: 556, Bornova, Izmir, pp. 3-72.
- Ozongun S., Dolunay E.M., Ozturk G., Pektas M. (2014). *Performance of some apple varieties in Eğirdir (Isparta) conditions*. *Fruit Science*, 1(2): 21-29.
- Ozturk A., Ozturk B. (2016). *Evaluation of phenological and pomological characteristics of some standard apple cultivars in Samsun ecological condition*. *The Anatolian Journal of Agricultural Sciences*, 31: 1-8.
- Radivojević D.D., Milivojević J.M., Oparnica C., Vulić T.B., Djordjević B.S., Ercişli S. (2014). *Impact of early cropping on vegetative development, productivity and fruit quality of Gala and Braeburn apple trees*. *Turk J Agric For.*, 38: 773-780.
- Soylu A. (2003). *Apple. Temperate Fruits-II, Pome Fruit Species*. Uludag University Faculty of Agriculture Lecture Notes, No: 72, Bursa, pp. 1-75.

DISPONIBILITY AND PERFORMANCE OF BENTONITE IN TOP WORKING OF WALNUT TREES AS GRAFTING WAX

Sebahattin YILMAZ*¹, Halil KAKÇI¹, Yaşar AKÇA²

¹Agricultural Faculty of the Ahi Evran University, Kırşehir, Turkey

²Agricultural Faculty of the Gaziosmanpaşa University, Tokat, Turkey

*Corresponding author: sebahattinyilmaz2005@gmail.com

Abstract

Bentonite is a form of clay consisting mostly montmorillonite. It is mainly used as drilling mud in geological studies. Hydration, swelling, water absorption, viscosity and thixotropic properties of bentonite make it a valuable material for a wide range of industrial uses and applications. Bentonite is used in foundry, cosmetic, medical, agriculture, food and construction industries. It is a natural, abundant, low cost and sterile material which can be used as a graft wax. Bentonite was experimented in top working of walnut trees to determine its disponibility and performance in grafting. Study was performed on 10-12 years old walnut trees in two orchards that are located at 750 and 1240 m altitudes. Experiment was designed with two replicates at two locations. Graftings were made using bentonite and water holder paint by bark modified grafting method at the beginning of May in 2015. Graft-take rates, length and thickness of shoots from grafted scions were measured, and total shoot lengths were calculated. During the growing season, disponibility of bentonite were evaluated by observations of top worked trees. The differences between graft-take rates and total shoot lengths were found statistically important according to wax type. Anti-bleeding effect of bentonite were observed that might overcome bleeding problem that is frequently seen in top working of walnut trees.

Keywords: *Walnut, top working, graft-take success, graft wax, bentonite*

Introduction

There is an urgent need to top working of walnut (*Juglans regia* L.) trees in Turkey. Insufficient fruit quality and low yield of seedling trees and damaging of national cultivars due to frosts that frequently occur in springs are main reasons (Akça, 2009). Top working can be applicable to fruit trees at different ages from a few years old thin saplings to several years old big trunks. In grafting of big trees generally scion grafting techniques are used. Cleft and bark grafting techniques are the most widely used techniques (Hartman et al., 1997). In walnut trees, it is being reported that the best graft-take rates could be obtained from bark grafting after a long time experiences (Akça, 2009; Rezaee and Vahdati, 2008; Reil et al., 1998)

Graft waxes of various types are used in fruit tree graftings to seal of cutting surfaces. Waxes help protection and remediation of tree wounds. Using of graft wax is important for graft success and also healing of cutting surfaces (Lewis and Alexander, 2008; Hartman et al., 1997). Tar (pitch), raw resin (rosin), bees wax, tallow, paraffin and similar substances can be used as graft waxes by itself and also mix with other substances like linseed oil (flaxseed oil), alcohol, vaseline, coal dust, chalk, polyvinyl acetate at different rates (Soylu, 2010; Anonymous, 2009; Charles, 1930). For ages, mud of clay soil has been used as sealing agent in grafting process. Still today, clay soil is being used for graft wax due to hardness of graft wax preparation, difficulty of

finding graft wax whenever you need and its cost. It is reported that 90-97 % graft-take success was obtained by using clay soil mud at walnut tree top working (Kömür, 2011).

Currently, there are approximately 13 million walnut trees all along the Turkey. Nearly four and half million of these trees are older than ten years and at bearing ages (Turkstat, 2016). Most of these trees are from seedling origin and give low quality nuts at low quantities. Also, a considerable part of these trees are undesired early leafing national cultivars that give irregular yield. Top working seems the best choice for the tree owners to convert walnut trees fruitful. Nowadays, there is a big trend of top working of walnut trees in Turkey.

Bentonite has special properties such as hydration, swelling, water absorption, viscosity, thixotropy make it a valuable material for a wide range of industrial uses and applications (Hosterman and Patterson, 1992). Raw bentonite can be treated to produce different forms (Anonymous, 2016a; Anonymous, 2016b). Different forms of bentonite are used in foundry, food and pharmaceutical industries for various purposes (Anonymous, 2016c; Anonymous, 2016d).

Bentonite is accepted an important raw material by the EU. Turkey is the fourth producer of the world with 718.260 tons amount and EU is the main importer of bentonite produced in Turkey with 211.982 tons (EU Commission, 2014). A necessity of affordable, easy accessible and applicable, abundant graft wax materials that have positive effect on graft success is essential. Right here, bentonite may be a good alternative to other waxes in walnut tree top working because of its abundance, naturalness, sterility and affordability. We did not find any research on usage of bentonite in grafting.

The aim of this research is to investigate disponibility of bentonite as graft wax and determine the performance. Results and observations of a practical study were presented in this paper.

Material and Methods

Experiment was designed and performed in spring 2015 with two replicates at two orchards in different locations in Turkey. Orchard 1 is located in Kaman county of Kırşehir province at 1240 meters altitude while orchard 2 is located in Yerköy district of Yozgat province at 750 meters altitude. Graftings were made on 10-12 years old seedling walnut trees at 1 and 2 May 2015. Healthy walnut trees near same trunk diameter were chosen for graftings. One year old shoots of “Kaman 1” cultivar were used as scion. Improved bark grafting method was used for top working of walnut trees according to Reil et al. (Reil et al., 1998). Five walnut trees were used for each treatment and each tree were grafted by inserting two or three scions.

Water holder paint (WHP) and bentonite mud were used as graft waxes on cutting surfaces and graft union. WHP was applied with a little brush directly from commercial pot. Distilled water was added to dust form of bentonite to prepare mud in gel form. Bentonite mud was applied with the help of spatula by hand at 6-10 mm thickness. Cutting surfaces and graft union were wrapped with stretch film to prevent drying.

Properties of Wax Materials

WHP is water based paint with one component consists of acrylic copolymer resin. WHP is very practical water isolation material that can be applicable to all surfaces by brushing. In commercial form, it is ready to use, elastic, paintable. It is in white colour but can be coloured. WHP can be applied whether horizontal or vertical surfaces on interior and exterior surfaces even on rough surfaces. It can cover very hard surfaces and has low labour and material cost (Anonymous, 2015a). Water based plastic paints are advised to use in grafting application for exposed graft areas (Lewis and Alexander, 2008). Usability of WHP in grafting applications comes from its

affordability, durability, elasticity, and breathability to allow callus formation. Detailed technical properties of WHP are given Table 1.

Bentonite is a special form of clay containing 60 % montmorillonite at least. It is generated from the alteration and chemical deterioration of volcanic ash or lavas containing rich aluminium and magnesium. It is soft, porous, ductile and often in colloidal silica structure. It has high ion exchange capacity. It can be various in colours including white, yellow, green and grey at first. It has large surface area (750 m²/g) and superior ability of swelling volumetrically as much as 15-20 fold. It can sustain the shape deformations that occurred under mechanical tension even after the tension is disposed. It becomes gel when contacted with water and may transform to liquid form when it is shaken (Anonymous, 2015b). In this study, bentonite in API 13 A standard was used. Bentonite has been supplied from one of the world's high-grade natural sodium bentonite source found in Reşadiye district of Tokat, Turkey (Anonymous, 2015c). Important physical and chemical properties of bentonite used in this study were given at Table 2.

Table 1. Technical properties of WHP used in graftings

Form	Semi liquid fluid
Colour	Produced at white colour, but also colorable or paintable with a water based paint having the same elasticity structure
Density	1,29 ± 0,05kg/lt.
Elasticity	Performs % 600 expansion after 24 hours at 1-1.5 mm. thickness and 23°C. Maintains its elasticity at temperature differences; 476% at 70°C, 397% at -17°C
Dry time	12 hours at 20 °C and 65% humidity
Durability	Durable against weak chemicals
Tensile strength	24.5 kgf/cm ² at 23°C after 24 hours and 55 kgf/cm ² after 72 hours
Adherence resistance	12 kgf/cm ² , mineral based surfaces: 7.15 kgf / cm
Water vapor permeability	27.6 g/m ² .day at 23°C and 65 % humidity after 24 hour
Consumption	Approximately 1-1,5 kg/m ² on horizontal surfaces depending on the surface structure, smoothness, porousness and gaps

Table 2. Physical and chemical properties of bentonite used in graftings

Physical properties	Chemical properties
Colour: Yellow	SiO ₂ : 61.28 %, Al ₂ O ₃ : % 17.79
Form: Dust	Fe ₂ O ₃ : 3,01 %, CaO: 4,54 %
Density: 0.8 – 1.0 gr/cm ³	Na ₂ O: 2.70 %, MgO: 2.10%
Amount of filtration: 12.5 cc maximum	K ₂ O: 1.24%
Yield Point, Plastic Viscosity ratio (YP/PV): 1.5 maximum	
Disperse Plastic Viscosity: 10 cp min.	

Graft-take results were recorded at June 2015 and calculated with two way as scion graft-take success rate (SGSR) and tree graft success rate (TGSR). At the end of growing season, number of shoots from scions was determined, thicknesses and lengths of each shoot were measured. Total shoot lengths (TSL) obtained from each grafting were calculated. During the growing season, behaviour of wax materials and events such as durability, diseases, browning, decay at grafting areas and callus formation capabilities were noted. Data were analysed according to Completely

Randomized Design (CRD), One Way ANOVA at $P < 0.05$ confidence level with Tukey's test for multiple pairwise comparisons by using Minitab statistical program (MINITAB, 2000).

Results and Discussion

Graft-Take Success

A mean of 57.40 % scion graft- take success rate (SGSR) and 67.50 % tree graft-take success rate (TGSR) were obtained in general. In orchard 1 (Kaman location) 58.50 %, in orchard 2 (Yerköy location) 56.25 % SGSR, 70.00 % and 65.00 % TGSR were obtained respectively. Difference at graft-take success rates between two orchards was not found statistically important. However, graft-take success rates were found significantly different between WHP and bentonite used graftings. Mean value of 40.30 % SGSR and 45.00 % TGSR were obtained from WHP used graftings while 74.50 % and 90.00 % were obtained respectively from bentonite used graftings (Table 3). SGSR and TGSR were considerably higher in bentonite used graftings. This results shows us that bentonite have positive effect on grafting success. Kömür has reported graft-take success rates between 90 % and 97 % in walnut trees by using clay soil mud (Kömür, 2011). Rezaee and Vahdati reported the graft take results of a long term study of top working of walnut trees. They obtained graft take success rates between 30 % and 100 % and survival rates between 0 % and 100 % depending on bark grafting methods, year and cultivar (Rezaee and Vahdati, 2008). Graft-take success over 50 % is accepted normal for top working of walnut trees in Turkey.

Number of Shoots, Shoot Thicknesses-Lengths and Total Shoot Lengths

The number of shoots (NS) originated from successful scions has changed between 1 and 5 depending of the joining degree of graft union and results are not discussed here. Mean shoot thickness (MST) of 28.83 mm, mean shoot lengths (MSL) of 137.58 mm were determined from all graftings. Mean of TSL of two orchards was found 1920.00 cm. MST values were determined 20.60 mm and 25.06 mm, MSL values 122.20 cm and 152.94 cm for orchard 1 and orchard 2 respectively. While the difference in MST was not important, the difference of MSL values between two orchards were found statistically important (Table 3). This can be originated from little differences of trunk diameters and scion thickness, soil conditions and health degree of trees. Total shoot lengths (TSL) values of 2223.00 cm in orchard 1 and 1616.00 cm in orchard 2 were obtained. Although, TSL value of orchard 1 is bigger than orchard 2, the difference was not statistically important. The effect of wax type on TSL was found significantly important while the effect on MST and MSL was not important. A higher value of TSL (2871.90 cm) was obtained from bentonite than WHP (967.15 cm) (Table 3). Also, vigorous development of shoots was distinctive in bentonite used graftings in orchard 1 by visual assessment. According to the measurements and visual assessments, it can be distinctly said that bentonite have promoted shoot elongation from buds of scions more than WHP.

Other observations

It is determined that WHP was found highly durable against to external conditions (daily and seasonal temperature fluctuations, sun, wind etc.) both in summer and winter seasons except of some deformations. Flowing and erupting of WHP from graft union due to bleeding of trees and darkening in paint colour were observed on some trees during the growing season. Cracking on upper surface of bentonite layer has been detected in some trees but that didn't cause disintegration. Bleeding from cutting surfaces is the result of excessive sap flow in some trees

and especially in walnuts (Shearman and Ellenwood, 1944; Soylu, 2010). Bleeding is reported to prevent graft success. An advantageous of bentonite was observed against to bleeding during the study. Bentonite has absorbed leaked water to itself and prevented bleeding, stayed longer in gel form without cracking. This situation has ensured suitable conditions for callus formation by providing moist environments and also gas exchange in graft union. Walnut is one of the most difficult trees to bud or graft due to its rather slow rate of callus formation (Lewis and Alexander, 2008). Juglone in sap flow is another factor that prevents graft success in walnuts (Karadeniz et al., 1997). Binding of juglone by compounds in bentonites after absorption may eliminate this negative effect. In visual assessments of callus formation, thicker layer of callus was observed in graftings made with bentonite. The durability of bentonite in cutted surfaces and graft union was found sufficient in every cases both in two seasons.

No disease were detected in WHP applied graftings but darkening under the paint layer was observed. Darkening may be caused by oxidation of juglone in sap flow of walnut trees. Apparent darkening was also observed in bentonite layer but no decay was observed in woods or barks of trees. Darkening in bentonite layer also may be caused by absorbed juglone from sap flow. In orchard 2, scale insects were detected over the bentonite applied surfaces on some trees. This may be the result of suitable humid conditions for insect development provided by bentonite layer.

Table 3. NS, SGSR, TGSR, MST, MSL and TSL values of successful graftings according to locations and wax types.

Locations	Wax types	NS	SGSR (%) ***	TGSR (%) ***	MST (mm) ***	MSL (cm) ***	TSL (cm) ***
Orchard 1	WHP	17	36.50	40.00	18.74	103.64	872.05
	Bentonite	50	80.50	100.00	22.46	140.82	3574.35
<i>Mean (Orchard 1)</i>			58.50a	70.00a	20.60b	122.20b	2223.00a
Orchard 2	WHP	14	44.00	50.00	24.58	150.34	1062.25
	Bentonite	28	68.50	80.00	25.56	155.54	2169.45
<i>Mean (Orchard 2)</i>			56.25a	65.00a	25.06a	152.94a	1616.00a
<i>Mean (All)</i>			57.38	67.50	22.83	137.58	1920.00
<i>Mean (WHP)</i>			40.30B	45.00B	21.66A	127.00A	967.15B
<i>Mean (Bentonite)</i>			74.50A	90.00A	24.01A	148.18A	2871.90A

Means with the same letter are not significantly different. Comparisons significant at the 0.05 level are indicated by ***

NS: Number of Shoots from Scions **SGSR:** Rates of Scion Graft-Take Success **TGSR:** Rates of Tree Graft-Take Success

MST: Mean of Shoot Thicknesses **MSL:** Mean of Shoot Lengths **TSL:** Total Shoot Length

Conclusion

This study was performed over the walnut trees found in two orchards at two different locations. By comparison of wax materials it is aimed to reveal the disponibility and performance of bentonite as graft wax. Results indicates that bentonite provides distinctly better graft-take success rates and total shoot lengths more than WHP that is commonly used in top working of walnut trees. Bentonite is presently a valuable and multipurpose material and with this study a

new use of bentonite is revealed. Bentonite mud in gel form can be used successively and safely as graft wax if there is no better or low cost alternative absent. Further researches are needed on bentonite usage in tree grafting applications. Although, bentonite mud provides sufficient graft wax performance, other investigations should be done such as using it as an additive to existing graft wax formulas, making new formulas with other substances, and using with plant growth regulators.

Acknowledgments

This work was supported by the Ahi Evran University Scientific Research Projects Coordination Unit. Project Number: ZRT.E2.16.028. Special thanks to the owners of walnut orchards at two locations for the permission of using their trees to graft for this study.

References

- Akça, Y. (2009). Çoğaltma (Propagation). Ceviz Yetiştiriciliği (Walnut Cultivation). 5. Bölüm. 3. Baskı. ISBN: 975-97498-07. Anıt Matbaası. Ankara, Turkey. (In Turkish)
- Anonymous (2009). Macunlar (Waxes). <http://www.agaclar.net/?t=14251&id=showthread> Accessed on 5/4/2015
- Anonymous (2015a). SUTUT (WATER HOLDER). <https://www.filliboya.com/upload/CmsBrand/BrandContentFile/1%20SUTUT%20Teknik%20B%C3%BClten.pdf> Accessed on 05/03/2015.
- Anonymous (2015b). Bentonite nedir? (What is bentonite?). http://www.karakaya.com.tr/?page_id=96 Accessed on 05/03/2015.
- Anonymous (2015c). Doğal Bentonit (katkısız) (Natural Bentonite (without additive)). http://www.karakaya.com.tr/?page_id=41 Accessed on 05/03/2015.
- Anonymous (2016a). What is Bentonite?. http://www.ima-na.org/?page=what_is_bentonite Accessed on 05/05/2016
- Anonymous (2016b). Bentonite. <https://en.wikipedia.org/wiki/Bentonite> Accessed on 05/05/2016
- Anonymous (2016c). 10 Proven Bentonite Clay Benefits and Uses. <http://draxe.com/10-bentonite-clay-benefits-uses/> Accessed on 05/05/2016.
- Anonymous (2016d). Bentonite. Products and Applications. <http://www.bentonite.com/bpm/index.page?node-id=hlf0nkvy> Accessed on 05/05/2016.
- Charles, B. (1930). Aşıcılık (Grafting Profession). Çeviren: Edirne Mebusu Faik, Türkiye Himayei Eşrar Cemiyeti Neşriyatından No:1, 690 s., Resimli Gazete Matbaası, İstanbul. (In Turkish)
- EU Commission. (2014). Report on Critical Raw materials for the EU. Retrieved April, 30, 2015.
- Hosterman, J.W., Patterson S.H. (1992). Bentonite and Fuller's Earth Resources of the United States. U.S. Geological Survey Professional. Paper 1522. United States Government Printing Office, Washington D.C., USA.
- Hartmann, H. T., Kester, D. E., Davies, F. T., & Geneve, R. L. (1997). Plant propagation: Principles and Practices. No. Ed. 6. Prentice-Hall Inc., USA.
- Karadeniz, T., Kazankaya, A., Balta, F. and Mehmet Sen, S. (1997). Relations between Phenolic Compounds and Graft Success in Walnut (*Juglans regia* L.). *Acta Hort.* 442, 193-196.
- Kömür, Y. K. (2011). Investigation of Usability of Cleft Grating Technique for Top Working In Walnut (*Juglans regia*) Trees. Master Thesis (Unpublished). Sütçü İmam University. Kahramanmaraş, Turkey. (In Turkish)
- Lewis W. J., Alexander DMcE. (2008). Grafting and budding: A practical guide for fruit and nut plants and ornamentals. Landlinks Press.

- Minitab (2000). User's Guide 1: Data, Graphics and Macros, Release 13 For Windows, USA.
- Rezaee, R.,, Vahdati K. (2008). Introducing a simple and efficient procedure for topworking Persian walnut trees. JOURNAL-AMERICAN POMOLOGICAL SOCIETY, 62(1), 21.
- Reil W., O, McGranahan, G. H., Leslie, C. A., Forde, H.I., and McKenna J.R. (1998). Propagation in Walnut Production Manual. pp:71-83.
- Shearman L. V., Elenwood C.V. (1944). Top-Working and Bench-Grafting Walnut Trees. Special Circular 69. March 1944. Ohio Agricultural Experiment Station Wooster, Ohio.
- Soylu, A. 2010. Ilıman İklim Meyve Ağaçlarında Budama ve Aşılama (Pruning and Grafting-Budding in Temperate Zone Fruit Trees). ISBN.978-975-8377-45-0. Hasad Yayıncılık. İstanbul. (In Turkish)
- Turkstat (2016). http://www.turkstat.gov.tr/PreTablo.do?alt_id=1001 Accessed on 05/05/2016

LONG-TERM EFFECTS OF STRAW INCORPORATION AND INCREASING DOSES OF NITROGEN ON THE WHEAT YIELD

Goran JAĆIMOVIĆ^{1*}, Vladimir AĆIN², Milan MIROSAVLJEVIĆ², Jovan CRNOBARAC¹,
Branko MARINKOVIĆ¹, Dragana LATKOVIĆ¹

¹University of Novi Sad, Faculty of Agriculture, Trg D. Obradovića 8, 21000 Novi Sad, Serbia

²Institute of Field and Vegetable Crops, Maksima Gorkog 30, 21000 Novi Sad, Serbia

*Corresponding author: jgoran@polj.uns.ac.rs

Abstract

Investigation of the effects of straw incorporation and fertilization with increasing amounts of nitrogen on the yield of three winter wheat cultivars was carried out at long-term stationary field trial, established in 1971 on the experimental field of Institute of Field and Vegetable Crops, Novi Sad (Serbia). It included the following variants: a) treatments with straw incorporation (SI) and application of increasing doses of nitrogen: 0 (Ø; control treatment), 60, 90, 120, 150 and 180 kg of nitrogen per hectare and b) treatments without SI and with application of increasing doses of nitrogen: 0, 90 and 150 kg N ha⁻¹. On average for all fertilization treatments with nitrogen application, grain yield obtained in the treatment with SI (6.49 t ha⁻¹), was for 540 kg ha⁻¹ higher in comparison to the average of fertilization treatments without SI. The highest yield on average of all three wheat cultivars (7.15 t ha⁻¹) was obtained with 120 kg N ha⁻¹ and with the SI. It was significantly higher in comparison to all treatments without straw incorporation. The positive effect of long-term SI on wheat grain yield (at comparable variants of experiment: 0, 90 and 150 kg N ha⁻¹) ranged from 100 to 840 kg ha⁻¹, depending on cultivar and amount of nitrogen applied. On average, long-term SI increased yield for 350 kg ha⁻¹ (about 6%) of grain (for all three cultivars and the doses of nitrogen applied). Yield increase by individual cultivars was 350, 390 and 320 kg ha⁻¹, for NS Ilina, Pobeda and Simonida, respectively.

Key words: *wheat, straw incorporation, nitrogen, grain yield*

Introduction

Crop residues represent the mass of organic matter left on the field after harvest or picking of the main products. It can be used for different purposes: as animal feed, litter in livestock production, ploughed (incorporated) into the soil, for mulching, composting and preparation of artificial manure, as a material for energy production etc. (Kastori and Tešić, 2006; Latković et al., 2015). Lack of livestock on farm implies that crop residues cannot be used as animal feed or litter, and returned back to the soil as manure. In that case incorporation of crop residues has advantages in comparison to the other ways of use (Malešević et al., 2009). It represents significant quantity of bio-mass of great importance in cycling of matter in agricultural ecosystem, especially under condition of insufficient use of organic fertilizers (Kastori and Tešić, 2006).

Fertilization with organic and mineral fertilizers has positive effect on humus content. Incorporation of organic matter and mineral fertilizers into the soil increases plant aerial and root mass. It does not only improve nutritional land potential, but also water capacity, aerial and thermal soil properties as well as microbiological activity necessary for mobility of biogenic elements (Manojlović and Jaćimović, 2014; Jaćimović et al., 2014).

On our fields, crop residues are often burned, causing partial or complete loss of biogenic elements. Burning of crop residues is prohibited by our legislation. Crop residues are characterized by a relatively high content of biogenic elements essential for plant nutrition. Long term, permanent removal of plant residues from fields or their burning leads to nitrogen and humus loss, and destruction of living organisms in soil (*Jaćimović et al., 2009*). In order to increase organic matter in soil, it is necessary to increase incorporation of biomass and crop residues by ploughing, or to apply organic fertilizers. Fate of crop residues (ploughed, burned or removed) has significant effect to the amount of nutrients that are need to be applied.

Incorporation of plant crop residues has positive effect to soil quality, primarily on organic matter content (*Manojlović and Jaćimović, 2014*). Incorporation of straw or maize stalks into the soil cannot fast increase the amount of humus. It is slow and a time consuming process, but it can improve soil structure, which is especially important for heavy soils. This enables better moisture preservation and uptake, forming of the favourable structure and “biological maturity” of soil, which allows easier and better late soil cultivation, with lower fuel consumption.

In plant production mass of crop residues (hay, stems, leaves, and roots) can be rather large. For instance, in maize it is even up to 10 t ha⁻¹, in wheat 4-6, in sunflower 4-5, in soybean about 4 t ha⁻¹, and in sugar beet even 40-60 t ha⁻¹ (*Jaćimović et al., 2009*). Ploughing, but not removal or burning of this mass, with combined use of organic and mineral fertilizers has effect on significant increase in nutrient content and availability, increase humus content in soil, and thus its general fertility. Application of mineral fertilizers only can partially and in short term amortize harmful effect of organic matter removal and burning of crop residues. According to *Bogdanović et al. (1993)*, in last decades humus content in Vojvodina province soil decreased for 0.2 to 0.81% (0.38% on average). In numerous trials in our country and in the world, positive effect of incorporation of crop residues to yield and its quality has been proved. Moreover, increase of total nitrogen and carbon, improved soil fertility or reduction in nitrogen leaching (*Nicholson et al., 1997; Powlson et al., 1987*), and on grain yield increase (*Pracházková et al, 2002; Silgram et al., 2002; Latković et al., 2012*) have been noted.

The aim of this research was to examine impact of effect of crop residues – wheat straw incorporation in combination with different nitrogen doses on grain yield of three winter wheat cultivars. It was expected that the obtained results show positive effects of long-term ploughing of crop residues on wheat grain yield.

Materials and methods

Two years study of the effect of crop residues – wheat straw incorporation (SI) with applying increasing nitrogen fertilization doses on the yield of three winter wheat cultivars was performed on international long-term stationary field trial (called ISDV - *Internationale Stickstoff Dauer Versuche*). The experiment was founded in 1971, within the series of trials of the International Commission for the study of soil fertility, at the experimental field of the Institute for Field and Vegetable crops in Rimski Šančevi (N 45° 19', E 19° 50'), Novi Sad (Serbia). The soil type of this site is the calcareous chernozem on loess, with slightly alkaline reaction, about 3% of humus in the upper layer, medium supplied with easily available phosphorus and well supplied with potassium. Winter wheat is grown in three-crop rotation system (maize-soybean-wheat).

Preceding crop was soybean. The sowing of wheat is performed machined, at row spacing of 10 cm and with sowing density of 550 grains per m². Wheat sowing was performed in optimal sowing time for conditions in Vojvodina province - mid-October in 2013/14 and 2014/15. This study presents the average results of these two years of the experiment. The trial was laid out in a two factorial in randomized block design (split plot pattern), in 4 replications. The trial had nine

variants, of which six were with SI, and three without it. The experiment included the following variants of nitrogen fertilization (Factor A):

- a) Treatments with SI and application of increasing nitrogen doses: 0 (Ø; control variant), 60, 90, 120, 150 and 180 kg of N ha⁻¹ (each year under maize about 5 t ha⁻¹ of wheat crop residues were ploughed, with addition of mineral fertilizer (10 kg N per 1t of straw) for more efficient decomposition),
- b) Treatments without SI and with application of increasing nitrogen doses of 0, 90 and 150 kg of N ha⁻¹.

As objects of investigation three winter wheat cultivars were selected (Factor B): NS Ilina, Pobeda and Simonida. Application of nitrogen doses was conducted in two occasions: ½ in autumn, before ploughing and ½ in early spring (in topdressing). In all variants the same amount of phosphorus and potassium were applied: 80 kg of P₂O₅ and K₂O ha⁻¹ in autumn before ploughing.

The obtained results of wheat grain yield were subjected to ANOVA for two factorial *split-plot* design (statistical software GenStat Release 9.1; *Rothamsted Experimental Station*). Mean comparison was implemented using a LSD test at $p \leq 0.05$ and $p \leq 0.01$.

Results and discussion

Analysis of variance (Table 1) showed highly significant effects of fertilization system and cultivars ($F_{pr} < 0.001^{**}$) while interaction of fertilization x cultivars did not have significant impact to grain yield ($F_{pr} = 0.089^{ns}$). Observation of the percentage share of individual sources of variation in the sum of total squares indicates that fertilization variants had the largest share in the total of yield variation (60%), followed by cultivars (17%) while interaction AxB participated in yield variation with only 5%.

Table 1. Analysis of variance of wheat grain yield

Sources of variation	Degrees of freedom	Sum of squares	Sum of squares (%)	Mean of squares	F-test	Probability of F-test (F_{pr})
Replications	3	4.012	5	1.337	9.65	/
Fertilization variants (A)	8	51.081	60	6.385	46.08	<0.001**
Residual	24	3.326	4	0.139	0.90	/
Cultivars (B)	2	13.998	17	6.999	45.38	<0.001**
AxB	16	4.052	5	0.253	1.64	0.089 ^{ns}
Residual	54	8.328	10	0.154	/	/
Total	107	84.796	100	/	/	/

Average grain yield in the trial was 6.31 t ha⁻¹ (Table 2). However, grain yield obtained by the treatment with SI (average for all variants of nitrogen fertilization) was 6.49 t ha⁻¹, and it was for 540 kg ha⁻¹ (i.e. for 9.13%) higher in comparison to the average for fertilization variants without incorporation of crop residues (5.95 t ha⁻¹).

On average for the all cultivars, the highest average yield of 7.15 t ha⁻¹ was obtained by fertilization with 120 kg ha⁻¹ of N with SI. Yield obtained in this variant was significantly higher in relation to all other variants with or without SI except at variant 150 kg N ha⁻¹ with SI.

In the treatment without SI, the highest grain yield of 6.48 t ha⁻¹ was achieved with the highest dose of fertilizer - 150 kg of N ha⁻¹, and was significantly higher in relation to treatment with no nitrogen added.

Results of *Malešević et al. (2009)* indicate statistical and economic justification of wheat fertilization by nitrogen in doses up to 120 kg ha⁻¹. Our results are in agreement with this investigation.

Table 2. Wheat grain yield (t ha⁻¹) at different N doses in treatments with and without straw incorporation

Fertilization variant (A)			Cultivars (B):				
Treatments:	No.	Doses of N (kg ha ⁻¹)	NS Ilina	Pobeda	Simonida	Average (A):	
a) With incorporation	straw	1	0	5.19	5.19	5.13	5.17
		2	60	6.52	6.88	5.68	6.36
		3	90	7.09	7.10	6.24	6.81
		4	120	7.49	7.42	6.54	7.15
		5	150	7.25	7.49	6.01	6.92
		6	180	6.65	6.75	6.17	6.52
		Average:	6.70	6.81	5.96	6.49	
b) Without incorporation	straw	7	0	5.09	5.26	4.89	5.08
		8	90	6.50	6.70	5.62	6.27
		9	150	6.89	6.65	5.91	6.48
				Average:	6.16	6.20	5.47
Average (B):			6.52	6.60	5.80	6.31	

		A	B	BxA	AxB
LSD	5%	0.31	0.19	0.54	0.56
	1%	0.42	0.24	0.72	0.74

On average for all fertilization variants, cultivars Pobeda (6.60 t ha⁻¹) and NS Ilina (6.52 t ha⁻¹) achieved statistically significantly higher yield (for 800 and 720 kg ha⁻¹) in comparison to cultivar Simonida (5.80 t ha⁻¹). On the treatments with and without SI, difference between mentioned cultivars was slightly higher and also statistically significant.

Positive effects of long-term straw incorporation on wheat grain yield at comparable variants of trial (treatments with and without SI and with application of increasing nitrogen doses of 0, 90 and 150 kg of pure N ha⁻¹) are presented in Table 3. Depending on studied cultivars and doses of the applied nitrogen, it was within limits of only 100 kg of grains for cultivars NS Ilina in variant without nitrogen fertilization and Simonida in variant 150 kg N ha⁻¹, up to 840 kg ha⁻¹ for cultivars Pobeda fertilized with 150 kg N ha⁻¹.

Table 3. Effect of straw incorporation at comparable variants of experiment to wheat grain yield (t ha⁻¹)

Nitrogen rate	Straw incorporation (SI)	Cultivars (B)			Average
		NS Ilina	Pobeda	Simonida	
0 kg N ha ⁻¹	With SI	5.19	5.19	5.13	5.17
	Without SI	5.09	5.26	4.89	5.08
	Difference:	0.10	-0.07	0.24	0.09
90 kg N ha ⁻¹	With SI	7.09	7.10	6.24	6.81
	Without SI	6.50	6.70	5.62	6.27
	Difference:	0.59	0.40	0.62	0.54
150 kg N ha ⁻¹	With SI	7.25	7.49	6.01	6.92
	Without SI	6.89	6.65	5.91	6.48
	Difference:	0.36	0.84	0.10	0.43
Average for all three N doses:	With SI	6.51	6.59	5.79	6.30
	Without SI	6.16	6.20	5.47	5.95
	Difference:	0.35	0.39	0.32	0.35

On average for three cultivars, on control variant without nitrogen use, SI increased grain yield for only 90 kg ha⁻¹; in variant with 90 kg N for 540 kg ha⁻¹, while the most intensive fertilized variant with 150 kg N ha⁻¹ and SI provided the medium effect on grain yield increase - 430 kg ha⁻¹.

On average for cultivars and all three N doses, SI increased yield for 350 kg ha⁻¹. Cultivar NS Ilina had increase of 350 kg, Pobeda for 390 kg and Simonida 320 kg ha⁻¹.

Table 3 shows that Simonida had significantly better reaction on SI on control and treatment with 90 kg N ha⁻¹, while the Pobeda gave a higher yield increase on the highest nitrogen dose.

In literature there many examples in which SI provides identical results as well as manure application on improvement of soil properties and grain yield. Use of N fertilizers also significantly increases quantity of plant residues which incorporation increases humus content and efficiency of carbon retention in the soil (*Halvorson et al., 1999*). In trials carried out in our country and in the world, beneficial effect of SI on yield and its quality has been proved (*Limon-Ortega et al., 2008; Jaćimović et al., 2009; Latković et al., 2011; 2012*).

Conclusion

Based upon results of the study, the following conclusions can be made:

On average for all fertilization variants with nitrogen application, grain yield obtained in the treatment with straw incorporation (6.49 t ha⁻¹), was for 540 kg ha⁻¹ higher in comparison to the average of fertilization treatments without SI. The highest yield on average of all three wheat cultivars (7.15 t ha⁻¹) was obtained with 120 kg N ha⁻¹ with the SI. It was significantly higher in comparison to all treatments without straw incorporation.

The positive effect of long-term SI on wheat grain yield (at comparable variants of experiment: 0, 90 and 150 kg N ha⁻¹) ranged from 100 to 840 kg ha⁻¹, depending on cultivar and amount of nitrogen applied. On average, long-term SI increased yield for 350 kg ha⁻¹ (about 6%) of grain (for all three cultivars and doses of nitrogen applied). Yield increasement by individual cultivars was 350, 390 and 320 kg ha⁻¹, for NS Ilina, Pobeda and Simonida, respectively.

Acknowledgement

The research was supported by Serbian Ministry of Education, Science and Technological Development (Project No. TR-031066)

References

- Bogdanović, D., Ubavić, M., Dozet, D. (1993). Hemijski sastav i obezbeđenost zemljišta Vojvodine neophodnim elementima (The chemical composition and supply of soils of Vojvodina with the necessary elements). In: Kastori, R. (Ed.): Teški metali i pesticidi u zemljištima Vojvodine, Poljoprivredni fakultet, Institut za ratarstvo i povrtarstvo, Novi Sad, 197- 215.
- Halvorson, D.A., Reule, C.A., Follet, R.F. (1999). Nitrogen fertilization effects on soil carbon and nitrogen in dryland cropping system. *Soil Sci. Soc. Am. J.*, Vol. 63, 912-917.
- Jaćimović, G., Malešević, M., Bogdanović, D., Marinković, B., Crnobarac, J., Latković, D., Aćin, V. (2009). Prinos pšenice u zavisnosti od dugogodišnjeg zaoravanja žetvenih ostataka (Wheat yield depending on long-term incorporation of crop residues). *Letopis naučnih radova, Poljoprivredni fakultet Novi Sad, God. (vol.) 33, br. I*, 85-92.
- Jaćimović, G., Marinković, B., Crnobarac, J., Aćin, V., Latković, D. (2014). Effects of the year and the rate of nitrogen fertilization on wheat production in Serbia. XIIIth Congress of the European Society for Agronomy (13th ESA Congress), University of Debrecen, Debrecen, Hungary, 25-29 August 2014. *Book of abstracts*, 57-58.

- Kastori, R., Tešić, M. (2006). Ekološki aspekti primene žetvenih ostataka njivskih biljaka kao alternativnog goriva (Environmental aspects of the application of crop residues of field plants as an alternative fuel), Zbornik radova, Institut za ratarstvo i povrtarstvo, Novi Sad, Sv. 42, 3-13.
- Latković, D., Marinković, B., Crnobarac, J., Berenji, J., Sikora, V., Jaćimović, G. (2015). Long-term effects of incorporation of crop residues and increasing doses of nitrogen on the maize yield. Sixth International Scientific Agricultural Symposium "Agrosym 2015", October 15-18, 2015, Jahorina, Republic of Srpska, Bosnia and Herzegovina. Book of proceedings, 395-400.
- Latković, D., Marinković, B., Crnobarac, J., Jaćimović, G., Berenji, J., Sikora, V. (2012). Influence of crop residues and increasing rates of nitrogen on the yield of maize. International Symposium „Trends in the European Agriculture Development“, May 17-18, 2012., Timisoara, Romania. Banat's University of Agricultural Sciences and Veterinary Medicine, Faculty of Agriculture Timisoara and University of Novi Sad, Faculty of Agriculture. Research Journal of Agricultural Science, Vol. 44 (3), 61-66.
- Limon–Ortega, A., Govaerts, B., Sayre, K.D. (2008). Straw management, crop rotation, and nitrogen source effect on wheat grain yield and nitrogen use efficiency. *Europ. J. Agronomy* 29: 21–28.
- Malešević, M., Jaćimović, G., Latković, D., Milošev, D., Šeremešić, S., Đalović, I., Stipešević, B. (2009). Utjecaj zaoravanja slame pri primeni različitih doza dušika na prinos ozime pšenice (The influence of straw incorporation with different nitrogen doses at winter wheat grain yield). 2nd international scientific/professional conference »Agriculture in Nature and Environment Protection«, Vukovar, Croatia, 4th – 6th June 2009., Proceedings, 99-105.
- Manojlović, M., Jaćimović, G. (2014). Značaj zaoravanja žetvenih ostataka za kvalitet zemljišta, produktivnost i prilagođavanje klimatskim promjenama (The importance of incorporation of crop residues for soil quality, productivity and adaptation to climate change). Naučno-stručno savetovanje „Dobar dan domaćine“, 23. Januar 2014. godine, Novi Sad. Univerzitet u Novom Sadu, Poljoprivredni fakultet, Departman za ratarstvo i povrtarstvo. Tematski zbornik radova, 27-33.
- Nicholson, F.A., Chambers, B.J., Mills, A.R. & Strachan, P.J. (1997). Effects of repeated straw incorporation on crop fertilizer nitrogen requirements, soil mineral nitrogen and nitrate leaching losses. *Soil Use and Management*, Vol. 13, 136–142.
- Powlson, S., Brookes, C., Christensen, T., (1987). Measurement of soil microbial biomass provides an early indication of changes in total soil organic matter due to straw incorporation. *Soil Biology and Biochemistry*, 19, 159-164.
- Pracházková, B., Málek, J., Dovrtěl, J. (2002). Effect of different straw management practices on yields of continuous spring barley. *Rostlinná Výroba*, Vol. 48 (1), 27–32.
- Silgram, M., Chambers, B.J. (2002). Effects of long-term straw management and fertilizer nitrogen additions on soil nitrogen supply and crop yields at two sites in eastern England. *Journal of Agricultural Science*, Vol. 139, 115–127.

CONTENT OF β -GLUCAN INCREASES THE PRODUCTIVITY OF BARLEY KERNELS

Sveto RAKIĆ^{1*}, Snežana JANKOVIĆ², Suzana ĐORĐEVIĆ MILOŠEVIĆ³, Radojica RAKIĆ¹,
Jela IKANOVIĆ¹

¹University of Belgrade, Faculty of Agriculture, 6 Nemanjina Street, Zemun, Belgrade 11080, Serbia

²Institute for Science Application in Agriculture, 68b Blvd. Despota Stefana, Belgrade 11000, Serbia

³"Singidunum" University, Faculty of Applied Ecology "Futura", 83a Pozeska Street, Belgrade, 11000, Serbia

*Corresponding author: sveto@agrif.bg.ac.rs

Abstract

β -glucan as a secondary metabolite of barley kernels is a biologically active component with a positive impact on human health. β -glucan from cereal grains is a soluble fibre that reduces the amount of cholesterol in blood, decreases glucose levels after meals, as well as insulin levels. From technological aspect, it negatively affects rheological properties of dough. Natural grain coat (chaff) and difficulties in its grinding as well as the lack of gluten narrows the applicability of barley in the fabrication of food. The content of β -glucan in barley kernels varies depending on genotype and agro-ecological conditions. Barley has multifunctional - medicinal role in human diet, which has led to an increase in market demand. The studying of β -glucan contents showed genotypic variations, ranging from 3% to 6.5%. Besides the genotype factors, the authors also detected some significant differences that came as a result of agro-ecological conditions and diseases. The tested samples were three genotypes of barley: *Rekord*, *Zlatnik* and *Nonius*. The content of β -glucan ranged from 3.91 to 4.21%. A higher content of β -glucan in barley kernels, a very important metabolite, is expected in increased demand and promotion of functional characteristics of food and food products. The aim of barley growers should be to increase the production of varieties with higher content of β -glucan. The use of modern technologies of cultivation, selection and breeding, and creation of mutagenic barley populations could pave the way for such development.

Keywords: *barley, β -glucan, fibres*

Introduction

(1-3), (1-4) β -D-glucan is a polysaccharide located in the structure of endosperm cell walls of barley kernels (Fincher, 1975). Compared to other types of cereals, β -glucan is most represented in oat and barley kernels. In recent years, fibres from different types of cereals, their functional properties and positive impact on human health have attracted considerable attention within scientific circles (Ronda *et al.*, 2015; Sarteshnizi *et al.*, 2015). β -glucan from cereal kernels is a soluble fibre that reduces cholesterol in blood, decreases postprandial glucose and insulin levels (EFSA, 2011), and affects the technological properties of dough (Ahmed, 2015; Ahmed & Thomas, 2015). The presence of this fibre in barley kernels can produce a number of problems in malt production during the fabrication of beer (McCleary & Glennie-Homes, 1985). Natural grain coat (chaff) and difficulties in its grinding as well as the lack of gluten narrows the applicability of barley in the fabrication of food. The content of β -glucan in barley kernels varies depending on the genotype and agro-ecological conditions; barley itself has a multi-functional, medicinal, role in human nutrition, and hence there is the trend of increased demand for barley in the market (Dickin *et al.*, 2011; Hetherington *et al.*, 2013; Pentikäinen *et al.*, 2014). According to the FDA,

products having 0.75 g of β -glucan per serving size may be characterized as functional (FDA, 1997; 2008). Due to their high content of β -glucan and a beneficial effect on the human organism, barley kernels are of great importance and quite desirable as a food component. In addition to the traditional and a rather favoured use of this type of cereal in the malt industry, there are also some other possibilities for using barley as a feed component. Given that β -glucan is a component of the endosperm cell wall, there are a number of studies that recommend using bare grain genotypes in the food industry, which would significantly reduce problems associated with barley kernel fabrication. Development of new varieties, as a result of genetics and breeding, can encourage a greater use of barley. Moreover, although direct consumption of barley in the human diet is lower than the direct consumption of other types of cereals, such as wheat, maize and rice, adding barley flour in the fabrication of bread and pasta has proved to be successful (Cavallero *et al.*, 2004). Breeding of barley for malt production has resulted in genotypes with reduced β -glucan content. Variations in the content are genotypic properties. By the (in)solubility of barley kernels in water, one can find two forms of β -glucan in barley kernels. The total content increases when plants are grown in warmer and dry conditions (Swanston *et al.*, 1997). This implies that genetic factors can be expressed in different ways and that the factor of the environment is an important condition in the production of barley kernels with increased genotypic expression requirements for β -glucan content. Although many studies have indicated health benefits of the inclusion of barley in diet, the selection of barley for yield and yield components is still the main goal of barley breeding. Knowing the relation between morphological and biological characteristics and quality would result in considerable saving of resources and at the same time it would increase the yields and improve the quality of barley.

Material and Methods

The experiment was carried out at the experimental field Rimski Sancevi of the Institute of Field and Vegetable Crops, Novi Sad in Serbia (19°51E, 45°20N, altitude 84 m) during the 2012/13 growing season. The soil type where the experiment took place was a non-carbonate chernozem with 2.89% of humus, 54.72 kg ha⁻¹ of NO₃, 20.5 kg ha⁻¹ of P, and 21.8 kg ha⁻¹ of exchangeable K before planting and had a pH of 7.74 (1:2 water). Weather records (daily maximum and minimum temperature and daily rainfall) were obtained from a meteorological station located 1 km away from the experimental site field.

Before sowing, fertilizer was top-dressed as mono-ammonium phosphate (12-48) and then harrowed providing 18 kg ha⁻¹ of nitrogen (N) and 72 kg ha⁻¹ of phosphorus (P₂O₅). According to N-min analysis, additional nitrogen fertilizer as ammonium-nitrate was applied in spring as a top-dressing at rate 33 kg nitrogen ha⁻¹. Pests and diseases were prevented or controlled by spraying recommended fungicides and insecticides, and weeds were periodically removed by hand. No artificial irrigation was applied throughout the growing season.

The experiment was conducted in a randomized complete block design with three replications. The plots were 1.0 m wide and 5 m long, with 0.1 m spacing between rows. Barley cultivars were sown on 8th of October 2012 with a plot seeder at planting density of 300 germinable grains per m² for six-rowed barley and 350 germinable grains per m² for two-rowed barley according to common practice in field scale production.

The subject of the research were the kernel samples of three winter barley varieties – *Rekord*, *Zlatnik* and *Nonius*, selected at the Institute of Field and Vegetable Crops in Novi Sad. The chemical analysis consisted of determining moisture (at 105°C to constant weight) and protein content according to Kjeldahl by applying a semi-micro procedure using the “Tecator-Kjeltec

System 1002” apparatus. The crude lipids were analysed according to Sohslet (Kaluderski and Filipović, 1998).

Determination of β -gluten

After the harvest, samples from the tested plots were selected and finely ground at a laboratory mill (0.5 mm sieve). Thus prepared samples of barley flour were used for the determination of total β -glucan. The total β -glucan concentration was analysed by the spectroscopic method 32-23.01 (AACC, 2003), using the Megazyme mixed linkage β -glucan assay kit (Megazyme International Ireland Ltd., Wicklow, Ireland).

Results and Discussion

The tests were performed on the samples of the three barley genotypes: *Rekord*, *Zlatnik* and *Nonius*. The basic characteristics of the samples are given in Table 1. The samples were crushed in the laboratory mill, the particle size was 0.5 mm, and then they were dried at the temperature of 105°C to constant weight.

Table 1. Characteristics of the analysed samples

Sample	Genotype	Appearance
1	<i>Rekord</i>	Dried and milled powder
2	<i>Zlatnik</i>	Dried and milled powder
3	<i>Nonius</i>	Dried and milled powder

The research also included the chemical analysis of the basic quality parameters of the barley kernels. Results are presented in Table 2.

Table 2. Chemical characteristics of the barley kernels

Genotype	Moisture (%)	Protein (%)	Lipids (%)	NFE (%)
<i>Rekord</i>	5.81	10.5	1.94	81.76
<i>Zlatnik</i>	5.91	10.0	1.71	82.38
<i>Nonius</i>	6.22	7.8	1.91	84.07

Legend: NFE. - Nitrogen free extract

Uniform values of water content were recorded in all tested samples. The content of protein was genotype-inherent and varied from 10 to 7.8%. The content of crude lipids ranged from 1.94 to 1.71%. The content of nitrogen free extracts (NFE) was in accordance with the other analysed chemical parameters.

The content of β -glucan in the tested barley samples ranged from 4.21 to 3.91%. The results are presented in Figure 1. A previous study (Gangopadhyay *et al.*, 2015) dealing with similar investigations states that the content of β -glucan in barley kernels range from 2.64 to 3.33% for some other genotypes in the region of North Europe. In terms of technology, an unfavourable role of β -glucan in barley bread production is well known (Ahmed, 2015) as well as the impact of β -glucan on flour rheological properties during the formation of dough (Ryua *et al.*, 2012).

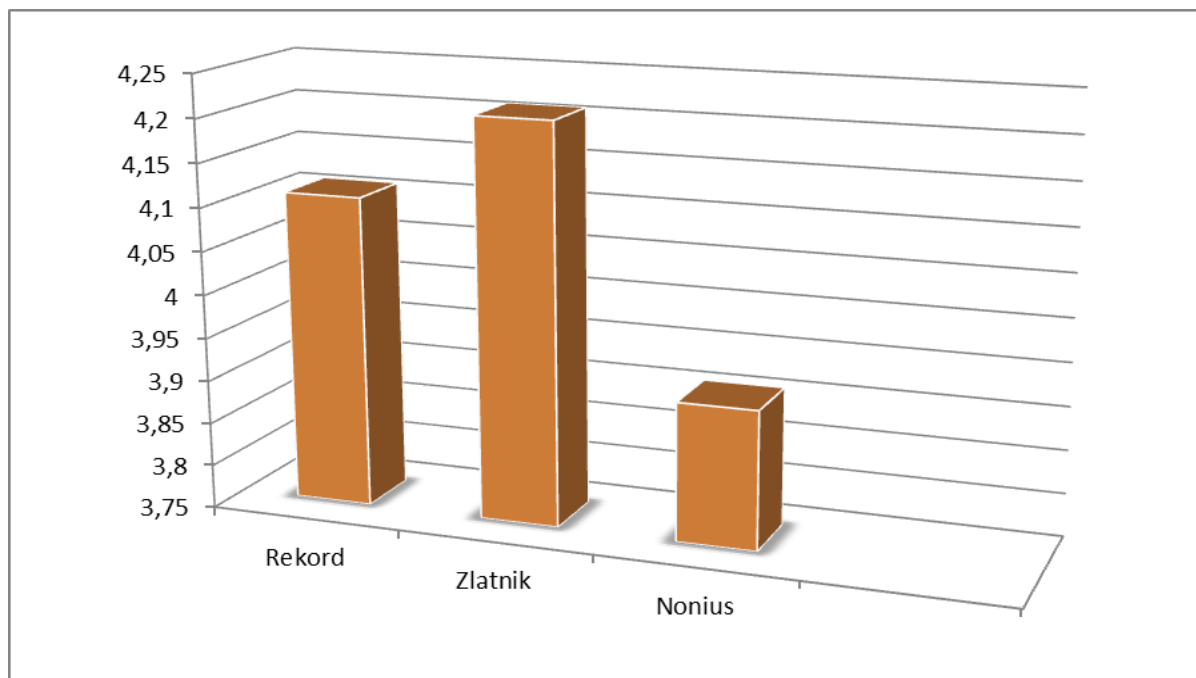

Graph 1. Content of β -glucan (%) in the tested barley samples

Conclusion

A higher content of β -glucan in barley kernels, a very important metabolite, is expected in increased demand and promotion of functional characteristics of food and food products. The aim of barley growers should be to increase the production of varieties with higher content of β -glucan. The use of modern technologies of cultivation, selection and breeding, and creation of mutagenic barley populations could pave the way for such development.

Acknowledgement

This work was supported by the Ministry of Education, Science and Technological Development, Republic of Serbia, Project TR 31066.

References

- AACC (2003). Approved methods (10th ed.). St. Paul, MN: American Association of Cereal Chemist.
- Ahmed J. (2015). Effect of barley β -glucan concentrate on oscillatory and creep behaviour of composite wheat flour dough. *Journal of Food Engineering*, No. 152, pp. 85–94.
- Ahmed J., Thomas L. (2015). Effect of β -D-glucan concentrate and water addition on extensional rheology of wheat flour dough, *LWT. Food Science and Technology*, No. 63, pp. 633-639.
- Cavallero A., Viva M. Stanca A.M. (2000). Improvement of spaghetti and bread with β -glucan and tocots from naked barley flour. In: *Proceedings of the Eighth International Barley Genetics Symposium*, Logue, S.J. (Ed.). Plant Science Dept., Adelaide Univ., Australia, Vol. II, pp. 282-285.
- Dickin E., Steele K., Frost G., Edwards-Jones G., Wright D. (2011). Effect of genotype, environment and agronomic management on β -glucan concentration of naked barley grain intended for health food use. *Journal of Cereal Science*, No. 54, pp. 44-52.

- EFSA (2011). Scientific opinion on the substantiation of health claims related to β -glucans from oats and barley and maintenance of normal blood LDLcholesterol concentrations (ID 236, 1299), increase in satiety leading to a reduction in energy intake (ID 851, 852), reduction of post-prandial glycaemic responses (ID 821, 824), and “digestive function” (ID 850) pursuant to Article 13(1) of Regulation (EC) No 1924/2006. *EFSA Journal*, 9(6), 2207.
- FDA (2008). Food labelling: specific requirements for health claims; health claims: soluble fiber from certain foods and risk of coronary heart disease (CHD). 21 Code of Federal Regulations, 2(101.81), 142-146.
- FDA (1997). Food labelling: health claims; Oats and coronary heart disease; Final rule. *Federal Register*, 62(15), 3583-3601.
- Fincher G.B. (1975). Morphology and chemical composition of barley endosperm cell walls. *J. Inst. Brew.*, 81, 116-122.
- Gangopadhyay N., Hossain M.B., Dilip K., Rai D.K., Brunton N.P. (2015). Optimisation of yield and molecular weight of β -glucan from barley flour using response surface methodology. *Journal of Cereal Science*, No. 62, pp. 38-44.
- Hetherington M.M., Cunningham K., Dye L., Gibson E.L., Gregersen N.T., Halford J.C., Van Trijp H.C. (2013). Potential benefits of satiety to the consumer: Scientific considerations. *Nutrition Research Reviews*, 26 (1), pp. 22–38.
- Kaluderski G., Filipović N. (1998). *Methods of analysis grain quality*. University of Novi Sad, Novi Sad.
- McCleary B.V., Glennie-Homes M. (1985). Enzymatic quantification of (1-3) (1-4)- β -D-glucan in barley and malt. *Journal of the Institute of Brewing*, No. 91, pp. 285–295.
- Pentikäinen S., Karhunen L., Flander L., Katina K., Meynier A., Aymard P., Vinoy S., Poutanen K. (2014). Enrichment of biscuits and juice with oat β -glucan enhances postprandial satiety. *Appetite*, No. 75, pp. 150–156.
- Ryua J.H., Leea S., Youb S.G., Shimc J.H., Yooa S.H. (2012). Effects of barley and oat β -glucan structures on their rheological and thermal characteristics. *Carbohydrate Polymers*, No. 89, pp. 1238–1243.
- Ronda F., Perez-Quirce S., Lazaridou A., Biliaderis G.C. (2015). Effect of barley and oat β -glucan concentrates on gluten-free rice based doughs and bread characteristics. *Food Hydrocolloids*, No. 48, pp. 197-207.
- Sarteshnizi R.A., Hosseini H., Bondarianzadeh D., Colmenero F.J., Khaksar R. (2015). Optimization of prebiotic sausage formulation: Effect of using β -glucan and resistant starch by D-optimal mixture design approach. *LWT. Food Science and Technology*, No. 62, pp. 704-710.
- Swanston J.S., Ellis R.P., Pérez-Vendrell A., Voltas J., Molina-Cano J.-L. (1997). Patterns of barley grain development in Spain and Scotland and their implications for malting quality. *Cereal Chem.*, No. 74, pp. 456-461.

YIELD AND POMOLOGICAL TRAITS OF RED CHIEF AND MONDIAL GALA APPLE CULTIVARS IN SUBTROPICAL CONDITIONS OF TURKEY

Safder BAYAZIT^{1*}, Oguzhan CALISKAN¹, Kazım GUNDUZ¹

¹Mustafa Kemal University, Faculty of Agriculture, Department of Horticulture, Antakya, Hatay, Turkey

*Corresponding author: sbayazit@mku.edu.tr

Abstract

The aim of this study is determined to yield and fruit characteristics of the ‘Red Chief’ and ‘Mondial Gala’ cultivars (*Malus domestica* Borkh.) grafted on M9 and MM106 rootstocks under subtropical conditions of Turkey. The experiment was conducted on a private sector orchard in the Eastern Mediterranean Region of Turkey (Yayladağı/Hatay) in 2011. In this study, harvesting date, yield parameters and pomological characteristics of ‘Mondial Gala’ and ‘Red Chief’ apple cultivars were evaluated. The fruit characteristics such as fruit weight, fruit width, fruit length, seed number per fruit, pH, TSS, acidity were investigated based on the cultivars and rootstocks. The results showed that, fruit harvesting was 18 August for the ‘Mondial Gala’ and 29 August for the ‘Red Chief’. Average fruit weight was 129.86 g for the Mondial Gala/MM106, 99.13 g for Mondial Gala/M9, 189.86 g for the Red Chief/MM106, and 178.10 g for Red Chief/M9. Yield produced was 0.60 kg/cm² for Red Chief/MM106, 0.89 kg/cm² for Red Chief/M9, 0.45 kg/cm² for Mondial Gala/MM106, and 0.27 kg/cm² for Mondial Gala/M9. In conclusion, according to pomological and yield properties, Mondial Gala/MM106 for summer apple and Red Chief/M9 for winter apple cultivations can be promising for the subtropical conditions in the region.

Keywords: *apple varieties, yield, pomological properties, subtropical conditions.*

Introduction

Anatolia, Caucasia, Turkistan, and Europe were centers of origin for the domestic apple (*Malus domestica* Borkh.), now grown in continental climates in the Northern and Southern Hemispheres. Apple cultivation has occurred since ancient times and is one of the most important fruit for human consumption. One reason is great variety in colours, flavours, flesh textures, and other features (Way et al.1990). The most important producer countries are China, United States, Turkey, France, Iran, and Italy. Annual apple production in Turkey is 3.128.000 t, is one of the important producers of the world (Anonymous, 2013). More than 500 cultivars of apple are known in Turkey. This abundance has resulted from natural hybridization and selection over thousands of years (Özbek, 1978). Until recent years, local cultivars, Starking Delicious and Golden Delicious are commonly produced in Hatay.

Generally, trade value of these cultivars in international market is very low due to the having subtropical climates of Hatay city. Nowly, summer apple cultivars are planted for early apple cultivation and their fruits are harvested from June to September. In addition to the summer apple varieties, by increasing production of mid-season apple cultivars, Mondial Gala and Red Chief would be supply more gains and also prevent to accumulate of crop in the late season. With become widespread orchards on cloned rootstocks, early fruiting and cultural treatments such as pruning, harvest, thinning and pest management can be easily and cheap. Until today orchard numbers with new cultivars and on dwarfing rootstocks were also very low in the region. It should be increased the number of orchard with early cultivars and on dwarf and semi-dwarf

rootstocks in order to increase yield and quality. Therefore, it is necessary to determine suitable cultivars in terms of high quality and yield for the region. In the present study, yield and pomological features of Red Chief and Mondial Gala apple cultivars were evaluated in Hatay (Turkey) conditions.

Material and Methods

The experiment was conducted at Yayladağı/Hatay (Latitude 35 58 04 N; 36 00 55 E; Elevation 766 m) in the orchard of private owners during 2011. Regular agricultural practices were used as usual. Hatay province has a typical Mediterranean climate; yearly mean temperatures are ranged between 8.2 and 27.7°C. The summer temperatures between June and September during fruit ripening period are 29.2 and 31.9°C. Total precipitation is 1144 mm which primarily falls in winter and spring seasons (Anonymous, 2015).

The experiment was carried out on eight year old apple cultivars consist of ‘Mondial Gala’ and ‘Red Chief’ grafted on dwarf (M9) and semi-dwarf (MM106) rootstock. The trees were planted in 2002 in four replications at a distance 3×1.25 m for M9 and 3×2.50 m for MM106 rootstock. All of the fruits samples were taken at the full maturity stage, which was visually determined. Harvesting date of the cultivars were determined. On the experimental trees the number of fruits were counted, yield (harvested and weighted per tree in kilograms) weighted. Trunk diameter measured at a height of 20 cm and converted to trunk cross - sectional area (TCSA, cm²). Average yield per tree and yield efficiency of each scion-stock combination were computed from the harvest data.

Three trees from each variety were used. A total of thirty fruits were taken randomly from four directions of trees (north-south-east-west). The used pomological methods were given elsewhere by Seferoglu et al. (2006). Fruit weight (g) was measured with a scale sensitive to 0.01 g (Precisa XB 2200 C). Fruit length (mm) and diameter (mm), were measured by a digital caliper (Mitutoyo, 0–150 mm).

Firmness was measured using hand penetrometer with 11 mm probe. The firmness measurements were done through two different areas of the equatorial part of the fruits in a way that forms an angle of 180° between them. The mean of the two measurements was taken as the mean of a fruit. Total soluble solids (TSS) content were determined with a hand-held refractometer (NOW, 0–32% Brix) and pH (WTW InoLab pH meter) measurements were performed using a pH meter. Acidity (expressed as malic acid %) was determined by titrating with 0.1 N NaOH upto pH 8.10. Seed number was counted per fruit.

All data were subjected to analysis of variance (ANOVA) using SAS (SAS, 2005). ANOVA tables were constructed using Least Significant Difference (LSD) method at $p < 0.05$.

Result and Discussion

Fruit ripening time is changed according to the apple cultivars, whereas rootstocks had no effects on fruit ripening times. Fruits of Mondial Gala cultivar have matured on 18th of August, while fruits of Red Chief cultivars matured on the 29th of August in subtropical climatic conditions (Table 1).

The beneficial effects of dwarfing rootstock on the precocity and efficiency of tree yields have often been attributed to a change in the partitioning of the dwarfed trees assimilate from shoot growth to fruit production. However, semi-invigorating clonal rootstocks, such as MM106, induce improved yield precocity and efficiency in comparison with seedling rootstocks inducing the same level of scion vigor (Wertheim and Callesen, 2000). Results showed that Red Chief cultivar grafted on M9 had a more yield per tree (4.6 kg tree⁻¹) than MM106. Contrary to the result, Mondial Gala cultivar grafted on M9 had a less yield per tree (2.76 kg tree⁻¹) and yield efficiency (0.33 kg cm²)

less than MM106 (Table 1). Haak (2003) reported that trees on the dwarfing rootstocks yielded one third lesser than the trees on the medium rootstock MM106. In this study, higher yield was obtained for the scions grafted on MM106 rootstock but the ratio in yield increase was not as high as reported by Haak (2003). Further, in this study, the parameters of the number of fruits on the tree, the amount of yield from the tree (kg/tree), and kg-yield/ cm² per tree of Red Chief varieties grafted on the M9 rootstock had higher values than the ones from the Red Chief grafted on the MM106 rootstock obtained. Similarly, Dodangeh et al. (2012) reported the cultivars grafted on the M9 had yielded for yield per tree (13.23 kg tree⁻¹), yield in hectare, and yield efficiency (kg cm²) than the Red Chief grafted on the MM106 for the same parameters.

Increased photosynthesis and yield efficiency in grafted cultivars on dwarfing rootstock deriving from reduction of shoot growth vegetative, competition between vegetative and productive growth, more light penetration in canopy and intensity in area unit (Webster, 2001) and then increase setting (Seleznova et al., 2008). Although it is assumed that tree on dwarf rootstocks have limited vegetative growth resulting higher yield (Robinson, 2007). Rootstock influenced apple yield productivity. One hypothesis is that trees on dwarfing rootstocks terminate shoot growth earlier in the summer than trees on more invigorating rootstocks and thereafter partition more of their available assimilates towards the sites of floral primordia and less towards further shoot growth (Ferree and Warrington, 2003).

Mondial Gala scions on MM106 rootstocks showed good vigor and growth performance with larger trunk diameter. However, as expected, the average trunk circumference of scions (52.17 mm) grafted on MM106 rootstock was larger than that obtained for M9 rootstock (32.47 mm). Number of fruits per tree or yield of Mondial Gala scion for MM106 rootstocks was higher than obtained from M9 rootstock-scion combinations. Unlike the Mondial Gala cultivar, number of fruits per tree or yield of Red Chief scion for M9 rootstock was higher than obtained from MM106-scion combinations (Table 1).

Our results indicated that maximum yield per cm² trunk (0.89 kg cm⁻²) was obtained from Red Chief cultivar budded on M9 rootstock whereas it was Mondial Gala for M9 rootstock (0.33 kg cm⁻²). Soylu et al. (2003) reported that Granny smith grafted on MM106 rootstock produced 7 yearly average yields of 26.4 kg per tree and 0.39 kg per cm² trunk under Görükle, Bursa, Turkey, ecological conditions. Seferoglu et al. (2006) reported a cumulative yield of 12.7 kg per tree for 2001 and 2002 years and a yield of 0.33 kg per cm² trunk in Aydın ecological conditions. The average yield obtained from a tree was smaller than those of aforementioned studies, but yield per cm² trunk was as high as two fold or more. Özongun et al. (2016) reported the M9 rootstocks produced higher yield per square centimeter than the rest of their rootstocks in their study.

Table 1. Harvest date and yield parameters of Red Chief and Mondial Gala cultivars grown on the M9 and MM106 rootstocks

Cultivars	Rootstocks	Harvest date	Number of fruit/tree	Yield (kg/tree)	Trunk circum. (cm)	TCSA (cm ²)	Yield (kg/cm ²)
Red Chief	MM106	29 August	24.22 b	4.60 b	31.65 a	7.90 a	0.60 b
	M9	29 August	34.30 a	6.02 a	29.30 a	6.75 a	0.89 a
	LSD (5%)		0.44	1.17	4.78	2.37	0.25
Mondial Gala	MM106	18 August	83.67 a	9.67 a	52.17 a	21.07 a	0.46 a
	M9	18 August	22.66 b	2.76 b	32.47 b	8.33 b	0.33 b
	LSD (5%)		23.95	1.58	5.99	3.27	0.14

In this study, the average number of fruits per tree was 83.67 for MM106-Mondial Gala combinations and 24.22 for MM106-Red Chief combinations. Number of fruits per tree was 34.30 for M9- Red Chief combinations and 22.66 for M9- Mondial Gala combinations. Racsco et al. (2004) tested the performance of 4 years old cultivars budded on M9, MM106, and a wild type rootstock in Nagyktas, western Hungary. They obtained the maximum yield from M9 and the minimum yield from wild type rootstock. The number of fruits per tree was 15.3 and 63.9 fruits per tree in 2002 and 2003, respectively, for Granny smith cultivar budded on M9 and those fruit numbers for Vista Bella were 6.1 and 48.2 per tree. For the MM106 rootstock the reported fruit numbers were 10.4 and 46.4 per tree for Granny smith and 10.4 and 51.9 per tree for Vista Bella. Fruits numbers under subtropics climatical condition, in our study, were higher than those reported by Racsco et al. (2004). Ozongun et al. (2016) tested the performance of different apple variety (Mondial Gala, Skyline Supreme, Lutz Golden, Granny Smith) grafted to clonal apple rootstocks (M9, M26, MM106, MM111) which have different vigour capacity were evaluated for yield development quality characteristics in Eđirdir Fruit Research Institute in the study. Rootstocks had a significant effect on yield but they had no significant stable effect on fruit quality. M9 rootstock was determined for highest yield.

The rootstocks did not statistically impact on the average fruit weight, width and length and the number of seeds for the Mondial Gala cultivar. However, the average fruit weight, width and length of grafted plants on MM106 rootstock were higher than the ones from the grafted plants on the M9. The number of seeds in the fruits was found to be higher in the grafted plants on the M9 rootstock compared to the the other rootstock (Table 2).

In Red Chief variety, the rootstock was found statistically effective on the average fruit weight and number of seeds in the fruits, whereas no statistical difference was found for the effect of rootstocks on the fruit width and hight. The average fruit weight, width, height, and the number of seeds have been found to be 189.86 g, 73.26 mm, 67 mm, and 6.89, respectively for MM106 rootstocks in comparison to the respective values 178.10 g, 72.11 mm, 66.49 mm, and 7.62 for the grafted plants on the M9 rootstocks. In both apple cultivars, the average fruit weight and size have been increased for the grafted on the MM106 rootstocks (Table 2). Hampson and Kemp (2003) observed fruits of the Mondial gala cultivar are small-medium size, and fruit weight is not affected by rootstock Ozongun et al.(2016) reported that uniformity of fruit size has decreased despite the increase in fruit weight/size on M26, MM106, and MM111 rootstocks which are stronger than the M9 rootstocks. Baytekin and Akça (2006), Turhal/Tokat ecological conditions, found fruit weights, width, and hight as 235.5 g, 8.21 cm, and 7.11 cm in Red Chief grafted on the MM106 rootstocks, respectively. In the current study, the Red Chief apple varieties have attracted attention in terms of fruit weight and fruit size. The average fruit weight of the Red Chief apple varieties in Eđirdir ecological conditions was found to be 198.82 g (Özongun ve ark.2011). Burak et al. (2003) determined average fruit width as 6.27 cm for Galaxy Gala/MM106, 7.60 cm for Red Chief/MM106, and 6.36 cm for Breaburn/MM106 under the ecological conditions of Yalova. Our results are in line with some references but, partly different from others. The difference may be resulted due to cultivar, rootstock, cultural practices as well as variations in fruit formation.

Table 2. Some fruit characteristics of Red Chief and Mondial Gala apple cultivars on M9 and MM 106 rootstocks

Cultivars	Rootstocks	Fruit weight (g)	Fruit width (mm)	Fruit length (mm)	Seed number per fruit
Red Chief	MM106	189.86 a	73.26 a	67.00 a	6.89 b
	M9	178.10 b	72.11 a	66.49 a	7.62 a
	LSD (5%)	7.84	4.03	4.85	0.36
Mondial Gala	MM106	129.86 a	62.87 a	53.91 a	6.33 a
	M9	99.13 a	59.28 a	51.25 a	7.00 a
	LSD (5%)	33.93	5.13	3.27	1.85

Fruit quality attributes such as weight, titrable acidity, and soluble solid concentration are some times measured in junction with fruit colour in ‘Gala’ apple evaluation. Fallahi et al. (2007) studied quality attributes of Pacific Gala’ and reported that irrigation methods and rootstocks type can have a major impact on fruit size, colour and SSC.

The rootstocks significantly impacted pH, TSS, and acidity values, while no significant effects were observed on the flesh firmness. The highest pH and TSS values were recorded from the Mondial Gala and Red Chief grafted on the M9 rootstocks, whereas the highest acidity was obtained from the Red Chief grafted on the M9 rootstocks and from the Mondial Gala grafted on the MM106 rootstocks (Table 3).

Baytekin and Akça (2011) observed TSS, pH, and total acidity for the Red Chief grafted on the MM106 rootstocks as 10.66%, 3.85, and 0.39 cm, respectively in the ecological conditions of Turhal, Tokat, Turkey. Özdemir et al. (1999) reported the Red Chief cultivars grafted on the MM106 rootstocks had an average TSS of 11.8%. This study, subtropical climatological conditions of Hatay province, Turkey, fruit properties of Red Chief and Mondial Gala cultivars, except average fruit weight, have been found similar to the values given for the above mentioned properties of the fruits.

Table 3. Chemical characteristics of Red Chief and Mondial Gala apple cultivars on M9 and MM 106 rootstocks

Cultivars	Rootstocks	pH	TSS (%)	Acidity (%)	Firmness (kg/cm ²)
Red Chief	MM106	3.45 b	10.80 b	2.41 b	3.30 a
	M9	3.78 a	14.27 a	2.67 a	3.48 a
	LSD (5%)	0.84	0.44	0.58	0.52
Mondial Gala	MM106	3.28 b	12.53 b	3.96 a	4.37 a
	M9	3.53 a	14.20 a	3.70 b	4.27 a
	LSD (5%)	0.13	0.59	0.17	0.13

Conclusion

Turkey being the original source of apple has sites suitable for apple production; however, studies in Subtropical conditions of Turkey, particularly in the Hatay city, is not sufficient. Our preliminary study showed that ‘Red Chief’ and ‘Mondial Gala’ cultivars, when grafted onto M9 and MM106 rootstocks, respectively, have high economic potential in the Subtropical conditions. Mid-season maturation of these cultivars fruits increases the economic value of the fruit in the market. Despite subtropical climatical conditions of Hatay district, ‘Red Chief’ and ‘Mondial Gala’ can be treated as high yield producing species. Since these cultivars are “mid-season maturing cultivars”, high temperature induced-disorders such as sun-burn can be common quality problems in the region.

References

- Anonymous, (2013). Agricultural Statistical Database, available online at: <http://faostat.fao.org> (Accessed: 24 April 2016).
- Anonymous, (2015). <http://tr.climate-data.org/location/26590/> (Accessed: 10 April 2016).
- Baytekin, S., Akça, Y. (2011). Determination of performances of some apple cultivars budded on MM106 apple rootstocks. *YYU J Agr Sci*, 21(2): 127-133.
- Burak, M., Türkeli, Y., Akçay, M. E., Yaşasın, A. S. (2003). Bazı yeni elma çeşitlerinin Doğu Marmara Bölgesindeki verim ve kalitelerinin belirlenmesi. *Türkiye IV. Bahçe Bitkileri Kongresi* s:303-305, Antalya.
- Dodangeh, M.R., Shakouri, M.J., Hamzehei, J., Dadashpour, A. (2012). Effects of M9 and MM106 rootstocks on agromorphological characteristics of ‘Golab kohanz’ and ‘Delbarstival’ apple cultivars in Abhar region of Iran. *Indian Journal of Science and Technology*. 5(1): 1844-1847.
- Ferree, D. C., Arrington, I. J., (2003). Apples: Botany, Production and Uses. CABI Publ
- Haak, E. (2003). The effect of clonal rootstocks and interstem to the growth and yield of apple trees. *J Agric Sci*. 14(5): 251-259.
- Hampson, R. C., Kemp, H. (2003). Characteristics of important commercial apple cultivars (Botany, Production and Uses). In Ferree D C & Warrington I J (Eds.) Apples, CABI Publishing. Cambridge, p: 61-89.
- Ozbek, S. (1978). Special Horticulture. Cukurova University Faculty of Agriculture publications number 128 Ankara University Press Ankara (in Turkish). 488 p.
- Ozdemir, A. E., Dündar, O, Kaplan, A. (1999). Determining the optimal harvest date of some new apple varieties. Turkey III. National Horticultural Congress. 14 - 17 September, p:685-694, Ankara.
- Ozongun, Ş., Dolunay, E. M., Oztürk, G., Karakuş, A., Kankaya, A., Küden, A. (2011). Apple Adaptation Trial I. Final Report, Eğirdir Horticultural Research Institute
- Ozongun, Ş., Dolunay, E M., Pektaş, M., Öztürk, G., Çalhan, Ö., Atay, E. (2016). Yield and Quality Alterations of Some Apple Cultivars on Different Rootstock Ege Üniv. *Journal of Agric. Faculty*. 53 (1):35-42
- Racsko, J., Nyeki, J., Szabo, Z., Soltesz, M., Farkas, E. (2004). Effect of rootstocks on blooming capacity and productivity of apple cultivars. *J.Agr. Sci*. 15.
- Robinson, T.L. (2007). Recent advances and future direction in orchard planting. *Acta Hort* 32, 367-382.
- Seferoğlu, H. G., Kankaya, A., Ertan, E., Tekintaş, F. E., (2006). Investigation on phenological and pomological properties of some apple cultivars budded on MM106 under Aydın and region, AD.Üniv. *Journal of Agriculture Faculty*, 3(2):31-34.

- Seleznova, A.N., Stuart, D., Thorp, T.G. (2008), Apple dwarfing rootstocks and interstocks affect the type of growth units produced during the annual growth type cycle: precocious transition to flowering affects the composition and Vigor of annual shoots. *Ann. Bot.*101 (5), 679-687.
- Soylu, A., Ertürk, Ü., Mert, C., Oztürk, Ö., (2003). Investigations on Yield and Quality of Apple Cultivars Budded on MM 106 Rootstock Under Görükle Condition -II II, Uludağ Üniv. *Journal of Agriculture Faculty*,17(2): 57-65.
- Way, R. D., Aldwinckle, H. S., Lamb, R. C., Rejman, A., Sansavini, S., Shen, T., Watkins, R., Westwood, M.N., Toshida, Y. (1990). Apples (*Malus*). *In: Genetic resources of temperate fruits and nut crops I*. Netherlands, ISHS. 488 p.
- Webster, A. D. (2001). Rootstocks and temperate fruit crops: current uses, future potential and alternative. *Acta Hort.* 557, 25-34.
- Wertheim, S.J., Callesen, O. (2000). Result of multi -site interstem trials with apple. *Gartenbauwissenschaft.* 65 (6), 251-259.

DETERMINATION OF YIELD AND YIELD CHARACTERISTICS OF SOME SMALL SIZED RED LENTIL LINES (*Lens culinaris* Medik.) IN F5 AND F6 LEVEL

Ayşe Gülgün ÖKTEM*, Abdullah ÖKTEM

Harran University, Agriculture Faculty, Field Crops Department, Şanlıurfa, Turkey

*Corresponding author; gulgunoktem@harran.edu.tr

Abstract

Lentil (*Lens culinaris* Medik.) is a source of high quality protein, mineral and vitamins and generally used for human food. The leaves, stems and threshed pods of lentil are used for animal feeding. Lentil plants fix nitrogen in the soil and increase nitrogen level of soil. Şanlıurfa province which is located in the Southeastern Anatolia Region has the most sowing area and production in Turkey. This study was aimed to develop the high yield red lentil varieties to Southeastern Anatolia Region of Turkey. Study was conducted in 2009-2010 and 2010-2011 growing seasons under Şanlıurfa conditions. Experiment was established to randomize complete block design with 4 replicates. In the study 20 small sized red lentil lines in F5 and F6 level which are obtained from Icarda (International Center for Agricultural Research in the Dry Areas) collection and 2 standard varieties were used as a crop material. Genotypes were significant about days to flowering, plant height, first pod height, thousand kernel weight, biological yield and grain yield. According to average of years; the highest grain yield obtained from line 1 (2280 kg/ha), whereas the lowest grain yield was found at Yerli Kırmızı standard variety (1389 kg/ha). Some better lines than others were selected in considering plant height, first pod height days to flowering, thousand kernel weight and grain yield values. Line 1, line 4, line 5, line 6, line 9, line 12, line 13, line 15, line 16, line 17, line 18 and line 19 were found better than others and were selected for next generation.

Keywords: *Red lentil, Small sized, Southeastern Anatolia, Grain yield*

Introduction

Lentils were among the earliest of humankind's plant domesticates and associated with the start of the 'agricultural revolution' about 10 000 years ago in the Near East (Cubero et al. 2009). Lentil is a source of high quality protein and generally used for human food. Whole, split, or ground into flour, it is used in soups, stews, salads, casseroles, snacks and vegetarian dishes. In southern Asia, split red lentils are used in curries. Lentil flour, added to cereal flour, is used to make bread. Lentils need less cooking time than other pulses and do not need to be pre-soaked. Dried lentils can be sprouted. Lentil contents high protein in their seed. Lentil grain is a vital source of protein, with a mean of 28.3% ranging from 15.9 to 31.4% over (Grusak, 2009), especially for the poor, who cannot afford animal products. Additionally lentil seed contains high amounts of macro and micronutrients (Ca, P, K, Fe and Zn), vitamins (Niacin, Vitamin A, Ascorbic Acid) and Inositol), fiber and carbohydrates for balanced nutrition (Bhatty, 1988; Savage, 1988). The leaves, stems and threshed pods of lentil are important for feeding sheep and goats in the Middle East. Lentil plants fix nitrogen in the soil, helping reduce the use of nitrogen fertilizer. The crop is grown in rotation with cereals in the winter in Mediterranean and sub-tropical regions and as a summer crop in temperate and high elevation areas. Red lentil has 207 469 ha sowing area, 340 000 tons production and 1640 kg/ha average yield in Turkey. Red lentil

is mostly grown in southeast Anatolia region in Turkey. Southeastern Anatolia Region has 200 995 ha sowing area and 331 574 tons production. Sanliurfa province which is located in the Southeastern Anatolia Region has the most sowing area and production in Turkey. Sowing area and red lentil production amount of Sanliurfa is 99 328 ha and 129 732 tons, respectively (Anonymous, 2015 a). Lentil breeding is important for developing new varieties to highly efficient and earlier in Southeastern Anatolia Region. This study was aimed to develop the high yieldly red lentil varieties to Southeastern Anatolia Region of Turkey. Some research results which made in red lentil are given below; Biçer and Sakar (2008) reported that red lentil grain yield ranged from 776.8 kg/ha (FLIP 96-47L) to 3242.3 kg/ha (FLIP 2004-49L) in Diyarbakır conditions. Shrestha et al. (2005) were reported that the seed yield of red lentil was 330-1270 kg/ha. Younis et. al. (2008) explained that days to flowering, plant height, biological yield and hundred seed weight are very important parameters in seed yield of lentil plant. Biçer and Sakar (2011) investigated nineteen lentil lines and two cultivars in Diyarbakır conduction. Differences among cultivars/lines were found significantly for days to flowering, plant height, first pod height, 1000 seed weight, grain yield and biological yield. Çölkesen et al. (2005) reported that the lowest grain yield was obtained from Emre variety while the highest grain yield was found at line of F90.41 L in Kahramanmaraş and Sanliurfa Conditions.

Material and methods

This study was conducted in 2009-2010 and 2010-2011 growing seasons under Sanliurfa conditions in Turkey. Soil samples representing the 0 to 20 cm layer were taken a day prior to seedling; air dried, passed through a 2.00 mm sieve, and analyzed (Jones 1984). The soil of research field was clay, slightly alkaline, high in lime content, and very low in salt content. Climatic data and soil properties were given in Table 1 and Table 2, respectively.

Table 1. Some meteorological parameters belong to the growth period of lentil[†].

Year		1	2	3	4	5	6	10	11	12
2009	Max. temp. (°C)	16.0	18.0	23.2	29.5	39.5	42.0	34.9	24.8	18.8
	Min. temp. (°C)	-7.1	-1.7	-1.0	5.0	9.0	16.0	10.0	0.0	0.9
	Av. temp. (°C)	5.7	8.9	10.5	17.3	23.7	30.4	22.3	12.0	9.5
	Av. Relative humidity (%)	53.1	61.8	62.3	52.1	37.8	35.6	52.1	68.7	76.2
	Total Rainfall (mm)	11.9	46.7	49.3	14.4	3.3	1.0	12.4	35.1	62.9
2010	Max. temp. (°C)	17.8	21.0	27.1	30.6	37.2	42.0	35.2	29.7	28.1
	Min. temp. (°C)	-4.0	-2.8	0.9	4.1	10.2	16.8	7.1	3.8	0.0
	Av. temp. (°C)	7.6	9.6	13.9	17.8	24.2	29.2	21.2	15.3	10.1
	Av. Relative humidity (%)	69.4	68.8	60.3	49.8	38.7	36.0	52.8	35.3	63.1
	Total Rainfall (mm)	36	12.6	23.5	3.6	5.7	0.6	9.6	-	26.8
2011	Max. temp. (°C)	14.6	17.8	25.2	28.5	34.9	38.9	32.7	21.4	16
	Min. temp. (°C)	0.3	-0.9	2.3	4.3	11.3	17.7	8.8	-0.4	0.8
	Av. temp. (°C)	7.3	7.6	12.3	15.4	21.3	28.3	19.3	9.4	7.4
	Av. Relative humidity (%)	62.9	64.7	46.1	59.9	46.6	30.3	53.7	53.7	57.4
	Total Rainfall (mm)	58	28.2	42	133.7	39.2	4.6	12.3	62.1	47.1

1.January, 2.February, 3.March, 4.April, 5. May, 6.June, 10.October, 11.November, 12.December

[†]Data collected from the Sanliurfa Meteorological Station (Anonymous, 2015).

Table 2. Some chemical properties of research area soil in 2010 and 2011.

Year	Deep (cm)	EC (dS/m)	CaCO ₃ (%)	pH	(kg/decare)			Cu	Fe	Mn	Zn
					P ₂ O ₅	K ₂ O	Org. Mat. (%)				
2010	0-20	1.174	25.80	7.79	2.44	123.1	1.36	1.985	8.351	33.58	0.415
2011	0-20	1.117	26.90	7.88	3.19	97.20	1.13	1.523	5.213	9.287	0.461

In the study 20 small sized red lentil lines in F5 and F6 level which are obtained from Icarda (International Center for Agricultural Research in the Dry Areas) collection and 2 standard varieties, which were Yerli Kırmızı (YK) and Fırat-87 (F-87), were used as a crop material.

Experiment was established to randomize complete block design with 4 replicates. Each parcel was arranged in 6 rows X 5 m X 0.2 m. The testing area firstly was ploughed (18-20 cm depth) and cultivated (10-12 cm depth) then prepared for planting with a single pass of a disk-harrow. Seeding was made by trial drill and 350 kernel/m² seed was used. At sowing, 60 kg ha⁻¹ of pure N and P, as a 20-20-0 composed fertilizer was applied to each plot. All tested characteristics were measured on randomly selected 10 plants in the center of each plot. An analysis of variance was performed to evaluate statistically differences between results. Means of the data obtained from research were compared using Duncan test at P≤0.05.

Results and discussion

Variance analyses were performed separately for each year and combined of years for all traits. Plant height, pod height, biological yield, thousand kernel number and grain yield were highly statistically significant (Table 3).

Table 3. Variance analyses of plant height, first pod height, days to flowering, biological yield and grain yield in 2009-2010, 2010-2011 and combined analyses.

2009-2010 Growing season										
Mean Squares										
Source of Variation	SD	Plant height (cm)	First pod height (cm)	Days to flowering (day)	Biological yield (g/m ²)	1000 kernel weight (g)	Grain Yield (kg/da)			
Replication	3	41.70	18.70	14.18	2825.29	0.66	12788.3			
Variety	21	34.87**	93.18**	103.22*	5651.00*	8.99**	36176.7**			
Error	63	9.34	9.9360	2.51	1930.25	1.13	4584.7			
Total	87									
CV		8.33	15.92	1.71	10.76	2.76	12.37			
2010-2011 Growing season										
Mean Squares										
Source of Variation	SD	Plant height (cm)	First pod height (cm)	Days to flowering (day)	Biological yield (g/m ²)	1000 kernel weight (g)	Grain Yield (kg/da)			
Replication	3	0.88	5.26	0.71	6677.65	0.72	1126.5			
Variety	21	20.05**	21.59**	23.30**	35840.72**	86.04**	30441.2**			
Error	63	3.48	1.9710	2.23	5742.6	1.09	2439.5			
Total	87									
CV		5.03	9.33	2.03	11.12	3.46	7.16			
Combined Analyses										
Mean Squares										
Source of Variation	SD	Plant height (cm)	First pod height (cm)	Days to flowering (day)	Biological yield (g/m ²)	1000 kernel weight (g)	Grain Yield (kg/ha)			
Year	1	8.90	989.71**	15914.42**	3185378.6**	64.52**	887486.8**			
Replication	3	23.13	14.90	5.12	7764.17	0.56	6441.1			
Variety	21	39.79**	94.34**	104.09**	22092.34**	164.75**	40.0**			
Year X Variety	21	15.13	20.42**	22.42**	19399.38**	7.04**	26575.6**			
Error	129	6.71	6.03	2.54	3762.0	192.79	3601.7			
Total	175									
CV		7.02	1.41	1.92	11.30	3.12	9.71			

*,** indicates statically significant at 0.05 and 0.01 respectively

According to results of variance analysis; plant height was found statistically significant (P<0.01 in both trait years (Table 3). In combined analyses, year was statistically significant (P<0.01). Plant height values ranged from 32.0 to 42.0 cm in first year and 40.0 to 33.50 cm in second growing season (Table 3). The highest plant height values were obtained from Fırat-87 and Yerli Kırmızı standard varieties in both years. More lodging was seen in Fırat-87 and Yerli Kırmızı standard varieties than others. Hanlan et al. (2006) explain that tall lentil plants have more lodging tendency. Plant height values of lines were smaller than standard varieties in both years. Similar results reported by some researchers. L'azaro et al. (2001) stated that landraces of plant

height were higher than Icarda lines in Spain. Also Bicer and Sakar (2007) reported that local varieties had higher plant height than Icarda lines in Diyarbakır.

As can be seen from Table 3, first pod height values were statically significant in both years ($P < 0.01$). In combined analysis year, variety and year x variety were statically significant ($P < 0.01$). First pod height ranged from 27.6 cm to 14.5 cm in average of years. The highest value was obtained from Fırat-87 variety in first growing season while the highest value was obtained from Yerli Kırmızı variety (Table 4). According to year combined analyses; first pod height of Fırat-87 and Yerli Kırmızı varieties were higher than Icarda lines. Similar finding were reported by Toğay ve Engin (2000). Researchers stated that the highest plant height and pod height obtained from yerli kırmızı standart variety. Our results are in agreement with the findings of some researchers. Biçer and Sakar (2007) reported that some pod height of Icarda lines were between 9.67 and 14.67 cm. Karadavut et al. (1999) emphasized that Icarda lines had lower pod height than standard varieties.

According to variance analyses day to flowering was significant in first ($P < 0.05$) year and second ($P < 0.01$) year. In combined analyses, year, variety and year x variety were significant at $P < 0.01$ level (Table 3). Days to flowering were between 104 (F.87) and 87.67 (line 18 and 19) days in first year, 70 (line 19) and 80 (F.87) days in second year. According to average of years days to flowering changed from 90.8 (Yerli Kırmızı) to 78.8 (Line 19) days (Table 4). The latest days to flowering were obtained from Yerli kırmızı and F.87 standard varieties. Icarda lines had early flowering period. Days to flowering period of number 11, 18 and 19 lines were earlier than other lines and varieties. Some researchers' findings were good agreement with our findings about days to flowering period. Turk and Atikyılmaz (1999) reported that the lines from Icarda were earlier than Yerli Kırmızı and Fırat-87. Aydoğan et al. (2005) reported that Fırat-87 variety had late maturation and late flowering period. Early flowering is warranty product as dry and hot climatic condition like as Southeastern Anatolia.

Table 4. Plant height, first pod height and days to flowering values and Duncan groups

Lines/ Varieties	Plant height (cm)			First pod height (cm)			Days to flowering (day)		
	2009-2010	2010-2011	Average	2009-2010	2010-2011	Average	2009-2010	2010-2011	Average
1	33.67 fgh [†]	35.50 efg	34.6 hij	17.67 b-f	14.88 c-f	16.3 cde	90.67 efg	72.75 c-f	81.7 e-i
2	39.00a-e	36.88 cde	37.9 c-f	18.67 b-f	15.63 cd	17.2 bcd	90.00 e-h	73.25 c-f	81.6 e-i
3	39.67 a-d	36.28 def	38.0 cdef	22.00 b	14.63 c-g	18.3 bc	90.33 efg	73.25 c-f	81.8 e-i
4	32.00 h	37 cde	34.5 hij	16.00 ef	12.88 gh ₁	14.4 ef	89.33 fgh	72.50 def	80.9 hij
5	34.33 fgh	37 cde	35.7 e-j	16.33 ef	13.38 e-i	14.9 def	89.33 fgh	73.75 cde	81.5 f-i
6	37.67 a-f	34.88 efg	36.3 e-i	21.00 bcd	14.75 c-g	17.9 bc	91.00def	74.00 cde	82.5 c-g
7	36.67 b-g	37 cde	36.8 d-h	21.00 bcd	15.13 cde	18.1 bc	92.00 de	73.25 c-f	82.6 c-f
8	37.00 b-g	39.25 bc	38.1 cde	18.67 b-f	15.00 cde	16.8 b-e	92.00 de	74.75 bc	83.4 cd
9	40.00 a-d	39.38 abc	39.7 abc	21.00 bcd	15.15 cde	18.1 bc	100.33 b	74.75 bc	87.5 b
10	34.33 fgh	36.88 cde	35.6 e-j	15.33 ef	13.63 e-h	14.5 ef	93.33 d	74.25 cd	83.8 c
11	32.67 gh	34.50 efg	33.6 j	18.67 b-f	12.00 h ₁	15.3 def	87.67 h	71.25 fg	79.5 jk
12	34.33 fgh	36.75 cde	35.5 f-j	19.00 b-e	14.88 c-f	16.9 bcd	89.33 f-e	71.25 fg	80.3 ijk
13	36.33 c-h	34.00 fg	35.2 g-j	17.67 b-f	16.00 c	16.8 b-e	102.00 ab	73.75 cde	87.9 b
14	34.67 e-h	40 ab	37.3 c-g	17.33 c-f	15.63 cd	16.5 b-e	92.00 de	72.00 efg	82.0 d-h
15	36.00 c-h	39.25 bc	37.6 c-g	18.00 b-f	16.13 c	17.1 bcd	92.33 de	74.00 cde	83.2 cde
16	35.67 d-h	35.9 defg	35.8 e-j	17.00 def	15.13 cde	16.1 c-f	90.00 e-h	72.00 efg	81.0 g-j
17	32.67 gh	35.50 efg	34.1 ij	21.67 bc	15.75 cd	18.7 b	97.00 c	76.50 b	86.8 b
18	36.67 b-g	33.50 g	35.1 g-j	14.33 f	13.00 f-i	13.7 f	87.67 h	72.25 def	80.0 jk
19	40.00a-d	35.88 d-g	37.9 c-f	19.00 b-e	11.50 i	15.3 def	87.67 h	70 g	78.8 k
20	40.33 abc	38.38 bcd	39.4 bcd	18.33 b-f	14.00 d-g	16.2 cde	88.33 gh	71.50 fg	79.9 jk
YK	41.00 ab	40.80 ab	40.9 ab	33.00 a	22.10 a	27.6 a	102.33 ab	79.25 a	90.8 a
F-87	42.00 a	42 a	42.0 a	33.67 a	19.88 b	26.8 a	104.00 a	80 a	92.0 a
Average	36.7	37.1	36.89	19.8 A	15.1 B	17.42	92.67 A	73.65 B	
LSD	4.641 **	2.637**	2.563**	4.538**	1.98**	2.428**	2.463**	2.11**	1.578**
Year LSD	ns.			0.732**			0.476**		

[†]: There is no statistical difference among values annotated with the same letter at $P < 0.05$ according to the Duncan test.

*, **: indicates statistical significant at 0.05 and 0.01 level, respectively.

In terms of biological yield, varieties were significant in first year ($P<0.05$) and second year ($P<0.01$). In combined analyses, year, varieties and year X varieties were significant at $P<0.01$ level (Table 3). Biological yield ranged from 530.8 to 382.7 g/m^2 in first trait year while it was between 770.2 g and 418.3 g/m^2 in second year (Table 5). Average of both years biological yield values were varied from 649.6 g/m^2 (line 1) to 412.9 g/m^2 (line 8). These results were supported by some studies. Bicer and Sakar (2011) were reported that biological yield changed between 6200 kg/ha and 3820 kg/ha for some lentil lines and varieties.

According to result of variance analyses; 1000 kernel weight value was found statistically significant ($P<0.01$). In combined analyses, year, varieties and year x varieties were significant ($P<0.01$). Thousand kernel weight values varied between 30.61 and 44.28 g in first year while 31.20 and 46.33 g in second trait year (Table 5). The highest values were obtained from line 21 in first year and line 24 in second year. According to both years average, the highest 1000 kernel weight value found at line 21. 1000 kernel weight value of second year was higher than first year value due to rainfall of 2010-2011 growing period was higher than 2009-2010 growing period. It is stated that the environment have a significant impact on thousand grain weight (Erksine and Ashkar 1993).

Table 5. Biological yield, 1000 kernel weight, grain yield values and Duncan groups

Lines/ Varieties	Biological yield (g/m^2)			1000 kernel weight (g)			Grain Yield (kg/ha)		
	2009- 2010*	2010- 2011**	Average	2009- 2010**	2010- 2011**	Average	2009- 2010**	2010- 2011**	Average
1	530.8 a [†]	768.1a	649.6 a	42.86 abc	41.45 d-g	42,16 de	1857 a-d	2704 a	2281 a
2	376.6 d	529.2 de	452.4gh	42.21 bcd	43.30 cd	42,76 b-e	1497 fg	2157 fgh	1827 fg
3	450.6 bc	491.9 ef	471.6 fgh	40.41 efg	40.73 fg	40,57 f	1740 b-f	2204 efg	1972 c-f
4	364.2 d	772.6 a	570.0 b-e	42.85 abc	44.08 bc	43,47abc	1540 efg	2583 ab	2062 bcd
5	413.6 bcd	720.9 ab	568.5 b-e	40.33 fg	42.95 cde	41,64 ef	1820 a-e	2593 ab	2207 ab
6	382.7 d	702.1 abc	542.6cde	44.28 a	44.50 abc	44,39 a	1570 d-g	2250 d-g	1910 d-g
7	388.9 cd	681.8 abc	535.3 cde	42.84 abc	44.43 abc	43,64 ab	1890 abc	2181 e-h	2035 b-e
8	407.4 cd	418.3 f	412.9 h	30.61 m	31.20 l	30,91 l	1417 g	2301 c-f	1859 efg
9	413.6 bcd	755.2 a	584.3 bc	39.89 fg	46.33 a	43,11bcd	1980 ab	2398 b-e	2188 ab
10	413.6 bcd	727.1 ab	571.4 bcd	31.53 lm	32.43 l	31,98 kl	1800 a-f	1690 k	1745 g
11	395.1 cd	700.5 abc	550.0 cde	37.37 h	37.25 ij	37,31 h	1757 b-f	2472 bc	2115abc
12	382.7 d	753.9 a	568.4 b-e	43.51 ab	41.25 efg	42,38cde	1577 c-g	2227 d-g	1902 d-g
13	401.2 cd	776.4 a	588.1 bc	32.33 kl	32.48 l	32,41k	2023 ab	2056 ghi	2040 b-e
14	401.2 cd	686.7 abc	543.5 cde	37.34 h	40.25 gh	38,80 g	1947 ab	1829 jk	1888 d-g
15	388.8 cd	703.3 abc	545.3 cde	41.35 def	42.60 c-f	41,98 de	1857 a-d	1926 ij	1892 d-g
16	401.2 cd	668.5 abc	534.8 cde	34.11 ij	35.98 jk	35,05 i	1847 a-e	1968 hij	1907 d-g
17	475.3 ab	770.2 a	622.2 ab	41.89 cde	43.58 bc	42,74b-e	2007 ab	2426 bcd	2217 ab
18	413.6 bcd	625.3 bcd	521.0 def	35.59 i	35.20 k	35,40 i	1887 abc	1921 ij	1904d-g
19	425.9 bcd	607.3 cde	519.2 def	39.06 g	38.58 h ₁	38,82 g	2090 a	2227 d-g	2158abc
20	407.4 cd	720.1 abc	564.5 b-e	43.49 ab	45.33 ab	44,41 a	1990 ab	2148 fgh	2069bcd
YK	382.7 d	659.6 a-d	515.9 def	30.84 m	35.20 k	33,02 jk	940 h	1838 ijk	1389 h
F-87	364.2 d	662.1 abc	509.6 efg	33.07 jk	35.35 jk	34,21 ij	1052 h	1866 ijk	145.9 h
Average	408.3 B	677.3 A		38.54 B	39.75 A		1731 B	2180 A	
LSD	62.676	108.471	60.677	1.49	1.94	1.209**	314.34	220.47	49.25
Year LSD		18.295**			0.365**			56.61**	

[†]: There is no statistical difference among values annotated with the same letter at $P<0.05$ according to the Duncan test.

*, **: indicates statistical significances at 0.05 and 0.01 level, respectively.

According to variance analysis results, grain yield was statistically significant in both years ($P<0.01$). In combined analyses; year, varieties and year x varieties were found statistically significant at 0.01 level (Table 3). Grain yield values ranged from 1389 kg/ha to 2281 kg/ha in mean of years. The highest value was obtained from line 19 and line 1 in first and second year, respectively (Table 5). The lowest value was found at Yerli Kırmızı (940 kg/ha) in first year and line 10 (1690 kg/ha) in second year. According to years of average, the highest grain yield was obtained from line 1 (2281 kg/ha) whereas the lowest grain yield was found at Yerli Kırmızı variety (1389 kg/ha). First year grain yield values were lower than second year. The low yields in

the 2010-2011 seasons can be explained insufficient rainfall during reproductive growth (Table 1). However grain yield values of second trait year were higher due to regular raining in pod binding period. Erksine and Ashkar (1993) reported that variation about 80% on grain yield stemmed from seasonal raining. Silim et al. (1993) emphasized that rainfall effects grain yield especially in pod binding period. If raining is regular in pod binding period, grain yield will be high.

Conclusion

According to two years research results; considering to flowering period, plant height, thousand kernel weight and grain yield; line 1, line 4, line 5, line 6, line 9, line 12, line 13, line 15, line 16, line 17, line 18 and line 19 were found better than others and were selected for next generation.

References

- Anonymous (2015a). Turkish Statistical Institute. <http://www.tuik.gov.tr>
- Anonymous (2015b). Climatic Report. Sanliurfa Meteorological Sation, Sanliurfa.
- Aydoğan A., Karagül V., Bozdemir Ç. (2005). Adaptation of winter type red lentil varieties in Central Anatolia. GAP IV. Agriculture Congress, 21-23 September, pp.820-825, Sanliurfa, Turkey.
- Bhatty R. S. (1988). Composition and quality of lentil (*Lens culinaris* Medik.): a review. Canadian Institute of Food Science and Technology, 21:144–160.
- Bicer B.T., Şakar D. (2007). Determination of yield and yield components in some red lentil lines and cultivars. J. of OMU Univ. Agric. Fac., 22 (3): 292-296.
- Bicer, B.T, Sakar D. (2008). Studies on variability of lentil genotypes in Southeastern Anatolia of Turkey. Agrobot. Cluj, 36 (1):20-24.
- Bicer B. T., Sakar D. (2011). The evaluation for yield and its components in the lentil (*Lens culinaris* Medik) lines J. of Harran Univ. Agric. Fac., 15(3):21-27.
- Cubero J. I., Vega, M., Fratini R. (2009). Origin, phylogeny, domestication and spread. The lentil: Botany, production and uses. Comm. Agric Bureau Int. pp. 13–33.
- Cölkese M., Çökküzgün A., Turan B.T., Kayhan K. (2005). Yield and quality characteristics of various winter type lentils (*Lens culinaris* Medic) cultivars under K.Maras and S.Urfa conditions. GAP IV. Agric. Congres. 21-23 September, pp. 826-833, Sanliurfa, Turkey.
- Erksine W., Ashkar F.E. (1993). Rainfall and temperature effects on lentil (*Lens culinaris* Medik) seed yield in the Mediterranean enviroment. J. Agric. Sci. 121:347-354.
- Grusak M.A. (2009). Nutritional and health-beneficial quality. In W. Erskine, F. J. Muehlbauer, A. Sarker, B. Sharma (Eds.), The lentil-Botany, production and uses (pp. 368–390). Wallingford.
- Hanlan T. G., Ball, R. A, Vandenberg, A. (2006). Canopy growth and biomass partitioning to yield in short-season lentil. Canadian J of Plant Sci., 86(1):109-119.
- Jones B.J. (1984) A laboratuary guide of exercises conducting soil tests and plant analyses. Madison, Wis. Benton lab., Inc. USA.
- Karadavut U., Erdoğan C., Özdemir S., Geçit H. H. (1999). A study of growing small sized lentil lines under Amik plain winter conditions. 3. Field crops Congress 15-18 November, Volume III, pp.407-412, Adana, Turkey.
- L'azaro, A., Ruiz M., Martín, I. (2001). Relationships between agro/morphological characters and climatic parameters in Spanish landraces of lentil (*Lens culinaris* Medik.). Genetic Res. and Crop Evolution, 48: 239-249.
- Savage, G. P. (1988). The composition and nutritive value of lentils (*Lens culinaris*). Nutrition Abstracts and Reviews (Series A), 58:320-343.

- Shrestha, R., Siddique, K. H. M., Turner, N. C., Turner, D. W., Berger, J. D. (2005). Growth and seed yield of lentil (*Lens culinaris* Medikus) genotypes of West Asian and South Asian origin and crossbreds between the two under rainfed conditions in Nepal. *Crop and Pasture Science*, 56(9):971-981.
- Silim S.N., Saxena M.C. and Erksine W. (1993) Adaptaion of lentil to the Mediterranean environment. I factors affecting yield under drought conditions. *Exp. Agric.* 29:9-19.
- Turk, Z., Atikyılmaz N. (2000). Determination of yield and yield characteristics of some lentil varieties under Diyarbakır conditions. *J. of Harran Univ. Agric. Fac.* 4 (3-4): 43-52.
- Toğay Y., Engin M. (2000). Effect of sowing times to yield and yield characteristics of lentil varieties under Van conditions. *Journal of Tarım Bilimleri* 6:32-36.
- Younis N., Hanif M., Sadiq S., Abbas G., Asghar M.J., Haq M.A. (2008). Estimation of genetic parameters and path analysis in lentil. *Pak. J. Agr. Sci.* 45(3):44-48.

DETERMINING THE PRODUCTION AMOUNT OF LEAF TOBACCO USING GOAL PROGRAMMING

Altay Uğur GÜL*, Funda GENCLER

¹School of Tobacco Expertise, Celal Bayar University, Manisa, Turkey

*Corresponding Author: ugurgul1@hotmail.com

Abstract

Tobacco farming is being done in Aegean, Marmara, Black Sea, East Anatolia, Southeast Anatolia and Mediterranean regions in Turkey. With the introduction of the new law (No: 4733) the marketing system of tobacco has totally changed and has been replaced with the auction system and contract production. The new Law abolished the Monopoly Status of TEKEL and this was the beginning of the withdrawal of the Government from all aspects of tobacco in Turkey. Private firms were allowed to produce cigarettes in Turkey. Leaf tobacco companies buy tobacco due to the contracts between them and the tobacco farmers every year. Tobacco farms vary considerably in size, location, yields and different characteristics in every region thus cause disparity in prices. For this reason this study aims to set the contracted tobacco production planning by using goal programming. This hypothetical study contributes some data for tobacco leaf purchaser companies in Turkey. Goal programming (GP) allows the decision maker to include multiple goals or objectives in the problem formulation. GP applies the linear programming model to situations which contain multiple goals or objectives. The GP approach involves the decision maker in a process that attempts to achieve a satisfactory level of achievement for several objectives, rather than an optimal outcome for a single objective. The goal programming consists of 6 variables and 8 goal functions. As a result, the solution of goal programming; it has been predicted that 61,450 ha. including Aegean Region, totally 90,000 ha contracted farming should be done, the amount of tobacco leaf is 78,708,650 kg and the purchase cost is \$ 337,365,060.00.

Keywords; *Turkish Tobacco Production, Contracting Farming, Goal Programming*

Introduction

Tobacco has been brought to Ottoman Empire in the beginning of 1700's from English and Italian sailors. It has been cultivated in Macedonia in 1687 initially in the Empire boundary. Afterwards, the production has become widespread. By the reason of attentive cultivation, accurate agricultural methods and proper ecologic conditions, Turkish tobacco has gained a good reputation with its high quality in the world markets (SPO, 2000). In 2002 as a result of a change in the privatization policies; the support of the state in tobacco (production) is abrogated. With the introduction of the new law (No: 4733) the marketing system of tobacco has totally changed and has been replaced with the auction system and contract production (Koçturk and Cebeci, 2005). The new Law abolished the Monopoly Status of TEKEL and this was the beginning of the withdrawal of the Government from all aspects of tobacco in Turkey. Private firms were allowed to produce cigarettes in Turkey. Once the government sold TEKEL it also ended tobacco production. Turkish tobacco production went from a totally supported subsidized producer base to a free market system based on contract farming under regulation of the TAPDK. The number of cigarette producers increased in the Turkish market and the number of leaf tobacco farmers

dramatically reduced. As the whole market went through a transformation several world class establishments and systems were applied to the Turkish production base. In the old system, tobacco had been produced all over the country based more on political whims than supply and demand.

Turkey is the biggest producer of aromatic Oriental tobacco and together with its product production base is becoming a sizable regional production hub. The tobacco business contributes over a billion dollars in exports and over 11 billion dollars is contributed to the inland revenue the Turkish farmer base is about 80,000 (TAPDK, 2015).

In Turkey tobacco farming is mainly done in following regions; Egean Region (Akhisar, Söke, Manisa, Denizli, Kütahya, Eşme), Black Sea Region (Erbaa, Vezirköprü, Bafra, Samsun, Bolu, Amasya, Trabzon), Marmara Region (Erbaa, Vezirköprü, Bafra, Samsun, Bolu, Amasya, Trabzon), Southeastern Anatolia Region (Malatya, Bitlis, Muş, Hakkari), Mediterranean (İskenderun, Yayladağı, Samandağ). The distribution of tobacco farming area is almost every region of Turkey, except Central Anatolia. Leaf tobacco purchasers use their own method in the market. This method depends on the variables from the other purchasers' demands and the previous experiences. Without any doubt, leaf tobacco market has different factors that affect itself such as quality, quantity, sustainability of production etc.

Goal programming (GP) allows the decision maker to include multiple goals or objectives in the problem formulation. GP applies the linear programming model to situations which contain multiple goals or objectives. The GP approach involves the decision maker in a process that attempts to achieve a satisfactory level of achievement for several objectives, rather than an optimal outcome for a single objective (Markland and Sweigart, 1987; Levin and Kirkpatrick, 1978). GP attempts to find the point which satisfies best the goal or goals in the problem (Budnick, 1988).

The aim of this study is to determine the amount of raw tobacco leaf which is conducted as a contract farming by using goal programming. This hypothetical study contributes some data for tobacco leaf purchaser companies in Turkey.

Material and methods

The data are gathered due to the aim of the study. These are; contracted tobacco farming regions in Turkey and their land size, tobacco production amount and the price of the raw leaf tobacco in these regions (Table 1, TAPDK and Tobacco Experts Association web site)

Table 1. Summary information for the contracted leaf tobacco production in Turkey* (2015).

Regions	The level of production (kg/ha)	Production costs (\$/ha)
Aegean	799.2	3499.35
Marmara	857.6	3718.31
Blacksea	1133.9	5576.36
East Anatolia	1806.1	3379.99
Southeastern Anatolia	918.3	2689.31
Mediterranean	1075.5	1993.52

Source: TAPDK* and Tobacco Experts Association, 2016.

* The Tobacco and Alcohol Market Regulatory Authority

Based on these data, the target values in Table 2 are determined to set out the leaf tobacco purchase.

Table 2. Target values of the objective function.

The Goal Function	Target Value (b_i)	The Goal Function	Target Value (b_i)
1	$\leq 350,000,000$ \$	6	15,000 ha
2	$\leq 90,000$ ha	7	50 ha
3	$\geq 75,000,000$ kg	8	8,000 ha
4	60,000 ha	9	2,000 ha
5	3,500 ha		

GP minimizes deviations from multiple goals or objectives subject to some constraints that are goal statements (Dijkstra,1984). The model is stated with the following set of the objective functions:

$$G_1 \rightarrow \sum_{j=1}^6 c_j x_j + d_1^- - d_1^+ = b_1$$

$$G_2 \rightarrow \sum_{j=1}^6 x_j + d_2^- - d_2^+ = b_2$$

$$G_3 \rightarrow \sum_{j=1}^6 a_j x_j + d_3^- - d_3^+ = b_3$$

$$G_i \rightarrow x_j + d_i^- - d_i^+ = b_i \quad (i = 4,5,\dots,9; j = 1,2,\dots,6)$$

where

x_j , decision variable, the contracted leaf tobacco production area in j th region,

c_j , the cost of leaf tobacco production in j th region (\$/ha),

b_i , target value of the i th function,

a_j , the leaf tobacco production in j th region (kg/ha),

In addition to the constraints, variables and constants described above, the following priorities (P_k) and achievement function (\bar{a}) are to be defined.

$$\bar{a} = \min \left\{ \underbrace{d_1^+}_{P_1}; \underbrace{d_2^+}_{P_2}; \underbrace{d_3^-}_{P_3}; \underbrace{\sum_{i=4}^9 d_i^- + d_i^+}_{P_4} \right\}$$

where

d_i^- , negative deviational variable of the i th goal,

d_i^+ , positive deviational variable of the i th goal,

P_k , priority level

Results and Discussion

The model is solved using the Decision Support Software for Windows and the results are summarized in Table 3 and 4.

According to the solution; 90,000 ha area is determined for contracted leaf tobacco. Total production amount is 78.7 million kilograms and the total cost is \$ 337,365,262.71 calculated.

Table 3. Summary of the solution to the GP model

Regions	Area (ha)	Production (kg)	Cost (\$)
Aegean	61,450	49,110,840	215,035,320.86
Marmara	3,500	3,001,600	13,014,080.00
Black Sea	15,000	17,005,500	83,645,373.21
East Anatolia	50	90,305	168,999.36
Southeastern Anatolia	8,000	7,346,400	21,514,457.14
Mediterranean	2,000	2,151,000	3,987,032.14
Total	90,000	78,708,650	337,365,262.71

According to the Table 4, the first three priority are assured. However, the cost of contract in the first priority is at most 350 million US dollars (G_1) leads 12.6 million US dollars negative deviation from the target. Also, in the third priority at least 75 million kilograms of tobacco leaf production realization (G_3) is actualized and approximately 3.71 million kilograms positive deviation from the target. The fourth priority was not achieved and in the Aegean region the production of 60,000 hectares of contracted tobacco leaf leads 1,450 hectares positive deviation from the (G_4) target.

Table 4. Priority and constraint analysis

Priority (P_k)	Non achievement	Goal (G_i)	d_i^+	d_i^-
1	0	1	0	12,634,940,000
2	0	2	0	0
3	0	3	3,708,650	0
4	1450	4	1,450	0
		5	0	0
		6	0	0
		7	0	0
		8	0	0
		9	0	0

Figure 1 shows the distribution of the area where the contracted leaf tobacco production is going to be done. The model shows that, the contracted tobacco farming can be done in the target levels of all regions except Aegean Region.

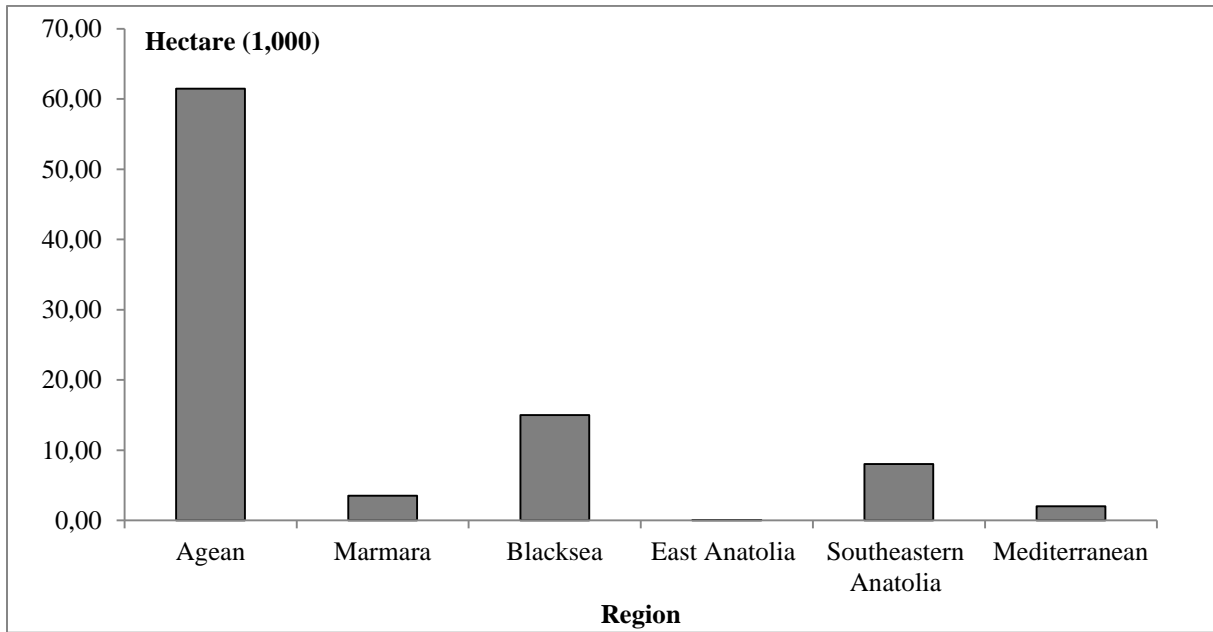

Figure 1. The distribution of the field of tobacco production.

In Figure 2, the distribution of the amount of contracted tobacco leaf production is shown. The Model shows that, the demand of tobacco production can be supplied from Aegean, the Black Sea and Southeastern Anatolia (93,34%) and Aegean Region (62,40%) solely.

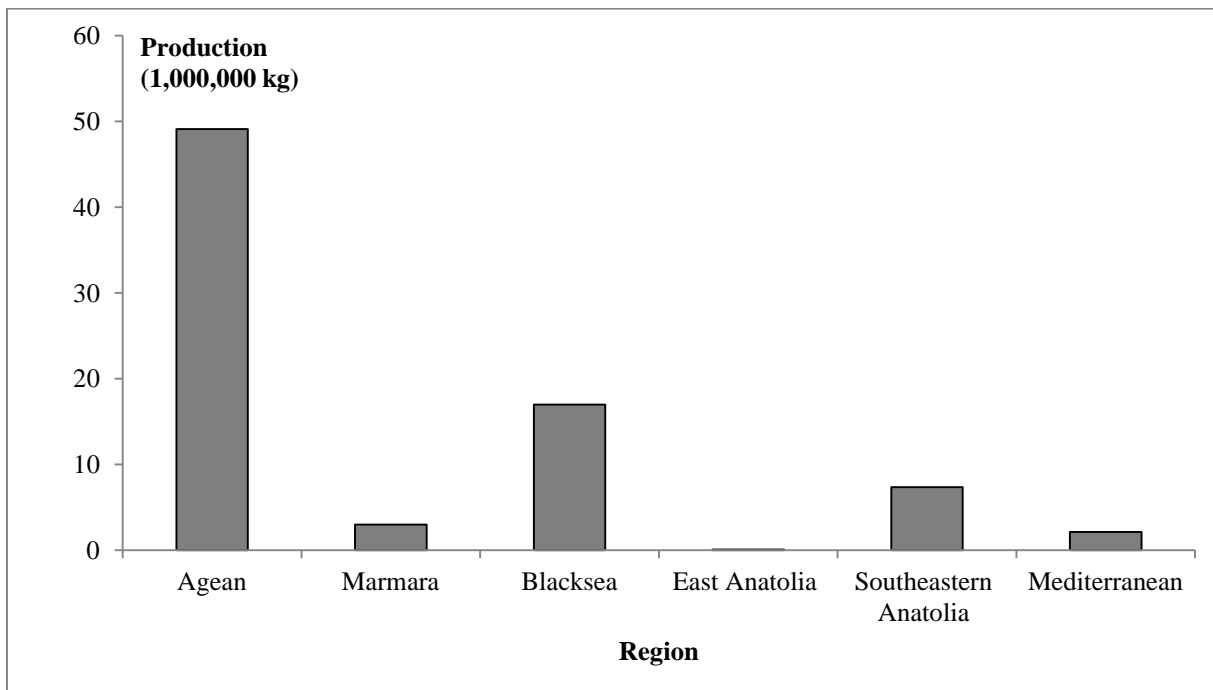

Figure 2. The distribution of tobacco production.

In Figure 3, the distribution of contracted tobacco leaf production cost is shown. The outcomes of the model indicate that the 94,91% of the production costs will be occurred in Aegean, the Black

Sea and the Southeastern Anatolia Regions and 63.74% of the production cost will be occurred in Aegean region.

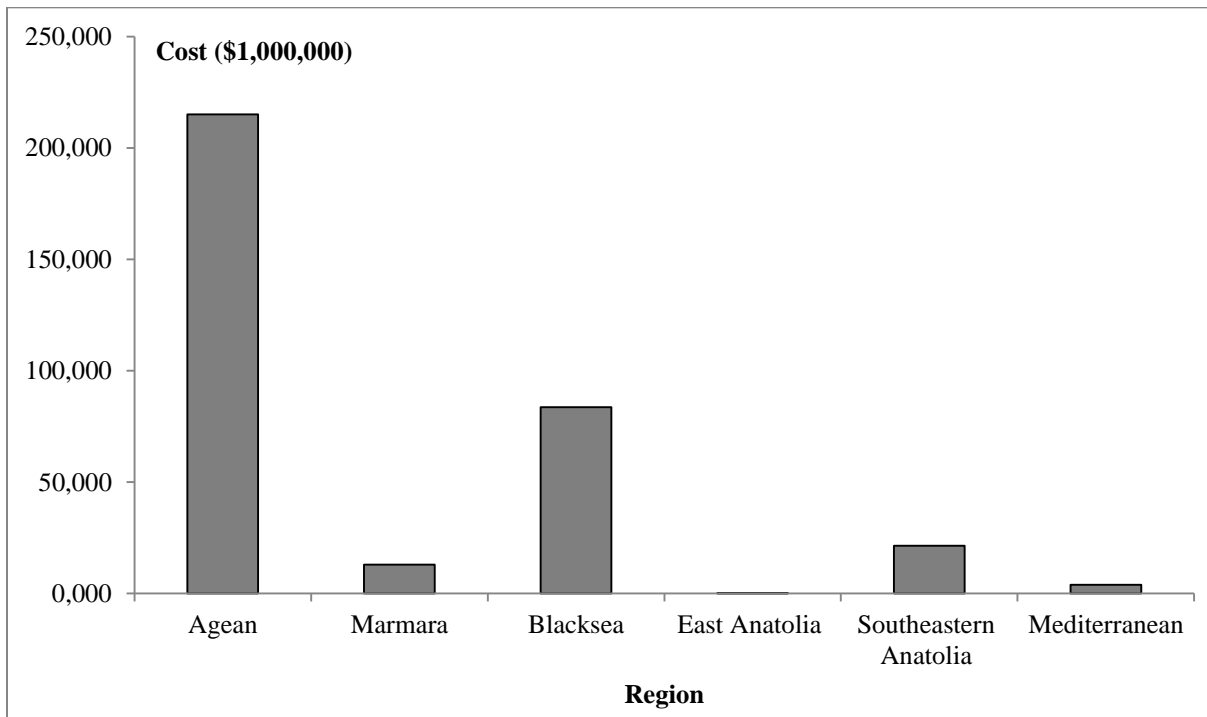

Figure 3. The distribution of the cost of tobacco production.

Priority GP models minimize firstly access function of the deviation variable which is located on the first priority, and then minimize the second, third and other deviation variables in priority areas respectively. In the above model, the first priority of leaf tobacco production is set not exceed 350 million dollars of the total cost, that means it is required to be minimized of the positive deviation. The negative direction deviation is released. The solution also ensured that priority, there is no positive deviation. In the negative direction, approximately 12.6 million US dollars deviation assures less cost in leaf tobacco production which is positive in this aspect. In the last priority, both negative and positive deviations have been asked to minimize the target values for leaf tobacco production areas in six districts. However, there has been a positive deviation 1450 hectares from Aegean Region land target, thus this priority has not been achieved. Because of obtaining a \$ 12.6 million less than the production cost in the first priority, the deviation should not be considered significant.

Conclusions

In Turkey, tobacco farming is generally carried out in the form of contracted tobacco production applications. The tobacco yield, tobacco production costs vary in each region. In this case, the tobacco companies are faced with the problem of controlling the amount of production, total tobacco purchasing costs and production areas. Goal programming is widely used as a mathematical method for this purpose. By using 2015 data, it is shown that how this model can be utilized in the determination of contracted tobacco purchases in Turkey.

As a result, the model solution, both production areas, production quantity and production costs aspects, the Aegean Region by 62-68% has an important role; Black Sea Region 16-25% and Southeastern Anatolia Region 6-9% are followed respectively.

References

- Budnick, F. S. (1988). Applied Mathematics for Business, Economics and the Social Sciences. McGraw-Hill Book Company, Third Edition, New York, pp 907.
- Dykstra, D. P. (1984). Mathematical Programming for Natural Resource Management. McGraw-Hill Book Company, New York, pp 318.
- Koçturk, O.M., Cebeci A. N. (2005). Journal of Agriculture and Rural Development in the Tropics and Subtropics Volume 106, No. 2, pp 167.
- Levin, R. I. Anf and Kirkpatrick, C. A. (1978). Quantitative Approaches to Management. McGraw-Hill International Book Company, Fourth Edition, New York, pp 625.
- Markland, R. E. and Sweigart, J. R. (1987). Quantitative Methods: Applications to Managerial Decision Making. John Wiley & Sons, New York, pp 827.
- SPO. (2000). Eighth Five-Year Development Plan, T.R. Prime Ministry State Planning Organization Publications, Ankara, pp 221.
- TAPDK. (2016). The Tobacco and Alcohol Market Regulatory Authority
<http://www.tapdk.gov.tr/tr.aspxgfr>

THE EFFECTS OF SEED PRIMING AND NITROGEN DOSES ON SEEDLING GROWTH TRAITS OF BREAD WHEAT (*TRITICUM AESTIVUM* L.) VARIETIES

Bekir ATAR^{1*}, Zekeriya AKMAN²

¹University of Süleyman Demirel, Agricultural Research and Training Center, 32260 Isparta, Turkey

²University of Süleyman Demirel, Faculty of Agriculture, Department of Field Crops, 32260 Isparta, Turkey

*Corresponding author: bekiratar@sdu.edu.tr

Abstract

This study was conducted to investigate the effects of seed pre-treatments (control, pure water, 100 and 200 ppm GA₃) and nitrogen doses (0, 25, 50 and 75 kg ha⁻¹) on seedling growth of bread wheat (*Triticum aestivum* L.). The field experiments were conducted at Süleyman Demirel University (Turkey), Agricultural Research and Experiment Station throughout the growing season of 2007-08 and 2008-09. The winter wheat cultivars, Dagdas-94, Bağcı-2002, and Karahan-99 were used in these experiments. The seeds which had been soaked up for 3 hours before sowing had been air dried at room temperature and then planted. Nitrogen dosages were applied with planting. The effects of seed priming on seedling growth traits were found to be significant. Gibberellic acid treatment (200 ppm) reduced the mean time for 50% germination and increased the length of seedling nearly 33%. Due to increase in the length of seedling, its stems turned out to be yellow and white and lodged. The number of plants per square meter was not affected by nitrogen doses or seed priming. Compared to control and pure water treatments, GA₃ treatments led to an increase in seedling root lengths in both years. Nitrogen doses on the seedling growth traits were not found to be significant.

Key words: *Seed priming, Wheat seedling, Gibberellic acid, Nitrogen doses*

Introduction

Homogeneous and strong seedling emergence is one of the most important factors that affect quality and high yield in direct field planting. Priming treatments are widely used especially in emergence period for the purpose of minimizing the effects of negative environmental factors and improving yield and yield elements. The method is useful in promoting seedling growth and increasing seedling resistance in saline soil and minimizing the adverse effect of late sowing and water deficiency on yield (Mahmood et al. 2009). In addition, it affects germination speed, germination rate, homogenous seedling emergence (Parera and Cantliffe 1994), water use efficiency, harvest index and early blooming and harvest (Harris et al. 2001), protein rate and yield (Bhat et al 1990) positively. The purpose of the study is to determine the effects of seed priming that contains Gibberellic acid (GA₃) and different nitrogen doses on emergence and seedling traits in wheat.

Material and methods

The experiment field has silty, clayed, loamy soil and high lime rate and pH (8.1). Table 1 shows the climatological data obtained during the experiment. The bread wheat varieties Karahan-99, Dağdaş-94 and Bağcı-2002 were used in the experiment, which was designed in a split-split plot with three replications. 0, 25, 50 and 75 kg/ha⁻¹ N doses, varieties, and seed priming were placed to main plots, upper subplots, and lower subplots, respectively. Four treatments were used:

control, pure water and gibberellic acid (GA₃) (100 and 200 ppm). The seeds were soaked in solutions and pure water for 3 hours, drained, and then surface-dried using blotting paper. They were dried at room temperature in the shade approximately up to their pre-treatment weights and put inside cloth bags to keep until sowing.

Table 1. Climatological data of province Isparta

Years/ Mont.	Mean temp. (°C)			Soil temp. at 5 cm. (°C)			Precipitation (mm)		
	October	November	December	October	November	December	October	November	December
2007-2008	14.4	7.5	2.7	16.2	8.3	4.0	30.7	91.8	97.2
2008-2009	12.8	9.0	3.7	14.4	10.1	5.0	32.0	60.0	5.4
Long term	12.8	6.9	3.0	13.9	7.6	3.4	38.0	51.5	70.9

Seedling emergence was followed up and counted on a daily basis. About 5 weeks after sowing, five plants were uprooted from each plot to determine seedling length and seedling root length.

Results and discussion

Mean time for 50% germination (E₅₀); E₅₀ was not affected by varieties, nitrogen doses or interactions. GA₃ treatments, however, were highly effective in shortening emergence time in both experiment years (Table 2). This difference lasted approximately 2 days in the first year of experiment and 3 days in the second year of experiment. The difference between GA₃ doses seem to be insignificant.

Table 2. Effects of seed priming and nitrogen doses interaction on E₅₀ (Day)

Year	Variety	N (kg ha ⁻¹)	Seed priming				
			Control	Pure w.	GA ₃ (ppm)		Mean
					100	200	
2007-08	Dağdaş-94	0	16.0	15.3	13.7	13.3	14.6
		25	16.0	14.0	14.0	13.0	14.2
		50	15.3	15.0	14.0	11.0	13.8
		75	14.7	14.3	15.0	13.7	14.4
		Mean	15.5	14.7	14.2	12.8	14.3
	Bağcı-2002	0	17.0	16.0	14.0	13.3	15.1
		25	13.3	16.7	14.3	13.3	14.4
		50	15.0	16.0	14.7	14.3	15.0
		75	16.0	13.7	13.7	14.7	14.5
		Mean	15.3	15.6	14.2	13.9	14.8
	Karahah-99	0	13.3	14.3	14.7	15.3	14.4
		25	15.0	15.7	15.0	14.3	15.0
		50	16.0	13.3	13.3	13.0	13.9
		75	16.3	14.7	14.7	14.3	15.0
		Mean	15.2	14.5	14.4	14.2	14.6
			1. Year Prim. Mean	15.3 A**	14.9 AB	14.2 BC	13.6 C
		1. Year N Mean	N ₀ =14.7	N ₂₅ =14.6	N ₅₀ =14.2	N ₇₅ =14.6	
2008-09	Dağdaş-94	0	15.0	13.0	10.3	10.7	12.2
		25	12.3	9.7	11.3	7.7	10.2
		50	13.3	12.3	11.0	8.7	11.3
		75	11.7	12.0	12.0	10.7	11.6
		Mean	13.1	11.8	11.2	9.4	11.3
	Bağcı-2002	0	14.0	12.3	11.0	10.7	12.0
		25	10.0	13.3	10.7	10.0	11.0
		50	12.0	12.3	10.7	10.3	11.3
		75	11.7	11.0	9.7	9.0	10.3
		Mean	11.9	12.2	10.5	10.0	11.2
	Karahah-99	0	12.3	11.3	10.3	10.7	11.2
		25	11.7	13.0	11.7	10.7	11.7
		50	12.7	10.3	11.0	9.3	10.8
		75	14.3	12.0	9.7	11.0	11.7
		Mean	12.7	11.7	10.7	10.4	11.4
			2. Year Prim. Mean	12.6 A**	11.8 A	10.8 B	9.9 B
		2. Year N Mean	N ₀ =11.8	N ₂₅ =11.0	N ₅₀ =11.2	N ₇₅ =11.2	

*, **: significant at P < 0.05 and P < 0.01 probability levels, respectively

Emergence time was shortened as the first and second stages of germination had been completed by allowing the seeds to absorb water through pre-sowing seed treatments (Heydecker and Coolbear, 1977). Besides, it is reported that GA promotes germination (Leubner-Metzger, 2006) and GA₁ synthesis rapidly increases 24 hours after the first water intake by the seed (Woodger et al., 2004). Emergence time was 14.5 days on the average in the first year but decreased to 11.3 days in the second. Higher amount of precipitation was observed in the first year compared to the post-sowing long-term average (Table 1). It is thought that high soil moisture gave rise to a decrease in oxygen rate, slowing germination down (Corbineau and Come, 1995), and further that the temperature of 5cm-deep soil in November, which was 1.8°C higher in the second year, accelerated emergence, resulting in differences between years in terms of emergence time.

The number of plants per square meter; The number of plants per square meter was not affected by nitrogen doses or seed priming (Table 3). In the first year, no difference was found between the varieties. However, in the second year, the highest value was encountered in Bağcı-2002 variety (385.3 plants).

Table 3. Effects of seed priming and nitrogen doses interaction on number plants per square (number)

Year	Variety	N (kg ha ⁻¹)	Seed priming				
			Control	Pure w.	GA ₃ (ppm)		Mean
					100	200	
2007-08	Dağdaş-94	0	320.3	352.0	364.3	322.7	339.8
		25	349.3	360.3	287.7	363.7	340.2
		50	337.0	276.3	343.3	305.3	315.5
		75	271.7	334.7	281.7	295.3	295.8
		Mean	319.6	330.8	319.2	321.7	322.9
	Bağcı-2002	0	342.7	334.3	307.7	293.0	319.4
		25	328.0	307.0	324.3	311.3	317.7
		50	353.0	285.3	319.0	332.7	322.5
		75	317.7	324.3	328.3	348.3	329.7
		Mean	335.3	312.7	319.8	321.3	322.3
	Karahah-99	0	304.3	273.7	273.7	278.3	282.5
		25	289.3	338.3	298.7	281.0	301.8
		50	337.0	312.7	268.7	292.7	302.7
		75	350.3	312.7	328.3	319.7	327.7
		Mean	320.2	309.3	292.3	292.9	303.7
		1. Year Prim. Mean	325.1	317.6	310.5	312.0	316.3 b*
	1. Year N Mean	N _n =313.9	N ₇₅ =319.9	N ₁₀₀ =313.6	N ₇₅ =317.7		
2008-09	Dağdaş-94	0	290.0	347.7	377.7	356.0	342.8
		25	391.7	412.7	351.0	401.0	389.1
		50	319.3	385.3	371.0	369.3	361.2
		75	360.3	373.3	328.0	341.0	350.7
		Mean	340.3	379.7	356.9	366.8	361.0 B*
	Bağcı-2002	0	366.0	408.7	403.7	430.7	402.2
		25	405.0	356.0	381.0	360.0	375.5
		50	401.0	381.7	351.3	409.3	385.8
		75	392.7	366.0	358.7	392.7	377.5
		Mean	391.2	378.1	373.7	398.2	385.3 A
	Karahah-99	0	372.7	365.0	351.7	274.3	340.9
		25	371.0	357.7	313.0	366.0	351.9
		50	360.0	404.3	353.7	361.7	369.9
		75	327.0	358.7	357.7	354.3	349.4
		Mean	357.7	371.4	344.0	339.1	353.0 B
		2. Year Prim. Mean	363.1	376.4	358.2	368.0	366.4 a
	2. Year N Mean	N _n =362.0	N ₇₅ =372.2	N ₁₀₀ =372.3	N ₇₅ =359.2		

*, **: significant at P < 0.05 and P < 0.01 probability levels, respectively.

During germination, environmental stress factors affected the varieties at different levels, which is thought to be a reason of the difference between the varieties. Variety x nitrogen dose interaction affected the number of plants per square meter in both years. In terms of the number of plants per square meter, the effect of nitrogen was not found to be significant. In both years, however, the highest values were obtained from 25 kg ha⁻¹ N dose. It has been suggested also by other researchers (Geçit and Çakır, 2006) that nitrogen doses and varieties affect the number of plants per square meter. The average number of plants per square meter was found to be 316.3 in the first year but 366.4 in the second. The reason of the difference between years is thought to be environmental factors. Although different seed treatments have been reported to increase germination and emergence in laboratory and field experiments (Iqbal, 2004; Salehzade et al., 2009), no such results were obtained in our study. It is proposed that seed priming promotes early and homogenous germination, rather than increasing seed viability (Basra et al, 2005). Moreover, considering that not only seed priming but also soil structure and temperature affect final

emergence in field experiments (Hardegee and Vactor, 2000), pre-sowing seed treatments can have limited effect on the number of emerging seedlings as in our study results.

Table 4. Effects of seed priming and nitrogen doses interaction on seedling length (cm)

Year	Variety	N (kg ha ⁻¹)	Seed priming				
			Control	Pure w.	GA ₃ (ppm)		Mean
					100	200	
2007-08	Dağdaş-94	0	7.2	6.5	9.9	11.5	8.8
		25	5.5	6.8	10.2	10.1	8.2
		50	5.7	7.1	7.8	8.6	7.3
		75	6.7	7.2	9.1	10.1	8.3
		Mean	6.3	6.9	9.2	10.1	8.1
	Bağcı-2002	0	6.7	8.1	8.4	8.8	8.0
		25	7.3	8.8	10.1	10.3	9.1
		50	7.9	9.2	9.2	9.0	8.8
		75	6.6	7.5	9.4	10.3	8.4
		Mean	7.1	8.4	9.3	9.6	8.6
	Karahah-99	0	7.0	9.1	9.5	9.4	8.7
		25	6.2	7.4	9.7	10.3	8.4
		50	7.8	8.0	10.7	9.8	9.1
		75	7.0	7.7	11.0	10.8	9.1
		Mean	7.0	8.0	10.2	10.1	8.8
			1. Year Prim. Mean	6.8 B**	7.8 B	9.6 A	9.9 A
		1. Year N Mean	N ₀ =8.5	N ₇₅ =8.5	N ₁₀₀ =8.4	N ₂₀₀ =8.6	
2008-09	Dağdaş-94	0	13.1	13.1	15.9	20.0	15.5
		25	12.3	14.3	16.1	17.7	15.1
		50	12.6	14.3	18.5	17.6	15.8
		75	14.7	13.3	14.5	16.0	14.6
		Mean	13.2	13.7	16.3	17.8	15.3
	Bağcı-2002	0	11.5	14.2	16.5	14.7	14.2
		25	16.4	15.4	16.2	18.5	16.6
		50	15.2	13.7	17.3	18.1	16.1
		75	12.7	11.8	17.2	18.8	15.1
		Mean	13.9	13.8	16.8	17.6	15.5
	Karahah-99	0	15.2	12.6	15.2	18.5	15.4
		25	15.3	12.9	16.5	18.4	15.8
		50	13.3	14.5	16.1	17.8	15.4
		75	16.2	17.1	17.3	16.6	16.8
		Mean	15.0	14.3	16.3	17.8	15.9
			2. Year Prim. Mean	14.0 B**	13.9 B	16.4 A	17.7 A
		2. Year N Mean	N ₀ =15.0	N ₇₅ =15.8	N ₁₀₀ =15.8	N ₂₀₀ =15.5	

*, **: significant at P < 0.05 and P < 0.01 probability levels, respectively.

Seedling length; The effects of varieties and nitrogen doses on seedling length were not found to be significant individually. However, seed priming and years had an apparent effect on seedling length (Table 4). In both vegetation periods, the longest seedlings were obtained from 200ppm GA₃ treatments (9.9 and 17.7cm) and the shortest seedlings were encountered in control plots (8.8 and 14.0cm). GA₃ affects seedling length as elongated tissue cells and accelerated cell division (Sun, 2004). There are a great number of researches demonstrating that GA₃ leads to longer seedlings (Salehzade et al., 2009). As a result of our study, it was found that GA₃ treatments caused whitening in seedling stems and inclination in seedlings, which are presumed to arise from the high doses used. The difference in wheat seedling lengths between the two production years was considerably significant. The average seedling length was found to be 8.5cm in the first year of the experiment and 15.5cm in the second year. In the first year,

seedlings got shorter as the delay in emergence times and lower soil and air temperatures in November (Table 1) slowed down plant growth to a large extent. In fact, Tosun et al. (1975) stated that temperature difference could affect seedling length.

Table 5. Effects of seed priming and nitrogen doses interaction on seedling root length (cm)

Year	Variety	N (kg ha ⁻¹)	Seed priming				
			Control	Pure w.	100	200	Mean
2007-08	Dağdaş-94	0	20.7	19.2	22.9	21.2	21.0
		25	19.5	21.0	21.3	19.2	20.2
		50	23.7	19.1	20.7	21.7	21.3
		75	19.4	18.4	21.7	19.4	19.7
		Mean	20.8	19.4	21.7	20.4	20.6
	Bağcı-2002	0	20.2	20.1	19.8	23.2	20.8
		25	20.2	19.6	21.3	19.7	20.2
		50	18.4	20.1	22.2	17.8	19.6
		75	18.4	20.2	21.2	21.2	20.3
		Mean	19.3	20.0	21.1	20.5	20.2
	Karahana-99	0	20.3	19.5	22.5	23.9	21.5
		25	18.4	17.5	19.3	20.6	18.9
		50	19.4	17.5	19.1	19.0	18.8
		75	22.0	18.6	21.2	22.2	21.0
		Mean	20.0	18.3	20.5	21.4	20.1
		1. Year Prim. Mean	20.0 AB*	19.2 B	21.1 A	20.8 A	20.3 a*
		1. Year N Mean	N ₀ =21.1	N ₂₅ =19.8	N ₅₀ =19.9	N ₇₅ =20.3	
2008-09	Dağdaş-94	0	15.7	18.6	16.2	17.4	17.0
		25	16.3	18.1	15.7	16.6	16.7
		50	17.7	15.9	17.5	16.2	16.8
		75	15.2	15.3	15.9	16.1	15.6
		Mean	16.2	17.0	16.3	16.5	16.5
	Bağcı-2002	0	16.3	16.3	16.5	16.8	16.5
		25	15.3	15.8	17.0	16.3	16.1
		50	14.7	15.0	16.0	16.5	15.5
		75	16.3	15.4	17.0	17.1	16.4
		Mean	15.7	15.6	16.6	16.7	16.1
	Karahana-99	0	14.8	15.9	16.3	15.7	15.7
		25	17.3	15.2	15.9	16.2	16.1
		50	16.4	15.8	15.7	17.0	16.2
		75	16.2	16.0	16.9	16.0	16.3
		Mean	16.2	15.7	16.2	16.2	16.1
		2. Year Prim. Mean	16.0	16.1	16.4	16.5	16.2 b
		2. Year N Mean	N ₀ =16.4	N ₂₅ =16.3	N ₅₀ =16.2	N ₇₅ =16.1	

*, **: significant at P < 0.05 and P < 0.01 probability levels, respectively.

Seedling root length: Compared to control and pure water treatments, GA₃ treatments led to an increase in seedling root lengths in both years. However, the first year was found to be statistically significant (Table 5). No difference was detected between the pure water treatment and the control treatment in terms of seedling root lengths. Researchers suggest that seed priming has different effects on root length depending on the method employed (Basra et al., 2005) but mostly affects it positively (Afzal et al., 2005). These findings are in parallel with the result we achieved. Kujira et al. (1994), in the study they conducted on different nitrogen dose levels,

concluded that variety-based genotypic traits affected total root length. Differences were observed between the years in terms of average seedling root lengths. The average seedling root length was 20.3cm in the first year of experiment but seen to be 16.2cm in the second year.

Conclusion

GA₃ treatments on seeds significantly shortened 50% seedling emergence time. This trait can be recommended as a method to employ in the completion of emergence before soil moisture is lost in case of lack of rain, which has been encountered in recent years in sowing period due to climatic irregularities. Increased seedling length is useful in bringing deep-set seeds to the soil surface. In addition, trials of GA₃ treatments with lower doses are required so as to determine suitable doses.

Acknowledgements

This research is supported by TUBITAK and Süleyman Demirel University, Scientific Research Project Management Unit. We are grateful for their financial support.

References

- Afzal, I., Basra, S.M.A., Iqbal, A. (2005). The effects of seed soaking with plant growth regulators on seedling vigor of wheat under salinity stress. *Journal of Stress Physiology & Biochemistry*, 1 (1), 6-14.
- Basra, S.M.A., Afzal, I., Rashid, R.A., Farooq, M. (2005). Pre-sowing seed treatments to improve germination and seedling growth in wheat (*Triticum aestivum* L.). *Caderno de Pesquisa Serie Biologia*, 17 (1), 155-164.
- Bhat, M.L., Sen, A., Misra, N.M. (1990). Rainfed wheat as affected by cycocel, ascorbic acid and gibberellic acid seed treatments. *Barley and Wheat Newsletter*, 9 (1), 17-20.
- Corbineau, F., Come, D. (1995). Control of seed germination and dormancy by the gaseous environment. In: *Seed Development and Germination*. (Kigel, J. and Galili, G., -eds.) Marcel Dekker, Inc. pp. 397-424. New York.
- Geçit, H.H., Çakır, E. (2006). Makarnalık buğdayda (*Triticum durum* L.) sulama ve azotlu gübrelemenin verim ve bazı verim öğeleri üzerine etkisi. *Tarım Bilimleri Dergisi*, 12 (3), 259-266.
- Hardegee, S.P., Vactor, S.S.V. (2000). Germination and emergence of primed grass seeds under field and simulated-field temperature regimes. *Annals of Botany*, 85, 379-390.
- Harris, D., Pahtan, A.K., Gothkar, P., Joshi, A., Chivasa, W., Nyamudeza, P. (2001). On-farm seed priming; using participatory methods to revive and refine a key technology. *Agricultural Systems*, 69, 151-164.
- Heydecker, W., Coolbear, P. (1977). Seed treatment for improved performance. survey and attempted prognosis. *Seed Science and Technology*, 5, 353-425.
- Iqbal, M. (2004). Inducing salt tolerance in wheat by pre-sowing seed treatment with plant growth regulators or inorganic salts. Faculty of Sciences University of Agriculture, Phd. Thesis, 227p, Faisalabad, Pakistan.
- Kujira, Y., Grove, J.H., Ronzelli, P. (1994). Varietal difference of root system in winter wheat seedling. *Jpn. Journal. Crop Science*, 63 (3), 524-530.
- Leubner-Metzger, G. (2006). Hormonal interactions during seed dormancy release and germination. In: *Handbook of Seed Science and Technology*. Edit: Basra, A.S., Food Products Press, London.
- Mahmood, T., Ashraf, M., Shahbaz, M. (2005). Does exogenous application of glycinebetaine as a pre-sowing seed treatment improve growth and regulate some key physiological attributes in

wheat plants grown under water deficit conditions?. *Pakistan Journal of Botany*, 41 (3), 1291-1302.

Parera, C.A., Cantliffe, D.J. (1994). Pre Sowing Seed Priming. (Janick, L. –eds.). *Horticultural Reviews*, 16, 109-141.

Salehzade, H., Shishvan, M.I., Ghiyasi, M., Forouzin, F., Siyahjani, A. (2009). Effect of seed priming on germination and seedling growth of wheat (*Triticum aestivum* L.). *Research Journal of Biological Sciences*, 4 (5), 629-631.

Sun, T.P. (2004). Gibberellin Signal Transduction in Stem Elongation and Leaf Growth. (Davies, P.J. -eds). *Plant Hormones*, pp. 304-320.

Tosun, O., Akbay., G., Yurtman, N. (1975). The effect of various temperatures on coleoptile, embryonic root and root weight of wheat and barley. *A. U. Ziraat Fakültesi Yıllığı*, 25 (4), 829-840.

Woodger, F., Jacobsen, J.V., Gubler, F. (2004). Gibberellin action in germinated cereal grains. In: *Plant Hormones Biosynthesis, Signal Transduction, Action*. Edit: Davies, P.J., Kluwer Academic Publishers, Netherlands.

DETERMINATION OF MYROBOLAN 29C ROOTSTOCKS REACTIONS AGAINST DROUGHT STRESS *IN VITRO* CONDITIONS

Muzaffer İPEK*, Lütfi PIRLAK

Department of Horticulture, Faculty of Agriculture, University of Selçuk, Konya/Turkey

*Corresponding author: mipek@selcuk.edu.tr

Abstract

In this study, it was investigated morphological response of Myrobolan 29C rootstock against drought stress establishing on culture media including different PEG (Polyethylene Glycol) levels. Three PEG levels (-0.5MPa, -1.0MPa, -1.5MPa) was used in order to make drought stress condition. Plants were measured at 0, 3, 5, 7, 9, 11, 13 and 15 days for morphological parameters (plant height, relative plant weight, leaf area, chlorophyll content) and collected leaves for proline and protein analysis. There were also measured the permeability of membranes and leaf relative water content (LRWC). The highest growth of plant height was obtained by control (4,04%), the lowest growth was obtained by -1,5MPa drought stress level (1,98%). Under all drought stress, plants died on 15 days of culture. The lowest drop rate of relative plant weight was measured from -1,5MPa drought stress level (18.22%). The lowest leaf area was determined to 1cm² in -1,5MPa while the highest leaf area was determined to control (2.77cm²). According to the leaf membrane permeability, -1,5MPa (97.92%) was the highest. LRWC was the lowest in -1,5MPa drought stress level (2.44%). Total protein level increased from initial day to 3 days and after this time its level decreased under all drought application to end of study. The proline content decreased in -0,5MPa and -1,0MPa until end of 13. Days while proline content decreased after 9 days in 1,5MPa.

Keywords: *Drought Stress, Myrobolan 29C, Plant Tissue Culture*

Introduction

Water scarcity is an important environmental limitation to plant productivity (Farooq *et al.*, 2009). It was the catalyst of the great famines of the past. Because of the world's water supply is limiting, future food demand for rapidly increasing population pressures is likely to further aggravate the effects of drought (Somerville and Briscoe, 2001). The severity of drought is unpredictable as it depends on many factors such as occurrence and distribution of rainfall, evaporative demands and moisture storing capacity of soils. While drought stress increase respiration in plants under drought stress, it causes to decrease of plant growth, yield, photosynthesis and disrupts water and nutrient content (Farooq *et al.*, 2009).

Plants respond and adapt to survive under drought stress by the induction of various morphological, biochemical and physiological responses. As a morphological response, plants shortens life cycle or growing season to attain adaptation before the environment becomes dry. Flowering time is an important trait related to drought adaptation, where a short life cycle can lead to drought escape (Araus *et al.*, 2002). As a drought period persists and soil drying becomes more severe, the plant closes stomates but it becomes unable to maintain hydration even with the stomates closed (Verslues *et al.*, 2014). . In terms of physiological response, the low water availability in the soil decreases photosynthesis and carbohydrate accumulation (M. Chaves and Oliveira, 2004; M. M. Chaves *et al.*, 2003; Flexas *et al.*, 2004).

The plant tissue culture techniques are increasingly used for abiotic stress tolerance in numerous plants. *In vitro* culture conditions, stress treatments can be easily controlled so tissue culture techniques are useful for abiotic stress studies (Errabii *et al.*, 2006). Moreover, *in vitro* cultures provide uniform clonal propagated and synchronously developed plants without genetic instability (Tal, 1983). In addition, *in vitro* culture techniques limit environmental variations via defined plant growth media, controlled atmosphere conditions and homogeneous of stress treatments. Also, tissue culture techniques obtain large plant population in a small area and less period for stress treatments (Sakthivelu *et al.*, 2008).

Material and Methods

This study was carried out in laboratory for horticultural biotechnology at Selçuk University (Turkey) between 2012 and 2014. Plantlets of plum rootstock ‘Myrobolan 29C’ was propagated through *in vitro* nodal explant cultures.

Establishing Drought Stress Conditions

The drought stress conditions were established according to do Michel (1983) formulation at different osmotic potentials (OP) (0,0, -0,5MPa, -1,0MPa and -1,5MPa). The liquid MS basal media without plant growth regulators was prepared and then PEG was added into liquid media according to the Michel’s formula (1983). The OP was calculated using the following formula:

$$OP = 1,29 \times C^2 \times T - 140 \times C^2 - 4 \times C$$

OP= Osmotic potential

C = PEG quantity

T = Temperature

Measurements of Morphological Parameters

In this study, plants were measured at 0, 3, 5, 7, 9, 11, 13 and 15days for morphological parameters (plant height, relative plant weight, leaf area, chlorophyll content) and collected leaves for proline and protein analysis. There were also measured the permeability of membranes and leaf relative water content (LRWC).

Relative Water Content of Leaves

In order to determine RWC, leaves collected from control and drought stress treated plants were measured for the fresh weight first. Then samples were put into culture tube filled double distilled water for 4h at room temperature for turgid weight (hydration). The turgid weight was measured and leaves were dried in an oven 65°C for 48h. The RWC percentage was calculated using the following formula:

$$RWC (\%) = (FW - DW) / (TW - DW) \times 100$$

where FW is fresh weight, DW dry weight, and TW turgid weight.

Permeability of Membranes

Leaves of three plants per treatment were harvested 0, 3, 5, 7, 9, 11, 13 and 15 days and cut 1cm² leaf disks. Leaf disks were washed with three changes of double distilled water to remove surface-adhered electrolytes. Leaf disks were placed in culture tubes containing 10 ml of double distilled water and incubated at 25°C on a rotary shaker. Electrical conductivity of the bathing solution (EC₁) was determined by EC-meter after 24h. Samples were then autoclaved at 121°C for 15min. and a last electrical conductivity reading (EC₂) was obtained upon equilibration at 25°C. The electrolyte leakage was calculated as EC₁/ EC₂ and expressed as percent (Lutts *et al.*, 1996).

Chlorophyll Content

Leaves were harvested for Chlorophyll Content. Chlorophyll content of leaves was determined using portable chlorophyll reader SPAD-502 (Konica Minolta), measuring absorbance at 650 nm, as a non-destructive method. Three readings were made on each leaf. The results were expressed in SPAD units.

Proline and Protein Content Determination

Assessment of proline content was performed with acid-ninhydrin method according to Bates *et al.* (1973). The protein amounts in leaf extracts were determined by the Bradford method (1976) using bovine serum albumin as a standard.

Data analysis

All analyses were done using a completely randomized design with 3 replicates. All data were subjected to one-way analyses of variance (ANOVA). Duncan's multiple range test was used to separate statistically different means at $P < 0.05$ via SPSS 23.0 version.

Results and Discussion

Drought is a meteorological term and is commonly defined as a period without significant rainfall. Generally drought stress occurs when the available water in the soil is reduced and atmospheric conditions cause continuous loss of water by transpiration or evaporation (Jaleel *et al.*, 2009). Drought stress, which effect yield and plant growth, is one of environmental stress factors and triggers some physiological, biochemical and molecular mechanism (Ozfidan *et al.*, 2013). The studies of drought stress help to improve species and cultivars with determination of physiological and biochemical responses to drought stress.

We found that plants which were under drought stress, grew little during study. Plants were not surviving until 15.day and they dropped leaves. Because of leaves drooped, there is not data for plant weight, leaf area, membran permeability, LRWC, chlorophyll content, protein content and proline content without plant height in 15th of drought stress. When OP level was increased, plants height of Myrobolan 29C slightly increased (Table-1). Sustainable plant growth and development depend on protection of plant water content. In case of deficit of water, cell division and development is limited so plants grow slowly (Bertamini *et al.*, 2006). Furthermore, photosynthesis rate is slowed due to lack of water and plant growth rate is decreased. Many studies result (Alizadeh *et al.*, 2011; Karimi *et al.*, 2012; Rostami and Rahemi, 2013) supported our study. Cell growth is considered one of the most drought-sensitive physiological processes due to loss of turgor pressure (Karimi *et al.*, 2012). Rostami and Rahemi (2013) reported that cell growth is limited due to loss of leaf turgor pressure.

In terms of dry plant weight, when OP levels were increased, dry plant weight markedly decreased compared to control. The most of losses of dry plant weight was calculated in -1.5MPa after 3rd day of stress (Table-1). Our results are in agreement with the earlier reports (Abbaspour *et al.*, 2012; Bolat *et al.*, 2014). Decreased dry matter accumulation of leaves as a result of stress may be attributed to the altered carbon and nitrogen metabolisms (Kluge, 1976).

Karimi *et al.* (2012) reported that leaves under drought conditions shows that leaf area development is more sensitive than dry weight accumulation in the leaves. Leaf growth is more sensitive than root against drought stress. Decreasing of leaf area helps to plants under water deficit. The excess of carbon in leaves was transferred to root and it improves root and increases root mass. Furthermore, small leaf area has low transpiration rate and loss less water (Taiz and Zeiger, 2002). In our study, leaf area was decreased when drought levels were risen. The smallest

leaf was obtained from -1.5MPa treatment (Table-1). The results of our leaf area agreed with Nogues and Baker (2000) in olive and Klamkowski & Treder (2008) in strawberry.

Under stress conditions, membranes are damaged by reactive oxygen species (ROS). The membranes which are damaged, cause to leaking of ions into intracellular space. Ions damage cells which are responsible for regulators of osmotic potential and enzyme activity. We found that when drought levels and time were increased, membrane damages were heavily observed. Membrane permeability rates were range from 86,55% to 97,92 in 13.day. Our data were agreed with Chai *et al.*(2005) in banana, Karimi *et al.* (2012) in 5 almond cultivars and GF 677 rootstock and Zonouri *et al.* (2014) in grape.

Typically, as the water content of the plant decreases, its cells shrink and the cell walls relax. This decrease in cell volume results in lower turgor pressure. Water stress limits not only leaf size, but also leaf number (Taiz and Zeiger, 2002). Under drought stress, Myrobolan 29C plantlets had lower LRWC rates than control. During stress study, the highest average of LRWC rate were observed in control plants with 45%, while the lowest average of LRWC rate was obtained from -1.5MPa drought stress level with approximately 8%. The study results of Boutra *et al.*(2010), Keyvan (2010), Ghaderi and Siosemardeh (2011) are similar to our LRWC result.

Water is important for chlorophyll synthesis. Following a heavy rain, the chlorophyll content of plant leaves will often increase, but during a drought, the chlorophyll content will decrease. On the other hand, if the soil is saturated with water, this results in a decrease in the chlorophyll content of the leaves. The water content of the leaf must be high for maximum chlorophyll content. In our study, chlorophyll content decreased due to drought levels and time of stress treatment. When the control plants had about average of 30ppm throughout 13 days, chlorophyll content in -1.5MPa drought level markedly decreased (26,5 to 9,19ppm). Some researcher reported that plants has lower chlorophyll content under drought condition (Alizadeh *et al.*, 2011; Ghaderi and Siosemardeh, 2011; Rad *et al.*, 2012; Zanjani *et al.*, 2012).

Drought stress causes to changing of protein metabolism and protein synthesis is decreased (Kutlu, 2010). Protein content increased until 10th day in all stress treatments aftermath it's level slightly decreased. This would indicate that the protein buildup occurred up to 10th day of drought stress. Increases in protein content suggest that under water stress conditions synthetic activity is enhanced to accommodate increased metabolic activity for maintaining the osmotic balance (Ali-Ahmad and Basha, 1998). Similar results were found some researcher such as Brito *et al.* (2003) in olive, Bertamini *et al.* (2006) in grape, Behnamnia *et al.* (2009) in tomato.

Stresses such as cold, heat, salt, drought, UV and heavy metal cause significant increase in the proline concentration in a variety of plants. This increase occurs over several hours or days. Interpretations of proline accumulation vary from its role as a useful adaptive response, helping organisms to withstand the effect of stress, to merely a consequence of stress induced damage to the cells. Therefore, proline may not be just a by-product of stress defense, but a chemically active compound, crucially involved in the physiology of stress protection (Ashraf and Iram, 2005). Similar results were reported Abbaspour *et al.* (2012), Rostami and Rahemi (2013) and Bolat *et al.* (2014).

Conclusion

In this study, performance of Myrobolan 29C, which was used extensively for plum and apricot, were determined in drought condition. The obtained data showed that Myrobolan 29C is susceptible drought stress. There was no survived plant in all stress level on 15.day of study except for control plants. The maximum plant height was obtained from control plants (3,09cm). Dry plant weight was higher in control (47.87%) than stress conditions. The largest leaf area was measured in control plant (2,77cm²). The highest membran permeability was calculated in -1,50MPa stress level (97,92%). The highest rate of LRWC was in control plants (42,58%) while the lowest rate of LRWC was obtain from -1,5MPa treatment (2,44%). The chlorophyll content in control plant (28,66ppm) was higher than other treatments. The highest protein content was calculated in -1,5MPa (667,73µg g⁻¹ FW). The -1,0MPa treatments had the highest proline content (29,52 µg g⁻¹ FW).

Acknowledgements

This research was supported by a grant from Selçuk University, Scientific Research Project Institute, Turkey (Project No: 12101007).

Table-1. Result of drought stress treatment in Myrobolan 29C.

	1.day	3.day	5.day	7.day	9.day	11.day	13.day	15.day
Change of Plant Height (cm)								
Control	2,97 a	2,99 a	3,00 a	3,00 a	3,04 a	3,07 a	3,09 a	3,09 a
-0,5MPa	2,86 a	2,86 a	2,87 a	2,89 a	2,89 b	2,90 a	2,91 a	2,93 a
-1,0MPa	2,02 c	2,02 c	2,03 c	2,03 c	2,04 c	2,04 c	2,05 c	2,07 c
-1,5MPa	2,52 b	2,52 b	2,53 b	2,53 b	2,54 b	2,54 b	2,55 b	2,57 b
LSD	0,40**	0,30***	0,82*	0,40**	0,33***	0,36***	0,39***	0,37***
Change of Dry Plant Weight (%)								
Control	19,16 c	23,52 d	44,25 a	40,40 a	43,53 a	46,67 a	47,87 a	50,47
-0,5MPa	22,99 b	34,17 c	43,80 a	38,31 b	39,08 b	37,35 b	31,06 b	-
-1,0MPa	22,36 b	46,37 a	32,27 b	29,93 c	27,96 c	26,11 c	18,91 c	-
-1,5MPa	28,11 a	38,13 b	22,29 c	19,64 d	23,47 d	22,14 d	18,22 c	-
LSD	2,12***	2,02***	2,33***	2,15***	2,32***	1,67***	1,67***	
Change of Leaf area (cm²)								
Control	1,36	2,36 a	2,20 a	2,86 a	2,24 a	2,10 a	2,77 a	2,24
-0,5MPa	1,76	2,07 a	2,10 ab	1,53 b	1,33 bc	1,14 bc	1,16 b	-
-1,0MPa	1,89	1,91 a	1,53 bc	1,75 b	1,62 b	1,58 b	1,35 b	-
-1,5MPa	1,39	0,73 b	0,96 c	1,31b	0,82 c	0,76 c	1,00 b	-
LSD	N.S	1,36**	0,85**	1,07**	0,80**	0,71***	1,01**	
Change of Membran Permeability in leaf (%)								
Control	41,67 d	33,01 d	54,65 d	39,95 d	59,55 d	63,16 d	26,50 d	45,75
-0,5MPa	44,12 c	75,37 c	76,63 c	78,55 c	84,60 c	85,17 c	89,55 c	-
-1,0MPa	67,69 b	84,48 b	84,71 b	86,98 b	87,40 b	91,91 b	94,06 b	-
-1,5MPa	74,43 a	87,07 a	93,28 a	95,12 a	96,58 a	96,96 a	97,92 a	-
LSD	0,79***	0,36***	0,61***	0,76***	0,79***	0,46***	0,38***	
Change of LRWC (%)								
Control	55,81 a	51,58 a	45,70 a	40,88 a	20,76 a	51,14 a	42,58 a	49,37
-0,5MPa	41,92 b	39,07 b	37,75 b	28,46 b	17,21 b	16,92 b	5,51 b	-
-1,0MPa	32,00 c	25,93 c	13,11 c	11,64 c	10,11 c	9,90 c	3,07 c	-
-1,5MPa	17,30 d	12,09 d	8,58 d	8,47 d	4,71 d	3,17 d	2,44 c	-
LSD	1,63***	1,89***	1,84***	1,60***	1,87***	1,57***	1,40***	

Change of Chlorophyll content in leaf (ppm)								
Control	26,18 d	36,15 a	30,23 a	29,88 a	33,12 a	28,46 a	28,66 a	26,06
-0,5MPa	40,08 a	33,63 a	27,79 b	23,53 b	22,63 b	19,94 b	17,69 b	-
-1,0MPa	31,66 b	30,12 ab	25,89 c	21,29 c	20,89 c	17,18 c	11,38 c	-
-1,5MPa	26,50 d	25,36 b	19,19 d	16,61 d	21,06 c	17,14 c	9,19 d	-
LSD	1,57***	10,72*	1,37***	1,67***	1,45***	1,46***	1,63***	
Change of Protein Content in leaf ($\mu\text{g g}^{-1}$ FW)								
Control	195,80 c	354,14 b	336,26 b	361,53 b	304,70 b	271,31 b	232,15 b	230,12
-0,5MPa	240,30 c	654,25 a	666,73 a	663,78 a	649,52 a	665,67 a	648,30 a	-
-1,0MPa	442,23 b	674,58 a	661,07 a	671,26 a	663,58 a	671,49 a	666,85 a	-
-1,5MPa	603,82 a	676,75 a	663,01 a	671,47 a	668,87 a	665,06 a	667,73 a	-
LSD	88,40***	70,82***	79,87***	47,74***	104,29***	52,75***	43,13***	
Change of Proline Content in leaf ($\mu\text{g g}^{-1}$ FW)								
Control	6,41 b	16,48 a	18,40 b	17,42 b	16,66 c	17,72 d	17,48 d	17,95
-0,5MPa	6,53 b	13,61 b	14,66 d	18,61 b	20,61 b	21,22 c	21,25 b	-
-1,0MPa	9,34 a	16,93 a	21,44 a	23,08 a	26,52 a	28,62 a	29,52 a	-
-1,5MPa	6,31 b	13,22 b	16,50 c	22,70 a	26,30 a	24,33 b	18,53 c	-
LSD	0,75***	2,89**	0,98***	1,73***	1,91***	1,26***	1,25***	

* P<0,05, ** P<0,01, *** P<0,001

References

- Abbaspour H, Saeidi-Sar S, Afshari H and Abdel-Wahhab M. (2012) Tolerance of mycorrhiza infected pistachio (*Pistacia vera* L.) seedling to drought stress under glasshouse conditions. *Journal of Plant Physiology*, 169(7), 704-709.
- Ali-Ahmad M and Basha S. (1998) Effect of water stress on composition of peanut leaves. *Peanut science*, 25(1), 31-34.
- Alizadeh A, Alizade V, Nassery L and Eivazi A. (2011) Effect of drought stress on apple dwarf rootstocks. *Technical Journal of Engineering and Applied Science*, 1(3), 86-94.
- Araus J, Slafer G, Reynolds M and Royo C. (2002) Plant breeding and drought in C3 cereals: what should we breed for? *Annals of Botany*, 89(7), 925-940.
- Ashraf M and Iram A. (2005) Drought stress induced changes in some organic substances in nodules and other plant parts of two potential legumes differing in salt tolerance. *Flora-Morphology, Distribution, Functional Ecology of Plants*, 200(6), 535-546.
- Bates L, Waldren R and Teare I. (1973) Rapid determination of free proline for water-stress studies. *Plant and soil*, 39(1), 205-207.
- Behnamnia M, Kalantari K, M and Rezanejad F. (2009) Exogenous application of brassinosteroid alleviates drought-induced oxidative stress in *Lycopersicon esculentum* L. *General and Applied Plant Physiology*, 35(1-2), 22-34.
- Bertamini M, Zulini L, Muthuchelian K and Nedunchezian N. (2006) Effect of water deficit on photosynthetic and other physiological responses in grapevine (*Vitis vinifera* L. cv. Riesling) plants. *Photosynthetica*, 44(1), 151-154.
- Bolat I, Dikilitas M, Ercisli S, Ikinici A and Tonkaz T. (2014) The effect of water stress on some morphological, physiological, and biochemical characteristics and bud success on apple and quince rootstocks. *The Scientific World Journal*, 2014.
- Boutraa T, Akhkhah A, Al-Shoabi A A and Alhejeli A M. (2010) Effect of water stress on growth and water use efficiency (WUE) of some wheat cultivars (*Triticum durum*) grown in Saudi Arabia. *Journal of Taibah University for Science*, 3, 39-48.
- Bradford M M. (1976) A rapid and sensitive method for the quantitation of microgram quantities of protein utilizing the principle of protein-dye binding. *Analytical biochemistry*, 72(1-2), 248-254.

- Brito G, Costa A, Fonseca H M and Santos C V. (2003) Response of *Olea europaea* ssp. *maderensis* in vitro shoots exposed to osmotic stress. *Scientia Horticulturae*, 97(3), 411-417.
- Chai T-T, Fadzillah N, Kusnan M and Mahmood M. (2005) Water stress-induced oxidative damage and antioxidant responses in micropropagated banana plantlets. *Biologia Plantarum*, 49(1), 153-156.
- Chaves M and Oliveira M. (2004) Mechanisms underlying plant resilience to water deficits: prospects for water-saving agriculture. *Journal of experimental Botany*, 55(407), 2365-2384.
- Chaves M M, Maroco J P and Pereira J S. (2003) Understanding plant responses to drought—from genes to the whole plant. *Functional plant biology*, 30(3), 239-264.
- Errabii T, Gandonou C B, Essalmani H, Abrini J, Idaomar M and Skali-Senhaji N. (2006) Growth, proline and ion accumulation in sugarcane callus cultures under drought-induced osmotic stress and its subsequent relief. *African Journal of Biotechnology*, 5(16).
- Farooq M, Wahid A, Kobayashi N, Fujita D and Basra S. (2009). Plant drought stress: effects, mechanisms and management *Sustainable Agriculture* (pp. 153-188): Springer.
- Flexas J, Bota J, Loreto F, Cornic G and Sharkey T. (2004) Diffusive and metabolic limitations to photosynthesis under drought and salinity in C3 plants. *Plant Biology*, 6(3), 269-279.
- Ghaderi N and Siosemardeh A. (2011) Response to drought stress of two strawberry cultivars (cv. Kurdistan and Selva). *Horticulture, Environment, and Biotechnology*, 52(1), 6-12.
- Jaleel C A, Manivannan P, Wahid A, Farooq M, Al-Juburi H J, Somasundaram R and Panneerselvam R. (2009) Drought stress in plants: a review on morphological characteristics and pigments composition. *Int J Agric Biol*, 11(1), 100-105.
- Karimi S, Yadollahi A, Nazari-Moghadam R, Imani A and Arzani K. (2012) In vitro Screening of Almond (*Prunus dulcis* (Mill.)) Genotypes for Drought Tolerance. *J. BIOL. ENVIRON. SCI*, 6(18), 263-270.
- Keyvan S. (2010) The effects of drought stress on yield, relative water content, proline, soluble carbohydrates and chlorophyll of bread wheat cultivars. *J. Anim. Plant Sci*, 8(3), 1051-1060.
- Klamkowski K and Treder W. (2008) Response to drought stress of three strawberry cultivars grown under greenhouse conditions. *Journal of Fruit and Ornamental Plant Research*, 16, 179-188.
- Kluge M. (1976). Carbon and nitrogen metabolism under water stress *Water and Plant Life* (pp. 243-252): Springer.
- Kutlu İ. (2010) Tahıllarda Kuraklık Stresi. *Türk Bilimsel Derlemeler Dergisi*, 3(1), 35-41.
- Lutts S, Kinet J and Bouharmont J. (1996) NaCl-induced senescence in leaves of rice (*Oryza sativa* L.) cultivars differing in salinity resistance. *Annals of Botany*, 78(3), 389-398.
- Michel B E. (1983) Evaluation of the water potentials of solutions of polyethylene glycol 8000 both in the absence and presence of other solutes. *Plant Physiology*, 72(1), 66-70.
- Nogués S and Baker N R. (2000) Effects of drought on photosynthesis in Mediterranean plants grown under enhanced UV-B radiation. *Journal of experimental Botany*, 51(348), 1309-1317.
- Ozfidan C, Turkan I, Sekmen A H and Seckin B. (2013) Time course analysis of ABA and non-ionic osmotic stress-induced changes in water status, chlorophyll fluorescence and osmotic adjustment in *Arabidopsis thaliana* wild-type (Columbia) and ABA-deficient mutant (*aba2*). *Environmental and Experimental Botany*, 86, 44-51. doi:10.1016/j.envexpbot.2010.09.008
- Rad M R N, Kadir M A and Yusop M R. (2012) Genetic behaviour for plant capacity to produce chlorophyll in wheat (*Triticum aestivum*) under drought stress. *Australian Journal of Crop Science*, 6(3), 415.

- Rostami A and Rahemi M. (2013) Responses of Caprifig Genotypes to Water Stress and Recovery (Original Research Article). *Journal of Biological and Environmental Sciences*, 7(21).
- Sakthivelu G, Devi M A, Giridhar P, Rajasekaran T, Ravishankar G, Nedev T and Kosturkova G. (2008) Drought-induced alterations in growth, osmotic potential and in vitro regeneration of soybean cultivars. *General and Applied Plant Physiology*, 34(1-2), 103-112.
- Somerville C and Briscoe J. (2001) Genetic engineering and water.
- Taiz L and Zeiger E. (2002) Plant Physiology. 3rd. Ed. Pub. Sinauer.
- Tal M. (1983) Selection for stress tolerance. *Handbook of plant cell culture (USA)*.
- Verslues P E, Govinal Badiger B, Ravi K and M Nagaraj K. (2014) Drought tolerance mechanisms and their molecular basis. *Plant Abiotic Stress, Second Edition*, 15-46.
- Zanjani K E, Rad A H S, Naeemi M and Taherkhani T. (2012) Effects of zeolite and selenium application on some physiological traits and oil yield of medicinal pumpkin (*Cucurbita pepo* L.) under drought stress. *Current Research Journal of Biological Sciences*, 4(4), 462-470.
- Zonouri M, Javadi T and Ghaderi N. (2014) Effect of Foliar Spraying of Ascorbic Acid on Cell Membrane Stability, Lipid Peroxidation, Total Soluble Protein, Ascorbate Peroxidase and Leaf Ascorbic Acid Under Drought Stress in Grapes. *International Journal of Advanced Biological and Biomedical Research*, 2, 349-354.

THE EFFECTS OF DIFFERENT COVER CROPS ON WEED INFESTATION IN POPCORN (*ZEА MAYS L. SSP. EVERTA STURT*)

Željko DOLIJANOVIĆ^{1*}, Milena SIMIĆ², Snežana OLJAČA¹, Dušan KOVAČEVIĆ¹, Vesna DRAGIČEVIĆ², Zoran JOVOVIĆ³, Đorđe MORAVČEVIĆ¹

¹University of Belgrade, Faculty of Agriculture, Belgrade, Serbia,

²Maize Research Institute, Zemun Polje, Belgrade-Serbia

³University of Montenegro, Biotechnical Faculty, Podgorica, Montenegro

*Corresponding author: dolijan@agrif.bg.ac.rs

Abstract

Cover crops are specific system of growing and mainly cover the surface of the soil during the winter, improve the physical and mechanical properties of the soil, water regime, increase the content of nutrients, reduce weed control and contribute to the achievement of higher yields of the main crops. The experiments were performed in 2014 and 2015 on experimental field of the Maize Research Institute in Zemun Polje. We have included individual winter cover crops: common vetch, oat, fodder kale and field pea, mixtures common vetch and field pea with oats and two control treatments: dead organic mulch and conventional (traditional) variant. Sowing cover crops is carried out in the autumn, the elementary plots of 35 m². Mowing and soil incorporation of cover crops was carried out in late April. Sowing popcorn was done manually in mid-May at a density of 65 000 plants ha⁻¹. In the phase of intensive growth of the popcorn, is determined total number of weed species, total number of plants per species and fresh biomass per m². In a year that was rich precipitation (2014), the smallest number of plants per species and fresh biomass of weeds per square meter have been established on the variant with common vetch as a cover crop. The fresh biomass of weeds in the two control treatments (dead organic mulch and conventional variant) was the highest (694.5 and 524.2 g m⁻²). In 2015, data about weed infestation differed in relation to the previous year, both in terms of total number of weed species and total number of plants per species, but also in terms of fresh biomass per unit area. We can be concluded that perennial weeds could be controlled effectively by sowing cover crops.

Key words: *cover crops, dead organic mulch, popcorn, weed infestation.*

Introduction

Popcorn (*Zea mays L. ssp. everta* Sturt.) is a specific type of flint maize, and popcorn that are formed from grains of popcorn are the favorite "snack" of people around the world (Srđić and Pajić, 2008). Growing popcorn without irrigation in the conditions of global climate change is a major challenge. As with other subspecies of maize, the yield is a very important feature, but the specificity of popcorn is that it is susceptible to infestation, especially in the beginning of the growing season. In addition to the quantity of the yield, is also important qualitative component, especially popping volume. That is why in recent years the most important goal of the breeding program popcorn correction quality yield but not at the expense of quantity. Aggravating factor in this process is that there is generally a negative dependence on these two yield components (Sakin et al., 2005), while increasing the popping volume causes a decrease in yield.

Popcorn is a direct human food crop, and the current public apprehension to genetically modified foods has prevented the use of genetic engineering to add genetic resistance to herbicides in

popcorn hybrids. Grosbach (2008) cited that narrow popcorn rows may canopy more quickly, some weed control should be expected that might normally be controlled by herbicides or mechanical cultivation.

Agriculture is an ever-changing industry. Producers are always looking to improve their production practices to make the most efficient use of inputs and resources in order to increase production and maximize profit. Correct choice of the growing system is particularly important for crops that are less represented in crop structure, and interesting for an early appearance on the market in such large quantities. The introduction of cover crops in cultivation systems popcorn has full justification, particularly in terms of increasing grain yield through reduction of weed infestation, soil protection and reduced application of fertilizers. Cover crops are a fundamental tool for weed control, especially in organic and low input farming. Species with different functional traits can be combined in mixtures to enhance weed suppression (Ranaldo et al., 2016). They identified 8 species belonging to 4 functional groups: large seeded legumes, characterized by higher height (*Pisum sativum* L., *Vicia sativa* L.), small seeded legumes, able to cover quickly the soil (*Trifolium incarnatum* L., *T. squarrosus* L.), highly competitive grasses (*Hordeum vulgare* L., *Avena sativa* L.) and allelopathic brassicas (*Raphanus sativus* L., *Brassica nigra* L.). Weed establishment and growth can be constrained by cover crops through different physical and chemical mechanisms, so they can be considered as potential biological filters in weed community. The seedbank determination can provide useful information of the longterm effect of management practices in weed control (Alonso-Ayuso et al., 2016) and after 8-years of cover crops rotation, differences in weed composition were found. The seedbank was dominated by *Amaranthus* sp. and *Setaria* sp. (>80%). Cover crops reduced the density of *Datura stramonium* L., *Polygonum* sp, and *Portulaca oleracea* L. However, it was remarkable that both of them enhanced the population of *Setaria* sp., and *Chenopodium album* L. density was higher in barley treatment. Hairy vetch, is widely utilized as winter cover crop in Mediterranean areas, but besides its soil fertility building capacity, the weed control potential of vetch is acknowledged by different species of vegetable (tomato-Testani et al., 2016 or sweet maize- Dolijanović et al., 2013). After vetch termination, allelopathic compounds of residues (i.e. cyanamide) can play a role in weed growth inhibition.

Cover crops are commonly used to suppress weeds prior to establishment of a main crop, along with other benefits (Reiss et al., 2016). Based on natural ecosystem characteristic, which has a positive relationship between diversity and productivity, we expect that more diverse cover crop mixtures would produce more biomass and consequently reduce weed biomass. The objective of this study was to determine the effect of different winter (dead mulch) cover crops and their mixtures with oats on weed infestation of popcorn.

Material and methods

The experiment included four kinds of winter cover crops (common vetch, oat, fodder kale and field pea as well mixtures of legume crops with oats), another variant in which the land was covered with dead organic mulch, and traditional variant, classical plowing in the fall and keeping bare land uncovered during the winter. All of the varieties being used as a cover crops belongs to Novi Sad Field Crops Institute. Crops were grown under rainfed conditions.

Field experiments were conducted in 2013/14 and 2014/15 at Maize Research Institute, Zemun Polje, in the vicinity of Belgrade (44°52'N 20°20'E). The soil was slightly calcareous chernozem with 47% clay and silt, and 53% of sand. The soil properties in layer 0-30-cm of depth were fallow: 3.22% organic matter, 0.19% total N, 1.9% organic C, 16.2 and 22.4 mg per 100 g soil of available P₂O₅ and extractable K₂O, respectively, 1.38% total CaCO₃ and pH 7.3. The experiments were located

in different plots in each year and winter wheat was the previous crop. Following nitrogen fixation rates in legume crops, as well recommended fertilization, we came up to the required amount of macronutrients for popcorn (120 kg ha⁻¹ N, 90 kg ha⁻¹ P₂O₅ and 60 kg ha⁻¹ K₂O). In the fall period, before planting of cover crops we have entered the entire amount of P and K in the forms of monopotassium phosphate plus additional quantity of nitrogen 50 kg/ha by ammonium nitrate, and on the two control variants, also all of P₂O₅ i K₂O and 40 kg ha⁻¹ N in the form AN.

In the next spring (May 20, 2014 and May 21, 2015) leguminous cover crops had received another 30 kg ha⁻¹ N in the form of AN (remaining 40 kg ha⁻¹ considered to be provided by nitrogen fixation), oats and fodder kale 70 kg ha⁻¹ N, and control plots another 80 kg ha⁻¹ N, also in the form of AN. The experimental plots being ploughed in the autumn, have followed one pass of a disk harrow and a field cultivator prior to sowing. Sowing of cover crops were done manually in October 30, 2013 and November 13, 2014. Mowing the above-ground biomass of winter cover crops were performed 7-10 days before planting of popcorn. Planting of popcorn seedlings were done on May 20, 2014 and May 21, 2015. Crops were harvested on October 07, 2014 and September 30, 2015. The meteorological conditions during the growing season are presented in Table 1.

Table 1. Average air temperatures and precipitation sums from April to September at Zemun Polje

Months	Temperature (°C)		Precipitation (mm)	
	2014	2015	2014	2015
April	13.7	12.9	84.8	19.7
May	17.4	19.1	192.5	97.8
June	21.1	22.1	71.2	31.1
July	23.2	26.4	187.4	7.2
August	22.6	25.7	41.0	56.0
September	18.0	20.2	75.6	73.6
Average/Sum	19.3	21.1	652.5	285.4

More favourable conditions in term of quantity and distribution of precipitation were in the first year of the investigation. Popcorn needs for precipitations depend on its development phase and they were lower at the beginning of growing period (about 100 mm), the highest (150–200 mm) in the period of flowering and ears formation. The first year examination also characterized by optimal air temperatures, which has had an effect on the studied parameters weed infestation of popcorn. Precipitation in June and July 2015 was the lowest and air temperatures were the highest and it caused a greater the appearance of weeds that are resistant to drought.

Experimental design

The experiment was in factorial setting with two factors in RCBD with four replications. Popcorn was sown in density of 65.000 plants ha⁻¹. The inter-row distance was 70 cm, while within-row plant distance was 22 cm. The new Zemun Polje (ZP) popcorn hybrids ZP 611k (FAO maturity group 600) was sown. The basic plot size was 16.8 m² (2.8 m by 6.0 m).

Measurements and statistical analysis

The fresh and air dried weed biomass in popcorn were analysed in this study. All stated parameters in weeds were determined from samples taken from 1m². The weed infestation analysis was performed on June 27, 2014 and June 22, 2015. Following weed sampling, manual hoeing was done in order to suppress weeds pressure in sweet maize. The yield data were underwent to ANOVA for the factorial trials set up according to the plan for two years, eight variants, where means differences were tested by the least significant difference (LSD) test.

Results and discussion

Generally, the greater weed infestation can be observed in the second year of the investigation and the reason for the worse weather conditions, especially high air temperatures and unfavourable distribution of precipitation which corresponds to more resistant weed species. Different effects in the soil-plant system by cover crop species (i.e. temperature and soil moisture, light interception) are very important to explain differences between investigation treatments. Differences in measured parameters of weediness depending on the year investigation were statistically significant, except for the aboveground fresh weight of weeds (Table 3). The dead organic mulch (straw) is justified in sustainable systems of cultivation of popcorn, primarily in terms of grain yield (Dolijanović et al., 2012). However, from an infestation, especially perennial species, the advantage is on the side of growing cover crops. The number of plants per species in mulch variant usually was higher than in treatment with cover crops, but fresh weight mass shows us a strong presence of perennial weeds (Table 2).

If you look at the impact of investigation kinds of cover crop on the infestation of the main crops we notice that in average the best result given fodder kale, oat and mixture of common vetch and oat in terms of number of species. Common vetch gave the best result in term of the number of plants per species (6.75 m⁻²). After vetch termination, allelopathic compounds of residues (i.e. cyanamide) can play a role in weed growth inhibition (Testani et al., 2016). However, in terms of number of plants per species and especially in respect of fresh weed biomass per unit area advantages had cover crops which gave highest aboveground biomass (common vetch, field pea, mixtures and fodder kale). Reiss et al (2016) and Rinaldo et al (2016) cited that mixtures of multiple cultivars of a single species tend to suppress weeds better (as biomass) than the average of the same cultivars planted alone. The improved weed suppression in cultivar and species mixtures suggests alternative mechanisms for reduced weed success in these diverse cover crop mixtures.

In all tested parameters, weeds in both investigation year significantly highest values are obtained in conventional treatment, especially in term of aboveground fresh weight of weeds. Winter oat showed the strong effect, especially in terms of the number of weed species and the number of plants per species. In earlier paper, it was emphasized that in terms of reducing the infestation of the main crops, oats gives the poorest results and generally it should be grown in mixtures with legumes (Dolijanović et al., 2013). Liebert et al (2016) investigated effect of mixture barley and cereal rye on the weed suppressive ability of each cover crop in monoculture (barley:cereal rye, 0:100 and 100:00) and in mixture (25:75, 50:50, and 75:25). Weed biomass tended to decrease as the proportion of cereal rye increased; however, they observed disproportionately lower weed biomass than expected in some mixtures given the relatively low cover crop biomass produced.

The differences investigated parameters of weeds, except the number of weed species, in popcorn cultivated after cover crops compared to traditional cropping system are generally statistically significant (Table 3). On the investigated locality, alternative farming systems (intercrops and

cover crops) showed efficacy in reducing weed infestation, particularly the number of plants per species and weed fresh weight per unit area (Dolijanović et al., 2007; 2015).

Observing the two control variants (dead organic mulch and conventional treatment) in both years, based on data in Table 2, we see higher values in the fresh weight of weeds in the conventional system in relation to the dead organic mulch variant. Increasing the biodiversity and number of crops in year per unit area, as in cover cropping, leads to a reduction in the biomass of weeds, more diverse cover crop mixtures would produce more biomass and consequently reduce weed biomass (Reiss et al., 2016). This is consistent with previous research showing that narrow-row corn canopies more quickly, reducing weed emergence (Staggenborg et al., 2001). Because popcorn is not genetically modified for herbicide resistance, narrow rows may be an effective cultural weed control option. Even with fewer weeds, harvest conditions were not ideal and the narrow-row corn header did not handle the weeds very well.

Table 2. Average weediness in period of investigation

Weed characteristics	Cropping system							
	1	2	3	4	5	6	7	8
Total number of weed species	4.75 ^{ab}	5.37 ^b	4.25 ^{ab}	4.13 ^{ab}	4.00 ^a	4.88 ^b	5.00 ^b	4.75 ^{ab}
Total number of plants per species	6.75 ^a	14.50 ^c	9.12 ^b	7.38 ^{ab}	11.75 ^c	10.63 ^{bc}	12.50 ^b	7.50 ^{ab}
Aboveground fresh weight of weeds (g m ⁻²)	127.40 ^{ab}	95.61 ^a	167.99 ^b	99.99 ^a	86.16 ^a	188.85 ^b	174.96 ^b	201.32 ^b
Aboveground dry weight of weeds (g m ⁻²)	28.94 ^b	20.22 ^{ab}	32.60 ^{bc}	17.60 ^a	15.99 ^a	40.59 ^c	24.66 ^{ab}	45.75 ^c

1-common vetch; 2-field pea; 3-fodder kale; 4-oat; 5-common vetch+oat; 6-field pea+oat; 7-mulch; 8-conventional treatment.

Values of means followed by the same letter are not significant at the level of 0.05;

Table 3. Statistical analysis of observed weed parameters in popcorn (lsd)

lsd	Total number of weed species			Total number of plants per species			Aboveground fresh weight of weeds			Aboveground dry weight of weeds		
	A ^{**}	B [*]	AB ^{**}	A ^{**}	B ^{**}	AB [*]	A ^{ns}	B ^{**}	AB [*]	A ^{**}	B ^{**}	AB ^{**}
0.05	0.39	0.78	1.11	0.98	1.97	2.80	25.98	51.96	73.49	5.27	10.53	14.89
0.01	0.78	1.04	1.48	1.31	2.63	3.72	34.63	69.27	97.96	7.02	14.04	19.86

p<0.01 very significant (**); p<0.05 significant (*); p>0.05 no significant (ns);

A-year of investigation, B-cropping system

Conclusion

The weed community was composed of a relatively small number of weed species and number of plants per species—3.47 and 11.81 (2014) and 5.81 and 8.22 (2015). Differences in the number of weed plants per species, as well as in air dried weed biomass obtained among observed investigation years were statistically significant. Favorable weather conditions during the first year of trials have resulted in an decreasing number of weed species and fresh weight of weeds, but no number of plants per species of main crop. In dry 2015 oat as an individual cover crop and in mixtures with legumes and dead organic mulch, in terms of fresh weight of weeds measured in main crops were the advantages compared to 2014. The cover crop with common vetch expressed greater efficiency in weed control in comparison to different cropping systems.

Growing cover crops before popcorn expressed a significant advantage in weed control particularly in troublesome perennial species in relation to traditional cropping system. In addition, cost inputs were reduced, but no other common benefits in the long term were found on winter cover crops (increase of organic matter, increase of biodiversity, etc.). The obtained results can help to understand the complexity of plant communities interactions but more research is needed in order to achieve effective weed control strategies.

Acknowledgement

This study was supported by the Ministry of Education, Science and Technological Development of the Republic of Serbia.

References

- Abdin, O.A., Zhou, X.M., Cloutier, D., Coulman, D.C., Faris, M.A., Smith, D.L. (2000): Cover crops and interrow tillage for weed control in short season maize (*Zea mays*). *European Journal of Agronomy*, 12: 93–102.
- Alonso-Ayuso, M., Gabriel, J.L., del Monte, J.P., Quemada, M. (2016): The weed seedbank after 8 years of winter cover cropping. *Proceedings of 7th International weed science congress*, June 19-25, 2016, Prague, Czech Republic pp 119.
- Dolijanović, Ž., Oljača, S., Kovačević, D., Simić, M. (2007): The distribution of weeds in the maize- soybean intercrop. *Journal of Scientific Agricultural Research*, Vol. 68. N° 244. pp 51-63.
- Dolijanović, Ž., Momirović, N., Mihajlović, V., Simić, M., Oljača, S., Kovačević, D., Kaitović, Ž. (2012): Cover crops effects on the yield of sweet corn. *Third International Scientific Symposium "Agrosym Jahorina 2012"*, November 15-17, 2012. *Proceedings*, 104-110.
- Dolijanović, Ž., Momirović, N., Simić, M., Kovačević, D., Oljača, S., Mikić, A. (2013): Fall and spring sown legume-cereal cover crops for sweet maize production. *2nd International Scientific Conference „Soil and Crop Management: Adaptation and Mitigation of Climate Change”*, September 26-28, 2013, Osijek, Croatia. *Proceedings*, 128-135.
- Dolijanović, Ž., Kovačević, D., Simić, M., Oljača, S., Dragičević, V., Jovović, Z. (2015): The effects of different cover crops on floristic composition of weeds in sweet maize. *Sixth International Scientific Agricultural Symposium "Agrosym 2015"*, Jahorina, October 15 - 18, 2015, *Book of proceedings*, 696-702.
- Grosbach, J. (2008): The Effect of Row Spacing on the Yield and Plant Growth of Popcorn (*Zea mays*). *Cantaurus*, Vol. 16, 9-12.
- Liebert, J.A., Di Tommaso, A., Ryan, M.R. (2016): Multi-tactic weed control in organic no-till soybean production: overcoming cover crop management challenges with a focus on shading. *Proceedings of 7th International weed science congress*, June 19-25, 2016, Prague, Czech Republic pp 120.
- Ranaldo, M., Carlesi, S., Costanzo, A., Barberi, P. (2016): Can weed management in vegetable systems be improved by cover crop species mixtures? Step 2: field implementation. *Proceedings of 7th International weed science congress*, June 19-25, 2016, Prague, Czech Republic pp 117.
- Reiss, E.R., Drinkwater, L.E., Ryan, M.R. (2016): Weed suppression by cover crops mixtures using intra- and inter- specific diversity. *Proceedings of 7th International weed science congress*, June 19-25, 2016, Prague, Czech Republic pp 116.

- Sakin, M.A., Gokmen, S., Yildirim, A., Belen, S., Kandemir, N. (2005): Effects of cultivar type on yield and quality of popcorn (*Zea mays everta*). *New Zealand Journal of Crop and Horticultural Science*, 33, 17-23.
- Srdić, J., Pajić, Z. (2008): Relation between grain yield and grain quality of popcorn hybrids (*Zea mays everta* Sturt.). *Zbornik naučnih radova, XXII savetovanje agronoma, veterinara i tehnologa*, Vol. 14 br. 1-2, 49-54.
- Staggenborg, S.A., Gordon, W.B., Martin, V., Fjell, D., Dumler, T., Kilgore, G., Taylor, R. (2001): *Narrow Row Corn Production in Kansas*. Kansas State University Agriculture Experiment Station and Cooperative Extension Service.
- Testani, E., Canali, S., Campanelli, G., Leteo, F., Tittarelli, F., Trotta, S., Ciaccia, C. (2016): Allelopathic effect of hairy vetch (*Vicia villosa*) cover crop on weeds: field evidences in a Mediterranean organic vegetable agro-ecosystem. *Proceedings of 7th International weed science congress*, June 19-25, 2016, Prague, Czech Republic pp 121.

EFFECTS OF 18 LOCAL *BEAUVARIA BASSIANA* (BALSAMO) VUILLEMIN ENTOMOPATHOGEN FUNGI ISOLATES ON PINK CORN BORER *SESAMIA CRETICA* LED. UNDER LABORATORY CONDITIONS

Dürdane YANAR, Yusuf YANAR, Turgut ATAY*, Murat YALÇIN, Orhan BELDEK

Gaziosmanpasa University, Faculty of Agriculture, Department of Plant Protection Tokat, Turkey

*Corresponding author: turgut.atay@gop.edu.tr

Abstract

The spread of silage maize production in Turkey caused significant increase at population level of corn borer, *Sesamia cretica* Led. (Lepidoptera: Noctuidae) In the management of this pest general insecticides, such as organic phosphates and synthetic pyrethroids are used. Its damage still occurs in corn fields, in spite of the use of biological control agents, such as entomopathogenic fungi, nematodes or bacteria and egg-larval-pupa parasitoids, as well as Bt-maize, as a popular application for management of *S. cretica*. In order to detect more effective microbial control agents against this pest and contribute to the integrated pest management studies of corn borer, a study of insecticidal effect of 18 different isolates of entomopathogenic fungi *Beauvaria bassiana* obtained from soil collected from different fields crop production areas in Tokat Province in 2015. The isolates consist of *B. bassiana* isolates (GOPT-19(2)-1, GOPT-41-1, GOPT-64, GOPT-107, GOPT-114, GOPT-122, GOPT-127, GOPT-144, GOPT-167, GOPT- 221, GOPT-284, GOPT-294, GOPT-302, GOPT-355, GOPT-440, GOPT-453, GOPT-458, GOPT-465). Pathogenicity of tested isolates to *S. cretica* was evaluated by dipping larvae (fourth instar) to spore suspension from each isolate. Within 9 days, all fungal isolates caused significant mortality against larva of *S. cretica*. *B. brassiana* isolates GOPT-144 was found to be the most virulent with 90.83% mortality among investigated fungal isolates, followed by GOPT-64 (75.42% mortality) and GOPT-107 (63.75% mortality) against the *S. cretica*. These results indicated that isolates with high virulence could be used for biological control and integrated management of *S. cretica*.

Key Words: *Sesamia cretica*, Corn borer, entomopathogen, *Beauvaria*

Introduction

Maize (*Zea mays* L.) is economically important cereal crop all over the world. Green maize plants as well as maize grains (corn seeds) are a significant source of nutrients for live stock fodder worldwide. In terms of world area and production, maize occupies the 3rd place after wheat and rice (Anonymous, 2015). Moreover, several food industries stand on processing maize grain and their by products, e.g. corn oil, corn flakes, starch, fructose etc. In Turkey, corn is produced on approximately 550 thousand hectares with annual production of 3.5 million tons. Production rate of corn as a second crop in most parts of the Turkey is very high (Özcan, 2009). Under field conditions, *Sesamia cretica* begins to attack maize seedlings within 1-2 weeks after seed germination, and continues invading until they become about 6 weeks old. Occasionally, *S. cretica* infestations may also occur on the mature plants where its full-grown larvae excavate into the stems creating relatively longitudinal tunnels full of larval feces. Similar tunnels may also be seen inside the basal secondary roots, ears and cobs. Infested young seedlings often die and show the characteristic dead-heart symptoms while older plants suffer severe yield-losses (Mostafa,

1981; Semeada, 1988; El-Naggar, 1997). General insecticides, such as organic phosphates and synthetic pyrethroids are used for the management of this pest. Even though the most popular measures like application of biological agents (entomopathogenic fungi, nematodes, bacteria and egg-larval-pupa parasitoids) and planting Bt-maize are regular, damages from *S. cretica* still occur in corn fields. In order to detect more effective microbial control agents against the pest and contribute to the integrated pest management studies of corn borer, we studied the insecticidal effects of 18 different *Beauveria bassiana* entomopathogenic fungi isolates obtained from field soil collected from different parts of Tokat Province in 2015.

Materials and Methods

Insect

Sesamia cretica larvae were initially collected from crop fields in Şanlıurfa. The larvae used in our experiment were in fourth instar.

Preparing of Inoculum

The entomopathogenic fungal isolates were transferred on PDA (Potato Dextrose Agar) from stock cultures for spore production. The fungus cultures were incubated at 25 ± 2 °C for 17 days. Ten ml of sterilized water with 0.02% Tween 80 was added to each plate and spore harvesting was done by gently rubbing the culture surface using a sterilized glass hokey. Spore suspension from each isolate was adjusted to 10^7 spores mL⁻¹.

In-vitro Efficacy of the Isolates

In this efficacy study, all 18 *B. bassiana* isolates (Table 1) were screened against larvae of *S. cretica*. Fourth instar *S. cretica* larvae were treated in a Petri dish by dipping into the spore suspension for 5 sn. Five larvae were introduced in each Petri dish with filter paper and young fresh corn ear inside. Sterile distilled water with 0.02% Tween 80 was used as negative control. Treated larvae were incubated at 27 °C and $70 \pm 5\%$ of relative humidity and maintained for 9 days. The experiment was set up in a Complete Randomized Design with three replications. In the course of the experiment, data on mortality was recorded at the end of 9th day after inoculation. The dead larvae were collected and held in conditions of high humidity in Petri dishes containing damp filter paper to provide sufficient humidity to promote fungal outgrowth. Petri dishes were incubated in the dark at 95% relative humidity and 27°C. Larvae were considered damaged by mycosis when growth of the fungus was visible on the external surface at the end of 14 day incubation period (Figure 1).

The effect of entomopathogenic fungi (EPF) isolates on the larval mortality was analyzed using one-way analysis of variance using SPSS 17.0 (SPSS, 2008) and means were compared using Tukey multiple comparison test ($p \leq 0.05$).

Results and Discussion

There is an increasing demand for finding more effective and safer methods to control plant pests. One way to achieve this is finding effective biocontrol agent against insect pests in agricultural areas and hence decrease the hazardous effects of chemical insecticides to the environment and other living organisms. Among the biocontrol agents entomopathogenic fungi are of greater interest since they are host specific and almost no hazard to the environment and

untargeted organisms. The entomopathogenic fungus *B. bassiana* is a well-known, naturally occurring and widely distributed pathogen of various lepidopteran pests and registered biopesticides based on this fungus are available for use against wide variety of insect pests (Zurek and Keddie, 2000; Sevim *et al.*, 2010; Wraight *et al.*, 2010). In the current study, fungal pathogens of *S. cretica* were tested as a possible biocontrol agent that can be used in the corn fields. In the present study, 18 *B. bassiana* isolates were tested against *S. cretica* *in vitro*. Within 9 days of incubation period, some of the isolates caused significant mortality against larva of *S. cretica*.

Beauveria bassiana isolates GOPT-144 was found to be the most virulent with 90.83% mortality among investigated isolates, followed by GOPT-64 (75.42% mortality) and GOPT-107 (63.75% mortality) (Table 1). Based on the cumulative mortality over the first 9 days it can be seen that some of the isolates of *B. bassiana* controlled more than 60% of the larval population of *S. cretica* (Table 1). The highest virulence was recorded from the isolate GOPT-144. The lowest mortality rate (35%) was obtained with isolate GOPT-302. Similarly, *Beauveria* (M7A and F11A) isolates caused high rate of mortality on *Sesamia calamistis* larvae within 4 days of incubation periods (Terefe *et al.*, 2012).

Table 1. Efficacy of local *Beauveria bassiana* isolates (1×10^7) spore/ml on *Sesamia cretica* at the end of 9th day incubation period.

<i>Beauveria bassiana</i> Isolates	Mortality rates (%)
Control	18.17±1.07a*
GOPT-19(2)-1	62.50±6.29abc
GOPT-41-1	45.00±5.00abc
GOPT-64	75.42±8.75bc
GOPT-107	63.75±3.75abc
GOPT-114	40.00±14.14abc
GOPT-122	60.00±8.16abc
GOPT-127	43.33±5.77abc
GOPT-144	90.83±5.34c
GOPT-167	60.00±0.00abc
GOPT-221	60.00±8.16abc
GOPT-284	66.25±13.44abc
GOPT-294	40.00±14.14abc
GOPT-302	35.00±5.00ab
GOPT-355	60.00±18.26abc
GOPT-440	45.00±9.57abc
GOPT-453	52.50±4.79abc
GOPT-458	37.14±14.43ab
GOPT-465	38.33±8.33ab

*Values in the same column followed by the different letters were significant different at the $p < 0.05$ level according to Tukey multiple range test tests

The highest mycelial development rates also were observed in treatments with isolates GOPT-144 (53.85 %), GOPT-355 (33.33 %) and GOPT-284 (28.27 %). This is followed by GOPT-294 (20 %), GOPT-167 (16.7 %) and GOPT-19(2)-1 (8.25 %). On the other hand, some of the isolates did not developed mycelial development on dead insects (Figure 1).

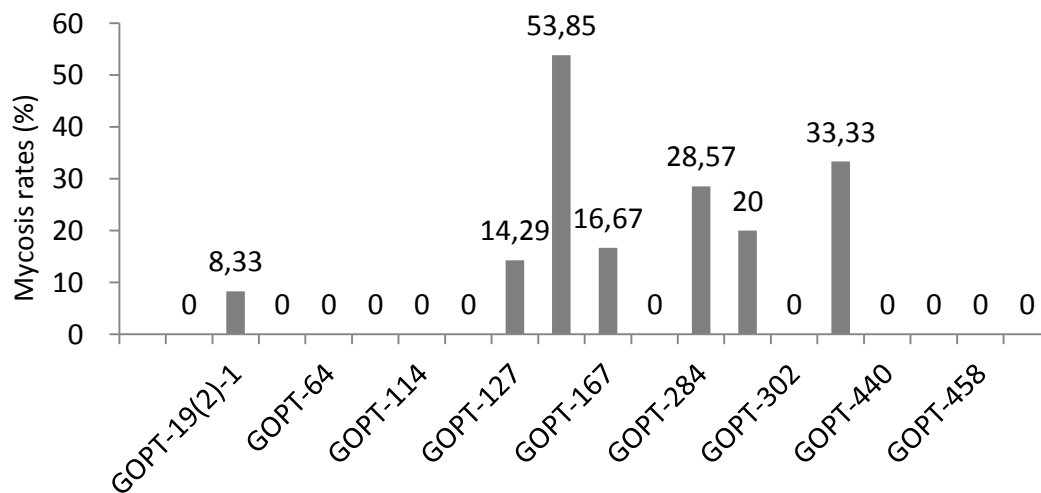

Figure 1. Rates of mycelial development of *Beauveria bassiana* isolates (1×10^7) spores mL^{-1} on *Sesamia cretica* 14 days post infection

Conclusion

Beauveria bassiana GOPT-144 isolate caused 90.83 % mortality and 53.85 % of mycelial development rate. This isolate is very promising one among the tested isolates. This one is followed by GOPT-284 (66.25 % mortality and 28.57 % mycosis) and GOPT-355 (60 % mortality and 33.33 % mycosis). Beside the mortality rates mycosis rates are also important for continuity of fungal infection. Addiss (2008), grouped the entomopathogen fungi as most virulent (84.8-98.32), moderately virulent (40-73) and weak virulent (<40) based on percent mortality. When we done the similar type of grouping GOPT-144 isolate was highly virulent, GOPT-19(2)-1 GOPT-64 GOPT-107 GOPT-122 GOPT-167 GOPT-221 GOPT-284 GOPT-355 GOPT-453 were moderately virulent and rest of them were of weak virulence. These results indicated that isolates with high virulence could be used for microbial and integrated management of *S. cretica*.

Acknowledgement

We thank to Dr. Mustafa Özdemir (Directorate of Plant Protection Research Institute, Ankara, Turkey) for identification of *Sesamia cretica*.

References

- Anonymous (2015). Food And Agricultural Organization of United Nations - FAOSTAT faostat.fao.org/site/567/DesktopDefault.aspx
- Addis T. (2008). Evaluation of fungal entomopathogens, *B. bassiana* and *M. anisopliae* against *Sitophilus zeamais* (Mostch.) (Coleoptera: Curculionidae) M.Sc., Thesis, Haramaya University, Ethiopia. pp.120.
- El-Naggar M. A. (1997). Further studies on greater sugarcane borer *Sesamia cretica* Led. and European corn borer *Ostrinia nubilalis* (Hub.) in Egypt. Ph. D. Thesis Fac. Agric., Tanta Univ., Egypt.

- Mostafa F. F. M. (1981). Biological and ecological studies on the pink borer *Sesamia cretica* Led. (Lepidoptera: Noctuidae). PhD thesis, Faculty of Agriculture, Cairo University.
- Özcan S. (2009). Modern Dünyanın Vazgeçilmez Bitkisi Mısır: Genetiği Değiştirilmiş (Transgenik) Mısırın Tarımsal Üretime Katkısı. *Türk Bilimsel Derlemeler Dergisi*, vol. 2, pp. 1-34.
- Terefe T. H., Selvaraj T., Mengistu L., Negery M. (2012). Evaluation of some native entomopathogenic fungi against pink stem borer (*Sesamia calamistis* Hampson) (Lepidoptera: Noctuidae) in sugarcane. *Journal of Agricultural Technology*, vol. 8, pp. 515-536.
- Semeada A.M. (1988). Management of *Sesamia cretica* Led. population in maize fields (Lepidoptera: Noctuidae). PhD thesis, Faculty of Agriculture, Cairo University.
- Sevim A., Demir I., Höfte M., Humber R.A., Demirbag Z. (2010). Isolation and characterization of entomopathogenic fungi from hazelnut-growing region of Turkey. *BioControl*, vol. 55, pp. 279-297.
- SPSS INC., 2008. SPSS Statistics for Windows, Version 17.0 Chicago.
- Wraight S. P., Ramos M. E., Avery P. B., Jaronski S. T., Vandenberg J. D. (2010). Comparative virulence of *Beauveria bassiana* isolates against lepidopteran pests of vegetable crops. *Journal of Invertebrate Pathology*, vol. 103, pp. 186–199.
- Zurek L., Keddie B. A. (2000). *Beauveria bassiana* (Balsamo) Vuillemin - a promising microbial control agent of the satin moth (Lepidoptera: Lymantriidae). *Biocontrol Science and Technology*, vol. 10, pp. 641-644.

ACCUMULATION OF NPK AND S BY WINTER OILSEED RAPE DEPENDING ON FERTILIZATION LEVEL AND BIOSTIMULANT APPLICATION

Małgorzata SZCZEPANEK^{1*}, Anetta SIWIK-ZIOMEK²

¹Department of Agrotechnology, UTP University of Science and Technology in Bydgoszcz, Poland

²Sub-Department of Biochemistry, Department of Soil Science and Soil Protection, UTP University of Science and Technology in Bydgoszcz, Poland

*Corresponding author: malgorzata.szczepanek@utp.edu.pl

Abstract

Plant growth and nutrient uptake and yield can be supported by the use of biostimulants. The study aimed to assess NPK and S accumulation by winter oilseed rape after biostimulant application at varied NPK and S fertilization levels. The field experiment was located in Poland (53°13'N; 17°51'E), conducted in 2011-2013, on a typical Alfisol (USDA). In this experiment the applied levels of NPK were as follows: high (180 N, 70 P, 132 K kg ha⁻¹) or low (144 N, 35 P, 66 K kg ha⁻¹), elementary S fertilization (36 or 0 kg ha⁻¹) and the application of biostimulant Kelpak (2 l ha⁻¹ in autumn + 2 l ha⁻¹ in spring) or without the preparation. Kelpak is obtained from marine alga (*Ecklonia maxima* Osbeck) and contains auxins and cytokinins (11 and 0.031 mg l⁻¹). This study indicated that the higher NPK rates or S fertilization as well as the use of the biostimulant increased NPK and S accumulation in the plants of oilseed rape during generative development stages. Biostimulant application in rapeseed with lower NPK or without S increased N and P accumulation to the level obtained at higher NPK and with S, without biostimulant. At the fruit development stage S fertilization increased the accumulation of N, P and K in oilseed rape, but only in the case of high doses of NPK. At flowering and maturing, S accumulation was by 10% higher after the application of biostimulant and without S fertilization as compared with that found in rapeseed fertilized with this element but without the preparation.

Keywords: *Growing stage, nutrient uptake, biostimulant, mineral fertilization*

Introduction

Oilseed rape is one of the most important oil crops in Europe. In recent years (2012-2014) it has been grown in an area of 9 M ha, and the mean seed yield amounted to 2.7 t ha⁻¹ (FAOSTAT, 2016). One of methods for increasing the yield of this species may be application of biostimulants. Among them, preparations produced from marine algae are an important group (Craigie 2011; Sharma et al. 2014). Favourable effects of extracts from algae indicate the usefulness of their use in horticultural and agricultural crops (Craigie, 2011; Khan et al., 2009). It was also proved that they improve the uptake of macro and microelements (Billard et al., 2014; Jannin et al., 2012), which may have a favourable impact on the quantity of yield. For winter oilseed rape the important nutrients are K and P. Despite the high soil abundance in P and K, plants may be malnourished (Gaj, 2011). Potassium is taken up by rapeseed in greatest amounts (Szczepaniak, 2014). Insufficient availability of this nutrient limits the plant growth and yield quantity (Govahi and Saffari, 2006). P deficiency in turn restricts both shoot and root growth (Wang et al., 2015). Sulphur is an essential element for plant growth that increasingly limits crops production in several regions of the world. In comparison with cereals, oilseed rape requires a large amount of mineral S (Zhao et al., 1997). A deficiency in S can reduce the amount

and the quality of seed yield (McGrath and Zhao, 1996). According to Wang et al. (2015), balanced application of nutrients should be considered with aim to build an appropriate population structure with balanced plant density and individual growth of rapeseed. The aim of this study was to assess NPK and S accumulation by the winter oilseed rape (roots and shoots) at successive stages of generative development: flowering, fruit development and ripening, after the application of a biostimulant in condition of varied NPK fertilization levels as well as after and without fertilization with S.

Materials and Methods

The study was based on the field experiment located in Poland, in Kuyavian-Pomeranian region (53°13'N.17°51'E), conducted in 2011-2013, on a typical Alfisol (USDA). The topsoil was characterized by a medium content of available P (64.0 mg kg⁻¹) and high of K (126.0 mg kg⁻¹) and a slightly acidic reaction (pH in 1M KCL 5.7-6.1). The content of organic carbon (7.55-7.80 g kg⁻¹) and total nitrogen (0.69-0.75 g kg⁻¹) in the soil was relatively low. The subject of this study was winter oilseed rape of the population variety Chagall. The factors were: NPK fertilization rates high (180 N, 70 P, 132 K kg ha⁻¹) or low (144 N, 35 P, 66 K kg ha⁻¹), elementary S fertilization (36 or 0 kg ha⁻¹), and the biostimulant Kelpak application (2 l ha⁻¹ in autumn, after formation of 4-5 leaves + 2 l ha⁻¹ in spring, 10-15 days after starting growth) or without the preparation. Kelpak is obtained from marine alga (*Ecklonia maxima* Osbeck) belonging to the division of brown algae, collected on the coast of Africa. It contains phytohormones: auxins and cytokinins (11 and 0.031 mg l⁻¹, respectively), alginians, amino acids, as well as macro and microelements. Rates commonly used in the farm were assumed to be a low fertilization rates. High fertilization level was determined taking into consideration soil abundance, unit uptake and the expected yield. Mineral fertilization into soil with P (triple superphosphate), K (potash salt) and S (Wigor S) was applied presowing in autumn, whereas nitrogen (ammonium nitrate) in spring, at starting growth (100 kg ha⁻¹), and the other part after 3 weeks. The experiment was established in the randomized split-block design, in four replications, and the plot area amounted to 13 m². Plant samples were collected three times every 30 days at the following developmental stages: flowering, development of fruit and ripening, from the area of 0.5 m². Accumulation of elements was expressed as a product of their content and the amount of the dry matter of the aboveground part and the roots. P content was determined with the vanadium-molybdenum method and K with the flame photometry. The content of nitrogen was determined with the Kjeldahl method and sulphate turbidimetric method. The obtained results were statistically worked out in the software Statistica, with the method of the analysis of variance ANOVA, and the differences were estimated with Tukey's test at $\alpha=0.05$.

Results and Discussion

The study indicated a significant effect of fertilization with NPK and S as well as the biostimulant Kelpak on accumulation of P and K in oilseed rape plants (Table 1.) During flowering, development of fruit and ripening, the accumulation of P and K in the oilseed rape plants increased after the application of higher rates of NPK as compared with the effect of lower rates. Similar results are presented by Szczepaniak (2014). In his study, K accumulation in oilseed rape at flowering and ripening was higher if the plants were fertilized with NPK as compared with control (without fertilization). Zou et al. (2011) in turn proved an increase in K uptake after the use of fertilization with this element. The present study showed that the application of the biostimulant increased P and K accumulation in plants almost in each analyzed developmental stage (Table 1). Moreover, irrespective of fertilization with S, P and K

accumulation in rape fertilized with higher NPK rates without the biostimulant was similar to that found after the application of lower rates and foliar application of Kelpak. Increase in P and K uptake after the application of biostimulants from algae was also shown in the studies of other crops (Shah et al., 2013). The effect of these preparations results from the stimulation of physiological processes responsible for the plant growth (Kurepin et al., 2014). The study

Table 1. Accumulation of P and K in oilseed rape (roots and shoots) in consecutive generative development stages depending on mineral fertilization level and biostimulant application, mean from 2011-2013 [kg ha⁻¹].

Nutrient	Biostimulant application#	Fertilization level§									
		NPK+			NPK-			S+	S-	Mean	
		S+	S-	Mean	S+	S-	Mean				
P		Flowering									
	K ⁺	37.8	29.9	33.9	28.9	28.5	28.7	33.3	29.2	31.3	
	K ⁻	29.4	28.9	29.2	26.1	23.2	24.7	27.8	26.1	26.9	
	Mean	33.6	29.4	31.5	27.5	25.9	26.7	30.5	27.6	29.1	
	NIR for NPK – 2.54; S – 2.54; K – 2.54; NPK x S – ns; NPK x K – ns; S x K – ns										
		Development of fruit									
	K ⁺	48.4	40.7	44.6	39.5	37.1	38.3	43.9	38.9	41.4	
	K ⁻	41.3	37.0	39.1	34.5	36.6	35.5	37.9	36.8	37.3	
	Mean	44.9	38.8	41.8	37.0	36.9	36.9	40.9	37.8	39.4	
	NIR for NPK – 2.28; S – 2.28; K – 2.28; NPK x S – 3.22; NPK x K – ns; S x K – ns										
		Ripening									
	K ⁺	57.7	45.1	51.4	46.9	45.6	46.2	52.3	45.3	48.8	
	K ⁻	45.8	45.8	45.8	37.8	37.3	37.5	41.8	41.5	41.7	
	Mean	51.7	45.4	48.6	42.3	41.5	41.9	47.0	43.4	45.2	
	NIR for NPK – 3.88; S – ns; K – 3.88; NPK x S – ns; NPK x K – ns; S x K – ns										
K		Flowering									
	K+	172	134	153	124	128	126	148	131	139	
	K-	131	130	131	123	102	113	127	116	122	
	Mean	151	132	142	123	115	119	137	124	131	
	NIR for NPK – 11.6; S – 11.6; K – 11.6; NPK x S – ns; NPK x K – ns; S x K – ns										
		Development of fruit									
	K+	424	340	382	322	315	318	373	327	350	
	K-	354	310	332	294	299	297	324	304	314	
	Mean	389	325	357	308	307	307	349	316	332	
	NIR for NPK – 21.9; S – 21.9; K – 21.9; NPK x S – 31.0; NPK x K – ns; S x K – ns										
		Ripening									
	K+	517	370	444	378	372	375	448	371	409	
	K-	398	384	391	333	321	327	365	353	359	
	Mean	457	377	417	356	346	351	407	362	384	
	NIR for NPK – 34.8; S – 34.8; K – 34.8; NPK x S – 49.2; NPK x K – ns; S x K – ns										

§NPK⁺: 180 N, 70 P, 132K; NPK⁻: 144 N, 35 P, 66 K; S⁺: 40 S; S⁻: 0 S [kg ha⁻¹]

#B⁺: Kelpak 2 l ha⁻¹ in autumn + 2 l ha⁻¹ in spring; B⁻: without treatment

by Jannin et al. (2012) proved an increase in the expression of genes responsible for nutrient uptake of oilseed rape after the application of algae preparations. In the present study also fertilization with S had a favorable effect on P and K accumulation (Table 1). At the fruit development stage S fertilization increased the accumulation of P in the biomass of oilseed rape, but only in the case of high doses of NPK. Identical relationship was indicated for K accumulation at the fruit development stage and at the ripening. The literature data shows that the accumulation of the given element by oilseed rape depends on the availability of the other ones. Wang et al. (2015) claim that P uptake reduces N and K deficiency and K uptake is lower both at the lesser availability of this element but also at deficiency of N and P. Application of some nutrients (e.g. N) has a strong effect on dry matter increase, which results in increased demand for the other elements. Giovahi and Saffari (2006) indicated K and S interaction in dry matter production. Brennan and Bolland (2009) proved that for obtaining high yields of oilseed rape at a growing level of fertilization with N it is necessary to increase P and K rates.

Increasing the NPK rates resulted in an increase in N uptake by oilseed rape plants at flowering, fruit formation and ripening (Table 2). Nitrogen uptake at these developmental stages on average for the other factors also increased after the application of sulfur.

Table 2. Accumulation of N and S in oilseed rape (roots and shoots) in consecutive generative development stages depending on mineral fertilization level and biostimulant application, mean from 2011-2013 [kg ha⁻¹].

Nutrient	Biostimulant application [#]	Fertilization level [§]								
		NPK ⁺			NPK ⁻			S ⁺	S ⁻	Mean
		S ⁺	S ⁻	Mean	S ⁺	S ⁻	Mean			
N	Flowering									
	K ⁺	199	150	175	146	148	147	172	149	161
	K ⁻	152	144	148	136	114	125	144	129	136
	Mean	176	147	161	141	131	136	158	139	149
	NIR for NPK -14.3; S - 14.3; K - 14.3; NPK x S - ns; NPK x K - ns; S x K - ns									
	Development of fruit									
	K ⁺	265	205	235	210	191	201	238	198	218
	K ⁻	224	185	204	185	193	189	204	189	197
	Mean	244	195	220	197	192	195	221	193	207
	NIR for NPK -14.9; S - 14.9; K - 14.9; NPK x S - 21.1; NPK x K - ns; S x K - ns									
	Ripening									
	K ⁺	276	208	242	220	214	217	248	211	230
	K ⁻	216	209	213	180	169	175	198	189	194
	Mean	246	209	227	200	191	196	223	200	212
	NIR for NPK -21.6; S - 21.6; K - 21.6; NPK x S - ns; NPK x K - ns; S x K - ns									
S	Flowering									
	K ⁺	8.16	6.40	7.29	6.83	7.52	7.17	7.50	6.99	7.24
	K ⁻	6.46	6.60	6.53	6.04	5.22	5.63	6.23	5.91	6.07
	Mean	8.16	6.40	7.29	6.83	7.52	7.17	7.50	6.99	7.24
	NIR for NPK - 0.157; S - ns; K - 1.137; NPK x S - 0.228; NPK x K - ns; S x K - ns									
	Development of fruit									
	K ⁺	19.1	15.3	17.2	13.9	17.3	15.6	16.5	16.3	16.4
	K ⁻	14.8	14.0	14.4	14.7	15.7	15.2	14.7	14.9	14.8
	Mean	17.0	14.7	15.8	14.3	16.5	15.4	15.6	15.6	15.6
	NIR for NPK - ns; S - ns; K - 0.479; NPK x S - 2.624; NPK x K - ns; S x K - ns									
	Ripening									
	K ⁺	16.8	12.7	14.7	12.8	13.4	13.1	14.8	13.1	13.9
	K ⁻	13.1	12.3	12.7	12.2	11.3	11.8	12.6	11.3	12.2
	Mean	14.9	12.5	13.7	12.5	12.4	12.4	13.7	12.4	13.1
	NIR for NPK - 0.414; S - 0.411; K - ns; NPK x S - ns; NPK x K - ns; S x K - ns									

[§]NPK⁺: 180 N, 70 P, 132K; NPK⁻: 144 N, 35 P, 66 K; S⁺: 40 S; S⁻: 0 S [kg ha⁻¹]

[#]B⁺: Kelpak 2 l ha⁻¹ in autumn + 2 l ha⁻¹ in spring; B⁻: without treatment

At the fruit formation stage nitrogen accumulation in plants was higher after presowing sulfur fertilization only in the case of increased rates of NPK fertilization. Also other authors point the relationship between the uptake of N and other macroelements. According to Gaj (2011), K deficiency limits N accumulation and transport, which leads to reduction in growth and assimilation area. Szczepaniak (2014) proved that N accumulation at the beginning of flowering of rapeseed depended on K accumulation in the aboveground part.

A favorable effect of the biostimulant on N uptake was found At each of analyzed developmental stages (Table 2). Moreover, it was proved that irrespective of S fertilization, N accumulation in oilseed rape treated with the biostimulant after the application of lower NPK rates was similar to that found at a higher NPK fertilization level without the biostimulant. In the study of oilseed rape it was stated that the extract from algae increased accumulation of N as well as of P and Ca (Billard et al., 2014). Those increases were explained by plant growth stimulation.

It is known from the literature data that similarly to nitrogen (N) uptake (Rossato et al., 2001), the S requirement of oilseed rape depends on the plant development stage (McGrath and Zhao, 1996). In the present study presowing application of sulfur caused an increase in the accumulation of this element in oilseed rape plants only at the ripening stage (Table 2). According McGrath and Zhao (1996) and Postma et al. (1999) the S requirement is not stable during the growth cycle of oilseed rape: S uptake increased from stem extension to the start of flowering, whereas little S uptake was generally (but not exclusively) observed during pod filling. In the present study the increased NPK fertilization had a favorable effect on sulfur accumulation in plants both at the flowering and ripening stages. Also the biostimulant Kelpak, on average for fertilization with NPK and S, increased the uptake of S at the flowering and ripening period. At these developmental stages the accumulation of S in plants, on average for NPK fertilization, was even lower (by 10.9 and 9.8%, respectively) after presowing application of S without the biostimulant than on the treatment without S fertilization but with the biostimulant.

Conclusion

This study indicated that the higher NPK rates or S fertilization as well as the use of the biostimulant Kelpak increased N, P and K accumulation in the plants (roots and shoots) of oilseed rape at the flowering, development of fruit and ripening. Presowing fertilization with S had a similar effect on the accumulation of these elements. Biostimulant application in oilseed rape with lower rates of NPK increased N, P and K accumulation in oilseed rape during generative development stages to the level obtained at higher NPK, without biostimulant. At the fruit development stage S fertilization increased the accumulation of N, P and K in the biomass of oilseed rape, but only in the case of high doses of NPK. Increasing NPK rates stimulated the accumulation of S in oilseed rape at the flowering and ripening stages. Presowing fertilization with S increased the accumulation of this element in plants only at the ripening stage. The use of the biostimulant increased S uptake during flowering and ripening of oilseed rape. At these developmental stages the accumulation of S was even higher after the application of the biostimulant and without S fertilization, as compared with the accumulation of this element in oilseed rape fertilized with S, but without the preparation.

References

- Billard V., Etienne P., Jannin L., Garnica M., Cruz F., Gracia-Mina J.-M., Yvin J.-C., Ourry A. (2014). Two biostimulants delivered from algae or humic acid induce similar response in the mineral content and gene expression of winter oilseed rape, *Journal of Plant Growth Regulation* 33, 305-316.
- Brennan, R.F., Bolland M.D.A. (2009). Comparing the nitrogen and potassium requirements of canola and wheat for yield and grain quality. *Journal of Plant Nutrition* 32 (12), 2008-2026.
- Craigie J. (2011). Seaweed extract stimuli in plant science and agriculture. *Journal of Applied Phycology* 23: 371-393.
- FAOSTAT (2016). FAO Statistics Division. <http://faostat3.fao.org/> Accessed on 08/06/2016.

- Gaj R. (2011). Effect of diversified phosphorus and potassium fertilization on plant nutrition at the stage of initial main shoot development and the yield and oil content in the seeds of winter rapeseed. *Acta Scientiarum Polonorum Agricultura* 10 (4), 57-68.
- Giovahi M., Saffari M. (2006). Effect of potassium and sulfur fertilizers on yield, yield components and seed quality of spring canola (*Brassica napus* L.) seed. *Journal of Agronomy* 5 (4), 577-582.
- Jannin, L., Arkoun M., Etienne P., Laine P., Goux D., Garnica M., Fuentes M., San Francisco M., Baigorri R., Cruz F., Houdusse F., Gracia-Mina J., Yvin J., Ourry A. (2012). *Brassica napus* growth is promoted by *Ascophyllum nodosum* (L.) Le Jol. seaweed extract: Microarray analysis and physiological characterization of N, C, and S metabolisms. *Journal of Plant Growth Regulation* 32 (1), 31-52.
- Khan W., Rayireth U., Subramanian S., Jithesh M., Rayoreth P., Hodges M., Critchley A., Craigie J., Norrie J., Prithiviraj B. (2009). Seaweed extracts as biostimulants of plant growth and development. *Journal of Plant Growth Regulation* 28, 386-399.
- Kurepin L., Zaman M., Pharis R.P. (2014). Phytohormonal basis for the plant growth promoting action of naturally occurring biostimulators. *Journal of the Science of Food and Agriculture* 94, 1715-1722.
- McGrath S.P., Zhao F.J. (1996). Sulphur uptake, yield response and the interactions between N and S in winter oilseed rape (*Brassica napus*). *Journal of Agricultural Science* 126, 53-62.
- Postma R., Van Erp P.J., Saanen R. (1999). Quantifying the sulphur supply to agricultural crops. In: Abrol YP, Ahmad A, eds. *Sulphur in plants*. Dordrecht: Kluwer Academic Publishers.
- Rossato L., Lai'ne' P., Ourry A. (2001). Nitrogen storage and remobilisation in *Brassica napus* L. during the growth cycle: nitrogen fluxes within the plant and changes in soluble protein patterns. *Journal of Experimental Botany* 52, 1655-1663.
- Shah M.T., Zodape S.T., Chaudhary D.R., Eswaran K., Chikara J.. 2013. Seaweed SAP as an alternative liquid fertilizer for yield and quality improvement of wheat. *Journal of Plant Nutrition* 36 (2), 192-200.
- Sharma, S.H.S., C. Fleming, Ch. Selby, J.R. Rao, and M. Trevor. 2014. Plant biostimulants: a review on the processing of macroalgae and use of extracts for crop management to reduce abiotic and biotic stresses. *Journal of Applied Phycology* 26: 465-490.
- Szczepaniak, W., 2014. The mineral profile of winter oilseed rape in critical growth stages – potassium. *Journal of Elementology* 19(3): 203-215.
- Wang Y., Liu T., Li X.K., Ren T., Cong R.H., Lu J.W. (2015). Nutrient deficiency limits population development, yield formation, and nutrient uptake of direct sown oilseed rape. *Journal of Integrative Agriculture* 14 (4), 670-680.
- Zhao F.J., Bilsborrow P.E., Evans E.J., McGrath S.P. (1997). Nitrogen to sulphur ratio in rapeseed and in rapeseed protein and its use in diagnosing sulphur deficiency. *Journal of Plant Nutrition* 20, 549-558.
- Zou, J., Lu J.W., Li Y.S., Li X.K. (2011). Regional evaluation of winter rapeseed response to K fertilization, K use efficiency, and critical level of soil K in the Yangtze River Valley. *Agricultural Science in China* 10 (6), 911-920.

OSMOTIC STRESS TOLERANCE OF FIELD PEA SEEDLINGS

Violeta MANDIĆ*, Zorica BIJELIĆ, Vesna KRNJAJA, Zorica TOMIĆ, Dragana RUŽIĆ-MUSLIĆ, Violeta CARO-PETROVIĆ, Aleksandar STANOJKOVIĆ

Department of Feed Science, Institute for Animal Husbandry, Republic of Serbia

*Corresponding author: violeta_randjelovic@yahoo.com

Abstract

The effect of different osmotic potential levels (0, -0.3 MPa, -0.6 MPa, -0.9 MPa, -1.2 MPa, -1.5 MPa) induced by NaCl on germination and early seedling growth in two divergent winter field pea cultivars ('Kosmaj' and 'Letin') was investigated. Germination was tested in sterile plastic vessels on filter paper moistened with 10ml of distilled water or salt test solutions, in the dark at $20 \pm 1^\circ\text{C}$. Cultivars 'Kosmaj' and 'Letin' had a high percentage of germination under high osmotic potentials because germination was more than 75% (minimum germination standards is $\geq 75\%$). However, the tested cultivars showed different NaCl tolerance at the seedling stage. Cultivar 'Kosmaj' had better shoot growth, while cultivar 'Letin' root growth. Cultivar 'Kosmaj' had significantly higher germination energy (GE) (55.38%), shoot length (ShL) (5.58 cm), shoot fresh weight (ShFW) (79.28 mg), shoot dry weight (ShDW) (7.86 mg), relative seedling water content (RSWC) (87.81%) and phytotoxicity of root (PhR) (44.58%) than cultivar 'Letin' (27.83%, 2.23 cm, 57.54 mg, 6.71 mg, 86.10%, 15.32%, respectively). Contrary, cultivar 'Letin' had significantly higher germination (G) (98.58%), root length (RL) (10.28 cm), root fresh weight (RFW) (90.16 mg), root dry weight (RDW) (13.22 mg) and seedling vigor index (SVI) (1237.97) than cultivar 'Kosmaj' (92.13%, 5.62 cm, 49.62 mg, 6.26 mg, 1068.10, respectively). GE, G, RL, ShL, RFW, ShFW, RDW, ShDW, SVI, RSWC and dry matter stress tolerance index (DMSI) significantly decreased, while PhR and phytotoxicity of shoot (PhSh) significantly increased with the increase in osmotic stress.

Keywords: *Early seedling growth, Field pea, Germination, Osmotic stress.*

Introduction

Plantings of field pea in the Republic of Serbia were estimated at about 5000 ha of forage pea, and 10000 ha of feed pea (Mihailović et al., 2005). It is very small, given that the favorable growing conditions. We distinguish in the agronomic sense, term forage pea which includes genotypes which should be harvested in full bloom at the beginning of the first pod and can be used as green forage, forage dry matter, forage meal, silage and haylage (Mikić et al., 2003), and term protein pea designating the genotypes for grain production and straw (Mikić et al., 2006). Field pea production in Serbia is traditionally based on domestic cultivars, about 95% of the harvested area (Mihailović and Mikić, 2010). Soil salinity adversely affects germination, resulting in poor plant stand. Estimates are that in Serbia about 4.6% of total of agricultural land is affected by salt (Ličina et al., 2011). Many researches showed that cultivars of pea significantly differ in respect to the salt stress. Jovičić et al. (2010) reported that Serbian cultivar 'Jantar' expressed a high level of tolerance to increased salt content than cultivars 'Javor', 'Partner', 'Kristal', 'Pionir', 'Junior', 'Trezor' and 'Dukat'. Petrović et al. (2016) reported that two pea Serbian cultivars 'Dukat' and 'Partner' are tolerant to salt stress during germination and early embryo growth, but showed greater susceptibility when it comes to growth parameters compared to seed germination. Shahid et al. (2012) classified thirty pea genotypes in terms of salt tolerance

as less salt tolerant, intermediate and high salt tolerant groups at seedling stage. Okçu et al. (2005) concluded that Turkish pea cultivar 'Bolero' was more resistant to salinity during seedling emergence, cultivar 'Sprinter' appeared tolerant and 'Utrillo' is very sensitive. Many researches showed that germination and growth of seedlings of pea significantly decreased with increasing NaCl osmotic potential (Okçu et al., 2005; Jovičić et al., 2010; Jovičić et al., 2013; Cokkizgin and Colkesen, 2012; Naz et al., 2014; Petrović et al., 2016). Munns (2005) indicated that salt inhibits plant growth because it reduces the plant's ability to absorb water, and may enter the transpiration stream and eventually injure cells in the transpiring leaves and these result in slower growth. The aim of this research was to estimate the effects of NaCl osmotic potentials (0, -0.3 MPa, -0.6 MPa, -0.9 MPa, -1.2 MPa, -1.5 MPa) on germination and early seedling growth in two field pea cultivars 'Kosmaj' and 'Letin' under laboratory conditions.

Materials and methods

The effects of NaCl osmotic potentials (0, -0.3 MPa, -0.6 MPa, -0.9 MPa, -1.2 MPa, -1.5 MPa) on germination and early seedling growth of winter field pea cultivars ('Kosmaj' and 'Letin') tested in laboratory conditions of the Institute for Animal Husbandry in Belgrade, in March 2016. Cultivar 'Kosmaj' is local cultivar produced by the Institute of Field and Vegetables Crops in Serbia. Cultivar 'Letin' is foreign cultivar produced by the Agricultural Institute Osijek in Croatia. The cultivars are intended for combined use (green forage and grain). Seeds of cultivars are produced in 2015. Hundred seeds were placed in sterile plastic vessels of dimensions 15cm×21cm×4cm on filter paper soaked with 10 ml of distilled water or NaCl osmotic solutions (-0.3 MPa, -0.6 MPa, -0.9 MPa, -1.2 MPa, -1.5 MPa) prepared according to Coons et al. (1990), and incubated at $20 \pm 1^\circ\text{C}$ in the dark for 14 days, in four replications (Mandić et al., 2012). The filter paper substrates in all vessels were changed every other day. Seeds were surface sterilized by soaking in 1% NaOCl for 5 min and washed three times by sterilized distilled water. Randomized Complete Block Design (RCBD) design was applied to an experiment. Germination energy (GE) and germination (G) were determined after 4 and 7 day after sowing (ISTA, 2008). Quantitative seedlings traits (root length (RL), shoot length (ShL), root fresh weight (RFW), shoot fresh weight (ShFW), root dry weight (RDW) and shoot dry weight (ShDW)) were measured after 14 days. RDW and ShDW were measured after drying at 80°C for 24 hours (Mandić et al., 2012). Seedling vigor index (SVI), relative seedling water content (RSWC), phytotoxicity of shoot (PhSh) and root (PhR) and dry matter stress tolerance index (DMSI) were calculated as described in the paper Mandić et al. (2014). The data were processed by ANOVA using program Statistica version 10. Duncan's test was used to compare the treatment means at 5% level.

Results and Discussion

Results of ANOVA showed that cultivar had highly significant effect on GE, G and all quantitative seedling traits (RL, ShL, RFW, ShFW, RDW and ShDW) (Table 1). The tested cultivars showed different NaCl tolerance at the seedling stage. Cultivar 'Kosmaj' had better shoot growth, while cultivar 'Letin' root growth in early seedling phase under osmotic stress conditions. Cultivar 'Kosmaj' had significantly higher GE (55.38%), ShL (5.58 cm), ShFW (79.28 mg), ShDW (7.86 mg) than cultivar 'Letin' (27.83%, 2.23 cm, 57.54 mg, 6.71 mg, respectively). Contrary, cultivar 'Letin' had significantly higher G (98.58%), RL (10.28 cm), RFW (90.16 mg) and RDW (13.22 mg) than cultivar 'Kosmaj' (92.13%, 5.62 cm, 49.62 mg, 6.26 mg, respectively). However, cultivars have a considerably high percent of germinated seeds under high osmotic potentials (the minimum germination standards is $\geq 75\%$) although root and

shoot growth was slowed down. Tested cultivars showed greater susceptibility to osmotic stress in early seedling growth compared to seed germination. Petrović et al. (2016) found that pea cultivars ‘Dukat’ and ‘Partner’ have a good germination even at 150mM salinity level. Jovičić et al. (2010) found genetic variability between cultivars for tolerance and phytotoxicity effect of NaCl.

Table 1. The effects of cultivar and different osmotic stress on germination energy (GE), germination (G), root length (RL), shoot length (ShL), root fresh weight (RFW), shoot fresh weight (ShFW), root dry weight (RDW) and shoot dry weight (ShDW) of field pea

Parameters	Cultivar (A)	Osmotic stress, MPa (B)						Means
		0	-0.3	-0.6	-0.9	-1.2	-1.5	
GE, %	‘Kosmaj’	91.00	88.25	77.25	62.00	11.25	2.50	55.38 ^a
	‘Letin’	87.50	52.50	14.00	13.00	0	0	27.83 ^b
	Means	89.25 ^a	70.38 ^a	45.62 ^b	37.50 ^b	5.62 ^c	1.25 ^c	41.60
G, %	‘Kosmaj’	97.75	96.75	96.50	95.00	88.25	78.50	92.13 ^b
	‘Letin’	100.00	99.50	99.50	98.50	97.50	96.50	98.58 ^a
	Means	98.88 ^a	98.12 ^a	98.00 ^a	96.75 ^a	92.88 ^b	87.50 ^c	95.36
RL, cm	‘Kosmaj’	10.18	7.14	6.69	5.24	2.40	2.04	5.62 ^b
	‘Letin’	12.18	11.97	11.74	9.60	8.21	8.00	10.28 ^a
	Means	11.18 ^a	9.56 ^b	9.21 ^b	7.42 ^c	5.31 ^d	5.02 ^d	7.95
ShL, cm	‘Kosmaj’	13.30	6.892	4.615	5.40	2.38	0.89	5.58 ^a
	‘Letin’	4.697	4.005	2.565	1.175	0.537	0.417	2.23 ^b
	Means	9.00 ^a	5.45 ^b	3.59 ^c	3.29 ^c	1.46 ^d	0.66 ^d	3.91
RFW, mg	‘Kosmaj’	85.23	77.21	45.10	49.32	22.79	18.10	49.62 ^b
	‘Letin’	115.28	108.99	106.29	77.94	66.42	66.02	90.16 ^a
	Means	100.25 ^a	93.10 ^a	75.70 ^b	63.63 ^c	44.60 ^d	42.06 ^d	69.89
ShFW, mg	‘Kosmaj’	140.68	120.94	80.08	80.94	38.34	14.69	79.28 ^a
	‘Letin’	133.08	104.81	62.57	28.28	9.32	7.15	57.54 ^b
	Means	136.88 ^a	112.88 ^b	71.32 ^c	54.61 ^c	23.83 ^d	10.92 ^d	68.41
RDW, mg	‘Kosmaj’	10.03	8.34	6.48	5.94	3.53	3.27	6.26 ^b
	‘Letin’	17.07	18.09	15.03	8.36	10.46	10.34	13.22 ^a
	Means	13.55 ^a	13.21 ^a	10.75 ^b	7.15 ^c	7.00 ^c	6.80 ^c	9.74
ShDW, mg	‘Kosmaj’	12.90	11.08	8.07	8.22	4.72	2.19	7.86 ^a
	‘Letin’	14.22	11.81	8.13	3.74	1.42	0.94	6.71 ^b
	Means	13.56 ^a	11.44 ^b	8.10 ^c	5.98 ^d	3.07 ^e	1.57 ^e	7.29
Factor	GE	G	RL	ShL	RFW	ShFW	RDW	ShDW
A	**	**	**	**	**	**	**	*
B	**	**	**	**	**	**	**	**
AB	**	**	**	**	*	ns	**	**

Means followed by the same letter within a column are not significantly different by Duncan’s Multiple Range Test at the 5% level; ** - significant at 1% level of probability, * - significant at 5% level of probability and ns - not significant

GE, G, RL, ShL, RFW, ShFW, RDW and ShDW were significantly decreased with increasing osmotic stress. The maximum GE (89.25%), G (98.88%), RL (11.18 cm), ShL (9.00 cm), RFW (100.25 mg), ShFW (136.88 mg), RDW (13.55 mg) and ShDW (13.56 mg) were recorded at 0 MPa and the minimum at -1.5 MPa (1.25%, 87.50%, 5.02 cm, 0.66 cm, 42.06 mg, 10.92 mg, 6.80

mg and 1.57 mg, respectively). Higher osmotic stress is leading to reduced emergence of seedlings and finally reduced germination. RL and ShL lengths provide important indications of a plant's response to salt stress because roots absorb water due to direct contact with soil and then shoots enable its supply in whole plant. Osmotic stress induced by NaCl slows down water uptake by seeds, inhibited the translocation efficiency and assimilation of stored materials due to this it's caused a reduction in root and shoot growth. The result is in agreement with Okçu et al. (2005), Jovičić et al. (2010), Jovičić et al. (2013), Naz et al. (2014) and Petrović et al. (2016) who observed that germination, seedling length and seedling fresh and dry weight of pea were significantly reduced by increasing osmotic stress. Reducing the weight of fresh seedlings with increasing concentrations of NaCl result is the accumulation of large quantities of sodium ions who negatively affect cell division, metabolism and imbalance of other nutrients (Mer et al., 2000). The interaction of cultivars and osmotic stress had significant effect on GE, G, RL, ShL, RFW, RDW and ShDW.

The cultivar had highly significant effect on SVI, RSWC and PhR (Table 2).

Table 2. The effects of cultivar and different osmotic stress on seedling vigor index (SVI), relative seedling water content (RSWC), phytotoxicity of root (PhR), phytotoxicity of shoot (PhSh) and dry matter stress tolerance index (DMSI) of field pea

Parameters	Hybrid (A)	Osmotic stress, MPa (B)						Means
		0	-0.3	-0.6	-0.9	-1.2	-1.5	
SVI	'Kosmaj'	2295.85	1359.74	1089.27	1010.32	422.89	230.51	1068.10 ^b
	'Letin'	1687.75	1589.88	1423.59	1061.80	852.16	812.64	1237.97 ^a
	Means	1991.80 ^a	1474.81 ^b	1256.42 ^c	1036.06 ^d	637.52 ^e	521.58 ^e	540.24
RSWC, %	'Kosmaj'	89.83	90.18	88.42	89.05	86.51	82.86	87.81 ^a
	'Letin'	87.38	85.92	85.96	88.45	84.28	84.58	86.10 ^b
	Means	88.61 ^a	88.05 ^a	87.19 ^a	88.75 ^a	85.40 ^b	83.72 ^b	86.95
PhR, %	'Kosmaj'	0	29.38	33.48	48.79	76.00	79.86	44.58 ^a
	'Letin'	0	1.96	2.96	20.69	32.25	34.06	15.32 ^b
	Means	0 ^a	15.67 ^b	18.22 ^c	34.74 ^c	54.13 ^d	56.96 ^d	29.95
PhSh, %	'Kosmaj'	0	48.11	65.24	59.19	82.10	93.39	58.01
	'Letin'	0	11.51	45.84	73.49	89.15	90.47	51.74
	Means	0 ^a	29.81 ^b	55.54 ^c	66.34 ^c	85.63 ^d	91.93 ^d	54.88
DMSI, %	'Kosmaj'	100.00	84.82	63.71	61.91	36.08	23.79	61.72
	'Letin'	100.00	95.90	74.02	38.81	38.09	36.14	63.82
	Means	100.00 ^a	90.36 ^b	68.86 ^c	50.36 ^d	37.08 ^e	29.96 ^e	62.77
Factor	SVI	RSWC	PhR	PhSh	DMSI			
A	**	**	**	ns	ns			
B	**	**	**	**	**			
AB	**	*	**	*	**			

Means followed by the same letter within a column are not significantly different by Duncan's Multiple Range Test at the 5% level; ** - significant at 1% level of probability, * - significant at 5% level of probability and ns - not significant

Cultivar 'Letin' had significantly higher SVI (1237.97) than cultivar 'Kosmaj' (1068.10). Contrary, cultivar 'Kosmaj' had significantly higher RSWC (87.81%) and PhR (44.58%) than

cultivar 'Letin' (86.10% and 15.32%). PhR of cultivar 'Letin' is lower because had better growth of the roots.

The osmotic stress had highly significant effect on SVI, RSWC, PhR, PhSh and DMSI. SVI, RSWC and DMSI significantly decreased, while PhR and PhSh significantly increased with the increase in osmotic stress. Mandić et al. (2014) reported similar results for maize. Cokkizgin et al. (2012) stated that increased NaCl concentration caused a harmful effect in the pea seed because increased SVI. The interaction of cultivars and osmotic stress had significant effect on SVI, RSWC, PhR, PhSh and DMSI.

Conclusions

The tested cultivars 'Kosmaj' and 'Letin' showed different NaCl tolerance at the seedling stage. Cultivar 'Kosmaj' had better shoot growth in all osmotic stress treatments, while cultivar 'Letin' root growth. Cultivar 'Letin' had better tolerance to osmotic stress than cultivar 'Kosmaj' because had higher values for G and SVI and lower values for PhR. Cultivar 'Letin' (foreign cultivar) can be recommended for cultivation in salt-affected areas. Increasing osmotic stress induced by NaCl caused reduction in germination and early seedling growth. GE, G, RL, ShL, RFW, ShFW, RDW, ShDW, SVI, RSWC and DMSI significantly decreased, while PhR and PhSh significantly increased with the increase in osmotic stress.

Acknowledgment

The research was supported by the Ministry of Science and Technological Development of Republic of Serbia, project TR 31053.

References

- Cokkizgin, A., Colkesen, M. (2012): Germination responses of pea (*Pisum sativum* L.) seeds to salinity, International Journal of Agricultural Science and Bioresource Engineering Research, Vol. 1 (No. 3), 71-77.
- Coons, M.J., Kuehl, R.O., Simons, N.R. (1990): Tolerance of ten lettuce cultivars to high temperature combined with NaCl during germination, Journal of the American Society for Horticultural Science, 115 (6), 1004-1007.
- International seed testing association (ISTA) (2008): International rules for seed testing, Zurich: ISTA.
- Jovičić, D., Vujaković, M., Milošević, M., Karagić, Đ., Taški-Ajduković, K., Ignjatov, M., Mikić A. (2010): Uticaj zaslanjenosti na klijanje i parameter porasta ponika stočnog graška (*Pisum sativum* L.) (The effect of salinity on seed germination and growth parameters of field pea (*Pisum sativum* L.), Ratarstvo i povrtarstvo / Field and Vegetable Crops Research, 47, 523-528
- Jovičić, D., Zdjelar G., Nikolić, Z., Ignjatov, M., Milošević, D., Karagić, Đ., Milošević B., (2013): Effect of drought and salinity stress on pea (*Pisum sativum* L.) germination and seedlings, Proceedings of 1st International Conference on Plant Biology and 20th Symposium of the Serbian Plant Physiology Society, Subotica, Serbia, 127.
- Ličina, V., Nešić, L.J., Belić, M., Hadžić, V., Sekulić, P., Vasin, J., Ninkov, J. (2011): The soils of Serbia and their degradation, Field and Vegetable Crops Research, 48, 285-290.
- Mandić, V., Krnjaja, V., Tomić, Z., Bijelić, Z., Žujović, M., Simić, A., Prodanović, S. (2012): Genotype, seed age and pH impacts on germination of alfalfa, Romanian Biotechnological Letters, 17 (2), 7205-7211.

- Mandić V., Bijelić Z., Krnjaja V., Tomić Z., Simić A., Ružić-Muslić D., Gogić M. (2014): The influence of genotype and osmotic stress on germination and seedling of maize, *Biotechnology in Animal Husbandry*, Vol. 30 (No.2), 357-366.
- Mer, R.K., Prajith, P.K., Pandya, D.H., Pandey, A.N. (2000): Effect of salts on germination of seeds and growth of young plants of *Hordeum vulgare*, *Triticum aestivum*, *Cicer arietinum* and *Brassica juncea*, *Journal of Agronomy and Crop Science*, 185 (4), 209–217.
- Mihailović, V., Mikić, A. (2010): Novel Directions of Breeding Annual Feed Legumes in Serbia. *Biotechnology in Animal Husbandry*, XII international Symposium on Forage crops of Republic of Serbia. Kruševac, Vol. 26 (Book 1), 81-90.
- Mihailović, V., Mikić, A., Erić, P., Vasiljević, S., Ćupina, B., Katić, S. (2005): Protein pea in animal feeding, *Biotechnology in Animal Husbandry*, Vol. 21 (No.5-6), 281-285.
- Mikić, A., Mihailović, V., Katić, S., Karagić, Đ., Milić, D. (2003): Protein pea grain – a quality fodder, *Biotechnology in Animal Husbandry*, Vol. 19 (No.5-6), 465-471.
- Mikić, A., Ćupina, B., Katić, S., Karagić, Đ. (2006): Importance of annual forage legumes in supplying plant proteins, *A Periodical of Scientific Research on Field and Vegetable Crops*, Vol. 42 (No. I), 91-103.
- Munns, R. (2005): Genes and salt tolerance: bringing them together, *New Phytologist*, 167, 645-663.
- Naz, F., Gul, H., Hamayun, M., Sayyed, A., Husna, Sherwani, S.K. (2014): Effect of NaCl stress on *pisum sativum* germination and seedling growth with the influence of seed priming with potassium (KCL and KOH), *American-Eurasian Journal of Agricultural & Environmental Sciences*, 14 (11), 1304-1311.
- Okçu, G., Kaya, M.D., Atak, M. (2005): Effects of salt and drought stresses on germination and seedling growth of pea (*Pisum sativum* L.), *Turkish Journal of Agriculture and Forestry*, 29, 237-242.
- Petrović, G., Jovičić, D., Nikolić, Z., Tamindžić, G., Ignjatov, M., Milošević, D., Milošević B. (2016): Comparative study of drought and salt stress effects on germination and seedling growth of pea, *Genetika*, Vol 48 (No. 1), 373 -381.
- Shahid, M.A., Balal, R.M., Pervez, M.A., Abbas, T., Ashfaq, M., Ghazanfar, U., Afzal, M., Rashid, A., Garcia-Sanchez, Mattson, N.S. (2012): Differential response of pea (*Pisum sativum* L.) genotypes to salt stress in relation to the growth, physiological attributes antioxidant activity and organic solutes. *Australian Journal of Crop Science*, 6, 828-838.

SOME LEAF PROPERTIES OF NATURAL *Laurus nobilis* L. POPULATION IN KARABURUN PENINSULA (IZMIR/TURKEY)

Aysun BOZA¹, Serra HEPAKSOY^{2*}

¹Ege Forestry Research Institute Urla, Izmir, Turkey

²Ege University, Faculty of Agriculture, Department of Horticulture Bornova, Izmir, Turkey

*Corresponding author: serra.hepaksoy@ege.edu.tr

Abstract

There is an increasing global demand to dried of bay laurel leaf, Many bay laurel areas, primarily in the Aegean region of Turkey, have been destroyed because of several factors: Therefore, new bay laurel areas should be established: New plantations should be formed by genotype(s) with superior characteristics. The present study was undertaken to examine leaf characteristics of natural laurel genotypes in Karaburun Peninsula, İzmir/Turkey. Two years old leaves samples were taken in the middle of March, June, September and December from 23 different trees. Leaf size and thickness, leaf area and leaf color were determined. As a result of study, average leaf length was found that ranged between 4,02 and 6,83 cm and average leaf width between 1,90 and 3,58 cm. Thickness of leaves changed between 0,250 and 0,306 cm and leaf areas ranged between 6,64 and 19,27 cm². Some values differed by season. As a result of study there were found differences among bay laurel genotypes grown in the Karaburun peninsula.

Keywords: *Laurus nobilis* L., Karaburun peninsula, leaf characteristics, Leaf color, Turkey

Introduction

Bay laurel (*Laurus nobilis* L.) belongs to the family *Lauraceae*, which included numerous aromatic and medicinal species. Laurel is an evergreen tree or large shrub up to 20 m height. It is also known as sweet bay, bay laurel, Grecian laurel, true bay, and bay. Bay laurel is grown commercially for aromatic constituents of leaves and fruits (Gökmen, 1973; Acar, 1987),

Bay laurel is native to Asia Minor and Balkans. It is also reported that these trees were seen in the Mediterranean coasts in ancient times. It spread to the many Mediterranean countries (Spain, south France, Corsica Island in Italy, North Africa, Israel and Cyprus) and where the Mediterranean climate is dominant Black Sea coasts of Russia and India (Acar, 1987, Leung and Foster, 1999).

In Turkey, bay laurel grows in the West and Central Black Sea, Marmara, Aegean and Mediterranean regions. In these regions it growing up to 600-800 m, altitude above sea (Davis, 1982) may grow as tall as 5-10 m. Its dried leaves and essential oils are used in Italy, France, Turkey, Algeria, Morocco, Spain, Portugal and Mexico as a valuable spice in the culinary and food industry (Santoyo et al., 2006). Leaves and fruits of bay laurel are utilized in perfumery, soap, food, medicine and varnish / chemical industries. Bay laurel is not only an aromatic and medical plant but also used as an ornamental plant. Due to the perennial and evergreen plant, are used in park and garden landscaping and roadside. Bay laurel are propagated by seeds or stools and cutting as vegetative (Anonymous, 2005).

Bay laurel has an important place in world trade and Turkey has a leading position in the market in terms of quality, price and quantity by holding 90% of the market. It has 10% share in the natural plant product export of our country. Bay laurel is exported as a dried leaves to approximately 60 countries. It was being exported to Britain, Switzerland, Romania, United

States of America, Russia, Canada, Western Germany, Netherlands, Syria, Austria, and laurel oil was exported to Syria during 1960's (Ateş, 1963). According to data of Aegean Exporters' Association (AEA), between 1997-2003 year the most important export countries were Hong Kong, USA, Germany, Brazil, Japan, Poland, Netherlands and France, respectively (Anonymous, 2003). Export amount of Turkey was 35.930.316 kg as dried leaf in 2015 and major importing countries were Vietnam (socialist), Brazil, USA, Poland and Singapore, respectively (Anonymous, 2015).

In Turkey, bay laurel grows naturally. But excessive destruction occurs in natural bay laurel areas due to severe and untimely harvest of leaves. For this reason, establishment of new bay laurel areas required. A large number nursery trees are necessary for planting new bay laurel groves for leaf production besides for to be used in landscaping. However, nursery trees propagated from unknown properties of mother plants. In this case may lead to low the quality of new bay laurel groves.

Therefore in this study leaf characteristics of natural laurel genotypes determined in Karaburun Peninsula, İzmir where one of the most important area in Turkey.

Material and methods

This study was conducted in Karaburun Peninsula, Izmir, Turkey. Leaf characteristic of 23 genotypes were determined. Two years old leaves samples were taken in the mid March, June, September and December in 2006.

Leaf width and length were measured by using a ruler. Leaf thickness measurements were conducted with a micrometer (Mitutoyo, Germany) having an accuracy of 0,001 mm. Leaf areas was firstly scanned in a Hewlett Packard Scanjet 3200 C scanner and then calculated with FLAECHE computer program (Odabaş and Gülümser, 2005).

Leaf color was measured on the both sides of 30 leaf using a colorimeter (CR-300, Minolta Co, Osaka, Japan), which provided CIE L^* , a^* , and b^* values. Color values were displayed as L^* , a^* , and b^* , which represent a light-dark spectrum from 0 (black) to 100 (white), a green-red spectrum from -60 (green) to +60 (red), and a blue–yellow spectrum from -60 (blue) to +60 (yellow), respectively. These values were then used to calculate Chroma ($C^* = [a^{*2} + b^{*2}]^{1/2}$), which indicates the intensity or color saturation, and hue angle ($h^\circ = \tan^{-1}[b^*/a^*]$), which is expressed in degrees: 0° (red–purple), 90° (yellow), 180° (bluish–green), and 270° (blue) (McGuire, 1992).

Statistical analyses of all data were performed with SPSS Version 16,. (SPSS Inc., Chicago, IL, USA), Differences between the means were compared by Duncan test at a significance level of $P < 0,05$.

Results and Discussion

It was found that there were differences significant ($p \leq 0.05$) among leaf length, width, thickness and area of bay laurel genotypes. As could be seen in Table 1 the seasons' average leaf length ranged between 4,02 and 6,83 cm while leaf widths ranged between 1,90 and 3,58 cm. Based on average leaf length of genotypes 6, 14, 21 and 22 were statistically similar and they had the longest leaves than other genotypes. Genotypes 4, 8 and 23 had the shortened leaves and theirs length of leaves were 4,02 cm, 4,05 cm and 4,28 cm, respectively. Based on average leaf width of genotype 20 had the largest leaves than other genotypes. In terms of seasons both length and width of leaves differences were not significant. Boza and Hepaksoy (2011) found that the average length and width of leaves ranged between 5,77-9,05 cm and 2,37-4,14 cm, respectively, in the Dilek peninsula where the other important area for bay laurel.

Table 1. Leaf characteristics of bay laurel genotypes

Genotype No	Ave, Length (cm)		Ave, Width (cm)		Ave, Thickness (mm)		Ave, Area (cm ²)	
1	5,33	e-g	2,59	f-h	0,274	a-f	12,04	d-g
2	5,40	e-g	2,86	e-f	0,243	ef	13,19	c-f
3	5,78	c-g	2,91	b-f	0,268	b-f	12,37	d-g
4	4,02	i	1,96	jk	0,269	a-f	7,90	i
5	5,14	f-h	2,43	hi	0,242	f	10,91	f-h
6	6,83	a	3,21	b	0,306	a	19,27	a
7	4,57	hi	2,00	jk	0,269	a-f	7,74	I
8	4,05	i	1,90	k	0,264	c-f	6,64	i
9	5,69	d-g	2,68	e-h	0,288	a-c	11,24	e-h
10	6,25	a-d	3,09	b-d	0,271	a-f	13,89	b-f
11	6,59	a-c	2,98	b-e	0,275	a-f	14,05	b-f
12	6,15	a-e	2,68	e-h	0,291	a-c	12,07	d-g
13	6,23	a-d	2,81	c-g	0,277	a-f	11,72	d-g
14	6,73	a	3,14	bc	0,272	a-f	14,64	b-d
15	5,88	b-f	2,76	d-h	0,275	a-f	11,91	d-g
16	6,11	a-e	2,99	b-e	0,304	ab	13,23	c-f
17	5,05	gh	2,49	g-i	0,286	a-d	9,35	g-i
18	5,83	b-g	2,90	b-f	0,280	a-e	12,38	d-g
19	6,09	a-e	2,84	c-g	0,264	c-f	14,50	b-e
20	6,65	a-b	3,58	a	0,283	a-d	16,58	ab
21	6,88	a	2,97	b-e	0,264	c-f	13,83	b-f
22	6,78	a	2,85	c-f	0,250	d-f	15,73	bc
23	4,28	i	2,25	ij	0,258	c-f	8,38	hi

The genotype # 15, 16 and 8 had the thickest leaves (respectively 0,306-0,304-0,288 mm) while # 5, 2 and 22 had the thinnest leaves (respectively 0,242-0,243-0,250 mm). The thickest leaves were found in September while the thinnest leaves were found in March month in terms of periods. Leaf widths range between 2 and 3 cm in 66,7% of the genotypes, while the leaf thickness were ranged between 0,25 and 0,30 mm in approximately 80% of the genotypes.

Tree # 6 had the largest leaf area with 19,27 cm² and the tree # 4 had the smallest leaf area with 6,64 cm². Any difference did not occur in leaf area of the trees among sampling months.

It general, leaf sizes of the genotypes were found to be small. Leaf sizes were ranged between 5 and 6 cm in the 50% genotypes, while ranged between 6 and 7 cm in the other half. Boza and Hepaksoy (2011) found that the average leaf areas between 11,05 cm² and 24,04 cm² in the Dilek peninsula of Aydın/Turkey.

Leaf length, width and area of trees grown in Karaburun peninsula were found to be smaller than trees grown in the Dilek peninsula. These differences may be caused by genetic structure or climatic and soil type.

Color values of upper and lower surface of leaves were determined as L, C*, Hue°, Hue° values of both surfaces were not found statistically significant among genotypes. Leaves color were darker green during summer and autumn seasons while a lighter green during winter and spring seasons. The most vivid color of upper surface was found in the genotype 2 (23,85); the lowest

value (17,08) was found in the genotype 10. Leaf lower surface of genotype 19 was determined to be the most vivid color (125,10) while the lowest chroma value were found at genotypes 22 (20,31) and 20 (20,29). It was observed that upper and lower surface of leaves had lower chroma values in winter and spring seasons, respectively. L values of trees' leaves ranged between 53,38 and 39,80 on the upper surface and 55,23 and 45,45 in the lower surface. It was seen that the lightest color leaves grow during spring time in terms of upper surface as period based, while the period has no effect in the lower surface (Table 2). In general leaf formation of bay laurel ends in April. Most probably for this reason, leaves have a darker green, saturated and more vivid color in June. Similarly, the leaves grow beginning again in September and they have more green and shiny at this time. Summer drought conditions stress trees. They may thus lose their leaves prematurely or start color production prematurely. The result is a reduction of color during the peak of the season. But air humidity is high in this region. For this reason lead color may higher during summer and autumn seasons.

Table 2. Color values of leaves belonging to bay laurel genotypes

Genotype No	Avg, Hue		Avg, Chr		Avg, L					
	Upper Surface	Lower Surface	Upper Surface	Lower Surface	Upper Surface	Lower Surface	Upper Surface	Lower Surface	Upper Surface	Lower Surface
1	123,66	118,61	18,70	d-g	23,26	a-c	46,40	b-g	49,40	b-e
2	122,83	117,80	23,85	a	23,78	a-c	44,60	b-g	47,40	c-e
3	121,08	118,74	22,96	a-c	23,47	a-c	49,20	a-e	50,00	b-e
4	121,96	116,26	19,78	c-g	21,41	a-c	50,70	a-c	53,10	ab
5	118,84	117,59	20,96	a-e	23,25	a-c	51,60	ab	52,20	a-c
6	123,05	117,01	23,56	ab	23,31	a-c	44,80	b-g	55,20	a
7	118,85	116,62	21,32	a-d	21,90	a-c	49,50	a-d	52,50	a-c
8	118,79	118,32	18,27	d-g	23,02	a-c	53,40	a	49,10	b-e
9	123,48	118,47	21,48	a-d	23,22	a-c	42,20	e-g	47,50	c-e
10	124,73	117,20	17,08	g	22,71	a-c	42,80	d-g	50,60	a-e
11	125,37	119,26	21,45	a-d	22,81	a-c	43,00	d-g	45,50	e
12	121,16	117,21	20,68	a-f	24,37	ab	45,50	b-g	49,10	b-e
13	120,02	118,20	19,87	c-g	20,64	bc	48,30	a-f	47,30	c-e
14	123,11	119,03	21,66	a-d	22,33	a-c	45,40	b-g	51,50	a-d
15	122,25	117,85	20,98	a-e	22,35	a-c	42,90	d-g	48,50	b-e
16	121,90	117,25	20,36	b-g	21,79	a-c	45,20	b-g	46,60	de
17	121,09	117,40	19,15	d-g	22,38	a-c	47,20	a-f	47,20	c-e
18	122,11	115,64	20,26	b-g	22,55	a-c	42,60	d-g	51,40	a-d
19	124,93	120,07	18,72	d-g	25,10	a	46,80	a-g	49,70	b-e
20	124,47	116,00	17,37	fg	20,29	c	39,80	g	48,20	b-e
21	124,49	118,18	17,74	e-g	21,68	a-c	41,90	fg	47,30	c-e
22	121,86	116,06	17,50	fg	20,31	c	42,40	e-g	48,60	b-e
23	120,10	115,15	19,69	c-g	22,11	a-c	43,80	c-g	49,90	b-e

Conclusions

The study conducted in Karaburun peninsula where significant bay laurel area exist in the Aegean Region located at the west part of Turkey. This study is very important because of that older studies held on bay laurel are mostly related with volatile oil content of leaves and fruits (Hafizoğlu and Reunanen, 1993; Pino *et al.*, 1993; Ozek *et al.*, 1998; Caredda *et al.*, 2002; Sangun *et al.*, 2007; Sellami *et al.*, 2011; Cherrat *et al.*, 2014). There was not study on leaf properties of trees. It is found that leaf characteristics of genotypes differ to each other. Average leaf length and width changed between 4,02 to 6,83 cm and 1,90 and 3,58 cm, respectively. As Turkish Standard Institution, laurel leaves are to be 25-100 mm length and 20-45 mm width for drying and trading. Base on research results, many genotypes may use for dried leaf. But it is determined all genotypes which grow at the other regions before decide to use as mother plant for nursery tree propagation.

References

- Acar İ. (1987). Laurel (*Laurus nobilis* L.) leaves and leaves of Essential Oil Production and Evaluation. Forestry Research Institute, Technical Bulletin No: 186, Ankara; Turkey.
- Anonymous (2003). Statistics of Aegean Exporters' Association.
- Anonymous (2005). Bay laurus. No: September-October, 30 p.
- Anonymous (2015). Statistics of Aegean Exporters' Associations.
- Ateş H. (1963). Turkey exported goods. Istanbul Chamber of Commerce publications, İstanbul, Turkey 221 p.
- Boza A., Hepaksoy S. (2011). Identification of Leaf Properties of Natural Bay Laurel (*Laurus nobilis* L.) Population in Dilek Peninsula (Kuşadası/Aydın). Proceeding of 6th National Horticultural Congress Vol. I: 786-790, Şanlıurfa/Turkey.
- Caredda A., Marongiu B., Porcedda S., Soro C. (2002). Supercritical Carbon Dioxide Extraction and Characterization of *Laurus nobilis* Essential Oil. J. Agric. Food Chem., 50 (6): 1492–1496.
- Cherrat L., Espina L., Bakkali M., Garcia-Gonzalo D., Pagan R., Laglaoui, A. (2014). Chemical composition and antioxidant properties of *Laurus nobilis* L, and *Myrtus communis* L. essential oils from Morocco and evaluation of their antimicrobial activity acting alone or in combined processes for food preservation. J. Sci. Food Agric., 94: 1197–1204.
- Davis P.H. (1982). Flora of Turkey and East Aegean Islands. Vol 7, pp.534-535.
- Gökmen H. (1973). Angiosperm Plants Volume I. Şark Press, Ankara, Turkey 576 p.
- Hafizoğlu B., Reunanen M. (1993). Studies on the components of *Laurus nobilis* from Turkey with special reference to laurel berry fat. Fat Sci. Technol., 9: 304–308.
- Leung A.Y., Foster S. (1999). Alloro, Enciclopedia delle Piante Medicinali; Aporie: Roma, Italy, pp 30–31.
- McGuire R.G. (1992). Reporting of objective color measurements. Hortic. Sci., 27: 1254–1255.
- Odabaş M.S., Gülümser A. (2005). Developing a Software for Determining Total Leaf Area on Faba Bean (*Vicia faba* L.), Journal of Tekirdag Agricultural Faculty, 2 (3): 268-272.
- Ozek T., Bozan B., Baser K.H.C. (1998). Supercritical CO₂ extraction of volatile components from leaves of *Laurus nobilis* L. Chem. Nat. Comp., 34: 668–671.
- Pino J., Borges P., Roncal E. (1993). The chemical composition of laurel leaf oil from various origins. Die Nahrung, 37: 592–595.
- Sangun M.K., Aydın E., Timur M., Karadeniz H., Caliskan M., Ozkan A., (2007). Comparison of chemical composition of the essential oil of *Laurus nobilis* L. leaves and fruits from different regions of Hatay, Turkey. J Environ. Biol., 28: 731–733.

- Santoyo S., Lloría R., Jaime L., Ibañez E., Señoráns F.J., Reglero G. (2006). Supercritical fluid extraction of antioxidant and antimicrobial compounds from *Laurus nobilis* L. Chemical and functional characterization. *Eur Food Res Technol.*, 222:565–571.
- Sellami H.I., Wannes W.A., Bettaieb I., Berrima S., Chahed T., Marzouk B., Limam F. (2011). Qualitative and quantitative changes in the essential oil of *Laurus nobilis* L. leaves as affected by different drying methods. *Food Chem.*, 126: 691–697.

RELATIONS BETWEEN FRUIT BEARING HABIT, AND CARBOHYDRATE / NITROGEN LEVELS IN ‘HACIHALILOGLU’ APRICOT CULTIVAR

Ibrahim BOLAT^{1*}, Mustafa SAHIN²

¹Department of Horticulture, Faculty of Agriculture, Harran University, Sanliurfa, Turkey

²Olive Resarch Instititue, Bornova, Izmir, Turkey

*Corresponding author: ibolat@harran.edu.tr

Abstract

Turkey is the biggest apricot producer in the world. Most of the apricots are produced in the Malatya region of Turkey. The ‘Hacihaliloglu’ cultivar is the main apricot cultivar in Malatya. It has an exceptional dried fruit quality, but there are problems in pruning application with respect to fruit bearing habit. In this study, fruit set and carbohydrate–nitrogen level changes were investigated in relation to branch age in ‘Hacihaliloglu’ apricot. The minimum and maximum fruit set were observed in 1- and 3-year-old branches in two consecutive experimental years, respectively. The flower bud ratios on 2- and 3-year-old branches were higher than those of 1-year-old branches. The carbohydrate contents measured in bark of 2- and 3-year-old branches were higher when compared to 1-year-old branches. On the other hand, the maximum nitrogen contents of shoot barks were obtained in 1-year-old branches. Total carbohydrate / nitrogen ratio was higher on 2- and 3-year-old branches than those of 1-year-old branches. In adjusting the crop load of ‘Hacihaliloglu’ apricots, there is a need to better recognition of the 1-, 2- and 3-year-old branches on the trees. In years with higher crop load, a thinning on 2- and 3-year-old branches of mature trees in winter pruning would be helpful as well as preserving those branches in the young trees.

Keywords: *Apricot, Fruit bearing, Branch age, Carbohydrate / nitrogen ratio*

Introduction

Apricot is one of the most important stone fruits that can be used fresh, dry and in various processed forms. Turkey takes the first place among apricot producing countries with 812 thousand tons, which is approximately 20% of the world apricot production. In addition Turkey meets 77% of dry apricot production which is 162 thousand tons (FAOSTAT, 2013). Most of the apricots are produced in Malatya province of Turkey. The ‘Hacihaliloglu’ is a leading apricot cultivar produced in Malatya. It is an exceptional cultivar in terms of dry fruit quality among other cultivars (Ercisli, 2014).

It is important to use all modern techniques in apricot production for high crop potential and quality of the fruit. Pruning is one of the most important cultural practices applied to temperate zone fruit trees. Pruning is made at different forms and periods, affects carbohydrate and nitrogen content in tissues and organs in fruit trees. In temperate zone trees and other woody plants, carbohydrates play an important role as a source of reserve energy. Nitrogen is known to be indispensable element for growth, development and productivity of plant. Carbohydrates and nitrogen are used in metabolism and transferred to other parts of plants. In order to achieve optimal condition for shoot growth, photosynthesis, leaf area, annual building of storage reserves and ultimate realization of good yield with high quality fruit, precise pruning is an essential factor (Lang, 2001; 2005; Demirtas et al., 2010). The pruning of trees results in changes in partitioning

of the reserves in the tree. For a successful pruning branch habit and fruiting behavior should be identified.

The aim of this study, therefore, was to determine the types of branches occurred in 'Hacihaliloglu' apricot variety, where flower buds and fruit sets are intensified. The second aim was to find the accumulation level of carbohydrate and nitrogen in branches of different ages.

Material and Methods

This study was conducted in Malatya Province with 24 years old 'Hacihaliloglu' apricot trees in an orchard with distance 10 x 10 m.

All the shoots on 3 marked skeleton branches of different 'Hacihaliloglu' apricot cultivar trees were measured and counted. All the data were calculated by using 1 linear meter of skeleton wood. The following classification was made for defining the shoots: dwarf shoots - up to 3 cm, spurs - 4-10 cm, floral shoots - 11-30 cm, mixed shoots - 31-60 cm, vegetative shoots – over 60 cm (Tsonev and Tsoneva, 1995).

The numbers of total buds and flower buds on branches in each age group before the period of buds swell at 1-, 2- and 3-year-old branches on the marked skeleton branches were determined. Then flower buds rates were found according to age of branch with the calculation (Askin, 1989). Similarly, branches were labeled by counting 350-600 flower buds at the period of pink buds in selected 1-, 2- and 3-year-old branches on marked skeleton branches. Fruit set levels were established by dividing the number of fruits at harvest time with the number of flower buds (Bolat and Guleryuz, 1994).

Barks of middle parts of the shoots selected at 1-, 2- and 3-year-old branches on skeleton branches in June and October were peeled and the samples of barks were dried at 65°C then in these samples, carbohydrate and nitrogen analysis were made by using methods of Antron (Kaplan, 1984) and Kjeldhal (Bremner, 1965) respectively.

The study was designed according to randomized block design with 3 replications. Significance of differences between averages was utilized using the test of "Least Significant Difference" (LSD) at 1% level.

Results and Discussion

In the 'Hacihaliloglu' apricot cultivar, the highest number of shoot with the levels of 52.24% and 56.08% and the lowest number of shoot with levels of 2.42 and 1.07% were found in dwarf shoots (0.00-3.99 cm) and mixed shoots (31.00-60.99 cm) respectively in both years (Table 1). Vegetative shoots could not be determined in both years. On the other hand, the highest rate in shoot length in the first year was occurred in floral shoots (53.65%) followed by spurs (20.02%) and the lowest rate was in mixed shoots (11.81 %). Similarly, while also spur and floral shoots took the highest part in the total shoot length, in second year, mixed shoots had the lowest value (Table 1). In the study of Tsonev and Tsoneva (1995) made on Kishinevskij rannij, Candelo, Pepitos, Radinskij, Carrascal, Ungarska kaisiya and Modesto apricot cultivars, they determined that spurs and floral shoots were dense and the level of mixed and vegetative shoots was at very low ratio on linear meter of skeleton branches. Moreover, they found that the shoot density in the 11-30 and 31-60 cm length in years of low yield increased and the level of dwarf shoot was high in years of high yield. Researchers pointed out that Candelo and Pepitos cultivars mostly generated spur type shoots, while Kishinevskij Rannij had mostly floral shoots and differences established in shoot types in cultivars must be taken into account in pruning applications.

Table 1. Percentage of shoot categories, with regard to shoot number and length of linear meter of skeleton branch

Categories of shoots	First year		Second year	
	Shoot number (%)	Shoot length (%)	Shoot number (%)	Shoot length (%)
Dwarf	52.24	14.52	56.08	22.82
Spur	24.56	20.02	32.86	37.62
Floral	20.78	53.65	9.99	31.92
Mixed	2.42	11.81	1.07	7.64
Vegetative	0	0	0	0

In ‘Hacihaliloglu’ variety, the flower bud ratios on 1-, 2- and 3-year-old branches were found to be 64.99-65.86%, 70.95-70.85% and 73.31-70.31% (Table 2). In both experimental years, flower buds in 2- and 3-year-old shoots was found in similar and higher ratios than those in 1-year-old shoots. In many of the temperate fruit species, the levels of flower buds are accepted to be a significant indicator for yield, and were observed to differ with respect to the age of branch. In the study Askın (1989), made on Tokaloglu, Turfanda Izmir, Sam and Malatya apricot cultivar, flower bud ratio in varieties was determined to change between levels of 54.35-79.43%.

The level of fruit set in 1-, 2- and 3-year-old branches in both years were found to be 11.41-10.89 %, 16.80-14.95 % and 20.62-15.98, respectively in ‘Hacihaliloglu’ variety (Table 2). The fruit set in 2- and 3-year-old branches had higher values than those in 1-year-old branches.

Table 2. Percentage of flower bud ratio and fruit setting at various age of branches

Branch age	First year		Second year	
	Flower bud ratio (%)	Fruit setting (%)	Flower bud ratio (%)	Fruit setting (%)
1-year-old	64.99 b	11.41 c	65.86 b	10.89 b
2-year-old	70.95 a	16.80 b	70.85 a	14.95 a
3-year old	73.31 a	20.61 a	70.70 a	15.98 a
Lsd 1%	2.07	1.77	2.38	1.60

(**):The means followed by the same letter in each column are not significantly different according to LSD test at 1% level.

Some researchers assigned that the level of fruit set could vary according to different portions and shoot types of tree. Therefore, Ozbek (1989), emphasized that yield was mostly formed in 2-year-old and older branches and they need to be saved during the pruning. On the other hand, Pugliano and Forlani (1985) conducted a study to investigate the productivity of shoots in 10 different apricot varieties and they established a difference between fruit set ratios and the level of flower among varieties. The level of fruit set in the terminal part of long shoots in 8 varieties was higher than fruit set ratio of the basal parts of the same shoots (in terminal part 46.90%, in basal part 31.60%).

Also Szujko-Lacza (1985), reported that in apricot trees, flower buds are larger than the vegetative buds and they are formed on the oldest side branches, twigs and on the basal part of the one-year old terminal shoots. Neri et al. (2010) also suggested that apricot varieties have different architectures in their tree habit and fruiting branches. He stated that there are 3 most common architecture groups (1) with a spreading habit and very vigorous, and a tendency to fruit

on spurs, brindles and sylleptic shoots; (2) with a semi-spreading habit and generally less vigorous, and with the capacity to fruit on spurs and more vigorous shoots; and (3) with a very vigorous, mixed spreading habit, and ability to fruit on all kinds of shoots.

When the carbohydrate contents in dry barks were compared, those in shoot bark of 2- and 3-year-old shoots were usually higher than in 1-year-old shoots in both years. The total carbohydrate contents were found to be 13.95 - 13.96 - 14.00 % in June and 13.33, 14.66, 15.36% in October (Table 3). The highest nitrogen contents in shoot barks were found in 1-year-old shoots and the nitrogen levels in 2- and 3-year-old shoots were determined to be same. The nitrogen contents in barks had values of 1.02 – 0.93 – 0.89 % in June and 1.11-1.02-0.99 % in October (Table 3). When total carbohydrate / nitrogen ratio was evaluated, in 2- and 3-year-old branches it was established to be higher than in 1-year-old branches. These ratios showed values of 14.06-15.76-16.57 in June and 12.00-13.95-15.51 in October (Table 3).

Table 3. Total carbohydrate (CH) and nitrogen (N) contents, carbohydrate/nitrogen ratio at various age of branches in average of two years

Branch age	June			October		
	CH (%)	N (%)	CH / N	CH (%)	N (%)	CH / N
1 year-old	13.95	1.02 a	14.06 b	13.33 b	1.11 a	12.00 c
2 year-old	13.96	0.93 b	15.76 a	14.66 a	1.02 b	13.95 b
3 year old	14.00	0.89 b	16.57 a	15.36 a	0.99 b	15.51 a
LSD(**)	---	0.03	1.02	0.85	0.05	1.20

(**):The means followed by the same letter in each column are not significantly different according to LSD test at 1% level.

In the temperate zone trees, total perennial parts have maximum carbohydrate contents in the autumn, that start to decrease in late winter, and rapidly decrease in early spring (Clair-Maczulajtys *et al.*, 1994 , Moing *et al.*, 1994). In temperate zone trees and other woody plants, carbohydrates have a role as an essential source of reserve energy. In metabolism they can become mobile and be transferred to other plant organs. Many factors, such as temperature, moisture, light, pruning, and time of planting affect the concentration and localization of carbohydrates, such as sugars and starches, within tissues (Daie, 1985).

In ‘Hacihaliloglu’ variety in the trial, carbohydrate contents of 3-year-old branches generally were established highest, followed by 2- and 1-year-old branches. Total carbohydrate / nitrogen ratios were revealed to have the same results. The results related to carbohydrate contents achieved from ‘Hacihaliloglu’ apricot variety are compatible with the findings of Stutte *et al.* (1994), Clair-Maczulajtys *et al.* (1994), Tamdogan (2006), Demirtas *et al.* (2010) and İkinci (2014) who conducted studies on apple, cherry, apricot, and peach varieties.

Conclusion

In fruit trees, it is suggested that total carbohydrate / nitrogen ratio known as an indicator of balance of vegetative and generative development is higher in older parts of tree than that in young parts. While in young trees, higher ratio is demanded for producing earlier yield as soon as possible, in old trees, this ratio is tried to be lowered. High total carbohydrate / nitrogen ratios in

'Hacihaliloglu' could be reduced by pruning. The fact that crop load of 'Hacihaliloglu' apricot variety is adjusted is a fundamental need for better recognizing of the 1-, 2- and 3-year-old branches on the trees. In years with high crop load, in winter pruning a thinning on 2- and 3-year-old branches of mature trees would be a good choice. Also, those branches should be saved in the young trees.

References

- Askin, M. A. (1989). Biological studies in some apricot varieties in Egean District [Ph.D. thesis], Ege University, Turkey, 133p.
- Bolat, İ., Güleriyüz, M. (1994). A study of fertilization biology of apricot (*Prunus armeniaca* L., cv. Hasanbey) grown in Erzincan ecological conditions. Journal of the Faculty of Agriculture, 25(4):509-519.
- Bremner, J.M. (1965). Inorganic Forms of Nitrogen Black C.A Methods of Analysis Vol. 2. Madison: American Society of Agronomy. pp :1179-1237
- Clair-Maczulajtys, D. Sarthou, C. and Bory, G. (1994). Effects of pruning on carbohydrate distribution in the trunk of sweet cherry (*Prunus avium* L.). Scientia Horticulturae, 59(1) : 61–67.
- Daie, J. (1985). Carbohydrate partitioning and metabolism in crops, Horticultural Reviews, 7, 69–108.
- Demirtas, M. N., Bolat I., Ercisli, S., İkinci, A., Olmez, H., Sahin, M., Altindag, M. and Celik, B. (2010). The effects of different pruning treatments on seasonal variation of carbohydrates in "Hacihaliloglu" apricot cultivar. Notulae Botanicae Horti Agrobotanici Cluj, 38, 223–227.
- Ercisli S. (2004). A short review of the fruit germplasm resources of Turkey. Genet. Res. Crop Evol., 51, 419–435.
- FAOSTAT (2013). Crops production in 2013. <http://faostat.fao.org/site/567/default.aspx#ancor>
- İkinci, A. (2014). Influence of pre- and postharvest summer pruning on the growth, yield, fruit quality, and carbohydrate content of early season peach cultivars. The Scientific World Journal 104865,1-8.
- Kaplankiran, M. (1984). The relationships between citrus rootstocks growth and phytohormone, minerals and carbohydrate content [Ph.D. thesis], Cukurova University, Turkey.
- Lang, G. A. (2001). Critical concepts for sweet cherry training systems. Comp. Fruit Tree, 34: 455-459.
- Lang, G.A. (2005) Underlying principles of high density sweet cherry production, Acta Horticulturae, 667, 325–333.
- Moing, A., Lafargue, B., Lespinasse, J. M. and Gaudillere, J. P. (1994). Carbon and nitrogen reserves in prune tree shoots: effect of training system. Scientia Horticulturae, 57(1-2): 99–110.
- Neri, D., Morini, F., Massetani, F. And Pirazzini, P. (2010). Pruning: how to manage shoot growth. Acta Horticulturae, 862: 355-364.
- Ozbek, S. (1989). General Fruit Growing. Cukurova University, Agricultural Faculty Press. 386 p.
- Pugliano, G., Forlani, M. (1985). Two-year observations on the biology and fructification of apricot. Acta Horticulturae 192: 383-400.
- Stutte, G. W., Baugher, T. A., Walter, S. P., Leach, D. W., Glenn, D. M. and Tworkoski, T. J. (1994). Rootstock and training system affect dry-matter and carbohydrate distribution in golden delicious apple trees. Journal of the American Society for Horticultural Science, 119(3): 492–497.

- Szujko-Lacza, J. (1985). Data on the morphology and anatomy of *Prunus armeniaca*. *Acta Horticulturae* 192: 9-18.
- Tamdogan, T. (2006). Pruning affects carbohydrate accumulation and fruit bud formation in cherries [MSc. thesis], Cukurova University, Turkey, 41p.
- Tsonev, R., Tsoneva, E. (1995). The growing habits of one year branches in some apricot varieties. *Acta Horticulturae*, 384: 449-453.

MINIMIZATION OF THE COST OF CONTRACTED TOBACCO PRODUCTION USING LINEAR PROGRAMMING

Funda GENCLER^{1*}, Altay Ugur GUL²

¹School of Tobacco Expertise, Celal Bayar University, Manisa, Turkey

*Corresponding author: funda.gencler@cbu.edu.tr

Abstract

Turkey has a key role in oriental tobacco farming all over the World. There has been a significant change in tobacco production due to Governmental policies since 2001. The overall marketing system has been transferred to private companies where they are solely determining the tobacco leaf prices. Currently contracted farming system is in charge in tobacco production in Turkey. Under contracted farming, tobacco growers would agree to sell their tobacco at a predetermined price negotiated with buyers before the planting season. The contracts, signed over a one year period with farmers, include details about the production such as the responsibilities of farmers and companies. The contract goes beyond being an explanatory text about the details of tobacco production and works as a tool reformatting the entire tobacco market. The scope of this study is to summarize the tobacco production and marketing policies for last two decades in Turkey and to find out different approaches minimizing purchase costs for private companies. The data that is used in the study were collected from different literature sources: contracted tobacco farming regions in Turkey and their land size, tobacco production amount and producing cost of raw leaf tobacco in these regions. This hypothetical application is done linear programming model with 6 variables and 15 constrains. As a result of the linear programming solution; it has been predicted that 65,556 ha. including Aegean Region, of total 93,117 ha. contracted farming should be done. The amount of tobacco leaf is 80,000 tons and the purchase cost is \$ 335,840,770.78.

Keywords; *Turkish Tobacco Policy, Minimizing Purchase Costs, Linear Programming*

Introduction

Tobacco is one of the most talked about and debated agricultural products not only in Turkey but in the whole world (Koçturk and Cebeci, 2005). Oriental tobacco is mainly cultivated in Turkey, Greece, Bulgaria, Macedonia, Moldavia and Kyrgyzstan, however quarter of total oriental tobacco production is performed in Turkey Tobacco is one of the most important export goods which symbolizes Turkey's agricultural export product and it has a vital importance for tobacco farmers. Turkey exports tobacco approximately to 50 countries. Mainly buyers of Turkish tobaccos are European Union countries and USA. The annually export value is just about 430 million dollars (Ersan, 2005).

Rapid increases in tobacco production beginning in 1987, and the expansion of tobacco farms in less than optimal areas resulted in increased stock costs and decreased leaf quality. As a result, the Turkish government developed policies to more effectively control tobacco farming. Quota applications and the development of alternative crops are among those policies. A quota system, introduced in 1995, was instituted each year (except 1997) with quotas set at varying levels (Ren & Alemdar, 2006).

Given that tobacco and its production have been of strategic importance in Turkey, legislation concerning the tobacco sector has all along been specially organized and regulated via institutions

under different statutes. Under Law No. 4733 of 2002, the state tobacco monopol Tekel (which had regulated the tobacco and alcoholic beverages sector since 1923) was transformed into an incorporated company and its market regulation responsibilities were transferred to TAPDK (The Tobacco and Alcohol Market Regulatory Authority).

It is important to note that tobacco production policy has been considerably modified since 2002, with the liberalization of the tobacco market, elimination of the subsidy system and adoption of a contract production model. Many producers could not adapt to the changing conditions, and the 478 000 producers in 2001 had fallen to 207 000 by 2007.

Until recently, tobacco leaf agriculture yielded substantial revenues. The production of leaf tobacco was, however, negatively affected by the arrival of the multinational tobacco industry in 1986 and consequent loss of market share in both the country and the region, combined with regulation of the tobacco sector by the IMF and World Bank in 2000. Turkey is still, however, the fifth largest cigarette producer in the world with approximately 142.9 billion cigarettes produced in 2015 (TAPDK, 2016).

Currently contracted farming system is in charge in tobacco production in Turkey. Under contracted farming, tobacco growers would agree to sell their tobacco at a predetermined price negotiated with buyers before the planting season. The contracts, signed over a one year period with farmers, include details about the production such as the responsibilities of farmers and companies. The contract goes beyond being an explanatory text about the details of tobacco production and works as a tool reformatting the entire tobacco market.

Linear programming (LP) is one of the best developed and most used branches of management science. It concerns the optimum allocation of limited resources among competing activities, under a set of constraints. These constraints could reflect financial, technological, marketing, organizational (Bradley et. al., 1976; Bunday, 1984). The basic problem of LP is one of either maximizing or minimizing a function of several variables, with the variables being subject to a number of constraints (Swanson, 1987). The three basic assumptions of all LP models are: linearity, divisibility and determinism (Markland and Sweigart, 1987).

The aim of this study was to actualize minimizing production costs of raw leaf tobacco by using linear programming in the scope of contracted tobacco farming practice in Turkey.

Materials and methods

The following data were collected from different literature sources: contracted tobacco farming regions in Turkey and their land size, tobacco production amount and producing cost of raw leaf tobacco in these regions (Table 1, TAPDK and Tobacco Experts Association web site).

Table 1. Summary information for the contracted leaf tobacco production in Turkey* (2015).

Regions	The level of production (kg/ha)	Production costs (\$/ha)
Aegean	799.2	3499.35
Marmara	857.6	3718.31
Black sea	1133.9	5576.36
East Anatolia	1806.1	3379.99
Southeastern Anatolia	918.3	2689.31
Mediterranean	1075.5	1993.52

Source: TAPDK* and Tobacco Experts Association, 2016

For minimizing the cost of leaf tobacco production was determined target values in Table 2 based on these data.

* The Tobacco and Alcohol Market Regulatory Authority

Table 2. Right hand side (RHS) values of the constraints

The constraints	RHS (b_i)
Area (1,000 ha)	70-100
Leaf tobacco production (1,000,000 kg)	≥ 80
Aegean (1,000 ha)	50-80
Marmara (1,000 ha)	3-5
Black sea (1,000 ha)	10-15
East Anatolia (ha)	30-60
Southeastern Anatolia (1,000 ha)	7-10
Mediterranean (1,000 ha)	1.5-2.5

The model is stated with the following set of equations:

$$Z_{\min} = \sum_{j=1}^6 c_j x_j$$

Subject to

$$\sum_{j=1}^6 x_j \leq b_1$$

$$\sum_{j=1}^6 x_j \geq b_2$$

$$\sum_{j=1}^6 a_j x_j \geq b_3$$

$$x_j \geq b_i \quad (i = 4,5,\dots,9; j = 1,2,\dots,6)$$

$$x_j \leq b_i \quad (i = 4,5,\dots,9; j = 1,2,\dots,6)$$

where

x_j , decision variable, the contracted leaf tobacco production area in j th region,

c_j , the cost of leaf tobacco production in j th region (\$/ha),

b_i , the righthand side of i th constraint (RHS),

a_j , the leaf tobacco production in j th region (kg/ha),

Results and Discussion

According to the solutions of the model; 6.883 hectares (6.88%) is under the upper limit value, and total 93.115 hectares of contracted tobacco leaf production area is determined. Total production quantity is 80 million kilograms and the total cost is \$ 335,840,770.78.

Table 3. Summary of the solution to the LP model

Regions	Area (ha)	Production (kg)	Cost (\$)
Aegean	65,557	52,392,884	229,405,984.94
Marmara	5,000	4,288,000	18,591,542.86
Blacksea	10,000	11,339,000	55,763,582.14
East Anatolia	60	108,366	202,799.23
Southeastern Anatolia	10,000	9,183,000	26,893,071.43
Mediterranean	2,500	2,688,750	4,983,790.18
Total	93,117	80,000,000	335,840,770.78

The distribution of the area for contracted leaf tobacco production is shown in Figure 1. The Model gives the results that the contracted tobacco farming can be done as follows; in Marmara, East Anatolia, Southeastern Anatolia and Mediterranean region, is within the upper limit level, in Black Sea in the lower limit level for Aegean Region is above 15.557 hectares (31.11 %) in the lower limit level.

Also; 91.88% of all tobacco production is in Aegean, Black Sea and Southeastern Anatolia Regions. This ratio is 70.40 % solely in Aegean Region.

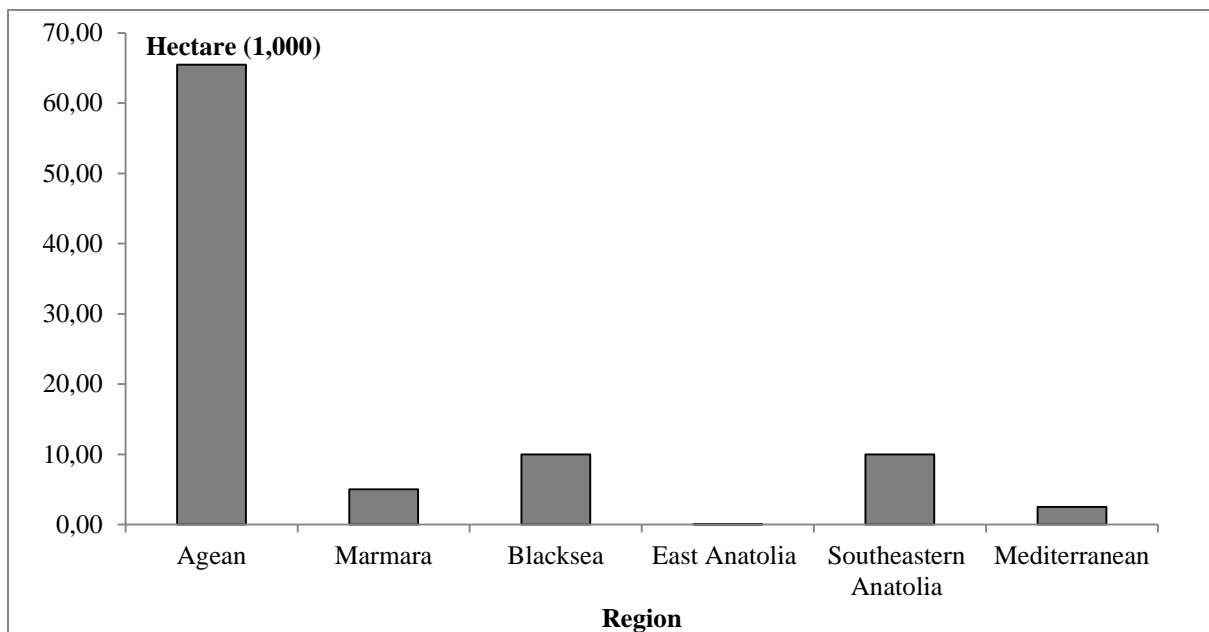

Figure 1. The distribution of tobacco production areas

Figure 1 shows the distribution of the area where the contracted leaf tobacco production is going to be done. The model shows that, 91.14 % of the contracted tobacco farming demand can be provided from the Aegean, the Black Sea and Southeastern Anatolia Regions. Also the ratio is 65.49 % in Aegean Region.

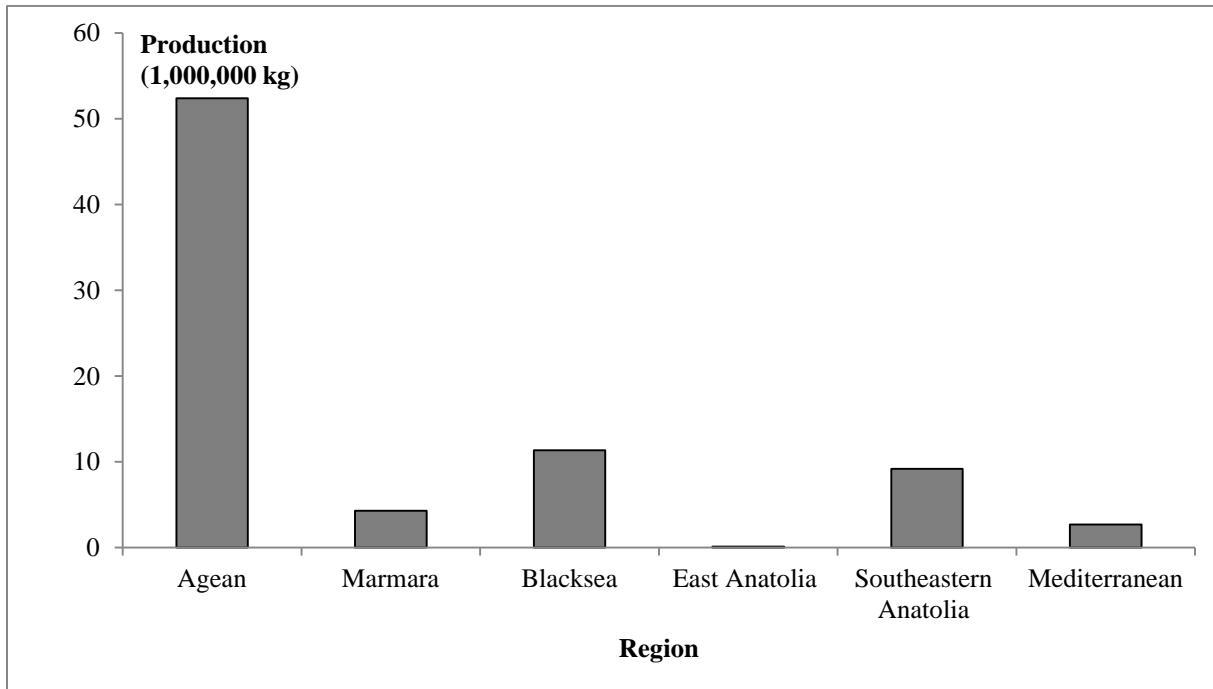

Figure 2. The distribution of tobacco production.

In Figure 3, the distribution of contracted tobacco leaf production cost is shown. The outcomes of the model indicate that the 92,92 % of the production costs will be occurred in Aegean, the Black Sea and the Southeastern Anatolia Regions and 68.31 % of the production cost will be occurred in Aegean region.

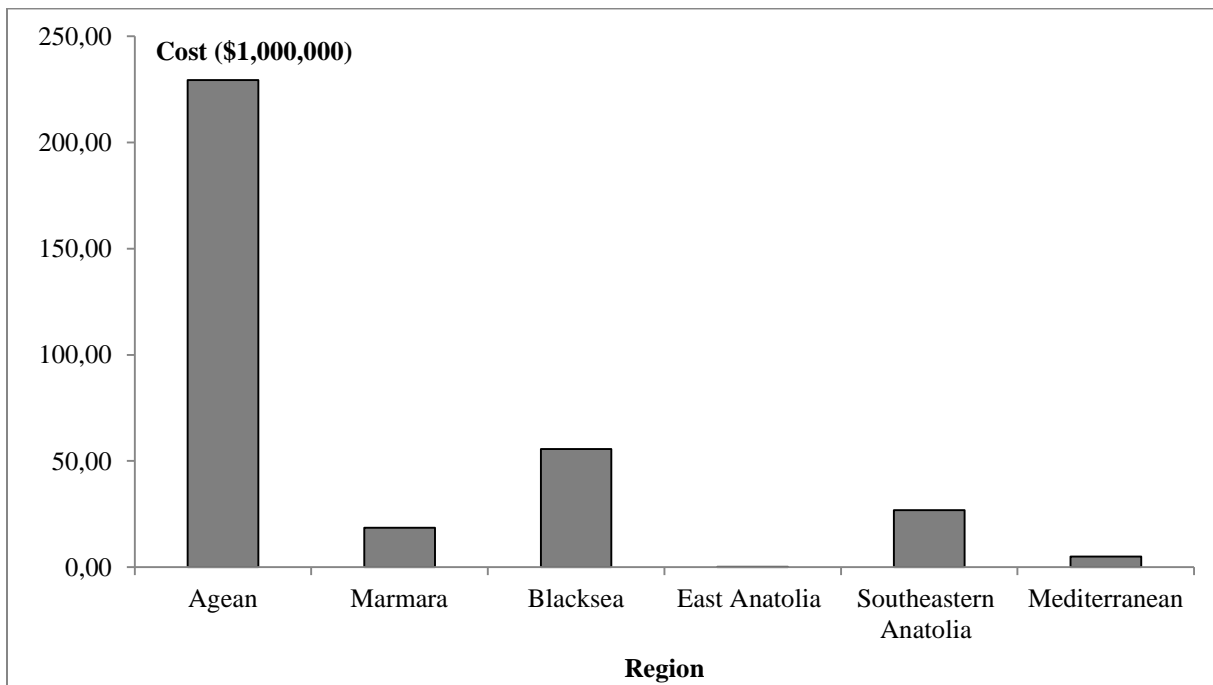

Figure 3. The distribution of the cost of tobacco production.

According to Table 1, the highest yield is in Eastern Anatolia Region and the lowest yield is in Aegean Region.

In the model, in order to minimize production costs, highest production costs in the Black Sea region is limited at the lower level, the limits are set at a maximum level in other regions except Aegean Region. According to Table 1; Black Sea region, is more productive than Aegean region but production costs are high. Therefore the model provides at least 80 million kilograms of tobacco leaf production constraints; Aegean region is selected 15,557 hectares more production area at the lower limit value instead of Black Sea region.

Conclusion

In Turkey, tobacco cultivation is generally carried out in the form of contracted tobacco production. In each region, the tobacco yields and tobacco production costs varies. In this case, the tobacco companies are faced with the problem of minimizing the total cost of tobacco production. Linear programming is widely used as a mathematical method for this purpose. By using 2015 data, it is showed that how this model can be used to minimize the costs of contracted tobacco purchase in Turkey.

As a result, the model solution, both production areas, production quantity and production costs aspects, the Aegean Region by 65-70 % has an important role; Black Sea Region and Southeastern Anatolia Region (10-15%) are followed.

References

- Bradley, A.P., Hax, A. C. and Magnanti, T. H.. (1976). Applied mathematical programming, Addison-Wesley Publishing Company, London, pp 715.
- Bunday, B. D. (1984). Basic linear programming. Edward Arnold, USA, pp 163.
- Ersan, A. (2004). Tobacco sector profile, Istanbul, Chamber of Commerce, Study and Research Department, Istanbul, pp116-123.
- Koçturk, O.M., Cebeci A. N. (2005). Journal of Agriculture and Rural Development in the Tropics and Subtropics Volume 106, No. 2, pp 167.
- Markland, R. E. and Sweigart, J. R. (1987). Quantitative methods: applications to managerial decision making, John Wiley & Sons, New York, pp 827.
- Ren M. N. Alemdar T. (2006). Technical efficiency analysis of tobacco farming in Southeastern Anatolia, Turkish Journal of Agriculture and Forest, Volume 30 TUBITAK, Ankara, pp. 165-172.
- Bilir N. et all, (2010). Tobacco control in Turkey, World Health Organization, ISBN 978 92 890 4182 9 Copenhagen, Denmark, pp35-37.
- Swanson, L. W. (1987). Linear programming: basic theory and applications, McGraw-Hill Book Company, New York, pp 218.
- TAPDK. (2016). The Tobacco and Alcohol Market Regulatory Authority <http://www.tapdk.gov.tr/tr.aspxgfr>

VITAMIN PROFILES OF MAIZE LANDRACES FROM A MINI CORE COLLECTION FOR GRAIN QUALITY

Jelena VANČETOVIC, Jelena MESAROVIC, Dragana IGNJATOVIĆ-MICIC, Sofija BOŽINOVIĆ, Ana NIKOLIC, Dragana MRĐEN, Milan STEVANOVIĆ

Maize Research Institute Zemun Polje

Abstract

Profiles of vitamins A and E were analysed in 16 maize landraces from mini core collection for grain quality using HPLC technique. Contents of $\gamma+\beta$ and δ tocopherols (vitamin E fractions) were moderate on the average, and neither landrace showed exquisite values of these compounds, while α -tocopherol content was high in two landraces ($13.330\mu\text{g g}^{-1}$ and $9.138\mu\text{g g}^{-1}$). Since these 16 landraces are not high-oil ones, lack of high concentrations of some vitamin E fractions would not be reflected on quality and stability of oil potentially extracted from them. The tested landraces are white to orange flints or semi flints, and vitamin A fractions ranged from the trace values (white landraces) to $11.37\mu\text{g g}^{-1}$ lutein, $40.91\mu\text{g g}^{-1}$ zeaxanthin and $5.248\mu\text{g g}^{-1}$ β -carotene. Maximum lutein value was not very high, but maximum values for zeaxanthin and β -carotene were high in comparison with the literature data. One landrace, named L 161, had high values of α -tocopherol (second in range) and both the highest values of zeaxanthin and β -carotene and it could be used for maize biofortification.

Keywords: *antioxidants, landraces, maize, vitamins*

Introduction

Humans and animals are incapable of carotenoid and tocopherol biosynthesis and they depend on dietary carotenoid and tocopherol sources. Carotenoids (provitamin A) and tocopherols (vitamin E) are lipid soluble antioxidants associated with decreased risk of several degenerative diseases. Increased zeaxanthin is important for improved eye-sight, while α -tocopherol and β -carotene are strong antioxidants. The increase of bioavailability of carotenoids, especially β -carotene, has been reported with high amount of protein and fat, a component of oil (Failla and Chitchumronchokchai, 2005). Starch and carotenoids are primarily located in the endosperm of maize grain, whereas oil and tocopherols, consisting mainly of α -, δ -, and γ -tocopherol, are located in the embryo (Sandman, 2001).

Two classes of carotenoid pigments comprise carotenes and xanthophylls, which are responsible for the yellow and orange colours of corn endosperm. Among the major food grains, only yellow maize contains significant levels of β -carotene (Buckner et al., 1990). Carotenoids are a complex class of isoprenoid pigments providing nutritional value as provitamin A (α -carotene, β -carotene, β -cryptoxanthin) and nonprovitamin A (lutein and zeaxanthin); their varied colours give additional commercial value as colorants in foods and nutrient supplementation (Matthews and Wurtzel, 2007). Yellow maize is also the main source of provitamin A in feed rations for swine and other animals (Brunson and Quackenbush, 1962). In broiler production, skin and shank pigmentation of birds are important quality factors that are supplied by yellow maize in the ration. Egg-laying poultry require high pigment levels in their feed for the production of eggs with dark yellow yolks that are desirable for baking products. Usually, flint maize has high content of proteins and β -carotene. Yellow maize kernels contain carotenoids ($0.25\mu\text{g g}^{-1}$ dry weight) with

provitamin A activity (β -cryptoxanthin, α - and β -carotene) but its content is typically small (15% to 18% of the total carotenoids fraction) compared to lutein (~ 45%) or zeaxanthin (35%), (Kurilich and Juvik, 1999; Brenna and Berardo, 2004). Thus, there is considerable attention for breeding maize with an enhance provitamin A concentrations by shifting carotenoid biosynthesis to favour provitamin A versus other types of carotenoids and thereby increasing nutritional value of the grain.

Among food crops, maize is the only principal source of non-provitamin A carotenoids, especially lutein and zeaxanthin. Zeaxanthin is a rare carotenoid in nature and together with lutein is an essential component of the macular pigment in the eye (Sandman, 2001). The presence of natural antioxidants, especially tocopherols in lipids improves their stability and delays oil rancidity (Weber, 1987a), gives maize oil flavour stability during storage and cooking and enhance shelf life of corn oil (Weber, 1987b; Watson, 1988; White and Pollak, 1995). There is evidence indicating that tocopherols, in particular γ -tocopherol, the predominant form of vitamin E in plant seeds, are indispensable for protection of the polyunsaturated fatty acids and have benefits in meat industry (Rocheferd et al., 2002).

Substantial variation in the levels of specific forms and total levels of carotenoids has been shown (Weber, 1987a). High heritability estimates for carotenoid (84-96%) and tocopherol (79-87%) fractions were found (Singh and Chaudary, 1985; Chander et al., 2008b), whereas medium to high levels of heritability for fractions of carotenoids (48-87%) and tocopherols (62-68%) were found by Galliher et al. (1985) and Wong et al. (2004). Moderate to high heritability estimates indicate that breeding for increased levels of both carotenes and tocopherols should be feasible.

Biofortification aims to develop micronutrient-enhanced crop varieties through conventional plant breeding (Ortiz-Monasterio et al., 2007). It should create micronutrient enhanced maize genotypes without compromising tolerance to abiotic and biotic stresses, grain yield, and acceptable end-use quality, thereby increasing the likelihood that farmers will adopt these cultivars and consumers will accept foods made from them. Since success in crop breeding depends on the existence of genetic variation for the target traits in the gene pool available. The goal of this research was to estimate A and E vitamin profiles of 16 maize landraces as potential sources for maize biofortification.

Material and Methods

Sixteen maize landraces comprising mini core collection for grain quality (Vančetović et al. 2015a, 2015b) and the check hybrid ZP 341 were used in this research. Landraces and the check hybrid were sown in two years (2014 and 2015) in Zemun Polje in two replications, according to the randomized complete block design (RCBD). Each landrace was multiplied by pair-crossing (full sibling), while the hybrid was selfed. At least 30 pollinated ears from each genotype were harvested, dried and shelled separately. One kernel from each ear was collected and gathered to form a sample for further analysis.

Maize kernels were milled (Perten 120, Sweden) into flour (particle size < 500 μ m) and stored at -20°C prior to analysis. Analysis was done on HPLC, for carotenoids by slightly modified method of Rivera and Canela (2012) and for tocopherols by modified procedure of Gliszczyńska-Świgłoet et al. (2007). HPLC grade solvents were: acetonitrile, 2-propanol and ethyl acetate purchased from Sigma Aldrich (Germany), and whilst methanol from J.T. Baker (Netherlands). Standards for tested carotenoids (lutein, zeaxanthin and β -carotene) and tocopherols (α -, γ - and δ) were purchased from Sigma Aldrich (Germany). All derived values are given in μ g g⁻¹ of dry weight (DW).

Two-way analysis of variance (ANOVA) was done for derived data and mutual comparisons between genotypes were done using the least significance difference (LSD) test at 0.05 level. The MSTAT-C software package (MSTAT Development Team, 1989) was used for statistical analyses.

Results and Discussion

Mean squares from two-way ANOVA for genotypes were significant at 0.001 level for all traits (Tab. 1). Differences between years were significant at 0.001 level for four traits, but not for vitamin δ E (significant at 0.01 level) and β -carotene (non-significant; data not shown). Population \times year interaction was significant (at 0.001 level) only for the three components of vitamin A. Average values of vitamin E and A compounds for the analysed genotypes are given in Tab. 1, as well as the results of LSD tests among them.

Table 1. Vitamin profiles of 16 maize landraces and check hybrid ZP 341

Vitamin		E	E	E	A	A	A
L/IP	Acc.No.	δ	γ + β	α	Lutein	Zeaxanthin	β -carotene
L	8	1.135def ¹	20.69def	3.154d	4.279e	19.42c	2.814e
L	161	1.836ab	20.64def	9.138b	5.687de	40.91a	5.248a
L	381	1.128def	21.34cde	13.330a	0.000f	0.00f	0.000h
L	449	1.552bc	26.14b	5.355c	5.683de	15.45cd	1.124g
L	451	1.279cde	28.41b	3.191d	5.398e	14.77cd	1.853f
L	492	1.661abc	33.18a	2.854d	5.668de	2.35ef	4.662ab
L	499	2.027a	28.85ab	5.731c	0.000f	0.00f	0.000h
L	626	1.329cd	26.73b	2.393d	7.295cd	2.65ef	1.275fg
L	933	1.289cde	26.80b	2.157d	5.794de	9.43de	2.970de
L	1190	1.488bcd	19.97ef	2.190d	0.983f	29.23b	3.595cd
L	1195	1.811ab	24.86bcd	2.440d	1.065f	30.61b	4.119bc
L	2283	1.122def	21.02cdef	6.327c	11.370a	2.16ef	1.443fg
IP	2314	0.857f	16.62fg	5.623c	8.639bc	4.03ef	3.631cd
IP	5038	0.921ef	15.23g	8.763b	0.000f	0.00f	0.000h
IP	6429	1.561bc	25.66bc	5.215c	4.097e	2.44ef	1.256fg
IP	7169	0.834f	16.83efg	3.148d	0.152f	0.14f	0.000h
Ch.	ZP 341	0.393g	8.95h	3.163d	10.110ab	11.56d	1.555fg
	LSD _{0.05}	0.399	4.669	1.213	1.741	7.340	0.7033
	Average	1.307	22.464	4.951	4.518	10.891	2.092
	MSG	0.711***	143.621***	37.708***	52.605***	636.145***	11.769***
	CV	21.21	14.45	17.03	26.78	46.85	23.38
	SD	0.48	7.11	3.09	3.98	14.00	1.78

¹ - values with different letters in the same column are significantly different at 0.05 level; L - landrace from Western Balkan; IP - introduced population; *** - statistically significant at 0.001 level; LSD_{0.05} – least significant difference value at 0.05 level; MSG - mean square of genotypes from two-way ANOVA; CV - coefficient of variation (%); SD - standard deviation of the trait

On the average, β -carotene comprised 11.95% of all the analysed vitamin A compounds, while lutein and zeaxanthin comprised the rest of 88.05%. This is in accordance with previous findings of Kurilich and Juvik (1999), Brenna and Berardo (2004), Howe and Tanumihardjo (2006) and Kuhnen et al. (2011). Zeaxanthin was the major carotenoid, the same as in the research of Egesel et al. (2003). However, data presented by Weber (1987b) indicated lutein to be the major

component of total carotenoids. These differences in the results are possibly due to different genetic materials analyzed. β -carotene in our research was the least abundant of the three carotenoid compounds and breeding for its higher concentrations are needed because of its high antioxidant activity. The efforts to breed maize for provitamin A have resulted in varieties with 9-17nmolg⁻¹ DW of total provitamin A carotenoids, primarily β -carotene (Kurilich and Juvik, 1999). In the mentioned research lutein content varied from 0 to 20mg kg⁻¹, and β -carotene from 0.07 to 7.64mg kg⁻¹.

Many studies have shown significant differences among maize genotypes in carotenoid and tocopherol levels. Wyatt et al. (1998) reported the value for total tocopherol content in Mexican corn to be 80.6 μ g g⁻¹, with relatively high content for γ -tocopherol of 58.0 μ g g⁻¹ and 22.6 μ g g⁻¹ for α -tocopherol. According to Tadmor et al. (2000) total tocopherol content in maize grain of inbred lines ranged between 65 and 90mg g⁻¹ DW, while the amount of α -tocopherol varied from less than 10 to more than 50%. Moros et al. (2002) have found a total xanthophyll content of 21.97mg g⁻¹, with lutein 15.7mg g⁻¹, zeaxanthin 5.7mg g⁻¹, and β -cryptoxanthin 0.57mg g⁻¹ among maize yellow dent genotypes. Analyses of CIMMYT accessions with yellow to dark orange kernels have identified large variation in the number of provitamin A molecules (Egesel et al., 2003) and their carotenoid profiles. Among more than 1000 tropical genotypes, promising materials with provitamin A concentrations (8 μ g g⁻¹) and/or carotenoid profiles were identified that can be used in breeding programs. Variability in the content of β -carotene of analyzed maize varieties by Howe and Tanumihardjo (2006) ranged from undetectable in the white maize to 0.77nmol g⁻¹ DW in the yellow, 5.6nmol g⁻¹ DW in the orange, and 13.9nmol g⁻¹ DW in the dark orange maize. The observed genetic variability in their research suggested profound differences in potential health promotion among genotypes. Eighty-seven elite maize inbreds representing major heterotic groups in China were evaluated for carotenoid and tocopherol fractions by HPLC (Chander et al., 2008a). β -carotene, β -cryptoxanthin, α -carotene, lutein, zeaxanthin, and total carotenoids ranged 0.016-1.726; 0.012-3.666; 0.004-0.852; 0.040-17.504; 0.022-6.728, and 0.096-22.495 μ g g⁻¹ with the joint mean values of 0.449, 0.876, 0.121, 5.803, 3.048, and 10.298 μ g g⁻¹, respectively. The pooled mean values of α -tocopherol, γ -tocopherol, δ -tocopherol, and total tocopherols were observed as 23.98; 32.90; 2.189; and 59.55 μ g g⁻¹, with ranges of 3.98-74.81; 2.81-78.16; 0.236-5.338 and 19.60-120.69 μ g g⁻¹, respectively. A total of 93 landraces belonging to the European Union Maize Landraces Core Collection (EUMLCC) were analysed for the content of lutein, zeaxanthin, and total carotenoids (Berardo et al., 2009). The range of these micronutrients was very large, namely for lutein 1.03 to 21.00mg kg⁻¹ DW, for zeaxanthin 0.01 to 35.00mg kg⁻¹ DW, and for total carotenoids 1.09 to 61.10mg kg⁻¹ DW. A single cross was developed from the population in this research with increased carotenoids content that has been used in Italian food industry. Kuhen et al. (2011) have evaluated 26 maize landraces from southern Brazil for their potential as natural colorants or as functional food ingredients. The highest value of total carotenoids was 11.72mg kg⁻¹, followed by 10.86mg kg⁻¹. Mugode et al. (2014) have found a content of 7.5 to 10.3 μ g g⁻¹ DW β -carotene in the biofortified maize hybrids. In our research, content of γ + β and δ -tocopherols (vitamin E fractions) on the average was moderate, and none of the landraces showed high values. For α -tocopherol two landraces had high values (13.330 μ g g⁻¹ and 9.138 μ g g⁻¹, respectively). Since these 16 landraces are not among the high-oil ones (data not shown), lack of high concentrations of some vitamin E fractions would not be reflected on the quality and stability of oil possibly extracted from them. On the other hand, these landraces are white, yellow and orange flints or semi flints, and vitamin A fractions ranged from the trace values (white landraces) to 11.37 μ g g⁻¹ lutein, 40.91 μ g g⁻¹ zeaxanthin and 5.248 μ g g⁻¹ β -carotene. Maximum lutein value in our research was not very high, but maximum

values for zeaxanthin and β -carotene were high in comparison with literature data. One landrace, named L 161, had high values of α -tocopherol (second in the range) and both the highest values of zeaxanthin and β -carotene. It can be used for the biofortification programs in maize, although its grain yield seemed to be very low (data not shown). This means that alongside with improvement of vitamin contents an attention during selection should be paid to grain yield and other important agronomic characters.

Appart from conventional breeding, marker assisted selection (MAS) can be applied in elevating vitamin content in maize grain. For instance, two inbreds (C1.7 and Deexp3) with high amount of β -carotene ($13.6\mu\text{g g}^{-1}$) have been identified in temperate germplasm and the molecular marker for β -carotene content in these inbreds has been developed (Ortiz-Monasterio et al., 2007; Harjes et al., 2008). Also, Wong et al. (2004) and Chander et al. (2008b) showed potential of MAS for carotenoids, and Chander et al. (2008c) for tocopherols.

Conclusion

A total of 16 maize landraces were analysed for their vitamin A and E profiles. The content of γ + β and δ -tocopherols was moderate, while two landraces showed high values of α -tocopherol. Maximum lutein value in our research was not very high, but maximum values for zeaxanthin and β -carotene were high in comparison with literature data. One landrace showed a high potential for breeding programs for improvement of vitamins contents (biofortification) alongside with agronomic traits.

Acknowledgments

This research was supported by the Project TR 31028 “Exploitation of maize diversity to improve grain quality and drought tolerance“ of the Serbian Ministry of education, science and technological development.

References

- Berardo, N., Mazzineli, G., Valoti, P., Lagana, P., Redaelli, R. (2009): Characterization of maize germplasm for the chemical composition of the grain. *J. Agric. Food Chem* 57, 2378-2384
- Brenna, O.V., Berardo, N. (2004): Applications of near-infrared reflectance spectroscopy (NIRS) to the evaluation of carotenoids content in maize. *J. Agric. Food Chem.*, 52, 5577-5582
- Brunson, A.M., Quackenbush, F.W. (1962): Breeding corn with high provitamin A in the grain. *Crop Sci.*, 2, 344-347
- Buckner, B., Kelson, T.L., Robertson, D.S. (1990): Cloning of the *yl* locus of maize, a gene involved in the biosynthesis of carotenoids. *Plant Cell*, 2, 867-876
- Chander, S., Meng, Y., Zhang, Y., Yan, J., Li, J. (2008a): Comparison of nutritional traits variability in selected eighty-seven inbreds from Chinese maize (*Zea mays* L.) germplasm. *J. Agric. Food Chem.*, 56, 6506-6511
- Chander, S., Guo, Y.Q., Yang, X.H., Zhang, J., Lu, X.Q., Yan, J.B., Song, T.M., Rocheford, T.R., Li, J.S. (2008b): Using molecular markers to identify two major loci controlling carotenoid contents in maize grain. *TAG*, 116, 223-233
- Chander, S., Guo, Y.Q., Yang, X.H., Yan, J.B., Zhang, Y.R., Song, T.M., Li, J.S. (2008c): Genetic dissection of tocopherol content and composition in maize grain using quantitative trait loci analysis and the candidate gene approach. *Mol. Breed.*, 22, 353-365
- Egesel, C.O., Wong, J.C., Lambert, R.J., Rocherford, T.R. (2003): Combinig ability of maize inbreds for carotenoids and tocopherols. *Crop Sci.*, 43, 818-823
- Failla, M., Chitchumronchokchai, C. (2005): In vitro models as tools for screening the relative bioavailabilities of provitamin A carotenoids in foods. *HarvestPlus Tech. Monogr.*, 3, 1-36

- Gallagher, H.L., Alexander, D.E., Weber, E.J. (1985): Genetic variability of alpha-tocopherol and gamma-tocopherol in corn embryos. *Crop Sci.*, 25, 547-549
- Gliszczyńska-Świątło, A., Sikorska, E., Khmelinskii, I., Sikorski, M. (2007): Tocopherol content in edible plant oils. *Polish journal of food and nutrition sciences*, 57 4(A), 157-161
- Harjes, C.E., Rocheford, T.R., Bai, L., Brutnell, T.P., Kandianis, C.B., Sowinski, S.G., Stapleton, A.E., Vallabhanneni, R., Williams, M., Wurtzel, E.T., Yan, J.B., Buckler, E.S. (2008): Natural genetic variation in lycopene epsilon cyclase tapped for maize biofortification. *Science*, 319, 330-333
- Howe, J.A., Tanumihardjo, S.A. (2006): Carotenoid-biofortified maize maintains adequate vitamin A status in mongolian gerbils. *J. Nutr.*, 136, 2562-2567
- Kuhnen, S., Lemos, P.M.M., Campestrini, L.H., Ogliari, J.B., Dias, P.F., Maraschin, M. (2011): Carotenoid and anthocyanin content of grains of Brazilian maize landraces. *J. Sci. Food Agric.*, 91, 1548-1553
- Kurilich, A.C., Juvik, J.A. (1999): Quantification of carotenoid and tocopherol antioxidants in *Zea mays* L. *J. Agric. Food Chem.*, 47, 1948-1955
- Matthews, P.D., Wurtzel, E.T. (2007): Biotechnology of food colorant production. In: *Food colorants: chemical and functional properties*. C. Socaciu. Ed. CRC Press, Boca Raton, FL, USA, pp. 347-398
- Moros, E.E., Darnoko, D., Cheryan, M., Perkins, E.G., Jerrell, J. (2002): Analysis of xanthophylls in corn by HPLC. *J. Agric. Food Chem.*, 50, 5787-5790
- MSTAT Development Team (1989): MSTAT-C: A microcomputer program for the design, management and analysis of agronomic research experiments. MSTAT Development Team, Michigan State University, East Lansing, USA.
- Mugode, L., Ha, B., Kaunda, A., Sikombe, T., Phiri, S., Mutale, R., Davis, C., Tanumihardjo, S., De Moura, F.F. (2014): Carotenoid retention of biofortified provitamin A maize (*Zea mays* L.) after Zambian traditional methods of milling, cooking and storage. *J. Agric. Food Chem.*, 62, 6317-6325
- Ortiz-Monasterio, J.I., Palacios-Rojas, N., Meng, E., Pixley, K., Trthowan, R., Pena, R.J. (2007): Enhancing the mineral and vitamin content of wheat and maize through plant breeding. *J. Cereal Sci.*, 46, 293-307
- Rivera, S., Canela, R. (2012): Influence of sample processing on the analysis of carotenoids in maize. *Molecules*, 17, 11255-11268
- Rocheford, T.R., Wong, J.C., Egesel, C.O., Lambert, R.J. (2002): Enhancement of vitamin E levels in corn. *J. Am. Coll. Nutr.*, 21, 191S-198S
- Sandman, G. (2001): Genetic manipulation of carotenoid biosynthesis: strategies, problems and achievements. *Trends Plant Sci.*, 6, 14-17
- Singh, R.K., Chaudhary, B.D. (1985): *Biometrical Methods in Quantitative Genetic Analysis*. Kalyani Publishers, New Delhi, India.
- Tadmor, Y., Larkov, O., Meir, A., Minkoff, M., Lastochkin, E., Edelstein, M., Levin, S., Wong, J., Rocheford, T., Lewinsohn, E. (2000): Reversed-phase high performance liquid chromatographic determination of vitamin E components in maize kernels. *Phytochem. Anal.*, 11, 370-374
- Vančetović J., Ignjatović-Micić, D., Božinović, S., Delić, N. (2015a): Maize core collection for increased grain quality. *Maydica*, 60, in press.
- Vančetović J., Ignjatović-Micić, D., Anđelković, V., Kravić, N., Božinović, S. (2015b): Phenotypic characterisation of a mini core collection for increased grain quality in maize. *Plant breeding and seed production*, 20, 1-11

- Watson, S.A. (1988): Corn marketing, processing, and utilization. In: Corn and Corn Improvement. G.F. Sprague and J.W. Dudley. Ed. ASA-CSSA-SSA, Madison, WI, USA, pp. 881-940
- Weber, E.J. (1987a): Carotenoids and tocopherols of corn grain determined by HPLC. J. Am. Oil Chem. Soc., 64, 1129-1134
- Weber, E.J. (1987b): Lipids of the kernel. In: Corn chemistry and technology. S.A. Watson and P.E. Romstad. Ed. American Assoc of Cereal Chem, Inc. St. Paul, MN, USA, pp. 311-349
- White, P., Pollak, L. (1995): Corn as a food source in the United States. 2. Processes, products, composition, and nutritive values. Cereal Food World, 40, 756-762
- Wong, J.C., Lambert, R.J., Wutzel, E.R., Rocheford, T.R. (2004): QTL and candidate genes phytoene synthase and ξ -carotene desaturase associated with the accumulation of carotenoids in maize. TAG, 108, 349-359
- Wyatt, C.J., Carballido, S.P., Mendez, R.O. (1998): α - and γ -tocopherol content of selected foods in the Mexican diet: Effect of cooking losses. J. Agric. Food Chem., 46, 4657-4661

THE EFFECTS OF IRRIGATION WATER AMOUNTS ON LEAF CHLOROPHYLL AND NUTRIENT CONTENTS OF IZMIR 1 POMEGRANATE VARIETY

Ahmed BAHAULDDİN¹, Serra HEPAKSOY^{2,*}

¹Kirkuk University, Faculty of Agriculture, Department of Horticulture, Kirkuk, Iraq

²Ege University, Faculty of Agriculture, Department of Horticulture, Izmir, Turkey

*Corresponding author: serra.hepaksoy@ege.edu.tr

Abstract

Pomegranate (*Punica granatum*) is an important horticultural crop for both domestic and export markets in Turkey. It adapts to all kinds of climate and soil. It is well adapted to the growth conditions in Turkey and Mediterranean countries is frequently found growing in wild or semi wild conditions. Pomegranates can tolerate long periods of drought once the plant is established but regular irrigation is mandatory in commercial production. We investigated the effect of different irrigation water amounts on nutrient uptake and content of leaf pigments of 10-year old pomegranate cv İzmir 1 trees two consecutive years (2009-2010). Three different irrigation water quantities (control, deficit and full irrigation) were applied by drip irrigation system. First leaf samples were taken a week before starting the irrigation treatments and continued until the end of the harvest season with four weeks interval. Results showed that leaf content of phosphorus, potassium, calcium, iron, and zinc was affected with quantity of irrigation water in the first year. But in the second year, only phosphorus content changed by the irrigation levels. In both years of the experiment chlorophyll a, b and total were not affected by the irrigation treatments but they differed during growth periods. Chlorophyll a and chlorophyll b contents increased in the first year, and decreased in the second year during vegetation periods. Total chlorophyll contents of leaves showed same behaviour as chlorophyll a and b. In the first year, all chlorophyll components contents in leaves were found to be higher compared to second year.

Key words: *Pomegranate, İzmir 1, drought stress, deficit irrigation, leaf content*

Introduction

Pomegranate (*Punica granatum* L.), belongs to the family *Punicaceae* which is believed to be native to the southern Iran and Northeast Turkey (Janick, 2007). The medicinal properties of pomegranate, especially in traditional systems, are known from time immemorial (Roy and Waskar, 1997). Commercial pomegranate orchards are grown in many regions of the world, including the Mediterranean Basin countries. It adapts to all kinds of climate and soil. It is well adapted to the growth conditions in Turkey and Mediterranean countries is frequently found growing in wild or semi wild conditions. Favourable growth takes place where winters are cool and summers are hot. It is tolerant to drought, salinity, iron chlorosis and active limestone (Hepaksoy et al., 2013). In Turkey the pomegranate is commercially significant specie due to adaptation is well and beneficial effects on health. Turkey is one of the main pomegranate producer countries in the world. It is possible grow pomegranates in all parts of Turkey except some regions (Onur, 1988). Turkey's pomegranate production has reached 445.750 tons in 2015 (Anonymous, 2015). The most important growing area of Turkey is the Mediterranean region. Aegean and Southeast Anatolia are other important regions of the country. Although pomegranate is known as a drought tolerant crop, regular irrigation is mandatory to commercial

production. Fruit culture in arid and semiarid areas must be directed towards the use of less water-demanding and more stress-resistant plant materials which, together with deficit irrigation, will allow significant water savings and the profitable production of high quality fruits (Rodríguez et al., 2012). Irrigation scheduling is very important to optimise the use of water resources (Hepaksoy et al., 2009). Water scarcity in arid and semi-arid areas has led to development of new water saving techniques, such as sustained deficit irrigation (Peña et al., 2013).

This study investigated the effects of different irrigation amounts on plant nutrients and leaf chlorophyll contents of pomegranate trees.

Materials and methods

This study was conducted with 'İzmir 1' pomegranate in Bornova County of Izmir province, Turkey (38°27'10" N and 27°13'19" E) during two consecutive years (2009-2010). The dominant climate is a mild Mediterranean. Fertilizers were not applied during the experiment. The experiment was designed in a randomized complete block design with four replications. In each replication one tree was used for sampling. Evaporation was measured in class A-pan placed near the research area. Three different irrigation water quantities (S_0 = no irrigation, S_1 = 50% and S_2 = 100% of the water quantity evaporating from class A pan) were applied by drip irrigation system. Emitters of system have taken place in the crown of the tree, and whole area per tree was not wetted. The crop pan coefficients (K_{cp}) for I_1 and I_2 irrigation treatment was taken 0.50 and 1.00, respectively. Irrigations were applied with 7-day interval. The applied quantity of irrigation water was calculated as given below formula:

$$I = E_{pan} \times K_{cp} \times A \times P$$

where:

I: The quantity of irrigation water (liters);

E_{pan} : The quantity of evaporation in class A pan (mm);

K_{cp} : Crop pan coefficient (0.50 for S_1 and 1.00 for S_2);

A: Tree area (18 m² per tree);

P: Wetted area percentage (30%).

The soil moisture to the field capacity within 60 cm soil depth at each treatment was provided a week before starting the irrigation treatments. Irrigation was started 16th June and 6th July; finished 8th and 14th September in first and second years, respectively. Applied water quantities are given in Tables 1 and 2. First leaf samples were taken a week before starting the irrigation treatments and continued until the end of the harvest season with four weeks interval. The leaf samples were taken totally five times. Analysis of Chl a, Chl b, and total Chl in plant tissue was performed by Arnon (1949). Nutrients content, except N, was measured with inductively coupled plasma atomic emission spectroscopy-ICP OES (SpectroGenesis EOP II, Spectro Analytical Instruments GmbH, Kleve, Germany). N analysis was made by the Kjehdahl method (Kacar, 1984).

Table 1. Quantities of irrigation water in first year (L/tree)

Irrigation No	Water quantity ¹		Irrigation No	Water quantity	
	S ₁	S ₂		S ₁	S ₂
1	140	281	8	173	346
2	105	210	9	174	348
3	165	329	10	158	317
4	140	280	11.	188	377
5	153	306	12	127	254
6	169	337	13	115	230
7	176	352	Total	1984	3968

¹S₁ and S₂: = 50 and 100% of the water quantity evaporating from class A pan, respectively.

Table 2. Quantities of irrigation water in second year (L/tree)

Irrigation No.	Water quantity ¹		Irrigation No.	Water quantity	
	S ₁	S ₂		S ₁	S ₂
1	124	248	7	144	289
2	137	273	8	160	319
3	154	308	9	133	267
4	165	330	10	87	174
5	127	255	11	80	161
6	129	258	Total	1441	2881

¹S₁ and S₂: = 50 and 100% of the water quantity evaporating from class A pan, respectively.

Statistical analyses of all data were performed with SPSS Version 16.0 (SPSS Inc., Chicago, IL, USA). Differences between the means were compared by Duncan test at a significance level of $P < 0.05$.

Results and Discussion

Leaf mineral nutrient content

Leaf content of the most important plant macro nutrient which is nitrogen was not affected both irrigation and vegetation period as a statistically. Average N contents were found to be 1,516%, 1,622% and 1,591% at the 0%, 50% and 100% irrigation treatments, respectively in the first year (Table 3). In the second year N contents were lower than first year. Average N contents in leaves were 1,282%, 1,450% and 1,428% at the 0%, 50% and 100% irrigation treatments, respectively (Table 4).

Phosphorus (P) content was significantly influenced by irrigation levels and throughout development periods were changed significantly in both seasons of study. Leaf P concentration was highest non-irrigated treatment at both year. The highest values were at the beginning of the season and the lowest values were at the end of season in both years. Average P contents were found to be 0,247%, 0,163% and 0,153% in first; 0,210%, 0,135% and 0,116% in second year non-irrigated, full irrigation and deficit irrigation treatments, respectively (Table 3 and 4).

Leaf potassium concentration was differed by the irrigation in the first year. Average K contents of leaves decreased with the irrigation in the first year. They were 1,156%, 0,922% and 0,878% I₀, I₁ and I₂ treatments, respectively (Table 3). K content throughout development periods was changed significantly at the both years. In the first year, K amount decreased towards fruit ripening and reached the lowest level after harvest time in the deficit and full irrigation

treatments. K content of non-irrigated trees increased till July 31, and then started to decrease and fall down the lowest content at the harvest time. In the second year, K content increased till mid-season and then started to decrease in the 0% and 50% irrigation treatments.

The leaf N percentage was increased slightly (not significant statistically) while P and K concentrations were decreased by the increasing irrigation amounts in the present study. This result for N is in agreement by Khattab et al. (2011) on pomegranate. Low leaf nitrogen concentration in spring was associated with a period of intense vegetative growth (Cabrita and Martins-Loução 1990). Leaf P content is expected to decrease with vegetation because plants uptake a large portion of phosphorus and potassium they need during the first periods of development (Kacar et al., 1979).

Calcium (Ca) contents were statistically affected by irrigation water quantities, between the sampling dates in the first season while the statistically significant differences were observed between the sampling dates in the second season. In the first year Ca content increased by irrigation water quantities. The lowest (1,485%) and the highest (2,474) leaf Ca contents were encountered in the trees non-irrigated and in the trees full irrigated, respectively. They were increased continuously during vegetation and reached the highest level after harvest time in all irrigation treatments (Table 3). In the second year, Ca contents were lower at the beginning of vegetation and after harvest, whereas higher content was observed in the middle of vegetation in all irrigation treatments. Old leaves generally contain a higher level of calcium compared to young leaves (Kacar et al., 1979). For this reason, as leaves got older with vegetation, the level of Ca was found to be higher. Calcium is considered to be an immobile element and the leaf concentration of this element generally increases throughout the growing season (Grigal et al., 1976; Worley, 1977).

Table 3. Macro and micro nutrient contents of leaves (1st year)

Irrig. Treat.	Sampling Date	N (%)	P (%)	K (%)	Ca (%)	Mg (%)	Cu (ppm)	Fe (ppm)	Mn (ppm)	Zn (ppm)
0% (S ₀)	June, 05	1,752	0,214	1,074	1,471	0,147	20,268B	105,162AB	27,395C	39,702
	July, 03	1,710	0,293	1,070	1,468	0,252	96,214A	113,569AB	38,191A	33,668
	July, 31	1,386	0,274	1,389	1,309	0,298	94,263A	118,048A	34,794AB	33,874
	August, 28	1,288	0,217	1,281	1,473	0,297	15,777B	58,441C	32,669ABC	27,540
	October, 5	1,442	0,239	0,964	1,706	0,277	12,261B	85,988BC	31,00BC0	25,610
	Average	1,516	0,247a	1,156a	1,485b	0,254	47,757	96,242a	32,810	32,079a
50% (S ₁)	June, 05	1,554	0,203	1,086	1,616	0,173	23,782A	69,557A	31,500	30,321
	July, 03	1,652	0,178	0,927	1,601	0,242	18,141A	69,042A	36,455	24,982
	July, 31	1,708	0,154	0,992	1,964	0,308	28,673A	64,647A	39,577	21,595
	August, 28	1,568	0,103	0,816	2,404	0,331	41,691A	63,824A	43,796	24,527
	October, 5	1,626	0,125	0,790	2,315	0,299	16,126A	75,558A	38,026	20,410
	Average	1,622	0,153b	0,922ab	1,980ab	0,271	25,683	68,525b	37,871	24,367b
100% (S ₂)	June, 05	1,415	0,195	0,979	1,588	0,261	15,677C	71,784A	34,941	26,057
	July, 03	1,526	0,169	0,904	2,909	0,355	29,023B	80,046A	45,139	22,169
	July, 31	1,708	0,131	0,856	2,629	0,375	78,911A	80,810A	44,487	28,503
	August, 28	1,750	0,156	0,774	2,771	0,319	36,855B	72,293A	40,233	26,722
	October, 5	1,554	-	-	-	-	-	-	-	-
	Average	1,591	0,163ab	0,878b	2,474a	0,327	40,116	76,233b	41,200	25,863ab

-No data

The leaf contents of magnesium (Mg) were not affected significantly by irrigation quantities whereas they changed significantly during the season in both years. In general, Mg content was found to be higher in the middle of the development season compared to the beginning. The lowest values were found at the beginning of season in all treatments at the both seasons. The rate of bonding of total magnesium in plant leaves to chlorophyll molecule is closely associated with magnesium (Kacar and Katkat, 2009).

There were no significant changes in the micro nutrients copper and manganese in the first year and all of them in the second year by the irrigated. Data were given in tables 3 and 4. All micro nutrient elements, except Cu in the first year and Fe in the second year, contents were changed statistically during growth period. The highest and the lowest both iron and zinc contents were encountered in the trees non-irrigated and in the trees deficit irrigated, respectively. Leaf iron contents differed during vegetation period in the first year and it decreased in the non-irrigated trees while increased slightly in the other treatments. Manganese contents were increased during growth period whereas zinc contents were decreased in the first year. The leaf contents of copper continuously decrease until the end of development season and the lowest contents were found after harvest time at the all treatments in the second year. Manganese and zinc contents of leaves increased in full irrigation (100%) treatments but decreased in non-irrigation (0%) and deficit irrigation (50%) treatments. According to Khattab et al. (2011) nutrient uptake retarded under water stress condition where a substantial decrease in transpiration rates and impaired active transport and membrane permeability and resulting in a reduced root absorbing power plant.

Table 4. Macro and micro nutrient contents of leaves (2nd year)

Irrig. Treat.	Sampling Date	N (%)	P (%)	K (%)	Ca (%)	Mg (%)	Cu (ppm)	Fe (ppm)	Mn (ppm)	Zn (ppm)
0% (S ₀)	June, 25	1,176	0,224AB	1,086	1,710	0,234	16,888	106,006	32,350	38,774
	July, 23	1,297	0,248AB	1,110	2,780	0,297	9,809	147,839	44,555	67,915
	August, 20	1,288	0,269A	3,081	2,703	0,301	14,455	122,935	39,320	39,506
	September, 17	1,461	0,179BC	1,499	1,774	0,265	14,782	139,193	40,617	29,775
	October, 25	1,190	0,129C	0,507	2,203	0,298	1,852	89,565	29,325	24,800
	Average	1,282	0,210a	1,457	2,234	0,279	11,557	121,108	37,234	40,154
50% (S ₁)	June, 25	1,442	0,159A	1,108	1,878	0,217	27,043	170,486	30,231	29,755
	July, 23	1,526	0,120A	1,199	2,712	0,295	30,336	142,348	35,178	56,524
	August, 20	1,498	0,102A	2,922	3,280	0,302	17,424	115,063	44,318	22,865
	September, 17	1,386	0,086A	2,540	2,229	0,265	6,759	77,036	29,772	26,348
	October, 25	1,400	0,115A	0,460	2,401	0,238	6,486	111,586	27,309	25,615
	Average	1,450	0,116b	1,646	2,500	0,263	17,610	123,304	33,362	32,221
100% (S ₂)	June, 25	1,456	0,187A	1,421	1,590	0,223	36,466	165,960	24,177	32,777
	July, 23	1,596	0,151AB	1,120	2,662	0,311	11,997	102,548	32,493	36,460
	August, 20	1,470	0,130AB	0,971	3,220	0,321	44,372	203,717	33,509	38,060
	September, 17	1,414	0,081B	2,052	2,864	0,293	8,401	94,361	28,026	27,138
	October, 25	1,204	0,129AB	1,559	2,903	0,271	8,592	113,240	28,284	39,235
	Average	1,428	0,135ab	1,425	2,648	0,284	21,966	135,965	29,298	34,734

Leaf chlorophyll concentration

In both years of the experiment chlorophyll a, b and total were not affected by the irrigation treatments but they differed during growth periods. In the first year, all chlorophyll components contents in leaves were found to be higher compared to second year. Chlorophyll a content increased in the first year, and decreased in the second year during vegetation periods. In the first year it increased from 4,252 mg/L to 5,090 mg/L in non-irrigation, from 3,672 mg/L to 7,270 mg/L in deficit irrigation and from 5,049 mg/L to 6,037 mg/L in full irrigation treatments. In second year it fall down from 3,390 mg/L to 2,375 mg/L in 0% irrigation, from 5,046 mg/L to 2,857 mg/L in 50% irrigation and from 5,981 mg/L to 2,262 mg/L in 100% irrigation (Table 5). As in the case of leaf chlorophyll a, chlorophyll b contents were higher in the first year and they increased in the first year, and decreased in the second year during vegetation periods. Chlorophyll b contents of leaves increased from 1,809 mg/L to 2,138 mg/L in S₀, from 1,554 mg/L to 3,104 mg/L in S₁ and from 1,356 mg/L to 2,548 mg/L in S₂ treatments in the first year. In second year it decreased from 1,732 mg/L to 1,120 mg/L in S₀ treatment, from 2,450 mg/L to 1,384 mg/L in S₁ treatment and from 2,857 mg/L to 1,139 mg/L in S₂ treatment (Table 5). Total chlorophyll contents of leaves showed same behaviour as chlorophyll a and b. Chlorophyll a, b and total contents were not significantly influenced by irrigation treatments but slight reductions were observed by decreasing irrigation amounts in both seasons. These results are in agreement by Khattab et al. (2011) on pomegranate. This increment in leaf pigment concentration could be attributed to increasing of macro element uptake, especially N and Mg as a consequence of improved soil moisture under irrigation. In fact, N and Mg contents of leaves increased a slight in present study.

Table 5. Leaf pigment (chlorophyll a, b and total) concentration of pomegranate trees

Irrig. Treat.	Sampling Date	1 st Year			2 nd Year		
		Chl a (mg/L)	Chl b (mg/L)	Total Chl (mg/L)	Chl a (mg/L)	Chl b (mg/L)	Total Chl (mg/L)
0% (S ₀)	June, 25	4,252a	1,809a	6,083a	3,590	1,732	5,368
	July, 23	4,492a	1,960a	6,437a	2,870	1,528	4,522
	August, 20	5,350a	2,499a	7,949a	1,938	0,990	2,943
	September, 17	4,041a	1,702a	5,728a	2,072	0,972	3,040
	October, 25	5,090a	2,138a	7,188a	2,375	1,120	3,481
	Average	4,645	2,022	6,677	2,570	1,268	3,871
50% (S ₁)	June, 25	3,672b	1,554b	5,250b	5,046	2,450	7,574
	July, 23	5,252ab	2,352ab	7,619ab	3,546	1,781	5,434
	August, 20	4,661b	2,011b	6,712b	2,972	1,553	4,554
	September, 17	4,392b	1,894b	6,309b	2,534	1,184	3,693
	October, 25	7,270a	3,104a	10,342a	2,857	1,384	4,235
	Average	5,049	2,183	7,246	3,391	1,671	5,098
100% (S ₂)	June, 25	2,988c	1,356c	4,367c	5,981	2,857	8,928
	July, 23	6,868a	3,053a	9,958a	3,536	1,805	5,437
	August, 20	4,341bc	1,922bc	6,343bc	3,234	1,558	4,787
	September, 17	6,037ab	2,548ab	8,567 ab	1,606	0,696	2,246
	October, 25	-	-	-	2,262	1,139	3,412
	Average	5,058	2,219	7,309	3,324	1,611	4,962

Conclusion

Experiment results showed that leaf content of phosphorus, potassium, calcium, iron, and zinc was affected with quantity of irrigation water in the first year. But in the second year, only phosphorus content changed by the irrigation levels. In general higher concentrations were obtained from non and full irrigated trees. Also leaf chlorophyll pigments (a, b and total) were not affected by the irrigation statistically. Both leaf nutrient elements and chlorophyll pigments changed during the vegetation periods. Data showed differences between years. Annual climatic changes may affect the growth or yield of tree. So deficit irrigation should be considered in commercial pomegranate orchard as a practice to be long years regularly applied to enhance fruit composition and reduction fruit splitting and cracking.

References

- Anonymous (2015). Turkish Statistical Institute. www.tuik.gov.tr
- Arnon D.I., (1949). Copper enzymes in isolated chloroplasts. Polyphenoloxidase in beta vulgaris. *Plant Physiology*, 24 (1):1-15.
- Cabrita R., Martins-Loução M.A. (1990). Seasonal biomass and nutrient allocation patterns in carob (*Ceratonia siliqua* L.). I Congresso Ibérico de Ciências Hortícolas, de 18 a 21 de Junho de 1990 em Lisboa. (in Portuguese) *Actas de Horticultura* 6, 405-411.
- Grigal F.D., Ohman L.F., Brander R.B. (1976). Seasonal dynamics of tall shrubs in northeastern Minnesota: biomass and nutrient element changes. *Forest Sci.* 22, 195–208.
- Hepaksoy S., Kukul Y.S., Engin H., Erogul D., Aksehirl M. (2009). Leaf water potential of pomegranate (*Punica granatum* L.) under different irrigation levels. *Acta Horticulturae* 818: 193-198.
- Hepaksoy S., Bahaulddin A., Kurtaş Kukul S.Y., Kavaklı Ş. (2013). Effects of irrigation level on leaf nutrient of pomegranate varieties. Proc. 1st Central Asia Congress on Modern Agricultural Techniques and Plant Nutrition, 1-3 October 2013, Bishkek, Kyrgyzstan. p.1398.
- Janick J. (2007). Fruits of the Bible. *HortScience* 42, 1072–1076.
- Kacar B., Przemek E., Özgümüş A., Turan C., Katkat A.V., Kayıkçioğlu İ. (1979). Determination of micronutrients in tea plantations and plant in Turkey. The Scientific and Technological Research Council of Turkey/ Report, 321, Ankara, Turkey. 67p.
- Kacar B. (1984). Practice of Plant Nutrition. (In Turkish) Ankara University, Ankara, Turkey. 140p.
- Kacar B., Katkat V.A. (2009). Plant Nutrition. (In Turkish). 2nd ed. Nobel Publishing, Ankara, Turkey. 659p.
- Khattab M.M., Shaban E.A., El-Shrief H.A., El-Deen Mohamed S.E. (2011). Growth and Productivity of Pomegranate Trees under Different Irrigation Levels. III: Leaf Pigments, Proline and Mineral Content. *Journal of Horticultural Science and Ornamental Plants* 3 (3): 265-269.
- Peña E.M., Artés-Hernández F., Aguayo E., Martínez-Hernández B.G., Galindo A., Artés, F. Gómez, A.P. (2013). Effect of sustained deficit irrigation on physicochemical properties, bioactive compounds and postharvest life of pomegranate fruit (cv. 'Mollar de Elche'). *Postharvest Biology and Technology* 86 (2013) 171–180.
- Rodríguez P., Mellisho C.D., Conejero W., Cruz Z.N., Ortuño M.F., Galindob A, Torrecillas A. (2012). Plant water relations of leaves of pomegranate trees under different irrigation conditions. *Environmental and Experimental Botany* 77: 19-24.

- Roy S.K., Waskar D.P. (1997). Pomegranate. In: Postharvest Physiology and Storage of Tropical and Subtropical Fruits. Mitra S.K. (ed.). CAB Int. Publishing, Wallingford. Oxfordshire, UK. p.365-374.
- Onur C. (1988). Pomegranate, *Derim*, 5 (4):147-190.
- Worley R.E. (1977). Pecan leaf analysis: I. Varietal, fertilizer, and seasonal effects. *Commun. Soil Sci. Plant Anal.* 8, 533-549.

EFFECT OF SALT STRESS (NaCl) ON GERMINATION AND PLANT PARAMETERS OF THREE VARIETIES OF BASIL (*Ocimum basilicum* L.)

Hassiba FRAJ^{1,2*}, Maher SOUGUIR¹, Stefaan WERBROUCK¹, Chérif HANNACHI²

¹Laboratory for Applied In Vitro Plant Biotechnology, Faculty of Bioscience Engineering, Ghent University, Ghent, Belgium

²Department of Horticultural sciences, High Institute of Agronomy, Chott-Meriem, 4042 Sousse Tunisia

*Corresponding author: hassibaing@live.fr

Abstract

Basil (*Ocimum basilicum* L.) is used as a medicinal. The effects of salt stress were studied on three varieties of basil ("Grand Vert" (GV), "Fin Vert" (FV) and "Grand Vert Sweet" (GVS)). Seeds were germinated in petri dishes and plants were cultivated under plastic house in plastic pots felled of black peat. Under salt stress (NaCl: 1-18g/l), seeds are able to germinate even at 15 g/l but germination period were delayed of 2 days. Plants grew up to 12g/ l, flowered and fruited up to 6 g/l. NaCl affected all organs of the plant (stem length, number of leaves, fresh and dry weight of stems and roots). Photosynthesis parameters (chlorophylls, photosynthetic active radiation, net photosynthesis, conductance, and CO₂) were also affected. Faced to salt stress (NaCl), variety "fin vert" (FV) was more tolerant thanks to large amounts of proline, synthesized and accumulated in stressed plants which had 13 times more than control plants which allowed probably their osmotic adjustment with culture medium.

Keywords: *Basil (Ocimum basilicum L.), NaCl, Germination, Photosynthesis Parameters, Proline.*

Introduction

Ocimum basilicum L. is an aromatic herb belonging to the Lamiaceae family which is characterized by a great variability of morphology. This medicinal plant has several functional characteristics including treatment of headaches, coughs, diarrhea, dyspepsia, flatulence, gastritis, constipation, warts, worms and kidney malfunctions (Simon *et al.*, 1999). It is known as culinary herb which has a distinctive flavor for many foods and it is a source of aroma compounds and essential oils containing biologically active constituents. Many researches have reported that this plant has insecticidal, nematicidal fungistatic (Reuveni, *et al.*, 1984). Basil extracts are also used in the manufacturing of cosmetic and pharmaceutical products. Medicinal and aromatic plants are cultivated especially for drugs. Owing to their high curing value and wild occurrence in diverse environments, they have been considered to be promising plants for marginal lands, new reclaimed-soils and semi-arid regions (Said-Alahl and Omer, 2011). However, one of the most important factors affecting plant growth and the production of secondary metabolites is salt stress. In fact, salinity is one of the important environmental stresses limiting soil fertility that adversely effects on growth and productivity of plants around the world (Hosni, 2009; Zahedi *et al.*, (2010). One of the most important changes in plant response to increasing soil salinity is stopping or reducing vegetative growth and leaf development. This reduction in growth is a consequence of several physiological responses including modifications of ion balance, water status, mineral nutrition, stomatal behavior, photosynthetic efficiency. The rate of photosynthetic CO₂ assimilation is generally reduced by salinity. This reduction is a result of a reduced stomatal

conductance and consequent restriction of the availability of CO₂ for carboxylation (Brugnoli and Lauteri., 1991). Also, Photosynthesis may decrease by direct effect of salt on the photosynthetic apparatus. However, conflicting results concerning the role of stomatal limitation of photosynthesis were reported. For instance, in bean (*Phaseolus vulgaris* L.), a salt-sensitive species, and cotton (*Gossypium hirsutum* L.), a salt-tolerant species, the reduction in assimilation was described as a result of a stomatal limitation (Brugnoli and Lauteri, 1991), but other works attributed the reduction in photosynthesis to non-stomatal limitation (Dunn and Neales, 1993). Compared with other salt tolerant plants, basil would be classified as a plant moderately tolerant to salt during seed germination and seedling emergence (Ramin, 2005).

That's why the objective of this work is to study the effect of salinity on germination, Photosynthesis parameters, and proline accumulation.

Material and methods

Germination in petri dishes:

The seeds were disinfected by sodium hypochlorite (1%) for 10 min, and then rinsed with distilled water. Afterwards, seeds were placed on petri dishes. Eight NaCl concentrations (0 (distilled water), 1, 3, 6, 9, 12, 15, 18 g/l) were used to determine the salt tolerance of seeds. NaCl was dissolved in distilled water. Seeds were germinated on two layers of filter paper in petri dishes (9 cm in diameter). The seeds were allowed to germinate at 25°C in the dark and they were considered as germinated when the emerging radicle was elongated to 2mm. The number of seeds germinated was counted daily for 7 days. Final germination rate was determined using this formula: Final germination rate (%) = $n/N \times 100$ with n: number of germinated seeds on the nth day and N: total number of seeds.

Growth in greenhouse:

The seeds were germinated in plastic pots (25cm of diameter) containing 2kg of soil, in a greenhouse under $27 \pm 3^\circ\text{C}$ day temperature, $85 \pm 5\%$ relative humidity and 12h of photoperiod. When fourth leaf was completely expanded, plants were irrigated permanently (every 5 days) with five salinity levels (0, 1, 3, and 6 g/l). Before flowering, chlorophyll a and b content in milligrams (mg) were calculated after estimating the absorbance of the chlorophyll solution, which was measured with a spectrophotometer (T60 Uv /vis) at 645 and 663 nm using the formula of Arnon (1949). Proline content ($\mu\text{ mol /g FW}$) was estimated based on proline's reaction with ninhydrin and the absorbance of the solution was read at 520 nm using toluene as blank by UV-visible spectrophotometer (Bates et al., 1973). After 45 days of salt treatment, growth performances of the plants in terms of shoot height, free proline contents, net photosynthetic rate and transpiration rate of *Ocimum basilicum* leaves were determined prior to the harvest. Net photosynthetic rate, transpiration rate and CO₂ in the first fully expanded leaf after exposure to salt stress (0, 1, 3, 6, and 9 g/l) were measured at 11.00 am using a portable photosynthesis system (CI-301PS de CID Inc).

The experimental designs were Completely Randomized Design for germination experience and Randomized Complete Block for pot experiment. The treatments were arranged in factorial ones with four replications. All data were analyzed by SPSS software and Duncan's Multiple Range Test was used to determine significance of differences between variables ($p < 0.05$).

Results and discussions

Germination in petri dishes

The results (Table 1) showed that different levels of salinity have significant effect on basil seed germination. Many researchers have reported similar results (Mousavi et al., (2011) and Zahedi et al., (2010). In all of cultivars, there was a decrease in germination percentage when the concentration of salt increase. While, in this experiment, cultivars had different response to the salinity. In control, seed germination percentage varied between 50% (“Grand Vert Sweet”) and 70% (“Fin Vert”). At the highest salt concentration (18 g/l), germination was not possible.

Chlorophyll content

Data regarding chlorophyll content is presented in Table 2. Statistical analysis of the data revealed that different salinity levels and the interaction between salinity and various genotypes had a significantly effect on chlorophyll a and b. By increasing salinity levels from 0 to 6 g/l, these photosynthesis pigments reduced. This decrease is consequence to the reduction of chlorophyll a for the varieties “Grand Vert” and “Fin Vert” and simultaneous the chlorophyll a and chlorophyll b for the variety “Grand Vert Sweet”. Maximum reduction was observed when plants were exposed to high salinity level (that is 6 g/l).

Photosynthetic parameters

Photosynthetic active radiation (PAR)

The photosynthetic active radiation, wish can fixes the CO₂ under the chlorophyll pigments a and b, can be lost as heat and fluorescence when the plant is under biotic or abiotic stress. Results showed that in absence of salt stress, the varieties “Fin Vert” and “Grand Vert Sweet” absorbent more than variety “Grand Vert”. Under salt stress, the absorbed photons content increases slightly when the concentration of NaCl increase for all the varieties. For exemple at 6 g/l of NaCl, this increasing varies from 2 (variety “Grand Vert”) to 12% (variety “Grand Vert Sweet”).

Internal CO₂ concentration

In control plants (0 g/l NaCl), internal concentration of CO₂ ranges from 100 of the variety “Grand Vert Sweet” to 300 ppm of the variety “Grand Vert”). In stressed plants (1-6 g/l NaCl), the concentration of CO₂ decrease by the increasing of the concentration of NaCl. At the highest concentration (6 g/l), the CO₂ content is only 1/3 comparing to control plants for the variety “Grand Vert”. The variety “Grand Vert” has the highest concentration of CO₂.

Net photosynthesis assimilation (Pn)

In control medium, the net photosynthetic assimilation (Pn) ranges from 4.45 (variety “Fin Vert”) to 9.5 $\mu\text{mol}\cdot\text{m}^{-2}\cdot\text{s}^{-1}$ (variety “Grand Vert”). With the increasing of NaCl, the photosynthetic assimilation decreases. Indeed, for 6 g/l, the Pn decreased by 48% compared to the control for the variety “Grand Vert”.

Transpiration

Transpiration varied from 0.5 (variety “Grand Vert Sweet”) to 0.9 $\text{mmol}^{-1}\cdot\text{m}^{-2}\cdot\text{s}^{-1}$ (variety “Grand Vert”) in control plants. When the concentration of salt increases, the transpiration increases. Indeed, under 6 g /l NaCl, the intensity of transpiration is 7.5 times higher than in the control for the variety “Grand Vert Sweet”.

Proline accumulation

Significant differences were observed between the genotypes of basil plants for proline in leaves (Table 2). In this study, the proline content varied among the basil genotypes whether the plants were grown with or without salinity stress. The control plants (grown in absence of NaCl) synthesize and accumulate proline which varied from 5 (variety "Fin Vert") to 30 mg/l (variety "Grand Vert Sweet"). In the presence of the highest concentration 6 g/l, proline content increased from 30 (0g /l) to 40 g/l (variety "Grand Vert Sweet") and from 5 (0 g /l) to 55 g/l (variety "Fin Vert") which means an increase of 11 times comparing to control.

Table 1: Germination of seeds under salt stress in petri dishes.

Germination (%)								
	0	1	3	6	9	12	15	18
Grand Vert	59a	55a	40c	51d	46c	12e	0	0
Fin Vert	67a'	65a'	63a'	68a'	65a'	53c'	42d'	0
Grand Vert Sweet	50d''	55b''	64a''	45d''	45d''	46d''	31e''	0

Table 2: effect of NaCl on chlorophylls, photosynthetic parameters and Proline.

Variety	NaCl (g/l)	Chl a (µg/ml)	Chl b (µg/ml)	PAR (µmol.m ⁻² .s ⁻¹)	Pn (µmol.m ⁻² .s ⁻¹)	Somatic conductance (mmol ⁻¹ .m ⁻² .s ⁻¹)	Transpiration (mmol ⁻¹ .m ⁻² .s ⁻¹)	CO ₂ (ppm)	Proline (µg/l)
Grand Vert	0	32a	39,94c	760c	9,69a	93,38a	1,3b	298a	10,92e
	1	31,3b	35,62c	700c	6,41b	72,92a	1,44b	227,5a	23,02e
	3	29,1b	34,55c	686c	6,12b	54,86b	1,52a	136,3c	24,6e
	6	27,28c	30,13c	810c	4,93c	95,29a	2,25a	100,6d	36,97d
Fin Vert	0	52,3ab'	51,91ab'	1150a'	4,79c'	54,06b'	0,77b'	204b'	5,04e'
	1	40,3ab'	44,59ab'	1070b'	4,6c'	51,82b'	1,35b'	157c'	7,76e'
	3	36,0b'	39,17ab'	900b'	4,22c'	31,2c'	1,48a'	147c'	29,6d'
	6	35,93b'	37,64ab'	1200a'	4,28c'	58,62b'	1,75a'	61,25d'	55,65b'
Grand Vert Sweet	0	77,8a''	66,61a''	1200a''	6,41c''	44,5c''	1,43b''	130b''	30,39d''
	1	57,0a''	62,74a''	1180a''	4,48c''	37,5c''	1,64b''	87,9b''	50,65c''
	3	57,6a''	58,19a''	1165b''	3,57c''	16,42c''	1,7a''	91,4d''	60,92b''
	6	31,3c''	34,1c''	1400a''	3,05c''	40c''	2,22a''	37,6d''	68,81a''

For most plants, the increase of salt (NaCl) causes a decrease in germination percentage; this can be the results of toxic effects of Na⁺ and Cl⁻. This toxicity changes the activity of some enzymes included in germination process, changes protein metabolism and interrupts hormonal balance (Gomes-Filho *et al.*, 2002). This reduction due to the accumulation of ions in the embryo and the mineral disequilibrium (Guerrier, 1980), and the invasion of tissues by Na⁺ et Cl⁻ depends on the useful ion (K⁺, NO³⁻ et PO₄²⁻) (Hannachi, 1997). In fact, those ions reduce the germinative capacity of basil (Al-Karaki., 2001) and they induce metabolic alteration of the germination process and in extreme cases they cause the death of the embryo by excess of ions (Bliss *et al.*, 1986).

Salt stress didn't affect only the germination stage but also the growth stage. So in this stage, there is an alteration of photosynthetic process. There is a reduction of photosynthesis which made the alimentation of all organs by the Carbone Hydrate. The decrease of photosynthetic capacity under salinity might be due to the stomatal closure, which limits stomatal conductance and photosynthetic CO₂ assimilation (Downton *et al.*, 1990; Yang and Lu, 2005). In a manner consistent with our results, stomatal closure in leaves of chickpea (Garg and Singla, 2004), sorghum (Netondo *et al.*, 2004) and *Jatropha curcas* L (Oliveria Campos *et al.*, 2012) is a prime constraint to photosynthesis by limiting CO₂ flux into the leaves of salt- stressed plants. However, these results are in contrast with those of Praxedes *et al* (2010), who proposed no significant effects of salt stress Pn in cowpea plants. It is well known that salt stress may induce a decline in the Pn (Lu *et al.*, 2009; Qin *et al.*, 2010). Sensitivity of Pn is an ideal indicator under saline stress. Decline in Pn was correlated with depressed plant growth. The decline in photosynthesis observed in case of salinity could be attributed to stomata factors. During salt stress the concentration of CO₂ in chloroplasts decreased because of the reduction in stomata conductance, inspite of the apparent stability of CO₂ concentration in intercellular spaces (Tourneux and Peltier, 1995). Brougnoly and Lauteri (1991) also indicated that reduced photosynthetic carbon assimilation was attributed to reduced stomata conductance. Generally, transpiration rate tended to decline with increasing salinity. This may be due to the fact that lowered water potentials in the root can trigger a signal from root to shoot (such as abscisic acid, which has been suggested to be the operating mechanism (Zhang and Davies, 1991). It was also observed that the stomata conductance of young bean plants declined with salinity. In order to reduce the effect of salt stress, plants produce proline. Proline accumulation in salt stressed plants is a primary defense response to maintain the osmotic pressure in a cell, which is reported in salt tolerant and salt sensitive cultivars of many crops (De Lacerda *et al.*, 2003; Kumar *et al.*, 2003; de Lacerda, *et al.*, 2005; Demiral and Türkan, 2005; Mansour *et al.*, 2005; Desingh & Kanagaraj, 2007; Koca *et al.*, 2007;). Many plants accumulate proline as a protective osmolyte under stress conditions. In fact, a positive correlation between proline accumulation and salt tolerance can be used like an index for salt tolerance between plants (Misra *et al.*, 2004).

Conclusion

In conclusion, this study demonstrated that seed germination of basil varied according to the change in NaCl levels. The increase of salt stress decreased the germination rate. All studied parameters on seedling growth were also affected by salt stress. We found that "Fin Vert" variety is the most resistant to salt stress. In order to improve the tolerance of basil to salt stress in arid and semi-arid region, biotechnological techniques may be useful to regenerate tolerant plants.

References

- Al-Karaki GN., 2001. Germination, sodium and potassium concentrations of barley seeds as influenced by salinity. *J. Plant Nutr.*, 24: 511-522.
- Arnon, D.I. (1949) Copper enzyme in isolated chloroplasts, polyphenoloxidase in *Beta vulgaris*. *Plant Physiol.*, 124, 1-15.
- Bates, L. S.; Waldren, R. P. & Teare, I. D. (1973): Rapid determination of free proline for water stress studies. – *Plant Soil* 39: 205–207
- Bliss R.D., Plant-Aloia K.A. and Thomson W.W., 1986. Osmotic sensitivity in relation to sensitivity in germination barely seeds. *Plant Cell and environment.* 9:727-733.
- Brugnoli E. and Lauteri M., 1991. Effects of Salinity on Stomatal Conductance, Photosynthetic Capacity, and Carbon Isotope Discrimination of Salt-Tolerant

- (*Gossypiumhirsutum* L.) and Salt-Sensitive (*Phaseolus vulgaris* L.)C3 Non-Halophytes.95 no. 2.628-635.
- De Lacerda, C.F., Cambraia, J., Oliva, M.A., Ruiz, H.A. and Tarquino Prisco, J. (2003) Solute accumulation and distribution during shoot leaf development in two sorghum genotypes under salt stress. *Environ and Expt. Bot.*, 49, 107-120.
- De Lacerda, C.F., Cambraia, J., Oliva, M.A. and Ruiz, H.A. (2005) Changes in growth and in solute concentrations in sorghum leaves and roots during salt stress recovery. *Environ. Exp. Bot.*, 54, 69-76.
- Hosni S., 2009. Tolerance to salt stress. Site : <http://hosni.unblog.fr/2009/01/13/latolerance-ausel>.
- Downton WJS, Loveys BR, Grant WJR. 1990. Salinity effects on the stomatal behavior of grapevine. *New Phytol* 116:499–503
- Dunn MA, Morris A, Jack PL, Hughes MA. 1993. A lowtemperature-responsive translation elongation factor 1 a from barley (*Hordeum vulgare* L.). *Plant Molecular Biology* 23, 221-5.
- Guerrier G., 1980. Capacité germinative des semences en fonction graduelle en NaCl Importance des transferts sur milieux sodés ou témoins. *Rev.Gént.Bot.*90 :3 – 21.
- Garg N, Singla R (2004) Growth, photosynthesis, nodule nitrogen and carbon fixation in the chickpea cultivars under salt stress. *Braz J Plant Physiol* 16(3):137–146
- Gomes-Filho E., Machado Lima C.R.F., Costa J.H., Da Silva A.C., Da Guia Silva Lima M., Gupta N.K., Meena S.K., Gupta S., Khandelwal S.K., 2002 - Gas exchange, membrane permeability and ion uptake in two species of Indian jujube differing in salt tolerance. *Photosynthetica*. 40:535-539.
- Hannachi C., 1997. Improved of the tolerance of potato (*SolanumTuberosum* L.) to salinity (NaCl) by biotechnological methods. Thesis in applied biology. University of Sciences of Agriculture of Ghent. Belgium p.152.
- Khan, M. J.; Drochner, W.; Steingass, H.; Islam, K. M. S., 2008. Nutritive evaluation of some tree leaves from Bangladesh for feeding ruminant animals. *Indian J. Anim. Sci.*, 78 (11): 1273-1277
- Koca M., Bor, M., Ozdemir, F. and Turkan, I. (2007) The effect of salt stress on lipid peroxidation, antioxidative enzymes and proline content of sesame cultivars. *Environ. Exp. Bot.*, 60, 344– 351.
- Kumar, S.G., Reddy, A.M. and Sudhakar, C. (2003) NaCl effects on proline metabolism in two high yielding genotypes of mulberry (*Morus alba* L.) with contrasting salt tolerance. *Plant Sci.*, 165, 1245-1251.
- Lu KX, Cao BH, Feng XP, He Y, Jiang DA. 2009. Photosynthetic response of salt-tolerant and sensitive soybean varieties. *Photosynthetica* 47:381–387
- Mansour, M.M.F., K.H.A. Salama, F.Z.M. Ali, and A.F.A. Hadid. 2005. Cell and plant responses to NaCl in *Zea mays* L. cultivars differing in salt tolerance. *Gen. Appl. Plant Physiol.*, 31: 29-41.
- Misra, N. et Dwivedi, U. N. ; 2004. Genotypic difference in salinity tolerance of green gram cultivars. *Plant Sci.*, 166: 1135-1142.
- Misra, A., Srivastava, N.K., 2000. Influence of water stress on Japanese mint. *J. Herbs Spices Medicinal Plants* 7, 51–58.
- Mousavi S.G. and Jouyban Z., 2011. Effect of salinity stress on germination and growth parametrsod seedlings of basil (*Ocimum basilicum* L.). 2011 TJEAS Journal-2012-2- 4/84-87.
- Netondo, G.W.; Onyango, J.C. et Beck, E.; 2004 a. Sorghum and salinity. I. Response of growth, water relations, and ion accumulation to NaCl salinity. *Crop Sci.*, 44(3): 797-805.

- Qin J., Dong W.Y., He K.N., Yu Y., Tan G.D., Han L., Dong M., Zhang Y.Y., Zhang D., Li Z.A., Wang Z.L. (2010): NaCl salinity induced changes in water status, ion contents and photosynthetic properties of *Shepherdia argentea* (Pursh) Nutt. seedlings. *Plant, Soil and Environment*, 56: 325–332.
- Oliveira Campos ML, Hsie BS, Almeida Granja JA, Correia RM, Almeida-Cortez JS, Pompelli MF. 2012. Photosynthesis and antioxidant activity in *Jatropha curcas* L. under salt stress. *Braz J Plant Physiol* 24:55–67
- Ramin, A.A. (2006). Effects of salinity and temperature on germination and seedling establishment of sweet basil (*Ocimum basilicum* L.). *J Herbs Spices Med Plants* 11(4): 81-90.
- Praxedes SC, Lacerda CF, DaMatta FM, Prisco JT, Gomes-Filho E (2010) Salt tolerance is associated with differences in ion accumulation, biomass allocation and photosynthesis in cowpea cultivars. *J Agron Crop Sci* 196:193–204.
- Reuveni R, Fleischer A, Putievsky E. (1984) Fungistatic activity of essential oils from *Ocimum basilicum* chemotypes. *Phytopathol Z* 110:20–22.
- Said, H.A.H., Omer, E.A. (2011). Medicinal and aromatic plants production under salt stress. A review. *Herba Polonica*. 57: 72-87.
- Simon, J.E.; Morales, M.R.; Vieira, M.F.; Whippen, W.B. ; Hao, Z. A source of raw aroma chemicals and a popular herb for culinary and ornamental market. In: Janick, J., ed perspectives of new crops and new uses. ASHS Press; 1999; 499- 505.
- Simon, J.E., 1995. Basil. New CropFactSHEET.
Disponiblesurwww.hort.purdue.edu/newcrop/CropFactSheets/basil.html.
- Singh, R. , Issar, D., Zala, P.V. and Nautiyal PC (2007) Variation in sensitivity to salinity in groundnut cultivars during seed germination and early seedling growth . *Journal of SAT Agricultural Research*, 5(1), 1-7.
- Stepien P, Klobus G (2006). Water relations and photosynthesis in *Cucumis sativus* L. leaves under salt stress. *Biologia Plantarum*. 50(4): 610-616.
- Tourneux, C., G Peltier, 1995. Effect of water deficit on the photosynthetic oxygen exchange measured using $^{18}O_2$ and mass spectrometry in *Solanum tuberosum* leaf disks. *Planta*, 195, 570-577. Yang X, Zhang X. Regulation of somatic embryogenesis in higher plants. *Crit Rev Plant Sci* 2010;29:36–57.
- Zahedi SM., Nabipour M., Azizi M., Gheisar H., Jalali M. and Amimi Z., 2010. Effect of kinds of salt and its different levels on seed germination and growth of basil plant. *World Applied Sciences Journal* 15 (7) : 1039- 1045.
- Zhang W, McElroy D, Wu R (1991) Analysis of rice Act1 5'-region activity in transgenic plants. *Plant Cell* 3:155–1165
- Zahedi SM., Nabipour M., Azizi M., Gheisar H., Jalali M. and Amimi Z., 2010. Effect of kinds of salt and its different levels on seed germination and growth of basil plant. *World Applied Sciences Journal* 15 (7) : 1039- 1045.

CROP YIELD AND SELECTED SOIL PHYSICAL PROPERTIES UNDER DIFFERENT TILLAGE

Rastislav BUŠO¹, Roman HAŠANA¹, Ivana KAŠIČKOVÁ¹, Soňa GAVURNÍKOVÁ¹

¹National Agricultural and Food Centre, – Research Institute of Plant Production Piešťany, Slovakia

Abstract

The aim of the study was to investigate an influence of different soil tillage technologies on selected physical properties of soil and yield of winter wheat and spring barley grain. Field experiment was established in growing seasons 2013 – 2015 in Research Station Borovce (NAFC – RIPP Piešťany), Slovakia. Experiment was conducted in four different soil tillage technologies: conventional, minimization, mulch and no-till technology. The highest soil bulk density in the depth of 0.0 to 0.1 m was in conventional technology, 0.10 – 0.20 m in no-till, 0.20 – 0.30 m was in minimization technology (1.46 t.m⁻³, 1.50 t.m⁻³ and 1.54 t.m⁻³ respectively). The highest porosity during the experimental period was observed in depth of 0 – 0.10 m in no-till technology (51.69 %). This was the highest value from the point of view of technology and sampling depth. The highest average value of soil moisture was in depth of 0 to 0.10 m, the most favorable value was reached in no-till technology (18.15 %) in this sampling depth. It was also the highest value throughout the whole soil profile (0 to 0.80 m). The highest grain yield of winter wheat and spring barley has reached in minimization technologies during growing season 2013 – 2015.

Keywords: *soil tillage technologies, physical properties of soil, yield of grain*

Introduction

In the last years, not only in our country but in all countries with intensive agriculture, are beginning to show the negative effects of mechanization in some technologies applied in agricultural production. Significantly, these negative tendencies speech to changes in the form of physical, chemical and biological soil properties, which affect on the crops stability. Soil cultivated significant influenced on its physical properties. The soil should be adjusted to the condition that the cultivation of crops to provide good conditions for growth and development, at the same time is required to minimize the negative impact on the habitats and the environment. Different farming systems and machining technologies have different effects on soil properties. Improper use of tillage can increase soil compaction, reducing the structural stability of the aggregates, disrupt the surface pores and thus the air exchange, reducing the retention and transfer of water and dissolved substances into the soil and increase its losses by surface runoff and erosion. Intensive tillage may also reduce the content of soil organic matter due to increased of mineralization as well as contributing to erosion and reduce of sediment delivery cycle of organic matter from crop residues (Žák et al., 2011). Minimization and land protection technology have a beneficial effect on the soil structural stat, better management of soil moisture, reducing water and wind erosion, reduce leaching of mobile forms of nitrogen and others (Vach and Javůrek, 2011). On the other side, a number of negative consequences, especially the accumulation of soil and stubble-borne plant diseases, the costs of purchasing equipment, residues of herbicides that restrict the choice of crops, accumulation of resistant weeds, concerns about the effects of herbicides on the environment and human health, limit a greather using of no-

tillage technology (Thomas et al., 2007). The goal of work was to compare the relationship between the physical soil properties and harvest of selected field crops under different tillage systems (conventional, minimization, mulch and no-till).

Material and Methods

Field experiment with different technologies of soil cultivation was observed on research institutes NAFC - RIPP in Borovce in 2013 – 2015 years. The area has a continental climate with long-term nature with annual average of rainfall 593 mm (358 mm during vegetation). Long-term average in temperature of 9.2 ° C (15.5 ° C during vegetation). Altitude is 167 m n. m. The area is included in the corn-barley production type. Land on an experimental station is loamy black-brown soil, loess humus with depth from 400 to 500 mm, with a mean supply of P and K, neutral to slightly acidic soil reaction. Topsoil and subsoil horizons are slightly compacted. Humus content in the topsoil profile is moderate (2.43%), in the subsoil horizons is low (0.87 to 1.84%). Selected crop rotation (winter wheat - grain corn - spring barley - soybean) partly reflects the current proportion of arable land of cereals in Slovakia (over 50%), represented by one legume crops and one cereal which is treated as root crops - grain corn. In experiment we found only two crops – winter wheat and spring barley. Within the problem-solving process are tested four technology tillage: conventional, minimization, mulch and no-till. Size of experimental plots was 35 x 9 m, it was founded in three repetitions. The results were processed by analysis of variance in the programming package Statgraphics and MS Office programs.

Results and Discussion

When we evaluating the growing years 2013 -2015, it should be noted that during the three years of the cases occurred to extreme differences in temperature and precipitation in each month, resulting also significant differences in the average of growing years.

Higher values of soil bulk density and lower porosity values in conventional soil cultivation compared with no-till systems also states Sidiras et al. (2001). On the other side, many authors report a higher specific weight and the lower total porosity variation, the no-till compared to conventional farming techniques with tillage (Hussain et al., 1999; Tebrügge, During, 1999).

In different years due to high rainfall in the spring we can a sawing of spring crops with a high content of soil moisture and consequently the compaction of soil agricultural machinery, causing a significant increase in specific weight in conventional agrotechnics compared to direct sowing without tillage (Kotorová, 2007) .The average of soil bulk density (Table 1) was from 1.32 t.m⁻³ at a depth of from 0.0 to 0.1 meters in minimization over 1.54 t.m⁻³ also in minimization. The highest value of bulk density in profile 0.0 to 0.3 m were observed in the conventional technology (1.49 t.m⁻³), the lowest 1.43 t.m⁻³ in minimization.

Table 1. The average of soil bulk density (t.m⁻³), Borovce 2013 - 2015

Technology	Depth (m)			
	0.0 – 0.10	0.10 – 0.20	0.20 – 0.30	Average
Conventional	1.46	1.49	1,51	1.49
Minimization	1.32	1.42	1.54	1.43
Mulch	1.36	1.48	1.52	1.45
No-till	1.35	1.50	1.53	1.46

In average of years 2013-2015 we observed the greatest porosity (Table 2) in depth of 0 to 0.10 meters in no-till technology (51.69%). This was the highest value regardless of the technology

and sampling depth. Also, in depth of 0.10 to 0.20 meters was the highest porosity in no-till technology too (48.13%). In a depth of 0.20 to 0.30 meters we observed the largest porosity in conventional technology (43.94%) and the lowest in no-till (41.49%). In average, irrespective of the sampling depth, the highest porosity was in the no-till technology (47.10%). The critical value of the soil porosity is clayey P <45%, and the clay-loamy is P <47% (Fulajtár, 2006).

Increase of soil bulk density and decrease of total porosity with depth, in parallel with the tillage and direct sowing in the soil also included Neudert (2007) and Badalíková - Gross (2004). In our experiments confirmed the relationship between density and porosity.

Table 2. The average of porosity (%), Borovce 2013 - 2015

Technology	Depth (m)			
	0.0 – 0.10	0.10 – 0.20	0.20 – 0.30	Average
Conventional	45.93	44.54	43.94	44.81
Minimization	50.61	47.66	42.59	46.95
Mulch	49.29	44.55	42.86	45.57
No-till	51.69	48.13	41.49	47.10

Average of soil moisture (Table 3) was the highest in depth of 0 to 0.10 m in no-till technology (18.15%). It was also the highest value in the whole profile donations (from 0 to 0.80 meters). In the depth of 0.50 to 0.60 m there was a return to the level of moisture like in the profile from 0.0 to 0.1 meters. On average, regardless of depth, we found the highest soil moisture in mulch technology (17.18%) but not in the conventional technology, we have found the value of 16.82%, which was subject to excessive moisture profile of 0.3 to 0.6 meters.

Table 3. Influence of technology and depth on average of soil moisture (%), Borovce 2013 - 2015

Technology	Depth (m)								
	0.0 – 0.10	0.10 – 0.20	0.20 – 0.30	0.30 – 0.40	0.40 – 0.50	0.50 – 0.60	0.60 – 0.70	0.70 – 0.80	Average
Conventional	16.73	17.17	16.95	17.20	17.44	17.24	16.41	15.42	16.82
Minimization	17.29	16.01	16.28	16.49	16.67	16.20	15.94	15.68	16.32
Mulch	17.23	16.42	16.47	16.92	17.41	17.32	16.58	15.87	16.78
No-till	18.15	17.36	16.95	17.04	17.39	17.45	16.99	16.16	17.18

In the growing years 2013 - 2015 we had the greatest grain yield of winter wheat in minimization technology ($6.62 \text{ t}\cdot\text{ha}^{-1}$) it was overcome of planned harvested by $0.62 \text{ t}\cdot\text{ha}^{-1}$. In spring barley crop was the highest grain yield on minimization technology ($4.87 \text{ t}\cdot\text{ha}^{-1}$), but not overcome the planned yield $5 \text{ t}\cdot\text{ha}^{-1}$ (Table 4). Lower grain yield of wheat in the no-till technology state Miština - Maple (2000), Kováč et al. (2010), Ball (2002), however, reported a higher yields for wheat in the cultivation of no tillage than with tillage.

Table 4. Grain yield (t.ha⁻¹), Borovce 2013 - 2015

Technology	Winter wheat	Spring barley
Conventional	6.55	4.42
Minimization	6.62	4.87
Mulch	5.88	3.35
No-till	6.22	4.37
Average	6.32	4.25

Winter wheat Hdd_{0,05} year = 0.25875 ++; technology = 0.3171 ++; Winter wheat Hdd_{0,01} year = 0.38321 ++; technology = 0.40209 ++; Spring barley Hdd_{0,05} technology = 41284 ++; Spring barley Hdd_{0,01} technology = 0,64495 ++

Conclusion

The average of soil bulk density in 2013 - 2015 was from 1.32 t.m⁻³ in a depth 0.0 - 0.1 meters in minimization technology to 1.54 t.m⁻³ also in minimization. The highest value of bulk density in profile 0.0 to 0.3 m were observed in the conventional technology (1.49 t.m⁻³), the lowest 1.43 t.m⁻³ in minimization.

The largest average of porosity in years 2013 - 2015, regardless of the sampling depth, we observed in no-till technology (47.10%).

On average, regardless of depth, we found the highest soil moisture in mulch technology (17.18%) but not in the conventional technology, we have found the value of 16.82%, due to higher humidity in profile from 0.3 to 0.6 meters.

In the years 2013 - 2015 winter wheat and spring barley grain yield reached the highest in minimization technology.

Acknowledgment

Processing of paper was supported by financial resources within the sectoral research and development project for the years 2013 - 2015 solutions based on the orders of the Ministry of Agriculture and Rural Development (MARD) SR "Innovation of cropping systems in sustainable agriculture in changing environmental conditions" - co-ordinating workplace: National Agricultural and Food Center (NAFC) Lužianky - plant production Research Institute (CRI) Piestany (Department of Cropping Systems - DCS); Coordinator: Ing. Roman Hašana, PhD.; Duration: 01/2013 - 12/2015.

References

- Badalíková B., Hrubý J. (2004). Různé zakládání porostu pšenice ozimé a jeho vliv na fyzikální vlastnosti půdy (Different winter wheat stand establishment and its impact on physical soil properties). In: Nové poznatky v pěstování, šlechtění a ochraně rostlin, Sborník referátů z konference s mezinárodní účastí konané v Brně, VÚP spol. s r. o., Troubsko, 2004, ISBN 80-902436-9-X, s. 261-264.
- Balla P. (2002). Energetické a ekonomické zhodnotenie pôdochranných technológií pri pestovaní pšenice letnej formy ozimnej (Energy and economic evaluation of soil protection technology in the cultivation of winter wheat), In: Zborník vedeckých prác OVÚ Agroekológie v Michalovciach, Michalovce: OVÚA, 2002, ISBN 80-968917-9-0, s. 7-14.
- Blanco-Canquil, H., Lal, R. (2007). Regional assessment of soil compaction and structural properties under no-tillage farming. Soil Sci Soc Am J, Vol. 71, 2007, pp. 1770-1778
- Fulajtár E. (2006). Fyzikálne vlastnosti pôd (Physical properties of soils). VUPOP. Bratislava. 2006. 142 s. ISBN 80-89128-20-3.

- Hůla J., Procházková B. et al. (2008). Minimalizace zpracování půdy (Minimizing tillage). Profipress, Praha 2008, ISBN 978 – 80 – 86726 – 28 – 1, 248 s.
- Hussain I., Olson K.R., Wander M.M., Karlen D.L. (1999). Adaptation of soil quality indices and application to three tillage systems in southern Illinois. *Soil Till. Res.*, Vol. 50, 1999, no. 3-4, pp. 237-249
- Kotorová D., Balla P. (2004). Obrábanie pôdy vo vzťahu k úrodám pšenice ozimnej. (Tillage in relation to the grain yield of winter wheat) online[cit. 2016-04-14]. Available on the internet:<http://fzki.uniag.sk/web/bpd2004/content/02Sekcia_agroklimatologie/Kotorova.pdf>
- Kováč K., Nozdrovický L., Macák, M. et al. (2010). Minimalizačné a pôdoochranné technológie (Minimisation and conservation technologies), Nitra: Agroinštitút, š. p., 2010, 142 s., ISBN 978-80-7139-139-5.
- Mišťina T., Javor, Ľ. (2000). Výskum obrábania pôdy vo Výskumnom ústave rastlinnej výroby Piešťany (Tillage research at the Research Institute of Plant Production Piestany). In: *Súčasnosť a perspektívne smery v obrábaní pôdy*, Zborník vedeckých prác z vedeckej konferencie s medzinárodnou účasťou, Nitra: SPU, 2000, ISBN 80-7137-764-3, s. 65 – 68.
- Mišťina T., Kováč K. et al. (1993). Ochranné obrábanie pôdy (Conservation tillage). 1 vyd., Piešťany: VÚRV, 1993, s. 4-9, ISBN: 80-7137-125-4
- Neudert L. (2007). Hodnocení vlivu různého zpracování půdy ke kukuřici na zrno na základní fyzikální vlastnosti půdy (Assessment of different tillage of grain maize and its impact on the basic physical soil properties). *Aktuální poznatky v pěstování, šlechtění, ochraně rostlin a zpracování produktů. Zborník z konf. Brno 8.-9.11.2007: CD-ROM*, Troubsko: VUP, 2007, s. 347-350
- Pikul J.L., Schwartz, R.C., Benjamin J.G., Baumhardt R.L., Merrill, S. (2006). Cropping system influences on soil physical properties in the Great Plains. *Renew. Agric. FD Syst.*, Vol. 21, 2006, No. 1, pp. 15-25
- Pospišil R., (2002). Energetická analýza úsporných systémov obrábania a hnojenia pôdy v rôznych sústavách rastlinnej výroby (Energy analysis of economy systems of tillage and fertilization in different crop systems). In *Poľnohospodárstvo*, roč. 48, 2002, č. 7, s. 374-379.
- Sidiras N., Bilalis D., Vavoulidou E. (2001). Effects of tillage and fertilization on some selected physical properties of soil (0-30 cm depth) and on the root growth dynamic of winter barley (*Hordeum vulgare* cv. Niki). *J. Agron. Crop Sci.*, Vol. 187, 2001, No. 3, pp. 167-176
- Šimon J., Lhotský J. (1989). Zpracování a zúrodňování půd (Processing and reclamation of soils), Praha: SZN, 1989, 320 s., ISBN 80-209-0048-9.
- Tebrügge F., Düring R.A. (1999). Reducing tillage intensity – a review of results from a long-term study in Germany. *Soil Till. Res.*, Vol. 53, 1999, No. 1, pp. 15-28
- Thomas G.A. et al., (2007). No-tillage and conservation farming practices in grain growing areas of Queensland – a review of 40 years of development. In. *Australian Journal of Experimental Agriculture*, 47(8), 2007, p. 887–898.
- Vach M., Javurek M., (2011). Efektivní technologie obdělávání půdy a zakládání porostů polních plodin (Efficient tillage technologies and field crops establishment). *Výzkumný ústav rostlinné výroby*. Online [cit. 2016-04-14]. Available on the internet: <<http://www.vurv.cz/sites/File/Publications/ISBN978-80-7427-079-6.pdf>>
- Žák, Š. et al. 2011. Pestovanie poľných plodín s orbou či bez orby? (Field crops cultivation with or without ploughing?). Nitra: Agrokomplex, 2011. 120 s., ISBN 978-80-89417-32-2

ADAPTATION OF WINTER WHEAT GENOTYPES TO LOW SOIL pH AND HIGH LEVELS OF MOBILE AL IN THE SOIL

Miodrag JELIĆ^{1*}, Jelena MILIVOJEVIĆ², Aleksandar PAUNOVIĆ³, Milomirka MADIĆ³, Vera ĐEKIĆ²

¹University of Pristina, Faculty of Agriculture, Kopaonicka bb, 38219 Lesak, Kosovo and Metohija, Serbia

²Small Grains Research Center, Save Kovacevica 31, 34000 Kragujevac, Serbia

³University of Kragujevac, Faculty of Agronomy, Cacak, Serbia

*Corresponding author: miodragjelic@yahoo.com

Abstract

Low soil pH and a high mobile Al content of the soil pose a significant threat to wheat production on over 60% of arable land in Serbia. Wheat is very sensitive to soil acidity and high levels of mobile Al in the soil. However, genotypes show different sensitivity to these stress factors and external factors. Some wheat genotypes exhibit significantly higher tolerance than other wheat genotypes, or other cereal crops. This paper presents the results of testing conducted over three years to evaluate 10 genotypes of winter wheat for their tolerance to low soil pH and high levels of mobile aluminum in the soil. The analysis of productive traits and grain Al content of plants showed that the highest tolerance to low pH and high levels of mobile Al in the soil was exhibited by the genotypes 'Roane', 'Rapsodija', 'Ornil', 'Nora' and 'Nevesinjka', as opposed to the low adaptability to these stress factors in 'Sana', 'Kalyan sona', and 'Zarrin'. Tolerant genotypes had grain yields higher on average by 105%, number of grains per spike by 61%, grain weight per spike by 38% and 1000-grain weight by about 27% in comparison to sensitive genotypes. Also, grain Al concentrations in tolerant winter wheat genotypes were significantly lower (0.18-0.39 mg g⁻¹) than in sensitive genotypes (0.95-1.30 mg g⁻¹).

Key words: *adaptation, aluminum, genotype, wheat, soil*

Introduction

Acid soils cover substantial areas of Central Serbia. The total land area of Central Serbia and Kosovo is 4.7 million ha, of which more than 60 percent or 2.8 million ha are acid in reaction, with 30% of them being extremely acid (Stevanović et al., 1995). As most crops require slightly acid, neutral to slightly alkaline soils, few plants can tolerate conditions existing in these soils. Pseudogleys (epigleys) in Central Serbia have extremely unfavorable physical and chemical characteristics. As found by Narro et al. (2001) and Sumner (2004), the low fertility of acid soils is due to reduced solubility of some biogenic elements (P, Mo, B) and increased presence of some toxic elements and compounds, primarily Al. Also, their reduced productive capacity is mainly the result of increased levels of mobile aluminum which is toxic to most crops (Jelić et al., 2004; Jelić and Đalović, 2008).

Response to low soil pH and high mobile Al levels in the soil differs across species and cultivars. When grown on acid soils, sensitive genotypes produce significantly lower yields, whereas tolerant ones achieve the same or slightly reduced yields compared to non-acid soils. Tolerant plant species and genotypes show different degrees of tolerance. Some of them are essentially more tolerant than others, even within a single species, and the difference in tolerance among genotypes within species may be higher than among species. Rye is among the most tolerant species within the family *Triticeae*. Previous studies on tolerance in cereals have shown that rye

is the most tolerant species among cereals, followed by triticale (*X Triticosecale* Wittmack), wheat (*Triticum aestivum* L.), and barley (*Hordeum vulgare* L.) as the least tolerant (Aniol and Madej, 1996).

Therefore, there has been an increasing need in the cultivation of wheat and other cereal crops on acid soils to formulate fertilization systems and choose genotypes to be adapted to soil and climatic conditions in all cereal producing regions. Therefore, the objective of this study was to conduct biotesting of some winter wheat genotypes to identify genotypes tolerant of low soil pH and high mobile Al content in the soil, which would help increase grain yield and quality of winter wheat on these soils.

Material and methods

Research was conducted at the experimental field of the Dr Đorđe Radić Secondary School of Agriculture and Chemistry in Kraljevo over a period of three years (2012-2014). The soil used in the trial is classified as acid Al-toxic pseudogley. A two-field (wheat-maize) rotation was used.

The experiment was laid out in a randomized block design with three replications. Plot size was 100 m². Thirty winter wheat genotypes of different geographic origins and exhibiting great divergence were tested. Results for 10 wheat genotypes ('Pobeda', 'Evropa 90', 'Ornil', 'Roane', 'Rapsodija', 'Nora', 'Nevesinjka', 'Sana', 'Kalyan sona', 'Zarrin') are presented. The genotypes were evaluated for their adaptability based on parameters regarding productivity (grain yield, number of grains per spike, grain weight per spike) and grain quality (test weight, thousand grain weight and grain Al concentration).

Fertilization was based on the soil fertility status and included the following rates of pure nutrients: 120 kg N ha⁻¹, 100 kg P₂O₅ ha⁻¹ and 80 kg K₂O ha⁻¹, applied as complex NPK fertilizer (8:24:16), superphosphate (17% P₂O₅) and ammonium nitrate (AN=17% N). Total amounts of phosphorus and potassium fertilizers along with one-third of nitrogen fertilizer were used during seedbed preparation, whereas the rest of the nitrogen was applied as a single treatment at the beginning of spring. The other crop management practices used during the winter wheat growing season were standard.

Seeding was performed at the end of October by a cereal seed drill at 650 germinating seeds per m². At full tillering, 1.2 Lha⁻¹ Maton was applied for weed control. The crops were harvested at full maturity. Wheat grain properties were determined as follows: grain yield (t ha⁻¹, calculated at 14% grain moisture), number of grains per spike, grain weight per spike (g), 1000 grain weight (g) and test weight (kg hl⁻¹). Thousand grain weight was determined by an automatic seed counter. Test weight was determined by weighing a measured volume of grain expressed in kilograms per hectoliter.

Soil profiles were opened at the experimental plot, and the soil was sampled for analysis. Samples were taken after wheat harvest, at the end of July 2012, from the humus horizon (Ah= 0-15 cm), subhumus eluvial-pseudogley horizon (Eg= 15-40 cm) and from one part of the transitional B₁tg horizon (60-80 cm). The soil was analyzed by standard physical methods (soil texture by the pipette method, a variant of the pyrophosphate method (Živković, 1966)); and chemical methods (soil pH was determined in a 1:2.5 soil - 1 M KCl suspension after a half-hour equilibration period; hydrolytic acidity by Ca acetate extraction using Kappen's method; total adsorbed base cations by Kappen's method; humus content by the Kotzmann method; total nitrogen by the Kjeldahl method, and available P₂O₅ and K₂O levels by the Egner- Riehm Al method). Results were averaged and subjected to statistical analysis - ANOVA (Mead et al., 1996).

Soil characteristics

The soil used in the experiment is classified as pseudogley. Pseudogleys are not suitable for wheat, as this crop is not tolerant of extremely acid environments. The tested soil was heavy loam in the 0-40 cm layer, and light clay in layers deeper than 40 cm (Table 2). The proportion of silt and clay combined i.e. physical clay in the arable horizon (0-20 cm) was relatively high (46.29%), whereas that of total sand was low (11.68%). In deeper layers of the soil, the proportion of physical clay in general and silt in particular increased (over 55%), and that of total sand decreased (5.33%). This indicates a heavy texture (heavy loam soil to light clay soil) and very unfavorable physical properties of the soil.

Table 1. *Texture of Pseudogley*

Depth (cm)	Percentage of soil particles (mm)							Textural class
	2-0.2	0.2-0.05	0.05-0.01	0.01-0.005	0.005-0.001	< 0.001	< 0.01	
0-20	5.47	6.21	42.03	9.28	14.25	22.76	46.29	Heavy loam
20-40	4.23	5.82	42.26	10.60	14.46	22.63	47.69	
40-60	1.03	4.43	34.05	7.78	12.34	40.37	60.49	Light clay
60-80	0.70	4.84	36.31	5.75	15.60	36.80	58.15	
80-100	0.63	4.70	39.30	7.79	13.94	33.64	55.37	

The chemical characteristics of the tested pseudogley are very unfavorable (Table 3). Namely, this soil exhibits high acidity, with relatively low active acidity (pH in H₂O 5.24) in the arable horizon (0-20 cm) and considerably reduced acidity (pH in H₂O 6.04) in the deepest layers. Exchangeable acidity (pH in KCl) of this type of soil across profile depth ranges from 4.48 to 4.80. Hydrolytic acidity (Y¹) is relatively high (15.47 ccm) in the arable layer (0-20 cm), and considerably lower (7.35 ccm) in deeper layers.

Table 2. *Agrochemical properties of Pseudogley*

Depth (cm)	Humus (%)	Y ¹ (ccm)	N (%)	T	S	T-S	pH		P ₂ O ₅ (mg 100 ⁻¹)	K ₂ O (mg 100 ⁻¹)
							H ₂ O	KCl		
0-20	2.18	15.47	0.14	16.71	8.08	8.63	5.24	4.48	8.0	13.8
20-40	1.84	13.98	0.13	16.69	9.79	6.90	5.55	4.58	7.0	13.6
40-60	0.66	12.45	0.09	26.24	20.02	6.22	5.46	4.42	1.3	8.5
60-80	0.71	9.97	0.07	26.29	21.31	4.98	5.64	4.52	1.0	7.6
80-100	0.63	7.35	0.02	25.62	22.02	3.60	6.04	4.80	0.8	4.3

The composition of the soil adsorption complex was very unfavorable (Table 3), showing very low values for adsorption capacity, total adsorbed base cations, and base saturation percentage. The humus content in the topsoil (0-20 cm) was low (2.18%) and decreases considerably with increasing depth. The pseudogley profile analyzed was moderately supplied with total nitrogen in the humus-accumulating horizon. Total nitrogen in the arable soil layer was 0.14% on average, and decreased significantly with increasing depth (0.02%). In the 0-40 cm soil layer, the soil was poorly supplied with readily available phosphorus (7.0-8.0 mg 100 g⁻¹ soil) and moderately supplied with readily available potassium (13.8 mg 100 g⁻¹).

Results and discussion

Results on the testing of winter wheat genotypes for their tolerance to low soil pH and high mobile Al content in the soil are presented in Table 3. Low tolerance was observed in most wheat genotypes. The average grain yield in the tested genotypes was very low (1.53-3.73 dt ha⁻¹), and only 'Roane' achieved an average grain yield of 4.16 dt ha⁻¹. Very low grain yields were obtained by 'Kalyan sona' and 'Sana' (1.53 and 1.87 dt ha⁻¹, respectively), and 'Zarrin' and 'Evropa 90' (2.30 and 2.83 dt ha⁻¹, respectively). As shown in Table 3 parameters, tolerance to extreme soil acidity and high mobile Al content was highest in 'Roane', followed by 'Rapsodija', 'Nevesinjka', 'Ornil' and 'Nora', which gave an average grain yield of 3.30 to 3.73 dt ha⁻¹. The low performance of plants in terms of the number of grains per spike and grain weight per spike were the main reasons for the low yields of the tested genotypes. The significantly higher grain yield in tolerant genotypes ('Roane' and 'Rapsodija') is associated with the formation of more grains per spike and their thousand grain weight.

Table 3. Grain yield and quality of ten winter wheat genotypes (averaged over three years)

Genotype	Tested parameters					
	Grain yield	Number of grains per spike	Grain weight per spike	Test weight	Thousand grain weight	Grain Al concentration
	(dt ha ⁻¹)		(g)	(kg hl ⁻¹)		(g)
'Roane'	4.16	26.1	0.66	74.85	31.0	0.18
'Rapsodija'	3.73	24.7	0.61	73.65	33.0	0.35
'Nevesinjka'	3.56	21.5	0.60	73.52	28.5	0.39
'Ornil'	3.36	22.3	0.56	75.65	25.0	0.43
'Nora'	3.30	20.0	0.55	72.85	30.0	0.44
'Pobeda'	3.12	15.3	0.52	74.05	33.5	0.60
'Evropa'	2.83	14.9	0.51	74.45	29.0	0.52
'Zarrin'	2.30	14.9	0.39	75.65	30.2	0.67
'Sana'	1.87	9.8	0.32	73.12	33.0	0.95
'Kalyan sona'	1.53	6.9	0.25	73.65	35.5	1.30
LSD 5%	0.233	0.233	0.321	0.263	0.729	0.061
1%	0.319	0.319	0.440	0.360	0.999	0.084

Number of grains per spike and grain weight per spike are important indicators of winter wheat productivity. The highest values of the two traits were recorded in 'Roane' (26.1 and 0.66 g, respectively), and the lowest in 'Kalyan sona' and 'Sana' (6.9-9.8 g and 0.25-0.32 g, respectively). Test weight was highest in 'Roane' and 'Zarrin' (75.65kg hl⁻¹), the former genotype being the most productive and the latter exhibiting significantly lower productivity. Therefore, this parameter is not a reliable indicator in evaluating genotype tolerance on acid soils.

Thousand grain weight is an important indicator of grain physical quality. This trait is directly dependent on grain filling percentage, hectoliter weight and some chemical properties (protein level, moisture, starch content, etc.). The highest 1000-grain weight was obtained by 'Kalyanscna' (35.5 g) and the other lower-yielding genotypes ('Pobeda'- 33.5 g, 'Sana'- 33.0 g), which may result from the significant decrease in the number of grains per spike and increase in grain filling. Moreover, grain yield in wheat on unstructured soils is positively affected by organic fertilizers (manure), but the effect of manure was not studied in the present experiment. Manure improves

the development of the root system, enhances the uptake of nutrients, prevents the loss of nutrients from fertilizers, and improves the nutrient binding capacity of the soil and subsequent nutrient release during continuous plant nutrition throughout the growing season (Arshad et al., 2004).

Significant genotypic variations were observed in grain Al concentrations (Table 3). Grain Al contents were high in 'Kalyan sona' and 'Sana' (1.30 and 0.95 mg g⁻¹), but were significantly lower in 'Roane', 'Rapsodija' and 'Nevesinjka' (0.18, 0.35 and 0.39 mg g⁻¹, respectively) compared to the other tested genotypes. The genotypes showing low grain Al concentrations achieved significantly higher grain yields, number of grains per spike and grain weight per spike, which is indicative of their better adaptability to low soil pH. Furthermore, tolerant wheat cultivars normally accumulate lower Al amounts and produce higher grain yields (Darko et al., 2004).

The coefficients of correlation between grain yield and productivity and grain quality parameters are given in Table 4.

Table 4. *Coefficients of correlation between grain yield and the tested productivity and grain quality parameters*

Parameters	GY	NGS	GWS	TW	TGW	CAI
GY	-	-	-	-	-	-
NGS	0.50*	-	-	-	-	-
GWS	0.88**	ns	-	-	-	-
TW	ns	ns	ns	-	-	-
TGW	ns	ns	ns	ns	-	-
CAI	-0.71**	-0.50*	-0.80**	ns	ns	-

GY- grain yield, NGS- number of grains per spike, GWS- grain weight per spike, TW- test weight, TGW- thousand grain weight, CAI- Al concentration in the grain

Grain yield showed a weak positive correlation ($r=0.50^*$) with grain number per spike and a strong positive correlation ($r= -0.88^{**}$) with grain weight per spike. However, grain Al concentration in the tested genotypes exhibited a much stronger negative correlation with grain yield and grain weight per spike ($r= -0.80^{**}$). Moreover, a negative correlation was observed between number of grains per spike and grain weight per spike and grain Al concentration. Similar results were reported previously elsewhere (Darko et al., 2004).

Conclusion

The results of testing winter wheat genotypes for tolerance to low soil pH and high mobile Al content in the soil showed the following:

Genotypes exhibiting lower than average grain Al concentrations achieved a significant increase in grain yield, number of grains per spike and grain weight per spike, which is indicative of their better adaptability to low soil pH.

The genotypes 'Roane', 'Rapsodija', 'Ornil', 'Nora' and 'Nevesinjka' showed better adaptation to local agroenvironmental and soil conditions, and are recommended as suitable for wheat production on acid soils.

Acknowledgements

The authors acknowledge the financial support of the Serbian Ministry of Education, Science and Technological Development through project No. TR 31054.

References

- Aniol, A., Madej, L. (1996): Genetic variation for aluminum tolerance in rye. *Votr. Pflanzenz.*, 35, 201-211.
- Arshad, M, Khalid, A., Mahmood, M.H., Zahir, Z.A. (2004): Potential of nitrogen and L-tryptophan enriched compost for improving growth and yield of hybrid maize. *Pak J Agric Sci* 41: 16-24.
- Darko, E., Ambrus, H., Banyai, E. S., Fodor, J. Bakos, F. and Barnabas, B. (2004): Aluminum toxicity, Al-tolerance and oxidative stress in an aluminum sensitive wheat genotype and in Al-tolerant lines developed by *in vitro* microspore selection. *Plant Sci.* 166: 583-591.
- Jelić, M., Dugalić, G., Stojanović, J., Milivojević, J., Živanović, S. (2004): Mobile aluminum in some Serbian acid soils and its toxic effect on wheat and maize plants. *Plant and Soil*, 53, 21-28.
- Jelić, M., Djalović, I. (2008): Mechanisms of adaptation of plants of small grains to acid soils- novel knowledge. *Proceedings, XIII Conference on Biotechnology*, 13 (14), 19-29.
- Mead, R., Curnow, R. N., Hasted, A. M. (1996): *Statistical methods in agriculture and experimental biology*. Chapman & Hall. London.
- Narro, L. A., Perez, J. C., Pandey, S., Crossa, J., Salazar, F., Arias, M. P. (2001): Implications of soil-acidity tolerant maize cultivars to increase production in developing countries. In: N. Ae (eds.) *Plant nutrient acquisition: New perspectives*. NIAES series 4. Springer- Verlag. Japan. 447-463.
- Stevanovic, D., Jakovljevic, M., Martinovic, Lj. (1995): Solution of acid soils problem as prerequisite for food production increase and soil protection. *Proceedings, Repair of acid soils Serbia applying lime fertilizer "Njival Ca", Paracin, Serbia*, 7-21.
- Sumner, M. E. (2004): Food production on acid soils in the developing world: problems and solutions. *Proceedings of the 6th International Symposium on Plant-Soil Interactions at Low pH*. Matsumoto H. Sendai, Japon, 2-3.
- Zivkovic, M. (1966): A comparative study on different methods of preparation of non-carbonated soils for mechanical analysis. *Plant and Soil*, 15: 305-321.

EFFECT OF DIFFERENT HARVESTING TIMES TO YIELD AND EAR CHARACTERISTICS OF BABY CORN OBTAINED FROM SWEET CORN

Abdullah ÖKTEM*, Ayşe Gülgün ÖKTEM

Harran University, Agriculture Faculty, Field Crops Department, Şanlıurfa, Turkey

*Corresponding author: aoktem@harran.edu.tr

Abstract

Baby corn is also known as young corn, mini corn, finger corn, or candle corn. Baby corn is a type of vegetable and consumed as a fresh or canned. It is eaten whole and cob included both raw and cooked. Its cob is too fresh and crisp for human consumption. Baby corn ears are hand-picked as soon as the corn silks emerge or few days after. The harvest of baby corn must be timed to avoid matured corn ears. This study was aimed to determine effect of different harvesting times to yield and ear characteristics of baby corn obtained from sweet corn. Study was conducted in 2014 and 2015 under Harran Plain, Şanlıurfa, Turkey. Experiment was established to randomize complete block design with 3 replicates. In the study 12 harvest times were used. Ears were harvested from 1 to 12 days after ear silk emergence. According to variance analysis, all tested characteristics were significant ($P \leq 0.01$). With husk and without husk ear length, ear diameter, ear weight and baby corn yield values increased with delaying harvest times but ear crispness decreased after 6 days. Considering to ear diameter, ear length and yield; harvest for baby corn can be done within 2-6 day, but considering crispness of ear and custom pleasure; the best harvest time was within 2-4 day after ear silk emergence.

Keywords: *Baby corn, Harvest times, Şanlıurfa.*

Introduction

Corn (*Zea mays* L.) has become the important food grain with wheat and rice in the world. Different consumption type of corn is baby corn. Baby-corn is a very promising product for the internal and external markets (Pereira et al., 1998a). Baby corn is imported mainly from Asia countries in Turkey. It is a relatively new crop in Turkey and has acquired the interest of farmers due to its high premium price in market. But, there are no statistical data about the cultivated area and production of baby corn in Turkey. Baby corn is also known as young corn, mini corn, finger corn, or candle corn. Baby corn is grown for vegetable purpose. Baby corn is a 6-7 cm long, unfertilized, yellow colored, dehusked cob young ear of corn plant harvested within 2-3 days of silking. Baby corn ears are hand-picked as soon as the corn silks emerge or few days after. The harvest of baby corn must be timed to avoid matured corn ears (Galinat, 1985). Production of baby corn has been open-pollinated, of composites, hybrids, sweet corn, and popcorn. The sweet corn and popcorn provided best results due to the major acceptance by consumers (Pereira et al., 1998b). Baby corn is a diversified product composed of baby or young ears consumed as a fresh or canned vegetable (Kumar and Kallo, 2000). Its cob is too fresh and crisp texture and a subtle for human consumption. It is eaten whole and cob included both raw and cooked. Fresh baby corn has slightly sweet corn flavor and produces delicious treat in many recipes for the preparation of special soups, jams, cream, pickles and other delicious eatables. Baby corn is prepared in the form of salads, soups, pickles and meals (Gosavi and Bhagat, 2009). Fresh or frozen baby corn is also used in sandwiches, pizzas, salads, fried food and making pickle (Najeeb

et al. 2011). It is rich in vitamins B and C, potassium, fibers and carotenoids, which helps in the prevention of coronary diseases. Some traits, such as weight, length and diameter of the ears should be considered for the standard baby corn production. Also population density, use of fertilization and harvest time should be investigated in baby corn production (Takur and Sharma, 1999). The present investigation was undertaken to study effect of different harvesting times to yield and ear characteristics of baby corn obtained from sweet corn.

Materials and methods

This study was conducted in Sanliurfa, Turkey during 2014 and 2015. The experimental field is located in Harran Plain (altitude: 465 m; 37°08' N and 38°46' E) where the climate varies from arid to semi-arid. Table 1. provides the climatic data obtained at the Sanliurfa City Meteorological Station. As can be seen from Table 1. the weather is hot and dry in the months of June, July and August where temperatures were all above 40 °C while the relative humidity was below 50%. Rainfall was not observed from June to August at the treatment years except June 2014.

Table 1. Monthly climatic data during the baby corn growth period in 2014 and 2015 in Sanliurfa[†].

Meteorological observations	Months											
	June		July		August		September		October		November	
	2014	2015	2014	2015	2014	2015	2014	2015	2014	2015	2014	2015
Min Temperature °C	15.3	16.7	20.3	21.4	20.2	22.1	14.5	18.7	9.5	12.7	4.8	6.8
Max Temperature °C	40.1	38.4	43.4	42.8	43.5	43.1	40.6	40.4	31.9	33.0	22.8	24.3
Aver. Temperature °C	28.4	27.7	32.5	33.2	32.4	31.5	26.2	29.8	20.3	21.6	12.	14.0
Aver. Humidity (%)	26.4	35.3	25.1	26.5	27.8	37.4	41.0	30.5	49.5	50.5	53.9	48.1
Rainfall (mm)	20.6	-	-	-	-	-	-	-	-	-	-	-

[†]Data collected from the Sanliurfa Meteorological Station (Anonymous, 2014 and 2015).

The soil of the research field was clay, slightly alkaline, high in lime and very low in salt contents. Field capacity of the soil was 33.8% on dry basis, permanent wilting point was 22.6% and bulk density was 1.41 g cm⁻³. Merit hybrid single cross sweet corn genotypes (*Zea mays* L. *saccharata*) were used as crop material. Land was ploughed and cultivated then prepared for planting with a single pass of a disk-harrow. The experiment was laid out in a randomize block design with three replications. Each plot area was 14 m² (5 m x 2.8 m) and consisted of four rows of 5 m in length. The plants were grown 70 cm apart between the rows with 18 cm spacing in each row. The seeds were sown in second part of June at a 50-60 mm depth in both years. At sowing, 80 kg ha⁻¹ of pure N, P and K, as a 15-15-15 composed fertilizer, was applied to each plot; this was followed by 160 kg ha⁻¹ of N as urea when the plants reached 30-40 cm in height. Irrigation water was first applied to all the plots using a sprinkler irrigation system. After the emergence of plants, plots were irrigated equally by the furrow irrigation system. All tested characteristics were measured on randomly selected 20 plants in the center of each plot. In the study 12 harvest times were used. Baby corns were harvested from 1 to 12 days after ear silk emergence. An analysis-of-variance (ANOVA) was performed to evaluate statistically differences between results. Means of the data obtained from research were compared using least significant difference (LSD) at $P \leq 0.05$.

Results and discussion

Baby corn yield without husk and ear characteristics

According to variance analyses, ear weight without husk, ear length without husk, ear diameter without husk and baby corn yield without husk were significant ($P < 0.01$). Ear weight without husk values were ranged from 9.52 to 128.85 g in 2014 whereas from 10.23 to 132.33 g in 2015 (Table 2). Kumar and Bohra (2014) reported that ear weight without husk values were 5.6-7.3 g when the baby corns were harvested within 2-3 days of silk emergence.

The highest ear weight without husk values obtained from harvest time of 12 day after ear silk emergence whereas the lowest values were seen at harvest time of 1 day after ear silk emergence in both years. Ear weight without husk increased with delaying harvest time.

Ear length without husk values were varied from 8.47 to 20.59 cm in 2014 whereas from 7.93 to 21.9 cm in 2015. Similar results were obtained by some researches when the baby corns were harvested within 2-3 days of silk emergence. Studies conducted on maize have shown that ear length without husk ranged from 6.40 to 10.53 cm (Rodrigues et al., 2003), 4.97-7.0 cm (Saha et al., 2007) and 8.1-10.6 cm (Kumar and Bohra, 2014). The highest ear length without husk values was seen at harvest time of 12 day after ear silk emergence whereas the lowest values were seen at harvest time of 1 day after ear silk emergence in both years (Table 2). Ear length without husk values increased with delaying harvest time.

Table 2. Ear weight without husk and ear length without husk values and LSD groups.

Harvest time†	Ear weight without husk (g)			Ear length without husk (cm)		
	2014**	2015**	Average**	2014**	2015**	Average**
1	9.52 k*	10.23 l	9.88 l	8.47 i	7.93 i	8.20 k
2	16.98 j	16.23 k	16.61 k	9.59 h	9.02 h	9.31 j
3	20.45 j	21.13 j	20.79 j	11.62 g	11.96 g	11.79 i
4	26.52 i	25.13 i	25.83 i	12.91 f	13.43 f	13.17 h
5	39.03 h	37.03 h	38.03 h	14.43 e	14.93 e	14.68 g
6	46.19 g	48.42 g	47.30 g	16.51 d	16.90 d	16.71 f
7	59.22 f	58.12 f	58.67 f	17.98 c	17.69 c	17.84 e
8	65.72 e	68.95 e	67.34 e	18.44 c	18.83 b	18.64 d
9	83.97 d	86.13 d	85.05 d	19.61 b	19.33 b	19.47 c
10	95.59 c	92.02 c	93.80 c	20.10 ab	21.47 a	20.79 b
11	114.88 b	118.93 b	116.91 b	20.39 a	21.83 a	21.11 ab
12	128.85 a	132.33 a	130.59 a	20.59 a	21.90 a	21.24 a
Average	58.91	59.55	59.23	15.89 B	16.27 A	16.08
LSD harvest	4.508	2.270	2.45	0.603	0.521	0.388
year	ns			0.158		
CV	4.52	2.25	3.56	2.24	1.89	2.08

†Harvest time, day after ear silk emergence; ns: no significant

*There is no statistical difference among values annotated with the same letter at 0.05 according to the LSD test

**Denotes significant difference among harvest times $P < 0.01$

Ear diameter without husk values ranged from 14.48 to 21.86 mm in 2014 whereas from 15.29 to 32.97 mm in 2015 (Table 3). Our results were supported by Rodrigues et al. (2003). These authors observed that ear diameter without husk values were 10.2-18.3 mm. The highest ear diameter without husk value was found at harvest time of 12 day after ear silk emergence in both years. The lowest ear diameter without husk value was seen at harvest time of 1 day after ear silk

emergence in both years. Values of average of years also were similar. Ear diameter without husk values increased with delaying harvest time.

Baby corn yield without husk values varied between 75.53 and 1022.71 kg/da in 2014 whereas between 81.22 and 1050.33 kg/da in 2015 (Table 3). The highest baby corn yields without husk values were found at harvest time of 12 day after ear silk emergence in both years. The lowest baby corn yields without husk values were seen at harvest time of 1 day after ear silk emergence in both years.

Some researchers stated that baby corn yield was 4.66-7.5 ton/ha at open pollination varieties and 9.38-15.0 ton/ha in hybrids (Anonymous, 2016a). Najeeb et al. (2011) emphasis that baby corn yield was 11.5-12.0 ton/ha. In other study baby corn yield was reported as 7214.4 kg/ha (Anonymous, 2016b). Kasikranan et al. (2001) stated that baby corn ears without husk values found between 1244.6 and 2164.9 kg/ha in six cultivars. Baby corn yields without husk values increased with delaying harvest time. But ear crisply decreased after 6 days after ear silk emergence. Ear diameter and ear length increased with delaying harvest time. Delaying harvest decreased crisply of ears from 6 day after ear silk emergence. Considering to ear diameter, ear length and yield; harvest for baby corn can be done within 2-6 day, but considering crisply of ear and custom pleasure; the best harvest time was within 2-4 day after ear silk emergence. Earlier studies stated that the best harvest time was 1-2 day (Anonymous, 2016c), 3 day (Bar-Zur and Saadi, 1990), 2-4 day (Anonymous, 2016a) and 6 day (Kasikranan, 2011) after ear silk emergence.

Table 3. Ear diameter without husk and baby corn yield without husk values

Harvest time†	Ear diameter without husk (mm)			Baby corn yield without husk (kg/da)			
	2014**	2015**	Average**	2014**	2015**	Average**	
1	14.48 k*	15.29 j	14.88 l	75.53 k	81.22 l	78.38 l	
2	14.95 jk	15.61 j	15.28 k	134.80 j	128.84 k	131.82 k	
3	15.45 j	16.53 i	15.99 j	162.29 j	167.74 j	165.01 j	
4	16.76 i	17.70 h	17.23 i	210.49 i	199.48 i	204.99 i	
5	18.54 h	18.20 h	18.37 h	309.81 h	293.93 h	301.87 h	
6	20.45 g	19.17 g	19.81 g	366.58 g	384.31 g	375.45 g	
7	21.63 f	22.63 f	22.13 f	470.06 f	461.32 f	465.69 f	
8	23.76 e	23.27 e	23.52 e	521.59 e	547.28 e	534.44 e	
9	25.47 d	24.75 d	25.11 d	666.50 d	683.61 d	675.06 d	
10	26.93 c	28.60 c	27.77 c	758.70 c	730.34 c	744.52 c	
11	29.66 b	31.67 b	30.66 b	911.80 b	943.97 b	927.89 b	
12	34.20 a	32.97 a	33.58 a	1022.71 a	1050.33 a	1036.52 a	
Average	21.86 B	22.20 A	22.03	467.57	472.70	470.14	
LSD	harvest	0.716	0.605	0.447	35.783	18.013	19.453
	year	0.182		ns			
CV		1.94	1.61	1.75	4.52	2.25	3.56

†Harvest time day after ear silk emergence; ns: no significant

*There is no statistical difference among values annotated with the same letter at 0.05 according to the LSD test

**Denotes significant difference among harvest times P<0.01

Baby corn yield with husk and ear characteristics

According to variance analyses, ear weight with husk, ear length with husk, ear diameter with husk and baby corn yield with husk were significant (P<0.01). Ear weight with husk value ranged from 26.33 to 183.33 g in 2014 and from 27 to 178.33. These results are supported by the findings of Kumar and Bohra (2014), where ear weight with husk values were 26.8-35.9 g when

the baby corns were harvested within 2-3 days of silk emergence. The highest ear weight with husk value was seen at harvest time of 12 day after ear silk emergence whereas the lowest value was found at harvest time of 1 day after ear silk emergence in both years. Ear weight with husk values increased with delaying harvest time.

Ear length with husk values ranged from 13.83 to 21.8 cm in 2014 and from 15.10 to 22.4 cm in 2015 (Table 4). These findings agree with the findings of Rodrigues et al. (2003) in baby corn where ear length with husk ranged from 16.93 to 26.63 cm. The highest ear length with husk value was seen at harvest time of 12 day after ear silk emergence whereas the lowest value was found at harvest time of 1 day after ear silk emergence in both years. Ear length with husk values increased with delaying harvest time.

The lowest ear diameter with husk value was 19.17 mm at harvest time of 1 day after ear silk emergence whereas the highest value (38.97 mm) was obtained from harvest time of 12 day after ear silk emergence at the average of years (Table 5). Similar results were obtained by Rodrigues et al. (2003) and Kumar and Bohra (2014). These authors observed that ear diameter with husk values varied from 20.1 to 24.6 mm, respectively.

Table 4. Ear weight with husk and ear length with husk values

Harvest time†	Ear weight with husk (g)			Ear length with husk (cm)		
	2014**	2015**	Average**	2014**	2015**	Average**
1	26.33 k*	27.00 l	26.67 l	13.83 h	15.10 i	14.47 j
2	37.00 j	38.00 k	37.50 k	16.80 g	16.57 h	16.68 i
3	55.33 i	48.67 j	52.00 j	17.13 g	17.53 g	17.33 h
4	66.67 h	60.00 i	63.33 i	17.73 f	17.87 g	17.80 g
5	70.67 h	72.33 h	71.50 h	18.33 e	18.80 f	18.57 f
6	87.00 g	82.00 g	84.50 g	19.23 d	19.73 e	19.48 e
7	98.33 f	101.33 f	99.83 f	19.57 d	20.01 e	19.82 e
8	109.00 e	113.33 e	111.17 e	20.27 c	20.77 d	20.52 d
9	120.66 d	128.00 d	124.33 d	20.77 bc	21.20 cd	20.98 c
10	142.00 c	148.00 c	145.00 c	21.03 b	21.63 bc	21.33 bc
11	161.66 b	165.00 b	163.33 b	21.27 ab	22.03 ab	21.65 b
12	183.33 a	178.33 a	180.83 a	21.80 a	22.40 a	22.10 a
Average	96.50	96.83	96.67	18.98 B	19.48 A	19.23
LSD harvest	6.556	3.322	3.701	0.565	0.661	0.415
year	ns			0.169		
CV	4.01	2.03	3.30	1.76	2.0	1.86

†Harvest time day after ear silk emergence; ns: no significant

*There is no statistical difference among values annotated with the same letter at 0.05 according to the LSD test.

**Denotes significant difference among harvest times P<0.01

Table 5. Ear diameter with husk and baby corn yield with husk values

Harvest time†	Ear diameter with husk (mm)			Baby corn yield with husk (kg/da)		
	2014**	2015**	Average**	2014**	2015**	Average**
1	19.03 k*	19.30 k	19.17 l	209.01 k	214.30 l	211.65 l
2	22.33 j	21.60 j	21.97 k	293.67 j	301.61 k	297.64 k
3	23.83 i	23.20 i	23.52 j	439.18 i	386.27 j	412.72 j
4	24.90 h	24.20 h	24.55 i	529.13 h	476.22 i	502.68 i
5	26.53 g	26.00 g	26.27 h	560.88 h	574.11 h	567.50 h
6	27.60 f	27.20 f	27.40 g	690.52 g	650.83 g	670.68 g
7	28.23 ef	28.77 e	28.50 f	780.47 f	804.28 f	792.38 f
8	29.00 e	29.47 e	29.23 e	865.13 e	899.53 e	882.33 e
9	30.90 d	31.23 d	31.07 d	957.73 d	1015.94 d	986.83 d
10	32.53 c	32.73 c	32.63 c	1127.05 c	1174.68 c	1150.87 c
11	34.90 b	36.60 b	35.75 b	1283.15 b	1309.61 b	1296.38 b
12	39.33 a	38.60 a	38.97 a	1455.12 a	1415.43 a	1435.27 a
Average	28.26	28.24	28.25	765.92	768.57	767.25
LSD	0.979	0.854	0.648	52.039	26.366	29.377
year	ns			ns		
CV	2.05	1.79	1.97	4.01	2.03	1.69

†Harvest time day after ear silk emergence; ns: no significant

*There is no statistical difference among values annotated with the same letter at 0.05 according to the LSD test

** Denotes significant difference among harvest times P<0.01

Baby corn yield with husk values varied between 209.0 kg/da and 1455.1 kg/da in 2014 whereas between 214.3 and 1415.4 kg/da in 2015 (Table 5). Harvest time of 12 day after ear silk emergence gave the highest baby corn yield but the lowest weight of baby corn yield with husk value was seen at harvest time of 1 day after ear silk emergence. Values of average of years also were similar. Baby corn yields with husk values increased with delaying harvest time. Similar results were obtained by some researchers. Rodrigues et al. (2003) reported that baby corn yield with husk values were 324-1190 kg/da. Kumar and Bohra (2014) observed that baby corn yield with husk values ranged between 760 and 980 kg/da. Kasikranan et al. (2001) stated that baby corn ears with husk values were between 4853.1 and 7186.7 kg/ha.

Conclusion

Based on the two years results it may be concluded; baby corn yield and ear characteristics with husk and without husk values increased with delaying harvest time. But delaying harvest decreased crisply of ears from 6 day after ear silk emergence. Considering to ear diameter, ear length and yield; harvest for baby corn can be done within 2-6 day, but considering crisply of ear and custom pleasure; the best harvest time was within 2-4 day after ear silk emergence.

References

- Anonymous (2014). Climatic report, Şanlıurfa Meteorological Station, Şanlıurfa.
 Anonymous (2015). Climatic report, Şanlıurfa Meteorological Station, Şanlıurfa.
 Anonymous (2016a). Baby corn. <http://www.uky.edu/Ag/CCD/introsheets/babycorn.pdf>. Accessed on 9/6/2016.
 Anonymous (2016b). Thai agricultural standard in baby corn (TAS 1504-2007). http://www.acfs.go.th/standard/download/eng/baby_corn.pdf. Accessed on 10/6/2016.

- Anonymous (2016c). Baby corn production, processing and marketing in Thailand. [http://www.volkerkleinhenz.com/publications/baby-corn-production-processing-and-marketing-in -Thailand](http://www.volkerkleinhenz.com/publications/baby-corn-production-processing-and-marketing-in-Thailand). Accessed on 11/6/2016.
- Bar-Zur A., Saadi H. (1990). Prolific maize hybrids for baby corn. *J. Hor.Sci.*, 65(1):97-100.
- Galinat W.C. (1985). Whole ear baby corn, a new way to eat corn. *Proc. Northeast Corn Improvement Conf.*, 40:22-27.
- Gosavi S.P., Bhagat S.B. (2009). Effect of nitrogen levels and spacing on yield attributes, yield and quality parameters of baby corn. *Ann. Agric. Res. New series* 30(3-4):125-128.
- Kasikranan S., Jones, H., Suksri A. (2001). Growth, yield, qualities and appropriate sizes of eight baby corn cultivars (*Zea mays* L.) for industrial uses grown on oxic paleustults soil, Northeast. *Pak. J. of Bio. Sci.*, 4(1):32-36.
- Kasikranan S. (2011). An investigation on different harvesting methods on young pods of KKU-992 maize cultivar for baby corn production. *Pak. J. of Bio. Sci.*, 14(7):461-465.
- Kumar S., Kalloo G. (2000). Attributes of maize genotype for baby corn production. *Maize Gen. Cooper. Newl.* 74:74.
- Najeeb S., Rather A.G., Sheikh F.A., Ahanger M.A., Teli N.A. (2011). Baby corn (*Zea mays* L.): A means of crop diversification under temperate conditions of Kashmir. *Maize Genetics Cooperation Newsletter* 85:46-54.
- Pereira F.I.A., Gama E.E.G., Furtado A.A.L. (1998a). Production of baby corn. *CNPMS/EMBRAPA Technical Notice* 7:1-4.
- Pereira F.I.A., Gama E.E.G., Cruz J.C. (1998b). Babycorn: planting density effect and cultivars in production and some corn plant characteristics. *CNPMS/EMBRAPA Technical Bulletin* 23:1-6.
- Kumar R., Bohra J.S. (2014). Effect of NPKS and Zn application on growth, yield, economics and quality of baby corn. *Archives of Agr. Soil Science*, 60(9):1193-1206.
- Rodrigues L.R.F., Silva N., Mori E.S. (2003). Baby corn single-cross hybrids yield in two plant densities. *Crop Breeding and Applied Biotechnology*, 3(3):177-184.
- Saha S., Appireddy G.K., Kundu S., Gupta H.S. (2007). Comparative efficiency of three organic manures at varying rates of its application to baby corn. *Archives of Agronomy and Soil Science*, 53(5): 507-517.
- Takur D.R., Sharma V. (1999). Effect of varying rates of nitrogen and its schedule of split application in baby corn (*Zea mays*). *Indian Journal Agricultural Science*, 69(2):93-95.

IDENTIFICATION OF AGRICULTURAL CHARACTERISTICS OF CERTAIN LINES AND SPECIES OF GRASS PEA IN KAHRAMANMARAS CONDITIONS TURKEY

Ömer Süha USLU^{1*}, Adem EROL¹, Gökhan Osman CENGİZ²

¹Department of Field Crops, Faculty of Agriculture, University of Sütçü İmam, Kahramanmaraş, Turkey

² Kahramanmaraş Province Directorate, Ministry of Food, Agriculture and Livestock, Kahramanmaraş, Turkey

*Corresponding author: suhauslu@ksu.edu.tr

Abstract

An experiment carried out for grass pea (*Lathyrus sativus* L.) crop in Kahramanmaraş conditions Turkey in 2012/2013 planting season in order to identify the agricultural characteristics of M1-7, M1-15, M1-16, FLS-225 lines and registered Gürbüz cultivar of grass pea. The lines and species used in experiment were planted in November 2012 and harvested in June 2013. Cultivation was made with the existing precipitation and no additional irrigation was made. The experiment was established as a completely randomized block with three replications. At the end of the experiment, no differences were observed in terms of some agronomic characteristics, yield and yield components such as plant height, number of florescence days, grain yield and thousand seed weight among lines and varieties tested. The highest grain yield and thousand seed weight was observed in M1-15 line as 390 kg da⁻¹ and 152.607 g respectively. The differences among species have been significantly important in terms of number of pods per plant, biological yield and harvest index and the highest value was obtained in M1-15 line as 27.67 pods, 1391.7 kg da⁻¹ and 37.8% respectively.

Keywords: *Grass pea, grain yield, biological yield, herbage yield, harvesting index*

Introduction

The biggest expense of livestock enterprises is fodder. Doing feed correctly has important role on taking efficiency from livestock. The use of high quality container and mixed livestock feed resources efficiently is one of the most important requirements. In Turkey, qualified forage pastures and forage crops are derived from two major sources. The efficiency of our natural meadows and pastures declined because of early and excessive grazing for a long time. The ecological structure of Turkey is suitable to breed successfully many kind of fodder crops, and it has enough meadows and pastures to close the gap of quality roughage. The problem of qualified roughage which is longing of our livestock sector can be solved with providing to increase production areas of forage crops with scientific, technical, economic and social measures (Alçiçek *et al*, 2010).

Forage crops have also effects on increasing the efficiency of soil, preventing erosion and the protection of the ecological balance. Because of wrong tillage farming methods and one-way products, the salinity and environmental pollution problems have emerged on our country lands. For this reason, it is necessary to increase the share of forage crops in cropping systems (Alay, 2008).

In Turkey, vetch, alfalfa, sainfoin and grass pea are extensively grown as forage crops. Approximately, 6.620 ha of alfalfa (green feed), 1.914 ha sainfoin (green feed), 868 ha of vetch, 6.881 ha of maize (grain), 195 ha grass pea (green feed), 24 ha of fodder beet and other forage

crops are grown according to 2015 data of TUIK (Turkish Statistical Institute). The total area of forage cropping is 24.830 ha (TUIK, 2016).

In Turkey, one of the annual forage crops that can be grown in arid areas is grass pea (*Lathyrus sativus* L.). Kahramanmaraş is located in south of Anatolia. Grass pea which is popular as Cilban in the southeast of Anatolia. It is an annual plant belonging to the family of legumes (*Fabaceae*) which can be self-pollination (Gedik, 2007).

There are many features of grass pea. Some of these are; resistance to environmental stress conditions and diseases, high yield potential in terms of peas, appropriates of the nutritional content of seeds. Also, it is strong and resistant to drought thanks to a strong root system of it. Grass pea can be grown in a variety of soil types, including very poor soils (Rybinski, 2003).

Four grass pea lines and one registered cultivar was used in this experimental study. The study was conducted in order to identify the yield potential and agricultural characteristics of certain four grass pea lines and one registered grass pea cultivar in early spring in Kahramanmaraş conditions. Also in this study was aimed recognition of grass pea lines and cultivar by producers.

Materials and Methods

Grass pea lines and variety used in this experiment were provided from Adana East Mediterranean Agricultural Research Institute. In this study, M1-7, M1-15, M1-16 and FLS-225 lines and registered Gürbüz cultivar were used.

This study was conducted at the lands of Kahramanmaraş Transitional Zone Research of Institute in southern Turkey as a main crop between November 2012 and July 2013 in order to identify the agricultural characteristics of M1-7, M1-15, M1-16, FLS-225 lines and registered Gürbüz cultivar of grass pea. Kahramanmaraş coasted in east Mediterranean region in south of Turkey, has a typical Mediterranean climate conditions. The Mediterranean climate is characterized by dry summers and mild, moist winters. The field trials were designed as completely randomized blocks with three replicates. After five months following wheat harvesting grass peas were sown. Primarily soil cultivation was made deeply with plow and then was used stalk chopper and rolling cylinder. Trial consists of three blocks and five parcels in each block. The trial has totally fifteen parcels. The distance between the blocks is 2,5 m and the distance between the parcels is 25 cm. Each parcel size is 10 m x 1 m and each plot contained five rows. Interrow distances are 20 cm. Parcel size is 10 m². Sowing was made by manually at November 21th 2012. Calculation was performed hundred kilograms of seed per hectare. 100 g seed was sown for each plot. Fertilizers and pesticides were not used in the experiment and plots were not irrigated. Harvest was made by hand, seeds are cleaned manually.

Investigated Characteristics

In this study following characteristics were examined;

Plant height (cm), heights of randomly selected 10 plants from each trial spot were measured manually 1-2 days before harvest. Number of florescence days (day) was designated as a number of days between sowing date with 50% florescence period in the parcels. Green forage yield (kg da⁻¹) was obtained by mowing and weighing 1 m² area in the middle of each parcel. Then the obtained data was converted to decare yield. Number of pods per plant (number), when bottom pods of selected same ten plants from each parcel turn yellow the number of pods is counted. Physiological maturity days (day), was designated as a number of days between sowing date with fully yellowing period of 3-4 pods on the bottom of plant. Thousand seed weight (g), primarily mean weight of four parallel received 100 seeds weight from each replications was calculated

then it was multiplied by 10. Grain yield (kg da^{-1}), was designated 0.5 m mowed from top and bottom of each parcel and removed, then when seeds mature and harvest time comes the plants mowed and separate from their seeds then obtained seeds were weighted. After then data provided convert to yield/decare. Biological yield (kg da^{-1}), after the plant reach harvest maturity stage, 0.5 m mowed as marginal affect and removed from two sides of each parcel, remaining plant harvested and performed values convert to yield/decare. Harvest index (%) was calculated by the method of biological yield/grain yield.

Data Analysis

Data were analyzed using MSTATC software. Means were separated using LSD test at $P \leq 0.01$ and $P \leq 0.05$ levels (Steel and Torrie, 1980).

Results and Discussion

Some agronomic characteristics, yield and yield components of five grass pea lines and cultivar are shown in Table 1. As shown in Table 1, statistically significant differences were observed between number of blooming days, number of pods per plant, physiological maturity days and harvest index, although no statistical difference was observed between plant height, number of blooming days, green forage yield, thousand seed weight, grain yield and biological yield of the species used in the experiment.

Table 1. Some agronomic characteristics, yield and yield component of grass pea lines and species.

	Investigated Characteristics								
	PH	NFD	HY	NPP	PMD	TSW	GY	BY	HI
M1-7	38.33	146.0 B	2823.3	24.67 AB	189.3 A	141.980	316.7	1351.7	23.0 B
M-15	38.67	147.3 AB	3069.3	27.67 A	187.7 A	152.607	390.0	1391.7	37.8 A
M1-16	38.33	146.0 B	3106.0	15.67 C	185.0 B	145.273	280.0	1253.3	22.1 B
FLS-225	37.67	148.7 A	2775.3	18.67 BC	188.3 A	150.617	356.7	1296.7	29.7 AB
Gürbüz	37.67	146.0 B	2659.3	16.67 C	183.0 C	140.773	256.7	1235.0	19.3 B

PH: Plant height (cm), NFD: Number of florescence days (day), GFY: Herbage yield (kg da^{-1}), NPP: Number of pods per plant (number plant⁻¹), PMD: Physiological maturity days (day), TSW: Thousand seed weight (g), GY: Grain yield (kg da^{-1}), BY: Biological yield (kg da^{-1}), HI: Harvest index (%)

The average values for plant height are shown in Table 1. While the highest plant height was observed in M1-15 line (38.67 cm), the lowest plant height was observed in Gürbüz and FLS-225 varieties (37.67 cm). In studies on plant height; it was found between 34.9 cm - 38.7 cm by Andiç *et al.* (1996), between 47.83 cm - 53.73 cm by Kökten *et al.* (2011). The obtained values are similar to the findings of Andiç *et al.* (1996).

Numbers of florescence day values are shown in Table 1. As shown in table the differences between varieties are important significantly. While the highest value in number of florescence days was obtained in FLS-225 line (148.7 days), the highest value in number of florescence days was obtained in M1-7, M1-16 and Gürbüz (146 days). In studies on number of florescence days; it was found the lowest 128 days and the highest 150.7 days by Gedik (2007), the lowest 54.6 days and the highest 56 days by Gündüz (2012), Also it was report as 177.27 days for first year and 180.58 days for second year by Başaran (2010). Our findings showed same results with Gedik (2007).

Herbage yield values are shown in Table 1. According to table the differences between varieties are not significantly important. While the highest value in herbage yield was obtained in M1-16 line (3106.0 kg da⁻¹), the lowest value in herbage yield was obtained in registered Gürbüz cultivar (2659.3 kg da⁻¹). In studies on herbage yield; it was found the lowest 961.1 kg da⁻¹ and the highest 1038.2 kg da⁻¹ by Alay (2008), between 2345.73-6180.55 kg da⁻¹ by Bucak (1999). Also it was report as 2175.2-2582.5 kg da⁻¹ by Karadağ *et al.* (2012). The obtained values are close to Bucak (1999) and Karadağ *et al.* (2012)'s findings.

The average numbers of pods per plant are shown in Table 1. As shown in table the differences between varieties are important significantly. While the highest value in number of pods per plant was obtained in M1-15 line (27.67 pods plant⁻¹), the lowest value in number of pods per plant was obtained in M1-16 and Gürbüz (16.17 pods plant⁻¹). In some studies on number of pods per plant; it was report between 21.89 pods plant⁻¹ and 27.89 pods plant⁻¹ by Gül *et al.* (2004). Also it was report as 14.97-32.87 pods plant⁻¹ by Bucak (1999). Otherwise it was narrated the lowest 14.7 pods plant⁻¹ and the highest 30.6 pods plant⁻¹ by Uzun (2000), between 36.18-78.37 pods plant⁻¹ by Bayram *et al.* (2004).

The average values of physiological maturity days are shown in Table 1. As shown in table the differences between varieties are important significantly. While the highest value in physiological maturity days was obtained in M1-7, M1-15 and FLS-225 lines (average 188.4 days), the lowest value in number of pods per plant was obtained in M1-16 and Gürbüz (185.0 and 183.0 days respectively). In studies on number of physiological maturity days; it was observed as 270-272 days by Uzun (2000). Also it was reported the lowest 157.2 days and the highest 160.5 days by Al-Doss *et al.* (1988). Otherwise it was report between 230 days - 244 days by Başaran (2010). Çakmaklı *et al.* (1999) calculated as 191 days maturity days of grass pea. Çakmaklı *et al.* (1999)'s result is close to our findings.

The average values of thousand seed weight are shown in Table 1. As shown in table the differences between varieties are not important significantly. The highest value in thousand seed weight was obtained in M1-15 lines (152.607 g) and then FLS-225, M1-16 and M1-7 lines followed (150.617 g, 145.273 g, 141.980 g respectively). The lowest value in number of pods per plant was obtained in registered Gürbüz cultivar (140.773 g). In studies on number of physiological maturity days; it was observed as 247 g by Milczak *et al.* (2001). It was reported as 270 g by Rybiński *et al.* (2003). Otherwise it was report between 58.2 g - 68.7 g for first year and 63.4 g- 76.3 g for second year by Sabancı and Özpınar (2000). Gül *et al.* (2004) calculated three years average values as 124.44 g-144.89 g. The obtained values are similar to the findings of Gül *et al.* (2004).

The average values of grain yield are shown in Table 1. As shown in table the differences between varieties are not important significantly. According to this the highest value in grain yield was obtained in M1-15 lines (390.0 kg da⁻¹) and the lowest value in grain yield was obtained in Gürbüz (256.7 kg da⁻¹). In some studies on grain yield; it was report between 70 and 83.9 kg da⁻¹ by Al-Doss *et al.* (1998). Also it was report as 71.0-150.23 kg da⁻¹ by Karadağ *et al.* (2008). Otherwise it was narrated the lowest 159.16 and the highest 205.37 by Gül *et al.* (2004), between 67.30-202.88 kg da⁻¹ by Bayram (2004).

Biological yield values are shown in Table 1. According to table the differences between varieties are not significantly important. According to this the highest value in biological yield was obtained in M1-15 line (1391.7 kg da⁻¹), the lowest value in biological yield was obtained in registered Gürbüz cultivar (1235.0 kg da⁻¹). In some studies on biological yield; it was report as 468.1 kg da⁻¹ by Al-Doss *et al.* (1998) and also was found first year between 781-1188 kg da⁻¹ and second year between 823-1115 kg da⁻¹ by Sabancı and Özpınar (2000). It was also report as

356.47-638.90 kg da⁻¹ by Karadağ *et al.* (2008). Otherwise it was narrated the lowest 511.33 kg da⁻¹ and the highest 636.89 kg da⁻¹ by Gül *et al.* (2004), between 622.2-666.7 kg da⁻¹ by Gündüz (2012). The obtained values are different from researchers above due to different cultivar and climate conditions.

The average values of harvest index are shown in Table 1. As shown in table the differences between varieties are important significantly. Mean values composed three groups. According to this the highest value in harvest index was obtained in M1-15 lines (37.8%) in group A, then FLS-225 line followed (29.7%) and the lowest value in harvest index were obtained in M1-7, M1-16 and registered Gürbüz cultivar respectively (23.0%, 22.1% and 19.3%). In some studies on harvest index; it was report as 17%-25% by Al-Doss *et al.* (1998). Also it was report as 27.66%-31.70% by Karadağ *et al.* (2012). Otherwise it was narrated the lowest 18.69% and the highest 19.10% by Uzun (2000), between 39.76%-53.95% by Başaran (2010). The obtained values are close to the findings of Karadağ *et al.* (2012).

Conclusions

At the end of the study, the highest values in grain yield, biological yield, thousand seed weight, number of pods per plant, plant height and harvest index were obtained in M1-15 line. According to all of results we recommend M1-15 which generally has superior characteristics between investigated lines and species, for the farmers who want to grow grass pea in Kahramanmaraş condition.

References

- Alay, F., (2008). Effect of Different Seed Ratios on Yield and Some Agronomical Properties of Grass Pea (*Lathyrus sativus* L.) Lines Under Tokat-Kazova Conditions. Tokat, 61 pages. (In Turkish)
- Alçiçek, A., Kılıç, A., Ayhan, V., Özdoğan, M., (2010). Forage Production and Problems in Turkey. Turkish Agricultural Engineering VII. Technical Congress. TMMOB Chamber of Agriculture Engineers (ZMO) 11-15 January 2010, 2, 1071-1080, Ankara. (In Turkish)
- Al-Doss, A. A., Assaeed A. M., Soliman A. S., (1998). Growth Characters and Yield of Some Selected Lines of Grass Pea (*Lathyrus sativus*). J. King Saud Univ. Vol. 10, Agric. Sci. (1), pp. 67-72.
- Andiç, C., Akdeniz, H., Yılmaz, İ., Terzioğlu, Ö., (1996). A Research on Forage Yield of Grass Pea Lines (*Lathyrus sativus* L.) in Van Arid Conditions. Turkey 3. Range Pasture and Forage Crops Congress, 704-709, Erzurum. (In Turkish)
- Başaran, U., (2010). Determining of Agricultural Characteristics, Protein Contents and Odap Levels of Grass Pea (*Lathyrus Sativus* L.) Populations in Turkey's Different Regions. MSc Thesis. Ondokuz Mayıs University, Graduate School of Sciences, Samsun, 118 pages. (In Turkish)
- Bayram, G., Türk, M., Budaklı, E., Çelik, N., (2004). A Research on Yield And Adaptability of Common Chickling (*Lathyrus sativus* L.) Lines in Bursa Conditions. Uludağ University, Journal of Faculty of Agriculture, 18(2): 73-84. (In Turkish)
- Bucak, B., (1999). Researches on Determining of Botanical and Agricultural Characteristics of Winter Local Grass Pea (*Lathyrus sativus* L.) in Harran Plain Conditions. MSc Thesis. Harran University, Graduate School of Sciences, Şanlıurfa, 130 pages. (In Turkish)
- Çakmaklı, S., Çeçen, S., Aydınoglu, B., (1999). The Feasibility of Growing a Rotation System of Certain Annual Forage Legume Crops For Seed and Straw Yield in Fall Season Plantings in Antalya. Tr. J. of Agriculture and Forestry 23 (3) 679-684. (In Turkish)

- Gedik, A., (2007). Research on the Determination of Morphological and Molecular Diversity Among Some Varieties, Lines and Cultivar of Grass Pea (*Lathyrus sativus* L.). MSc Thesis. Çukurova University Graduate School of Sciences. 61 pages. (In Turkish)
- Gül, İ., Sümerli, M., Yılmaz, Y., (2004). Determination of Yield and Yield Components of Some Grass Pea (*Lathyrus sativus* L.) Lines under Diyarbakır Conditions. Journal of Agricultural Science, 10 (4) 416-421. (In Turkish)
- Gündüz, G., M., (2012). Seed Yield and Some of Plant Characteristics of Grass Pea (*Lathyrus sativus* L.) Landraces. MSc Thesis. Selçuk University, Graduate School of Sciences, Konya, 38 pages. (In Turkish)
- Karadağ, Y., İptaş, S., Yavuz, M., (2008). Determining the Kind of Suitable Grass Pea (*Lathyrus sativus* L.) Candidates in Anatolia's Tokat and Amasya Provinces. Research Journal of Agricultural Sciences, 1 (2):19-26. (In Turkish)
- Karadağ, Y., Özkurt, M., Akbay, S., Kır, H., (2012). Determination of Yield and Some Agronomical Properties of Grass Pea (*Lathyrus sativus* L.) Lines Under Tokat-Kazova Conditions. Research Journal of Agricultural Sciences, 5 (2) 11-13. (In Turkish)
- Kökten, K., Bakoğlu, A., Kavurmacı, Z., (2011). Effect of Different Row Spacing on The Seed Yield and Yield Components of Grass Pea (*Lathyrus sativus* L.) on Elazığ Conditions. Bingöl University, Turkish Journal of Nature and Science, 1(1) 37-42. (In Turkish)
- Milczak, M., Pedzinski, M., Mnichowska, H., Szwed-Urbas1, K., Rybinski, W., (2001). Creative breeding of grasspea (*Lathyrus sativus* L.) in Poland. Lathyrus Lathyrism Newsletter 2, 85-89.
- Rybiński, W., (2003). Mutagenesis as a Tool for Improvement of Traits in Grasspea (*Lathyrus sativus* L.). Lathyrus Lathyrism Newsletter, 27-31.
- Sabancı, C., O., Özpınar, H., (2000). Adaptations of Some Forage Crops to Menemen Conditions II. Grass Pea (*Lathyrus sativus* L.). Anadolu, J. of Agri. 10 (1) 43-51. (In Turkish)
- Steel, R. G. D., and Torrie, J. H., (1980). Principles and Procedures of Statistics. 2nd ed. New York: McGraw-Hill.
- Uzun, F., (2000). The Effects of Sowing Dates on Yields and Some of Agricultural Characters of Some Vetch and Chickling Vetch Varieties in Ladik Ecological. MSc Thesis. Ondokuz Mayıs University Graduate School of Sciences, Samsun, 146 pages. (In Turkish)
- TUIK, (2016). http://www.tuik.gov.tr/PreTablo.do?alt_id=1001 (Access date: 10.06.2016)

**TESTING PRODUCT AND PRICE RELATIONS IN THE COBWEB THEORY USING
ALMON MODEL:
DRY ONION FOR TURKEY**

Mehmet Arif ŞAHINLI¹, Ahmet ÖZÇELİK²

¹Ankara University, Agricultural Economics Department, Ankara, Turkey, Phone: +(90) 312 596 14 77, Ankara 06110 Turkey, e-mail: asahinli@ankara.edu.tr (Corresponding Author)

²Ankara University, Agricultural Economics Department, Ankara, Turkey

Abstract

In Turkey, product-price relation in dry onion production is analyzed. Almon model is one of the distributed lag models employed in this study. There are several external factors that affect the production of dry onion. In this study, the secondary data belonging to Turkish Statistical Institute (TURKSTAT) will be used between 1991-2014. In this model, the amount of dry onion production is used as a dependent variable, price series of dry onion and the distributed lag values of the dry onion prices as an independent variables. In the light of these data, the yield of dry onion in Turkey for its predictions various econometric models through inspection will attempt to demonstrate the best fit model. Due to an Almon model obtained from the study, dry onion yield estimation can be made for the future years. Moreover, Whether cobweb effect for dry onion will be analyzed in free market conditions or not. The cobweb theory is an economic model. This model explains why prices might be subject to periodic fluctuations in certain types of market conditions.

Keywords: *Almon model, Dry onion, Cobweb, Distributed lag values, Turkey.*

Introduction

The onion plant has been grown and selectively bred in cultivation for at least 7.000 years. The onion plant is a traditionally crucial plant in Turkish meals. This plant is always used for preparing the Turkish meals. It is a biennial plant, but is usually grown as an annual. For that reason, its storage has only one production year. Nearly, all of this plant's production is used in domestic and the remains is exported to other countries. In Turkey, dry onions is grown up by small scale farmers especially below 50 decares land. This production is very commercially produced not only in own using.

(Şahinli and Özçelik, 2016) in their studies that emphasized there are several external factors that affect the production of hazelnuts. In this study, the secondary data belonging to various institutions will be used between 2000-2014. In the light of these data, the yield of nuts in Turkey for its predictions various econometric models through inspection will attempt to demonstrate the best fit model. Due to an Almon model obtained from the study, nuts yield estimation can be made for future years.

Dry onions statistics about production and price are given in Table 1. According to the Table 1, two different statistics are calculated belong to these variables and 1991=100 is taken as a base year. In 2014 compared to 1991 year, production value increased 11.88 per cent and price value for the same year increased 6.12 per cent. And then, by using the production and price values were calculated for which was used the previous year. In 2014 compared to the 2013 year

production values decreased 6.03 per cent and price values decreased 1.89 per cent (Turkstat, 2016).

Table 1. Production and Price for Dry Onion in Turkey, 1991-2014

Yıl	Production		Price	
	1991=100	According to the previous year is calculated	1991=100	According to the previous year is calculated
1991	-	-	-	-
1992	6.25	6.25	13.27	13.27
1993	3.13	-2.94	50.46	32.84
1994	12.50	9.09	20.17	-20.13
1995	78.13	58.33	29.69	7.92
1996	18.75	-33.33	58.22	22.00
1997	31.25	10.53	4.76	-33.79
1998	41.88	8.10	16.45	11.16
1999	56.25	10.13	7.56	-7.64
2000	37.50	-12.00	20.48	12.02
2001	34.38	-2.27	82.29	51.30
2002	28.13	-4.65	33.54	-26.74
2003	9.38	-14.63	17.48	-12.03
2004	27.50	16.57	3.81	-11.63
2005	29.38	1.47	-26.53	-29.23
2006	10.34	-14.72	-14.29	16.67
2007	16.22	5.33	-2.04	14.29
2008	25.44	7.94	-12.24	-10.42
2009	15.60	-7.85	10.20	25.58
2010	18.75	2.73	81.63	64.81
2011	33.84	12.70	55.10	-14.61
2012	8.49	-18.94	0.00	-35.53
2013	19.05	9.74	8.16	8.16
2014	11.88	-6.03	6.12	-1.89

In this study, we examine the relationship between the dry onion's products and price. During this examination, Almon model is used in this study. At first, the frame of this work is given as follows: Introduction is given in the first section, material and methods is given in the second section and third section is belong to empirical results and conclusion.

2. Material and Methods

A secondary data on dry onion obtained from the Turkish Statistical Institute for the period of 1991-2014 was used for this study. The data is made up of yearly production quantities of dry onion and the corresponding agricultural prices gathering by agricultural farmers (CEF). The CEF has been deflated by inflation values for taking to real values (Turkstat, 2016).

Unit root test is very important to test for stationary for dependent and independent variables. The need for adequate information of the data generation process necessitates the unit root test. As typical of time series data it is imperative to understand the nature of the variable whether is stationary or otherwise. This would avoid estimates which cannot be relied upon as spurious regression might result from the estimation of stationary data which would inevitably produce type one error (Gbetnkomb & Khan, 2002).

Augmented Dickey Fuller (ADF) test was used to determine whether the production quantity variable has a unit root. This is to ensure that it has the properties of a time series variable (Dickey and Fuller, 1979).

$$\Delta Q_t = \alpha_0 + \delta Q_{t-1} + \sum_{i=1}^k \beta_i \Delta Q_{t-1} + u_t \quad (1)$$

The hypothesis testing follows that;

$H_0: \delta = 0$ (Y_t has a unit root)

$H_1: \delta < 0$ (Y_t has no unit root/stationary)

Lag length Selection is so crucial that Almon model will be tested after that. The process of lag length selection remains a very important aspect in the estimation of Distributed Lag Model (DLM). The selection of longer lags could result in the inclusion of irrelevant variables either way the selection models with fewer variables has the tendency of leaving out relevant variable that could otherwise contribute to the proper explanation of the dependent variable. The convention according to Davidson and Mackinnon is that lags should be examined starting from higher lags to lower ones (Davidson & Mackinnon, 1993).

A generalised polynomial lag model with k parameters has the form stated below;

$$Y_t = \alpha + \beta_0 X_t + \beta_1 X_{t-1} + \beta_2 X_{t-2} + \dots + \beta_k X_{t-k} + u_t \quad (2)$$

Using the notation operator, the generalised model stated above can be simplified as follows;

$$Y_t = \alpha + \sum_{i=0}^k \beta_i X_{t-i} + u_t \quad (3)$$

During the creation of Almon model, Weierstrass theorem was used (Almon, 1965).

For instance According to array of lagged,

As an illustration suppose we postulate a second-degree polynomial, that is,

$$\beta_i = a_0 + a_1i + a_2i^2, \quad (4)$$

We can write a general approximation to the mth-degree polynomial as follows;

$$\beta_i = a_0 + a_1i + a_2i^2 + \dots + a_mi^m \quad (5)$$

If β fits to the second-degree polynomial under an assumption, We can explain the Almon arrays as indicated below;

$$Y_t = \alpha + \sum_{i=0}^k (a_0 + a_1i + a_2i^2)X_{t-i} + u_t \quad (6)$$

As we distribute X_{t-i} to inside of parentheses;

$$Y_t = \alpha + a_0 \sum_{i=0}^k X_{t-i} + a_1 \sum_{i=0}^k iX_{t-i} + a_2 \sum_{i=0}^k i^2X_{t-i} + u_t \quad (7)$$

Let us define the expressions as follows;

$$Z_{0t} = \sum_{i=0}^k X_{t-i} \quad (8)$$

$$Z_{1t} = \sum_{i=0}^k iX_{t-i} \quad (9)$$

$$Z_{2t} = \sum_{i=0}^k i^2X_{t-i} \quad (10)$$

We can make an arrange the Almon array;

$$Y_t = \alpha + a_0 Z_{0t} + a_1 Z_{1t} + a_2 Z_{2t} + u_t \quad (11)$$

After making an arrange the Almon array, we can solve the regression for Z variables. Ordinary Least Squares (OLS) are used for estimating this model. The lag distributed model is estimated by OLS but anyone must be careful to evaluate these statistical numbers (Tinbergen, 1949).

At this time, gathered estimations of α and a_i provide for OLS assumptions. After estimating for α, β of the distributed lag model will be estimated as follows;

$$\widehat{\beta}_0 = \hat{a}_0 \quad (12)$$

$$\widehat{\beta}_1 = \hat{a}_0 + \hat{a}_1 + \hat{a}_2 \quad (13)$$

$$\widehat{\beta}_2 = \hat{a}_0 + 2\hat{a}_1 + 4\hat{a}_2 \quad (14)$$

.....

$$\widehat{\beta}_k = \hat{a}_0 + k\hat{a}_1 + k^2\hat{a}_2 \quad (15)$$

We can summarize the application phase of Almon model;

1. k lag number is determined before. At the process, Davidson and MacKinnon suggestions are used (Davidson and MacKinnon, 1993).
Akaike Information Criterion (AIC) or Schwartz Bayesian Criterion (SBC) are used for determining the lag number (k) (Schwartz, 1978).
2. After detemining the lag number (k), polynomial degree (m) is determined (Gujarati, 1999).
3. Later, Z is easily determined after gathering m and k.

3. Empirical Results

In order to explain the Almon model in this study, we used the production value and price of dry onion from 1991 to 2014. During this phase, price is deflated by consumer price index (CPI). As to scrutinize the price values in the long term, prices would bring the real situation. At the frame of these explanations, production (tonnes) depends on in year and the before years for that reason distribution lag model is established as follows;

$$Y_t = \alpha + \beta_0 X_t + \beta_1 X_{t-1} + \beta_2 X_{t-2} + \dots + \beta_k X_{t-k} + u_t \quad (16)$$

In this model;

Y_t : Production (tonnes)

X_t : Attained price by the farmers (Turkish Liras (TL) / Kg)

In this study, this price variable is examined under the its effects to production and AIC values were calculated and then this result is given by Table 2 as follows;

Table 2. According to the Akaike Information Criterion (AIC), lagged numbers (k)

Variables	k	AIC
Price (TL/Kg)	3	-3.50 (1st difference)
Production (tonnes)	1	-3.94 (Level)

According to the polynomial degree, we make an assumptions like this $\beta_i = a_0 + a_1i + a_2i^2$. In this situation, we can make an arrange as a Almon model.

$$Y_t = \alpha + a_0 Z_{0t} + a_1 Z_{1t} + a_2 Z_{2t} + u_t \quad (17)$$

After using above the equation, parameter estimations of model are given Table 3.

Table 3. Parameter Estimations belong to the Dry Onion

Değişkenler	Values
Sabit terim	2028169
Std.error	(65260.68)
P_t	1185.56
Std.error	(417288.2)
P_{t-1}	21334.72
Std.error	(641615.5)
P_{t-2}	996.22
Std.error	(216893.1)

According to the Z values, we can reach at the regression model below by using Y and Z values:

$$\hat{Y} = 2028169 + 1185.56Z_{0t} + 21334.72Z_{1t} + 996.22Z_{2t} \quad (18)$$

By estimated a coefficients, $\widehat{\beta}_0 = \widehat{a}_0$ relations will be calculated then approximately as follows;

$$\beta_0 = a_0 = 1185.56 \quad (19)$$

$$\beta_1 = a_0 + a_1 + a_2 = 1185.56 + 21334.72 + 996.22 = 23516.5 \quad (20)$$

$$\beta_2 = a_0 + 2a_1 + 4a_2 = 1185.56 + 2 * 21334.72 + 4 * 996.22 = 47839.88 \quad (21)$$

After re-arranging and transformations by using β_0 , β_1 and β_2 , the new Almon model is given as follows;

$$\hat{Y} = 2028169 + 1185.56P_t + 23516.5P_{t-1} + 47839.88P_{t-2} \quad (22)$$

Conclusions

In Turkey, dry onion has the lowest production rate 3.13 per cent in 1993 and the highest production value 78.13 per cent in 1995. After examining these statistical indicators, we can decide these values of production and price for dry onion that producers follow the prices for growing the dry onion.

In this study, Almon model is examined and implemented for the dry onion and cobweb theorem relations are looked for the previous year of the dry onion. During this phase, production and price are searched for depend on the unit root. And then, according to the unit root test, production value has level stationary and price value has the first level stationary.

After determining these lagged numbers, we started to implement the Almon model in the dry onion's values. Later, we made different transformations into this model and decided to the fit model belong to the dry onion.

The cobweb theory is an important economic theory that explains the relations with the price and lagged dry onion prices. Supply and demand in a market are used for explain to relations with quantity and price of dry onion. It describes cyclical supply and demand in a market where the amount produced must be chosen before prices are observed. Producers especially in agricultural products expect for the current prices and the previous prices of dry onion and later if the previous prices of dry onion belong to any products are tend to increase, producers will be grown up the plants in their fields.

As a result, we found the relations between the production and price of the dry onion using by Almon model. According to the obtained results from our model, the dry onion productions t-1 and t-2 were effected. In the study, increases in the prices for t, t-i period effects the production in upward process compatible with the economics theory.

References

- Dickey, D. A. & Fuller, W. A. (1981). Likelihood Ratio Statistics for Autoregressive Time Series with a Unit Root. 4(49):1057– 1072
- Gbetnkom, D., & Khan, S. A. (2002). Determinants of agricultural Exports: The case of Cameroon. AERC Research Paper 20
- Gujarati D. N., Basic Econometrics, McGraw-Hill, New York, 1999
- Güriş S., Çağlayan E., "Econometrics Basic Concepts", Der publications, Istanbul, 2010
- Turkstat (2016). Turkish Statistical Institute. <http://www.turkstat.gov.tr>

- Almon S., "The Distributed Lag Between Capital Appropriations and Expenditures" *Econometrica*, 33(1):178 – 196, 1965
- Tinbergen J., "Long-Term Foreign Trade Elasticities" *Metroeconomica*, 1(3): 174-185, 1949
- Davidson R., MacKinnon J.G., "Estimation and inference in Econometrics". Oxford University Press, New York: 675-676, 1993
- Schwartz G., "Estimating the Dimension of a Model" *The Annals of Statistics*, 5(2): 461-464, 1978
- Şahinli, M. A., & Ozcelik, A. (2016). Hazelnut Supply Function Prediction Model: An Econometric Application for Turkey. *Nevsehir Journal of Science and Technology*, 79-88.

PHENOLOGICAL TRAITS, YIELD AND FRUIT QUALITY OF PLUM CULTIVARS BRED AT THE FRUIT RESEARCH INSTITUTE IN ČAČAK, SERBIA

Dragan MILATOVIĆ^{1*}, Dejan ĐUROVIĆ¹, Gordan ZEC¹, Mirjana RADOVIĆ²

¹Faculty of Agriculture, University of Belgrade, Serbia

²Faculty of Agriculture, University of East Sarajevo, Bosnia and Herzegovina

*Corresponding author: mdragan@agrif.bg.ac.rs

Abstract

Phenological traits, yield and fruit characteristics of ten plum cultivars bred at the Fruit Research Institute in Čačak were studied in the region of Belgrade in the period of four years (2012-2015). Average time of flowering of tested cultivars was in the first half of April. The earliest flowering was recorded in 'Čačanska Rana' and 'Valerija', at the latest in 'Zlatka'. The range of fruit maturity was about 2.5 months, from June 24 ('Boranka') to September 6 ('Pozna Plava'). The average yield per tree was the lowest in 'Boranka' (7.8 kg) and the highest in 'Čačanska Najbolja' (23.6 kg). The cultivars 'Čačanska Rodna', 'Nada' and 'Valerija' stand out for high cumulative yield efficiency (0.34 to 0.36 kg/cm²). Fruit weight was the lowest in the cultivar 'Mildora' (23.9 g), and the highest in the cultivar 'Čačanska Rana' (51.3 g). The cultivar 'Zlatka' is distinguished by a small stone (weight of 0.83 g and the share in a fruit weight of 3.1%). The cultivars 'Mildora', 'Pozna Plava' and 'Čačanska Rodna' are characterized by high soluble solids content (19.8-21.0%), while the cultivars 'Mildora' and 'Nada' are characterized by low acid content (0.47-0.48%) and a very sweet taste. The highest scores for fruit appearance obtained the cultivars 'Čačanska Najbolja', 'Čačanska Rana' and 'Nada', and for taste the cultivars 'Nada', 'Mildora' and 'Čačanska Rodna'.

Key words: *Prunus domestica*, flowering, maturation, yield, fruit characteristics

Introduction

Plum is the most important fruit species in Serbia. The average production of 466.735 t in the period of 2010-2012 ranks Serbia on the third place in the world, behind China and Romania (FAO, 2016). However, plum production in Serbia has some negative characteristics. The average yield is very low, only 3 t/ha. This is because the production is mainly extensive and cultural practices are often at a low level. The use of fruits is very unfavorable. The largest amount of produced fruits is processed into brandy (more than 60%). Much smaller amounts of plums are dried, frozen, and processed into other products, while fresh consumption is quite small. In recent years, there is a tendency to increase export of fresh fruits, mostly in Russia (Milatović, 2013).

Plum breeding has been developed in continuity at the Fruit Research Institute in Čačak since its establishment in 1946. The result of this programme are 15 released cultivars (Glišić et al., 2015). The main breeding objectives are high fruit quality, self-fertility, regular and high yield and resistance or tolerance to Sharka (Plum Pox Virus).

New plum cultivars bred at the Fruit Research Institute in Čačak were studied by many researchers in Serbia (Ogašanović et al., 2005; Mitrović et al., 2006; Glišić et al., 2011; Milatović et al., 2011; Milošević and Milošević, 2011) and abroad (Hodun et al., 1998; Blažek et al., 2004; Dragoyski et al., 2005; Dinkova et al., 2007).

The aim of this study was to evaluate phenological traits, yield and fruit characteristics of ten plum cultivars bred at the Fruit Research Institute in Čačak. The best performing cultivars will be recommended for growing in the region of Belgrade, as well as in other regions with similar environmental conditions.

Material and methods

The study was conducted in the plum collection orchard at the Experimental Station “Radmilovac” of the Faculty of Agriculture in Belgrade during the period of four years (2012–2015). The orchard was planted in 2009. The rootstock is Myrobalan (*Prunus cerasifera* Ehrh.) seedling, training system is central leader, and planting distance is 4.5 x 3 m. All cultivars are represented by five trees.

The study included ten plum cultivars bred at the Fruit Research Institute in Čačak: ‘Boranka’, ‘Čačanska Lepotica’, ‘Čačanska Najbolja’, ‘Čačanska Rana’, ‘Čačanska Rodna’, ‘Mildora’, ‘Nada’, ‘Pozna Plava’, ‘Valerija’ and ‘Zlatka’.

Flowering was recorded by recommendations of the International Working Group for pollination: start of flowering – 10% open flowers, full bloom – 80% open flowers, end of flowering – 90% of the petal fall (Wertheim, 1996). Trunk cross-sectional area (TCSA) was calculated on the basis of trunk circumference measured at the height of 30 cm above the ground level. Cumulative yield efficiency was calculated by dividing the cumulative yield over three years by TCSA in the last year (2015). Fruit characteristics were measured on a sample of 25 fruits per cultivar. Fruit shape index was calculated using the formula: length × length / width × thickness. Soluble solids were determined by refractometer and total acids (expressed as malic acid) by titration with 0.1 N NaOH. Sensory characteristics of the fruit (appearance and taste) were evaluated by a five-member jury, scoring the cultivars using the scale from 1 to 5 points.

The obtained data were statistically analyzed using analysis of variance. The significance of differences between mean values was determined using Duncan’s multiple range test at 0.05 level of probability.

Results and discussion

Average time of flowering of tested cultivars was in the first half of April (Table 1). The earliest flowering was recorded in ‘Čačanska Rana’ and ‘Valerija’, at the latest in ‘Zlatka’. The average difference between cultivars with earliest and latest flowering was 4 days, and by years it varied from 2 to 8 days.

Table 1. Phenological characteristics of plum cultivars (average, 2012–2015).

Cultivar	Flowering dates			Duration of flowering (days)	Harvest date	No. of days from full flowering to harvest
	Start	Full	End			
Boranka	7 April	8 April	14 April	7.8	24 June	77
Čačanska Lepotica	6 April	8 April	15 April	9.0	22 July	107
Čačanska Najbolja	6 April	8 April	14 April	8.5	9 August	125
Čačanska Rana	5 April	7 April	14 April	8.5	4 July	90
Čačanska Rodna	6 April	8 April	14 April	7.8	13 August	129
Mildora	7 April	9 April	14 April	7.5	15 August	130
Nada	7 April	9 April	16 April	8.8	16 August	131
Pozna Plava	8 April	10 April	15 April	7.8	6 September	151
Valerija	5 April	7 April	15 April	9.5	18 July	104
Zlatka	9 April	10 April	16 April	7.0	12 August	125

Among years, the earliest flowering was in 2014, when the average date of the flowering onset for all cultivars was March, 24. The latest flowering was in 2013 when the average date of the flowering onset was April, 17. The difference between years with earliest and latest flowering was 24 days and it was much bigger than difference between cultivars with earliest and latest flowering.

Flowering of plum cultivars in the region of Belgrade was earlier comparing to Central Bulgaria (Dragoyski et al., 2010), Western Serbia (Glišić et al., 2011) and Northern Montenegro (Božović and Jaćimović, 2012). Differences in flowering time can be explained by differences in environmental conditions between the study regions.

The average duration of flowering ranged from 7.0 days (‘Zlatka’) to 9.5 days (‘Valerija’). Among years, the average duration of flowering for all cultivars ranged from 7.4 days in 2015 to 9.6 days in 2014.

The range of fruit maturity was about 2.5 months, from June 24 (‘Boranka’) to September 6 (‘Pozna Plava’). Similarly, the number of of days from full flowering to harvest ranged from 77 to 151. For most cultivars the earliest fruit maturation was in 2014, and the latest in 2012. Difference between years with earliest and latest fruit maturation varied from 2 to 15 days. Similar to flowering time, harvest dates in conditions of Belgrade were earlier than in Czeck Republik (Blažek et al., 2004), Central Bulgaria (Dragoyski et al., 2010), Western Serbia (Glišić et al., 2011) and Northern Montenegro (Božović and Jaćimović, 2012).

The average yield per tree was the lowest in ‘Boranka’ (7.8 kg) and the highest in ‘Čačanska Najbolja’ (23.6 kg)(Table 2). Although in some previous studies cultivar ‘Čačanska Najbolja’ showed medium productivity (Blagojević et al., 2006; Milatović et al., 2011) in this study it was the most productive cultivar. High yield in this cultivar was also reported by Faber et al. (2002) in Poland and Blažek et al. (2004) in Czeck Republik. Since ‘Čačanska Najbolja’ is self-incompatible cultivar (Nikolić and Milatović, 2010), its cropping highly depends on pollen transfer from polliniser cultivars and on weather conditions during flowering. High yield of this cultivar can be explained by favourable weather conditions during the period of study.

Table 2. Yield, trunk cross-sectional area, and yield efficiency of plum cultivars.

Cultivar	Yield (kg per tree)				Trunk cross-sectional area (cm ²)	Cumul. yield efficiency (kg/cm ²)
	2013	2014	2015	Average		
Boranka	3.9	7.7	11.9	7.8 d	72.6 ab	0.11 d
Čačanska Lepotica	10.3	36.7	7.5	18.2 ab	63.9 abc	0.28 b
Čačanska Najbolja	14.9	23.5	32.3	23.6 a	85.7 a	0.28 b
Čačanska Rana	2.8	12.1	9.8	8.2 d	71.7 ab	0.11 d
Čačanska Rodna	8.5	15.6	21.6	15.2 bc	42.5 c	0.36 a
Mildora	12.3	23.5	5.3	13.7 bc	83.6 a	0.16 cd
Nada	5.9	26.5	23.4	18.6 ab	53.1 bc	0.35 a
Pozna Plava	3.1	15.8	11.4	10.1 cd	56.8 bc	0.18 c
Valerija	13.3	29.4	12.1	18.3 ab	53.8 bc	0.34 a
Zlatka	2.7	10.4	11.2	8.1 d	51.8 bc	0.16 cd

Mean values followed by the same letter within a column do not differ significantly according to Duncan's multiple range test at $P \leq 0.05$.

Among studied cultivars, the lowest vigour was found in 'Čačanska Rodna', and the highest in 'Čačanska Najbolja'. Cumulative yield efficiency ranged from 0.11 to 0.36 kg/cm². The cultivars 'Čačanska Rodna', 'Nada' and 'Valerija' stand out for high cumulative yield efficiency. The results for yield efficiency correspond well to results obtained by other authors (Blažek et al. 2004; Dinkova et al., 2007; Milošević and Milošević, 2011).

Fruit weight ranged from 23.9 g in the cultivar 'Mildora' to 51.3 g in the cultivar 'Čačanska Rana' (Table 3). Most of the studied cultivars are characterized by large fruit (more than 30 g). Exceptions are only cultivars: 'Mildora', 'Čačanska Rodna', 'Zlatka' and 'Pozna Plava' that had medium large fruit.

The cultivar 'Zlatka' is distinguished by a small stone (weight of 0.83 g and the share in a fruit weight of 3.1%). On the other hand, 'Čačanska Rana' had the largest stone (2.67 g).

Table 3. Fruit characteristics of plum cultivars (average, 2012–2015).

Cultivar	Fruit weight (g)	Stone weight (g)	Stone share (%)	Fruit dimensions (mm)			Shape index	Stalk length (mm)
				Length	Width	Thickness		
Boranka	32.0 c	1.31 de	4.1	38.0 c	36.2 abc	36.6 bc	1.09	10.2 d
Čačanska Lepotica	39.1 b	1.56 cd	4.0	43.9 b	38.3 ab	37.6 b	1.34	13.9 cd
Čačanska Najbolja	40.8 b	2.01 b	4.9	47.0 ab	37.6 ab	37.8 b	1.55	18.1 bc
Čačanska Rana	51.3 a	2.67 a	5.2	50.5 a	39.5 a	34.3 bc	1.89	22.7 ab
Čačanska Rodna	25.7 cd	1.23 e	4.8	42.7 bc	31.9 c	33.9 bc	1.69	24.6 a
Mildora	23.9 d	1.11 ef	4.6	38.0 c	31.6 c	31.9 c	1.43	11.2 d
Nada	40.2 b	1.71 bc	4.4	47.5 ab	37.6 ab	37.5 b	1.61	18.4 bc
Pozna Plava	28.5 b	1.56 cd	5.5	42.7 bc	33.9 bc	32.6 bc	1.65	23.1 ab
Valerija	46.0 ab	1.98 b	4.3	42.5 bc	41.1 a	43.2 a	1.02	16.9 c
Zlatka	26.6 cd	0.83 f	3.1	44.4 b	31.0 c	33.2 bc	1.92	17.5 c

Mean values followed by the same letter within a column do not differ significantly according to Duncan's multiple range test at $P \leq 0.05$.

Significant differences were found between cultivars for fruit dimensions. Based on the fruit dimensions the shape index was calculated, whose values ranged from 1.02 in ‘Valerija’ (round shape) to 1.92 in ‘Zlatka’ (elliptic shape). Stalk length was the shortest in ‘Boranka’ (10.2 mm), and the longest in ‘Čačanska Rodna’ (24.6 mm).

Results of fruit characteristics are in accordance with the previous findings for some cultivars (Hodun et al., 1998; Blažek et al. 2004; Ogašanović et al., 2005; Dragoyski et al., 2010; Glišić et al., 2011; Milatović et al., 2011).

The cultivars ‘Mildora’, ‘Pozna Plava’ and ‘Čačanska Rodna’ are characterized by high soluble solids content (19.8-21.0%), while the cultivars ‘Mildora’ and ‘Nada’ are characterized by low acid content (0.47 to 0.48%) and a very sweet taste (Table 4).

Table 4. Indices of fruit quality of plum cultivars (average, 2012–2015).

Cultivar	Soluble solids (%)	Total acids (%)	Soluble solids /Total acids	Sensory evaluation (1-5)	
				Appearance	Taste
Boranka	12.3 e	1.13 ab	11.0	3.1 d	3.1 c
Čačanska Lepotica	15.5 cd	1.30 a	13.1	4.3 abc	4.1 a
Čačanska Najbolja	17.4 bc	0.95 bc	19.1	4.8 a	4.0 ab
Čačanska Rana	13.6 de	1.19 ab	11.5	4.7 ab	3.8 ab
Čačanska Rodna	19.8 ab	0.64 de	33.8	3.3 d	4.3 a
Mildora	21.0 a	0.48 e	46.9	2.3 e	4.3 a
Nada	18.5 ab	0.47 e	42.0	4.5 ab	4.4 a
Pozna Plava	20.0 ab	0.78 cd	27.5	3.9 c	4.0 ab
Valerija	14.2 de	0.98 bc	14.7	4.2 bc	3.4 bc
Zlatka	18.0 bc	0.78 cd	23.8	3.3 d	4.0 ab

Mean values followed by the same letter within a column do not differ significantly according to Duncan’s multiple range test at $P \leq 0.05$.

The results of the soluble solids content in the fruits of the cultivars examined in this study confirm the existence of a positive correlation between the soluble solids content and the ripening time of the fruit (Neumüller, 2010). Late ripening cultivars had soluble solids content over 17% which is in accordance to high quality requirements (Neumüller, 2010). Very high soluble solids content and low acid content of cultivar ‘Mildora’ confirms its suitability for drying (Ogašanović et al., 2005).

It is a well-known that the ratio between the soluble solids content and total acids (SSC/TA), rather than the very content of soluble solids, represents a reliable indicator of a cultivar’s suitability for acceptance by consumers (Crisosto et al., 2004). Early ripening cultivars had lower values of SSC/TA ratio (11,1-19,1) while late ripening cultivars had much higher values (24.8-46,9).

The data on the chemical composition of fruits are in good agreement with most of the previous findings (Mitrović et al., 2006; Dragoyski et al., 2010; Glišić et al., 2011; Milatović et al., 2011). Significantly higher soluble solids content for some cultivars was obtained in this study comparing with the results of Fajt and Usenik (2010) in Slovenia.

The highest scores for fruit appearance obtained the cultivars ‘Čačanska Rana’ and ‘Nada’, and for taste the cultivars ‘Nada’, ‘Mildora’ and ‘Čačanska Rodna’.

Conclusion

Based on the four-year evaluation of ten plum cultivars bred at the Fruit Research Institute in Čačak, for growing in Belgrade area can be recommended the cultivars 'Čačanska Lepotica' and 'Čačanska Najbolja' for fresh fruit consumption and 'Čačanska Rodna' and 'Mildora' for fruit processing. Besides them, the cultivar 'Nada' seems to be very promising as a cultivar of combine traits, suitable both for fresh consumption and processing.

Acknowledgements

This work was realized as a part of the project TR 31063 financed by the Ministry of Education, Science and Technological Development of the Republic of Serbia.

References

- Blagojević, M., Mitrović, M., Karaklajić-Stajić, Ž. (2006). Uticaj sistema gajenja i gustine sadnje na prinos nekih sorti šljive. (The influence of growing system and spacing on yield of some plum cultivars). *Voćarstvo*, 40: 49–55.
- Blažek, J., Vávra, R., Pišteková, J. (2004). Orchard performance of new plum cultivars on two rootstocks in a trial at Holovousy in 1998-2003. *Horticultural Science*, 31(2): 37–43.
- Božović, Đ., Jaćimović, V. (2012). Phenological properties of plums under the conditions of Northern Montenegro. *Agriculture and Forestry*, 58(4): 153–159.
- Crisosto, C.H., Garner, D., Crisosto, G.M., Bowerman, E. (2004). Increasing 'Blackamber' plum (*Prunus salicina* Lindley) consumer acceptance. *Postharvest Biology and Technology*, 34: 237–244.
- Dinkova, H., Minev, I., Stoyanova, T. (2007). Vegetative and reproductive characteristics of plum cultivar Čačanska Rodna in Troyan region. *Voćarstvo*, 41(1): 41–44.
- Dragoyski, K., Dinkova, H., Spasova, T., Minev, I. (2005). Growth and fruit-bearing performance of the plum cultivar Čačanska lepotica grown in the region of the Central Balkan mountains. *Voćarstvo*, 39: 271–277.
- Dragoyski, K., Minev, I., Dinkova, H., Stoyanova, T., Minkov, P. (2010). Evaluation of some introduced plum cultivars in RIMSA Troyan. *Acta Horticulturae*, 874: 311–316.
- Faber, T., Lech, W., Małodobry, M., Dziedzic, E. (2002). Assessment of growth and cropping of plum trees grafted on 'Wangenheim Prune' rootstock and originated from *in vitro*. *Journal of Fruit and Ornamental Plant Research*, 10: 123–129.
- Fajt, N., Usenik, V. (2010). Plum cultivar testing in the western part of Slovenia. *Acta Horticulturae*, 874: 275–280.
- FAO (2016). <http://faostat.fao.org/> Accessed May 22, 2016.
- Glišić, I., Karaklajić-Stajić, Ž., Mitrović, O. (2011). Fenološko-pomološke osobine i organoleptička ocena ploda novih sorti šljive Zlatka i Pozna plava u agroekološkim uslovima Čačka. (Pheno-pomological properties and organoleptic assessment of newly bred plum cultivars 'Zlatka' and 'Pozna Plava' grown in Cacak region). *Voćarstvo*, 45: 173–178.
- Glišić, I., Milatović, D., Milošević, N., Lukić, M. (2015). Biological and pomological properties of promising plum hybrids created at the Fruit Research Institute, Čačak. VI International Scientific Agricultural Symposium "Agrosym 2015", Jahorina, Bosnia and Herzegovina, 15-18 October 2015. pp. 424–429.
- Hodun, G., Hodun, M., Grzyb, Z.S. (1998). The promising plum cultivars evaluated in the field collection at Skierniewice, Poland. *Acta Horticulturae*, 478: 193–197.
- Milatovic, D. (2013). Pflaumen- und kirschenanbau in Serbien. *Obstbau*, 38(2): 115–119.

- Milatović, D., Đurović, D., Zec, G. (2011). Ispitivanje stonih sorti šljive na području Beograda. (Evaluation of dessert plum cultivars in Belgrade area) *Voćarstvo*, 45: 101–108.
- Milošević, T., Milošević, N. (2011). Growth, fruit size, yield performance and micronutrient status of plum trees (*Prunus domestica* L.). *Plant, Soil and Environment*, 57: 559-564.
- Mitrović, O., Gavrilović-Damnjanović, J., Popović, B., Kandić, M. (2006). Karakteristike čačanskih sorti šljive pogodnih za sušenje. (Properties of Cacak's plum cultivars suitable for drying). *Voćarstvo*, 40: 255–261.
- Neumüller, M. (2010). Fundamental and applied aspects of plum (*Prunus domestica* L.) breeding. *Fruit, Vegetable and Cereal Science and Biotechnology*, 5 (spec. issue 1): 139–156.
- Nikolić, D., Milatović, D. (2010). Examining self-compatibility in plum (*Prunus domestica* L.) by fluorescence microscopy. *Genetika*, 42(2): 387–396.
- Ogašanić, D., Ranković, M., Paunović, S., Mitrović, O., Stamenković, S. (2005). Mildora – nova sorta šljive za sušenje. (Mildora – a new plum cultivar for drying). *Jugoslovensko Voćarstvo*, 39: 251–256.
- Wertheim, S.J. (1996). Methods for cross pollination and flowering assessment and their interpretation. *Acta Horticulturae*, 423: 237–241.

ANALYSIS OF TOTAL POLYPHENOLS FROM POSTDISTILLATION WASTE MATERIAL OF DIFFERENT CORIANDER ACCESSIONS GROWN IN SERBIA

Milica AĆIMOVIĆ*, Dimitrije MARA², Vele TEŠEVIĆ, Jovana STANKOVIĆ, Mirjana CVETKOVIĆ³, Miroslav UROŠEVIĆ⁴, Vladimir FILIPOVIĆ⁵

¹Institute of Field and Vegetable Crops, Novi Sad, Serbia

²Faculty of Chemistry, University of Belgrade, Serbia

³Institute of Chemistry, Technology and Metallurgy, University of Belgrade, Serbia

⁴Scientific Institute for Reproduction and Artificial Insemination of Domestic Animals “Temerin”, Serbia

⁵Institute of Medicinal Plants Research “dr.JosifPancic”, Belgrade, Serbia

*Corresponding author: acimovicbabicmilica@gmail.com

Abstract

Coriander (*Coriandrum sativum* L.) is an aromatic plant grown for seed (*Coriandri fructus*) which contains essential oil (*Coriandri aetheroleum*) with a specific fragrance originating from the main component, limonene. Essential oil is obtained by steam distillation from the dried ripe seed. However, the content of essential oil in seed is low, between 0.1 and 1.8%, depending on variety, geographical origin, agroecological conditions, growing technology, etc. Still, the majority of the produced plant material remained unused. The aim of our investigation was to determine the total polyphenols content in postdistillation waste material which remains after coriander essential oil distillation. Evaluation of its antioxidative capacity was the other purpose of this study. Six coriander accessions of different origins were grown on an experimental field in Mošorin, Serbia, during 2014. According to the obtained results, postdistillation coriander seed waste material, as estimated by the Folin–Ciocalteu method, contained between 40.9 and 57.2 mg GAE/g dry extract of total polyphenols. However, according to DPPH method the antioxidative potential of coriander postdistillation seed waste was poor and it is ranged between 0.03 and 0.04 TE. Further research will be focused on agro-food implementation of postdistillation waste material of coriander and other plants which are used for essential oil production.

Keywords: *Coriandrum sativum*, postdistillation waste material, total polyphenols, DPPH, antioxidative capacity

Introduction

Coriander (*Coriandrum sativum* L.) is annual aromatic plant from the Apiaceae family. It is grown for seed (*Coriandri fructus*) which can be used as spice or for essential oil distillation (*Coriandri aetheroleum*). The dry, ripe fruit and oil have a specific fragrance, sweet, hot and pungent. The scent originates from the main components in the essential oil: limonene, α -pinene and geranyl-acetate. However, the content of essential oil in seed is low, between 0.1 and 1.8% (Diederichsen 1996). The amount of the essential oil and its quality can vary depending on: varieties and cultivars, the geographical position of the region of production, the climate and weather conditions, soil type, agro technology, the stage in which the harvest is performed, drying, storage and applied extraction techniques (Aćimović 2014).

Material efficiency is nowadays an essential topic to promote the sustainable use of natural resources, waste materials and industrial by-products, in agreement with the principle of sustainable development and life cycle assessment (Prokkola et al., 2012). Because of this, the

biological potential of various plant waste materials is in focus of numerous studies. These studies are important, both in terms of economy and ecology, in order to elucidate the way to exploit post-distillation waste material of aromatic plants and other plant waste materials more efficiently (Gavarić et al., 2015).

The aim of our investigation was to determine the total polyphenols content in postdistillation waste material which remains after coriander essential oil distillation. The study of antioxidant activity of postdistillation waste material was the other purpose of this paper.

Material and methods

Plant material. Six different ecotypes of coriander plants were grown for the trial purposes. The local ecotype of coriander seed, widely grown in province of Vojvodina was obtained from medicinal plants grower from Kulpin (plants used for extraction of the oil marked as Coriander 1), while other five types of seed were bought at the local market. The seed producers were: Institute for Medicinal Plant Research “dr Josif Pančić” Serbia, “Semenarnacooop” Serbia, “Master seeds” Serbia, “Sgaravatti” Italy and “Blumen” Italy (plants used for extraction of the oils marked as Coriander 2, 3, 4, 5 and 6, respectively). Coriander was sown in the first decade of April, by hand at row spacing 35 cm, and around 70 seeds per meter in a row (density of 200 plants per m²). The size of the experimental plots was 5m². Weeds were controlled by hoeing and weeding when needed. Disease and insect control measures were not applied. Harvest was carried out by hand in the phase of full maturity, at the end of July. After harvest, the seed was kept in paper bags at room temperature until required for further analysis.

Experiment location and growing conditions. The experimental field was set in a village called Mošorin (45°18' N, 20°09' E) in 2014. Mošorin is located in the north part of the Republic of Serbia. This area has moderate continental climate with some tendencies towards continental. The whole region is located in a semi-arid area where variations in the amount of precipitation, air temperature and other important climatic elements are substantial over the years. The soil at experimental field had a neutral reaction to soil solution (pH 7.3 in KCl) and was moderately supplied with humus (2.7%). The soil is classified as highly calcareous loamy chernozem (with 8.4% CaCO₃). The content of readily available phosphorus and potassium was high (81.6 and 75.1 mg/100g of soil, respectively).

Essential oil isolation. The dried samples of coriander were subjected to hydro-distillation using an all glass Clevenger-type apparatus to extract essential oils according to the method outlined by the European Pharmacopoeia.

Determination of the total polyphenolics. The amount of total phenolics in water soluble extracts which remains after essential oil distillation (postdistillation waste material) was determined using the Folin-Ciocalteu reagent with gallic acid as a standard. The reagent was prepared by diluting a stock solution with distilled water (1:10, v/v). Samples (1 ml, three replicates) were placed into test cuvettes, and 5 ml of Folin-Ciocalteu phenol reagent and 4 ml of Na₂CO₃ (7.5 %) were added. The absorbance of the samples was measured at 765 nm using a UV/VIS spectrophotometer Cintra 40 after incubation at 20 °C for 1 h. The results were expressed as milligrams of gallic acid equivalent per 1 g of fresh weight, (mg GAE/g).

Characterisation of phenolics compounds. The water soluble extracts of coriander seed which remains after essential oil distillation were dissolved in methanol to an approximate concentration of 5 mg/ml. The LC/DAD/MS analyses were carried out by an Agilent 1200 HPLC instrument (Agilent Technologies, Waldbronn, Germany) with a binary pump, an autosampler, a column

compartment equipped with a Zorbax Eclipse Plus C18 column (1.8 μm , 4.6 mm \times 150 mm, Agilent Technologies) and a diode-array detector coupled with a 6210 time-of-flight LC/MS system (Agilent Technologies). The mobile phase consisted of water containing 0.2% formic acid (A) and acetonitrile (B). A combination of isocratic and gradient modes of elution was used as follows: 0–1.5 min 5% B, 1.5–26 min, 5–95% B, 26–35 min, 95% B. The mobile phase flow rate was 1.4 mL/min, the column temperature was 40 $^{\circ}\text{C}$ and the injection volume was 5 μl . Spectral data from all the peaks were accumulated in the range of 190–450 nm and chromatograms were recorded at 260, 280, 290 and 320 nm. MS-data were collected by applying the following parameters: ionization negative ESI, capillary voltage 4000 V, gas temperature 350 $^{\circ}\text{C}$, drying gas 12 L/min, nebulizer pressure 45 psi, fragmentor voltage 140 V, mass range 100–2000 m/z . A personal computer system running MassHunter Workstation software was used for data acquisition and processing. Phenolic compounds were detected as $[\text{M}-\text{H}]^{-}$ or $[2\text{M}-\text{H}]^{-}$ signals using these parameters. Compounds were characterized by their retention times (t_r), mass spectra and UV spectra, and were tentatively identified based on previous data published by other authors. Their complete identification was not possible since the full scan mass spectra of the chromatographically separated compounds gave only deprotonated $[\text{M}-\text{H}]^{-}$ ions, and MS/MS experiments were not possible with the instrumentation used.

Antioxidant activity. The antioxidant activity of the samples was evaluated by means of the 2,2-diphenyl-1-picrylhydrazil (DPPH) radical scavenging method. This spectrophotometric assay uses stable DPPH radical as reagent. The methanolic solution of the investigated sample (200 μl) (with starting concentrations of 200, 300, 400, 500 $\mu\text{l/ml}$ of solution) was added to a 1800 μl methanolic solution of DPPH radical (concentration of 0.04 mg/ml) and after shaking, the reaction mixture was left to react in the dark for 30 min at room temperature. Then absorbance of the remaining DPPH radical was measured at 517 nm (A_1) on Cintra 40 UV–Visible spectrophotometer. Every concentration was done in triplicate and the same experiment was done with Trolox standard, a well known synthetic antioxidant. The results were expressed as mM of trolox equivalent per 1 g of fresh weight, (mM TE/g). Blank probes were used in the same way, with methanol instead of the investigated solution (A_0). The decrease in the absorption of DPPH solution at 517 nm is calculated by the following equation:

$$I = \frac{A_0 - A_1}{A_0} * 100\%$$

Concentrations of the extracts which reduce the absorption of DPPH solution by 50% (EC_{50}) were obtained from the curve dependence of absorption of DPPH solution at 517 nm from the concentration for each extract and standard antioxidant. Origin 8.0 software was used to calculate these values. Tests were carried out in triplicate.

Statistical Analysis. Data was subject to statistical analysis using the program package Statistica 10 (StatSoft Inc., 2011, University of Novi Sad license) and were expressed as mean value.

Results and discussion

The average content of essential oil in different accessions of coriander seed grown in Serbia was 0.57%, and varied between 0.42 and 0.95% (Table 1). The highest content of essential oil was determined in local ecotype (Coriander 1). It is well known that essential oil content depends on many factors, among which the genotype is a major determinant for the synthesis of secondary metabolites (Gil et al., 2002).

Still, the majority of the produced plant material remained unused (more than 99%). However, the total polyphenole content in coriander postdistillation seeds waste material as estimated by

the Folin–Ciocalteu method in average was 53.78 mg GAE/g dry extract (Table 1). The lowest amount of total phenolic compounds was determined in Coriander 3 (40.9 mg GAE/g dry extract), and highest in Coriander 4 (57.2 mg GAE/g dry extract). However, data about total polyphenole content in methanolic coriander seed extract is very different, and ranged between 18.70 GAE/g dry weight (Dua et al., 2014), up to 65.58 mg GAE/g dry weight (Sriti et al., 2012). According to DPPH method, the antioxidative potential of coriander postdistillation seed waste was poor and it is ranged between 0.03 and 0.04 mM Trolox Equivalents/g sample (Table 1). However, in the study with fruit methanolic extract of three coriander varieties (Tunisian, Syrian and Egyptian) EC₅₀ values of reducing power activity varied significantly from 54.20 to 122.01 µg/mL (Msaada et al., 2014).

Table 1. Essential oil content (%) in coriander seed, total polyphenole content (mg Gallic Acid Equivalent/g sample) and antioxidative capacity (mM Trolox Equivalent/g sample) of methanolic extract of coriander postdistillation waste material.

	Essential oil content (%)	Total polyphenole content (mg GAE/g sample)	Antioxidative capacity (mM TE/g sample)
Coriander 1	0.95	55.7	0.04
Coriander 2	0.56	55.9	0.03
Coriander 3	0.45	40.9	0.03
Coriander 4	0.42	57.2	0.04
Coriander 5	0.49	56.2	0.04
Coriander 6	0.56	56.8	0.04
Average	0.57	53.78	0.037

by applying the lc/dad/ms analysis, 43 phenolic compounds were detected in the postdistillation waste material of coriander seed. there are a couple of groups: hydroxybenzoic and hydroxycinnamic acids, as well as glycosides flavanones and flavanols. the most abundant are different hydroxycinnamic acids and their derivatives, and glycosides flavanols. esculin, glycosides coumarines, is found in methanolic extract of coriander seed.

Table 2. The phenolics compounds of methanolic extract of coriander seeds postdistillation waste material identified by LC/DAD/MS

No	RT (min)	Molecular weight	Molecular formula	Absorbance maxima (nm)	Identification	Reference
1	1,04	602,1454	C ₃₂ H ₂₆ O ₁₂ C ₂₅ H ₃₀ O ₇		NI	
2	1,04	210,0389	C ₁₂ H ₁₈ O ₃		Jasmonic acid	Babovic et al., 2010
3	1,05	166,0484	C ₅ H ₁₀ O ₆		NI	
4	1,07	440,0936	C ₁₉ H ₂₀ O ₁₂ C ₂₆ H ₁₆ O ₇		NI	
5	1,07	224,0545	C ₇ H ₁₂ O ₈		NI	
6	1,14	208,2021		204;216;310	NI	
7	1,21	190,0131	C ₆ H ₆ O ₇		NI	
8	1,21	134,0255			NI	
9	1,28	104,0119	C ₃ H ₄ O ₄		NI	
10	1,37	192,0290	C ₆ H ₈ O ₇		NI	
11	1,44	192,0284	C ₆ H ₈ O ₇	216;252sh	NI	
12	1,51	129,0433		276sh;260	NI	
13	1,64	222,0395	C ₇ H ₁₀ O ₈	248;280sh	NI	
14	1,67	116,0123	C ₄ H ₄ O ₄		NI	
15	1,72	118,0278	C ₄ H ₆ O ₄	218;300sh	NI	
16	1,72	148,0392	C ₅ H ₈ O ₅		NI	
17	1,91	162,0530	C ₆ H ₁₀ O ₅		NI	
18	2,04	531,1606	C ₂₃ H ₂₅ N ₅ O ₁₀ C ₂₂ H ₂₉ NO ₁₄ C ₂₆ H ₂₅ N ₃ O ₈	208;254;292sh	NI	
19	2,20	369,1082		200;214;256;296sh	NI	
20	3,54	214,0853	C ₁₀ H ₁₄ O ₅		NI	
21	3,54	340,1205	C ₁₅ H ₁₆ O ₉		Esculin	Parejo et al., 2004
22	3,61	316,0890	C ₁₆ H ₁₂ O ₇	214;236;314	Izorhameti	Hossain et al., 2010
23	4,68	204,0912		220;276	NI	
24	5,17	370,0558	C ₁₆ H ₁₈ O ₁₀	244;304sh;328	Hydroxyl- cafeoilhinonicacid	Kaiser et al. 2013
25	5,37	176,0692	C ₇ H ₁₂ O ₅	242;294sh;330	NI	
26	5,63	430,1529	C ₃₀ H ₂₂ O ₃		NI	
27	5,70	254,1173	C ₁₃ H ₁₈ O ₅		NI	
28	5,93	180,0429	C ₉ H ₈ O ₄	218sh;233;294sh;326	Caffeicacid	Vallverdu- Quetalz et al., 2014
29	6,04	402,1543	C ₁₈ H ₂₆ O ₁₀		NI	
30	6,20	350,0686	C ₉ H ₁₈ O ₁₄		NI	
31	6,35	432,2016	C ₂₁ H ₂₀ O ₁₀		Apigenin-7-O- glukozid	Vallverdu- Quetalz et al., 2014
32	6,35	384,0710	C ₁₆ H ₁₆ O ₁₁ C ₉ H ₂₀ O ₁₆		NI	

33	7,18	378,1905	C ₁₇ H ₃₀ O ₉	230;296sh;312	NI	
34	7,18	368,1620	C ₁₇ H ₂₀ O ₉	230;296sh;312	Ferouilhinonicacid	Kaiser et al., 2013
35	7,41	412,1426	C ₃₀ H ₂₀ O ₂		NI	
36	7,53	426,1219	C ₁₂ H ₂₆ O ₁₆ C ₃₀ H ₁₈ O ₃	230;278	NI	
37	7,72	410,1270	C ₁₂ H ₂₆ O ₁₅ C ₃₀ H ₁₈ O ₂	222sh;238;296sh;322	NI	
38	7,76	194,0590	C ₁₀ H ₁₀ O ₄	222sh;238;296sh;322	Ferulicacid	Vallverdu- Quetalz et al., 2014
39	7,76	370,1781	C ₁₆ H ₁₈ O ₁₀	222sh;238;296sh;322	Hydroxyl- cafeoilhinonic acid	Kaiser et al., 2013
40	7,90	414,1547	C ₁₉ H ₂₆ O ₁₀		NI	
41	8,14	410,1273	C ₁₂ H ₂₆ O ₁₅ C ₃₀ H ₁₈ O ₂	238;264sh;308	NI	
42	8,34	476,2269	C ₂₁ H ₁₆ O ₁₃		NI	
43	12,64	330,2421	C ₂₀ H ₂₆ O ₄		Carnosol	Babovic et al., 2010

Conclusion

Our findings suggest that coriander postdistillation waste material represents a source of polyphenoles, but has low antioxidative capacity according to DPPH method. However, further research needs to be focused on its implementation in agro-food industry, in order to provide high exploitation of plant material.

References

- Aćimović M. (2014): Coriander (*Coriandrum sativum* L.). Andrejević Endowment, Belgrade.
- Diederichsen A. (1996): Coriander (*Coriandrum sativum* L.). Promoting the conservation and use of underutilized and neglected crops.3, ed. Institute of plant genetics and crop plant research, Gatersleben/International plant genetic resources institute, Rome, Italy.
- Dua A., Garg G., Kumar D., Mahajan R. (2014): Polyphenolic composition and antimicrobial potential of methanolic coriander (*Coriandrum sativum*) seed extract. International Journal of Pharmaceutical Sciences and Research, 5(6):2302-2308.
- Gavarić N., Kovač J., Kretschmer N., Kladar N., Smole-Možina S., Bucar F., Bauer R., Božin B. (2015): Natural products as antibacterial agents - antibacterial potential and safety of post-distillation and waste material from *Thymus vulgaris* L., Lamiaceae. In: Concepts, Compounds and the Alternatives of Antibacterials, 123-151.
- Gil A., de la Fuente E.B., Lenardis A.E., Pereira M.L., Suarez S.A., Bandoni A., van Baren C., Lira P.D.L. and Ghersa C.M. (2002): Coriander essential oil composition from two genotypes grown in different environmental conditions. Journal of Agricultural and Food Chemistry, 50(10):2870–2877.
- Msaada K., Jemia M.B., Salem N., Bachrouch O., Sriti J., Tammar S., Bettaieb I., Jabri I., Kefi S., Limam F., Marzouk B. (2014): Antioxidant activity of methanolic extracts from three coriander (*Coriandrum sativum* L.) fruit varieties. Arabian Journal of Chemistry, IN PRESS.
- Prokkola H., Kuokkanen T., Lassi U. (2012): Material-efficient utilization of waste oils- Biodegradability and other chemical properties of vegetable recycling oils. Green and Sustainable Chemistry, 2:133-140.

- Sriti J., Wannas W.A., Talou T., Jemia M. B., Kchouk M.E., Marzouk B. (2012): Antioxidant properties and polyphenol contents of different parts of coriander (*Coriandrum sativum* L.) fruit. *La Rivista Italiana Delle Sostanze Grasse*, 49:253-262.
- Parejo I., Jauregui O., Sanchez-Rabeneda F., Viladomat F., Bastida J., Codina C. (2004): Separation and characterization of phenolic compounds in fennel (*Foeniculum vulgare*) using liquid chromatography-negative electrospray ionization tandem mass spectrometry. *Journal of Agricultural and Food Chemistry*, 52:3679-3687.
- Vallverdu-Quetalz A., Reguerio J., Martinez-Huelamo M., Alvarenga J.F.R., Neto Leal L., Lamuela-Raventos R. M. (2014): A comprehensive study on phenolic profile of widely used culinary herbs and spices: Rosemary, thyme, oregano, cinnamon, cumin and bay. *Food Chemistry*, 154:299-307.
- Babovic N., Djilas S., Jadranin M., Vlasj V., Ivanovic J., Petrovic S., Zizovic I. (2010): Supercritical carbon dioxide extraction of antioxidant fraction from selected Lamiaceae herbs and their antioxidant capacity. *Innovative Food Science and Emerging Technologies*, 11:98-107.
- Hossain M.B., Rai D.K., Brunton N.P., Martin-Diana A.B., Barry-Ryan C. (2010): Characterization of Phenolic composition in Lamiaceae Spices by LC-ESI-MS/MS. *Journal of Agricultural and Food Chemistry*, 58:10576-10581.
- Kaiser A., Kammerer D.R., Carlem R. (2013): Impact of blanching on polyphenol stability and antioxidant capacity of innovative coriander (*Coriandrum sativum* L.) pastes. *Food Chemistry*, 140:332-339.

DETERMINATION OF YIELD AND SOME PLANT CHARACTERISTICS IN SOME SILAGE CORN VARIETIES

Bilal KESKİN*, Hakkı YILMAZ, Süleyman TEMEL, Barış EREN

Iğdir University, Faculty of Agriculture, Department of Agronomy, Iğdir, Turkey

*Corresponding author: bilalkeskin66@yahoo.com

Abstract

The study was conducted to determine the yield and some plant characteristics of some silage corn varieties which are grown as the main product in Iğdir province. The study was applied to randomized complete block design pattern with three replications in irrigate conditions. In this research, plant height (cm), forage yield ($t\ ha^{-1}$), dry matter ratio (%), dry matter yield ($t\ ha^{-1}$), leaf ratio (%), stem ratio (%), cob ratio (%), the number of leaf (number/ plant), plant weight (g) were determined in 10 silage corn varieties. According to the results; plant height was determined between 204.2 cm (OSSK-602) and 313.9 cm (OSSK-644), forage yield 60.5 $t\ ha^{-1}$ (OSSK-602) and 110.5 $t\ ha^{-1}$ (TK-6063), dry matter ratio 30.3% (OSSK-644) and 38.6% (TK-6063), dry matter yield 20.3 $t\ ha^{-1}$ (OSSK-602) and 41.5 $t\ ha^{-1}$ (TK-6063), leaf ratio 14.3% (OSSK- 596) and 18.3% (RX-9292), stem ratio 42.3% (Hido) and 51.0% (OSSK-644), cob ratio 36% (OSSK-644) and 45.6% (OSSK-602), the number of leaf 11.0 (OSSK-602) and 13.3 (TK-6063) plant weight 635.9 g (OSSK-602) and 1160.6 g (TK-6063). As a result, TK-6063, HİDO and SHEMALL varieties has been determined as suitable for the region's ecology.

Key Words: *Silage corn varieties, yield components, plant characteristics*

Introduction

In recent years, the production of silage fodder crops has been increased because of inadequate increase fodder crops depending on rising animal number and especially malnutrition of animals in winter season, Turkey. In this sense, corn (*Zea mays* L.) is a fodder sustain the animals' fodder need and generally used as silage both in homeland and in the world (Basbag et al., 1997). Corn is a plant which its production is increased throughout the world in silage fodder crop side as it is tasty and high nutrition value in the last half century. At the same time, high green weed profit unit area and its being appropriate to make silage without the additive are among most important features of corn. Because of its peculiarities that are mentioned above, the importance of corn plant's production increases to serve the need of fodder those animals require (Acıkgöz, 1995; Kilic, 1986; Sade, 2002). There are a wide variety of plants used in the production of silage in our country. It can be said that corn and sorghum are the most used kinds in these plants (Saglamtimur et al., 1998). The important thing in silage corn production is highness of green weed production. The highness of green weed profit depends on long vegetation duration. Because of the increase in the vegetation period the plant has provided high yield increases (Temel and Tan, 2002). Stub development in corn plants affects in 50% green weed profit. Because of this, vegetation duration is important in stub development of corn production (Ayaz et al., 2013). It is known that not being able to produce roughage in enough quantities, has very disadvantages in farming and animal products. Especially in Iğdir province that is suitable for agriculture, silage corn kinds should be used as fodder to serve the roughage need. In this regard, it can be said that silage corn production in irrigated land will add important effects to the

region's silage corn production capacity. In this study, appropriate and high profit kinds are aimed to determine for silage corn production in Iğdir province.

Materials and methods

This research was carried out in aqueous trial areas of the Agricultural Research and Application Center of the Iğdir University in 2015. In this study, ten corn varieties (respectively, 72 MAY 80, OSSK-644, TK-6063, OSSK-596, TK-6060, HİDO, RX- 9292, 71 MAY 69, SHEMALL, OSSK-602) were used. Climate values occurred in 2015 in Iğdir province are given in Table 1.

Table 1: Average Climate Properties Values of Iğdir Province in 2015.

		March	April	May	June	July	August	Sum/Avg.
Average	Temperature	11,0	16,4	21,3	28,5	31,8	30,2	23,2
(°C)								
Monthly	Total	52.0	44.1	41.5	27.8	0.3	14.3	30
Precipitation	(mm)							
Monthly	Avg. relative	50,8	47,7	52,9	40	33,6	40,7	44.2
Humidity	(%)							

The characteristics of the soil of trial area is as follows: clay-loamy texture, severe alkaline (pH: 8.6, lightly salted (EC 1.37 dS/m), low organic matter content, (1.20%) and rich lime content (CaCO₃: 22.27%). Moreover, suitable phosphorus and potassium contents in the soil was determined as 51.7 ppm and 852.4 ppm, respectively (Erdogan, 2013). Studies were designed as 3 replications according to randomized block pattern. Planting process has been made in a manner that row spacing, row top, parcel length and parcel width will be respectively 70 cm, 15 cm, 5 m and 3.5 m by means of marker on 04.04.2015 date. Each plot area was 17.5 m². In this research, total 160 kg/ha nitrogen, 80 kg/ha phosphorus fertilization of maize plants were carried out. Half of nitrogen fertilizer was given during planting, but the other half is provided from after plants is 50 cm long raised. Cultural practices such as weed control and tractors anchors which is necessary from sowing to harvest process have been made. At the same time, watering process was regularly made until the harvest by opening furrow after plants is 15-20 cm long. Harvest process is applied in 7.9.2015 date. And then, yield and plant characteristics were determined by measuring over 30 varieties corn randomly selected in each plot. Data obtained from the results of research that we were carried out in Iğdir conditions were analyzed with IBM SPSS 17.0 packet program and Duncan's multiple comparison test that was used to reveal the differences between each other's varieties (Anonymous, 2008).

Results and discussion

Plant height (cm):

Plant height of corn varieties used in the study is range from 204.2 to 313.9 cm. In this study, the highest plant height and the lowest height are OSSK 644 and OSSK 602 varieties, respectively. According to result of study carried out in conditions of Van province, the highest plant height and the lowest plant height was 242.6 cm and 143.7 cm (Akdeniz et al., 2004). The average plant height in maize has been reported to range from 1.5 to 3 m (Kun, 1997). The effect of genetic structure is an important factor affected plant height (Hallauer et al., 1988). When studies related to plant height in maize plant considering, we can say that varieties used in the experiment have adequate plant height. It supposes that these differences in results are caused from regional

climate and soil characteristics. Because of hereditary properties of quantitative characters are very low, plants are significantly affected by environmental conditions.

Forage yield (t ha⁻¹), dry matter yield (t ha⁻¹), dry matter ratio (%)

Forage yield is an important factor affecting silage yield (Ayaz et al., 2013). Forage yield in corn varieties used in the study were show statistically significant differences and yields ranged from 60.5-110.5 t ha⁻¹. While the highest value of forage yield was TK6063, the lowest yield value was obtained from OSSK 602 variety. Iptas et al., (2004) have obtained values between 87.9 and 67.2 t ha⁻¹ in forage yield as result of studies carried out in Tokat- Kozova conditions. Akdeniz et al., (2004) showed that the highest value in forage yield was 78.4, and the lowest values were 27.2 t ha⁻¹ in their study. Dry matter ratio of 10 corn varieties used in the study ranged from 30.3 to 38.6%. While the highest value of dry matter ratio was TK 6063, the lowest dry matter ratio was obtained from OSSK 644 variety. Dry matter yields of varieties are ranged from 20.3 and 41.5 t ha⁻¹. While the highest value of dry matter yield among corn varieties used in this study was 41.5 t ha⁻¹ (TK 6063), the lowest dry matter yield value was 20.3 t ha⁻¹ (OSSK 602). Iptas et al., (2004) have obtained that the highest value was 23.6 t ha⁻¹ and the lowest value was 18.5 t ha⁻¹ in dry matter yield as result of studies carried out in Tokat- Kozova conditions. In a study carried out in Van conditions, dry matter yield obtained between 14.6 and 7.4 t ha⁻¹ (Akdeniz et al., 2004).

In result of our study carried out Igdır province conditions, we found that forage and dry matter yields obtained from maize varieties was to be higher than the findings of other researchers. It is assume that these differences will be result from different varieties used in study and environmental conditions.

Leaf ratio, stem ratio and cob ratio

While leaf ratio between corn varieties used in the research that we conduct in Igdır conditions is insignificant, stem and cob rate was significant. The stem and cob rate of varieties are range from between 42.3-51.0%, and 36.0-45.6% respectively. While OSSK 644 variety has higher stem ratio, HİDO variety has lowest stem ratio. The highest value and the lowest value in terms of cob ratio among corn varieties was belong to OSSK 602 and OSSK 644 varieties, respectively. Akdeniz et al., (2004) obtained values of cob ratio with 38.2-49.0% and stem ratio with 28.1-43.6% in study carried out in Van conditions.

Leaf number (pieces)

Multiple comparison results belong to leaf number in maize varieties are given in Table 3. Values of between 11.0 and 13.3 in the number of leaves of the corn variety used in this study were obtained. According to our results, while TK 6063 variety has highest leaf number (13.3), OSSK 602 variety has lowest leaf number (11.0). Gunes and Acar, (2006) was found that highest and lowest value in leaf number among maize varieties grown as second production in study carried out in Karaman is 15.8 and 13.8 number/plant, respectively.

Plant weight (g)

Plant weights obtained in this study were significant among maize varieties. Multiple comparison results belong to plant weight in maize varieties are given in Table 3. The highest plant and the lowest plant weight in study were measured as 1160.6 g and 635.9 g. The highest and lowest value of plant weight of maize varieties grown as second production in study carried out in Karaman was determined among 1198.0 g and 913.6 g, respectively (Gunes and Acar, 2006)

Table 2: Plant height, forage yield, dry matter ratio and dry matter yield of maize varieties

Varieties	Plant height (cm)	Forage yield (t ha ⁻¹)	Dry Matter ratio (%)	Dry Matter yield (t ha ⁻¹)
72 MAY 80	250,3 bc	83.7 bcd	33,3 bcd	27.4 bc
OSSK 644	313,9 a	88.1 abc	30,3 d	26.6 bc
TK 6063	242,5 bcd	110.5 a	38,6 a	41.5 a
OSSK 596	278,0 ab	95.0 abc	34,6 bcd	32.7 ab
TK 6060	242,1 bcd	96.7 abc	34,0 bcd	32.8 ab
HİDO	242,8 bcd	109.4 a	35,0 bc	38.2 ab
RX 9292	237,1 bcd	87.7 abc	36,3 ab	32.1 abc
71 MAY 69	230,4 cd	82.2 cd	36,6 ab	30.6 abc
SHEMALL	260,8 bc	107.9 ab	33,6 bcd	36.5 ab
OSSK 602	204,2 d	60.5 d	33,6 bcd	20.3 c
Average	250,2	91.7	34,6	31.9

* There were not significant differences in 0.05 level among averages shown with same letter. (P<0.05)

Table 3: Leaf ratio, stem ratio, cob ratio, leaf number and plant weight of maize varieties

Varieties	Leaf ratio (%)	Stem ratio (%)	Cob ratio (%)	Leaf number (Pieces)	Plant weight (g)
72 MAY 80	16,0	47,4 ab	39,3 cd	13,2 a	879,0 bcd
OSSK 644	15,3	51,0 a	36,0 d	13,0 a	925,2 abc
TK 6063	16,3	47,0 abc	39,6 cd	13,3 a	1160,6 a
OSSK 596	14,3	48,3 ab	39,0 cd	12,6 ab	997,8 abc
TK 6060	14,6	43,0 d	44,6 ab	12,3 ab	1016,3 abc
HİDO	18,0	42,3 d	44,6 ab	13,0 a	1149,6 a
RX 9292	18,3	48,6 ab	38,3 cd	13,0 a	921,6 abc
71 MAY 69	18,0	47,0 abc	40,3 bcd	12,6 ab	863,8 cd
SHEMALL	16,0	44,6 bcd	43,0 abc	12,3 ab	1133,2 ab
OSSK 602	17,6	43,3 cd	45,6 a	11,0 ab	635,9 d
Average	16,44	46,25	41,03	12,63	968,3

* There were not significant differences in 0.05 level among averages shown with same letter. (P<0.05)

Conclusion

In silage maize production, while forage yield, leaf number, leaf ratio, plant weight, dry matter yield and cob ratio of maize crops is desirable to be high, high stem ratio is not desirable. According to data obtained from study, the most suitable varieties to these criteria are TK6063, HİDO and SHEMALL. In result of study, moreover, we found that these varieties were advisable to grow in Iğdir conditions.

References

- Acıkgöz E. (1995). Forage. Uludağ University Faculty of Agriculture. Bursa.
- Akdeniz H., Yılmaz I., Andic N., Zorer S. (2004). A Study on Yield and Forage Values of Some Corn Cultivars. YYU, Agricultural Faculty, Tarım Bilimleri Dergisi (J.Agric.Sci.), 14(1): 47-51.
- Anonymous, 2008. IBM SPSS Statistics 17.0.

- Ayaz M., Ozpinar H., Yaman S., Acar AA., Aksu Y., Yavruturk Y., Niksarligil F., Aksu S., Aygun Y. (2013), Evaluation of The Yield and The Quality Characteristics of The Corn Kinds for Silage Used or To Be Used Commonly in After Crop Agriculture. *Harran Agriculture and Food Sciences Magazine*, 17(3): 1-11.
- Başbag M., Demirel R., Gul I., Saruhan V. (1997). Opportunities to Grow Corn and Sorghum As A Material For Silage In The Region Of South-Eastern Anatolia Project. The Republic of Turkey The First Silage Congress. Hasad Publishing. 251-255. Istanbul.
- Erdogan HE. (2013). *Soil Definition Guide.*, ISBN: 978-605-4672-20-2., 2013
- Gunes A., Acar R. (2006). Determination of Facilities Second Crop Cultivation of Hybrid Corn Silage Type in Karaman Ecological Conditions. *Selcuk Univ. Zir. Fak. Derg (Agri. Faculty Journal)*, 20(39):84-92.
- Hallauer AR., Carena MJ., Miranda Filho JB. (1988). *Quantitative Genetics İn Maize Breeding.* Iowa State Univ. Press, Ames, Iowa.
- Iptas S., Oz A., Boz A. (2004). Comparison Of Yield And Some Agronomic Properties Of First And Second Crop Silage Maize Cultivated Under Tokat-Kazova Conditions, *OMÜ Zir. Fak. Dergisi*, 19(1):19-25
- Kilic A. (1986). *Silo Feed (Teaching, Learning And Practice Recommendations)*, Bilgehan Basımevi, Bornova-İzmir, 327 S.
- Kun E. (1997). *Grains II (Warm Climate Cereals)*. A.Ü. Agricultural Faculty Textbook. Ankara. Pp:141.
- Sade B. (2002). *Corn Agriculture*. Konya Commodity Exchange Publishing No: 1. Konya.
- Saglamtimur T., Tansi V., Baytekin H. (1998). *Forage Crops Cultivation*. Cukurova University Agricultural Faculty Textbook No:74. Adana.
- Temel S., Tan M. (2002). A Research On Determination Of Seeding And Cutting Time İn Common Vetch (*Vicia Sativa L.*) Under Erzurum Conditions. *Atatürk University. Faculty Of Agriculture. Ed.*, 33 (4): 363-368.

EFFECTS OF RAIN-SHIELD CULTIVATION SYSTEM ON MORPHOMETRIC AND CHEMICAL PROPERTIES OF BLACKBERRIES ČAČANSKA BESTRNA

Žaklina KARAKLAJIĆ-STAJIĆ^{1*}, Mihailo NIKOLIĆ², Rade MILETIĆ¹,
Jelena TOMIĆ¹, Marijana PEŠAKOVIĆ¹, Svetlana M. PAUNOVIĆ¹

¹Fruit Research Institute, Čačak, Republic of Serbia

² Faculty of Agriculture, University of Belgrade, Republic of Serbia

*Corresponding author: zaklinaks@yahoo.com

Abstract

In terms of economic significance, blackberry ranks 3rd in the Serbian production of berry fruits, following immediately after raspberry and strawberry. New systems for blackberry cultivation in enclosed and semi-enclosed areas which have gained global popularity over the past several years offer certain advantages – primarily in terms of protection of fruits from adverse weather conditions, but also by indirectly reducing the threat of infection with economically significant pathogens, thus yielding an overall advantage over open-field production methods. Considering that the Serbian blackberry yield suffers an annual loss of around 30% due to gray mold caused by the phytopathogenic fungi *Botrytis cinerea* Pers., introduction of more intensive blackberry cultivation systems is imperative in order to prevent adverse action of rain and other abiotic components, thus securing continuous harvest and supply of improved-quality fruits. The paper presents results of a three-year study (2011–2013) of rain-shield cultivation system on morphometric and chemical properties of blackberries Čačanska Bestrna. The results showed that most of the tested parameters were affected by production system and environmental conditions during the research, as well as by their interaction. The rain-shield system did not cause any deviation of morphometric properties compared to open-field cultivation. In terms of the chemical properties, soluble solids content (10.26%), total and invert sugar content (6.77%; 6.06%), and sucrose content (0.68%) were higher in blackberries under rain shields.

Keywords: *Blackberry, Rain shields, Fruit quality, Serbia.*

Introduction

Blackberries are popular fruits widely distributed throughout nature, except the polar regions, and grown worldwide. Berries of this species had pleasant flavor and high nutritive and health value (Milošević et al., 2012).

The economic significance of the European blackberry (*Rubus* subg. *Rubus* Watson) makes it an important berry fruit in Serbia, where it is positioned immediately after raspberry and strawberry (Nikolić and Milivojević, 2015). The blackberry production constitutes 69% of the European and 17.82% of the world's production (Strik et al., 2007), which places Serbia among the four leading global producers of this fruit. The blackberry orchards in Serbia are dominated by the 'Čačanska Bestrna' and 'Thornfree' cultivars, with more than a 95% share, followed by the 'Black Saten', 'Dirksen Thornless' and some more recent cultivars, such as 'Loch Ness', 'Chester Thornless', 'Triple Crown' (Nikolić et al., 2012; Nikolić and Milivojević, 2015). Considering the fact that over the past several years the difficulties in marketing blackberry have been partly due to a relatively weaker fruit quality of the most widely grown cultivars ('Čačanska Bestrna' and 'Thornfree'), it is necessary to introduce new technologies and changes to the cultivars.

Regarding this, intensifying the technology of blackberry cultivation is mostly focused on reducing the adverse impact of inclement weather (low and high temperatures, rain and light). The system of blackberry cultivation in enclosed areas (tunnels) is widely favoured, mostly owing to the protection of the fruits from adverse weather conditions it provides, thereby gaining advantage over open-field production (Thompson et al., 2009). Depending on the construction type, cultivation of blackberry in enclosed and semi-enclosed areas may take different forms. Double-row rain shields (semi-tunnels) represent simple and highly cost-effective cultivation techniques, conducive to improved fruit quality and increased yields. Gaskell (2004) reported that high tunnels and rain shields cultivation improve fruit quality by moderating the environment and excluding rain and extending the harvest seasons.

The objective of the research is to indirectly examine the impact of the rain-shield cultivation on morphometric and chemical properties of blackberry 'Čačanska Bestrna'.

Material and methods

Experimental design

The investigation was conducted over a three-year period (2011–2013) in the experimental trial of blackberry cultivar 'Čačanska Bestrna', which was established in 2006 and is located at Gornja Gorevnica (43° 53'N latitude, 20° 20' E longitude, 290 m altitude) near Čačak city, Western Serbia. This is mainly an upland area, with an average altitude of about 290 m, characterised by the temperate continental climate. The blackberries were planted in rows spaced 3.0 m apart with plants set at 1.5 m apart in the row, and trained as a three-wire trellis. Plastic arches were placed on the existing trellis structure in the blackberry orchard. The arches were covered using 150 μ thick foil, forming the shape of an umbrella (rain-shield cultivation). The trial was conducted using a randomised block design and it included four replications of each treatment. Fertilization and irrigation practices standard for the region were provided during the period of investigation.

Plant material

Blackberry 'Čačanska Bestrna' was created in 1984 by crossing 'Dirksen Thornless' \times 'Black Satin' at the Fruit Research Institute, Čačak. It is a highly vigorous cultivar, producing 4–5 strong canes bent in mid-section, having short internodes. The flowering season is mid-late. It is a self-fertile, abundant cropper. Resistant to low winter temperatures, it is medium resistant to yellow rust (*Kuehneola uredinis* (Link)) and susceptible to purple blotch of blackberry (*Septocya ruborum* (Lib.) Petrark). Ripening season is mid-early, at the beginning of the third decade of July. The fruit is large, with an average fruit weight of around 9.3 g. It is elongated-cylindrical, glossy black, with a sweet-subacidic taste and pronounced aroma. 'Čačanska Bestrna' is suitable for both fresh use and freezing and for various forms of processing as well. In different agro-ecological conditions, this cultivar has displayed excellent performance in respect of cropping and resistance to diseases and low winter temperatures.

Determination of fruit quality traits

Twenty-five fruits in each replication were randomly selected to determine average fruit weight using the METLER balance (± 0.01 g accuracy) and the data were expressed in g per fruit. The fruit dimensions (mm) (length, breadth, and fruit shape index) were also determined in the selected samples using the 'Inox' vernier scales (± 0.05 mm accuracy). Chemical parameters viz. soluble solids (SS), total sugars (TS), reducing sugars (RS), titratable acidity (TA), pH, sucrose (SC) and ripening index were measured at the commercial maturity stage. SS ($^{\circ}$ Brix) was determined using a hand refractometer (ATC, Belgium). TS (%) and RS (%) were determined as

fresh weight basis, using the Luff-Schoorl method. TA was measured by neutralization to pH 7.0 with 0.1N NaOH, the data being presented as percentage of malic acid. Juice pH was measured using a pH meter (Cyber scan 510, Mettler Toledo, USA). SC was calculated by multiplying the difference of the total and reducing sugars contents by the 0.95 coefficient. RI was calculated as soluble solids/titratable acidity ratio.

Statistical analysis

The results are presented as mean \pm standard error of mean (SE). Differences between mean values were compared by LSD test in two-way analysis of variance (ANOVA) using MSTAT-C statistical computer package (Michigan State University, East Lansing, MI, USA). Differences with p values of ≤ 0.05 were considered insignificant.

Results and discussion

Within the morphometric characteristic of the fruits of the studied blackberry cultivar, the results of examining fruit weight and dimensions (length and width) are shown (Table 1), as well as the fruit shape index (Table 1) in the function of the cultivation system over the three-year period of trial.

Table 1. Effect of cultivation techniques on morphometric properties of blackberry fruits 'Čačanska Bestrna'

Treatment	Weight(g)	Dimensions of fruit		Shape index	
		Length(mm)	Breadth(mm)		
Cultivation techniques (A)					
Rain-shield	7,36 \pm 0,17 a	25,55 \pm 0,51 a	18,85 \pm 0,32 a	1,36 \pm 0,01 a	
Standard	5,94 \pm 0,13 a	22,80 \pm 0,27 b	17,84 \pm 0,25 b	1,28 \pm 0,02 b	
Year (B)					
2011	6,48 \pm 0,21 b	23,09 \pm 0,61 b	16,96 \pm 0,39 b	1,37 \pm 0,03 a	
2012	6,98 \pm 0,29 a	25,66 \pm 0,63 a	18,94 \pm 0,24 b	1,35 \pm 0,02 a	
2013	6,51 \pm 0,25 ab	23,76 \pm 0,38 b	19,14 \pm 0,19 a	1,25 \pm 0,01 b	
Cultivation techniques \times Year(A \times B)					
Rain-shield	2011.	6,88 \pm 0,33 a	24,04 \pm 1,13 b	17,46 \pm 0,71 a	1,38 \pm 0,02 ab
	2012.	7,92 \pm 0,11 a	27,68 \pm 0,32 a	19,60 \pm 0,18 a	1,42 \pm 0,01 a
	2013.	7,29 \pm 0,28 a	24,93 \pm 0,42 b	19,50 \pm 0,28 a	1,28 \pm 0,01 c
Standard	2011.	6,09 \pm 0,20 a	22,16 \pm 0,28 b	16,45 \pm 0,25 a	1,35 \pm 0,02 b
	2012.	6,04 \pm 0,33 a	23,64 \pm 0,64 b	18,29 \pm 0,29 a	1,29 \pm 0,02 c
	2013.	5,70 \pm 0,05 a	22,59 \pm 0,21 b	18,77 \pm 0,18 a	1,21 \pm 0,01 d
ANOVA					
A	ns	*	*	*	
B	*	*	*	*	
A \times B	ns	*	ns	*	

Values within each column followed by the same small letter are insignificantly different at the $p \leq 0.05$ by LSD test;
ns - non significant differences.

The variance analysis showed that the training system and the year made a statistically significant impact on the length and width of the blackberry fruit, whereas their interaction made a significant impact on the length and the fruit shape index. The only impact made on the blackberry fruit weight was that of the year of study. Fruit weight, length, breadth and shape

index ranged from 5.70 ± 0.05 to 7.92 ± 0.11 g, 22.16 ± 0.28 to 25.66 ± 0.63 mm, 16.45 ± 0.25 to 19.60 ± 0.18 mm, and 1.21 ± 0.01 to 1.42 ± 0.01 , respectively. The comparison of the different cultivation techniques showed that the morphometric traits (fruit weight, length, and breadth) and shape index were higher in the rain-shield treatment. The weight and length were the highest in second growing year, whereas the breadth was the highest in the third growing year and fruit-shape index reached its peak in the first growing year. In general, the morphometric traits were found to be worse in first growing year, except the shape index.

The obtained results of the morphometric properties of the blackberry cultivar examined in this paper indicate that the application of the rain-shield system made a positive impact on the fruit weight and dimensions, with significant differences occurring in the length and width. Compared to the results obtained by Stanisavljević (1998), a lower fruit weight of the blackberry 'Čačanska bestrna' was obtained by Milivojević (2008) in the Central Serbia conditions and Miletić et al. (2006) in the Eastern Serbia condition. Similarly to these results, Thompson et al. (2009) did not detect major fluctuations in the fruit weight of the primocane blackberry 'Prime Jan' grown in the rain-shield system. On the other side, Miller and Tworzkovski (2003) reported that the optimum distribution of light in the shielded and semi-shielded space have a positive impact on differentiation of generative buds in annual plants, as well as on the fruit quality of biennial canes, especially the fruit size and colour, but also the soluble solids content in the fruit. Observed by the year of study, the obtained results for the cultivar under consideration reveal significant fluctuations in the values of the fruit weight and dimensions, which can be explained by the different environmental conditions in the respective years of study. Based on the values obtained in the investigation, it can be observed that the shape index in all treatments was higher than 1, which corresponds to the conic shape of the fruits of the examined blackberry cultivar.

Table 2a and b. Effect of cultivation techniques on chemical properties of fruits 'Čačanska Bestrna' blackberry

Treatment	SS (°Brix)	Content of sugars (%)			
		TS	RS	SC	
Cultivation techniques(A)					
Rain-shield	10.26 ± 0.08 a	6.77 ± 0.11 a	6.06 ± 0.13 a	0.68 ± 0.04 a	
Standard	9.66 ± 0.04 b	6.29 ± 0.11 b	5.61 ± 0.10 b	0.65 ± 0.05 a	
Year (B)					
2011	9.99 ± 0.13 a	6.92 ± 0.13 a	6.17 ± 0.13 a	0.71 ± 0.05 b	
2012	9.95 ± 0.10 a	6.49 ± 0.14 b	5.97 ± 0.11 b	0.49 ± 0.03 c	
2013	9.94 ± 0.13 a	6.18 ± 0.09 c	5.36 ± 0.10 c	0.78 ± 0.04 a	
Cultivation techniques × Year(A × B)					
Rain-shield	2011	10.25 ± 0.20 a	7.04 ± 0.21 a	6.35 ± 0.19 a	0.65 ± 0.05 bc
	2012	10.18 ± 0.14 a	6.83 ± 0.19 a	6.26 ± 0.17 a	0.54 ± 0.04 d
	2013	10.35 ± 0.07 a	6.44 ± 0.10 a	5.56 ± 0.16 a	0.84 ± 0.06 a
Standard	2011	9.73 ± 0.05 b	6.80 ± 0.15 a	5.99 ± 0.12 a	0.77 ± 0.09 a
	2012	9.73 ± 0.08 b	6.16 ± 0.09 a	5.69 ± 0.12 a	0.45 ± 0.04 d
	2013	9.53 ± 0.04 b	5.92 ± 0.06 a	5.16 ± 0.03 a	0.73 ± 0.03 ab
ANOVA					
A	*	*	*	ns	
B	ns	*	*	*	
A × B	*	ns	ns	*	

Values within each column followed by the same small letter are insignificantly different at the $p \leq 0.05$ by LSD test;

ns - non significant differences.

Chemical parameters analysed so far showed a significant effect of cultivation techniques, except SC and TA. On other hand, growing years significantly affected the number of TS, RS, SC, TA, and pH (Table 2a and b). Interaction effect of cultivation techniques and the growing year significantly affected all the chemical parameters, except TS and RS. SS, TS, RS, SC, TA, pH, ripening index in fruit ranged from 9.53 ± 0.04 to 10.35 ± 0.07^0 Brix, 5.92 ± 0.06 to $7.04 \pm 0.21\%$, 5.16 ± 0.03 to $6.35 \pm 0.19\%$, 0.45 ± 0.04 to $0.84 \pm 0.06\%$, 1.12 ± 0.03 to $1.31 \pm 0.07\%$ of malic acid, 2.97 ± 0.03 to 3.47 ± 0.02 , and 7.80 ± 0.28 to 9.31 ± 0.20 , respectively. Higher chemical parameters, except TA were recorded in the rain shield cultivation. Thompson et al. (2009) reported that it is as yet unknown whether plastic foil used in tunnel system off cultivation makes an impact on the synthesis of primary and secondary metabolites in plants. The average values of the soluble solids content in all the treatments were higher than the values obtained Miletic et al. (2006) for the same cultivar, while at the same time lower in comparison with the values obtained by Stanisavljevic (1999).

The analysis of interaction effect of cultivation techniques and growing year (Table 2a and b) inferred that SS, SC, pH, and ripening index were the highest in the rain shield cultivation during the third year, and TS, RS, and TA were the highest under the same cultivation techniques in the first year.

Table 2b.

Treatment		Titrateable acidity (%of malic acid)	pH	Ripening index
Cultivation techniques (A)				
Rain-shield		1.20 ± 0.03 a	3.22 ± 0.05 a	8.75 ± 0.27 a
Standard		1.24 ± 0.02 a	3.10 ± 0.04 b	7.85 ± 0.13 b
Year (B)				
2011		1.29 ± 0.04 a	3.07 ± 0.04 b	7.80 ± 0.28 a
2012		1.18 ± 0.03 b	3.00 ± 0.03 b	8.54 ± 0.29 a
2013		1.17 ± 0.02 b	3.41 ± 0.02 a	8.56 ± 0.25 a
Cultivation techniques \times Year(A \times B)				
Rain-shield	2011.	1.31 ± 0.07 a	3.16 ± 0.04 c	7.96 ± 0.52 c
	2012.	1.16 ± 0.05 bc	3.03 ± 0.04 d	8.99 ± 0.47 ab
	2013.	1.12 ± 0.03 c	3.47 ± 0.02 b	9.31 ± 0.20 a
Standard	2011.	1.28 ± 0.04 ab	2.97 ± 0.03 d	7.65 ± 0.26 c
	2012.	1.22 ± 0.04 abc	2.99 ± 0.03 d	8.08 ± 0.23 bc
	2013.	1.21 ± 0.03 abc	3.35 ± 0.02 a	7.82 ± 0.15 c
ANOVA				
A		ns	*	*
B		*	*	nz
A \times B		*	*	*

Values within each column followed by the same small letter are insignificantly different at the $p \leq 0.05$ by LSD test;
ns - non significant differences.

Based on the obtained results, it can be concluded that the structure of total sugars is dominated by invert sugars (glucose and fructose), with the fluctuation of the values reflecting the same tendency as the total sugars. The average values of the total sugars obtained in all of the treatments were higher than the values obtained by Miletic et al. (2006) and Veberic et al. (2014).

The sucrose share in the fruits of the studied cultivar was lower, with significant fluctuations in the respective years of study, which is in accordance with the findings of Kaume et al. (2012). In the conditions of the applied cultivation systems, the recorded values of the sucrose content were at a similar level, though slightly higher in the rain-shield system off cultivation. Observed by the year of study, the obtained results indicate that the values of the sucrose content in the blackberry cultivar under consideration recorded significant fluctuations demonstrating a different tendency compared to the total sugars content.

According to Talcott (2007), the organic acids play a key role in the formation of the colour and extension of the storage capacity of fresh and processed fruits. Reyes-Carmona et al. (2005) state that the values of the total acids contents in blackberry fruits vary within the range from 1.02% to 4.22%, whereas Nikolić and Milivojević (2015) and Veberic et al. (2014) conclude that citric and malic acids are the most dominant. The values of the total acids obtained in this study for the different cultivation systems were relatively levelled and showed no significant differences among the respective variants. Each cultivation system was characterised by an identical variation in the levels of the total acids content in the fruit, in each year, meaning that the interaction between the cultivation system and the year made a significant impact on this parameter. Based on the study into the content of sugar and organic acids in the fruit of wild blackberry and economically most important blackberry cultivars conducted over a period of three years, Milivojević (2008) established that the total acids content in the fruits of the 'Čačanska Bestrna' amounts to 0.20 mg g⁻¹. Similar values of the total acids contents in the fruits (17.7 g kg⁻¹) are stated by Veberic et al. (2014) and Miletić et al. (2006).

Conclusion

During the three years of study, the rain-shield cultivation system made a positive impact on the morphometric characteristics of blackberry fruits and the content of the studied parameters of biochemical composition. Regarding this, the preliminary results of studies into the more recent cultivation system, i.e. implementation of the rain-shield system in blackberry production, growers can be advised and given guidelines in the blackberry growing technology with a potential to advance the fruit quality.

Acknowledgements

This study is the part of the project No. 31 093 and financed by the Ministry of Education, Science and Technological Development of the Republic of Serbia. We hereby express our sincere gratitude for the support.

References

- Gaskell M. (2004), Field tunnels permit extended season harvest of small fruits in California. *Acta Horticulturae*, 659: 425–430.
- Kaume L., Howard L.R., Devareddy L. (2012): The blackberry fruit: a review on its composition and chemistry, metabolism and bioavailability, and health benefits. *Journal of Agricultural and Food Chemistry*, 62, 6926–6935.
- Miletić R., Žikić M., Mitić N., Nikolić R. (2006): Pomological and technological characteristics of fruits of certain blackberry cultivars in the agro-ecological conditions of eastern Serbia. *Pomology*, 40, 156, 331–339.
- Milivojević J. (2008): Pomological and anti-oxidant characteristics of berry fruits. PhD Thesis, University of Belgrade, Faculty of Agriculture in Belgrade.

- Miller S.S., Tworowski T. (2003): Regulating vegetative growth in deciduous fruit trees. *PGRSA* 31, 1, 8–46.
- Milošević T., Milošević N., Glišić I., Mladenović J. (2012): Fruit quality attributes of blackberry grown under limited environmental conditions. *Plant, Soil and Environment*, 58, 7, 322–327.
- Nikolić D., Keserović Z., Magazin N., Paunović S., Miletić R., Nikolić M., Milivojević J. (2012): State and perspective of pomology development in Serbia. Paper and abstracts proceedings of 14th.Serbian congress of fruit and grapevine producers with international participation. Vrnjačka Banja, Republic of Serbia, 3–22.
- Nikolić M., Milivojević J. (2015): Berry fruit–Technology of Fruit Growing. Faculty of Agriculture, Belgrade.
- Reyes-Carmona J., Yousef G.G., Martinez-Peniche R.A., Lila M.A. (2005): Antioxidant capacity of fruit extracts of blackberry (*Rubus* sp.) produced in different climatic regions. *Journal of Food Science*, 70, 497–503.
- Stanisavljević M. (1998a): New small fruit cultivars from Čačak: 1. A new blackberry (*Rubus* sp.) cultivar ‘Čačanska Bestrna’. Book of Abstracts of VII *Rubus-Ribes* Symposium, Melbourne, Australia, 19.
- Strik B.C., Clark J.R., Finn C.E., Banados M.P. (2007): Worldwide blackberry production. *HortTechnology*, 17, 2, 205–213.
- Talcott S.T. (2007): Chemical components of berry fruits. In: ‘Berry fruit, value-added products for health promotion’. Zhao Y. (ed.), Taylor & Francis Group, pp. 51–73.
- Thompson E., Strik B., Finn C.E., Zhao Y., Clark J.R. (2009): High tunnel versus open field: Management of primo-cane-fruiting blackberry using pruning and tipping to increase yield and extend the fruiting season. *HortScience*, 44, 6: 1581–1587.
- Veberic R., Stampar F., Schmitzer V., Cunja V., Zupan A., Koron D., Mikulic-Petkovsek M. (2014): Changes in the contents of anthocyanins and other compounds in blackberry fruits due to freezing and long-term frozen storage. *Journal of Agricultural and Food Chemistry*, 62, 6926–6935.

EFFECT OF MULCH TYPE ON THE PRODUCTIVITY OF POTATO

Jasmina OLJAČA^{1*}, Nebojša MOMIROVIĆ¹, Zoran BROČIĆ¹, Dušan KOVAČEVIĆ¹, Dobrivoj POŠTIĆ², Danijel PANTELIC³, Ivana MOMČILOVIĆ³

¹University of Belgrade, Faculty of Agriculture, Belgrade, Serbia

²Institute for Plant Protection and Environment, Belgrade, Serbia

³Institute for Biological Research „Siniša Stanković“, Belgrade, Serbia

*Corresponding author: jasmina.oljaca@agrif.bg.ac.rs

Abstract

Even though soil mulching is a common practice in vegetable crop production, there is only scarce information about effect of this technique on the yield of potato (*Solanum tuberosum* L.). Field experiments were conducted to investigate the effects of different mulch materials on productive characteristics of three potato cultivars: Marabel (medium early), Desiree (medium late) and Jelly (medium late) under agro-ecological conditions of Southern Srem, Serbia. Treatments were arranged in a randomized complete block design with four replications with irrigation drip system at the site of Zemun Polje (44°88'N, 20°35'E, 79 m a.s.l.) in years 2011 and 2012. The variants with silver plastic mulch, red plastic mulch and straw mulch were compared to a control plot with bare soil. The highest average number of tubers per plant was determined in cv. Marabel subjected to the straw mulch treatment (11.85), while the lowest average number of tubers was determined in the cv. Desiree's control variant (8.65). Mulching combined with irrigation caused 2-3-fold increase in tuber yield compared to the average yield of potato in commercial production in Serbia. In a two-year study, treatment with red plastic mulch resulted in the highest average total yield in cv. Marabel and cv. Jelly, 55.9 t ha⁻¹ and 46.7 t ha⁻¹, respectively, while combination of irrigation and straw mulch resulted in the highest average total yield of cv. Desiree (45.2 t ha⁻¹). The study showed that two investigated factors, type of mulch and cultivar, significantly affected the number of tubers per plant and total yield of potato.

Key words: *mulching, potato, potato yield, number of tubers*

Introduction

Potato yield depends on the chosen variety and its genetic potential, agro-ecological conditions, applied cropping practices, tuber viability, seed tuber size, the number of stems per plant and the number of tubers per plant (Momirović et al., 2010; Poštić et al., 2012). Potatoes are grown on around 78,000 ha in Serbia, with average yield of 11.4 t ha⁻¹ (Statistical Yearbook of Serbia, 2014). This yield is significantly lower than average yield of potato in EU and the world (Belgium 44 t ha⁻¹, Netherlands 43 t ha⁻¹, USA 45 t ha⁻¹). In Serbia, the intensive crop management is not extensively used in potato production, especially in the small and economically weak farms. Increase in potato yield can be achieved by adherence to good agricultural practices, adoption of optimal agro-technical deadlines and well-adjusted assortment to agro-technical conditions of production (Bročić and Stefanović, 2012).

Soil mulching with organic or synthetic materials aims to: prevent the development of weeds, improve water and air regime, change the thermal regime of the soil, reduce erosion, increase the level of CO₂ in the zone of the plants. This procedure has been widely used in the production of vegetable crops since, due to a smaller contact with the soil, it contributes to earlier-maturing, cleaner and high-quality fruits and reduces the occurrence of rot. A favourable effect of mulching

type on the growth and development of plants and increased yield was found in maize (Awal and Khan, 2000) and melon (Ibarra et al., 2001). Mulching is increasingly applied in crop production because it also positively affects the structure, as well as the chemical, physical and biological properties of the soil.

Soil mulching with organic material is one method of soil water protection and also helps maintain a constant soil temperature within the root system of crops (Awal and Khan 2000, Kar and Kumar, 2007 Sinkevičienė et al. 2009, Samaila et al. 2011). Straw is most commonly used material for ground covering in crop and vegetable production because of its good thermal insulation properties. The temperature of the soil under the straw can be 5-8 °C lower than the temperature of bare soil which is especially important in the summer. Reduction of soil temperature has a great importance in countries with hot climate conditions, but now, as the climate is warming, temperature conditions for crops are becoming more unfavourable (Sinkevičienė et al., 2009). Also, the straw decomposition can enrich the soil with organic matter. On the other hand, the use of silver polyethylene films reduces aphids-, white flies- and red spider-attack since reflecting tungsten has a repellent effect on insects (disorientation and change the direction of flight). Red polyethylene film is commonly used in the production of tomatoes and lettuce since it well regulates the temperature, while light diffusion accelerates ripening for 10-14 days (Momirović et al., 2010).

Mulching reduces water evaporation, stabilizes soil temperature and improves soil conditions for plant growth and development. For all these reasons, soil mulching becomes more important also in moderate climate conditions, but there is scarce information about influence of this technique on the yield of potato. The aim of this paper was to evaluate the effect of different mulch materials (organic and plastic mulch) on the number of tubers per plant and potato yield in the lowland regions of Serbia.

Materials and methods

Investigation of the effect of mulching on productive characteristics of three potato cultivars: Marabel (medium early), Desiree (medium late) and Jelly (medium late) was conducted in Zemun Polje, Serbia (44°88'N, 20°35'E, 79 m a.s.l.) during 2011 and 2012. Treatments were arranged in a randomized complete block design with four replications and with irrigation drip system, on the slightly calcareous chernozem soil type. Standard tillage treatment for potato crop was used. Pre-sowing soil treatment included fertilization with Multi-Comp base and BitterMag, as well as organic fertilizer Stallatiko. Plants were foliarly fertilized with Haifa Bonus (N:P:K = 13:2:44, 6 kg ha⁻¹), Haifa Chemicals, Israel. The crop was regularly treated with preparations against downy mildew and Colorado potato beetle. Irrigation tapes were placed in the middle of a shallow bank and incorporated into the soil (sub-irrigation) and soil moisture maintained at about 75% of FWC.

Mulching was conducted in order to preserve moisture, reduce weed infestation, change thermal conditions and improve soil microbial activity. The variants with silver plastic mulch, red plastic mulch and straw mulch were compared to a control plot with bare soil. In plots with plastic mulch, ridges were formed firstly and then covered by the silver and red polyethylene film. Tubers were hand-planted in previously prepared holes in the plastic mulch. In the variant with organic mulch, straw was layered to 25 mm thickness directly after planting and the formation of ridges. Plots without mulch (control) were maintained free of weeds by hand-weeding, especially early in the season.

In both years the planting of tubers (planting density: 80 x 30 cm) was carried out in the first decade of April. Potato harvesting was carried out at the stage of technological maturity in the

second ten days of September; number of tubers per plant was determined, as well as tuber mass and total yield.

Meteorological conditions in the period of investigations

Table 1. The average monthly air temperatures and monthly precipitation sums during the growing season 2011. i 2012. and multi-year average at Zemun Polje

Months	2011		2012		1980-2010	
	°C	mm	°C	mm	°C	mm
April	14.7	14.1	14.6	66.9	12.3	54.6
May	18.3	66.8	18.0	127.9	17.7	56.0
June	21.9	41.1	24.6	16.0	20.9	101.0
July	24.3	95.0	27.0	39.0	22.6	69.2
August	24.6	14.0	26.0	4.5	22.4	55.4
September	23.0	47.7	22.0	30.7	17.5	64.7
Average/Sum	21.1	278.7	22.0	285.0	18.9	400.9

The average air temperatures during potato vegetation period in 2011 and 2012 were 2.2 °C and 3.1 °C higher, respectively, than 1980-2010 multi-year average; this was mostly result of average temperature increase in June, July and August. Temperature increase in June was especially significant, considering that this month is important for stolon formation and tuber initiation. Precipitations in summers 2011 and 2012 were below limits of multiple-year average with an uneven distribution during vegetative period in both years. Precipitations in summers 2011 and 2012 were below limits of multiple-year average with an uneven distribution during vegetative period in both years.

Statistical analysis was performed using STATISTICA 10 (StatSoft, Inc. 1984-2011, USA). The data concerning tuber number, tuber mass or yield were subjected to two-factor analysis of variance ANOVA with Cultivar and Mulch Type as factors. If significant interaction between factors was determined, Fisher's-LSD multiple range test was used for analysis at all Cultivar x Mulch combinations. The meteorological conditions during the potato growing season were presented in the Table 1.

Results and discussion

Analysis of number of tubers per plant and total yield (Table 2) showed highly significant differences influenced by potato genotype (G), mulch type (M) and interaction of these two factors (G × M).

Table 2. F-values for observed factors

Factors	Number of tubers per plant	Total yield
Genotype (G)	**	**
Mulch (M)	**	**
G × M	**	**

** - significant at $p < 0.01$; * - significant at $p < 0.05$; ns - not significant

The highest average number of tubers per plant (all three cultivars/genotypes) was recorded in the variant with red plastic mulch (11.0), somewhat smaller number of tubers was determined on variants with organic mulch (10.7) and the variant with a silver plastic mulch (10.3), while the lowest number of tubers per plant (9.6) was determined in control (Table 3).

Considering factor cultivar (Table 3), the lowest number of tubers per plant was found in cv. Desiree (10.1), moderate number in cv. Jelly (10.4), while the highest number of tubers per plant was established in cv. Marabel (10.7).

The smallest number of tubers were formed by cv. Desiree control plants (8.65), while the largest number of tubers per plant was determined in cv. Marabel on the variant with organic mulch (11.85).

Table 3. Average number tubers per plant in 2011. and 2012. year

Mulch	Genotype			Average
	Marabel	Desiree	Jelly	
Silver plastic	9.65	10.70	10.55	10.3
Red plastic	11.50	10.10	11.50	11.0
Straw	11.85	10.85	9.50	10.7
Bare soil	9.95	8.65	10.10	9.6
Average	10.7	10.1	10.4	10.4

LSD 0.05 0.57
0.01 0.97

The highest average yield of three cultivars/genotypes (Table 4) was determined on variant with organic mulch (48.5 t ha⁻¹), followed by yield of potato plants treated with red plastic mulch (46.8 t ha⁻¹), while the lowest yield compared to control was determined in variant with silver plastic mulch (39,5 t ha⁻¹). With exception of treatment with silver plastic mulch, these results are in accordance with previous findings that mulching of soil significantly increases number of tubers per plant and yield of potato (Momirović et al., 1997; Singh and Ahmed, 2008; Zhao et al., 2012). Considering factor cultivar (Table 4), the lowest yield was determined for cv. Desiree (39,3 t ha⁻¹), moderate yield for cv. Jelly (43,8 t ha⁻¹), while the highest yield was found in cv. Marabel (51,7 t ha⁻¹).

Table 4. Average total yield (t ha⁻¹) in 2011. and 2012. year

Mulch	Genotype			Average
	Marabel	Desiree	Jelly	
Silver plastic	46.2	34.3	37.9	39.5
Red plastic	55.9	37.9	46.7	46.8
Straw	55.0	45.2	45.2	48.5
Bare soil	49.5	39.7	45.3	44.8
Average	51.7	39.3	43.8	44.9

LSD 0.05 2.43
0.01 4.15

Considering yield of particular cultivars in different mulching treatments, the highest yields of cv. Marabel i Jelly were determined in variants with organic or red plastic mulch, while cv. Desiree

was showing the highest yield in variant with organic mulch. The lowest yield of each particular cultivar was determined in treatment with silver plastic mulch (Table 4).

Conclusions

In general, soil mulching significantly increased number of tubers per potato plant. Compared to control (bare soil; 9.6), the highest number of tubers per plant was determined in treatment with red plastic mulch (11.0). The highest potato yield was determined in treatment with organic mulch (48.5 t ha⁻¹), while treatment with silver plastic mulch reduced yield (39.5 t ha⁻¹) compared to control (44.8 t ha⁻¹).

Considering production potential of particular cultivars/genotypes, the highest yields of cvs. Marabel i Jelly were achieved in treatments with organic or red plastic mulch. Cv. Desiree was showing the highest yield and percent of mercantile tubers on variant with organic mulch. Conversely, the lowest yield of each particular cultivar was determined in treatment with silver plastic mulch indicating that this mulch type is not appropriate for potato growing under agro-ecological conditions of Southern Srem, Serbia.

Acknowledgement

This work was supported by Ministry of Education, Science and Technological Development of the Republic of Serbia, Project Grant TR31049.

References

- Awal M.A., Khan M.A.H. (2000): Mulch induced ecophysiological growth and yield of maize. Pak. J. Biol.Sci. 3(1): 61-64.
- Bročić Z, Stefanović D. (2012): Potato. Production, economy and market. University of Belgrade, Faculty of Agriculture.
- Ibarra L., Flores J., Díaz-Pérez J.C. (2001): Growth and yield of muskmelon in response to plastic mulch and row covers. Sci. Hort. 87(1-2): 139-145.
- Kar, G., Kumar, A. (2007): Effects of irrigation and straw mulch on water use and tuber yield of potato in eastern India. Agricultural Water Management 94, 109–116.
- Momirović, N., Mišovic, M., Brocic, Z. (1997): Effect of organic mulch application on the yield of potato seed crop. Acta Hort. (ISHS), 462: 291-296.
- Momirović N., M. Oljača, Ž. Dolijanović, D. Poštić. (2010): Energy efficiency of protected crop production of peppers regarding different types of polyethylene films. Agricultural engineering, Vol 35(3): 1-13.
- Momirović N., Z. Bročić, D. Poštić, Jasna Savić. (2010): Effect of fertilization level on potato yield for processing under subsurface drip irrigation. IX. Alps-Adria Scientific Workshop, Novenytermeles, Czech Republic, Špičák, 12-19, April, 59, (4): 365-368.
- Poštić D., Momirović N. Dolijanović Ž. Bročić Z., Jošić, D., Popović T, Starović M. (2012): Effect of potato tubers origin and weight on the yield of potato variety Desiree in Western Serbia. Field and Vegetable Crops Research, 49 (3): 236-242.
- Samaila A.A., Amans E.B., Abubaka r I.U., Babaj i B.A. (2011): Yield and fruit quality of tomato (*Lycopersicon esculentum* Mill) as influenced by mulching, nitrogen and irrigation interval. Int. Res. J. Agric.Sci. Soil Sci. 1(3): 90-95.
- Sinkevičienė A., Jodaugienė D., Pupalienė R., Urbonienė M. (2009): The influence of organic mulches on soil properties and crop yield. Agron. Res. 7(1): 485-491.
- Singh N. and Ahmed Z. (2008): Effect of mulching on potato production in high altitude cold arid zone of Ladakh. Potato J. 35 (3 - 4): 118-121

Zhaoa H., You-Cai Xiong, Feng-Min Li. (2012): Plastic film mulch for half growing-season maximized WUE and yield of potato via moisture-temperature improvement in a semi-arid agroecosystem. *Agricultural Water Management* 104, 68– 78.

EFFECT OF GROWING SEASONS ON SOME QUALITY PROPERTIES OF WINTER WHEAT GENOTYPES

Kristina LUKOVIĆ^{1*}, Milivoje MILOVANOVIĆ¹, Veselinka ZEČEVIĆ², Slaven PRODANOVIĆ³, Kamenko BRATKOVIĆ¹

¹Centre for Small Grains, Kragujevac, Serbia.

²Faculty of Biofarming, Bačka Topola, John Naisbitt University Belgrade, Serbia

³Faculty of Agriculture, University of Belgrade, Zemun, Serbia

*Corresponding author: kika@kg.ac.rs

Abstract

In this research, 16 genotypes of winter wheat (*Triticum aestivum* L.) were analyzed where 15 genotypes represent perspective lines created in Center for Small Grains in Kragujevac and one standard cultivar. Field experiment was conducted in three growing seasons (2012/13, 2013/14 and 2014/15) on the experimental field of Center for Small Grains in Kragujevac (Serbia). Some grain quality parameters (hectoliter weight and 1000 grain weight) were analyzed in this paper. In average for three years, values of hectoliter weight varied from 76.65 kg hl⁻¹ (KG-60-3/3) to 80.05 kg hl⁻¹ (KG-1/6). The analyses of variance showed highly significant differences in hectoliter weight between genotypes (F=4.554**) and investigated years (F=150.082 **), but interaction genotype x year was significant (F=1.629*). The highest values of 1000 grains weight expressed line KG- 52/23 (46.75 g) and the lowest line KG-28/6 (39.90 g). Compared to the standard cultivar Pobeda, 10 genotypes had higher values of 1000 grains weight. There were highly significant differences in the weight of 1000 grains among genotypes (F=25.011**), investigated years (F=117.267**), as well as their interaction (F=8.684**).

Key words: *wheat, growing seasons, hectoliter weight, 1000 grain weight.*

Introduction

Genetic potential for yield and quality of specific cultivar has a huge influence in its production. However, the true value of cultivar as well as its impact on wheat production depends not only of its productivity, but of its stability in different environmental conditions (Hristov *et al.*, 2007).

The way genotype reacts to different environmental conditions shows stability and it is very useful in selection and agricultural production. The lower the value of the genotype x environment interaction (GE), the more stable the genotype is. Intensive genotypes, such as high-yield cultivars of wheat which require intensive agricultural technology, are very sensitive to agricultural environment and show greater GE interaction (Dimitrijević *et al.*, 2006).

When breeding bread wheat, there is always a tendency appropriate breeding terms high-yield and stable genotypes. Wheat yield is very complex and depends on quantitative traits as its components. Yield depends on number of spikes per surface area, number of grains per spike and mass of grains per spike (Kraljević-Balalić *et al.*, 2001). However, these quantitative traits affect genes with minor effect whose expression depends on environmental conditions. Research of behavior of genotypes in different agricultural conditions and their interactions with environment in which they grow, helps to choose an ideal genotypes for specific areas of growth. It is preferable that new cultivars of wheat, besides high yield potential and quality of grain, has a lower variability of these traits in different agroecological conditions (Zečević *et al.*, 2013).

In Centre of Small Grains in Kragujevac, high yield cultivars were always a tendency as well as lower stem and earlier maturity and higher resistance to main biotic and abiotic factors of environment (Milovanović *et al.*, 2003; Milovanović *et al.*, 2012). Besides high yield, maturity and other traits, KG cultivars possess an excellent technological quality for production of bread and pastry (Milovanović *et al.*, 2008).

The goal of this research is investigation of influence of ecological factors, genotypes and their interactions on some wheat quality traits.

Material and Methods

In this research, 16 genotypes of winter wheat (*Triticum aestivum* L.) were analyzed where 15 genotypes represent perspective lines created in Center for Small Grains in Kragujevac (KG – 27/6, KG- 244/4, KG – 199/4, KG – 307/4, KG – 331/4, KG – 28/6, KG – 162/7, KG – 40-12/1, KG – 40-39/3, KG – 52/23, KG – 60-3/3, KG – 52/3, KG – 47/21, KG – 191/5-13 and KG – 1/6) and one standard cultivar (Pobeda). The experiment was done in field conditions, on the experimental field of the Center for Small Grains in Kragujevac, during three growing seasons (2012/13, 2013/14 and 2014/15).

The experiment was a randomized complete block design with three replicates on a plot of 5m². It was carried out by the standard technology of scientific farming production of wheat.

Wheat quality characteristics (hectoliter weight and weight of 1000 grains) were analyzed.

Hectoliter weight was determined according to the JUS E.B1.200 method, and the weight of 1000 grains according to JUS E.B1.200 method. The results of the research were studied by Analysis of Variance (ANOVA) according to completely randomized block design with two main factors (genotype and year) and using MSTAT-C statistical program. Evaluation of the importance of difference between average values of studied characteristics was tested by separate LSD test (Hadživuković, 1991). Components of variance (genetic, interaction and environment) were calculated by Falconer (1981).

Results and Discussion

The obtained results are shown in the table 1. The highest average value of 1000 grains weight was achieved by the line KG -52/23 (46.75 g), and the lowest by the line KG – 28/6 (39.91 g).

According to the growing season of research, in all three growing seasons the highest average 1000 grains weight was achieved by the line KG-52/23 (49.06 g, 44.39 g and 46.82 g). In the years 2012/13 and 2013/14 the lowest average 1000 grains weight had the line KG-28/6 (39.6 g and 37.41 g, respectively), while in the third year of the research (2014/2015) the lowest average value of 1000 grains weight had the line KG-27/6 (38.60 g), table 1. The highest average value of 1000 grains weight for all researched lines of wheat was achieved during the year 2012/2013 (45.58 g), and the lowest (41.90 g) during the year 2013/14.

Table 1. Mean values for 1000 grains weight in different growing seasons

Genotype	1000 grains weight (g)			Average
	Year			
	2012/13	2013/14	2014/15	
KG-27/6	43.85ghijklmn	38.96xyz	38.60yz	40.47g
KG-244/4	48.71ab	43.79hijklmn	42.36lmnopqrs	44.95b
KG-199/4	41.66opqrstuv	44.32fghijkl	41.02qrstuvw	42.34f
KG-307/4	44.52fghijk	43.44hijklmno	45.90cdef	44.62bc
KG-331/4	40.41stuvwxy	40.89rstuvwxy	40.10vwxy	40.47g
KG-28/6	39.60wxy	37.41z	42.72klmnopqr	39.91g
KG-162/7	45.46efgh	43.65hijklmno	43.17ijklmnop	44.09bcd
KG-40-12/1	49.67a	43.30ijklmno	45.83defg	46.27a
KG-40-39/3	44.89efghij	42.16mnopqrstu	41.92nopqrstuv	42.99def
KG-52/23	49.06a	44.39fghijk	46.82bcde	46.75a
KG-60-3/3	45.18efghi	40.33stuvwxy	40.86rstuvwxy	42.12f
KG-52/3	49.46a	40.86rstuvwxy	44.05fghijklm	44.79bc
KG-47/21	48.76ab	41.15pqrstuvw	43.87ghijklmn	44.59bc
KG-191/5-13	47.88abc	40.70rstuvwxy	45.42efgh	44.67bc
KG-1/6	47.76abcd	42.91ijklmnopq	40.14stuvwxy	43.60cde
Pobeda	42.35lmnopqrst	42.15mnopqrstu	43.98fghijklm	42.83ef
Average	45.58a	41.90b	42.92b	-

Distinct letters in the row indicate significant differences according to LSD test ($P \leq 0.05$).

In comparison to the standard cultivar Pobeda, 10 lines had higher average value of the weight of 1000 grains, what indicates that the most of the perspective KG lines are characterized by grains of medium to large size.

Table 2. Analysis of variance for 1000 kernels weight

Source	DF	MS	F	LSD		Components of variance	
				0.05	0.01	σ^2	%
Genotype (A)	15	36.873	25.011**	1.220	1.686	2.675	23.76
Year (B)	2	172.885	117.267**	1.066	2.460	3.335	29.62
AB	30	12.802	8.684**	2.024	2.726	3.776	33.53
Error	94	1.474	-	-	-	1.474	13.09
Total	143	-	-	-	-	11.260	100

* Significant at $P = 0.05$ level; ** significant at $P = 0.01$ level

Through the analysis of variance high significant differences were determined among 1000 grains weight of different genotypes ($F=25.011^{**}$), then among years of research ($F=117,267^{**}$), and their interactions as well ($F=8.684^{**}$). Results of this research are in accordance with the previous research (Hristov *et al.*, 2007). Analysis of variance's components has shown that the biggest share in it have the interaction genotype x environment (33.53%), and the year (29.62%), table 2.

Table 3. Mean values for hectoliter weight in different growing seasons

Genotype	Hectoliter weight (kg hl ⁻¹)			
	Year			Average
	2012/13	2013/14	2014/15	
KG-27/6	79.42bcdefghij	73.06r	77.80hijklmn	76.76f
KG -244/4	80.63abcde	75.78mnopq	77.87ghijklmn	78.09bcdef
KG-199/4	80.70abcde	76.05mnopq	77.37ijklmno	78.04cdef
KG-307/4	78.00fghijklm	74.78qr	77.73hijklmn	76.84f
KG-331/4	78.77efghijk	77.20jklmnop	80.22abcdefg	78.73abcd
KG-28/6	79.00defghij	73.05r	79.20cdefghij	77.08ef
KG-162/7	81.73ab	75.52nopq	79.63bcdefghi	78.96abcd
KG-40-12/1	80.02abcdefgh	74.92pqr	79.97abcdefgh	78.30abcde
KG-40-39/3	80.62abcde	75.72mnopq	80.37abcdef	78.90abcd
KG-52/23	81.43abc	75.65mnopq	79.70bcdefghi	78.93abcd
KG-60-3/3	78.68efghijkl	74.92pqr	76.38lmnopq	76.66f
KG-52/3	80.95abcde	75.98mnopq	81.57abc	79.50ab
KG-47/21	80.68abcde	75.65mnopq	79.70bcdefghi	78.68abcd
KG-191/5-13	81.03abcde	76.45klmnopq	80.70abcde	79.39abc
KG-1/6	81.16abcd	75.85mnopq	82.17a	79.73a
Pobeda	77.52ijklmno	75.25opqr	79.90abcdefgh	77.56def
Average	80.02a	75.36b	79.39a	-

Distinct letters in the row indicate significant differences according to LSD test ($P \leq 0.05$).

The achieved results for the hectoliter weight are shown in the table 3. In period of growing seasons average values of hectoliter weight varied from 76.66 kg hl⁻¹ (KG-60-3/3) to 79.73 kg hl⁻¹ (KG-1/6). In the first year of the research, the highest average value of the hectoliter weight had the line KG-162/7 (81.73 kg hl⁻¹), and in the second year the line KG-331/4 (77.20 kg hl⁻¹). In the year 2014/2015 the line KG-1/6 had achieved the highest average value of the hectoliter weight (82.17 kg hl⁻¹). The highest average value of hectoliter weight of all researched wheat lines was determined in the 2012/13 growing season (80.02 kg hl⁻¹), and the lowest (75.08 kg hl⁻¹) in the 2013/14 growing season. In comparison to the standard cultivar (Pobeda), 11 lines had higher value of hectoliter weight.

Analysis of variance (Table 4) has shown highly significant differences in hectoliter weight among genotypes ($F=4.554^{**}$), researched years ($F=150.082^{**}$), as well as the differences in interaction genotype x year ($F=1.629^*$). The results are in accordance with the previously

obtained results (Kaya and Akcura, 2014; Ayalew *et al.*, 2014; Zečević *et al.*, 2012). Through the analysis of the variance's components it was determined that the biggest share of the variance has year (66.59 %).

Table 4. Analysis of variance for hectoliter mass

Source	DF	MS	F	LSD		Components of variance	
				0.05	0.01	σ^2	%
Genotype (A)	15	9.301	4.554**	1.436	1.985	0.664	7.08
Year (B)	2	306.536	150.082**	1.255	2.895	6.247	66.59
AB	30	3.328	1.629*	2.383	3.209	0.429	4.57
Error	94	2.042	-	-	-	2.042	21.76
Total	143	-	-	-	-	9.382	100

* Significant at P = 0.05 level; ** significant at P = 0.01 level

Hectoliter weight and the 1000 grains weight are genetically controled traits, which can vary a under the influence of the environment. Lines examined in these researches had different values of hectoliter and 1000 grains weight in the years of examination what indicates to the reaction of a genotype to different conditions during its development. Moreover, it was determined that among the examined lines of wheat the analyzed traits were also different, what indicates that these genotypes are specific.

Conclusion

Values of the examined traits of wheat's quality were different in different years of research, what indicates variability of results for the influence of genetical and ecological factors, and their interaction. It is also detemined that the values of hectoliter weight varied from 76.66 kg hl⁻¹ (KG-60-3/3) to 79.73 kg hl⁻¹ (KG-1/6). Analysis of variances established highly significant differences among the 1000 grains weight between genotypes, years of research and their interaction.

The line KG- 52/23 (46.75 g) had the highest average value of 1000 grains weight, but the lowest value was achivedby KG-28/6 (39.91 g). In this research, highly significant differences were established in the weight of 1000 grains between genotype x year and their interactions.

Hectoliter weight and 1000 grains weight can be used as preliminary indicators for evaluation of productivity and quality of wheat cultivars. For the expression of these characteristics, enviromental factors as well as genetic factors are very important.

Acknowledgements

This investigation supported by Ministry of Education, Science and Technology Development of Republic of Serbia, Project III 46006.

References

- Ayalew, H., Wondale, L., Teshager, A. (2014): GGE biplot analysis on the performance of wheat genotype for hectolitre weight and mega environments identification in north western Ethiopia. *Australian Journal of Crop Science*, 8 (10): 1435-1440.
- Dimitrijević, M., Petrović, S., Belić M. (2006): Modeli za procenu interakcije genotip/spoljna sredina na halomorfnom zemljištu. *Selekcija i Semearstvo*, Novi Sad, 12 (1-2): 7-14.
- Falconer, D. S. (1981): *Introduction to quantitative genetics*. Longman, London and New York.
- Hadživuković, S. (1991): *Statistički metodi*. Drugo prošireno izdanje. Radnički univerzitet "Radivoj Ćirpanov", Novi Sad.
- Hristov, N., Mladenov, N., Kondić-Špika, A. (2007): Ekološka stabilnost fizičkih osobina zrna pšenice. *Zbornik radova, Institut za ratarstvo i povrtarstvo*, Novi Sad, 43: 29-37.
- Kaya, Y., Akcura, M. (2014): Effects of genotype and environment on grain yield and quality traits in bread wheat (*T. aestivum* L.), *Food Sci. Technol*, Campinas, 34 (2): 386-393.
- Kraljević-Balalić, M., Worland, A.J., Porceddu, E., Kuburović, M. (2001): Variability and gene effects in wheat. *Genetics and Breeding of Small Grains*, Belgrade, pp. 9-49.
- Milovanović, M., Perišić, V., Protić, R., Janković, S., Kovačević B., Staletić, M. (2003): Rezultati i perspektive oplemenjivanja strnih žita za različite uslove gajenja u SCG. *Poljoprivredne aktuelnosti*, (3-4): 47-57.
- Milovanović, M., Staletić, M., Rajčić, V., Nikolić, O., Perišić, V. (2012): Actualities of hard winter wheat breeding in Center for small grains in Kragujevac. *XVI International Eco-Conference, Proceedings Safe Food*, Novi Sad: 115-123.
- Milovanović, M., Staletić, M., Perišić, V., Bratković, K. (2008): Vizija – nova sorta ozime pšenice. *Zbornik radova visoke tehničke škole, Požarevac*, 1-2: 66-72.
- Zečević, V., Bošković, J., Knežević, D., Micanović, D., Milenković, S. (2013): Influence of cultivar and growing season on quality properties of winter wheat (*Triticum aestivum* L.). *African Journal of Agricultural Research*. 8 (21): 2545-2550.
- Zečević, V., Bošković J., Knežević, D., Mićanović, D. (2012): The effect of fertilization and liming on some grain quality properties of wheat. *Review on Agriculture and Rural Development. "Science for Rural Areas" XI. Wellmann International Scientific Conference, Hódmezővásárhely (Hungary), 10th May, 2012. Conference CD supplement*, pp. 470-475.

EFFECT OF AMMONIUM FERTILIZER ON GROWTH AND QUALITY OF *Cichorium spinosum* PLANTS

Stavroula ANESTI¹, Konstantina FASOLI¹, Spyridon PETROPOULOS^{1*}, Georgia NTATSI²,
Vasilios ANTONIADIS¹, Isabel C.F.R. FERREIRA³

¹University of Thessaly, Department of Agriculture, Crop Production and Rural Environment, Fytokou Street,
38446, Volos, Greece

²Agricultural University of Athens, Department of Crop Production, Iera Odos 75, 11855 Athens, Greece

³Mountain Research Centre (CIMO), ESA, Polytechnic Institute of Bragança, Campus de Santa Apolónia, 1172,
5301-805 Bragança, Portugal

*Corresponding author: spetropoulos@uth.gr

Abstract

In the present study, the effect of ammonium fertilizer rate on plant growth and quality of *Cichorium spinosum* L. was examined. Five fertilizer treatments were applied regarding the ammonium nitrogen percentage of total nitrogen, namely (1) 14%, (2) 24%, (3) 34%, (4) 43%, and (5) 53% of total nitrogen applied in the form of ammonium nitrogen. All the treatments received the same total nitrogen rate. Seeds of *C. spinosum* were sown in seed trays containing peat, and young seedlings were transplanted in 2L pots containing peat and perlite in a ratio 1:1. Plants were harvested twice during growing period and when rosettes reached the marketable size. On the harvest days, plant features regarding plant development (the number of leaves, the fresh and dry weight of leaves, and rosette diameter), as well as quality mineral composition, SPAD index of leaves) were recorded. From the results it is suggested that fertilizer composition had a significant effect on plant growth and quality. In particular, fresh weight for both harvests, as well total fresh weight were higher in treatments 4 and 5, where 43 and 53% of the total nitrogen was applied as ammonium nitrogen. Dry weight did not differ significantly in the first harvest, while in the second harvest treatment 1 had the lowest dry weight. Diameter and number of leaves were the lowest in treatments 2 and 3, respectively, while significant differences were also observed between treatments regarding the quality features.

Keywords: *ammonium nitrogen, Cichorium spinosum* L., *nitrogen, stamnagathi*.

Introduction

Cichorium spinosum L., also known as “stamnagathi”, is a native plant of the Mediterranean basin, which abounds in the coastal areas of the mainland as well as in many Greek islands, especially in Crete where it is well known for centuries and used as a vital component of the so-called Mediterranean diet (Melliou et al., 2003).

The fact that the species usually grows in coastal areas suggests a tolerance potential to high salinity and harsh conditions due to sea water intrusion in groundwater deposits (Chartzoulakis & Klapaki, 2000). Despite the fact that during the last few years farmers in Greece as well as in other Mediterranean countries have started to commercially cultivate the species with very promising results, scarce literature is available regarding the cultivation practices of *C. spinosum*, especially regarding the nutrient requirements and the effect of fertilizers on yield and quality of the final product.

Nitrogen is an essential macronutrient for plant growth, since it is a structural compound of chlorophyll, various enzymes, amino acids and proteins (Barker et al., 1974). As a fertilizer, it is one of the most used agrochemicals throughout the world, and is available in various forms, such as nitrate, ammonium and ureic nitrogen. Although the use of fertilizers has rapidly increased yield and farmers' income during the last decades, the irrational use of nitrogen fertilizers has many negative implications for the environment and the consumers' health. Excessive rates of nitrogen fertilizers can be a serious threat for human health, especially in the case of leafy vegetables that tend to accumulate nitrates (Hord et al., 2009). Nitrate accumulation in vegetables is dependent on various factors such genotype, growth conditions, and nitrogen form and application rate (Santamaria, 2006; Petropoulos et al., 2008). However, apart from nitrate content, nitrogen form may affect quality of the final product through the content of various phytonutrients such as organic and fatty acids (Fontana et al., 2006; Szalai et al., 2010).

The aim of the present study was to evaluate the effect of the ammonium nitrogen percentage of total applied nitrogen on both plant growth and quality of *C. spinosum*. For this purpose, five fertilizer treatments were applied, namely (1) 10%, (2) 20%, (3) 30%, (4) 40%, and (5) 50% of total nitrogen applied in the form of ammonium nitrogen.

Materials and Methods

Seeds of *Cichorium spinosum* L. (Asteraceae) were put in seed trays on October 10th 2015 containing peat and transplanted at the stage of 3 leaves (56 days after sowing) on December 5th, 2014 in 2 L pots containing peat (Klassman-Deilmann KTS2, 1.0 L) and perlite (1.0 L). After transplantation plants were fertilized with the same amount of nitrogen (300 mg L⁻¹) through the irrigation water with five fertilizer treatments which differed in their ammonium nitrogen content, namely (1) 14%, (2) 24%, (3) 34%, (4) 43%, and (5) 53% of total nitrogen applied in the form of ammonium nitrogen. In order to prepare the various solutions, the following fertilizers were used: a) 20-20-20 (N-P-K) with nitrogen consisting of urea (10%), NO₃-N (5.6%) and NH₄-N (4.4%), b) ammonium nitrate (34.5% total nitrogen, with a ratio of 1:1 for NO₃-N: NH₄-N), c) calcium nitrate (15.5% nitrogen, [NO₃-N (14.4%) and NH₄-N (1.1%)], and 26.5% CaO), d) urea (46% nitrogen in urea form), e) ammonium sulphate (21% of nitrogen in NH₄-N form, and 24% sulfur. Nutrient solution composition is presented in Table 1.

Plants were harvested twice during growing period and when rosettes reached the marketable size, while extra plants were harvested only once at the same day when the second harvest took place (uncut plants). The day of harvest, SPAD index of leaves was recorded, while after harvest, rosette diameter, number of leaves, and fresh and dry weight of were measured.

For dry weight evaluation, samples of fresh leaves were oven dried at 72 °C to a constant weight (approximately for 48 hours). Water content was estimated as % percentage by subtracting dry weight from the initial fresh weight. Dried samples were analysed for mineral composition. For mineral composition dried samples of leaves tissues were ground to powder, subjected to dry ashing and extracted with 1 N HCl to determine the mineral. Ca, Mg, Fe, Mn, and Zn content were determined by atomic absorption spectrophotometry (Perkin Elmer 1100B, Waltham, MA) and Na and K content by flame photometry (Sherwood Model 410, Cambridge, UK).

For plant growth, statistical analysis was conducted with the aid of JMP v 4.0.2 (SAS Institute Inc.) and Statgraphics 5.1.plus (Statistical Graphics Corporation). Data were evaluated by analysis of variance for the main effects, whereas the means of values were compared by the LSD test and DMRT (p = 0.05). For chemical composition analyses, three samples were analysed for each treatment, whereas all of the assays were carried out in triplicate. The results were expressed as mean values and standard deviations (SD), and analysed using one-way analysis of variance

(ANOVA) followed by Tukey's HSD Test with $\alpha = 0.05$. This analysis was carried out using SPSS v. 22.0 program (IBM Corp., Armonk, NY, USA).

Results and Discussion

From the results it is suggested that fertilizer composition had a significant effect on plant growth and quality features of *Cichorium spinosum* aerial parts. In particular, fresh weight for both harvests, as well total fresh weight for cut plants were higher in treatments 4 and 5, where 43 and 53% of the total nitrogen was applied as ammonium nitrogen, indicating that slow release of nitrogen is essential for higher yields. However, for uncut plants although total fresh weight was higher for treatment 4, it did not differ significantly from treatments 1 and 3 (Table 2). In addition, in any case total fresh weight was higher when plant were harvested twice comparing to plants that were harvested one time, while fresh weight for second harvest was significantly lower than that of the first harvest (Table 2). Similar results have been reported for other leafy vegetables, where multiple harvests increased significantly total yield comparing to single harvest (Kmiecik and Lisiewska, 1999; Cszinzsky, 1999). This could be attributed to the fact that leafy vegetables that form rosettes are able to continue vegetative growth after harvest, as soon as the apex is not destroyed and growth conditions do not induce transition to flowering stage. In contrast, Szalai et al. (2010) have reported a negative effect of high ammonium nitrate concentration in nutrient solution on fresh weight of purslane plants, which could be due to the shorter growth cycle of purslane comparing to *C. spinosum* plants that does not allow nitrification of ammonium nitrate to take place.

Table 1. Nutrient solution composition expressed in ppm.

Elements	Treatments				
	1	2	3	4	5
N	299.95	300.13	300.40	300.01	299.97
NO ₃ -N	108.87	138.86	148.81	131.00	110.99
NH ₄ -N	41.20	71.19	101.14	129.07	159.05
Urea	149.87	90.07	50.44	39.93	29.92
Ca	75.22	75.22	75.22	23.93	23.93
S	0.00	0.00	22.86	45.71	102.85

Table 2. Fresh weight (g) of aerial parts of *Cichorium spinosum* in relation to fertilizer treatments and harvest stage.

Treatment	Fresh weight (g)					
	1 st cut	2 nd cut	LSD	Cut total	Uncut	LSD
1	29.3 bc(a)	21.4 bc(b)	4.7	50.7 b(a)	39.5 ab(b)	11.5
2	25.4 c(a)	16.4 d(b)	4.3	41.8 b(a)	29.0 b(b)	7.3
3	31.8 bc(a)	18.0 cd(b)	7.2	49.8 b(a)	34.3 ab(b)	12.4
4	41.7 a(a)	24.0 ab(b)	9.5	65.6 a(a)	44.0 a(b)	18.8
5	35.5 ab(a)	27.2 a(b)	7.4	62.7 a(a)	30.0 b(b)	12.5
LSD	8.5	4.7		11.8	11.4	

*Means in rows followed by different letters without parenthesis, and means in columns followed by different letters in parenthesis are significantly different at $p < 0.05$ by LSD test.

Dry weight did not differ significantly in the first harvest, while treatment 1 and treatments 1 and 4 had the lowest dry weight in the second harvest and for uncut plants, respectively (Table 3).

Similar results have been reported by Wang et al. (2009) who also observed an increase in dry weight of spinach plants when nitrogen: ammonium nitrogen changed from 1:0 to 0:1. Additionally, uncut plants had higher dry weight than cut plants in almost every treatment (apart from treatment 4), which could be attributed to the consumption of more carbohydrate reserves for the regrowth of cut plants, comparing to the uncut plants which accumulated carbohydrates in larger amounts (Erice et al., 2011; Table 3).

Table 3. Dry weight (%) of aerial parts of *Cichorium spinosum* in relation to fertilizer treatments and harvest stage.

Treatment	Dry weight (%)					
	1 st cut	2 nd cut	LSD	Cut	Uncut	LSD
1	9.4±0.2	8.8±0.8b	1.3	8.8±0.8b(b)	10.9±0.2b(a)	1.3
2	9.5±0.4	10.2±0.1a	0.7	10.2±0.1a(b)	11.1±0.1ab(a)	0.3
3	8.5±0.4(b)	10.1±0.6a(a)	1.1	10.1±0.6a(b)	11.9±0.4a(a)	1.1
4	8.4±1.9	9.5±0.8ab	3.2	9.5±0.8ab	10.6±0.9b	2.0
5	8.7±0.4(b)	10.2±0.1a(a)	0.7	10.1±0.1a(b)	11.9±0.1a(a)	0.3
LSD	1.63	1.06		1.63	0.85	

*Means in rows followed by different letters without parenthesis, and means in columns followed by different letters in parenthesis are significantly different at $p < 0.05$ by LSD test.

Diameter and number of leaves were the lowest in treatments 2 and 3 for both harvests, respectively, while for uncut plants treatment 4 resulted in higher rosette diameter, comparing to treatments 2 and 5 (Tables 4 and 5). Differences in rosette diameter were also observed between cut and uncut plants, only for treatments 4 and 5, indicating that higher amounts of ammonium nitrate have no beneficial effect on plant size when multiple harvests are applied (Table 4). In addition, ammonium nitrate has a positive effect on total number of leaves only when multiple harvests are applied, since slow release of nitrogen through nitrification process allows for better regrowth and leaf formation, comparing to plants where a single harvest is applied (Table 5).

Table 4. Rosette diameter (cm) of *Cichorium spinosum* in relation to fertilizer treatments and harvest stage.

Treatment	Rosette diameter (cm)					
	1 st cut	2 nd cut	LSD	Cut	Uncut	LSD
1	34.0 ab	35.3 ab	2.9	35.3 ab	40.1 ab	5.9
2	31.3 b	33.4 b	4.3	33.4 b	33.9 bc	4.3
3	39.3 a	37.4 ab	7.0	37.4 ab	38.9 ab	7.4
4	39.0 a	34.0 ab	5.3	34.0 ab(b)	42.9 a(a)	6.9
5	36.2 ab	37.9 a	4.8	37.9 a(a)	31.0 c(b)	5.0
LSD	5.3	4.4		4.4	7.5	

*Means in rows followed by different letters without parenthesis, and means in columns followed by different letters in parenthesis are significantly different at $p < 0.05$ by LSD test.

Table 5. Number of leaves of *Cichorium spinosum* in relation to fertilizer treatments and harvest stage.

Treatment	Number of leaves					
	1 st cut	2 nd cut	LSD	Cut total	Uncut	LSD
1	34.8 a	26.7 a	10.7	61.6 a(a)	39.1(b)	19.3
2	28.0 ab(a)	20.1 ab(b)	4.4	48.1 b	40.1	9.5
3	24.4 b(a)	18.5 b(b)	5.6	42.9 b	35.4	12.3
4	29.0 ab(a)	22.1 ab(b)	5.6	51.1 ab(a)	35.7(b)	11.6
5	27.1 ab	23.7 ab	7.3	50.8 ab(a)	34.7(b)	10.9
LSD	7.1	6.8		11.2	8.1	

*Means in rows followed by different letters without parenthesis, and means in columns followed by different letters in parenthesis are significantly different at $p < 0.05$ by LSD test.

Significant differences were also observed between treatments regarding the quality features. SPAD index was the highest when ammonium nitrogen constitutes 24%, 34% and 53% of total nitrogen in the first harvest, and 24% and 53% in the second harvest (Table 6). Moreover, SPAD index was higher in the second harvest and for treatments 2, 4 and 5, whereas the comparison of cut and uncut plants showed no specific trend being decreased, increased or unaffected by multiple harvests.

Table 6. SPAD index of *Cichorium spinosum* leaves in relation to fertilizer treatments and harvest stage.

Treatment	SPAD index					
	1 st cut	2 nd cut	LSD	Cut	Uncut	LSD
1	60.5 b(a)	51.4 c(b)	8.8	51.4 c(b)	100.7 a(a)	10.7
2	75.9 a(b)	84.6 a(a)	7.6	84.6 a(b)	94.9 a(a)	9.2
3	71.9 a(a)	76.8 b(a)	7.0	76.8 b(a)	80.1 b(a)	10.4
4	61.0 b(b)	71.9 b(a)	8.0	71.9 b(a)	54.4 c(b)	8.7
5	74.5 a(b)	86.9 a(a)	7.8	86.9 a(a)	96.6 a(a)	11.9
LSD	8.0	7.6		7.6	13.4	

*Means in rows followed by different letters without parenthesis, and means in columns followed by different letters in parenthesis are significantly different at $p < 0.05$ by LSD test.

Mineral composition of the aerial parts was affected by fertilization treatments (ammonium: nitrate ratio) for most of the minerals evaluated in the present study (data not shown). Differences were also observed between the two harvests but only for specific minerals and fertilization treatments, while significant differences were detected in uncut plants (one harvest at the end of the growing season). In particular, K and Zn content was higher in the first harvest and for (3) and (4) fertilizer treatments, respectively, while Na, Mn and Fe content was higher in the second harvest and for (5), (3) and (1) fertilizer treatments, respectively (data not shown). In addition, cut and uncut plants differed in their mineral content, where in most cases cut plants had a higher content than uncut plants, especially in Fe content and for (3), (4) and (5) fertilizer treatments (data not shown). To our knowledge this is the first time that mineral composition of *C. spinosum* in relation to fertilization rates is studied; however mineral composition of wild or cultivated ecotypes has been already reported by (Petropoulos et al., 2016; Zeghichi et al., 2003; Zeghichi et al., 2003).

Conclusion

The application of high ammonium: nitrate rates (43% and 53% of total nitrogen) increases significantly total yield of *C. spinosum* only when multiple harvests are applied, mainly through the formation of more leaves that consequently result in higher total fresh comparing to a single harvest practice. The application of multiple harvests could increase the growing period and therefore allow for higher rates of ammonium transformation into nitrate nitrogen which is more readily available for plants, comparing to ammonium nitrogen. In addition, quality was not negatively affected by high ammonium: nitrate rates regarding SPAD index and mineral composition, indicating that multiple harvests combined with high ammonium: nitrate nitrogen could have a beneficial effect in terms of both quality and yield.

References

- Barker, A.V., Maynard D.N., Mills H.A. (1974). Variations in nitrate accumulation among spinach cultivars. *Journal of the American Society for Horticultural Science*, 99: 132-134.
- Chartzoulakis, K., Klapaki, G. (2000). Response of two greenhouse pepper hybrids to NaCl salinity during different growing stages. *Scientia Horticulturae*, 86: 247-260.
- Csizinszky, A.A. (1999). Yield response of herbs to nitrogen and potassium in sand in multiple harvests. *Journal of Herbs, Spices and Medicinal Plants*, 6(4): 11-22.
- Erice, G., Sanz-Sáez, A., Aranjuelo, I., Irigoyen, J.J., Aguirreolea, J., Avice, J.-C., Sánchez-Díaz, M. (2011). Photosynthesis, N₂ fixation and taproot reserves during the cutting regrowth cycle of alfalfa under elevated CO₂ and temperature. *Journal of Plant Physiology*, 168: 2007–2014
- Kmieciak, W., Lisiewska, Z. (1999). Comparison of leaf yields and chemical composition of the hamburg and leafy types of parsley. I. Leaf yields and their structure. *Folia Horticulturae*, 11(1):53-63.
- Fontana, E., Hoeberechts, J., Nicola, S., Cros, V., Palmegiano, G.B., Peiretti, P.G. (2006). Nitrogen concentration and ni- trate ammonium ratio affect yield and change the oxalic acid concentration and fatty acid profile of purslane (*Portulaca oleracea* L.) grown in a soilless culture system. *Journal of the Science of Food and Agriculture*, 86: 2417-2424.
- Hord, N.G., Tang, Y., Bryan, N.S. (2009). Food sources of nitrates and nitrites: the physiologic context for potential health benefits. *American Journal of Clinical Nutrition*, 90: 1-10.
- Melliou, E., Magiatis, P., Skaltsounis, A.L. (2003). Alkylresorcinol derivatives and sesquiterpene lactones from *Cichorium spinosum*. *Journal of Agricultural and Food Chemistry*, 51: 1289-1292.
- Petropoulos, S.A., Olympios, C.M., Passam, H.C. (2008). The effect of nitrogen fertilization on plant growth and the nitrate content of leaves and roots of parsley in the Mediterranean region. *Scientia Horticulturae*, 118: 255-259.
- Petropoulos, S.A., Ntatsi, G., Levizou, E., Barros, L., Ferreira, I.C.F.R. (2016). Nutritional profile and chemical composition of *Cichorium spinosum* ecotypes. *LWT - Food Science and Technology*, 73: 95–101.
- Santamaria, P. (2006). Nitrate in vegetables: toxicity, content, intake and EC regulation. *Journal of the Science of Food and Agriculture*, 86, 10-17.
- Szalai, G., Dai, N., Danin, A., Dudai, N., Barazani, O. (2010). Effect of nitrogen source in the fertilizing solution on nutritional quality of three members of the *Portulaca oleracea* aggregate. *Journal of the Science of Food and Agriculture* 90(12): 2039-2045.
- Wang, J., Zhou, Y., Dong, C., Shen, Q., Putheti, R. (2009). Effects of NH₄⁺-N/ NO₃⁻-N ratios on growth, nitrate uptake and organic acid levels of spinach (*Spinacia oleracea* L.). *African Journal of Biotechnology*, 8(15): 3597-3602.

- Zeghichi, S., Kallithraka, S., Simopoulos, A.P. (2003). Nutritional composition of Molokhia (*Corchorus olitorius*) and Stamnagathi (*Cichorium spinosum*). *World Review in Nutrition and Dietetics*, 91: 1-21.
- Zeghichi, S., Kallithraka, S., Simopoulos, A.P., Kyriotakis, Z. (2003). Nutritional Composition of selected wild plants in the diet of Greece. *World Review in Nutrition and Dietetics*, 91: 22-40.

EFFECT OF CLIMATIC FACTORS ON FRUIT QUALITY OF BLACK CURRANT (*RIBES NIGRUM* L.) CULTIVARS

Svetlana M. PAUNOVIĆ^{1*}, Mihailo NIKOLIĆ², Rade MILETIĆ¹, Mira MILINKOVIĆ¹, Žaklina KARAKLAJIĆ-STAJIĆ¹, Jelena TOMIĆ¹

¹Department of Technology of Fruit Growing, Fruit Research Institute, Čačak, Serbia

²Department of Fruit Science, Faculty of Agriculture, University of Belgrade, Belgrade, Serbia

*Corresponding author: svetlana23869@gmail.com

Abstract

The experiment evaluated the effect of climatic factors (air temperature and rainfall) on the content of primary metabolites (soluble solids, total sugars, invert sugars, proteins, titratable acidity and pH) and vitamin C in the fruit of seven black currant cultivars, including ‘Ben Lomond’, ‘Ben Sarek’, ‘Tsema’, ‘Titania’, ‘Čačanska Crna’, ‘Tisel’ and ‘Tiben’. During the three-year experimental period, significant differences in the parameters tested were observed among the cultivars. Soluble solids content was highest in ‘Tisel’ (15.8%) and ‘Tiben’ (15.6%). High value of total sugars (14.1%) was found in ‘Titania’, and those for invert sugars (8.92%), proteins (1.28%) and vitamin C (227.5 mg 100 g⁻¹ FW) were recorded in ‘Čačanska Crna’. The highest content of titratable acidity (2.76%) and the highest pH value (3.21) of the fruit were determined in ‘Tisel’. Climatic factors (air temperature and rainfall) had a significant effect on fruit chemical properties. High air temperatures and low rainfall amounts during berry formation and ripening promoted the synthesis and accumulation of soluble solids (15.4%), total sugars (11.2%), invert sugars (8.97%) and proteins (1.36%). Conversely, low air temperatures and high rainfall amounts had a positive effect on the synthesis of titratable acidity (3.00%) and pH value (3.06) of the fruit, whereas vitamin C content (210.0 mg 100 g⁻¹ FW) was highest at moderate air temperatures and moderate rainfall levels.

Keywords: *black currant, climatic factors, chemical fruit traits*

Introduction

The black currant abounds with chemical components beneficial for human health. Its fruit is a rich source of sugars and organic acids as important primary metabolites which play a key role in cell metabolism and reproduction (Hartmann, 2007; WCRF/AICR, 2008). The chemical composition of the fruit is governed by the genetic predisposition of cultivar (Bordonaba and Tery, 2008) and maturity stage, but also to a large extent by climatic factors (Zheng et al., 2009; Walker et al., 2010; Vagiri et al., 2013). Internal fruit quality is determined by the content of primary metabolites (sugars, organic acids, etc.) and secondary metabolites (mostly phenols and carotenoids) which contribute to the flavor, aroma and appearance of the fruit (Veberič et al., 2012). An important goal in black currant breeding is to improve the chemical composition of the fruit i.e. its content of sugars, acids, vitamin C and colorants (Mišić and Nikolić, 2003). Black currants thrive in humid mountainous areas characterized by cool summers, high rainfall amounts and high humidity levels. Climatic conditions in a particular environment affect the planting longevity, productivity, fruit quality and the overall profitability of black currant production (Nikolić and Milivojević, 2010).

With this in mind, the objective of this study was to evaluate the effect of climatic factors on fruit quality i.e. the content of primary metabolites and vitamin C in the tested black currant cultivars.

Materials and methods

The research was conducted at the Fruit Research Institute, Čačak, Western Serbia, during 2012-2014. A black currant planting was established in the spring of 2011 using two-year-old plants. Black currants were grown as bushes at a spacing of 3 m between rows and 1 m in the row. Seven cultivars were involved: 'Ben Lomond', 'Ben Sarek', 'Tsema', 'Titania', 'Čačanska Crna', 'Tisel' and 'Tiben'.

The chemical analysis of the fruit included the following: 1. Soluble solids content was determined by a digital refractometer (Kruss, Germany); 2. Total sugars and invert sugars were analyzed by the Loof-Schoorl method (Egan et al., 1981); 3. Titratable acidity was assessed by the 0.1 N NaOH titration method using phenolphthalein as indicator; 4. Protein content was determined by Kjeldahl's method (Helrich, 1990); 5) Actual acidity (pH value) was measured by a pH Meter Iskra MA 5707, Slovenia; 6) Vitamin C was quantified using a Perkin Elmer UV/VIS spectrometer (Lombda 25) and expressed as mg of vitamin C per 100 g of fresh weight (FW).

The experimental data obtained during the three-year research period were subjected to statistical analysis using Fisher's two-factor analysis of variance - ANOVA. Significant differences between the mean values of the tested factors and the interaction means were determined by LSD test at $P \leq 0.01$ and $P \leq 0.05$ significance levels. The results are presented in tabular form.

The average mean monthly and annual air temperatures for the experimental period 2012-2014 are given in Table 1, while the average monthly and annual rainfall totals are presented in Table 2.

Table 1. Mean monthly air temperatures ($^{\circ}\text{C}$), mean annual air temperatures (A) and mean air temperatures for the vegetative growth period (VG)

Year/ month	I	II	III	IV	V	VI	VII	VIII	IX	X	XI	XII	A	VG
2012	1.8	2.5	6.8	12.2	17.3	24.1	26.6	25.4	20.9	13.8	9.5	1.4	13.1	20.0
2013	3.5	3.8	6.6	13.2	18.2	20.6	23.3	24.1	17.2	14.5	8.9	2.0	13.0	18.7
2014	4.0	6.6	10.2	12.8	16.1	21.1	22.7	22.1	17.5	13.5	8.9	3.1	13.2	18.0

Table 2. Average monthly rainfall totals (mm m^{-2}), annual rainfall totals (A) and rainfall totals for the vegetative growth period (VG)

Year/ month	I	II	III	IV	V	VI	VII	VIII	IX	X	XI	XII	A	VG
2012	60	70	10	47	68	38	22	0	7	30	24	88	464	212
2013	51	68	66	37	78	61	10	62	87	17	40	4	581	352
2014	21	6	52	104	125	103	163	56	101	50	19	90	890	702

Results and discussion

The analysis of variance (F-test) showed highly significant differences in the content of primary metabolites and vitamin C among the cultivars and years. Cultivar x year interactions were observed. The results on the levels of primary metabolites and vitamin C in the tested black currant cultivars are presented in Tables 3 and 4.

Table 3. Content of soluble solids, sugars and proteins in the fruit of tested black currant cultivars

Cultivar/Year	Soluble solids (%)	Total sugars (%)	Invert sugars (%)	Proteins (%)	
Cultivar (A)	'Ben Lomond'	14.5±0.13 c	9.30±0.21 d	8.50±0.14 bc	1.19±0.04 c
	'Ben Sarek'	14.5±0.14 c	10.2±0.17 c	8.07±0.27 e	1.19±0.05 c
	'Tsema'	15.0±0.12 b	9.12±0.19 de	8.57±0.16 bc	1.23±0.04 b
	'Titania'	15.0±0.13 b	14.1±0.28 a	8.42±0.10 cd	1.23±0.04 b
	'Čačanska Crna'	14.6±0.12 c	12.7±0.64 b	8.92±0.18 a	1.28±0.05 a
	'Tisel'	15.8±0.17 a	8.94±0.11 e	8.61±0.16 b	1.20±0.03 bc
	'Tiben'	15.6±0.15 a	8.94±0.19 e	8.29±0.06 d	1.20±0.04 bc
Year (B)	2012	15.4±0.08 a	11.2±0.50 a	8.97±0.08 a	1.36±0.01 a
	2013	15.1±0.14 b	10.3±0.44 b	8.46±0.04 b	1.20±0.01 b
	2014	14.5±0.17 c	9.79±0.39 c	7.95±0.11 c	1.08±0.01 c
<i>ANOVA</i>					
Cultivar (A)	**	**	**	**	
Year (B)	**	**	**	**	
A x B	**	**	**	**	

Means followed by different letters within the cultivar and year columns are significantly different at $P \leq 0.01$ and $P \leq 0.05$ according to LSD test and ANOVA (F-test) results.

During the three-year experimental period, the highest content of soluble solids was determined in 'Tiben' (15.6%) and 'Tisel' (15.8%), and the lowest in 'Ben Lomond' (14.5%), 'Ben Sarek' (14.5%) and 'Čačanska Crna' (14.6%). 'Titania' had the highest content of total sugars (14.1%), as opposed to 'Tisel' and 'Tiben' (8.94%), which exhibited the lowest values. Invert sugars and proteins were highest in 'Čačanska Crna' (8.92% and 1.29%, respectively), and lowest in 'Ben Sarek' (invert sugars – 8.07% and proteins – 1.19%) and 'Ben Lomond' (proteins – 1.19%).

Table 4. Titratable acidity, pH and vitamin C content in the fruit of tested black currant cultivars

Cultivar/Year	Titratable acidity (%)	pH	Vitamin C (mg 100 g ⁻¹ FW)	
Cultivar (A)	'Ben Lomond'	2.46±0.23 c	3.19±0.03 ab	206.1±3.11 c
	'Ben Sarek'	2.56±0.11 b	3.17±0.03 bc	207.3±5.03 bc
	'Tsema'	2.57±0.17 b	3.15±0.04 c	209.0±3.41 b
	'Titania'	2.38±0.27 d	3.19±0.03 ab	207.3±6.19 bc
	'Čačanska Crna'	2.47±0.19 c	3.08±0.02 d	227.5±8.80 a
	'Tisel'	2.76±0.12 a	3.21±0.02 a	200.7±6.01 d
	'Tiben'	2.44±0.29 c	3.14±0.04 c	201.8±6.30 d
Year (B)	2012	1.75±0.08 c	3.06±0.01 c	188.5±2.04 c
	2013	2.85±0.02 b	3.17±0.01 b	210.0±3.46 b
	2014	3.00±0.02 a	3.27±0.02 a	227.4±1.09 a
<i>ANOVA</i>				
Cultivar (A)	**	**	**	
Year (B)	**	**	**	
A x B	**	**	**	

Means followed by different letters within the cultivar and year columns are significantly different at $P \leq 0.01$ and $P \leq 0.05$ according to LSD test and ANOVA (F-test) results.

In contrast, as regards acids, the highest values for titratable acidity (2.76%) and fruit pH (3.21) were obtained in 'Tisel', whereas the lowest levels of titratable acidity and fruit pH were recorded in 'Titania' (2.38%) and 'Čačanska Crna' (3.08), respectively. The fruit of 'Čačanska Crna' (227.5 mg 100 g⁻¹ FW)

outperformed the other cultivars in terms of vitamin C content, which was the lowest in 'Tiben' (201.8 mg 100 g⁻¹ FW) and 'Tisel' (200.7 mg 100 g⁻¹ FW) fruit.

Across years, the highest levels of soluble solids, total sugars, invert sugars and proteins were determined in 2012 and the lowest in 2014. The values for titratable acidity, fruit pH and vitamin C content were highest in 2014 and lowest in 2012.

Over the experimental years, during berry formation and ripening, air temperature was 2.1°C higher and rainfall totals were 122.5 mm m⁻² lower in 2012 than in 2014, which had a stimulating effect on the synthesis of soluble solids, sugars and proteins. In contrast, the synthesis of total acids, fruit pH and vitamin C content were higher in 2014, which had more moderate air temperatures and rainfall amounts compared to the other two experimental years. These results can be supported by the findings of Rubinskiene et al. (2006) who observed a positive correlation between air temperature and the content of soluble solids and sugars, and a negative correlation between rainfall and these parameters. Also, Rubinskiene et al. (2006) found that high amounts of rainfall and low air temperatures during the growing season favor the synthesis of larger amounts of acids in the fruit. Similarly, as determined by Kaldmae et al. (2013), temperature is positively correlated with the contents of soluble solids and sugars, and negatively with vitamin C content, as opposed to rainfall. The conclusions drawn by these authors provide a full explanation of the results of the present experiment. Under the environmental conditions of Čačak, higher levels of sugars and vitamin C, but lower levels of acids were determined in the tested cultivars compared to the findings of numerous authors (Kampuss and Strautina, 2004; Siksnianas et al., 2006; Mladin et al., 2009; Raudsepp et al., 2010), who conducted their research in northern and northeastern Europe at high altitudes. The difference in the measured contents can be explained by strong variations in the synthesis and accumulation of chemical compounds under different climates. Zheng et al. (2009) recorded higher values for invert sugars, and lower levels of vitamin C in black currants grown in southern Finland compared to black currants grown in the north of Finland. The authors found that temperature was positively correlated with the content of sugars and acids, and negatively with vitamin C content. In Walker et al. (2010), black currants grown on south facing slopes that received more warmth and solar radiation contained up to 20% more vitamin C than those grown on north facing slopes. Vagiri et al. (2013) reported higher soluble solids content but lower acids and vitamin C levels in currants grown in the south of Sweden compared to currants grown in the north of Sweden. As explained by the authors, the values obtained were the result of higher air temperatures during harvest season, which was not confirmed in the present study.

Conclusion

The cultivars had high levels of primary metabolites and vitamin C, which directly contributed to fruit quality. 'Čačanska Crna' had a high content of most of the chemical properties tested.

Climatic factors (air temperature and rainfall) have an important effect on plant metabolism and promote the synthesis of different chemical compounds in the fruit, thus positively affecting the quality and commercial value of the fruit.

Acknowledgement

This study is part of Project Ref. No. 31093 financed by the Ministry of Education, Science and Technological Development of the Republic of Serbia.

References

- Bordonaba, G.J., Terry, A.L. (2008). Biochemical profiling and chemometric analysis of seventeen UK-grown black currant cultivars (*Ribes nigrum* L.). *Journal of Agricultural and Food Chemistry*, 56 (16), 7422–7430.
- Egan, H., Kirk, R., Sawyer, R. (Eds) (1981). The Luff Schoorl method. Sugars and preserves. In *Pearson's chemical analysis of foods*. 8th edn. Harlow. UK: Longman Scientific and Technical, 151–153.
- Hartmann, T. (2007). From waste products to ecochemicals: Fifty years research of plant secondary metabolism. *Phytochemistry*, 68, 2831–2846.
- Helrich, K. (1990). Official methods of analysis of the association of official analytical chemists Arlington: Association of Official Analytical Chemists Inc., p. 807.
- Kaldmae, H., Kikas, A., Arus, L., Libek, A. (2013). Genotype and microclimate conditions influence ripening pattern and quality of blackcurrant (*Ribes nigrum* L.) fruit. *Zemdirbyste-Agriculture*, 2 (100), 164–174.
- Kampuss, K., Strautina, S. (2004). Evaluation of blackcurrant genetic resources for sustainable production. *Journal of Fruit and Ornamental Plant Research*, 12 (special ed.), 147–158.
- Mišić, P., Nikolić, M. (2003). *Berry Fruits*. Agricultural Research Institute Serbia, Belgrade.
- Mladin, P., Coman, M., Sasnauskas, A., Chitu, E., Mladin, G., Ancu, I., Nicola, C., Sumedrea, M. (2009). Contributions to the agro-biological study of the black currant and blueberry within the cultivar evaluation European network. *Scientific papers of the R.I.F.G. Pitesti*, 25, 15–20.
- Nikolić, M., Milivojević, J. (2010). *Small fruit crops. Production technology*. Scientific Pomological Society of Serbia, Belgrade.
- Raudsepp, P., Kaldmae, H., Kikas, A., Libek, A.V., Pussa, T. (2010). Nutritional quality of berries and bioactive compounds in the leaves of black currant (*Ribes nigrum* L.) cultivars evaluated in Estonia. *Journal of Berry Research*, 1, 53–59.
- Rubinskiene, M., Viskelis, P., Jasutiene, I., Duchovskis, P., Bobinas, C. (2006). Changes in biologically active constituents during ripening in black currants. *Journal of Fruit and Ornamental Plant Research*, 14 (12), 237–246.
- Siksnianas, T., Stanys, V., Sasnauskas, A., Viskelis, P., Rubinskiene, M. (2006). Fruit quality and processing potential in five new blackcurrant cultivars. *Journal of Fruit Ornamental Plant Research*, 14, 265–271.
- Vagiri, M., Ekholm, A., Oberg, E., Johansson, E., Andersson, C.S., Rumpunen, K. (2013). Phenols and ascorbic acid in black currants (*ribes nigrum* L.): Variation due to genotype, location, and year. *Journal of Agricultural and Food Chemistry*, 61, 9298–9306.
- Veberič, R., Slatnar, A., Jakopič, J., Štampar, F., Mikulič Petkovšek, M. (2012). Primary and secondary metabolites in fruits. *Zbornik radova i apstrakata 14-og kongresa voćara i vinogradara Srbije sa međunarodnim učešćem, Vrnjačka Banja, Srbija*, 9, 55–62.
- Walker, P.G., Viola, R., Woodhead, M., Jorgensen, L., Gordon, S.L., Brennan, R.M., Hancock, R.D. (2010). Ascorbic acid content of black currant fruit is influenced by both genetic and environmental factors. *Functional Plant Science and Biotechnology*, 4, 40–52.
- WCRF/AICR (World Cancer Research Fund) (2008). *Food, nutrition, physical activity, and the prevention of cancer: A global perspective*. American Institute for Cancer Research, Washington.
- Zheng, J., Yang, B., Tuomasjukka, S., Ou, S., Kallio, H. (2009). Effects of latitude and weather conditions on contents of sugars, fruit acids and ascorbic acid in black currant (*Ribes nigrum* L.) juice. *Journal of Agricultural and Food Chemistry*, 57, 2977–2987.

INFLUENCE OF ROOTSTOCKS ON THE PROPERTIES OF FRUITING TWIGS IN PLUM CULTIVARS

Mirjana RADOVIĆ¹, Dragan MILATOVIĆ², Gordan ZEC²

¹Faculty of Agriculture, University of East Sarajevo, Bosnia and Herzegovina

²Faculty of Agriculture, University of Belgrade, Serbia

E-mail: rmirjana26@yahoo.com

Abstract

The paper presents the results of research on the influence of three clonal rootstocks ('Pixy', 'Fereley' and 'St. Julien A') and one seedling rootstock (Myrobalan as a control) on the properties of fruiting twigs of three table plums cultivars ('Čačanska Rana', 'Čačanska Lepotica' and 'Čačanska Najbolja') for a period of three years (2013-2015). Morphological properties of fruiting twigs (long and short): length, thickness, number of flower buds and vegetative buds were examined. The average length of long fruiting twigs was from 51.4 cm to 73.4 cm. The results of the study showed that clonal rootstocks 'Pixy' had a statistically significant influence on the lowest length and thickness of long fruiting twigs. The medium vigorous clonal rootstock 'Fereley' had a statistically significant influence on the formation of the highest number of the flower buds per twig. Myrobalan seedling rootstock had the highest number of the vegetative buds per twig. Cultivar 'Čačanska Rana' had lower number of the flower buds per twig in relation to 'Čačanska Lepotica' and 'Čačanska Najbolja' cultivars. The average length of short fruiting twigs was from 2.8 cm to 7.1 cm. Number of flower buds per short fruiting twig ranged from 2.3 to 4.8, while the number of vegetative buds ranged from 2.4 to 4.1. Myrobalan seedling rootstock had influence on the formation of lower number of flower buds per short fruiting twigs in relation to clonal rootstocks.

Key words: *Prunus domestica*, rootstock, short fruiting twigs, long fruiting twigs, buds.

Introduction

Plum is the most important fruit species in Serbia. The average production of 466,735 t in the period 2010-2012 ranks Serbia on the 3rd place in the world behind China and Romania (FAO, 2016). Despite of the high production, there are some negative characteristics: big share of old orchards, out-of-date cultivars, and inadequate application of cultural practices.

Intensification of plum production is necessary for the achievement of a high and regular yields and good quality of fruits. It is necessary to plant new orchards with virus-free nursery trees, to introduce new quality cultivars, and to apply regularly cultural practices, with special emphasis on soil management, fertilization, irrigation, pruning and plant protection. The pruning is one of the most complex practices in fruit production. For the proper pruning performance it is necessary to know the basic physiological properties of species and cultivar and the morphology of bearing wood, e.g. properties of fruiting twigs.

Veličković et al. (1997) analyzed the fruiting twigs of plum in function of cultivars and combinations cultivar/rootstock. They found significant differences between plum cultivars in the share of different types of fruiting twigs. Significant differences were found in the flower buds density in different species and cultivars of stone fruits, which are directly related to yield (*Albuquerque et al.*, 2004; *Thurzó et al.*, 2006; *Nenadović-Mratinić et al.*, 2007; *Milatovic et al.*,

2010). Cultivars which are characterized with higher flower bud density are adapted to the conditions of continental climate, considering that this increases the probability of survival of generative organs due to the frost appearance, thereby provides the higher yield (*Okie and Werner, 1996*).

The number of flower buds per fruiting twig is primarily caused by genetic factors and it is correlated with the yield (*Milatović et al., 2010*). The intensity of the flower bud formation on the short fruiting twigs is significantly reduced with increasing of the bearing woodage. The density of flower buds is important for determination of the intensity of pruning, because the cultivars with higher number of flower buds require heavy pruning, while the cultivars with less number of flower buds require light pruning (*Milatović and Đurović, 2010*).

The aim of this study was to examine the influence of rootstocks on the morphological properties of long and short fruiting twigs on table plums cultivars. On the basis of the results obtained, the recommendations will be done for pruning performance, which is the most important cultural practice for yield regulation.

Materials and methods

The study was conducted in the plum orchard at the Experimental Station “Radmilovac” of the Faculty of Agriculture in Belgrade (Serbia). During the three-year period (2013-2015) the influence of a seedling rootstock (Myrobalan as a control) and three clonal rootstocks (‘Pixy’, ‘Fereley’ and ‘St. Julien A’) was studied on the properties of fruiting twigs of three table plum cultivars (‘Čačanska Rana’, ‘Čačanska Lepotica’ and ‘Čačanska Najbolja’).

The orchard was planted in spring of 2010. Planting distance is 4 m between rows, and in the row different distances were applied depending on the rootstock vigor: 2.3 m for Myrobalan seedling, 2.0 m for ‘Fereley’ and ‘St. Julien A’ and 1.7 m for ‘Pixy’. Training system is Spindle. Standard cultural practices were applied, including drip irrigation. Every combination cultivar/rootstock was represented by six trees (two replications with three trees).

The fruiting twigs were taken in the spring, before flowering. From each combination cultivar/rootstock were taken 20 long fruiting twigs (shoots) and five two-year old twigs, where all short fruiting twigs (spurs) were analyzed. Length of twigs was measured with a meter, and thickness with a caliper. Number of flower and vegetative buds was registered on every node. The density of flower buds was calculated as the number of flower buds per 1 m length of fruiting twig (*Lombard et al., 1988*).

The results were processed statistically using the analysis of variance. The significance of differences between mean values was evaluated using Duncan's multiple range test for significance level of 0.05. Data analysis was performed using the statistical software package IBM SPSS Statistics 20 (SPSS Inc., Chicago, IL, USA).

Results and discussion

The properties of long fruiting twigs of table plums cultivars are show in table 1.

The largest values of length of long fruiting twigs were found in combination ‘Čačanska Lepotica’/Myrobalan (73.4 cm), while the lowest values were found in combination ‘Čačanska Lepotica’/‘Pixy’ (51.4 cm). Among rootstocks, a dwarf rootstock ‘Pixy’ had a statistically significant lower value of the length of long fruiting twigs then other rootstocks. Between other three rootstocks there were no statistically significant differences.

Among cultivars the average length of long fruiting twigs, varied from 66.1 cm (‘Čačanska Rana’) to 69.4 cm (‘Čačanska Lepotica’). Differences in the length of long fruiting twigs between cultivars were not statistically significant.

Table 1. The properties of long fruiting twigs in plum cultivars on different rootstocks (average, 2013-2015).

Combination Cultivar/rootstock	Length (cm)	Thickness (mm)	No. of FBs per twig	No. of VBs per twig	Ratio FB/VB	No. of FBs per 1 m	
Čačanska Rana/Pixy	56.2 e	7.1 de	9.0 ef	18.2 f	0.5	16.0	
Čačanska Lepotica/Pixy	51.4 bcde	6.9 de	15.7 bc	22.4 de	0.7	30.5	
Čačanska Najbolja/Pixy	60.7 de	6.8 e	17.7 bc	22.5 de	0.8	29.2	
Čačanska Rana/Myrobalan	72.8 a	7.5 bcd	7.3 f	26.1 abc	0.3	10.0	
Čačanska Lepotica/Myrobalan	73.1 a	7.8 bc	15.4 bcd	27.6 ab	0.6	21.1	
Čačanska Najbolja/Myrobalan	70.8 a	7.6 bcd	16.3 bc	28.3 a	0.6	23.0	
Čačanska Rana/Fereley	67.6 abcd	7.3 cde	14.6 cd	22.8 de	0.6	21.6	
Čačanska Lepotica/Fereley	69.8 abc	7.9 bc	23.3 a	25.0 bcd	0.9	33.4	
Čačanska Najbolja/Fereley	67.2 abcd	8.0 ab	19.1 b	24.3 cde	0.6	22.5	
Čačanska Rana/St. Julien A	68.0 abcd	7.4 bcde	11.6 de	21.8 e	0.5	17.1	
Čačanska Lepotica/St. Julien A	73.4 a	8.5 a	15.0 bcd	26.7 abc	0.6	20.4	
Čačanska Najbolja/St. Julien A	70.3 ab	7.8 bc	18.0 bc	26.1 abc	0.7	25.6	
Rootstock	Pixy	59.4 b	6.9 b	14.1 b	21.0 c	0.7	23.7
	Myrobalan	72.2 a	7.6 a	12.9 b	27.4 a	0.5	17.9
	Fereley	68.2 a	7.8 a	19.0 a	24.0 b	0.8	27.9
	St. Julien A	70.6 a	7.9 a	14.9 b	24.9 b	0.6	21.1
Cultivar	Čačanska Rana	66.1 a	7.3 b	10.6 b	22.2 b	0.5	16.0
	Čačanska Lepotica	69.4 a	7.8 a	17.4 a	25.4 a	0.7	25.1
	Čačanska Najbolja	67.3 a	7.6 ab	17.8 a	25.3 a	0.7	26.5

Mean values followed by the same letter within a column do not differ significantly according to Duncan's multiple range test at $P \leq 0.05$; FB-Flowering buds; VB-Vegetative buds.

Differences in the length of long fruiting twigs were statistically significant between years. In the second year of the study (2014), the length of long fruiting twigs was the largest (80.8 cm), while it was the lowest (48.1 cm) in the third year of study (2015).

Our results of length of long fruiting twigs were slightly lower than in the report of *Milatović et al.* (2015), who studied 11 European plum cultivars grafted on the seedling rootstock Myrobalan in conditions of Belgrade. However, in our study the length of long fruiting twigs of cultivars 'Čačanska Najbolja' and 'Čačanska Rana' was larger, while in cultivar 'Čačanska Lepotica' was lower than in results of *Nenadović-Mratinić et al.* (2007). The differences can be explained by the influence of different factors such as environmental conditions, rootstocks, age of trees, yield, and cultural practices.

Among rootstocks, the average thickness of the long fruiting twigs varied from 6.9 mm ('Pixy') to 7.9 ('St. Julien A'). Among cultivars, these values were from 7.3 mm ('Čačanska Rana') to 7.8 mm ('Čačanska Lepotica'). Significant differences in thickness of the long fruiting twigs were also found between years. The largest value of thickness of the long fruiting twigs was in 2015 (8.9 mm), while the lowest value was in 2014 (6.5 mm). Results of thickness of the long fruiting twigs in our research were in accordance with the previous findings (*Nenadović-Mratinić et al.*, 2007; *Milatović et al.*, 2015).

The medium vigorous clonal rootstock 'Fereley' had a statistically significant influence on the formation of higher number of the flower buds per twig (19.0 on average) than other rootstocks. Among cultivars, 'Čačanska Rana' had a significantly lower number of the flower buds per twig in relation to 'Čačanska Lepotica' and 'Čačanska Najbolja' cultivars. Significant differences in

number of the flower buds per twig were also found between years. The highest number of the flower buds per twig was in the first year of study (2013), compared to two other years.

Myrobalan seedling rootstock had the highest number of vegetative buds per twig (27.4 on average) compared to three other rootstocks. Among cultivars, 'Čačanska Rana' had lower number of the vegetative buds per twig in relation to 'Čačanska Lepotica' and 'Čačanska Najbolja' cultivars. Significant differences were also found between years. The highest number of the flower buds per twig was in the second year of study (2014).

According to many authors (Nenadović-Mratinić *et al.*, 2007; Thurzó *et al.*, 2008; Milatović *et al.*, 2014), the density of flower buds is an important parameter which indicates the potential yield of cultivars. The highest density of flower buds on one-year old twigs (27.9 per 1 m) was on the medium vigorous clonal rootstock 'Fereley', while this value was lowest in the control rootstock - Myrobalan (17.9 per 1 m). Results of density of flower buds in our research were lower than in the study of Milatović *et al.* (2015), and higher than in the study of Nenadović-Mratinić *et al.* (2007).

Very important parameter for the yield and quality of fruit is a balanced relationship between flower buds and vegetative buds. Specifically, a certain number of leaves per fruit was necessary to achieve optimal quality of fruit. The lowest ratio of flower to vegetative buds per long fruiting twig was in the combination 'Čačanska Rana'/Myrobalan (0.3) while the highest ratio was in the combination 'Čačanska Najbolja'/'Fereley' (0.9). The lower value of the ratio of flower to vegetative buds points to lower yield, while the higher ratio indicates a potentially higher yield, but can have negative characteristics in terms of lower fruit quality because in that case a smaller number of leaves per fruit could be expected.

The short fruiting twigs were analyzed on the two-year old twigs and their characteristics are shown in table 2.

Table 2. The properties of short fruiting twigs in plum cultivars on different rootstock (2013-2015).

Combination Cultivar/rootstock	Length (cm)	No. of FBs per twig	No. of VBs per twig	Ratio FB/VB	No. of FB per 1 m of 2-year old twig	
Čačanska Rana/Pixy	7.1 a	3.7 bcd	4.1 a	0.9	58.4	
Čačanska Lepotica/Pixy	3.8 cde	3.4 cd	2.8 bcd	1.2	59.9	
Čačanska Najbolja/Pixy	3.4 de	4.4 ab	2.4 d	1.8	85.6	
Čačanska Rana/Džanarika	4.6 bcd	2.3 e	2.9 bcd	0.8	37.8	
Čačanska Rana/Myrobalan	3.1 e	2.8 de	3.1 bc	0.9	51.7	
Čačanska Lepotica/Myrobalan	3.6 de	3.8 bc	2.7 bcd	1.4	70.8	
Čačanska Najbolja/Myrobalan	5.7 b	3.6 bcd	3.0 bcd	1.2	68.1	
Čačanska Rana/Fereley	3.9 cde	3.3 cd	3.2 b	1.0	63.1	
Čačanska Lepotica/Fereley	4.0 cde	4.7 a	2.5 cd	1.9	99.0	
Čačanska Najbolja/Fereley	4.9 bc	3.1 cde	2.9 bcd	1.1	71.6	
Čačanska Rana/St. Julien A	2.8 e	3.1 cde	2.5 cd	1.2	64.6	
Čačanska Lepotica/St. Julien A	3.7 cde	4.8 a	2.8 bcd	1.7	102.0	
Rootstock	Pixy	4.8 a	3.8 a	3.1 a	1.7	66.5
	Myrobalan	3.7 c	2.9 b	2.9 a	1.2	51.6
	Fereley	4.6 ab	3.9 a	2.9 a	1.0	76.6
	St. Julien A	3.8 bc	3.6 a	2.7 a	1.3	78.1
Cultivar	Čačanska Rana	5.6 a	3.2 b	3.2 a	1.3	58.1
	Čačanska Lepotica	3.4 b	3.1 b	2.9 b	1.0	58.7
	Čačanska Najbolja	3.7 b	4.4 a	2.6 b	1.1	88.2

Mean values followed by the same letter within a column do not differ significantly according to Duncan's multiple range test at $P \leq 0.05$; FB-Flowering buds; VB-Vegetative buds.

Among rootstocks, the average length of short fruiting twigs varied from 3.7 cm (Myrobalan) to 4.8 cm ('Pixy'). Cultivar 'Čačanska Rana' had statistically significant higher length of short fruiting twigs compared to cultivars 'Čačanska Lepotica' and 'Čačanska Najbolja'. Among years, the differences in the length of short fruiting twigs were statistically significant. In the third year of the study (2015), the length of short fruiting twigs was the largest compared to other two years. Compared to results of *Milatovic et al.* (2015) in our study the lower length of short fruiting twigs was found.

Number of flower buds per short fruiting twig ranged from 2.3 to 4.8. Myrobalan seedling rootstock had influence on the formation a less number of flower buds per short fruiting twig compared to clonal rootstocks. Cultivar 'Čačanska Najbolja' had a statistically significant influence on the formation of higher number of the flower buds per twig then other cultivars.

The number of vegetative buds ranged from 2.4 to 4.1, and there were no statistically significant differences between the rootstocks. Among cultivars, 'Čačanska Rana' had the higher number of the vegetative buds per twig then cultivars 'Čačanska Lepotica' and 'Čačanska Najbolja'.

The average ratio of flower to vegetative buds was from 0.8 ('Čačanska Rana' /Myrobalan) to 1.9 ('Čačanska Najbolja'/'Fereley'). Too high ratio can indicate lower fruit quality and also greater tendency to bare wood formation.

The number of flower buds per 1 m of 2-year old twig was lowest in the combination 'Čačanska Rana'/Myrobalan (37.8), while the highest value was in cultivar 'Čačanska Najbolja' grafted on 'St. Julien A' (102.2). Among rootstocks, the lowest value was on the control - Myrobalan (51.6), and the highest was on the clonal rootstock 'St. Julien A' (78.2). Among cultivars, the lowest value was on cultivar 'Čačanska Rana' (58.1), and the highest in cultivar 'Čačanska Najbolja' (88.2). This parameter indicates the potential yield of the cultivar, as the low density of flower buds points to a lower yield potential. Results of flower bud density on 2-years old twig in our research were lower in cultivars 'Čačanska Najbolja' and 'Čačanska Lepotica' and higher in cultivar 'Čačanska Rana' compared with the previous findings (*Milatović et al.*, 2015; *Nenadović-Mratinić et al.*, 2007).

Conclusions

Based on the three-year trial in the region of Belgrade, it can be concluded that the rootstocks had significant influence on the properties of long and short fruiting twigs on table plums cultivars. The clonal rootstocks 'Pixy' had a statistically significant influence on the lowest length and thickness of long fruiting twigs. The medium vigorous clonal rootstock 'Fereley' had a statistically significant influence on the formation of the highest number of the flower buds per twig. Myrobalan seedling rootstock induced the highest number of the vegetative buds per twig. Myrobalan seedling rootstock had influence on the formation a less number of flower buds per short fruiting twigs in relation to clonal rootstocks.

Based on the number of flower buds per 1 m, it can be concluded that in studied table plums cultivars flower bud density was higher on short fruiting twigs than on long fruiting twigs. Therefore, the short fruiting twigs are the main holders of the yield.

Based on these results, we can make recommendations for pruning performance. Cultivars and rootstocks, which are characterized with higher density of flowers buds on short and long fruiting twigs, require more severe pruning for the better quality of fruit and preventing the bare wood formation. The cultivar/rootstock combinations that have lower density of flower buds require pruning of lower intensity. Among cultivars, 'Čačanska Lepotica' and 'Čačanska Najbolja' had

higher flower bud density than 'Čačanska Rana'. Also, flower bud density was higher on clonal rootstocks compared to Myrobalan seedling rootstock.

Acknowledgements

This work was realized as a part of the project No. 19/6-020/961-91/14 financed by the Ministry of Science and Technology of the Republic of Srpska.

Literature

- Albuquerque, N., Burgos, L., Egea, J. (2004): Influence of flower bud density, flower bud drop and fruit set on apricot productivity. *Scientia Horticulturae* 102:397-406.
- FAO (2016) <http://faostat.fao.org/>
- Lombard, P.B., Callan, N.W., Dennis, F.G.Jr., Looney, N.E., Martin, G.C., Renquist, A.R., Mielke, E.A. (1988): Towards a standardized nomenclature, procedures, values, and units in determining fruit and nut tree yield performance. *Hort Science* 23(5):813-817.
- Milatović, D., Đurović, D. (2010): Characteristics of one-year old shoots of peach and nectarine cultivars. *Journal of Pomology*, 44, 169-170 (2010) 27-34.
- Milatović, D., Đurović, D., Zec, G. (2014): Morphological properties of fruit bearing shoots of apricot cultivars. *Journal of Agricultural Sciences (Belgrade)* 59(3):265-274.
- Milatović, D., Đurović, D., Zec, G. (2015): Fruit bearing shoot characteristics of European plum (*Prunus domestica* L.) and Japanese plum (*Prunus salicina* Lindl.) cultivars. *Journal of Agricultural Sciences* Vol. 60, No. 2: 149-158
- Milatović, D., Nikolić, D., Đurović, D. (2010): Variability, heritability and correlations of some factors affecting productivity in peach. *Horticultural Science (Prague)* 37(3):79-87.
- Nenadović-Mratinić, E., Milatović, D., Đurović, D., Jovičić, Z. (2007): Morphological characteristics of fruiting twigs in plum cultivars (*Prunus domestica* L.). *Journal of Pomology*, 41:51-56.
- Okie, W.R., Werner, D.J. (1996): Genetic influence on flower bud density in peach and nectarine exceeds that of environment. *Hort Science* 31:1010-1012.
- Thurzó, S., Drén, G., Dani, M., Hlevnjak, B., Hazic, V., Szabó, Z., Racskó, J., Holb, I.J., Nyéki, J. (2006): Fruit bearing shoot characteristics of apricot and sweet cherry cultivars in Hungary. *International Journal of Horticultural Science* 12(2):107-110.
- Thurzó, S., Szabó, Z., Nyéki, J., Racskó, J., Drén, G., Szabó, T., Nagy, J., Holb, I.J., Veres, Z.S. (2008): Some fruit-bearing shoot characteristics of nine sweet cherry cultivars in Hungary. *Acta Horticulturae* 795:673-676.
- Veličković, M., Jovanović, M., Oparnica, Č. (1997): Zastupljenost različitih tipova rodnih grančica u važnijih sorti šljive. *Voćarstvo*, 31:83-88.

EFFECT OF SOME PLANT GROWTH PROMOTING RHIZOBACTERIA ON GROWTH, LEAF WATER CONTENT AND MEMBRANE PERMEABILITY OF TWO CITRUS ROOTSTOCK UNDER SALT STRESS CONDITION

Şeyma ARIKAN*, Muzaffer İPEK, Lütfi PIRLAK

Department of Horticulture, Faculty of Agriculture, University of Selçuk, Konya, Turkey

*Corresponding author: arikan@selcuk.edu.tr

Abstract

Some plant growth promoting rhizobacteria (PGPR) (*Bacillus subtilis* EY2, *Bacillus atropheus* EY6, *Bacillus sphaericus* GC subgroup B EY30, *Staphylococcus kloosii* EY37 and *Kocuria erythromyxa* EY43) were investigated under salt stress conditions in two citrus rootstocks (*Citrus aurantium* L., *Poncirus trifoliata* L. Raf.). Effects of EY2, EY6, EY30, EY37 and EY43 were tested on plant growth (plant height, plant and root fresh weight, root length), leaf relative water content (LRWC), and membrane permeability in citrus rootstock. The plants were grown in pots and irrigated with a NaCl solution (100 mM). Irrigation was applied once a week during growing period which continued for ten weeks. All bacteria treatments significantly increased plant height and root length in both citrus rootstocks. The LRWC range from 58.62% (100 mM NaCl treatment) to 87.08% (EY43 bacteria strain) in trifoliata. On the other hand, in sour orange, LWRC ranged from 23.20% (100 mM NaCl treatment) to 75.49% (Control). The highest membrane permeability rate was determined in NaCl treatment in sour orange and trifoliata orange.

Keywords: PGPR, NaCl, citrus rootstock, plant growth

Introduction

Because of saline soil occurs in the arid and semi-arid zones of the world, the most of soils in the world has saline structure. In such areas, long periods of drought coincide with high temperatures (Alizadeh *et al.*, 2011). However, salinity occurs quickly in these regions with irrigation. Salt in the upper layers of soil transported to by capillary during the irrigation and evaporation and accumulates in the rhizosphere. The wrong applications of irrigation, presence of high soluble salts level in water, lack of drainage and salinity are among other causes. Salinity is one of the major problems in the agricultural area of Turkey. Agricultural fields, about 1.500.000 ha, are faced with salinity problem in Turkey (Anonymous, 2008). Salinity is one of the most effective factors which limited yield and soil fertility in production areas. Salt stress cause increasing of respiration rate, ion toxicity, changes of plant growth, mineral disorders, damaging of membrane permeability, decreasing of photosynthetic activity. On the other hand, soil salinity has negative impacts on nitrogen and carbon metabolism. The salinity tolerances of different species or cultivars and their sensitivity at different stages of growth, different soil and environmental conditions show differences. The reactions of fruit species to salinity were examined (Maas and Hoffman, 1977) and it was observed that many fruit species are very sensitive to salinity. (Table1).

Table. Response of fruit species against Salinity (Maas and Hoffman, 1977)

<u>Tolerant</u>	<u>Moderately Sensitive</u>	<u>Too Sensitive</u>
<i>Pheoneix dactylifera</i>	<i>Ficus carica</i>	<i>Citrus paradisi</i>
	<i>Punica granatum</i>	<i>Citrus limon</i>
	<i>Olea europea</i>	<i>Citrus reticulata</i>
		<i>Citrus sinensis</i>
		<i>Prunus amygdalus</i>
		<i>Prunus armeniaca</i>
		<i>Prunus avium</i>
		<i>Pyrus communis</i>

In order to breeding of soil salinity, it needs lots of time and more money. Therefore, these methods cannot be applied prevalently countries. Many studies focused on chemical treatments and suitable rootstocks against for saline soil but nowadays, biological treatments with plant growth promoting rhizobacteria (PGPR) have been started to use for solve this problem (Ashraf *et al.*, 2004; Karlidag *et al.*, 2010).

PGPR are free-living microorganisms as colonizing in the rhizosphere of plants (Karlidag *et al.*, 2010). These bacteria have a great importance in sustainable agriculture which increased root growth and plant pathogens kept under the control. Such as bio-control of plant disease, plant growth promoting, bio-fertilizers and growth regulator substances production have been functions (Antoun and Prévost, 2005). PGPR effects on plants a-symbiotically notwithstanding plant species. In naturally, bacteria which stay in low concentration, is applied to plant roots, it effects on plant growth and development. PGPR can have beneficial effects on plant growth and yield by two main mechanisms. These is direct and indirect mechanisms. There are different ways in the direct effect mechanism. Direct mechanisms may act on the plant itself and auxins, cytokinins, and gibberellins or lowering of the ethylene in plant, solubilization of inorganic phosphate and mineralization of organic phosphate, asymbiotic fixation of atmospheric nitrogen, and stimulation of disease-resistance mechanisms (Antoun and Prévost, 2005; Zahir *et al.*, 2003). In the indirect mechanism, PGPR act like biocontrol agents reducing disease or stimulate other beneficial symbioses or protect the plant (Jacobsen, 1997). Additionally, PGPR improve plant's tolerance to stresses, such as drought, high salinity, metal toxicity, and pesticide load (Bashan and de Bashan, 2005).

In the present study, we aimed to determine effect of PGPR strains (*Bacillus subtilis* EY2, *Bacillus atropheus* EY6, *Bacillus sphaericus* GC subgroup B EY30, *Staphylococcus kloosii* EY37, *Kocuria erythromyxa* EY43, *Rhodococcus* 9/4, *Pseudomonas* 53/6) which were identified positive effects on vegetables, apple, cherry and crops on plant growth, leaf relative water content and membran permeability of sour orange and trifoliate orange.

Material and Methods

This study was carried out under controlled greenhouse conditions at Selçuk University Department of Horticulture in 2014-2015 in Turkey. Sour and Trifoliate Orange was used as plant materials and seedlings were planted to 2 liter pots in March, 2014. The pots contained 2:1 peat: perlite mixture.

Strains of bacteria, EY2, EY6, EY30, EY37, EY43 were obtained from University of Iğdır in Turkey. A single bacteria colony was transferred to 500 ml flasks containing Nutrient Broth (NB), and grown aerobically in flasks on a rotating shaker (150 rpm) for 48 h at 27°C. The

bacterial suspension was then diluted in sterile distilled water to a final concentration of 10^9 CFU ml^{-1} (Karlidag *et al.*, 2010).

The all bacteria strain inoculation roots before planting to pots. Roots were hold in bacteria suspension for 30 minutes. After planting seedling was watered two times with bacteria suspension once in a month. Seedlings of bacterial inoculation was made after one-month planting with irrigation twice a week 100 mM NaCl application in pots and have continued during the growth period. Growth promoting effects of bacterial treatments were evaluated by determining plant height, root length, stem and root fresh weight, leaf relative water content (LRWC) and membrane permeability in seedling.

Experiment divided into seven application groups including seven seedlings with three replicates in a completely randomized design. The collected data were analysed statistically using the SPSS 17. All data in the present study were subjected by analysis of variance (ANOVA) and means were separated by Duncan's Multiple Range Tests at 5% level of significance.

Results and Discussion

In both sour orange and trifoliolate orange, plant height range from 20.22cm to 38.94cm. The highest plant height was obtained from EY43 bacteria strain in both sour (24.83cm) and trifoliolate orange (38.94cm). The EY43 strain increased plant height 16.40% in sour orange and 14.93% in trifoliolate orange in comparison to control plants (Table2). These results were explained that soil salinity reduces the soil water potential and the ability of plants to take up water. These reduces the rate of cell expansion in growing tissues (Munns, 2011). However, Jha and Subramanian (2013) reported that PGPR under saline conditions increase 31% plant height in paddy rice. Similarly, *Pseudomonas* strain treatment was significantly increased plant height compared with any treatment under salt stress in rice plants (Sen and Chandrasekhar, 2014).

The root length of rootstocks was measured between 18.61cm and 27.47cm. While EY43 bacteria strain had the longest root length in trifoliolate orange (22.72cm), EY37 strain had the longest root length in sour orange (27.47cm) (Table2). The higher concentrations of NaCl caused a significant reduction in root length. The reduction in root length might be due to the inhibitory effects of salt on the metabolic activities which associated with cell division, differentiation and elongation (Abdel-Hussein, 2006; Heszky *et al.*, 1992). Some author reported that PGPR treatments increase root growth. Sen and Chandrasekhar (2014), in ADT43 rice genotype, decreasing of root length was measured in treatment of *Pseudomonas* strain TDK1 under salinity. Like-wise, Yildirim *et al.* (2008) were found that PGPR treatment had greater root length than the control treatment in radish under salt stress conditions.

In terms of fresh root weight, two bacteria strain appeared with good result. The EY43 and EY6 bacteria strain had the best result for fresh root in both sour and trifoliolate orange. In sour orange, EY6 strain obtained 8.63g, when EY43 obtained 8.55g for fresh root weight. In trifoliolate orange, EY43 had the best result with 12.87g. Bacteria strains increased fresh root weight of both rootstocks. The fresh root weight was increased by EY6 (25.07%) and EY43 (23.90%) strain in comparison to control in sour orange (Table2). The four bacteria strain appeared in fresh plant weight in both citrus rootstocks. The EY6 and EY30 had the highest fresh plant weight in sour orange, when the EY2 and EY43 had the highest fresh plant weight. EY6 and EY30 increased fresh plant weight approximately 50% in sour orange. On the other hand, EY2 and EY43 strain increased fresh plant weight about 70% and 60% respectively. Yildirim *et al.* (2008) identified under salt stress EY2 strain that gave the highest value for shoot and root fresh weight in radish plants.

The leaf relative water content results were difference in both rootstocks. The control group led with 75.49% in sour orange while EY43 led with 87.08% in trifoliolate orange. The all bacteria strain treatments were behind the control group in sour orange. In trifoliolate orange, EY43 and EY37 were in front of the control group with 87.08 and 87.60% respectively (Table2). The highest damage in membrane was obtained from NaCl treatment in both rootstocks. The membrane damages of sour orange were the higher than trifoliolate orange's. EY30 reduced damage of membrane with 11.21% in trifoliolate orange, when EY37 (18.70%) bacteria strain reduced damage of membrane in comparison to NaCl treatment in sour orange. The LRWC result of our study is supposed by Karlidag *et al.* (2010) in strawberry. They determined LRWC decreased by salt treatment but all bacteria inoculations were increased LRWC. EY2 bacteria treatment having the best result was found to increased LRWC rate 88.4%. Cell membrane stability can be conserved by bacterial inoculation. They also found that all bacterial strains significantly decreased membrane permeability compared with 35 mM NaCl treatment.

As a result of, trifoliolate orange has more tolerant than sour orange with EY43 bacteria treatments. In terms of LRWC, membrane permeability and other parameters, EY43 bacteria strain showed more effective and protective role in both rootstocks. Because of this positive effect, EY43 bacteria strain can be recommended to use for salinity problems in land.

Conclusions

The results of the present study showed that used bacteria strains had been ameliorative of the deleterious effects under salt stress in citrus rootstocks. This study was observed to improved plant growth and reduced membrane injury with bacterial applications. EY43 bacteria strain had the best effect on plant height in both Sour Orange (24,83cm) and Trifoliolate Orange (38,94cm). In root length, E37 bacteria strain (24.47cm) was found the best result in Sour Orange, while EY43 bacteria strain (22,72cm) was found the best result in Trifoliolate Orange. In Sour Orange, maximum fresh root weight was obtained from EY43 (6,83g) and EY6 (6,55g). EY43 significantly increased fresh root weight in Trifoliolate Orange. EY6 (10,48g) and EY30 (10,25g) dramatically increased fresh plant weight in Sour Orange, while EY2 (13,66g) and EY43 (12,40g) bacteria strain significantly increased fresh plant weight in Trifoliolate Orange. The maximum LRWC was obtained from control plants (75,49%) in Sour Orange. In Trifoliolate Orange, the highest LRWC was found in EY30 bacteria strain (87,60%). The NaCl treatments increased membrane permeability in both Sour Orange (88,58 %) and Trifoliolate Orange (32,63%).

Table2. Effect of NaCl treatments on morphological parameters of sour and trifoliate orange's seedling

	Plant Height (cm)		Root Length (cm)		Fresh Root Weight (g)		Fresh Plant Weight (g)		LRWC (%)		Membrane Permeability (%)	
	S.O	T.O	S.O	T.O	S.O	T.O	S.O	T.O	S.O	T.O	S.O	T.O
Control	21,33 bc	33,88 bc	26,31 ab	20,41 b	6,9 bc	7,73 c	6,09 c	7,87 c	75,49 a	77,23 b	19,28 c	11,12 c
NaCl	20,22 c	28,77 d	22,89 c	18,61 c	5,92 c	7,97 bc	6,35 c	6,04 c	23,20 e	58,62 c	88,58 a	32,63 a
EY2+NaCl	25,16 a	35,46 ab	24,86 bc	20,55 b	6,93 bc	10,60 ab	4,25 d	13,66 a	42,05 bc	74,85 b	53,30 b	16,76 c
EY6+NaCl	24,50 a	37,22 ab	24,89 bc	20,44 b	8,63 a	9,57 bc	10,48 a	10,92 ab	44,83 b	64,55 c	61,39 ab	15,27 c
EY30+NaCl	23,50 ab	31,55 cd	25,97 ab	20,77 b	8,64 a	10,27 bc	10,25 a	7,74 bc	29,58 de	65,27 c	62,18 ab	28,97 ab
EY37+NaCl	23,16 ab	31,66 cd	27,47 a	21,05 b	7,41 ab	8,55 bc	7,95 b	11,26 a	35,83 bcd	87,60 a	72,05 ab	18,77 bc
EY43+NaCl	24,83 a	38,94 a	24,41 bc	22,72 a	8,55 a	12,87 a	9,42 ab	12,40 a	32,27 cde	87,08 ab	67,69 ab	10,37 c

S.O: Sour Orange, T.O: Trifoliate Orange

References

- Abdel-Hussein M. A-A. (2006). Evaluation of MM106 and Omara apple rootstocks for salt tolerance in vitro. *Journal of Karbala University*, 4(2), 184-191.
- Alizadeh A, Alizade V, Nassery L and Eivazi A. (2011) Effect of drought stress on apple dwarf rootstocks. *Technical Journal of Engineering and Applied Science*, 1(3), 86-94.
- Anonymous. (2008) www.fao.org Access date: 2016.
- Antoun H and Prévost D. (2005). Ecology of plant growth promoting rhizobacteria *PGPR: Biocontrol and biofertilization* (pp. 1-38): Springer.
- Ashraf M, Hasnain S, Berge O and Mahmood T. (2004) Inoculating wheat seedlings with exopolysaccharide-producing bacteria restricts sodium uptake and stimulates plant growth under salt stress. *Biology and Fertility of Soils*, 40(3), 157-162. doi:10.1007/s00374-004-0766-y
- Bashan Y and de Bashan L. (2005) Plant growth-promoting. *Encyclopedia of soils in the environment*, 1, 103-115.
- Heszky L E, Gyulai G and Csillag A. (1992) Plant regeneration of NaCl-pretreated cells from long-term suspension culture of rice (*Oryza sativa* L.) in high saline conditions. *Plant cell, tissue and organ culture*, 29(2), 75-82.
- Jacobsen C S. (1997) Plant protection and rhizosphere colonization of barley by seed inoculated herbicide degrading Burkholderia (*Pseudomonas*) cepacia DBO1 (pRO101) in 2, 4-D contaminated soil. *Plant and Soil*, 189(1), 139-144.
- Jha Y and Subramanian R. (2013) Paddy plants inoculated with PGPR show better growth physiology and nutrient content under saline condition. *Chilean journal of agricultural research*, 73(3), 213-219.
- Karlidag H, Esitken A, Yildirim E, Donmez M F and Turan M. (2010) Effects of plant growth promoting bacteria on yield, growth, leaf water content, membrane permeability, and ionic composition of strawberry under saline conditions. *Journal of Plant Nutrition*, 34(1), 34-45.
- Maas E V and Hoffman G. (1977) Crop salt tolerance-current assessment. *Journal of the irrigation and drainage division*, 103(2), 115-134.
- Munns R. (2011) Plant adaptations to salt and water stress: differences and commonalities. *Adv Bot Res*, 57, 1-32.
- Sen S and Chandrasekhar C. (2014) Effect of PGPR on growth promotion of rice (*Oryza sativa* L.) under salt stress. *Asian J Plant Sci Res*, 4, 62-67.
- Yildirim E, Turan M and Donmez M F. (2008) Mitigation of salt stress in radish (*Raphanus sativus* l.) by plant growth promoting rhizobacteria. *Roumanian Biotechnol Lett*, 13, 3933-3943.
- Zahir Z A, Arshad M and Frankenberger W T. (2003) Plant growth promoting rhizobacteria: applications and perspectives in agriculture. *Advances in Agronomy*, 81, 97-168.

YIELD AND CHEMICAL COMPOSITION OF CAULIFLOWER (*BRASSICA OLERACEA* L.VAR. *BOTRYTIS*) CULTIVATED USING MICROBIOLOGICAL FERTILIZER

Daniela DIMOVSKA^{1*}, Marija ZDRAVKOVSKA¹, Igor ILJOVSKI¹, Dzoko KUNGULOVSKI²,
Natalia ATANASOVA - PANCHEVSKA²

¹ Faculty of Agriculture Sciences and Food – Skopje, Ss Cyril and Methodius University in Skopje, Republic of Macedonia

² Faculty of Natural Sciences and Mathematics – Skopje, Ss Cyril and Methodius University in Skopje, Republic of Macedonia

*Corresponding author: ddimovska1@gmail.com

Abstract

As a result of the intensive tillage, application of various agrotechnical measures, the use of large amounts of fertilizers and pesticides, during the production of horticultural crops with relatively high yields, including the cauliflower, disrupts natural processes in the soil. The microbiological activity and fertility of the soil can be improved by using pure cultures of the microorganisms used for the production of microbiological fertilizers – bio -fertilizers, that create or improve conditions for microbiological activity in the rhizosphere, without disrupting the natural processes in the environments. This research was aimed at determining the impact of microbiological fertilizer Slavol, applied in two ways, foliar with dorsal sprinkler and through the drip irrigation system, on the yield and chemical composition (water, dry matter, fiber, protein and calcium) of cauliflower produced outdoors during 2011, 2012 and 2013. The results of this study showed that the application of Slavol significantly affected the yield of the cauliflower, especially when applying through the drip irrigation system. Chemical analyzes showed increased content of water, fiber, protein and calcium in the curds of the cauliflower treated with the microbiological fertilizer.

Keywords: *cauliflower, microbiological fertilizer, yield, chemical composition*

Introduction

Cauliflower is one of the popular winter season vegetable grown throughout the world. The edible curd is a rich source of protein, minerals and vitamins which protects human from certain cancers and heart diseases (Keck, 2004).

Intensification of the vegetable production in order to achieve high yield at the expense of the quality of the vegetables and environmental conditions, impose new trends in the agricultural production. These trends are including limitation of the application of fertilizers and pesticides whose uncontrolled use affects the microbiological and physical-chemical properties of the soil (Najdenovska and Čolo, 2012) and their replacement with microbial fertilizers, which because of the ability of microorganisms to provide necessary food for plants, occupy a significant place in the vegetable production.

Soil is an essential precondition for the crop production and it is favorable environment for the development of various biochemical and microbiological processes. The soil contains a number of different groups of bacteria. Their number and activity in the soil is an important indicator for the fertility, for the growth and development of the plants, for the degradation of some inorganic

substances and more. Their representation is conditioned by: climate characteristics, soil type, water-air regime, temperature, mechanical composition, the presence of organic matter, and more.

Knowing the role and the flow of the microbiological processes in the soil can be directed towards increasing the intensity of microbial activity and soil fertility, using the effective strains of azotobacter and phosphorus soluble bacteria that can replace or reduce the use of mineral fertilizers. The effect of use of bio-inoculants in cauliflower and its agronomic efficiency is not well known (Sharma et al., 2009). Further, the integrated use of different organic materials not only increase the nutrient status of agricultural soil but also help to improve various physical, chemical and biological properties of soil leading to improved soil fertility and also to increased fertilizer use efficiency (Dick and Gregeorich, 2004).

The positive impact of the microbiological fertilizers is visible in the early stages of plant development through the improved process of germination, growth, increased activity of roots and activity of photosynthesis, improved plant nutrition with nitrogen, phosphorus, potassium and trace elements, increased yield for 10 to 25%, increased microbial biomass in the soil, improved water-air regime and reduced or eliminated negative impact of pesticides and mineral fertilizers. According to Bashyal L.N. (2011), biofertilizers increased the efficiency of nitrogen fertilizer, and subsequently increases the yield and quality of cauliflower.

The main objective of this research was aimed at determining the impact of microbiological fertilizer Slavol, applied in two ways, foliar with dorsal sprinkler and through the drip irrigation system, on the yield and chemical composition (water, dry matter, fiber, protein and calcium) of cauliflower produced outdoors during 2011, 2012 and 2013.

Material and method

The experiment was set near Skopje (Capital of Macedonia), in the village of Jurumleri, with coordinates 41°58'20,84" north and 21°33'24,44" east, 276 m above sea level, on alluvium soil type, during the seasons in 2011, 2012 and 2013.

As research material was used cauliflower (*Brassica oleracea* L. var. *botrytis*), hybrid Barcelona F1.

The cauliflower was cultivated from seedlings produced in cold beds, transplanted on open field. During 2011 and 2012, the sowing of the cauliflower was performed on May 20th, while in 2013 sowing was on May 25th. The germination of 50% of the seeds was observed for 5 to 7 days after sowing.

The transplantation of the seedlings was on open field in experimental plots with size of 3,2 m², distributed according to a random block system (method of Fisher) in three variants, with four repetitions. The seedlings were planted at a distance of 0,5 m in the row, and 0,8 m between the rows, which means that in each experimental plot has 8 plants.

The variants were set according to the time and way of treatment with the microbiological fertilizer Slavol, which is a combination of 6 bacteria: *Azotobacter chroococcum* (10⁸ cfu/mL), *Azotobacter vinelandii* (10⁸ cfu/mL), *Derxia sp.* (10⁸ cfu/mL), *Bacillus licheniformis* (10⁹ cfu/mL), *Bacillus subtilis* (10⁹ cfu/mL) and *Bacillus megaterium* (10⁹ cfu/mL). It also contains natural vitamins, enzymes and biostimulants.

The variants were set in the following order:

1. Ø control - without application of microbial fertilizer;
2. Variant 1 (V-1) - treatment of the seedlings by dipping in a solution of 5 L of water and 50 mL Slavol for 5 minutes and treatment of the plants during the vegetation through the leaves with dorsal sprinkler every seven days with a solution of 2 mL Slavol dissolved in 2 L of water, and
3. Variant 2 (V-2) - treatment of seedlings by dipping in a solution of 5 L of water and 50 mL Slavol for 5 minutes and then treatment of the plants during the vegetation through the drip irrigation system with a solution of 150 mL Slavol, dissolved in 150 L of water, with floodplain rate of drop per rate of 2 L per hour, every two days.

The time of the treatment with dorsal sprinkler in the three years of research is given in Table 1, while treatment by drip irrigation system is given in Table 2.

Table 1. Time of treatment with dorsal sprinkler by year

Year of research	July			August					September			
2011	19	26		2	9	16	23		6	13		
2012	21	28		4	11	18	25		1	8	15	22
2013	20	27		3	10	17	24	31	7	14	21	

Table 2. Time of treatment by drip irrigation system

Year of research	July				August					September								
2011	25	27	29	31	2	4	6	8	10	1	3	5	7	9				
					12	14	16	18	20	11	13	15	17					
					22	24	26	28	30									
2012	18	20	22	24	1	3	5	7	9	2	4	6	8	10				
					26	28	30		11	13	15	17	19	12	14			
									21	23	25	27	29					
									31									
2013	21	23	25	27	2	4	6	8	10	1	3	5	7	9				
					29	31			12	14	16	18	20	11	13	15	17	
									22	24	26	28	30					

After harvesting the curds of the cauliflower was measured the weight of each curd by using a scale, while the total yield per hectare was calculated by multiplying the average yield of the plant with the number of plants per hectare (25 000 plants).

The analysis for the chemical composition of the curds are made by the following methods:

- Total content of water and dry matter in the curds is determined by drying the fresh plant material at a temperature of 105°C to constant weight (Sarić, 1990);
- Proteins are determined by the method of Kjeldahl (Sarić, 1990);
- The content of fiber is determined gravimetric;
- The total protein content is determined accrual % of total nitrogen x 6.25 (Jekic, 1988);
- Calcium is determined by atomic absorption spectrophotometry (Sarić, 1990).

Statistical analysis were made with a computer program SPSS, v19.0.

Results and discussion

Harvesting cauliflower can be done by uprooting the whole plant, then cut the leaf stalks, outer leaves are cut at the base, leaving 3 to 5 leaves for protection of the curd. Harvesting is successive, and the yield ranges from 20 to 50 t/ha (Đurovka, 2008). The average yield in the three years of testing in our research showed highly statistically significant differences between all variants. The average yield of the curds of the cauliflower in the three years of testing ranged from 34 161,46kg/ha for the control, 40 824,22 kg/ha for V-1 and the B-2 average yield was 46 548 18 kg / ha.

Table 3. Average values and standard error for the average yield in cauliflower in kg/ha

Variants	Mean	Standard deviation	Error of the mean (\pm SE)
Control	34 161,46	5920,83	604,29
V-1	40 824,22	5961,40	608,43
V-2	46 548,18	9195,66	938,53

Analysis of the values for the yield of the cauliflower per hectare between the variants made by the method of analysis of variance showed highly statistically significant differences ($p < 0.01$) between all of the factors of variation.

Table 4. Results of the analysis of variance for the average yield in cauliflower with different ways of applying the microbiological fertilizer

Source of variation	Sum of squares (SS)	Degrees of freedom (df)	Mean square (MS)	F	Sig.
Between groups	7 378 780 056,424	2	3 689 390 028,212	71,336	0,000***
Within groups	14 739 714518,229	285	51 718 296,555		
Total	22 118 494574,653	287			

Table 5. LSD - test for the average yield in cauliflower

Dependent variable		Difference between means	Standard error	Sig.	Confidence interval 95%		
					Lower bound	Upper bound	
Yield	Control	V-1	-6662,76*	1038,01	0.000	-8705,90	- 4619,62
		V-2	-12386,71*	1038,01	0.000	-14429,86	-10343,58
	V- 1	Control	6662,76*	1038,01	0.000	4619,62	8705,90
		V-2	-5723,95*	1038,01	0.000	-7767,10	-3680,82

The data in Table 5 show a statistically significant difference ($p < 0.001$) between all tested variants.

Bambal et al. (1998) has studied the effect of bio fertilizers (by dipping of seedlings) and nitrogen on the growth and yield of cauliflower. Different treatments were applied using *Azotobacter* and *Azospirillum* individually and in combination with different doses of nitrogen, 0, 50, 75 and 100% of the recommended doses of 125: 75: 60 kg/ha N: P₂O₅ and K₂O. In addition, treatment

with *Azospirillum* and *Azotobacter* and 100% of nitrogen, has resulted with obtaining the highest yield (29,64 t/ha) and the shortest vegetation period.

Islam et al. (2014), in their research for the effect of the bioinoculant on the characteristics of the cauliflower found that dipping of the root seedlings in bio-fertilizer significantly impacts on the growth and yield of the cauliflower. They assume that increased growth and yield is due to increased availability, solubility and mobility of nutrients, because of the made bioinoculation of the the seedlings.

Cauliflower features a slightly higher nutritional value than the cabbage. The water content in the cauliflower curds is around 92%, carbohydrates around 5.3%, 1.98% protein and contains very little fat around 0,10% (Červenski and Gvozdenović, 2007). In addition, cauliflower contain quite minerals and vitamins. From the minerals highest contained are potassium, sulfur, phosphorus and calcium, while from the vitamins the vitamin C is present with the highest content.

The results of the analyses for the percentage of water in curds of the cauliflower during the three years of research are presented in Table 6.

Table 6. Average values for the water content in % in the curds of the cauliflower for the three variants in 2011, 2012 and 2013

Year	Control	V-1	V-2
2011	92,37	93,63	93,14
2012	92,04	90,49	92,34
2013	91,73	90,28	91,41
Average	92,04	91,46	92,29

During the three years of research lowest percentage of water content was obtained in the curds of the V-1 from 90.28% in 2013, while the highest percentage of water from 93.63% was also obtained in the curds of V-1 in 2011. The highest average water content for the three years of research was obtained in the curds of V-2 from 92.29%, and the lowest from 91.46% in V-1. According to Lešič et al. (2002), the cauliflower contains a relatively high percentage of water from 90.9 to 94.5%.

From technological aspect, the content of dry matter in plant products is a major factor in determining the quality characteristics of the products themselves.

Table 7. Average values for the dry matter content in % in the curds of the cauliflower, for the three variants in 2011, 2012 and 2013

Year	Control	V-1	V-2
2011	7,63	6,37	6,86
2012	7,96	9,59	7,66
2013	8,27	9,72	8,59
Average	7,95	8,56	7,70

From the data in Table 7 for the content of dry matter in the curds of the cauliflower, can be seen that the lowest content was 6.37% in V-1 in the year 2011, and the highest was 9.72% also in V-1 in 2013. The average content of dry matter in the three years of testing was highest in V-1 where it was 8.56%, while the lowest it was in the V-2 from 7.70%.

From the scientific research for the application of bio-fertilizers combined with mineral fertilizers, Khurana et al. (2009), determined the effect on the increase of the dry matter in the curds of the cauliflower. The highest content was determined in the curds where it was applied *Azotobacter* with a recommended dose of a mineral fertilizer (N: P: K 120 60 60 kg/ha), where the percentage of dry matter was 8.33% in 2007 to 9.30% in 2008.

Fiber found in fruits, vegetables, grains and legumes are characterized as a kind of carbohydrates that are not absorbed by the body. There are two types of fiber, soluble and insoluble.

Table 8 shows the average values for the content of fiber in the curds of the cauliflower in the three years of research for the three variants.

Table 8. Average values for the fiber content in % in the curds of the cauliflower, for the three variants in 2011, 2012 and 2013

Year	Control	V-1	V-2
2011	20,60	26,15	26,69
2012	31,37	26,98	31,07
2013	27,30	28,22	29,08
Average	26,42	27,12	28,95

The content of fiber in the curds of the cauliflower has the lowest with the control in 2011 from 20.6% of, and the highest was also in the control in 2012 from 31.37%. According to the average values for the three years of research, the percentage of fiber was highest in V-2 with 28.95%, while lowest it was in the control with an average value of 26.42%.

Plant proteins are containing many amino acids, but not a single plant product contains all of the essential amino acids. The average protein content in curds of the cauliflower according to Tudzarov (2011), is around 3.3%, while according to Lešič et al. (2002) the proteins are present from 1.5 to 2.72%.

Table 9 shows the percentages of protein per year and the average protein content in the three years of research.

Table 9. Average values for the proteins content in % in the curds of the cauliflower, for the three variants in 2011, 2012 and 2013

Year	Control	V-1	V-2
2011	1,92	2,03	2,20
2012	1,98	2,08	2,28
2013	2,30	2,34	2,72
Average	2,07	2,15	2,40

The lowest percentage of protein from 1.92% was observed in the control in 2011, while the highest from 2.72% was in V-2 in 2013. According to the average values for the three years of testing, protein content was the lowest in the control from 2.07%, then in V-1 from 2.15% and in V-2 it was highest with 2.4%.

The calcium content in the curds of cauliflower, according to Lešič et al. (2002), ranges from 17 to 31 mg/100 g, and according to Tudzarov (2011) the content of calcium in the cauliflower is 53 mg/100 g.

Table 10. Average values for the calcium content in mg/100 g in the curds of the cauliflower, for the three variants in 2011, 2012 and 2013

Year	Control	V-1	V-2
2011	50,00	70,00	112,00
2012	87,00	69,00	113,00
2013	96,00	99,00	150,00
Average	87,60	79,30	125,00

From Table 10 may be noted that the content of calcium in the cauliflower's curds was highest in V-2 with 150 mg/100 g in 2013, while the lowest calcium content was noted in the control from 50 mg/100 g in 2011. From the data it can be seen that in 2013 the three variants have significantly higher calcium content than previous two years. The average values for the three years showed that V-1 has the lowest calcium content of 79,3 mg/100 g, while V-2 has the highest content of calcium of 125 mg/100 g.

Conclusions

From the results obtained in the three years research for the impact of the microbiological fertilizer Slavol on the important economic properties of the cauliflower (*Brassica oleracea* L.var. *botrytis*), we can make the following conclusions:

- The average yield of the curds for the three years of testing ranged from 34 161,46 kg/ha for the control, 40 824,22 kg/ha for V-1 and 46 548,18 kg/ha for V-2. Statistical analysis of the data showed highly statistically significant differences among the three studied variants.
- The average content of water, fiber, calcium and protein was highest in the curds of V-2;
- The average dry matter content was highest in the curds of V-1.

References

- Bambal AS, Verma R.M, Panchbhai D.M, Moharkar V.K and Khankhane R.N (1998). Effect of biofertilizers and nitrogen levels growth and yield of cauliflower (*Brassica oleracea* var. *botrytis*). *Orissa J.Hortic* 26(2): 14-17;
- Bashyal L.N. (2011), Response of cauliflower to nitrogen fixing biofertilizer and graded levels of nitrogen. *J. Agri. Env.*, 12: 41-50;
- Dick W.A. and Gregorich E.G. (2004), Developing and maintaining soil organic matter levels. In: *Managing Soil Quality: Challenges in Modern Agriculture*, Schjonning P., Elmbolt S. and Christensen B.T. (Eds.), CAB International, Willingford, UK pp. 103-120;
- Islam S., Chatterjee R., Datta S. (2014). Effect of bio-inoculants on the performance of cauliflower (*Brassica oleracea* var. *botrytis* L.). *Journal of Crop and Weed*, 10 (1): 93-97;

- Jekič M., Brkovič M., Doberdoljani B., (1988), Praktikum iz agrohemije sa ishranom bilja, Poljoprivredni fakultet, Priština;
- Keck A.S. (2004), Cruciferous vegetables: cancer protective mechanisms of glucosinolate hydrolysis products and selenium. Integrative Cancer therapies 3: 5-12;
- Khurana D.S., Muthreja N., Gangwar M., Kulbir S. (2009). Influence of biofertilizers on growth, yield and quality of late cauliflower (*Brassica oleracea* var. *botrytis*). Haryana J. hortic. Sci., 38: 147-149;
- Lešić R., Borošić J., Buturac I., Ćustić M., Poljak M., Romić D. (2002). Povrčarstvo. Čakovec; Najdenovska O., Čolo J. (2012). Izvorizagađzenjaagroekosistema. Monografija. Univerzitet u Sarajevu, Poljoprivredno- prehrambenifakultet;
- Sarić D. (1990 drugo izdanje). Praktikum iz fiziologije bilja;
- Sharma A., Kumar P., Parmar D.K., Singh Y. and Sharma K.C., (2009), Effect of bio-inoculants and graded level of biofertilizers on growth, yield and nutrient uptake in cauliflower (*Brassica oleracea* var. *botrytis* L.) Veg Sci 36 (3 Suppl.): 344-348;
- Đurovka M., Lazić B., Bajkin A., Potkonjak A., Marković V., Ilin Ž., Todorović V. (2008). Proizvodnja povrća i cveća u zaštićenom prostoru. Univerzitet u Novom Sadu, Poljoprivredni fakultet.

EFFECTS OF BRT[®] EVERGREEN AND AQUA +3 APPLICATION ON *AQUILEGIA FLABELLATA* VAR. *PUMILA* AND *PELARGONIUM PELTATUM* 'RAINBOW ROSE'

Ildikó KOHUT, Anna RADÓ-TAKÁCS*, Ildikó RISZTER, Andrea TILLYNÉ MÁNDY

Department of Floriculture and Dendrology, Szent István University, Budapest, Hungary

*Corresponding author: takacs.annavera@gmail.com

Abstract

Nowadays, climate change is a serious problem in the world. The water management has become increasingly important because of the temperature increasing and the precipitation decreasing. The water holding capacity of the growing media have major role in the ornamental plant production. During our work, two moisture controlling agents, such as Finnish BRT[®] Evergreen in 10 v/w% and German Aqua +3 in 8 g/l and 16 g/l were applied in *Aquilegia flabellata* var. *pumila* and *Pelargonium peltatum* 'Rainbow Rose' production. Plant diameter, plant height, fresh weight, root parameters, chlorophyll content, phosphorous and potassium content of media were measured. BRT[®] had significant effects on plant diameter and plant height of *Aquilegia* and also doubled the chlorophyll content. BRT[®] had 50% increase in plant height of *Pelargonium*. The fresh weight was doubled and tripled by Aqua+3 (16 g/l) and BRT[®] as well. Aqua+3 (8 g/l) doubled and Aqua+3 (16 g/l) and BRT[®] tripled the number of roots. Aqua+3 (8 g/l) had 50% increase in root length and root weight. Chlorophyll content had 50% increase by Aqua+3 (16 g/l) and was doubled by BRT[®]. In the soil mixture of BRT[®]-containing group 50% of potassium and 150% phosphorous was measured comparing to the control. The results proved that the use of BRT[®] Evergreen and Aqua +3 have economic benefit for plant growers. With these products, the plants have more fresh weight without more irrigation water. Stress tolerance of plants is getting better using of these agents.

Keywords: *moisture controlling agents, chlorophyll, fresh weight, plant height*

Introduction

Nowadays, climate change is a serious problem in the world. The water management has become increasingly important because of the temperature increasing and the precipitation decreasing. The water holding capacity of the growing media have major role in the ornamental plant production. The decreasing of water consumption, the moisture controlling agents such as the Finnish BRT[®] EverGreen and German Aqua+3 (Geohumus[®]) have important role in the cultivation.

In the last decades, soil amendments and moisture controlling agents were tested in the horticultural production. Superabsorbents (hydrogels or superabsorbent polymers) are synthetic substances and water-insoluble polymers (PORA *ET AL.*, 2015). It has got the ability to swelling in water and retaining of water within their structure (ZOHURIAAN-MEHR AND KABIRI, 2008). Zeba[®] increased moisture conservation and nutrient use efficiency of cotton (NGOBEN *ET AL.*, 2007) and Zeba[®] particles hold moisture in the soil of oat, onion and watermelon (VIZTIU *ET AL.*, 2014). Stockosorb[®] reduced the required water of the soils (ABEDI-KOUPAI AND ASADKAZEMI, 2006), had a positive effect on turfgrass (ZHENG *ET AL.*, 2005) and had better water holding capacity on *Salvia officinalis* (SAVI *ET AL.*, 2014). The mineral-polyacrylate water absorbent Geohumus[®], helped to improve soil water content, reduce plant stress, and extend plant survival period of

Dianthus chinensis, *Mukdenia rossii* and *Pachysandra terminalis* (LI ET AL., 2016), decreased irrigation application rate of *Hydrangea macrophylla* (KAPSIMALIS ET AL., 2011) and responded stronger drought stress on *Zea mays* (DUONG AND ASCH, 2012). Hydrogel enhanced the efficiency of water uptake and utilization of photosynthetic products of *Eucalyptus* species grown in soil (ORIKIRIZA ET AL., 2009), increased salt stress tolerance of turfgrass (HADAM ET AL., 2011), improved nutrients uptake efficiency of *Solanum tuberosum* (FARIED ET AL., 2014) and also increased root and shoot biomass of *Fagus sylvatica*, *Picea abies* and *Pinus sylvestris* (ORIKIRIZA ET AL., 2013).

Material and Methods

Aquilegia flabellata var. *pumila* seeds were sown and *Pelargonium peltatum* cuttings were grown in the greenhouse of the Department of Floriculture and Dendrology, Szent István University, Budapest in 2013. The processing of samples was performed in the labour of the Department of Floriculture and Dendrology and Department of Soil Science and Water Management, Szent István University, Budapest.

Aquilegia flabellata var. *pumila* (Huth) Kudo (syn. *A. japonica* Dwarf.) is a 10-15 cm high perennial. Native in Japan, Kurilen, Sachalin and Korea. The flower stems reach up to 20 cm. Leaves are lacy and often coloured red. Species can be planted in rock garden (JELITTO AND SCHACHT, 1990, RICE, 2006).

Pelargonium peltatum is one of the most popular potted balcony ornamental plant. Rainbow series are a big and simple flower geranium with compact habit and does not require to deadhead. 'Rainbow Rose' is pink flower geranium (FELTWELL, 2001).

The moisture controlling agent Aqua+3 is composed polymerization of various substances and volcanic rocks is added. It contains bentonite, sand, magnesium oxide, calcium oxide and water-insoluble polyacrylate. This product is able to store up to 130% of its volume. Aqua+3 is reduced the leakage of water and evaporation. Mineral elements of Aqua+3 help the growth of seedlings and the biomass. It provides several years of intense growth, soil ventilation, nutrients and minerals better use and a 30% reduced rate of irrigation (DUONG, 2012).

The Finnish developed BRT[®] EverGreen is a moisture control and soil amendment product. It is composed of methylene-urea resin. During the manufacturing, phosphorous acid is added and after the foaming, wetting agent is added. It is a slow releasing nitrogen and phosphorous fertilizer as well. The product is hydrophilic, able to store up to 90% of its volume and release it slowly to plant root systems and also provides roots with extra oxygen needed for growth. Using of this product, the number of irrigations and the amount of water used for irrigation will be reduced. The recommended concentration is between 10% and 30% (REMES, 2014).

Three treatment groups (control (C), 8 g/l Aqua+3 and 10 g/l BRT[®] EverGreen) were set up for *Aquilegia flabellata* and four treatment groups (control (C), 8 g/l and 16 g/l Aqua+3 and 10 g/l BRT[®] EverGreen) were set up for *Pelargonium peltatum*. Plant height (cm), diameter (cm) and chlorophyll content were examined on *Aquilegia flabellata*. Plant height (cm), fresh weight (g), root weight (cm), root number, root length (cm) and chlorophyll content were examined on *Pelargonium peltatum*. During soil testing the available phosphorous and potassium were examined.

To determine chlorophyll content, 300 mg leaf samples were collected. With quartz sand the samples were homogenized and completed with 80 % Acetone solution to 10 ml. After 24 hour rest the light absorbance of the solution was measured on 663, 644 and 480 nm wave length (ARNON, 1949).

Available phosphorous and potassium content were determined with acid ammonium lactate extraction (EGNÉR *ET AL.*, 1960).

Statistical analysis was performed by IBM® SPSS STATISTICS (Version 22) by 95% significance level. One-way ANOVA model was used to compare the varieties. The assumptions of homogeneity of variance were hold. Normality of residuals was proved by Kolmogorov-Smirnov test. Pairwise comparisons were run by Tukey’s Post Hoc test (TABACHNICK AND FIELDS, 2013).

Results and Discussion

Aquilega flabellata var. *pumila*

Plant height, plant diameter and chlorophyll content were examined on *Aquilegia flabellata* var. *pumila* (Table 1.).

We detected significant differences between treatments groups for plant diameter [F(3;57)=304.148; p<0.001]. BRT® group was significantly wider than the Aqua+3 and control groups. The product approx. 1 cm increased the diameter of plant.

Significant differences were detected for plant height [F(2;57)=776.269; p<0.001]. BRT® group and Aqua+3 were significantly higher than the control group. The differences were 1.2-fold. The height of plant is one of the most important quality properties.

The chlorophyll content was detected by laboratory measurements, on average samples. All of the treatment groups significantly differed from the control [F(2;12)=587.398; p<0.001]. BRT® doubled the chlorophyll content. Aqua+3 1.5-fold increased the chlorophyll content. Higher concentration of chlorophyll increases photosynthetic activity which makes better “fitness” of plants.

Table 1. The results of morphological characteristics and chlorophyll content of *Aquilegia flabellata* var. *pumila*.

	Plant diameter	Plant height	Chlorophyll content
C (control)	13.84 a	4.32 a	558.7 a
Aqua+3 8 g/l	14.27 b	5.18 b	833.9 b
BRT® EverGreen 10 g/l	15.12 c	5.58 b	1315.6 c

Pelargonium peltatum ‘Rainbow Rose’

Plant height, fresh weight, root weight, root number, root length and chlorophyll content were examined on *Pelargonium peltatum* (Table 2.).

We detected significant differences between treatments groups for plant height [F(3;56)=7.308; p<0.001]. BRT® group was significantly higher than the other treatment groups. The product 1.5-fold increased the height of plant. This result may be remarkable in ornamental plant production. Soil amendments, Hydrogel doubled the height of potato seedlings (FARIED *ET AL.*, 2014). The height of plant is one of the most important quality properties. The results (7 cm higher) may be remarkable in the ornamental plant production, it could result more marketable seedlings.

Significant differences were detected for fresh weight [F(3;56)=40.624; p<0.001]. All of the treated groups differed from the control. 8 g/l Aqua+3 was approx. 1.5-fold increased the fresh weight. 16 g/l Aqua+3 doubled and BRT® 2.5-fold increased the fresh weight. It is an important

result. The bigger fresh weight means greater leaf area with greater photosynthetic surface which increases plant productivity.

We detected significant differences for weight of roots [F(3;56)=4.831; p=0.008]. Plants of 8 g/l Aqua+3 treatment group became significantly heavier than the control. The difference was 1.5-fold. The same trend was observed for number of roots and the fresh weight. Significant differences were between the treatments groups [F(3;99)=106.217; p<0.001]. All of the treatments groups differed from the control. 8 g/l Aqua+3 doubled, 16 g/l Aqua+3 and BRT[®] 2.5-fold increased the number of roots. Length of roots had the same trend as the weight of roots. 8 g/l Aqua+3 had significantly longer roots than the control [F(3;56)=3.823; p=0.015]. The difference was 1.5-fold. At first we thought that the reason for the marked difference of root length was phosphorus deficiency, but the soil examination did not substantiated it. More roots could have better nutrient uptake which makes better “fitness” for plants. The result of the roots may be important for the growers.

Physiological conditions were examined by chlorophyll content. The chlorophyll content was detected by two laboratory measurements, on average samples. At the first time BRT[®] group significantly differed from the control [F(3;16)=4.371; p=0.020]. BRT[®] approx. doubled the chlorophyll content. At the second measurement we did not able to detect significant differences between the treatments group [F(3;16)=0.969; p=0.431]. Some medium additives such as biochar or humic acid increased the chlorophyll content of *Calathea insignis* (ZHANG ET AL., 2014). Higher concentration of chlorophyll increases photosynthetic activity which makes better “fitness” of plants.

Table 2. The results of morphological characteristics and chlorophyll content of *Pelargonium peltatum* 'Rainbow Rose'.

	plant height		fresh weight		root weight		root number		root length		chlorophyll content (2013)		chlorophyll content (2014)	
C (control)	10.13	a	2.32	a	1.67	a	10	a	20.33	a	337.0	a	365.4	a
Aqua+3 8 g/l	10.46	a	3.14	b	2.67	b	19	b	30.83	b	389.1	ab	399.4	a
Aqua+3 16 g/l	12.43	a	5.06	c	2.04	ab	26	c	25.83	ab	584.1	ab	456.9	a
BRT[®]	17.20	b	6.35	c	1.85	a	26	c	21.50	a	640.1	b	454.6	a

We detected significant differences between treatment groups for the potassium and phosphorous content of medium (Table 3.). All of the treated groups differed from the control [F(3;16)=1061.448; p<0.001]. BRT[®] reduced by half the potassium content. All of the treated groups also differed from control for phosphor content [F(3;16)= 452.560; p<0.001]. BRT 1.5-fold increased the phosphorous content. Several measurements were taken with the nutrient uptake of geraniums. The added phosphor had positive effect on foliar magnesium and potassium content (SEDIBE AND ALLEMANN, 2012). Phosphorous stress reduced the number of shoots and flowers (BAAS ET AL, 1995). In peat grown geranium, higher nitrogen content and lower potassium content was measured than in cork oak bark (AGUADO ET AL., 1993). Foliar Ca, P and

K content significantly differed from control for the phosphorus concentration in the nutrient solution (SEDIBE AND ALLEMANN, 2013). Potassium application had positive effect on plant height, potassium tissue content and oil composition (KHETSHA AND SEDIBE, 2015). In the case of our results, all of the treatment groups contained appropriate amount phosphorous for growing of geranium but BRT[®] had negative effect for potassium content. Nevertheless, there were no deficiency symptoms in plants, because of the short examination time.

Table 3. The potassium and phosphorous content of medium.

	Potassium content (mg/100 g)	Phosphorous content (mg/100 g)
C (control)	285 a	135 a
Aqua+3 8 g/l	256 b	155 b
Aqua+3 16 g/l	263 b	150 b
BRT[®] 10 g/l	149 c	220 c

Conclusions

Aquilegia flabellata var. *pumila* and *Pelargonium peltatum* ‘Rainbow Rose’ treated with two moisture control agents.

BRT[®] EverGreen and also Aqua+3 increased the plant height, plant diameter and chlorophyll content of *Aquilegia flabellata* var. *pumila*. BRT[®] doubled the chlorophyll content and 1.5-fold increased the height of plants. BRT[®] EverGreen increased the plant height and fresh weight of *Pelargonium peltatum*. Both characteristics were 1.5-fold higher than the control. 8 g/l Aqua+3 increased the root length and root weight. It is excluded that 1.5-fold longer roots was caused by phosphorus deficiency. BRT[®] EverGreen doubled the chlorophyll content. These are remarkable in practical aspect as well. These results may be important for growers to improve the most important morphological characteristics during ornamental plant production. All of the treatment groups contained appropriate amount phosphorous for growing of geranium but BRT[®] had negative effect for potassium content.

Summarizing, further experiments are suggested. Using of these agents is recommended on *Aquilegia flabellata* var. *pumila* and *Pelargonium peltatum* ‘Rainbow Rose’.

References

- ABEDI-KOUPAI, J., ASADKAZEMI, J. 2006. Effects of a Hydrophilic Polymer on the Field Performance of an Ornamental Plant (*Cupressus arizonica*) under Reduced Irrigation Regimes. *Iranian Polymer Journal*, 15(9): 715-725.
- AGUADO, M.T., ORTEGA, M.C., MORENO, M.T., SUAREZ, M.P. 1993. Growth and nutrient content of *Pelargonium* grown in cork oak bark substrate. *ISHS Acta Horticulturae* 342: 293-296.
- ARNON, D.I. 1949. Copper enzymes in isolated chloroplasts. Polyphenoloxidase in *Beta vulgaris*. *Plant Physiology*, 24(1): 1-15.
- BAAS, R., BRANDTS, A., STRAVER, N. 1995. Growth regulation of bedding plants and Poinsettia using low phosphorous fertilization and ebb-and flow irrigation. *ISHS Acta Horticulturae*, 378: 129-137.

- DUONG, V.N., ASCH, F. 2012. Effects of Geohumus on physiological traits of maize (*Zea mays* L. cv. Mikado) under variable water supply. Tropentag, September 19-21, 2012, Göttingen - Kassel/Witzenhausen (abstract)
- DUONG, V.N. 2012. Environmental effects on physical properties of Geohumus and effects of its application on drought responses in maize. PhD dissertation. University of Hohenheim. Faculty of the Agricultural Sciences.
- EGNÉR, H., RIEHM, H., DOMINGO, W.R. 1960. Studies on the chemical analysis of the soil as the basis for assessing the nutritional status of the soil (in German: Untersuchungen über die chemische Bodenanalyse als Grundlage für die Beurteilung des Nährstoffzustandes der Böden). Ann. Royal Agricultural Collage. 26, Sweden, 199-215.
- FARIED, H.N., PERVEZ, M.A., AYYUB, C.M., YASEEN, M., BUTT, M., BASHIR, M. 2014. Effect of soil application of humic acid and Hydrogel on morphophysiological and biochemical attributes of potato (*Solanum tuberosum* L.). Pakistan Journal of Life and Social Sciences, 12(2): 92-96.
- FELTWELL, J. 2001. Geraniums and Pelargoniums. Anova Books. ISBN: 9781855858459. p. 128.
- HADAM, A., WROCHNA, M., KARACZUN, Z. 2011. Effect of hydrogel on the turf grass species growing under salt stress. Annals of Warsaw University of Life Sciences – SGGW Land Reclamation, 43(1): 47–55.
- JELITTO, L., SCHACHT, W. 1990. Hardy Herbaceous perennials. Volume I. A-K. Timber Press. Inc. 51-54. p.
- KAPSIMALIS, M.T., OWEN, J. S., JR. STOVEN, M., STOVEN, H.M., ALTLAND, J.E. 2011. Response of containerized *Hydrangea macrophylla* 'Endless Summer' to a mineral-polyacrylate substrate amendment and reduced overhead water application. SNA Research Conference, 56: 260-265.
- KHETSHA, Z.P., SEDIBE, M.M. 2015. Effect of potassium and potting-bag size on foliar biomass and related attributes and oil composition of rose geranium (*Pelargonium graveolens*). South African Journal of Plant and Soil, 32(2): 113-115.
- LI, Y., KIM, D.Y., KIM, H.B., KIM, Y. KI. 2016. Effects of Geohumus Mixed with Artificial Soil on Soil Water Retention and Plant Stress Response. Journal of the Korea Society of Environmental Restoration Technology, 19(1): 1-11.
- NGOBEN, N.D., BUTHELEZI, N.M., MATARUKA, D. 2008. Growth and yield response of cotton cultivars to „Zeba” superabsorbent polymer and N-application under irrigation. African Crop Science Conference Proceedings. 8: 213-217.
- ORIKIRIZA, L.J.B., AGABA, H., EILU, G., KABASA, J. D., WORBES, M., HÜTTERMANN, A. 2013. Effects of Hydrogels on tree seedling performance in temperate soils before and after water stress. Journal of Environmental Protection, 4: 713-721.
- ORIKIRIZA, L. J. B., AGABA, H., TWEHEYO, M., EILU, G., KABASA, J. D., HÜTTERMANN, A. 2009. Amending soils with Hydrogels increases the biomass of nine tree species under non-water stress conditions. Clean, 37(8): 615 – 620.
- PORA, E., KASZUBKIEWICZ, J., KAWAŁKO, D. 2015. Selected methodological aspects of determination of the water desorption curves of superabsorbents. Environment Protection Engineering, 41(4): 37-48.
- REMES, L. 2014. BRT EverGreen absorber grain effect on light peat and plantation growth (in Finnish: BRT EverGreen – imeytysrouheen vaikutus vaaleaan rahkaturpeeseen ja kasvien kasvuun) Master Thesis. University of Helsinki. Faculty of Agriculture and Forestry. Department of Agricultural Sciences.
- RICE, G. (edit.). 2006. American Horticultural Society Encyclopedia of Perennials, London, p. 428-432.

- SAVI, T., MARIN, M., BOLDRIN, D., INCERTI, G., ANDRI, S., NARDINI, A. 2014. Green roofs for a drier world: Effects of hydrogel amendment on substrate and plant water status. *Science of the Total Environment*, 490: 467–476.
- SEDIBE, M.M., ALLEMANN, J. 2012. Yield and quality response of rose geranium (*Pelargonium graveolens* L.) to sulphur and phosphorus application. *South African Journal of Plant and Soil*, 29(3-4): 151-156.
- SEDIBE, M.M., ALLEMANN, J. 2013. Yield and mineral response of rose geranium (*Pelargonium graveolens*) to phosphorus and two irrigation methods. *Life Science Journal*, 10(3): 884-888.
- TABACHNICK, B.G., FIDELL, L. S. 2013. *Using Multivariate Statistics*. 6th edition. Boston: Pearson.
- VIZTIU, O., CALCIU, I., SIMOTA, C., MIHALACHE, M. 2014. Soil water conservation - a measure against desertification. 14th International Multidisciplinary Scientific GeoConference SGEM, 3(2): 253-258.
- ZHANG, L., SUN, X., TIAN, Y., GONG, X. 2014. Biochar and humic acid amendments improve the quality of composted green waste as a growth medium for the ornamental plant *Calathea insignis*. *Scientia Horticulturae*, 176: 70–78.
- ZHENG, Q., WANG, X., LIU, Z., XU, M. 2005. Water-saving of Superabsorbent Polymers in Turf Establishment. *Journal of Sichuan Grassland*. 2005-10.
- ZOHURIAAN-MEHR, M.J., KABIRI, K. 2008. Superabsorbent Polymer Materials: A Review. *Iranian Polymer Journal*, 17(6): 451-477.

THE EFFECT OF N-FERTILIZATION ON *ROSMARINUS OFFICINALIS* L. (AN UPRIGHT VARIETY) YIELD IN CENTRAL GREECE

Eleni WOGIATZI-KAMWOUKOU, Nickolaos GOUGOULIAS, Zoi PAPADOULI, Baia THEODOSIOU, Kyriakos D GIANNOULIS

Department of Agronomy Technology, Technological Educational Institute of Thessaly, T.E.I., 41110, Larisa, Greece

*Corresponding author: kyriakos.giannoulis@gmail.com

Abstract

The effect of three different N-fertilization levels (N1: 625, N2: 385 and N3: 770 kg ha⁻¹; where in case of N1 was used the 3-6-10+3MgO+30% OM and in cases of N2-N3 the 26-0-0 fertilizers) on fresh and dry weight of the perennial *Rosmarinus officinalis* (upright cultivar) was investigated during the 2nd year after establishment at the Experimental Farm of the Technological Educational Institute of Thessaly in Greece (TEI; Larissa plain) in 2015. It is well documented that the crop reaches its potential yield on the third year of cultivation and continues producing biomass for as long as eight years. Complete weather data (air temperature, radiation, air humidity, precipitation) were recorded hourly in an automatic meteorological station, which was installed to the experimental farm of TEI. Upon harvest (November 3rd 2015), the crop reached a maximum fresh yield of 11.67 tons per hectare and dry yield of 4.3, respectively. The average fresh weight was 8.2, 8.4 and 8.9 t ha⁻¹ and the dry weight were 2.6, 3.1 and 3.2 t ha⁻¹ for the N1, N2 and N3 levels, respectively. Furthermore the higher moisture content was observed in the case of N1 level (68%). Therefore, the above data show that rosemary cultivation could be a promising alternative crop, especially in case of the consideration that average selling price of dry rosemary in Greece is 3.5 € kg⁻¹ and the average gross income exceeds the amount of 10.000 € ha⁻¹.

Keywords: *Rosmarinus officinalis* L., fertilization, upright variety, fresh yield, dry yield.

Introduction

Rosemary is an evergreen perennial shrub, which belongs to the class Magnoliopsida, subclass Lamiales, family of Lamiaceae or Labiate (Labiatae) which comprises up to 200 genera and about 3500 species, and it is naturally found in all of the coastal regions of the Mediterranean Sea (do Amaral Franco and daRocha Afonsa, 1972) and the genus *Rosmarinus*, *officinalis* species. The plant botanically characterized from its square stems, while leaves are opposite in pairs and arranged crosswise. Most important of all is the fragrant smell.

Generally rosemary is a plant which grows in areas where there is mild hot and cold climate. A feature of the plant is that it can be grown in lowland areas with an elevation of up to 600 meters (Dordas, 2012). *Rosmarinus officinalis* L., has been widely cultivated since antiquity as herb and garden plant, and also for its essential oil (Porte et al., 2000).

The red light affects the morphology of rosemary, the phenology as well as the essential oil. More specifically, the quantity and quality of the essential oil of rosemary which was grown in greenhouse conditions, affected by the wavelength of red light (660 nm) and dark-red (730 nm) which was applied (Mulas et al., 2006). Photoperiod is a very important factor, who irrelevant to the formation of the plant metabolic mechanism, from the production of photosynthetic carbon to determine the path that leads either to the class selection (terpenoids, phenylpropanoids) or in group selection (monoterpenes, sesquiterpenes, etc.) (Sangwan et al., 2001).

The temperature seems to be an important factor determining both the composition of the essential oil and the content of plant essential oil. The effects of temperature and moisture in growth, development and morphology of plants cannot easily be studied separately as it is closely related and interdependent environmental factors. The sum of the amount of the four main components represents the phenolic path and appears to be affected by how hot the climate is (Vokou et al., 1993). The number of flowers and their total weight was greatest at low than at high temperatures (Putievsky et al., 1997). Plants adapted to hot and dry climates environments develop small leaves, wrapped and covered with a dense coat to resist the water loss from the surface (Fitter and Hay, 1987).

Irrigation must be done depending on the precipitation of the selected region. Thus, in areas with low rainfall where plants get strong root system is necessary supplemental irrigation. In contrast, in areas with rainfall (over 500 mm) and in case that the plants have fully installed, the crop can continue to develop with minimal irrigation at critical points. Specifically, the lack of water and the water stress in rosemary reduces plant growth in contrast to the proportion of the essential oil which is increased (Leithy et al., 2006).

Rosemary is cultivated for green and dry drug and essential oil. The harvest period is determined by the desired product. Because the crop is perennial, harvest takes place from the second year of crop establishment and the plant goes into full production in the third year. The aroma of flowers diffused in the environment so attracted insects and as a result have better pollination and crossing of not self-pollinating plants (Mahmoud & Croteau, 2002).

This study was conducted in the main agricultural plain (Thessaly) to evaluate the effect of Nitrogen fertilization on the fresh and dry yield of Rosemary repens and upright (*Rosmarinus officinalis*) in Greece.

Materials and Methods

Rosemary upright was cultivated in the Farm TEI of Thessaly. The planting took place on 09.04.2014 and the harvest during its second year after establishment at the start of the flowering period when the concentration of essential oils maximized (Marquard et al., 2001). The effect of three different N-fertilization levels (N1: 625, N2: 385 and N3: 770 kg ha⁻¹; where in case of N1 was used the 3-6-10+3MgO+30% OM and in cases of N2-N3 the 26-0-0 fertilizers) on fresh and dry weight of the perennial *Rosmarinus officinalis* (upright cultivar) was investigated during the 2nd year after establishment at the Experimental Farm of the Technological Educational Institute of Thessaly (TEI; Larissa plain) in 2015. The experiment had a randomized block design and each experimental piece had an area of 16 m² with 28 plants. The leaves and shoots after harvesting were dried in a dark place at room temperature. The fresh and dry weight data were analyzed using the GenStat 7th Edition statistical package.

Results and Discussion

Soil Analysis

The soil used for the rosemary cultivation was of low organic matter content and low salinity as it is presented in the following Table 1.

Table 1. Chemical properties of the Rosemary field experiment.

Property	Soil depth (0-25) cm	Soil depth (25-50) cm
	Before transplanting	After harvest
Texture	Loam	Loam
pH (1part soil:5parts H ₂ O)	7.81 ± 0.16	7.82 ± 0.16
Electrical conductivity, extract(dSm ⁻¹) (1part soil:5parts H ₂ O)	0.11 ± 0.01	0.10 ± 0.01
Organic matter (%)	0.93 ± 0.05	0.77 ± 0.04
N-inorganic (mg kg ⁻¹)	44.8 ± 4.07	41.3 ± 3.44
K-exchangeable (mg kg ⁻¹)	373.3 ± 7.45	314.5 ± 7.86
P –Olsen (mg kg ⁻¹)	13.1 ± 1.87	10.2 ± 1.46
CaCO ₃ (%)	0.63 ± 0.07	1.04 ± 0.12

Data represent average means and SE deviation. (n)=4

Fresh Yield

In Figure 1 is illustrated the average fresh weight of rosemary as it is affected from the three different used nitrogen levels and fertilizer types. There was not found any statistical significant difference (Table 2) between the used nitrogen levels. It was found that the use of the N1 type and level of fertilizer (625 kg ha⁻¹ from 3-6-10+3MgO+30% OM) which was almost the double quantity of N2 (385 kg ha⁻¹ from 26-0-0) produced an average yield of 8.19 t ha⁻¹, yield almost the same with the produced in case of N2 level (8.36 t ha⁻¹). Moreover by increasing the quantity of the 26-0-0 to the double dose the average yield increased only by 0.54 t ha⁻¹.

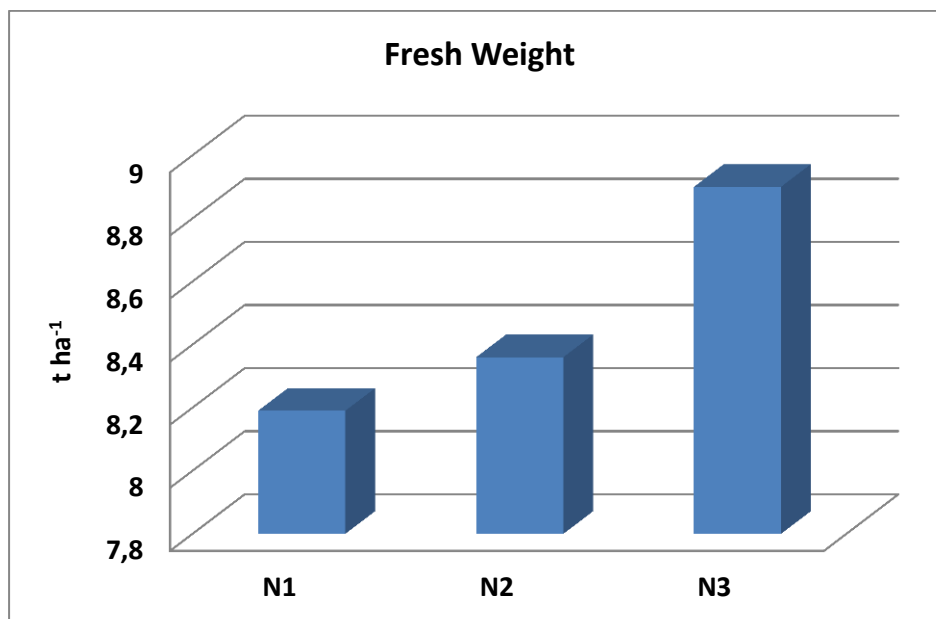

Figure 1. Fresh weight of *Rosmarinus officinalis* as affected of the three different nitrogen levels and fertilizer types.

Dry yield

Figure 2 illustrates the average dry weight of rosemary as it is affected from the three different nitrogen levels and fertilizer types. There was found no statistical difference (Table 2) for the examined factor. Verified the results of fresh weight, it was found that by increasing the quantity of the 26-0-0 to the double dose (N2 vs. N3) the average dry yield increased only by 0.15 t ha⁻¹. In case of the N1 the average dry yield was 2.64 t ha⁻¹.

Therefore, it could be assumed that N1 type is not delivering the expected results, and rosemary is a plant of low nitrogen requirements, since by increasing the dose in double, the yield of the plant does not perform statistical significant differences.

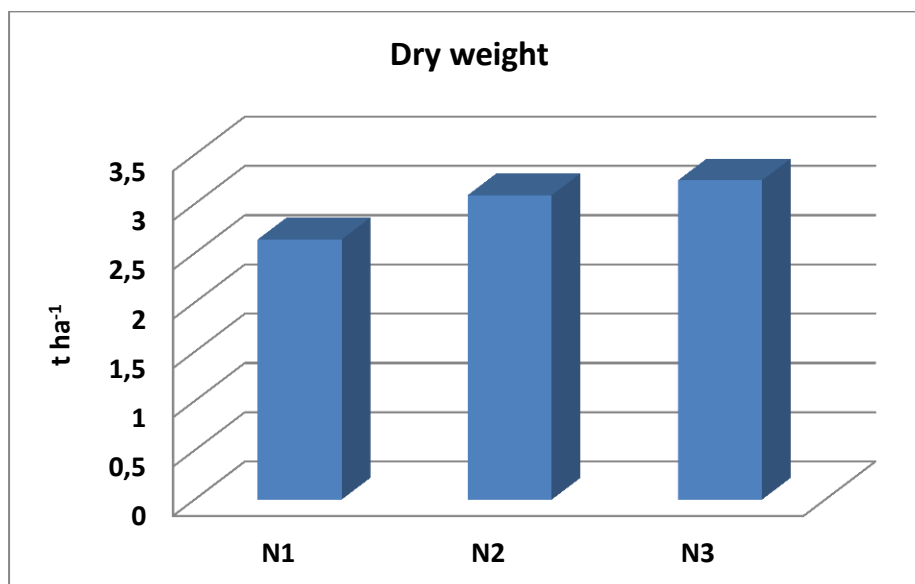

Figure 2. Dry weight of *Rosmarinus officinalis* as affected of the three different nitrogen levels and fertilizer types.

In comparison with previous studies in six different locations (Gurbuz et al., 2015) ranged between 0.55 to 0.82 t ha⁻¹, yield which is lower than the half of the produced in this study. In contrary, it was reported (Kirpik, 2005) a yield 7.82 t ha⁻¹ during the first year after establishment and reached up to 22.12 t ha⁻¹ for the year after. This high difference may best be explained by ecological conditions and different crop age. In a two year trial Sonmez (2007) yielded 1.23–2.18 t ha⁻¹ for two continuous years, which results are in agreement with those that were found. Furthermore the higher moisture content was observed in the case of N1 level and fertilizer type (68%).

Table 2. Fresh and dry weight of *Rosmarinus officinalis* under different nitrogen levels and fertilizer types.

<i>Rosmarinus officinalis</i>	Fresh Weight (t ha ⁻¹)	Dry Weight (t ha ⁻¹)
Nitrogen Levels		
N1 (625 kg ha ⁻¹ ; 3-6-10+3MgO+30% OM)	8,19	2,64
N2 (26-0-0; 385 kg ha ⁻¹)	8,36	3,09
N3 (26-0-0; 770 kg ha ⁻¹)	8,90	3,24
LSD _{0,05}	ns*	ns*
CV %	17,6	15,0

ns: non significant difference

Conclusions

The general conclusion that was found from this study is that *Rosmarinus officinalis* is a low nitrogen requirement crop, where by doubling the fertilization dose there was only observed constant voltage supremacy. The N-fertilization level of 385 kg ha⁻¹ using the 26-0-0 fertilizer type produced an average dry yield of 3.09 t ha⁻¹ setting this level as the best choice for farmers if someone will take in mind the fertilization costs. Therefore, the above data show that rosemary cultivation could be a promising alternative crop, especially in case of the consideration that average selling price of dry rosemary in Greece is 3.5 € kg⁻¹ and the average gross income exceeds the amount of 10.000 € ha⁻¹, but further investigation is necessary to be conducted as to be able to lead to safer conclusions.

References

- Amaral Franco J., da Rocha Afonsa M.L., (1972). *Rosmarinus L.* In: Tutin, T.G., Heywood, V.H., Burges, N.A., Moore, D.M., Valentine, D.H., Walters, S.M., Webb, D.A. (Eds.), *Flora Europaea, Diapensiaceae to Myoporaceae*, vol. 3. Cambridge University Press, Cambridge, p. 187.
- Dordas X., (2012). *Aromatic and Medicinal Plants*, Modern Education Publications, Thessaloniki.
- Fitter A.H. and Hay R.K.M., (1987). *Environmental Physiology of Plants*. Academic Press, London.
- Gurbuz B., Bagdat R.B., Uyanik M., Afshar Pour Rezaeieh K., (2015). Rosemary (*Rosmarinus officinalis L.*) cultivation studies under Ankara ecological conditions. *Industrial Crops and Products*, article in press.
- Kirpik M., (2005). Evaluating qualitative Rosemary (*Rosmarinus officinalis L.*) Lines growing in Arid soils of Cukurova Region. In: PhD Thesis. Cukurova University Institute of Science, Adana, 97 p.
- Leithy S., El-Meseiry T.A., Abdallah E.F., (2006). Effect of Biofertilizer, Cell Stabilizer and Irrigation Regime on Rosemary Herbage Oil Yield and Quality. *Journal of Applied Sciences Research*, 2(10): 773-779.
- Mahmoud S.S. and Croteau R.B., (2002). Strategies for transgenic manipulation of monoterpene biosynthesis in plants. *Trends plant Sci* 7: 366-373.
- Marquard R., Kroth E., (2001). *Anbau und Qualitätsanforderungen ausgewählter Arzneipflanzen*, (Cultivation and quality requirements of selected medicinal plants) Agrimedia, Bergen Dumme.
- Mulas G., Gardner Z., and Craker L.E., (2006). Effect of light quality on growth and essential oil composition in rosemary. In: *First International Symposium on the Labiatae: Advances in Production, Biotechnology and Utilisation*, Italy International Society for Horticultural Science, 427-732.
- Porte A., Godoy R., Lopes D., Koketsu M., Torquilha S.L., Torquilha H., (2000). Essential oil of *Rosmarinus officinalis L.* (rosemary) from Rio de Janeiro, Brazil. *J.Essent. Oil Res.* 12, 577–580.
- Putievsky E., Dudai N., Ravid U., (1997). In: Padulosi G. ed. *Cultivation, selection and conservation of Oregano species in Israel*. Proceedings of the IPGRI International Workshop on Oregano, 8-12 May 1996, Valenzano, Bari, Italy, 102-109.
- Sangwan N.S., Farooqi A.H.A., Shabih F., Sangwan R.S., (2001). Regulation of essential oil production in plants. *Plant Growth Regul* 34: 03-21.

- Sonmez, C., (2007). Determination of Some Agronomic and Technological Properties in Different Originated of Rosemary (*Rosmarinus officinalis* L.). In: MSc Thesis. Cukurova University, Institute of Science, Bornova-Izmir, 66p.
- Vokou D., Kokkini S., and Bessiere J.M., (1993). Geographic variation of Greel oregano (*origanum vulgare* ssp. *hirtum*) essential oils. *Biochem, Systematics and Ecol.* 21 (2): 287-295.

BREEDING LOW LINOLENIC ACID CONTENTED LINSEED VARIETIES FOR SAMSUN ECOLOGICAL CONTIDITONS

M. Safa HACIKAMİLOĞLU, Merve GÖRE*, Orhan KURT

University of Ondokuz Mayıs, Faculty of Agriculture, Department of Field Crops, Samsun, Turkey

*Corresponding author: merve.gore@omu.edu.tr

Abstract

Research results indicate that stem weight found 1.2-5.1 g per plant, seed weight 0.07-1.02 g per plant, biological weight 1.7-6.8 g per plant, plant height 40.4-57.8 cm per plant, number of branches per plant 2.6-6.5, number of capsules per plant 4.6-37, capsule weight per plant 0.14-1.7 g/plant, palmitic acid rate 5.5-6.0%, stearic acid rate 3.7-6.8%, oleic acid rate 17.6-31.0%, linoleic acid rate 10.3-55.0%, linolenic acid rate 10.1-6.1%. There were positive and significant correlation found between palmitic acid and stearic acid; positive and significant correlations found between palmitic-linoleic acid and stearic-oleic acid; significant and negative correlations found between linoleic-linolenic acid and linolenic-palmitic acid. Agricultural characters and fatty acid composition is not significantly correlated. According to our results, BxW combination has the lowest linolenic acid content and it is considerable most suitable for edible oil.

Keywords: *linseed, linolenic acid, gene pool*

Introduction

Oil is an organic substance that composes one of the essential nutrients in human and animal diets. Plant based oil is preferred by people because it is known as a good source of unsaturated fatty acids. Plant-oil composition differs with genotype and environment and these factors limit the quantity and quality of oil (Uysal and Kurt, 2014). The most common plant-oil quality factors are palmitic (C₁₆:0), stearic (C₁₈:0), oleic (C₁₈:1), linoleic (C₁₈:2) and linolenic (C₁₈:3) acid rates (Baydar and Turgut, 1999). Turkey has been importing a vast quantity of plant oil to compensate for its oil deficit. Turkey needs to develop better quality varieties, expand the cultivation areas for oil crop to increase the yield, and also find some alternative oil seed crops (Kurt, 2002; Uysal and Kurt, 2014). Linseed is one of the multi-purpose oil seed crops, which can be cultivated in any season. Linseed belongs to the *Linum* genus. The *Linaceae* family consist of 11 sub-families and 200 species but only *Linum usitatissimum* L. can be cultivated for oil and fibre production. This variety is widely cultivated in Europe, America and Asia. Some species are located naturally in Anatolia and about half of them are endemic. Varieties that have height and less branches are used for only fibre production and varieties which are shorter and with more branches are used for both seed and oil production. *Linum* seeds contain 35-45% oil content. Varieties with 45-65% linolenic acid are used for industrial purposes and varieties with low linolenic acid (< 2 %) are used for edible oils (Kurt, 1996; Kurt et al., 2005).

Linseed oil has positive effect on health due to the presence of high omega-3 fatty acid contents (especially α -linolenic acid). Several studies demonstrated that linseed oil inhibits blood clotting and prevents cardiovascular diseases and embolism. α -linolenic acid (ALA) reduces the LDL (low density lipoprotein) and inhibits arthrosis, which is known as vessel wall thickening. Linseed contains excess amounts of dietary fibre. Fibre contents are good for preventing constipation. The seed also contains SDG lignans (secoisolariciresinal diglucoside). Lignan

component improves the antioxidant properties of seeds and also good for cancer prevention. The phytoestrogens and lignans in seed composition enhance and balance the hormones especially progesterone levels in women to meliorate post-menopause problems. Researchers recommend that the daily use of 10g of linseed helps prevent cancers, constipation and forgetfulness. Recent studies indicate that linseed acts as an antioxidant and protects against diseases if the patient consumes 10g of seeds per day for a long period of time. Short-period usage is not effective. Scientist decided to blend linseed flour into bread and some other daily foods to provide a long term intake. Several studies indicate that the flavour of linseed oil is bitter when cooked and also it reduces the shelf-life. Poly-unsaturated fatty acids cause this effect more prominently. There is no low-linolenic content linseed in the *Linum* gene pool. For this reason, different studies are ongoing in this topic. In this study, high quality linseed varieties and local lines were crossbred and agronomic and biochemical analyses were done in order to evaluate linseed genotypes.

Materials and methods

This study was conducted in the research area of the Faculty of Agriculture, Ondokuz Mayıs University-Samsun (Turkey). According to the soil analysis report, it was medium in organic matter having clay-loam structure. The experiment was conducted 120 meters above sea level. Ecological conditions in 2013 were stable but a little drier than the long term annual average. Plant materials were Windermere (W), Nareum (N), Bionda (B), Antares (A), Mureş (M), local (Ay) and their some combinations [WxAys, BxWs, WxA, (WxA)xWk, WxN, (WxA)xWs, WxNs, WxAk, WxMu, (WxN)xWs, (AxW)xAs, WxWs]. The experiment was arranged according to augmented experimental design. Each experimental unit was 2m in length and contained 5 rows. The distance between the rows was 20cm. All experimental units were fertilised at the time of stem formation with ammonium nitrate. Plants were harvested when mature. Agricultural characters were analysed in 10 randomly selected plants from each line, and the rest of the plants were used for oil analysis according to Kurt et al. (2005) protocol. Statistical analysis was done with SPSS 21 and the graphs were created with Microsoft Excel.

Result and discussion

Agronomic parameters and fatty acid contents are given in Table 1&2 respectively. According to Table 1, stem weight varies between 1.2 (12) -5.1 (5) with mean value 2.6 g; seed weight 0.07 (15) -1.02 (5) g, mean 0.3 g, biological weight per plant 1.7 (16) -6.8 (5) g mean 3.2 g; plant height changed between 40.4 (4) -57.8 (13) cm, and mean 50.0 cm, number of branches changed between 2.6 (16) -6.5 (13) and mean 4.1; number of capsules 4.6 (12) -37.7 (5) and mean 14.3; capsule weight per plant 0.14 (11,12) -1.7 (5) g, mean 0.47 gr.

Fatty acid parameters are given in Table 2. According to Table 2; palmitic acid rates of all lines varied between 5.5 %(5)- 6% (2) and the mean 5.8%; stearic acid rate varied between 3.7 %(10)- 6.8 %(15), mean 4.7%. Poly-unsaturated fatty acid oleic varied between 17.6 %(4)-31.0 %(15) and mean 21.6 %; linoleic acid rate varied between 10.3 %(15)-55 %(2) and mean 43.7%; linolenic acid rate varied between 10.1 %(2)-16.1 %(9) and mean 43.7 %.

Kurt (2012) found that palmitic acid rate 6.41%, stearic acid rate 2.84%, oleic acid rate 16,47%, linoleic acid rate 37,77% and linolenic acid rate 36,49% in their hybrid plants. Literature findings are compatible with this study. Kurt (2012) has found lowest linolenic rate in WxN combination with 9.44%, but the lowest rate in this study in BxW combination with 10.07 %.

Table 1. Agronomic parameters of hybrid combinations

Combination		Plant Height (cm)	Number of Branches	Number of Capsule	Capsule Weight (g)	Biological Weight (g)	Stem Weight (g)	Seed Weight (g)
No	Name							
1	WxAys	49.83	6.50	24.67	0.78	4.80	4.02	0.46
2	BxWs	52.33	4.00	8.00	0.20	3.95	3.75	0.10
3	WxA	45.50	4.20	6.00	0.20	2.21	2.01	0.12
4	(WxA)xWk	40.40	5.20	24.80	0.49	3.10	2.32	0.40
5	WxN	55.00	5.38	37.63	1.70	6.78	5.08	1.02
6	WxN(1)	52.00	3.86	11.86	0.46	2.52	2.02	0.29
7	(WxA)xWs	49.38	4.50	12.50	0.47	3.75	3.28	0.46
8	WxNs	49.08	4.00	12.08	0.59	3.42	2.82	0.55
9	WxN(2)	46.58	5.17	13.08	0.38	2.99	2.61	0.22
10	WxN(3)	49.44	2.88	15.50	0.60	2.88	2.28	0.27
11	(WxN)xWs	49.56	4.00	10.78	0.14	2.49	2.07	0.22
12	(AxW)xAs	42.21	2.79	4.57	0.14	2.49	1.18	0.08
13	WxAk	57.75	3.25	11.75	0.32	3.23	2.90	0.28
14	WxMu	56.31	3.85	18.00	0.46	3.07	2.61	0.19
15	WxN(4)	52.20	2.83	8.08	0.28	1.84	1.56	0.07
16	WxWs	52.10	2.65	8.55	0.31	1.74	1.43	0.16

Linum bienne populations from different locations showed variations in fatty acid compositions. The palmitic acid rate changed between 5.47% - 8.58%, stearic acid rate 0.00% -6.51%, oleic acid rate 12.72%-37.13%, linoleic acid rate 5.22%-13.25% and linolenic acid rate 42.47%-70.85% (Uysal and Kurt, 2014). In this study, linolenic acid content is relatively lower and oleic acid rate is higher than the findings above.

Table 2. Oil compositions of hybrid combinations

Combination		Fatty Acid Contents (%)				
No	Name	Palmitic	Stearic	Oleic	Linoleic	Linolenic
1	WxAys	5.77	4.95	19.43	16.05	53.80
2	BxWs	6.69	5.94	22.28	55.01	10.07
3	WxA	5.55	3.82	19.22	29.35	42.06
4	(WxA)xWk	5.74	4.03	17.64	19.57	53.02
5	WxN	5.50	3.80	20.91	24.94	44.85
6	WxN(1)	5.77	4.38	20.91	36.25	32.69
7	(WxA)xWs	6.14	4.67	22.37	26.56	40.25
8	WxNs	5.76	5.45	21.87	15.75	51.17
9	WxN(2)	5.55	4.05	20.60	15.73	54.06
10	WxN(3)	5.81	3.71	20.44	18.81	51.24
11	(WxN)xWs	5.72	4.57	20.70	27.91	41.10
12	(AxW)xAs	5.91	4.85	21.73	18.84	48.67
13	WxAk	6.33	5.67	26.00	26.48	35.52
14	WxMu	5.65	4.59	18.84	26.74	44.17
15	WxN(4)	5.74	6.78	31.00	10.31	46.17
16	WxWs	5.58	4.17	20.50	19.61	50.14

Statistical correlations on fatty acids are given in Table 3. As seen in the chart; a significant positive correlation is found between palmitic and stearic acid ($r= 0.558$) and a significant negative correlation is found between linolenic acid and linoleic acid ($r= -0.932$).

Linseed oil quality is commonly affected by oleic and linolenic acid levels. Studies have shown that linoleic acid level increases by the linolenic acid decrease because of the reduction enzyme absence. This mechanism causes a negative correlation between linoleic and linolenic acid rates (Green, 1986). The findings of this study are compatible with this literature.

There is an association between linoleic and linolenic acid being broken in this generation and prospective relations can be estimated that this relation will not be seen in future generations. Other fatty acids are not related to linolenic content and will not affect future generations. This explains linoleic-linolenic and linolenic-palmitic correlations.

Table 3. Correlations between fatty acids

	Palmitic	Stearic	Oleic	Linoleic	Linolenic
Palmitic	1	0.558*	0.320	0.624**	-0.759**
Stearic		1	0.801**	0.065	-0.384
Oleic			1	-0.154	-0.210
Linoleic				1	-0.932**
Linolenic					1

*Correlation is significant at the 0.05 level (2-tailed); **Correlation is significant at the 0.01 level (2-tailed).

Conclusion

The aim of creating a gene pool is to develop a high quality edible linseed oil. In order to achieve this aim, several lines were crossed to obtain low-linolenic linseed lines. According to the results, BxWs combination produced the lowest linolenic content (10.07%). Phenotypic parameters are not associated with oil parameters. On the other hand, the negative correlations found between linoleic and linolenic acid seem promising for developing better quality linseed varieties, however, further studies are required. New linseed genotypes with low linolenic and high oleic acid content would be beneficial for the Turkish market.

References

- Baydar, H., Turgut, İ. 1999. Variations of Fatty Acid Composition According to Some Morphological and Physiological Properties and Ecological Regions in Oilseed Plants. Turkish Journal of Agriculture and Forestry, 23(1): 81-86.
- Green, A. G. 1986. Genetic Control of Polyunsaturated Fatty Acid Biosynthesis in Flax (*L. usitatissimum*) Seed Oil., Theor. Appl. Genet., 72: 654-661.
- Kurt, O. 1996. An Investigation on Yield and Yield Components and Some of the Agricultural Characters of Linseed (*Linum usitatissimum* L.) Cultivars. Journal of Agricultural Faculty of OMU, 1996, 11(1): 87-92.
- Kurt, O. 2002. Tarla Bitkileri Yetiştirme Tekniği (Field Crops Cultivation). Textbook of Agriculture Faculty of OMU, No: 44.
- Kurt O., Doğan, H., Demir, A. 2005. An Investigation to Establish of Suitable Winter Linseed Cultivars for Samsun Ecological Condition. Journal of Agricultural Faculty OMU, 21/1: 1-5.
- Kurt, O., Uysal, H., Demir, A. 2012. A Research on Breeding of High Edible Oil Quality Linseed (*L. usitatissimum* L.) Lines. Journal of Agricultural Sciences, 5(1): 68-72.
- Uysal, H., Kurt, O. 2014. Determination Of Fatty Acid Composition Of Pale Flax (*Linum bienne* Mill.) Populations Originated From Turkey. Anadolu Journal of Agricultural Sciences, 2014, 29(2): 121-125.

FORAGE YIELD AND QUALITY PERFORMANCE OF HUNGARIAN VETCH AND ANNUAL RYEGRASS MIXTURES UNDER DRY LAND CONDITIONS*

Süleyman ŞİMŞEK¹, Tamer YAVUZ^{2**}

¹Kırıkkale Directorate of Provincial Food Agriculture and Livestock, Republic of Turkey Ministry of Food Agriculture and Livestock, Kırıkkale, Turkey

²Department of Field Crops, Faculty of Agriculture, Ahi Evran University, Kırşehir, Turkey

**Corresponding author: tameryavuz551@hotmail.com

Abstract

The aim of this study was to determine the performance of yield and some quality features of sole sowing and different mixture ratios of Hungarian Vetch and annual ryegrass. The experiment was conducted in a randomized complete block design with Altnova-2002 Hungarian vetch and Trinova annual ryegrass varieties in Kırşehir (39°08'32"N, 34°06'48" E), Turkey. Fresh herbage, dry matter and crude protein yields were determined between 683.5 and 963.3 kg da⁻¹, 205.3 and 315.9 kg da⁻¹, 23.70 and 50.18 kg da⁻¹, respectively. Crude protein, ADF, and NDF ratios ranged between 11.58 and 17.86%, 28.69 and 39.66%, 37.12 and 59.67%, respectively. Dry matter yields of mixtures were higher than those of pure sown Hungarian vetch and annual ryegrass. The highest value of this yield component was obtained from the Hungarian vetch 80% + annual ryegrass 20% mixture. Because of the increasing rate of Hungarian vetch in the mixtures, NDF and ADF ratios of mixtures decreased. Reductions in ratios of NDF and ADF caused increases in the crude protein content and yield. Consequently, Hungarian vetch 80% + annual ryegrass 20% mixture was found superior than the other pure sown species and mixtures in terms of yield and quality features. It is concluded that this mixture can be grown successfully for the production of high quality roughage in Kırşehir or similar ecological conditions.

Key words: *Hungarian vetch, annual ryegrass, yield, ADF, NDF*

Introduction

The first culture forms of Hungarian vetch were found in Hungary. It is a resistant forage and can grow under extreme climatic conditions where many forages cannot (Balabanlı, 2009; Aksoy and Nursoy, 2010). However, lodging problem frequently seen in vetch species decrease the herbage and seed yields (Açıkgöz, 2001). Therefore, mixed seeding with cereals was recommended (Bakoğlu and Memiş, 2002). In vetch + cereal mixtures, annual ryegrass can be used as an alternative to cereals including barley, oat and triticale. Ryegrass is an annual grass forage and can form intensive tillering at higher altitudes. Also, it can be cultivated as a mixture with some legume forages and contributes to the yield and quality of the mixtures and improves the production of roughage (Baytekin *et al.*, 2009).

In Central Anatolia, the share of forage agriculture in field crop agriculture is very low. Forage cultivation conducted in Central Anatolia comprises only 13.7% of the forage cultivation carried out in Turkey. Agricultural areas in Kırşehir comprise 6% of the total cultivation area in Central Anatolia Region, and only 2.9% of this area for forage cultivation (Anonymous, 2014).

Intensive wheat and barley farming carried out in Central Anatolia leads to an intensive use of cereal straw as roughage. In this case, not quantitatively but qualitatively, a serious amount of

* This paper is a part of MSc thesis of Süleyman ŞİMŞEK.

roughage shortage arises. Therefore, annual legumes and their mixtures are of paramount importance in order to meet the coarse feed needs. Because, cultivation of annual forages which can also be sown in fallow lands as sole crops or mixtures will contribute to the reduction of fallow lands in Kırşehir which has 1.2 million ha of fallow lands (Anonymous, 2014).

The aim of this study was to determine the mixture ratios of Hungarian vetch and annual ryegrass that can be cultivated in the region in terms of yield and quality performance as an alternative to the classic annual legumes and cereal mixtures.

Materials and methods

The study was conducted at 2013-2014 vegetation period at the experimental field located at Ahi Evran University Bağbaşı Campus (39°08'32"N, 34°06'48" E) using Altinova-2002 Hungarian vetch (*Vicia pannonica* Crantz) and Trinova (*Lolium multiflorum* Lam.) annual ryegrass varieties. The characteristics of the soil in the experimental field were poor in organic matter, rich in phosphorus, potassium and calcium, moderate alkaline with clay and loam content. The average temperature (7.3 °C) of the vegetation period for 2013-2014 in which the study was conducted was higher than the average long-term temperatures (6.9 °C) for the same period. The average temperature values of all months, except December, was higher than the average monthly long-term temperature values. The total precipitation (259.3 mm) was lower than the average long-term total precipitation (315.8 mm) for the same months. Particularly, total precipitation values for January and April were significantly lower than the average long-term total precipitation values.

The study was designed in randomized complete block design in three replications. In the study, two sole species (100% Hungarian vetch- HV, 100% annual ryegrass- AR) and four mixtures (20% HV + 80% AR; 40% HV + 60% AR; 60% HV + 40% AR; 80% HV + 20% AR), a total of six subjects were examined. In sole plantings, 10 kg da⁻¹ seed was used for Hungarian vetch while 2 kg da⁻¹ seed was used for annual ryegrass. Sole species and mixtures were sown manually on 25 October 2013 with 30 cm row spacing on 8 rows with a length of 6 m. The size of the plot in the study was 14.4 m². Weed control was applied in the spring manually or using a hoe. In the study, mowing schedule was determined according to Hungarian vetch species. All species and mixtures were harvested during the full flowering period of Hungarian vetch (on 30th May 2014). Two end-rows of eight rows of each plot and 50 cm distances from the starting point of each plot was removed as the edge impact. The remaining 9 m² area was mowed and herbage yield was determined. The weight of each herbage sample were 500 g and dried at drying oven at 60 °C until the consecutive weights were fixed (Sleugh *et al.*, 2000). The dried samples were weighed using a precision scale to calculate dry matter yield. Nitrogen contents of the samples in the study were determined by the Kjeldahl method. Total nitrogen values were multiplied by 6.25 coefficient value to calculate crude protein contents of species and mixtures (Helrich, 1990). Then, crude protein ratios were multiplied by dry matter yield value, and crude protein yield of the species and mixtures were calculated. Acid Detergent Fiber (ADF) and Neutral Detergent Fiber (NDF) contents of the species and mixtures were determined using ANKOM 200 Fiber Analyzer (ANKOM Technology Corp. Fairport, NY, USA) (Anonymous, 2005). Analysis of variance of the data obtained in the study was performed according to the randomized complete block design using the MSTAT-C statistical software. The significant differences between the mean values were compared by Duncan multiple comparison method.

Results and discussion

Fresh herbage yields of the species and mixtures were between 683.5 kg da⁻¹ and 963.3 kg da⁻¹ while the dry matter yield values were between 205.3 kg da⁻¹ and 315.9 kg da⁻¹. The lowest yield values in species and mixtures were determined in sole annual ryegrass whereas the highest yield was obtained in 80% HV + 20% AR (Table 1). The differences between dry matter yields were statistically not significant, however dry matter yield values of all mixtures were higher than those of sole Hungarian vetch and annual ryegrass.

Sabancı and Ürem (1993) reported that 90%-10% or 80%-20% mixtures of Persian clover + annual ryegrass were suitable in terms of both fresh herbage and dry matter yields. Luginbuhl (1998) reported that the fresh herbage yield of annual ryegrass as 3581 kg da⁻¹ while Kuşvuran (2011) found that 470 kg ha⁻¹ and 550 kg ha⁻¹ nitrogen treatments produced 54834 kg ha⁻¹ and 54976 kg ha⁻¹ herbage yield, respectively. Kuşvuran and Tansı (2011) determined 80754 kg ha⁻¹ herbage and 14932 kg ha⁻¹ hay using 30 cm inter row spacing. Kuşvuran *et al.* (2014), in their study on different mixture and row spacing applications, determined the highest herbage yield (33.4 t ha⁻¹) and hay yield (7.5 t ha⁻¹) values in the 60% HV + 40% AR mixture and 30 cm row spacing application. Fresh herbage and dry matter values obtained in the present study were lower than those reported in the studies mentioned and summarized above. These results can be associated with different applications such as fertilization as well as the positive effects of ecological factors including precipitation and temperature on yield.

Table 1. Yields of fresh herbage, dry matter, crude protein and the ratios of crude protein, ADF and NDF of species and mixtures

Species and Mixtures	Fresh herbage yield (kg da ⁻¹)	Dry matter yield (kg da ⁻¹)	Crude protein ratio (%)	Crude protein yield (kg da ⁻¹)	ADF (%)	NDF (%)
HV	840.5	244.5	17.86 a**	43.78 ab**	28.69 f**	37.12 f**
AR	683.5	205.3	11.58 f	23.70 c	39.66 a	59.67 a
20% HV+80% AR	749.2	261.1	13.42 e	35.17 b	38.83 b	53.04 b
40% HV+60% AR	801.4	271.4	14.22 d	38.80 b	34.95 c	50.18 c
60% HV+40% AR	861.1	283.0	15.16 c	42.84 ab	33.66 d	46.75 d
80% HV+20% AR	963.3	315.9	15.83 b	50.18 a	32.17 e	44.35 e
Mean	816.5	263.5	14.67	39.07	34.16	48.51

** : Means followed by the same letter in the same column are statistically not significant (p<0.01).

Crude protein ratios varied between 11.58% and 17.86%, in average as 14.67% (Table 1). The lowest crude protein ratio was found in sole annual ryegrass planting whereas the highest was obtained from sole Hungarian vetch planting. It can be said that when Hungarian vetch ratios increased in mixtures, ADF and NDF ratios of mixtures were decreased, allowing increases in crude protein ratios of the mixtures. Caddel and Allen (1997) reported that the crude protein ratio of legume roughage was higher 19% before flowering than after flowering and the crude protein ratios in the mixtures varied between 11% and 19%, depending on the ratio of grass. Geren *et al.* (2003) found out that the crude protein ratio of hairy vetch + annual ryegrass mixtures in the hay as 21.37%. Kuşvuran *et al.* (2014) reported that the crude protein ratios of Hungarian vetch, annual ryegrass and their mixtures were 18.6% and 11.4%, respectively, while the crude protein ratios of their mixtures varied between 12.6% and 15.8%.

In the present study, crude protein yields of species and mixtures varied between 23.70 kg da⁻¹ and 50.18 kg da⁻¹. The highest crude protein yields group was determined in 80% HV + 20% AR mixture, sole Hungarian vetch planting and 60% HV + 40% AR mixture whereas the lowest

crude protein yield was determined in sole annual ryegrass planting (Table 1). Crude protein yield is associated with crude protein ratio and dry matter yield. Indeed, crude protein yields of the species and mixtures were in line with their dry matter yields and crude protein ratios and the samples with the highest dry matter yield and crude protein ratio values were the ones with the highest crude protein yield values. Kuşvuran *et al.* (2014), in line with the findings of the present study, determined the highest crude protein yield in 80% HV + 20% AR mixture.

The lowest ADF ratio in the species and mixtures were obtained in sole Hungarian vetch planting (28.69%) whereas the highest ADF ratio was obtained in sole annual ryegrass planting (39.66%). The average ADF ratios of species and mixtures was 34.16%. ADF ratios of the mixtures decreased as the ratio of Hungarian vetch in the mixture increased (Table 1). In the study of Caddel and Allen (1997), the ADF ratio of dry legume before flowering was 31%. Bingöl *et al.* (2007) determined it in Hungarian vetch as between 30.35% and 31.80%, while Yolcu *et al.* (2009) found out it between 29.59% and 31.10%, and Canbolat *et al.* (2013) as 27.57%. Kuşvuran *et al.* (2014) concluded that the ADF ratios as 35.8% for Hungarian vetch, as 39.7% for annual ryegrass and between 36.7% and 38.5% for Hungarian vetch + annual ryegrass mixtures. According to Bingöl *et al.* (2007), Vetch varieties had different ADF ratios. Yılmaz *et al.* (2015) reported that the ADF ratios decreased by inclusion of Hungarian vetch in the mixture.

NDF ratio values of species and mixtures were in line with the ADF ratios. The lowest NDF ratio was determined in sole Hungarian vetch planting (37.12%) whereas the highest NDF ratio was in sole annual ryegrass planting (59.67%) (Table 1). NDF ratios of the mixtures, similar to the ADF ratios, decreased by Hungarian vetch inclusion. NDF ratios of the mixtures varied between 53.04% (20% HV + 80% AR) and 44.35% (80% HV + 20% AR). The average NDF ratio values of the samples was 48.51% (Table 1). In the study of Yılmaz *et al.* (2015), the increase inclusion of Hungarian vetch in the mixture reduced the NDF ratio. Bingöl *et al.* (2007) indicated that, as in ADF ratio values, NDF ratio values of vetch varieties varied.

Conclusion

Crude protein ratios of the mixtures increased as the Hungarian vetch ratio in the mixture increased. ADF and NDF values of species and mixtures decreased as the crude protein ratios increased. The crude protein yields were also high in species and mixtures with high dry matter yield and crude protein ratio values. NDF and ADF ratios of the mixtures decreased by increased inclusion of Hungarian vetch in the mixture. The decrease in the NDF and ADF values of the mixtures increased the crude protein ratios. To conclude, 80% Hungarian vetch + 20% annual ryegrass mixture demonstrated superior properties in terms of yield and, especially, quality to get a good quality roughage production for Kirşehir or areas with similar ecological conditions.

Acknowledgement

This work was supported by the Ahi Evran University Scientific Research Projects Coordination Unit. Project Number: ZRT.E2.16.018.

References

- Açıkgöz, E. (2001). Forages. (Renewed third edition). Amplification Foundation of Uludag University Issue No: 182, Vipaş Inc. Issue No: 58. Istanbul, 584 pp. (Tr).
- Aksoy, İ. and Nursoy, H. (2010). Determination of the Varying of Vegetation Harvested Hungarian Vetch and Wheat Mixture on Nutrient Content, Degradation Kinetics, in vitro Digestibility and Relative Feed Value. The Journal of the Faculty of Veterinary Medicine, University of Kafkas, 16 (6), 925-931.

- Anonymous, (2005). The Ankom 200 Fiber Analyzer, Procedures for NDF, ADF and ADL Analyses. Ankom, Fairport, NY, <http://www.ankom.com>. (Accessed on 08.06.2014)
- Anonymous, (2014). Crop Production Statistics. Turkish Statistical Institute, http://www.tuik.gov.tr/PreTablo.do?alt_id=1001 (Accessed on 12.06.2015).
- Balabanlı, C. (2009). Hungarian vetch. Editors: Avcıoğlu, R., Hatipoğlu, R. and Karadağ, Y., Forage Crops, Forage Legumes, The Ministry of Agriculture and Rural Affairs, Emre Publication, İzmir, 2: 417-420.
- Bakoğlu, A. and Memiş, A. (2002). Determination of Seed Yield and Some Characteristics in Common Vetch (*Vicia sativa* L.) and Barley (*Hordeum vulgare* L.) Mixtures at Different Rates Cropping. Science and Eng. J of Fırat Univ., 14 (1): 29-35.
- Baytekin H., Kızılsimşek M., Demiroğlu G. (2009). Ryegrass species. Editors: Rıza Avcıoğlu, Rüştü Hatipoğlu, Yaşar Karadağ, Forage Crops, Forage crops from Poaceae and other families. The Ministry of Agriculture and Rural Affairs, Emre Publication, İzmir, 3 (19):561-572.
- Bingöl, .T, N., Karşlı, M., A., Yılmaz, İ., H. and Bolat, D. (2007). The Effects of Planting Time and Combination on the Nutrient Composition and Digestible Dry Matter Yield of Four Mixtures of Vetch Varieties Intercropped with Barley. The Journal of the Faculty of Veterinary Medicine, University of Kafkas, 31(5): 297-302.
- Caddel, J., and Allen, E. (1997). Forage Quality Interpretations. <http://virtual.chapingo.mx/dona/paginaCBasicos/f-2117.pdf>. (Accessed on 05.01.2015).
- Canbolat, Ö., Kara, H. and Filya, İ. (2013). Comparison of In vitro Gas Production, Metabolizable Energy, Organic Matter Digestibility and Microbial Protein Production of Some Legume Hays. Journal of Agricultural Faculty of Uludag University, 27 (2): 71-81.
- Geren, H., Soya, H. and Avcıoğlu, R. (2003). Investigations on the Effect of Cutting Dates on Some Quality Properties of Annual Italian Ryegrass and Hairy Vetch Mixtures, E.U. Faculty Of Agriculture - Electronic Journal. 40 (2):17-24.
- Helrich, K.C. (1990). Official methods of Analysis of the AOAC. Volume 2 (Ed. 15). Association of Official Analytical Chemists Inc.
- Kuşvuran, A. (2011). The effects of different nitrogen doses on herbage and seed yields of annual ryegrass (*Lolium multiflorum* cv. caramba). African J. of Biotech. 10(60):12916-12924.
- Kuşvuran, A. and Tansı, V. (2011). The effects of different row spacing on herbage and seed yields of annual ryegrass (*Lolium multiflorum* cv. caramba). Bulgarian J. of Agri. Sci, 17(6): 744-754.
- Kuşvuran, A., Kaplan, M. and Nazlı, I., R. (2014). Effects of Mixture Ratio and Row Spacing in Hungarian Vetch (*Vicia Pannonica* Crantz.) And Annual Ryegrass (*Lolium Multiflorum* Lam.) Intercropping System on Yield and Quality under Semi arid Climate Conditions. Turkish Journal of Field Crops, 19(1): 118-128.
- Luginbuhl, J.M. (1998). Winter Annual Forage: Gazing Experiment Progress Report- Meat Goats and Forage Systems. Department of Animal Science, Ncsu. http://www.cals.ncsu.edu/an_sci/extension/animal/meatgoat/MGForage.htm (05.05.2015).
- Sabancı, C.O. and Ürem, A. (1993). Effects of different mixture rate of Persian clover (*Trifolium resupinatum* L.) and Italian ryegrass (*Lolium multiflorum* Lam.) on green and dry matter yields. Journal of Aegean Agricultural Research Institute, 3(2):89-97.
- Sleugh, B., Moore, K.J., George, J.R. and Brummer, E.C. (2000). Binary Legume – Grass Mixtures Improve Forage Yield, Quality, and Seasonal Distribution, Agronomy Journal, 92:24-29.

- Yılmaz, Ş., Özel, A., Atak, M. and Erayman, M. (2015). Effects of seeding rates on competition indices of barley and vetch intercropping systems in the Eastern Mediterranean. *Turkish Journal of Agriculture and Forestry*, 39(1), 135-143.
- Yolcu, H., Polat, M. and Aksakal, V. (2009). Morphologic, Yield and Quality Parameters of Some Annual Forages as Sole Crops and Intercropping Mixtures in Dry Conditions for Livestock. *Journal of Food, Agriculture & Environment*, 7 (3-4): 594-599.

EFFECTS ON SOME PLANT GROWTH PARAMETERS OF GA₃ APPLICATIONS IN PEPPER PLANTS UNDER SALT STRESS

Ozlem UZAL*, Fikret YASAR

Yuzuncu Yil University, Agriculture Faculty, Horticulture Department, Van, -Turkey

*Corresponding author: ozlemuzal@yyu.edu.tr

Abstract

Seedlings of Demre sharp pepper varieties, in the hydroponic system containing Hoagland nutrient solution were grown in climate – controlled plant growth room. In the study, 100 mM NaCl was applied to three week old seedlings in stages and salt applications were continued in the same concentrations at the stage of refreshment of solutions that were renewed on a weekly basis. In order to reduce the negative effect of salt on plant development, GA₃ (gibberellic acid) with 5 ppm, 7.5 ppm and 10 ppm dose together with salt were added to pepper seedlings. In the samples taken on 10th and 20th day of this application were investigated physiological changes that occurred as a result of salt stress. Also, plant root, stem, leaves wet weight, number of leaves, plant height and node intermediate distance were investigated. Furthermore, a scale of stress resistance was created based on the symptoms on leaves. In GA₃ applications made along with salt during the study, the best plant growth was observed in plants which had been applied the 10 ppm dosage of GA₃. Furthermore, it was observed that the NaCl+10 ppm GA₃ application caused the least morphological damage and the lowest scale value among NaCl applications.

Keywords: *Pepper (Capsicum annuum L.), gibberellic acid, hormone, plant growth, salt stress*

Introduction

Salinity is a significant source of stress which can emerge in arid and semi-arid areas where incorrect fertilization and incorrect irrigation are practiced, and areas and greenhouses where the salinity of irrigation water is a problem, and can have a negative influence on plant production or in some cases render it impossible. Since the pepper plant has a significant share in open and greenhouse cultivation, it is negatively influenced by salt stress. Crop losses due to these negative conditions can reach significant amounts. However the most significant and surest way of eliminating these negative influences is to develop plant types and varieties that are tolerant to salinity, and to conduct applications that eliminate the detrimental effects of salinity. In order to develop such species and varieties with high tolerance, the stress mechanism of the plant must be illuminated very well.

The administration of growth regulators such as GA₃ and cytokinin to plants is beneficial in altering the negative effect of salt stress (Xiong *et al.* 2002). Indeed, in a study conducted by Lin and Kao (1995), the authors have claimed that GA reduces the hindrance to development of offshoots in saplings in rice seedlings to which salt had been applied. In the study conducted by Rodriguez *et al.* (2006) the authors have reported that GA₃ applications played a role in reducing the promotion of the hindrance to plant development in some plants including rice. In the same study, the application of salt had a negative influence on all measured parameters except chlorophyll. It was also stated that the application of GA₃ prevented the influence of salt on chlorophyll b, carotenoid content, the dry weight of shoot, and the length of shoots.

In this study whose results we have provided, gibberallic acid (GA₃) was applied to pepper plants that had been subjected to salt stress with the purpose of determining the reaction of plants to stress.

Material and Methods

Seedlings of Demre sharp pepper varieties, in the hydroponic system containing Hoagland nutrient solution were grown in climate – controlled plant growth room. For this purpose pepper seeds were planted into 45 cm plastic germination containers that had been filled with pumice, with 100 seeds to each container, and watered with tap water. Germination containers were placed in a climate controlled room with 25°C temperature and 70% humidity, the containers that had been covered with moist paper were regularly checked and continued to be watered in small quantities with tap water to prevent the drying out of the pumice. Papers were removed when germination began to be observed. Seedlings that had grown their 2nd real leaves in the pumice environment were transferred to a water culture in 18 cm plastic tubs filled with Hoagland nutrient solution. Pepper seedlings were wrapped in small pieces of sponge and placed on plastic trays that had been specially prepared with perforations for each seedling. The trays were placed over the tubs making sure to immerse plant roots in the nutrient solution. Aeration was conducted by immersing thin plastic pipes connected to aquarium pumps into the nutrient solution.

Application of salt was begun on seedlings with 4-5 real leaves that had been cultivated in a water culture for two weeks. The trial was set up with three repetitions with 10 plants to each repetition, according to the pattern of random based trial pattern. NaCl was added to provide a salt concentration of 100 mM in the nutrient solution for seedlings that would be administered salt. Salt applications were continued in the same concentrations at the stage of refreshment of solutions that were renewed on a weekly basis. Gibberellic acid was added in doses of 5.0 ppm, 7.5 ppm, and 10 ppm to pepper seedlings along with salt in the study.

Sampling was conducted twice on the 10th and 20th days of salt application. In these samples the wet weights of green parts of bodies, the number of leaves, the height of plant, and node intermediate distance were measured and a scale of stress resistance was formed according to the symptoms on leaves.

Plants were assigned scores between 1 and 5 according to the symptoms listed below on the 10th and 20th days of salt application (Uzal, 2009).

- 1: No effect on plant from salt stress
- 2: Slowing down in growth, local yellowing and curling on leaves
- 3: Yellowing on leaves and necrotic spotting in 25%
- 4: Necrotic spotting and shedding, and death in 20%-75% on leaves
- 5: Severe necrosis in 75%-100% in leaves or complete plant death

Results and Discussion

Some plant development parameters pertaining to pepper plants that had been in the control and test groups are provided in Table 1. Significant variation occurred as compared to the control in terms of leaf weight and count on samples taken on the 20th day. A statistically significant difference compared to the control group was also observed on samples taken on the 10th and 20th days with respect to plant height and node intermediate distance. In applications of GA₃ along with NaCl, statistically significant differences were observed with respect to root weight on the 20th day, and in terms of leaf weight and count in NaCl +7.5 ppm GA₃ application on the 20th day, and in all NaCl + GA₃ applications. While a statistically significant difference existed

as compared to the control group on the 10th day in all NaCl+GA₃ applications, no differences as compared to the control group were found in the NaCl+10 ppm GA₃ application on the 20th day. No statistically significant differences as compared to the control group were observed in the node intermediate distance on the 10th and 20th days in the NaCl+10 ppm GA₃ application. In comparing NaCl+GA₃ applications with plants to which only salt had been administered no statistically significant differences were determined with respect to root, stem, leaf weight and count, statistically significant differences were observed on the 10th and 20th days in the NaCl+10 ppm GA₃ application with respect to plant height and spacing between nodes. The spacing between nodes were also found to be different to a statistically significant extent in both periods of NaCl + GA₃ applications as compared to plants to which only salt had been administered. As expected, the plant height and node intermediate distance of NaCl+GA₃ applications as compared to plants to which only salt had been administered were found to be significantly increased in the NaCl+10 ppm GA₃ application. These values were found to be almost identical to the values of control plants. As expected, in plants that had only been applied GA₃, the leaf count, plant height, and spacing between nodes had increased as compared to the control in samples taken on the 20th day on all plants that had been applied GA₃.

Table 1. Plant growth parameters in the samples taken on 10th and 20th day of applications (plant root weight (g), stem weight (g), leaves weight (g), number of leaves (number), plant height (cm), node intermediate distance (cm))

Application	Root W. (g)		Stem W. (g)		Leaves w. (g)		Number of Leaves (number)		Plant height (cm)		Node intermediate distance (cm)	
	10 th day	20 th day	10 th day	20 th Day	10 th Day	20 th day	10 th day	20 th Day	10 th day	20 th day	10 th Day	20 th day
Control	1.80AB	2.23B	1.93A	2.25CD	3.27A	8.40B	8.33A	12.33C	18.0 C	17.6C	3.16B	2.66A B
NaCl	1.07B	2.01BC	1.24A	1.51D	3.03A	5.09D	7.66A	10.66D	11.0 EF	13.0D	1.50 E	1.50C
NaCl +5 ppm GA ₃	1.42AB	1.94BC	1.06A	1.82D	3.39A	5.63CD	7.00A	10.66D	9.66F	12.3D	1.83D E	1.83B C
NaCl +7,5 ppm GA ₃	1.26B	1.77C	1.30A	1.82D	3.86A	5.63CD	8.00A	10.66D	11.6E	12.0D	2.16C -E	1.83B C
NaCl + 10 ppm GA ₃	1.66AB	1.90BC	1.15A	1.58D	3.38A	4.86D	7.66A	10.33D	14.0D	16.3C	2.50B -D	2.66A B
5 ppm GA ₃	1.66AB	2.06BC	2.04A	3.50B	3.98A	8.12B	8.33A	14.00B	19.0BC	23.0A B	2.83B C	3.33A
7,5 ppm GA ₃	2.47 A	2.01BC	1.61A	2.69C	2.80A	6.19C	7.33A	12.33C	20.6AB	22.0B	2.66B -D	2.66A B
10 ppm GA ₃	1.51AB	2.67A	1.30A	5.06A	3.15 A	10.37A	7.00A	15.33A	22.3A	24.6A	4.00A	3.33A

Mean values indicated by the same letter are not significant different (p<0.05).

Table 2. The scale resistance according to the symptoms of stress in leaves (point)

Application	10 th day	20 th day
Control	1	1
NaCl	3	4.5
NaCl+5 ppm GA ₃	3	4
NaCl+7,5 ppm GA ₃	3	4
NaCl+ 10 ppm GA ₃	2	3.5
5 GA ₃	1	1.5
7,5 GA ₃	1	1.5
10 GA ₃	1	1

As had been stated in the method of creating a scale for the purpose of expressing the degree of the morphological damage in plants, the seedlings were assigned scores from 1 to 5 (Table 2). Thus, the application with the highest score was found to be NaCl, NaCl +5 ppm GA₃, NaCl +7,5 ppm GA₃ with the assessment conducted on the 10th day. The application with the highest score was found to be NaCl, NaCl +5 ppm GA₃, NaCl +7,5 ppm GA₃ according to the assessment conducted on the 20th day. According to these values these were found to be the applications that suffered the highest effects from salt, had the highest score in the salt resistance scale, and suffered the highest morphological damage as of the 10th and 20th days. It was observed that the NaCl+10 ppm GA₃ application caused the least morphological damage and the lowest scale value among NaCl applications.

Examining data obtained with respect to some plant development parameters, no statistically significant differences were observed as compared to the control group in groups that had been administered only salt or administered NaCl+GA₃, as well as a significant decrease in these groups as compared to the control with respect to leaf weight and count, but no difference was observed among NaCl+GA₃ applications. As expected, in plants that had only been applied GA₃, the leaf count, plant height, and spacing between nodes had increased as compared to the control in samples taken on the 20th day on all plants that had been applied GA₃. On the 20th day, the plant height and spacing between nodes were found to be within the same statistical group with the control plants in the NaCl+10 ppm GA₃ application. This proves the expected effect of GA₃ on plant height and spacing between nodes. Parallel findings were made in comparing these values with scale values.

Karanlık (2001) has expressed that the necrosis and chlorosis observed in plants as a result of salt stress exhibited a close correlation with the decreases in yield of wheat genotypes, and that a scale that would be created by assessing the symptoms which emerge on leaves as a result of salt stress could provide information on the sensitivity of genotypes to salt stress. Dasgan *et. al.*(2002) have reported that, in the 1-5 scale which they had used in their salinity study on tomato, genotypes that exhibit less damage as a result of salt stress had lower scale values, and in contrast the degree of damage increased as a function of Na accumulation with genotypes taking high scale values. In the study they conducted on the level of genotypes with respect to tolerance to salt in melons, Kuşvuran *et.al.*(2007b) have determined that scale values could be used as an effective parameter in determining tolerance to salt. In an aridity trial conducted on okra, it was reported that genotypes exhibited variations with respect to scale values, and had different scores (Kuşvuran *et.al.*, 2007a).

Ashraf *et. al.*(2001) have determined decreases in the wet and dry weights of offshoots and roots, plant height, and leaf with increases in salt, but applications of GA have caused significant

improvement in both varieties with respect to these development parameters. In general GA applications have promoted vegetative development of both varieties of wheat under salt stress but GA has caused an insignificant decrease in grain yield. In the same study a significant increase was observed in the concentration of Na and Cl in the shoots and roots of two lines of wheat in a saline development environment, but the accumulation of Na and Cl was reported to increase in both roots and shoots with the application of GA₃. Xiong *et. al.*, 2002 have reported benefits in altering the negative influence of salt stress with application to plants of growth regulators such as GA₃ and cytokinin while a study conducted by Lin and Kao (1995), GA₃ was reported to decrease the hindrance to development of shoots of rice seedlings to which salt had been applied, and a study conducted by Rodriguez *et. al.*, 2006 has reported that applications of GA₃ played a role in reducing the promotion of the hindrance to plant development in some plants including rice. Gibberellins promote growth by stimulating cell division and increasing plastids in cell walls, convert carbohydrates to sugar, and reduce pressure on the cell wall. Thus since water is taken into the cell, cell lengthening occurs (Arteca, 1995). Furthermore, while GA₃ increases the height of short plants it reduces stem thickness, reduces the area of leaves, and causes a lightening in the green color of leaves (Cecconi *et. al.*, 2002; Bibi *et. al.*, 2003). The results we have obtained in the study conform to the studies mentioned, in these aspects.

Conclusions

In this study whose results we have provided, gibberellic acid was applied to pepper plants that had been subjected to salt stress with the purpose of determining the reaction of plants to stress. In GA₃ applications made along with salt during the study, the best plant growth was observed in plants which had been applied the 10 ppm dosage of GA₃. Furthermore, it was observed that the NaCl+10 ppm GA₃ application caused the least morphological damage and the lowest scale value among NaCl applications.

“This work was supported by Research Fund of the Yuzuncu Yil University. Project Number:2010-ZF-B014”

References

- Arteca RN. (1995). Plant Growth Substances: Principles and Applications. Chapman and Hall, 288 pages.
- Ashraf M., Karim F., Rasul E. (2001). Interactive effects of gibberellic acid (GA₃) and salt stress on growth, ion accumulation and photosynthetic capacity of two spring wheat (*Triticum aestivum* L.) cultivars differing in salt tolerance. Plant Growth Regulation. 1-11.
- Bibi M., Hussain M., Qureshi M.S. and Kousar S. (2003). Morpho-chemical and physiological response of sunflower (*Helianthus annuus* L.) to gibberellic acid and nitrogen. Pak. J. Life Soc. Sci., 1(1): 51-53.
- Cecconi F., Gaetani M., Lenzi C. and Durante M. (2002). The sunflower dwarf mutant dw1: effects of gibberellic acid treatment. Helia, 25(36): 161-166.
- Dasgan H.Y., Aktas H., Abak K., Cakmak I. (2002). Determination of Screening Techniques to Salinity Tolerance in Tomatoes and Investigation of Genotype Responses. Plant Science, 163: 695-703.
- Hoagland D.R., Arnon D.I. (1938). The water culture method for growing plants without soil. Circ. Calif. Agr. Exp. Sta., 347-461.
- Kusvuran S., Uzen N., Dasgan H.Y., Abak K. (2007a). Investigation has shown that the response of different Okra Genotypes Under Salt Stress. V. National Horticultural Congress, Erzurum

- Kusvuran S., Ellialtıoglu S., Abak K., Yasar F. (2007b). Responses of Some Melon (*Cucumis* Sp.) Genotypes to Salt Stress. *Journal of Agricultural Sciences, Ankara University Faculty of Agriculture*. 13 (4): 395- 404.
- Lin CC, Kao CH. (1995). NaCl stress in rice seedlings: starch mobilization and the influence of gibberellic acid on seedling growth. *Bot Bull Acad Sin* , 36:169-173.
- Rodriguez A.A., Stella AM, Storni MM, Zulpa G and Zaccaro MC. (2006). Effects of cyanobacterial extracellular products and gibberellic acid on salinity tolerance in *Oryza sativa* L. *Saline Systems*, 2:7.
- Üzal Ö. (2009). Effects of jasmonic acid on plant growth and antioksidant enzyme activity of some strawberry cultivars grown under salt stress (Ph.D.Thesis). University of Yuzuncu Yıl, Van.
- Xiong L, Zhu JK. (2002). Salt tolerance. In *The Arabidopsis Book* Edited by: Somerville C, Meyerowitz E. Rockville MD, American Society of Plant Biologists:1-22.

DETERMINATION OF PROPAGATION PERFORMANCE FROM SEEDS IN RHODODENDRON SPECIES*

Bahadır ALTUN^{1*}, Hüseyin ÇELİK²

¹Department of Horticulture, Faculty of Agriculture, Ahi Evran University, Kırşehir, Turkey

²Department of Horticulture, Faculty of Agriculture, Ondokuz Mayıs University, Samsun, Turkey

*1Corresponding author: bahaltun@gmail.com

Abstract

This study was carried out to determine the possibility of propagation of seeds in 5 different Rhododendron species of Turkey. The seed materials of the worked species were collected from the flora of East Black Sea Region in the period of August and October 2010. Study was carried out in randomized block design with 5 species and 4 replications each including 100 seeds. Results showed that the weight of thousand seed were between 0.067 and 0.142 g and their emergences were between 21 and 45 days. The longest emergence time was seen in *R. caucasicum* species having the smallest seed while the shortest emergence time was seen in *R. luteum* having the heaviest seed weight. There was a positive correlation between the particular size of seed and emergence rate. The emergence rate was determined as between 55.50-78.50 %. To conclude, the emergence results evidenced the possibility of propagate Rhododendron species from their seeds.

Keywords: *Rhododendron*, seed sowing, seed weight, seed emergence

Introduction

Being rich in diversity of plants, Turkey flora includes rhododendrons. Rhododendrons belonging to Ericaceae family, with having 1.000 natural species, are defined as evergreen or deciduous shrub and rarely in the form of small tree (Küçük, 2005). In many countries, Rhododendrons have been popularly used as outdoor arrangements and potted plants because of their ornamental traits. These plants have become important ornamental plant due to their flower colors, plant forms and leaf structure (Nelson, 2000). Rhododendrons have never lost their actuality since the date of firstly diagnosing, and the attentions of researchers have been still on them. Their distribution in our country and in the world has been studied by many researchers and still ongoing (Stewens, 1978; Oh et al., 2000; Choo and Kim 2005; Cullen, 2005; Boratyn's et al., 2006; Mao and Gogoi, 2007; Veteas et al., 2007; Sigdel, 2008; Gao et al., 2008; Ashish et al., 2010; Altun, 2011). Although the most of the species of rhododendron have distributed in the northern hemisphere, some species have grown in South hemisphere, especially in Mountain Carstensz, Papua New Guinea and Bellenden Ker Mountain in Australia (Avcı, 2004). In Turkey, rhododendrons are seen along the whole Black Sea coast, starting from the east of Artvin province, spreading overlooking site of mountain to the Black Sea, to Istranca Mountains. Eastern Black Sea contains the intensive species diversity of rhododendrons.

Two species (*R. ponticum* L. and *R. luteum* Sweet.) of rhododendron are present outside of the Black Sea region. These species were determined intensively in Marmara region, Sakarya and Kocaeli provinces and in small populations found in Bursa (Iznik), Yalova, Istanbul and Kırklareli provinces. Also, two small populations of *R. luteum* Sweet species, being away from

each other, were found in the southern slopes of the Kaz Dağı in Canakkale (Stewens, 1978; Altun et al., 2016).

Aesthetic beauty of rhododendrons has let them to use in landscape design for "aesthetic" and "functional" purposes rather than other goals. Many rhododendrons cultivars which improved by breeding have been recently used in Urban landscape planning, beside of natural cultivated rhododendrons species (Harrison and Jenny, 1997; Pulatkan, 2001). Nowadays, the use of natural species has become more popular than the standard commercial ornamental plants. In this context, most of the natural plants could not be transferred from originated locations to city center because of limited knowledge of production and propagation methods. Therefore, in this preliminary study, the emergence rates of seeds in rhododendrons species were investigated to determine whether it will be a candidate ornamental plant in Turkey, as intensively used in many other countries.

Materials and methods

The seeds were collected from 5 rhododendrons species (*R. ponticum* L., *R. luteum* Sweet, *R. caucasicum* Pallas, *R. smirnovi* Trautv. and *R. ungeri* Trautv.) in Turkey flora, as experimental material. Capsules were harvested before scattering and fully opening capsules when they become brown color. Then, samples were placed to clean and dry cloth labelled bags and transferred to experimental area in Black Sea Agricultural Research Institute (Samsun, Turkey). Seed capsules were placed in large plates in a dry place at room conditions until when the capsules are fully opened. Seeds from opened capsules were extracted and ready for sowing. In order to determine the weight of 1.000 seeds, three series of 1000 the seeds were counted and weighed with precision glass scales. Also photographed on graph paper and binoculars in the seed and created an archive.

Seeds were sowed in acidic filled with foam containers peat on the surface (Güngör et al., 2002) in randomized plot trial with 4 replications each contained 100 seeds in mist propagation conditioned room. After sowing, the emergence of seeds were counted by using a magnifying glass for 7-d intervals until the reaching of the same seedlings number for consecutive counting. Then, emergence values were calculated as percentage based on the number of seeds at the beginning of sowing. The Randomized Complete Block Design were used with 4 replications and 100 seeds in each replication. The percent data transformed using arcsin√x transformation and statistical analyses applied to these data.

Results and Discussion

In the present study, it was aimed to determine 1000-seed weight and emergence rate of rhododendrons in Turkey. The results are given in Table 1 and Figure 1. The determined 1000-seed weight was found out between 0.142 g and 0.067 g (Table 1).

Table 1. Rhododendrons 1000 seeds weight

Species	Mean (g)
<i>Rhododendron ponticum</i> L.	0.073
<i>Rhododendron luteum</i> Sweet	0.142
<i>Rhododendron smirnovii</i> Trautv.	0.076
<i>Rhododendron ungerii</i> Trautv.	0.071
<i>Rhododendron caucasicum</i> Pallas	0.067

The means of 1000-seed weights were determined as 0.073 g, 0.142 g, 0.076 g, 0.071 g and 0.067 g in *R. ponticum*, *R. luteum*, *R. smirnovi*, *R. ungeri* and *R. caucasicum*, respectively. Czekalski (1998) determined 1000-seed weights of rhododendron species grown in Riga Botonik Garden (Latvia) and found out that these weights were 0.078 g for *R. caucasicum* and 0.105 g for white-flowered *R. ponticum*. These findings are not in line our findings on 1000-seed weights. This is, more likely, due to the condition of the seed is taken from the botanical gardens. On the literature, it can be come across the least 1000-seed weight as evidenced by Var and Dinçer (2006)'s finding 0.0081 g for *R. ponticum*.

Emerging rates (%) were subjected to arcsin \sqrt{x} transformation before statistically analyzed (Table 2). Analyses showed that there was significant difference between species with respect to emerging rate (Table 3, P<0.01). The means were compared with Duncan Multiple Range Test (JUMP, 7.00). The earliest emergence incidence was obtained on 21st day after sowing for *R.luteum* seeds while the latest emergence was obtained 45th day after sowing for *R. ungeri* and *R caucasicum* seeds. The highest emergence rate was found as 78.50%, in *R. ponticum* scenes while with the lowest rate was 55.50% in *R. caucasicum* species (Figure 1).

Table 2. Analysis of Variance

Source	DF	Mean Square
C. Total	19	
Factor A	4	253,70*
Error	15	58,77
CV	13,98	

*:P<0.05

Table 3. Rhododendrons seed emergence values (%)

Species	<i>R. ponticum</i>	<i>R. luteum</i>	<i>R. smirnovii</i>	<i>R. ungerii</i>	<i>R. caucasicum</i>
Means (%)	78.50 a	76.00 a	64.75 ab	57.25 b	55.50 b

LSD Value (P<0.05) 13,98

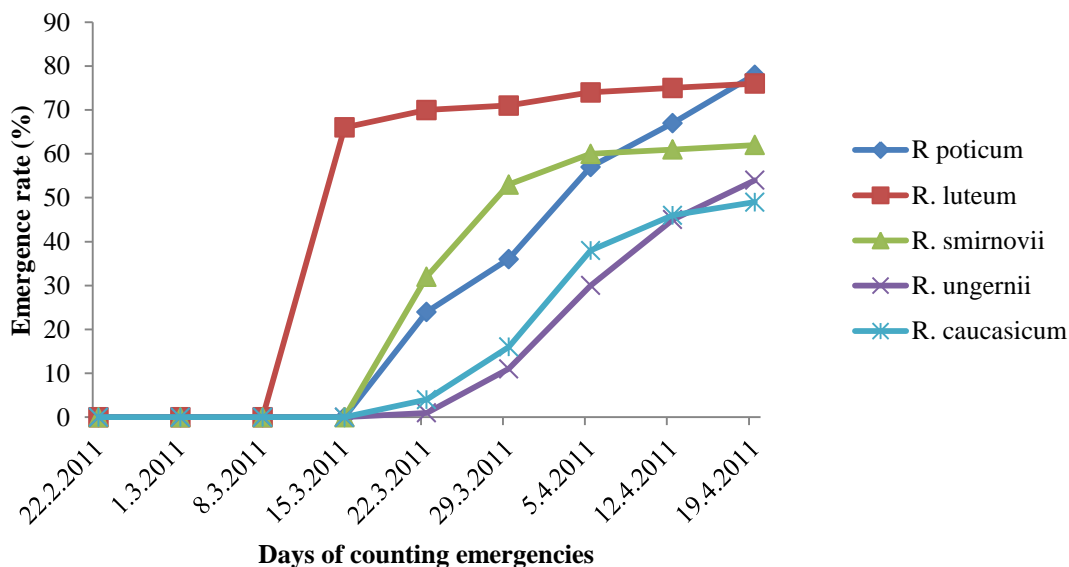

Figure 1. Weekly emerging rates of seeds of Rhododendron species

In the present experiment, it was determined the emergence time as 30 days after sowing of *R. ponticum* ve *R. smirnovii* seeds. Similarly, in the study of Sekergider (2002), this emergence time was 28 days in *R. ponticum* and *R. luteum*, agreeing with the current finding for *R. ponticum* ve *R. smirnovii* seeds. Zhang et al. (2006) sowed 5 rhododendron subgenus seeds in early May and found out Pentanthera seeds from these subgenus gave the highest seed germination rate. When *R. luteum* Sweet's thought to be involved in these subgenera, their finding is in line with our finding. In the present study, the highest emergence rate was determined in the seeds of *R. ponticum* L. (78.5%), followed by *R. luteum* Sweet (76.00%), *R. smirnovii* Trautv. (64.75%), *R. Ungerni* Trautv. (57.25%), and *R. caucasicum* Pallas, which gave the lowest emergence rate (55.50%). Sakharova (1993) obtained 71.00% emergence in *R. luteum* Sweet. This result was supported by our finding on *R. luteum* Sweet. Czekalski (1998) collected *R. smirnovii* Trautv seeds from nature and obtained 80.00-85.00% emergence rate 12-15 days after sowing. He, also, obtained germination in *R. ungerii* Trautv seeds 19-22 days after sowing. The present findings were lower than his results. This difference may be attributed to the difference between rootstock plants, sowing times, ambient temperature.

According to the study carried out by Cherevko and Sapozhenkov (1975), freshly sowed *R. kotschyi* Simonka seeds gave lower emergence rates 6.00-12.00%. When these seeds were sowed after 8-11 months waiting, emergence was found as between 30.00-43.00%. However, these higher rates were reduced when 4-5 years old seed used, because of losing its liability. Rhododendrons seeds require light for germination. Because of this, seed are sowed on the surface of medium to be emerged easily. However, only light is not sufficient for germination. The success in seed germination in Rhododendrons are dependent upon year (air), seed collection time, ambient temperature and pH (Sakharova, 1993). Blazich et al. (1991) investigated the effect of photoperiod on germination of *R. catawbiense* Michaux and *R. maximum* L. seeds in different temperatures. They found out 64% germination rate on 30th day after sowing in control, and 95 % germination rate on 15th day after sowing in 0.5-12 hours photoperiod treatment. Jin et al. (2007) reported that media is very important factor on seed germination. The optimum temperature for the germination of Rhododendrons seed was 16 - 20 ° C according to the study of

Zhang et al. (2006). Also they stated that the ideal environment was topsoil seed + seaweed mixture for germination. Vologdina (2006) collected seeds from natural populations of *R. dauricum* L., *R. mucronulatum* Turcz. ve *R. sichotense* Pojark found out that their seeds were sensitive to lighting and germinated about 73.00-90% in 20-23 °C ambient temperature. In conclusion, Rhododendron species can be propagate by their seed although these species were different in each other with respect to seed weight, germination time and rate. For ornamental design, *Rhododendron ponticum* L. and *Rhododendron luteum* Sweet species will be suggested because of their higher emergence rates.

Acknowledgement

This study is a part of PhD thesis of corresponding author. This presentation was supported by the Ahi Evran University Scientific Research Projects Coordination Unit. Project Number: ZRT.E2.16.013.

References

- Altun, B., 2011. Collection and cultivation of Rhododendrons in Turkey. The Institute of Natural and Applied Sciences of Ondokuz Mayıs University. PhD Thesis (unpublished). Samsun.
- Altun, B.; Sağlam, S.; Gümüş, H.; Türet, M.; Çelik, H.; Eminağaoğlu, Ö.; Yazıcı, T.Y.; Kaya, İ.T., 2016. Studies on the determination of genotypes of Rhododendrons (*Rhododendron* spp.), morphological and molecular identification, propagation and ex-situ conservation in Turkey. The final report of research project (Reg. no:112O500, unpublished) of The Scientific and Technological Research Council of Turkey.
- Ashish P.; Khan, M. L.; Das, A. K.; Dutta, P. K., 2010. Diversity and distribution of *Rhododendrons* in Arunachal Himalaya, India. American Rhododendron Society Journal. 64, 4:200-205.
- Avcı, M., 2004. Rhododendrons and their Natural Occurrences in Turkey. The Journal of Geography. The Faculty of Literacy of Istanbul University.12: 13-29.
- Blazich, F. A.; Warren, S. L.; Acedo, J. R.; Reece, W. M., 1991. Seed germination of *Rhododendron catawbiense* and *Rhododendron maximum*: influence of light and temperature. Journal of Environmental Horticulture.9, 1: 5-8.
- Boratyn'ski, A.; Piwczyn'ski, M.; Didukh, Y. P.; Tasenkevich, L.; Romo, A.; Ratyn'ska, H., 2006. Distribution and phytocoenotic characteristics of relict populations of *Rhododendron myrtifolium* (Ericaceae) in the Ukrainian Carpathians. Polish Botanical Studies.22:53-62.
- Cherevko, M. V.; Sapozhenkova, T. V., 1975. Seed vigour and emergence in *Rhododendron kotschyi*. Ukrains'kii Botanichnii Zhurnal.32, 3:361-366, 400.
- Choo, G.C.;Kim, G.T., 2005. Vegetation structure of mountain ridge from Bubong to Poamsan in Baekdudaegan, Korea. Korean Journal of Environment and Ecology.19, 2:83-89.
- Cullen, J., 2005. Hardy Rhododendron Species A Guide to Identification. Timber Press, Inc, 496p.
- Czekalski, M., 1998. Rhododendrons in the Former Soviet Union Caucasian Species. American Rhododendron Society.52, 2:81-89.
- Gao, Y.; Yao, L.; Qiu, Z.; Yan, J.H., 2008. Community structure and species diversity in Wulian Mountain of Shandong. Bulletin of Botanical Research.28, 3:359-363.
- Güngör, İ., Atatoprak, A., Özer, F., Akdağ, N., Kandemir, N.İ., 2002. Introducing the World of Plants Details of plants with Seedling Cultivation Principles. Lazer Ofset Yayınları, 241-242s, Ankara.

- Harrison, L. F.; Jenny M., L., 1997. Landscape plants for eastern North America: exclusive of Florida and the immediate Gulf Coast. 541-551p. Michigan University. USA.
- Jin, P.F.; Bian, C.M.; Yang, W.; Ke, J.M., 2007. Seed breeding and sapling transplantation of *Rhododendron fortunei* in Linhai. Journal of Zhejiang Forestry Science and Technology.27, 2:34-36, 53.
- Küçük, M., 2005. Natural Rhododendrons of Turkey. Environment and Human 3(62): 20-29.
- Mao, A. A.;Gogoi, R., 2007. Rediscovery of a critically endangered endemic Rhododendron. Indian Forester.133, 12:1699-1702.
- Nelson, S., 2000. Rhododendrons in the Landscape. Timber Press Inc. Portland, Oregon. USA.
- Oh, K.K.; Cheong, S.J.; Lim, Y.H., 2000. Vegetation structure of trail edge in the eastern region, Chirisan National Park. Korean Journal of Environment and Ecology.13, 4:309-315.
- Pulatkan, M., 2001. A Research on evaluation of rhododendron taxa in landscape architecture and propagation of *Rhododendron luteum* in various rooting medium. The Institute of Natural and Applied Sciences of Karadeniz Technical University. MSc Thesis (unpublished), Trabzon.
- Sakharova, S. G., 1993. Laboratory germination of Rhododendron seeds. Byulleten' Glavnogo Botanicheskogo Sada.167:124-129.
- Sekergider, D., 2002. Investigation about the growth of *Rhododendron luteum* Sweet and *Rhododendron ponticum* L. using tissue culture and seeding methods and their use in landscape architecture. The Institute of Natural and Applied Sciences of Karadeniz Technical University. MSc Thesis (unpublished), Trabzon.
- Sigdel, S. R., 2008. Altitudinally coordinated pattern of plant community structure in the Shivapuri National Park, Nepal. Banko Janakari.18, 1:11-17.
- Stewens, P.F., 1978. "Rhododendron L." Flora of Turkey and the East Aegean Island (Ed. P.H. Davis), 6: 91-94, Edinburgh University Press, Edinburgh.
- Var, M., Dinçer, D., 2006. The Replication of the Purple-flowered Rhododendron (*Rhododendron ponticum* L.) by Seed and Chances of Survival in Replanting in different media. Turkish Journal of Agriculture and Forestry TÜBİTAK. 30,145-152.
- Veteas, O.R., Jørgensen. M., Salvesen, H., Chaudary P., 2007. Relationships between Climatic Limits for Rhododendron Species in The Himalaya-Region and in Arboreta, <http://www.uib.no/people/nboov/>, reaching time 20 August 2011.
- Vologdina, O. S., 2006. Biology of *Rhododendron dauricum*, *R. mucronulatum* and *R. sichotense* (Ericaceae) seeds germination. Rastitel'nye Resursy.42, 2:55-60.
- Zhang, L.H., Liu, X.P., Wang, K.H., Wang, Z.H., Li, X.H., 2006. A study on seed germination and seedling growth of Rhododendrons. Acta Horticulturae Sinica.33, 6:1361-1364.

MAIZE POPULATIONS AS A SOURCE OF MICRONUTRIENT IMPROVEMENT

Snežana MLADENović DRINIĆ^{1,2*}, Jelena MESARović¹, Violeta ANĐELKOVIĆ¹, Dragan KOVAČEVIĆ¹, Vojka BABIĆ¹

¹Maize Research Institute Zemun Polje, Belgrade, Serbia

²Academy of Engineering Sciences of Serbia, Belgrade, Serbia

*Corresponding author: msnezana@mrizp.rs

Abstract

Maize grains contain a high level of β -carotene and tocopherols. This research was performed to estimate differences in tocopherols (α -, β + γ -, δ -), β -carotene, zeaxanthin and lutein content in thirty maize populations from the MRI gene bank by using high-performance liquid chromatography (HPLC). Among the genotypes, variation was observed in the traits of interest: α -tocopherol content was higher in the introduced than in the local populations. The local populations showed a higher concentration of lutein (1.50 - $15.94\mu\text{gg}^{-1}$) than the introduced populations (1.24 - $6.79\mu\text{gg}^{-1}$). The content of β -carotene ranged from 0.55 to $4.80\mu\text{g g}^{-1}$ in the local populations and from 0.26 to $7.95\mu\text{gg}^{-1}$ in the introduced populations. The zeaxanthin content was higher in the introduced (0.48 to $40.86\mu\text{gg}^{-1}$) than in the local populations (1.51 to $30.05\mu\text{gg}^{-1}$). The population 25 with orange kernels had a high level of zeaxanthin, β -carotene and tocopherols. That population is used for improvement of tocopherol and carotene content in inbred lines. The population was crossed with 5 inbred lines during 2015. β -carotene content in the inbreds ranged from 0.47 to $2.98\mu\text{gg}^{-1}$, and in the crosses from 3.22 to $16.48\mu\text{gg}^{-1}$. Furthermore, the content of tocopherols was higher in the crosses than in the inbred lines per se. This population could be used in future breeding programs for improving the nutritive value of commercial inbred lines.

Keywords: *maize, population, tocopherols, carotene*

Introduction

In addition to protein, oil and carotenoid, tocopherol content has been a focus of modern agriculture. Pigmented maize has received increased attention from a nutraceutical perspective because it contains several bioactive phytochemicals such as carotenoids, tocopherols, phytic acid and phenolic compounds (Bacchetti *et al.*, 2013). Carotenoids (provitamin A) and tocopherols (vitamin E) are lipid soluble antioxidants occur naturally in maize. Maize kernel is a major component in diets of humans and animals, and may have added value with increased content of carotenoids and tocopherols. Two classes of carotenoid pigments are carotenes and xanthophylls, which are responsible for the yellow and orange color of maize endosperm. Yellow maize kernels contain several carotenoid isoforms, including two carotenes- α and β -carotene and three xanthophylls— β cryptoxanthin, zeaxanthin, and lutein. β -carotene is present in the highest concentration, while either lutein or zeaxanthin is the most prevalent form of the xanthophylls. Daood *et al.* (2003) estimate genetic variation among the different types of maize on the basis of carotenoid content and found that lutein and zeaxanthin were the dominant carotenoids. Harjes *et al.* (2008) and Hulsof *et al.* (2007) reported a range of 55.5 - 66mg g^{-1} and 9.90 - 39.96mg g^{-1} respectively for carotenoids in maize kernel. According to Safawo *et al.* (2010) grain color and

carotenoid content showed the low correlation between visual grain colour and total carotenoids $R^2= 0.184$, β -carotene $R^2=0.033$, in diverse inbreds.

Tocopherols are the major lipid-soluble antioxidants in maize grain. Vitamin E antioxidant activity order is as follow: α -Tocopherol > β - Tocopherol > γ - Tocopherol > δ - Tocopherol . α -tocopherol is the major vitamin E in nearly all green plants, in non-green plant parts, such as seeds and fruits, where γ -tocopherol is preferentially found (Matea *et al.*, 2008).

Maize kernels have low α -tocopherol content, the compound with the highest vitamin E activity, thus, raising the risk of vitamin E deficiency in human populations relying on maize as their primary vitamin E source. Several studies have shown significant differences among maize inbreds for carotenoid and tocopherol levels (Egesel, 2001).

The study was conducted to identify carotenoids and tocopherol content in maize grain in locally adapted and introduced populations.

Material and methods

Carotenoids and tocopherol content in maize grains were studied on thirty accessions from MRIZP gene bank, 15 local and 15 introduced populations (Table 1).

Table 1. Color and type of kernal for local and introduced populations

Local populations			Introduced populations		
number	Kernal color	Kernal type	number	Kernal color	Kernal type
1	yellow	semi dent	16	orange	flint
2	yellow -orange	dent	17	orange	flint
3	yellow -orange	flint	18	orange	flint
4	yellow	semi dent	19	orange	flint
5	yellow -orange	semi flint	20	orange	flint
6	yellow	semi flint	21	orange	flint
7	orange	semi flint	22	white	flint
8	orange	semi dent	23	yellow	flint
9	orange	semi dent	24	orange	flint
10	orange	semi flint	25	orange	flint
11	orange	semi flint	26	orange	flint
12	orange	semi flint	27	orange	flint
13	orange	semi dent	28	orange	flint
14	yellow	semi flint	29	orange	flint
15	yellow	semi flint	30	orange	flint

Maize grains were milled (Perten 120, Sweden) into flour (particle size < 500 μ m) to obtain greater surface contact, and stored at -20°C prior to analysis.

Carotenoids were extracted according to the slightly modified method proposed by Rivera *et al.* (2012). Briefly, 0.15 g of the grain maize sample was extracted twice with 5 mL of mixture methanol-ethyl acetate (6:4, v/v) for 30 min at ambient room conditions. Collected extracts after centrifugation (3000 rpm, for 5 min) were evaporated under the stream of nitrogen to the dryness, and redissolved in 1mL of the mobile phase. Afterwards, extracts were filtered through syringe filter and analyzed by Dionex UltiMate 3000 liquid chromatography system (Thermo Scientific,Germany) fitted with photodiode array detector (DAD-3000) analytical column, Acclaim Polar Advantage II, C18 (150 \times 4.6mm, 3 μ m). Mixture of methanol-acetonitrile, (90:10,

v/v) was used as mobile phase. The flow rate was 1.0 mL/min, temperature of column was set at 25 °C and the injection volume was 50 µL. Chromatograms were generated at 450 nm and 470 nm. Carotenoids were identified and quantified by comparing characteristic retention time of appropriate standards, and expressed as micrograms per gram of dry matter.

Tocopherols (α -, γ + β - and δ) were extracted by method proposed by Gliszczyńska-Świgło *et al.* (2007) with minor modification. Approximately 0.2 g of sample was mixed with 2-propanol (4 mL) and homogenised for 30 min at room temperature. The extracts were then centrifuged at 3000 rpm for 5 min, filtered through a 0.45 µm membrane filter and a aliquot of clear supernatant was directly injected into the Dionex UltiMate 3000 liquid chromatography system (Thermo Scientific, Germany) equipped with fluorescence detector (FLD-3100). Chromatographic separation of tocopherols was accomplished on analytical column, Acclaim Polar Advantage II, C18 (150 × 4.6 mm, 3 µm) operated at 30 °C. Mixture of acetonitrile and methanol (1:1, v/v) was used as a mobile phase at flow rate of 1 mL/min. Injection volume was 5 µL, while the wavelengths for excitation and emission were maintained at 290 nm and 325 nm, respectively. Tocopherols were identified, and quantified comparing characteristic retention time of corresponding standards. The tocopherols content is expressed as micrograms per gram dry matter.

Carotenoids standards (lutein, zeaxanthin and β -carotene) and tocopherols standards (α -, γ - and δ), were from Sigma Aldrich (Germany).

Results and discussion

Maize displays considerable natural variation for carotenoid and tocopherols content. The carotenoid in population with white kernel (sample 22), was not detected. White kernel maize lacks carotenoids due to the presence of recessive *yl* (non-functional *phytoene synthase1*) in homozygous state, which are involved in biosynthetic pathways of carotenoids. In addition, yellow kernel maize exhibits tremendous natural variation for both provitamin A (α -carotene, β -carotene and β -cryptoxanthin) and non-provitamin A (lutein and zeaxanthin) carotenoids. The local populations showed a higher concentration of lutein (1.50-15.94 µg g⁻¹, average 7.64 µg g⁻¹) than the introduced population (1.24-6.79 µg g⁻¹, average 2.99 µg g⁻¹). The zeaxanthin content was higher in the introduced (0.48 to 40.86 µg g⁻¹, average 11.79 µg g⁻¹) than in the local populations (1.51 to 30.05 µg g⁻¹, average 8.95 µg g⁻¹). Population 18 has the highest zeaxanthin content (40.86 µg g⁻¹) among introduced and population 5 (30.05 µg g⁻¹) among local populations. Local populations have average content of β carotene 2.39 µg g⁻¹ and introduced populations 3.39 µg g⁻¹. Population 25 has the highest β carotene content (7.95 µg g⁻¹) and population 30 the lowest one (0.265 µg g⁻¹). In breeding program for high carotenes maize lines, Safawo *et al.* (2010) have also determined high variation in β -carotene in maize grains. Vignesh *et al.* (2015) found wide genetic variation for lutein (0.36–15.75 µg g⁻¹), zeaxanthin (0.25–22.76 µg g⁻¹), and β -carotene (0.07–17.41 µg g⁻¹) in 48 diverse maize inbreds. Allelic variations and dosage effects may be responsible for the wide range of variability for carotenoids in yellow maize (Chander *et al.*, 2008). High level of β - carotene was observed in populations 25, 24, and 27 and they would be used in the breeding programs to enhance the β - carotene contents.

Table 2. Content of carotenoids in thirty maize populations

Local populations				Introduced populations			
No.	Lutein	Zeaxantin	β carotene	No.	Lutein	Zeaxantin	β carotene
1	9,4388	7,0545	1,5919	16	2,7841	14,0195	2,6119
2	1,5043	8,9583	1,0971	17	4,3599	4,2640	2,2511
3	9,0934	10,6077	3,3811	18	1,4462	40,8608	4,7777
4	7,2309	9,4844	2,3395	19	1,6027	13,0347	4,8324
5	9,1416	30,0547	3,0140	20	4,7018	7,1558	4,4940
6	5,6902	4,1450	0,5490	21	6,7992	4,5922	1,4341
7	3,8041	1,5069	0,6761	22	ND	ND	ND
8	2,9074	1,8874	1,0573	23	2,9459	2,0451	0,5677
9	9,9891	19,8594	4,3858	24	1,9262	16,4661	5,4301
10	7,6411	15,1882	4,7724	25	1,2437	22,7502	7,9527
11	7,0309	3,1291	1,3083	26	1,7367	10,4042	5,0878
12	7,3521	1,8726	4,0707	27	2,9967	4,4766	5,5234
13	15,4930	10,3772	4,7908	28	2,1937	7,1380	1,4940
14	3,7678	2,2809	0,7387	29	2,1976	9,2825	1,1428
15	14,4811	7,8641	2,0403	30	3,7987	3,8602	0,2646
Average	7,6377	8,9514	2,3875	Average	2,9095	11,1678	3,0617

Average content of α tocopherol was higher in introduced ($5.78\mu\text{gg}^{-1}$) than in local populations ($4.59\mu\text{gg}^{-1}$) but local populations have higher content of γ tocopherol ($25.23\mu\text{g g}^{-1}$) than introduced populations ($20.66\mu\text{gg}^{-1}$). Content of α tocopherol varied from 1.043 to $7.93\mu\text{gg}^{-1}$ for local, and from $1.99\mu\text{gg}^{-1}$ to $27.20\mu\text{gg}^{-1}$ in introduced populations. γ tocopherol content range from $13.25\mu\text{gg}^{-1}$ to $37.27\mu\text{gg}^{-1}$ for local, and from $14.22\mu\text{gg}^{-1}$ to $37.56\mu\text{gg}^{-1}$ for introduced populations (Table 3). The local population 12 have high α and γ tocopherol content as well as introduced population 25. Tocopherol levels in maize kernels vary widely, however, α -tocopherols constitutes less than 20% of total in maize kernels (Rochefford, 2002).

The population 25 with orange kernels had a high level of zeaxantin, β -carotene and tocopherols. That population is used for improvement of tocopherol and carotene content in inbred lines. The population was crossed with 5 inbred lines during 2015. β -carotene content in the inbreds ranged from 0.47 to $2.98\mu\text{gg}^{-1}$, and in the crosses from 3.22 to $16.48\mu\text{gg}^{-1}$. Furthermore, the content of tocopherols was higher in the crosses than in the inbred lines *per se* (Anđelković *et al.*, 2016).

Table 3. Content of tocopherols in thirty maize populations

Local populations				Introduced populations			
No.	Delta	Gama+beta	Alfa	No.	Delta	Gama+beta	Alfa
1	2,2131	31,3314	7,9238	16	1,2871	21,8386	1,9947
2	6,0068	28,6978	3,1146	17	1,0181	17,9048	3,0173
3	1,9124	22,0217	4,3712	18	0,9246	14,2293	3,7523
4	1,4944	22,9836	3,4091	19	1,7868	23,9700	4,9442
5	1,6326	24,2941	4,6284	20	0,8271	17,4978	4,7197
6	4,3844	30,5768	1,5707	21	1,7242	15,8650	4,7010
7	1,5714	19,1500	1,0433	22	2,3592	24,1170	1,5088
8	2,0027	34,3998	3,0670	23	2,2555	22,7062	3,1647
9	0,9721	13,2576	3,5670	24	2,0655	28,0074	5,5681
10	1,7212	25,7349	4,1694	25	1,6266	37,5693	27,2008
11	1,4701	30,0606	6,9781	26	1,2469	19,6259	3,2103
12	2,0789	37,2733	7,7082	27	1,1857	17,9438	8,4258
13	1,3174	15,5490	6,5277	28	1,0478	17,7345	2,0402
14	1,8798	23,1318	6,2379	29	0,7495	14,5369	4,7642
15	1,1070	19,9919	4,5122	30	1,6966	16,4302	7,6389
Average	2,1176	25,2303	4,5886	Average	1,4143	19,5000	4,5026

Conclusions

Variability for carotenoids and tocopherols in grain of 15 local and 15 introduced maize populations was determined. The population 18 had the highest concentration of zeaxanthin and local population 9 of lutein. The β – carotene and zeaxanthin content were higher in introduced populations with orange kernal. The local population 12 and introduced population 25 with high α and γ tocopherol content could be used in further breeding program for improving the nutritive value of commercial inbred lines.

Acknowledgement

This study is supported by the Ministry of Education, Science and Technological Development of the Republic of Serbia as part of a project TR 31068.

References

- Andelković, V., Mesarović J., Mladenović Drinić S. (2016). Variability of tocopherol and β carotene content in maize grain of inbred lines, populations and their crosses. Book of abstracts of V symposium of the section of the breeding of the organisms of the Serbian Genetic Society, pp.4., Kladovo 27.5-31.5.2016.
- Bacchetti, T., Masciangelo, S., Micheletti, A. and Ferretti G. (2013). Carotenoids, Phenolic compounds and Antioxidant Capacity of Five Local Italian Corn (*Zea Mays L.*) Kernels. J. Nutr. Food Sci 3(6), 237.
- Daood, H.G., Nagy-Gasztonyi, M., Vörösváry, G., Holly, L., Horváth, L. and Nyerges M. (2003). Analysis of carotenoids in some Hungarian maize landraces. 54. Tagung der Vereinigung der Pflanzzüchter und Saatgutkaufleute Österreichs 2003
- Egesel, C.O. (2001). Genetic variation among maize genotypes for carotenoid and tocopherol compounds. Ph.D. Thesis (62-08, secB; P3423). University of Illinois at Urbana-Champaign.

- Gliszczyńska-Świgło, A., Sikorska E., Khmelinskii I., Sikorski M. (2007). Tocopherol content in edible plant oils, *Polish journal of food and nutrition sciences*, 57, 4(A), 157-161.
- Harjes, C.E., Torbert, R.R., Ling, B., Thomas, P., Brutnell, C.B.K., Stephen, G.S., Ann, E.S., Ratnakar, V., Mark, W., Eleanore, T.W., Jianbing, Y., Edward S.B. (2008). Natural genetic variation in lycopene epsilon cyclase tapped for maize biofortification. *Science* 319, 330-333.
- Hulshof, P.J.M., Kosmeijer, S.T., West, C.E., Hollman P.C.H. (2007). Quick screening of maize kernel for provitamin A content. *J Food Comp Anal* 20, 655–661.
- Matea, C. T., Negrea, O., Has, I., Ifrim, S., Bele, C. (2008). Tocopherol and Fatty acids contents of selected Romanian cereal grains. *Chem. Listy* 99.
- Rivera, S. and Canela R. (2012). Influence of Sample Processing on the Analysis of Carotenoids in Maize Molecules, 17, 11255-11268.
- Rochefford, T.R., Wong, J.C., Egesel, C.O., Lamber, R.J. (2002). Enhancement of vitamin E levels in corn. *J Am Coll Nutr* 21, 191S–198S.
- Safawo, T., Senthil, N., Raveendran, M., Vellaikumar, S., Ganesan, K. N., Nallathambi, G., Saranya, S., Shobhana, V. G., Abirami, B. and Vijaya Gowri E. (2010). Exploitation of natural variability in maize for β - carotene content using HPLC and gene specific markers. *Electronic Journal of Plant Breeding*, 1(4), 548-555
- Vignesh, M. Hossain, F., Thirunavukkarasu, N., Pandey, N., Vishwakarma, A. K., Saha, S., Gupta H. S. (2015). Molecular Characterization of Exotic and Indigenous Maize Inbreds for Biofortification with Kernel Carotenoids. *Food Biotechnology*, 29, 3, 276-295.

MEDICINAL AND AROMATIC PLANT POTENTIAL OF RİZE/TURKEY

Fatih SEYİS*, Yusuf ŞAVŞATLI, Emine YURTERİ, Aysel ÖZCAN

Field Crops Department, Faculty of Agriculture and Natural Sciences, Recep Tayyip Erdogan University, Rize, Turkey

*corresponding author: fatih.seyis@erdogan.edu.tr

Abstract

Rize has a different and special flora because of its geographical position, climate, and topography. The natural plants of Rize have a very big usage potential and value in some sort of industrial branches. In particular, the different activity traits of natural plant oils and extracts have formed the basis of many applications, including raw and processed food preservation, pharmaceuticals, alternative medicine and natural therapies. Rize is located in the northeast Anatolia to the east of coastline of Eastern Black Sea between 40° 22' and 41° 28' meridians east and 40° 20' and 41° 20' parallels of latitude north. Rize is surrounded by District of Trabzon in the west, İspir District of Erzurum in the south, Yusufeli District and Arhavi District of Artvin in the east and Black Sea in the north. It covers an area of 3,920 km² except lakes. It has a mountainous and rugged terrain. Rize region is highly rich in terms of forested land and plant species diversity. This study gives brief information about medicinal and aromatic plant species in Rize. Our statement is that plants, which are grown naturally in our province represent a potential source of abundance, should be utilized for medical and economic purposes, and also researched for more potential uses in medicine and pharmacy.

Keywords: *medicinal and aromatic plants, Rize*

Introduction

Turkey is one of the countries with richest plant diversity in the Mediterranean (Davis 1965-1986; Davis *et al.*, 1988; Guner *et al.*, 2001). A number of human races and tribes have settled here during different periods bringing in different cultures and customs. As a result of this we come across a great accumulation of knowledge of traditional medicine in the country. A recent survey of traditional and folk medicine in Turkey has revealed that most of these plants are still in use by the local inhabitants (Yesilada and Sezik, 2003).

Turkey is located in three biogeographical regions: Anatolian, Mediterranean, the Black Sea region, and their transition zones. Its climatic and geographical features change within short intervals of space due to the country's position – a bridge between two continents. Thanks to its location, Turkey's biological diversity can be compared to that of a small continent: the country's territory consists of forests, mountains, steppe, wetlands, coastal and marine ecosystems and different forms and combinations of these systems. This extraordinary ecosystem and habitat diversity has produced considerable species diversity (Kahraman *et al.*, 2011; Kahraman *et al.*, 2012). Regarding biodiversity the Black Sea region belongs to one of the richest regions of Turkey. Totally 2239 species are present in the East Black Sea region, 514 of them are endemic and the endemism ratio is ca. 23 %. More than half of the plants distributed at the East Black Sea region are present in the Rize province. 70 % of the plants are of medicinal and aromatic value.

Plant diversity in Rize

Floristic studies carried out in Rize revealed that 2239 species diversity and 222 endemic plant taxons are present in this province (Anşın, 1980). Regarding species diversity Rize is one of the

richest provinces in Turkey. In an TÜBİTAK founded project 1430 different plant species and 110 endemic plant species were detected in Rize. 15 of this species were new records for the Turkish flora, 4 were new records were new for the world fauna (Güner *et al.*, 1987). Therefore this region displays rich biological diversity.

Medicinal and Aromatic Plants in Rize

Because Turkey is located in a region of three crossing floristic regions it displays a rich plant diversity. One of this locations is the Rize province at the East Black Sea region. There are citations that about medicinal and aromatic plants are present in this region but the correct number is still unknown (Gül, 2014). Birinci (2008) stated that 117 plants are used for medicinal and aromatic purposes. Yıldız *et al.* (2010) pointed out that farmers in Rize have knowledge only about the production of lime tree, black sesame, chili pepper, cumin, cinnamon, hibiscus, mint, pepper, green tea and ginger; the study revealed that the same farmers had no knowledge about other medicinal and aromatic plants.

Studies investigating the province rize grouped the present plant species. Akbulut (2013) separated the species according to their ethnobotanical features: plants for medicinal uses, plants used as food, plants used in animal healing and fodder, plants used as spice and tea, plants used for firing and plants used for different purposes. Further, Yıldız (2010) grouped traded and natural plants in Rize as natural tea used plants, plants sold for its flowers, plants used as spice, plants used for food, gum and resin obtained plants, plants used in animal healing, plants used as insecticides, plants for paint production and plants used for medicine raw material abroad.

Table 1 illustrates plant species in Rize used for medicinal purposes.

Tabel 1. Plants used for medicinal purposes

Plant name	Used for	Plant name	Used for
<i>Achillea millefolium</i> subsp. <i>millefolium</i>	Breath clearing, wounds, haemorrhoid	<i>Castanea sativa</i> Mill.	Rough, dropping blood pressure
<i>Alchemilla crinita</i> Buser	Tranquilizer, wound healing,	<i>Centaurium erythraea</i> Koth. subsp. <i>turcicum</i>	Haemorrhoid
<i>Alnus glutinosa</i> (L.) Gaertn subsp. <i>barbata</i> (C.A. Mey.) Yalt	Haemorrhoid, wound cleaning, tummy ache, astringent	<i>Chelidonium majus</i> L.	Eczama, acne
<i>Anthemis cotula</i> L.	Gynaecological diseases	<i>Cirsium arvense</i> (L.) Scop. subsp. <i>vestitum</i> (Wimmer&Grab.) Petrak	Diabetes
<i>Anthemis tinctoria</i> L. var. <i>pallida</i> DC.	Gynaecological diseases, Difficulty in breathing	<i>Convolvulus arvensis</i> L.	Arthralgia
<i>Anthemis vulgaris</i>	Appetising, antifebrile	<i>Coryllus avellana</i> subsp. <i>avellana</i>	Cough
<i>Atropa bella-donna</i>		<i>Crataegus monnogyne</i> Jacq. subsp. <i>monnogyne</i>	Roborant
<i>Asplenium trichomanes</i> L.	Tummy ache, haemorrhoid	<i>Cyclamen coum</i> Miller	Sinusitis
<i>Ballota nigra</i>	Sleeplessness, cough	<i>Dactylorhiza urvilleana</i> (Steudel) Baumann & Künkele	Roborant
<i>Bellis perennis</i> L.	Cold, diuretic	<i>Datura stramonium</i>	Difficulty in breathing, painkiller
<i>Calluna vulgaris</i> (L.) Hull	Cold, cough	<i>Digitalis ferruginea</i> L. subsp. <i>schischkinii</i> (Ivan) Werner	Urologic problems
<i>Camellia sinensis</i>	Cancer, diarrhea preclusion	<i>Dioscorea communis</i> (L.) Caddick& Wilkin	Body pain
<i>Carduus acanthoides</i> subsp. <i>sintenisii</i> Kazmi in Mitt.	Antifebrile, increase in urine	<i>Diospyros lotus</i> L.	Gastritis, prevention of diarrhea

Developed using Akbulut (2013), Güner *et al.* (1987) and Yıldız (2010)

Tabel 1. Plants used for medicinal purposes (continued)

Plant name	Used for	Plant name	Used for
<i>Dryopteris filix-mas</i> (L.) Schott	Tummy ache	<i>Polygonum persicaria</i> L.	Haemorrhoid, mouthwash of gingival bleeding
<i>Equisetum arvense</i> L.	Blood purification, urological problems, quinsy	<i>Rhododendron caucasicum</i> Pall.	Difficulty in brathing, cancer
Euphorbia L.	Wound, wart	<i>Rhododendron ponticum</i> L. subsp. <i>ponticum</i>	Headache, eczema
<i>Fagus orientalis</i> Lipsky.	Tummy ache, dropping worms	<i>Rosa canina</i> L.	Diabetes, cold
<i>Ficus carica</i> L. subsp. <i>carica</i>	Wart, tootache, chilblain	<i>Rubinia pseudoacacia</i> L.	Tranquilizer, stoppage,
<i>Frangula alnus</i> Miller. subsp. <i>alnus</i>	Haemorrhoid	<i>Rubus idaeus</i> L.	Cancer, eczema
<i>Hedera helix</i> L.	Tummy ache	<i>Rumex acetosella</i> L.	İgestive disorders, gingivitis, tummy ache, sinusitis
<i>Helichrysum plicatum</i> DC. subsp. <i>plicatum</i>	Dropping kidney sand	<i>Salvia glutinosa</i> L.	Wound, burnt
<i>Helleborus orientalis</i> L.	Dropping worms	<i>Sambucus ebulus</i> L.	Haemorrhoid, rheumatic pain
<i>Hypericum perforatum</i> L.	Regulating blood pressure, tranquilizer, haemorrhoid	<i>Sambucus nigra</i> L.	Haemorrhoid
<i>Hypericum xylosteifolium</i> (Spach) Robson	burnt	<i>Sanicula europaea</i> L.	Difficulty in breathing, tummy ache in babys
<i>Juglans regia</i> L.	Diabetes, reducing cholesterol, asthma	<i>Sedum spurium</i> M. Bieb.	callosity
<i>Lamium puppureum</i> L. var. <i>purpureum</i>	Balancing cholesterol, roborant	<i>Smilax excelsa</i> L.	Renewal of brain cells
<i>Laurocerasusofficinalis</i> Roem.	Diabetes, ulcer, kidney diseases, cough	<i>Solidago virgaurea</i> L. subsp. <i>virgaurea</i>	Body immaflation
<i>Laurus nobilis</i> L.	Reducing cholesterol, flu, cold, tootache, rheumatism	<i>Stachys arvensis</i>	Haemorrhoid
<i>Lycopodium clavatum</i> L.	Body irritants	<i>Stachys macrantha</i> (C. Koch.) Stearn.	Relief od stomache
<i>Malva sylvestris</i>	Breathing difficulty, antifebrile	<i>Symphytum asperum</i> Lepech.	cough
<i>Mentha aquatica</i> L.	Nauseation, gastritis, bad breath	<i>Panacetum partenium</i> (L.) Schultz Bip.	Body immaflation
<i>Morus nigra</i> L.	Cancer, reducing blood sugarici	<i>Taraxacum officinale</i>	costiveness
<i>Nasturtium officinale</i> R. Br.	Haemorrhoid, prostat diseases, tummy ache	<i>Thymus pseudopulegioides</i> Klokov Des.-Shost	Cold, stomache diseases
<i>Origanum vulgare</i> L. subsp. <i>viride</i>	Cold	<i>Tilia rubra</i> DC. subsp. <i>caucasica</i> (Rups.) V. Eng	Diaphoretic, cough, asthma
<i>Oxalis corniculata</i>	costiveness	<i>Trachystemon orientalis</i>	İntestine disorders
<i>Picea orientalis</i> (L.) Link	İnflamated wounds	<i>Tussilago farfara</i>	Cough, expectorant
<i>Phyllitis scolopendrium</i> (L.) Newn.	Haemorrhoid, tummy ache, arteriosclerosis, burnt	<i>Verbascum thapsus</i>	cold
<i>Physalis alkekengii</i> L.	Blood pressure, diabetes	<i>Viscum album</i> L.	Heart diseases, Haemorrhoid
<i>Phytolocacca americana</i> L.	Painkiller	<i>Urtica dioica</i> L.	Cancer,haemorrhoid, rheumatic pain

Developed using Akbulut (2013), Güner et al. (1987) and Yaldız (2010)

In Table 1 not only herbaceous medicinal plants are listed, also shrubs and trees are present. As can be seen from the Table different plants from different species have widely use in the treatment of different diseases and other aims.

In Table 2 we can see the plants used as natural tea and spice in the Rize province. Of course, we have to mention black tea (*Camellia sinensis* L.) which is of big economic value for the local farmers. Plants usage as tea and spice known by local people are listed in this table.

Tabel 2. Plants used as tea and spice

Plant name	Used for	Plant name	Used for
<i>Achillea millefolium</i>	Tea	<i>Mespilus germanica</i>	Fruit stew
<i>Angelica sylvestris</i>	Tea	<i>Origanum vulgare</i> L. subsp. <i>viride</i>	Spice
<i>Buxus sempervirens</i>	Tea	<i>Physalis alkekengi</i>	Tea
<i>Calamintha grandiflora</i>	Spice, tea	<i>Plantago major</i>	Tea
<i>Camellia sinensis</i>	Tea	<i>Plantago lanceolata</i>	Tea
<i>Castanea sativa</i>	Tea	<i>Primula vulgaris</i> Huds.	Tea
<i>Daphne glomerata</i>	Spice	<i>Rhus coriaria</i>	Spice
<i>Fragaria vesca</i>	Syrup	<i>Rosa canina</i>	Tea
<i>Fragaria viridis</i>	Syrup	<i>Rubus idaeus</i>	Tea
<i>Galium aperine</i>	Tea	<i>Salvia glutinosa</i>	Tea
<i>Hippophae rhamnoides</i>	Tea	<i>Tanacetum parthenium</i>	Spice
<i>Humulus lupulus</i>	Tea	<i>Thymus pseudopulegioides</i>	Tea, spice
<i>Hypericum perforatum</i>	Tea	<i>Tilia rubra</i> subsp. <i>caucasica</i>	Tea
<i>Laurocerasus officinalis</i>	Tea	<i>Urtica dioica</i>	Tea
<i>Matricaria camomilla</i>	Tea	<i>Vaccinium myrtillus</i>	Tea
<i>Mentha aquatica</i>	Spice	<i>Vaccinium vitisidaea</i>	Tea
<i>Mentha longifolia</i>	Tea, spice	<i>Verbascum thapsus</i>	Tea
<i>Mentha piperita</i>	Tea, spice		

Developed using Akbulut (2013), Güner et al. (1987) and Yaldız (2010)

Of course the number of medicinal and aromatic plants are not restricted with the listed plant species. More research is necessary to cover all potential plants in a whole survey. Furthermore chemical analysis is needed to determine the compounds in investigated species

In areas where agricultural land are limited is it necessary to detect medicinal and aromatic plants for employment increase. The next step has to be the introduction of plants with high economical value to local farmers, to develop an sustainable plant collection strategy and the education of farmers regarding medicinal and aromatic plants.

If these steps are handled accurately and with correct marketing strategies based on market demand local farmers will get higher economical income and many social benefits.

Conclusion

Almost all people living in rural areas are engaged in agriculture which plays a key role in rural development. For this reason, arrangements in crop planning and marketing and sales are extremely important. While making arrangements, the regional priorities and the climatic data should be considered and alternative agricultural crops must be recommended. Additionally, agricultural production and quality should be ameliorated and the living standards of people living in rural areas should be improved by using new agricultural production techniques (Samet and Cikilli, 2015).

Medicinal and aromatic plants are of big importance for additive plant production Rize. Rize contains very rich natural resources. Therefore detailed ethno pharmacological and botanical

research is necessary to find out the other herb families and species of economic value beside determined ones.

Many endemic and endangered species are still collecting and selling by local people. These activities could bring some profits to the local people but also dangers many endemic species and prevents the sustainability (Toksoy et al., 2008).

Current political and economical practices could not obstruct the incorrect usage of the natural resources. Some suggestions from determined results are given below, to provide the sustainability and manageability of the natural herb resources (Toksoy, 2010).

i. The herb collecting from the nature, (used domestically or for exportation) must be regularly and sustainable. Institutional and educational studies must be increased.

ii. Production and marketing activities have to be coordinated with the global markets and needs

iii. Blacksea region has very rich natural herb resources, but the people don't have enough information about these resources. This deficiency must be eliminated with right methods, like education activities.

iv. The need of scientific researches is very high. It is highly recommendable to making botanical and pharmacological researches.

References

- Davis PH. (1965-1985) Flora of Turkey and the East Aegean Islands. Vol 1-9 Edinburgh Press Edinburgh.
- Davis PH., Mill RR., Tan K. (1988). Flora of Turkey and the East Aegean Islands. Vol 10. Edinburgh University Press, Edinburgh.
- Gül V. (2014). A General View to Medicinal and Aromatic Plants Belonging to Rize Province. Review Article. Iğdır University, Institute of Science and Technology 4 (4): 97-107.
- Güner, A., Vural M., Sorgun K. (1987). Vegetation of the Flora of Rize and Pollen Analysis of Local Honey. TÜBİTAK, Project No. TBAG-650.
- Güner A., Özhatay N., Ekim T. (2001). Flora of Turkey and the East Aegean Islands, Volume 11, Edinburgh University Press, Edinburgh.
- Kahraman A., Doğan M., Celep F. (2011). *Salvia siirtica* sp. nov. (Lamiaceae) from Turkey. Nord J Bot 29: 397-401.
- Kahraman A., Bagherpour S., Karabacak E., Doğan M., Doğan H.M., Uysal İ., Celep F. (2012). Reassessment of conservation status of *Salvia* L. (Lamiaceae) in Turkey II. Turk J Bot 36: 103-124.
- Samet H., Cikli Y. (2015). Importance of medicinal and aromatic plants as an alternative crop in the rural development of Turkey. The Journal of Rural and Community Development, 10(4), 75-84.
- Toksoy D., Bayramoglu M., Hacisalihoglu S. (2010). Usage and the economic potential of the medicinal plants in Eastern Black Sea Region of Turkey. Journal of Environmental Biology September 31(5) 623-628.
- Yaldız, G., Yüksek, T., Şekeroğlu N. (2010). Importance of Medicinal and Aromatic Plants in Development of Forest and Coastal Villages of Rize Province. III. National Forestry Congress. 1176-1186.
- Yesilada E., Sezik E. (2003). A survey on the traditional medicine in Turkey: semi-quantitative evaluation of the results. In: Singh, V.K., Govil, J.N., Hashmi, S., Singh, G. (Eds.), Recent Progress in Medicinal Plants, vol. 7: Ethnomedicine and Pharmacognosy II. Studium Press LLC, Houston, TX, USA; pp. 389-412.

THE DETERMINATION OF SOME MEDICINAL PROPERTIES OF BERMUDAGRASS, WHITE CLOVER AND BUCKWHEAT USING AS FORAGE CROPS

Nur KOC, Sadiye Ayse CELIK, Ramazan ACAR, Yuksel KAN

Department of Field Crops, Selcuk University, Selcuklu, Konya, Turkey
Corresponding author: nurkoc@selcuk.edu.tr

Abstract

The plants of *Cynodon dactylon* (L) Pers, *Trifolium repens* L, and *Fagopyrum esculentum* Moench, which have vegetable properties such as their being able to use erosion control plant and soil improving plant, due to pollution in resources, which increases in the recent years in the world, are considered as forage plants not only for breeding but also in terms of sustainability. In addition, bermudagrass, white clover, and buckwheat, due to important effective substances (respectively, vitexin, quercetin, myricetin and rutin) they have, are used in the traditional medicine in the different places of the world. Therefore, in our study carried out as three repeated pot trial in greenhouse conditions, these three species of plants were grown in such a way that there will be five plants in each pot. In our study, bermudagrass and white clover, were mowed in 130 days after seeding; buckwheat, in 50th days when flowering of 10 % occurred. After the heights and wet weights of plants are determined, the plants mowed were dried at shadow and their wet weights, and ash, moisture, antioxidant activity, total phenol, and total flavonoid contents were identified. It was detected antioxidant activity, total phenols and total flavonoids using by spectrometer as a method DPPH free radical scavenging activity. As a result of trial we carried out, in buckwheat and bermudagrass, while antioxidant activity and total flavonoids are high, in white clover, total phenol was found high. In this study, the similarities and differences of three plants in terms of medical use were tried to be interpreted.

Keywords: Bermudagrass (*Cynodon dactylon* L. Pers.), Buckwheat (*Fagopyrum esculentum* Moench), Forage crops, Medicinal plant, White clover (*Trifolium repens* L.)

Introduction

In the today's world, when a high quality fodder plant is mentioned about, the features such as becoming preferable by animal i.e. flavor, chemical composition and digestibility of plant firstly come into mind. In short, that a fodder plant gives a rise to increase in yield values of animals such as live weight, and amount of milk and wool shows that it is high quality fodder (Yavuz et al., 2009). However, the values such as raw protein, raw oil, raw fiber, carbohydrate are metabolites used in plants, it should not be forgotten that secondary metabolites are also synthesized in every plant.

Although the amount of secondary metabolites synthesized by plants is less, the importance of defense mechanism of plants in pollination is considerably high. In addition, they are relatively important substances for human health in terms of features of providing flavor, odor, and color in human food and of being a medical raw material (Verpoorte and Memelink, 2002). Besides that they are important to human health, in addition to the features such as odor and flavor provided by plant about the preferences of animals as fodder, with their features such

as development of rumen ecosystem of extracts of plants, its increasing the affectivity of rumen mechanism, and promoting or inhibiting the secretion of some hormones in animals, it should not be forgotten that they are important to animal health (Greathead, 2003). Therefore, while the issue of being preferred of a fodder plant by animals are dealt with, it is also necessary to deal with the importance of secondary metabolites. Especially this issue, for the reasons such as the increasingly pollution and decrease of resources in the world, as a result of gradually limitations of agriculture, is considerably important about knowing the effects of fodder plants, which we can use to eliminate the needs of animals for fodder, on animal health. We used in the study the fodder plants of bermudagrass, white clover, and buckwheat, have botanical features such as their being able to be used as erosion control plant and soil improving plant. And these plants are used in the traditional medicine in the different regions of the world with the secondary metabolites (vitexin, quercetin, myricetin, and rutin, respectively) (Babu et al., 2009; Schittko et al 1999, Kreft et al 2006). It is known buckwheat is a good fodder plant and a good medical plant with its rutin content it has. White clover is used in the traditional medicine for treatment of diseases such as rheumatic disorder, deworming remedy, sore throat, fever, pneumonia, meningitis, etc. (Kolodziejczyk-Czepas, 2012). Bermudagrass can be used in traditional medicine as anti-inflammatory, diuretic, antiemetic, antidiabetic and blood-purifying agent (Rai et al 2010). Therefore, in order to identify the medical features of these three fodder plants, in the study, their activities of total phenol, total flavonoids, and antioxidant activities were determined.

Materials and methods

This research was carried out during February and June 2016 in Breeding Greenhouse of the Department of Field Plants, Faculty of Agriculture, Selcuk University. The populations of bermudagrass, white clover and buckwheat were used as a material for this research. In this study, designed as three repeated according to Test Design of Random Parcels, the plants were grown in the pots in the dimensions of 16x16 cm. Seeding was made in such a way that there will be five plants in each pot. In the trial, the cutting was made when each plant was flowered by 10%. While buckwheat was cut after 50 days from seeding, bermudagrass and white clover were cut after 130 days from seeding in such a way that it will be from root collar. Also, plant height (cm), fresh weight (g), and dry weight (g) were identified. It was determined dry matter (%), moisture content (%) of these plants by using moisture analyzers. After moisture content (%) had been found in moisture analyzers, dry matter (%) was calculated. For finding the ash %, these plant samples were weighted, firstly. Then, these samples were burned at 8 hours in temperature 600°C in ash oven. The samples taken out from ash oven were weighted, and ash content % was calculated by the following formulas.

$$Ash \% = \frac{[(Crucible\ Weigh + Ash) - Crucible\ Tare]}{[(Crucible\ Weigh + Sample\ Weigh) - Kroze\ Tare]} * 100$$

Determination of Antioxidant Activity in Extracts

2,2-Diphenil -1-picrihydrazil (DPPH) Determination of free radical scavenger

The stable 2,2-diphenyl-1-picrylhydrazyl (DPPH) radical scavenging activity was determined by the method of Blois (1958). DPPH free radical scavenger activity of extracts was determined by spectrophotometrically measuring transformation from dark violet color into light yellow color in UV visible region in wave length of 517 nm against the radical of 2,2 -diphenyle, 1,2-

picrilhydrazide (DPPH) (Sigma-Aldrich Chemie, Steinheim, Germany). Of the extracts we have prepared, the necessary amounts of DPPH stock solutions of 250 µg/ml, 500 µg/ml and 1000 µg/ml were weighed in such a way that there would be in the concentration of 6×10^{-5} mol/l solved in ethanol (75%). Taking 300 µl of each sample by means of micropipette into test tubes, 2700 µl of DPPH solution was added onto them. Then, tubes were kept for 20 minutes at dark at room temperature. At the end of the time, absorbance of samples was read on spectrophotometer (Agilent Technologies UV-Visible spectrophotometer, Germany) against ethanol used as blind at the wave length of 517 nm. % inhibitions of samples against DPPH free radical of samples were calculated according to the formulas given below. Each sample was treated in three parallel works and % scavenger effects of the results were statistically examined.

$$\text{Inhibition \%} = [(A1 - A2) / A1] \times 100$$

A1 = Absorbance of DPPH stock solution at the wave length of 517 nm.

A2 = Absorbance of DPPH sample solution at the wave length of 517 nm.

Determination of total phenolic and flavonoid contents in the extracts

For determining total content of phenol, method of Folin-Ciocalteu, modified by Singleton and Rossi (1965), was used. In brief, some dilutions of gallic acid (50– 500µgmL⁻¹) were obtained to prepare a calibration curve. The extracts and gallic acid dilutions diluted in ethanol (75%) were mixed with 750µL of Folin –Ciocalteu's reagent and 600µL of sodium carbonate in test tubes. The tubes were then vortexed and incubated at 40°C for 30min. Afterward, absorption was measured at 760 nm at a Unico 4802 UV–visible double beam spectrophotometer (Dayton, NJ, USA). The total flavonoid content of the extracts was established by aluminum chloride colorimetric method (Woisky and Salatino, 1998). To sum up, some dilutions of quercetin (50–500µgmL⁻¹) were obtained to prepare a calibration curve. Then, the extracts and quercetin dilutions were mixed with ethanol (75%), aluminum chloride reagent, 0.1mL of sodium acetate as well as distilled water. Following incubation for 30 min at room temperature, the absorbance of the reaction mixtures was measured at a wavelength of 415 nm with a Unico 4802 UV–visible double beam spectrophotometer (Dayton, NJ, USA). The total phenol and flavonoid contents of the extracts were expressed as Gallic acid and quercetin equivalents (mgg–1 extract), respectively.

Results and discussion

In this study we have carried out to determine the medical features of three sorts of fodder plant, while the values obtained related to the height, wet weight, dry weight, rate of wet weight/dry matter, ash content, and moisture of the plant are presented in Table 1, the results of antioxidant activity, total phenol, and total flavonoids were given in Table 2.

Table 1. Average values of the plant height, fresh weight, dry weight, dry matter, ash content, and moisture content of the plant obtained from three sorts of plant

Plants	Plant Height (cm)	Fresh Weight (g)	Dry Weight (g)	Dry Matter (%)	Ash (%)	Moisture Content (%)
White Clover	13,78	0,98	0,50	91,41	12,87	8,59
Buckwheat	45,11	2,36	0,64	92,20	14,59	7,80
Bermudagrass	38,44	2,27	0,81	91,04	6,86	8,96

Table 2. Antioxidant activity, total phenols and total flavonoids of white clover, buckwheat, and bermudagrass

Plants	DPPH (% free radical scavenging activity)	Total Phenols (mg/g GAE)	Total Flavonoids (mg/g KE)
White Clover	22,949	14,91	1,026
	23,029	14,92	1,024
	23,016	14,96	1,024
Buckwheat	79,343	9,515	2,032
	79,397	9,514	2,033
	79,330	9,513	2,000
Bermudagrass	71,957	8,251	1,318
	71,971	8,305	1,320
	72,131	8,257	1,319

As a result of the trial we have carried out, while in terms of plant height, buckwheat was found as the longest plant, it was followed by bermudagrass, and white clover, respectively. While the plant height of white clover, and bermudagrass, obtained in the trial, showed the similar results to Vahdati et al (2012), FAO (2012) and Anonymous (2016), the plant height of buckwheat showed difference with Guzelsarı (2016). When fresh weight was examined, while the plant of buckwheat was the heaviest, it was followed by the plants of and bermudagrass, and white clover. When regarded to fresh weight examined in the trial, while buckwheat showed similarity to Park (1995), in the studies carried out, it was found that Nazarı et al 2014 and Vahdati et al (2012) showed difference. In terms of rate of dry matter, the rate of dry matter of buckwheat is high and the other two of them is the same. The rate of dry matter, obtained in the study we have carried out, it was identified that the other two, except for white clover (Anonymous 2016), were the same as the other studies carried out (Anonymous 2016, Campell 1997). When ash % they contain was examined, while buckwheat had the highest ash content, bermudagrass, had the least ash content. It was identified that ash content %, other than white clover. (Anonymous 2016), in the studies carried out was different from the other two plants (Anonymous 2016, Guzelsarı 2016). In terms of moisture content %, bermudagrass, and white clover is the same, moisture content buckwheat is the lowest. While the average values we have taken related to moisture content % is the same as the studies on bermudagrass (Anonymous 2016), it was identified that those of buckwheat and white clover were different from the other studies (Guzelsarı 2016, Anonymous 2016) carried out. The difference occurring in the results we obtained in the trial may be due to completion of the trail at the beginning of flowering or the material used.

It was found that buckwheat was a plant species, whose antioxidant activity and total flavonoids, and whose medical value is the most, are the highest. Following buckwheat, it was identified that bermudagrass, had the highest antioxidant activity and total flavonoids. When compared to white clover and equivalence of gallic acid, it has considerably higher phenol content than the other two. The results obtained in our study was compared with those of the other studies carried out (Kahrören et al 1999, Oleszek and Stochmal 2002, Auddy et al 2003, Sun and Ho 2005, Francini et al 2007, Severino et al 2007, Mangathayaru et al 2009, Krishanti et al 2010) and it was identified that they showed similarity.

Conclusion

According to the results of the study we have carried out, while antioxidant activity and total flavonoids of buckwheat and bermudagrass are high, total phenol of white clover is high. According to this study, carried out to identify the medical properties of these three plants, these species of three plants are medically important, and we have an opinion that from medical point of view, more studies should be carried out on especially the plants of bermudagrass and white clover.

References

- Anonymous (2016). <http://www.feedipedia.org/content/feeds?category=15965>
- Auddy B, Ferreira M, Blasina F, Lafon L, Arredondo F, Dajas F, Tripathi PC, Seal T, Mukherjee B (2003). Screening of antioxidant activity of three Indian medicinal plants, traditionally used for the management of neurodegenerative diseases, *Journal of Ethnopharmacology* Vol (84) pages (131-138).
- Babu DSR, Neeharika V, Pallavi V, Reddy MB (2009). Antidiarrheal activity of *Cynodon dactylon*. *Pers, Pharmacognosy Magazine* Vol (5) 19 pages (23-27).
- Blois MS (1958). Antioxidant Determinations by the Use of a Stable Free Radical, *Nature* Vol (181) Pages (1199 – 1200).
- Campell CG (1997). Buckwheat (*Fagopyrum esculentum* Moench.). Promoting the Conservation and Use of Underutilized and Neglected Crops 19. IBPGR. Rome.
- FAO (2012). Grassland Index. A searchable catalogue of grass and forage legumes. FAO, Rome, Italy
- Francini A, Nali C, Picchi V, Lorenzini G (2007). Metabolic changes in white clover clones exposed to ozone, *Environmental and Experimental Botany* Vol (60) pages (11-19).
- Greathead H (2003). Plants and Plant Extracts For Improving Animal Productivity. *Proceeding of the Nutrition Society* Vol (62) pages (279-290).
- Guzelsarı U (2016). Investigation of Agronomic and Quality Characteristics of Buckwheat (*Fagopyrum Esculentum* Moench) Cultivated as Secondary Crop in Karaman Ecology Conditions (Ms thesis) (Karaman Ekolojik Şartlarında 2. Ürün Olarak Yetiştirilen Karabuğdayın (*Fagopyrum esculentum* MOENCH) Agronomik Ve Kalite Özelliklerinin Araştırılması). Selcuk Univercity.
- Hatano T, Edamatsu R, Hiramatsu M, Mori A, Fujita Y (1989). Effects of the interaction of tannins with co-existing substances. VI: effects of tannins and related polyphenols on superoxide anion radical and on 1,1-diphenyl-2-picrylhydrazyl radical. *Chem. Pharm. Bull.* Vol (37) pages (2016–2021).
- Kreft I., Fabjan N, Yasumoto K (2006). Rutin content in buckwheat (*Fagopyrum esculentum* Moench) food materials and products, *Food Chemistry* Vol (98) 3 pages (508-512).
- Krishanti M, Rathinam X, Kasi M, Ayyalu D, Surash R, Sadasivam K, Subramaniam S al (2010). A comparative study on the antioxidant activity of methanolic leaf extracts of *Ficus religiosa* L, *Chromolaena odorata* (L.) King & Robinson, *Cynodon dactylon* (L.) Pers. and *Tridax procumbens* L, *Asian Pacific Journal of Tropical Medicine* 3(5):348-350.
- Kolodziejczyk- Czepas J (2012). *Trifolium* species-derived substances and extracts--biological activity and prospects for medicinal applications. *J Ethnopharmacol.* Vol (143)1 pages (14-23).

- Mangathayaru K, Umadevi M, Umamaheswara Reddy C (2009). Evaluation of the immunomodulatory and DNA protective activities of the shoots of *Cynodon dactylon*. *J. Ethnopharmacol.* Vol (123) pages (181-184).
- Nazari F, Javadi T, Farahmand H, Akbari M (2014). An Evaluation of the Growth and Quality of Monoculture and Seed Mixtures of Cool/Warm Season Turfgrasses in Temperate Area, *Journal of Applied Biological Sciences* Vol 8 (2) pages (86-90).
- Park HC (1995). A Study on Small Scale Indoor Culture of Buckwheat Vegetable in Korea, *Current Advances in Buckwheat Research* Vol (1995) Pages (675 – 679).
- Rai Pk, Jaiswal D, Rai Dk, Sharma B, Watal G (2010). Antioxidant Potential Of Oral Feeding Of *Cynodon dactylon* Extract On Diabetes-Induced Oxidative Stress. *Journal of Food Biochemistry* Vol (34) pages (78–92).
- Schittko U, Burghardt F, Fiedler K, Wray V, Proksch P (1999). Sequestration and distribution of flavonoids in the common blue butterfly *Polyommatus icarus* reared on *Trifolium repens*, *Phytochemistry* Vol (51) 5 pages (609-614).
- Severino JF, Stich K, Soja G (2007). Ozone stress and antioxidant substances in *Trifolium repens* and *Centaurea jacea* leaves. *Environmental Pollution* 146 (2007) 707-714.
- Singleton VL, Rossi JA (1965). Colorimetry of total phenolics with phosphomolybdic-phosphotungstic acid reagents. *Am. J. Enol. Vitic.* Vol (16) pages (144-158).
- Sun T, Ho CT (2005). Antioxidant activities of buckwheat extracts, *Food Chemistry. Food Chemistry* Vol (90) 4 pages (743-749).
- Oleszek W, Stochmal A (2002). Triterpene saponins and flavonoids in the seeds of *Trifolium* species, *Phytochemistry* Vol (61) pages (165–170).
- Vahdati N, Tehranifar A, Neamati SH, Selahvarzi Y (2012). Physiological and Morphological Responses of White Clover (*Trifolium repens*) and Red Clover (*Trifolium pratense*) Plants to Salinity Stress, *Journal of Ornamental and Horticultural Plants*, Vol2 (4) pages (233-241).
- Verpoorte R and Memelink J (2002). Engineering Secondary Metabolite Production in Plants. *Plant biotechnology* Vol (13) pages (181–187).
- Woisky R, Salatino A (1998). Analysis of propolis: some parameters and procedures for chemical quality control. *J. Apic. Res.* 1998; 37: 99-105.
- Yavuz M, Iptaş S, Ayhan V, Karadağ Y (2009). Quality in Forage Crops, and nutritional deficiencies arising from forage crops. *Forage Crops (Yem bitkilerinde Kalite ve Yem bitkilerinden Kaynaklanan Beslenme Bozuklukları, Yem bitkileri)* Vol 1. (Eds; Avcıoğlu R, Hatipoğlu R, Karadağ Y.), T.C. Tarım ve Köy İşleri Bakanlığı, İzmir.

DETERMINATION OF ALKALOIDS AND OIL RATIOS IN SOME POPPY (*Papaver somniferum* L.) VARIETIES AND LINES

Levent YAZICI^{1*}, GÜNGÖR YILMAZ², NEŞET ARSLAN³, KÜBRA YAZICI⁴

1Directorate of Middle Black Sea Transition Zone Agricultural Research Institute, Tokat, Turkey.

2Department of Field Crops, Faculty of Agriculture, Gaziosmanpaşa University, Tokat, Turkey.

3Department of Field Crops, Faculty of Agriculture, Ankara University, Ankara, Turkey.

4Department of Garden Crops, Faculty of Agriculture, Gaziosmanpaşa University, Tokat, Turkey.

*Corresponding author: leventyzc@gmail.com

Abstract

Opium poppy (*Papaver somniferum* L.) is an important industry plant whose capsule yields alkaloids and seeds yield oil. This study was carried out to determine oil and alkaloid contents (such as morphine, codeine, oripavine, thebaine, noscapine, and papaverine) of some opium poppy (*Papaver somniferum* L.) varieties and lines. In the research, registered by different organizations 5 standard opium poppy varieties (Ofis 95, TMO3, Kemer kaya, Seyitgazi, Tinaztepe) and 97 advanced line material were used. The experiment was carried out with a randomized complete block design, under the field conditions in 2015 year at experiment plots of the Central Black Sea Gateway Zone Agricultural Research Institute, Tokat, Turkey. Oil analyses were done in Soxhlet device using extraction method in Central Black Sea Gateway Zone Agricultural Research Institute. On the other hand, alkaloid analyses were done in HPLC device in the laboratory of Bolvadin Alkaloid Factory. As a result, varieties and lines; morphine, codeine, oripavine, thebaine, noscapine and papaverine ration values ranged between (0.26 - 1.46%, 0.045 - 0.33%, 0.006 - 0.11%, 0.011-1.75%, 0,01 - 0.49 %, 0.02 - 0.40 %) respectively, and oil ration values ranged between 32.5-51.7%.

Key words: *Poppy*, *Papaver somniferum* L., *alkaloid*, *oil*, *seeds*

Introduction

One of the medicinal plants, opium poppy (*Papaver somniferum* L.) is an important pharmaceutical industry plant whose capsule yields alkaloids and seeds yield oil. It is grown in Turkey, India, Australia, Spain, France and Hungary as legal main producer countries under the supervision of the United Nations to obtain opium and opium alkaloids for medicinal purposes in World. India produces opium gum, whereas other countries produce dried opium capsules. The average legal opium poppy cultivation area in 2011-2016 is 103.893 ha on the basis of main producers in the world. The average cultivation area in Turkey in 2011-2016 is 43.151 ha, which accounts for 41.5 % share of total legal opium poppy cultivation areas in the world. The average capsule production of the main producer countries of the world in 2010-2014 was 63.856 tons. Turkey had a 35 % share among legal capsule producers with 22.699 tons of average capsule production in 2010-2014 (Anonymous, 2016).

Opium poppy farming in Turkey is implemented within the 70 thousand hectares limit allocated by the United Nations Organization for our country in areas permitted by the Council of Ministers and within the planning framework of General Directorate of Turkish Grain Board. The production is subject to licensing and control in the form of dried opium poppy capsules without incision. The cultivation in 2015/2016 winter and summer farming season took place in

Afyonkarahisar, Denizli, Konya, Burdur, Uşak, Isparta, Eskişehir, Kütahya, Manisa, Balıkesir, Çorum, Amasya and Tokat provinces.

Today, opium poppy makes a significant contribution to the country economy in terms of making up both morphine and derivatives export and grain export of Turkey. In Afyon Alkaloids Factory with its 25.000 tons/year dried un-incised poppy capsule processing capacity, which was established to commercialize opium poppy and meet the legal alkaloid requirement of the market, approximately 80-100 tons of morphine is produced based on the proportion of morphine content of capsules. 10 % of the morphine and derivatives produced is used in domestic pharmaceutical industry and the rest 90 % is exported for medical purposes. 85 % of the export goes to the USA and the rest goes to Asian, European and African countries. The opium based drug consumption in the world for medicinal and scientific purposes is about 450-500 tons. Turkey holds around 20 % of this market share (Anonymous, 2015).

In addition to the main alkaloids of poppy capsule having medical significance such as morphine, codeine, thebaine, noscapine, and papaverine, it contains 30 various alkaloids and has been found to contain around 40 alkaloids by recent studies (Valizadeh, 2015). They are used to produce semi-synthetic active pharmaceutical raw materials with derivatives and high added value. Of these alkaloids, morphine and codeine have drug properties, whereas noscapine and papaverine do not. Poppy capsule contains morphine at most. In addition to its drug properties, this alkaloid is used as a pain killer. Several semi-synthetic materials such as heroin, pentazocine and oxycodone can be obtained from morphine. Noscapine is used as a medicine due to its antitussive (cough suppressant) properties. It is not addictive and it is not a drug or pain killer. Thebaine is the most poisonous opium alkaloid, and it has been used in the production of semi-synthetic medicines with analgesic, antitussive (cough suppressant) and depressant properties. Codaine is found in the form of colorless white crystals or powder, it has little analgesic effect, and it is a good antitussive (cough suppressant) since it eliminates cough reflex. Papaverine loosens smooth muscles. It treats muscle spasm. Duodenum is used in the composition of drugs used in intestinal spasm and gallbladder obstruction (Arslan et al., 2008).

In Turkey, opium poppy seeds are traded in free market conditions. Compared to its 25 thousand tons of poppy seeds production, Turkey has an annual export potential of about 40 thousand tons. The most significant property of opium poppy seeds is that it has 45-55 % oil and 20-30 % protein content. The seeds are traditionally used in bread and pastries. The oil obtained by pressing the seeds is used in cooking and food industry. In addition, it is also known to be used in cosmetic and dye industry (Kahraman, 2011).

Several varieties of opium poppy have been registered so far through breeding programs within the collaboration framework of the General Directorate of Turkish Grain Board (TMO), Research Institutes of Ministry of Food Agriculture and Livestock and universities in Turkey. However, it is necessary to determine the genotypes found in the current gene pool to improve alkaloids and oil rates higher varieties through opium poppy breeding. This study was carried out to determine oil and alkaloid contents (such as morphine, codeine, oripavine, thebaine, noscapine, and papaverine) of some opium poppy (*Papaver somniferum* L.) cultivars and lines.

Material and Method

This experimental study was conducted in the trial field of Central Black Sea Gateway Zone Agricultural Research Institute (Turkey) in 2015. In the study, 5 standard opium poppy varieties (Ofis 95, TMO3, Kemer kaya, Seyitgazi, Tinaztepe) registered by different organizations and 97 advanced line material obtained from Ankara University, Agricultural Faculty, Agronomy Department genetic stock were used. Each variety/line was planted in two rows 3 m in length

according to randomized blocks experimental design. Row spacing was set to 40 cm and plant spacing was set to 10 cm later by thinning. The summer planting was implemented on 27 February, 2015. Oil analyses were done as two replicates in soxhlet device using extraction method in Central Black Sea Gateway Zone Agricultural Research Institute. On the other hand, alkaloid analyses were done in HPLC device in the laboratory of Bolvadin Alkaloid Factory. Plant care such as fertilization, thinning, irrigation, and hoeing works was conducted and diseases and pests were fought when necessary during the vegetal development of opium poppy plant. 20-20-0 Compound NP fertilizer was applied as 5 kg/da N during sowing and AN (ammonium nitrate) fertilizer was administered as 5 kg/da N before the first hoeing. Upon the maturation of all capsules in the trial field, they were harvested by picking up by hand on 30 July, 2015.

Results and Discussion

Table 1 presents the mean and T-test values for alkaloid (morphine, codeine, oripavine, thebaine, noscapine, and papaverine) and oil proportions of 5 varieties and 97 advanced lines used in the trial.

Table 1. T-test and mean values concerning alkaloids and oil proportions of varieties and lines.

Variety/Line	Morphine rations (%)	Codeine rations (%)	Oripavine rations (%)	Thebaine rations (%)	Noscapine rations (%)	Papaverine rations (%)	Oil rations (%)
Seyitgazi	0,71	0,15	0,02	0,10	0,19	0,07	41,7
Tınaztepe	0,70	0,13	0,01	0,09	0,04	0,05	45,3
Kemer kaya	0,61	0,29	0,03	0,10	0,08	0,11	48,7
Ofis 95	0,52	0,33	0,03	0,16	0,12	0,06	50,7
TMO 3	0,36	0,04	0,01	0,06	0,02	0,02	45,0
AUAF-1	0,54	0,16	0,05	0,09	0,27	0,40	51,7
AUAF-2	0,41	0,24	0,02	0,06	0,15	0,18	46,7
AUAF-3	0,49	0,08	0,02	0,02	0,11	0,14	50,0
AUAF-4	0,58	0,06	0,05	0,01	0,14	0,20	49,5
AUAF-5	0,62	0,10	0,02	0,02	0,16	0,19	49,3
AUAF-7	0,37	0,12	0,03	0,03	0,08	0,18	44,8
AUAF-8	0,29	0,16	0,05	0,06	0,15	0,20	46,2
AUAF-9	0,32	0,18	0,05	0,08	0,14	0,12	47,8
AUAF-10	0,51	0,14	0,07	0,05	0,16	0,22	41,7
AUAF-11	0,60	0,18	0,02	0,06	0,01	0,16	47,0
AUAF-12	0,43	0,07	0,04	0,02	0,09	0,10	47,2
AUAF-13	0,49	0,09	0,04	0,04	0,13	0,17	47,3
AUAF-14	0,54	0,11	0,03	0,07	0,11	0,15	48,8
AUAF-15	0,51	0,09	0,04	0,03	0,03	0,08	50,5
AUAF-16	0,43	0,16	0,04	0,04	0,10	0,14	44,8
AUAF-17	0,57	0,13	0,05	0,04	0,05	0,18	46,0
AUAF-18	0,44	0,18	0,02	0,05	0,12	0,22	49,0
AUAF-19	0,27	0,20	0,04	0,14	0,11	0,16	50,3
AUAF-20	1,04	0,12	0,06	0,38	0,06	0,17	44,5
AUAF-21	0,48	0,11	0,03	0,05	0,06	0,13	46,0
AUAF-22	0,39	0,08	0,03	0,03	0,19	0,19	43,5
AUAF-23	0,42	0,14	0,03	0,10	0,02	0,11	49,7
AUAF-24	0,46	0,12	0,03	0,09	0,06	0,07	49,5
AUAF-25	0,39	0,17	0,03	0,09	0,07	0,09	44,8
AUAF-26	0,47	0,19	0,03	0,14	0,11	0,17	44,0
AUAF-27	0,36	0,11	0,06	0,01	0,07	0,21	43,5
AUAF-28	0,44	0,07	0,01	0,03	0,18	0,18	45,8

AUAF-29	0,46	0,22	0,01	0,05	0,18	0,21	43,5
AUAF-30	0,48	0,14	0,01	0,14	0,05	0,21	41,0
AUAF-31	0,72	0,11	0,04	0,03	0,18	0,15	47,0
AUAF-32	0,44	0,10	0,04	0,04	0,09	0,15	44,3
AUAF-33	0,43	0,09	0,03	0,02	0,04	0,10	46,5
AUAF-34	0,52	0,13	0,04	0,04	0,16	0,25	47,3
AUAF-35	0,44	0,11	0,02	0,16	0,15	0,12	46,8
AUAF-36	0,55	0,05	0,04	0,04	0,23	0,15	45,0
AUAF-37	0,55	0,16	0,04	0,07	0,17	0,22	47,0
AUAF-38	0,43	0,11	0,02	0,13	0,03	0,18	45,5
AUAF-39	0,35	0,17	0,03	0,04	0,06	0,12	39,0
AUAF-40	0,48	0,14	0,05	0,03	0,08	0,13	44,5
AUAF-41	0,45	0,11	0,03	0,04	0,08	0,12	47,0
AUAF-42	0,43	0,15	0,02	0,05	0,10	0,17	41,8
AUAF-43	0,28	0,26	0,03	0,04	0,07	0,04	44,5
AUAF-44	0,50	0,09	0,03	0,05	0,07	0,13	42,5
AUAF-45	0,53	0,09	0,04	0,06	0,11	0,24	42,7
AUAF-46	0,48	0,16	0,03	0,10	0,03	0,12	50,8
AUAF-47	0,42	0,13	0,03	0,08	0,14	0,09	43,8
AUAF-48	0,47	0,14	0,04	0,05	0,02	0,11	47,9
AUAF-49	0,54	0,14	0,04	0,06	0,15	0,19	49,3
AUAF-50	0,42	0,19	0,04	0,05	0,10	0,09	49,0
AUAF-51	0,40	0,05	0,05	0,01	0,11	0,13	45,0
AUAF-52	0,47	0,07	0,06	0,16	0,09	0,16	51,5
AUAF-53	0,51	0,11	0,04	0,06	0,03	0,16	32,5
AUAF-54	0,74	0,21	0,05	0,13	0,03	0,18	44,2
AUAF-55	0,49	0,13	0,04	0,05	0,07	0,10	47,7
AUAF-56	0,51	0,12	0,03	0,05	0,14	0,18	43,8
AUAF-57	0,43	0,10	0,04	0,00	0,06	0,12	45,3
AUAF-58	0,42	0,10	0,03	0,03	0,11	0,12	45,2
AUAF-59	0,41	0,20	0,03	0,07	0,13	0,18	47,3
AUAF-60	0,41	0,13	0,02	0,04	0,15	0,09	50,2
AUAF-61	0,31	0,22	0,05	0,11	0,16	0,14	47,0
AUAF-62	0,41	0,06	0,03	0,03	0,09	0,12	46,3
AUAF-63	0,40	0,14	0,03	0,11	0,09	0,13	44,7
AUAF-64	0,47	0,14	0,03	0,05	0,14	0,15	43,8
AUAF-65	0,43	0,16	0,03	0,09	0,10	0,16	42,3
AUAF-66	0,36	0,11	0,03	0,01	0,01	0,13	49,8
AUAF-67	0,42	0,11	0,02	0,22	0,19	0,16	43,5
AUAF-68	0,28	0,36	0,03	0,07	0,15	0,14	51,5
AUAF-69	0,36	0,12	0,01	0,02	0,07	0,15	43,3
AUAF-70	0,51	0,15	0,02	0,17	0,01	0,16	43,0
AUAF-71	0,46	0,09	0,02	0,02	0,06	0,12	47,2
AUAF-72	0,32	0,20	0,01	0,02	0,11	0,15	45,7
AUAF-73	0,39	0,21	0,02	0,06	0,08	0,10	41,2
AUAF-74	0,51	0,19	0,04	0,08	0,03	0,16	47,8
AUAF-76	0,41	0,09	0,03	0,08	0,05	0,05	45,3
AUAF-77	0,39	0,12	0,01	0,01	0,11	0,16	42,3
AUAF-78	0,40	0,16	0,01	0,28	0,09	0,05	41,0
AUAF-79	0,50	0,15	0,04	0,09	0,02	0,25	49,2
AUAF-80	0,38	0,21	0,01	0,20	0,08	0,11	47,2
AUAF-81	0,44	0,15	0,06	0,34	0,03	0,12	43,0
AUAF-82	0,43	0,07	0,02	0,01	0,12	0,14	43,3
AUAF-83	0,49	0,14	0,03	0,09	0,14	0,15	42,5

AUAF-84	0,52	0,16	0,01	0,08	0,06	0,15	45,8
AUAF-85	0,31	0,12	0,02	0,19	0,13	0,17	41,3
AUAF-86	0,52	0,11	0,03	0,09	0,04	0,17	41,8
AUAF-87	0,49	0,12	0,03	0,13	0,05	0,05	45,7
AUAF-88	0,41	0,11	0,04	0,04	0,08	0,15	48,0
AUAF-89	0,42	0,10	0,04	0,09	0,07	0,13	43,2
AUAF-90	0,47	0,10	0,03	0,03	0,16	0,20	44,8
AUAF-91	0,47	0,08	0,03	0,02	0,10	0,12	44,8
AUAF-92	0,47	0,08	0,04	0,05	0,08	0,09	44,2
AUAF-93	0,44	0,11	0,02	0,08	0,06	0,13	48,0
AUAF-94	0,34	0,21	0,01	0,07	0,10	0,09	45,0
AUAF-95	0,27	0,11	0,03	0,06	0,05	0,11	38,3
AUAF-96	0,33	0,10	0,03	0,02	0,12	0,11	46,2
AUAF-98	0,55	0,12	0,03	0,04	0,07	0,11	43,5
AUAF-99	0,42	0,12	0,02	0,06	0,18	0,15	48,5
AUAF-100	0,65	0,17	0,03	0,10	0,08	0,22	46,0
<i>Means of varieties</i>	0,58	0,18	0,02	0,10	0,09	0,06	46,28
<i>Means of lines</i>	0,45	0,13	0,03	0,07	0,09	0,14	45,38
<i>Standard deviation (varieties)</i>	0,14	0,11	0,01	0,03	0,06	0,03	3,49
<i>Standard deviation (lines)</i>	0,10	0,05	0,01	0,06	0,05	0,05	3,90
<i>T value</i>	2,52	0,99	2,01	0,97	0,32	3,71	0,49
<i>P value</i>	0,01	0,37	0,04	0,33	0,74	0,00	0,61

* $p < 0,05$ level is important.

As is seen in Table 1, a statistically significant difference was found when the mean morphine proportion values of the varieties and lines were compared. The morphine proportion value of the varieties varied between 0.36 - 0.71 %, whereas it ranged between 0.26 – 1.03 % for lines. The highest morphine proportion value among lines belonged to AUAF – line 20 with 1.03 %. Values of 6 advanced lines (20, 54, 31, 5, 100, and 11) in research appeared over (0,58 %) mean morphine proportion of varieties. In previous studies, morphine proportions were found as follows: Erdurmuş (1989), 0.32 – 0.82 %; Novak and Strakova (1989), 0.66 – 0.75 % in 20 opium poppy varieties; and Arslan (2000), 0.25 – 0.89 % in 353 samples collected from various regions. The results obtained from our study exhibit great similarities to the findings from these studies.

Significant difference was not found when the mean codeine proportion values of the varieties and lines were compared. The codeine proportion value of the varieties varied between 0.04 - 0.33 %, whereas it ranged between 0,05-0,36 % for lines. The highest codeine proportion value among lines belonged to AUAF – line 2 with 0,36 %. Values of 17 advanced lines (2, 31, 54, 24, 5,55, 23, 16, 88, 73, 85, 10, 65, 76, 79, 35 and 51) in research appeared over (0,18 %) mean codeine proportion value of varieties. Subrtova et al. (1989) found the lowest codeine content as 0 % and the highest as 0.39 % in 25 opium poppy varieties of selected poppy populations. The findings of this study are also similar to those of ours.

Significant difference was found when the mean oripavine proportion values of the varieties and lines were compared. The oripavine proportion value of the varieties varied between 0,01-0,03 %, whereas it ranged between 0,01-0,07 % for lines. The highest oripavine proportion value among

lines belonged to AUAF – line 10 with 0,07 %. Values of 70 advanced lines in research appeared over (0,02 %) mean oripavine proportion value of varieties.

Significant difference was not found when the mean thebaine proportion values of the varieties and lines were compared. The thebaine proportion value of the varieties varied between 0,06-0,16 %, whereas it ranged between 0,00-0,38 % for lines. The highest thebaine proportion value among lines belonged to AUAF – line 20 with 0,38 %. Values of 17 advanced lines (20, 81, 78, 67, 80, 85, 70, 35, 52, 19, 26, 30, 38, 54, 87, 61 and 63) in research appeared over (0,10 %) mean thebaine proportion value of varieties. Subrtova et al. (1989) found the lowest thebaine content as 0 % and the highest as 0.35 % in 25 opium poppy varieties of selected poppy populations. The findings of this study are also similar to those of ours.

Significant difference was found when the mean noscapine proportion values of the varieties and lines were compared. The noscapine proportion value of the varieties varied between 0,02-0,19 %, whereas it ranged between 0,01-0,27 % for lines. The highest noscapine proportion value among lines belonged to AUAF – line 1 with 0,27 %. Values of 46 advanced lines in research appeared over (0,09 %) mean noscapine proportion value of varieties.

Significant difference was found when the mean papaverine proportion values of the varieties and lines were compared. The papaverine proportion value of the varieties varied between 0,02-0,11 %, whereas it ranged between 0,02-0,40 % for lines. The highest papaverine proportion value among lines belonged to AUAF – line 1 with 0,40 %. Values of 93 advanced lines in research appeared over (0,06 %) mean papaverine proportion value of varieties. Subrtova et al. (1989) found and the highest as 0.30 % in 25 opium poppy varieties of selected poppy populations. The results obtained from our study exhibit higher than the findings from these studies.

Statistically significant difference was found when the mean oil proportions values of the varieties and lines were compared. The oil proportion proportion value of the varieties varied between 41,7-50,7 %, whereas it ranged between 32,8-51,7 % for lines. The highest oil proportion proportion value among lines belonged to AUAF – line 1 with 51,7 %. Values of 39 advanced lines in research appeared over (46,28 %) mean oil proportion proportion value of varieties. Arslan (2000), oil proportions values was found between 38.86-53.39 % in 325 samples collected from various regions. The findings of this study are also similar to those of ours.

Conclusion

As a result, the outstanding genotypes of 5 opium poppy varieties and 97 opium poppy lines in terms of alkaloid proportions were found to be AUAF-line 20 in terms of morphine and thebaine proportion, AUAF-line 2 with respect to codeine, AUAF-line 10 in terms of oripavine, and AUAF-line 1 in terms of noscapine, papaverine and oil proportion. Varieties with higher alkaloids (morphine, codeine, oripavine, thebaine, noscapine, and papaverine) and oil rates can be grown by carrying out breeding programs on these identified lines.

References

- Anonim, 2016. INCB Narcotic Drugs Estimated World Requirements for 2016. United Nations Publication, New York.
- Anonim, 2015. 2014 Poppy Sector Report. Turkish Grain Board General Directorate, Ankara
- Arslan, N., Büyükgöçmen, R., Gümüşçü A. 2000. Oil And Morphine Contents Of Turkish Poppy Populations. Field Crops Central Research Institute Journal. (9), 1-2 2000.
- Arslan, Y., Katar, D., Kayaçetin, F., Subaşı, İ., 2008. Opium Alkaloids and Their Importance. Field Crops Central Research Institute Journal. Compilation, 2008, 17 (1-2).

- Erdurmuş, A. 1989. In Poppy lines (*Papaver somniferum* L.) relationships with the morphine and seed yield of phenological and morphological characters. PhD Thesis, Graduate School of Natural and Applied Sciences, Ankara University-Ankara.
- Kahraman, M. 2011, Policies Implemented on Poppy in Turkey and Poppy Importance for Turkey. Namik Kemal University, Institute of Science and Technology, Department of Agricultural Economics, Master Thesis, Aydın.
- Novak, J. and Strakova, V. 1989. Evaluation of selected poppy (*Papaver somniferum* L.) varieties. Rostlinna Vyroba. Vysoka Skola Zemedelska, 16521 Prague, 6- Suchdol, Czechoslovakia.
- Subtrova, D., Rehakova, V., Hubacek, J. and Pondelik, P. 1989. Contents of the major alkaloids selected cultivars of opium poppy. Sbornik, Vyseke, Skoly, Zemedelske- Praze, Fakulta, Agronomica. 51:65–83. Plant Breeding Abstract 1991: 061–06497.
- Valizadeh, N., 2015. Effect of Heterosis On Yield and Yield Components of Hybrids From Alkaloid Types Poppy Cultivars And Lines. PhD Thesis, Graduate School of Natural and Applied Sciences, Ankara University-Ankara.

DETERMINATION OF SOME BOTANICAL AND AGRICULTURAL CHARACTERISTICS IN OPIUM POPPY (*Papaver somniferum* L.) VARIETIES AND LINES

Levent YAZICI^{1*}, Güngör YILMAZ², Neşet ARSLAN³ Sezai GÖKALP¹, Başak ÖZYILMAZ¹

¹Directorate of Middle Black Sea Transition Zone Agricultural Research Institute, Tokat, Turkey

²Department of Field Crops, Faculty of Agriculture, Gaziosmanpaşa University, Tokat, Turkey

³Department of Field Crops, Faculty of Agriculture, Ankara University, Ankara, Turkey

*Corresponding author: leventyzc@gmail.com

Abstract

Turkey is the, center for many plant species, where is one of the world's richest countries in terms of the diversity of plants. In our country opium poppy cultivation is traditional, *Papaver somniferum* L., which is a one-year crops. The aim of study was to determine some botanical and agricultural characteristics of opium poppy (*Papaver somniferum* L.) varieties and lines. The research was carried out under the field conditions year at experiment plots of the Middle Black Sea Transition Zone Agricultural Research Institute in 2015. In this study were used the 5 varieties of opium poppy with 97 ahead of opium poppy as standard. The lines were planted in a randomized block design. Capsules and seed yield have been investigated with some phonological and morphological signs of value. According to the research results, the output was observed within 15-20 days, while the output time did not show a significant difference. Flowering time 80-100 days, plant height from 46.22 to 79.77 cm, the number of branches per plant from 2.4 to 5.4, the number of capsules per plant from 2.4 to 5.4, the capsule length 26.2 - 40.44 mm, the capsule width from 21.88 to 40.2 mm, the number of stigmatic rays from 7.00 to 11.83, capsule yield per decare from 28.78 to 181.57 kg, seed yield per decare from 43.9 to 205,32 kg, were found.

Keywords: *Opium poppy*, *Papaver somniferum* L., capsule yield, seed yield.

Introduction

Papaver somniferum L. the opium poppy, is a traditionally cultivated annual cultivar. It is from *papaveraceae* family of *Rhoedales* group. It is classified in *Papaver* genus of this family. There are 28 genera and nearly 250 species in *papaveraceae* family. (Davis *et al.*1988).

It is grown in Turkey, India, Australia, Spain, France and Hungary as legal main producer countries under the supervision of the United Nations to obtain opium and opium alkaloids for medicinal purposes in World. India produces opium gum, whereas other countries produce dried opium capsules. The average legal opium poppy cultivation area in 2011-2016 is 103.893 ha on the basis of main producers in the world. The average cultivation area in Turkey in 2011-2016 is 43.151 ha, which accounts for 41.5 % share of total legal opium poppy cultivation areas in the world. The average capsule production of the main producer countries of the world in 2010-2014 was 63.856 tons. Turkey had a 35 % share among legal capsule producers with 22.699 tons of average capsule production in 2010-2014 (Anonymous, 2016).

Opium poppy farming in Turkey is implemented within the 70 thousand hectares limit allocated by the United Nations Organization for our country in areas permitted by the Council of Ministers and within the planning framework of General Directorate of Turkish Grain Board. The production is subject to licensing and control in the form of dried opium poppy capsules without

incision. The cultivation in 2015/2016 winter and summer farming season took place in Afyonkarahisar, Denizli, Konya, Burdur, Uşak, Isparta, Eskişehir, Kütahya, Manisa, Balıkesir, Çorum, Amasya and Tokat provinces.

Opium poppy of *Papaver somniferum* L. species, an annual herbaceous plant, can grow to 60-200 cm depending on climate and growing conditions. The leaves of opium poppy are hairy lobed and hairy fragmented. The flower bud and flowers in opium poppy plant are found at the end of the stem. The bud is egg and pear-shaped. The poppy flowers are quite large and up to 8-10 cm in diameter. There are two sepals surrounding the flower and they fall when it blossoms. It has 4 petals inside. The petals are large and have flashy colors in a range of pink, purple and white. Inside the flower are the male parts around 80-150 in number. There is one female part in the middle of the flower topped with around 4-20 stigmas. The closed capsule (cocoon) is the fruit of the plant and it may have oval, conical and cylindrical shapes. Opium poppy is a 90 % self-fertilized species. Depending on the variety and environmental factors, foreign fertilization is also observed in varying rates. Opium poppy attracts insects and particularly bees with its numerous stamens, large and colorful flowers and abundant pollen. These insects and bees increase the rate of foreign fertilization by carrying the pollen from a flower to another (Valizadeh and Arslan, 2013).

Several varieties of opium poppy have been registered so far through breeding programs within the collaboration framework of the General Directorate of Turkish Grain Board (TMO), Research Institutes of Ministry of Food Agriculture and Livestock and universities in Turkey. However, it is necessary to determine the genotypes found in the current gene pool to improve more quality and efficient varieties through opium poppy breeding. This study was to determine some botanical and agricultural characteristics of poppy (*Papaver somniferum* L.) varieties and lines.

Material and Method

This experimental study was conducted in the trial field of Central Black Sea Gateway Zone Agricultural Research Institute in 2015. In the study, 5 standard opium poppy varieties (Ofis 95, TMO3, Kemer kaya, Seyitgazi, Tınaztepe) registered by different organizations and 97 advanced line material obtained from Ankara University, Agricultural Faculty, Agronomy Department genetic stock were used. Each variety/line was planted in two rows 3 m in length according to randomized blocks experimental design. Row spacing was set to 40 cm and plant spacing was set to 10 cm later by thinning. The summer planting was implemented on 27 February, 2015. Plant care such as fertilization, thinning, irrigation, and hoeing works was conducted and diseases and pests were fought when necessary during the vegetal development of opium poppy plant. 20-20-0 Compound NP fertilizer was applied as 5 kg/da N during sowing and AN (ammonium nitrate) fertilizer was administered as 5 kg/da N before the first hoeing. Upon the maturation of all capsules in the trial field, they were harvested by picking up by hand on 30 July, 2015.

Results and Discussion

When we examined the emergence durations of 5 varieties and 97 lines used in the trial, emergences were observed within 15-20 days and no difference was found in terms of emergence durations of varieties and lines. The flowering durations in materials used in the trial took between 80-100 days. The earliest flowering duration was observed in TMO 3 (varieties), and Ankara University Agricultural Faculty (AUAF) –line 30 (lines). On the other hand, the latest flowering was observed in Kemer kaya and Ofis 95 (varieties) and AUAF –line 46 (lines). White, violet tones (light medium and dark tones) and red flower colors were observed in the population. Gümüşçü and Arslan (1999) reported 192-211 days of flowering durations in winter poppies, and

81-96 days of flowering in summer poppies. The findings of our study are similar with the results of this study.

Table 1 presents the mean and t-test values for plant height (cm), number of capsule/plant, number of branches/plant, stigmatic rays/plant, capsule length (mm), capsule width (mm), seed yield (kg/da) and capsules yield (kg/da) of 5 varieties and 97 advanced lines used in the research.

Table 1. T-test and mean values concerning morphological observations, seed and capsules yield of varieties and lines.

Variety/Line	Plant height (cm)	Capsules /plant	Branches /plant	Stigmatic rays/plant	Capsule length (mm)	Capsule width (mm)	Seed yield (kg/da)	Capsule yield (kg/da)
Seyitgazi	61,3	3,9	3,4	10	33,1	40,2	151	126
Tınaztepe	62,1	3,6	3,8	10,4	28,5	33,5	151	126
Kemer kaya	56,8	3,4	3,5	11,8	35,5	29,1	117	90
Ofis 95	61,4	3,8	3,9	8,2	30,3	30,5	177	125
TMO 3	62,6	3,3	3,5	10	35,9	32,8	128	120
AUAF-1	73,89	4,33	4,33	10,17	34,56	31,78	149	129
AUAF-2	58,00	3,89	4,11	9,33	29,67	28,00	112	107
AUAF-3	54,67	3,78	3,78	9,67	32,78	28,56	138	128
AUAF-4	53,89	5,00	5,11	9,17	34,11	27,33	136	122
AUAF-5	49,78	3,56	3,78	8,67	36,44	25,56	77	65
AUAF-7	58,78	3,11	3,00	8,50	35,11	25,78	84	59
AUAF-8	54,22	3,22	3,22	8,83	35,00	25,78	114	77
AUAF-9	66,33	3,33	3,33	9,00	38,11	31,00	133	91
AUAF-10	66,78	3,56	3,56	9,83	38,67	30,78	160	133
AUAF-11	49,00	3,11	3,11	7,33	36,89	24,22	81	48
AUAF-12	52,78	3,33	3,33	7,00	33,89	24,67	81	60
AUAF-13	60,78	4,22	4,33	8,33	30,56	24,78	124	88
AUAF-14	58,11	3,11	3,11	8,17	38,00	28,67	99	66
AUAF-15	56,78	3,33	3,44	8,17	36,78	28,67	95	60
AUAF-16	60,11	4,67	5,00	9,33	34,78	29,00	128	117
AUAF-17	62,67	3,22	3,33	9,17	35,33	27,00	138	107
AUAF-18	62,11	3,78	3,78	9,17	28,78	29,11	96	78
AUAF-19	55,56	3,67	3,78	8,17	27,44	27,22	89	69
AUAF-20	67,89	4,22	4,22	9,33	30,00	30,11	157	125
AUAF-21	58,56	4,78	4,78	8,00	34,22	30,33	174	130
AUAF-22	50,78	4,22	4,22	7,67	28,78	27,78	116	94
AUAF-23	58,00	3,78	3,78	9,83	31,00	31,67	125	103
AUAF-24	65,78	4,33	4,33	8,33	37,00	34,22	190	153
AUAF-25	59,33	4,00	4,00	9,33	33,00	33,22	148	124
AUAF-26	79,78	4,11	4,11	7,33	36,44	32,78	138	122
AUAF-27	66,56	3,78	3,78	7,33	32,22	27,78	151	120
AUAF-28	68,78	4,11	4,11	8,83	35,78	30,22	150	129
AUAF-29	61,56	3,89	3,89	7,33	32,22	31,67	143	121
AUAF-30	66,67	4,56	4,56	10,50	34,22	31,22	163	160
AUAF-31	64,89	3,56	3,56	8,50	35,44	31,89	167	114
AUAF-32	60,89	4,22	4,22	9,17	31,56	28,11	126	96
AUAF-33	57,78	3,89	3,89	7,00	30,22	27,00	105	73
AUAF-34	53,11	3,78	3,78	9,00	28,67	25,89	85	72
AUAF-35	57,00	3,78	3,78	9,33	31,89	33,11	145	126
AUAF-36	58,11	3,56	3,67	9,00	31,56	27,00	95	88
AUAF-37	55,89	4,00	3,89	8,00	33,22	28,78	137	107
AUAF-38	65,00	4,00	4,00	8,50	29,22	31,11	142	117

AUAF-39	49,33	3,22	3,22	7,83	30,33	23,56	143	128
AUAF-40	58,11	3,89	4,00	8,33	33,56	28,33	139	101
AUAF-41	61,67	3,67	3,56	9,00	36,00	26,78	132	83
AUAF-42	46,22	2,44	2,44	8,33	30,11	21,89	43	28
AUAF-43	51,00	3,67	3,78	8,83	27,67	22,78	63	51
AUAF-44	60,56	4,00	4,00	8,33	32,89	29,44	140	87
AUAF-45	47,22	3,11	3,11	9,00	31,89	23,67	54	50
AUAF-46	57,33	3,44	3,44	9,17	28,56	28,33	123	79
AUAF-47	46,78	3,33	3,33	7,17	31,11	25,89	68	59
AUAF-48	60,22	3,00	3,00	9,67	29,33	27,11	94	75
AUAF-49	57,44	2,78	2,78	7,67	34,33	26,78	88	56
AUAF-50	61,56	3,56	3,56	8,50	32,11	26,00	102	78
AUAF-51	53,78	3,33	3,33	8,50	31,67	28,67	126	81
AUAF-52	69,00	3,00	3,11	9,17	32,56	32,22	165	101
AUAF-53	65,33	3,00	3,00	10,33	35,67	32,78	147	99
AUAF-54	73,44	2,89	2,89	8,33	31,78	36,89	139	120
AUAF-55	69,44	2,89	2,89	8,90	37,56	32,89	151	103
AUAF-56	66,44	3,89	3,89	9,50	37,44	32,33	155	147
AUAF-57	65,56	4,11	4,22	9,17	34,22	29,00	134	115
AUAF-58	62,67	3,56	3,78	9,67	31,33	28,44	116	113
AUAF-59	61,22	3,89	4,00	8,83	35,33	30,67	133	103
AUAF-60	54,67	3,78	3,89	8,67	32,78	30,44	127	115
AUAF-61	64,11	4,33	4,67	9,83	37,67	32,89	205	145
AUAF-62	57,56	3,89	4,22	9,83	34,89	27,00	147	105
AUAF-63	58,67	4,00	4,00	9,83	30,11	29,67	111	100
AUAF-64	58,56	3,56	4,00	9,67	33,22	28,44	131	102
AUAF-65	59,00	3,78	3,89	9,33	32,00	30,33	119	83
AUAF-66	57,89	4,33	4,33	9,00	31,44	28,78	162	118
AUAF-67	65,44	3,89	4,00	8,17	32,67	28,78	140	117
AUAF-68	63,44	4,89	5,11	9,33	36,44	31,67	164	129
AUAF-69	63,11	4,11	5,00	9,33	33,67	30,33	152	138
AUAF-70	59,00	3,67	3,78	8,17	33,67	30,33	165	136
AUAF-71	63,11	3,44	4,00	11,00	26,56	30,00	81	76
AUAF-72	54,67	3,89	4,11	9,50	28,00	26,44	121	96
AUAF-73	49,78	3,78	4,22	8,83	34,78	25,89	84	60
AUAF-74	58,89	3,78	3,78	11,83	29,89	31,89	135	115
AUAF-76	52,22	3,89	3,89	9,33	36,22	27,44	146	114
AUAF-77	50,78	4,22	4,22	8,67	30,33	26,11	123	88
AUAF-78	63,33	5,11	5,11	10,00	35,67	31,44	199	157
AUAF-79	53,11	3,56	3,56	8,83	31,89	26,00	103	100
AUAF-80	59,89	4,56	4,56	9,33	32,33	29,33	129	110
AUAF-81	66,33	4,67	5,22	9,33	35,56	31,44	117	106
AUAF-82	47,67	2,89	3,11	8,00	34,33	25,67	56	49
AUAF-83	51,11	3,22	3,67	8,83	35,11	27,00	67	53
AUAF-84	57,56	3,89	4,00	8,17	33,00	26,56	120	75
AUAF-85	55,56	3,44	3,56	8,50	36,11	30,78	100	84
AUAF-86	62,33	4,56	4,78	9,17	33,67	33,22	170	120
AUAF-87	59,56	4,22	4,33	9,33	35,22	31,78	177	113
AUAF-88	63,22	4,44	4,67	9,00	30,22	26,56	118	104
AUAF-89	61,89	4,11	4,11	9,50	36,11	30,00	173	115
AUAF-90	66,11	4,78	4,78	9,00	33,78	30,56	197	135
AUAF-91	62,78	4,56	4,56	8,67	33,33	28,00	159	117
AUAF-92	65,00	4,11	4,11	8,33	35,67	33,22	187	137
AUAF-93	65,89	3,67	4,00	9,00	40,44	33,00	148	126

AUAF-94	66,78	4,33	4,56	10,00	35,00	32,89	175	132
AUAF-95	67,33	4,00	4,00	9,83	35,78	31,44	156	137
AUAF-96	65,44	3,67	3,67	8,50	33,67	31,44	118	109
AUAF-98	67,89	5,44	5,44	8,67	35,78	34,22	141	105
AUAF-99	65,00	3,89	3,89	9,17	32,56	33,22	138	125
AUAF-100	72,22	4,67	4,89	10,17	37,33	36,67	183	181
<i>Means of lines</i>	60,12	3,83	3,92	8,90	33,35	29,24	130	103
<i>Means of varieties</i>	60,84	3,60	3,62	10,08	32,66	33,22	145	117
<i>Standard deviation (lines)</i>	6,51	0,55	0,59	0,84	2,84	2,99	34,97	29,03
<i>Standard deviation (varieties)</i>	2,32	0,25	0,21	1,28	3,22	4,28	23,11	15,63
<i>T value</i>	-0,24	1,88	2,69	-2,01	0,47	-2,04	-1,38	-1,90
<i>P value</i>	0,80	0,10	0,02	0,11	0,65	0,10	0,22	0,10

* $p < 0,05$ level is important.

As is seen in Table 1, a statistically significant difference was not found when the mean plant height (cm) values of the varieties and lines were compared. The plant height (cm) value of the varieties varied between 56,8-62,6 cm, whereas it ranged between 46,2-79,7 cm for lines. The highest plant height (cm) value among lines belonged to AUAF – line 26 with 79,7 cm. The highest plant height (cm) value among varieties belonged to TMO 3 variety with 62,6 cm. Values of 44 advanced lines in research appeared over (64.84 cm) mean plant height of varieties.

Significant difference was not found when the mean number of capsules per plant values of the varieties and lines were compared. The number of mean capsules per plant value of the varieties varied between 3,3-3,9, whereas it ranged between 2,4-5,4 for lines. The highest number of capsules value among lines belonged to AUAF – line 98 with 5,4. The highest number of capsules value among varieties belonged to Seyitgazi variety with 3,9. Values of 65 advanced lines in research appeared over (3,60) mean number of capsules per plant of varieties. Büyükgöçmen (1993), a study on opium poppy it reported that the number of capsules per plant ranged from 1,30 to 4,39. This study showed similar results with our work.

Significant difference was found when the mean number of branches per plant values of the varieties and lines were compared. The mean number of branches per plant value of the varieties varied between 3,4-3,9 whereas it ranged between 2,4-5,4 for lines. The highest number of branches value among lines belonged to AUAF – line 98 with 5,4. The highest number of branches value among varieties belonged to Ofis 95 variety with 3,9. Values of 68 advanced lines in research appeared over (3,62) mean number of branches per plant of varieties.

Significant difference was not found when the mean number of stigmatic rays per plant of the varieties and lines were compared. The mean number of stigmatic rays per plant value of the varieties varied between 8,2-11,8 whereas it ranged between 7,0-11,8 for lines. The highest number of stigmatic rays value among lines belonged to AUAF – line 74 with 11,8, The highest number of stigmatic rays value among varieties belonged to Kemer kaya variety with 11,8. Values of advanced lines (1, 30, 53, 71, 74 and 100) in research appeared over (10,8) mean number of stigmatic rays per plant of varieties.

Significant difference was not found when the mean capsule length (mm) values of the varieties and lines were compared. The mean capsule length (mm) value of the varieties varied between

28,5-35,9 mm, whereas it ranged between 26,55-40,44 mm for lines. The highest capsule length (mm) value among lines belonged to AUAF – line 93 with 40,44 mm, The highest capsule length (mm) value among varieties belonged to TMO 3 variety with 35,9 mm. Values of 58 advanced lines in research appeared over (32,66 mm) mean capsule length of varieties.

Significant difference was not found when the mean capsule width (mm) values of the varieties and lines were compared. The capsule width (mm) value of the varieties varied between 29,1-40,2 mm, whereas it ranged between 21,88-36,88 mm for lines. The highest capsule width (mm) value among lines belonged to AUAF – line 54 with 36,88 mm, The highest capsule width (mm) among varieties belonged to Seyitgazi variety with 40,2 mm. Values of advanced lines (24, 54, 98 and 100) in research appeared over (33,22 mm) mean capsule width value of varieties.

Significant difference was not found when the mean seed yield (kg/da) values of the varieties and lines were compared. The mean seed yield (kg/da) value of the varieties varied between 117-177 kg/da, whereas it ranged between 43-205 kg/da for lines. The highest seed yield (kg/da) value among lines belonged to AUAF – line 61 with 205 kg/da, The highest seed yield (kg/da) among varieties belonged to Ofis 95 variety with 177 kg/da. Values of 32 advanced lines in research appeared over (145 kg/da) mean seed yield of varieties. Valizadeh (2015), reported that seed yield (kg/da) varied between 88.62-188.2 kg/da in study to determine effect of heterosis on yield and yield components of hybrids from alkaloid types opium poppy cultivars and lines. The findings of this study are also similar to those of ours.

Significant difference was not found when the mean capsule yield (kg/da) values of the varieties and lines were compared. The mean seed yield (kg/da) value of the varieties varied between 90-126 kg/da whereas it ranged between 28-181 kg/da for lines. The highest seed yield (kg/da) value among lines belonged to AUAF – line 100 with 181 kg/da, The highest seed yield (kg/da) among varieties belonged to Seyitgazi and Tinaztepe variety with 126 kg/da. Values of 31 advanced lines in research appeared over (117 kg/da) mean capsule yield of varieties. Valizadeh (2015), reported that capsule yield (kg/da) varied between 68.44-160.40 kg/da, in study to determine effect of heterosis on yield and yield components of hybrids from alkaloid types poppy cultivars and lines. The findings of this study are also similar to those of ours.

Conclusion

As a result, In this study seen come to the fore of AUAF (26, 98, 74, 93, 54, 61 and 100) advanced lines. On the other hand, 24 advanced lines value were found more higher than mean seed and capsule yield of varieties used as standard. Varieties with higher seed and capsule yield can be grown by carrying out breeding programs on all these identified lines in Turkey.

References

- Anonymous, 2016. INCB Narcotic Drugs Estimated World Requirements for 2016. United Nations Publication, New York.
- Büyükgöçmen, R., 1993. Some plant characteristics of domestic and foreign poppy populations obtained from different regions. Master Thesis, Graduate School of Natural and Applied Sciences, Ankara University-Ankara.
- Davis, P.H., Mill, R.R. and Tan, K. 1988. Papaver L. Flora of Turkey and East Aegean Islands. Univ. Pres., Edinburg.
- Gümüüşçü, A. ve Arslan, N. 1999. A Comparison of Yield Components Between Selected Varieties and Lines in Poppy. Tr. J. of Agriculture and Forestry, 23 (1999) Additional number 4, 991-997. Ankara.

Valizadeh, N., Arslan, N. 2013. Poppy Breeding. Turkish Scientific Collection Journal 6 (2): 86-92, 2013. ISSN: 1308-0040, E-ISSN: 2146-0132.

Valizadeh, N., 2015. Effect of Heterosis On Yield and Yield Components of Hybrids From Alkaloid Types Poppy Cultivars And Lines. PhD Thesis, Graduate School of Natural and Applied Sciences, Ankara University-Ankara.

TOTAL PHENOLIC CONTENT OF DIFFERENT APPLE CULTIVARS

Mirko KULINA^{1*}, Gorica PAUNOVIĆ², Mirjana RADOVIĆ¹

¹University of East Sarajevo, Faculty of Agriculture, Republic of Srpska, Bosnia and Herzegovina

²University of Kragujevac, Faculty of Agronomy, Cacak, Republic of Serbia

*Corresponding author: kulinamirko@yahoo.com

Abstract

Apples are one of the most frequently consumed fruits in the world. From 2003 to 2005, the average per capita apple consumption in Europe was 61 g per day, which is twice as high as the per capita consumption worldwide and represents one quarter of the total European fruit consumption. Apple fruits are an important source of secondary plant metabolites and one of the major sources of dietary phenolic compounds. The apple cultivars evaluated in this study were: Braeburn, Fuji, Granny Smith and Red Delicious, grown in Sarajevo region, Bosnia and Herzegovina. The total phenols contents (TPC) in the apple samples were measured by using a modified colorimetric Folin-Ciocalteu method. Total polyphenol content was calculated by means of an external standard calibration with methanolic catechin standards and expressed as mg catechin equivalents/100 g fresh matter (FM). The mineral contents (N, P, K Ca and Fe) of samples were analysed by Inductively Coupled Plasma Atomic Emission Spectrometry (ICP-AES). The cultivar, Fuji contained the lowest amount of polyphenols (expressed as mg catechin equivalents/100 g), 98 mg per 100 g of edible FM), followed by Granny Smith and Red Delicious (117 and 125 mg per 100 g of edible FM), while Braeburn contained the highest concentrations (143 mg per 100 g of edible FM). These results suggest that variability accounted for fruit quality was due to either genotypes or environmental conditions prevailing in the growing areas or interaction of both the factors.

Key words: *Apple, Phenolic Content, Mineral Composition, Cultivars.*

Introduction

Apple (*Malus × domestica* Borkh.) is one of leading fruits which is being grown in temperate region of the world. According to the FAO database (2013), global fruit production in 2013 was 610.15 million tons, of which apple production comprised 80.82 million tons, accounting for 13% of total fruit production. From 2003 to 2005, the average per capita apple consumption in Europe was 61 g per day, which is twice as high as the per capita consumption worldwide and represents one quarter of the total European fruit consumption (Ceymann et. al., 2012).

Chemical composition of apple fruit is very complex. It consists of numerous organic and inorganic compounds and macro- and micro biogenic elements. Organic and inorganic compounds content in fruit depends on fruit cultivar, ripeness, physiological condition of a tree as well as soil and weather conditions (Wu et al., 2006). Apple fruits are an important source of secondary plant metabolites and one of the major sources of dietary phenolic compounds. Polyphenols are secondary plant metabolites and contain one or more aromatic rings and at least two hydroxyl groups. Several thousand different polyphenols are known (Sies, 2010). The two main classes of polyphenols in foods are phenolic acids and flavonoids. Flavonoids are further divided into flavones, flavonols, flavan-3-ols, flavanones, isoflavones and anthocyanidins. Generally, five major polyphenolic groups are found in apple cultivars: hydroxycinnamic acids,

flavan-3-ols/ procyanidins, anthocyanins, flavonols, and dihydrochalcones (van der Sluis et al., 2001). Sun et al. (2002) found that apples had the highest soluble free phenolics when compared to 10 other commonly consumed fruits. The distribution of phenolic compounds in fruits varies considerably among different cultivars and also within different tissues (Khanizadeh et al., 2008). The objective of this study was to evaluate phenolic content of different apple cultivars, grown in Sarajevo region, Bosnia and Herzegovina.

Material and Methods

The apple cultivars evaluated in this study were: Braeburn, Fuji, Granny Smith and Red Delicious, grown in Sarajevo region, Bosnia and Herzegovina, during 2014 year. The apple samples were collected at their commercial maturity. Each sample is composed of 20 fruits. The fruits were grown on trees with normal crop load and, with an integrated plant protection strategy. The chemical characteristics of the soil were moderate acid pH (5.9 in 1M KCl), medium humus content (2.7%), slightly assuring of nitrogen, phosphorus and potassium in the top soil layer (0–40 cm). The total phenols contents (TPC) in the apple samples were measured by using a modified colorimetric Folin-Ciocalteu method. The total polyphenol content method described by Singleton et al. (1999). Ten μL of Folin-Ciocalteu reagent and 100 μL of distilled water were automatically pipetted to 10 μL of methanolic extract in a 200 μL cuvette. After 1 min, 40 μL sodium carbonate solution (200 g/L) and 40 μL distilled water were added, thoroughly mixed and incubated for 30 min at 37⁰C. Absorption was measured automatically at 700 μm . Total polyphenol content was calculated by means of an external calibration with methanolic catechin standards and expressed as mg catechin equivalents/100 g fresh matter (FM). Statistical analyses were conducted using analysis of variance (ANOVA) to evaluate significant differences ($P < 0.05$).

Results and Discussion

Apples constitute an important part of the human diet, as they are a source of monosaccharides, minerals, dietary fibre, and various biologically active compounds, such as vitamin C, and certain phenolic compounds which are known to act as natural antioxidants (Wu et al., 2006). Phenols are secondary plant products that can be found in the peel and pulp of apples. The polyphenol content of apples depends on their biosynthesis, which can be influenced by light, mineral nutrition, rootstock, production method, growing season, growing region, cultivar and mutant variety (Treutter, 2010).

Total phenolics contents (TFC) of different cultivars of apple fruit is given in tab. 1.

Tab. 1. Total phenolics contents (TFC) of different cultivars of apple fruit

Cultivar	Total phenolics contents (TFC) (mg catechin equivalent/100 g of edible fresh matter)
Fuji	98 \pm 3.21 ^c
Granny Smith	117 \pm 2.25 ^b
Red Delicious	125 \pm 2.11 ^b
Braeburn	143 \pm 4.90 ^a

The cultivar, Fuji contained the lowest amount of polyphenols (expressed as mg catechin equivalents/100 g), 98 mg per 100 g of edible FM), followed by Granny Smith and Red Delicious

(117 and 125 mg per 100 g of edible FM), while Braeburn contained the highest concentrations (143 mg per 100 g of edible FM) (tab. 1).

The differences between varieties were significant. This could be caused by different amounts of individual phenolics constituting apple phenolic complexes of varieties with different antioxidant and antiradical efficiency. Vanzani et al. (2005) estimated that polyphenols contributed from 47% (Granny Smith) to 78% (Braeburn), with an average value of 54% to the total antioxidant efficiency experimentally measured in the apple extracts.

Recent studies have shown that the content of phenolic compounds in apples varies considerably among different cultivars (Alonso-Salces et al. 2004; Hecke et al., 2006; Renard et al., 2007; Wojdylo et al., 2008). The chemical composition and concentrations of polyphenolic compounds have been found to be affected mainly by genetic variation, although they can also be influenced to some degree by growing conditions (Tsao, 2003). The results of our present investigation are in agreement with those reported by Vieira et al. (2009), who found that peel extract of different varieties of apple fruit contained greater amount of phenolics, anthocyanins and flavonoids than pulp extract. A previous study has demonstrated that the concentration of polyphenolic compounds in apple fruit can vary considerably between different apple cultivars in Sweden (Ahmadi-Afzadi, 2015). Lata (2007) measured phenolics spectrophotometrically in 19 different cultivars over two growing years. They detected either no variation in individual polyphenol classes for cvs. Gala and Red Rome or up to three-fold differences for cv. Granny Smith. Comparable experiments have been carried out in New Zealand (McGhie et al. 2005), Italy (Lamperi et al. 2008) and Chile (Yuri et al. 2009) for one or more cultivars and in these studies growing environment more consistently influenced the polyphenol content of the apples. McGhie et al. (2005) found significant differences between three growing environments in New Zealand for 10 different apple cultivars. They concluded that the growing environment influenced the polyphenol content, but the level of change was highly cultivar-dependent. However, a comparison of the studies remains difficult due to the different methods used. For example, some authors investigated apple skin and apple flesh separately and other reported data of freeze dried samples. Additionally, the cultivars investigated were common dessert apple cultivars or regionally cultivated ones. Clearly, many studies concerning polyphenol contents in apples have already been made, however more investigations are needed which compare the different cultivars with the same analytical technique.

Conclusion

This study demonstrated that total phenolic content vary among apple cultivars. These results suggest that variability accounted for fruit quality was due to either genotypes or environmental conditions prevailing in the growing areas or interaction of both the factors. The fruits with high contents of phenolic substances may impart health benefits when consumed and should be regarded as a valuable source of antioxidants.

References

- Ahmadi-Afzadi, M., Nybom, H., Ekholm, A., Tahir, I., Rumpunen, K. (2015): Biochemical contents of apple peel and flesh affect level of partial resistance to blue mold. *Postharvest Biology and Technology*, 110: 173–182.
- Alonso-Salces, R.M., Herrero, C., Barranco, A., Berrueta, L.A., Gallo, B., Vicente, F. (2004): Technological classification of Basque cider apple cultivars according to their polyphenolic

- profiles by pattern recognition analysis. *Journal of Agricultural and Food Chemistry* 52 (26): 8006–8016.
- Ceymann, M., Arrigoni, E., Scharer, H., Nising, A.B., Hurrell, R.F. (2012): Identification of apples rich in health-promoting flavan-3-ols and phenolic acids by measuring the polyphenol profile. *Journal of Food Composition and Analysis* 26: 128–135.
- FAOSTAT (2013): Statistical database, available from <<http://www.science-direct.com/science/>>
- Khanizadeh, S., Tsao, R., Rekika, D., Yang, R., Charles, M.T., Rupasinghe H.P. (2008): Polyphenol composition and total antioxidant capacity of selected apple genotypes for processing. *Journal of Food Composition and Analysis* 21: 396-401.
- Hecke, K., Herbinger, K., Veberic, R., Trobec, M., Toplak, H., Stampar, F., Keppel, H., Grill, D. (2006): Sugar acid and phenol contents in apple cultivars from organic and integrated fruit cultivation. *European Journal of Clinical Nutrition* 60: 1136–1140.
- Lata, B. (2007): Relationship between apple peel and the whole fruit antioxidant content: year and cultivar variation. *Journal of Agricultural and Food Chemistry* 55: 663–671.
- Lamperi, L., Chiuminatto U., Cincinelli, A., Galvan, P., Giordani, E., Lepri, L., Del Bubba, M. (2008): Polyphenol levels and free radical scavenging activities of four apple cultivars from integrated and organic farming in different Italian areas. *Journal of Agricultural and Food Chemistry* 56 (15): 6536–6546.
- McGhie, T.K., Hunt M., Barnett, L.E. (2005): Cultivar and growing region determine the antioxidant polyphenolic concentration and composition of apples grown in New Zealand. *Journal of Agricultural and Food Chemistry* 53: 3065–3070.
- Renard, C.M., Dupont, N., Guillermin, P. (2007): Concentrations and characteristics of procyanidins and other phenolics in apples during fruit growth. *Phytochemistry* 68: 1128–1138.
- Sies, H. (2010): Polyphenols and health: Update and perspectives. *Archives of Biochemistry and Biophysics* 501 (1): 2–5.
- Singleton, V.L., Orthofer R., Lamuela-Raventós M.R. (1999): Analysis of total phenols and other oxidation substrates and antioxidants by means of Folin-Ciocalteu reagent. *Methods in Enzymology* 299: 152–178.
- Sun, J., Chu, Y.F., Wu, X., Liu, R.H. (2002): Antioxidant and antiproliferative activities of common fruits. *Journal of Agricultural and Food Chemistry* 50: 7449–7454.
- Treutter, D. (2010): Managing phenol contents in crop plants by phytochemical farming and breeding-vision and constraints. *International Journal of Molecular Sciences* 11 (3): 807–857.
- Tsao, R., Yang, R., Young, J.C., Zhu, H. (2003): Polyphenolic profiles in eight apple cultivars using high-performance liquid chromatography (HPLC). *Journal of agricultural and food chemistry*, 51 (21): 6347–6353.
- Van der Sluis, A.A., Dekker, M., Jager D.A., Jongern F.M.W. (2001): Activity and Concentration of Polyphenolic Antioxidants in Apple: Effect of Cultivar, Harvest Year, and Storage Conditions. *J. Agric. Food Chem.* 49 (8): 3606–3613.
- Vanzani, P., Rossetto, M., Rigo, A., Vrhovsek, U., Mattivi, F., D'amato, E., Scarpa, M. (2005): Major phytochemicals in apple cultivars: contribution to peroxy radical trapping efficiency. *Journal of Agricultural and Food Chemistry*, 53: 3377–3382.
- Vieira, F.G.K., Borges, G.D.S.C., Copetti, C., Amboni, R.D.D.M.C., Denardi, F., Fett, R. (2009): Physico-chemical and antioxidant properties of six apple cultivars (*Malus domestica* Borkh) grown in southern Brazil. *Sci. Hortic.* 122: 421–425.

- Yuri, A.J., Neira, A., Quilodran, A., Motomura, Y., Palomo, I. (2009): Antioxidant activity and total phenolics concentration in apple peel and flesh is determined by cultivar and agroclimatic growing regions in Chile. *Journal of Food, Agriculture and Environment* 7 (3–4): 513–517.
- Wojdylo, A., Oszmianski, J. (2008): Polyphenolic compounds and antioxidant activity of new and old apple varieties. *Journal of Agricultural and Food Chemistry* 56: 6520–6530.
- Wu, J., Gao, H., Zhao, L., Liao, X., Chen, F., Wang, Z., Hu, X. (2006): Compositional characterization of some apple cultivars. *Food Chemistry*, 103: 88–93.

DEPENDENCE QUALITY INDICATORS OF PEPPER SEEDS OF TESTING METHOD

Dobrivoj POŠTIĆ^{1*}, Nebojša MOMIROVIĆ², Željko DOLIJANOVIĆ², Jasmina OLJAČA²,
Ratibor ŠTRBANOVIĆ¹, Marijenka TABAKOVIĆ³, Rade STANISAVLJEVIĆ¹

¹ Institute for Plant Protection and Environment, Belgrade, Serbia

² Agricultural Faculty, University of Belgrade, Serbia

³ Maize Research Institute, Belgrade, Serbia

*Corresponding author: pdobrivoj@yahoo.com

Abstract

The aim of this study was to determine the dependence on the two most important indicators of the quality of peppers seeds, germination energy and total germination of the test methods. Rating seed germination was performed on two different substrates (filter paper and sand). For the study two hybrids (SK-5 F1 and Atris F1) and one local variety (Elephant's ear) were used. Results of germination energy and total germination studied hybrids and cultivars show significantly ($p=0.01$) higher values on the surface filter paper, compared to the values obtained in the surface sand. The highest average germination energy 82% and total germination 95%, was found in the hybrid SK-5 F1, while the lowest average values of 68% and 77% recorded in the variety Elephant ear. Statistical analysis of the total germination showed significant ($p = 0.01$) difference under the influence of varieties and substrate tests. Between the two test methods for vigor, a significant correlation was established ($r = 0.889$, $p = 0.01$), while for the total germination determined highly significant correlation ($r = 0.987$, $p = 0.001$) was observed. It is very important that the seeds of peppers have a high germination energy and total germination, because uniform germination of seeds depends on them.

Keywords: *Germination energy, total germination, pepper.*

Introduction

Seeds are one of the basic preconditions of successful agricultural production, ie stable, high yields of good quality, and the identification and testing of seed quality is of great importance. Quality of pepper seeds is varietal characteristics and at the same time depends on the biological and agroecological conditions (Gvozdenović et al., 1995). The most important indicator of the quality of seed germination certainly, which is also an indicator of the viability of which depends on the use value of seed (Poštić et al., 2010b). If soil conditions are almost ideal (temperature and soil moisture) seed germination obtained in laboratory conditions is a good indicator of seed vigor on the basis of which can be predicted seeds sprouting in the field (Durrant and Gummerson, 1990). However, germination of seed is not a sufficient indicator of seed quality. In addition to meeting the standards that are prescribed in the rules on the quality of seeds, it is important that the seeds have a high germination energy, especially if you are sowing seeds performs in the open field (mainly in the production of industrial processing) Postić et al., 2010a. In practice, it is very important quick and uniform emergence of plants. Germination energy is an important indicator of quality seeds, which precisely speaks of the ability of seeds for rapid and uniform germination (Veselinov, 1984; Gvozdenović et al., 1995; Poštić et al., 2010a).

If the germination and sprouting of plants slowly, all the greater percentage of seeds and seedlings die because of the attacks of pests and diseases, formation crusts of soil, or the deviation from the optimum conditions for germination. The aim was to carry out assessment of

the two most important indicators of the quality of seeds depending on the different testing methods.

Material and methods

As a material used in the research is the local variety of pepper (Elephant ear) and two hybrids of red peppers in type, strokes, which are grown by us (SK - 5 F1 and Atris F1). Assessment of quality indicators (germination energy and total germination) pepper seeds carried in 2011 and 2012 in the laboratory for testing the quality of seeds of agricultural plants, the Institute for Plant Protection and Environment, Belgrade (Serbia). Used two test methods for determining seed germination: 1) standard laboratory filter paper moistened between 0.2% aqueous solution of KNO₃ and 2) in sterile sand. The seed was incubated for 14 days at a temperature of 20-30 ° C and a relative humidity of 95%. Seventh-day incubation period is estimated germination energy, and 14 total germination, and the number of typical seedlings (ISTA Rules, 2009).

According to the Regulations on the quality of the seed (Gazette SFRJ no. 47/87), the minimum permitted germination of seeds is 65% for release seed on the market, while the Regulations on the medical examination of crops and facilities for the production of seeds, seedlings and planting materials (Gazette RS no. 119/2007) was examined by the health of seed (table 1):

Table 1. Allowed (%) presence pests in the seeds of peppers

Pests	Allowed (%) in the plant material in trade
<i>Fusarium solani</i>	5
<i>Alternaria solani</i>	5
<i>Colletotrichum dematium</i>	5
<i>Rhizoctonia solani</i>	1
<i>Sclerotinia sclerotiorum</i>	1
<i>Phytophthora capsici</i>	0

Obtained results were analysed by the analysis of variance (ANOVA, F-test; $P \leq 0.05$ and $P \leq 0.01$) and effect of factors (year, genotype, method and their interaction). Correlation between observed parameters were determined by Pearson correlation coefficients (r). Data were processed by program STATISTICA, version 8 (StatSoft Inc, Tulsa, OK, USA).

Results and discussion

Analysis of germination energy and total germination of seeds (table 2) showed highly significant differences influenced by the variety factor (G). The impact test methods factor (M) on the germination energy was not statistically significant, while the total germination very significant impact. Very significant interactions studied factors in terms of total germination seed of peppers were obtained with the mutual influence of factors $G \times M$. Significant interactions studied factors in terms of germination energy and total germination were obtained with the cumulative impact factor $Y \times G \times M$ (table 2).

In hybrids was found higher germination energy and total germination on both substrates, as compared to the variety Elephant ear (table 3). These results are consistent with the results (Poštić et al., 2010a).

Table 2. F-values for observed factors

Factors	Germination energy	Total germination
Year (Y)	ns	ns
Genotype (G)	**	**
Method (M)	ns	**
Y × G	ns	ns
Y × M	ns	ns
G × M	*	**
Y × G × M	*	*

** - significant at 0.01; * - significant at 0.05; ns - not significant

By applying the method to the filter paper was influenced by that germination energy of the tested genotypes increased by an average of 3.5 to 6.0%, compared to the determined germination energy on the medium sands (table 3).

The genotypes showed an average increasing total germination for 7.5 to 12.5% on the medium filter paper, compared to the other tested surface sand.

Table 3. Germination energy and total germination pepper seeds

Method	SK 5 F1		Atris F1		Elephant's ear	
	GE	TG	GE	TG	GE	TG
Sadn	79,75	93,25	74,50	85,50	64,75	71,75
Filter paper	83,25	95,75	80,50	93,00	70,50	81,25
Average	81,50	94,50	77,50	89,25	67,63	76,50

Legend: GE - germination energy, TG - total germination.

The lowest average germination energy 67.6% and total germination 76.5 % was found in the variety Elephant's ear, while the highest germination energy 81.5% and 94.5% total germination founded in hybrids F1 SK 5 (table 3). Germination energy is an important biological properties of the seeds of which depends on the speed and uniformity of germination and emergence (Poštić et al., 2010a). Considering that the largest percentage of pepper seedlings produced in greenhouses without additional heating of the amount of energy depends directly on the seed germination and percentage of emerged plants.

Table 4. The correlation coefficients between the observed traits (n=6)

Germination energy	Total germination
0,889**	0,987***

Pearson correlation coefficient: *** P ≤ 0.001, ** P ≤ 0.01, * P ≤ 0.05, respectively

Germination is the percentage of seed capable of producing a typical seedlings, that emerge in a field under optimal environmental conditions (Postic et al., 2010a). For predicting field emergence seed total germination is a very reliable indicator. Durrant and Gummerson (1990) found a high correlation (r = 0.75 to 0.97) germination energy and total germination, but only under ideal field conditions.

Statistical analysis of the total germination showed significant ($p = 0.01$) difference under the influence of varieties and substrate tests. Between the two test methods for vigor, a significant correlation was established ($r = 0.889$, $p = 0.01$), while for the total germination determined highly significant correlation ($r = 0.987$, $p = 0.001$) was observed (table 4).

Conclusion

Based on the presented results of testing the quality of seeds studied cultivars and two hybrids of pepper, we can conclude the following:

By applying the filter paper method resulted in higher germination energy of the tested genotypes by an average of 3.5 to 6.0% and an increase in the total germination for 7.5 to 12.5%, compared to the established germination energy and total germination on surface sand.

The higher the value of in hybrids germination energy and total germination will affect faster and more even emergence of seed that will especially be important in the production of pepper seedlings in greenhouses without additional heating.

Estimated indicators of the quality of pepper seeds were above the legally prescribed standards and meet the requirements of putting seeds in the market. Very high quality hybrid seeds of peppers is a good basis to need additional production conditions (soil management, fertilization, irrigation and protection) can be achieved high yields of good quality. It is very important that the seeds of peppers have a high germination energy and total germination, because uniform germination of seeds depends on them.

Acknowledgements:

Research was financed by the Ministry of Education, Science and Technological Development, Republic of Serbia, project TR 31018.

References

- Durrant, M. J., Gummerson, R. J. (1990): Factors associated with germination of sugarbeet seed in the standard test establishment in the field. *Seed Sci. and Technology*, 18, 1-10.
- Gvozdenović, Đ., Takač, A., Jovičević, D., Bugarski Dušanka i Červenski, D., (1995): Production of pepper, *Proceedings of the Institute*, 23, pp. 397 - 403.
- ISTA (2009): *International Rules for Seed Testing*. ISTA, Switzerland.
- Rules on the quality of seeds of agricultural plants (1987), *Official Gazette of the SFRJ* number 47. pp. 1-71.
- Rules on health examination of crops and objects for the production of seeds, seedlings and planting materials and health inspection seeds, seedlings and planting materials (2007), *Official Gazette* number 119.
- Poštić, D., Momirović, N., Dolijanović, Ž., (2010a): Evaluation of the quality of pepper seeds. *International Scientific Conference, Proceedings*, 09-11. December, Jahorina. pp. 405-410.
- Poštić, D., Protić, R., Aleksić, G., Gavrilović, V., Živković, Svetlana, Trkulja, N., Ivanović, Ž., (2010b): Seed quality of winter wheat during the period 2000-2005 years, *Plant Protection, Institute for Plant Protection and Environment, Belgrade*, Vol. 61, pp. 20-24.
- Veselinov, E., (1984): *Piper*, Sofija.

SEED QUALITY PARAMETERS IN A SET OF SINGLE CROSS MAIZE HYBRIDS, THEIR INBRED COMPONENTS AND RECIPROCAL CROSSES

Olivera ĐORĐEVIĆ¹, Sofija BOŽINOVIĆ¹, Jelena VANČETKOVIĆ¹, Radmila
VUKADINOVIĆ¹, Marija MILIVOJEVIĆ¹, Milan STEVANOVIĆ^{1*}

¹Maize Research Institute “Zemun Polje”, Slobodana Bajića 1, 11185 Belgrade, Serbia

*Corresponding author: mstevanovic@mrizp.rs

Abstract

Standard seed germination rate (GR) and cold test germination rate (CTGR) were scored for 10 maize singlecrosses, their reciprocals and inbred line components, where five hybrids belong to FAO 300-400 and five to FAO 500-600 maturity group. A total of 12 inbreds was included, since the hybrids comprising the same maturity group have one inbred in common. The aim was to estimate influence of the reciprocal crosses on GR and CTGR. Analysis of variance showed statistically significant effect of genotypes on both parameters, while reciprocal crosses significantly influenced only GR. Average GR for hybrids was from 94,0% (ZP 335) to 99,25% (ZP 388), while among inbreds it ranged from 93,0% (ZPL12) to 99,5% (ZPL9). Average CTGR for hybrids was from 91,5% (ZP 335) to 99,5% (ZP 366), while for inbreds it was from 94,0% (ZPL6) to 99,0% (ZPL10). Among original hybrids with ZPL1 as the male parent average GR i.e. CTGR was 96,0% i.e. 95,8%, while among their reciprocals it was 98,6% i.e. 95,8%. The average GR i.e. CTGR for original later maturity hybrids (ZPL7 as the male parent) was 95,9% i.e. 97,4% and for their reciprocals it was 96,8% i.e. 97,2%. The highest difference in GR between original and reciprocal cross for a single hybrid was estimated for ZP 335, where original version had 89,5% and reciprocal 98,5% germination rate. Regarding this parameter both ZPL1 and ZPL7 performed better as a female parent.

Key words: *cold test, maize, germination rate, reciprocal cross.*

Introduction

Seed germination rate (GR) and cold test germination rate (CTGR) represent one of the most important physiological seed quality parameters. Standard (warm) seed germination rate is an indicator of the ability of the seed to emerge from the soil to produce a plant in the field under normal conditions, while CTGR represents ability of the seed to emerge under cold, wet conditions of planting season and is an indicator of seed vigor. Seed germination under low temperature is of great importance not only in northern-growing maize regions, but in southern as well. Namely, farmers in Serbia and neighbouring countries were faced with cold and humid springs in the last couple of years, followed by extremely hot summers. Under these conditions, both GR and CTGR become highly important parameters influencing final grain yield.

Reciprocal effect in maize refers to phenotypic difference between reciprocal F1 hybrids. This effect has been reported by several researchers for various agronomic traits in different types of maize for diverse use (Egesel et al., 2003; Lunsford et al., 1974; Mann and Pollmer, 1981; Mann et al., 1981; Melchinger et al., 1985; Seitz et al., 1995). Several factors attribute to differences between reciprocal crosses such as genomic imprinting (parent-of-origin effect), xenia (the effect of pollen on the endosperm phenotype in the same generation), dosage effects (in case of triploid tissue such as endosperm), and cytoplasmic effects (so-called maternal effects). Reciprocal effect

on various kernel and germination traits has also been detected. In particular, studies reported the effect on whole-kernel growth rate (Groszmann and Sprague, 1948), embryo and endosperm dry weight (Bagnara and Daynard, 1983), embryo oil and protein (Miller and Brimhall, 1951), zein synthesis (Chaudhuri and Messing, 1994), seed germination at low temperatures (Pinnell, 1949) and tolerance to drying injury (Bdliya and Burris, 1988).

The aim of this study was to examine the influence of reciprocal effects on standard and cold germination rate for ten maize single cross hybrids belonging to different maturity group. We also wanted to determine if the two shared inbred lines perform better as female or male parent regarding studied parameters. The results could serve as a recommendation for a seed production of the tested hybrids.

Materials and methods

Plant material

Ten single-cross hybrids, their reciprocal crosses and their parental inbred lines were selected for this study. Five hybrids belong to medium early (FAO 300-400), while five belong to late (FAO 500-600) maturity group. Twelve inbred lines in total were included, since the hybrids comprising the same maturity group had one parental component in common. ZPL1 inbred line was a common parent for medium early maturing hybrids, while ZPL7 was a common parent for late maturing hybrids. Hybrids and their corresponding parental components are listed in the Table 1. All the examined genotypes were multiplied in 2015. year.

Table 1. Single-cross hybrids, their reciprocal crosses and parental components used in the study

FAO 300-400		FAO 500-600	
Hybrid	Components	Hybrid	Components
ZP 333 normal	ZPL2 × ZPL1	ZP 606 normal	ZPL8 × ZPL7
ZP 335 normal	ZPL3 × ZPL1	ZP 648 normal	ZPL9 × ZPL7
ZP 366 normal	ZPL4 × ZPL1	ZP 684 normal	ZPL10 × ZPL7
ZP 388 normal	ZPL5 × ZPL1	ZP 685 normal	ZPL11 × ZPL7
ZP 4007 normal	ZPL6 × ZPL1	ZP 749 normal	ZPL12 × ZPL7
ZP 333 reciprocal	ZPL1 × ZPL2	ZP 606 reciprocal	ZPL7 × ZPL8
ZP 335 reciprocal	ZPL1 × ZPL3	ZP 648 reciprocal	ZPL7 × ZPL9
ZP 366 reciprocal	ZPL1 × ZPL4	ZP 684 reciprocal	ZPL7 × ZPL10
ZP 388 reciprocal	ZPL1 × ZPL5	ZP 685 reciprocal	ZPL7 × ZPL11
ZP 4007 reciprocal	ZPL1 × ZPL6	ZP 749 reciprocal	ZPL7 × ZPL12

Seed quality parameters analysis

Standard seed germination rate and cold seed germination rate for all the genotypes were scored at the ISTA accredited Seed Testing Laboratory of the Maize Research Institute Zemun Polje. Method between the filter paper was used for standard warm germination test. Two hundred seeds per each genotype were placed between the two wet filter papers in four replicates (50 seeds per replicate) and wrapped in a roll. After seven days at 20°C genotypes were scored. The percentage germination is calculated from the number of normal seedlings out of the total number of seeds evaluated. Cold test was performed using a method in a rolled filter paper. Two hundred seeds per each genotype were tested in a four replications. Fifty seeds per replicate were placed on a wet filter paper covered with a thin layer of soil, and then covered with another wet filter

paper and wrapped in a roll. The rolls were first placed in a germinator for seven days at 10°C, and then for another seven days at 20°C. After this the emerged seedlings were counted and the cold germination percentage is calculated.

Statistical analysis

Three factorial nested ANOVA has been done, with common parental component and reciprocal effect as the main factors and hybrid as the nested factor. A t-tests have been performed for testing the significance of differences between the normal hybrids and their reciprocal versions. All the analysis have been done using SPSS 16.0 software.

Results and discussion

Average GR for inbred lines ranged from 93.0% (ZPL12) to 99.5% (ZPL9) (Table 2), while average values (AVG) for hybrids were from 94.0% (ZP 335) to 99.25% (ZP 388) (Table 3). Average CTGR for inbreds was from 94.0% (ZPL6) to 99.0% (ZPL10) and for hybrids it ranged from 91.5% (ZP 335) to 99.5% (ZP 366). Although GR and CTGR values among the inbred lines significantly differed all of them showed good germination ability in both tests. It can be noticed that several inbreds showed better CTGR than GR values, and that the later maturing inbred lines had slightly better performance regarding tested parameters.

Table 2. Mean values (%) of standard germination rate (GR) and cold test germination rate (CTGR) for inbred lines

Inbred line	FAO 300-400		Inbred line	FAO 500-600	
	GR	CTGR		GR	CTGR
ZPL1	96.5	97.5	ZPL7	98.5	98.0
ZPL2	96.5	95.5	ZPL8	95.5	97.0
ZPL3	96.0	95.5	ZPL9	99.5	98.0
ZPL4	95.0	98.5	ZPL10	94.0	99.0
ZPL5	95.0	97.5	ZPL11	97.5	97.5
ZPL6	95.0	94.0	ZPL12	93.0	97.0
AVG	95.7	96.4	AVG	96.3	97.8

Table 3. Mean values (%) of standard germination rate (GR) and cold test germination rate (CTGR) for normal and reciprocal hybrids

Hybrid	GR			CTGR		
	normal	reciprocal	AVG	normal	reciprocal	AVG
ZP 333	96.0	100.0	98.00	100.0	98.0	99.00
ZP 335	89.5	98.5	94.00	86.0	97.0	91.50
ZP 366	98.0	98.5	98.25	100.0	99.0	99.50
ZP 388	99.5	99.0	99.25	98.0	94.0	96.00
ZP 4007	97.0	97.0	97.00	95.0	91.0	93.00
AVG	96.00	98.60	97.3	95.80	95.80	95.8
ZP 606	99.0	95.5	97.25	98.0	98.0	98.00
ZP 648	95.5	97.0	96.25	98.0	98.0	98.00
ZP 684	95.5	99.5	97.50	97.0	99.0	98.00
ZP 685	96.5	94.5	95.50	100.0	94.0	97.00
ZP 749	93.0	97.5	95.25	94.0	97.0	95.50
AVG	95.90	96.80	96.35	97.40	97.20	97.3
AVG	95.95	97.70	96.80	96.60	96.50	96.55

ANOVA showed significant effect of hybrids on both parameters, while reciprocal effect significantly influenced only GR (Table 4). Common parental inbred line significantly influenced only CTGR, while there was no statistical difference for GR. Finally, interaction between reciprocal effect and shared parents was highly significant for both traits.

Five out of ten hybrids showed significant reciprocal effect for GR (Table 5). Three out of five early maturing hybrids had higher GR in reciprocal crosses, but the difference was significant only for ZP 333 and ZP 335. Hybrid which showed the worst result regarding this parameter was ZP 335, where reciprocal version had 9% higher GR than the normal one. On the other hand two late maturing hybrids had significantly negative reciprocal effect on GR. Namely, ZP 606 and ZP 685 normal versions had significantly higher GR score than their reciprocal versions. Nevertheless, ZPL1 and ZPL7 on average performed better when used as female parents. The obtained differences could be explained by the strong maternal influence on seed size and weight (Zheng et al., 2016). Namely, seed size affects germination rate in maize, where larger seeds have higher GR than the smaller (Yusuf et al., 2014).

Table 4. ANOVA of standard germination rate (GR) and cold test germination rate (CTGR) for hybrids

Source of variation	df	Mean squares	
		GR	CTGR
(R) Reciprocal effect	1	61.25**	0.087ns
(P) Common parental component	1	18.05ns	19.565**
(H) Hybrid(P)	8	20.25**	20.386***
R×P	1	14.45ns	0.087ns
H(R×P)	8	28.6***	20.378***

, * Significant at 0.01 and 0.001 probability levels, respectively; ns – statistically not significant.

Table 5. Significance of difference between the normal and reciprocal hybrids for standard germination rate (GR) and cold test germination rate (CTGR)

Hybrid	GR	CTGR
ZP 333	*	ns
ZP 335	**	ns
ZP 366	ns	ns
ZP 388	ns	ns
ZP 4007	ns	ns
ZP 606	*	ns
ZP 648	ns	ns
ZP 684	*	ns
ZP 685	*	ns
ZP 749	ns	ns

*, ** Significant at 0.05 and 0.01 probability levels, respectively; ns – statistically not significant.

Practically no difference between normal and reciprocal versions was detected for CTGR in both groups (Table 5). This was not in accordance with the results of Pinell (1949) who determined significant reciprocal effect on cold germination rate. The discrepancy could easily be explained by the different genotypes used in the two experiments. Novel modern elite inbred lines are now being selected for resistance to main abiotic stresses, as well as for good specific and general combining ability. This allows them to be used successfully both as female and male component in hybrids. Although ANOVA didn't show significant reciprocal effect on CTGR, ZP 335 reciprocal had 11% higher CTGR score than ZP 335 normal.

Normal and reciprocal versions of early maturing hybrids had significantly lower CTGR score than late maturing ones - average CTGR for early hybrids was 95.8%, while for late it was 97.3%. It can be concluded that ZPL7 line positively influenced this parameter, whether it was used as female or male component.

Finally, diallel analysis should be done to more deeply explore combining abilities and reciprocal effect on these two parameters (Cockerham, 1963). Also, according to Mann et al. (1981) the differences between reciprocal crosses were not stable over environments. Considering this and the fact that year of multiplication significantly influences seed quality, the same analysis will be done for genotypes multiplied in 2016.

Conclusion

Reciprocal effect has been reported for many important agronomic traits of maize. Influence of this effect on kernel traits, especially seed quality parameters is of special interest for plant breeding. We showed high significant reciprocal effect on standard germination rate of ten maize hybrids belonging to different maturity groups. The effect was both positive and negative depending on the genotype itself. On the contrary, we did not detect reciprocal effect on cold germination test rate, although one of the hybrids reacted positively regarding this parameter. Diallel analysis will be done in order to explore the analysed effect more detailed.

References

- Bagnara D., Daynard T.B. (1983). Reciprocal differences in kernel growth among four maize inbreds. *Maydica*, Vol. 27: 357–363.
- Bdliya P.M., Burris J.S. (1988). Diallel analysis of tolerance of drying injury in seed corn. *Crop Science*, Vol. 28: 935–938.
- Chaudhuri S., Messing J. (1994). Allele-specific parental imprinting of *dzr1*, a posttranscriptional regulator of zein accumulation. *Proceedings of the National Academy of Sciences of the United States of America*, Vol. 91: 4867–4871.
- Cockerham C.C. (1963). Estimation of genetic variances. In: Hanson W.D., Robinson H.F. (eds). *Statistical genetics and plant breeding*, Vol. 982. NAS-NRC Publication, pp 53–94.
- Egesel C.O., Wong J.C., Lambert R.J., Rocheford T.R. (2003). Gene dosage effects on carotenoid concentration in maize grain. *Maydica*, Vol. 48: 183-190.
- Groszmann A., Sprague G.F. (1948). Comparative growth rates in a reciprocal maize cross: 1. The kernel and its component parts. *Journal of the American Society of Agronomy*, Vol. 40: 88–98.
- Lunsford J., Futrell M.C., Scott G. (1974). Maternal influence on response of corn to *Fusarium moniliforme*. *Phytopatology*, Vol. 65: 223-225.
- Mann C., Pollmer W. (1981). Reciprocal-cross differences between maize hybrids of inbred lines from different gene pools. *Maydica*, Vol. 26: 263–271.
- Mann C., Pollmer W., Klein D. (1981). Magnitude and stability over environments of reciprocal-cross differences in maize hybrids and their implications on maize breeding. *Maydica*, Vol. 26: 239–252.
- Melchinger A., Geiger H., Schnell F. (1985). Reciprocal differences in single-cross hybrids and their F2 and backcross progenies in maize. *Maydica* Vol. 30: 395–405.
- Miller P.A., Brimhall B. (1951). Factors influencing the oil and protein content of corn grain. *Agronomy Journal*, Vol. 43: 305–311.
- Pinnell E.L. (1949). Genetic and environmental factors affecting corn seed germination at low temperatures. *Agronomy Journal*, Vol. 41: 562–568.
- Seitz G., Melchinger A., Geiger H., Singh I. (1995). Reciprocal differences for forage traits in single and three-way crosses of maize. *Plant Breeding*, Vol. 114: 231–234.
- Yusuf C.S., Makate N., Jacob R. (2014). Effect of seed size on germination and early growth of maize (*Zea mays*). *International Journal of Scientific and Research Publications*, Vol. 4, Issue 10, October 2014 (published online).
- Zhang X., Hirsch C.H., Sekhon R.S., Leon N., Kaepler S.M. (2016): Evidence for maternal control of seed size in maize from phenotypic and transcriptional analysis. *Journal of Experimental Botany*, Vol. 67 (6): 1907-1917.

EVALUATION OF THE EFFECTS OF PARTIAL ROOT ZONE DRYING IRRIGATION ON CORN YIELD AND YIELD COMPONENTS

Mahmoud RAEINI-SARJAZ*, Mohammad HOSSEINI, Ali SHAHNAZARI

Department of Agricultural Engineering, Sari Agricultural Sciences and Natural Resources University, Sari, Iran,
PO-Box 578.

*Corresponding Author: m.raeini@yahoo.com; m.raeini@sanru.ac.ir

Abstract

Water scarcity is the main constraint in crop production within arid and semi-arid regions. In recent decades, the subject of partial root-zone drying irrigation (PRD) gained a lot of attention for increasing water use efficiency (WUE) in many plant species. The effect of water shortage stress on corn (*Zea mays* L.), single cross (SC704) yield was evaluated on a silt-sandy soil during 2012 farming season in Mahmoudabad, 5 km south of the Caspian Sea shore, Mazandaran province, Iran. A RCB design with 4 treatments of 1) Full irrigation (FI) plants receiving 100% of field capacity (FC); 2) PRD₈₀ plants receiving 80% of FC; 3) PRD₅₀, which plants received 50% of FC and 4) Deficit irrigation (DI₅₀), which plants received 50% of FC. The effect of water treatments on corn yield and yield components were highly significant ($p < 0.001$). The PRD₈₀ treatment consumed 18% less water relative to FI treatment during its growing season, while its yield was not significantly different from FI. The high water stressed treatments of PRD₅₀ and DI₅₀ yields were significantly lower than that of FI and PRD₈₀ treatments. The substantial compensatory effect of PRD irrigation on yield and yield components indicates that ABA and stomatal regulation in favouring of photosynthesis to transpiration could be the key. During calm, clear sky nights dew deposited on corn leaves, which finally dropped to soil close to the corn stem. No difference was found between water treatments regarding dew deposition. In conclusion, the PRD irrigation strategy in comparison with conventional DI irrigation could benefit corn growth and development.

Keyword: *Corn, deficit irrigation, water stress, ABA, PRD*

Introduction

Water scarcity in arid and semi-arid regions is a major constraint in crop production. Iran major areas are in arid and semi-arid regions, where water availability is vital for livelihood and crop production. In these regions drought occurrence, as one of the most common environmental stresses in crop production, is a regular feature of the nature. Thus, a great deal of emphasis is on crop physiology and crop water management to use water efficiently (Stikic et al., 2003). In sub-humid and humid regions of northern Iran, south of Caspian Sea, crop production during the late spring and early summer encounter water scarcity and drought conditions.

Partial root-zone drying (PRD) irrigation, as a further development in deficit irrigation (DI) method nowadays, based on crop physiology and crop water management, is gaining a lot of attention for reducing crop water consumption and increasing water use efficiency. The partial root-zone drying irrigation (PRD) relative to conventional deficit irrigation (DI) is more beneficial, where plant root system gets alternate irrigation on both sides. Water stress mainly reduces stomatal conductance, where transpiration rate reduction is more inhibited relative CO₂ gain, therefore, in general WUE increases by water stress (Raeini-Sarjaz et al., 1998).

Meanwhile, in PRD strategy the dry part of the plant root system in response to water deficit generates abscisic acid hormone (ABA), which regulates stomatal pores to control transpiration (Liu et al., 2003; Liu et al., 2005), by which plant WUE enhances. The PRD is commonly considered as a DI method, because it does not receive more than 50-70 percent of water relative to full irrigation (Marsal et al., 2008).

Corn (*Zea mays* L.) is a C₄ plant and relative to C₃ plants has a higher WUE. The PRD irrigation strategy may further enhance its WUE. Based on Yazar et al. (2009) this water management strategy relative to full irrigation (FI) and DI method increased maize WUE significantly, while Sepaskhah and Khajehabdollahi (2005) reported a reduction in WUE for semi-arid regions.

In coastal areas one source of plant water availability is dew deposition on the plant leaves. Dew formation occurs when the water vapor pressure of the air is higher than the saturation water vapor pressure at leaf surface temperature.

The objective of this study was to evaluate the effect of partial root-zone drying irrigation strategy on corn grain yield relative to deficit and full irrigation strategies in a humid climate with low rain during late spring and early summer period.

Materials and Methods

Experiment layout

The experiment was conducted in a silt- sandy soil during farming season of 2012 in the Haraz Extension and Development Technology Center, Mahmoudabad (Iran) 10 km south of Caspian Sea shore with a humid climate based on de Martin classification, to investigate the effects of water stress on corn yield (*Zea mays* L., single cross SC704) and yield components. To conduct the experiment a complete randomized block design with four treatments and four replications were employed. The treatments were: 1) full irrigation (FI), as control, which plants received 100 percent of field capacity (FC); 2) Partial root-zone drying irrigation (PRD), which plants received 80 percent of FC (PRD₈₀); 3) Partial root-zone drying irrigation, which plants received 50 percent of FC (PRD₅₀) and 4) Conventional deficit irrigation, which plants received 50 percent of FC (DI₅₀). Plants were grown on late May 2012 on rows spaced 75 cm apart with 25 cm between plants on rows. Soil water content for each water treatment was monitored using TDR (time domain reflectometry) soil moisture meter and plants received corresponding water level using drip irrigation system. During the corn growth and development crop yield components and finally grain yield were measured.

To investigate dew deposition on corn leaves, as source of water, during some clear and cool nighttime stable weather conditions, dew deposition on flag leaves was measured. Deposited dew amount on specified leaf area was collected using paper towels. Each moist paper towel was then inserted in a zip-lock plastic bag and dew amount was measured using a precise balance (0.001 g). Corn yield and yield components data were analyzed using ANOVA of SAS software (SAS 9.1), and the SNK post hoc test was employed to compare treatment means.

Results and Discussion

All treatments received 130 mm of water for crop establishment before to implement water stress strategies, therefore, for the whole corn growth and development stages the control treatment (FI) received 750 mm of water. During this period no precipitation was registered. The water-stressed treatments of PRD₈₀, PRD₅₀ and DI₅₀ received 635, 445 and 445 mm of water, respectively.

The effect of water treatment on corn yield and yield components was highly significant ($p < 0.05$). The mean yield across different water treatments is presented on Table 1. Soil water

content significantly affected corn yield. The highest grain yield achieved with full irrigated treatment, although not significantly different from PRD80 treatment. In this case mean FI grain production was 13.5 percent higher than that of PRD80, while FI plants on average consumed 18 percent more water. On the other hand, the mean yield of both severe stressed treatments of PRD50 and DI50 was significantly less than those of FI and PRD80, while no difference was registered between PRD50 and DI50, but when considering the percentage declines PRD50 produced 21 percent more seed in compared to DI50, although both received the same amount of water. It seems behavior of corn in response to same amount of soil water content, but with different water strategies, is slightly different, as could be seen for FI and PRD80 treatments. Hakeem et al. (2016) had four treatments of FI, alternate PRD (APRD), fixed PRD (FPRD) and deficit irrigation (DI), all three deficit irrigation strategies received 50% of FI water quantity. The FI significantly produced the highest corn grain yield, while APRD grain yield was significantly more than that of FPRD and DI, almost by 15%. Yazar et al. (2009) with a 7-day scheduling irrigation cycle also reported higher grain production with FI relative to deficit irrigations of PRD and DI which received 50% of FI water amount.

It is an obvious knowledge that water stress makes plants more conservative, through stomatal conductance, to reduce transpiration rate (Raeni-Sarjaz 1997), which is ultimately translated to growth reduction. The response of plants to similar water-stress seems depends on water strategy managements. The response of plants to partial root-zone drying system is better than conventional deficit irrigation. This response has been assigned to ABA generation on dry-zone of the root system, which receives water alternately (Stoll et al., 2000), and signals stomata to regulate the pore to conserve water, while the moist zone of the root receives adequate water to continue photosynthesis (Liu et al., 2003). Therefore, better achievements of PRD treatments relative to DI could be due to better stomatal response to water shortage at root zone. The fixed PRD data in Hakeem et al. (2016) showed that this method is not helping the ABA generation strategy of PRD procedure.

Table 1) Mean corn yield and yield components across different water treatment.*

Treatments	Yield (tone hc ⁻¹)	100 seed weight (g)	Ear length (cm)	Ear diameter (cm)	Seeds per row	Seeds per column
FI	8.4±0.9 ^a	34.6 ^a	25.2 ^a	4.81 ^a	15 ^a	51 ^a
PRD80	7.4±0.5 ^a	35.8 ^a	24.6 ^a	4.75 ^a	14 ^b	49 ^a
PRD50	5.7±1.0 ^b	35.2 ^a	21.6 ^b	4.35 ^b	13 ^c	41.3 ^b
DI50	4.7±0.9 ^b	32.6 ^a	20.5 ^b	4.22 ^b	13 ^c	37.8 ^c

* On each column means that carrying the same letters are not significantly different (5% level).

Yield components which could be an indicator of final grain yield, such as mean ear length, ear diameter, seeds per row and per column also copied the same trend as did grain yields. Means of ear length and ear diameter and seeds per column were similar in both FI and PRD80, while both treatments were significantly different from PRD50 and DI50 treatments (Table 1). The mean 100 seeds weight across different water treatments was not significantly different between the treatments (Table 1). Mean plant heights of FI and PRD80 significantly were more than those of severe stress treatments of PRD50 and DI50 along the time (Table 2). Results of yield components of this experiment are in agreement with those of Hakeem et al. (2016) except 100 grains weight. In current trial other factors might have compensated for water shortage, such as dew deposition on corn leaves during clear and cool nights.

Table 2) Mean corn height (cm) during corn growth across different water treatment.*

Treatments	Corn height (cm) days after seed emergence				Mean dew deposition on leaf (g m^{-2})
	44	58	68	91	
FI	82.5 ^a	185 ^a	268.3 ^a	290.5 ^a	116.9
PRD80	74.7 ^b	171.7 ^a	240.7 ^a	270 ^{ab}	118.6
PRD50	51.7 ^c	138.3 ^b	204.3 ^b	242.3 ^{bc}	117.3
DI50	51.5 ^c	137.5 ^b	200.5 ^b	230.3 ^c	121.3

* On each column means that carrying the same letters are not significantly different (5% level).

Mean dew deposition on leaf across different water treatments was not significantly different (Table 2). Dew deposition onto surfaces, due to air and soil water vapor condensations, is a natural phenomenon. Dew is a vital source of moisture for ecosystems in arid and semi-arid climates (Jacobs et al., 1998), although it promotes diseases in susceptible plants, but in some plants it could be considered as a source of water requirements. Visual observation showed that in corn because of leaf structure and leaf angle relative to stem, the deposited dew finally drops to stem base on the soil. In light soils, such as sandy loams it could be absorbed by root system. The location of the present study was 10 km south of the Caspian Sea, therefore the chance of dew formation on light soils during calm, clear, cool nights is high. Mean of 118 gm^{-2} of water deposition on corn leaf (Table 2) could compensate for water shortage in stress treatments. Similar 100 grains weight in different water treatments, or not significantly different grain yield in FI and PRD80 might be due to this source of water.

Conclusion

The irrigation strategies that keeps root-zone water content close to field capacity produce higher grain. In the case of PRD strategy in our experiment, grain yield was comparable to full irrigation with almost 13% yield reduction and 18% water saving. It looks water management and climate has a major influence on this success. The region where the experiment was held has a humid climate with late spring and early summer free-rain period, but humid air. It is speculated that leaf dew deposition compensate for part of deficit irrigation. Others reported higher water-use efficiency for alternate PRD relative to the FI strategy (Hakeem et al., 2016), while Yazar et al. (2009) found no benefit in corn yield compared to conventional deficit irrigation under water scarcity conditions in the Mediterranean region of Turkey.

References

- Hakeem A., Liu Y., Xie L., Ata-Ul-Karim S.T., Samiullah, Huang J. (2016). Comparative effects of alternate partial root-zone drying and conventional deficit irrigation on growth and yield of field grown maize (*Zea mays* L.) hybrid. *Journal of Environmental and Agricultural Sciences*, 6:23-31.
- Jacobs, A.F.G., Heusinkveld, B.G., Berkowicz, S.M., (1998). Dew deposition and early morning evaporation in a desert environment. 23rd Conf. on Agricultural and Forest Meteorology.
- Liu, F., C.R. Jensen and M.N. Andersen, (2003). Hydraulic and chemical signals in the control of leaf expansion and stomata conductance in Soybean exposed to drought stress. *Funct. Plant Biol.*, 30: 65-73.
- Liu, F., Jensen C.R., Shahnazari A., Andersen M.N. and Jacobsen S.E. (2005). ABA regulated stomatal control and photosynthetic water use efficiency of potato (*Solanum tuberosum* L.) during progressive soil drying. *Plant Sci.*, 168: 831-836.

- Marsal J., Mata M., del Campo J., Arbones A., Vallverdú X., Girona J. , Olivo N. (2008): Evaluation of partial root-zone drying for potential field use as a deficit irrigation technique in commercial vineyards according to two different pipeline layouts. *Irrigation Science*, 26: 347–356.
- Raeini Sarjaz M., N.N. Barthakur, N.P. Arnold and P.J.H. Jones. (1998). Soil moisture, water use efficiency, carbon isotope discrimination and leaf gas exchange of bush bean. *J. Agronomy and Crop Science*, 180: 173-179.
- Sepaskhoh A.R., Khajehabdollahi M.H. (2005). Alternate furrow irrigation with different irrigation intervals for maize (*Zea mays* L.). *Plant Production Science*, 8: 592-600.
- Stikic R., S. Popovic, M. Srdic, D. Savic, Z. Jovanovic, J. Zdravkovic, Lj. Prokic. (2003). Partial root drying (PRD): A new technique for growing plants that saves water and improves the quality of fruit. *Bulg. J. Plant Physiol. Special Issue*, 164–171.
- Stoll, M., B. Loveys, P. Dry, (2000). Hormonal changes induced by partial root-zone drying of irrigated grapevine. *J. Exp. Bot.*, 51, 1627–1634.
- Yazar A., Gökçel F., Sezen M.S. (2009). Corn yield response to partial root zone drying and deficit irrigation strategies applied with drip system. *PLANT SOIL ENVIRON*, 55, 494–503.

GERMINATION TEST METHODS OF INSECTICIDE-TREATED SEEDS

Jasna KOJIĆ*, Marija MILIVOJEVIĆ, Tanja PETROVIĆ, Dragana BRANKOVIĆ RADOJČIĆ,
Snežana JOVANOVIĆ, Marijenka TABAKOVIĆ

Maize Research Institute, Zemun Polje, Slobodana Bajića 1, 11185 Belgrade, Serbia

*Corresponding author: kojicjasna@gmail.com

Abstract

The seed treatment with insecticides in certain cases causes lower values of seed germination due to phytotoxicity, which is manifested as a truncated and thickened main root. In the Seed Testing Laboratory, the method most suitable for seed germination was sought out in order to reduce effects of phytotoxicity of treated seeds to the minimum. This study encompassed germination tests of 10 seed lots of maize hybrids of different maturity groups stored in the controlled-environment chamber for a year. One part of seeds was treated with the fungicide Maxim XL, while the remaining part was treated with the fungicide Maxim XL + insecticide Sonido. The seed germination tests were carried out in the Seed Testing Laboratory, Maize Research Institute, Zemun Polje, by the between paper method (4x100 and 8x50 seeds) and the sand method (4x100 seeds). Seeds were germinated in the room germinator at the alternating temperature of 20<=>30°C and 16:8 (light : dark) photoperiod. The first counting was done on the fourth day and the final one on the seventh day when the BP method was used. In cases when the S method was applied, the final counting was done on the seventh day. When seeds were germinated, the control sample was also placed for germination. Considering results of the last year germination, it was determined that seed germination was not significantly changed after a year of storing in the controlled-environment chamber. The comparison of results on germination of seeds treated only with the fungicide with seeds treated with fungicide+insecticide, shows lower values in seed germination in all three treatments in fungicide+insecticide-treated seeds. The lowest germination values were recorded in seeds treated with fungicide+insecticide in sand, while the highest values were obtained by the BP method (8x50 seeds).

Key words: *germination, insecticide*

Introduction

Seed germination is the most important parameter of seed quality and it is represented by the total germination, i.e. by the number of seedlings that will be developed into a normal plant. The reduction in seed germination occurs due to unfavourable environmental factors, untimely technological procedures, as well as by treatments of seeds with insecticides prior to sowing. (Bača *et al.*, 2008) concluded that insecticides on seeds did not essentially affect either the increase or the decrease of the plant stand and even resulted in higher average grain yields. Although seed treatments with insecticides result in the lowest consumption of insecticides, attention should be paid to their phytotoxic effects on seed that will lead to the reduction of the total seed germination.

The presence of pesticides and insecticides on seeds under conditions of high humidity and temperatures during the process of seed germination reduces the total seed germination by the occurrence of abnormal seedlings. On this occasion, due to the phytotoxic effect on seeds, the root system thickens and shortens or the above-ground seedling parts elongate. (Vujaković *et al.*,

2003) reported that certain dressing agents adversely affected the growth of above-ground parts of wheat seedlings. During the process of seed germination, it is important to apply the adequate seed germination method that will mitigate the adverse effect of insecticides and thereby show an actual value of the total germination. (Stanković *et al.*, 1995) determined that prolonged storage of insecticide-treated seeds resulted in higher toxicity and therefore in the significant reduction of germination.

According to ISTA Rules, (ISTA Rules 2016), maize seed germination is tested by the following methods: between paper (BP), in sand (S) and on top of crepe paper and sand (TPS). Germination tests of maize seeds are mainly performed using the between paper method, because it is easiest to apply, while sand is used and recommended when testing of infected samples is impractical because of infection spread among seeds and seedlings, for research purposes and when seedlings express phytotoxic symptoms.

Material and Methods

This paper presents results on germination first count and total germination of 10 lots of maize hybrids of different maturity groups, stored in the controlled-environment chamber (18°C, 60% RH) for a year. One portion of seeds was treated with fungicide Maxim XL 035FS, while the remaining portion was treated with fungicide Maxim XL 035FS and insecticide Sonido.

Seed germination testing was carried out 2016 year in the Seed Testing Laboratory of the Maize Research Institute, Zemun Polje, using the between paper method (4x100 and 8x50 seeds) and in sand (4x100 seeds). Tests were performed under controlled conditions at alternating temperatures 20<=>30°C and the light regime 16 h : 8 h (light : dark). When the between paper method had been used, the first count was made at four days, while the total germination was determined on the seventh day, (ISTA Rules 2016). Obtained values were expressed in percentage of normal seedlings. Gained results were statistically processed by the computer program MSTAT. The two factorial analysis of variance and the least significant difference (LSD) test were applied, (Hadživuković 1991).

Results and Discussion

The analysis of variance shows statistically significant differences in the total germination over tested seed lots, as well as between the applied seed treatment and germination method. Interactions among observed factors were also statistically significant (Table 1).

There were no statistically significant differences between replications and interactions of all three observed factors.

Table 1. Statistical significance of effects of observed factors on total germination of seeds

Factor	Degree of freedom (DF)	Mean squares (MS)	F value
Replication	3	3.494	0.7264 ^{ns}
Factor A	9	341.178	70.9187 ^{**}
Factor B	1	653.400	135.8186 ^{**}
AB	9	23.150	4.8121 ^{**}
Factor C	2	56.963	11.8405 ^{**}
AC	18	16.435	3.4162 ^{**}
BC	2	7.238	1.5044 ^{**}
ABC	18	9.960	2.0703 ^{ns}
Error	177	4.811	

ns – not significant; ** - significant at the level of 0,01%; df – degree of freedom

The average total germination over seed lots ranged from 84.71% to 97.38% for observed methods and the applied treatment. The analysis of results based on the LSD test for the interaction between methods and the seed treatment shows the lowest value of the total germination for the lot 10 (F), which is a statistically significant difference, while differences determined in lots 2 and 4 (A) were not statistically significant.

Table 2 shows that the total germination was reduced for all test methods after seeds had been treated with insecticides. (Tamidžić *et al.*, 2013) revealed that all insecticides, regardless of the type of active ingredients, affected the reduction in seed germination of maize inbred lines.

Table 2. Average values of germination expressed in % of seeds over methods and lots

Method	Method	Tested lots										Average over methods
		1	2	3	4	5	6	7	8	9	10	
Maxim XL	S	98	98	95	98	89	97	97	95	98	89	95.35 B
	BP 4x100	98	99	98	99	96	96	97	97	98	90	96.70 A
	BP 8x50	96	98	97	98	93	97	98	96	96	87	95.57 B
Maxim XL + Sonido	S	94	97	90	95	87	93	91	91	95	81	91.43 D
	BP 4x100	96	95	89	99	95	97	97	90	95	83	93.45 C
	BP 8x50	97	97	95	94	91	93	94	93	97	78	92.85 C
Average over lots		96.58 ABC	97.38 A	93.92 D	96.83 A	91.88 E	95.38 C	95.54 BC	93.42 D	96.63 AB	84.71 F	

S - sand, BP – between paper

Values of the total germination of seeds treated with fungicide + insecticide were on the average equal regardless of applied methods (BP with 4x100 and 8x50 seeds). These two testing methods are the most reliable for insecticide-treated seeds. The lowest value of the total germination was recorded when the S-method was applied, pointing out that this seed germination method was not reliable for insecticide-treated seeds (Table 2).

The highest total germination of fungicide-treated seeds was obtained by the BP method (4x100 seeds), while values of the total germination obtained by methods BP (8x50) and S were equal (Table 2).

In recent times the use of soil, as a substrate, has been increasingly mentioned and recommend for seedlings manifesting phytotoxic symptoms, not as a primary substrate but as alternative one. It has been observed that the total germination of seeds germinated in soil under laboratory conditions was the highest in inbred line seeds treated with insecticides.

Conclusion

According to obtained results, it can be confirmed that the total seed germination reduces after seeds were treated with insecticides. The BP method (4x100 and 8x50 seeds) is the most reliable germination method. The sand method did not prove reliable in tests of insecticide-treated seeds. The standard germination method (BP 4x 10 seeds) proved to be the best for fungicide-treated seeds. Furthermore, the BP method (8x50 seeds) that is used in our laboratory for testing germination of insecticide-treated seeds proved to be the best. Based on achieved results it is observable that the BP method (4x100 seeds) was equally reliable and therefore it will be more applied in the future work. Future objectives of laboratory studies should be aimed at testing soil

as a germination substrate for testing insecticide-treated seeds in order to obtain results on the total germination as reliable as possible and to reduce phytotoxic effects.

References

- Bača, F., Gošić-Dondo, S., Videnović, Ž., Erski, P. (2008). Effect of maize seed treatments with imidacloprid and thiametoxam the plant spacing and grain yield, Books of proceedings of XXIIInd Conference of Agronomist, Veterinarians and Technologist Institut PKB Agroekonomik, Padinska skela, str. 61-70
- Hadživuković S., (1991), Book of statistical methods. Second edition, Faculty of Agriculture Novi Sad.
- International Seed Testing Association (2016). International Rules for Seed Testing, ISTA Basserdorf, CH
- Stanković R., Medić S. (1995). Investigation of the insecticide effects on the sunflower and corn seed germination capacity and germination energy, Journal of Plant breeding and seed production, vol IV, br. 1-2, str. 205-210
- Tamindžić G., Nikolić Z., Danojević D., Župunski V., Ignjatov M., Petrović D., Zdjelar G. (2013). Effect of insecticides on seed germination and seedling growth of maize inbred lines, Journal of Plant protection, vol. 64, br.2, str. 101-109
- Vujaković M., Milošević M., Nikolić Z., Zlokolica M.,(2003). Effect of preparation for seed treatment on germination and vigour of wheat seed (*Triticum aestivum* L.), Journal of processing and energy in agriculture, vol 7, br. 3-4, str. 75-78

THE EFFECT OF CULTIVAR AND HARVESTING DATES ON ROOT YIELD AND SUGAR CONTENT OF WINTER SOWN SUGAR BEET

Süreyya Gülfem ALTUNBAY

Sugar Institute, Plant Breeding Department, T.ŞF.A.Ş. Ankara, Turkey

*Corresponding author: : sureyyagulfem@hotmail.com

Abstract

Sugar beet is cultivated on irrigated areas in summer; sugar beet cultivation, root yield and sugar content are dependent on irrigation significantly. In addition, summer sown sugar beet harvest begins in October at the earliest, until this month the sugar factories waiting for work. This condition is caused by the rising costs of production and sugar factories remain idle. Using less water in the production of sugar beet, sugar beet factories to process early and in order to grow a second crop after sugar beet harvest, wintery sugar beets were sown. The aim of this study was to determine root yield and sugar content of two winter sugar beet species (Eudora and Sculta) in three harvesting dates (June 11, 27 and July 19). This study was conducted in 2011-2012 growing season of Kahramanmaraş, established as a split plot design with 3 replicates. Species in main plots and harvesting dates in the sub-plots were placed. In the study, the head and leaf yield, root yield and sugar content were examined. As a result of analysis of variance, it was determined that there were no significant differences between species in terms of investigated features, the effect on the head and leaf yield and root yield of harvesting times were significant. At the end of the study, 14.43% sugar content, 2.63 ton/da head and leaf yield and 6.83 ton/da root yield from Eudora; 14.34% sugar content, 2.84 ton/da head and leaf yield and 6.80 ton/da root yield from Sculta species were obtained. The effect of harvesting dates on head + leaf and root yields except sugar content were significant. The highest head and leaf yield (3.13 ton/da) in the second harvest (June 27), the highest root yield (8:42 ton/da) in the third harvest (July 19) was obtained. Delayed harvest date increased root yield, the head and leaf yield decreased after the second harvest. Drying of leaves and leaf losses resulted in the head and leaf yield reduction in the time of final harvest.

Keywords: *Sugar beet, Beta vulgaris L., winter beet, root yield, sugar content*

Introduction

Sugar beet is the most important plant that sugar is obtained after the sugar cane. 30 % of the sugar production of the world is obtained from sugar beet. Compared to the average of the last 3 years (2009-10-11). Turkey cultivates sugar beet in the field of 315 487 ha and 17 million tons of sugar beet is produced (Anonim, 2011). Economic sugar production is realized only in planting high technological quality of sugar beet. The climatic conditions of the region and cultivation techniques are important in generating satisfactory income by cultivating a product. Ensuring the necessary conditions in cultivating sugar beet is important with respect to product yield and quality. Provided that sugar beet is early cultivated in favorable climatic and soil conditions, the root yield and quality become higher (Durr and Boiffin, 1995). The productivity and sugar content are influenced by kinds and harvest season as well as environmental factors (Takada, 1998). The sugar beet is a cultivated plant which is planted in summer time normally. However, the matter that sugar beet is planted winterly in fall is quite old. The reclamation of a kind of

winter resistant sugar beet is handled in Kleinwanzleben city of Eastern Germany in 1930 by the researchers and the durability characteristic to run to seed is more given the top importance in the selections made. It was proved in the tests made with the species obtained that those species were not appropriate to fall planting but they are superior to other types with respect to durability to run to seed. The studies regarding wintery sugar beet after the Second World War more velocity are accelerated. First reclaimed species; are the kinds AA (German), Cesena NSA (Italian), US15 and US75 (American). New kinds have been placed on the market in recent years and these are; Kaweinterpoly, Kawe Tr, 861 (Germany), Semerave, H 5612 (The Netherlands), Alba Autopoly Alba Polka, Mezzano Au Poly, Mezzano Poly A (Italian), Autopoly (Denmark), Aupoly, Monatonna (Sweden), Aj. Poly 1 (Poland) and USH 10, SP 9B, S 45H (America). These species can be planted in fall in the regions that sugar beet could maintain its vegetative growth in which the winter is pretty hot and not subject to danger of frost especially, and they are planted in the beginning of summer. In this way, the agriculture of sugar beet in California, Spain and in southern regions of Italy is being applied successfully today.

In the test of wintery sugar beet that was carried out in England, it was stated that the rate of running to seed reduced due to the fact that wintery sugar beet planting changed from the end of september to the middle of october, and this resulted from the shortening of the growth period of the plant which is sensitive to cold (Wood and Scott, 1975). Because the matter of wintery sugar beet has become actual in our country recently, some studies were conducted on this matter in southern regions of our country between the years of 1976 - 1981. The sugar beet has been cultivated every summer preferably since 1926 that is the first production year of Turkey. The opinion that the investigation of the possibilities of planting the sugar beet both in winter and summer period in southern regions of the country came up with GAP project firstly in the mid of 70's. The possibilities of cultivating sugar beet in winter in southern regions of Turkey was investigated by using wintery Kaweinterpoly kind between the years 1976-77 and 1981-82 (Özgür and Erdal, 1982). The researchers tested 7 harvesting time in one month intervals each between February 1 and August 1, and in 20 days intervals between July 1 and November 20. It was pointed out that the optimum harvesting time of wintery planting is june and july, it causes a major frost damage in young plantsin Aegean region and exclusively in Southeastern Anatolia Region with the delay of harvesting time and the slow down of development, on the other side, taking forward the planting time (taking to the beginning of october or mid-september) encourages the run to seed for all wintery sugar beet species, that the species like Kaweinterpoly, Aupoly, Autopoly, Monatunno are highly durable against running to seed (Castilo and Garcia, 1986). It was pointed out that early planting provides higher quality dry matter accumulation, encourages the growth of leaves and this increases the root and sugar yield in the study where the productivity of sugar and root in wintery sugar beet is investigated by using 3 different planting periods (october, november, december) of 3 years, 2 different plant population (100 000 and 80 000 plant/ha) and 3 kinds (Monauta, Monatonno and Kaweinterpoly). The researchers stated that the wintery sugar beet starts the active development by the end of the winter season after 160 days upon the plantation and it has mostly in this period the dry matter accumulation and leaf area index; furthermore, wintery sugar beet planting is possible in Mediterranean region where winter season is temperate, that harvesting of wintery sugar beet runs into hot periods of summer season, and so the precipitation of winter and spring seasons are better benefited (Lopez and Bellido, 1986). In another research [8], 3 planting periods (September 1, September 20 and November 10) and 3 harvest seasons (April 15, May 15 and June 15) were researched and it was pointed out that the first planting period had the highest rate of running to seed, while the third plantin period had the lowest rate of running to seed and harvest season of September 1 and May

15 are better for root yield. This researchers stated in the planting time attempt carried out in Kermanshah region that (Basati and Neamati, 2003) the most appropriate planting time for the region is till September 20, while the most appropriate harvesting time is until May 15. In a research [9] conducted by using two sugar beet species (DEZ and BRI), 3 planting periods (August 22, September 10, October 2) and 3 harvest seasons (April 3, May 4 and June 4), it was reported that DEZ kind has more root and sugar yield than BRI kind, the rate of running to seed and substances apart from sugar are less in DEZ kind, the best planting period is August 22 with sugar yield of 9.64 ton/ha, root yield of 85.09 ton/ha and sugar content of % 11.44, while the best harvest season is July 4 with sugar yield of 9.38 ton/ha. In a study (Rinaldi and Vonella (2006) conducted in Apulia region of Italy by using the planting of fall (October, December) and spring (May), it was stated that fall planting had higher root yield, dry substance amount and sugar content than spring period. In another study (Reinsdorf and Koch, 2010), it was pointed out that the dry substance amount of wintery sugar beet that is planted lately decreases considerably, sugar beet has high yield in early planting, resistance to cold winter conditions depended on climate conditions (low temperature and snow cover) and morphological features of sugar beet (root diameter), furthermore, snow cover increases the tolerance of wintery sugar beet against frosts. It can be seen from the conducted studies that in planting the wintery sugar beet, the rate of sugar is lower than the planting in summer time. However, when taking into consideration some advantages, it is possible to plant sugar beet in winter season too in areas where winter is moderate. The campaign period of sugar beet could be up to six months in case wintery sugar beet is planted. Thanks to planting wintery sugar beet, sugar plants will be ensured to operate for longer periods. The costs will be lower in terms of farmers in wintery sugar beet planting and so the costs like irrigation and disinfection will decrease. Furthermore, the possibility that our farmers could plant the second product corn and other products that are appropriate for the second product will come out because the farm is harvested in may. It will be possible to obtain two products in a year through the wintery sugar beet application.

Material and Method

The study was established as 3 repetitions according to experimental design of split plot in growing season of 2011–2012 in Kahramanmaraş conditions (Turkey) with wintery sugar beet species. The species (Eudora and Sculta) were placed into main parcels, while harvest seasons (June 11, June 27 and July 19) were placed into sub-plots. Seed sowing was applied in October 10 by beet seeder of 5-rows, 120 kg N and 60 kg P₂O₅ for each hectare and the plants were grown without irrigation. Irrigation was performed once before harvest season in order to simplify harvesting process only. The productivity of top and leaves, body yield and sugar content were investigated in the study. Data regarding investigated features was analysed by using MSTATC statistical program package.

Result and Discussion

The values regarding investigated features in the study and the formed groups are given in Chart 1.

Chart 1. The Values Regarding Investigated Features in Wintery Sugar Beet and the Formed Groups

Variety	The yield of top+leaves	Root Yield (ton/da)	Sugar Content (%)
Eudora	2,63	6,83	14,13
Sculta	2,84	6,80	14,34
Average	2,74	6,81	14,38
11 Haziran	2,61 b	5,94	14,33
27 Haziran	3,13 a	6,08 b	14,47
19 Temmuz	2,47 c	8,42 a	14,35
LSD (% 5)	0,05	0,27	NS
Çeşitler (A)	NS	NS	NS
Hasat Zamanları (B)	**	**	NS
AXB	**	NS	NS

It can be seen in Chart 1 that there is no important differences among species in terms of investigated characteristics, while harvest season is effective on the productivity of top and leaves and body yield, moreover it can be understood that the kind-harvest season interaction is important. It was obtained %14.43 of sugar content, 2.63 ton/da of productivity of top and leaves and 6.83 ton/da of body yield from Eudora kind; while %14.34 of sugar content, 2.84 ton/da of productivity of top and leaves and 6.80 ton/da body yield was obtained from Sculta kind. The sugar content has not changed importantly according to harvest season, the highest productivity of top and leaves (3.13 ton/da) was obtained from second harvest season (June 27), while the highest body yield (8.42 ton/da) was obtained from the third harvest season (19 July). It was pointed out by many researchers that harvest season is effective on body yield [4, 5, 6, 7, 8, 9, 10, 11]. As harvest season was delayed, the body yield increased; while the productivity of top and leaves reduced after the second harvest season. Reduction of productivity of top and leaves in the last harvest season is supposed to cause by first drying of the leaves and increase in leaf loss.

Conclusion

As a result of the conducted study, it was pointed out that the planting of wintery sugar beet could be realized in mild winter climate conditions like the climate of Kahramanmaraş in case there is appropriate kind, and that sugar content of 14 %, body yield about 6 ton and productivity of top and leaves about 2.7 ton could be obtained.

References

- Anonim, 2011. TÜİK Verileri. <http://www.tuik.gov.tr>
Durr, C. and Boiffin, 1995. Sugarbeet Seedling growth from germination to first leaf stage. *Agric. Sci. Camb.*, 124, 427-435.

- Harvey, C.W. and J.V. Dutton, 1995. The Sugar Beet Crop: Science into Practise. In: Cooken, D.A., R.K. Scott (Edd). Root Quality and Processing Chapman and Hall. London, pp: 571-617.
- Takada, S., D. Hiroyuki, and M. Hayashida, 1988. Interaction Between Varietal Characteristics and Enviromental Factors. Proc. Japan Soc. Sugar Beet Technol. 30:23-28.
- Wood, D.W. and R.K. Scott, 1975. Sowing Sugar Beet in Autumn in England. The Journal of Agricultural Science, 8 4, pp 97-108.
- Özgür, O.E. ve M. Erdal, 1982. Türkiye’de Kışlık Şeker Pancarı Yetiştirilmesi Üzerine Araştırmalar. Şeker E. Etimesgut. Ankara.
- Castillo Garcia, J.E. ,L. Lopez Bellido, 1986. Growth and Yield of Autumn-Sown Sugar Beet: Effects of Sowing Time, Plant Density and Cultivar. Field Crops Research, 14,1-14.
- Basati, J., M. Kolivand and A. Neamati, 2003. Study of Autumn Sowing of Sugar Beet in the Tropical Areas of Kermanshah Province. Journal of Sugar Beet 18 (2):119-130.
- Javaheri, M.A., H. Najafinezhad and Azad F.A.D. Shahraki, 2006. Study of Autumn Sowing of Sugar Beet in Orzouiee Area (Kerman Province). Pajouhesh-VA-Sazandegi Summer.19(2).71. In Agronomy and Horticulture. 85-93.
- Rinaldi, M. and A.V. Vonella, 2006. The response of autumn and spring sown sugar beet (*Beta vulgaris* L.) to irrigation in Southern Italy: Water and radiation use efficiency. F. Crops Res., 95: 103-114.
- Reinsdorf, E. and H.J. Koch, 2010. Effects of Crop Management on Winter Hardiness and Yield of Bolting Winter Beet Cultivated for Anaerobic Digestion. Institut für Zuckerrübenforschung (IfZ), Holtenser Landstr. 77, D-37079 Göttingen.

IMPACT OF LIMING ON CHEMICAL PROPERTIES OF SOIL IN RASPBERRY ORCHARD

Ljiljana BOŠKOVIĆ-RAKOČEVIĆ*, Gorica PAUNOVIĆ, Radmila ILIĆ, Goran DUGALIĆ,
Ivan GLIŠIĆ

University of Kragujevac, Faculty of Agronomy, Čačak, Serbia

*Corresponding author: ljiljabr@kg.ac.rs

Abstract

The decline and dieback of raspberry plantings observed in western Serbia not only lead to a decrease in yield in the current growing season, but also reduce productivity in future years. In order to determine possible causes of raspberry dieback, soil samples were taken in the 2012 growing season at Leušići (Municipality of Gornji Milanovac). Sampling results provided information on soil acidity, the content of available forms of macroelements (N, P, K, Ca, Mg) and microelements (Fe, Mn), the level of mobile aluminum and the total content of heavy metals (Ni, Pb, Cd, Cr). Samples of plant material (leaf and fruit) were also collected and analyzed for the concentrations of the above mentioned elements. To reduce acidity, two lime treatments, each at a rate of 500 kg/ha CaO, were applied, i.e. broadcasting treatment and row application. The soil exhibited an acid reaction (pH/H₂O 5.70; pH/KCl 4.45), a moderate humus supply (4.56%), good availability of nitrogen and potassium, and phosphorous deficiency. Regardless of the good soil Ca and Mg availability, the ratio between the two elements was unfavorable. The content of microelements was within the allowable concentrations, with no aluminum detected. The total levels of Ni and Cr were above the maximum allowable concentrations and the content of Pb was within the allowable range, whereas no Cd was found. Lime-induced changes in the chemical properties of the soil were likely to match the implemented soil neutralization, with the broadcast application of CaO being more effective.

Keywords: *Raspberry, soil acidity, macro- and microelements, heavy metals*

Introduction

Raspberries have highly specific requirements for good growing conditions, including the proper choice of soil and favorable climatic conditions. They grow best and produce the highest yields on deep, loose, fertile soils having a favorable nutrient ratio. Also, good results are achieved in upland and mountainous areas if a proper cultivar choice is made. However, the soil can act as a limiting factor in raspberry production under these agroenvironmental conditions, especially if it has an acid reaction due to intensive fertilizer use. On such soils, raspberry yields are lower, fruit quality is poorer and the risk of partial or complete decay of raspberry orchards is higher.

In western Serbia, acids soils account for more than 50% of the total land area (Stevanovic et al., 1987). Therefore, raspberry growing technology should necessarily involve the use of physiologically alkaline fertilizers, especially during supplemental fertilization, to reduce the risk of blocked nutrient uptake while creating favorable conditions to establish nutrient balance and obtain good quality fruit. The content of almost all macro- and microelements in the leaf is correlated with their content in the soil (Güleriüz et al., 1995; Yu-Yen, 2006).

While analyzing the soil situation and changes in soil properties in raspberry orchards in the Arilje region, Stevanovic et al. (2004) found that the agrochemical properties and nutrient content

of the soil under “healthy” raspberry canes were significantly different from those of the soil under “sick” raspberry canes. The soil taken from the root zone of diseased raspberry canes showed an increase in acidity by an average of 0.9 pH units and an increase in the level of available forms of phosphorus, potassium and aluminum by 6 mg/100 g soil, 3 mg/100 g soil and as much as 17 mg/100 g soil, respectively, while the magnesium content was decreased by 7 mg/100 g soil, when compared to soil samples collected from the root zone of healthy canes. Similarly, in their analysis of causes of root and cane base rot of raspberries in the Arilje raspberry growing region, Gajic et al. (2004) suggested that, in addition to the acid soil reaction, this problem is largely caused by the presence of Al-ions in the adsorption complex which lead to poor root and cane development, resulting in inferior plant appearance and low disease resistance. Based on the above, the aim of this research was to examine the initial status regarding agrochemical soil properties, determine changes in the soil as induced by different liming treatments, and evaluate the leaf nutrient content of raspberries.

Material and Methods

The experiment was carried out at Leušići, Municipality of Gornji Milanovac (Serbia), on ranker soil in a ‘Willamette’ raspberry orchard, where the average soil sample was taken before trial establishment. The sample was taken from the 0-30 cm soil layer and tested for the following parameters: active acidity (pH/H₂O), exchangeable acidity (pH/KCl), humus content, available forms of macro- and microelements (N, P, K, Ca, Mg, Fe, Mn), and the content of harmful elements (Al, the total contents of Ni, Pb, Cd, Cr, available contents of Ni and Cr).

Based on the initial results on soil acidity, the need for liming was established, and CaO was applied in the following treatments:

1. CaO - 500 kg / ha (row application)
2. CaO - 500 kg / ha (broadcast treatment – over the entire surface).

Liming was performed in autumn 2012. Following the 2013 growing season, 20 soil samples were taken for agrochemical tests and 50 raspberry leaf samples were collected. Soil tests were the same as those performed before the experiment. Leaf samples were analyzed for the content of biogenic elements (N, P, K, Ca, Mg, Fe, Mn) and heavy metals (Ni, Pb, Cd, Cr).

During the 2013 growing season, 600 kg/ha NPK 15:15:15 was applied through basal fertilization and 350 kg/ha CAN as supplemental fertilization.

The soil pH was measured at a 1: 2.5 soil:distilled water ratio and soil:KCl ratio, using the pH meter. The humus content was determined by Kotzman’s method, the nitrogen content by Kjeldahl’s method, available phosphorus and potassium by the Egner-Riehm AL-method (phosphorus - colorimetrically, potassium - flame photometrically). The content of available Ca, Mg and microelements was determined by atomic absorption spectrophotometry. Total heavy metal concentrations in the soil samples were measured using the aqua-regia (HCl/HNO₃, 3/1) extraction method by an atomic absorption spectrophotometer. Available Ni and Cr content was determined by extraction with 0.005M DTPA + 0.01M CaCl₂ + 0.1M TEA solution, pH=7.3.

In leaves, total N was determined by Kjeldahl analysis; P was analyzed spectrophotometrically by the phospho-vanadate colorimetric method; K was determined by flame photometry; Ca, Mg, Fe and Mn by atomic absorption spectroscopy (AAS1N, Carl Zeiss, Jena). Total heavy metal concentrations were digested with HNO₃ and HClO₄ at a 5:1 ratio and determined by an atomic absorption spectrophotometer.

Results and Discussion

Before the experiment, the raspberry orchard soil was found to be of very acidic reaction (pH/KCl 4.45), well supplied with humus, total nitrogen and available potassium, and poorly supplied with available phosphorus (Tab. 1). The content of available forms of Ca and Mg was satisfactory, but their ratio was unfavorable (about 2: 1).

Table 1. Chemical properties of the soil before the experiment

Depth (cm)	pH		Humus (%)	N (%)	P ₂ O ₅	K ₂ O	Ca	Mg
	H ₂ O	KCl						
0-30	5.70	4.45	4.56	0.215	3.09	21.1	156.91	77.23

The content of available forms of microelements (Fe, Mn) was within the permissible concentration range (Tab. 2). As for harmful elements, no presence of Al and Cd was detected, while total Pb was within the maximum allowable concentration (MAC). Total Ni was 278.0 mg/kg and total Cr 159.2 mg/kg i.e. above the MAC (Kabata-Pendias and Pendias, 2001). The increased content of Ni and Cr is most likely of natural origin, because the soil is formed on serpentines, although it may be due to human influence associated with the use of fertilizers and pesticides (Bogdanović, 2007). The absence of mobile aluminum ensures successful cultivation of raspberries in the soil having a strongly acid reaction (pH/KCl 4.45). However, this acidity comes from H⁺-ions, and not from Al³⁺-ions which at levels above 10 mg/100 g soil block the uptake of certain nutrients (particularly phosphorus), thus adversely affecting the growth and development of raspberry (Stevanovic et al, 2004).

Table 2. Available concentrations of biogenic elements and total content of harmful elements before the experiment

Depth (cm)	Fe	Mn	Al	Ni	Pb	Cd	Cr
	mg/kg		mg/100 g	mg/kg			
0-30	27.35	103.0	0.0	278.0	28.0	0.0	159.2

Liming induced changes in the chemical properties of the soil, primarily including decreased acidity and increased levels of phosphorus, calcium and magnesium (Tab. 3). A better effect was achieved by the broadcast application of CaO, with the soil classified as slightly acid to neutral based on the pH/H₂O of 7.16 and pH/KCl of 6.30 pH units. The content of P₂O₅ was increased to 6.6 mg/100 g of soil, but the level of this nutrient is still insufficient and, therefore, NPK-fertilizer with a high content of phosphorus should be used because raspberries require 8-10 mg P₂O₅/100 g of soil for their growth (Petrovic and Milosevic, 2002). The content of available Mn and Fe was reduced by liming, with the decrease being more pronounced after the broadcast application of CaO.

Table 3. Chemical properties of the soil after liming

Treatment	pH		P ₂ O ₅	K ₂ O	Ca	Mg	Fe	Mn	Pb	Cd
	H ₂ O	KCl	mg/100 g of soil				mg/kg			
Before the experiment	5.70	4.45	3.09	21.1	156.91	77.23	27.35	103.0	28.0	0.0
CaO (row application)	5.72	5.36	3.60	22.3	375.0	150.0	21.0	90.0	26.2	0.0
CaO (broadcast application)	7.16	6.30	6.60	22.4	375.0	225.0	15.0	74.23	25.8	0.0

Given the increased content of total Ni and Cr in the soil before the experiment, their available levels were also determined, indicating that they account for a small percentage of the total content of less than 5% (Tab. 4). These values suggest that the content of Ni and Cr comes from the parent material on which the soil is formed, which is in compliance with the previous research of Ninkov et al. (2016). The tested soil contains increased amounts of both Ni and Cr, which is also evidence of their natural origin, given their coexistence in nature. The increase in soil pH after liming is an important factor in reducing the mobility and availability of Ni and Cr in soil, which is associated with an increase in the adsorptive properties of the solid phase of soil (Uren, 1992; Bogdanović et al., 1994).

Table 4. Total and available contents of nickel and chromium in soil (mg/kg)

Treatment	Ni		Cr	
	Total	DTPA-Ni	Total	DTPA-Cr
Before the experiment	278.0	12.10	159.2	1.3
CaO (row application)	58.0	8.95	42.1	1.0
CaO (broadcast application)	40.0	7.05	36.5	0.9

The content of all biogenic elements in the raspberry leaf (Tab. 5) was within the allowable limits (Tab. 6, Bergmann, 1983), indicating normal plant development and nutrient uptake from the soil, which is associated with the optimum soil pH after liming.

Table 5. The content of biogenic elements and heavy metals in the raspberry leaf

Treatment	(% d.m.)					mg/kg of dry matter					
	N	P	K	Ca	Mg	Mn	Fe	Ni	Pb	Cd	Cr
CaO (row application)	2.86	0.38	1.92	1.27	0.45	104.0	75.5	1.04	2.14	-	0.21
CaO (broadcast application)	2.90	0.41	2.15	1.35	0.40	86.0	68.7	0.95	2.43	-	0.34

The content of the tested heavy metals in the raspberry leaf (Tab. 5) was within the normal range (Tab. 6, Radojevic and Baskhin, 2006). This result was expected given the soil reaction (pH/KCl 6.30) which led to reduced mobility of heavy metals in the soil and, hence, possibly to reduced translocation of these elements from the root to the leaf of the plant. Heavy metals are uptaken from the soil through root cells; then, they pass through the plasma membrane and enter the cell via plant transporters. Their mobility from roots to leaves and further on to fruits is restricted by the internal detoxification system (Cieśliński et al., 1996) which is able to reduce the translocation of these elements, thus causing a decrease in their levels in the above-ground parts and, hence, reducing their toxicity to plants. The major mechanism in tolerant species of plants appears to be compartmentalization of metal ions, i.e. sequestration in the vacuolar compartment, which excludes them from cellular sites where processes such as cell division and respiration occur, thus proving to be an effective protective mechanism (Chaney et al., 1997; Hall, 2002).

Table 6. Allowable limits of biogenic elements and heavy metals in the raspberry leaf

Element	(%)					mg/kg dry matter					
	N*	P*	K*	Ca*	Mg*	Mn*	Fe*	Ni [#]	Pb [#]	Cd [#]	Cr [#]
	2.8-3.5	0.25-0.50	1.8-2.5	0.8-1.5	0.3-0.6	25-150	61-200	0.02-5.0	0.2-20	0.1-2.4	0.03-14

*Bergmann (1983); [#]Radojevic and Baskhin (2006)

It is especially important to note that there was no uptake of excess Ni and Cr, which is related to their deposition in the soil and the fact that their uptake and accumulation by plants was primarily caused by the soil reaction rather than by their total amount in the soil (Jakšić et al., 2013).

Conclusion

Based on the objective and results of this study, the following conclusions were drawn:

- Liming caused changes in the chemical properties of the soil, primarily including reduced soil acidity and increased contents of phosphorus, calcium and magnesium. A better effect was achieved by the broadcast application of CaO;
- The content of all biogenic elements in the raspberry leaf was within the allowable limits, indicating normal plant development and nutrient uptake from the soil;
- The contents of the examined heavy metals in the raspberry leaf were within the normal range, as was to be expected considering the soil reaction (pH/KCl 6.30) which led to reduced mobility of heavy metals in the soil.

References

- Bergmann, W. (1983). Ernahrungstorunger bei Kulturpflanzen. VEB Gustav Fischer Verlag, Jena.
- Bogdanović, D., Dozet, D., Ubavić, M., Malešević, M. (1994). Heavy metals in chernozem soil with different fertilization system. *Zemljište i biljka*, 42 (1), 41-46.
- Bogdanović, D. (2007). Izvori zagađenja zemljišta hromom (Sources of soil pollution by chromium). *Letopis naučnih radova*, 31, 1, 29-35.
- Chaney, R.L., Malik, M., Li, Y.M., Brown, S.L., Brewer, E.P., Angle, J.S., Baker, A.J.M. (1997). Phytoremediation of soil metals. *Curr. Opinion Biotechnol.*, 8, 279-284.

- Ciešliński, G., Neilsen, G.H., Hogue, E.J. (1996). Effect of soil cadmium application and pH on growth and cadmium accumulation in roots, leaves and fruit of strawberry plants (*Fragaria x ananassa* Duch.). *Plant Soil*, 180, 267-276.
- Gajić, B., Milivojević, J., Cupać, S., Matović, G., Bošnjaković, G., Cević, N. (2004). Hemijske osobine zemljišta pod zasadima maline zahvaćenih truljenjem korena i prizemnog dela izdanka (Chemical properties of the soil under raspberry plantings infected by root and ground cane rot). *Jugoslovensko voćarstvo*, Vol. 38, No 147-148, 155-161.
- Güteryüz M., Bolat I., Pirlak L., Esitken A., Ercisli S. (1995). Seasonal variations in the amount of plant nutrient elements (PNE) in leaves and their relationship with PNE in soil in apricot orchard (cv. Salak). *Acta Hortic.*, 384, 441-448.
- Hall, L. (2002). Cellular mechanisms for heavy metal detoxification and tolerance. *J. Exp. Biology*, 53, 1-11.
- Jakšić, S., Vučković, S., Vasiljević, S., Grahovac, N., Popović, V., Šunjka, D., Dozet, G. (2013). Akumulacija teških metala u *Medicago sativa* L. i *Trifolium pratense* L. na kontaminiranom fluvisolu (Accumulation of heavy metals in *Medicago sativa* L. and *Trifolium pratense* L. on a contaminated fluvisol). *Hemijska industrija*, 67(1), 95-101.
- Kabata-Pendias, A., Pendias, H. (2001). Trace elements in soils and plants. 3rd edition, Florida: CRC Press, Boca Ration.
- Ninkov, J., Vasin, J., Marinković, J., Jakšić, S., Milić, S., Banjac, D., Marković, S. (2016). Pedološke i agrohemijske karakteristike vinogradarskog rejona Tri Morave (Pedological and agrochemical characteristics of three wine-growing regions of Morava). Monografija, urednik: Ninkov J., Institut za ratarstvo i povrtarstvo, Novi Sad.
- Petrović, S., Milošević, T. (2002). Malina-tehnologija i organizacija proizvodnje (Raspberry-technology and organization of production). Agronomski fakultet, Čačak.
- Radojevic, M., Bashkin, V.N. (2006). Practical Environmental Analysis. Cambridge: Royal Society of Chemistry.
- Stevanović D., Marković N., Martinović Lj., 1987. Prilog proučavanju zakišeljavanja zemljišta na užem području Srbije (Contribution to the study of soil acidification in Serbia proper). *Agrohemijska*, 6, 427-431.
- Stevanović, D., Martinović, Lj., Šalipurović, B. (2004): Stanje i promene agrohemijskih osobina zemljišta Ariljsko-Ivanjičkog malinogorja (Status and changes in agrochemical characteristics of the soil in Arilje-Ivanjica region). *Jugoslovensko voćarstvo*, Vol. 38, br. 147-148 (2004/3-4), 139-147.
- Uren, N.C. (1992). Forms, reactions and availability of nickel in soils. In: *Advances in Agronomy*, Vol. 48 (D.L. Sparks, Ed.), 141-203, Academic Press, Inc.
- Yu-Yen, L., 2006. Seasonal changes in the foliar nutrients of major species in three topographic types of Fushan. PhD. Theses. School of Forestry and Resource Conservation, Taiwan.

EFFECT OF PLANTING DATES AND SPACING ON THE GROWTH AND YIELD OF TURMERIC (*Curcuma longa* L.).

Timothy Alaba FARIYIKE*¹, Omowumi. M. ODELEYE², Oyeboade. S. ADEBAYO¹

¹Spices Research Programme, National Horticultural Research Institute, P.M.B 5432, Jericho Reservation Area, Idishin, Ibadan, Oyo State, Nigeria

²Farming system programme, National Horticultural Research Institute, P.M.B 5432, Jericho Reservation Area, Idishin, Ibadan, Oyo State, Nigeria

*Corresponding author: alabafarry@yahoo.com

Abstract

Climatic conditions prevailing during crop growth, the period to which crops are planted and varying population densities are great determinants of yield of crops. Turmeric growers are faced with a lot of barriers affecting the production and the yield in Nigeria ranging from appropriate sowing date, inadequate plant population, and insufficient information about the emergence and growth and yield patterns. In an attempt to assess appropriate sowing date and spacing for turmeric, an experiment was carried out in the rainy season of 2010 at the National Horticultural Research Institute, Ibadan, Nigeria. Planting dates and spacing had a significant effect on the plant height, number of leaves and rhizome yield of turmeric. Early planting in May produced significantly higher plants, number of leaves and number of tillers while planting in June produced the highest rhizome yield. Wider spacing of 45cm x 40cm had significantly highest plant height, number of leaves and number of tillers while close spacing of 45cm x 10cm gave the highest rhizome yield. The appropriate planting date and spacing for optimum production of turmeric is recommended for the month of June and 45cm x 10cm spacing respectively.

Keywords: *Population density, planting dates, Curcuma longa, yield*

Introduction

Turmeric (*Curcuma longa* L.) is one of the most important spices with diversified uses in Nigeria that belongs to the family Zingiberaceae. The tuberous rhizomes or underground stems of turmeric have been used from antiquity as condiments, dye and as an aromatic stimulant in several medicines (Islam, 2002). Turmeric is very important spice in India, which produces nearly entire whole world's crop and consumes 80% of it. India is by far the largest producer and exporter of turmeric in the world (82%), followed by China (8%), Myanmar (4%), Nigeria (3%) and Bangladesh (3%) though figures about area and production are not available (Singh *et al.* 1997)

Demand for turmeric is increasing year by year in Nigeria because of the larger industrial request for dye making in textile and local mat manufacturing. However, development of suitable production technology to boost the crop yield is essential as the yield potential alone is not sufficient for increasing the yield. Proper planting period is an important non-monetary input in crop production. Too early or delayed planting will affect the growth, yield and performance of the crop. Another important factor is the plant spacing which determines the optimum plant population, the degree of competition between plants and consequently the yield.

Turmeric growers are faced with a lot of difficulties ranging from weed management, fertilizer application, and inadequate plant population because of insufficient information about the emergence, growth patterns and yield of turmeric plants, weed growth in relation to the planting

date. Turmeric production per unit land area is very low because of poor knowledge on proper cultivation technology of the farmers (Ishimineet *al.*, 2003; Kiran *et al.*, 2013).Improvement of crop cultivation technology for local climatic and edaphic factors is important for successful production (Ishimineet *al.*, 2003; Kiran *et al.*, 2013). The yield of the turmeric can be increased by adapting improve production technology like proper plant spacing. Spacing is being one of the most important factors which actively influence the inter plant competition, growth and ultimate yield of turmeric (Kiranet *al.*, 2013). Plant spacing is an important agronomic attribute since it is believed to have effects on light interception during which photosynthesis takes place which is the energy manufacturing medium using green parts of the plant. The climatic condition prevailing during crop growth is also a great determinant of yield of crop. In Nigeria, the erratic nature of rainfall and high temperature makes determination of sowing date crucial. Also population density determines the size and geometry of crop which indirectly influences photosynthetic activity which has direct influence on yield. This is because if the plant is small, the leaves will be small and the surface area for absorbing the energy for photosynthesis will be reduced resulting in low yield. The importance of this factor necessitated the determination of turmeric under varying environmental conditions and population density to improve its productivity. Therefore the objective of this trial was to determine the appropriate sowing date and spacing for optimum production of turmeric.

Materials and methods

The experiment was carried out between May and December 2010 at the National Horticultural Research Institute, Ibadan, Nigeria (07⁰ 24'N, 03⁰ 35'E, and 213m above sea level).Ibadan lies in the derived savannah of South Western Nigeria. The trial was laid out in a 4 x 4 factorial in randomized complete block design in three replications. Treatments compared were four spacing viz 45 x 10cm, 45 x 20cm, 45 x 30cm and 45 x 40cm and four sowing dates May 26th, June 9th, June 23rd and July 7th. The plot size was 3m x 3m.Data on morphological characters which includes plant height, number of leaves, and number of tillers were taken fortnightly while the yield components were recorded at harvesting.

Results and discussion

Plant spacing and planting dates had a significant effect on the plant height, number of leaves and yield of turmeric (Table 1).

Table 1: Effect of planting date and spacing on the growth and yield of Turmeric

Date	Plant Height(cm)			Number of Leaves			Number of Tillers			Yield(t/ha)
	6	10	14WAP	6	10	14WAP	6	10	14WAP	
May 26	17.2	21.7	27.9	8.0	9.7	10.5	1.62	3.3	5.75	23.39
June 9	14.2	20.6	27.2	7.3	9.5	9.5	0.42	3.0	5.34	27.06
June 23	12.5	20.1	26.3	6.0	9.0	9.0	0.85	2.7	5.25	27.36
July 7	9.0	18.7	24.4	4.9	8.7	8.7	-	1.7	5.05	24.61
LSD(0.05)	1.00	1.60	1.60	0.40	0.52	0.60	0.20	0.33	0.40	11.6
Spacing(cm)										
45 x 10	13.2	18.2	23.1	6.52	7.25	8.75	0.44	1.95	4.30	42.0
45 x 20	13.2	19.7	25.3	6.45	7.50	9.14	0.55	2.50	4.90	22.44
45 x 30	13.3	20.7	27.8	6.78	8.92	9.68	0.56	2.92	5.80	16.41
45 x 40	13.6	22.2	29.5	6.60	9.38	10.14	0.61	3.38	6.40	13.71
LSD(0.05)	1.00	1.60	1.20	0.40	0.56	0.68	0.31	0.39	0.42	13.5
P.D x S	NS			NS			NS			NS

WAP= Weeks after Planting, P.D-Planting dates, S- Spacing and NS-Non significant

This in agreement with Islam *et al.*, (2002) who reported that plant spacing, had significant effect on number of leaves and the yield. Early planting in May produced significantly higher plants, number of leaves and number of tillers (Table 1). This is in agreement with the findings of Yadav *et al.* (2013) who showed significant effect on plant height, number of tillers and yield of ginger with different planting dates and early planting. Enhanced vegetative growth was also observed as the spacing widens. Wider spacing of 45 x 40cm had significantly highest plant height, number of leaves and number of tillers. This is also in agreement of the findings of Islam *et al.*,(2002) who reported a significantly highest plant height and number of leaves with a wider spacing and Gopichand *et al.*,(2006) who reported the same for the number of tillers. However planting turmeric in June generally resulted in highest rhizome yield, while close spacing at 40 x 10cm gave the highest rhizome yield (Table 1). These results are also in agreement with the findings of Chaudhury *et al.* (2000) who described that closer spacing (50 x 15cm) gave the higher yield of turmeric when conducted an experiment with three spacing viz 50 x 15cm, 50 x 20cm and 50 x 25cm. Islam *et al.*,(2002) also gave similar results with closer spacing of(45 x 10cm) when conducted an experiment with four spacing viz 45 x 10cm, 45 x 20cm, 45 x 30cm and 60 x 30 cm. Planting date and spacing interaction was not significant(Table 1).

Conclusion

It can be concluded from the experiment that planting of turmeric in May produced good vegetative growth even as spacing widens, planting in June produced the highest rhizome yield. Spacing of 40 x 10cm also produced the highest rhizome yield.

Acknowledgements

The Executive Director of National Horticultural Research Institute, Ibadan, Nigeria is appreciated for the financial and logistics support. MrsAkinlolu H.T., Bolodeoku P.O for the technical input and the field workers for their indefatigable assistance on the field.

References

- Choudhury, A.K., A.F.M.E. Hoque, Z.A. Firoz and M.A. Quayyum, 2000. Performance of Turmeric-Legume inter cropping system. *Bangladesh J. Agric. Res.*, 25: 325-332.
- Gopichand R.D., Singh R.L., Meena M.K., Singh, V.K., Kaul B. Lal, A. Ruchi and P. Ramdeen. Effect of manure and plant spacing on crop growth, yield and oil-quality of *Curcuma aromatica* Salis. 2006. In mid hill of western Himalaya *Industrial crops and products*, 24(2): 105-112.
- Ishimine Y., M.A. Hossain, Y. Ishimine and S. Murayana, 2003. Optimal planting depth for turmeric (*Curcuma longa* L.) cultivation in dark red soil of Okinawa Island, Southern Japan. *Plant Prod. Sci.*, 6: 83-89.
- Islam, F., M.R. Karim, M. Shajahan, M.O. Hoque, M. Robilalam and M.A. Hossain. 2002. Study on the effect of plant spacing on the production of turmeric at farmer's field. *Asian J. Plant Sci.*, 1(6): 616-617.
- Kiran M., R. Bibi, M.S. Jilani, K. Waseem, G. Ullah, S. Jevaria and M. Niamatullah, 2013. Effect of plant spacing on profitable yield of turmeric (*Curcuma longa* L.). *Pakistan Journal of Science* vol. 65 (4): 486-491.
- Singh, J., Y.S. Malik, B.K. Nehra and P.S. Partap. 1997. Effect of size of seed rhizomes and plant spacing on growth and yield of turmeric (*Curcuma longa* L.). *Haryana- J. Horti-Sci.*, 29(3/4): 258-260.
- Yadav A.R., R.N. Nawale, G.N. Korake and R.G. Khandekar. 2013. Effect of dates of planting and spacing on growth and yield characteristics of ginger (*Zingiber officinale* Ros.) var IISR Mahima. *Journal of Spices and Aromatic Crops* vol. 22 (2): 209-214

EFFECT OF INOCULATION ON SOME IMPORTANT CHARACTERISTICS OF PEAS GROWN IN HERZEGOVINA REGION (BOSNIA AND HERZEGOVINA)

Višnja VASILJ^{1*}, Marin ŠEGO¹, Adrijana FILIPOVIĆ², Sanja SIKORA³, Ana MANDIĆ¹

¹Faculty of Agriculture and Food, Technology University of Mostar, Bosnia and Herzegovina

²Federal Agro Mediterranean department of Mostar, Bosnia and Herzegovina

³Faculty of Agriculture, University of Zagreb, Croatia

*Corresponding author: visnja.vasilj@yahoo.com

Abstract

Biological (symbiotic) nitrogen fixation plays an important role in sustainable crop production. It is a safe, productive and cost-effective form of land management which provides a significant input of biologically-fixed nitrogen in soil. In sustainable crop production, inoculation of pea seeds (*Pisum sativum* L.) with effective strains of *Rhizobium leguminosarum* becomes more and more exploited. Selection of *R. leguminosarum* strains that are effective and adapted to specific environmental condition is essential prerequisite for successful inoculation. The experiment was set up with two most common pea cultivars in Herzegovina in randomized block design with three replications. Influence of referent and indigenous strains on pea cultivars characteristics was assessed. The results confirm that higher values of nitrogen content in grain of peas are significantly affected by cultivars, while the nitrogen content in the aboveground plant parts were significantly affected by the interaction between the elected indigenous and referent strains and pea cultivars. The highest yield (3.83 t ha⁻¹) was obtained by application of referent strain of *R. leguminosarum* 1001 (inoculated) but without statistical significant differences to indigenous strains and control. The number of root nodules and their dry weight were significant affected by the indigenous strain S1 but the number of nodules was also influenced by the cultivars. Besides observing the effect of seed inoculation on some important characteristics in two pea cultivars (yield, number of nodules, dray weight of nodules, nitrogen content in the aboveground plant and grain) the paper also shows their correlations relationships.

Keywords: *Rhisobium leguminosarum*, pea, nitrogen, yield, nodulations

Introduction

Legume inoculation is a way of assuring of *Rhizobium* strain appropriate for the cultivar being planted was present in the soil at the proper time and in sufficient number assuring a quick and effective infection (nodulation) and subsequent nitrogen fixation (Bejandi et al., 2012) Burns and Hardy (1975) reported that nodulation bacteria fixed about 175×10^6 tons of nitrogen per year. It is a much higher amount of nitrogen in comparison with the world annual production of nitrogen fertilizers being 30×10^6 tons (Postgate, 1982). Many authors stated that yields could be increased by legume seed inoculation compared to nitrogen fertilizer variants (Kálalová and Šimon, 1993; Dobereiner et al., 1995). The inoculation of seeds with *Rhizobium* increase nodulation, nitrogen uptake and seed protein (Bejandi et al., 2011; Tahir et al., 2009). Selection of appropriate inoculation strains in nitrogen deficient soils may offer an excellent opportunity for improving legume growth and development as an alternative to commercial nitrogen fertilizers. Bacterial inoculation of legumes seed presents an important ecological and economic measure. This is one of the preliminary researches conducted in Herzegovina region relating to the study of the composition and characteristics of indigenous strains of *Rhizobia* on pea

cultivars. Yet it can be assumed that there is a natural population of these bacteria and that the indigenous strains significantly differ in their symbiotic impact on plant. The study aimed also to encourage use of symbiotic nitrogen fixation as natural process for sustainable pea cultivation in the area of Herzegovina region.

Material and methods

A field trial with two pea cultivars Čudo Amerike and Mali Provansalac inoculated with bacterial strains was located in Mostar city area (Donja Jasenica) in 2014. Seeds were inoculated with two isolated indigenous strains (S1 and S13) and one reference strain of *R. leguminosarum* bv. *viciae* (S 1001) and results were compared to the uninoculated–control plants (K). The trial was set up in three repetitions on the area of 294 m², with 28 m² per experimental plot. Peas are sown by hand in second half of March 2014. Selected indigenous and reference strains were amplified and prepared for the soil inoculation of pea seeds at the Department of Microbiology, Faculty of Agriculture University of Zagreb. In the harvest period five whole plants were selected from each central plot part for analysis. Number of nodules per plant, dry weight of nodules per plant (g), total nitrogen content (%) in the aboveground part of the plant, grain and grain yield of peas (t ha⁻¹) were measured to evaluate symbiotic effectiveness. Determination of nitrogen in aboveground plant part and grain was carried out by a standard Kjeldahl method. All collected data were analyzed with statistical package Genstat 7.2 (Rothamsted Experimental Station, 2004). The trial site was extensively used in the vegetable productions; however, the soil nutrients state before peas sowing was performed. The chemical analysis of soil included the determination of soil reaction in water and 1M KCl humus (%) basis by Kozmann-in, total nitrogen (%) by Kjeldahl method, physiologically active phosphorus (P₂O₅ mg 100 g⁻¹ of soil) and potassium (mgK₂O 100 g⁻¹ of soil) by AL-method. The weather data were taken from Federal Hydro-meteorological Institute stations in Mostar.

Results and discussion

Standard chemical analyzes were conducted on soil samples collected from experimental locations in Herzegovina (Table 1). Soil samples were taken from the surface layer (0-30 cm depth) before setting up the trial.

Table 1. Chemical soil characteristics

Soil sampling depth	pH H ₂ O	pH KCl	Total CaCO ₃ %	Humus (%)	Total nitrogen (% N)	Potassium mg K ₂ O/100 g soil	Phosphorus mg P ₂ O ₅ /100 g soil
0-30	8,26	7,51	25,94	4,32	0,15	21,76	35,36

According to chemical analyzes of the soil at the location Donja Jasenica soil pH reaction was alkali. The soil has high humus rate due to its intensive use for the vegetable cultivation and manure fertilization. The nitrogen content in the soil was good. Soil supply with physiological active phosphorus and potassium was very good.

Mean annual air temperatures in 2014 were significantly higher than normal values for the period 1961-1990 in the entire observed area of Bosnia and Herzegovina. Air average humidity for March till May was 64% and precipitation average for these three months was 96.66 mm. After the pea sowing the first period was very dry while the April was very pluvial and at the end of vegetation season again dries time. This had reflected on development phase of pea plants. It has been known influence of plant and environmental factors on native and introduced Rhizobia in

the soil. Rhizobia prefer a soil temperature of 25° to 30°C, a pH value of 6.0 to 6.8 and sufficient soil moisture. The soil moisture was not satisfying factor in our trial regarding the dry period on the beginning and the end of pea vegetation. Based on the analysis of variance results of trials showed a strain S1 (LSD 5% = 0.32) significantly influence on nitrogen content (3.78%) in the aboveground mass of the pea relative to the other strains applied and the control. There were no significant differences for other strains on nitrogen content. Plants grown whit strains S1001 and S13 had 8.5-9.5% lower value of nitrogen in the aboveground mass and the control strain (K-uninoculated) up to 15% lower content than strain S1 (Figure 1). Nitrogen content in aboveground mass of pea cultivars Mali Provansalac and Čudo Amerike statistically were not differed.

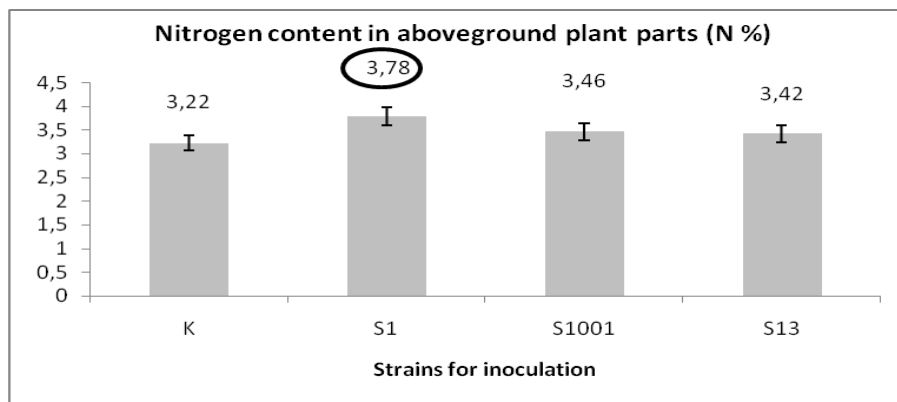

Figure 6. Average nitrogen content in aboveground plant parts (N %) regarding applied different strains

Results of statistical analysis indicated that there was significant interaction between applied strains and cultivars of pea. Nitrogen content for cultivar Mali Provansalac in the aboveground part of pea shows significant differences (LSD_{1%} = 0.46%) in the applied strain S1 (about 22% higher) comparing to the control (K) and other applied strains (S1001 and S13) (Figure 2). According to the research of Hadi and Elsheikh (1999) protein content of cultivars could be improved by selecting a good cultivar and a competitive, infective and effective Rhizobium strain.

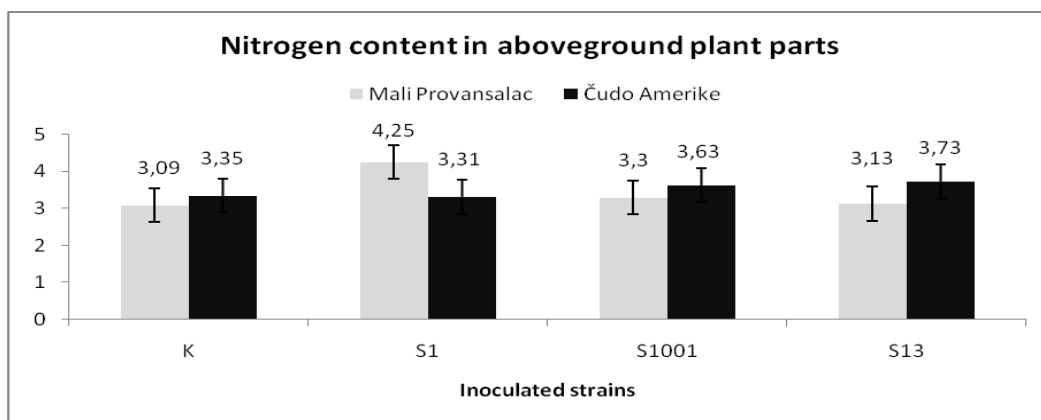

Figure 7. Average nitrogen content in aboveground plant parts (N %)

The results of the ANOVA indicated that the nitrogen content of the pea grain regarding to control and applied strains did not statistically differed. But results showed that the nitrogen

content in the pea grain significantly differed between used cultivars. Cultivar Čudo Amerike has had significantly higher nitrogen content in the grain (4.94 % N to 4.33; $LSD_{1\%} = 0.23$). Interaction between these two factor is absent for recorded character.

Results of analysis of ANOVA showed that the cultivars as well as selected strains have no significant effect on the yield. The lowest yield was achieved by using strain S1 (2.76 t ha^{-1}), which showed 33% lower yield than control treatment and 38% to 19% lower than strains S1001 and S13. Although there were no significant differences between used cultivars in the experiment Čudo Amerike had 6.5% higher yield (3.51 t ha^{-1}) (Figure 3). There were no significant interaction between cultivar and strain for the yield. According to the Jordan (1984) infectivity and effectiveness of inoculation representing individual characteristics and they may vary within a wide range depending on the bacterial strain and genetic factors of the host plant. The capacity of modulation is more stable property than the fixation ability. Also important factor for effectiveness of strains on most of pea cultivar characteristic were environmental conditions which may be inconvenient not only for cultivar development progress but also for bacterial activity in the soil.

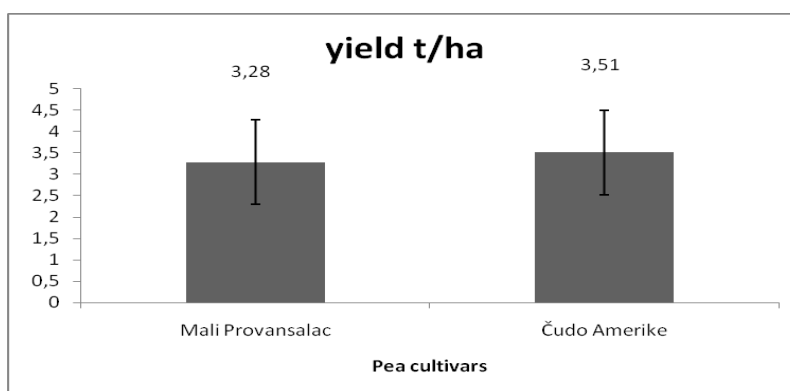

Figure 8. Average yield values of different peas cultivar

Comparing the results of indigenous strains to reference strain 1001 there is no significant differences in yield even the referent strain should have limited genetic potential in relation to the indigenous which should be well adapted to the certain environmental conditions and easier adopt to the environmental changes.

Statistical analysis showed significant differences in dry matter of nodules identified on pea root at the level of $LSD_{1\%} = 0.16$. The differences in dry matter of nodules were showed between pea plants inoculated with S1 strain compared to the control and the other two applied strain. The difference in the dry matter of nodules in plants inoculated with the strains S1001 and S 13 were not significant and also dry matter of nodules was much higher with these two strains compared to the uninoculated variant-control (Figure 4).

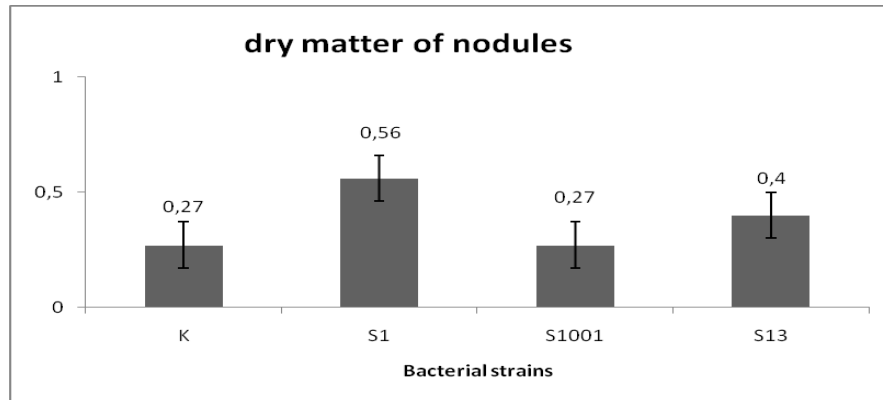

Figure 9. Dry matter of nodules regarding inoculated and uninoculated plants

Cultivars did not show differences in dry matter of nodules.

Salih (1984) recorded significant differences in dry matter of nodules with inoculants treatment and cultivar.

Statistical analysis for the characteristic number of nodules on roots indicate highly significant influence of the strains on the level of LSD 1% = 13.47%. The differences between the numbers of nodules per plant inoculated with variant strain S1 showed a statistically significant difference compared to the other two strains, as well as in relation to the variant without inoculation. S1 strain showed 70% higher number of nodules compared to the control and the 57% higher number of nodules in relation to S1001 and S13 strains (Figure 5). Differences in the number of nodules between control and those plants inoculated with strains S1001 and S 13 were not significant. According to the authors Elsheikh (1992), Mahdi (1992) inoculation with a selected *Rhizobium* strain can result in a significant increment of nodule number per plant, its dry matter and yield.

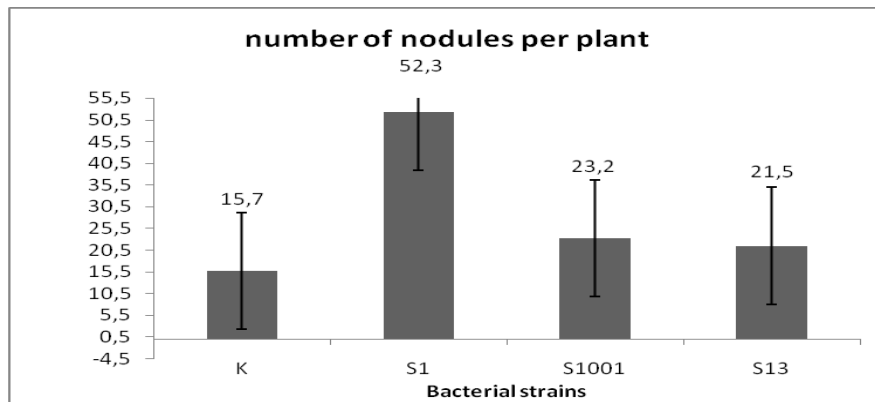

Figure 10. Number of nodules regarding inoculated and uninoculated plants

Cultivar has had significant impact on number of nodules per plant with $LSD_{1\%} = 9.52$. Cultivar Čudo Amerike showed a higher nodulation on the roots of peas for even 39% compared to cultivar Mali Provansalac.

Between the number of nodules identified on pea root and its dry matter it was established a positive moderate correlation with Pearson's correlation coefficient of $r = 0.31$. Meaning that with the increase of root nodules number the dry matter was slightly increased. Correlation between yield and the number of nodules, as well as between yield and dry matter of nodules is very weak

or absent. Nitrogen content in the pea grains and the number of nodules, as well as nitrogen content in aboveground mass of plants and the number of nodules were not in strong correlation. Negative and mild correlation showed between the dry matter of root nodules and nitrogen content in the pea grains with Pearson coefficient of $r = -0.23$. Positive and mild correlation was found between the dry matter of root nodules and nitrogen content in the aboveground mass of plants with Pearson coefficient of $r = -0.33$ meaning that with increasing nitrogen content in the aboveground mass the dry matter content in the root nodules grow. Among other correlative relationship mildly positive correlation was found between the yield of pea and nitrogen content in aboveground mass of peas with a Pearson correlation coefficient of $r = 0.21$, while a correlation between nitrogen content in the pea grain and yield was absent. The *Rhizobium*-legume symbiosis, which is a N_2 -fixing system, the process of N_2 fixation is strongly related to the physiological state of the host plant. Therefore, a competitive and persistent rhizobial strain is not expected to express its full capacity for nitrogen fixation if limiting factors (e.g., salinity, unfavorable soil pH, nutrient deficiency, mineral toxicity, temperature extremes, insufficient or excessive soil moisture, inadequate photosynthesis, plant diseases, and grazing) impose limitations on the vigor of the host legume (Peoples et al., 1995). The very low or absent correlation between evaluated characteristic were probably result of some limiting environmental factor so the research should be repeated again in same or similar condition for making same strong conclusion.

Conclusion

Studied indigenous and referent strains have different nodulation and symbiotic ability with selected pea cultivars and environmental condition of location. The best results of adaptation in environment of selected location regarding the nodulation, dry matter of nodules and aboveground nitrogen content have sowed indigenous S1 strain. Cultivar Čudo Amerike has shown statistically higher nitrogen grain content without significant difference in selected strains and control. The same cultivar showed also higher, but not statistically significant, yield (3.51 t ha^{-1}) to the other cultivar. The most positive correlation effect was that increase of nitrogen content in the aboveground mass increase the dry matter content in the root nodules. In the future it should be more agronomic studies on legume seed inoculation with miscellany of strains to provide more information on its effectiveness in different terms of the growth.

Reference

- Bejandi, TK., Sharifii, RS., Sedghi, M., Namvar, A. (2012). Effects of plant density, Rhizobium inoculation and microelements on nodulation, chlorophyll content and yield of chickpea (*Cicer arietinum* L.). Annals of Biological Research; Vol. 3 Issue 2, p951
- Bejandi, TK., Sharifii, RS., Sedghi, M., Namvar, A. (2011). Effects of plant density, Rhizobium inoculation and microelements on nodulation, chlorophyll content and yield of chickpea (*Cicer arietinum* L.). J. of Biol. And Agric, Res 23: 1067-1178.
- Burns, RC., Hardy, RWF., (1975). Nitrogen fixation in bacteria and higher plants. Springer-Verlag, New York.
- Dobereiner, J., Uguiaga, S., Boddey, RM. (1995). Alternatives for nitrogen nutrition of crops in tropical agriculture. Fertil. Res., 42: 339–346.
- Elsheikh, EAE. (1992). Effect of salinity on growth, nodulation and nitrogen yield of inoculated and nitrogen fertilized chickpea (*Cicer arietinum* L.). Arch Biotech. 11:17–28

- Hadi, El E.A., Elsheikh, EAE. (1999). Effect of Rhizobium inoculation and nitrogen fertilization on yield and protein content of six chickpea (*Cicer arietinum* L.) cultivars in marginal soils under irrigation. *Nutrient Cycling in Agroecosystems* 54: 57–63.
- Jordan, DC. (1984). Rhizobiaceae. In N. R. Krieg and J. G. Holt (ed.), *Bergey's Manual of Systematic Bacteriology*, vol. 1. Willames & Wilkins Co., Baltimore. 234-254
- Kálalová, S., Šimon, T. (1993). Efficiency of commercial inoculants for soybean. *Rostl. Vým.*, 39: 827–834.
- Mahdi, AA. (1992). The biofertilizer use of Rhizobium strain TAL 634 and CM 127 for bean and chickpea in the Sudan. *Arch Biotechnol* 1: 10–16
- Peoples MB., Ladha JK., Herridge DF. (1995). Enhancing legume N₂ fixation through plant and soil management. *Plant Soil* 174:83–101.
- Postgate, J.R. (1982). *The fundamentals of nitrogen fixation*. Cambridge Univ. Press., Cambridge, London.
- Salih, FA. (1984). Chickpea cultivars × Rhizobium interaction in Northern Sudan. *Inter Chickpea Newsl* 10: 22–24.
- Tahir, MM, Kaleem, A., Nasir R., Abdul K., Mushtaq HK. (2009). Effect of Rhizobium inoculation and NP fertilization on growth, yield and nodulation of soybean (*Glycine max* L.) in the sub-humid hilly region of Rawalakot Azad Jammu and Kashmir, Pakistan. *African Journal of Biotechnology* 8: 6191-6200.

THE EFFECT OF DIFFERENT DOSES OF NITROGEN ON THE YIELD AND THE EXUBERANCE OF CHAMOMILE

Aleksandra GOVEDARICA-LUČIĆ*¹, Goran PERKOVIĆ¹, Ivana RAŠEVIĆ¹, Ivana BOŠKOVIĆ¹, Alma RAHIMIĆ²

¹Faculty of Agriculture, University of East Sarajevo, Bosnia and Herzegovina

²Agro-mediterranean Faculty, University of "Džemal Bijedić", Mostar, Bosnia and Herzegovina

*Corresponding author: sandraklepic@yahoo.com

Abstract

Application of fertilizers in the production of aromatic herbs and other crops depends on several factors, whereby the soil fertility and requirements for individual nutrients culture are the most important. The principle of application of mineral fertilizers should ensure optimal conditions for maximum nutrition grown culture, whereas the contamination of the environment is not questionable. Since the Chamomile is characteristic plant of poor soil, it requires very little nutrients. However, intensive farming and carefully balanced fertilization helps achieving better. The present study was carried out to determine the effects of different nitrogen doses on yield and exuberance of Chamomile flower. The experiment was set in randomized block design with four replications which included four different types of fertilizers. Fertilization consisted of applying increasing nitrogen unit in quantities of: a1-control, A2-15 kg / ha, a3-27 kg / ha, a4-41kg / ha. Larger amounts of nitrogen resulted in the increased share of green mass (herb). The most vigorous plants have been registered with the highest nitrogen concentration variant a4 (57,51cm; 25,13g). On the other hand increased nitrogen rates had a negative impact on the formation and development of the flower. The least number of flowers was registered in the variant with the highest nitrogen concentrations a4 (11.68), while the highest number of flowers was registered in the variant a2 (21.68).

Keywords: *chamomile, fertilization, exuberance, yield.*

Introduction

Herbal medicine is the oldest method of treatment. Many nations throughout its history have learned to use medicinal herbs which succeeded in their climate (Turudija Živanović, 2010). In addition to the pharmaceutical industry, the medical and aromatic plants are used by cosmetic industry (bakery industry, industry of alcoholic and non-alcoholic beverages, confectionery industry) and others (Turudija Zivanovic, 2010). Some ingredients of the herbs are used as flavorings of the aroma, taste and color and flavour enhancers as the product performance itself is improved by their active ingredients. It is significant to mention the use of herbs in cooking (Turudija Živanović, 2010). The very purpose of the production of medicinal plants is their useful ingredients, essential substances and essential oils notably used in today's medicine and pharmaceutical industry. They were used in ancient Greece, India, China (Janick and Hummer, 2010)

Chamomile (*Matricaria chamomilla* L.) is a hardy, wild medicinal plant widespread throughout the world. It contains a large number of active substances, and the main ingredients are easily withdrawable essential oil (0.3 to 1.3%), which has a bactericidal action, it normalizes function of the stomach and intestines, and promotes sweating. Important components of the chamomile oil

are alpha bisabolol, farnesene and bisabolol oxides. Thanks to its ingredients, Chamomile has anti-inflammatory, antioxidant, antimicrobial, spasmolytic, carminative effect. It accelerates the processes of wound healing and regulates the metabolism of the skin while Chamomile polysaccharides show immune stimulating effect. It is used in local therapy with acute and chronic inflammation of the skin (dermatitis, eczema), neurodermatitis (atopic eczema), wound treatment, solar skin damage, babies eczema and treatment of hemorrhoids. (Arsic, 2005)

Chamomile is one of the oldest remedies of traditional medicine. As early as 1570 Hieronymus Bock wrote about its curative effect: „Nothing can be achieved without this flower, quite ordinary flower of Chamomile since there is no medicinal herb more useful than this one used for all diseases“.

Because of medicinal properties, its production and consumption is of high interest in most countries. The growth indices, flower yield and active substance of chamomile plants are affected by genetic background and environmental conditions (Hadi et al., 2015). These attributes are strongly modified by many other factors and management skills such as using the different kinds of fertilizers.

Among the macro- elements, nitrogen has the most significant effect on growth characteristics of chamomile. Increasing concerns about the negative effects of chemical fertilizers have generated substantial interest in the use of other nitrogen sources [11- 13]. Despite the importance of nitrogen in production of field crops and medicinal plants, application of this nutrient element from chemical sources has resulted in environmental problems and pollution of the global ecosystem (Hadi et al., 2015).

Conventional agriculture with focus on chemical fertilizers has caused rapid reduction in organic matter and fertility of soils. Therefore, it is essential to apply proper production management in order to improve physical, chemical and biological characteristics of soils (Hadi et al., 2015).

As practice shows, the highest Chamomile yield and growth is achieved with the use of combined mineral and organic fertilizers (Shams et al., 2012.). The present study was carried out to determine the effects of different nitrogen doses on yield of chamomile flower.

Materials and methods

Field experiment was conducted in the research field of the Faculty of Agriculture, University East Sarajevo (entity of Republic of Srpska, Bosnia and Herzegovina). The experiment was set in a randomized block design with four replications at the end of the second week in May 2014 and 2015. Seeds were sown on the rows with 0.30 cm spacing. The standard measures of care as hoeing, watering, fertilization and weed control have been carried out during the experiment.

Fertilization consisted of applying increasing nitrogen unit in quantities of: a1-control; A2 200kg / ha of NPK (7:20:30); a3-200kg / ha NPK (7:20:30) +100 kg / ha KAN (27%); 100 a 4 kg / ha KAN (27%)

Vegetative and generative increase has been analyzed on a sample of 5 plants with all variants of fertilization. Vegetative increase is analyzed through the following components: average weight of above-ground portion of plants and plant height. Generative increase is analyzed through the number of flowers per plant. The study results were processed by the analyses of variance, and the difference between the variants was tested by LSD-test and presented in tables.

Results and discussion

Soil and climatic conditions

Based on the mechanical composition analysis of the samples taken from the alluvial soil conducted on the experimental field of the Faculty of Agriculture (University of East Sarajevo) it was found that the soil is light textured because the content of the total sand fraction (<0,02 mm) is 56,30 to 58,50%.

Powder composition (0.02 to 0.002 mm) is 22.40 to 24.90%, while the percentage of clay particles (<0,002 mm) 18.80-19.10% (Tab. 1).

Tab.1 The results of chemical analyses of soil

Soil sampling depth (cm)	Coarse sand 2-0.2 mm(%)	Fine sand 0.2-0,02 mm(%)	Powder 0.02-0.002 mm(%)	Clay 0.002 mm(%)
0-25	11.09	47.41	22.40	19.10
25-50	10.79	45.51	24.90	18.80

Based on analysis of texture, ie. texture of soil type such as fluvisol, it was found that it belongs to the class of sandy clay (Tab. 1).

Tab.2 The results of chemical analyzes of soil types, alluvium (fluvisol)

Soil sampling depth (cm)	pH/H ₂ O	pH/KCl	CaCO ₃ (%)	Humus (%)	N	P ₂ O ₅ (mg/100 g)	K ₂ O (mg/100 g)
0-25	7.38	6.13	<1	2.3	0.151	> 40	34.6
25-50	7.49	6.75	1.5	2.4	0.158	> 40	36.8

Chemical analysis of samples taken from soil type fluvisol with depth of 0-25 cm, indicates that the soil has slightly acid to neutral reaction with minor carbonate content, intermediary secured with humus and with an increased amount of available phosphorus and potassium (Tab. 2). Chemical analysis of soil samples taken from a depth of 25-50 cm showed similar values of the analyzed soil samples taken from the depth 0-25 cm, except that the carbonate content and humus was increased at the depth of 25-50 cm, while the content of available phosphorus was decreased compared to values obtained from a depth of 0-25 cm (Tab. 2)

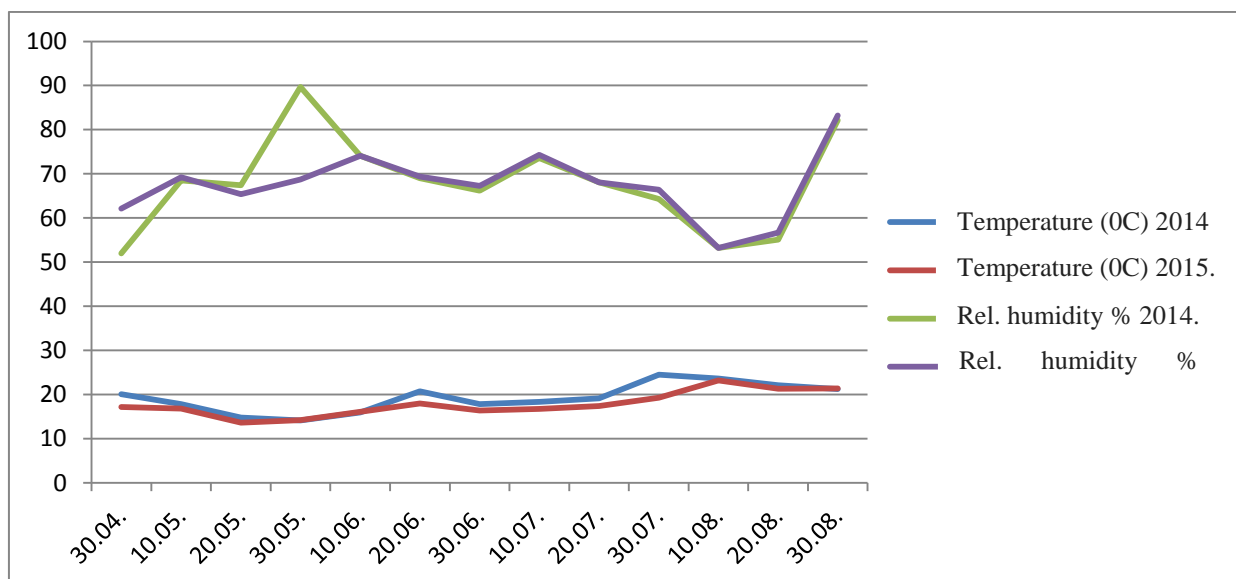

Graf.1 Average daytime temperature and relative humidity at the time of experimental performance

Tab.3 Analysis of variance for measured properties of chamomile (*Matricariachamomilla* L.)

Fertilization	The average weight of the fresh stem (g)		The average height of the fresh stem (cm)		Number of flowers per plant		
	2014.g	2015.g	2014.g	2015.g	2014.g	2015.g	
a_1	15.69	19.94	49.40	47.03	14.35	8.53	
a_2	14.17	24.37	55.82	46.28	19.40	13.96	
a_3	29.29	27.47	58.83	56.20	13.01	10.35	
a_4	22.80	18.66	43.03	36.10	18.73	13.78	
LSD	5%	1.89	4.61	3.94	6.18	5.90	3.26
	1%	2.53	6.17	5.28	8.29	7.91	4.37

The average weight of the fresh stem

Variants applied to nitrogen had a statistically significant impact on the fresh plant's weight. Maximum weight of plants (29,29g; 27,47g) was achieved in the variant with the highest nitrogen rate (200 kg / ha NPK (7:20:30) +100 kg / ha KAN (27%)

The average height of the fresh stem

Variants applied to nitrogen had a statistically significant impact on the height of fresh plant. Maximum height of plants (58.83cm; 56,20cm) was achieved in the variant with the highest nitrogen rate (200kg/ha NPK (7:20:30) +100 kg/ha KAN (27%) parallel with the results of Kariminejad and Pazoki (2015).

Number of flowers per plant

The research results clearly indicate that the minimum flower production has been achieved through the variant fertilized with the highest rate of nitrogen units. Increased amounts of nitrogen in the soil affected larger share of green mass and number of flowers reduced per Chamomile plant. Many scientific studies show similar results (Zeinali et al.,2014; Dadkhahet al., 2012).

Conclusion

The results of this research indicate that the use of increased nitrogen fertilizers led to the expansive growth of green mass reducing the number of chamomile flower. The research results indicate that the maximum amount of nitrogen needed to achieve high yield is 200kg / ha of NPK using 7:20:30 fertilizer formulation. Exceeding the maximum dose leads to increasing the share of green mass and plants lodging which significantly hampers or prevents the harvest. Primarily, increased plant height can be attributed to the effect of nitrogen on the vegetative growth and division of cells in the plant, stalk particularly.

References

- Turudija Živanović, S. (2010): Serbian market trends of medicinal and aromatic plants. Medical raw material. Number.30, page.3-14, Belgrade
- Arsić, I. (2005): "The influence of encapsulation of standardized extracts of chamomile *Chamomilla recutita* (L.) Rausch. (Asteraceae) on the stability and anti-inflammatory activity for local use & # 34 ;. Doctoral thesis. Belgrade
- Hadi, M.R.H.S, Fallah, M.A., Taghi Darzi, M. (2015): Influence of Nitrogen Fertilizer and Vermicompost Application on Flower Yield and Essential Oil of Chamomile (*Matricaria chamomile* L.). Journal of Chemical Health Risks 5(3), 235-244. Iran.
- Shams, A., Abadian, H., Gholamali, A., Koliai, A., Zeinali, H. (2012): Effect of organic and chemical fertilizers on Amount of Essence. Scholars Research Library. Annals of Biological Research 3(8):3856-3860. Iran.
- Kariminejad M. and Pazoki A. (2015) : (Effect of Biological and Chemical Nitrogen Fertilizers on Yield, Yield Components and essential oil content of German Chamomile (*Matricaria chamomilla* L.) in Shahr-e-Ray Region. *Biological Forum – An International Journal* 7(1).page: 1698-1703.
- Zeinali, H., Moslehi Yazddeli, A., Safaee, L., Jaberalansar, Z., Akhoondi A., Eskandari, Z., (2014): Effects of Nitrogen, Phosphorous and Potassium fertilizers on quantitative and qualitative characteristics of chamomile (*Matricaria chamomilla* L.). Iran J Med Aroma Plants. 30(4), 511-518.
- Dadkhah, A., Amini Dehaghi, M., Kafi, M. (2012): Effects of nitrogen and phosphorous fertilizers on quantitative and qualitative yield of chamomile. Iran J Field Crop Res. 10(2), 321-326.

YIELD POTENTIAL OF LINES AND VARIETIES OF TRITICALE IN THE BREEDING PROGRAM OF THE AGRICULTURAL INSTITUTE OF REPUBLIC OF SRPSKA – BANJA LUKA (BOSNIA AND HERZEGOVINA)

Dragan MANDIĆ^{1*}, Goran ĐURAŠINOVIĆ¹, Iskra ARAPOVIĆ¹, Novo PRŽULJ², Dijana MIHAJLOVIĆ², Zoran JOVOVIĆ³

¹Agricultural Institute of Republic of Srpska, Banja Luka, Republic of Srpska, Bosnia and Herzegovina

²Faculty of Agriculture, University of Banja Luka, Republic of Srpska, Bosnia and Herzegovina

³Biotechnical Faculty, University of Montenegro, Montenegro

*Corresponding author: iskra.mihic@gmail.com

Abstract

Breeding of grain crops (wheat, barley, triticale, rye and oats) in our institution lasts about 50 years, but the completion of the breeding program of these plant species has been occurred in the last ten years. Realistically, there is a need and the possibility of breeding work on triticale, which resulted in the creation of multiple varieties and excellent lines of great genetic potential. The created lines have the weight of spike over 4 g and over 65 grains per spike in terms of less seeding. Significantly, our new lines, as well as recognized varieties, confirmed its production values in the experiments as well as in production. Besides varieties Oskar and Viktor, it is important to emphasize the excellent line of triticale, which was reported to the Directorate of Plant Protection, Ministry of Agriculture and Environment of Republic of Serbia under the code BL T – 55 at the end of 2011. In the trials conducted at 6 locations, this line achieved higher yield, 350 kg/ha⁻¹ more than standard variety Odisej, and proved to be a significant carrier of genetic yield potential with a maximum yield of 12.141 kg/ha⁻¹ at the location of Sombor city (Serbia). High-yield, early to mid-early variety of winter triticale Oskar was developed by crossing genetically divergent parents, variety Presto and one of the local lines of winter triticale. Variety Oskar is characterized with a high fertility potential, good technological quality, very good resistance to lodging, excellent resistance to low temperatures, as well as the causal agents of major diseases of grain crops. According to the two-year results of the Commission for the registration of varieties, variety Oskar achieved excellent grain yield of 8952 kg/ha⁻¹. The highest yield was achieved in conditions of intensive production in Serbia, in particular in municipality of Sremska Mitrovica (9509 kg/ha⁻¹), and cities of Novi Sad (9077 kg/ha⁻¹) and Kragujevac (8452 kg / ha⁻¹). In three-year comparative trials at the production part of the Public Institution (PI) Agricultural Institute of Republic of Srpska - Banja Luka, this variety achieved a yield of 8805 kg/ha⁻¹. This variety is characterized by extremely coarse grain, absolute mass of about 44 g, excellent gravity about 72 kg and the protein content of about 15%.

Keywords: *Breeding, Potential, Variety, Line, Yield, Quality.*

Introduction

The paper analyzes the genetic and production potential for yields of new lines and varieties of triticale, which will represent a new generation that are creating at the PI Agricultural Institute in Republic of Srpska. Our analysis are based on the results achieved by these lines and varieties, both in our conditions and on a number of sites and for several years, in comparison with standard varieties and our lines. In the Institute, it is recognized the fact that triticale can be very rational plant species in terms of food sources, primarily in the field of animal husbandry.

Breeding program in our Institution lasts about 15 years and this work has resulted with the creation of several varieties and several important lines of this plant species. Certainly, this is an important species for growing in our conditions, sowing area of 10000 ha, so considerable attention is devoted here which is quite modest in comparison to more developed breeding centers.

Triticale grain quality depends on the efficiency of breeding and production conditions. 1000 grain weight is a reliable parameter in assessing the quality and technological characteristics of grain and positively correlated with grain protein content. Varieties with higher test weight also have a higher content of the extract.

A large number of varieties from our collection, as well as the newly created lines have very good to excellent resistance to low temperatures. Winter without snow cover and a longer frost can lead to significant degradation of certain materials. Here is a common problem how to find a combination whose progeny have good or excellent agronomic and technological characteristics as well as good resistance to low temperature. The results are different in the earlier and later generations, but during the process of breeding and monitoring of material it is possible to reach the right target.

The aim of work

This paper aims to present the principle activity of breeding work on triticale, the essential characteristics of the new varieties and lines with values that show a significant genetic potential as well as the characteristics of a variety in production with its main agronomic and technological characteristics. Variety "Oskar" represents a material worthy of attention with economical and stable production potential as well as the good results achieved in the production in favorable growing conditions with adequate production technology.

Material and methods

Our gene collection of different varieties of winter triticale is about 150 genotypes, which are grouped into appropriate groups that are needed in order to facilitate and to make easier the formation of breeding programs, as well as the realization of the same. 100 crossing combinations are made annually. All material is grown in combination of pedigree and bulk method depending on the generation of separation. Selected lines are sown in the preliminary and comparative trials, tested to the required characteristics and then applying to the Variety Commission. The basic material for this program were the following varieties: Almo, Bogo, Alda, Ticino, Agrano, Bc Goran, Amarilo, Corn Mah, Corn winter, Presto, KG-20, Jugo TS -11, Jugo TS 16 and the domestic lines of hexaploid wheat and the lines of triticale.

The hybrid material was bred using pedigree method. Phenotypically uniform lines were selected over the past few years. All the important and necessary characteristics were monitored during the preliminary and comparative trials on the experimental field of the Agricultural Institute, in comparison with about thirty varieties (foreign, domestic, old and new ones) as well as the leading varieties in production in our region. Lines are submitted for testing to Variety Commission in Belgrade, for testing sites (Novi Sad, Pančevo, Sremska Mitrovica, Zaječar, Sombor, Kragujevac, Banja Luka), and based on the two-year results are recognized and permitted to be introduced into production at the area of Republic of Serbia, as well as the territory of BiH.

Results and discussion

Top seven triticale lines were analyzed and observed the characteristics of the number of grains per spike, weight of grains per spike and spike length (Tab. 1). From the above values, which are shown in the table, it can be concluded that triticale has great genetic potential, judging by the number of grains per spike and weight of these grains. Those lines were grown under the conditions of less sowing and show the possible values for the realization of genetic yield potential.

Tab. 1 Analyzed lines of BL triticale

Line	Average number of grains/spike	Grain weight/spike (g)	Spike length (cm)
Bl T - 1	65	3,42	12,5
BL T - 2	54	2,63	10,5
Bl T - 3	55	2,62	12,0
BL T - 4	70	3,04	11,3
BL T - 5	52	2,59	11,5
BL T - 7	60	3,55	11,7
BL T -12	69	3,91	12,4

Yield increase according to our research at the above lines was accompanied by an increase in length and number of grains per spike, and ultimately the weight of spike. Plant height at the mentioned lines is around 110 cm, and we have an increase in harvest index, thereby increasing the yield which is in accordance with the results of Austin (1982). Increased productivity per spike can be attributed to the impact of gene for number and grain weight, not only the redistribution of organic matter.

Testing in Serbia lasts two years at six locations. At the end of 2011, one line of winter triticale was reported for recognition in Serbia (Belgrade) under the code BL T-55, which filled the necessary requirements to enter in the recognition process. Seed and spike were delivered for VCU and DUS test. Variety achieved a higher yield or 350 kg from standard variety Odisej, but not statistically significant and it was not recognized by the Commission. Although deviations in terms of grain yield were not highly significant, line T-55, in most years and in most locations showed higher yields compared to the standard, which is a significant success as a result of several years of work.

Tab. 2. Grain yield of winter triticale line on six locations in comparison with a standard

Site	Year	Grain yield (kg/ha)	
		T-55	Odisej
Kikinda	10/11.	7408	8786
	12/13.	8218	7931
		7813	8358
Kruševac	12/13.	7333	6758
Novi Sad	10/11.	11524	10594
	12/13.	10320	10070
		10922	10332
Pančevo	12/13.	10557	8463
S. Mitrovica	10/11.	10196	8878
Sombor	10/11.	12141	11593
	12/13.	10043	11093
		11092	11315
□	10/11.	10317	9963
	12/13.	9294	8969
□ (2010/11 i 2012/13.)		9749	9399
h	0,05	365	
	0,01	486	
Cv		7,61	

Line T-55 achieved a maximum yield of 12141 kg⁻¹ at the site of Sombor, as well as the significant values of the yield on locations of Novi Sad and Pančevo. The average two-year yield for all locations, a total of 6, was 9749 kg⁻¹. These values (tab. 4) show that it is a line with great genetic potential.

In terms of physical-chemical or technological properties of grain of which depends the quality of flour, the results obtained by the line T-55 were in the level of standard. It is known that the standard variety Odisej, one of the best varieties that are grown in our region, and also the variety that occupies the largest area in our country and in the production achieves yields of over 4.5 t/ha⁻¹.

Tab. 4. Grain yield of the line BL T-21 and standard in 2005. (kg/ha⁻¹)

Variety	Localities						x
	Kragujevac	N. Sad	Pančevo	S Mitro.	Sombor	Zaječar	
BLT 21	8452	9077	7960	9509	8700	9516	8869
KG-20	8088	8046	7680	6850	5800	8740	7534

By the time of heading variety Oskar is very early variety. In our agroecological conditions tillering stage is at the beginning of May. It has excellent resistance to low temperatures. Plant height is about 115 cm, with a very long (about 15 cm) semi loose spike. This line is characterized by extremely coarse grain, absolute mass of about 44 g and excellent gravity about 72 kg. Flag leaf is semi erect and as such is held by the end of milk ripeness, when lightly falls in a horizontal position. Basic and essential characteristics of other several lines we can briefly show through agronomically important features shown in the following table. In addition to these properties, essential characteristic is the protein content around 15%.

Tab. 5. The yield of triticale varieties at the site of the Agricultural Institute in 2013

No.	Variety	Date of heading	Plant height	kg/ha
1.	ODISEJ	16.V	108	6896
2.	OSKAR	23.V	118	7199
3.	AGRANO	23.V	109	7520
4.	KG 20	20.V	95	4640
5.	BL T 8	24.V	115	6880
6.	BL T 17	1.VI	100	6670
7.	TRIMERAN	26.V	110	6540
8.	BL T 10	18.V	117	7161

It is significant to note that our new lines and recognized varieties confirm their production values, both here and in the production trials with farmers.

Conclusion

With the introduction of varieties Oskar and Viktor in the production assortment, of our region, our assortment is richer and more diverse. The new lines of winter triticale show a positive trend in terms of increasing the genetic potential that is the main component of yield. It is very likely that some of these lines will be recognized in the near future as new varieties and will be involved in the production in our region.

In addition to the excellent agronomic characteristics, these varieties or lines have excellent technological properties. The protein content is from 12 to 15%, and is followed by a very good values of other agronomic and technological characteristics.

Due to breeding, the average annual increase of genetic yield potential in our broader terms as estimated per year or 0.61%.

References

- Austin, R. B. (1982): Crop characteristics and yield potential of wheat .J. agric.Sci. Canb.,98 :247-453.
- Đokić A., (2000): Plant genetics. Belgrade.
- Mladenov N, Denčić S, Kobiljski B, Hristov N. (2001): Using genetic potential of NS varieties of winter wheat. Institute of field and Vegetable Crops, Novi Sad, Proceedings, XXXV Seminar of Agronomists, 83-90.
- Mladenov, N., Denčić, S., Hristov, N., Kobiljski, B.,(2002): Contribution of breeding to wheat yield increases. Proceedings, XXXVI Seminar of Agronomists, 175-183.
- Mandić, D., Nikolić, S., Đurašinović, G. Nožinić, M. (2005): New lines BL triticale. Proceedings, consulting and 1 international conference of Croatian Agronomists, Opatija.
- Mladenov N, Denčić S, Kobiljski B, Hristov N (2001): Iskorišćenje genetičkog potencijala novosadskih sorti ozime pšenice. Naučni institut za ratarstvo i povrtarstvo, Novi Sad, Zbornik referata, XXXV Seminar agronoma, 83-90
- Nožinić M., Mandić, D., Marković, M., Đurašinović, G., Pržulj, Novo. 2009. Triticale in the years with extreme weather conditions. Selekcija i semenarstvo, 15: 35-54.

BIOLOGICAL AND POMOLOGICAL CHARACTERISTICS OF INTRODUCED PLUM VARIETIES (*Prunus domestica* L.)

Nada ZAVIŠIĆ*, Željko ROSIĆ

Agricultural Institute of Republic of Srpska, Banja Luka, Bosnia and Herzegovina

*Corresponding author: nada.z@blic.net

Abstract

In the area of Balkans, plum was the most common fruit species based on the number of trees and quantity of the production. The biggest problem in growing of plum trees is plum pox virus (PPV), which endangers growing of the most important plum variety (Požegača) in our areas. One of the solutions to the problem of PPV is to grow resistant and tolerant varieties. To date, the series of plum varieties, which are tolerant to PPV, are selected. In addition to some well-known selections from Čačak (Serbia), there are also varieties selected in other selection centres. Trials with resistant varieties are the basis for the introduction of new varieties in commercial production. Research was carried out during 2013 and 2015 in the collection orchard of the introduced plum varieties: Katinka, Haroma, Topper, Topfive, Jojo, Topfirst, Elena and Presenta. Čačanska ljeptica and Čačanska rodna were used as standards. In 2009, the orchard was set up in Banja Luka (Bosnia and Herzegovina). All varieties were grafted onto Myrobalan (*Prunus cerasifera*) and set up at planting distance of 4 x 2 meters, and growth form was the spindle bush. Each variety was represented with 5 trees. Protection against diseases and pests was carried out according to the principles of integrated production. The orchard was without irrigation. The biological (flowering and ripening) and pomological (fruit and stone weight, height and width of the fruit, the fruit yield) were analysed, as well as the content of soluble dry matter in the fruit. According to the research results, the varieties Jojo and Presenta showed the best characteristics of the fruit. Time of ripening cannot be determined on the basis of skin colour. Analysis and monitoring of soluble solids content (SSC) in the fruit during ripening could give more reliable information on the determination of harvest time.

Keywords: *Plum, variety, flowering, fruit quality*

Introduction

In the area of Balkans, plum was the most common fruit species based on the number of trees and volume of the production. Variety Požegača was once the leading variety of plum but due to high susceptibility to plum pox virus (PPV), its cultivation in question.

The biggest problem in the cultivation of the plum is PPV. One of the solutions to the PPV problem on plum is growing of resistant and tolerant varieties. To date, a series of plum varieties that are tolerant to the PPV were selected. Apart from some, to us well-known selections from Čačak (Čačanska rana, Čačanska najbolja and Čačanska lepotica), there are varieties selected at other selection centres.

The aim of breeding work within the species *Prunus domestica* L. was conducted to adapt to characteristics of moderate continental climate, size and fruit quality, yield, spreading of ripening time, less vigour, and resistance to the most economically important diseases and pests with special emphasis on resistance to PPV (Mišić, 1987). In last two decades there have been

recognized a number of varieties of plums, of which the most interesting varieties was that which are resistant to PPV (Nikolić and Radović, 2010).

The largest number of new high-quality varieties, tolerant to PPV was created in breeding centres in Germany and to the selection of Hohenheim and Geisenheim (Jacob, 2002; Hartmann, 1994). The use of the German varieties led to extending the harvesting period and offers of plum on the market even to mid-October (Agnes, *et al.*, 2016).

New varieties tolerant to plum pox virus, which are suitable for growing in our agro-ecological conditions, have not been significantly represented in nursery production. Those same varieties, because of size and fruit quality, maturation time, deserve their place in the orchards of plums. Introductory experimental orchards are the basis for the introduction of new varieties in commercial production. That is because without verification of biological and production characteristics of the variety in concrete conditions are not recommendable to expand production significantly.

The aim of this study was to examine biological and pomological characteristics of some new plum selection in comparative monitoring with the known varieties in agro-ecological conditions in Banja Luka.

Materials and Methods

The study of biological and pomological characteristics of plum varieties carried out in the collection orchard of the Department of Fruit growing and Viticulture, Public Institution Agricultural Institute of Republic of Srpska, Banja Luka (PI AIRS) (Figure 1).

Seedlings for orchard were obtained from "Rasadnik" doo Nevesinje which imported buds of new varieties of plums from Germany for their own needs. Orchard was planted in 2009 in Banja Luka (Bosnia and Herzegovina). All varieties are grafted on cherry plum (*Prunus cerasifera*). The distance between trees were 4 x 2 meters, a growth form was the spindle bush. In the test plantation is located five of each variety of plum trees: Katinka, Haroma, Topper, Topfive, Jojo, Topfirst, Elena and Presenta. As the standards varieties were used Čačanska leptica and Čačanska rodna. Plant protection against diseases and pests is carried out in accordance with the principles of integrated pest management. Orchard hasn't been irrigated.

In period after planting growth stages of flowering and maturation were regularly monitored. In 2013 and 2015, on average sample of 25 fruits of all varieties, were carried out following pomological measurements: fruit and stone weight (g) measured with precision automatic scales, width and height of the fruit (mm) measured with calliper with automatic micrometre. Also it was determined flesh ratio of fruit and the soluble solids content (SSC) is determined by refractometer. The exception was the variety Katinka, which were without fruits due to human factors, so we could not do pomological measurements in 2015. The significance of differences was determined on the basis of an analysis of variance with the use of F-test for two-factorial trial. For individual comparisons LSD test was used. Statistical analysis did not include the variety Katinka because it was without fruits in 2015.



Figure 1. The experimental orchard of new varieties of plums at Economy PI AIRS, Banja Luka

Results and Discussion

In the studies of the varieties resistant and tolerant to the PPV, (Malinowski *et al.*, 2013) sensitivity to the PPV was monitored during the period of eight years. Varieties Katinka and Presenta showed high sensitivity to PPV. For variety Jojo tree analysis shown no presence of the virus, but on the fruits changes were recorded in the flesh of the fruit in the form of stone structures.

Pomological and chemical characteristics of the newer varieties of plums in Croatia (Gadze *et al.*, 2011) according to the characteristics of the studied time and maturation, among others, the variety Jojo stands out as interesting for our production orchards. Our trial results regarding the variety Jojo were similar to the results of trails in Croatia.

Table 1 shows the average values of pomological and technological characteristics of the fruit varieties of plums during the two-year test.

Fruit size is varietal characteristics, but also depends on climatic conditions and technological process of production, as well as the number and position of the fruit on the tree. Size of the fruit can be expressed by mass or dimensions of the foetus.

The results of measuring the size of the fruit and soluble solids contents (SSC) in our research for some varieties of plums (Čačanska Lepotica, Jojo, Elena and Čačanska rodna) were similar to the results from Bulgaria (Minev and Stoyanova, 2012).

Table 1. Pomological and technological characteristics of the tested varieties of plums in 2013 and 2015, in Banja Luka

Variety	Year	Date of picking	Fruit weigh (g)	Fruit width (mm)	Fruit eight (mm)	Stone weigh (g)	Flesh stone ratio (%)	Soluble solids (%)
Katinka	2013	12.07.	21,39	29,60	38,10	1,09	94,90	13,00
	2015	-	-	-	-	-	-	-
	Average		21,39	29,60	38,10	1,09	94,90	13,00
Top first	2013	25.07.	40,57	35,30	45,60	2,08	94,86	18,20
	2015	30.07.	33,61	34,40	41,40	1,53	95,50	17,66
	Average		37,09	34,80	43,50	1,81	95,18	15,43
Topper	2013	29.07.	29,59	35,30	40,70	1,34	95,47	18,00
	2015	30.07.	33,61	34,40	41,40	1,53	95,50	17,66
	Average		31,60	34,80	41,50	1,43	95,48	17,83
Čačanska lepotica	2013	31.07.	31,36	33,60	39,10	1,56	95,20	17,50
	2015	30.07.	27,35	33,30	38,50	1,34	95,10	15,66
	Average		29,35	33,40	38,80	1,45	95,15	16,55
Top five	2013	06.08.	29,35	34,70	39,90	1,26	95,70	20,00
	2015	30.07.	24,07	30,80	36,30	1,19	95,00	16,80
	Average		26,71	32,70	38,10	1,22	95,35	18,40
Čačanska rodna	2013	30.08.	21,05	30,90	39,70	1,24	94,11	20,20
	2015	26.08.	23,35	29,80	42,20	1,23	94,70	23,53
	Average		22,20	30,30	40,90	1,23	94,40	21,86
Jojo	2013	30.08.	29,52	33,90	46,20	1,57	94,68	18,80
	2015	26.08.	34,91	36,40	48,50	1,89	94,50	25,00
	Average		32,21	35,10	47,30	1,73	94,59	21,90
Haroma	2013	28.08.	28,36	34,10	45,50	1,61	94,32	20,20
	2015	26.08.	36,08	37,40	48,20	1,79	95,00	22,80
	Average		32,22	35,70	46,80	1,70	94,66	21,50
Elena	2013	20.09.	22,06	31,30	38,40	1,36	93,80	19,60
	2015	17.09.	21,07	32,00	39,30	1,58	92,50	20,60
	Average		21,56	31,60	38,80	1,47	93,15	17,86
Presenta	2013	20.09.	24,06	30,20	41,10	1,07	95,55	21,80
	2015	15.09.	19,62	29,20	40,80	1,31	93,40	21,16
	Average		21,84	29,70	40,90	1,19	94,47	21,48

Variety Jojo, which resulted from crossing Stanley and Ortenauer varieties, is similar to Stanley according to the characteristics of the fruit, and is suitable for drying due to good and uniform fruit size (Mitrović *et al.*, 2009). Results of analysing fruit weight (32.21 g), stone weight (1.73 g) and the contents of SSC (21.9%) of Jojo variety are similar to results from Čačak (Mitrović *et al.*, 2009).

Results of statistical data analysis for pomological characteristics of the fruit in a two-year research are shown in Table 2.

The average fruit weight was 29.63 g, and found differences between varieties were statistically significant, while differences occurred under the influence of the year as factors were not significant.

Table 2. Pomological characteristics of fruit for the analyzed plum varieties, Banja Luka locality (averag of 2013 and 2015)

Variety	Fruit weight (g)	Fruit width (cm)	Fruit height (cm)
Topfirst	38.45	3.49	4.54
Topper	31.55	3.58	4.07
Topfive	27.84	3.29	3.82
Jojo	33.88	3.63	4.77
Haroma	32.84	3.72	4.63
Elena	24.04	3.67	3.67
Prezenta	22.14	3.61	3.61
Čačanska ljeptica	32.57	3.58	4.14
Čačanska rodna	23.40	3.12	4.17
Average varieties	29.63	3.52	4.16
Average year			
2013	29.05	3.62	4.04
2015	30.21	3.41	4.27
LSD (A ,variety)			
0,05	3.84	0.20	0.21
0,01	5.11	0.26	0.28
LSD (B ,year)			
0,05	1.81	0.09	0.10
0,01	2.41	0.12	0.13
LSD (AxB)			
0,05	6.08	0.32	0.33
0,01	8.07	0.42	0.44

There are significant differences between varieties in terms of the fruit dimensions, the height and width, respectively. The interaction factor between the year and the varieties significantly affects the resulting fruit dimensions of the analyzed plum varieties.

The variety Elena according to characteristics of the fruit is similar to Čačanska rodna. Because of late ripening the variety Elena offers the possibility to extend the season of fresh plums for nearly a month and therefore deserves to be expanding (Dinkoca *et al.*, 2009). The results of the size of the fruit and the content of the SSC indicate that this variety is suitable for consumption both as fresh, but also for drying and processing.

Soluble solids content increases with ripening fruit and is a good indicator of quality and ripeness in fruits. SSC in fruits in variety Elena in our research is similar to the results in Zagreb (Družić *et al.*, 2007).

The content of SSC in the fruit varies from year to year, which is caused by rainfall and weather conditions during the period of maturation. In 2013 and 2015, there were large variations in the content of SSC with the same variety. The differences in the content of SSC exist between varieties with earlier period of ripening (Katinka and Top First) and are characterized by the values for the lower SSC content related to later varieties.

Conclusion

The varieties of plums in the test plantation in Banja Luka, Bosnia and Herzegovina have covered a wide period for market of fresh plums from the earliest such as Katinka and Topfirst (second half of June), to the late, Elena and Presente (end of September). Fruit skin colour is not a sure indication for determining of ripeness and the moment of picking. Analysis and monitoring of

SSC in the fruit during maturation is the best indicator for determining the picking time. Picking time depends on the usage of the fruits, whether it is for consumption or for processing.

Based on the results of pomological and technological characteristics of the fruit varieties of plums can be recommended for different purposes. The varieties Katinka and Topfirst ripen earlier and because of that they are recommended for consumption as fresh. Variety Jojo, because of size and quality of the fruit is suitable for various kinds of processing and drying. Varieties Elena and Presenta, due to late ripening time extend season of fresh plums on market, and can be used in different ways.

References

- Molnar M.A., Ladanyi M., Kovacs S. (2016). Evaluation of the production traits and fruit quality of german plum cultivars. *Acta Universitatis agriculturae et Silviculturae Mendelianae brunensis*, vol. 64, pp. 106-1214.
- Dinkova H., Stefanova B., Dragoyski, K. (2009): Plum cultivar Elena in the Troyan conditions. *Voćarstvo*, 43, 165-166: 27-30.
- Družić J., Voća S., Čmelik, Z., Dobričević N., Duralija, B., Skendrović B. Martina (2007): Fruit quality of plum cultivars Elena and Bistrica. *Agriculturae Conspectus Scientificus*, Vol. 72. No. 4: (307-310).
- Gadže J., Čmelik, Z., Kaštelanac D. (2011): Pomological and chemical properties of introduced plum cultivars (*Prunus domestica* L.). *Pomologia Croatica*. Vol. 17, broj 3-4:67-75.
- Hartmann W. (1994): Plum breeding in Germany. *Acta Horticulturae* 359: 55-62.
- Hartmann W., & Neumüller M. (2006). Breeding for resistance: breeding for Plum pox virus resistant plums (*Prunus domestica* L.) in Germany. *EPPO Bulletin*, 36, 332-336. <http://dx.doi.org/10.1111/j.1365-2338.2006.01010.x>
- Jacob H. B. (2002): Breeding of plums, prunes and mirabelles in Geisenheim, Germany: breeding goals and previous realisation. *Acta Hort.* 577: 39-43.
- Malinowski T., Rozpara E., Grzyb, S. Z. (2013): Evaluation of the susceptibility of several plum (*Prunus domestica* L.) cultivars to Plum Pox Virus (PPV) infection in the field. Sharka –like symptoms observed on Jojo fruit are not related to PPV. *Journal of Horticultural Research*, Vol.21(1):61-65.
- Minev, I., Stoyanova T. (2012): Evaluation of plum cultivars in the Troyan region. *Voćarstvo*, 46, 177-178: 49-54.
- Mišić D.P. (1987): General fruit breeding. Nolit, Beograd.
- Mitrović O., Zlatković, B., Kandić, M., Gavrilović D. J., Popović, B., Milinković V. (2009): The technological characteristics of the fruit of some new varieties of plums for drying. *Fruit growing*, 43, 167-168:101-106.
- Nikolić, D., Radović, A., (2010): Promising varieties and rootstocks of certain types of fruit trees and vines. The first scientific symposium on Agriculture with International Participation "Agrosym", Jahorina, December, 09-11. Proceedings, 12-29..
- Walkowiak-Tomczak, D., Regula J., Lysiak G. (2008). Physico-chemical properties and antioxidant activity of selected plum cultivars fruit. *Acta Sci. Pol., Technol. Aliment* 7(4):15-22.

STUDY OF THE EFFECT OF DROUGHT STRESS ON GERMINATION AND SEEDLINGS GROWTH OF FIVE VARIETIES OF RAPESEED (*BRASSICA NAPUS*)

Souhail CHANNAOUI^{1,2}, Rahal ELKAHKAHI², Hamid MAZOUZ², Jamal CHARAFI¹, Mohamed EL FECHTALI¹, Abdelghani NABLOUSSI^{1*}

¹Research Unit of Plant Breeding and Plant Genetic Resources Conservation, National Institute of Agricultural Research, Regional Agricultural Research Center of Meknes, Morocco

²Laboratory of Plant Biotechnology and Molecular Biology, Department of Biology, Faculty of Science, University Moulay Ismail, Morocco

*Corresponding author: abdelghani.nabloussi@gmail.com

Abstract

Drought stress is one of the major abiotic factors affecting seed germination and plant growth especially in arid and semi-arid regions. In current study, we investigated the effects of drought stress on seed germination and seedling growth of five varieties of rapeseed. Seven drought stress levels of zero (control), -3, -5, -7, -9, -11 and -13 bars were considered using polyethylene glycol-6000 (PEG-6000). Complete randomized design with three replications was used for this experiment. Germination percentage (GP), germination rate (GR), mean germination time (MGT), root length (RL) and shoot length (SL) were used to evaluate the varieties response to PEG-induced drought stress. Drought stress, variety and interaction of both had a significant effect on all studied parameters. GP and GR decreased with the increase in stress level while MGT increased. Rapeseed varieties 'INRA-CZH2' and 'INRA-CZH3' performed better in germination and early seedling growth. There was no seed germination for all varieties at the -11 bars and -13 bars. Shoot length decreased with increasing drought stress but varieties showed different performance under this stress. Root length decreased with increasing levels of severe drought stress. However, the presence of moderate drought stress could improve the root growth of the investigated varieties. The varieties 'INRA-CZH2' and 'INRA-CZH3' exhibiting the highest germination percentage could be recommended for environments with early cropping cycle drought.

Keywords: *Rapeseed; Drought stress; Germination; Seedling growth; varieties.*

Introduction

Rapeseed (*Brassica napus* L.) is one of the most important sources of vegetable oils and protein rich meals worldwide. Rapeseed ranks fifth among economically important crops following wheat, rice, maize, and cotton (FAOSTAT, 2011). Rapeseed is the world's third most important source of vegetable oil after palm and soybean (Beckman, 2005).

Drought was always present in Morocco's history, but during this last decade, drought has become more frequent, with a net reduction in precipitation and an increasing temperature trend. Climatic data during the period 1961-2004 showed an increase in drought frequency, severity and spatial distribution (Stour and Agoumi, 2008). In Morocco with an arid and semi-arid climate, rapeseed is more often planted in late autumn and harvested in early summer. Accordingly, this stress is also considered as an essential limiting factor for rapeseed growth and production due to poorly distributed rainfall over the crop growing season. Drought is a severe limitation of plant growth, development and productivity, particularly in arid and semi-arid regions (Galle et al.,

2007), where the rainfall varies from year to year. However, depending upon plant species, certain stages such as germination, seedling or flowering could be the most critical stages for drought stress.

The objective of this study was to evaluate the effect of drought stress on rapeseed germination and early seedling growth, and to determine whether there was intraspecific variation in drought tolerance between different rapeseed varieties.

Materials and methods

The plant material used in this study consists of five varieties of rapeseed (*B. napus*) from the collection of the National Institute for Agricultural Research (INRA), namely 'INRA-CZH2', 'INRA-CZH3', 'INRA-CZSyn1', 'Moufida' and 'Narjisse'.

The experiment was conducted in a double factorial completely randomized design, with three replications. The first factor was the variety, with five levels, and the second was the drought stress, with seven levels. Drought stress was induced by polyethylene glycol (PEG-6000) solutions. Application of six levels of drought stress, with osmotic potentials of -3, -5, -7, -9, -11 and -13 Bars, was used and prepared as described by Michel and Kaufmann (1973). Distilled water was used as control. For each treatment, 100 seeds were allowed to germinate in a Petri dish double lined with filter paper moistened with 15 ml of the appropriate level of PEG-6000 at 25 ± 1 °C for 8 days. Germination counts were made after 2, 4, 6 and 8 days after planting. Seeds were considered germinated when the radicle was at least 3 mm long. For germination percentage, the number of seeds germinated on day 8 was considered. The germination rate index was determined by $GR = \sum (Ni/Di)$ as described by Carlton *et al.* (1968), where Ni is the number of seeds germinated between two counting's and Di represents the day of counting. Mean Germination Time (MGT) expressed in d, is the inverse of GR ($MGT = 1/GR$). Root length and shoot length were measured on the eighth day after germination (end of experiment).

The statistical analysis was conducted with the software package SPSS for Windows (Version 22). Data were subjected to an analysis of variance (ANOVA) at 5% probability level. Differences between rapeseed varieties and treatments means were compared by Duncan's Multiple Range Test (DMRT).

Results and discussion

Drought stress effect on germination

Results of analysis of variance indicated that drought stress (PEG-6000) significantly influenced rapeseed seed germination percentage (GP), germination rate index (GR) and mean germination time (MGT) (Table 1). There were also significant effects of variety and variety \times drought on these parameters (Table 1). All seed germination parameters measured, GP, GR and MGT, were affected by drought stress. One could observe that GP (Figure 1) and GR (Figure 2) decreased with the increase in stress levels, while MGT (Figure 3) increased. These findings agree with those of Zraibi *et al.* (2011) in safflower and El Harfi *et al.* (2016) in sesame. However, the varieties 'INRA-CZH2' and 'INRA-CZH3' were less affected than 'INRA-CZSyn1', 'Moufida' and 'Narjisse', indicating that, during seed germination, 'INRA-CZH2' and 'INRA-CZH3' were more tolerant to drought stress than 'INRA-CZSyn1', 'Moufida' and 'Narjisse'. To germinate, all varieties of rapeseed could tolerate until -9 bars, and from -11 bars, no seed germination was recorded. Kaya *et al.*, 2006 reported that none of sunflower seeds could germinate at -12 bars and in a recent study on sesame, it was shown that seeds ceased to germinate already from -12 bars (El Harfi *et al.*, 2016), indicating that sunflower and sesame should be more tolerant than

rapeseed to drought stress during germination stage. However, for safflower, seeds ceased to germinate already from -2.5 bars (Zraibi *et al.*, 2011).

Table 1. Analysis of variance (mean squares) for seed germination and seedling related traits of five rapeseed varieties evaluated under drought stresses.

Source of Variation	Degree of freedom	Germination	Germination rate	Mean germination time	Root length	Shoot length
Variety (V)	4	1003.32***	681.11***	0.0018***	3.45*	20.10***
Drought (D)	6	28360.17***	5142.93***	0.0103***	383.33***	748.11***
V × D	24	200.20***	62.16***	0.0005***	3.35***	9.26***

*, **, *** Significant at 0.05; 0.01 and 0.001 of probability levels, respectively.

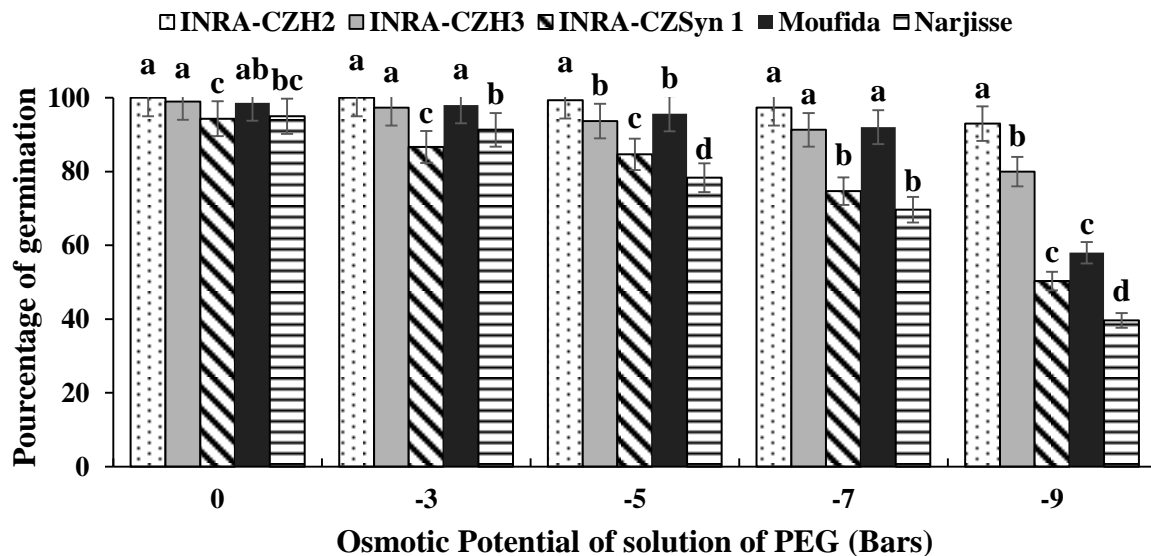

Figure 1. Effect of PEG induced drought (bars) on seeds germination percentage of five rapeseed varieties. Values with different alphabetical superscripts are significantly different ($p \leq 0.05$) according to DMRT.

Drought effect on seedling growth

The effect of drought stress (PEG) on shoot length (SL) and root length (RL) was statistically highly significant in all varieties (Table 1). Shoot length decreased with increase of osmotic potential of PEG treatment (Figure 4) but different varieties showed different performance under stress environment. Our findings agree with other studies on different species including Zraibi *et al.* (2011) in safflower and El Harfi *et al.* (2016) in sesame. There are many reports which are in agreement with the present findings, indicating that drought stress severely reduce the shoot length. Root length also decreased with increasing levels of severe drought stress. However, the presence of moderate drought stress could even improve root growth of investigated varieties (Figure 5).

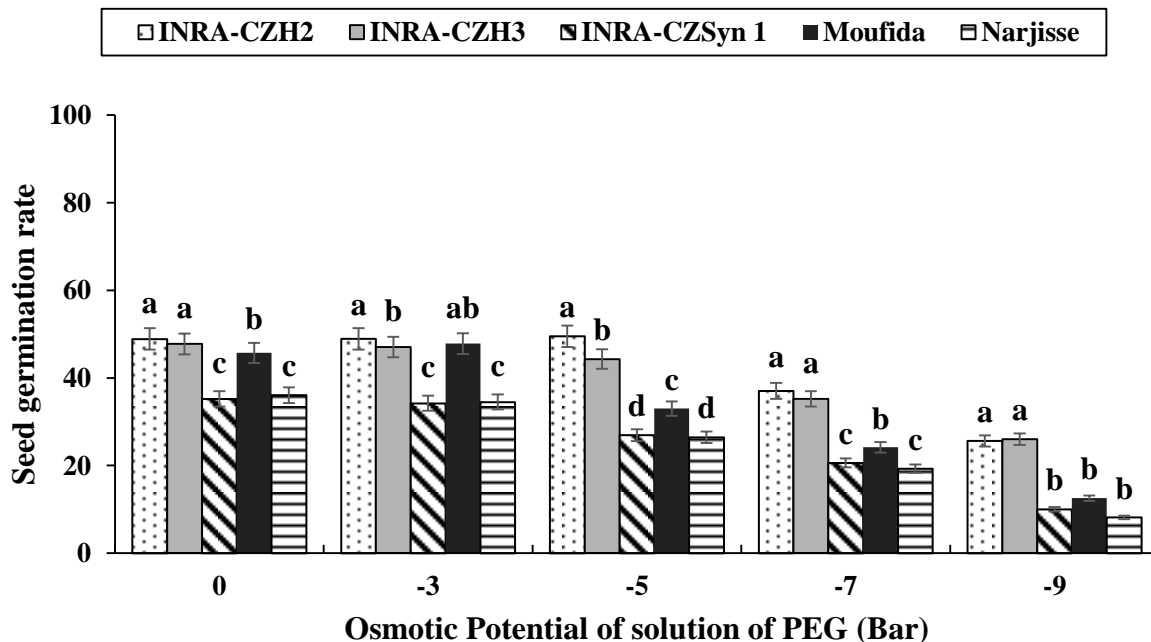

Figure 2. Effect of PEG induced drought (bars) on seeds germination rate (GR) of five rapeseed varieties. Values with different alphabetical superscripts are significantly different ($p \leq 0.05$) according to DMRT.

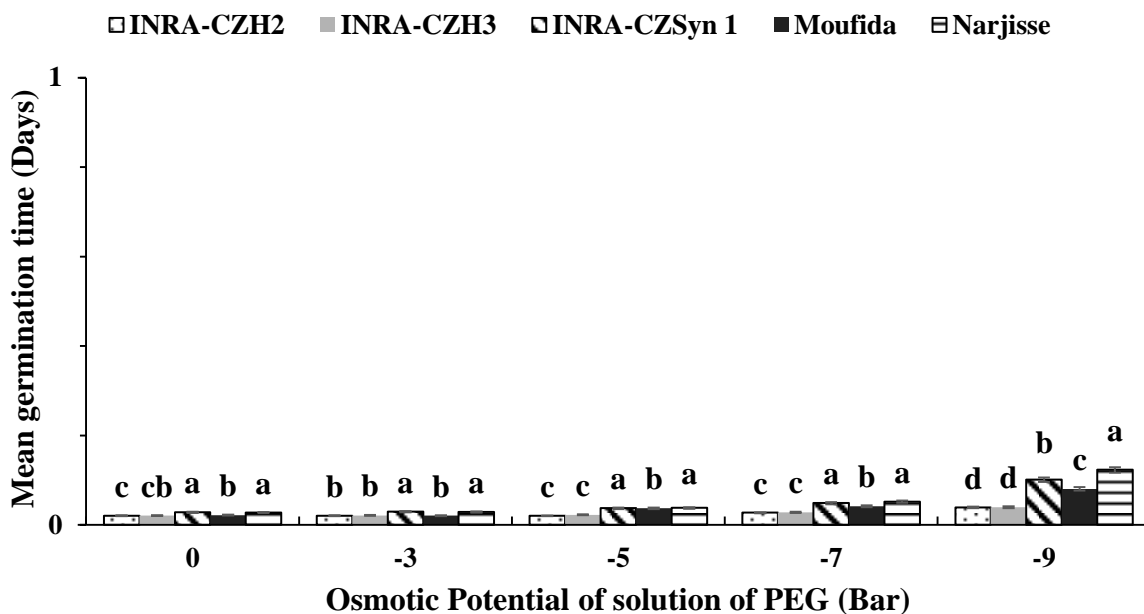

Figure 3. Effect of PEG induced drought (bars) on mean germination time (MGT) of five rapeseed varieties. Values with different alphabetical superscripts are significantly different ($p \leq 0.05$) according to DMRT.

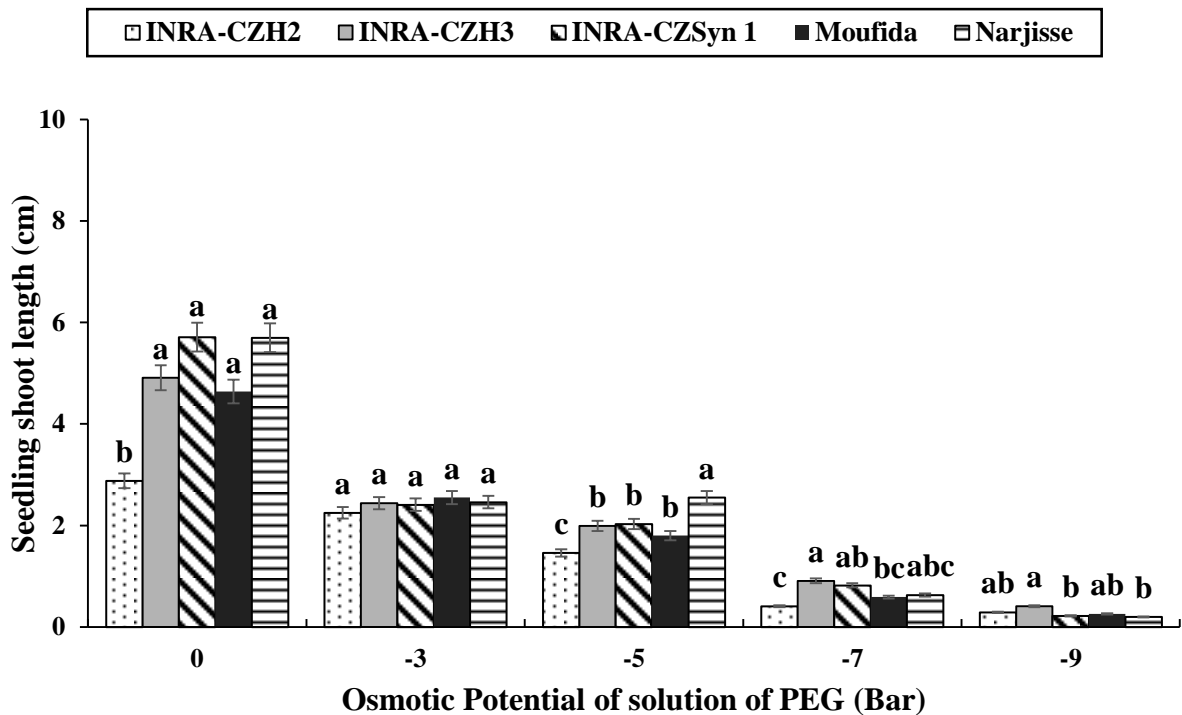

Figure 4. Effect of PEG induced drought (bars) on seedling shoot length of five rapeseed varieties. Values with different alphabetical superscripts are significantly different ($p \leq 0.05$) according to DMRT.

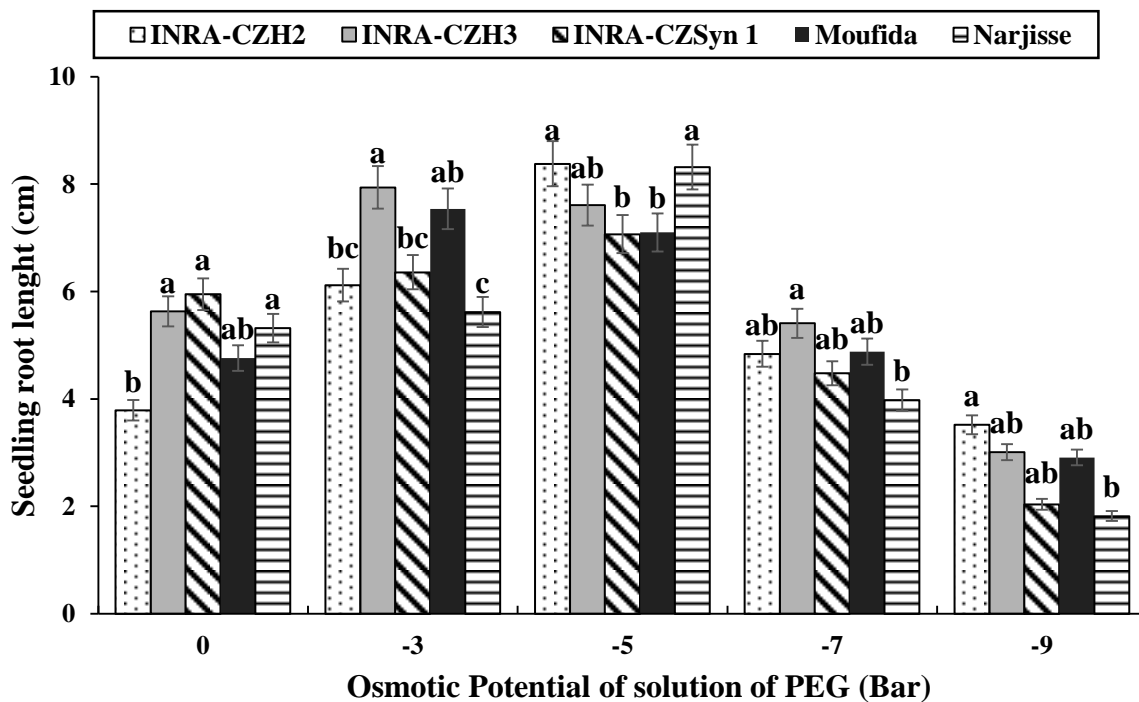

Figure 5. Effect of PEG induced drought (bars) on seedling root length of five rapeseed varieties. Values with different alphabetical superscripts are significantly different ($p \leq 0.05$) according to DMRT.

Conclusion

Based on the results of this study, the varieties 'INRA-CZH2' and 'INRA-CZH3' showed better seed germination and early seedling growth, under drought conditions, than 'INRA-CZSyn1', 'Moufida' and 'Narjisse'. It is also concluded that variation among varieties was found to be a reliable indicator of drought tolerance in rapeseed. This suggests that the choice of the rapeseed variety to be planted in a given environment should depend upon the presence and the degree of the stress observed in such environment. In a non-stressed environment, 'INRA-CZSyn1' and 'Narjisse', even with an intermediate germination percentage, should be selected because they had the best seedling growth (root and shoot length). In drought stressed environments, 'INRA-CZH2' and 'INRA-CZH3', exhibiting the highest germination percentage, should be recommended.

References

- Beckman, C., 2005. Vegetable oils: competition in a changing market. Bi-weekly Bulletin, Agriculture and Agri-Food Canada, 18 (11)
- Carlton, A.E., C.S. Cooper, L.E. Wiesner, 1968. Effect of seedpod and temperature on speed of germination and seedling elongation of sainfoin (*Onobrychis viciaefolia* Scop). Agron. J., 60: 81-84
- El Harfi, M., H. Hanine, H. Rizki, H. Latrache and A. Nabloussi, 2016. Effect of Drought and Salt Stresses on Germination and Early Seedling Growth of Different Color-seeds Sesame (*Sesamum indicum* L.). Int. J. Agric. Biol., DOI: 10.17957/IJAB/15.0145.
- FAO, FAOSTAT, 2011. Available at: <http://faostat.fao.org/site/339/default.aspx/>. (Accessed 15 January 2011)
- Galle, A, P. Haldimann and U. Feller, 2007. Photosynthetic performance and water relations in young pubescent oak (*Quercus pubescens*) trees during drought stress and recovery. New Phytol., 174:799-810
- Kaya, M.D., A. Ipek and A. Ozturk. 2003. Effects of different soil salinity levels on germination and seedling growth of safflower (*Carthamus tinctorius* L.). Turk. J. Agric. 27:221–227
- Michel, B.E. and K. Kaufmann, 1973. The osmotic potential of polyethylene glycol 6000. Plant Physiol. 51: 914–916
- Stour, L. and A. Agoumi, 2008. Climatic drought in Morocco during the last decades. Hydroécol. Appl. 16:215–232
- Zraïbi, L., A. Nabloussi, M. Kajeïou, A. El Amrani, A. Khalid and H. Serghini Caid, 2011. Comparative germination and seedling growth response to drought and salt stresses in a set of safflower (*Carthamus tinctorius*) varieties. Seed Technol., 33: 39–52

**PRODUCTIVITY OF HEXAPLOID SPELT WHEAT - *TRITICUM AESTIVUM SPP.*
SPELT GROWN ON DEGRADED SOIL**

Jela IKANOVIĆ¹, Vera POPOVIĆ², Snezana JANKOVIC³, Gordana DRAŽIĆ⁴, Ljubiša ŽIVANOVIĆ¹, Željko LAKIĆ⁵, Mladen TATIC², Jasna SAVIĆ¹

¹University of Belgrade, Faculty of Agriculture, 6 Nemanjina Street, Belgrade, 11080, Serbia

²Institute of Field and Vegetable Crops, 30 Maksima Gorkog Street, Novi Sad, 21000, Serbia

³Institute for Science Application in Agriculture, 68b Blvd. Despota Stefana, Belgrade, 11000, Serbia

⁴University "Singidunum", Faculty of Applied Ecology "Futura", 83 Požeška, 11030 Belgrade, Serbia

⁵Agricultural Institute of Republika Srpska, 78000, Banja Luka, Bosnia and Herzegovina

*Corresponding author: jela@agrif.bg.ac.rs, bravera@eunet.rs

Abstract

The paper presents the results of three years research (2011-2012) on productivity of the alternative cereal– spelt, grown on degraded land in two localities: the mine Stanari (ST) (Bosnia and Herzegovina) and the “Nikola Tesla” thermal power plant - “TENT 2” in Obrenovac (OB) (Serbia). Spelt was examined by using standard agricultural practices for growing this alternative cereal. Harvest was carried out manually at full maturity and the yield was determined by measuring biomass yield. The average yield of spelt biomass, when observed all the factors, both localities and all three years of research, was 1,509 kg ha⁻¹. When observed by locality, the average biomass yields ranged from 1,792 kg ha⁻¹ (OB-Serbia) to 1,225 kg ha⁻¹ (ST-B&H). There was a statistically significant difference in biomass yields between the localities. The locality by year interaction had a statistically significant impact on biomass yield. Fluctuations in biomass yields were due to different soil conditions – different nutrient contents and distribution of precipitation at early stages of crop growth.

Key words: *alternative cereal, spelt, deposed-type soil, biomass yield, locality*

Introduction

Harmonising a sustainable development strategy with the environment, having more strict regulations on protection of living/working environments and adjusting environmental management to be in line with a series of international standards, are the matter of extreme importance that should be addressed with special attention. Given that global demand for alternative cereals increases continuously, with qualitative changes in human diet these cereals are given back the importance they once had (*Glamočlija et al.*, 2010, 2015). This is mostly due to their nutritional specificity (use-value). Over a long history, alternative cereals have been cultivated in less favourable agro-ecological and soil conditions, hence developing natural resistance and tolerance to abiotic stress, increasingly present nowadays as an effect of global climate change. Plant species that are most successful in meeting nutrition requirements with their productive parts, regardless of their origin, will soon occupy the world’s largest agricultural areas. Hence, the largest areas under wheat and other small cereals are situated in China, North America and South America, although wheat originated in the Fertile Crescent.

There is a bad trend of increasing the areas with degraded soil (*Allen*, 2000) as a consequence of multiplication of degradation factors that comes from nature itself and from people (*Dragičević et al.*, 2008). On certain soil, crops cannot be cultivated at all (very saline soil, marsh soil, soil

affected by erosion, chemical agents, etc.). One should point out that alternative cereals, like some other cultivated plants, give higher yields of good quality if grown on better soil (*Janković et al.*, 2015).

Many research papers that cover this topic can be found in literature. There is much evidence that alternative cereals grow well on different types of soil and on soil with poorer productive characteristics as well. Especially important is that they can also grow on degraded soil. It is estimated that there are about 1.5 billion hectares of such soil worldwide (*Rodríguez-Quijano et al.*, 2010). In the last forty years, about 30% of agricultural land has suffered from degradation processes, especially in developed countries. In Serbia there is about 30,000 hectares of corrupted (degraded) soil. Yet these areas have been slightly exploited, which seriously affects national agriculture. Degradation dynamics is such that about 4,000 hectares of agricultural land is “destroyed” each year (*Dorđević et al.*, 2010). Soil is mostly affected by mining activities, open pits, industry, traffic routes, water supply reservoirs, landfills and tailings (*Zhelceva-Bogdanova*, 1995).

There have been some attempts to restore/re-cultivate degraded soil, but such results in our country and in the world are mostly symbolic. A lot of researchers imply that such soil can be restored (*Lukač and Knežević*, 2010). In Serbia, there is a rising awareness of the importance of soil, including degraded soil, for food production (*Dražić*, 2010). The same authors point out that more and more research has been done lately to restore and exploit degraded soil. Therefore, some appropriate experiments have been conducted and their results published. It is concluded that certain cultivated crops, including alternative cereals, achieve satisfactory results on degraded soil. Some tangible results have been already obtained regarding alternative cereals, such as spelt wheat, buckwheat, miscanthus, and some others.

On the territory of Republika Srpska recultivation of soil is done in the coal mine Stanari. The Stanari is the first open pit mine that has received a new ecological permission from the Ministry of Environmental Protection of Republika Srpska and achieved international standards by getting ISO 14001 certification on environmental protection management.

Reviving of spelt production has started in hilly and mountainous areas of Switzerland, Germany and Austria, and later in other countries in mid- and west Europe and North America. In the late 20th century this cereal started to raise interest in our country, too, being grown until recently in hilly and mountainous areas (*Hristov et al.*, 2008). The nutritive value of spelt kernels implies that they could be used to produce quality and healthy food, particularly suitable for those who are allergic to gluten from common wheat.

Triticum aestivum spp. *speltis* hexaploid wheat with 21 chromosomes. It is a spring form originated in 5,000-6,000 BC in the Middle East (present-day Turkey) by spontaneous cross-breeding of grass species (*Pavićević* 1988, *Janković et al.*, 2015, 2016). Spelt is more tolerant to adverse agro-ecological conditions and pathogens and it does not require intensive cropping practices used for soft (common) wheat. Hard, leathery chaffs are good at protecting kernels from air contaminants and pests, whereas waxy layers on stalks and leaves prevent the occurrence of pathogen fungi that are disease agents. Spelt is more adapted to adverse abiotic conditions than common wheat and therefore suitable for growing in the system of organic farming (*Glamočlija et al.*, 2010, 2015, *Popović*, 2010).

The goal of this paper was to determine the biomass yield of spelt wheat grown on degraded soil in two localities: Stanari (B&H) and “TENT 2” (Serbia).

Material and method

The experiments were conducted during 2010, 2011 and 2012 on degraded deposole-type soil in two localities. Locality 1 is in the vicinity of the Stanari mine (ST-B&H), and locality 2 is next to the “Nikola Tesla” thermal power plant – “TENT 2” (OB-Serbia). The experiments were set up in a randomised block design with four repetitions. The subject-matter was alternative cereal – spelt.



Prior to setting-up the experiments, agro-chemical properties of these soils were determined at accredited laboratories in Bosnia and Herzegovina and in Serbia (Table 1).

The conducted agro-chemical analyses showed that the soil in both localities had a pronouncedly acidic pH reaction. pH in KCl varies from 4.1 (“TENT 2”) to 4.6 (Stanari). *Resulović et al.* (2008) and *Veselinović et al.* (2010) point out that Stanari deposoles are more acidic than Kolubara deposoles but less acidic than deposoles in the area of the “Nikola Tesla” thermal power plant in

Obrenovac. Picture.1. Biomass of Triticum spelt

Janković et al. (2016) state that the soils had a low percentage of organic matter and humus, and the level of nitrate salts in the surface layer ranged from 0% to 0.4%. These soils were also classified as very poor in easily approachable phosphorus and potassium.

Table 1. Agro-chemical properties of soil fertility, deposole-type soil

Values	pH		Organic matter (%)	Humus (%)	N (%)	Easily approachable forms	
	H ₂ O	KCl				P ₂ O ₅ mg/100g	K ₂ O mg/100g
Stanari	5.8	4.6	1.6	0.01	0.0	0.38	1.94
TENT 2	5.2	4.1	1.8	0.01	0.4	1.82	3.25

*Jankovic et al. 2016.

The standard cropping technology was in both localities - conventional basic tillage, soil preparation with harrows and manual sowing. Spelt was sown in mid-March. Manual weeding and hoeing were crop tending measures used for keeping the inter-row space clear. Once the crops reached technological maturity (Pic.1), manual harvest was done and the yields were calculated by measuring the yield of above-ground biomass from each basic plot.

The data were then analysed by using analytical statistics and statistical analysis software *STATISTICA 12 for Windows (StatSoft)*.

Meteorological conditions

In this research, the key meteorological indicators, such as precipitation distribution and sums and temperature conditions during the period of vegetation, were monitored and analysed. Data on monthly precipitation sums and average temperatures of air in 2010/2012 were retrieved from the Hydro-meteorological Office of the Republic of Serbia and the Hydro-meteorological Centre of Bosnia and Herzegovina.

Precipitation. Regarding precipitation sums and distribution by month and by year, water regime during the period of spelt vegetation was relatively favourable in both localities, Graph 1.

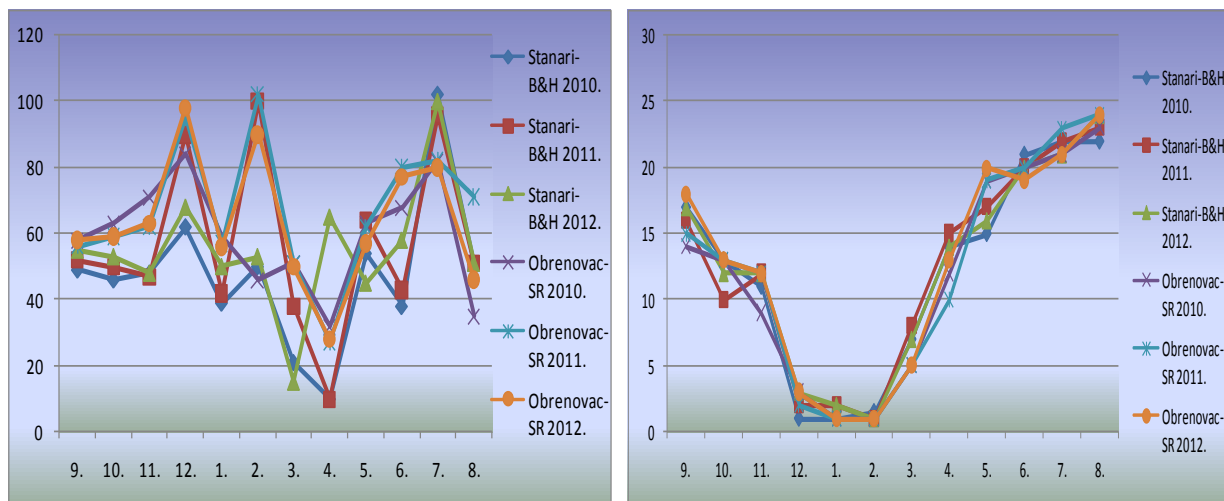

Graph 1. Precipitation (mm), and temperature, Obrenovac-Serbia and Stanari B&H, 2010-2012

Monthly distribution of precipitation in both localities showed that the crops were well supplied with water during the period of vegetation despite the fact there was very little rainfall in April. A lack of precipitation was more pronounced in the locality of Obrenovac, yet this did not have a significant impact on winter crops since abundant rainfall provided enough water for early spring growth of crops in all three years of research. On the other hand, although less precipitation in both localities in April had an adverse impact on the early growth of spelt, tillering was satisfactory, especially in 2011.

Temperature conditions. During the years of research, monthly temperature distribution favoured spelt growth and development, especially in 2011. In both localities, the pre-winter period (October, November and the first half of December) with the average temperatures of air above 10⁰C enabled the optimal autumn growth for the crops to tiller and such enter the winter, Graph. 1b.

Temperature distribution in the springtime and gradually increased temperatures until the summer enabled the crops to pass from the vegetative stage to the generative stage of growth, having the optimal temperature regime. There were no big variations between the localities in average monthly temperatures, although the temperatures in Obrenovac were 1-2⁰C lower in the autumn/winter and higher in the spring/summer.

The temperature regime favoured the early stages of plant growth, resulting in emergence, early growth and tillering of spelt. The summertime was characteristic for high temperatures of air, especially in the locality of Stanari. However, due to increased precipitation, it did not have negative effect on the generative growth of the crops.

Results and discussion

Yield of the above-ground biomass in the investigated localities

The results of this three-year research on above-ground biomass yield conducted in two localities clearly show that growing crops on degraded soil results in satisfactory yields.

The average yield of spelt biomass when observed all the factors, both localities and all three years of research, was 1,509 kg ha⁻¹. The average yields of the biomass ranged from 1,792 kg ha⁻¹ (OB-TENT, Serbia) to 1,225 kg ha⁻¹ (ST-Mine, B&H). A statistically significant difference in yields between the localities was recorded, Tables 2 and 3, Graphs 3 and 4.

Table 2. Biomass yield of spelt on degraded soil, localities ST and OB*

Locality	Year	Grain biomass, kg ha ⁻¹				
		Mean	Std.Err.	-95.00%	+95.00%	Std. Dev
(OB-TENT)	2010	1980.00	17.79	1923.36	2036.63	35.59
	2011	1912.50	31.45	1812.39	2012.61	62.92
	2012	1485.00	33.04	1379.85	1590.15	60.08
(ST - Mine)	2010	1028.75	17.60	972.73	1084.77	35.21
	2011	1072.50	30.37	975.82	1169.18	60.76
	2012	1575.00	28.00	1470.66	1679.34	65.57
Average		1508.96	77.31	1349.02	1668.89	378.76
Average OB		1792.50	67.71	1643.46	1941.54	234.56
Average ST		1225.42	76.12	1057.88	1392.95	263.67
LSD		Year	Locality*	Interaction Y x L*		
	0.05	58.670	47.905	82.973		
	0.01	80.935	66.083	114.459		

Table 3. Analysis of variance for grain yield of spelt

Source of variation	df	SS	MS	F	p
Repetition	4				
Intercept	1	54646926	54646926	17419,27	0.000000
Year (Y)	2	5877	2939	0,94	0.410210
Locality (L)	1	1929501	1929501	615,05	0.000000
Interaction YL	2	1307652	653826	208,41	0.000000
Error	18	56469	3137		
Total	23	3299499			

The locality by year interaction had a statistically significant importance on spelt biomass yield, Table 3.

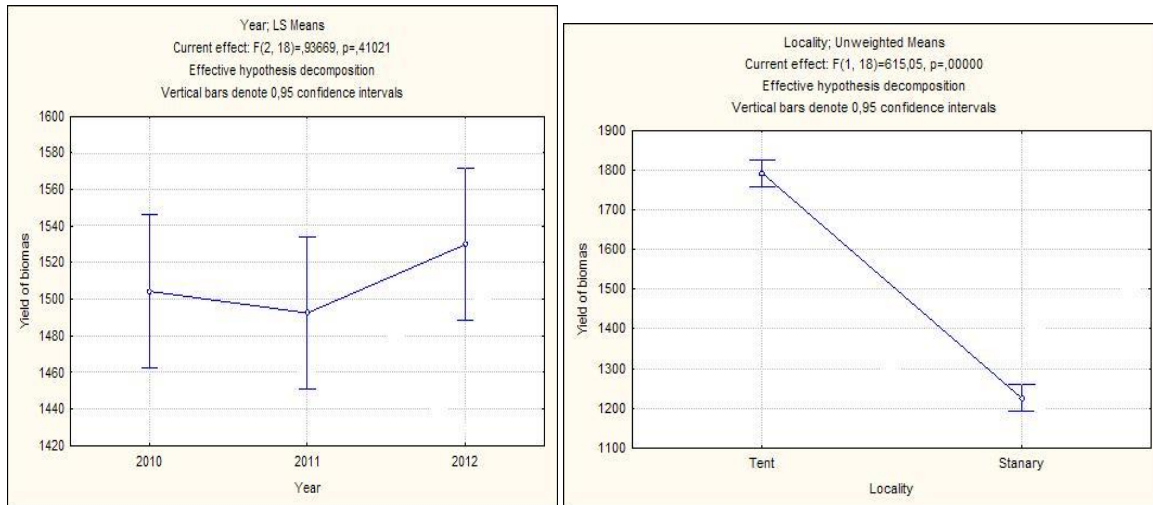

Graph 3. Average biomass yield of spelt, by year and locality, ST and OB*

Between the years, there was no statistically significant difference in yields in the locality of Obrenovac or in the locality of Stanari.

In the locality of Obrenovac, the highest biomass yield was obtained in 2010 (1,980 kg ha⁻¹) and the lowest biomass yield in 2012 (1,485 kg ha⁻¹), Table 2, Graphs 4. In this locality, standard deviation for all years averaged 234.65, Table 2. Soil conditions had a great impact on biomass yield, given that deposoles have less favourable chemical and physical properties so water quickly leaves the surface layer of soil.

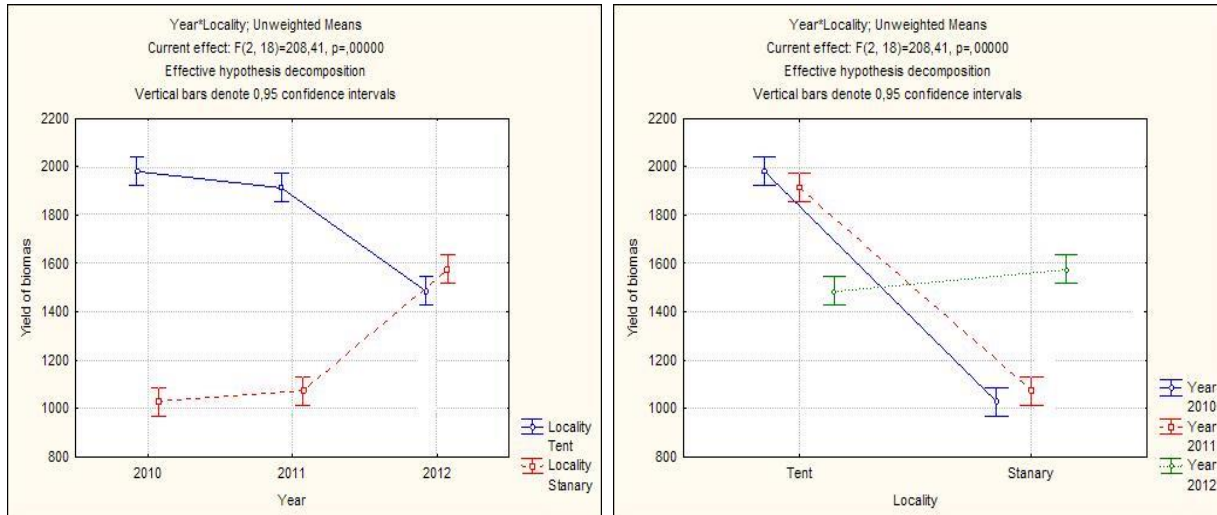

Graph 4. Spelt biomass yield, given by year (2010-2012) and locality (ST and OB*)

In the locality of Stanari, the highest yield was obtained in 2012 (1,575 kg ha⁻¹), and the lowest in 2010 (1,028 kg ha⁻¹), Table 2, Graphs 4. In this locality, standard deviation for all years averaged 263.67, Table 2.

Discrepancies in the yields came as a result of different soil compositions and different distribution of precipitation in early stages of growth. The average biomass yield was lower than yields obtained on agricultural soil. However, it should be pointed out that such a low yield was generally satisfactory, bearing in mind the average values from both localities.

Biomass, i.e. harvest residues in fields, represents a significant amount of organic matter suitable for ploughing down into the soil. Ploughing of harvest residues into deposesoles is very important since decomposing of harvest residues activates microbiological processes, increases the number of useful micro-organisms and humus content in the soil.

Having studied the ways to re-cultivate deposesoles in the areas of open-pit coal mines and to start agricultural production, *Krümmlbein et al.* (2010) conclude that productive properties of cultivated crops depend on their ability to adopt plant assimilates but also on amounts of these nutrients in degraded soil.

In terms of finding the most suitable crops for deposesole recultivation, *Ikanović et al.* (2010), *Glamočlija et al.* (2011) and *Janković et al.* (2015) favour plants with strong roots that better utilise assimilates from deeper layers of soil.

Conclusion

Based on the results of the research on the impact of agro-ecological conditions and locality on yield of the alternative cereal – spelt grown on degraded soil, one can make the following conclusion:

- The average yield of spelt biomass for all the investigated factors, both localities and all three years was 1,509 kg ha⁻¹.
- The obtained average biomass yields ranged from 1,792 kg ha⁻¹ (OB-TENT, Serbia) to 1,225 kg ha⁻¹ (ST-Rudnik, B&H).
- Observed by year, there was no statistically significant difference in yields between the locality of Obrenovac and the locality of Stanari.
- A statistically significant difference in biomass yields was recorded between the localities.
- The locality by year interaction had a statistically significant impact on biomass yield.
- Pronounced variation in grain yields by locality depended on soil conditions and precipitation distribution in early stages of growth of this alternative grain.
- Soil conditions had a great impact on biomass yield. Deposesoles are characteristic for having less favourable chemical and physical properties, thus making water leave the surface layers of soil faster.
- The most appropriate crops for deposesoles re-cultivation are plants with strong root that are better at using plant assimilates from deeper layers of soil.

Acknowledgements

The results presented in this paper are part of Projects TP 31078 and TR 1661021 funded by the Ministry of Education, Science and Technological Development of the Republic of Serbia.

References

- Allen, T. (2000): The World Supply of Fall (Winter) Rye. From Crop Development Center, University of Saskatchewan, Saskatoon, Canada.
- Glamočlija Đ., Janković, S., Pivić, R. (2012a): Alternativna žita: privredni značaj, uslovi uspevanja, vrste i agrotehnika. Institut za zemljište, Zemun, str. 42-43.
- Glamočlija, Đ., Žarković, B., Dražić, S., Radovanović, V., Popović, V., Urganović, V. (2013): Morfological and productivity characteristics of spelt wheat on the chernozem and degraded soil. Proceedings of research paper. Institute of PKB Agroekonomik, Belgrade, pp. 23-31.

- Glamočlija, Đ., Janković, S., Pivić R. (2012): Alternativna žita. (Privredni značaj, uslovi uspevanja, vrste i agrotehnika). Monografija, Institut za zemljište, Beograd, 100.
- Glamočlija, Đ., Ikanović, Jela, Dražić, S., Zekić, N., Pavlović, S., Dončić, D., Milutinović, M. (2012): Proučavanje morfoloških i produktivnih osobina dve populacije korasan pšenice (*Triticum turgidum*, ssp. *Turanicum* Jakubz.) u agroekološkim uslovima istočnog Srema. Zbornik izvoda, Simpozijuma Savetovanje agronoma, Teslić.
- Glamočlija, D.J., Janković, S., Popović, V., Filipović, V., Kuzevski, J., Ugrenović, V., 2015. Alternative crops in conventional and organic growing system. Monograph, IPN Belgrade Serbia, ISBN 978-86-81689-32-5, 1-355; 20-40.
- Dražić, G. (2010): Biodegradation and ecoremediation of soil in Serbia – project activities of the faculty „Futura“. In International conference „Degraded areas & Ecoremediation“, ISBN 978-86-86859-23-5, pp. 245-259.
- Dražić, G. (2011): *Ekoremedijacije*. Univerzitet Singidunum, Fakultet za primenjenu ekologiju, Futura, Beograd, pp. 162.
- Dragičević, S. i M. Stepić (2008): Prirodni potencijali i degradirane površine opštine Obrenovac. Monografija, Jantar grupa, Beograd
- Đorđević, Ana, Tanja Cupać, Tijana Čoporda-Mastilović (2010): Identifikacija degradiranih površina na području opštine Sokobanja. Međunarodna konferencija Degradirani prostori i ekoremedijacija (Zbornik radova), Beograd, str. 349-358
- Hadžić, V., J. Vasin, Lj. Nešići M. Belić (2001): Prikaz nove svjetske baze za zemljišne resurse – Word Reference Base for Soil Resources (WRB), Zbornik referata XXXV seminara agronoma, Naučni institut za ratarstvo i povrtarstvo Novi Sad, str. 375-384.
- Ikanović, Jela, Dj. Glamočlija, Radojka Maletic, Snezana Jankovic, Marijenka Tabakovic, Lj. Zivanovic (2010a): The genotype traits of forage sorghum, sudan grass and their interspecies hybrid in the conditions of intensive nutrition. *Genetika*, Vol 42, 2, pp. 49-358.
- Ikanović J., Popović Vera, Janković S., Živanović Lj., Rakić S., Dončić D. (2014): Khorasan wheat population researching (*Triticum Turgidum*, sp. *Turanicum* (McKEY) in the minimum tillage conditions. *Genetika*, Belgrade, 46 (1), pp.105-115.
- Jankovic S., Ikanovic J., Popovic Vera, Rakic S., Pavlovic S., Ugrenovic V., Simic D., Doncic D. (2015): Morphological and productive traits of spelt wheat – *Triticum spelta* L. "Agriculture and Forestry", Podgorica, <http://www.agricultforest.ac.me>, V. 61, 2, 173-182.
- Krümmlbein, Julia, O. Thomas Raab, A. Zink, O. Bens and R. F. Hüttl (2010): Agricultural recultivation of brown coal mining areas – initial soil physical properties after site construction. 19th World Congress of Soil Science, Soil Solutions for a Changing World (DVD).
- Lončar S., M. Đurović M. Trbić N. Malić (2009): Presek dugoročnog planare kultivacije površinskih kopova ugljenog basena Stanari, Zbornik radova VIII međunarodne konferencije – Nemetali Vrujci, str. 126-133.
- Podwojewski, P., J. L. Janeau and Y. Leroux (2008): Effects of agricultural practices on the hydrodynamics of a deep tilled hardened volcanic ash–soil (Cangahua) in Ecuador. *CATENA*, Vol. 72, Issue 1, pp. 179-190.
- Resulović, H., H. Čustović, I. Čengić (2008): Sistematika zemljišta (nastanak, svojstva i plodnost), Univerzitet u Sarajevu: Poljoprivredno-prehrambeni fakultet Sarajevo, 149-162.
- Veselinović, D. (2010): Fizičko-hemijski osnovi zaštite životne sredine (Knjiga I: Stanja i procesi u životnoj sredini, Univerzitet u Beogradu, Fakultet za fizičku hemiju, Beograd, p.131-162.

- Hristov, N., N. Mladenov, A. Kondić-Špika, S. Štatkić, N. Kovačević (2008): Direktni i indirektni efekti pojedinih svojstava na prinos zrna pšenice. *Ratartstvo i povrtarstvo*, 2008, vol. 45, br. 2, p. 15-20
- Pavićević, Ljubo (1988): O nastanku pšenice, njenom unapređenju i počecima gajenja u našoj zemlji. *Crnogorska Akademija nauka i umetnosti. Glasnik Odeljenja prirodnih nauka*, 6, 1988. Podgorica, CG, UDK 633.11 (497.1), 19-36.
- Popovic Vera (2010): *Agrocultural and agroecological practices on seed production of wheat, maize and soybean*. Ph.D. Doctoral dissertation, University of Belgrade, Faculty of Agriculture, Zemun, 1-145, 62-65.
- Popovic Vera, Sikora V., Ikanovic J., Rajičić Vera, Maksimović L., Mickovski Stefanovic V., Katanski S. (2013a): Production, productivity and quality of buckwheat in organic growing systems in course environmental protection, 17th International Eco-Conference[®], 10th Eco-Conference on Environment protection of urban and suburban settlement, Novi Sad, Serbia, 25–28.09.2013. ISBN 978-86-83177-46-2,
- Rodríguez-Quijano, Marta, et al. (2010). Allelic Variation and Geographical Patterns of Prolamins in the USDA-ARS Khorasan Wheat Germplasm Collection. *Crop Science* 50 (6): 2383–91. DOI:10.2135/cropsci2010.02.0089.
- Sacks, Gordon (2005): Kamut: A New Old Grain. *Gastronomica* 5 (4), pp. 95–98.
- Stallknecht, G. F., K. M. Gilbertson, and J. E. Ramey (1996): Alternate wheat cereals as food grains: Einkorn emmer, spelt, kamut, and triticale. p. 156–170. In: J. Janick (ed.), *Progress in new crops*. ASHS Press, Alexandria VA.
- *STATISTICA 12.0 (2009), StatSoft. University Licence, University of Novi Sad, Serbia
- Zhelceva-Bogdanova, Elena (1995): Technology for recultivation of areas damaged by the mining industry by applying fertilizers and sideration. Third Ministerial Conference Environment for Europe, pp. 46.

EFFECT OF MODIFIED ATMOSPHERE PACKAGING ON QUALITY OF FRESH PROCESSED TUNISIAN POMEGRANATE ARILS CV. GABSI

Mouna BEN AMARA*, Raoudha KHANFIR, Sabrine ABDELLI, Jameleddine BEN ABDA

Higher Agronomic Institute of Chott-Meriem – Sousse University- Tunisia

*Corresponding author: benamaramouna@gmail.com

Abstract

Tunisia is a major producer of pomegranate fruit; many varieties are cultivated such as Jbeli, Gabsi, Khalledi, Tounsi, Zaghouani, and Zehri. Gabsi is the important commercial variety. The valorisation of this type of fruit as fresh cut produce could be an important alternative for many pomegranate varieties. The objective of the present work is to study the aptitude of *Gabsi* variety to be commercialized as fresh cut fruit and to determine the postharvest shelf life. Fresh arils were hand extracted; chlorine disinfected, rinsed and dried then packed in polyethylene bags. Treatments were passive modified atmosphere packaging (MAP), enriched CO₂ MAP and control, each one had three replicates. Quality evaluation was assessed on days 5 and 10. Weight loss, luminosity (L*), redness (a*), Chroma (C), Hue angle (H), firmness, titratable acidity (TA), Total soluble solids (TSS), pH and anthocyanins content were determined and a sensorial evaluation was done. MAP treatment reduced significantly arils weight loss, increased C, a* and hue angle (H) parameters compared to control. Arils firmness was not significantly affected by MAP and enriched CO₂-MAP. MAP Treatments had not significant decrease in TSS and pH, an increase of TA and total anthocyanins in MAP. No significant changes were observed for all treatments in sensory analysis and did not affect the eating quality. For an acceptable quality attributes of ready to eat *Gabsi* pomegranate arils a storage conditions with MAP or CO₂-MAP at 4°C and a postharvest shelf life for 10 days were achieved.

Keywords: *Pomegranate arils, MAP, quality, postharvest shelf life*

Introduction

Pomegranate (*Punica granatum* L.) fruit consumption is growing due to its unique sensory and nutritional properties coupled with medicinal benefits attributed to high content of antioxidant.

Pomegranates constitute a typical product of many Mediterranean countries such as Tunisia, which present huge variety diversification for this fruit. Gabès is the major governorate of variety cultivation and production under the oasis system. The important commercial variety is Gabsi which is fully mature from October.

Minimally processed pomegranate arils have high economic importance due to their benefits and their desirable sensory characteristics as compared to whole produce, which poses difficulties in extracting arils (Artès *et al.*, 2007).

Modified atmosphere packaging (MAP) is a postharvest tool used to preserve quality of several whole and minimally processed fruit and vegetables. MAP combined with low temperature storage has been successfully used to extend the shelf life of many fresh fruits and vegetables. Thereby maintaining packaged produce freshness, quality attributes and microbial safety (Banda *et al.*, 2015). Ready to eat pomegranate arils have become many interested due to their convenience, sensory attributes and health benefits. However maintaining pomegranate arils is a major challenge, since it loose quality attribute easily such as texture and colour together with an

increase in microbial spoilage (Caleb *et al.* 2012). Otherwise shelf life of pomegranate arils is shorter than whole fruit. While the latter can be stored for 3 to 4 months at temperatures below 10 °C, pomegranate arils have a shelf life of 1 to 2 weeks when stored under 5 °C. Modified atmosphere and cold storage could extend the shelf life of minimally processed pomegranate arils.

The aim of the present study is to determine the effect of two different packaging atmospheres on the quality attributes of minimally processed pomegranate arils (cv. Gabsi).

Materials and methods

Sample preparation and packaging

Pomegranate fruits (cv. *Gabsi*) were harvested at commercially ripened stage in October 2015. They were purchased from a farm in Tastour-Tunisia. Fruit free from visible physical defects and with healthy outer skins and uniform in size and appearance were selected. Husks were carefully cut with shrap knives and arils were manually extracted.

Arils were collected in a tray, washed in chlorine solution ($100\mu\text{L L}^{-1}$) for 3 minutes and further rinsed in tap water, drained and excess water removed from arils with paper towels. Approximately 200 g of fresh arils were filled in trays and packaged with polyethylen plastic film 'ZOEPAC' supplied by 'Deccoiberica postcoscha, Valencia, Spain'.

Arils were divided in 3 lots for the following treatments: Control, Modified atmosphere packaging (MAP), CO₂ enriched MAP (CO₂-MAP). Each treatment was tri-replicated.

A total of 18 samples were stored at 4°C using the cold facilities of the postharvest laboratory of the Higher Agricultural Institute of Chott-Mariem. Quality evaluation was carried out after 5 and 10 days.

Aril quality determination

Weight loss

To evaluate arils weight loss, three 200g samples of arils per treatment were weighed at the beginning and the end of storage. Weight loss % (WL) was calculated according to the following equation:

$$\text{WL (\%)} = \frac{\text{Initial weighted according t}}{\text{Initial weight}} * 100$$

Firmness

Firmness of individual arils was measured using fruit texture analyser model GS by compression. Averages of 20 arils were tested for each treatment. Firmness was expressed as maximum compression to reputeure arils force in Kg/cm².

Colour

Colour of arils was determined on basis of CIE L*a*b* colour system by Commission International de l' Eclairage (CIE) measured using a digital colour meter (Minolta Chroma Meter, CR-400, Japan). Calibration of the colour meter was performed against a white tile background prior to each measurement. Arils were spread to cover a petri dish and colour measurements were taken from different points of the dish. Colour parameters, lightness (L*), redness/greenness (a*) and yellowness/blueness (b*) were measured. Chroma (C) values, which indicate the quantitative attribute of colour intensity and hue angle (H) which is considered as the qualitative attribute of samples colour were calculated using equations (1) and (2) (Pathare *et al.* 2013).

$$(1) C = \sqrt{a^2 + b^2}$$

$$(2) H = \text{Arctg} \left(\frac{b}{a} \right)$$

Total soluble solids, titratable acidity and pH

Arils were juiced using a Molinex centrifuge. TSS was measured by a digital refractometer (Model PAL-1, ATAGO) expressed in °Brix. Each treatment was done in three replicates with three values for each replicate.

Titratable acidity (TA) measured by titration with 0.1 mol L⁻¹ NaOH to an end-point of pH 8.2 using a digital burette, TA was expressed as g per 100mL of pomegranate juice of citric acid. Each treatment had three replicates with two values for each replicate.

pH was measured by a pHmeter (Crison model). Each treatment had three replicates.

Total anthocyanins concentration

Total anthocyanin concentration (TAC) was quantified using the pH differential method with two buffer systems comprising of potassium chloride (pH 1, 0.025 mol L⁻¹) and sodium acetate (pH 4.5, 0.4 mol L⁻¹) (Banda *et al.*, 2015; Fawole *et al.*, 2013).

0.4 mL of juice sample was mixed with 3.6 mL of pH 1 and pH 4.5 buffers, separately. The absorbance of the mixtures was measured at 520 and 700 nm using a UV-vis spectrophotometer (ZUZI spectrophotometer Model 4201/50), after 30 min incubation. All analyses were carried out in triplicates. Results were expressed g Cyd-3-glucoside equivalent per litre of pomegranate juice (g L⁻¹). TAC was expressed as cyanidin-3-glucoside using the following equations:

$$\text{TAC} = \frac{A \cdot \text{MW} \cdot \text{DF} \cdot 100}{\epsilon \cdot l}$$

$$A = (A_{510} - A_{700})_{\text{pH } 1.0} - (A_{510} - A_{700})_{\text{pH } 4.5}$$

Where A = absorbance (nm), ϵ = 26,900 molar extinction coefficient, MW = molecular weight of Cyd-3-glucoside (449.2 g mol⁻¹), DF = dilution factor and L = cell path length (1 cm).

Sensory evaluation

Sensory evaluation of pomegranate arils was performed during storage (5 and 10 days) by a sensory panel of 10 untrained panelists. Panelists were asked to evaluate colour, taste, aroma, richness in sugars, acidity, and product acceptability using a 9-point scale. Scores of 5 and above were considered as acceptable for commercial purposes. Overall product acceptability was scored on a 9-point hedonic scale where 9 corresponded to extremely liked and 1 corresponded to extremely disliked.

Statistical analysis

Data were analysed using the General Linear Model of SPSS (version 18.0) statistical package. Multifactor analysis of variance was conducted. Tukey test was used to perform post-hoc evaluations, when F-values were significant at the $p < 0.05$, mean differences were separated by the least significant difference procedure.

Results and discussion

Weight loss

The effect of MAP treatments was significant on the weight loss. Arils weight had lower loss with MAP and CO₂-MAP (weight loss did not exceed 1.2%) compared to the control (approximately 12%) (Table 1). Arils packed with MAP or with CO₂-MAP at 4°C had no significant difference after 5 and 10 days of storage.

Caleb *et al* (2013) studied the effect of modified atmosphere packaging and storage temperature on volatile composition and postharvest life of minimally processed pomegranate arils (cvs. ‘Acco’ and ‘Herskawitz’, under 5°C storage conditions MA-packaged ‘Acco’ and ‘Herskawitz’ pomegranate arils were best kept than at 10 and 15°C.

The observed increase in weight could be associated with the evaporation of moisture from the aril surface and initial condensation inside the package.

The use of polymeric films in MAP serves as a mechanical barrier to the movement of water vapour and helps to maintain a high level of relative humidity within package, and reduce produce weight loss (Caleb *et al.*, 2013).

Table 1. Effect of MAP treatments on weight loss (WL)

Days	5			10		
WL (%)	Control	MAP	CO ₂ -MAP	Control	MAP	CO ₂ -MAP
	5.93 ^b	0.88 ^c	0.91 ^c	12.66 ^a	1.23 ^c	1.00 ^c

Firmness of arils

Firmness of arils decreased during storage. MAP treatments had no significant difference on arils firmness. Compared to control arils firmness was best kept under MAP; high arils firmness was observed for MAP on day 5 and for CO₂-MAP on day 10 of storage (Table 2).

This observation is similar to that reported by Ayhan and Esturk (2009) who observed slight or no significant change in firmness for ‘Hicaznar’ pomegranate arils stored in passive-MAP or active-MAP until day 15 at 5°C. Gimenez *et al* (2003) stated that high O₂ concentration may also contribute to loss of texture in arils packaged in MAP.

Table 2. Effect of MAP treatments on aril firmness

Days	0	5			10		
Aril Firmness (Kg/cm ²)	Initial	Control	MAP	CO ₂ -MAP	Control	MAP	CO ₂ -MAP
	0,80	0,67 ^b	0,75 ^a	0,68 ^a	0,66 ^b	0,76 ^a	0,71 ^a

Colour

MAP and CO₂-MAP had no significant influence on the changes in chromatic parameters (Table 3). Minimal change in chroma colour intensity (C), redness (a*) and hue angle (H) values were observed across packaging treatments over storage days. An increase in chroma was observed in arils packed under MAP followed by CO₂-MAP compared to control at days 5 and 10 of storage. Arils kept its redness with MAP treatments without significant difference. Hue angle had a little decrease for MAP treatments compared to control. There was no significant difference between MAP treatments for all colour parameters.

Gil *et al* (1996) reported a relatively small change in L* values for ‘Mollar’ arils packed in oriented polypropylene (OPP) bags stored at 8, 4 and 1°C for 7 day. Sepulveda *et al* (2000) observed no colour change in minimally processed ‘Wonderful’ arils stored at 4°C ± 0.5 in semi-permeable films for 14 day.

Ayhan and Esturk (2009) reported that MAP application or storage time had no significant effect on redness a* and yellowness of b*, but observed small fluctuations throughout the 18 days of storage at 5°C.

Table 3. Effect of MAP treatments on aril colour

Days	0	5			10		
	Initial	Control	MAP	CO ₂ MAP	Control	MAP	CO ₂ -MAP
C	9.02	9.19 ^a	9.78 ^a	9.53 ^a	8.67 ^b	9.12 ^a	9.34 ^a
H	20.39	24.78 ^a	24.57 ^a	24.77 ^a	22.94 ^a	22.24 ^a	23.63 ^a
a*	19.05	20.61 ^a	23.41 ^a	24.15 ^a	14.0 ^b	19.49 ^a	20.19 ^a

Total soluble solids, titratable acidity and pH

MAP had no significant effects on chemical attributes of minimally processed arils for both packaging atmospheres, except for pH on day 5 (Table 4). TSS values of arils ranged from 15.3% to 13.2% across treatments. TSS decreased by the end of the storage day. Titratable acidity (TA) ranged from 0.21 to 0.29 g 100 mL⁻¹. CO₂-MAP had lower TA on days 5 and 10 than MAP (Table 4).

Grady *et al* (2014) showed a non significant effect of packaging and storage on TA, TSS and pH of pomegranate arils juice.

Variability in pH, TA and TSS values in the studies could be attributed to the effect of increased CO₂ solubility inside the packages (Caleb *et al.*, 2013).

Table 4. Effect of MAP treatments on TSS, TA and pH of arils

Days	0	5			10		
	Initial	Control	MAP	CO ₂ -MAP	Control	MAP	CO ₂ -MAP
TSS(°Brix)	15.34	15.00 ^a	14.36 ^b	14.27 ^b	14.82 ^a	13.26 ^b	13.95 ^{ab}
TA (g 100 mL ⁻¹)	0.30	0.24 ^a	0.24 ^a	0.21 ^a	0.28 ^a	0.29 ^a	0.24 ^a
pH	3.75	3.06 ^a	2.80 ^b	3.02 ^a	2.77 ^a	2.87 ^a	2.90 ^a

Total anthocyanin

Anthocyanins are water soluble polyphenolic compounds responsible for the red colour in pomegranate fruit peel and arils (Banda *et al.*, 2015). Total anthocyanin concentration (TAC) fluctuated with storage day in MAP. Generally MAP maintained the levels of TAC compared

CO₂-MAP. In addition, higher TAC was observed in arils packaged under MAP compared to CO₂-MAP with significant difference only on day 5 of storage.

Bhatia *et al* (2013) showed that arils packed in PP bags had highest average anthocyanins content. Anthocyanins are unstable and susceptible to degradation, during processing and storage. Various factors such as processing temperature, storage conditions, application postharvest treatments, chemical nature of anthocyanins, pH, sugars, exposure to light and metals can affect the stability of anthocyanins (Maghoumi *et al.*, 2013)Table 5. Effect of MAP treatments on total anthocyanins

Days	0			5			10			
	Initial	Control	MAP	CO ₂ -MAP	Control	MAP	CO ₂ -MAP	Control	MAP	CO ₂ -MAP
TAC (g L ⁻¹)	0.95	0.66 ^{ab}	0.82 ^a	0.58 ^b	0.74 ^{ab}	0.82 ^a	0.69 ^{ab}			

Sensory evaluations

The shelf life based on overall acceptability scores was limited to 10 days for arils packaged with MAP treatments. Panelists evaluated all arils treatments with a score of 6 out of 9 which present moderate intensity for arils colour, aroma, taste, acidity and richness in sugars in day 5 of storage. However by the end of storage period (10), panelists evaluated arils below the level of acceptability due to loss in texture, colour and aroma.

Conclusion

According to the results, the use of MAP for minimally processed pomegranate arils (cv. Gabsi) had a relevant effect to maintain arils weight loss, firmness and colour. TA, TSS and pH, were not significantly affected by packaging.

Total anthocyanin content was best kept in MAP. Otherwise, in this study, using a passive MAP only or with enriched CO₂-MAP was found to have similar characteristics to maintain arils quality, product shelf life (5 days) and overall acceptability. This study provides a useful guide towards improved postharvest handling, packaging and storage of minimally processed Tunisian pomegranate arils.

Acknowledgment

The authors want to thank the Institution of Research and Higher Agricultural Education- IRESA Tunisia for the financial support.

References

- Ayhan Z., Esturk O. (2009). Overall quality and shelf life of minimally processed and modified atmosphere packaged 'ready to eat' pomegranate arils. *J. Food Sci*, vol.74, pp. 399-405.
- Artés F., Gomez P. A., Artés H. F. (2007). Physical, physiological and microbial deterioration of minimally fresh processed fruits and vegetables. *Food Sci and Technol International*, vol.13, pp.177-188.
- Banda K., Caleb O. J., Jacobs K., Opara U.L. (2015). Effect of active-modified atmosphere packaging on the respiration rate and quality of pomegranate arils (cv. *Wonderful*). *Postharvest Biol. and Technol*, vol.109, pp.97-105.
- Bhatia K., Asrey R., Varghese E. (2015). Correct packaging retained phytochemical antioxidant properties and increases shelf life of minimally processed pomegranate (*Punica granatum* L) arils Cv. Mridula. *Indian J. Sci and Industrial Research*, vol.74, pp.141-144.
- Caleb O.J., Opara U.L., Mahajan P.V., Manley M., Mokwena L., Andreas G.J., Tredoux A.G.J. (2013). Effect of modified atmosphere packaging and storage temperature on volatile

- composition and postharvest life of minimally-processed pomegranate arils (cvs. 'Acco' and 'Herskawitz'). *Postharvest Bio. Technol*, vol.79, pp.54-61.
- Caleb O.J., Opara U.L., Witthuhn C.R. (2012a). Modified atmosphere packaging of pomegranate fruit and arils: a review. *Food Bioprocess Technol*, vol.5, pp.15-30.
- Caleb O.J., Mahajan P.V., Opara U.L., Witthuhn C.R. (2012b). Modelling the respiration rates of pomegranate fruit and arils. *Postharvest Biol. Technol*, vol. 64,pp. 49–54.
- Fawole O. A., Opara U. L. (2013). Changes in physical properties, chemical and elemental composition and antioxidant capacity of pomegranate (cv. *Ruby*) fruit at five maturity stages. *Sci. Hortic*, vol.150, pp.37-46.
- Gimenez M., Olarte C., Sanz S., Lomas C., Echavarri J. F., Ayala F. (2003). Relation between spoilage and microbiological quality in minimally processed artichoke packaged with different films. *J. Food Microbiology*, vol. 20, pp.231-242.
- Gil M. I., Martinez J. A., Artés F. (1996). Minimally processed pomegranate seeds. *Lebensm-Wiss-Technol*, vol.29, pp.708-713.
- Grady L., Sigge G., Caleb O. J., Opara U. L. (2014). Effects of storage temperature and duration on chemical properties, proximate composition and selected bioactive components of pomegranate (*Punica granatum* L.) arils. *LWT and Food Science and Technology*, vol.57, pp.508-515.
- Maghoubi M., Gómez P.A., Artés H. F., Mostofi Y., Zamani Z., Artés F. (2013). Hot water, UV-C and superatmospheric oxygen packaging as hurdle techniques for maintaining overall quality of fresh-cut pomegranate arils. *J. Sci. Food Agric*, vol.93, pp.1162-1168.
- Pathare P. B., Opara U. L., Al-Said F. A. (2013). Colour measurement and analysis in fresh and processed foods: a review. *Food and Bioprocess Technology*, vol.6, pp.36-60.
- Sepulveda E., Galletti L., Saenz C., Tapia M. (2000). Minimal processing of pomegranate var. *Wonderful*. *CIHEAM-Opitions Mediterr*, vol. 42, pp.237–242.

THE VARIATION OF SOME SOIL TRAITS UNDER LEGUME X CEREALS MIXTURE AND SILAGE CORN ROTATION

Erdem GULUMSER^{1*}, Zeki ACAR²

¹Bozok University, Faculty of Agriculture, Department of Field Crops, Yozgat, Turkey

²Ondokuz Mayıs University, Faculty of Agriculture, Department of Field Crops, Samsun, Turkey

*Corresponding author: erdem.gulumser@bozok.edu.tr

Abstract

This study was conducted to determine some soil traits under legume (*Vicia pannonica* Crantz) x cereals mixtures (*Hordeum vulgare* L., *Triticum aestivum* L. and *Triticosecale* Wittmack) and silage corn rotation during 2013-2014 and 2014-2015 growing seasons. The experiment was conducted in the experimental field of Bozok University in Yerkoy-Yozgat (Middle Anatolia, Turkey). The firstly of Hungarian vetch (*Vicia pannonica* Crantz) and cereals (*Hordeum vulgare* L., *Triticum aestivum* L. and *Triticosecale* Wittmack) were sown as binary mixtures with different seed rates (100:0 70:30, 60:40, 50:50 and 40:60) and harvested at different stage (flowering and milk dough stages) as forage. Then silage corn was sown. The experiment was planned in split plot-design with four replications, main plots were cutting time and sub plots were mixture ratio. Soil samples were taken 30 cm deep and by three different points of each treatment analyzed to fallow traits; nitrogen, organic matter, phosphorus, potassium, salt and lime content. According to results, soil samples that beginning of experiment was more different than at the end of study. Nitrogen and organic matter of soil did not change after Hungarian vetch+cereals mixtures, while they decreased after silage corn. Phosphorus content of the soil decreased continuously during the trial.

Key words: *Hungarian vetch, cereals, silage corn, rotation, soil.*

Introduction

The mixed cropping of legumes with cereals may affect the growth rate of individual species in mixtures as well as forage yield and quality. Incorporation of legume with cereal could be of importance for nutritive value forage mixture and also to subsequent soil health. Inclusion of legumes into crop rotation increases organic matter and nitrogen content in the soil. Increased levels of soil organic matter enhance water and nutrient retention, and decreases synthetic fertilizer requirements. Therefore, smaller amounts of nitrogen fertilizers are necessary in legumes cultivation.

In legume-cereal intercropping systems, the amount of nitrogen by fixed legumes depends on legume species, morphology, type of growing and competition with cereals (Ofori and Stern, 1987). The fixed Nitrogen by legumes are used by cereals during the growing season and it's may be meet the potential demand of following crop. According to Heichel (1978) and Pimentel et al. (1978), continuous rotation of corn and soybean cannot be sustained without substantial additions of fertilizers. Also, N over application results in environmental contamination through nitrate, N runoff or leaching that making nitrate the most common contaminant of the soil and ground water.

Crop rotation is a key principle of agricultural sustainability and has many benefits in improves soil structure, prevent erosion, reduces soil degradation, reduces risks of water-logging, water

supply to soil during droughts. Organic matter, total N, pH, salinity, lime content and soil aggregation are important indicators of dynamic soil quality because they are responsive to changes in soil management (Wander, 2004).

So, these traits should be determined and well known. The objective of the study was to determine the changing of some traits in soil under legume x cereals mixtures and silage corn rotation.

Material and methods

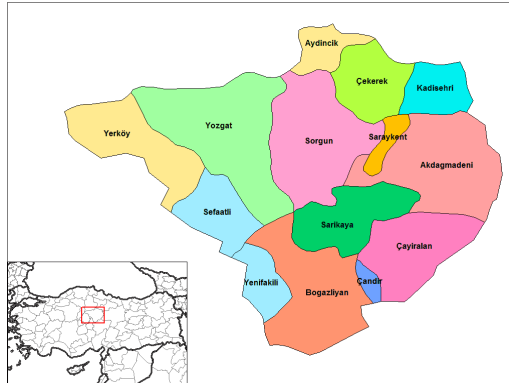

This study was conducted to determine the effects of legume x cereals mixtures and silage corn rotation on some soil traits under during 2013-2014 and 2014-2015 growing seasons. The experiment was conducted in the experimental field of Bozok University in Yerkoy-Yozgat (Turkey) (34° 28' 0" E, 39° 37' 0" N) with the altitude of 774 m above sea-level. The annual precipitation and mean temperature are 574.4 mm and the 9 °C respectively (Table 1).

Fig. 1. Map of Yerkoý District (Turkey)

Firstly, Hungarian vetch (*Vicia pannonica* Crantz) and cereal (*Hordeum vulgare* L., *Triticum aestivum* L. and *Triticosecale* Wittmack) were sown as binary mixtures with different seed rates (100:0 70:30, 60:40, 50:50 and 40:60) and harvested at different stage (flowering and milk dough stages) as forage. Then silage corn was sown. The experiment was planned in split plot-design with four replications, main plots were cutting times and sub plots were seed ratio. Soil samples taken 30 cm deep and by three different points of each treatment were analyzed in Turkish chamber of agriculture cooperation for organic matter, nitrogen, phosphorus, potassium, salt and lime content.

Table 1. Climatic conditions in experimental area.

Months	Long-term			2013-2014			2014-2015		
	Temp. (°C)	Moist. (%)	Precip. (mm)	Temp. (°C)	Moist. (%)	Precip. (mm)	Temp. (°C)	Moist. (%)	Precip. (mm)
October	10.3	65.9	36.5	9.0	55.4	22.1	10.8	69.3	72.6
November	4.6	72.5	56.2	6.5	67.2	36.5	4.2	70.2	61.3
December	0.5	77.3	76.3	-2.9	71.0	25.1	4.1	77.9	53.3
January	-1.9	77.5	67.9	1.4	75.5	58.7	-1.0	76.7	54.5
February	-1.0	75.8	62.3	3.3	61.9	17.6	0.8	73.3	68.0
March	2.9	71.0	65.2	5.6	63.5	116.7	4.4	69.5	115.3
April	8.3	66.6	62.3	11.0	53.4	31.6	6.1	61.9	28.0
May	13.0	64.2	65.0	13.3	60.4	121.3	14.1	59.9	131.6
June	16.8	60.5	43.5	16.6	56.0	79.8	16.0	71.5	95.3
July	19.7	56.8	12.3	21.5	43.2	3.7	19.8	54.7	7.1
August	19.6	55.7	8.9	22.4	43.5	27.1	21.3	56.7	5.4
September	15.5	58.1	18.0	14.5	58.1	28.2	20.1	49.4	24.7
Average	9.0	66.82		10.18	58.65		10.05	65.91	
Total			574.4			568.4			717.1

*Tukish State Meterological Service

Table 2. Analyze of soil standards.

Soil Traits	Standard measure	Meaning	Soil Traits	Standard measure	Meaning
Soil reaction (pH)	> 4.5	Strong acid	Soil salinity	0.0-0.15	Saltless
	4.6-5.5	Middle degree acid		0.15-0.35	Light
	5.6-6.5	Light degree acid		0.35-0.65	Middle
	6.6-7.5	Neutral		0.65+	High
	7.6-8.5	Light alkali			
	8.5+	Strong alkali			
Organic matter (%)	0-1	Very little	Nitrogen (%)	>0.05	Insufficiently
	1-2	Little		0.05-0.10	Middle
	2-3	Middle		0.10-0.15	Good
	3-4	Good		0.15+	Sufficiently
	4+	High			
Phosphorus (kg/da)	0-3	Very little	Potassium (kg/da)	0-20	Little
	3-6	Little		20-30	Middle
	6-9	Middle		30-40	Sufficiently
	9-12	Good		40+	High
	12+	High			
Lime (%)	0-1	Little			
	1-5	Limey			
	5-15	Middle			
	15-25	Much			
	25+	Too much limey			

Results and discussion

According to results, organic matter of soil samples that beginning (1.91%) of experiment was higher than at the end of study (1.53%) (Table 3). These results can be attributed to intensive tillage during the experiment. Oxygen entering into soil with tillage promotes the organic material consumption by the microorganism and results its reduction (Doran and Smith, 1987).

The effect of Hungarian vetch+cereals mixtures on soil organic matter content was not high; however, it significantly reduced after silage corn (Table 3 and Fig. 2). Degradation of the Hungarian vetch + cereals residue in soil is slow (Saglam, 1997). However, silage corn is a hoe plant irrigated during vegetation and these treatments accelerates degradation and organic matter content (Kavut and Geren, 2015).

As seen in table 3, initial nitrogen content of soil, is 0.095% was 0.0763% by decreasing at the end of study (Fig. 3). The nitrogen content of the soil decreased after corn is an expected result. But the reduction in nitrogen after legume-cereal mixtures is quite interesting. This might be attributed to the high organic matter in soils at the beginning. It is highly possible. Because the experiment area was fallowed previous three years with no cultivation. In fact, the second year data explained this situation with the increase in soil N content after Legume x cereal mixtures and also with the decrease after corn. The variation of organic matter and N content in soil was in line between first and second cutting time.

Hungarian vetch + cereals mixture of organic matter and nitrogen ratio that second cutting time was higher than at the first cutting time. It may be due to vegetation period. Vegetation period is long especially legumes give more organic matter and nitrogen to the soil (Kara *et al*, 2011).

Table 3. Traits of experimental soil.

Soil traits	Means	Beginning	2013-2014		2014-2015	
			HV+C	SC	HV+C	SC
Organic matter content (%)	First cutting	1.91	1.70	1.35	1.68	1.58
	Second cutting	1.91	1.72	1.31	1.69	1.47
	General mean	1.91	1.71	1.33	1.68	1.53
Nitrogen content (%)	First cutting	0.095	0.0843	0.0676	0.0805	0.0787
	Second cutting	0.095	0.0863	0.0656	0.0825	0.0739
	General mean	0.095	0.0853	0.0666	0.0815	0.0763
Phosphorus content (kg/da)	First cutting	8.62	4.82	3.18	2.04	0.92
	Second cutting	8.62	6.48	3.15	2.04	0.97
	General mean	8.62	5.65	3.17	2.04	0.95
Potassium content (kg/da)	First cutting	48.47	47.88	54.65	48.47	50.40
	Second cutting	48.47	49.07	59.53	50.35	50.50
	General mean	48.47	48.48	57.09	49.41	50.45
Salt content (%)	First cutting	0.018	0.0145	0.0211	0.0101	0.0159
	Second cutting	0.018	0.0136	0.0158	0.0103	0.0137
	General mean	0.018	0.0145	0.0211	0.0101	0.0159
pH content	First cutting	8.20	8.48	8.51	8.22	8.10
	Second cutting	8.20	8.43	8.61	8.42	8.22
	General mean	8.20	8.46	8.56	8.32	8.16
Lime content (%)	First cutting	7.93	8.75	9.54	9.55	8.93
	Second cutting	7.93	9.48	9.72	9.81	8.88
	General mean	7.93	8.75	9.54	9.55	8.93

HV:Hungarian vetch, C:Cereals, SC:Silage corn

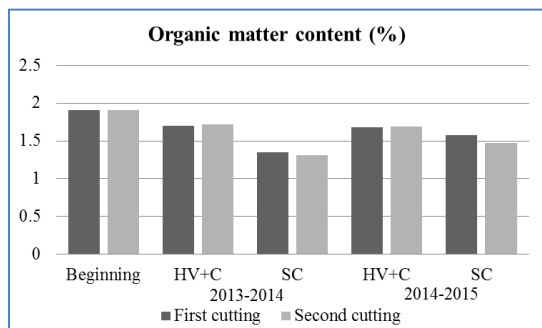

Fig. 2. Change of organic matter content in experiment soil during the trail.

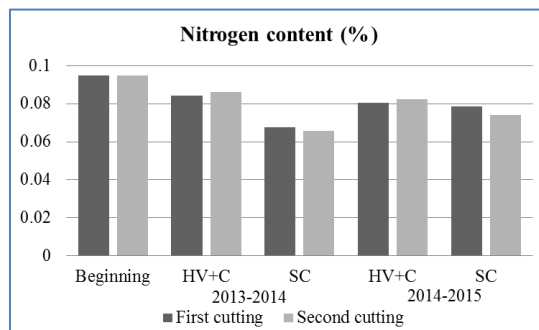

Fig.3. Change of nitrogen content in experiment soil during the trail

Phosphorus is known to be second limited mineral in the cultivated soils of the arid and semi-arid regions after nitrogen. If phosphorus not sufficient in soil, absorption of other minerals were adversely affected. Phosphorus content of experiment soil is middle degree (Table 2) and it was 8.62 kg/da at beginning of the experiment. Phosphorus content of the soil decreased continuously during the trial (Table 3). This result can be explained with substantially Phosphorus consumption of plant and also with fixed Phosphorus by soil. Contract to Phosphorus, Potassium content of experiment soil was high and it did not changed during the trial (Table 3 and Fig. 5). Salt content of the experiment soil was decreased after Hungarian vetch+cereals mixtures, while it increases after silage corn (Table 3 and Fig. 7) it can be connected with irrigation or the salt reached to surface by dissolving due to irrigation and high evaporation (Dolarslan and Gul, 2012).

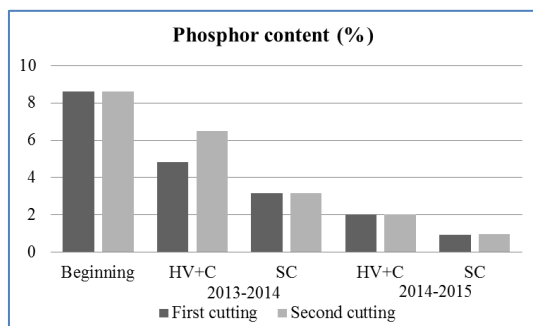

Fig. 4. Change of phosphorus content in experiment soil during the trail.

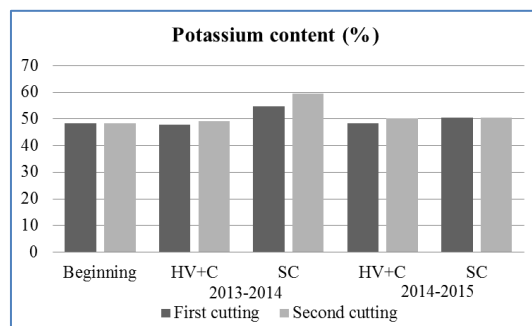

Fig. 5. Change of potassium content in experiment soil during the trail.

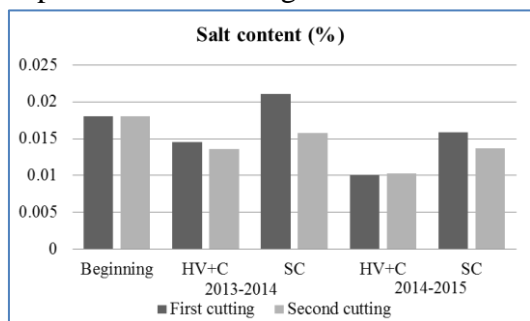

Fig. 6. Change of salt content in experiment soil during the trail.

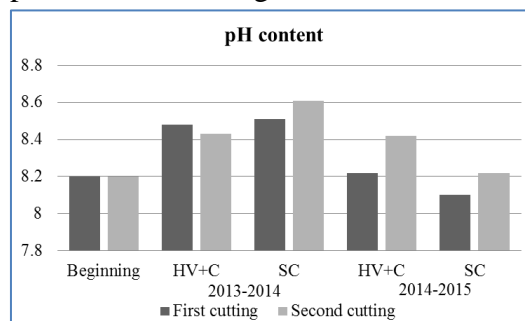

Fig. 7. Change of salt content in experiment soil during the trail.

The pH content of experiment soil is light alkali (Table 2). Arid and semi-arid soils exhibits generally alkaline characters, which are mostly result of insufficient precipitation for leaching the soluble salt in the present experiment pH did not change significantly among treatments and years.

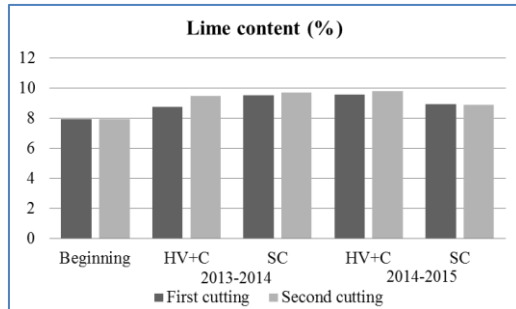

Fig. 8. Change of lime content in experiment soil during the trail.

The lime content of experiment soil is middle degree in both years (Table 2). Final lime content of soil was higher than that was at the beginning (7.93%) (Table 3 and Fig. 8). Saglam, (1997) reported that high root residue in intense agricultural regions can be results to increase in lime content of soil. So, the increase in lime content in the present study may be connected with increase root biomass after Hungarian vetch + cereals and silage corn rotation.

Conclusion

Crop Rotation helps maintain the agriculture and soil healthy for a long time. Crop rotation, especially legume-cereal rotation is crucial for sustainability. When legumes are part of the rotation, they fixes nitrogen, therefore, supply the nitrogen for following crop and decrease chemical fertilizer uses. In addition crop rotation ameliorates soil physical traits, organic matter content and aggregation. This study showed that Hungarian vetch + cereals and silage corn rotation resulted significant changes and also present study indicated that the effect of crop rotation on soil highly depend on general characters of climate and soil.

References

- Doran, J.W., Smith, M.S., 1987. Organic matter management and utilization of soil and fertilizer nutrients. In: Follett, et al. (Eds.), *Soil Fertility and Organic Matter as Critical Components of Production Systems*. SSSA and ASA, Madison, pp. 53–72.
- Dölarıslan, M., Gül, E., 2012. Soil Plant Interaction in Regard to Salinity. *Turkish Journal of Scientific reviews*. 5(2): 56-59.
- Heichel, G.H. 1978. Stabilizing agricultural energy needs: Role of forages, rotation, and nitrogen fixation. *J. Soil Water Conserv.* 33:279–282.
- Kara, B., Kara, N., Akman, Z., Balabanlı, C., 2011. The value of previous crops and effects crop rotation of field crops. *Journal of Batı Akdeniz Agricultural Research Institute*, 28 (1): 12-24.
- Kavut, Y. T., Geren, H., 2015. The Effects of Different Previous Crop and Sowing Date on the Yield and Some Quality Characteristics of Silage Corn (*Zea mays* L.) *Turkish Journal of Agricultural and Natural Sciences* 2(2): 163–170.
- Ofori, F. and W.R. Stern, 1987. Cereal-legume intercropping systems. *Adv. Agron*, 41: 41-49.
- Pimentel, D., J. Krummel, D. Gallahan, J. Hough, A. Merrill, I. Schreiner, P. Vittum, F. Koziol, E. Back, D. Yen, and S. Fiance. 1978. Benefits and costs of pesticide use in U.S. food production. *Bioscience* 28:772–784.
- Saglam, M.T., 1997. *Soil of Chemistry*. Trakya University, Journal of Faculty Agriculture. 190. Textbook, 21.

Temel, A., Keskin, B., Yıldız, V., 2015. Investigation of Dry Hay Yield and Quality Characteristics of Common Vetch (*Vicia sativa* L.) Cultivars for in Iğdir Plain Download Conditions. Iğdir Univ. J. Inst. Sci. & Tech. 5(3): 67-76.

Wander, M.M. (2004) in Advances in agroecology, Soil organic matter fractions and their relevance to soil function, eds Magdoff F., Weil R. (CRC Press, Boca Raton, FL), pp 67–102.

TOTAL PHENOLIC CONTENT AND ANTIOXYDANT ACTIVITY OF RHODODENDRON SPECIES COLLECTED FROM THE RİZE PROVINCE (TURKEY)

Aysel ÖZCAN, Emine YURTERI, Fatih SEYİS*

Field Crops Department, Faculty of Agriculture and Natural Sciences, Recep Tayyip Erdogan University,
Rize, Turkey

*Corresponding author: fatih.seyis@erdogan.edu.tr

Abstract

Rhododendron species (mountain laurel) are deciduous or evergreen shrubs commonly used as garden plants worldwide. Six Rhododendron species, one of which (*R. smirnovii*) is endemic, grow naturally in Turkey, especially in the northeastern Anatolia (Black Sea region). Turkish Rhododendron species grow naturally from sea level to altitudes of 2500 (3100) m. They take the form of shrubs (*R. luteum* Sweet), dwarf shrubs (*R. caucasicum* Pallas) and large shrubs (*R. ponticum* L., *R. ungeronii* Trautv., *R. smirnovii* Trautv.). Rhododendron samples obtained from Rize province (Turkey) were screened for total phenolic content by the modified Folin–Ciocalteu method, for potential antioxidant activity using phospho-molybdenum assay and by the 1,1-diphenyl-2-picryl hydrazyl (DPPH) and FRAP method for antiradical activity. Total phenolic content and antioxidant activity plant parts (flower, leaf) of two Rhododendron species, namely *Rhododendron luteum* L. and *Rhododendron ponticum* L. were determined. The total phenolic content of leaves of *Rhododendron luteum* L. collected from different altitudes ranged between 112,363 and 219,071 mg GAE/gr DW. Total phenolic content of flower parts of the same species ranged between 82,275 and 201,642 mg GAE/gr DW. The total phenolic content of different parts of *Rhododendron ponticum* L. were higher compared with *Rhododendron luteum* L. On the other side, the antioxidant activity values of leaf parts of *Rhododendron luteum* L. were lower compared with flower parts and like the phenolic content the antioxidant activity values of *Rhododendron ponticum* L. parts were higher compared with *Rhododendron luteum* L.

Keywords: Rhododendron, phenols, antioxidant activity

Introduction

According to Metcalfe and Chalk (1950) Ericaceae, particularly Rhododendron L. is widely distributed, but species are numerous especially in China and South Africa. Rhododendron species are distributed in China, Tibet, Burma, Nepal, New Guinea, Tropical Asia, Europe and North America. There are about 700 species in these regions (Heywood, 1978; Davidian, 1989). Suzuki and Ohba (1988) stated that habitats of Rhododendron species show a wide range, from low montane forests to alpine regions more than 4000 m high. These species are usually shrubs and tall trees about 30 m high and 100 cm in diameter in Nepal. In Turkey, the ones distributed from sea level to about 3200 m, are usually large shrubs (*R. ponticum* L., *R. ungeronii* Trautv.), shrubs (*R. smirnovii* Trautv., *R. luteum* Sweet.) or dwarf shrubs (*R. caucasicum* Pallas). *R. luteum* is deciduous, and the others are evergreen shrubs. *R. caucasicum* is alpine type, and the others are forest type. Rhododendrons (*Rhododendron ponticum* L. and *Rhododendron luteum* Sweet) dominate the understories of the mesic forests of the Black Sea Region (BSR) of Turkey (Eşen *et al.*, 2006). They are deciduous short trees with green leaves and have flowers of different colours and an aesthetically important role in landscape.

Many species of the genus *Rhododendron* contain a large number of phenolic compounds and antioxidant activities that could be developed into pharmaceutical products (Qiang *et al.*, 2011). In addition, some members of the genus are already used in traditional medicine for several ailments, especially arthritis, acute and chronic bronchitis, asthma, pain, inflammation, rheumatism, hypertension, and muscle and metabolic diseases (Popescu and Kopp, 2013; Iwata *et al.*, 2004; Li *et al.*, 2011; Wu and Li, 2011; Fu *et al.*, 2012). The total phenolic content and antioxidant activity of flower and leaf parts of *Rhododendron luteum* and *Rhododendron ponticum* collected from different altitudes were investigated in this study.

Materials and methods

The research material was collected during 2016 in the Çat district of the Rize province (Turkey). The information of investigated material is given in Table 1.

Table 1: Collection site of *Rhododendron* species

Species	Definition	Altitude	Analysed part
<i>Rhododendron luteum</i>	SK- 1 (L)	749 m	Leaf (L)
<i>Rhododendron luteum</i>	SK-1 (F)	749 m	Flower (F)
<i>Rhododendron luteum</i>	SK-2 (L)	968 m	Leaf (L)
<i>Rhododendron luteum</i>	SK-2 (F)	968 m	Flower (F)
<i>Rhododendron luteum</i>	SK-3 (L)	980 m	Leaf (L)
<i>Rhododendron luteum</i>	SK-3(F)	980 m	Flower (F)
<i>Rhododendron luteum</i>	SK-4 (L)	1062 m	Leaf (L)
<i>Rhododendron luteum</i>	SK-4 (F)	1062 m	Flower (F)
<i>Rhododendron ponticum</i>	MK-1 (L)	740 m	Leaf (L)
<i>Rhododendron ponticum</i>	MK-1 (F)	740 m	Flower (F)
<i>Rhododendron ponticum</i>	MK-2 (L)	980 m	Leaf (L)
<i>Rhododendron ponticum</i>	MK-2 (F)	980 m	Flower (F)
<i>Rhododendron ponticum</i>	MK-3 (L)	1107 m	Leaf (L)
<i>Rhododendron ponticum</i>	MK-3 (F)	1107 m	Flower (F)

- All samples were collected from Çat district, Rize/Turkey

Chemical Analysis

Total Phenolic content

The total phenolic content of collected samples were determined using UV-Vis spectrophotometer as mg GAE/gr DW.

Antioxidant activity

The FRAP assay was used to determine the antioxidant activity of collected samples as mg FSO₄/gr DW.

Statistical analysis:

Principal component and Biplot analysis was used to distinguish the collected samples regarding analysed characteristics (Backhaus *et al.*, 1989). Principal component and Biplot analysis was

performed using XLSTAT2016 Trial Version. The calculated first two Principal Components are corresponding in % to the present variation regarding the investigated traits.

Results and discussion

The obtained total phenolic contents and antioxidant activity values of collected samples are given in Table 2 and Fig. 1. As can be seen in Table 2, the total phenolic content of leaves of *Rhododendron luteum* increased generally with increasing altitudes. The same can be remarked for the flower parts of the same species with increasing altitude. In case of antioxidant activity the determined levels were lower in leaf parts of this species compared with the flower parts.

In *Rhododendron ponticum* also the total phenolic content and antioxidant activity increased up to 980 m altitude, then both values decreased at 1107 m altitude in leaf and flower parts of this species. The determined values for both traits were in leaf parts higher compared with flower parts of this species. If we compare both species, the total phenolic contents and antioxidant activities of leaf and flower parts of *Rhododendron ponticum* was higher compared with *Rhododendron luteum* (Table 2 and Fig. 1).

Table 2: Total phenolic contents and antioxidant activity values of collected samples

Species	Definition	Altitude	Total phenolic content (mg GAE/gr DW)	Antioxidant activity (mg FSO ₄ /gr DW)
<i>Rhododendron luteum</i>	SK- 1 (L)	749 m	188,228	22,191
<i>Rhododendron luteum</i>	SK-1 (F)	749 m	98,223	505,628
<i>Rhododendron luteum</i>	SK-2 (L)	968 m	196,874	42,400
<i>Rhododendron luteum</i>	SK-2 (F)	968 m	82,275	561,896
<i>Rhododendron luteum</i>	SK-3 (L)	980 m	112,363	106,990
<i>Rhododendron luteum</i>	SK-3(F)	980 m	146,398	201,300
<i>Rhododendron luteum</i>	SK-4 (L)	1062 m	219,071	463,624
<i>Rhododendron luteum</i>	SK-4 (F)	1062 m	201,642	768,744
<i>Rhododendron ponticum</i>	MK-1 (L)	740 m	230,580	933,192
<i>Rhododendron ponticum</i>	MK-1 (F)	740 m	213,974	1062,769

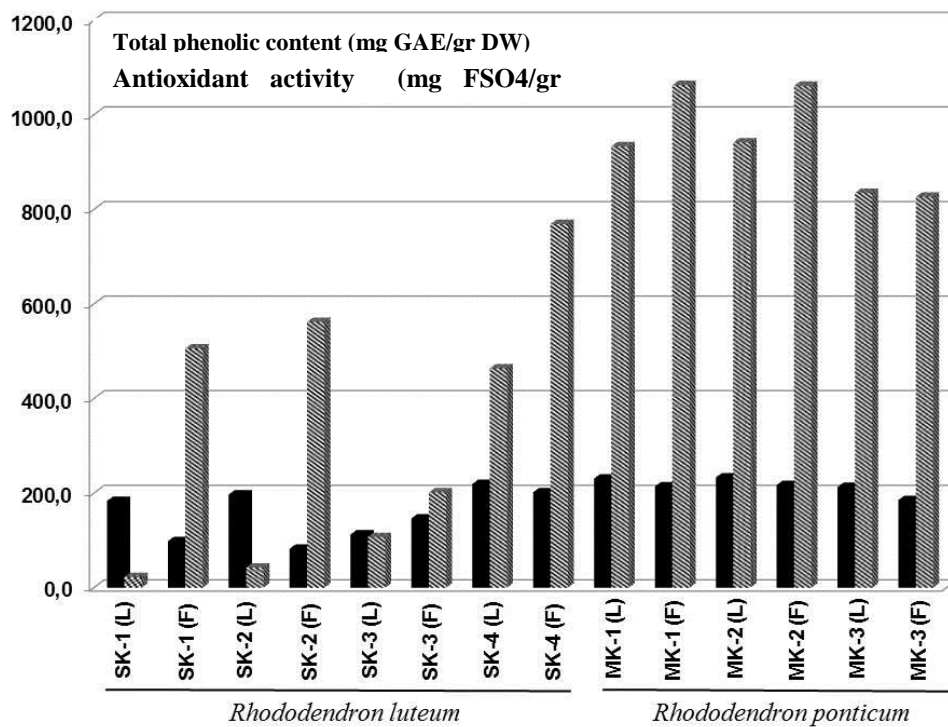

Fig. 1. Comparison of total phenolic contents and antioxidant activity values of collected samples

As can be seen in Fig. 2 the investigated samples of *Rhododendron luteum* could be clearly separated from the leaf and flower samples of *Rhododendron ponticum*. Especially the higher total phenolic contents and higher antioxidant values of *Rhododendron ponticum* samples led to this clear diversification.

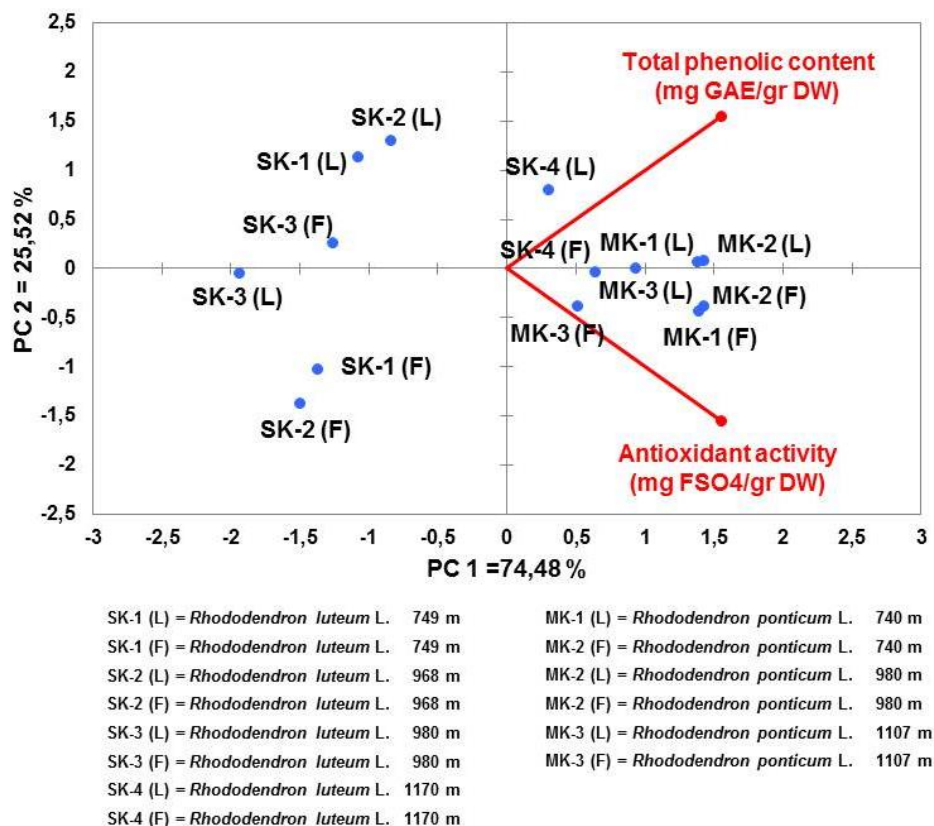

Fig. 2: Biplot analysis of different parts of *Rhododendron* species based on their phenolic contents and antioxidant activity values

Environmental factors, such as soil composition, temperature, rainfall and ultraviolet radiation incidence can affect the concentrations of phenolic compounds (Kouki and Manetas, 2002; Monteiro *et al.*, 2006). Among phenolic compounds, the tannins can be influenced by development of the plant and by environmental changes (Hatano *et al.*, 1986; Salminen *et al.*, 2001). Thus, phenolic compounds and others secondary metabolites represent a chemical interface between plants and environment (Gobbo-Neto and Lopes, 2007). Changes in phenols amounts influence directly the quality of the plant for medicinal application (Santos *et al.*, 2006). Therefore it is not surprising that the collected samples differed in their total phenolic content and antioxidant activity.

Conclusion

In folk medicine, the tincture prepared from *Rhododendron* plant leaves are use to treat gout, epilepsy, headaches, insomnia, intimate and diuretic conditions, rheumatism, dysentery, sharp and chronic colic. Broth prepared from rhododendron is recommended by folk medicine as a cure against syndrome of oxygen insufficiency.

Also in general and in the study area present *Rhododendron* plants are present as deciduous short trees with green leaves and have flowers of different colours and an aesthetically important role in landscape.

In the present study only two species and two traits were analysed. Further studies should involve different species from different locations and determination of compounds which could be helpful in future studies.

References

- Alekseev B.D. (1977). Vegetative resources of Dagestan. Makhachkala. (in Russian).
- Backhaus K., Erichson B., Plinke W., Weiber R. (1989). *Multivariate Analysis Methods*. Springer Verlag. Heidelberg.
- Davidian, H. H., *The Rhododendron Species*, Timber Press, Portland Oregon, (1989).
- Eşen D., Yıldız O., Kulaç Ş., Sargıncı M. (2006). Controlling *Rhododendron* spp. in the Turkish Black Sea Region An international Journal of Forest Research. 79 (2): 177-184.
- Fu Y., Zhang L., Chen G. (2012). Far infrared-assisted extraction followed by MEKC for the simultaneous determination of flavones and phenolic acids in the leaves of *Rhododendron mucronulatum* Turcz. *The Journal of Separation Science*, vol. 35, no. 3, pp. 468–475.
- Gobbo-Neto L., Lopes NP. (2007). Medicinal plants: factors effecting seconder metabolite content. *Quim Nova* 30: 374-381.
- Hatano T., Kira R., Yoshizaki M., Okuda T. (1986). Seasonal changes in the tannins of *Liquidambar formosana* reflecting their biogenesis. *Phytochemistry* 25: 2787-2789.
- Heywood, V. H., *Flowering Plants of the World*, Oxford Univ. Press, Oxford (1978).
- Iwata N., Wang N., Yao X., Kitanaka S. (2004). Structures and histamine release inhibitory effects of prenylated orcinol derivatives from *Rhododendron dauricum*. *Journal of Natural Products*, Vol. 67, no. 7, pp. 1106–1109.
- Kouki M., Manetas Y. (2002). Resource availability affects differentially the levels of gallotannins and condensed tannins in *Ceratonia siliqua*. *Bioch Syst Ecol* 30: 631- 639.
- Metcalf CR. and Chalk L. (1950). *Anatomy of the Dicotyledons*, Clarendon Press, Oxford.
- Monteiro JM., Albuquerque UP., Lins Neto EMF., Araújo EL., Albuquerque MM., Amorim ELC. (2006). The effects of seasonal climate changes in the Caatinga on tannin level. *Rev Bras Farmacogn* 16: 338-344.
- Li Q.-Y., Chen L., Zhu Y.-H., Zhang MWang., Y.-P., Wang M.-W. (2011). Involvement of estrogen receptor-B in farrerol inhibition of rat thoracic aorta vascular smooth muscle cell proliferation. *Acta Pharmacologica Sinica*, vol. 32, no. 4, pp. 433–440.
- Popescu R., Kopp B. (2013) The genus *Rhododendron*: an ethnopharmacological and toxicological review. *Journal of Ethnopharmacology*, Vol. 147, no. 1, pp. 42–62, 2013.
- Qiang Y., Zhou B., Gao K. (2011). Chemical constituents of plants from the genus *Rhododendron*. *Chemistry and Biodiversity*, Vol. 8, no. 5, pp. 792–815.
- Salminen JP, Ossipov V, Haukioja E, Pihlaja K 2001. Seasonal variation in the content of hydrolysable tannins in leaves of *Betula pubescens*. *Phytochemistry* 57: 15-22.
- Santos SC., Costa WF., Batista F., Santos LR., Ferri PH., Ferreira HD., Seraphin JC. (2006). Seasonal variation tannins in barks of *barbatimao*. *Rev Bras Farmacogn* 16: 552- 556.
- Suzuki, M., Ohba, H., *Wood Structural Diversity Among Himalayan Rhododendron*, IAWA Bulletin n. s. Vol. 9(4), 317-326, Leiden (1988)
- Wu ZY., Li RT. (2011). Chemical constituents of the roots of *Rhododendron spiciferum*. *Natural Product Research & Development*, vol. 23, no. 2, pp. 253–257.

DETERMINING THE APPROPRIATE PLANTING TIME FOR PEANUT (*Arachis hypogaea L.*) PLANT IN CONDITIONS OF GAP REGION

Halil HATIPOĞLU^{1*}, Servet ABRAK¹, Mehmet KARAKUŞ¹, Hüseyin ARSLAN², M. Atilla GÜR³

¹ GAP Agricultural Research Institute, Şanlıurfa, Turkey

² University of Siirt, Faculty of Agriculture, Department of Field Crops, Siirt, Turkey

³ University of Harran, Faculty of Agriculture, Department of Field Crops, Şanlıurfa, Turkey

*Corresponding author: halilhhatipoglu63@hotmail.com

Abstract

This research was carried out in order to determine the suitable sowing time for peanut in the condition of GAP region (is located in Turkey's Southeast) at the GAP Agricultural Research Institute Talat Demirören Research Station in 2013-2014. Two peanut cultivars (NC-7, Halisbey) and eight different sowing dates (April 15, April 25, May 5, May 15, May 25, June 5, June 15 and June 25) were studied. Trial was conducted as split plots design with three replications. The main plots were consisted of planting dates; the sub-plots were consisted of cultivars. In the result of combined analysis of two year, the differences between sowing dates were found significant at the level of 1% in terms of capsules number per plant, seed number per plant, seed yield, protein ratio, and oil yield except 100-seed weight. As a result of two-year interaction of this research, the seed yield ranged between 489.1 kg/da and 325.4 kg/da in terms of sowing times. While the highest seed yield was obtained either from the sowing date of April 25 with 489.1 kg/da or from the sowing date of May 15 with 488.7 kg/da, the lowest capsule yield was obtained from the sowing date of June 25 with 325.4 kg/da. While the highest oil yield was obtained from the variety of NC-7 with 144.3 kg/da in the sowing date of May 5, the lowest oil yield was from the variety of Halisbey with 84.6 kg/da in the sowing date of June 25, and the highest protein ratio received from the variety of NC-7 with the 20.75 % in the sowing date of June 25.

Keywords: *GAP region, peanut, sowing date, variety, yield and yield components*

Introduction

The world's peanut production made in many countries (*Arachis hypogaea L.*) for both human nutrition or although finding large proportion of usage in livestock and various branches of industry, in our country is consumed only for as an appetizer.

Peanut seeds is a valuable source of food for humans and animals with contains oil, protein, carbohydrates, vitamins, and mineral substances. Peanut seeds contains, varies according to the variety, the rate of 44-56% oil, the rate of 22-30% protein, and 18% carbohydrate (Rowell et al., 1999). Because of easily digestible of amino acids which constituting the protein in peanut increases the nutritional value. Therefore, peanut seeds are consumed in large quantities in fresh or dry roasted snack (Arioğlu, 1999).

Tocopherol is an abundant antioxidant in Peanut oil and prevents oil from degradation by oxidation. Especially, peanut oil is mixed as proportion of 30% with diesel fuel (biodiesel) are used as fuel in the operation of diesel engines (Woodroof, 1983).

In 2013, 45.2 million tons of peanut were produced from the 25.5 million hectares of cultivation area in the world, and 141.263 tonnes were produced from the 39 943 ha in Turkey (FAO, 2013).

With the completion of Southeastern Anatolia Project, 1.7 million hectares of agricultural land will open to irrigation gradually, and the planting area and production of oil crops will also increase substantially. As envisaged in the GAP Master Plan; the share of soy bean was 10%, peanut, sunflower and sesame were 5% in crop pattern (Kolsaracı et al., 2005).

Our country is divided into natural geographical regions, each of these regions has a different climate. As a result of this, the plant species grown in the region reveals differences even in the same species plants show different reactions in different ecologies. Therefore, in our country, crop planting techniques and times constitute an important part of the researches.

The research has contributed to expand the range of cultivated crops in our region and also with providing optimal planting time for peanut in the conditions of GAP region tried to ensure value added to the region and the country's economy.

Materials and methods

Trials was carried out in the experimental field of GAP Agricultural Research Institute Talat Demirören Research Station in 2013 and 2014 years. Talat Demirören Research Station is 34 km away from downtown and located between the town of Akçakale and Şanlıurfa province. Geographical location, 36° 42' North and 38° 58' East and 410 m above sea level.

NC-7 and Halisbey peanut varieties were used. The study established in randomized complete block design split plots with with three replications. Eight different planting time (April 15, April 25, May 5, May 15, May 25, June 5, June 15 and June 25) were placed as main plots and varieties (NC-7 and Halisbey) in sub plots in the trial. The parcels; row spacing of 70 cm, intra row spacing of 20 cm and parcel row organized length of 6 m ($4 \times 0.70 \times 6 = 16.8 \text{ m}^2$) with 4 rows.

Results and discussion

Number of Pods and Seeds Per Plant

Table 1 examined; according to the average of two-year, the number of pods and seeds per plant in terms of sowing date x cultivar interaction was found significant ($p < 0.01$). While the highest number of pods per plant obtained from the variety of Halisbey with 73.9 pieces/plant on April 15, the lowest number of pods per plant obtained from the variety of Halisbey with 26.3 pieces/plant on June 25. The highest number of seeds per plant obtained from the variety of NC-7 with 86.0 pieces/plant on May 5, the lowest number of seeds per plant obtained from the variety of Halisbey with 32.6 pieces/plant on June 25

Table 1. The average number (pieces/plant) of pods and seeds per plant according to planting time x variety interaction and groups formed according to LSD test

Planting Time x Variety	Number of pods per plant (pieces/plant)			Number of seeds per plant (pieces/plant)		
	2013**	2014**	Average**	2013**	2014**	Average**
April 15 NC-7	50,2 b-d	70,9 b	60,5 c	64,7 cd	76,5 de	70,6 de
April 15 Halisbey	60,7 a	87,1 a	73,9 a	78,9 ab	91,0 ab	85,0 ab
April 25 NC-7	44,6 c-e	61,7 c	53,1 de	65,5 cd	84,6 bc	75,1 cd
April 25 Halisbey	60,0 a	74,3 b	67,1 b	60,5 de	95,9 a	78,2 c
May 5 NC-7	54,5 ab	51,5 d-f	52,9 de	89,7 a	82,3 cd	86,0 a
May 5 Halisbey	41,2 de	54,4 c-e	47,7 e-g	60,5 de	74,2 ef	67,4 e
May 15 NC-7	37,2 ef	48,3 e-g	42,7 gh	66,8 cd	68,2 fg	67,5 e
May 15 Halisbey	47,6 b-d	46,3 fg	46,9 fg	64,3 cd	68,5 fg	66,4 e
May 25 NC-7	53,4 a-c	55,0 c-e	54,1 c	72,2 bc	81,7 cd	77,0 cd
May 25 Halisbey	50,0 b-d	56,3 cd	53,1 de	70,8 b-d	82,4 cd	76,6 cd
June 5 NC-7	53,8 a-c	50,4 d-f	52,1 def	78,3 ab	79,7 c-e	79,0 bc
June 5 Halisbey	43,5 de	50,3 d-f	48,8 fg	62,6 c-e	67,2 g	64,9 ef
June 15 NC-7	42,1 de	52,2 d-f	47,1 fg	68,4 b-d	80,7 c-e	74,6 cd
June 15 Halisbey	31,4 f	45,9 fg	38,6 h	52,5 e	67,0 g	59,8 f
June 25 NC-7	17,3 g	42,5 g	29,9 i	30,9 f	62,6 g	46,8 g
June 25 Halisbey	19,5 g	33,1 h	26,3 i	33,1 f	32,1 h	32,6 h
LSD	9.76	7.69	5.78	11.47	6.48	6.49
CV (%)	12.76	8.08	10.07	10.40	5.01	8.11

*: Difference between the groups was significant compared to the 5% significance level.

** : Difference between the groups was significant compared to the 1% significance level.

100-Seed Weight and Seed Yield

Table 2 examined; according to the average of two-year, the 100-seed weight in terms of sowing date x cultivar interaction was found not significant, in terms of seed yield was found significant ($p < 0.01$). While the highest seed yield (kg/da) obtained from the variety of Halisbey with 489.1 kg/da on April 25 and 488.7 kg/da on May 15, the lowest seed yield obtained from the variety of Halisbey with 325.4 kg/da on June 25.

Table 2. The average 100-seed weight (g) and seed yield (kg/da) according to planting time x variety interaction and groups formed according to LSD test

Planting Time x Variety	100-Seed Weight (g)			Seed Yield (kg/da)		
	2013	2014	Average	2013*	2014**	Average**
15 April NC-7	75,6	88,5	82,1	281,6 fg	446,7 g-1	364,2 e
15 April Halisbey	86,8	92,7	89,8	319,4 c-f	595,8 ab	457,6 bc
25 April NC-7	79,2	90,5	84,9	322,5 c-f	477,4 fg	399,9 d
25 April Halisbey	97,8	96,0	96,9	378,5 ab	599,7 a	489,1 a
5 May NC-7	86,1	93,1	89,6	360,8 bc	560,6 b-d	460,7 bc
5 May Halisbey	95,8	97,7	96,8	361,6 bc	593,8 ab	477,7 ab
15 May NC-7	87,3	92,0	89,7	389,5 ab	490,4 ef	439,9 c
15 May Halisbey	98,8	94,5	96,7	411,9 a	565,4 a-c	488,7 a
25 May NC-7	89,6	92,6	91,1	358,0 b-d	526,7 de	442,4 c
25 May Halisbey	106,6	95,0	100,8	399,0 ab	541,4 cd	470,2 ab
5 June NC-7	96,2	89,1	92,7	329,0 c-e	476,1 fg	402,6 d
5 June Halisbey	113,1	90,6	101,9	317,9 d-f	501,3 ef	409,6 d
15 June NC-7	97,4	86,8	92,1	302,6 e-g	428,5 ij	365,6 e
15 June Halisbey	113,1	90,9	102,0	270,0 g	473,2 f-h	371,6 e
25 June NC-7	90,7	86,7	88,7	270,9 g	399,1 j	335,0 f
25 June Halisbey	101,9	90,5	96,2	213,3 h	437,4 h1	325,4 f
LSD	Ö.D.	Ö.D.	Ö.D.	42.17	36.35	26.74
CV (%)	3.07	1.42	2.56	7.37	4.14	5.43

*: Difference between the groups was significant compared to the 5% significance level.

** : Difference between the groups was significant compared to the 1% significance level.

Protein Ratio and Oil Yield

Table 3 examined; according to the average of two-year, the protein ratio and oil yield in terms of sowing date x cultivar interaction was found significant ($p < 0.01$).

While the highest protein ratio (%) was obtained from the variety of NC-7 with 20.75 % on April 25, the lowest protein ratio (%) was obtained from the variety of Halisbey with 18.61 % on May 5 and from the variety of NC-7 with 18.61 % on May 25. The highest oil yield (kg/da) was obtained from the variety of NC-7 with 144.3 kg/da on May 5, the lowest oil yield (kg/da) obtained from the variety of Halisbey with 84.6 pieces/plant on June 25

Table 3. The average protein ratio (%) and oil yield (kg/da) according to planting time x variety interaction and groups formed according to LSD test

Planting Time x Variety	Protein Ratio (%)			Oil Yield (kg/da)		
	2013**	2014	Average**	2013**	2014**	Average**
15 April NC-7	16,7 b-d	23,74	20,22 a-d	88,5 de	139,4 de	113,9 fg
15 April Halisbey	17,2 bc	23,21	20,20 a-d	86,1 e	162,8 a	124,5 d-f
25 April NC-7	16,4 c-e	22,91	19,65 c-f	107,4 bc	143,8 d	125,6 c-e
25 April Halisbey	17,7 b	23,62	20,66 ab	103,3 cd	170,1 a	136,7 a-c
5 May NC-7	16,3 c-e	23,22	19,76 b-e	120,5 ab	168,0 a	144,3 a
5 May Halisbey	14,3 g	22,92	18,61 g	106,3 bc	160,3 ab	133,3 a-d
15 May NC-7	17,6 b	23,26	20,43 a-c	126,9a	148,8 b-d	137,8 ab
15 May Halisbey	15,8 d-f	21,70	18,75 fg	107,4 bc	162,3 a	134,8 a-d
25 May NC-7	14,6 fg	22,63	18,61 g	108,7 bc	158,3 a-c	133,5 a-d
25 May Halisbey	16,4 c-e	22,01	19,20 e-g	127,8 a	137,5 de	132,7 a-d
5 June NC-7	15,1 fg	22,58	18,84 e-g	112,0 a-c	146,8 b-d	129,4 b-d
5 June Halisbey	17,4 bc	21,86	19,63 c-f	88,3 de	136,2 de	112,3 g
15 June NC-7	15,5 ef	23,25	19,37 d-g	103,5 cd	128,7 ef	116,1 e-g
15 June Halisbey	17,8 b	22,86	20,33 a-d	72,8 e	126,6 e-g	99,7 h
25 June NC-7	19,5 a	22,01	20,75 a	87,9 de	121,6 fg	104,7 gh
25 June Halisbey	16,4 c-e	22,60	19,50 c-g	55,7 f	113,6 g	84,6 i
LSD	1.16	Ö.D.	0.98	16.93	13.21	11.65
CV (%)	4.07	3.40	4.33	9.76	5.25	8.20

*: Difference between the groups was significant compared to the 5% significance level.

** : Difference between the groups was significant compared to the 1% significance level.

Conclusion

According to the results of two years of sowing date x cultivar interaction; it has been identified the most appropriate planting time for peanut in the GAP region were late April and first half of May, and varieties of Halisbey and NC-7 can be easily cultivated in the conditions of GAP region. Also; in order to prevent seed decay and growth disorders it would be useful to avoid quite possible from early sowing. And with a sudden rise in the temperature in the event of sowing late may passes plant to generative period early. It has been identified that these negativeness may be caused to the decline in yields.

As a result; with this study as determined the appropriate sowing time offered to farmers in the region were helped to establish the supply-demand balance in production, contributed the producers to get higher income by created alternative products.

References

- Arioğlu, H.H., 1999. Peanut Cultivation Breeding, Oil Crops Textbooks, Ç.U.A.F. G.Y. No:220, P. No: A-70, P. 74, Adana.
- FAO, 2013. <http://faostat.fao.org>
- Kolsaracı, Ö., Gür, M.A., Kaya, M.D., İşler, N. and Başalma, D., 2005. Oilseeds Production Plants. VI. Turkey Agricultural Engineering Technical Congress, Volume 1, January 3-7, P. 41-62, Ankara.
- Rowell, T., Mortley, D.G., Loretan, P.A., Bonsi, C.K. and Hill, W.A., 1999. Continuous Daily Light Period and Temperature Influence Peanut Yield in Nutrient Film Technique. Crop Science 39: 1111–1114.
- Woodroof, J.G., 1983. Peanuts. Production, Processing Products. Third Edition. Avi Pub. Comp. Inc. Connecticut, 414 s.

**EVALUATION OF MACRO PROPAGATION TECHNIQUE ON *Ananas comosus* cv
smooth cayenne (PINEAPPLE) STUMP AND NURSERY PERFORMANCE OF
PLANTLETS**

Vincent Onah EBRE¹, Julius Akinyemi FAGBAYIDE², Semeton Akinduro AMOSU¹, Oladiran
OLALEYE¹

¹National Horticultural Research Institute Ibadan, Nigeria

²Department of Agronomy, University of Ibadan, Nigeria

*Corresponding author: ebrevincent01@gmail.com

Abstract

An experiment was set up to evaluate techniques of multiplication of plantlets through stumps was laid in a Randomized complete Block Design (RCBD) with 10 treatments in two replications. The treatments were of different sizes of 5,7,10 and 20cm split and unsplit with a whole stump as control. Data were days to 50% emergence, number of plantlets and weight of sucker. The evaluation of sources and rate of Nitrogen influence on rapid early growth of plantlets was in a completely randomised design (CRD) with 10 treatments replicated 3 times. The treatments: control, brewery waste + poultry dung 200, 150 and 100 kg N/ha, brewery waste + cattle dung 200, 150 and 100 kg N/ha, N.P.K 20:10:10 200, 150 and 100 kg N/ha. Parameters were; area of the D leaf (cm²), Plant height (cm) Number of leaves and weight of suckers (g). Data were analysed using descriptive (ANOVA). Significant means were separated with DMRT at α 0.05. Apical, middle and basal portions gave 100%, 87.5% and 75% emergence respectively. The number of plantlets was significant on control (2.5) and split 5cm (7.0) weight of plantlets on split cut 20cm (66.25) and control (70.15). All fertilizer sources at 150 kg N/ha rate gave a significant difference in size (450-500g), area of the D leaf (47.87) and number of leaves (25.33). Therefore, 20cm cut is recommended for high quality plantlet on weight basis while 5cm cut gave highest number of plantlets and fertilizer rate of 150 kg N/ ha is also recommended.

Keywords: *plantlets, pineapple sucker, compost, macro-propagation.*

Introduction

Ananas comosus is an herbaceous perennial with narrow leaves that may or may not possess spines and a characteristic peculiar fruits fragrance, (Jonathan, 2013). It is an important fruit crop with high demand at the international market (Fawole, 2008) and cherished by large population in Nigeria, it is of higher economic value since the demand from local fruit juice industries and fresh fruits consumers are more than the supply, hence it is necessary to improve pineapple production techniques in order to increase yield per hectare as well as increase farmers gain. One of the major challenges militating against pineapple production is scarcity of adequate planting materials that is usually obtained from the old pineapple field 5-8 months after fruit harvest under rainfed condition, this material will be produced at different intervals hence they have different sizes resulting in unsynchronized fruiting. Within the period farmers wait for suckers from old orchard to plant a new field, some stands may not produce sucker, some cases maximum of two undersize suckers might be produced. Planting period that will favour rainfed crop becomes late resulting in small fruiting in the drought. However, in this study, stumps that are regarded as waste which should have been thrown away as a trash during re-cropping or eradication of old

orchard will be use for sucker production. A sucker in pineapple is a type of vegetative propagules which eventually grows up to become a pineapple plant (Morton, 1987). The technique of pineapple sucker generation was described by (Macluskie, 1939) and (Py, 1957) how an old pineapple stumps could be use to produce pineapple plantlets to solve the farmers challenges of insufficient planting materials.

Materials and Methods

The experiment was sited at the university of Ibadan teaching and research farm at these coordinates Latitude 7.45176N and Longitude 3.896E within 4 meters location beginning from 30th April 2014 followed by plantlet growth performance in the screen house of the department of Agronomy, University of Ibadan (Nigeria) with the following coordinates Latitude 7.45176N and Longitude 3.896E within 4 meters location. An experiment was set up to evaluate techniques of multiplication of plantlets through stumps was laid in a Randomized complete Block Design (RCBD) with 10 treatments in two replications. The treatments were of different sizes of 5,7,10 and 20 cm split. and unsplit with a whole stump as control. Data were days to 50% emergence, number of plantlets and weight of plantlets. Followed by the evaluation of different sources and rates of Nitrogen influence on rapid early growth of plantlets was in a completely randomised design (CRD) with 10 treatments replicated 3 times. The treatments: control, brewery waste + poultry dung compost (BPD) 200, 150 and 100 kg N/ha, brewery waste + cattle dung compost (BPC) 200, 150 and 100 kg N/ha, N.P.K 20:10:10 200, 150 and 100 kg N/ha. Parameters measured were; area of the D leaf (cm²), Plant height (cm) Number of leaves and weight of suckers (g). Matured pineapple plants of the same age were selected from University of Ibadan orchard after fruit harvest. They were uprooted, defoliated exposing axial buds on the stumps (Ucheagwu and Obiefuna, 1991) and (Olaniyi and Kelani 2010) and the stumps were cut into 5 cm, 7 cm, 10 cm and 20 cm having both cuts unsliced and sliced sizes (Olaniyi and Kelani 2010) the control 20 cm was not cut nor sliced. Top soil was used for planting of cut stumps at 2 cm depth and at a spacing of 10 cm apart. Each stump pieces (split) and whole bears at least two axial buds. (Ucheagu and Obiefuna, 1982). The cut stumps were air dried for two hours to ensure drying and healing of the wound to harden the materials against pest and disease invasion. The stumps (split or whole) were planted randomly with each having its label. Adequate moisture was maintained by wetting when necessary. Suckers were observer for emergence at 4 weeks after planting and suckers were milked at 8 weeks after planting. For the second experiment, top soil was sampled using soil auger from 0-15 cm to know physicochemical properties of the soils sites used for the experiment, when the soil was analysed, nitrogen was deficient and 3 kg soil was potted into polyethylene bags. There were perforated to enhance drainage. The actual quantity of fertilizer types were applied using a hand trowel to scoop soil from the polyethylene bag creating a hollow, the fertilizer materials was placed and a little quantity of soil was placed on the fertilizer before the plantlets of uniform seizes were planted on the fertilized polyethylene bags after which it was wetted forth night. Before, application of treatment a test was carried out to ascertain the quantity of water that will wet the soil at field capacity.

Results and Discussion

The apical, middle and basal portions gave 100%, 87.5% and 75% emergence respectively, (Py, 1957) apical portions seems to emerge suckers earlier than the basal portions. The number of plantlets was significant on control (2.5) and split 5 cm (7.0) weight of plantlets on split cut 20 cm (66.25) and control (70.15). In site B, (table 1.) the soil nitrogen, phosphorus, potassium were low, low and very high respectively, the pH was slightly acidic to neutral. However the textural

class was loamy sand (USDA) which is suitable growing pineapple, though nitrogen application was necessary for adequate growth. (Morton, 1987).

Table 1. Pre-planting soil analysis for site B (Nursery)

Parameters	Value
pH (H ₂ O 1:1)	6.7
Total Nitrogen (g/kg)	0.67
Organic Carbon (g/kg)	1.32
Available Phosphorus (mg/kg)	6.23
Exchangeable Bases (cmol/kg)	
K	1.97
Ca	0.71
Na	0.61
Mg	0.64
Micro nutrients (mg/kg)	
Fe	43.1
Cu	13.3
Mn	664
Particle Size Distribution (g/kg)	
Sand	880
Silt	20
Clay	100
Textural Class (USDA)	Loamy sand

Table 2. N. P. K content of the compost fertilizers materials (%)

Fertilizer	N	P	K
BPD Compost	2.27	0.92	0.73
BCD Compost	2.23	0.81	0.40
N.P.K Inorganic	20	10	10

Key: Brewery waste +poultry dropping (BPD) and Brewery waste and cattle dropping (BCD) Nitrogen, phosphorus and potassium (N. P.K)

Nitrogen sources and rates applied have significant influence on area of D leaf of pineapple, at 20 weeks after planting, IBCD 200 kg/ha gave (48.57 m²) significantly ($p \leq 0.05$) larger area of D leaf than control (33.73 m²), (IBPD 150 kgN/ha, IBPD 100 kg N/ha and IBCD 100 kg N/ha but not

significantly different from other treatments owing to the fact that pineapple perform well on sandy to sandy loam soils (Collins 1960; Morton 1987). This result corroborate with that of (Omotoso and Akinrinde, 2007) that N-rates have significant influence on area of D leaf in pineapple.

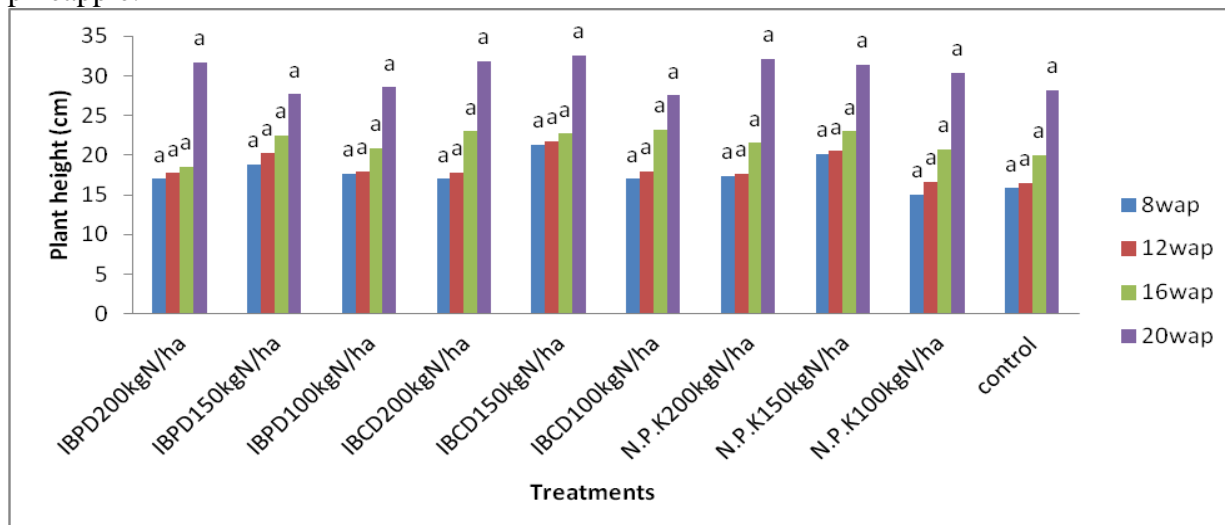

Figure 1. Effect of fertilizer types and rates on height of pineapple plantlets in the nursery

There was a significant difference ($p \leq 0.05$) in height and number of leaves at 20 weeks after planting, 200,150 and 100 kg N/ha from all the sources have significantly ($p \leq 0.05$) higher number of leaves than other treatment but not significantly different from other treatments (figure 1). However, at the end of the observation, 200 and 150 kg N/ha rates from all the sources gave the highest size (weight) of pineapple sucker, (Najafvand *et. al*, 2008) also found out that nitrogen rates increased number of leaves and plant height of tomato. This result is also in line with (Omotoso and Akinrinde, 2007) that N-rates have significant influence on number of leaves in pineapple.

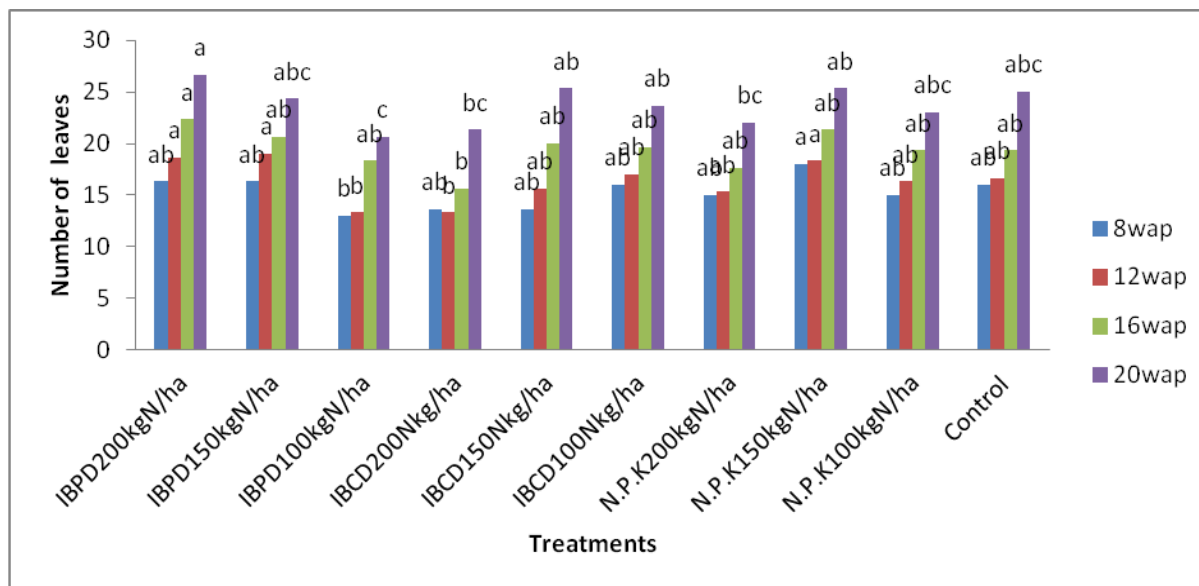

Figure 2. Effect of fertilizer types and rates on number of leaves of pineapple plantlets in the nursery

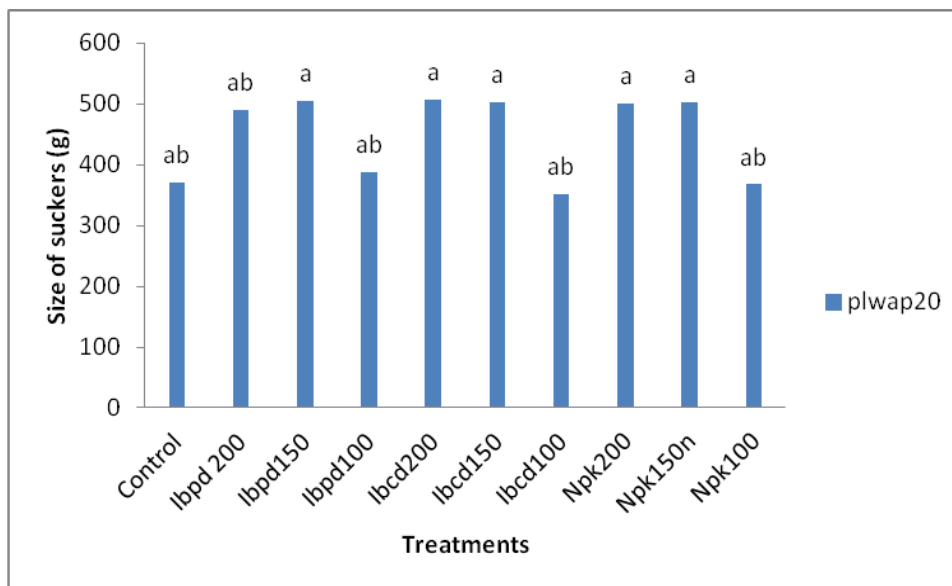

Figure 3. Effects of fertilizer sources and rates on the size of pineapple suckers for field planting

Conclusion

The apical portion gave the highest percentage emergence (100%). The control gave the least number of plantlets whereas highest significant plantlet weight at milking; the bigger the weight of pineapple stump, the bigger the plantlets produce and the higher the quality of propagules. The split 5cm cut gave the least weight and highest number of plantlets and highly significant from other treatment, it also shows that it can give 8 times more number of suckers than the control (whole 20cm stump length). Nitrogen has significant influence on area of D leaf, Numbers of leaves, plant height and weight of suckers by all fertilizer sources used and at 150 kg N per hectare rate. Therefore, I recommend apical portion for early and 100% emergence, 5-7cm cut for higher plantlets production, control or 20cm for plantlet that will meet field size (500g) early and 150 kgN/ha rate for all the sources used based on soil analysis report. More work need to be done on pineapple plantlet multiplication using plastic mulch technique on the nursery field.

References

- Collins, J. L. 1960. The pineapple. Interscience Publishers, New York. 294 pp.
- Fawole O. P, 2008. Pineapple farmers' information sources and usage in Nigeria. Bulgarian Journal of Agricultural Sciences, Agricultural Academy, 14 (No4) pp 381-389
- Federal Fertilizer Department, Federal Ministry of Agriculture and Rural Development, Abuja, 2012. Fertilizer use and Management Practices for crops in Nigeria. 4th edition, National Program for Food Security pp154-156.
- Jonathan, H. C, 2013. Pineapple growing in the Florida Home Landscape. U.S. Department of Agriculture, UF/IFAS Extension Service, University of Florida, IFAS, Florida A & M University Cooperative Extension Program, and Boards of County Commissioners Cooperating. Nick T. Place, dean for UF/IFAS Extension.
- Morton J. F. Ed. 1987. Fruits of warm climates. Florida: Maimi
- Najafvand S. D, Alemzadeh N. A. and Sedighie F. D. 2008. Effect of different levels of nitrogen fertilizer with two types of bio-fertilizers on growth and yield of two cultivars of tomato (*Lycopersicum esculentum* Mill). Asian Journal of Plant Sciences, 7:757-761.

- Olaniyi J.O. and Kelani, K. 2010. Evaluation of rapid multiplication method for pineapple (*Ananas comosus*). *Proceedings of the 3rd International e-Conference on Agricultural BioSciences*, Abstract ID: IeCAB010-321b p41.
- Omotoso S.O. and Akinrinde A.E. 2007. Influence of propagules weights and nitrogen fertilizer rates on growth and yield of pineapple (*Ananas comosus* (L.) Merr) *Asian journal of Agricultural Research* 1:131-136
- Py C, Tisseau Ma, Oury B. and Ahmada F. 1957. Culture of pineapples in Guinea. Manual planter. Edition QRTA p331
- Ucheagu A. C. and Obiefuna J. C. 1991. The effect of the anterior, central and posterior regions of matured pineapple stumps on proliferation of propagules. *Nigeria National horticultural Research institute P. M. B 5432, Idi-Ishin, Ibadan, Technical Bulletin* 17: 2-3
- Ucheagwu A. C., Majumder P. K. And Obiefuna J. C., 1987. *Fertilizer rates for increased pineapple production in tropical ferralitic soils of South Western Nigeria*. Fertilizer Research. Martinus Nijhoff publishers, Dordrech-printers, Netherland, Volume 12, pp 99-105.
- Weerasinghe S. S. And Siriwardana A. U, 2006. *Fast propagation of pineapple (Ananas comosus) with stem cuttings*. Agriculture Research Station, Thrliija.Mathara, Sri lanka. *The Journal of Agricultural science*, 2006, vol.2 no. 2 pp 55.

AIRJECTION® INTO SUB-SURFACE DRIP IRRIGATION SYSTEMS AS A TOOL FOR CLIMATE-SMART IRRIGATION

Michael DAVIDSON

Davidson Consultants, USA

*Corresponding author: michael.davidson@climatesmartirrigation.com

Abstract

Climate-smart Agriculture (CSA) has been developed as a model to address socio-ecological systems. CSA consists of a suite of tools and methods that, when implemented in a sustainable manner and locally supported, leads to the achievement of three basic objectives; mitigation of environmental damage caused by traditional agricultural practices; adaptation of farming methods and regimes that cope with the uncertainty and variability of climate change; and food security or improved agricultural production and profitability for the grower. Organic agriculture is a framework that integrates the triple goals of CSA but not all tools are appropriate for organic agriculture. Among the recent innovations of CSA that is particular appropriate for organic agriculture is the development of air injection. This paper summarizes the work of Goorahoo, et al and presents the results of an 8-year study that satisfies the objectives of CSA and can serve as an important tool for cost-effective agricultural improvement in organic landscapes. The Goorahoo case study provides evidence that injecting air into a sub-surface drip irrigation system creates an aerobic oxygen/nitrogen root environment with no added chemicals or additives, which significantly and positively improves production with no increases in fertilizers, water or fuel. This study evaluates the carbon and nitrogen cycling implications, and cost benefit analysis benefits of the AirJection® System on cantaloupes, corn, honeydew and bell peppers in central California.

Keywords: Climate-smart agriculture, sub-surface irrigation, air injection, root zones

Introduction

The primary components of soils are: solids (mineral and organic fractions); water; and air (Hutmacher, 2016). The "pore volume" is the aggregate of water and air, which is a characteristic of soils, but can be modified by managing compaction (Hutmacher, 2016). All crops require water, oxygen and proper nutrition. Roots trapped in anaerobic environments are deprived of sufficient oxygen and stressed to the extent that crop yields and quality are significantly and negatively impacted. Photosynthesis is weakened and roots cannot absorb naturally occurring and applied nutrients. Hypoxia stress is the mechanism that explains how "air is squeezed out of the soil in the process of traditional irrigation" (Yuan, et al., 2016). In addition to irrigation applications, all tractor work and, in particular, deep plowing, increase hypoxia stress in the root zone. There are many methods for alleviating this stress and creating a more aerobic environment for the root zone. This paper examines the process of injecting oxygen into a sub-surface drip irrigation (SDI) system for the purpose of reducing hypoxia stress. AirJection has been successfully applied to improve yields, water use efficiency and crop health in pineapple (Dhungel, Bhattard, & Midmore, 2012). This paper reviews an eight-year study on cantaloupes in the San Joaquin Valley of California that compared changes in crop yield, energy costs and investment costs over one year and over an eight-year period. This study significantly

contributes to the efficacy of the CSA model and has significant and positive implications for organic agriculture.

Materials and Methods

This original, controlled, experiment was installed at Stamoules Farms in Mendota, California. The AirJection® system was installed by the farm operation with the oversight of technicians from the Mazzei Company in Bakersfield, California who is the manufacturer of the AirJection® system. This experiment used venturi-type injectors on each drip lateral. The injection rate was calibrated to achieve 15% by volume (California Council on Science and Technology, 2014). The AirJection® system operated simultaneously and always with the irrigation system.

The cantaloupe crop was grown on 5 feet (1.5 meters) (Goorahoo, Decker, S, Zoldoske, & Mazzei, 2014). "The experimental plot consisted of four alternating replications of AirJection® and no air injection (control). Each replicate was made up of seven beds to accommodate the width of the tractor-drawn trailers during harvesting" (Goorahoo, Decker, S, Zoldoske, & Mazzei, 2014). A diesel pump was supplied to increase line pressure from 15 psi (1 bar) to 25 psi (1.7 bar).

Figure 1 schematically illustrates the buried water supply line and buried injectors with snorkels for air suction that were utilized in this experiment. Figure 2 is a photo of the AirJection® system.

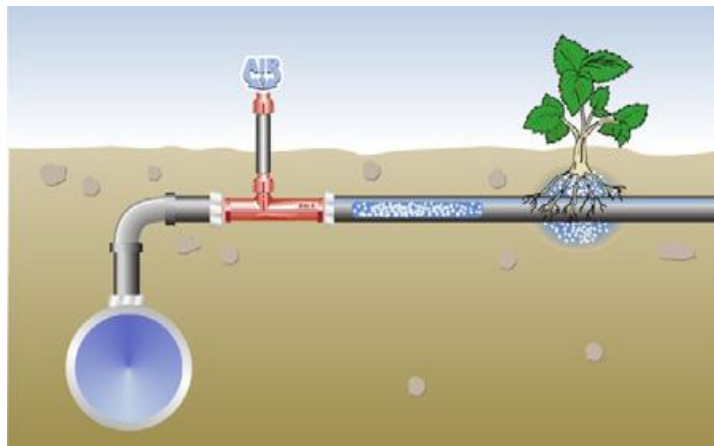

Figure 11 Buried water supply line with buried injector with snorkels for air suction (Mazzei)



Figure 12 photo of AirJection® system (Mazzei)

Results

The experimental results were positive to the extent that the Stamoules company decided to expand the AirJection® system to a commercial scale.

First Year

The first-year results of the AirJection® application showed an ROI of about \$1 million on 1500 acres (600 hectare) of cantaloupes. Table 1 is a summary of installation costs and production outputs for year 1. Table 2 illustrates the energy costs and ROI for year 1.

Table 3 Summary of installation costs and production outputs for year 1

Acreage	Number of AirJection® units/acre (ha)	Installation cost/acre (ha)	Total installation cost for field	Total of produce boxes with AirJection®	Total box for control
1497	5.5 (13.75)	\$140 (\$350)	\$209,580	1,597,664	1,190,362

Table 4 Energy costs and ROI for year 1

Total additional energy cost	Additional energy cost per acre (ha)	Average per acre increase in cantaloupe boxes (ha)	Total box increase over farm average	Conservative net price per box	ROI	1st year Net ROI
\$15,554	\$10.35 (\$25.88)	272 (680)	407,302	\$3.00	\$1,221,906	\$996.772

Eight Year Average

The eight-year average for the cantaloupe crop consists of 6,480 acres (2,622 ha) and showed an average increase of 1.3 million boxes. Table 3 illustrates the average (mean) of production and increase from 2005-2012. Table 4 illustrates the average production over eight years and the energy costs of AirJection® compared to the control.

Table 5 Average (mean) of production and increase, 2005-2012

Crop	Total AirJection® acreage (ha)	Total of AirJection® boxes	Total boxes for controlled acreage	Average per acre increases in boxes (ha)	Total box increase over control
Cantaloupe	6,480 (2,622)	6,891,383	5,590,794	201 (502)	1,300,590

Table 6 Average summary of energy costs for AirJection® and control, 2005-2012

Crop	Total AirJection® acreage (ha)	Total AirJection® boxes	AirJection® energy cost per box	Total boxes for control	Non-AirJection® equivalent energy per box
Cantaloupe	6,480 (2,622)	6,891,383	\$0.02	5,590,794	\$0.012

Overall yields over the eight-year period were 12%-34% greater than in prior years. Figure 1 illustrates the increases in yield per year from 2005-2012

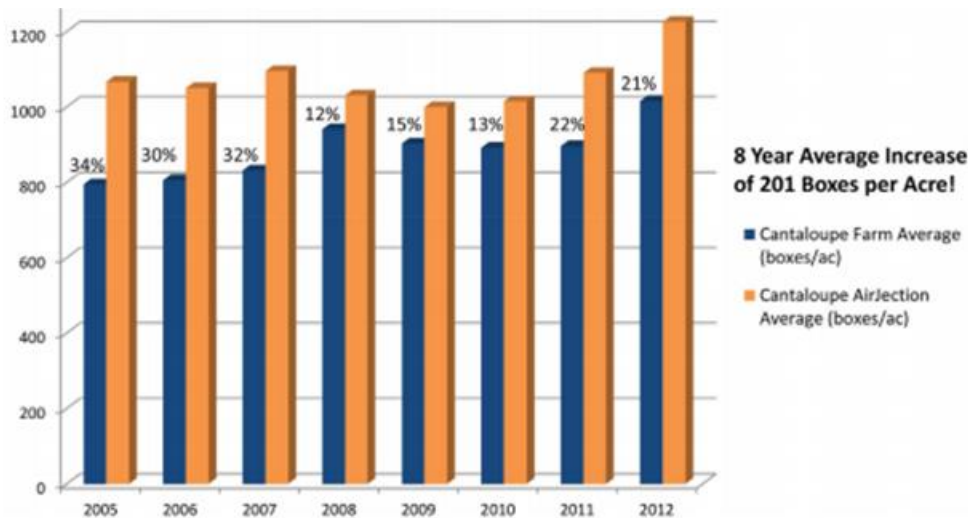

Figure 13 Increases in yield per year ,2005-2012

Discussion

The grower experimented with AirJection in the first year on 600 hectares of cantaloupes and realized a net return on his investment of almost \$1,000,000 or \$1667/hectare. The installation of the AirJection system was the only intervention in the first year. After the first season, the grower expanded the scope of his investment and installed the AirJection system on 2,622 hectares and realized a significant and positive return on investment in each of the subsequent seven years. The average increase in yield over the eight-year period was just over 200 boxes per acre (500 boxes/hectare), which is equivalent to \$600/acre or \$1,500/hectare.

The grower had experience in sub-surface drip technology and had already achieved a high degree of water-use efficiency.

Conclusions

The conclusions for this experiment are of significant value for all SDI systems. No additional fertilizers or irrigation water were applied. The ROI was positive in the first year and the associated energy costs per box in the subsequent eight years were insignificant. The AirJection® system was calibrated and adjusted during the first year and maintained its operation efficiency

over the following eight years with no additional calibration. The increase in yield was significant and positive.

The implications for organic agriculture are also significant and positive. There are no associated material costs to absorb when using the AirJection® system and the only elements that are injected are oxygen and nitrogen. No chemicals are used.

A second significant implication is the added value AirJection® brings to SDI in general. SDI reduced evaporation, improves transpiration losses and has the highest water-use efficiency values of any irrigation system. Increasing yields and achieving higher water and nutrient -use efficiency by incorporating AirJection® with SDI is very promising.

Acknowledgements

This research is a summary of the experiments conducted by Goorahoo, et al (Goorahoo, Decker, S, Zoldoske, & Mazzei, 2014). Goorahoo is the lead author of the original study on the AirJection® study.

References

- California Council on Science and Technology. (2014). *Achieving a Sustainable California Water Future Through Innovations in Science and Technology*. California Council on Science and Technology. Sacramento: California Council on Science and Technology.
- Dhungal, J., Bhattard, S., & Midmore, D. (2012). Aerated water irrigation (oxygen) benefits topineapple yield, water use efficiency and crop health. *Advanced Horticultural Science*, 3-16.
- Goorahoo, D., Decker, P., S, C. F., Zoldoske, D., & Mazzei, A. (2014). *Aeration in Subsurface Drip Irrigation: Academic and Commercial Review of Eight Years of Consistent Crop Yield Increase and Water Use Efficiency*. Fresno: Plant Science Department and Center for Irrigation Technology.
- Hutmacher, B. (2016). Soil Physical Characteristics: Impacts on Irrigation Management-SDI and others. *United States Committee on Irrigation and Drainage*, (pp. 1-34). San Diego.
- Mazzei. (n.d.). *AirJection® Irrigation*. Retrieved from Mazzei: <http://mazzei.net/irrigation-airjection/>
- Yuan, L., Wenquan, N., Jingwei, W., Jian, X., Mingzhi, Z., & Kangyong, L. (2016, March). Review on advances of airjection irrigation. *International Journal of Agriculture and Biological Engineering*, 92(1), 1-10. Retrieved from <http://ijabe.org>

VARIATION IN *Digitalis ferrugineae* L. MULTIPLICATED WITH SEED UNDER THE PROVINCE RIZE CONDITIONS IN TURKEY

Yusuf SAVSATLI*, Muhammed İkbal CATAL, Fatih SEYİS

Department of Field Crops, Faculty of Agriculture and Natural Sciences, Recep Tayyip Erdoğan University, Pazar, Rize, Turkey

*Corresponding author: yusuf.savsatli@erdogan.edu.tr

Abstract

This study was carried out to examine the variation of some traits of *Digitalis ferrugineae* L. at Pazar/Rize/Turkey conditions. The experiment was conducted in 2014/2015 in the field trials belonging to the Faculty of Agriculture and Natural Science, Recep Tayyip Erdoğan University. *Digitalis ferrugineae* L. seeds were sown firstly into viols in greenhouse. The seedlings were planted into the field at 5-6 leave stage in 2014. All measurements were done using selected twenty plants in 2015. There were great variation between the plants investigated in the study. The change interval was 68,5-148,5 cm for plant height; 28,0-95,5 cm for spike length; 3,92-10,08 mm for spike diameter just below the first capsule; 5,92-13,5 mm for root collar diameter; 0-14 for number of branches per plant; 0,3-9,4 g for seed yield per plant and 0,31-0,69 g for 1000 seeds weight. The positive correlations were found significant ($P < 0.05$) between seed yield per plant and three characters which were spike length ($r = 0,4890$), spike diameter ($r = 0,5181$) and root collar diameter ($r = 0,5799$). In addition, relationship between plant height and spike length was found significant. As a result the plants of *Digitalis ferrugineae* L. multiplied with seed displayed great variation and could be advantageous for further breeding studies.

Keywords: *Digitalis ferrugineae*, spike, seed, variation

Introduction

Digitalis ferruginea (= *D. aurea* Lindley) is a widespread member of the eight *Digitalis* species from the family *Plantaginaceae* (= *Scrophulariaceae*) in Turkey (Davis, 1978). The genus *Digitalis* composed of more than 20 species, and is commonly known as the “foxglove”. The name *Digitalis* means “finger of a glove” as Latin which refers to the shape of the flowers (Clemente et al., 2011). Members of the genus *Digitalis* L. are medicinally and economically important plants as they comprise the main source of cardiac glycosides, which are therapeutically used for the healing of congestive heart failure and regulate heart rhythm (Baytop, 1999).

It is known that only two species have been grown as a source of glycosides for pharmaceutical industry, especially *Digitalis lanata* Ehrh. and *Digitalis purpurea* L. (Bown 1995). These species successfully grown at farms with excellent biomass and seed production capacity in recent years (Negi et al., 2012). Moreover it is known that *D. lanata* were cultivated in 230 hectares of Netherlands by 1984s (Mastenbroek, 1985).

Apart from cardiotoxic therapeutic efficacy, it is also used as diuretic and in the reduction of oedema due to its ability to improve cardiovascular circulation (Perez-Bermudez et al., 1990). In addition, preliminary studies have revealed that digoxin and digitoxin obtained from *Digitalis* species are also effective agents in cancer, in particular for prostate and breast cancer treatments (Yeh et al., 2001; Lopez-Lazaro, 2007; Newman et al., 2008).

In fact, the *Digitalis* species which also have ornamental value have been the subject of studies for the improvement the cultivars with high content in cardiotoxic glycosides to be used for medicinal purposes (Ardelean et al., 2006).

All parts of *D. ferruginea* are poisonous (Chiej, 1984) and this species is known as “rusty foxglove” all over the world and "pas renkli yüksük otu" in Turkey (Ozturk et al., 2008) It is a biannual or perannual plant. As with other *Digitalis* species, *D. ferruginea* also comprises cardiac glycosides and is the most abundant of *Digitalis* members in Turkey flora.

There is no research on agricultural traits of *D. ferruginea* before. Cultivation with sowing of seeds in medicinal plants in particular can lead to a new variation in the plants which are available to cross pollination. That variation is great in terms of breeders is a great opportunity to improve new cultivars. In this study, the plants of *D. ferruginea* L. multiplied by seed were compared regarding the stem, spike and seed traits.

Materials and methods

This research was conducted in 2014/2015 in the field trials belonging to the Faculty of Agriculture and Natural Science in Recep Tayyip Erdoğan University in Pazar district of Rize Province in the Black Sea Region of Turkey. Experimental field is located at 41°10.668' N latitude, 40°54.018'E longitude with an average altitude of 65 m above mean sea level.

The district Pazar has a climate displaying warm summer, moderate winter and rainfall in every season. According to the records of the Turkish State Meteorological Service, the District's Long-term average precipitation is 1978.1 mm; long-term average of growing season (April-October) is 1100.1 mm (TSMS, 2013).

The seeds of *Digitalis ferruginea* L. populations (foxglove) from flora were firstly sown into viols in greenhouse on 21th of february in 2014. When the seedlings reached the stage with 5-6 leaves, they were planted into the field. The distances between the plants were 40x30 cm. Twenty plants were selected and some traits of these plants were determined in the next year (2015) of the experiment.

In this study, examined agricultural traits of foxglove were plant height, spike length, spike diameter (just below the first capsule), root collar diameter, seed yield per plant and 1000 seeds weight.

Results and discussion

Stem characteristics

Plant height is one of the most important agricultural traits to enable harvest in almost all crops. Moreover, plant height may also influence to prevent yield loss at harvest. The plant with high height generally are under risk to yield loss because of laying. In addition, there are possible correlations in between the plant height with other traits of plants.

In the present study, plant height varied from 68,5 cm to 148,5 cm (Table 1). Plant height was positively correlated with spike length and spike diameter. The highest value (10,08 mm) regarding to spike diameter were obtained from the plant number 2 which plant height was 100 cm. Similarly, the plant number 2 had also the highest value regarding to root collar diameter.

Positive correlation was found between root collar diameter and spike diameter. These two characters assure a stronger stem structure in plant against adverse environmental conditions such as heavy rainfall and wind. In this study, firstly, the plant number 2 with number 15 had more advantageous of stem structure than others. On the other hand, an unusual branching on the bottom part of the stem was determined in only a plant.

The plant number 15 had been the only plant showing branching on the bottom of the stem. The stem traits of twenty plants examined showed a wide variation and it is clear that among these plants regarding to stem stiffness, in particular number 2 had a strong stem.

Table 1. The values belonging characters examined in the study

Gntyp	Plant height (cm)	Spike length (cm)	Spike diameter (mm)	Root collar diameter (mm)	Branching on spike (unit)	Seed yield per plant (g/bitki)	1000 seeds weight (g)	Seed color
1	104,5	42,5	5,81	8,26	0	2,59	0,644	AK
2	100	93,7	10,08	13,5	10	6,06	0,542	K
3	126	66,5	7,15	10,58	0	9,42	0,436	K
4	99,8	53,6	5,97	8,62	0	3,3	0,354	K
5	87,4	41,5	5,04	6,25	0	1,42	0,370	K
6	131	63	6,22	7,36	0	4,47	0,442	AK
7	119	58	6,35	8,62	0	5,08	0,360	K
8	83	28	3,92	7,26	0	0,27	0,388	KK
9	116,5	79,5	8,12	8,87	12	4,06	0,374	K
10	110,5	48	5,47	7,68	0	1,97	0,457	AK
11	94	37	4,37	6,07	0	1,7	0,509	AK
12	130	57	5,48	6,64	0	0,77	0,432	AK
13	95,3	44,5	7,03	9,63	0	2,1	0,308	K
14	144	95,5	7,37	8,49	6	4,24	0,469	K
15	148,5	93	9,15	12,22	14	4,09	0,485	K
16	100	35	5,34	8,57	0	3,27	0,448	AK
17	110	55,3	4,68	6,26	0	2,03	0,435	AK
18	68,5	44,5	5,36	5,92	0	0,45	0,436	KK
19	119,5	62,6	6,75	8,38	0	2,6	0,686	K
20	114,7	52,5	5,62	7,23	0	6,2	0,491	K

Gntyp: plant, B: brown, DB: dark brown, LB: light brown

Spike characteristics

Spike length is one of the important characteristics that affect the seed yield. The positive correlations were found significant ($P < 0.05$) between spike length and four characters which were plant height ($r = 0,6980$), spike diameter ($r = 0,8698$), root collar diameter ($r = 0,6648$) and seed yield per plant ($r = 0,4890$) (Table-2). Among the plants examined in the study, spike length showed a large variation between 28,0 cm and 95.5 cm. The highest spike length was obtained from the plant number 14 and followed it plant number 2 with 93.7 cm, plant number 15 with 93.0, plant number 9 with 79.5 cm, plant number 3 with 66.5 cm and others respectively.

A total of four plants occurred branching in their spikes. Numbers of branch ranged from 0 to 14 in the plants. The highest values regarding to spike lengths were obtained from same four plants. In addition, these four plants took place within the first eight for seed yield per plant and seed yield per plant ranged from 0,27 g to 9.42 g for all the plants. This research showed that the seed yield per plant correlated with three characters, spike length, spike diameter and root collar diameter. In terms of seed yield per plant, the highest values as 9.42 g, 6.20 g and 6.06 g obtained from plants number 3, 20 and 2 respectively. The only negative relationship which was not statistically significant occurred between seed yield per plant and 1000 seeds weight. Although some plants (such as plant number 2) had higher both spike length and 1000 seeds weight, their seed yield per plant was lower. This decrease in the seed yield per plant could probably arise from differences in the number of capsules per spike and number of seeds per capsule.

Table 2. The relationships (corelations) between characters

	Characters	Plant height	Spike length	Spike diameter	Root collar diameter	Seed yield per plant	1000 seeds weight
1	Plant height	1,0000					
2	Spike length	0,6980*	1,0000				
3	Spike diameter	0,4772*	0,8698*	1,0000			
4	Root collar diameter	0,3596	0,6648*	0,8896*	1,0000		
5	Seed yield per plant	0,4141	0,4890*	0,5181*	0,5799*	1,0000	
6	1000 seeds weight	0,1855	0,1676	0,1501	0,1299	-0,0192	1,0000

*P<0.05 (the relationships between characters was determined according to 5 % of significant level)

Seed characteristics

The plants forming leaf rosette in the first year comprised spike in the second year. After the planned measurements were carried out, the harvest was performed in complete dry period of the spikes. All the plants harvested on 10th of August in 2015 except the plants number 19 and 13 which harvested on 20th of August and 25th of August respectively.

Great differences were determined in the plants regarding to seed color, seed length, seed width and 1000 seeds weight. Seed colors were in eleven plants was brown, light brown in seven and dark brown in two. 1000 seeds weight in the examined plants ranged from 0.308 g to 0.686 g. The longest seeds obtained from the plant number 15 while the largest seeds observed in the plants number 1, 13 and 19. The highest 1000 seeds weight was determined from the plants with large seeds except number 13. A great part of the seeds of the late maturing plant number 13 were undersized and did not have the ability to germinate. This immature seeds caused to decrease 1000 seed weight of the plant number 13. On the other hand, in terms of germination ability, the strong seeds of the same plant were combined and measured for 1000 seeds weight. Its seeds were even larger than the plants number 1 and 19, and reached to 1 g regarding to 1000 seeds weight.

Twenty plants were compared with Cluster Analysis for total of 6 characters (from stem, spike and seed characteristics) to determine the relationships between each other. The dendrogram obtained from cluster analysis showed in Figure-1. It was seen that the plants number 1, 2, 3, 4, 6, 7, 9, 14, 15, 19 and 20 with other plants number 5, 8, 10, 11, 12, 13, 16, 17 and 18 constituted two distinct groups in the dendrogram. As seen in the cluster, the closer pairs of plants were number 10-17, 5-8, 6-7 and 10-12 respectively. Plants which the most distant to each other were between number 1 and 3 plants including number 3, 2 and 5 respectively.

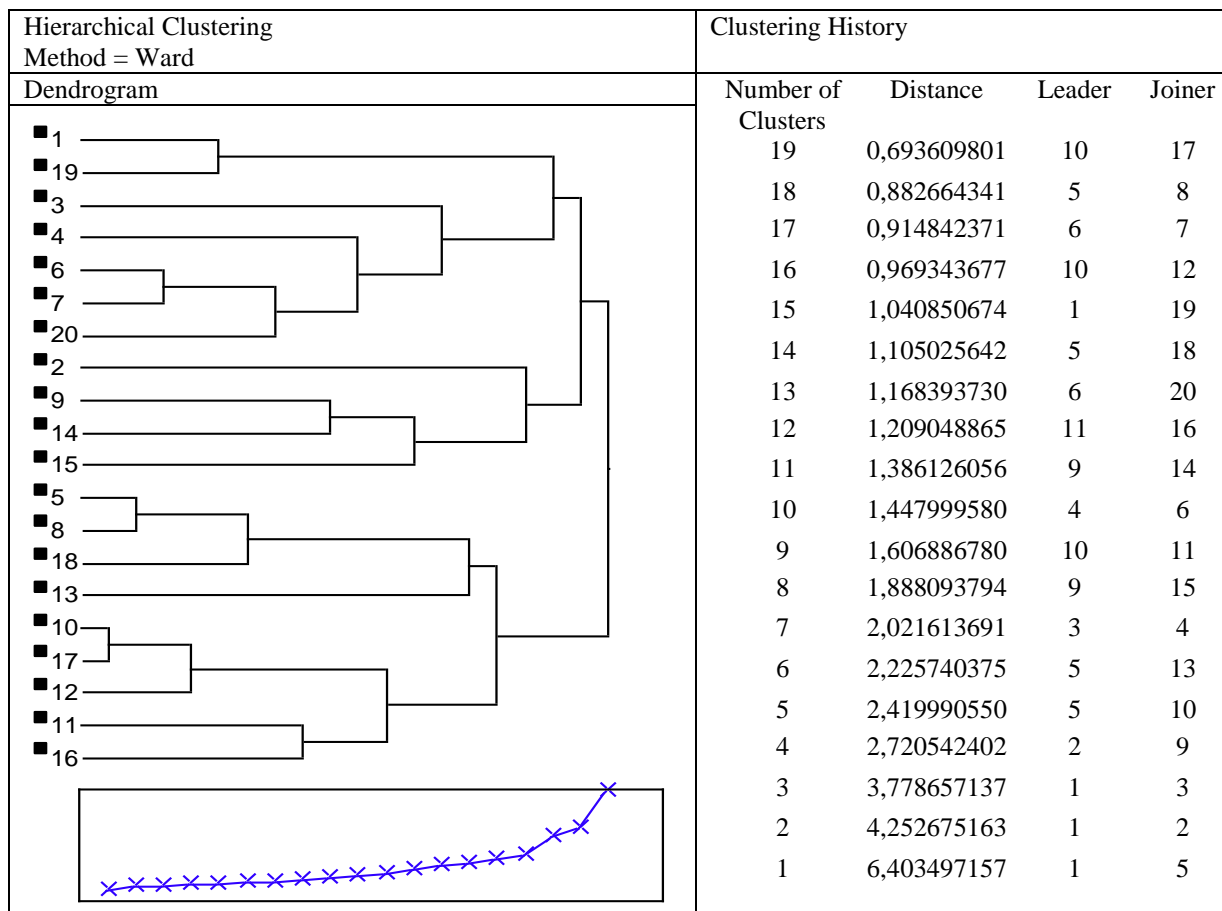

Figure 1. The Dendrograms from total of six characters

Conclusion

The data obtained from this study are important for creating resources in future researches. A wide variation was determined in a limited number of plants in *Digitalis ferruginea* L. multiplied with seed regarding to stem, spike and seed characteristics. In addition, it may be possible to obtain a wider variation by increasing the number of plants grown in present conditions. A great variation can create an advantage for breeders in terms of their studies and also provides ease of superior material selection.

References

- Ardelean M., Costea A., Cordea M. (2006): Experimental results on breeding foxglove (*Digitalis* spp.) for medicinal and/or ornamental purposes. XXII International Symposium Section Ornamentals. Breeding for beauty, book of abstracts, 11-15 September 2006, Editors: A. Mercuri & T. Schiva, Sanremo, Italy
- Baytop T. (1999): Therapy with Medicinal Plants in Turkey (2nd ed, in Turkish). İstanbul: Nobel Tıp Kitabevi.
- Bown D. (1995): (ed) Encyclopaedia of herbs and their uses. Dorling Kindersley, London, UK
- Chiej R. (1984): Encyclopaedia of Medicinal Plants. MacDonald ISBN 0-356-10541-5
- Clemente E. S., Muller-Uri F., Nebauer S. G., Segura J., Kreis W., Arrillaga I. (2011). *Digitalis*. Wild Crop Relatives: Genomic and Breeding Resources, Plantation and Ornamental Crops, p 73-112

- Davis P. H. (1978): Flora of Turkey and the east Aegean Islands. University press, Edinburgh, Vol. 6, p. 680.
- Lopez-Lazaro M. (2007): Digitoxin as an anticancer agent with selectivity for cancer cells: Possible mechanisms involved. *Expert Opin Ther Tar* 11: 1043-1053.
- Mastenbroek C. (1985): Cultivation and breeding of *Digitalis lanata* in the Netherlands. *Br Heart*, 54: 262-8
- Negi J. S., Bisht V. K., Bhandari A. K., Sundriyal R. C. (2012): Determination of mineral contents of *Digitalis purpurea* L. and *Digitalis lanata* Ehrh. *Journal of Soil Science and Plant Nutrition*, 12 (3) 463-469
- Newman R. A, Yang P., Pawlus A. D., Block K. I. (2008). Cardiac glycosides as novel cancer therapeutic agents. *Mol Interv* 8: 36-49.
- Ozturk M., Uysal M., Gucl S., Mert T., Akcicek E., Celik S. (2008): Ethnoecology of Poisonous Plants of Turkey and Northern Cyprus. *Pak. J. Bot.*, 40(4): 1359-1386
- Perez-Bermudez P., Cornejo M. J., Segura J. (1990): *Digitalis* spp.: In vitro production of haploids. In: Bajaj YPS (ed.) *Biotechnology in Agriculture and Forestry*, Vol. 12, Haploids in Crop Improvement I, pp. 277-288. Berlin: Springer-Verlag.
- TSMS (2013). Turkish State Meteorological Servis, 2013 Reports, Ankara
- Yeh J. Y., Huang W. J., Kan S. F., Wang P. S. (2001): Inhibitory effects of *Digitalis* on the proliferation of androgen dependent and independent prostate cancer cells. *J Urol* 166: 1937-1942.

PROLONGING STORAGE LIFE OF '0900 ZIRAAT' CHERRIES BY USE OF MODIFIED ATMOSPHERE PACKAGING (MAP)

Mehmet Seckin KURUBAS, Mustafa ERKAN*

Akdeniz University, Faculty of Agriculture, Department of Horticulture, Antalya, Turkey

*Corresponding author: erkan@akdeniz.edu.tr

Abstract

In this research, the effects of modified atmosphere packaging on postharvest life and fruit quality of '0900 Ziraat' cherries (*Prunus avium* L.) were investigated. For this purpose cherries were harvested at optimal maturity and stored at 0°C temperature with 90-95% relative humidity for 50 days in three different modified atmosphere packaging (MAP). The first group of cherries was packed into ordinary non-perforated polyethylene bags (MAP-1). The second group of cherries was packed into ZOEpack (MAP-2) and the third group of cherries was packed into ordinary perforated polyethylene bags (MAP-3-control). Fruit samples were taken at 10 days intervals from different storage conditions and various physical and chemical analyses such as weight loss, flesh firmness, fruit removal force, soluble solids content, titratable acidity, skin color (L^* , C^* and h°), percentage of pitting and stem browning and taste were conducted. Furthermore, the changes in O₂ and CO₂ concentrations in MA bags during long term storage were recorded. Experimental results showed that the lowest weight loss was on the cherries stored in MAP-2. The fruit stored in MAP-2 had the highest flesh firmness, fruit removal force, soluble solids, titratable acidity, L^* , C^* , and taste scores at the end of storage. The most effective MAP for controlling pitting and stem browning was MAP-2. It can be concluded that '0900 Ziraat' cherries were successfully stored at 0°C temperature and 90-95% RH in MAP-2 for 50 days with minimal quality loss.

Keywords: *Cherry, 0900 Ziraat, modified atmosphere packaging, postharvest, quality*

Introduction

The leading cherry producer and exporter country in the world is Turkey. The total world production of cherries is about 2.333.155 tons (Anonymous, 2013a). The total production of cherries in Turkey is about 494.325 tons and export value of Turkey is approximately 155 million dollars (Anonymous, 2013b). '0900 Ziraat' is the most prominent cherry cultivar grown in Turkey and almost all of Turkey's cherry export comprises with this cultivar.

Sweet cherry (*Prunus avium* L.) is highly perishable non-climacteric fruit. Their shelf life is very short, manifested by browning and drying of the stems, darkening of fruit color, shrivel, and development of decay (Alique et al., 2003). The main parameters for cherry quality are fruit and stem color, sweetness, sourness and firmness (Kim et al., 2005). Fruit quality is determined by visual appearance, stem color, firmness and flavor. Loss of firmness, discoloration of the stem, shriveled fruit surface, darkening of fruit color, and development of decay are the major problems in shortening the shelf life of cherries (Esturk et al., 2012).

Modified atmosphere packaging (MAP) is a useful technique to maintain postharvest quality and extend storage life of different horticultural crops as well as cherries. MAP can be defined as an alteration in the composition of gases in and around fresh produce by respiration and transpiration when such commodities are sealed in plastic films. The use of MAP in postharvest

preservation of cherries is the most important technique to reduce weight losses as well. High relative humidity in the atmosphere surrounding the product, low O₂, and high CO₂ concentrations in the package can potentially reduce respiration rate, ethylene sensitivity, and production, as well as decay and physiological changes such as oxidation, with the resulting benefit of extending product life (Thompson, 2010).

The objective of this study was to determine the effects of different MAPs during long term storage on postharvest fruit quality of '0900 Ziraat' cherries.

Materials and methods

0900 Ziraat, which is the leading cherry cultivar in Turkey, was used as fruit material in the experiment. Cherries were harvested at the optimum harvest maturity and pre-cooled by cold water just after harvest and fruit were immediately transported to the storage unit of Department of Horticulture, Akdeniz University. Cherries were carefully selected for uniform size, free from visual symptoms of any disease, decay or blemishes. Superior quality fruit 26-30 mm in size were selected for the experiment.

The packaging applications were as given below: (1) MAP-1, these group of fruit was packed into non-perforated ordinary polyethylene bags (83x85 cm), (2) MAP-2, these group of cherries was packed into ZOEPack (Patent no: 203563, Serpak Co., Antalya, Turkey) and the third group of cherries was packed into perforated ordinary polyethylene bags (with 128 holes of 5.5 mm diameter, and total perforated area of 0.43%) (83x85cm), MAP-3 and this group of cherries was considered as control. After packaging, all groups of fruit samples were placed in cold storage room and stored for 50 days at 0°C with 90-95% relative humidity (RH). Fruit samples were taken at 10 days intervals and various physical and chemical changes on the fruit were determined.

For weight loss, at harvest 100 individually numbered fruit were weighed, and at the end of each storage period these fruit were re-weighed again and cumulative weight loss was determined and expressed as percent loss from their initial weight.

Flesh firmness was measured by Chatillon Digital Force Gauge equipped with an 8 mm tip. One hundred fruit, in each replication, were penetrated at three different sides of their equatorial axes and the firmness was recorded and expressed as N.

Fruit removal force was measured by Chatillon Digital Force Gauge equipped with notch adapters. One hundred fruit, in each replication, were picked off fruit stem and the fruit removal force was recorded and expressed as N.

External skin color was measured using a Minolta Chromameter (CR 200, MINOLTA Camera Co., LTD Ramsey, NJ, USA) and CIE $L^*a^*b^*$ color space values were recorded. According to CIELAB system, which express color in three parameters: L^* , that corresponds to lightness. Depending on a^* and b^* values, hue angles [$h^\circ = \tan^{-1}(b^*/a^*)$] and chroma values [$C = (a^{*2} + b^{*2})^{1/2}$] were calculated. h° is the angle formed by a line from the origin to the intercept of a^* (x axis) and b^* (y axis) co-ordinates, where $0^\circ =$ red, $90^\circ =$ yellow, $180^\circ =$ green, $270^\circ =$ blue. Chroma is the perpendicular distance from the lightness axis, indicating the color intensity (Mozetic et al., 2004). Measurements were taken on opposite sides of each fruit along their equatorial axes and the mean values were determined.

Stem browning and pitting were visually evaluated during the experiment. Any cherries with visible stem browning and pitting were considered browned and pitted. Stem browning and pitting were expressed as percentage of fruit showing symptoms.

Cherries were evaluated by 5 trained panelists at day 10, 20, 30, 40, and 50 of storage. Each treatment group was coded, presented in random order and evaluated based on general visual appearance using this scale: 5 = excellent; 4 = very good; 3 = good; 2 = poor; 1 = very poor.

The O₂ and CO₂ concentrations of the headspace inside the packages were measured using O₂ and CO₂ analyzer (Servomex Oxygen Analyzer 570 A Inj. and Bühler CO₂ Analyzer IR Analysator Typ-3000). Three replicates and three bags for each replication were used to measure O₂ and CO₂ concentrations in the bags. The results were expressed as kPa O₂ and kPa CO₂ inside the package.

For soluble solids content (SSC) fruit juices were extracted using a hand blender and SSC were determined using a digital refractometer and means were expressed as percentage (%).

Titrate acidity was determined by titrating 2 mL of fruit juice in 38 mL of distilled water with 0.1 N NaOH to the end point of pH 8.1 and expressed as percent of malic acid equivalents.

The experimental design was completely randomized. Groups of three replicates of 100 fruit per treatment for the cold storage were established. Statistical differences with P-values under 0.05 were considered significant. The Duncan test was used for comparing the averages of the sources of variation.

Results and Discussion

Weight losses of '0900 Ziraat' cherries were given in Table 1. The effects of both storage period and MAP on weight losses were found statistically significant ($p < 0.05$). As it is seen from Table 1, the weight loss of cherries increased by the storage time prolonged. The weight loss of cherries stored in MAP-1, MAP-2 and MAP-3 were 2.73%, 1.29%, and 3.81% respectively. During the storage period while the lowest weight loss was obtained from the cherries stored at MAP-2 (1.29%), the highest weight loss was obtained from the cherries stored at MAP-3 (3.81%). Weight loss of cherries increased in all treatments during the storage period. MAP-2 significantly reduced weight loss during cold storage. In our study, while the lowest weight loss was obtained from the cherries stored at MAP-2 the highest weight loss was obtained from the cherries stored at MAP-3. Esturk et al. (2012) reported that the weight loss of control fruit was 28% after 42 days of storage, it was below 1% in the fruit stored at micro perforated MAP.

Flesh firmness is an important quality attribute in cherries that affects consumer acceptance, fruit storage potential, and resistance to mechanical damage (Brown and Bourne, 1988). The effects of storage period on flesh firmness were found statistically significant but the effects of MAPs on flesh firmness were found similar ($p < 0.05$). Flesh firmness of cherries at harvest was 17.95 N and decreased to 7.15 N at the end of storage (Table 1). The highest flesh firmness was obtained from the cherries stored at MAP-2 (13.04 N) and the lowest flesh firmness was obtained from the fruit stored in MAP-3 (11.90 N). Flesh firmness was affected by MAPs and MAP-2 was more suitable than the other MAPs in maintaining of flesh firmness of cherries. Our results were similar to the findings of Remon et al. (2000) indicated that micro perforated MAPs were maintained the flesh firmness of 'Burlat' cherries.

The values of fruit removal force of cherries were given in Table 1. While the effects of storage period on fruit removal force were found statistically significant the effects of MAPs on fruit removal force weren't found statistically significant ($p < 0.05$). As it is seen from Table 1, the fruit removal force of cherries decreased by the storage time prolonged. Fruit removal force of cherries at harvest was 8.30 N and decreased to 4.37 N at the end of storage. The highest fruit removal force was obtained from the cherries stored at MAP-3 (6.13 N) and the lowest fruit removal force was obtained from the fruit stored in MAP-1 (5.71 N). The fruit removal force

values of cherries decreased by the storage time increased. Our results showed that fruit removal force values of MAP-2 and MAP-3 were higher than that of stored at MAP-1.

Skin color is the most important visual indicator of quality and maturity of fresh cherries (Gao and Mazza, 1995). L^* values of cherries were given in Table 1. The effects of both storage period and MAPs on L^* values were found statistically significant ($p < 0.05$). L^* value of cherries at harvest was 28.67 and it was determined as 25.94 after 50 days of storage. At the end of storage, the highest L^* value was obtained from the cherries stored at MAP-2 (28.10) and the lowest was obtained from the fruit stored in MAP-3 (26.92). The L^* values decreased in all treatments but the highest values obtained from MAP-2. These results were similar to the findings of Giacalone and Chiabrande (2013) observed that L^* values were higher in cherry fruit packaged with micro perforated MAP.

Hue angles (h°) of cherries were given in Table 1. The effects of storage period on h° were found statistically significant but the effects of MAPs on h° weren't found statistically significant ($p < 0.05$). h° value of cherries at harvest was 7.31 and it was determined as 7.68 after 50 days of storage. At the end of storage, the highest h° value was obtained from the cherries stored at MAP-3 (7.27) and the lowest was obtained from the fruit stored in MAP-2 (6.74).

C^* values of cherries were given in Table 1. The effects of both storage period and MAPs on C^* values weren't found statistically significant ($p < 0.05$). C^* values of cherries at harvest was 15.52 and decreased to 13.54 at the end of storage (Table 1). While the lowest C^* value (13.69) was obtained from the cherries stored at MAP-3, the highest (15.19) was obtained from MAP-2. Our results showed that the C^* values of cherry fruit packaged with MAP-2 was higher than that of MAP-1 and MAP-3. Similar results were obtained by Padilla-Zakour et al. (2004) on 'Lapins' cherries. These researchers indicated that cherries packaged with micro perforated MAP had significantly higher chroma values than that of control group.

The effects of both storage period and MAPs on pitting development were found statistically significant ($p < 0.05$). Longer storage periods resulted in higher amount of pitting during storage. The mean amount of pitting was 0% at harvest (day 0) and increased to 70% on the 50th day of storage. The highest pitting was obtained from the cherries stored at MAP-1 (52%) and the lowest was obtained from the MAP-2 (28%) (Table 1). Surface pitting of cherries increased by the storage time increased but the lowest surface pitting was obtained from the MAP-2. Our results were similar to the findings of Kappel et al. (2002) on cherry fruit. These researchers observed that cherry fruit stored in micro perforated MAP had lower surface pitting than that of control group.

Table 1. Weight loss, flesh firmness, fruit removal force, skin color (L^* , C^* , h°), pitting, stem browning, taste, soluble solids and, titratable acidity of ‘0900 Ziraat’ cherry cultivar during storage at 0°C.

Testing index	Packaging Treatments	Storage Period (Days)						Overall
		0	10	20	30	40	50	
Weight loss (%)	MAP-1	-	0,49	1,77	3,07	3,66	4,65	2,73b
	MAP-2	-	0,28	0,78	1,08	1,60	2,71	1,29c
	MAP-3	-	0,74	2,01	3,33	4,30	8,66	3,81a
	Overall	-	0,50e	1,52d	2,49c	3,19b	5,34a	
Flesh firmness (N)	MAP-1	17,95	24,65	9,74	8,30	6,96	7,65	12,54a
	MAP-2	17,95	23,77	12,52	8,27	8,76	6,96	13,04a
	MAP-3	17,95	24,48	9,74	6,57	5,85	6,83	11,90a
	Overall	17,95b	24,30a	10,67c	7,71d	7,19d	7,15d	
Fruit removal force (N)	MAP-1	8,30	4,22	6,24	5,92	4,61	4,97	5,71a
	MAP-2	8,30	5,49	6,24	6,24	5,95	4,48	6,12a
	MAP-3	8,30	6,63	6,96	7,45	3,76	3,66	6,13a
	Overall	8,30a	5,45c	6,48b	6,54b	4,77cd	4,37d	
L^*	MAP-1	28,67	29,29	26,44	30,13	24,70	24,03	27,21b
	MAP-2	28,67	27,86	25,90	28,86	28,45	28,84	28,10a
	MAP-3	28,67	26,86	27,61	29,37	24,07	24,95	26,92b
	Overall	28,67b	28,00c	26,65d	29,45a	25,74e	25,94e	
h°	MAP-1	7,31	5,97	7,67	8,20	6,73	6,59	7,08a
	MAP-2	7,31	5,44	6,57	4,96	9,16	7,01	6,74a
	MAP-3	7,31	5,28	7,15	7,01	7,45	9,44	7,27a
	Overall	7,31ab	5,56b	7,13ab	6,72ab	7,78a	7,68ab	
C^*	MAP-1	15,52	13,77	15,12	17,44	11,22	12,75	14,30a
	MAP-2	15,52	14,10	17,12	12,12	19,06	13,21	15,19a
	MAP-3	15,52	12,45	14,04	13,46	12,02	14,65	13,69a
	Overall	15,52a	13,44a	15,43a	14,34a	14,10a	13,54a	
Pitting (%)	MAP-1	0	0	78	48	94	92	52a
	MAP-2	0	0	38	34	44	50	28c
	MAP-3	0	0	60	64	76	68	45b
	Overall	0d	0d	59b	49c	71a	70a	
Stem Browning (%)	MAP-1	0	0	52	36	50	66	34a
	MAP-2	0	0	34	22	30	36	20c
	MAP-3	0	0	28	26	40	50	24b
	Overall	0d	0d	38b	28c	40b	51a	
Taste	MAP-1	-	3,80	3,80	4,00	3,40	3,00	3,60a
	MAP-2	-	4,80	4,40	3,20	3,40	3,20	3,80a
	MAP-3	-	3,60	3,20	1,70	2,60	2,60	2,74b
	Overall	-	4,07a	3,80ab	2,97c	3,13bc	2,93c	
Soluble solids	MAP-1	16,60	16,93	17,67	17,67	15,67	18,00	17,09a
	MAP-2	16,60	17,47	17,87	17,60	17,47	16,87	17,31a
	MAP-3	16,60	17,67	16,93	16,47	16,80	16,20	16,78a
	Overall	16,60b	17,36ab	17,49a	17,25ab	16,65ab	17,02ab	
Titratable acidity	MAP-1	2,94	4,86	2,98	3,14	2,14	1,93	3,00a
	MAP-2	2,94	4,65	3,00	3,18	2,30	2,06	3,02a
	MAP-3	2,94	4,44	2,75	2,70	1,78	1,65	2,71b
	Overall	2,94b	4,65a	2,91b	3,01b	2,07c	1,88d	

Stem browning of cherries was given in Table 1. The effects of both storage period and MAPs on stem browning was found statistically significant ($p < 0.05$). Stem browning dramatically increased especially in MAP-1 and MAP-3 with prolonging storage duration. The mean amount of stem browning was 0% at harvest (day 0) and increased to 51% on the 50th day of storage. The

highest stem browning was obtained from the cherries stored at MAP-1 (34%) and the lowest was obtained from the MAP-2 (20%) (Table 1). Our results are supported by the findings of Kappel et al. (2002) on different cherry cultivars.

The effects of both storage period and MAPs on taste were found statistically significant ($p < 0.05$). Taste scores of cherries were given in Table 1. The taste score was 4.07 on the 10th day, 3.80 on the 20th day, 2.97 on the 30th day, 3.13 on the 40th day and 2.93 on the 50th day of storage. The highest taste value was obtained from the cherries stored at MAP-2 (3.80) and the lowest was obtained from the MAP-3 which was 2.74 (Table 1). Our results were similar to the findings of Padilla-Zakour et al. (2004) remarked that micro perforated MAP had better eating quality compared to control cherries.

Soluble solids content of cherries were given in Table 1. The effects of storage period on soluble solid content were found statistically significant but the effects of MAPs on soluble solid content weren't found statistically significant ($p < 0.05$). Soluble solids content of cherries increased by the storage time prolonged. Soluble solids content of cherries at harvest was 16.60% and increased to 17.02% at the end of the 50 days storage period. During the all storage period while the highest soluble solids content was obtained from the cherries stored at MAP-2 which was 17.31%, the lowest soluble solids content was obtained from the cherries stored at MAP-3 which was 16.78%. Titratable acidity of cherries was given in Table 1. The effects of both storage period and MAP on titratable acidity were found statistically significant ($p < 0.05$). Titratable acidity at harvest was 2.94% and decreased to 1.88% at the end of the storage period. The highest titratable acidity was obtained from the cherries stored at MAP-2 (3.02%) and the lowest was obtained from the MAP-3 (2.71). In our study, titratable acidity increased at day 10 then decreased in all treatment groups and the highest titratable acidity was obtained from the cherries stored at MAP-2. Similar results were obtained by Giacalone and Chiabrando (2013) on 'Sweetheart' cherry fruit. These researchers indicated that cherry fruit stored in micro perforated MAP had higher titratable acidity than that of control group.

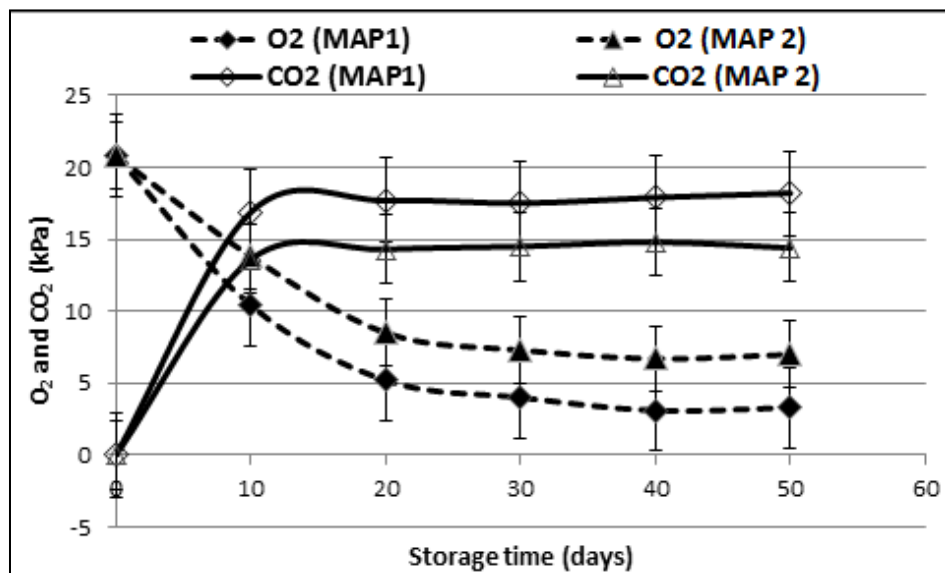

Figure 1. The changes O₂ and CO₂ levels in MAPs during storage

The variations in O₂ and CO₂ concentrations in different MAPs during storage were presented in Fig. 1. The initial O₂ concentration was approximately 21% in MAPs and the level of O₂

decreased from 20.8% to 3.3% in MAP-1 and to 7.0% in MAP-2 after 50 days of storage. The level of CO₂ increased from 0.03% to 18.2% in MAP-1 and to 14.4% in MAP-2, during the 50 days of storage. During storage, a decrease in O₂ and an increase CO₂ levels occurred inside MAP-1 and MAP-2 but the O₂ and CO₂ levels in the MAP-2 remained constant throughout the 50 days of storage. Similar trends of decreases in O₂ and increases in CO₂ levels during storage of MAP cherries were detected by in previous studies. Similar results were obtained by Padilla-Zakour et al. (2004) on ‘Hedelfingen’ and ‘Lapins’ cherries.

Conclusion

Micro perforated MAP (MAP-2) extended the postharvest life of ‘0900 Ziraat’ cherry fruit by decreasing weight loss, maintaining firmness and visual appearance (*L**, *C**), reducing the rate of acidity loss and surface pitting, preserving taste quality and by retaining stem freshness. As a conclusion, the most effective MAP was MAP-2 for maintaining quality of the ‘0900 Ziraat’ cherry fruit.

References

- Alique, R., Martinez, M.A. and Alonso, J. (2003). Influence of the modified atmosphere packaging on shelf life and quality of Navalinda sweet cherry. *Eur. Food Res. Technol.* 217:416–420.
- Anonymous, 2013a. Food and Agriculture Organization of the United Nations. FAOSTAT database. (<http://faostat3.fao.org/download/Q/QC/E>. Accessed on 06/14/2016).
- Anonymous, 2013b. Food and Agriculture Organization of the United Nations. FAOSTAT database. (<http://faostat3.fao.org/download/T/TP/E>. Accessed on 06/14/2016).
- Brown S.K., Bourne M.C. (1988). Assessment of components of fruit firmness in selected sweet cherry genotypes. *Hort. Sci.*, 23: 902–904.
- Esturk, O., Ayhan, Z. and Ustunel, M.A. (2012). Modified Atmosphere Packaging of “Napoleon” Cherry: Effect of Packaging Material and Storage Time on Physical, Chemical, and Sensory Quality. *Food Bioprocess Technol.* 5, 1295–1304.
- Giacalone, G. and Chiabrande, V. (2013). Modified atmosphere packaging of sweet cherries with biodegradable films. *International Food Research Journal.* 20(3): 1263-1268.
- Kappel, F., Toivonen, P., McKenzie, D. L. and Stan, S. (2002). Storage characteristics of new sweet cherry cultivars. *HortScience*, 37(1), 139-143.
- Kim, D.O., Heo, H.J., Kim, Y.J., Yang, H.S. and Lee, C.Y. (2005). Sweet and sour cherry phenolics and their protective effects on neuronal cells. *Journal of Agricultural and Food Chemistry.* 53: 9921-9927.
- Padilla-Zakour, O.I., Tandon, K.S., and Wargo, J.M. (2004). Quality of Modified Atmosphere Packaged ‘Hedelfingen’ and ‘Lapins’ Sweet Cherries. *HortTechnology.* July–September. 14(3).
- Remon, S., Ferrer, A., Marquina, P., Burgos J. and Oria, R. (2000). Use of modified atmospheres to prolong the postharvest life of Burlat cherries at two different degrees of ripeness. *Journal of the Science of Food and Agriculture.* 80, 1545-1552.
- Thompson, A.K. (2010). Controlled atmosphere storage of fruits and vegetables./editor A. Keith Thompson. 2nd ed. Section: 8. Modified Atmosphere Packaging. 81-115

NOZZLES TRANSVERSE DISTRIBUTION MODEL DEVELOPMENT: EFFECT OF PRESSURE AND ANTI DRIFT NOZZLE

Vladimir VIŠACKI, Aleksandar SEDLAR, Rajko BUGARIN, Jan TURAN, Lazar PAVLOVIC,
Sanja LAZIĆ, Dragana ŠUNJKA

Faculty of Agriculture, University of Novi Sad, Trg D. Obradovića 8, 21000 Novi Sad, Serbia

*Corresponding author: vladimir.visacki@polj.uns.ac.rs

Abstract

Timely and high-quality application of pesticides contributes to environmental protection, economical production and production of healthy food. The efficacy of pesticide application depends not only on the quality of pesticides but also the quality of the application. One of the factor that most influences on the applications quality, from the standpoint of mechanization, are nozzles. They applied liquid on the surface of the plant which resulting that same volume of pesticide is applied to the entire surface of the plants. To achieve this goal, nozzles must performed uniform application of liquid per unit area, or working width. The variable factor in the application of pesticides may be nozzle and operating pressure. With increasing working pressure it was obtained smaller droplets. The paper presents test of three different nozzles. Each nozzle is characterized by a flat jet with an angle of 110° and a flow rate of 1.6 l / min at a pressure of 3 bar. Differences between each other is the way of jet disintegration. Exactly this characteristic causes that with pressure change coming to changes in the uniformity of nozzles transverse distribution. The best distribution has nozzle with a flat jet. The coefficient of variation is between roughly from 4 to 6% at the pressure application of 2 to 4 bar. Obtained mathematical model that describes changes in the coefficient of variation depending on pressure applications can be a good basis for easy harmonization parameters in the pesticide application.

Keywords: *nozzle, coefficient of variation, uniformity of distribution, pressure, sprayer, disintegration.*

Introduction

Today's way of plants protecting require a modern technique for pesticide application. The technique as sprayer must be well chosen, functional, calibrated and maintained. Nozzles are important because of their impact on biological efficiency, environmental protection and weed control efficiency. Their quality is reflected at the work in altered weather conditions, in that they have wide range of operating pressure, flexibility in terms of flow with movement speed change. For efficient application of pesticides, nozzles must be uniformly distributed over the entire surface of boom working width. In this effect is influenced by two components. One of them is a horizontal-enabled application that depends on the boom, the distance between nozzles, nozzles type and exploitation factors. Leung et al. (1990) adds that pressure and height of boom as the operational parameters and that they are the most important for the pesticides uniform application. Nowakowski (2007) states that the pressure plays a major role in the quality of the transverse distribution in terms of variation coefficient. Douzals (2012) in the examination of flat jet nozzles at a pressure of 1.5 bar to 3.5 bar and boom height from 0.3 to 0.9 m comes to the entire data spectrum of variation coefficient. On that basis he concluded if pressure increases it result to reduction variation coefficient. Rising up to a value of 1.08% at a pressure of 3.5 bar and

the boom height 0.9 m. Similarly, Sawa et al. (2012) confirms indicated by recommending that one of the most important factors just a good selection of nozzles. Nozzles precisely characterized by transverse distribution as the most important factor. This characterizes them and to their most important feature according to Bahadir and Saim (2011). Application in rows is even better technique pesticide application because the treatment is done predefined part (Nigar et al. 2011). Worn or damaged nozzles will not only have a bad transverse distribution of fluids, but also larger droplets Subra et al (2015). The task was to carry out a measurement of the transverse distribution of three different nozzles in the laboratory. The aim is to show the impact of different types of anti-drift nozzles on the transverse distribution. The resulting mathematical models describing the change at the coefficient of variation of other parameters tested applications for nozzles.

Materials and methods

In the laboratory control techniques for the application of pesticides is done measuring the transverse distribution of three different nozzles. All nozzles are flow rate of 1.6 l / min, red in color and are set to triple rack nozzles on the wing length of 6 m for every 0.5 m. All nozzles were tested at pressures recommended by the manufacturer. These are pressures from 2 to 4 bar or 2 to 6 bar examination every 0.5 bar. Identification of the nozzles AD, AD / D and ADIA. The first nozzle was labeled with AD is anti drift nozzle with a flat jet angle of 110°. The second is the same as the first but it has only long nozzles body and rotated jet by 30 ° in the negative direction. The last tested nozzle was injector nozzle with a spray angle of 110 °. Nozzles are shown in the following photos.



AD

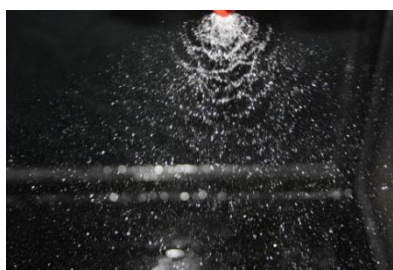

AD/D



ADIA

Applications height was 0.5 m. The temperature was about 25 ° C and the relative humidity exceeded 65%. Everything was done in accordance with ISO 16122-2: 2015 Agricultural and forestry machinery - Inspection of sprayers in use - Part 2: Horizontal boom sprayers. Given that the said standard relates to crop sprayers, all measurements were done on crop sprayer. It is a field sprayer, which is used for laboratory purposes, where drive of piston diaphragm pump of 85 l / min is performed by electric motor. The tank holds 300 liters and measuring and control device is a mechanical pressure gauge with a measuring range up to 8 bar. Booms are 6 m width and divided into two sections , every 3 m.

For measuring the transverse distribution was used Spray scanner company AAMS Salvarani. The dimension is 1.2 m x 0.8 m in width which was divided into 8 funnels. All the liquid collected in funnels flowing in tubes of a known volume. The tubes have upper and lower contacts, which measures the time required for filling the tube. In this way, the total flow rate is calculated. On the computer among other parameters, shows the coefficient of variation as a measure of the transverse distribution uniformity. If this ratio is less than 10%, the average

distribution nozzles is acceptable. For a coefficient of variation greater than 10%, the horizontal distribution of the working fluid is unacceptable.

Results and discussion

By measuring the transverse distribution are obtained coefficient of variation indicated in the following table. In all nozzles were recorded mainly coefficient of variation of less than 7%, which is an excellent horizontal distribution at all tested pressures. Thus, at lower pressures the best lateral distribution has nozzle as AD at a pressure of 2.5 bar coefficient of variation of only 4.83%. This is less than 7.19%, which has rotated the nozzle spray to 30 ° at a pressure of 2 bar.

Tab. 1. Coefficients of variation of tested nozzles

Nozzle/ Pressure, bar	AD 110-04	AD/D 110-04	ADIA 110-04
2	5,15	7,19	6,19
2,5	4,83	6,25	5,93
3	5,2	6,68	5,67
3,5	5,37	6,8	5,395
4	5,72	7,04	5,12
5	/	/	5,77
6	/	/	5,81

At higher pressure applications deteriorates transverse distribution of fluids. In this regard, the dispenser AD / D has a higher coefficient of variation of 7% at a pressure of 4 bar. This is still an acceptable value or distribution is not perfect. At the same pressure distribution has the best horizontal injector nozzle with a spray 5.12%. It is interesting that at higher pressures the coefficient of variation does not increase dramatically with this nozzles and amounts 5,77% at 5 bar person respectively 5.81% at 6 bar. This is very important at the application of pesticides. Generally, anti drift nozzle with a fan-shaped jet has the best distribution with a note that statistics do not differ much uniformity from one another.

Fig. 4. Changing coefficient of variation depending on the nozzles type and pressure.

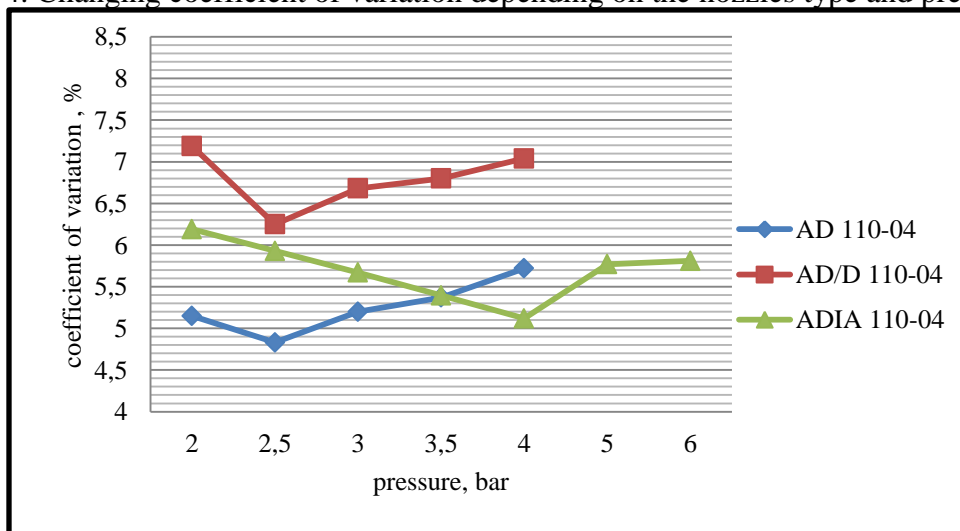

On the previous picture is shown a graph which represent changes variation coefficient with the change of pressure and nozzles type. For all the notes that as the pressure increases, the quality of the transverse distribution improves and then with further increasing pressure it start to be worse. However, the changes are not so drastic and have a great impact on the quality of distribution. The equations that describe the change in the coefficient of variation of the following:

$$\text{AD: } y = -0,042x^3 + 0,463x^2 - 1,323x + 6,034R^2 = 0,945$$

$$\text{ADIA: } y = -0,010x^4 + 0,175x^3 - 0,935x^2 + 1,590x + 5,345, R^2 = 0,873$$

$$\text{AD/D: } y = -0,104x^3 + 1,083x^2 - 3,311x + 9,492, R^2 = 0,879$$

Given equation can be used to obtain the coefficient of variation for pressures and tested nozzles. They have an important role at application chooses the parameters of crop sprayers and given nozzles.

Conclusion

In examining three different anti drift nozzles at the recommended pressure can conclude the following:

- Best horizontal transverse distribution of the working fluid has a nozzle with AD coefficient of variation of 4.83% to 5.72%;
- It is expected that the injector nozzle has the worst distribution but this is not the case, because AD / D jet nozzle has rotated by 30 °, which leads to lower transverse distribution with a range of 6.25% to 7.19%;
- Injector nozzle maintains uniform distribution of working liquid despite the high pressures of between 5 and 6 bar.

The obtained equations can be very useful when selecting operational parameters pesticide application. It is necessary to ddatno perform tests at different altitudes because the applications boom is not a course are not always parallel, at a distance of 0.5 m.

Note: The paper is the result of research on the project TR 31073, Improving the production of maize and sorghum in the conditions of stress, which is funded by the Ministry of Education and Science of the Republic of Serbia.

References

- Nowakowski, T. (2007). Interaction between selected spraying parameters on the variability coefficient of liquid transverse distribution. *Inzynieria Rolnicza*, 3(91), 135-141.
- J.P. Douzals, A. Porte, P. Fernandez. Simulating CoV from nozzles spray distribution: a necessity to investigate spray distribution quality with drift reducing surfactants.. *CIGRAgEng2012*, Jul 2012, Valencia, Spain. *CIGR-AgEng*, 6 p., 2012.
- Alaa Kamel Subra, Józef Sawaa, Stanisław Parafiniuka (2015). Practical deviation in sustainable pesticide application process. *Agriculture and Agricultural Science Procedia* 7 (2015): 241-248.
- Sawa J. Wójcicki Z., Tabor S., Wajszczuk K., 2004. Wpływ nowych technologii na poziom i strukturę nakładów materiałowo-energetycznych na jakość surowców rolniczych. *Sprawozdanie końcowe KBN Nr 3 P06R 037 22 AR Lublin (maszynopis)*.
- Sawa J. , Huyghebaert B. , Parafiniuk S. , 2012. Testing device for a complex measurement of the performances nozzles ,*SPISE* 4, Lana, Italy, 228-233.
- ISO 16122-2:2015 Agricultural and forestry machinery - Inspection of sprayers in use - Part 2: Horizontal boom sprayers.

- Gajtkowski A.: Technika ochrony roślin. Poznań 2000. Wydawnictwo Akademii Rolniczej w Poznaniu, s. 122.
- Leunda P, Debouche C, Caussin R (1990). Predicting the transverse volume distribution under an agricultural spray boom. *Crop protection* Vol. 9, 111-114.
- Nigar Y, Ekrem A, Ali M, Huseyin Y, Nebile D, Tunahan E, Ebru K (2011). Effect of different pesticide application methods on spray deposits, residues and biological efficacy on strawberries. *Afr. J. Agric. Res.* 6(4):660-670.
- Bahadir S, Saim B (2011). Spray distribution uniformity of different types of nozzles and its spray deposition in potato plant. *Afr. J. Agric. Res.* 6(2):352-362.
- J.P. Douzals, M. Al Heidary. How spray characteristics and orientation may influence spray drift in a wind tunnel. *International Advances in Pesticide Application 2014*, Jan 2014, Oxford, United Kingdom. Association of Applied Biologists, p.271 - p.278, 2014

BIOETHANOL PRODUCTION FROM SUGAR BEET

Süreyya Gülfem ALTUNBAY

Department of Plant Breeding, Sugar Institute, T.Ş.F.A.Ş. Ankara, Turkey

*Corresponding author: sureyyagulfem@hotmail.com

Abstract

Today, gradually running out of fossil fuels, the destruction of ecosystems, efforts to avoid depending on foreign countries for energy and to increase energy diversity have increased the importance of fuels such as bioethanol. Biomass production of bioethanol from sugar beet molasses will lead to open a new market for beet producers, to widespread the crop rotation, to create an energy farming culture and lead to an increase in sugar beet growing areas. Bioethanol also contributes favorable support to the ecology by providing diversity in agricultural production and it is important for creating sustainable agricultural structure and supporting rural development. Bioethanol in general is obtained by fermentation of plants containing sugar and starch. Sugar beet molasses is used for the production of bioethanol from sugar beet. Production of bioethanol from molasses is carried out at three stages such as yeast reproduction, fermentation and distillation. The alcohol obtained in 96% purity during ethanol production process is not used as biofuel. In order to be used as biofuel it should be in 99.5% purity. Therefore, in alcohol plants the purification and distillation units are needed in addition to fermentation unit. Attention should be paid to alternative energy sources such as bioethanol since the oil reserves are decreasing and environment problems are increasing.

Keywords: *Sugar Beet, bioethanol, energy, biomass*

Introduction

The combination of volatility in the oil market and finite oil resources and effect on global climate change from the addition of CO₂ to atmosphere as a result of burning fossil fuels has increased the interest in sustainable energy generation from renewable biofuels. At present, approximately 10% of the primary global energy demand is met using biomass (Antoni et al. 2007). Secondary biofuels often are divided into 1st generation (with a feedstock of seeds, grains, or sugars), 2nd generation (from lignocellulosic biomass) and sometimes 3rd generation (from algae and seaweed) (Nigam and Singh 2010; Larson 2006). Most 1st generation biofuels in current production are liquid (either bioethanol or biodiesel) with the bioethanol the product of fermentation (Antoni et al. 2007; de Vries et al. 2010; FAO 2008).

Sugar crops due to cultivating a wide area has some many advantages according to grain. Sugar beet provides an abundance of sucrose, which is easily fermented by many microbes. The amount of sucrose extracted per hectare is dependent on three factors, the weight of the beets harvested, the percentage sucrose in those beets, and the amount of the sucrose that is extractable. The root of the sugar beet may contain 20% sucrose by fresh weight. However the amount extracted is less (15,3 % average from the U.S. crop 200-2009) (USDA-ERS 2010) because some cations (e.g., Na⁺ and K⁺) or amino nitrogen compounds (e.g., betaine and glutamine) interfere with the extraction of sucrose (McGinnis 1982).

After the sucrose has been extracted, the remaining juice is molasses. The molasses from one tonne (t=Mkg) of sugar beet (fw) weights about 20 kg and is approximately 50% sucrose

(Shapouri et al. 2006). Pulp or marc remains after the sucrose and molasses have been extracted from the crop. The pulp represents the 22-28% of the dry mass of the sugar beet root that is not solubilized during the sugar beet extraction process (Scott and Jaggard 1993) and is fermentable. The conversion of sucrose to ethanol is a simple process requiring only yeast fermentation, whereas producing ethanol from maize, wheat or other cereal grains e.g., requires enzymes to convert starch to sugars (Antoni et al. 2007; Jacobs 2006).

Sugar beet as a Feedstock for Ethanol Production

Sugar beets are defined at a factories and unlike sugarcane, are produced directly into white, refined sugar (Eggleston, 2008). This makes the processing of sugar beet ethanol more economical than for sugarcane (Anon, 2009c). The major products from sugar beet processing are pulp, which is the fibrous root material left over after the extraction process, and molasses which consist of the soluble impurities left after sucrose extraction (Harland et. al., 2006). Both are used as animal feed.

The sucrose content of sugarbeets ranges from 16-18% (wet weight), whereas sucrose in sugarcane varies from 10-15%. In a recent study, it was calculated that the yield of ethanol from the sucrose in a sugarbeet was 118 l/t of root (we weight) (Shapouri et. al., 2006). This calculation was based on a refined sucrose recovery of 15.5% (of wet weight) and a yield of 20 kg of sucrose from 1 t of beet molasses. The pulp represents the 22-28% of the dry mass of the sugarbeet root that is not solubilized during the sugar beet extraction process. A large portion of the pulp might provide additional feedstock for the production of cellulosic biofuels if the sugars can be released from the biomass. Theoretically available sugars could be solubilized using enzyme digestion (Kozak and Laufer, 2009).

Sugar Beet and Ethanol

The yield of sugarbeet is dependent on many factors, including whether it is irrigated or rainfed, disease or other abiotic stresses present. All things being equal, the amount of sucrose in the beet is directly proportional to the amount of solar radiation intercepted by a full canopy (Millford,2006). Sucrose content also varies by location and would play an important part in ethanol yield if the ethanol were to be produced from the fermentation of sucrose. For ethanol produced solely from pulp and molasses, the yield would range between 7 and 11 l/t wet weight of sugarbeet assuming a 30 and 50% conversion of pulp to feedstock (Eggleston et al. 2008).

The conversion of sucrose to ethanol is a simple process requiring only yeast fermentation, whereas producing ethanol from maize, wheat or other cereal grains e.g., requires enzymes to convert starch to sugars (Antoni et .al. 2007; Jacobs 2006).

On a per hectare basis, sugar beet is one of the most efficient sources of ethanol. It has been calculated that sugar beet produces between 100 and 120 l/t (fw) of ethanol through the fermentation process (110 l/t (FAO 2008), 103,5 l/t (Shapouri et al. 2006), 117 l/t (Panella and Kafka 2010)). The dry weight equivalent of one tonne of sugar beet (fw) has been calculated to contain about 3.89 GJ of energy (Tzilivakis et al. 2005). Ethanol has an energy content of 21.2 MJ/l (Schmer et al, 2008), which would be give an energy value of 2.44 GJ/t sugar beet (fw), assuming production of 115 l/t when converted to ethanol. FAO (2008) calculates 5,060 l/ha yield for sugar beet compared with a 1,960 l/ha yield for maize or 952 l/ha for wheat, using a global estimate of average yield (46 t/ha for beet, 4.9 t/ha for maize, 2.8 t/ha for wheat). Von Felde (2008) has estimated that anaerobic digestion methods for whole beets to produce bio-methane would produce 137% more energy than would fermentation of sugar beet to ethanol.

It is relatively easy to extract sugar from sugar beets. The beets are chopped into thin chips called cossettes and washed in a counter current flow with water. The washed cossettes are pressed to remove remaining water and sugar. The sucrose rich water is then cleaned of impurities with lime and filtration and separated by drying and crystallization (Process description, 2000). If the sugar from beets was used to create ethanol instead of sugar, the cleaned sucrose rich water could be put through a fermentation step instead of drying and crystallization. The current sugar extraction process could be duplicated exactly up until this point. The sucrose water mixture might have to be diluted or concentrated to be a recover ethanol, most likely by distillation, would finish the process of creating ethanol from sugar beets.

Sugar Beet Breeding for Bioethanol Production

For energy beets, breeding progress, and as with sugar beet variety development. Well adapted, high sucrose content sugar beet will be best choice for founder populations of energy beets. High biomass, defined as the yield of dry matter, is desirable for an energy crop. Relationships between water and dry matter, dry matter and sucrose content have a genetic and physiological basis (Carter, 1987). In most regions over the next few years economic conditions will require a sugar beet may be grown as a sugar crop as well as an energy crop. However, in those areas where sugar beet is used only as biofuel feedstock, different criteria will become important. Earlier studies have shown that if biomass yield is the most important parameter, crossing fodder beet and sugar beet in hybrid combination will yield more biomass (Doney and Theurer 1984; Theurer et al. 1987).

Situation of Turkey's Bioethanol Production

In Turkey, production of bioethanol has just begun. First generation bioethanol production is still carried out by eight factories, most of them are sugar factories and use molasses to produce bioethanol. Only in Amasya, Çumra and Eskişehir do the sugar factories perform dehydration and vinasse enriching (Bayrakçı, 2009). The Çumra sugar and ethanol factory is still producing bioethanol, while the others are closed because of policy and budget problems. The Turkish Energy Regulatory Agency (EMRA) issued a new regulation for biofuel blending which will be mandatory starting from 2013 and 2014 respectively for bioethanol (2%) and biodiesel (1%). The blending ratio will be increased up to 3% respectively for bioethanol in 2014 and biodiesel in 2016 (EMRA,2011).

Conclusions

Increasing number of motor vehicle, too high fuel consumption, the destruction of ecosystems, increasing energy demand by the years bring the new approach about bioethanol. Fossil fuels will not be able to respond to all energy requirements after approximately 150 years. Only by adding a dehydration unit in the premises of sugar factories, alcohol production facilities will be able to make the production of bioethanol. Sugar beet production should be increased. When using gasoline with bioethanol content, the performance of vehicle will increase, the agricultural sector will be supported. Bioethanol should have been seen as one part of a portfolio of technological and policy solutions. The research and development must be envisioned.

References

- Antoni D., Zverlov V., Schwarz W., 2007. Biofuels from microbes. *Applied Microbiology and Biotechnology*, 77:23-35.
- Anon, 2009c. Sugar Beet Ethanol. Ethanol –still-plans.com. http://www.ethanol-still-plans.com/sugars_beet_ethanol.htm, accessed 24 July 2009.
- Bayrakçı, A.G., 2009. An Investigation on bioethanol production from different biomass resources. Ege University Solar Energy Institute.
- Carter, J.N., 1987. Sucrose production as affected by root yield and sucrose concentration of sugar beet. *J. Am. Soc. Sugar Beet Technol.* 24: 14-31.
- Dooney, D.L., Theurer, J.C. 1984. Potential of breeding for ethanol fuel in sugar beet. *Crop Science* 24:255-257.
- De Vries, S.C., Van de Ven, G.W.J., Van Ittersum, M.K., Giller, K.E. 2010. Resource use efficiency and environmental performance of nine major biofuel crops, processed by first-generation conversion techniques. *Biomass and Bioenergy* 34:588-601.
- Eggleston, G. 2008. Sugar and related oligosaccharides. In *Glyco-science*, ed. B. Fraser-Reid, Thiem, T.K. 1164-1183. Heidelberg, Germany: Springer Verlag.
- EMRA. 2011. Energy Market Regulatory Agency, 2011, www.epdk.gov.tr (5/03/2012).
- FAO. 2008. The state of food and agriculture. Biofuels:Prospects,risks and oppurtunities. Rome, Italy: FAO Electronic Publishing Policy and Support Branch Communications Division. Accessed 10 Jan 2011.
- Harland, J.I., Jones, C.K., Hufford, C. 2006. Co-Products. In *Sugar Beet*, ed. A.P. Draycott, 443-463. Oxford, UK: Blackwell Publishing, Ltd.
- Jacobs, J. 2006. Ethanol from sugar: What are the prospects for U.S. sugar coops. P.5.<http://www.rurdev.usda.gov/rbs/pub/sep06/ethanol.html>.
- Kozak, R., Laufer, C.S., 2009. Addition of a thermostabilized pectin methylesterase significantly enhances the rate of saccharification of sugar beet pulp by the commercial pectinase preparation Pectinex. Ultra SPL, *Journal of Sugar Beet Research* 46: 71-72.
- Larson, E.D. 2006. A review of life-cycle analysis studies on liquid biofuels systems for the transport sector. *Energy for Sustainable Development* 10:109-126.
- McGinnis, R.A. 1982. Beet-sugar technology. Fort Collins. CO: Beet Sugar Development Foundation.
- Nigam, P.S., Singh, A. 2010. Production of liquid biofuels from renewable resources. *Progress in Energy and Combustion Science*. Doi:10.1016/j.pecs.2010.01.003.
- Process Description. 2000. Imperial Bioresources LLC.
- Panella, L., Kaffka., S.R. 2010. Sugar beet as a biofuel feedstock in the United States. In *Sustainability of the sugar and sugar ethanol industries*, ed. G. Eggleston, 163-175. American Chemical Society Symposium Series. New York, NY:Oxford University Press.
- Scott, R.K., Jaggard, K.W. 1993. Crop physiology and agronomy. In *the sugar beet crop: Science into practice*, ed. D.A. Cooke, 179-237. London:Chapman and Hall.
- Shapouri, H., Salassi, M., Fairbanks. 2006. The Economic feasibility of ethanol production from sugar in the United States, Joint publication of OEPNU, OCE, USDA, and LSU. www.usda.gov/oce/reports/energy/
- Schmer, M.R., Vogel, K.P., Mitchell, R.B., Perrin, R.K. 2008. Net energy of cellulosic ethanol from switchgrass. *Proceedings of the National Academy of Sciences of USA* 105:464-469.
- Theurer, J.C., Doney, D.L., Smith, G.A. 1987. Potential ethanol production from sugar beet and fodder beet. *Crop Science* 27: 1034-1040.

- Tzilivakis, J., Warner, M., May, K.A., Lewis, J., Jaggard, K. 2005. An assessment of the energy inputs and greenhouse gas emissions in sugar beet production in the UK. *Agricultural Systems* 85: 101-119.
- Von Felde, A. 2008. Trends and developments in energy plant breeding-special features of sugarbeet. *Zuckerindustrie* 133: 342-245.

THE EFFECTS OF DIFFERENT TIMES APPLICATIONS OF IRRIGATION TERMINATION ON CORN

Leyla IDIKUT^{1*}, Mehmet DAVUT SAHIN²

¹Kahramanmaraş Sutcu Imam University, Faculty of Agriculture, Department of Field Crops 46100, Onikisubat,
Kahramanmaraş / Turkey

^{2*}Institute of GAP Agricultural Research, Sanliurfa / Turkey

*Corresponding author: icesurer@ksu.edu.tr; leylaidikut@gmail.com

Abstract

Climate change requires the conscious use of water for agricultural production, both in Turkey and in the world. The most important factor in getting nutrient for a plant is water. Water is the most important factor in the plant's nutrient intake. Therefore, the farmers always irrigate corn field until the harvest. The forming of corn grain start with fertilization that pollens falling over their stigma of ear. Corn grain formation begins after fertilization of the ear tassel by ear tuft. If plants are exposed to water stress during this period their physiological activities will stop. Therefore, fertilization will not occur and desired grain yield would not be provided. In the study, irrigation termination process was started after tassel emergence 7th day, water cut-off operations continued in 7 days interval. The total of irrigation termination consisted of 6 application. The last time of water cut-off was 42nd day after tassel emergence. In this study, P. T83 hybrid corn was planted in GAP Agricultural Research Institute in Sanliurfa on 20, June, 2015. The trial was conducted as randomized block experimental design with 3 replications. In the study, the effect of irrigation termination at seven-day intervals in six different stage after tasseling on plant height, ear diameter, grain yield, grain protein, starch and oil content of P. 32T83 hybrid corn grown in the first cropping season were investigated. Research results showed statistically significant differences according to the last irrigation on examining all the features of corn. Research results were showed statistically significant differences according to the last irrigation time in terms of plant height, ear diameter, grain yield, protein, starch and fat rate. The values of these parameters have been changed between 213.33 - 226.33 cm, 25.00 - 30.33 mm, 4910.93 - 9140.36 kg ha⁻¹, 9.33% - 10.80%, 74.16% – 75.06%, 3.06% - 3.30% respectively.

Keywords: *Corn, irrigation, grain yield.*

Introduction

Corn (*Zea mays* L.) located in grains group is one of the plants versatile research, due to the use of very intensive industries in recent years. Corn (*Zea mays* L.) is one of the plant in grain groups investigated as versatile plant due to its very intensive usage in industry recently. Corn plant needs a certain temperature because of the C4 plant. It can be grown either first or second crop, if the temperature required by the corn plant are fully met. The production of forage, silage and fresh ear are made in places where the temperature is insufficient, so maize farming is spread over a wide area. The corn plant take nutrients from the soil as fast, because of growing in a very short time and creating a lot of above-ground biomass (Kırtok, 1998). The greatest contribution to the nutrient intake of maize is provided by water. The amount of water corn needed is greater in total due to its total transpiration surface, the amount of dry matter, and high evaporation in the growing period. The most sensitive period of water stress on corn have reported previous two and

the next two to three weeks of ear silk emergence (Singh and Singh 1995). Formation of corn grains begin after fertilization of ear tuft by tassel if plants are exposed to water stress during this period, due to the cessation of physiological activities fertilization will not occur and grain formation will not take place. The lack of water will decrease yield of corn (Kaya et al., 2006). The reduction in the amount of available water in the world and Turkey especially affects the agricultural sector significantly, It makes mandatory controlled usage of irrigation water resources Therefore, in this study, the effect of irrigation termination at seven-day intervals in six different stage after tasseling on plant height, ear diameter, grain yield, grain protein, starch and oil content of P. 32T83 hybrid corn grown in the first cropping season will be investigated.

Materials and Methods

The field trial area, plowed with plow and no action was taken in the field until spring after the harvest of the previous year sesame plant. The trial area was tilled with a second class tillage tools and flattened with rollers before planting. Seed sowing was made by sowing machine in 20 May 2015. 5 meters in length each parcel consisted of 70x20 cm plant density with four rows. During cultivation 8 kg/da phosphorus and 8 kg/da nitrogen fertilizer was applied. Then as top fertilizer 170 kg ha⁻¹ of nitrogen fertilizer is given. Hoeing and earthing up is done twice 2,4-D and florasulam active ingredient of herbicides for weed control, thiacloprid active ingredient of insecticides for the pest were used. 473 mm total irrigation water was used until tassel emergence considering field capacity. The irrigation termination process was started after tassel emergence 7th day, water cut-off operations continued in 7 days interval.

The first application of irrigation water was applied as 58 mm 7 days after tassel emergence (W1). The second application of irrigation was 110 mm in two times application in total 14 days after tassel emergence (W2). The third application was applied 21 days after tassel emergence with 3 times using 155 mm of irrigation water (W3). The fourth application was performed 28 days after tassel emergence with four-times irrigation using 200 mm water (W4). In the fifth applications 247 mm water was used in five times irrigation 35 days after tassel emergence (W5). The sixth application was done by applying 290 mm water in six times after 42 days of tassel emergence (W6). Plants were harvested in the second week of October. The climatic data of the field trial are shown in Table 1. The effect of last irrigation times in the generative stage of corn on plant height, ear diameter, grain yield, grain protein, starch and oil content were investigated. The amount of irrigation water after tassel emergence was calculated multiplying the crop-pan coefficient (K_{cp}) by total of seven days evaporation from Class A pan. The volume of irrigation water was calculated by the following equation.

$$V = K_{cp} \times E_o \times A,$$

Where;

V: The irrigation water amount (lt), K_{cp}= coefficient of irrigation water, (K_{cp}=1.00), E_o= Seven day Class A-pan evaporation (mm), A= Plot area (m²).

EC, lime, pH, phosphorus, potassium, organic matter and saturation of the 0-30 cm depth in the soil were reported 83 dS/m, 24.7%, 7.7, 4.2 kg/da, 193.2 kg/da, 2.19 and 70% respectively (Anonymous, 2015a).

Table 1. Climatic data in the study arae

2015	May	June	July	August	September	October
Max. tem. (°C)	36.9	38.4	42.8	43.1	40.4	33.0
Min. tem.(°C)	11.8	16.7	21.4	22.1	18.7	12.7
Ave. tem. °C)	22.8	27.7	33.2	31.5	29.8	21.6
Relative hum.(%)	38.0	35.3	26.5	37.4	30.5	50.5
Total rainfall (mm)	10.3	0.7	0.2	0.0	0.0	58.8

(Anonim 2015b)

The months in trial conducted had any rainfall and low humidity (Table 1.). Therefore, the plants water requirement was met by irrigation.

Results and Discussion

Table 2. The average and groups of the examined characteristics concerning to irrigation termination of six different times after tassel emergence of the corn plant.

Applic ations	The amount of water (mm)	plant height (cm)	ear diamete r (mm)	grain yield (kg ha ⁻¹)	% protein rate	% starch rate	% oil rate
W1	58	218.00 b	25.00 d	4910.33 c	9.93 c	74.16 c	3.06 c
W2	110	217.00 b	25.66 d	6190.90 bc	10.20 b	74.40 bc	3.13 bc
W3	155	220.00 ab	27.00 c	6550.46 b	10.30 b	74.53 b	3.13 bc
W4	200	213.33 b	27.33 c	7180.46 b	10.40 b	74.60 b	3.16 bc
W5	247	226.03 a	28.66 b	8660.53 a	10.76 a	74.96 a	3.23 ab
W6	290	216.00 b	30.33 a	9140.36 a	10.80 a	75.06 a	3.30 a

Plant height (cm)

The statistically significant in plant height of P. 32T83 corn variety is achieved differences according to termination of irrigation. Plants height of the first, second, fourth and sixth application that watering termination made on the seventh, fourteenth, twenty-eighth and forty second day after tassel emergence were 218.00, 217.00, 213.33 and 216 cm respectively. The differences amongst once, twice, four and six times irrigation after tassel emergence in terms of plant height was statistically insignificant and located in the same group. Plants height of the fifth application that watering termination made on the thirty-fifth day after tassel emergence were 226.03 cm and consisted statistically different group from other applications except for three times irrigation. Bassou et al. (2012) were reported that plant height was highest under the full watering applications compared to other limited watering ones. Their findings are in agreement with our findings (Table 2).

Ear diameter (mm)

The statistically significant in ear diameter of P. 32T83 corn varieties is achieved differences according to the watering termination. The lowest value of ear diameter was obtained from the first irrigation which is applied on the seventh day after tassel emergence is 25.00 mm. After this the second value in the second practice that watering cut- off on the fourteenth day after tassel emergence with an ear diameter of 25.66 mm was measured. . There are no statistically differences in terms of ear diameter between two and three times irrigation after tassel emergence. Both are located in the same group and statistically different from other applications. The third highest value belongs to the third application that watering cut- off on the twenty-first day after tassel emergence is 27.00 mm. In fourth, ear diameter was measured as 27.33 mm for the fourth application that water cut-off made on the twenty-eighth day after tassel emergence. There isn't significant statistically differences in terms of ear diameter between three and four times irrigation after tassel emergence. They are located in the same group and consist of as statistically different group from other applications. The maximum ear diameter is measured as 30.33 mm in the sixth application in which last irrigation made on the forty-second day after tassel emergence statistically significant different from other applications Second maximum ear diameter is 28.66 mm for fifth application that is irrigation termination on the thirty-fifth day after tassel emergence. It was determined that showed statistically significant differences from other applications. (Table 2). Ertek and Kara (2013) findings support our findings.

Grain yield (kg ha⁻¹)

The irrigation practices of corn plant were terminated in different periods after tassel emergence. Grain yield obtained according to the irrigation termination periods had significant statistical difference. The lowest grain yield for the P. 32T83 corn variety obtained from the first application (481.33 kg) that was irrigation termination on the seventh day after tassel emergence. It was determined to be statistically significant differences from the others except for the second applications and included in the different groups. Grain yield for the third (three times) and the fourth (four times) applications that were finished irrigation on the twenty-first and twenty-eighth day after tassel emergence were 655.46 kg/da and 718.46 kg/da respectively. They do not constitute any statistical difference between them and located in the same group, but they had statistically significant differences from the others. The second application in term of lowest grain yield was the second with 619.90 kg/da yield and consists a transition between the first application and the third, the fourth applications. The grain yield of the fifth and the sixth application was 866.53 kg/da and 914.36 kg/da, respectively. They weren't any statistical difference between each other. It was determined that they take place in the same group and showed significant differences from the other applications (Table 2). Our findings are in agreement with Abou-El-Kheir and Mekki (2007), Castiglioni et al (2008), Ertek and Kara (2013), Ghamarni et al. (2013), and Kuşcu et al (2013) findings. They were reported that grain yield reduction may vary according to the varieties irrigated with limited watering. Durmus et al (2015) determined that total grain yield decline slightly as a result of limited water application.

Protein Rate (%)

Protein rate (%) in grain for P. T83 corn variety according to the termination time of irrigation in different times were collected under three groups that different from each other. The lowest value

of protein rate was obtained with 9.33 % from the first application that made irrigation on the seventh day after tassel emergence. The statistically significant differences were noted compared to other applications. The protein rates of the second, the third and the fourth application were 10.20, 10.30, 10.40 % respectively. They observed in the same group and there was not statistically significant difference between each other. The highest protein ratio obtained from the sixth application as 10.76 %, it were followed by the fifth application as 10.76 %. There weren't statistically differences between each other and they were consisted statistically different group from other applications (Table 2). The findings of Karasu et al (2015) are not consistent with our findings in terms of the effect of irrigation levels on protein rate. Ertek and Kara (2013) findings support our findings that protein rate of corn can be decreased due to low or high amount of irrigation levels. Khan (2016) reported that grain protein could be altered to 8.1% from 10.8% depending on the genotype or the N supply. In other words, corn protein content is stated to vary according to application.

Starch rate (%)

After tasselling hybrid P.32T83 corn plant according to the termination time of irrigation in different periods the starch content differences in the grains was observed among the three groups and it has been shown to be a transition group. The lowest value of starch was obtained with 74.16 % in the first application that made irrigation on the seventh day after tassel emergence. It was consisted statistically different group from other applications except for the second application. The starch rates of the third and the fourth application were 74.53% and 74.60 % respectively and they took place in the same group. They made statistically significant difference from the others, except for the second application. The starch rate (%) of the second application was reported as 74.40 %. It took place between the first and the third, fourth application. The second application was a transition group. The highest starch rate obtained as 75.06 % from the sixth application, it was followed by the second row as 74.96 % with the fifth application. There weren't statistically differences between each other and they were consisted statistically different group from the other applications (Table 2). Ertek ve Kara (2013) reported that if the level of irrigation water was applied more or less than certain amount for corn, it caused reduced content of starch. These findings support our findings. Khan (2016) revealed that starch rates were varied from 67.7% to 69.6% and oil rate from 4.8% to 5.1%. These findings not support our findings. Because the starch content of oilseed varieties are low and oil rates are high.

Oil rate (%)

The % amount of oil rates in corn grain according to the termination time of irrigation in different periods after tasselling of the hybrid P.32T83 corn plant were significant and noted that there were two different groups and two transition group. The lowest value of oil was obtained from the first application as 3.06 % that made irrigation on the seventh day after tassel emergence. It were consisted statistically different group from other applications except for the second, the third and the fourth applications. The oil rates of the the second, the third and the fourth application were 3.13%, 3.13%, and 3.16% respectively. They took part in the same transition group and were statistically significantly different from the other applications. The oil rate of the fifth application that made irrigation on the thirty-fifth day after tassel emergence was 3.23% and consisted statistically different group from the first applications. In addition to this, it is noted that it formed a second transition group in the other groups. The highest oil ratio

obtained from the sixth application as 3.3 %, It was consisted statistically different group from other applications except for the fifth application that had one transition group. Karasu et al (2015) were said that oil values ranged between 3.0-3.6%. These findings are in agreement with our findings. Khan (2016) was declared that increased grain yield resulted in greater oil production per unit of land area and the amount of nitrogen was ineffective on the oil content. It is an evidence of the characteristic of this variety.

Conclusion

The negative effect about lack of water before the tassel emergence for maize is known. Therefore, when considering the irrigation termination after tassel emergence, it was determined that irrigation should be done at least twice. The number of irrigation should be increased according to the climatic conditions, soil type, variety, and purpose of consumption.

References

- Abo-El-Kheir M.S.A., Mekki B.B. (2007). Response of Maize Single Cross to Water Deficits During Silking and Grain Filling Stages. *World Journal of Agricultural Sciences*, 3(3), (269-272).
- Anonymous (2015a). Sanliurfa Meteorology Station.
- Anonymous (2015b). Institute of GAP Agricultural Research, Soil Department Laboratory Analysis Results. Sanliurfa.
- Bassou B., Dimitri X., Bouaziz A., Pierre R., Jean-Claude M. (2012). Effect of water stress on growth, water consumption and yield of silage maize under flood irrigation in a semi-arid climate of tadla (Morocco), *Biotechnologie, agronomie, societe et environnement*. 16 (4), (468-477).
- Castiglioni P., Warner D., Bensen R.J., Anstrom D. C., Harrison J., Stoecker M., Abad M., Kumar G., Salvador S., D'Ordine R., Navarro S., Back S., Fernandes M., Targolli J., Dasgupta S., Bonin C., Luethy M.H., Heard J. E. (2008). Bacterial RNA Chaperones Confer Abiotic Stress Tolerance in Plants and Improved Grain Yield in Maize under Water-Limited Conditions, *Plant Physiology*, 147 (2), (446–455).
- Durmus E., Cakalogulları U., Tatar Ö. (2015). Relations Between Water Use Efficiency and Related Physiological Parameters of Maize in Field Conditions. *Journal of Agriculture Faculty of Ege Universty*, 52 (3), (307-315).
- Ertek A., Kara B. (2013). Yield and quality of sweet corn under deficit irrigation. *Agricultural Water Management*, 129, (138– 144).
- Ghamarnia H., Amin P.M., Arji I., Rezvani V. (2013). An evaluation and comparison of drip and conventional furrow irrigation methods on maize, *Archives of Agronomy and Soil Science*, 59 (5), (733-751).
- Karasu A., Kuscü H., Oz M., Bayram G. (2015). The Effect of Different Irrigation Water Levels on Grain Yield, Yield Components and Some Quality Parameters of Silage Maize (*Zea mays indentata* Sturt.) in Marmara Region of Turkey, *Not Bot Horti Agrobo*, 43(1), (138-145).
- Kaya C., Tuna L., Higgs D. (2006). Effect of Silicon on Plant Growth and Mineral Nutrition of Maize Grown Under Water-Stress Conditions, *Journal of Plant Nutrition*, 29, (1469–1480).
- Khan A. (2016). Maize (*Zea mays* L.) Genotypes Differ in Phenology, Seed Weight and Quality (Protein and Oil Contents) when Applied with Variable Rates and Source of Nitrogen. *Plant Biochemistry & Physiology*, 4 (1), 1-7.
- Kirtok Y. (1998). Kirtok Y (1998). Corn production and utilization. Kocaelik Basın ve Yayınevi, Kurtuluş Caddesi, Ali Aykac Is Merkezi No: 131/1, Adana.

- Kuscu H., Karasu A., Oz M. Demir O.A., Turgut I. (2013). Effect Of Irrigation Amounts Applied With Drip Irrigation On Maize Vapotranspiration, Yield, Water Use Efficiency, And Net Return In A Sub-Humid Climate, Turkish Journal of Field Crops, 18(1), (13-19).
- Singh B.R., Singh D.P. (1995). Agronomic and Physiological Responses of Sorghum, Maize and Pearl Millet to Irrigation, Field Crops Res, 42, (57-67).

DETERMINATION OF YIELD AND SOME PLANT FEATURES OF GRAIN CORN VARIETIES

Barış EREN*, Bilal KESKİN, İbrahim H. YILMAZ, Bahattin KARAKUŞ

Iğdir University, Faculty of Agriculture, Department of Agronomy, Iğdir, Turkey

*Corresponding author: bariseren86@gmail.com

Abstract

This study was conducted to determine the yield and plant characteristic of 10 (ten) grain corn varieties in Iğdir (Turkey) University Agricultural Research and Application Centre field trial in 2015. The study was established in randomized complete blocks experimental design with three replications. The difference between yield and plant characteristic of corn varieties were statistically found. It was found between plant height of varieties 217.0 with 181.0 cm, grain yield 2780.3 with 1589.2 kg/da, the first cob height 125.8 with 77.6 cm, the length of the cob 24.3 with 18.6 cm, cob weight 313.1 with 214.6 g, grain weight in cob 288.4 with 156.3 g, diameter of cob 50.1 with 45.0 cm and 1000-grain weight 475.1 with 339.2 g. According to research results it was found RX 9292 and TK 6060 varieties of grain yield was higher. It can be recommended for these types of ecology. At the same time, grain yield which is taken from the unit of area will increase the plant height and cob of the grain weight held in breeding studies.

Keywords: *Grain corn, yield, variety, plant characteristic.*

Introduction

Corn plant (*Zea mays* L.) is a forage plant belonging to the *Poaceae* (Gramineae) family, the use of which has been increasing day by day, and has agricultural importance for both our country and the world. Corn plant is the subsequent plant after wheat among the grains in the world in terms of planting and production. Being produced as main crop and after crop, corn (*Zea mays* L.) is also a successful alternative plant (Başbağ et al., 1997; İdikut and Kara, 2013). Corn plant is highly demanded in the world due to its rich variability among grains and its capability of high yield and adaptation (Petrovici, 1977; Hill, 1993; Yaşak et al., 2003; Kırtok, 1998; Alan et al., 2005). Upon evaluation of the corn production data, it was reported that the production in the year 2014 was 1.02 billion tons in 183 million hectare of cultivation area with the yield of 577 kg/da. Corn plant is mainly planted for the purpose of grain production in our country (İptaş et al., 2002). Upon evaluation of the grain corn production data, it was reported that the cultivation area was 688.170 hectare, the harvested area was 6.861.686 da, the production was 6.400.000 tons, and the yield was 933 kg/da (TÜİK–The Statistical Institute of the Republic of Turkey, 2015). The grain corn production in the province of Iğdir according to the data of the year 2015 was as 37.091 da of harvested area, 31.323 tons of production, and 844 kg/da of yield. It can be mentioned that the production amount and the yield of corn across the province of Iğdir is less than the other provinces. Nevertheless, Iğdir is a region with high potential in terms of corn production. Especially, a wide variety certificated corn seeds are used for grain production. It becomes more of an issue to determine the most appropriate kinds for the region. In this study, it is aimed to determine the kinds with high yield in the ecological conditions of Iğdir.

Materials and Methods

The study was carried out under irrigating conditions in the test fields belonging to the Agricultural Practice and Research Centre of Iğdir University from March to August in the year 2015. Commonly used 10 kinds of corn (72 MAY 80, OSSK-644, TK-6063, OSSK-596, TK-6060, HIDO, RX- 9292, 71 MAY 69, SHEMALL, OSSK-602) were used in the test. The climate values belonging to the months within the year the study was carried out are shown in the Table 1. It was found out for the province of Iğdir from March to August in the year 2015 as 30 mm of the amount of precipitation in average, 23.2 °C of mean temperature and 44.2 of mean relative humidity. The type of the soil in the test field was clayey-loamy, the values of which was as follows; pH: 8.6, EC: 1.37 ds/m, organic matter: 1.20%, lime (CaCO₃): 22.27%, nitrogen: 0.06%, phosphor: 51.7 ppm, potassium: 852.4 ppm.

Table 1. Average climate values of the province of Iğdir in the year 2015

Months	Mean Temperature (°C)	Total Monthly Amount of Precipitation (mm)	Monthly Mean Relative Humidity (%)
March	11.0	52.0	50.8
April	16,4	44.1	47.7
May	21,3	41.5	52.9
June	28,5	27,8	40
July	31,8	0.3	33.6
August	30.2	14,3	40.7
Average	23,2	30	44.2

The test was designed in 3 repetition according to random blocks test pattern. Planting was applied manually after row spacing had been specified as 70 cm and intrarow spacing had been specified as 15 cm. Each parcel area was designed as 17.5 m² by 5 m length and 3.5 cm width. Planting was executed on 04/04/2015 after the parcelling procedures. Nitrogen and phosphor fertilizers were sprinkled during planting. After specifying nitrogen (N) as 16 kg/da and phosphor (P₂O₅) as 8 kg/da, the half of the amount was applied during planting while the other half was applied after the plants grew for 50 cm. Irrigation was made in the cases when available soil moisture capacity was below 50% upon measurements of the soil by moisture meter during the test. The irrigation system of sprinkling was used until the plants grew for 50 cm. Then, the row irrigation system was applied after the plants grew for 50 cm. Hoeing and necessary weeding were also applied the plants grew for 20 cm. The process of earthing up was executed after the plants grew for 40-50 cm and the nitrogen application. The grain harvests of corn kinds were made on 25/09/2015 and the yield and the vegetal characteristics of corn kinds were specified. The data were exposed to GLM (General Linear Models) with SPSS (version 20) on the basis of main effects. Mean separating were performed using Duncan test.

Results and Discussion

Plant Length (cm)

In our study, the values from 190.6 cm up to 217.0 cm were obtained for plant lengths. The highest value for plant length in the study was obtained for RX 9292 (217.0 cm) while the lowest value was for HIDO (190.6 cm). Plant lengths obtained in the study of Ayaz et al. (2013) varied

between 258.7 cm and 266.6 cm, while the highest value for plant length was 203.2 cm and the lowest value for plant length was 199.1 cm in the study of Avcioğlu et al (2003). In their two year study, Özata and Kapar (2013) obtained values for plant length that varied between 255.8 cm and 335.8 cm. It is also known that the highest difference for the plant length of corn plant varies 2 m up to 3 m (Kün, 1997). When compared to the studies carried out, the data we obtained reveals close values to the literature values.

Grain Yield (kg/da)

In the study, the average grain yield was 21.6 t ha⁻¹, the highest grain yield was 27.8 with RX 9292 kind and the lowest grain yield was 15.8 t ha⁻¹ with OSSK 644 kind. In the study of Kuşvuran et al (2014), the average grain yield was 16.0 t ha⁻¹, while the lowest and the highest values varied between 14.0 t ha⁻¹ and 18.6 t ha⁻¹. In the study carried out in different provinces of Öz and Kapar (2006), the lowest and the highest values were found as 8.4 t ha⁻¹ and 11.9 t ha⁻¹ respectively. Karaşahin and Sade (2011) reported that the average grain yield was 17.3 t ha⁻¹ in their two year study which row irrigation system was applied. The results we obtained in this study were higher than those obtained in the studies of Öz and Kapar (2006), Karaşahin et al. (2011) and Kuşvuran et al. (2014). It is possible to observe differences in the values obtained due to the variables such as diversity in genetic structures and environmental compliance. The results obtained in this study that was carried out under Iğdir conditions reveal that higher grain yield was achieved than it was in a great deal of studies carried out in other regions.

Table 2. Plant length, grain yield, first cob height and cob length of corn kinds grown for the purpose of grain production

Kinds	Plant Length (cm)	Grain Yield (t ha⁻¹)	First Cob Height (cm)	Cob Length (cm)
72 MAY 80	214.0 ab	21.7 bc	108.4 abc	20.4 bc
OSSK 644	212.0 ab	15.8 d	118.2 ab	18.6 c
TK 6063	207.3 ab	22.0 bc	98.7 bcd	23.2 ab
OSSK 596	215.3 ab	20.1 bcd	125.8 a	21.1 bc
TK 6060	191.3 ab	25.1 ab	108.4 abc	20.8 bc
HIDO	190.6 ab	19.7 cd	109.7 abc	21.7 abc
RX 9292	217.0 a	27.8 a	116.6 ab	22.5 ab
71 MAY 69	192.3 ab	21.6 bc	88.0 cd	20.7 bc
SHEMALL	211.3 ab	19.9 cd	104.0 abc	21.6 abc
OSSK 602	181.0 b	22.6 bc	77.6 d	24.3 a
Average	203.2	21.6	105.5	21.4

* There is no significant difference at the level of 0.05 between the averages indicated by the same letter (P<0.05)

First Cob Height (cm) and Cob Length (cm)

The average first cob height of 10 corn kinds used in the study was found as 105.5 cm. The highest value for the first cob height was for OSSK 596 (125.8 cm) and the lowest value for the first cob height was for OSSK 602 (77.6 cm). The results we obtained in this study were higher than those obtained in the studies of Öktem and Öktem (2006) and İdikut and Kara (2013) but lower than those obtained in the studies of Özata and Kapar (2013) and Kuşvuran et al. (2014). The average cob length was found as 21.4 cm, the highest value for cob length was found as 24.3 cm and the lowest value for cob length was found as 18.6 upon evaluation of the Table 2. The

results of the study showed parallelism with those of Kuşvuran et al. (2014) and İdikut and Kara (2013), while they were higher than those obtained in the study of Tuncay et al. (2005).

Cob Diameter (mm)

The average cob diameter of 10 corn kinds analysed in the study was found as 47.5 mm. The highest value for cob diameter was for TK 6060 (50.1 mm) and RX 9292 (49.5 mm), while the lowest value for cob diameter was SHEMALL (45.0 mm). Karaşahin and Sade (2011) reported that cob diameter was 52.6 mm in their two year study which row irrigation system was applied. Kuşvuran et al. (2014) found the average cob diameter as 49.0 mm, the highest value for cob diameter as 51.8 mm and the lowest value for cob diameter as 46.6 mm.

Cob Weight and Grain Weight on Cob (g/pcs)

There were significant differences in terms of cob weight among the kinds. The average cob weight among the kinds were found as 268.9 g/pcs, while the highest value for cob weight was for TK 6060 (313.1) and for RX 9292 (310.5), and the lowest value for cob weight was for OSSK 644 (214.6 g/pcs). In their study in Cankiri, Kuşvuran et al. (2014) reported that cob weight varied between 233 g/pcs and 308 g/pcs, and the average cob weight was 277 g/pcs. In their two year study, Öktem and Öktem (2006) obtained the data of values for cob weight between 167.8 g/pcs and 251.7 g/pcs. Turgut (2000) reported the average cob weight as 302.9 g/pcs in his study carried out under Bursa conditions. On the other hand, the highest value for grain weight on cob was for RX 9292 (288.4 g/pcs) and the lowest value for grain weight on cob was for OSSK 644 (156.3 g/pcs), while the average grain weight on cob was 223.5 g/pcs. In their study, Kuşvuran et al. (2014) reported that grain weight on cob varied between 159 g/pcs and 211 g/pcs, while the average grain weight on cob was 180 g/pcs.

Table 3. Cob weight, grain weight, cob diameter and weight of one thousand grains of corn kinds grown for the purpose of grain production

Kinds	Cob Weight (g/pcs)	Grain Weight on Cob (g/pcs)	Cob Diameter (mm)	Weight of One Thousand Grains (g)
72 MAY 80	255.5 abc	228.5 ab	45.1 b	414.0 abc
OSSK 644	214.6 c	156.3 b	45.4 b	339.2 c
TK 6063	276.2 abc	231.6 ab	49.2 ab	398.3 abc
OSSK 596	232.7 bc	208.4 ab	45.2 b	421.1 ab
TK 6060	313.1 a	264.4 a	50.1 a	397.9 abc
HIDO	295.8 bc	207.7 ab	48.7 ab	422.5 a
RX 9292	310.5 a	288.4 a	49.5 ab	475.1 a
71 MAY 69	259.7 abc	227.3 ab	47.9 ab	407.9 abc
SHEMALL	250.2 abc	212.8 ab	45.0 b	345.7 ab
OSSK 602	280.8 abc	209.8 ab	49.1 ab	462.3 a
Average	268.9	223.5	47.5	408.4

* There is no significant difference at the level of 0.05 between the averages indicated by the same letter (P<0.05)

Thousand Grain Weight (g)

The average weight of one thousand grains was found as 408.4 upon evaluation of the Table 3. The highest value for weight of one thousand grains was for RX 9292 (475.1 g), OSSK 602 (462.3 g) and HIDO (422.5 g). Among the corn kinds, the lowest value for weight of one thousand grains was for OSSK 644 (339.2 g). In their test in Konya which row irrigation system was applied, Karaşahin and Sade (2011) reported the average weight of one thousand grains as 375.0 g. In their study carried out in Konya, Ayrancı ve Sade (2004) reported weight of one thousand grains between 203 g and 341 g.

Conclusion

Increasing in importance day by day for both human and animal nutrition, corn kinds with high grain yield has been of vital importance. Iğdir is known for its ecological suitability for corn production. Under ecological conditions of Iğdir, the kinds RX 9292 and TK 6060 have the highest values in terms of agronomic characteristics, especially grain yield.

References

- Alan, Ö., Akdemir, H., Budak, B. (2005). A study on the grain yield of some kinds of crossbred corns (*Zea mays* L.) under Kucuk Menderes conditions. The Republic of Turkey VI. Field Crops Congress. 5-9 September 2005. Antalya. 57-59.
- Ayrancı, R., Sade, B. (2004). Determination of the kinds of horsetooth crossbred corns (*Zea mays* L. *indentata* Sturt.) that can be grown under ecological conditions of Konya. *Vegetal Research Magazine*, 2(1), 6-14.
- Avcioglu. R., Geren. H and Cevheri. A.C.. (2003). Effect of sowing date on forage yields and agronomic characteristics of six maize varieties grown in the Aegean region of Turkey. *Optimal Forage Systems for Animal Production and the Environment*. EGF 26-28 May 2003. Pleven-Bulgaria. Vol:8. p:311-314
- Ayaz, M., Özpinar, H., Yaman, S., Acar, A., Aksu, Y., Yavrutürk, Y., Niksarlı İnal, F., Aksu, S., Aygün, Y. (2013), Evaluation of the yield and the quality characteristics of the corn kinds for silage used or to be used commonly in aftercrop agriculture. *Harran Agriculture and Food Sciences Magazine*, 17.3: 1-11.
- Başbağ, M., Demirel, R., Gül, İ., Saruhan, V. (1997). Opportunities to grow corn and sorghum as a material for silage in the region of South-Eastern Anatolia Project. The Republic of Turkey the First Silage Congress. Hasad Publishing. 251-255. Istanbul.
- Hill, J.H. (1993). How a corn plant develops; Special reports № 48, Iowa State University of Science and Technology Cooperative Extension Service, Ames, Iowa. www.extension.iastate.edu
- Iptas, S., Oz, A., Boz, A., Geçit, H. H., Kaydan, D., Kaya, M. D., Altuğ, S. (2002). The Growing Possibilities of Silage Maize as First Crop in Tokat Kazova Conditions. *Journal of Agricultural Sciences*, 8 (4) 267-273.
- İdikut, L., Kara, S. N. (2013). Determination of Some Yield Components with Grain Starch Ratios of Second Crop Corn for Grain Growing. *KSU J. Nat. Sci.*, 16(1).
- Karaşahin, M., Sade, B. (2011). Effects of different irrigation methods on the grain yield and the yield parameters of hybrid corn (*Zea mays* L. *indentata* s.). *Uludag University the Faculty of Agriculture Magazine*, 25(2).
- Kırtok, Y. (1998). Production and use of corn. Kocaoluk Printing and Publishing, 445 s. Ankara.
- Kuşvuran, A., Kaplan, M., Nazlı, R. I., Saruhan, V., Karadağ, Y. (2015). Determination of possibilities to grow some corn (*Zea mays* L.) cultivars for silage production under Middle

- Kizilirmak Basin ecological conditions. Journal of Agricultural Faculty of Gaziosmanpasa University, 32(1), 57-67.
- Kün. E.,(1997). Grains II (Warm Climate Cereals). A.Ü. Agricultural Faculty Textbook. Ankara. Pp:141.
- Öktem, A., Öktem, A. G. (2006). Determination of yield characteristics of some sugar corn (*Zea mays saccharata* Sturt) genotypes under Harran Plain conditions. Uludag University the Faculty of Agriculture Magazine, 20(1).
- Özata, E., Kapar, H. (2013). Determination of the quality and the performance of some horsetooth hybrid corn (*Zea mays indentata* Sturt) genotypes under Samsun conditions. Agricultural Sciences Research Magazine, 6(2), 19-26.
- Petrovici, T. (1977). Experimental Results with Maize Hybrids at the Podu-Iloaiei Station. Field Crop. Abstr. 30 (27):155.
- Tuik, (2015). The Statistical Institute of the Republic of Turkey, Vegetal production statistics. <http://tuikapp.tuik.gov.tr/bitkiselapp/bitkisel.zul>. (Date of access: 16 June 2016).
- Tuncay, Ö., Bozokalfa, M. K., Eşiyok, D. (2005). Determination of Ear Characteristic and Technological Properties of Some Sweet Corn (*Zea mays* L. var. *saccharata*) Varieties as Main and Second Crop. Ege Üniv. Ziraat Fak. Derg., 2005, 42(1):47-58.
- Turgut, İ. (2000). Effects of plant frequency and azote doses on the fresh cob performance and the yield parameters of sugar corn (*Zea mays saccharata* Sturt.) grown under Bursa conditions. Turk. J. Agric. For, 24, 341-347.
- Yaşak, S., Çınar, A., Tugay, M.E. (2003). Effects of seeding time on seed catchment and some other characteristics of corn (*Zea mays* L.). The Republic of Turkey 5. Field Crops Congress 13-17 October 2003. Diyarbakır. s. 352-357.

CORRELATION BETWEEN CLIMATIC CONDITION, YIELD AND CHEMICAL COMPOSITION IN MUST ON THREE GRAPES VARIETY

Violeta DIMOVSKA^{1*}, Fidanka ILIEVA¹, Nataša GUNOVA¹, Vesna GUNOVA²

¹University “Goce Delcev”, Faculty of Agriculture, Krste Misirkov bb, 2000 Stip, Republic of Macedonia

²University “Goce Delcev”, Faculty of computer science, Krste Misirkov bb, 2000 Stip, Republic of Macedonia

*Corresponding author: violeta.dimovska@ugd.edu.mk

Abstract

In this research were examined three different grape varieties Tempranillo, Sangiovese, Petit Verdot a period of 2010-2012 at the locality Lepovo, near Negotino an altitude of 250 m. The main parameters in these research are yield (kg/ha) and chemical characteristics of the must, sugar (g/L) and total acids (g/L) from this three grape varieties.

The climatic factors, the vegetative sum of precipitation and the vegetative temperature sum measured at the meteorological station on Winery Bovin, at the locality Lepovo. We made a comparison between the correlation coefficient among the climatic factors and yields for each variety individually and correlation coefficient between climatic factors and chemical characteristics of each grape variety.

The obtained results from this work were statistically processed using the SPSS statistical software package 19, from where it can be measure the frequency, the percentage share of data, measures of central tendency (median, standard deviation, dispersion, arithmetic mean), such as graphic representation of data (a histogram). The analysis indicates that there is a high correlation value between yield and climatic factors, chemical characteristics and climatic factors. Although the correlation between yield, sugar and total acids in the must with the vegetative sum of precipitation is a negative value, still shows a high correlation coefficient.

Key words: *Yield, chemical characteristics, climatic condition, correlation coefficient*

Introduction

Vitis vinifera L., includes many varieties of grapevines that are grown in different viticultural areas. Considering the ecological conditions, almost every country has its own grape wine assortment formed over a long time (Božinovic, 2010).

Sangiovese is the most planted variety in Italy (about 10 percent of total acreage), especially in Tuscany. Sangiovese has been cultivated in Italy for well over a thousand years, and is presently the most widely planted grape cultivar there, covering some 2,350 hectare or approximately 10% of total vineyard acreage. Although considered indigenous to Tuscany, Sangiovese is grown throughout Italy, indicating its adaptability to different environmental conditions. (Molon, 1906; Calo et. al., 2001, Giavedoni and Gily, 2005).

The Tempranillo grape variety, known as Tinto Fino, originated from Spain, the area Rioja. The core of almost every red wine from this area is Tempranillo (Bettiga, 2003). The wines are characterized by a good balance of alcohol content, color and acidity, and aging receive smooth structure, specific fruity taste that lasts long. In Spain produce 28 different types of wines with a protected designation of origin (Dimovska et al. 2015).

Petit Verdot is a variety used for red wine production. It originates from Bordeaux, France. The highest concentration of vineyards is being in the St. Emilion district. Later, it appears in many

vine-growing regions of southern Europe, America and Australia. The name Petit Verdot derives from the berries characteristics, and indicates the small (petit) size of the grape berries, and it is roughly translated as “green one” and reflects the variety’s propensity to under-ripeness, and it looks like the bunch of grapes is speckled with green. (*Dimovska et al. 2014*). Introduction of varieties is a method that is widely used in the global grape wine science and practice. These three newly introduced varieties Sangiovese, Tempranillo, Petit Verdot, are included in R. Macedonia recently. They are located on collection plantations or on small production areas (*Božinovic, 2010*).

The main purpose of this research is to make a comparison between the correlation coefficient among the climatic factors and yields for each variety individually and correlation coefficient between climatic factors and chemical characteristics of each grape variety.

Material and Methods

In this research as a material for testing were used three different grape varieties Tempranillo, Sangiovese, Petit Verdot a period of 2010-2012 at the locality Lepovo, near Negotino an altitude of 250 m. The grapevines were grown by applying appropriate agro-technical and ampelo-technical measures. The plantations were planted in 2006 with certified planting material at the distance of 2.4 m between the rows and 1 m between the grapevines in a row. The applied farming system is the two legged Guyot system by leaving 7 buds per vine. The plantations are under a drop-by-drop irrigation system (drip irrigation system).

The main parameters in these research are yield (kg/ha) and chemical characteristics of the must, sugar (g/L) and total acids (g/L) from this three grape varieties.

The climatic factors, the vegetative sum of precipitation and the vegetative temperature sum measured at the meteorological station on Winery Bovin, at the locality Lepovo. We made a comparison between the correlation coefficient among the climatic factors and yields for each variety individually and correlation coefficient between climatic factors and chemical characteristics of each grape variety.

The obtained results from this work were statistically processed using the SPSS statistical software package 19 (*Badioze Zaman H. et al. 2013*), from where it can be measure the frequency, the percentage share of data, measures of central tendency (median, standard deviation, dispersion, arithmetic mean), such as graphic representation of data .

For the analyzed properties is calculated the Pearsons’s correlation coefficient. Dependent variables critical in our work are the yield (kg/ha) and chemical characteristics of the must, sugar (g/L) and total acids (g/L) from this three grape varieties. These parameters are dependent variables from climatic factors.

Using the software package SPPS 19 is made table display of correlation between yield and climatic factors, chemical characteristics and climatic factors.

Results and discussion

Beside the characteristics of the variety and their biological potential, yield depends on agroecological conditions where the variety is grown. (*Karoglan J et al. 2000*). In Table 1. is detailed overview of the main climatic parameters measured a period of 2010-2012 at the meteorological station on Winery Bovin, at the locality Lepovo, vegetative temperature sum (° C) and vegetative sum of precipitation (l/m²). The vegetation period lasts on average from 206 to 209 days, enough for the grapes to reach technological and full maturity.

The average vegetative temperature sum a period of 2010-2012 amount 4179 °C, where the highest was recorded in 2012 and amount 4528 °C. The average vegetative sum of precipitation a period of 2010-2012 amount 232 l/m², where the highest was recorded in 2010 and amount 268 l/m².

Table 1. Climatic factors at the locality Lepovo, vegetative temperature sum (°C) and vegetative sum of precipitation (l/m²)

Climatic factors		
Year	Vegetative temperature sum (°C)	Vegetative sum of precipitation (l/m ²)
2010	4339	268
2011	4424	238
2012	4528	190
2010/2012	4179	232

The yield of this three different grape varieties Sangiovese, Petit Verdot and Tempranillo by 1ha was mathematically calculated.

In table 2. are presents the results of the main parameter yield (kg/ha), calculated a period of 2010-2012. The average yield, a period of 2010-2012 amount 12.090 kg/ha of the variety Sangiovese, 12.926 kg/ha of the variety Petit Verdot, and the highest value 14.233 kg/ha of the variety Tempranillo. This indicates that the variety Tempranillo has achieved the highest yield in terms of these ecological and climatic factors, any year from research.

Table 2. Yield of the grape (kg/ha), a period of 2010/2012

Yield (kg/ha)			
Year	Sangiovese	Petit Verdot	Tempranillo
2010	8.190	11.401	13.039
2011	12.120	12.600	13.747
2012	15.960	14.777	15.914
2010/2012	12.090	12.926	14.233

The content of sugar in the must was determined by Oechsle Scale, and the composition of total acids was determined by titration method using solution of N/4 NaOH with factor 1.0000.

In table 3. is detailed overview of the main chemical characteristics of the must, from this three different grape varieties Sangiovese, Petit Verdot and Tempranillo sugar (g/L) and total acids (g/L) from this three grape varieties a period of 2010/2012.

The results explained that the variety Petit Verdot and Tempranillo have approximately the same values for measured sugar (g/L) and total acids (g/L) in the must, where Petit Verdot has the average value of sugar 238 g/L, Tempranillo 237 g/L and the average value of total acids in the must are 5.53 g/L for the variety Petit Verdot, 5.6 g/L for variety Tempranillo. The variety Sangiovese has a difference from the two previous varieties, with 226 g/L sugar and 6.8 g/L total acids in the must.

Table 3. Chemical characteristics of the must, sugar (g/L) and total acids (g/L) from this three grape varieties a period of 2010/2012.

Year	Chemical characteristics					
	Sangiovese		Petit Verdot		Tempranillo	
	Sugar (g/L)	Total acids(g/L)	Sugar (g/L)	Total acids(g/L)	Sugar (g/L)	Total acids(g/L)
2010	220	6.8	228	5.5	215	5.4
2011	228	6.7	232	5.0	225	5.5
2012	230	7.1	254	6.1	270	5.8
2010/2012	226	6.8	238	5.53	237	5.6

Using the software package SPSS 19 is made table display of correlation between yield and climatic factors, chemical characteristics and climatic factors. Comparing by the Pearson's coefficient of correlation we can see which parameters have a higher connectivity. If $\rho = 1$, it means that there is a perfect linear dependence and the growth of the one variable well the other variable is growing.

Display of Pearson's coefficient of correlation (ρ) received from correlation between yield, sugar and total acids with climatic factors (vegetative sum of precipitation and the vegetative temperature sum), from this three grape varieties a period of 2010/2012 is given in Table 4.

The analysis indicates that there is a high correlation value between yield and climatic factors, chemical characteristics and climatic factors. Although the correlation between yield, sugar and total acids in the must with the vegetative sum of precipitation is a negative value, still shows a high correlation coefficient.

Table 4. Display of Pearson's coefficient of correlation (ρ) received from correlation between yield, sugar and total acids with climatic factors (vegetative sum of precipitation and the vegetative temperature sum), from this three grape varieties a period of 2010/2012

Variety	Pearson's coefficient of correlation (ρ)					
	Yield-Rain	Yield-Temp.	Sugar-Rain	Sugar-Temp.	Total acids-Rain	Total acids-Temp.
Sangiovese	-0,99000	0,99800	-0,89300	0,92400	-0,80600	0,76000
Petit Verdot	-0,999	0,994	-0,925	0,895	-0,651	0,592
Tempranillo	-0,988	0,974	-0,976	0,957	-0,989	0,975

On the graph 1. is displayed correlation coefficient between the yield, sugar and total acids with climatic factors for this three grape varieties a period of 2010/2012.

The variety Tempranillo has a highest connectivity, and the variety Sangiovese lowest connectivity for all parameters, although the correlation between yield, sugar and total acids in the must with the vegetative sum of precipitation is a negative value (-).

As indicated above that correlation coefficient ranging between 0.9 and 1 means a very high connectivity, we can conclude that this three varieties Sangiovese, Tempranillo and Petit Verdot, showed high correlation between climatic factors (vegetative sum of precipitation and the

vegetative temperature sum) with yield (kg/ha), and chemical characteristics of the must, sugar (g/L) and total acids (g/L).

The climate conditions has a direct effect on the quantity and quality of the grapes and on the wine production (*Angelov L, Stalev B.,2011*).

This research explain that climatic factors have a significant impact on the yield and quality of grape must and wine from this three newly introduced varieties Sangiovese, Tempranillo and Petit Verdot.

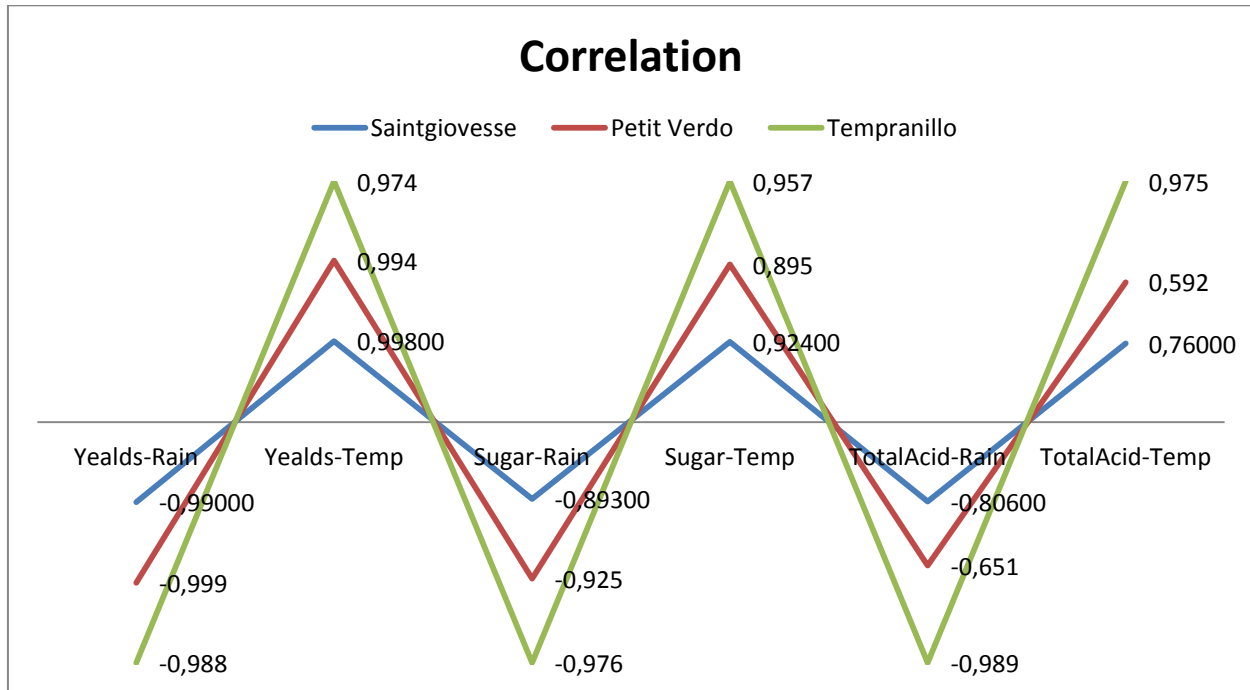

Graph 1. The graph shows correlation coefficient between the yield, sugar and total acids with climatic factors for this three grape varieties

Conclusion

1. This research explain that climatic factors have a significant impact on the yield and quality of grape must and wine from three introduced varieties.
2. We made a comparison between the correlation coefficient among the climatic factors and yields for each variety individually and correlation coefficient between climatic factors and chemical characteristics of each grape variety. The variety Tempranillo has a highest connectivity, and the variety Sangiovese lowest connectivity for all parametars, although the correlation between yield, sugar and total acids in the must with the vegetative sum of precipitation is a negative value (-).
3. The analysis indicates that there is a high correlation value between yield and climatic factors, chemical characteristics and climatic factors. Although the correlation between yield, sugar and total acids in the must with the vegetative sum of precipitation is a negative value, still shows a high correlation coefficient, which is approximately the value 1, and indicating a very high connectivity.

References

- Angelov L, Stalev B. (2011). Study on the quality of wines produced from ‘Syrah’ and ‘Tempranillo’ cultivars planted in two microregions in Southern Bulgaria. *Folia Hort.* 23/1. 49-53.
- Badioze Zaman H. et al. (2013). *IVIC.LNCS 8237*. p.p.549-557.
- Bettiga L, 2003. *Vine grape varieties in California*. ISBN 978 -1879906631. pp. 151-153.
- Bozinovic Z. (2010). *Ampelografija*. Agrinet. Skopje.
- Dimovska V. Ilieva F. Ivanova V. Sofijanovska E. Neceva Z. (2015). Characteristics of Tempranillo Grape Variety (*Vitis vinifera* L.), Grown in Tikves's Vineyard. *Scientific works. University of food technologies*. Vol 620. 251-255.
- Dimovska V. Ilieva F. Neceva Z. Durakova S. Bogeva E. (2015). Characteristics of Petit verdot grape variety (*Vitis vinifera* L.) grown in Tikveš vineyards. *Proceeding of International Symposium on Agriculture, Dubrovnic, Croatia*. 651-657.
- Molon, G., “*Ampelografia*” Vol. II, p.1059-1070, Hoepli, Milan (1906).
- Yuste J, Albuquerque M. (2014). Vine spacing on cv. Tempranillo in the Appellation of Origin Cigales (Spain): Agronomy and quality effects. *BIO Web of Conferences* 3, 01012-p.p.57-62.
- Karoglan J, Maletic E, Mirosevic N, Kozina B, Maric J. (2000). Production characteristics of some introduced grapes cultivars (*Vitis vinifera* L.). *Agriculture conspectus scientificus*. Vol. 65, n^o 2. p.p 107-114.

USE OF EFFECTIVE MICRO-ORGANISMS TO ENHANCE THE PRODUCTIVITY AND QUALITY OF DRY BIOMASS OF THE BASIL CULTIVAR “SITNOLISNI AROMATIČNI“

Vladimir FILIPOVIĆ¹, Gorica CVIJANOVIĆ², Vladan UGRENOVIĆ³, Milica AĆIMOVIĆ⁴, Vera POPOVIĆ⁵, Dragoja RADANOVIĆ¹, Slađan STANKOVIĆ^{6*}

¹Institute for Medicinal Plant Research “Dr Josif Pančić”, Tadeuša Košćuška 1, 11000 Belgrade, Serbia

²Megatrend University in Belgrade, Faculty of Bio-farming, Maršala Tita 39, 24300 Bačka Topola, Serbia

³Agricultural Advisory Service - “Tamiš” Institute, Novoseljanski put 33, 26000 Pančevo, Serbia

⁴Institute of Food Technologies, Bulevar cara Lazara 1, 21000 Novi Sad, Serbia

⁵Institute of Crop and Vegetable Production, Maksima Gorkog 30, 21000 Novi Sad, Serbia

⁶Institute of Science Application in Agriculture, Despota Stefana 68b, 11000 Belgrade, Serbia

*Corresponding author: sstankovic@ipn.bg.ac.rs

Abstract

The trials conducted during 2014 and 2015 on plots and at the seed laboratory at the Institute of Medicinal Plant Research “Dr Josif Pančić” from Belgrade, located in Pančevo, (Vojvodina, Serbia) investigated the impact of pre-planting application and foliar application (pre-planting soil treatment and foliar treatment) of the product called EM-AKTIV on morphological, productive and qualitative properties of the basil (*Ocimum basilicum* L.) cultivar “*Sitnolisni aromatični*”, which is grown and propagated at the Institute. The plots on which the product was not applied were used as a control variant. The trial was set up in a complete randomised block design with four replications and the size of basic plots was 3.25 m² (5.0 m x 0.65 m). The research investigated the impact of the EM-AKTIV on plant height, root length, plant width, the number of inflorescences, above-ground fresh biomass yield, dry biomass yield, essential oil content and essential oil yield per hectare. The highest yield of dry biomass was obtained in the first year in the soil treatment variant (3,134 kg ha⁻¹). The same variant in the second year of research gave the highest content of essential oil (25.9 kg ha⁻¹). These years were quite different in terms of climatic conditions, and precipitation sums, distribution and average daily temperatures in the first year favoured the formation of higher values for most of the investigated parameters.

Key words: *basil, above-ground biomass, plant height, yield, essential oil content, EM-AKTIV product*

Introduction

Due to its aroma, basil (*Ocimum basilicum* L.) has long been used in this region as a medicinal, sacred herb and a spice. Basil is grown for its above-ground parts (*Basilici herba*), from which essential oil is extracted (*Basilici aetheroleum*). Dry matter of basil biomass contains 0.5-1.5% of essential oil, characteristic for its pleasant and pungent smell (Stepanović and Radanović, 2011). In our country, the most commonly grown basil cultivar is “*Sitnolisni aromatični*”, good as a culinary herb and as an ornamental plant. According to its general characteristics, “*Sitnolisni aromatični*” yields about 3,000 kg ha⁻¹ of dry biomass (Anonymous, 2016). Moreover, it contains significant amounts of good-quality essential oil suitable for use in the pharmaceutical industry. Biomass productivity/yields depend on a series of factors. In order to achieve desired results for a certain plant cultivar, it is necessary to meet all agro-ecological, agro-technical, edaphic,

genotypic, seeding and other factors that affect chances of obtaining expected quantities of raw material of satisfactory quality (Glamočlija et al., 2015).

By using effective micro-organisms in basil fields, one can achieve intensive proliferation of micro-organisms, especially in early stages of plant growth, which in some cases leads to an increased intake of mineral nitrogen (N) and inhibits growth of plants (Frąszczak et al., 2012).

Over the last twenty years the use of effective micro-organisms (EM) has been intensified. Higa (2003) claims that EMs are capable of producing anti-oxidants and preventing the emergence and growth of free radicals with oxygen. Free radicals contribute to the development of certain diseases, whereas anti-oxidants produced by EM eliminate those diseases, combat them or enhance the effects of oxygen activity. Microbiological products with active PGM micro-organisms diminish negative effects of water deficit; especially in combined inoculation where many useful micro-organisms can affect the direction and dynamics of micro-organisms and hence maintain and improve fertility in the soil (Heidari and Golpayegani, 2011).

Aside from getting vigorous plants with high quality biomass, the role of basil reflects in the fact that soil remains clear after harvest, with no weed but with good physical properties, which makes basil a great preceding crop for most crop species, especially if it is included in crop rotation on fields with organic production (Glamočlija et al., 2015).

The use of EM-based products is one more way to produce organic herbs. Hence the goal of this paper was to determine the possible impact of the product EM-AKTIV on morphological, productive and qualitative properties of basil biomass.

Material and methods

This research investigated the basil (*Ocimum basilicum* L.) cultivar "Sitnolisni aromatični" grown and propagated at the Institute for Medicinal Plant Research "Dr Josif Pančić" in Belgrade. The trials were carried out during 2014 and 2015 on plots and in the seed laboratory at the Institute in Pančevo (44°52'20"N; 20°42'06"E; 74 m altitude). The trial was set up in a complete randomised block design with four repetitions, and the size of basic plots was 3.25 m² (5.0 m x 0.65 m). The researchers investigated the impact of the EM-AKTIV (Effective Micro-organisms) on morphological parameters, productivity and the quality of basil biomass and essential oil content. The EM-AKTIV is a product containing a mix of lacto-acid bacteria (*Lactobacillus casei*, *L. plantarum* and *Streptococcus lactis*), photosynthetic bacteria (*Rhodopseudomonas palustris* and *Rhodobacter spaeroides*), yeasts (*Saccharomyces carevisiae* and *Candida utilis*), actinomycetes (*Streptomyces albus* and *S. griseus*) and moulds (*Aspergillus aryzae* and *Mucor hiemalis*). In this research it was used twofold. In the first variant, the soil was treated with the EM-AKTIV three days before harvest, when the product was raked directly into the soil. In four repetitions, 0.4 dl of the EM-AKTIV with 7 l water was applied into the soil. In the second variant, the EM-AKTIV was used foliarly – three weeks after transplanting, when 0.13 dl of the EM-AKTIV with 7 l water was applied. A plot without the EM-AKTIV was used as a control variant.

Meteorological data for the vegetation period of basil were retrieved from the Meteorological station of the "Tamiš" Institute, Pančevo (Table 1).

Table 1. Meteorological data for the vegetation period of basil, 2014 and 2015

Parameters	V	VI	VI I	VIII	IX	X	Sum	Ave r. T
Precipitation 2014	220.2	52.1	87.1	113.7	140.6	39.9	653.6	-
Precipitation 2015	88.2	20.1	4.8	69.1	86.4	68.3	336.9	-
Temperatures 2014	16.4	21.5	22.7	22.4	18.1	13.6	-	19.1
Temperatures 2015	18.5	23.3	27.5	25.5	20.9	10.7	-	21.1
Precipitation 1994- 2013	61.4	81.7	61.8	49.6	65.2	49.7	369.4	-
Temperatures 1994-2013	18.6	21.9	23.8	23.5	18.0	12.6	-	19.7

Basil seedlings were produced in a plastic greenhouse. The production was standard, like production of vegetable seedlings. Seeds for future seedlings were sown in late February. Three months later, in mid-May, the seedlings were transplanted. At that time the seedlings had 3-4 pairs of leaves and were 10-12 cm high, being at the stage when seedlings have the best chances to grow after transplantation. The marigold (*Calendula officinalis* L.), a medicinal plant species, was a preceding crop on the trial plots. Planting was done manually, on May 8 in the first year, and on May 18 in the second year. Row spacing was 50 cm, and crop spacing 30 cm. The first watering was carried out the day before planting, and the second watering right after planting, whereas other watering was done when needed. A watering norm in each of four watering was 25 mm/m².

Standard crop tending measures were applied during the period of vegetation. Weeds were eliminated mechanically, without using pesticides. During vegetation, no disease or pest infestations were recorded, and therefore there was no need for protective measures.

The first harvest of green biomass was conducted at full bloom, in late July. In that stage, basil contains most of essential oil and green biomass yields are highest. The second harvest was conducted in early October. Prior to harvest, a sample of five plants from each plot was taken to measure plant height, root length, plant width and the number of inflorescences. Harvest was carried out manually, with a sickle, at the cut height of 8 cm, in nice and sunny weather. After harvest, weight of fresh biomass was measured, and yield per hectare was calculated and expressed in kilograms. The green biomass was air-dried in a draught place, after which dry biomass yield was measured and samples were taken for determining the content of essential oil. Essential oil was extracted in the process of hydro distillation of dry material by using a Clevenger apparatus, following the procedure described in Ph. Jug. IV (Ph. Jug. IV, 1984). 20 g of the fragmented plant material was hydro distilled in a balloon of 1000 ml with 400 ml of water. The mass was then heated to the point of boiling and such distilled for two and a half hours. After distillation, the volume (ml) of the essential oil was detected and the content of the essential oil (in %) in 100g of dry biomass (v/w) was calculated according to the following formula:

$$C = (b : a) \times 100$$

Where: a – measured biomass quantity (in g); b – essential oil content (in ml); C – content (in %) of essential oil in 100 g of biomass. Results of determining the content of essential oil in basil biomass are the mean value of three continuous determinations. The yield of essential oil per hectare was determined by calculating the percentage of oil in biomass weight per hectare and expressing it in kilograms.

Testing the significance of differences between the mean values of the investigated factor (use of the EM-AKTIV) was conducted by using the model of the analysis of variance, in the following mathematical form:

$$Y_{ijk} = \mu + \alpha_i + \beta_j + \gamma_k + \epsilon_{ijk} \quad (i=1,2,3;\dots,r; j=1,2,\dots,s; k=1,2,3,4)$$

All the assessments of significance were based on the F-test and LSD-test at the level of 5% and 1%. The analysis of variance (ANOVA, in *Randomized Blocks*) was done with Statistica for Windows 10 (STATISTICA, 2010). The same software was used to calculate the coefficient of variation (C_v).

Results and discussion

High variation in morphological and productive parameters of the basil cultivar “Sitnolisni aromatični“ is the result of a long dry period recorded in the second year (Table 1, 2 and 3).

Table 2. Morphological parameters of the basil cultivar “Sitnolisni aromatični“

Years	Treatment	Plant height (cm)	Root length (cm)	Plant width (cm)	Number of inflorescences
2014	Control (no product used)	47.3	36.7	26.1	92.3
	Soil treatment	54.2	40.2	33.2	106.7
	Foliar treatment	52.9	41.3	31.0	102.0
2015	Control (no product used)	37.7	28.9	23.7	76.7
	Soil treatment	44.4	31.5	24.6	85.6
	Foliar treatment	43.8	32.4	23.9	79.7
2014	Average	51.5	39.4	30.1	100.3
2015	Average	42.0	30.9	24.1	80.7
	Total average	46.7	35.2	27.1	90.5
	The coefficient of variation	13.2	14.3	14.9	13.6
LSD	0.05	22.2	11.7	15.4	30.5
	0.01	29.7	16.4	20.6	40.2

Plant height is an important property both from the agro-technical and the production aspect. Knowing this parameter allows us to define and assess more precisely the habitus of basil. In this research, the highest values for plant height, in both years of research, were obtained in the variant treated with the EM-AKTIV, 54.2 cm on average (in 2014), which was statistically much higher than values obtained in the control variant, i.e. the variant with lowest height (37.7 cm, in 2015). In the research of Labra et al. (2004), the height of tiny-leaf forms of basil ranged from 30 cm to 35 cm, and the height of large-leaf forms ranged from 40 cm to 45 cm. Analysing the results obtained for root length, one can see that the use of the EM-AKTIV (in both variants) increases root length, whereby the recorded differences were not statistically significant. Plant width and plant height together define plant habitus. In other words, by comparing plant height and plant width one can determine plant habitus. Plant width in this research ranged from 23.7 cm (control in 2014) 33.2 cm (soil treatment variant in 2015). Eckelmann (2002) claims that basil height and width mostly depends on environmental conditions, whereas its shape, leaf area and tips are genetically determined and represent identifying properties of cultivars. This opinion is backed by Polish researchers (Nurzyńska-Wierdak and Borowski, 2011), who treated basil with foliar fertilisers. Basil develops dichasial inflorescences of different length. The number of inflorescences in this research ranged from 106.7 (recorded in the soil treatment variant in 2014),

to 76.7 (in the control variant in 2015). Basil is morphologically diverse in terms of size, shape, colour, leaves and inflorescence (Szabó et al., 1996). Statistically significant discrepancies in certain properties of basil were recorded in the research of Rahimi et al. (Rahimi et al., 2013), when different types of bio-stimulators and bio-fertilisers were used.

In the second year of the research more dry weight was recorded, which can be seen from the fresh-dry matter ratio that averaged 4.1 : 1. Unfortunately, low humidity in 2015 resulted in 31.5% lower dry biomass yield (Table 1 and 3).

Table 3. Yield, content and yield of essential oil from dry biomass of the basil cultivar "Sitnolisni aromatični"

Years	Treatment	Yield of fresh biomass (kg ha ⁻¹)	Yield of dry weight biomass (kg ha ⁻¹)	Essential oil content (%)	Essential oil yield (kg ha ⁻¹)
2014	Control (no product used)	13,728.0	2,965	0.74	21.8
	Soil treatment	12,880.7	3,134	0.75	23.6
	Foliar treatment	12,831.0	2,820	0.66	18.5
2015	Control (no product used)	6,896.1	1,810	1.05	19.0
	Soil treatment	9,635.3	2,333	1.11	25.9
	Foliar treatment	8,560.8	1,968	1.13	22.2
2014	Average	13,146.6	2,973	0.71	21.3
2015	Average	8,364.1	2,037	1.10	22.4
	Total average	10,755.3	2,505	0.91	21.8
	The coefficient of variation	25.8	21.9	23.6	12.8
LSD	0.05	4,638.3	1,374.5	0.089	4.21
	0.01	6,388.8	1,687.2	0.128	5.72

The highest yield of fresh biomass (13,728.0 kg ha⁻¹) was recorded for the control variant (the variant without the EM-AKTIV) achieved in the first year of research. It was twice as higher value than the minimum value recorded for the same variant but a year later (6,896.1 kg ha⁻¹). Previous experience has shown that the maximum weight of biomass is achieved in the period from the end of bloom to the beginning of seed maturity. Depending of agro-ecological conditions, that period can last from 150 to 180 days after planting (Putievsky and Galambosi, 1999). After drying, the highest biomass yield was recorded in the soil treatment variant (3,134 kg ha⁻¹) in the first year of research, and the lowest yield in the control variant in the second year of research (1,810 kg ha⁻¹). The average yield of dry biomass in this research was 34.0% lower than in the research of Adamović (Adamović, 2012), where it was 3,800 kg ha⁻¹ in early harvest, and 2,500 kg ha⁻¹ in late harvest – what was in line with our research. The content of essential oil in dry biomass averaged 0.91%, whereby the coefficient of variation was 23.6%. The highest content of essential oil was achieved in the second year in the variant with the foliar EM-AKTIV treatment (1.13%). The same variant in the first year of research gave the lowest content of essential oil (0.66%). In general, the content of essential oil in dry biomass was significantly higher than in some of the latest national research (Bulut, 2012; Filip, 2014). Essential oil yield had the most uneven values of all investigated parameters. For that situation a reason can be found in climatic factors, which are in correlation between yield and essential oil content. The highest content of essential oil was obtained in the soil treatment variant in the second year (25.9 kg ha⁻¹), and the lowest in the foliar treatment variant in the first year of research (18.5 kg ha⁻¹). Plant development stages affect the yield of oil to a great extent. A study conducted in the late

20th century showed that the maximum concentration of oil was achieved at full bloom (Putievsky and Galambosi, 1999), which was also conducted in this research.

Conclusions

The goal of this research was to determine whether there is an impact of the EM-AKTIV product on morphological and yield parameters, and on the content of essential oil of the basil cultivar “*Sitnolisni aromatični*”. When compared the years and all morphological parameters, yield of fresh biomass and yield of dry biomass, one can see a statistically significant differences in 2014 and 2015. Precipitation sums and average daily temperatures during the first year were favourable for having higher values for the investigated parameters. Agro-ecological indicators in the second year were more favourable for the content of essential oil and its higher yields. When observed both years of the research, the soil treatment variant with the EM-AKTIV obtained the highest values for plant height, root length, plant width, the number of inflorescences, yield of green biomass and yield of dry biomass. However, the highest values for root length (in 2014 and 2015) and the content of essential oil in 2015 were recorded in the foliar variant.

Acknowledgement

This paper presents part of the results obtained within Project III 46006, funded by the Ministry of Education, Science and Technological Development of the Republic of Serbia.

References

- Adamović, D. (2012): Agronomic factors affecting yield and essential oil of *Ocimum basilicum* L. Proceedings of VIIth Conference on Aromatic and Medicinal Plants of Southeast European Countries. May 27-31. 2012. Subotica, Serbia, 299-302.
- Anonymous (2016): Katalog semena lekovitog, aromatičnog i začinskog bilja Instituta za proučavanje lekovitog bilja „Dr Josif Pančić“. Institut za proučavanje lekovitog bilja „Dr Josif Pančić“, Beograd.
- Bulut, S. (2012): Karakterizacija herbe bosiljka i semena korijandera i analiza promena koje nastaju tokom skladištenja ovih droga. Tehnologijada. Lepenski Vir, 14- 18.05.2012. Zbornik izvoda, 31.
- Eckelmann, S. (2002): Biodiversität der Gattung *Ocimum* L., insbesondere der Kultursippen. PhD dissertation, University of Kassel.
- Filip, S. (2014): Ekstrakcija bosiljka (*Ocimum basilicum*, Lamiaceae) ugljendioksidom u superkritičnom stanju i modelovanje ekstrakcionog sistema. Doktorska disertacija. Tehnološki fakultet Univerziteta u Novom Sadu.
- Frąszczak, B., Kleiber, T., Klama, J. (2012): Impact of effective microorganisms on yields and nutrition of sweet basil (*Ocimum basilicum* L.) and microbiological properties of the substrate. African Journal of Agricultural Research, 7(43), 5756-5765.
- Glamočlija, Đ., Janković, S., Popović, V., Filipović, V., Kuzevski, J., Ugrenović, V. (2015): Alternativne ratarske biljke u konvencionalnom i organskom sistemu gajenja. Monografija, Institut za primenu nauke u poljoprivredi, Beograd, Srbija.
- Heidari, B., Golpayegani, M., A. (2011): Effects of water stress and inoculation with plant growth promoting rhizobacteria (PGPR) on antioxidant status and photosynthetic pigments in basil (*Ocimum basilicum* L.). Journal of the Saudi Society of Agricultural Sciences, 11, 57-61.
- Higa, T. (2003): EM Technology application in agriculture and environment protection. Proceedings of the 38 International. Microbiological Symposium Effective Microorganisms

- (EM) in Sustainable Agriculture and Environmental Protection. SGGW, Rogów kŁodzi, Poland. 17-18.
- Jugoslovenska farmakopeja (Ph.Yug. IV): Savezni zavod za zdravstvenu zaštitu, Beograd.
- Labra, M., Miele, M., Ledda, Grassi, F., Mazzei, M., Sala, F. (2004): Morphological characterization, essential oil composition and DNA genotyping of *Ocimum basilicum* L. cultivars. *Plant Science*, 167, 725-731.
- Nurzyńska-Wierdak, R., Borowski, B. (2011): Dynamics of sweet basil (*Ocimum basilicum* L.) growth affected by cultivar and foliar feeding with nitrogen. *Acta Scientiarum Polonorum-Hortorum Cultus*, 10(3), 307-317.
- Putievsky, A., Galambosi, B. (1999): Production system of sweet basil. In: Hiltunen, R., Holm, Y. (eds.) *Basil. The Genus Ocimum. Medicinal and Aromatic Plants-Industrial profiles*. Harwood Academic Publishers, 39-65.
- Rahimi, A., Mehrafarin, A., Naghdi Badi, H. and Khalighi-Sigaroodi, F. (2013): Effects of bio-stimulators and bio-fertilizers on morphological traits of basil (*Ocimum basilicum* L.). *Annals of Biological Research*, 4(5), 146-151.
- STATISTICA (Data Analysis Software System), v.10.0 (2010): Stat-Soft, Inc, USA (www.statsoft.com)
- Stepanović, B., Radanović, D. (2011): Tehnologija gajenja lekovitog i aromatičnog bilja u Srbiji, Institut za proučavanje lekovitog bilja "Dr Josif Pančić", Beograd.
- Szabó, K., Németh, É., Praszna, L., Bernáth, J. (1996): Morphological variability of basil genotypes. *Proc. International Symposium Breeding Research on Medicinal and Aromatic Plants* (June 30–July 4, 1996), Quedlinburg, Germany, 76–79.

TEXTURAL AND PHYSICO-CHEMICAL CHARACTERISTICS OF ŞALAK (APRICOSE) APRICOT CULTIVAR

Ersin GÜLSOY*, Tuncay KAYA, Mücahit PEHLUVAN, Berna DOĞRU ÇOKRAN

Department of Horticulture, Faculty of Agriculture, Iğdır University, 76000, Iğdır, Turkey

*Corresponding author: ersin.gulsoy@igdir.edu.tr

Abstract

Fruit quality characteristics of Şalak (Apricose) apricot cultivar, which is grown under climatic conditions of regions located in Aras Basin (Turkey) at different altitudes, were studied for two consecutive years. Physical attributes (width, length, height, fruit shape index, fruit weight, kernel weight, fresh/kernel ratio), chemical parameters (total soluble solids content, pH and acidity) and textural parameters (hardness, adhesiveness, springiness, cohesiveness, gumminess, chewiness and resilience) were evaluated in the study. These properties are important in the design of equipment for harvesting, separating, packing, processing and transportation. Fruit width, fruit length, fruit height, fruit weight, seed weight and kernel weight of Şalak (Apricose) apricot cultivar collected from four different locations varied between 41.06-48.83 mm, 49.47-56.80 mm, 40.53-47.27 mm, 53.42-73.82 g, 2.24-2.72 g and 0.75-0.85 g, respectively. Based on the chemical properties of Şalak (Apricose) apricot cultivar, it was determined that total soluble solids, pH and acidity contents changed from 13.72 to 16.40 %, from 4.46 to 4.96 and 1.01-1.69 %, respectively. In terms of textural properties the average hardness, adhesiveness, springiness, cohesiveness, gumminess, chewiness and resilience were detected as 9.13 N, -27.48 g.s, 0.57, 0.24, 195.88 g, 142.11 g and 0.08, respectively.

Keywords: *Apricot, Physical Properties, Textural Properties.*

Introduction

Apricot belongs to the family Rosaceae and this fruit is botanically known as *Prunus armeniaca*. (Özbek, 1978). Turkey is the leading apricot producer in the world with 795 768 tons produced annually (FAO, 2012). About 78% of total apricot production is provided from Malatya, Erzincan, Mersin and Iğdır provinces in Turkey. Iğdır, located in Aras Valley, produces 2/3 of total Turkish apricot production. In this region, the most widely used apricot cultivar is Şalak and it is grown on traditionally generative rootstocks. As an attractive cultivar, Şalak has rather large, delicious and medium hardness fruits and it is suitable for fresh consumption. It has vigorous growth and large canopy size and it is grown on altitudes from 830 m to 1400 m in Aras Valley. Şalak tree may produce about 150-200 kg of yield depending on cultural practices and maintenance conditions (Ozyoruk and Guleryuz, 1992; Ercisli, 2009).

Apricot is a very sensitive and easily perishable stone fruit and very exposed to some physical damage and disease. Therefore, it softens very quickly and this situation limits its marketing duration (Antunes et al, 2003) Apricot is generally consumed fresh, as well as being processed into some food commodities such as dried, frozen or canned, jam, jelly, marmalade, pulp, juice, etc. (Bruhn et al., 1991; Botondi et al., 2000; Missang et al., 2011).

Apricot has a short shelf life and is also a perishable species. Thus its texture and physical properties are essential quality parameters.

The fruit texture is a very important trait for maintaining good taste and shelf life of the fruit. As a significant quality parameter, fruit hardness affects postharvest physiology as well as the consumer preferences (Vicente et al., 2007).

Both fresh and processed fruit and vegetables are considered as to their sensory quality parameters, such as texture, colour, flavour and taste (sweet, sour, salt and bitter sensations) and physical properties such as size and shape (Stow, 1995; Karlsen, et al., 1999).

Texture, color, antioxidant and other biochemical properties are important for fruit acceptability. Appearance of the fruit is particularly affected by texture and color (Takahashi, et al., 2009).

Various important studies have been carried out concerning the physical and textural properties of fruits and vegetables such as sweet and sour cherry (Blahovec et al., 1995), apple (Karlsen et al., 1999; Guine et al., 2011), cherry laurel (Calisir and Aydin, 2004), pear (Huang and Hsieh, 2005), wild plum (Haciseferogullari et al., 2005), mango, (Jha et al., 2006), apricot (Haciseferogullari et al., 2007), kiwi fruit (Razavi and Parvar, 2007), pineapple (Montero-Calderon et al., 2010), tomato (Sirisomboon et al., 2012)

According to our knowledge, there are limited studies on the textural properties of apricot as a sensory analysis. Therefore, this study was aimed to determine some physical, chemical and textural properties of Şalāk (Apricose) apricot cultivar grown in Aras Valley.

Materials and Methods

Material

In this study, Şalāk apricot cultivar was used as a fruit material grown at four different altitudes of the Aras Valley during 2012 and 2013. For this purpose, fruit samples were collected from trees that are at commercially mature stage in Iğdır (800 m), Tuzluca (1100 m), Kağızman (1200 m) and Üçkaya (1400 m) provinces (Turkey).

Some Physical and Chemical Characteristics

Fruit, kernel and seed weight of sampled apricots were measured using precision scales with an accuracy of 0.01 g. In addition, fruit width, fruit length and fruit height were measured using a digital caliper with an accuracy of 0.05 mm. Soluble solids content (SSC) was determined using hand refractometer. Reaction of fruit juice was determined using digital pH meter. TA, expressed as a percentage of malic acid was determined with well mixed juice by titration against NaOH (0.1 M), using a pH meter (El-Motty et al., 2007; Lara et al., 2004).

Texture Profile Analyses

The fruits were peeled and cut into 10*5mm (D * H) pieces. Texture profile analysis (TPA) was performed with the fruit pieces by a TA-XT plus texture analyzer (Stable Micro Systems Ltd., Godalming, Surrey, UK). The operating parameters were as follows: load cell = 30 kg, probe = 35 mm diameter aluminum cylinder, pre-test speed = 5 mm/s, test-speed = 0.5 mm/s, post-test speed = 0.5 mm/ s, compression degree = 30%, time = 3 s, and trigger force = 3.0 g (Shao, Tu, Zhao, Chen, & Zhao, 2006). Hardness is defined as the peak force of the first compression of the sample. Ten apricots were measured individually for each treatment group.

Texture parameters used in TPA analyses consist of hardness, adhesiveness, springiness, cohesiveness, gumminess, chewiness and resilience. Definitions of these parameters are given in Table 1.

Table 1. Definition of texture characteristics evaluated in conventional profiling in apricot fruit (Bourne, 2002)

Characteristic name	Definition
Hardness	the force required to compress a substance between the molar teeth (in the case of solids) or between the tongue and palate (in the case of semisolids)
Adhesiveness	Force required to remove material that adheres to the mouth (generally the palate) during the normal eating process
Springiness	Force with which sample returns to its original size/shape, after partial compression.
Cohesiveness	Amount of deformation undergone by the material before rupture, when biting completely through the sample.
Gumminess	Energy required to disintegrate a semisolid food to a state ready for swallowing.
Chewiness	The length of time required to masticate a sample at a constant rate of force application to reduce it to a consistency suitable for swallowing.
Resilience	Degree to which the sample returns to the original shape (elasticity)

Statistical analyses

The experimental design was randomized with three replications. Data were subjected to variance analysis using SPSS statistical software. Differences between means were tested using the LSD test.

Results and discussion

Physicochemical Properties

Fruit samples were taken from the orchards at different altitudes ranged from 800 m (Iğdır) to 1400 m (Üçkaya). It was determined that there were statistically significant ($P \leq 0.05$) differences between some fruit quality properties of Şalak apricot variety cultivated at different altitudes (Table 2). Table 2 shows multiple comparison test of the values obtained from the study. As the results were examined, the difference between regions in terms of fruit width, length, height, and weight, seed weight, and kernel weight of Şalak variety was found to be differences according to two-year mean data. While the highest fruit width (48.83 mm), length (56.80 mm), height (47.27 mm), and fruit weight (73.82 g) were obtained from Iğdır region, the lowest fruit width (41.06 mm), length (49.47 mm), height (40.53 mm), and fruit weight (53.42 g) were obtained from Kağızman region. In the study, it was found that seed weight was 2.24 - 2.72g and kernel weight was 0.75 - 0.85 g. Özyörük and Güteryüz, (1992) determined fruit weight and seed weight of Şalak apricot variety in Iğdır region as 62.1 g and 2.4 g, respectively. Batmaz (2005) reported that fruit weight varied between 16.60 and 72.33 g and seed weight varied between 2.43 and 7.33g in 16 apricot genotypes. Haciseferoğulları et al., (2007) determined that fruit length, width, thickness, and seed weight in 6 different apricot varieties were 29.26-46.98 mm, 30.16-40.43 mm, 27.64-36.76 mm, and 1.44-2.94 g, respectively. Muradoğlu et al., (2011) found that mean weights of fruit, seed, and kernel in Şalak variety among 6 apricot varieties cultivated in Iğdır region were 51.79g, 2.05g, and 0.75g, respectively.

When different regions were examined in terms of SSC (Soluble Solid Content) levels; SSC in fruit samples from Iğdır, Tuzluca, Üçkaya, and Kağızman regions were found to be statistically different. While the highest SSC was found in samples (16.40%) from Üçkaya region, the lowest SSC was determined in samples (13.72%) from Kağızman region. The pH values in Şalak variety samples obtained from Iğdır, Tuzluca, Üçkaya, and Kağızman regions were statistically different. Whilst the highest pH value was obtained in samples of Iğdır region (4.96), the lowest pH value was determined in samples of Tuzluca region (4.46). There were statistical differences between acidity levels of samples from Şalak variety. Among apricot samples, the highest acidity amount was found in apricots from Tuzluca region whereas the lowest acidity level was observed in apricots from Üçkaya region.

Batmaz (2005) determined that pH value varied between 3.19 and 3.71, acidity varied between 0.93% and 2.47%, and SSC varied between 12.6% and 18.4% for 16 apricot genotypes. In their study, Haciseferoğulları et al., (2007) reported that pH value ranged between 4.16-5.23, acidity level ranged between 0.17-0.79%, and SSC ranged between 17.69-23.63% for 6 apricot varieties. Muradoğlu et al., (2011), found that pH was 5.27 on average, while acidity was 0.2%, and SSC was 14.67%.

Table 2. Some pomological and chemical properties of Şalak apricot cultivar grown in different regions

Regions	Fruit width (mm)	Fruit length (mm)	Fruit height (mm)	Fruit weight (g)	Seed weight (g)	Kernel weight (g)	TSSC	pH	Acidity (%)
Iğdır	48.83 ^{a*}	56.80 ^a	47.27 ^a	73.82 ^a	2.69 ^a	0.85 ^a	14.22 ^b	4.96 ^a	1.25 ^b
Üçkaya	45.89 ^{ab}	54.91 ^a	44.95 ^{ab}	68.20 ^{ab}	2.72 ^a	0.82 ^{ab}	16.40 ^a	4.88 ^a	1.01 ^b
Tuzluca	42.64 ^{bc}	49.81 ^b	42.30 ^{bc}	59.17 ^{bc}	2.24 ^c	0.75 ^b	15.66 ^{ab}	4.46 ^b	1.69 ^a
Kağızman	41.06 ^c	49.47 ^b	40.53 ^c	53.42 ^c	2.42 ^b	0.77 ^b	13.72 ^b	4.50 ^b	1.29 ^b

P≤0.05 least significant difference at 0.05 level. * Means within treatment variables not followed by the same letter are different at 5% levels.

Textural Properties

Table 3 shows values of hardness, adhesiveness, springiness, cohesiveness, gumminess, chewiness, and resilience examined as textural properties of Şalak apricot variety. A significant difference was not found between regions in terms of textural properties of Şalak apricot variety. Accordingly, textural properties of Şalak fruits showed no changes in terms of different altitudes and climatic characteristics and preserved its quality.

According to the obtained results, values of hardness, adhesiveness, springiness, cohesiveness, gumminess, chewiness, and resilience in apricot fruits were measured as 12.13 N, -24.42 g.sec, 0.56, 0.24, 336.76, 198.37, and 0.08 in Tuzluca region; 8.40 N, -36.88 g.sec., 0.57, 0.26, 243.17, 138.93, and 0.09 in Iğdır region; 8.39 N, -22.31 g.sec., 0.57, 0.24, 22.84, 130.81, and 0.08 in Kağızman region; 7.58 N, -26.32 g.sec., 0.56, 0.22, 180.75, 100.33, and 0.08 in Üçkaya region, respectively.

Among regions, the highest values of hardness, gumminess, and chewiness were obtained from Tuzluca region (12.13 N, 336.76, 198.37) and the highest value of adhesiveness was obtained from Iğdır region (-36.88 g.sec.) while similar results were obtained in terms of springiness, cohesiveness and resilience values. Haciseferoğulları et al., (2007) determined average hardness value in Zerdali, Çataloğlu, Hacıhaliloğlu, Hasanbey, Soğancı, and Kabaası varieties as 5.64,

8.20, 7.18, 7.63, 6.16, and 8.48 N, respectively. As for different fruit species, average hardness value were determined as 7.85 N for wild plum, 4.3 N for wild medlar, and 8.83 N for strawberry (Calisir et al., 2005; Haciseferogullari et al., 2005; Ozcan et al., 2007).

Guiné et al., (2011) found that adhesiveness, cohesiveness, springiness, and chewiness values in different apple varieties were between -0.06 and -0.27, 0.43 and 0.75, 0.70 and 0.92, 5.28 and 15.19; respectively. Compared to the results of this study, adhesiveness and chewiness values of Şalak fruits were observed to be higher.

Table 3. Textural properties of Şalak apricot cultivar grown in different regions

Regions	Hardness (N)	Adhesiveness (g.sec)	Springiness	Cohesiveness	Gumminess	Chewiness	Resilience
Tuzluca	1237.20	-24.42	0.56	0.24	336.76	198.37 ^a	0.08 ^a
Iğdır	856.76	-36.88	0.57	0.26	243.17	138.93 ^a	0.09 ^a
Kağızman	855.62	-22.31	0.57	0.24	22.84	130.81 ^a	0.08 ^a
Üçkaya	772.53	-26.32	0.56	0.22	180.75	100.33 ^a	0.07 ^a
Average	930.53	-27.48	0.57	0.24	195.88	142.11	0.08

Conclusion

Apricot is generally consumed as fresh, dried, frozen or as processed such as jam, marmalade, and fruit juice. It is important to know textural properties of apricot in order to enrich these different usage areas and to facilitate product processing processes. There is a limited number of studies in the literature on textural properties of apricot. Textural properties of Şalak variety, an important table fruit which has been cultivated significantly in Aras Basin, were determined in this study. As a result, it was concluded that textural properties of Şalak fruits does not change according to regions and preserves its fruit quality. The results obtained from this study would be useful for further studies such as harvesting, packaging, elongation, storing and processing for various purposes.

References

- Antunes, M. D. C., Correia, M. P., Miguel, M. G., Martins, M. A., & Neves, M. A. 2003. The effect of calcium chloride postharvest application on fruit storage ability and quality of 'Beliana' and 'Lindo' apricot (*Prunus armeniaca* L.) cultivars. *Acta Horticulturae*, 604, 721–726.
- Blahovec, J., Jeschke, J., Houška, M., 1995. Mechanical properties of the flesh of sweet and sour cherries. *Journal of Texture Studies* 26 (1), 45–57.
- Botondi, R., Crisà, A., Massantini, R., Mencarelli, F., 2000. Effects of lowoxygen short-term exposure on postharvest physiology and quality of apricots harvested at two ripening stages. *Journal of Horticultural Science and Biotechnology*, 75(2), 202–208.
- Bourne, M.C., 2002. *Food texture and viscosity: Concept and measurement* (2nd ed.). New York: Academic Press.
- Bruhn, C. M., Feldman, N., Garlitz, C., Harwood, J., Ivans, E., Marshall, M., 1991. Consumer perceptions of quality: apricots, cantaloupes, peaches, pears, strawberries and tomatoes. *Journal of Food Quality*, 14, 187–195.

- Calisir, S., Aydın, C., 2004. Some physical–mechanical properties of cherry laurel (*Prunus lauracerasus* L.) fruits. *Journal of Food Engineering*, 65, 145–150.
- Calisir, S., Haciseferogullari, H., Ozcan, M., Arsalan, D., 2005. Some nutritional and technological properties of wild plum (*Prunus* spp.) fruits in Turkey, *Journal of Food Engineering*, 66, 233-237.
- El-Motty, E.Z.A., El-Shiekh, M.H., Mohamed, F.M., Shahin, M I.F., 2007. Effect of preharvest calcium and boric acid treatments on characteristics and storability of ‘Canino’ apricot fruits. *Research Journal of Agriculture and Biological Sciences*, 3, 430–439.
- Ercisli, 2009. Apricot culture in Turkey Scientific Research and Essay Vol.4 (8), pp. 715-719,
- FAO, 2012. Agriculture Statistics Database. Available from: <http://www.fao.org> (accessed May 2016)
- Guine R.P.F., Andrade S., Correia A.C., Jordao A.M., Lopes A.D.,and Ferreira D., 2011. Evaluation of textural properties in apples of regional varieties. *Int. J. Food Prop.*, 14, 331-338.
- Haciseferogullari, H., Ozcan, M., Sonmete, M. H., Ozbek, O., 2005. Some physical and chemical parameters of wild medlar (*Mespilus germanica* L.) fruit grown in Turkey. *Journal of Food Engineering*, 69,1–7.
- Haciseferogullari, H., Gezer, I., Ozcan, M.M., Muratasma, B., 2007. Postharvest chemical and physical–mechanical properties of some apricot varieties cultivated in Turkey. *Journal of Food Engineering* 79 (1), 364–373.
- Huang, X., Hsieh, F.H., 2005. Physical properties, sensory attributes, and consumer preference of pear fruit leather. *J Food Sci* 70:E177–86.
- Jha, S.N., Kingsly, A.R.P., Chopra, S., 2006. Physical and mechanical properties of mango during growth and storage for determination of maturity, *Journal of Food Engineering*, 72, 73-76.
- Karlsen, A.M., Aaby, K., Sivertsen, H., Baardseth, P., Ellekjaer, M.R., 1999. Instrumental and sensory analysis of fresh Norwegian and imported apples. *Food QualityPrefer.* 10, 305–314.
- Lara, I., García, P., Vendrell, M., 2004. Modifications in cell wall composition after cold storage of calcium-treated strawberry (*Fragaria ananassa* Duch.) fruit. *Postharvest Biology and Technology*, 34, 331–339.
- Missang C.E., Maingonnat, J.F., Renard, C.M.G.C, Audergon J.M., 2011 Texture variation in apricot: intra-fruit heterogeneity, impact of thinning and relation with the texture after cooking *Food Research International*, 44 , pp. 46–53
- Montero-Calderón, M., Rojas-Graü, M.A., Martín-Belloso, O., 2010 . Mechanical and Chemical Properties of Gold Cultivar Pineapple Flesh (*Ananas Comosus*). *European Food Research and Technology* , 230, 675–686.
- Özbek, S. 1978. Special Horticulture. C, .U” . Faculty of Agriculture no. 128, Adana, Turkey.
- Ozcan, M.M., Haciseferogullari, H., 2007. The strawberry (*Arbutus unedo* L.) fruits, chemical, composition, physical properties and mineral contents, *Journal of Food Engineering*, 78, 1022-1028.
- Özyörük, C., Güteryüz, M., 1992. Iğdır ovasında yetişen kayısı çeşitleri üzerine pomolojik, biyolojik ve fenolojik araştırmalar. *Atatürk Üni. Ziraat Fak. Derg.* 23(1), 16-28.
- Razavi S.M., Parvar M.B., 2007. Some physical and mechanical properties of kiwifruit, *International J. Food Eng.*, 3(6), 1-14.
- Shao, X., Tu, K., Zhao, Y., Chen, L., Zhao, L., 2006. The effect of intermittent warming and delayed storage on the cold storage of peach ‘Baifeng 2’. *Journal of Jilin Agricultural University*, 28, 98–102.

- Sirisomboon, P., Tanaka, M., Kojima, T., 2012. Evaluation of tomato textural mechanical properties. *Journal of Food Engineering*, 111, 618–624.
- Stow, J. 1995. Quality measurements of apples. *Postharvest News and Information*, 6, 32N±33N.
- Takahashi, T., Hayakawa, F., Kumagai, M., Akiyama, Y., Kohyama, K., 2009. Relations among technical properties, human bite parameters, and ease of chewing of solid foods with various textures. *J Food Eng.* doi:10.1016/j.foodeng.2009.05.023
- Vicente, A. R., Saladié, M., Rose, J. K. C., Labavitch, J. M., 2007. The linkage between cell metabolism and fruit softening: Looking to the future. *Journal of the Science of Food and Agriculture*, 87, 1435–1448.

THE YIELD TRAITS OF SOME COWPEA (*Vigna sinensis* L.) GENOTYPES CULTIVATED IN KIRŞEHİR PROVINCE OF TURKEY

Omer SOZEN^{1*}, Ufuk KARADAVUT²

¹Department of Field Crops, Faculty of Agriculture, Kırşehir, Turkey

²Department of Animal Science, Faculty of Agriculture, Kırşehir, Turkey

*Corresponding author: ekim_55@hotmail.com

Abstract

This study aimed to determine cowpea seed varieties that may be suitable for the production efficiency and affecting yield factors in Turkey's located Middle Anatolia ecological conditions. The study was conducted for 2 years in 2014-2015. In research, 4 cowpea varieties (Amazon, Sirma, Karagoz, Akkız) and control Nevşehir / Hacıbektas, obtained from the district domestic genotype 1, were used. Research was conducted in a randomized complete block experimental design with three replications. Sowing was performed on 10 May 2014 and on 8 May 2015. The local cowpea cultivars and genotypes according to the two-year average 50% flowering number of days 68-80 days, 50% pod connecting number of days 93-102 days, plant height 41-83 cm, pod number in plant 2-10 pieces, pod length of 5-15 cm, 100 seed weight and seed yield 11.46-18.75 g per plant between 1:21 to 6:19 g/plant ranged. As a result, number of pods per plant and seed per plant, plant and yield per plant and the number of days between the number of pods per pod connect with biological yield was found to be very important relationship. At the same time the first pod height, plant height and number of pods with one seed per plant were among the important relationships that were identified in both years. In cowpea breeding programs, in the number of pods per plant, yield per plant, number of pods per plant and has laid the biological traits could be used as selection criteria.

Key words: *Kırşehir, cowpea, local genotypes, yield, yield components*

Introduction

Cowpea is an important food legume as fresh and dry seed in human diet and as animal feed and green fertilizer for the improvement of soil fertility (Akcin, 1988). Depending on the cultivar and environment conditions, it contains 18-31.6% protein, 50-67% carbohydrates, 1.3% oil, 3.9% cellulose and 3.6% ash. Fresh pods and dry seeds of cowpea are used as edible legumes. Due to eating habits in human diet, priority is given to the consumption of animal-derived proteins. However, for a healthy diet, plant-derived proteins, as well as animal-derived proteins, should be consumed. Because, cowpea plant is rich in amino acids, lysine, tryptophan, carotene and B1 vitamin (Ozturk, 2010). Cowpea which is an edible legume is the third in legume production in the world following beans and chickpeas with 11.926.786 ha cultivation area, 6.224.698 tons of production and 52 kg da⁻¹ yield. In Turkey, it is fifth in legume production following chickpeas, beans, lentils and broad beans with 1.941 ha cultivation area, 2.006 tons of production and 103 kg da⁻¹ yield (FAO, 2013). Cowpea cultivation in Turkey is unsatisfactory. Cowpea cultivation should be developed and a cultivator culture should be established on this subject. As in other culture plants, it is of great importance, as well as other cultural applications, to use cultivars suitable to the ecological conditions for increasing the yield per unit area (Sertve Ceyhan, 2012).

Ozturan and Gulumser (2004), in their study on Akkız and Karagoz cultivars, determined some yield properties including plant height, pod number in plant, yield per plant, seed yield, 1000-seed weight and crude protein have reported the highest seed yield as 273.1 kg da⁻¹. The researchers obtained the highest seed yield per plant in Karagoz cultivar (69.0 g). Oztokat and Demir (2010), in their study on 31 different cowpea genotypes in Aegean region, determined the highest yield as 84.20 kg da⁻¹. Vural et al. (2000), in their study, stated that growing condition is the most important factor that affects the yield. The researchers have reported that ecological conditions seriously affect the fertility. Tomer and Verma (1989) have reported that seed weight had a sufficient effect on the growth and development in cowpea. Gul (1996) has reported that the humidity should be high for the germination of cowpea. The researchers determined that cowpea may not germinate in soils where most of the legume types easily can. Kırsehir is ecologically suitable for cowpea cultivation. However, the production level is not satisfactory due to the consumption habits of the producers. The aim of this study is to determine the genotypes of cowpea (line/variety) in terms of yield suitable for Kırsehir/Turkey ecological conditions which features all the characteristics of Central Anatolian ecological conditions.

Material and Methods

The present study aims to determine the yield and some agronomic properties of cowpea (*Vignasinensis*L.) genotypes under Kırsehir/Turkey ecological conditions. The study was conducted for 2 years in 2014-2015 at trial farmlands in Kırsehir. The altitude of Mucur country in which the study was carried out is about 80 m and it is located at 39°3'48.00"K latitude and 34°22'19.71"D longitude (Figure 1).



Figure 1. Locations where the conduct of the trials

Examining the analysis results for the soil used in the study, it was seen that the soil had a clayey-loamy structure with mild alkaline characteristics, saltless, calcareous, moderate in phosphorus, rich in potassium and moderate in organic substance for the every both years.

The average monthly temperatures and relative humidity ratios for both years were highly similar to those of long-term temperature and relative humidity values. However, examining the monthly total precipitation values, the total precipitation values for all months for both 2014 and 2015 were considerably higher compared to the long-term average values. Particularly, 161.4 mm precipitation value for June 2015 was 11 times higher than the long-term average values (Table 1).

The study was established according to the randomized complete block experimental design in three replications. Four cowpea standard cultivars (Akkız, Amazon, Karagoz, Sırma) and one domestic population, a total of five cowpea genotypes were included in the study. The seeds were sown in plots consisting of 4 rows which were prepared using a 5 m marker with 60 row spacings (5 x 2.40 m= 12 m²) and 10 cm intra-row spacings manually between 10 May 2014 and 8 May 2015. In addition to planting, the necessary fertilization (15 kg diamonium phosphate per decare)

was distributed among the plots homogeneously and herbicide application was carried out before planting and sprouting. Additionally, plants were irrigated our during the required period for the plants. Harvest was carried out manually between 14 September 2014 and 11 September 2015. In each plot consisting of 4 rows, the 1st and the 4th rows of the plots and 50 cm distances from the starting point of each plot was removed as the edge impact and total harvesting was performed in the remaining area.

Flowering and pod setting values of all cowpea genotypes in all plots for the two years and phonological and agronomic properties including plant height (cm), first pod height (cm), the number of pods per plant (piece/plant), the number of seed per pod (piece/pod), the number of seed per plant (piece/plant), seed yield per plant (g), 100 seed weight (g), pod height (cm) and biological yield (g) for 10 plants randomly selected from each plot were determined according to Akcin (1974) and Gulumser (1981).

Table 1. Climate data for the Kırşehir.

Climatic Factors	Years	Months				
		May	June	July	August	September
Total Rainfall (mm)	2014	46.6	36	13	17	30.4
	2015	39.2	161.4	20.6	11.8	1
	ALY*	10.7	13.9	2.9	1	2.6
Average temperature (°C)	2014	16.9	20.8	27.6	28.2	20.1
	2015	16.4	18.9	24.9	25.9	23.8
	ALY*	16.2	20.6	24.8	24.9	19.6
Average Relative Humidity (%)	2014	59.5	51.6	33.6	33.6	50.8
	2015	57.5	65.6	41.5	45.4	41.1
	ALY*	56.2	50.9	38.4	37.6	43.3

*ALY: Average Long Years

The combined data of the two years were subjected to the ANOVA using JUMP5.0 statistical software. The “LSD Multiple Comparison Test” was used for the comparison between the significant differences between the average values. The study comprised combined data of the each property examined for the both years.

Results and Discussion

50% The Number of Flowering and Pod Connecting Days

In terms of the average 50% number of flowering days for the both years, the differences between the cowpea genotypes were very significant ($P < 0.01$). The genotypes with the longest 50% flowering periods were sirma and akkız genotypes with 75.9 days and 75.5 days, respectively (Table 2). The shortest 50% flowering period was determined in the domestic genotype with 69.5 days. The average 50% flowering period for all genotypes were 73.2 days. These results were in line with the results reported by Gulumser et al. (1989) who have reported that the flowering period for native cowpea genotypes varied between 66 and 73 days. Similarly, Buyukkılıç (1995), in their study conducted under Sanlıurfa conditions have reported that flowering period varied between 56 and 57 days. This was associated with the different ecological conditions in terms of humidity and temperature of the area that the study was conducted. Pod connecting and flowering periods are directly related to each other 50% pod connecting period is described as the number of days for the plant until the date of 50% pod connecting. The average pod setting for

the two years in the study was determined as 96.7 days and the differences between the genotypes were statistically not significant (Table 2). The genotype with the longest pod connecting period was sirma with 99 days whereas the shortest pod setting period was determined in the native population with 94.5 days.

Plant Height

Analysis of variance revealed that the differences between the average plant heights of cowpea genotypes for the two years were very significant ($P < 0.01$). The average values of plant height for cowpea genotypes for the two years and the LSD groups are shown in Table 2. The genotypes with the highest plant heights were sirma, amazon and native cowpea genotypes with 61.5 cm, 59.9 cm and 57.7 cm, respectively. The lowest plant heights were determined in akkız and karagoz genotypes with 45.8 cm and 47.6 cm, respectively. The average plant height was determined as 54.5 cm. The difference between the plant heights of the highest genotype and the lowest genotype was 15.7 cm. In a study on the determination of the effects of different intra-row spacings and via on seed yield and some agronomic properties of cowpea (*Vignasinensis* (L.) Savi) cultivars under Hatay province ecological conditions, the plant height values varied between 33.22 cm and 60.37 cm (Sert, 2011). In another study on the determination of plant properties and ability of cowpea cultivars under Hatay ecological conditions, the differences between the plant height values of ecotypes were statistically significant (Atıs ve Yılmaz, 2005). The results obtained by the researchers were in line with the results obtained in the present study.

First Pod Height

Results for the analysis of variance for first pod height values of the cowpea genotypes and the LSD groups in the study are shown in Table 2. As seen in Table 2, the differences between the first pod height values of the genotypes were statistically significant ($P < 0.05$). Examining the average values for the two years, first pod height varied between 21.3 cm and 25.4 cm. The highest first pod height values were determined in amazon and akkız genotypes with 25.4 cm and 25.1 cm, respectively.

These two genotypes were statistically located in the same group (a). The lowest first pod height was determined in domestic cowpea genotype with 21.3 cm. The average first pod height for the cowpea genotypes was 23.9 cm (Table 2). The higher first pod height values obtained in the present study was associated with high plant height values. Karasu (1999), in their study on the determination of the agronomic characteristics of some cowpea ecotypes under Isparta ecological conditions 1996-1997, have reported the first height between 17.8 cm and 22.7 cm. Although the variation was high, our results were within this variation.

Table 2. Two-year average of the investigated properties for cowpea genotypes

Genotypes	50% flowering number of days	50% pod connecting number of days	plant height (cm)	first pod height (cm)
Sirma	75,9 a	99	61.5 a	24.5 ab
Akkız	75,5 a	95.5	45.8 b	25.1 a
Karagoz	74,5 b	96.5	47.6 b	23.4 ab
Amazon	70,5 c	98	59.9 a	25.4 a
Domestic	69,5 d	94.5	57.7 a	21.3 b
means	73.2	96.7	54.5	23.9
level of significance	**	ns	**	*

ns, *, ** =not significant and significant effect at 5 and 1 % respectively

The Number of Pods in the Plant

One of the most important components that affect the yield is the number of pods in the plant. As a result of the analysis of variance for the combined data of the two years, the differences between the genotypes in terms of the number of pods in the plant were significant ($P < 0.01$). The groups formed in terms of the number of pods in the plant and LSD values are shown in Table 3. Examining Table 3, it was seen that the number of pods in the genotypes varied between 3.7 and 6.5 pieces. Genotypes with the highest number of pods were akkız, amazon, sırma and native genotype with 6.5, 5.5, 5.5 and 5.5 pieces respectively. The genotypes were statistically located in the same group (a). The lowest number of pods were determined in karagoz genotype with 3.7 pods. The difference between the lowest and the highest number of pods (between sırma and akkız genotypes) was 2.8.

Ceylan and Sepetoglu (1983), in their study, have reported that the number of pods in cowpea genotypes varied between 2.1 and 26.5. On the other hand, Karasu (1999) have determined the number of pods in the plant between 29.4 and 40.6. In a study on the determination of the effects of different row spacings and via on seed yield and some agronomic characteristics conducted under Hatay ecological conditions in 2009, have reported the number of pods in the plant between 12.19 and 14.59 (Sert, 2011).

The number of pod obtained in the present study was lower than those obtained by other researchers. This was mainly associated with the decrease in plant growth in pod connecting period as well as the increase in high temperatures.

The Number of Seeds per Pod

The average number of seeds per pod values of cowpea genotypes and the groupings are shown in Table 3. Examining Table 3, the differences between the genotypes in terms of the number of seeds per pod were significant ($P < 0.01$).

The number of seeds per pod varied between 4.1 and 5.6. The highest number of seeds per pod was determined in amazon genotype with 5.6 seeds. This genotype was statistically located in (a) group. This genotype was followed by akkız, sırma and karagoz genotypes with 5.3, 4.6 and 4.4 seeds, respectively. These three genotypes were located in the same group (ab). The lowest numbers of pods were determined in native genotype with 4.1 pods.

Clarke and Skeete (1982), in their study on arauca cowpea cultivars, have reported that, in five different plant spacing applications, planting spacing frequency had no effects on the number of seeds per pod and 100-seed weight. Bahceci (1987), in their study conducted under Cukurova ecological conditions, have reported that the number of seeds per pod increased as the intra row space increased.

In a study on the effects of different row spacings and nitrogen fertilization on the yield and yield components of akkız and karagoz cowpea cultivars under Samsun ecological conditions, the number of seeds per pod varied between 10.4 and 11 (Ozturan, 2003).

Pod Length

The average pod length values of cowpea genotypes for the two years are shown in Table 3. The differences between the genotypes in terms of pod lengths were found to be statistically not significant. Pod lengths of the genotypes in the study varied between 8.7 and 9.6 cm and other genotypes varied between these two genotypes.

The average pod length of the genotypes was 9.12 cm. The highest pod length value was determined in Amazon genotype with 9.6 cm whereas the lowest pod length values was in karagoz genotype with 8.7 cm. In a study on the determination of physiological and morphological properties and yield and yield components of cowpea (*VignaSinensis L.*) ecotypes cultivated under Ordu ecological conditions, it has been reported that pod length values varied between 15.1 and 19.8 cm (Ozturk, 2010).

In another study on the determination of the most suitable variety and seed planting period for cowpea (*VignaunguiculataL.Walp*) under dry and aqueous ecological conditions of Isparta, the highest pod length value was determined in akkız cultivar with 16.19 cm whereas the lowest pod length values was determined in sarigobek cultivar with 12.34 cm (Unlu, 2004). Pod length values obtained by the researchers were substantially higher than those obtained in the present study. This was associated with the increase in temperature and the decrease in humidity in the area that the study was conducted during pod setting period and the decrease in plant growth.

Table 3. Two-year average of the investigated properties for cowpea genotypes

Genotypes	the number of pods per plant	the number of seed per pod	pod length
Akkız	6,5 a	5.3 ab	9.0
Amazon	5,5 a	5.6 a	9.6
Sırma	5,5 a	4.6 ab	9.0
Domestic	5,5 a	4.1 b	9.3
Karagoz	3,7 b	4.4 ab	8.7
means	5.34	4.8	9.12
level of significance	**	**	ns

ns, *, ** =not significant and significant effect at 5 and 1 % respectively

100 Seed Weight

The average 100 seed weight values of cowpea genotypes and statistical groupings are shown in Table 4. The effect of genotypes on 100 seed weight was statistically very significant ($P<0.01$). 100 seed weight values of the genotypes varied between 13.56 g and 16.94 g and the highest 100 seed weight value was determined in sırma genotype with 16.94 g. On the other hand, the lowest 100seed weight values were determined in native genotype and akkız genotype with 13.56 g and 14.24 g, respectively. These two genotypes were statistically located in the same group. The difference between the highest and the lowest 100 seed weight values was 3.38 g and the average 100 seed weight was 15.36 g. In a study on the determination of plant characteristics and adaptation capabilities in different cowpea ecotypes obtained from different parts of Turkey under Hatay ecological conditions, 100 seed weight value varied between 12.93 and 21.94 g (Atış, 2000). In a study on the determination of the most suitable cowpea cultivar (akkız, karnıkara and sarigobek) and seed planting period under dry ecological conditions in Isparta, 100seed weight was reported between 12.55 and 21.53 g (Unlu, 2004).

Seed Yield per Plant

The average seed yield per plant values and statistical groupings are shown in Table 4 and the differences between the genotypes in terms of seed yield per plant values were very significant at 1% level. Examining Table 4, seed yield per plant values varied between 1.916 and 3.003 g. The two genotypes with the highest seed yield per plant values were akkız and amazon cowpea

genotypes with 3.003 g and 2.998 g, respectively. These two genotypes were statistically located in the same group (a). This was followed by sirma and native genotypes with 2.684 g and 2.382 g and these two genotypes were statistically located in the same group (ab). The lowest seed yield per plant was determined in karagoz genotype with 1.916 g.

The difference between the highest and the lowest seed yield per plant values was 1.087 g. In a study conducted under Cukurova conditions, Bahceci and Engin (1989) have reported that the highest seed yield per plant values were determined in karagobek cultivar in 30 cm (44.03 g) and 25 cm (35.53 g) planting spacings, respectively, and in kırmızı cultivar in 25 cm (32.35 g) and 30 cm (28.30 g) planting spacings, respectively.

In another study conducted under Samsun ecological conditions, seed yield per plant values varied between 48.4 and 69 g (Ozturan, 2003). The seed yield per plant values obtained in the present study were lower than those obtained by other researchers. This associated with the effect of temperatures much above 30 °C in maturation period on seed maturation.

Table 4. Two-year average of the investigated properties for cowpea genotypes

Genotypes	seed yield per plant	100 seed weight
Akkız	3,003 a	14.24 c
Amazon	2,988 a	15.81 b
Sırma	2,684 ab	16.94 a
Domestic	2,382 ab	13.56 c
Karagoz	1,916 b	16.22 ab
means	2.594	15.36
level of significance	**	**

ns, *, ** =not significant and significant effect at 5 and 1 % respectively

Conclusion

The aim of the present study was to determine the yield properties and the factors that affect the yield in cowpea under Kırsehir/Turkey ecological conditions 50% flowering number of days, 50% pod connecting number of days, plant height (cm), first pod height (cm), the number of pods per plant (piece/plant), the number of seed per pod (piece/pod), seed yield per plant(g/plant), 100 seed weight (g) and pod length (cm) values were examined and compared with other studies.

In conclusion, the results obtained for the two years were not satisfactory to make a clear conclusion. However, the result obtained in terms of yield components in particular, the number of seeds, 100 seed weight and the yield per plant were promising for some cultivars. Indeed, high yields were obtained from akkız, sırma and amazon cultivars. In order to acquire better results on cowpea cultivation, it was concluded that the study should be conducted for a couple more years in Kırsehir and neighboring locations.

Considering the importance of edible legumes in human diet, there is need for research and development on the breeding and cultivation techniques for cowpea. These research studies will contribute to the development of agricultural production and hence the elevation of socio-economic structure.

Acknowledgement

“This work was supported by the Ahi Evran University Scientific Research Projects Coordination Unit. Project Number: ZRT.E2.16.015”

References

- Akcin, A. (1974). An Investigation of the Effect of Fertilization, Planting Time and Row Spacing on Grain Yield and Phonological, Morphological and Technological Characters Some Dry Bean Varieties Under Grown Erzurum Ecological Conditions. Journal of Agricultural Faculty of Ataturk University, Erzurum, 157: 1-112 p.
- Akcin, A. (1988). *Legumes*. Journal of Agricultural Faculty of Selcuk University, Konya, 43(8): 377 p.
- Atis, İ. (2000). Determination of Yield and Yield Components Cowpea (*Vigna sinensis* L.) That Can Be Grown Second Crop Conditions to Obtain Seed and Green Grass in Hatay Conditions. Institute of Science of Mustafa Kemal University, Hatay, Master's Thesis, 73 p.
- Atis, İ., Yılmaz, S. (2005). Determination of Yield and Yield Components Cowpea (*Vigna sinensis* L.) That Can Be Grown Second Crop Conditions to Obtain Green Grass in Hatay Conditions. The Sixth Field Crop Congress, Antalya, Part: II, 985-988 p.
- Bahceci, B. (1987). Effects of Some Plant and Agricultural Characteristics of Different Sowing in Two Cowpea Varieties. Institute of Science of Cukurova University, Adana, Master's Thesis, 47 p.
- Bahceci, B., Engin, M. (1989). A Study on the Effects of Some Herbal and Agronomic Traits in Two Different Sowing Cowpea Varieties. Cukurova University, Institute of Science and Technology, 3 (3): 21-27 p.
- Ceylan, A., Sepetoglu, H. (1983). Cowpea (*Vigna unguiculata* (L.) Walp) Research on the Variety-Planting Time. Journal of Agricultural Faculty of Ege University, 20 (1): 25-40 p.
- Clarke, B.A., Skeete, S.A. (1982). Response of cowpea (*Vigna unguiculata* (L.)), cultivar arauca, to planting density. 18th Annual Meeting, *Carribean Food Crops Society*, 98-103 s.
- Fao, (2013). faostat.fao.org/site/Desktop.PageID=336.
- Gul, K., (1996). A Study on to Determine of Adaption to Tokat-Kazova Ecological Conditions and Favorable Sowing Time of Cowpea (*Vigna Sinensis* (L.) Endi) Institute of Science of Gaziosmanpasa University Master's Thesis, Tokat.
- Gulumser, A. (1981). Effects of Nitrogen Fertilization, Irrigation Grain Yield and Its Protein Content in Peas. Field Crop, Faculty of Agricultural, Ataturk University, Erzurum, Doctorate Thesis.
- Gulumser, A., Tosun, F., Bozoglu, H. (1989). A Research On Cowpea Cultivation in Samsun Ecological Conditions. Journal of Agricultural Faculty of Ondokuzmayıs University. 4(1-2) 49-65 p.
- Karasu, A. (1999). Agronomic Research in Character Some of Cowpea (*Vigna angulate* L.) Cultivar and Ecotype of in Isparta Ecological Conditions. Türkiye The Third Crop Science Congress, Adana, 371-376 p.
- Öztokat, C., Demir, İ. (2010). The Comparison Of Some Cowpea Populations According to Their Growth, Yield and Seed Quality. In: 2nd International Symposium on Sustainable Development, Sarajevo.
- Özturan, Y. (2003). The Effects of Different Row Spacing and Nitrogen Fertilization on Yield and Yield Components of Cowpea (*Vigna unguiculata* (L.) Walp.) Under Samsun Conditions. Institute of Science of Ondokuzmayıs University, Samsun, Master's Thesis, 77 p.
- Özturan, Y., Gülümser, A. (2004). The Effects of Row Spacing and Nitrogen Fertilization on Yield and Yield Components of Cowpea (*Vigna unguiculata* (L.) Walp.). Journal of Agriculture Faculty, 19(3): 41-49 p.

- Öztürk, D. (2010). Determination of Some Physiological and Morphological Features With Production and production Element of Cowpea Ecotypes That Wil Be Cultivated in ordu Ecological Conditions. Institute of Science of Ordu University, Ordu, Master's Thesis, 77 p.
- Sert, H. (2011). The Effects of Seed Yield and Some Agricultural Characters of Plant Density on Cowpea (*vignasinensis*(l.) *savi*) in Hatay Ecological Conditions. Institute of Science of Selcuk University, Konya, Master's Thesis, 52 p.
- Sert, H., Ceyhan, E. (2012). The Effects of Seed Yield and Some Agricultural Characters of Different Plant Density on Cowpea (*Vigna sinensis* (L.) Savi) in Hatay Ecological Conditions. Selcuk Journal of Agricultural and Food Sciences. 26 (1): (2012) 34-43p.

QUALITATIVE AND PRODUCTIVE PROPERTIES OF BIO-FORTIFICATION SOFT WHEAT OF THE VARIETIES , "RADIKA"

Marija MENKINOSKA*, Valentina PAVLOVA, Tatijana BLAZEVSKA

Technology-technical Faculty, "PetrePrlichkov" str., no. 42, 1400 Veles, University "St. ClimentOhridski", 7000 Bitola, Republic of Macedonia

*Corresponding author: marija_menkinoska@yahoo.co.uk

Abstract

Wheat is considered the most important cereal as a staple food for humans. For normal growth and development plants need at least 14 mineral elements such as micronutrients nitrogen, phosphorus, potassium, calcium, magnesium and sulfur and macronutrients chlorine, bromine, iron, manganese, copper, zinc, nickel, and molybdenum. Deficit on any kind of these mineral elements in the soil reduced plant growth, yields and nutritional quality of products. Nowadays, the causes and consequences of zinc deficiency and iron in the soils are well documented and there are well-established effective methods to overcome the deficiencies in agriculture. Bio-fortification is a process with help on which increase concentration on micronutrients such as zinc, iron, manganese and etc. in the agriculture products—especially in the wheat cultures. The aim of this research is to examine the influence of Fe-EDTA and Zn-EDTA fertilizers through soil, foliar and soil+foliar application on qualitative and productive characteristics of soft wheat variety Radika. The analysis of variance for comparing on average values has shown existing of important differences between variants in morphologic characteristics only in the place of the number of little ear the hectoliter mass of wheat obtained with foliar application on Zn-EDTA showed value of 76.05(kg/hl), which is 1.33 % more than value of the control 75.05(kg/hl). During the investigation we determined that the largest weight of 1000 grains showed wheat obtained by application of Fe EDTA soil + foliar for 8.21%, compared to the control variant. It might be concluded that the agronomic bio-fortification which nowadays is emphasizes alternative economic justified solution leads to improvement of the qualitative and productive features.

Keywords: *bio-fortification, Fe-EDTA u Zn-EDTA,*

Introduction

Bio-fortification is a process with it is help increases concentration on micro-nutrients like Zn, Fe, Mg, and etc. in agriculture products—especially in wheat cultures. There are two kinds:

-Agronomic bio-fortification, includes using of fertilities with higher concentrations of Zn and other micro-nutrients.

- Genetic bio-fortification uses special raised cultures that will be capable to accumulate more Zn and other micronutrients from the soil in nutritional parts of the grains (Ryan, 2010)

There are more evidence showing that the combination of foliar or soil+foliar fertilization with Zn/Fe under field conditions is very practical and efficient way to increase the uptake and accumulation of Zn in wheat grain. With the increase of the percentage of Zn in the seeds being improved yield, resistance to abiotic factors, resistance to diseases and germination of the seed. Agronomy bio-fortification is essential to maintain the enough and the available amount of Zn in soil and providing adequate transportation to seed during the reproductive stages of plant growth.

Also it is necessary for optimizing and providing conditions for the success of genetic bio-fortification. Better plant nutrition in terms of micronutrients depends on many factors in the soil (Abbas 2012). The amount of nutrients which accumulate in plants, fruits or seeds mainly depends on the availability of each element in the soil and the ability of plants to accumulate those one and trans-locate nutrients to the appropriate parts.

One of the ways to increase the content of micronutrients in a plant grains to provide the micronutrients in highly soluble efficient form throw the soil or throw foliar application. According to (Wiedemuth et al., 2005) Fe fertilizer can be applied to inorganic form (such FeSO_4) or chelated form (such as Fe-EDTA, Fe-EDDHA or Fe-citrate).

This research was conducted to investigate the impact of the use of chelating Fe and Zn fertilizers on the quality of qualitative and productive qualities of soft wheat variety Radika

Material and methods

Plant material

The variety of the type “Radika” soft wheat (*Triticum aestivum*), was used as a plant material in this research.

Location and setting experiment

On the lands belonging to the Agricultural Institute in Skopje (Macedonia), in the testing economy “Dolno Lisiche”, during the production year 2012/2013, a test was placed according to the method of accidental bloc system, with 7 variants, three time repeated, while the testing parcel being of 30 m² size. The distance between the variants and the repeating procedures was 50 cm. The procession of the parcel was a standard one by bringing the plowed layer in condition of normal sowing. The sowing was conducted manually with 600-650 life-able grain/m².

Application of fertilizer

The following variants are included in the test of this research:

- Fe application in soil (variant 1)
- Fe application in soil and foliar (variant 2)
- Fe foliar application (variant 3)
- Control – without fertilizing (variant 4)
- Zn application in soil (variant 5)
- Zn application in soil and foliar (variant 6)
- Zn foliar application (variant 7)

Basic characteristics of the fertilizers

Yara Vera™ Amidas is a highly qualitative granular fertilizer which contains nitrogen and sulfur. The nitrogen is mostly available in the form of urea. The sulfur is available in the form of sulfate and is totally water-soluble. The ratio between the nitrogen and sulfur is from 7 towards 1. Nutrichem folifer-Fe EDTA chelate product, which is used for a foliar nutrition of the plants. Yara Vita Rexolin is a product for prevention of a shortage of zinc formulated in the form of EDTA chelate. Containing 15% and 148 grams of zinc per kilogram a product can be used for soil or foliar application.

Period of application of fertilizer

The nutrition of the wheat is conducted in the following stages of development:

1. Germination stage-fertilizing with NPK(9:15:15) 200 (kg/h) soil at the variants 1,2,3,4,5,6 and 7. Fe EDTA 10 (kg/h) soil application with the variants 1 and 2. Zn EDTA 20 (kg/h) soil application with the variants 5 and 6.
2. Tillering stage- applied Yara Vera Amidas 160 (kg/h) soil at the variants 1,2,3,4,5,6 and 7.

3. Booting stage- Yara Vera Amidas 100 (kg/h) soil at the variants 1,2,3,4,5,6 and 7.
4. Booting stage- Fe EDTA 1 (kg/h) foliar at the variants 2 and 3. Zn EDTA 1kg/h(0.1%) foliar at the variants 6 and 7
5. Heading and flowering- Fe EDTA 1(kg/h) foliar at the variants 2 and 3.Zn EDTA 1kg/h(0,1%) foliar at the variants 6 and 7
6. Flowering Fe EDTA 1 (kg/h) foliar at the variants 2 and 3. Zn EDTA 1kg/h(0,1%) foliar at the variants 6 and 7

The foliar fertilizing was conducted by a dorsal sprinkler, with 3 liters of solution (mixture) with the variants 2 and 3 at the early morning hours.

Biometric methods for analysis of the morphologic and producing characteristics

The examinations of the morphologic and producing characteristics were conducted by biometric measuring at the end of the vegetation, following the collection of material in the laboratory.

From morphological characteristics analyzed: stem height, ear's length. Measuring the height of the main stem to class (n=20). Before the sowing, a material of 1m² is taken from each parcel for laboratory analyses. The laboratory analyzed the following product characteristics: number of little ears, grains number, grains weight, ear's weight, weight of 1000 grain and hectoliter mass.

Methods of soil analysis

Before placing the test, soil tests were taken with a view to precisely determining the soil's fertility. The tests were made (i.e. undertaken) from several places in the depth from 0 up to 30 cm, according to chess method for small parcels (Menkinoska M. 2014).

Statistical analysis of data

The statistical procession of the data was conducted by means of the statistic-analytical program SPSS and Statistika 8.0. The statistical analysis includes ANOVA for testing the equality of average values of the examined parameters, LDS post hoc analysis for the significance of the obtained differences, as well as modeling of generalized linear models (GLM). As a level of significance is taken 0,05, that is, the values of the test-statistics are considered as significant of $p < 0,05$.

Results and discussion

Characteristics of the Experimental Fields

Weather characteristics and soil conditions

During the tested year, while the period from the sowing to sprouting, there was a sufficient quantity of rainfalls and an optimal temperature for the wheat's sprouting (Menkinoska M. 2014). The contents of the soluble iron in the examined soil test is 13.54 ppm and belongs to the soils with a low level of Fe (Menkinoska M. 2014). The content of soluble zinc in the examined soil test is 1.62 ppm and belongs to soil with low level of Zn.

Morphologic and producing characteristics of wheat

The analysis of variance for comparing the average values (Tab.1) showed the existence of significant differences between variants in the morphological characteristics only in number of little ears. According Post hoc analysis (Tab.2) is supplied that the significance of the test due to significant differences in number of little ears between variant 1 and 3 (LSD 0.8 $p = 0.00$), variant 1 and 5 (LSD = 1.3 $p = 0.00$) and variant 1 and 7 (LSD 0.7 $p = 0.00$). The addition of Fe soil fertilizer showed better results in number of little ears compared to the control, soil Zn and Zn soil + foliar. LSD showed difference between variants 2 and 5 (LSD = -0.8 $p = 0.01$), 4 and 5 (LSD = -0.7 $p = 0.02$) and 5 and 6 (LSD = -0.9 $p = 0.00$), which means that application of soil+foliar Fe, control and Zn soil + foliar fertilizer has a better effect on the

number of little ears compared with the addition of Zn soil. According to (Manasievska, S. 2002) the number of little ears depends on the length of class spindle, also from the number of fertile on the class spindle , in which in our research we found that of all varieties to increase the of number of little ears leads application of Fe EDTA in the soil, while the addition of Zn soil did not show the effect over the tested perimeter.

Table1. Analysis of a variant of the morphologic features of the wheat under the fertilizer`s influence

ANOVA

		Sum of Squares	df	Mean Square	F	Sig.
Stem height	Between Groups	415,367	6	69,228	1,942	0,073
	Within Groups	14720,433	413	35,643		
	Total	15135,800	419			
Ear`s length	Between Groups	11,224	6	1,871	1,969	0,069
	Within Groups	392,433	413	0,950		
	Total	403,657	419			
Number of little ears	Between Groups	57,014	6	9,502	3,280	0,004*
	Within Groups	1196,650	413	2,897		
	Total	1253,664	419			
Ear`s weight	Between Groups	2,670	6	0,445	1,810	0,096
	Within Groups	101,526	413	0,246		
	Total	104,196	419			
Grains number	Between Groups	656,867	6	109,478	2,094	0,053
	Within Groups	21596,017	413	52,291		
	Total	22252,883	419			
Grains` weight	Between Groups	2,311	6	0,385	1,759	0,106
	Within Groups	90,413	413	0,219		
	Total	92,724	419			

Table 2. Comparison of the average values from the morphologic features of the wheat with LSD-test

<i>LSD average difference</i>								<i>LSD values for p</i>						
Number of little ears	1	2	3	4	5	6	7	1	2	3	4	5	6	7
1		0,5	0,8	0,5	1,3	0,3	0,7		0,12	0,00*	0,78	0,00*	0,36	0,03*
2	-0,5		0,3	0,1	0,8	-0,2	0,2	0,12		0,28	0,83	0,01	0,52	0,52
3	-0,8	-0,3		-0,3	0,4	-0,5	-0,1	0,00*	0,28		0,39	0,16	0,09	0,67
4	-0,5	-0,1	0,3		0,7	-0,3	0,1	0,08	0,83	0,39		0,02	0,39	0,67
5	-1,2	-0,8	-0,4	-0,7		-0,9	-0,6	0,00*	0,01*	0,16	0,02*		0,00*	0,07
6	-0,3	0,2	0,5	0,3	0,9		0,4	0,36	0,52	0,09	0,39	0,00*		0,19
7	-0,7	-0,2	0,1	-0,1	0,6	-0,4		0,03*	0,52	0,67	0,67	0,07	0,19	

Mass of 100 grains and hector-liter weight

The test parameter is especially important because according to (Ilieva V. et al., 2011) mass of 1000 grains depends on the size of the grain, it is fullness and healthy condition.

Therefore often mass of 1000 grains also an indicator of the size of the seed. The seed with greater mass usually has better developed stub and gives better developed and more resistant plants in the early stages of development. If the seed is larger, that has more expressed life ability-capacity. The larger seed more uniformly raises, the plants more uniformly grow and developed, that brings to better yield of surface area. During the research we found un-significant higher values for the mass on 1000 grains to the variance 1 for 3.45%, variance 2 for 8.21%, variance 6 for 2.5 % and variance 7 for 0.99 %, while the variance 3 for 3.13% and 5 for 0.04% lower values in comparison with the variance 4. The largest absolute mass of the grain of wheat dependable of the application of fertilizer showed variance 2 for 8.21% compared to the variance 4. The mass of 1000 grains it is important parameter in the bakery industry, because it is found that the larger grain, with more compact endosperm, with higher percentage of clearness and thinner wrapper gives more amount of flour by unit weight on the seed (Manasievska S., 2002). Also according Draganavic S., Maksimovic, L. (2000) the biggest difference in absolute mass shows up between varieties of soft wheat, which presents genetic characteristic. From the literature reviewed we found the data from the research of G. Abbas et al., 2009, which are not in accordance with our results, conducted by the application of N, P and K in doses of 150: 100: 60 kg N: P₂O₅: K₂O ha⁻¹ and the usage of FeSO₄ with doses of 0, 4, 8, 12 and 16 kg/h, the time of sowing. The results showed that the implementation on NPK fertilizer brings to significant increase of the height of the plants, length of the class, number of grains in main class, yield and mass on 1000 grains in comparison with the control, (within NPK). The best results are obtained when applied FeSO₄ a dose of 12 kg/h with the recommended dose of NPK.

Similar results have been presented and the authors Pahlavan-Rad, M. R. ; Pessarakli, M. 2009 which found the biggest mass 1000 grains with usage of 80kg/h ZnSO₄ and foliar application of Fe. Usage of 80kg/h ZnSO₄, combined with foliar application of Mn significantly increases the yield. From our results and from reviewed literature we concluded that, the mass of 1000 grains though it represents a genetic characteristic depends also from the kind of usage fertilizer from it is form, dose and the time of application.

Table3. Physical features of the seed of the varieties Radika

Variance	Hectoliter mass		Weight of 1000 grains	
	(kg/hl)	Index of the control	(g)	Index of the control
1	75,85	101,06	48,80	103,45
2	75,45	100,53	51,03	108,21
3	75,25	100,27	45,68	96,87
4	75,05	100,00	47,16	100,00
5	75,85	101,06	47,14	99,96
6	75,86	101,07	48,32	102,50
7	76,05	101,33	47,63	100,99

As for the hectoliter mass of variance 1 for 1.06 % , variance 2 for 0.53 % , variance3 for 0.27 % , variance 5 for 1.06 % , variance 6 for 1.07 and variance 7 for 1.33% all of them have non-significant higher values that are approximately close in relation of the variance 4. According the data in the Table3 the largest volume on the grain of the tested variance depends of the application of the fertilizer, has the variance 4. The most suitable variance for getting of the grains with large hectoliter mass are the variance 1, 5, 6 and 7.

The high hectoliter mass point on minor and round grains with cuddly surface area, compact endosperm and small content of moisture, also low hectoliter mass give the large and oblong grains with smooth surface and larger content of moisture. Our results are close to the results with Ivanoski, M. and Stanoev, V (2006), which found that the foliar fertilizer Kristalon™ Special with (N:P:K:Mg 18:18:18:3) and micro elements Br (0.025%), Cu (0.01%), Fe (0.07%), Mn (0.04%), Mo (0.004%) and Zn (0.025%) applied at the time with the vegetation on five yields of soft wheat leads to biggest increasing of the mass of 100 grains of the yields Radika in comparison with the control, while the biggest increasing of hectoliter mass showed the yield Treska in the two variance in relation with the control.

Conclusion

Based on the results obtained may be adopted the following conclusions:

With agronomic bio-fortification throw soil, foliar and soil-foliar application with Zinc and Fe chelating fertilizers it is found that:

- Existence on significant differences between variance in morphologic characteristics depends of the kind of application of the fertilizer it is concluded only in Number of little ears.
- It was found the highest value of the mass of 1000 grains for wheat gained with the application of Fe soil-foliar.
- The largest volume of the grain from the tested variance dependable has the variance 7 in relation to the variance 4.

In this case of study, it is concluded that , the agronomic bio-fortification with Zinc and Iron leads to improvement of the qualitative and productive features on soft yield radika.

References

- Abbas Ghulam, Fida Hussain, Zoubair Anwar, Jabar Zaman Khan Khattak, Muhammad Ishaque Asmat ullah 2012 Effects of Iron on the Wheat Crop (*Triticum aestivum L.*) by Uptake of Nitrogen, Phosphorus and Potassium *Asian Journal of Agricultural Sciens*, 4(3): 229-235
- Draganavic S., Maksimovic, L. (2000) The effect of the terms of harvest yield and quantitative characteristics of some varieties of winter wheat. Proceedings Volume 33
- Ilieva V., Mitrev S., Karov I., Markova N., Todorovska 2011. The variability of some quality characteristics of the seed of the wheat Annual Proceedings UDK: 633.11-153.1.02
- Ivanovski, M., Stanoev, V. (2006) Results of applying foliar fertilizer Kristalon™ Special for soft wheat Yearbook of the Institute of Agriculture Skopje UDK: 633.11.631.8
- Manasievska, S. (2002) Protein profile of some types wheat and their morphological, biological and production characteristics Master's Thesis Faculty of Agricultural Sciences and Food „University St. Cyril and Methodius "Skopje
- Menkinoska M., I. Gjorgoski, S. Manasievska-Simic, V. Pavlova, Z. Popeska, V. Stanoev, T. Blazevska, H. Poposka, N. Gjorgovska , V. Levkov The Influence of Fe-chelates Fertilizers on the Soft Wheat's Quality International Journal of Emerging Technology and Advanced Engineering Website: www.ijetae.com (ISSN 2250-2459, ISO 9001:2008 Certified Journal, Volume 4, Issue 9, September 2014
- Pahlavan-Rad, M. R., Pessarakli, M. (2009) Response of wheat plants to zinc, iron, and manganese applications and uptake and concentration of zinc, iron, and manganese in wheat grains. *Communications in Soil Science and Plant Analysis* Vol. 40 No. 7/8 pp. 1322-1332
- Ryan E. 2010 Trace Element Nutrition: Revitalising Health and Agriculture Nuffield Australia Project No 0911
- Wiedemuth K., Müller J., Kahlau A., Amme S., Mock H. P., Grzam A., et al. 2005. Successive maturation and senescence of individual leaves during barley whole plant ontogeny reveals temporal and spatial regulation of photosynthetic function in conjunction with C and N metabolism. *Asian Journal of Agricultural Sciences* 4(3): 229-235, 2012 ISSN: 2041-3890

STABILITY OF FLOWER HEAD YIELD IN CHAMOMILE VARIETIES
(*Chamomilla recutita* L. Rausch.)

Slobodan DRAŽIĆ¹, Tomislav ŽIVANOVIĆ², Snežana PAVLOVIĆ^{3*}, Svetlana TURUDIJA-ŽIVANOVIĆ³, Đorđe MORAVČEVIĆ²

¹Serbian Association of Plant Breeders & Seed Production, Belgrade, Serbia

²University of Belgrade, Faculty of Agriculture, Belgrade-Zemun, Serbia

³Institute for Medicinal Plant Research "Dr Josif Pančić", Belgrade, Serbia

*Corresponding author: snezanapavlovic47@gmail.com

Abstract

The objective of this study was to evaluate stability of the flower head yield in different chamomile varieties (Banatska, Bona, Novbona and Mina) using the model which provides not only regression coefficient bi , but also a second stability parameter - standard deviation from regression S^2di . Significant differences for the yield were determined among studied genotypes. Variety Mina expressed notably higher yield in comparison to the others. Significant differences in F-test were obtained on experimental locations. On locality in Stara Pazova all experimental varieties achieved significantly higher yields. Analysis of stability parameters bi and S^2di showed that varieties have different levels of stability. According to the method applied, stable genotype is achieved with $bi = 1$, and it is desirable that S^2di tends towards zero. In relation to the parameter bi , Banatska is the most while. Bona is the least stable variety. Variety Bona grows better in favorable cultivating conditions, while Mina variety is better adapted to unfavorable growing conditions. This implies that appropriate environmental conditions are crucial for growing these varieties in large extent.

Key words: *chamomile, flower head yield, stability, variety*

Introduction

Productive traits of chamomile depend on the genetic potential of the variety, while stability depends on the variety response to environmental conditions which is highly dependent on its genetic composition. As the response of a variety varies over different growing conditions there is an interaction between the variety and the environment. It is believed that the genotype with the stable yield has a minimal interaction with the environment and respond esfavourably to the improvement of the environmental conditions (Dražić et al., 2007). Several procedures for the determination of stability parameters and their application in the analysis of breeding material of different cultivated plants have been developed. One of the first studies based on the application of the regression analysis was performed by Yates and Cochran (1938), and then by Finlay and Wilkinson (1963). Plaisted and Peterson (1959) developed a procedure that provided the evaluation of the proportion of the each genotype x environment interaction in the total variance of the genotype x environment interaction. The model coined by Yates and Cochran was modified by Eberhart and Russell (1966). Their model is based on the calculation of the linear regression (bi) for each genotype in relation to the environmental conditions, as well as, the deviation from regression S^2di . Afterwards, similar other developed methods were also based on the regression analysis (Perkins and Jinks, 1968, Freeman and Perkins, 1971).

The objective of this study was to evaluate stabilities of the flower head yield of different varieties, with the application of the model, which provides not only regression coefficient bi , but also a second parameter of stability, standard deviation from regression S^2di (Eberhart and Russell, 1966).

Material and methods

Two local varieties, Banatska and Mina, as well as two varieties, Bona and Novbona, introduced from Slovakia were used in the trial (Oravec, 1996., Salamon, 1998., Dražić and Dražić, 2011). The previous studies carried out with these varieties showed the differences between means and their variations (Dražić, 2000). The experiments were conducted in 3 locations in Serbia: Nova Pazova (location 1), Pančevo (location 2) and Kučevo (location 3). According to the morphological and genetic characteristic, the soil at the experiment plot in Nova Pazova municipality belongs to chernozem, Kučevo to cambisols, while the one in Pančevo belongs to marsh soil. Average annual temperatures of these locations were approximately 12°C. Due precipitation in Nova Pazova (620-800 mm) was higher when compared to locations in Pančevo (500-550 mm) and Kučevo (550-600 mm). Based on the analysis of the agroecological conditions, we can state that the conditions in Nova Pazova were the most favourable. The four-replication trial was set up according to the randomized block design. The elementary plot size was 4m². Sowing was done in September, while harvest was performed in the succeeding year. Based on the following mathematical model developed by Eberhart and Russell (1966), the values of stability parameters (bi) for each genotype and the deviation from the regression line (S^2di) were used to estimate stability of yields:

$$Y_{ij} = \mu_i + biI_j + \delta_{ij}, \text{ where:}$$

Y_{ij} - mean of genotypes i at the location j

μ_i - grand mean of genotypes i at all locations

bi - regression coefficient of genotypes i over locations

I_j - environmental index (ecological index)

δ_{ij} - deviation from regression

The first stability parameter is a standardised regression coefficient (bi), which is standardised in relation to 1: $bi = \frac{\sum Y_{ij}I_j}{\sum I_j^2}$

Statistical significance of the regression coefficient (bi) is estimated by the group F-test or the individual t-test. Another stability parameter is the standard deviation from regression that is estimated by the definition: $S^2di = \frac{(\sum \delta_{ij}^2 : (n-2))}{r} - Se$, where: Se - error mean squares from the analysis of variance, n - number of locations and, r - number of replications.

Results and discussion

Varieties responded differently to the conditions of production, so the mean value of the yield varied over locations. The average yield ranged from 595 kg/ha (variety Bona) to 839 kg/ha (variety Mina). The varieties Banatska and Novbona had almost equal yields that were considerably lower than the variety Mina but higher than the yield recorded for the variety Bona. The coefficient of variation indicates different responses of genotypes to the environmental conditions (CV=4.8%-Mina and 16.7%-Bona). A relatively higher coefficient of variation in the variety Bona implies a significant effect of the environment. This effect was reflected upon the variation of yields over locations (489-700 kg/ha), Table 1. This points out that adequate ecological conditions for large scale production of these varieties have to be provided.

Table 1. Flower head yield (kg ha⁻¹)

N ^o	Variety	Locations			Average	Rank	CV (%)
		1	2	3			
1.	Banatska	789	751	670	737	2	6.7
2.	Bona	700	595	489	595	4	16.7
3.	Novbona	793	735	676	735	3	6.5
4.	Mina	887	839	790	839	1	4.8
	Average	793	730	656	727	-	-
	LSD _{0.05}	78					
	LSD _{0.01}	118					

It is quite common that better yielding genotypes also respond better to environmental conditions and vice versa (Eberhart and Russell, 1969; Lamky and Hallauer, 1984; Živanović, 1993), which was also confirmed by these studies (variety Mina, Table 1). Petrović et al. (1988) determined that the yield dependence and the values of regression coefficient could be positive and negative, as was also established in these studies (Table 3). These authors emphasise that genotypes, improved by selection, have not only better combining abilities for the yield, but also respond better to favourable growing conditions than the initial populations.

Table 2. Analysis of variance

Source of variation	d.f.	MS
		Flower head yield
Genotype (G)	3	30.206**
Location (L)	2	20.192**
G x L	6	0.152
Total	11	-

** , significant at 0.01 probability level

Considerable differences among locations were established with the F-test (Table 2). The most and the least favourable location for cultivation were Nova Pazova (location 1) and Kučevo (location 3), respectively. The highest average yield of flower heads for all varieties was recorded in Nova Pazova (793 kg/ha). It is important to emphasise that the variety Mina had the highest yield in all three locations (Table 1).

Table 3. Stability parameters

Variety	Flower head yield			
	bi	Rank	S ² di	Rank
Banatska	0.8800	1	0.0897	3
Bona	1.5453	4	-0.0489	1
Novbona	0.8570	2	-0.0817	2
Mina	0.7176	3	0.1172	4
Se _{bi}	0.8912			

The analysis of stability parameters, *bi* and *S²di*, indicated that different varieties showed different stability levels in yield of flower head (Table 3.). According to this method, a stable genotype has *bi*=1 and it is desirable that *S²di* does not deviate from zero. Based on the parameter

bi the most stable yield was detected in the variety Banatska ($bi=0.8800$). This was expected because the variety Banatska is an autochthonous variety that has been produced for more than a decade. It is highly adaptable to different environmental conditions. The least stable was Bona ($bi=1.5453$). It better responded to various environmental conditions, while the variety Mina better responded to unfavourable environmental conditions ($bi=0.7176$). To support this it may be added that the highest yields were recorded in the variety Mina (Table 1.). According to the other stability parameter S^2di , the most stable was the variety Bona while the least stable was the variety Mina (0.1172). Values of *bi* stability parameter were insignificant, probably because of a small number of tested genotypes, so the value of Se_{bi} was high (0.8912), Table 3.

Conclusion

Significant differences in yields were observed in studied genotypes. A significantly higher yield was recorded in the variety Mina than in remaining varieties. Significant differences for locations were established by the F-test. Significantly higher yields for all varieties observed in the trial were recorded in Nova Pazova. The analysis of stability parameters, *bi* and S^2di , indicate that these varieties were characterised with different stability. Based on the parameter *bi* the most stable variety was Banatska. On the other hand the least stable was the variety Bona, which better responded to more favourable conditions. The variety Mina better responded to unfavourable production conditions. The obtained results indicate that is a need for further studies of the relationship between genotypes and environmental conditions, for the purpose of determining the most favorable region for cultivating chamomile.

References

- Dražić S. (2000). Variability and correlations of yield components, harvest index and yield of chamomile flower heads. *Rostlina vyroba* 46, (2):93-96.
- Dražić S., Živanović T., Prodanović S. (2007): Stability of productive traits of genotypes of cultivated medicinal plants of the family *Apiaceae*. *Biotechnology, Biotechnological, Equipment*, vol.21, 1, 100-106.
- Dražić S. and Dražić M. (2011). Mina-new chamomile cultivar. University of Belgrade, Faculty of Agriculture, V Symposium with international participation, Innovations in Crop and Vegetable Production, Book of Abstracts, pp.95-96.
- Eberhart S. A. and Russel W.A. (1966). Stability parameters for comparing varieties. *Crop Sci.* 6: 36-40.
- Eberhart S. A. and Russel W.A. (1969). Yield and stability for a 10 line of single-cross and double-cross maize hybrids. *Crop Sci.* 9: 357-361.
- Finlay K. W. and Wilkinson G.N. (1963). The analysis of adaptation in a Plant Breeding Programme. *Aust. J. Agric. Res.*, 14: 742-754.
- Freeman G. H. and Perkins J. M. (1971). Environmental and Genotype Environmental Components of Variability. VIII Relatives between Genotypes Grown in Different Environments and Measure of these Environments. *Heredity* 27: 15-23.
- Lamky K. R. and A. R. Hallauer (1984). Comparasion of maize populations improved by recurrent selection. *Maydica* 29: 257-274.
- Oravec V.(1996). Varieties of chamomile produced in Slovakia and concentration of their effective components. Book of Abstracts, Days of Medicinal Plants, Brezovica, Yugoslavia, p.3.
- Perkins J. M. and Jinks J.L. (1968). Environmental and Genotype Environmental Components of variability IV. Non Linear Interactions for Multiple Inbred Lines. *Heredity* 23: 525-530.

- Petrović R. Stojnić O. and Ivanović M. (1988). Maturity group and Yield Potential and Yield Stability in Maize (*Zea mays* L.). *Genetika*, 20/3: 269-279.
- Plaisted R. L. and Peterson L. C. (1959). A technique for Evaluating the ability of Selections to Yield Consistently in Different Locations of Seasons. *Potato Jour.* 36: 381-385.
- Salamon I. (1998). Selected herbs, identification of their natural components and medicinal quality. *Book of Abstracts, Days of Medicinal Plants*, B. Koviljača, Yugoslavia, p.72.
- Yates F. and Cochran W.G.(1938). The analysis or Groups of Experiments. *J. Agric. Sci.* 28: 556-580.
- Živanović T. (1993). The influence of recurrent selection on traits of ZPSinS₄ population maize combining ability. Master's thesis. University of Belgrade, Faculty of Agriculture, Belgrade-Zemun, Serbia.

THE EFFECT OF MINERAL NITROGEN NUTRITION ON THE PRODUCTIVE ELEMENTS OF SPRING MALTING BARLEY EARS

Jasmina KNEŽEVIĆ^{1*}, Desimir KNEŽEVIĆ¹, Miroljub AKSIĆ¹, Nebojša GUDŽIĆ¹, Dalibor TOMIĆ², Dragan TERZIĆ³

¹University of Priština, Faculty of Agriculture, Kopaonička Street nn, 38219, Lešak, Republik of Serbia

²University of Kragujevac, Faculty of Agronomy, Cara Dušana 34, 32000 Čačak, Republik of Serbia

³Institute for Forage Crops, 37251 Globoder, Kruševac, Republik of Serbia

*Corresponding author: jasmina.kneska@gmail.com

Abstract

During the two-year period the studies were carried out on the effect of increasing doses of nitrogen on the productive elements of the ears with different varieties of spring malting barley. The experiment was set on a farm in the vicinity of Krusevac (village Globoder). The experiment involved the following factors: fertilizing with increasing nitrogen application rates N₀, N₆₀, N₈₀, N₁₀₀. On the variants with nitrogen rate also used were 90 kg ha⁻¹ P₂O₅ and K₂O and varieties Kraguj, Dunavac, Uros and Slavko. The experiment was set up in four replications according to a split-plot method with random assignment of treatments. The basic plot size was 5.0 m². The aim of this research was to determine the role of mineral nitrogen nutrition on productive elements of ears with different varieties of spring malting barley depending on the amount of nitrogen. All in order to contribute to increased yield with varieties of spring malting barley based on better understanding of importance of nitrogen in the production process. The obtained results showed that the use of nitrogen had a positive effect on the productive elements of the ears in all variants and in all varieties. By applying increasing doses of nitrogen the maximum weight of grains per ear and the number of grains per spike at the variant of fertilisation with 80 kg ha⁻¹ N were determined. The ear length was achieved at the highest dose of nitrogen of 100 kg ha⁻¹. The different reaction of the tested varieties to the use of mineral fertilizers is the result of their varietal characteristics.

Keywords: *spring malting barley, nitrogen, fertilization, variety, productive characteristics.*

Introduction

The quality of malting barley to a significant degree also depends on the applied agrotechnics. However, of all the agricultural measures, the most significant impact has fertilizing using mineral fertilizers, both from the standpoint of quantity and from the standpoint of ratios of assimilatives. Nitrogen has a special impact on the quality of barley (Knežević, 2005). The optimum amount of nitrogen that is applied in barley nutrition should be uniform (Veigh and Rajkai, 2006; Paunović et al., 2009). In Novi Sad program of malting barley refining the increased number of grains per ear is one of the important ways to increase yield (Pržulj and Momčilović, 1995). After the formation of the number of ears and number of grains per ear during the vegetative phase, the yield becomes largely dependent on grain weight, which is the function of the intensity and duration of grain filling. Grain filling rate represents an average increase of grain weight during the filling period, while grain filling period is the period from flowering to physiological maturity. Physiological maturity represents the moment at the end of the period of grain filling, after which there is no significant increase in dry weight of grains

(Wiegand and Culler, 1981). It is preferable that the malting barley varieties have a low and firm stem with the coefficient of the tillering productivity of 2 to 3. It is known that barley tilts the most of all the right grains and has an average of 4 to 5 stems and the number of stems may vary up to a few tens. Malešević and Starčević (1992) and Paunović et al. (2007a) state that in barley of the sparse structure prolonged tillering is observed, with the coefficient of tillering that can be extended from 4 to 6. By specifying the appropriate sowing density and mineral nutrition plants are enabled to establish the optimal number of ears, which will provide high yield (Paunović et al. 2007b). In addition to the direct effect of nitrogen nutrition on productive characteristics of spring malting barley, nitrogen often acts indirectly through the sinking of plants, which results in a reduction in yield. The aim of this study was to determine the optimum amounts of nitrogen that provide high yield and good quality of productive traits of spring malting barley in agroecological conditions of Krusevac (Serbia).

Material and methods

Preceding crop to barley in the experiment was potato, in the first year, and corn in the second year. The main soil cultivation was carried out during the autumn of last year, at 25 cm depth. Pre-sowing soil preparation was performed directly before sowing. Thereat applied was the standard acrotechnics. The following fertilizers were used: triple superphosphate (45% P₂O₅) and potassium salt (40% K₂O). Of nitrogen fertilizers calcium ammonium nitrate (27%) was applied. The total amount of phosphorus and potassium fertilizers and ½ of nitrogen fertilizer was applied in pre-sowing soil preparation. The rest of the nitrogen fertilizer was used as the top dressing. There were two top dressings (each with half of the remainder of nitrogen fertilizer), first in the tillering stage, and the second in the beginning of plants growing into a stem. In the first year of the trial the sowing was done in the second half of February, manually in rows with 400 germinating seeds/m², while in the second year of the trial the sowing was carried out also manually, in early March in the same seeding density. During the growing season all the changes in crop were tracked and all observations were recorded at the very experimental plot. For the analysis of ear length, number of grains per ear and grain weight in the ear, samples were taken from each plot by plucking the plants. The obtained data were processed using the method of variance analysis and correlation analysis.

Results and discussion

Ear length

The results in the first year of the trial showed that the average maximum ear length had the variety Uroš 11.7 cm, which was also the longest average ear length in the period studied, and the shortest average ear length had variety Kraguj 9.7 cm. Under the influence of fertilization the largest increase in the ear length showed the variety Uroš. Considering the effect of nitrogen on the ear length it was found that there were highly significant differences in the ear length in the first year of testing, between control and fertilization variants with 60, 80 and 100 kg ha⁻¹ (Table 1). The differences in the ear length between increasing doses of nitrogen were very significant.

The results in the second year of the study showed that there was a significant difference in the ear length between the varieties both by years of testing and by the applied dosages of fertilizer. The average maximum ear length had the variety Uroš 9.5 cm, and the average minimum ear length had the variety Kraguj 7.8 cm (Table 2).

A two-year study showed that with increasing nitrogen rate the barley ear length increased. The maximum ear length was in the variety Uroš (10.5 cm), and the minimum in variety Kraguj (8.9 cm), where we can see a clear difference in ear length between the selected varieties of spring

barley tested. Based on these data, we can conclude that the average ear length in the two-year period for the tested varieties was 9.75 cm. The ear length in all tested varieties was significantly dependent on increasing nitrogen rates.

Table 1. The effect of increasing doses of nitrogen on the ear length of spring barley

Fertilizin g variants	Cultivar												Total average
	Kraguj			Dunavac			Uroš			Slavko			
	2007.	2008.	\bar{x}	2007.	2008.	\bar{x}	2007	2008.	\bar{x}	2007	2008	\bar{x}	
0	8.3	7.1	7.7	9.5	7.8	8.7	9.9	8.7	9.3	9.5	8.1	8.8	8.6
N ₁ PK	9.9	7.5	8.7	11.1	8.6	9.9	11.6	9.4	10.5	11.1	8.9	10.0	9.8
N ₂ PK	10.3	8.1	9.2	11.4	8.9	10.2	12.2	9.7	11.0	11.4	9.5	10.5	10.2
N ₃ PK	11.1	8.7	9.9	11.7	9.4	10.6	12.4	10.5	11.5	11.7	9.7	10.7	10.7
\bar{x}	9.9	7.9	8.9	10.9	8.7	9.8	11.5	9.6	10.6	10.9	9.1	10.0	9.8
lsd	(A)	(B)	(AxB)	(C)	(AxC)	(BxC)	(AxBxC)						
0,05	1.06	1.06	2.13	0.80	1.50	1.50	3.01						
0.01	1.41	1.41	2.82	0.90	1.90	1.90	3.99						

A - cultivar; B - rate of fertilizer; C - year of study.

The number of grain per ear

The final number of grains per ear depends on the maximum number of spikelets that are germed in the ear and the percentage of survival of these spikelets. Spikelets develop in the period from developing flowers to awns emergence, and surviving of spikelets is in the period from emergence of primordia awns to flowering, which actually corresponds to the period of tillering (Pržulj et al., 2010). In the first year of the trial the results show that fertilization influences the increase in the number of grains per ear up to increasing nitrogen rates of 80 kg ha⁻¹ and then with increasing doses of nitrogen up to 100 kg ha⁻¹ the number of grains in the ear drops, but only slightly. The varieties statistically differ significantly and the increasing dose of nitrogen has a statistically significant effect. The average number of grains per ear in this year amounted to 33.05 (Table 2).

During the second year of study we conclude that the variety Uroš, which had the highest average number of grains per ear significantly differed from all other varieties. The number of grains per ear in the variety Dunavac was on average higher than in the variety Kraguj and Slavko, and at the level of variety Uroš. Based on the obtained results (Table 2) we note that the average number of grains per ear for all tested varieties and all variants of fertilizing in the two-year study period was 30.93. In Novi Sad malting barley refining programs, the increased number of grains per ear is one of the important ways of increasing yield (Pržulj and Momčilović, 1995). On average for the two-year period the variety Uroš (32.62) had a significantly higher number of grains per ear in relation to all the other, the variety Dunavac higher than the variety Kraguj and Slavko. The number of grain in the ear depends on the nitrogen, conditions in the embryonic period, ear differentiation and flowering. The number of grains per ear, as well as numerous other elements of the ear structure, is the varietal characteristics, but it also depends on other factors, including nitrogen nutrition (Lazović et al., 1997).

The weight of grains in ear

The results in 2013 show that the tested varieties differed statistically significantly and that the increasing dose of nitrogen had a statistically significant effect on grain weight per ear. Also, the

effect of mineral nutrition increased to the increasing nitrogen dose of 80 kg ha⁻¹ and then decreases with increasing nitrogen dose of 100 kg ha⁻¹. In the studies by Pecio and Bichonski (2006) a significant reduction in grain weight with increasing doses of nitrogen was determined. Compared to the control variant the increasing nitrogen dose showed a larger mass of grains per ear. Analyzing the average mass of grain per ear among the tested varieties, we conclude that the variety Uroš had a larger grain weight per ear (1.56 g) compared to all other varieties; the variety Kraguj had a lower grain weight per ear (1.35 g) in relation to other varieties.

Table 2. The effect of increasing doses of nitrogen on the grain number in the ear of malting spring barley

Fertilizing variants	Cultivar												Total average
	Kraguj			Dunavac			Uroš			Slavko			
	2007.	2008.	\bar{x}	2007.	2008.	\bar{x}	2007.	2008.	\bar{x}	2007.	2008.	\bar{x}	
0	27.8	23.8	25.8	29.3	26.1	27.7	31.1	26.3	28.7	28.8	25.5	27.2	27.1
N ₁ PK	31.1	26.3	28.7	32.1	28.5	30.3	34.5	29.3	31.9	31.8	28.3	30.1	30.2
N ₂ PK	34.1	29.1	31.6	35.5	32.3	33.9	38.5	33.1	35.8	37.1	30.8	34.0	33.8
N ₃ PK	33.1	27.5	30.3	35.5	32.1	33.8	36.8	31.8	34.3	32.8	31.1	32.0	32.6
\bar{x}	31.5	26.7	29.1	33.1	29.8	31.4	35.2	30.1	32.7	32.6	28.9	30.8	30.9
lsd	(A)	(B)	(AxB)	(C)	(AxC)	(BxC)	(AxBxC)						
0,05	1.1	1.1		2.1	0.8		1.5			1.5			3.0
0,01	1.4	1.4		2.8	0.9		1.9			1.9			4.0

A - cultivar; B - rate of fertilizer; C - year of study.

In the second year of the study phenotypic differences among the cultivars significantly affect this property, while the influence of fertilization is manifested to a lesser extent. The increase of grain weight at variants of fertilization with increasing nitrogen rate up to 80 kg ha⁻¹ was observed, and then it decreased and the grain weight was the smallest on the variants with the highest nitrogen rate of 100 kg ha⁻¹. Our results are consistent with previous findings (Campbell et al., 1993; Cantero-Martinez et al., 2003; Malecka and Blecharczyk, 2008). The two-year study showed that on average for all varieties and fertilization variants, the mass of grains in ear in the second year of the trial (1.18 g) was significantly lower than in the first year of the trial (1.46 g). When examining the mass of grains per ear in barley during the two-year period, we noticed that there were statistical differences and that there was the statistical significance of the effect of increased doses of nitrogen on this property, including the control. The average weight of grain in the ear for all the tested varieties was 1.33 g (Table 3). Nitrogen topdressing affected the increase in grain weight per ear. Absolute variation in grain weight per ear was 0.92 g (of the variety Kraguj in 2014) to 1.68g (the variety Uroš in 2013). Lalić and Rakočević (1978) point out that analogously to the number of grains per ear, the grain weight per ear behaves according to the same laws. On average weight of grains per ear ranged depending on variant nutrition from 0.82 to 0.96 g. Grain weight per ear was the lowest in the unfertilized plots, and by using NPK and especially by increasing the quantity of the fertilizer, the grain weight per ear increased, and the differences were statistically highly significant.

Table 3. The effect of increasing doses of nitrogen on the grain weight in the ear (g) of malting spring barley

Fertilizing variants	Cultivar												Total average
	Kraguj			Dunavac			Uroš			Slavko			
	2007.	2008.	\bar{x}	2007.	2008.	\bar{x}	2007	2008.	\bar{x}	2007	2008.	\bar{x}	
0	1.1	0.9	1.0	1.2	1.1	1.2	1.3	1.1	1.2	1.3	1.1	1.2	1.1
N ₁ PK	1.3	1.1	1.2	1.4	1.2	1.3	1.6	1.2	1.4	1.5	1.2	1.4	1.3
N ₂ PK	1.5	1.2	1.4	1.6	1.3	1.5	1.7	1.4	1.6	1.7	1.3	1.5	1.5
N ₃ PK	1.4	1.2	1.3	1.6	1.2	1.4	1.6	1.3	1.5	1.5	1.3	1.4	1.4
\bar{x}	1.3	1.1	1.2	1.5	1.2	1.3	1.6	1.3	1.4	1.5	1.2	1.4	1.3
lsd	(A)	(B)	(AxB)		(C)	(AxC)		(BxC)		(AxBxC)			
0,05	0.04	0.04	0.08		0.03	0.06		0.06		0.12			
0,01	0.05	0.05	0.11		0.04	0.08		0.08		0.16			

A - cultivar; B - rate of fertilizer; C - year of study.

Conclusion

The results show that the use of nitrogen had a positive effect on the productive elements of the spring malting barley ears in all variants of fertilization and in all varieties. By applying increasing doses of nitrogen the maximum weight of grains per ear and number of grains per ear at nitrogen rate of 80 kg ha⁻¹ were determined. The maximum ear length was achieved using the highest nitrogen rate of 100 kg ha⁻¹. The different reaction of tested varieties to the use of mineral fertilizers is the result of their varietal characteristics.

Acknowledgement

The work is part of the research project TR-31092, funded by the Ministry of Science and Technological Development of the Republic of Serbia.

References

- Campbell, C., Selles, F., Zentner, R., McConkey, B. (1993): Available water and nitrogen effects on yield components and grain nitrogen of zero-till spring wheat. *Agronomy Journal*, 85: 114-120.
- Cantero-Martinez, C., Angas, P., Lampurlanes, J. (2003): Growth, yield and water productivity of barley (*Hordeum vulgare* L.) affected by tillage and N fertilization in Mediterranean semiarid, rainfed conditions of Spain. *Field Crops Research*, 84:341-357.
- Knežević, J. (2005): Efekat mineralne ishrane azotom na komponente prinosa i tehnološke osobine zrna jarog pivskog ječma. Magistarska teza. Univerzitet u Prištini, Kosovska Mitrovica.
- Lalić, R., Rakočević, Č. (1978): Uticaj različitih doza i odnos NPK đubriva na prinos ječma na smonici Kosova, *Agrohemija*, No 3-4, Beograd.
- Malecka, I., Blecharczyk, A. (2008): Effect of tillage systems, mulches and nitrogen fertilization on spring barley (*Hordeum vulgare*). *Agronomy Research*, 6(2):517-529.
- Malešević, M., Starčević, Lj. (1992): Proizvodnja pivarskog ječma. U: Lazić, V. (Ed.). *Pivski ječam i slad*. Monografija, Sladara Maltinex, Čelarevo, pp. 14-52.

- Paunović, A., Madić, M., Knežević, J., Knežević, D., Bokan, N. (2007a): Osobine kvaliteta pivskog ječma. XII Savetovanje o biotehnologiji - Zbornik radova. Univerzitet u Kragujevcu, Agronomski fakultet Čačak, pp. 237-242.
- Paunović, A., Madić M., Knežević, D., Bokan, N. (2007b): Sowing density and nitrogen fertilisation influences on yield components of barley. *Cereal Research Communications*, 35(2):901-904.
- Pecio, A., Bichoński, A. (2006): Response of some cultivars of brewing barley on varied nitrogen fertilization. *Pamiętnik-Pulawski*, 142:333-348.
- Pržulj, N., Momčilović, V. (1995): Oplemenjivanje pivskog ječma. *Pivarstvo*, 28(3-4):161-163.
- Pržulj, N., Momčilović, V., Nožinić, M., Jestrović Z., Pavlović, M., Orbović, B. (2010): Importance and breeding of barley and oats. *Field and Vegetable Crops Research*, 47(1):33-42.
- Veigh, K.R., Rajkai, K. (2006): Root growth and nitrogen use efficiency of spring barley in drying soil. *Cereal Research Communications*, 34(1):267-270.
- Wiegand, C. L., Culler, J. A. (1981): Duration of grain filling and kernel weight of wheat as affected by temperature, *Crop Sci.* 21: 95-101.

CHANGES IN PROTEIN CONTENT IN DIFFERENT PLANT PARTS OF PEA DURING VARIOUS GROWTH STAGES

Hatice SARI^{1*}, Ali GÜLÜMSER²

¹University of Akdeniz Faculty of Agriculture Field Crops Department, Antalya, Turkey

²University of Ondokuz Mayıs Faculty of Agriculture Field Crops Department, Samsun, Turkey

*Corresponding author: htchte116@gmail.com

Abstract

Adequate and balanced nutrition is important key for a healthy life. Needs for food and protein increase due to drastic increases in the world population and decreased resources. The world protein needs are supplied from plant sources, about 70%. Peas (*Pisum sativum* L.) are one of the important sources of protein. This study was conducted to evaluate changing of crude protein contents in different part of pea during various growth stages at the experimental area of Faculty of Agriculture, Ondokuz Mayıs University, Samsun (Turkey). We monitor crude protein contents at vegetative stage, 50% flowering stage, full bloom stage, seed filling stage and at seed maturity period in different parts of the plants such as leaves, stem, flowers, and in matured seeds. Crude protein contents of different plant parts showed **broad range of variation due to growth stages**. Crude protein contents of leaves, stem flowers and seeds were ranged between 8.78-24.72%, 3.27-11.13%, 38.97-40.80% and 21.99-25.76%, respectively. In conclusion, the highest crude protein contents were found in flowers, According to study results, overall protein content has gradually decreased with the growing stages. Leaves had the largest range for crude protein content among the plant parts. Also different parts are harvested according to their usage during the production, and consumption regarding appropriate development can be determined.

Key Words: *Crude protein, Pea, Growth stages*

Introduction

Legumes are cultivated throughout the world. Species are used that are adapted to climates ranging from temperate to tropical, humid to arid. Edible legumes, with the high amount and quality vegetable protein source thereof, differ from other groups of plants. Edible legumes are quite rich in B vitamins and contain a large amount of dietary fiber (18% in peas, lentils and chickpeas, and 28% in beans) (Pekşen and Artık, 2005). Legumes are rich sources of protein and the essential amino acid. The proteins contained in legumes are similar to proteins of animal origin in terms of essential amino acids (leucine, isoleucine, lycine, methionine, threonine, tryptophane, valine) (Çiftçi, 2004). Provision of adequate proteins of animal origin is difficult and expensive. An alternative for improving nutritional status of the people is to supplement the diet with plant proteins. Attention, therefore, has to be directed to the nutritional evaluation of proteins from plant species. Legumes (poor man's meat) play an important role in human nutrition since they are rich sources of protein, calories, certain minerals and vitamins (Deshpande, 1992). Adequate and balanced nutrition are essential for people in order that they can continue their lives in a healthy way. There is a big problem of insufficient and unbalanced nutrition in addition to the hunger problem in the world. Production has to be increased to reduce the number of malnourished population while production of vegetable and animal proteins with high protein content has also to be increased in order to reduce the number of populations having

unbalanced nutrition. This study aims to detect the protein changes at different developmental periods of peas and determine the most appropriate parts and development period of the plant.

Material and Methods

Soil samples received from trial fields of the Faculty of Agriculture, Ondokuz Mayıs University (Turkey), from a depth of 0-20 cm to determine physical and chemical properties thereof showed that the soil had an argillaceous structure, its salt content was in medium level (0.359 %), slightly acidic (pH: 5.88) and less calcareous (0.38 %). Phosphorus and potassium contents and organic substance of the soil of the trial field were determined as 4 kg/ha, 45 kg/da and 2.88 %, respectively. Samsun province located in the coastal region of Central Black Sea is mild and rainy in winters and hot and humid in summer seasons. The temperature and precipitation value of the year (2013), in which the experiment was conducted, is provided in Table 1.

Table 1. Temperature and rainfall monthly

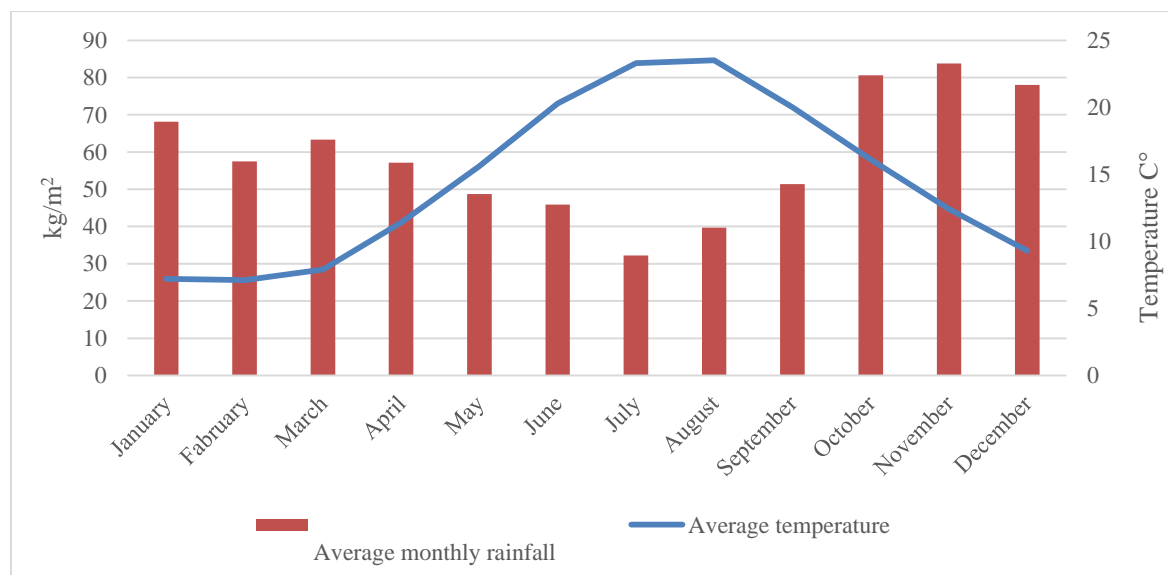

Rondo, which is registered pea (*Pisum sativum* L.) variety obtained from the Field Crops Central Research Institute, was cultivated as genetic material in this study. It has large adaptation and so can be grown almost anywhere in Turkey. It also has strong development and its pods are big and suitable for fresh consumption with high yield. The study was conducted in randomized plot experimental design in 2013. The design had 4 parcels contained 12 rows in each parcel. Inter-row and intra-row spacing were 40 cm and 10 cm, respectively. Plants were harvested in 5 different development periods as vegetative period (I), 50 % flowering period (II), full blooming period(III), grain filling period (IV) and maturity period (V). 40 individual plants were harvested for each period. Harvested plant samples were firstly dried and then these samples were grinded for analysis of crude protein. Amount of crude protein was measured in grinded samples. Crude protein content was determined by Dumas method. Principle of Dumas Method is measurement of nitrogen which passes to gas phase after combustion. The samples were flared with pure oxygen by combusting in 800 to 950°C. The residual gases as a result of combustion are kept in the filters and then eliminated and when oxygen is removed on hot copper, NO_x is converted into N₂. In this way, quantitative analysis is performed by measuring nitrogen in

helium with thermal conductivity. Protein amount of the samples was determined by multiplying obtained nitrogen amount with protein conversion factor (6.25).

Results and Discussion

While protein contents of leaves and stem were analyzed in vegetative period (I) sampling, protein contents of leaves, flowers and the stem were determined in 50 % flowering period (II) and full blooming period (III). During the grain filling period (IV), protein content of the grains were also determined in addition to leaves, stem and flowers. Finally, protein contents of all plant parts were determined in maturity period (V). The results of protein contents were given in Figure 1., Figure 2. and Figure 3.

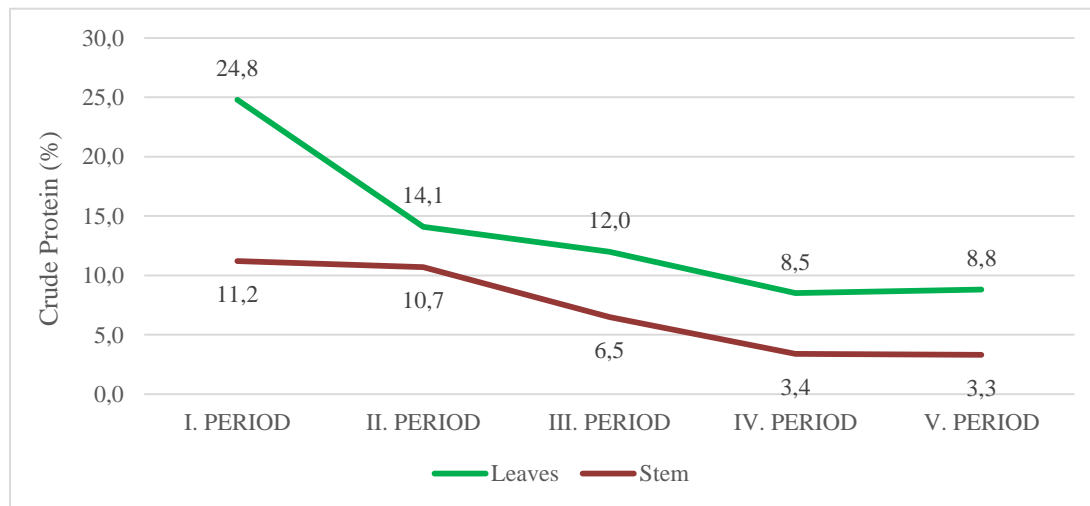

Figure 1. According to different development periods in the leaves and stem of peas (*Pisum sativum* L.) crude protein (%)

Crude protein ratio shows decrease from vegetative period (24.8 %) to maturity period (8.8 %) (Figure 1.). These results also show similarity with the results of protein ratio of the stem. While crude protein ratio was found as 11.2 % in vegetative period, this ratio was 3.3 % in maturity period (Figure 1.). This decrease in protein content among periods is caused by transferring protein from leaves and stem to flowers and grains.

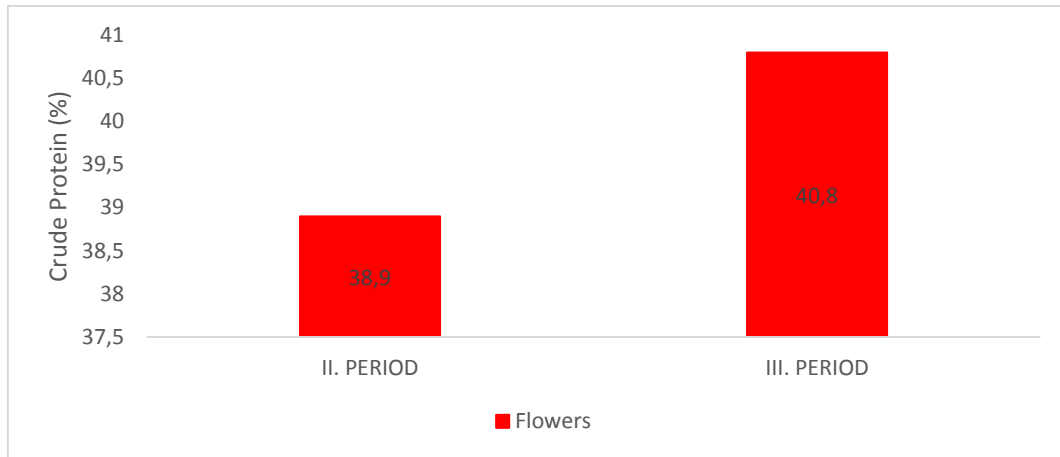

Figure 2. According to different development periods in flowers of peas (*Pisum sativum* L.) crude protein (%)

When we examine Figure 3.2 we see that the pea flowers contain high protein. Crude protein ratio of 50% at blooming period (II) was found to be 38.9%, while it was found to be 40.8%. at fullblooming period (III)

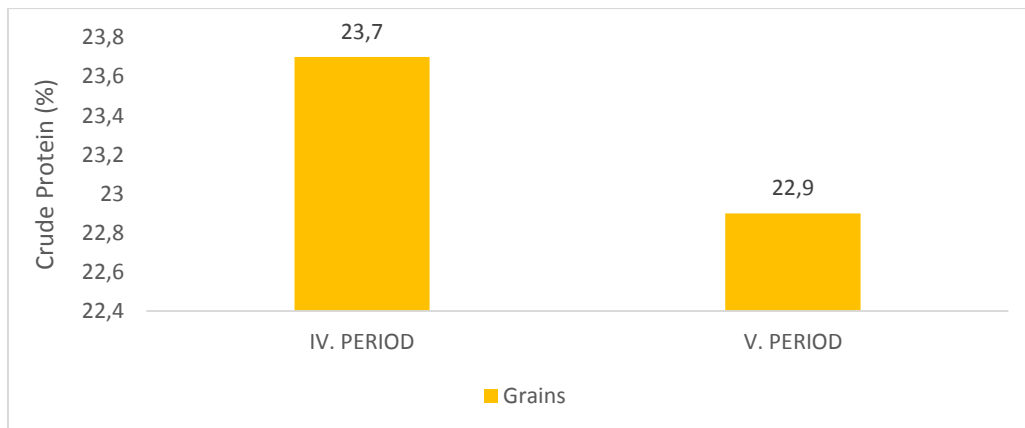

Figure 3. According to different development periods in grains of peas (*Pisum sativum* L.) crude protein (%)

When we examine Figure 3.3 we see that the crude protein in the grains harvested in development periods IV and V was determined as 23.7% and 22.9% respectively considering their development periods. Crude protein content in plants is reduced in the development periods depending on the development of plant growth periods.

Gülümser (1981) has investigated effects of nitrogen fertilization and irrigation on yield and yield components and the protein ratio of the grain on Valor and WR-195 type of peas in ecological conditions of Erzurum. The researcher has been reported that crude protein contents of the grain vary between 32.92% and 28.75% by making some applications on seed varieties. Gülümser et al. (1994), in the study they have carried out to determine the effect of different seeding time of peas on grain yield in ecological conditions of Samsun have found that, protein ratio of different

types seeded in winter vary between 19.75% and 24.01%. Results obtained from the research Gülümser et al. is in parallel with the results of this study.

Pekşen et al., (2002), in the study they have carried out to determine the effect of different inter row spacings on fresh grain yield of pea varieties (Carina, Sprinter and Utrillo) and some other features in conditions of Samsun (20, 30 and 40 cm) they have found the grain protein content as 27.24%, 26.40% and 28.10% at 20, 30 and 40 cm inter row spacings respectively, Protein contents determined in Pekşen's work is seen higher than the ones detected this study. Karayel (2012) has reported in the study he has carried out for identification of local pea genotypes and some agronomic characteristics thereof that protein content of genotypes ranged between 16.3 to 23.6% as a result of the examinations carried thereby.

Seyis (1994), has found in the study he has carried out to determine seed yield of pea varieties and some major features planted in summer in ecological conditions of Samsun that the crude protein content in grain is between 18.72% and 24.37%. The results of the studies are found to be close to the reported results. Ceyhan and Önder (1999) have studied the effects of different seeding times and edible pea varieties on yield and yield quality. Protein content was determined as 22.80% considering the average of different seeding times and edible pea varieties.

Cousin et al., (1985) have reported that dry pea seeds contain 23-33% protein in the study conducted thereby. Grain protein content obtained in studies conducted on peas is consistent with the study results. In studies conducted in regions with different climatic conditions on different genotypes it was reported that content of crude protein in feed peas ranged between 16.9% and 26.3 (Kearl et al., 1979; Açıkgöz and Çelik, 1986; Tekeli and Ateş, 2007; Uzun and Aşık, 2009). Manga et al., (1995) have reported as a result of the study they have made on feed peas that the grains contain crude protein of 20-30%. Soya et al. (1989) have researched the effects of different seeding time and the distance of inter row spacing on grain yield and certain features of the feed peas. In the application made in the studies crude protein content of the grain was 24.22% and 24.05%. in 40 cm and 60 cm inter row spacing respectively. The results of studies on protein content in feed peas are similar to the content of protein content of the edible peas investigated in this study.

Conclusions

Crude protein content of the leaves of peas grown in the study conducted was 34,720%, 14,139 %, 11,996 % 8,496% and 8,776% in Period I, Period II, Period III, Period IV, Period V respectively while crude protein values of the stem, as a result of analyzes performed, was found to be % 11.125 - 10.629 - 6.452 - 3.393 - 3.274 during the same growth periods. The crude protein content found in flower was 38.965% during 50% blooming period and 40,798% during fullblooming period. As a result of the examination on grains crude protein content was found as 23,685% in Period IV and 22,978% in Period V.

The highest crude protein content was found as 40.8% in fullblooming period. When outcomes obtained from this study is observed a decrease in general was found in crude protein content of the leaves stems and grains as the growth period continued. Crude protein content of different organs of peas grown in ecological conditions of Samsun in different development periods was determined. Although it varies according to the purpose of usage ,plant selection can be done in terms of crude protein content. Soil structure can be developed by growing in soils which are not rich in organic substances by mixing stems and leaves with high protein content remaining after harvest with soil. If it is desired to consume higher amounts of protein; it is in harvested grain filling period (filling seeds) and made ready for consumption as tins. Production and

consumption of edible legumes which are similar to and cheaper than animal protein sources can be increased in order to eliminate the protein deficiency of developing countries by harvesting different organs during appropriate development periods in line with their usage purpose. The stem and pods of edible legumes remaining from the harvest and post-harvest can be used in animal nutrition since they contain high protein.

References

- Açıkgoz, E. and N. Çelik. 1986. Preliminary investigations on the quality and hay yield of some important annual legume in Bursa arid conditions. The Journal of Agricultural Faculty of Uludag University. Vol. (5), pp. 47-53.
- Ceyhan, E. and Önder, M., 1999. Effects on yield and quality in different types of edible peas (*Pisum sativum* L) sowing time in Konya ecological conditions, III. Congress of field crops, Forage crops and grain legumes, Adana, Turkey, pp. 377-382.
- Cousin, R., Messenger, A., ve Vingere, A., 1985. Breeding for yield in combining peas, in the Pea Crop, Butterworths London, pp. 115-129.
- Çiftçi, C. Y., 2004. Agriculture Grain Legumes in the world and Turkey, UCTEA chamber of agricultural engineers technical publications sequence, Vol. 5, 197 p.
- Gülümser, A., 1981. The effect on grain protein and yield components ratio of nitrogen fertilization and irrigation in peas (*Pisum sativum* L.), Associate Professor thesis, Atatürk University Faculty of Agriculture, Erzurum, Turkey, 103 p.
- Gülümser, A., Seyis, F. and Bozoğlu, H., 1994. Determination of grain yield with canned properties of pea varieties spring and winter sown in Samsun ecological conditions, EU Faculty of Agriculture Crops field department TÜBİTAK and ÜSİGEM, Field Crops Congress, İzmir, Turkey, Vol.1, pp. 87-90.
- Karayel, R., 2012. Determination of some physicochemical components of pea genotypes sown in Samsun and evaluation of their suitability for breeding, Phd Thesis, Ondokuz Mayıs University Institute of Science, Samsun, Turkey, 83 p.
- Kearl, L.C., L.E. Harris, H. Lyord, M. Farrid and M. Wardeh. 1979. Arab and Middleeast tables of feed composition Utah State Univ. Agr. Exp. Res. Rep. 30 p.
- Manga, İ., Acar, Z. and Ayan, İ., 1995. Legume crops, Ondokuz Mayıs University publications lecture notes, Samsun, Turkey, Vol.7, 342 p.
- Pekşen, E., and Artık, C., 2005. Antinutritional factors and nutritive values of food grain legumes. The Journal of Agricultural Faculty of Ondokuz Mayıs University, 20(2):111-121.
- Pekşen, E., Bozoğlu, H., Pekşen, A. and Gülümser A., 2002. Determination of the effects of different row spacings on yield and some other properties of pea (*Pisum sativum* L.) cultivars sown in spring and autumn, 2nd Balkan Symposium on Vegetables and Potatoes, Thessaloniki, Hellas, 11-15 October 2000.
- Sarı, H., 2015. Determine crude protein contents in different parts of some food grain legumes during various growth stages, Master's thesis, Ondokuz Mayıs University Institute of Science, Samsun, Turkey, 92 p.
- Seyis, F., 1994. Grain yield with some important features and a study on the relationship between them of pea varieties planted as spring in Samsun ecological conditions, Master's thesis, Ondokuz Mayıs University Institute of Science, Samsun, Turkey, 75.
- Soya, H., Tosun, M. and Çelen A. E., 1989. The effect on some yield components and grain yield in forage pea (*Pisum arvense* L.) of row spacing and time of planting, Journal of Agriculture Faculty of Ege University, Vol. 26:2, pp. 207-219.

- S.S. Deshpande., Food legumes in human nutrition: a personal perspective. *Reviews in Food Science and Nutrition*, 32 (1992), pp. 333–363.
- Tekeli, A.S. and E. Ateş. 2007. The effects of tetany rate with forage yields and quality on mixture forage peas (*Pisum arvense* L.) – wheat (*Triticum aestivum* L.) of different reaping periods, Turkey VII. Field Crops Congress, Erzurum, pp. 106-109.
- Uzun, A. and F. F. Aşık. 2009. The effects on quality and forage yield of reaping periods and different mixture ratios in peas + oat mix, Turkey VIII. Field Crops Congress, Hatay, pp. 584-588.

HERITABILITY OF YIELD AND YIELD COMPONENTS OF ZAER LENTIL LANDRACE

Nadia BENBRAHIM*, Fatima GABOUN, Mona TAGHOUTI

National Institute of Agricultural Research (INRA), Morocco

*Corresponding author: nadiabenbrahim@gmail.com

Abstract

Lentil (*Lens culinaris* Medik.) is one of the most important food legumes grown in Morocco under rainfall conditions. Zaer is the second lentil production region which is characterized by annual rainfall variability with a high incident of drought and heat mainly during flowering and pod filling season. Lentil is produced from both a landrace and L56 variety on farm conserved. They are distinguishing according to some agro-phenotypic characters. The landrace is threatened by both climate change and L56 variety. Thus, the aim of this study is to evaluate landrace yield variability and to estimate the contribution of ten agronomic traits related to yield for 24 accessions of the landrace. The analysis of recorded agronomic data of both 230 lines collected from farmers' field and 108 lines regenerated in experimental field, showed a high significant effect of genotype, year and genotype x year interaction on yield and yield components. In addition, the path analysis multiple regression methods provide us with the effective components of yield determination. Indeed, the result revealed that plant height, number of pods per peduncle, number of pods per plant, number of seeds per plant and thousands seed weight are the most effective components of the yield which account 50% of yield variation. Number of pods per plant (13%) and thousands seed weight (24%) are among the major components of yield according to their contribution to yield variability. Moreover, their broad sense heritability was high with 0.67 and 0.92 respectively. This information is useful to improve landrace yielding.

Keywords: *Lentil, landrace, yield components, path analysis, heritability*

Introduction

Lentil (*Lens culinaris* Medik.) as a legume plays a significant role in supporting sustainable agriculture worldwide. Legumes provide numerous ecosystem services in soil fertility and functionality and body requirements of dietary protein and essential minerals. Moreover, legumes are also valuable as fodder for livestock, and play an important role in pulse-based cropping systems within the improvement of soil fertility especially nitrogen availability, the enhancement of organic carbon in the soil because of the input of high quality biomass. Thus improve soil structure and increase efficiency of water and storage of nutrients in the soil. The biological nitrogen fixation can supply 50-80% of nitrogen uptake by legumes (Rattan Lal, 2016). The residual of fixed nitrogen contribute to the following cereal crop. In Morocco, lentils are mainly produced by small farmers in rainfall traditional agro-system with low input from landraces (98%). Lentils contribute to food security of vulnerable people and farmers' incomes depending on growing season climate. Landraces are often preferred because of their specific and dynamic adaptation to environment adversity; add to their high food quality (Frankel et al., 1970, Altieri et al., 1987; Almekinders et al., 1994). However, at Zaer region which provides 28% of national lentil production, the increase of drought incidence at the end of growing season led farmer's to

adopt in addition of their landrace an improved variety for its earliness. The landrace is identified by its seed diversity, agronomic potential, nutritional and tasty quality. Farmers identify their landrace as a genetic and a cultural heritage.

The main objective of this study is to strengthen the on-farm conservation of the local base genetic diversity which is threatened by both climate change and the improved variety. This could be achieved through improving yield in Zaer environment constraints. In this context, current study undertakes the evaluation of yield potential and the yield components contribution to yield for 24 accessions of Zaer landrace collected from three locations. Moreover, Path analysis of yield components and the estimation of broad-sense heritability are useful for identifying the main agronomic selected criteria of promising lines within the meta-population of the landrace towards improving seed yield and yield stability.

Materials and Methods

The current study was carried on lentil landrace of Zaer. 230 lines of the landrace have been collected during 2012/13 from 24 farmers' field across three locations of Zaer region according to the standards referenced in the practice guide of Marchal et al. (1994). Fields were randomly selected. At field level, fifteen plants were randomly collected at physiological seed maturity stage along field diagonal at regular intervals. After harvest, a sample of seeds were collected from correspondents' farmers to be sown during the next growing season (2013/14) at the experimental field station of the National Institute of Agronomic Research at Marchouch (6.71°W, 33.60°N, 410 m altitude). The trial was set in randomized complete blocks design with three replications. Each experimental plot consisted of four rows of 2m long spaced from 30 cm (2.4 m²). Fertilizers were applied during seed bed preparation at the rate of 30 kg P₂O₅, 15 kg K₂O and 15 kg N/ha.

The days to flowering, days to maturity and seed yield were recorded on a whole plot. The agro-morphological traits related to yield components such as plant height, primary and secondary branches, number of vegetative and fertile knots, number of pods/peduncle, number of pods/plant, number of fertile pods/plant, number of seed/pod, number of seed/plant, and thousand seeds weight were recorded from a random sample of ten plants in each experimental plot.

Data analysis of variance with Duncan's multiple comparison tests was used for the determination of the means of accessions over years and by sites was determined for all characters. Variance components were estimated from expected mean squares of genotype variance, genotype x year variance, and phenotype variance. The value of broad-sense heritability of the quantitative characters was estimated by the ratio of genotypic variance to phenotypic variance (σ^2_g / σ^2_p). The Path coefficient analysis was conducted to determine direct and indirect contribution of various yield components to seed yield using forward selection analysis.

Results and Discussion

Variance analysis over two growing season for all agro-morphologic characters indicated that year, genotype and genotype x year were highly significant. The effect of year was larger for almost all recorded characters (Table 1). Yield components vary across years according to climate (Figures 1-2) and across locations (Figures 3) related to the accession diversity size in accordance with Muehlbauer et al. study (1985). Variability within the landrace was greatest for number of secondary branches (57.5%), number of fertile knots (61.6%), number of pods per plant (58.8%), number of fertile pods per plant (66.9%) and number of seeds per plant (65.2%). This result suggests that there is a large possibility for yield improvement through selection of

productive lines. Maximum of inter-annual variability was recorded for number of secondary branches (58.3%), number of vegetative knots (51.6%), number of fertile knots (42.7%), number of pods per plant (46.2%), number of fertile pods per plant (49.4%) and number of seeds per plant (50.0%) (Figure 1, Table 1). The coefficients of genotypic inter-annual variation exhibit the environment effect on yield formation from many components contribution. The estimation of broad sense heritability of yield components might be useful for selecting the most determining traits of grain yield towards improving and stabilizing yield in changing climate (Ortiz et al., 2000).

Table 1: Variance analysis and mean squares for the main investigated agro-morphological traits of lentil landrace accessions

Sources of variation	D.F	Plant height	R2	NDF	Pods/Peduncle	Seeds /pods	Pods /plant	Filled pods/plant	Seeds /plant	1000 seed weight
Year	1	2417.5***	2104.7***	26152.5***	11.34***	9.69***	5513.1*	292.3 ^{ns}	1881.5 ^{ns}	21.4***
Genotype	23	78.2***	46.8***	4457.1***	0.297 ^{ns}	0.84***	8900.0***	7962.8***	13225.7***	10.67***
Gen. x Year	23	129.7***	56.04***	5574.7***	0.697***	0.41***	10849.9***	9323.6***	14785.8***	4.473***
Error	336	10.34	21.23	557.9	0.213	0.145	1069.9	879.2	1278.2	0.970
CV%		9.93	58.3	42.7	18.6	29.8	46.2	49.4	50.0	2.66
Mean		32.4	7.90	55.3	2.49	1.28	70.8	60.0	71.5	36.99
Range		21-49	0-35	9-225	1-3	1-3	12-270	9-259	11-350	33.3-40.5
LSD ($\alpha=0.05$)		0.645	0.925	4.742	0.093	0.08	6.567	5.953	7.177	0.198

Significant at 0.05 (*), 0.01 (**), and at 0.001 (***) probability level respectively

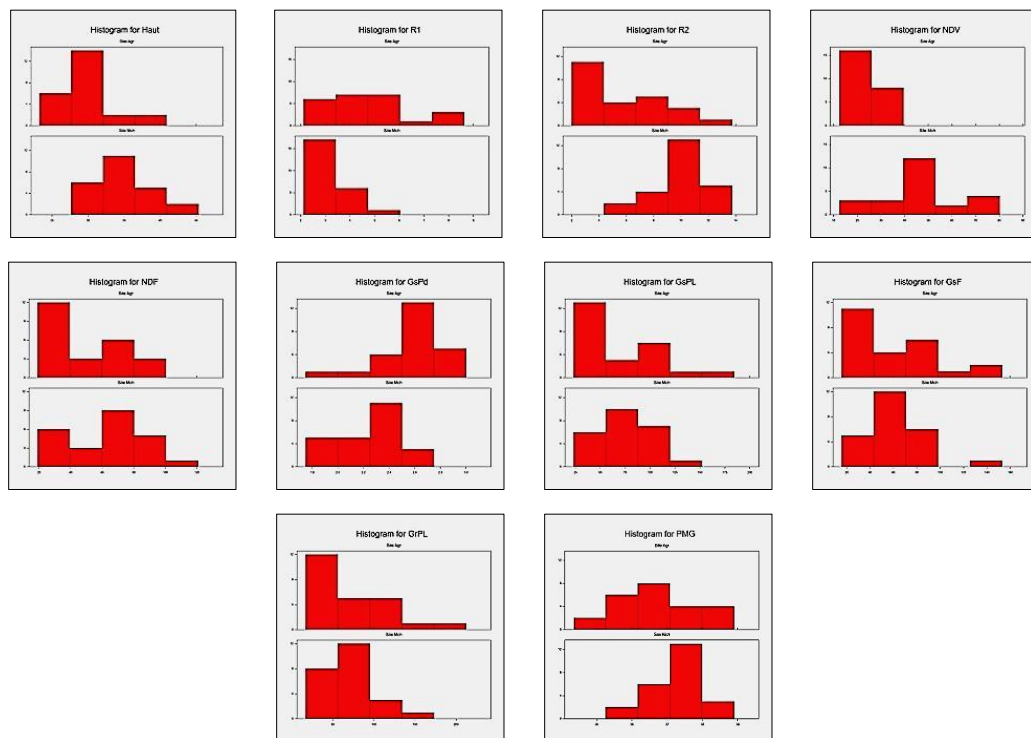

Figures 1: Inter-annual variation on yield components of Zaer landrace

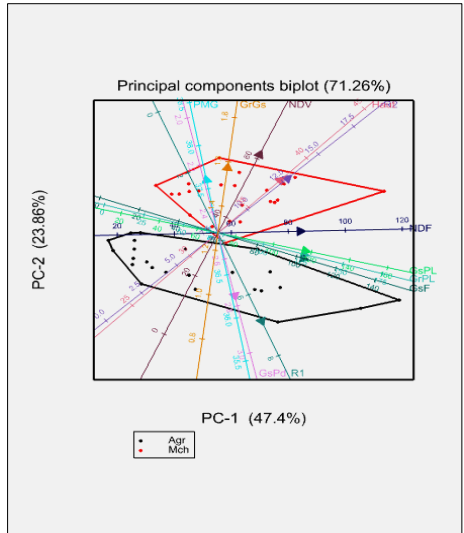
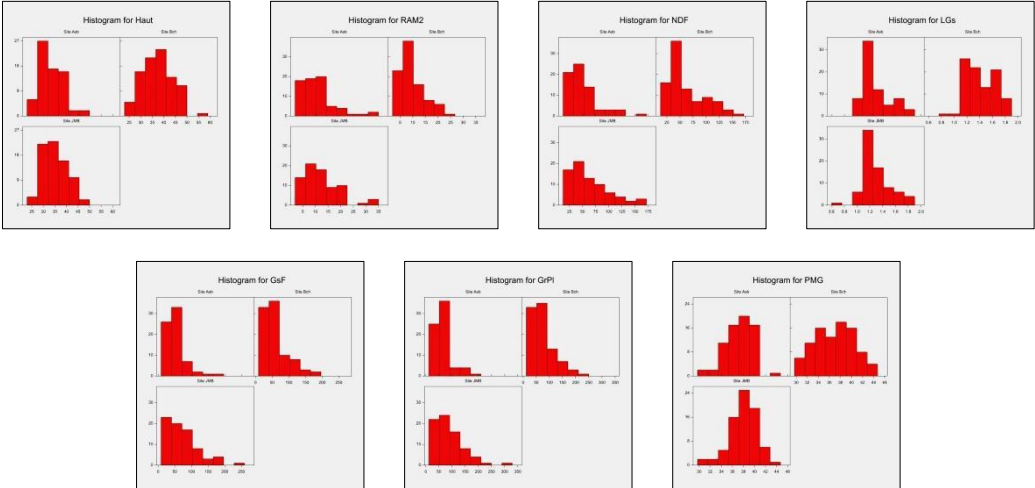

Figure 2: Effect of climate and agriculture practices on yield components



Figures 3: Inter-locations variation on mean yield components of Zaer landrace

Plant height varied from 21.0 to 49.0 cm (Table 1). This characteristic exhibited moderate heritability (0.42) reported also by Dixit et al. (1985) and Chauhan et al. (1998). First branches, and vegetative knots had also moderate heritability with respectively (0.40) and (0.39) (Table 2). The principal component analysis showed that the effect of environment such as agriculture practices and climate from first to second year, on the most of agronomic characters seemed high (Figure 2). The correlation between plant height and seed yield was negative and no significant (-0.141^{ns}). The direct effect of this character on seed yield was small and no significant (0.044^{ns}) according to path analysis of forwards selection. However, plant height has an indirect effect on seeds yield through the number of fertile knots (0.624^{***}), number of pods (0.581^{***}) and seeds per plant (0.565^{***}) which are positively and highly correlated. Number of fertile knots (0.64), number of pods per plant (0.67) and number of seeds per plant (0.66) had high value of broad sense heritability indicating that a great genetic gain could be achieved for these traits by using Zaer landrace in lentil breeding programs. The difference between number of fertile pods heritability (0.62) and total number of pods per plant heritability (0.67) is related to climate effect on yield formation. The rainfall condition had also a significant effect on secondary branches and number of pods per peduncle that had low estimates broad sense heritability (0.28 and 0.37 respectively). Sharma, (2011) had reported that pods per peduncle is highly influenced by environment conditions.

Table 2: Variance components estimated from expected mean squares and broad sense heritability

Sources of variation	Plant height	R1	R2	NDV	NDF	Pods/ Peduncle	Seeds /pods	Pods /plant	Filled pods /plant	Seeds /plant	1000 seed weight
Genotype	8.265	0.844	2.927	105.732	415.753	0.026	0.047	765.884	628.031	1089.2	0.805
Gen. x Year	11.265	1.248	7.411	162.043	232.306	0.044	0.043	379.689	376.307	551.724	0.066
Error	10.34	2.03	21.23	318.90	557.96	0.213	0.145	1070.0	879.2	1278.2	0.970
Phenotype	19.530	2.092	10.337	267.776	648.059	0.071	0.090	1145.57	1004.339	1640.92	0.872
Heritability	0.423	0.403	0.283	0.395	0.641	0.371	0.526	0.668	0.625	0.664	0.923

Seed weight varied from 33.3 to 40.5 g/1000 seeds (Table 1). The variability of seeds weight over year was lower (2.66%) and the broad sense heritability value was the highest with (0.92) compared to others yield components (Table 2). That's suggested that seeds weight character was not affected by the growing environment. High heritability of seed weight was also reported by Rajput et al. (1989), and Chauhan and Singh (1998). Sharma, (2011) investigation showed that seed weight is under polygenic control and the alleles for low seed weight have partially dominant effects.

Seed weight was positively and significantly correlated to earliness (0.583^{***}) and pods length (0.159^{*}). While it was negatively and significantly correlated with almost yield components such as plant height (-0.481^{***}), primary branches (-0.243^{**}), secondary branches (-0.172^{*}), number of fertile knots (-0.332^{***}), number of pods per peduncle (-0.457^{***}), pods per plant (-0.319^{***}), fertile pods per plant (-0.292^{***}) and seeds per plant (-0.278^{***}).

Days to 10% flowering of accessions varied between 91 and 96 days (Table 3). Flowering initiation is under control of a single recessive gene "sn" (Sarker et al., 1999). Chauhan et al. (1998) reported low broad sense heritability for day to flowering, where Muehlbauer et al., (1995) reported moderate a large heritability and Biçer et al. (2004), Biçer et al. (2008) and Biçer et al. (2010) reported high heritability for days to flowering respectively (0.82), (0.94) and (0.71). The earliness was positively correlated with plant height (0.375^{*}), number of pods per peduncle (0.300^{*}), number of pods per plant (0.323^{*}) and number of seeds per plant (0.323^{*}) and negatively

and highly correlated with 1000 seed weight (-0.583^{***}) and with yield (-0.054^{ns}). Days to maturity varied between 152 – 160 days. Broad sense heritability value was high for days to maturity (0.80) according to Bicer et al. (2010) and Chauhan et al. (1998) studies. Days of maturity was negatively and highly correlated with 1000 seed weight (-0.410^{***}). The mean of seed yield varied from 8.9 to 19.4 quintal/ha with large effect of the environment (Table 3). Muelbauer et al. (1995), Bicer et al. (2004) had reported high variability and low heritability of seed yield per plant (0.26) and Bicer et al. (2004) had reported moderate heritability for grains yield (0.41). Seed yield is negatively and significantly correlated to primary branches (-0.299^{*}), number of fertile knots (-0.398^{**}) and number of pods per plant (-0.345^{*}). Correlation coefficients implied that number of primary branches, number of fertile knots and number of pod/plant could be considered as the mean selected traits for yield improvement.

Table 3: Analysis of variance of some agronomic characters on landrace accessions at Marchouch

Sources of variation	Days to 10% flowering	Days to maturity	1000 seed weight	Seeds yield
Genotype	3.37 ^{ns}	9.04 ^{ns}	2.31 ^{ns}	16.8 ^{ns}
Error	2.26	3.41	7.84	27.9
Means	93.96	156.1	37.66	17.08
CV%	1.60	1.18	7.44	29.01
Range	91-96	152-160	31.9-43.2	8.9-19.4
LDS	1.46	1.79	2.72	5.14

Significant at 0.05 (), 0.01 (**) and at 0.001 (***) probability level respectively*

The variation in yielding ability of the landrace under two different growing year condition, leads us to evaluate the relationship of seed yield with divers yield components. The path analysis multiple regression Forward selection methods may provide us with the effective components of yield determination to be used as selection criteria for landrace genetic improvement of yield (Yadav et al., 2003; Karadavut, 2009).

The result revealed that plant height, number of pods per peduncle, number of pods per plant, number of seeds per plant and thousands seed weight are the most effective components of the yield which account 50% of yield variation. Number of pods per plant and thousands seed weight are among the major components of yield with significant and direct effect on the yield according to their contribution to yield variability with 13% and 24% respectively (Table 4). Dixit et al. (2005) study showed that number of pods per plant, weight of 100 seeds and number of seeds per pods had the most positive and direct effect on yield which was reported also by Barghi et al. (2012). Muehlbauer (1974) have reported that the number of pods per plant is one of the major components of yield while, Bitaraf et al. (2010) has reported that 100 seed weight is the most component of yield in lentil.

Table 4: Path coefficient of forwards selection to identify direct and indirect contribution of agromorphologic traits to seeds yield

Zaer Landrace	R ² partial	R ² model	C(p)	F value
Weight of 1000 seeds	0.24	0.24	1.9624	7.98***
Number of pods per plant	0.13	0.37	-0.2166	4.83*
Number of pods per peduncle	0.05	0.42	0.0219	2.13 ^{ns}
Plant height	0.04	0.47	0.5834	1.80 ^{ns}
Number of seeds per plant	0.03	0.50	1.4383	1.46 ^{ns}
<i>Significant at 0.05 (*), 0.01 (**) and at 0.001 (***) probability level respectively</i>				

Correlation analysis showed that the weight of thousands seed was positively correlated to plant height (0.187^{*}), number of total pods per plant (0.276^{**}), number of filled pods per plant (0.309^{***}) and to number of seeds per plant (0.299^{**}). Whereas, number of pods per plant was positively correlated to plant height (0.422^{***}), secondary branches (0.569^{***}), number of fertile knots per plant (0.735^{***}), number of pods per peduncle (0.387^{***}), number of filled pods per plant (0.974^{***}), number of seeds per plant (0.958^{***}) and to thousands seeds weight (0.276^{***}). Based on these results, we deduce that plant height; number of secondary branches; number of fertile knots per plant; number of filled pods per plant; number of seeds per plant and seeds weight are the main agronomic selected traits of promoted lines within the landrace for improving yield. Add to earliness as key factor for adaptation to Zaer climate change.

Conclusion

The main objective of this study was to strengthen the on-farm conservation of lentil landrace through improving yielding in changing climatic condition. Grain yield is the result of many yield components contribution. The study was therefore based on the assessment of genetic variability of yield components and their heritability in order to determine the direct and effective selection component on yield. Heritability of agronomic characters could be useful to guide selection for improving yield across generations.

Indeed, this study has described a high phenotypic diversity for the main agro-morphological traits of Zaer landrace of lentil. Variation between lines within the meta-population for the majority of measured traits implies great genetic diversity and potential for breeding program through selection of high yielding lines with early flowering and maturing, high plant vigor (plant height, primary and secondary branches) and high ability for seed production (number of pods and seeds/plant, and high seed weight) in accordance with Al-Ghzawi (2011) study. Plant height, pods per peduncle, pods per plant, seeds per plant and 1000 seeds weight are the most effective seed yield components. Moreover, number of pods per plant, seeds per plant and thousand seed weight are the primary components that have direct effect on yield. Their broad sense heritability was high (67%, 66% and 92% respectively) indicating low environmental effects. Thus, selected criteria of promoted lines among the meta-population should be based on those characters in order to improve and stabilize yielding in changing climate. Otherwise, this study has demonstrated that Zaer landrace has a rich genetic potential to be advanced for breeding program of lentil.

References

- Al-Ghzawi A., E. Bsoul, F. Aukour, Z. Al-Ajlouni, M. AlAzzam, and Ajlouni M. (2011). Genetic variation for quantitative traits in Jordanian lentil landraces. *Advances in environmental Biology*, Vol. 5 (11), 3676-3680.
- Almekinders C.J.M., N.P. Louwaars and De Bruiji G.H. (1994). Local seed systems and their importance for an improved seed supply in developing countries. *Euphytica*, Vol 78, 207-216.
- Altieri M. A. and Merrick L. C. (1987). In situ conservation of crop genetic resources through maintenance of traditional farming systems. *Economic Botany*, Vol. 41, 86-96.
- Barghi S.S., H. Mostafaii, F. Peighami and Zakaria R.A. (2012). Path analysis of yield and its components in lentil under end season heat condition. *Int. J. Agri. Res*, 969-974.
- Bicer B. T. and Sakar D. (2004). Genetic variability and heritability for grain yield and other characters in lentil. *Journal Biological Science*, Vol. 4, 216-218.
- Bicer B. T. and Sakar D. (2008). Heritability and path analysis of some economical characteristics in lentil. *Journal of Central European Agriculture*, Vol. 9, 191-196.
- Bicer B. T. and Sakar D. (2010). Heritability of yield and its components in lentil (*Lens culinaris* Medik.). *Bulgarian Journal of Agricultural Science*, Vol. 16, 30-35.
- Bitaraf N., Khoddambashi M., and Hooshmand S. (2010). Correlation and path analysis of grain yield and its components for lentil under Shahre kord climate. *Iranian Journal of Pulses Research*, Vol. 1 (1), 51-56.
- Chauhan, M.P., Singh, I.S. (1998). Genetic variability, Heritability and genetic advance for seed yield and other quantitative characters over two years in lentil. *Lens News letter*. Vol. 25 (1-2), 3-6.
- Dixit, P. and Dubey, D. K. (1985). Path analysis in lentil (*Lens culinaris* Medik.). *Lens Newsletter*, Vol. 11, 15-17.
- Dixit R.K., H.L. Singh and Singh S.K. (2005). Selection criterion in lentil (*Lens culinaris* Medic.). Fourth International Food Legumes Research Conference. New Delhi. India. 18-22 October.
- Frankel OH. (1970). Genetic conservation in perspective. In Frankel OH and Bennett E (eds). *Genetic Resources in Plants - Their Exploration and Conservation*, Vol. 11, 469-489.
- Karadavut, U. (2009). Path analysis for yield and yield components in lentil (*Lens culinaris* Medik.). *Turk. J. Field Crops*, Vol. 14(2), 97-104.
- Marchenal P. and Lagarde M.F. (1994). *Conservatoire Botanique de Porquerolles des variétés locales de plantes cultivées, Guide pratique*.
- Muehlbauer F.J. (1974). Seed yield components in lentils. *Crop Sciences*. Vol. 14, 403-406.
- Muehlbauer F.J., Cubero J.I. and Summerfield R.J. (1985). Lentil (*Lens culinaris* Medic.). In Summerfield R.J. and Roberts E. H. (eds). *Grain Legumes Crops*. 266-311.
- Muehlbauer F.J, Kaiser W. J., Clement S. L. and Summerfield R.J. (1994). Production and breeding of lentil. *Advances in Agronomy*. Vol. 54, 315-332.
- Ortiz R. and Ng N.Q. (2000). Genotype x Environment Interaction and its Analysis in Germplasm Characterization and Evaluation. In Ekanayake IJ, Ortiz R (eds) *Genotype x Environment Interaction Analysis of IITA mandate crops in Sub-Saharan Africa*, 32-40.
- Rajput M.A. and Sarwar G. (1989). Genetic variability, correlation studies and their implication in selection of high yielding genotypes in lentil. *Lens Newsletter*. Vol. 16(2), 5-7.
- Rattan lal. (2016). Soil health and environmental management for sustainable agricultural production systems. *International Conference on Pulses*, 18-20 April Marrakesh-Morocco.

- Sarker A., Erskine W., Sharma B., Tyagi, M.C. (1999). Inheritance and linkage relationship of days to flower and morphological loci in lentil (*Lens culinaris* Medikus subsp. *culinaris*). *J Hered*, Vol. 90 (2), 270-275.
- Sharma B. (2011). Genes for traits of economic importance in lentil. In *Grain Legume research magazine*, Diego Rubiales (eds), Vol. 56, 15-17.
- Yadav S.S., D.S. Phogat, I.S. Solanki and Tomer Y.S. (2003). Characters association and path coefficient analysis in lentil. *Indian J. Pulse Res.*, Vol. 16 (19), 22-24.

GROWTH AND PRODUCTIVITY OF THYME AS AFFECTED BY NITROGEN FERTILIZATION IN CENTRAL GREECE: FIRST YEAR (ESTABLISHMENT) RESULTS

Konstantinos MARTINOS^{*}, Elpiniki SKOUFOGIANNI, Nicholas G. DANALATOS

Laboratory of Agronomy and Applied Crop Physiology, Department of Agriculture, Crop Production and Rural Environment, University of Thessaly, Volos, Greece

*Corresponding author: kmartinos@agr.uth.gr

Abstract

Thyme (*Thymus vulgaris* L.) is a medicinal and aromatic plant intensively used in pharmaceutical, food, and cosmetic industries. The first-year of a thyme (*Thymus vulgaris* L.) crop's growth and productivity as affected by nitrogen fertilization was investigated under field conditions in central Greece. In April 2015, winter cuttings of a native thyme cultivar were transplanted to an experimental field set up in Nea Aghialos, Magnesia, central Greece. The experimental design was a completely randomized design with three nitrogen dressings (0, 50, 100, kg N ha⁻¹) in four replications. The growth and final productivity of the crop was measured in three destructive samplings of the crop during the summer of 2015. The results demonstrated that nitrogen fertilization had a significant effect on thyme productivity and final yield in the first year of the crop.

Introduction

Thyme (*Thymus vulgaris* L.) is a member of the Lamiaceae family, which is met in different areas of the Mediterranean and Asia. Thyme has been used medicinally since ancient times (Hornok, 1992). It is used as a raw material in the production of plant medicine having a series of bactericidal and fungicidal effects. Thyme crops are of increasing economic importance for North America, Europe and North Africa (Letchamo and Gosselin, 1996) as thyme is commercially cultivated in large scale in many countries due to the fact that it has shown great economical potential (Bernath, 1990; Youdim et al., 2002; Badi et al., 2004). Thyme is a perennial shrub which grows up to 40-50 cm in height, forming many branches (Bernáth, 1993a). The sessile leaves vary in shape from elliptic to linear or diamond-shaped towards the apex. The flowers, varying in color from white to purple, are found in clusters at the top of the branches. The fruits consist of a smooth, dark-colored 4 - sectioned nutlet found in the remains of the calyx (Bernáth, 1993b). Since garden thyme is cultivated commercially (Bernáth, 1990), the optimum amount of nitrogen fertilization has been the subject of many investigations (Hornok et al., 1975, Shalaby and Razin, 1992, Ceylan et al., 1994). The main purpose of this trial was to determine, whether N supply could have a significant effect on the growth parameters of thyme under Greek conditions, even in the first year which is considered an establishment year for the crop.

Materials and methods

Crop establishment

The experiment was set up in the rural area of Nea Aghialos in Central Greece (39°16'02.3"N 22°47'47.5"E) on May 5, 2015. The soil of the experimental plots was a sandy loam one with a pH of 6.8 and an organic carbon (C) of 2.5 g kg⁻¹. Thyme cuttings (40 days old) were obtained from a local nursery. The soil was prepared and divided into plots; each of them was 4,2 m \times 2,4 m and contained three drip rows. The cuttings were transplanted on May 5. Distance between plants and distance between rows were both 60 cm. Twelve plots containing a total of 216 plants were arranged in a completely randomized design with irrigation being the main factor and nitrogen fertilization the factor split into sub-plots. Each experimental unit consisted of three rows of plants, 0.6 m apart, with the two outer rows serving as buffers. There were 17 plants per row, spaced 60 cm apart.

Fertilization

Nitrogen dressings were manually applied in three levels: N0, N50 and N100 (0, 50 and 100 kg ha⁻¹ respectively) in the form of a urea fertilizer on June 9 of 2015.

Irrigation

The amount of irrigation water was equal to 100% (562 mm) of the recorded evaporation values of a class-A pan. Another 110mm of rain fell during the months of the experiment. Irrigation water was applied by drip irrigation system and the irrigation interval was seven days. Surface drip irrigation system consists of an irrigation pump connected to sand and screen filter and a hydraulic fertilizer injection pump was used. The actual water discharge rate was 8 L h⁻¹ along the drip lines. Weed control was carried out via application of a polyethylene transpiring mulch as this material has demonstrated a 100% efficiency in weed control among other tested mulches in other medicinal species according to Hoeberechts et al (2004).

Harvesting and Drying

Harvests (destructive samplings) were carried on transplant – May 5, June 29, July 29 and finally August 28. Two plants per plot were harvested and all aerial parts of the plants were cut 5 cm above ground and the following growth parameters were determined: plant height, fresh weight of leaves/plant and fresh weight of stem/plant. The same parameters were determined after drying plant material in dark storage rooms on specially designed shelves. This method of drying was chosen as it is the method most commercial growers in Greece actually use. The results of the three final harvests are demonstrated in this paper.

Statistical analysis

All recorded values of this experiment were statistically analyzed using analysis of variance through the Genstat Program. Means were compared using revised L.S.D. test at 0.05 levels. The first harvest was not subjected to analysis of variance due to extensive rainfall during June.

Results and discussion

During the third and final harvest (28/08/2015) dry leaf yield (t ha⁻¹) and dry stem yield (t ha⁻¹) were significantly affected by nitrogen fertilization level. Dry stem yield means were 0.28, 0.20 and 0.32 t ha⁻¹ for treatments N0, N50 and N100 (Figure 2) respectively while dry leaf yield means were 0.24, 0.23 and 0.35 t ha⁻¹ for treatments N0, N50 and N100 respectively (Figure 1). During the second harvest (29/07/2015) nitrogen fertilization had no significant effect on the crop's growth parameters (Figure 1, 2). Dry leaf yields were 0.30, 0.23 and 0.36 t ha⁻¹ and dry stem yields were 0.29, 0.20 and 0.31 for treatments N0, N50 and N100 respectively. Plant height remained unaffected by nitrogen fertilization during the experiment. The LSD test showed that dry leaf yields of treatment N100 differed greatly than the rest during the final harvest (Table 1) while dry stem yields of treatments N0, N50, N100 all differed greatly when compared to each other.

Figure 14. Dry leaf yield ($t\ ha^{-1}$) means grouped by nitrogen fertilization level during the experiment.

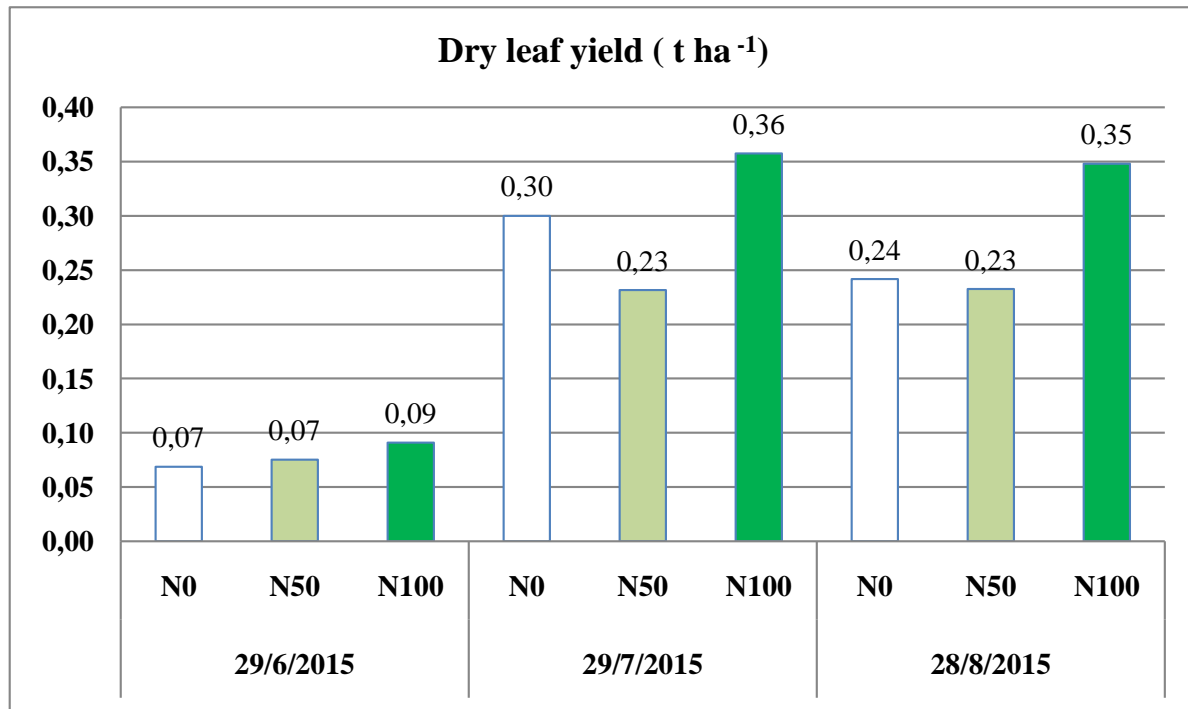

Figure 15. Dry stem yield ($t\ ha^{-1}$) means grouped by nitrogen fertilization level during the experiment.

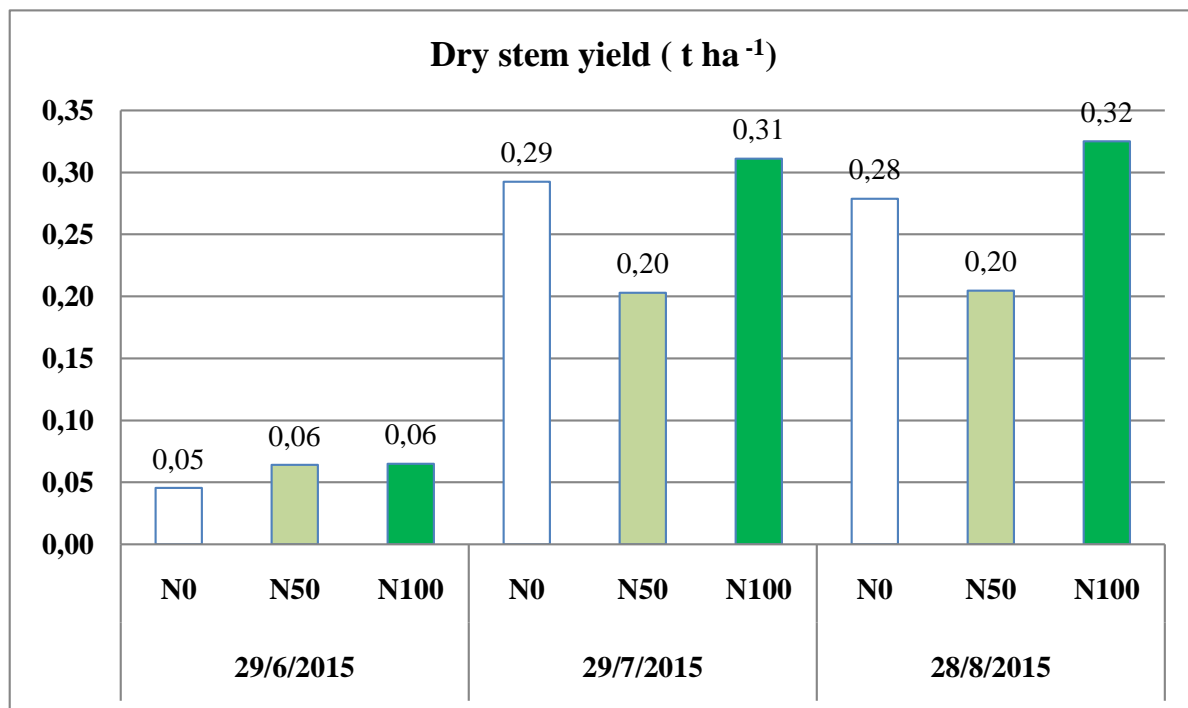

Figure 16. Plant height (cm) means grouped by nitrogen fertilization level during the experiment.

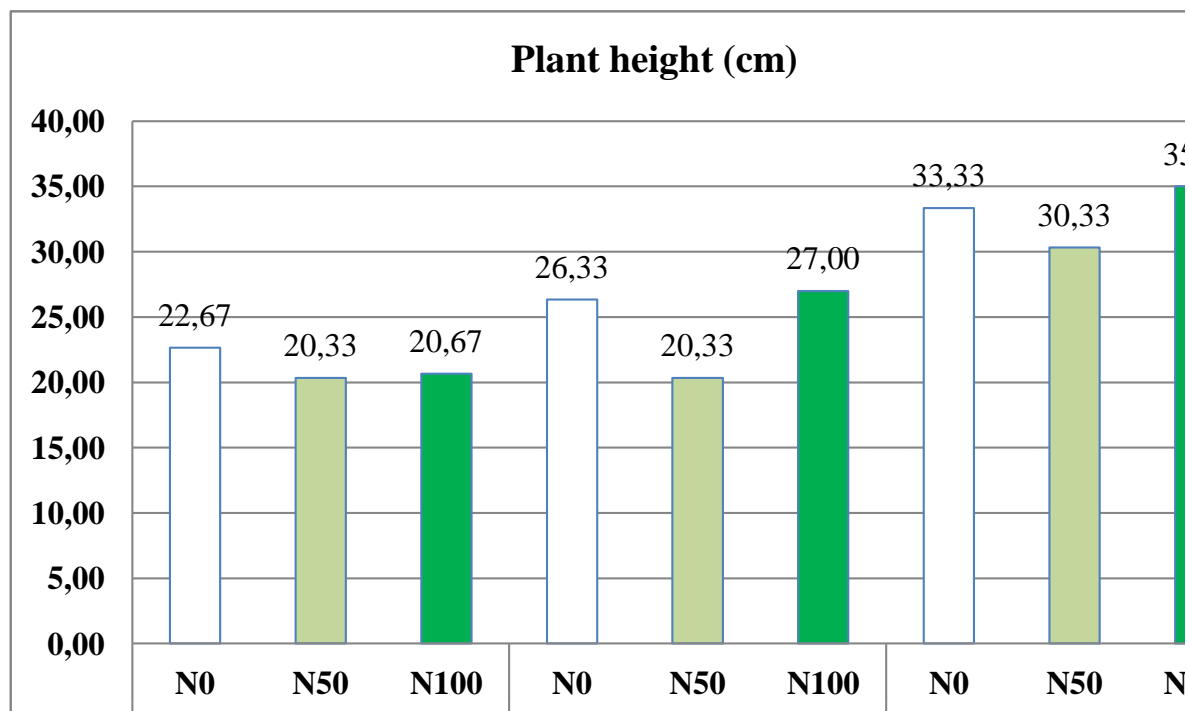

Table 7. Means of vegetative growth data of thyme as affected by different nitrogen fertilization regimes and nitrogen during the experimental season.

Harvest date	Nitrogen treatment	Plant height (cm)	Dry stem yield (t ha ⁻¹)	Dry leaf yield (t ha ⁻¹)
29/06/2015	N0	22,67a	0,05a	0,07a
	N50	20,33a	0,06a	0,07a
	N100	20,67a	0,06a	0,09a
29/07/2015	N0	26,33a	0,29a	0,30a
	N50	20,33a	0,20a	0,23a
	N100	27,00a	0,31a	0,36a
28/08/2015	N0	33,33a	0,28a	0,24a
	N50	30,33a	0,20b	0,23a
	N100	35,00a	0,32c	0,35b

Means followed by different letters were significantly different according to revised L.S.D. test at 0.05 level.

Conclusion

During the first year of the crop's establishment nitrogen's paramount effects were demonstrated. Future experiments for consecutive growing seasons and in different soil types are recommended in order to assess the prospects of thyme cultivation in Greece and the possible financial interest of the crop. As nitrogen pollution of underground water reserves has been prominent in the past years in Greece, this aromatic and medicinal crop shows potential as it can prove lucrative with little nitrogen inputs when compared to other traditional crops of central Greece. Finally, soil

erosion continues to be a problem in Greece (Kosmas et al, 2001), making perennial crops like thyme a suitable candidate for the eradication of the problem.

References

- Badi, H.N., Yazdani, D., Ali, S.M., Nazari, F. (2004). Effects of spacing and harvesting time on herbage yield and quality/quantity of oil in thyme, *Thymus vulgaris* L. *Ind. Crops Prod.* 19, 231–236
- Bernáth, J. (1993a). Vadon Termő és Termesztett Gyógynövények (Wild and cultivated herbs.). Mezőgazda Kiadó. Budapest, 566.
- Bernáth, J. (1993b). Introduction and cultivation of traditional and new medicinal and aromatic plant crops in Hungary. *Acta Hort.* 344, 238 - 248.
- Bernath, J., (1990). Ecophysiological approach in the optimization of medicinal plant agrosystems. *Herba Hung.* 29, 7.
- Ceylan, A., Bayram, E. and Ozay, N. (1994). The effects of N-fertiliser on the yield and quality of *Thymus vulgaris* in ecological condition of Bornova-Ismir. *Turkish J. Agr. and Forestry.* 18, 249- 255
- Hoeberechts, J., Nicola, S. and Fontana, E. (2004). Growth of lavender (*Lavandula officinalis*) and rosemary (*Rosmarinus officinalis*) in response to different mulches. *Acta Hort.* 629, 245-251.
- Hornok, L. (1992). Cultivation and Processing of Medicinal Plants. Akadémiai Kiadó. Budapest, 337.
- Hornok, L. Földesi, D. and Szász, E. (1975). Experiment of adapting the growth methods of common thyme (*Thymus vulgaris*). *Herba Hungarica.* 14, 47-64.
- Kosmas, C., Danalatos N., Kosmopoulou P. (2001). Soil erosion in Greece. In: Boardman, J. & J. Poesen (Eds), *Soil erosion in Europe.* J. Wiley & Sons Ltd., London.
- Letchamo, W., Gosselin, A. (1996). Transpiration, essential oil glands, epicuticular wax and morphology of *Thymus vulgaris* are influenced by light intensity and water supply. *J. Hort. Sci.* 71, 123–134.
- Shalaby, A.S. and Razin, A.M. (1992). Dense cultivation and fertilisation for higher yield of thyme (*Thymus vulgaris*). *J. of Agr. Crop Sci.* 168, 243 - 248.
- Youdim, K.A., Deans, S.G., Finlayson, H.J. (2002). The antioxidant properties of thyme (*Thymus zygis* L.) essential oil: an inhibitor of lipid peroxidation and a free radical scavenger. *J. Essent. Oil Res.* 14, 210–215.

GROWTH AND PRODUCTIVITY OF THYME AS AFFECTED BY IRRIGATION IN CENTRAL GREECE: FIRST YEAR (ESTABLISHMENT) RESULTS

Konstantinos MARTINOS*, Elpiniki SKOUFOGIANNI, Nicholas G. DANALATOS

Laboratory of Agronomy and Applied Crop Physiology, Department of Agriculture, Crop Production and Rural Environment, University of Thessaly, Volos, Greece

*Corresponding author: kmartinos@agr.uth.gr

Abstract

Thyme, a native plant of the Mediterranean, is a crop which holds an increasing importance for the essential oil production in the industry of cosmetics and food additives. The first-year of a thyme (*Thymus vulgaris* L.) crop's growth and productivity as affected by irrigation volume was investigated under field conditions in central Greece. In April 2015, winter cuttings of a native thyme cultivar were transplanted to an experimental field set up in Nea Aghialos, Magnesia, central Greece. The experimental design was a completely randomized design with three irrigation levels (0, 50, and 100% of potential evapotranspiration) in four replications. Irrigation was carried out via a drip system. The growth and final productivity of the crop in dry yield was measured in three destructive samplings of the crop during the summer of 2015. The results demonstrated the important effects of irrigation on thyme productivity and final yield in the crop's first year.

Keywords: *thyme, fertilization, growth, nitrogen, evapotranspiration.*

Introduction

Thyme (*Thymus vulgaris* L.) is a member of the Lamiaceae family, which is met in different areas of the Mediterranean and Asia. Thyme has been used medicinally since ancient times (Hornok, 1992). It is used as a raw material in the production of plant medicine having a series of bactericidal and fungicidal effects. Thyme crops are of increasing economic importance for North America, Europe and North Africa (Letchamo and Gosselin, 1996) as thyme is commercially cultivated in large scale in many countries due to the fact that it has shown great economical potential (Bernath, 1990; Youdim et al., 2002; Badi et al., 2004). Thyme is a perennial shrub which grows up to 40-50 cm in height, forming many branches (Bernáth, 1993a). The sessile leaves vary in shape from elliptic to linear or diamond-shaped towards the apex. The flowers, varying in color from white to purple, are found in clusters at the top of the branches. The fruits consist of a smooth, dark-colored 4 - sectioned nutlet found in the remains of the calyx (Bernáth, 1993b). Since garden thyme is cultivated commercially (Bernáth, 1990), the crop's growth parameters have been the subject of many investigations (Hornok et al., 1975, Shalaby and Razin, 1992, Ceylan et al., 1994). The main purpose of this trial was to determine, whether irrigation could have a significant effect on the growth parameters of thyme under Greek conditions, even in the first year which is considered an establishment year for the crop.

Materials and methods

Crop establishment

The experiment was set up in the rural area of Nea Aghialos in Central Greece (39°16'02.3"N 22°47'47.5"E) on May 5, 2015. The soil of the experimental plots was a sandy loam one with a pH of 6.8 and an organic carbon (C) of 2.5 g kg⁻¹. Thyme cuttings (40 days old) were obtained

from a local nursery. The soil was prepared and divided into plots; each of them was 4,2 m \times 2,4 m and contained three drip rows. The cuttings were transplanted on May 5. Distance between plants and distance between rows were both 60 cm. Twelve plots containing a total of 216 plants were arranged in a completely randomized design with irrigation being the main factor and nitrogen fertilization the factor split into sub-plots. Each experimental unit consisted of three rows of plants, 0.6 m apart, with the two outer rows serving as buffers. There were 17 plants per row, spaced 60 cm apart.

Fertilization

A nitrogen dressing was manually applied (50 kg ha⁻¹) in the form of a urea fertilizer on June 9 of 2015.

Irrigation

The amount of irrigation water was equal to 0% (rainfed – 110 mm), 50% (281 mm) and 100% (562 mm) of the recorded evaporation values of a class-A pan. Irrigation water was applied by drip irrigation system and the irrigation interval was seven days. Surface drip irrigation system consists of an irrigation pump connected to sand and screen filter and a hydraulic fertilizer injection pump was used. The actual water discharge rate was 8 L h⁻¹ along the drip lines. Weed control was carried out via application of a polyethylene transpiring mulch as this material has demonstrated a 100% efficiency in weed control among other tested mulches in other medicinal species according to Hoeberechts et al (2004).

Harvesting and Drying

Harvests (destructive samplings) were carried on transplant – May 5, June 29, July 29 and finally August 28. Two plants per plot were harvested and all aerial parts of the plants were cut 5 cm above ground and the following growth parameters were determined: plant height, fresh weight of leaves/plant and fresh weight of stem/plant. The same parameters were determined after drying plant material in dark storage rooms on specially designed shelves. This method of drying was chosen as it is the method most commercial growers in Greece actually use. The results of the three final harvests are demonstrated in this paper.

Statistical analysis

All recorded values of this experiment were statistically analyzed using analysis of variance through the Genstat Program. Means were compared using revised L.S.D. test at 0.05 levels. The first harvest was not subjected to analysis of variance due to extensive rainfall during June.

Results and discussion

During the second harvest (29/07/2015) dry leaf yield and dry stem yield were significantly affected by irrigation volume. During the second harvest dry stem yield means were 0.25, 0.24, 0.36 t ha⁻¹ (Figure 2) and dry leaf yield means were 0.22, 0.26 and 0.41 t ha⁻¹ (Figure 1) for treatments I1, I2 and I3 respectively. These values were the highest recorded during the experiment. During the third and final harvest (28/08/2015) irrigation volume, all recorded growth parameters were unaffected (Figure 1, 2, 3). Plant height remained unaffected by irrigation volume throughout the experiment (Figure 3). The LSD test showed that dry stem and dry leaf yields of treatment I3 differed greatly than the rest during the second harvest (Table 1).

Figure 17. Dry leaf yield (t ha⁻¹) means grouped by irrigation volume during the experiment.

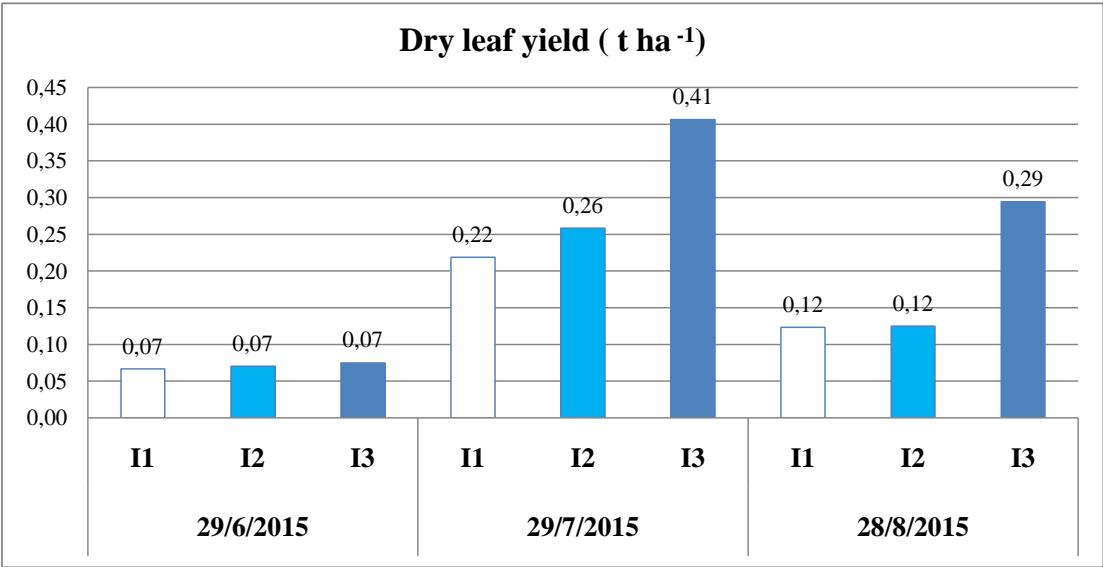

Figure 18. Dry stem yield (t ha⁻¹) means grouped by irrigation volume during the experiment.

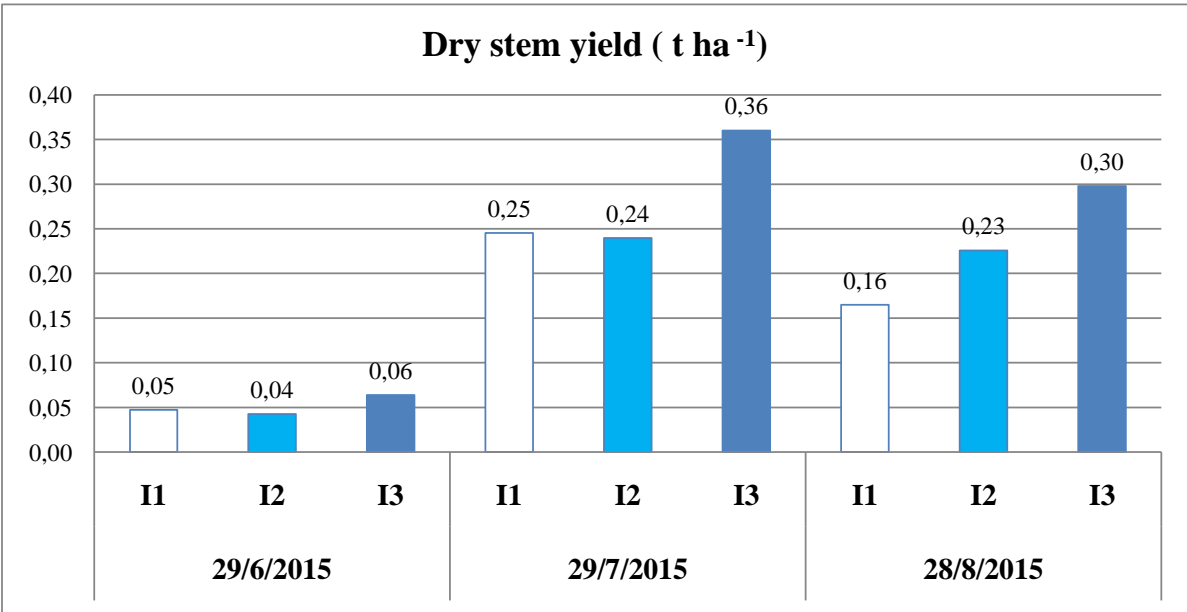

Figure 19. Plant height (cm) means grouped by irrigation volume during the experiment.

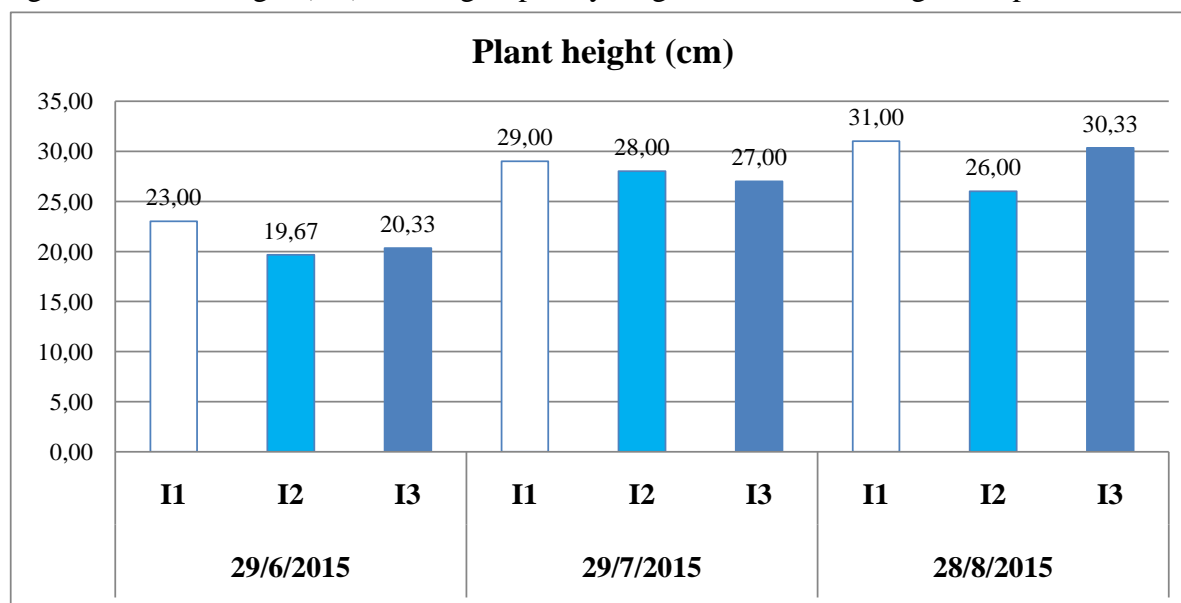

Table 8. Means of vegetative growth data of thyme as affected by different irrigation volumes during the experimental season.

Harvest date	Irrigation treatment	Plant height (m)	Dry stem yield (t ha ⁻¹)	Dry leaf yield (t ha ⁻¹)
29/06/2015	I1	23,00a	0,05a	0,07a
	I2	19,67a	0,04a	0,07a
	I3	20,33a	0,06a	0,07a
29/07/2015	I1	29,00a	0,25a	0,22a
	I2	28,00a	0,24a	0,26a
	I3	27,00a	0,36b	0,41b
28/08/2015	I1	31,00a	0,16a	0,12a
	I2	26,00a	0,23a	0,12a
	I3	30,33a	0,30a	0,29a

Means followed by different letters were significantly different according to revised L.S.D. test at 0.05 level.

Conclusion

During the first growing season year of the crop, irrigation had a significant effect on plant growth. Future experiments for consecutive growing seasons featuring different cultivation strategies (spacing, harvest times etc.) and different soil types are recommended in order to assess organized thyme cultivation in Greece. It seems that water is an important input for thyme crops in central Greece as its supply leads to higher herbage yields. Finally, soil erosion continues to be a problem in Greece (Kosmas et al, 2001), making perennial crops like thyme a suitable candidate for the eradication of the problem.

References

- Badi, H.N., Yazdani, D., Ali, S.M., Nazari, F. (2004). Effects of spacing and harvesting time on herbage yield and quality/quantity of oil in thyme, *Thymus vulgaris* L. *Ind. Crops Prod.* 19, 231–236
- Bernáth, J. (1993a). Vadon Termő és Termesztett Gyógynövények (Wild and cultivated herbs.). Mezőgazda Kiadó. Budapest, 566.
- Bernáth, J. (1993b). Introduction and cultivation of traditional and new medicinal and aromatic plant crops in Hungary. *Acta Hort.* 344, 238 - 248.
- Bernath, J., (1990). Ecophysiological approach in the optimization of medicinal plant agro-systems. *Herba Hung.* 29, 7.
- Ceylan, A., Bayram, E. and Ozay, N. (1994). The effects of N-fertiliser on the yield and quality of *Thymus vulgaris* in ecological condition of Bornova-Ismir. *Turkish J. Agr. and Forestry.* 18, 249- 255
- Hoeberechts, J., Nicola, S. and Fontana, E. (2004). Growth of lavender (*Lavandula officinalis*) and rosemary (*Rosmarinus officinalis*) in response to different mulches. *Acta Hort.* 629, 245-251.
- Hornok, L. (1992). Cultivation and Processing of Medicinal Plants. Akadémiai Kiadó. Budapest, 337.
- Hornok, L. Földesi, D. and Szász, E. (1975). Experiment of adapting the growth methods of common thyme (*Thymus vulgaris*). *Herba Hungarica.* 14, 47-64.
- Kosmas, C., Danalatos N., Kosmopoulou P. (2001). Soil erosion in Greece. In: Boardman, J. & J. Poesen (Eds), *Soil erosion in Europe.* J. Wiley & Sons Ltd., London.
- Letchamo, W., Gosselin, A. (1996). Transpiration, essential oil glands, epicuticular wax and morphology of *Thymus vulgaris* are influenced by light intensity and water supply. *J. Hort. Sci.* 71, 123–134.
- Shalaby, A.S. and Razin, A.M. (1992). Dense cultivation and fertilisation for higher yield of thyme (*Thymus vulgaris*). *J. of Agr. Crop Sci.* 168, 243 - 248.
- Youdim, K.A., Deans, S.G., Finlayson, H.J. (2002). The antioxidant properties of thyme (*Thymus zygis* L.) essential oil: an inhibitor of lipid peroxidation and a free radical scavenger. *J. Essent. Oil Res.* 14, 210–215.

THE INFLUENCE OF ZEOLITE ON THE MORPHO-PRODUCTIVE CHARACTERISTICS OF *GLYCINE MAX. L.* IN ORGANIC FARMING SYSTEM

Vera POPOVIĆ¹, Vladimir SIKORA¹, Mladen TATIĆ¹, Livija MAKSIMOVIĆ¹, Dragan TERZIĆ², Vladimir FILIPOVIĆ³, Gordana DOZET⁴, Vera ĐEKIĆ⁵

¹Institute of Field and Vegetable Crops, Maksima Gorkog 30, Novi Sad, Serbia

²Institute for Forage Crops, Kruševac, 37251, Goboder, Kruševac, Serbia

³Institute of medicinal Plant Research Josif Pančić, Belgrade, Serbia

⁴Nezbit University, Biopharming, Marsala Tita, Bačka Palanka, Serbia

⁵Center of small grains, Save Kovačevića 31, Kragujevac, Serbia

*Corresponding author: bravera@eunet.rs

Abstract

Natural zeolites can perform adsorption of ammonium ions of manure and in the mixture the manure can be used as organic-nitrogen fertilizer. There are about 50 different types of natural zeolites (Analcime (analcite), clinoptilolite, chabazite, faujasite, phillipsite, mordenite, etc.). Clinoptilolite and chabazite are the most commonly used natural zeolites, which are increasingly used in agriculture. Clinoptilolite added to the soil improves its physical and chemical characteristics. Zeolite may retain the N, K, Ca, Mg and micronutrients in many plants and the root zone to allow their use when needed, thus allowing efficient use of N and K fertilizer. The application of zeolite, because of these qualities, applies small amounts of fertilizer, which reduces production costs and allows increased yields. The aim was to determine the effect of zeolite on the morphologic and productive characteristics of soybean produced in the organic farming system. In this research three varieties *Glycine Max.*: NS Kaća, (000 MG), NS Pantera (00 MG) and Galina (0 MG) in two types of cultivation: the first control and the second variant with zeolite - Clinoptilolite. The average weight of plants, plant height, first pod height and weight of pods of soybean plants was higher in variants with zeolite compared to the control. Plant height was significantly higher in the variant with zeolite compared to the control. The maximum mass of plants, the first pod height and weight of the pods had a variety Galina compared to the cultivars. Significantly higher average plant height had NS Pantera in relation to the variety tested. Variety Pantera had higher plants in variants with zeolite for 11.8 cm respectively for 9.27%, while the variety Galina had higher plants in the 2nd variant for 16.76 cm respectively for 19.20% compared to the first variant- control. Application of zeolite prevents the leaching of nutrients, is of great importance both from the economic as well as the ecological aspect and also for achieve bigger productivity of soybeans.

Keywords: *Soybean, variety, zeolite, morpho-productive characteristics, organic farming system*

Introduction

Glycine Max. L. Merr is a legume that from year to year recorded a significant increase in area and production. Soybean yields recorded fluctuations and in large dependence on meteorological conditions during the vegetation growing period. Areas under soybean in the World in 2013 amounted to 111.27 million hectares, with the total production of 276.40 million tonnes. America is the world's largest producer of soybean, with an area of 85.63 million ha, or with total world share of 76.95%, followed by Asia with an area of 20.69 million hectares and Europe with an

area of 3.18 million hectares and total production of 5.94 million tonnes. (Zivanović&Popović, 2016).The seeds of soybean contain 40% good quality protein, 17-24% highly palatable oil containing zero cholesterol level, 6% ash, 29% sugars (Essa and AlAni, 2001; Agarwal, 2007; Shi and Cai, 2010, Popović, 2010,Popovic et al. 2012a, 2012b, 2013). Except above all benefits, it is also a good source of polyunsaturated fat, fibers, vitamins and contains a small amount of minerals and energy (Krishnan, 2001). It contains about 85% of the world oil seed and placed in group of the oil seed crop. Soybean seed is processed into soybean meal and vegetable oil. Soybean may be a significant source for biofuel production (Anonymous, 2009).

In the organic farming system, fertilization of plants is possible only with means that are allowed for use in organic farming system. Natural zeolites can perform adsorption of ammonium ions of manure and in the mixture the manure can be used as organic-nitrogen fertilizers and in organic cropping system. Its implementation is desirable because it improves the physical and chemical characteristics of the soil. Zeolites are natural microporous crystals which consist of the elements of the Earth's crust: silicon, aluminum and oxygen. Natural zeolite deposits were created millions of years ago by volcanic ash. There are about 50 types of natural zeolites. Zeolites are used for various applications in industry, agriculture and environmental protection. Clinoptilolite features, such as such as the selectivity to certain ions and the ion exchange capacity, motivate research on the possibilities of its application in agriculture; particularly in the areas of crop production, where there is expressed need for carriers of nutrients and micro-elements. Application of natural zeolites in agriculture is based on their ability to binding other substances and their mechanism of ion exchange or adsorption.

The zeolites exhibit affinity for the binding (removal) of ammonia from aqueous solutions. The way that they can carry out the adsorption of ammonium ions from manure zeolites in a mixture with manure can be used as organic-nitrogen fertilizer. This allows their use in agriculture and horticulture. Application of zeolites is also possible in the processing of waste water which be used than in agriculture. As soil additives land, can reduce acceptance of mercury and other heavy metals by plants, and so prevent their entry into the food chain. Clinoptilolite is the most commonly used natural zeolite clinoptilolite, because of its high adsorption capacity, the possibilities of ion exchange and applications of ion exchange catalyst, , as well as of its high dehydrating capacity. The application of zeolites in agriculture and especially in the field of nutrition of livestock is largely based on their ability to bind the various chemicals species, either by ion exchange or adsorption mechanisms. Zeolites showing exceptional selectivity for the adsorption of ammonia from aqueous solutions. This allows their use in agriculture and horticulture (natural zeolites are used as organic-nitrogen fertilizer - ammonium ion adsorption from manure is one of the main applications of natural zeolite clinoptilolite). This characteristic also allows the use for purification of industrial and agricultural waste water, fisheries and livestock feed. As soil additives, natural zeolites reduce the adoption of mercury and other heavy metals by plants and prevents their entry into the food chain (Armbruster, 2001, Polat et al., 2004).

There is nearly 50 different types of natural zeolites (Analcime (analcite), clinoptilolite, chabazite, faujasite, phillipsitemordenite, etc.). Deposits of natural zeolites were created millions of years ago of volcanic ash aluminosilicate which were reacted with water in which the dissolved inorganic salts. The synthetic zeolites are more numerous in the database of the International Zeolite Association (International Zeolite Association - IZA; www.iza-structure.org). In 1970 was stated 27; 2001 133 and 2009 180 different structural types of zeolite.

Clinoptilolite and chabazite are commonly used natural zeolites and their application are increasing continuously. The structure of clinoptilolite is layered. Openings the door of the channels are elliptical in shape (Armbruster, 2001).

Clinoptilolite is very prevalent in nature, usually located in open pits, and is readily available and inexpensive. Its properties, such as high adsorption capacity, ion exchange capacity, catalytic activity, dehydration activity, make this mineral can be important for plant production. Clinoptilolite added to the soil improves its physical and chemical characteristics. Zeolites may retain N, K, Ca, Mg and many microelements in the plants root zone and to allow their use when needed, thereby enabling more efficient utilization N and K fertilizers. The application of zeolites, because of these qualities, applied small amounts of fertilizer, which reduces production costs and to increase the yield (Rakic et al., 2015).

Prevention of nutrient leaching is very significant economically as well as it is ecologically. Namely, it is particularly important avoid loss of nutrients of fertilizers that often occurs in some of the types of land, most often in the sandy (Mumpton, 1999).

The aim of the study was to determine the effect of zeolite on morpho-productive characteristics soybean produced in the organic farming system.

Materials and methods

Experiment with three soybean varieties (*Glycine max* L.): NS Kaća (000 MG), NS Pantera (00 MG) and Galina (0 MG) was carried out on experimental field of Institute of Field and Vegetable Crops at certified plots in BackiPetrovac, Serbia, 2015, in two growing variants: 1.variant - Control – withoutzeolite and 2.variant- the application with zeolite - Clinoptilolite.

The standard technology for growing early soybean varieties was applied during the experiment. Sowing was carried out at the optimum time. Crop cultivation were applied during the vegetation period. Plants were irrigated three times each with 35 l of water in the flowering stage, the formation of pods and grain filling. The harvest is carried out manually in technological maturity. Samples were taken with each plot and morphological analysis of plant have been done.

Statistical Analysis: All information presented here were results of three replication experiment. Results were interpreted by using a statistical package, statistic 12.

Results and discussion

Genetic differences in plants provide a valued tool in assortment of genotypes with required traits (Misra and Dwivedi, 2004, Popovic, 2015). Genotype variant had a statistically significant effect on plant height. Plants height of by an average of all tested varieties was significantly higher in variants with zeolite compared to the control. The average plant weight, plant height, first pod height and weight of pods of soybean plants was higher in variants with zeolite compared to the control, table 1.

Significantly higher average plant height had variety NS Pantera in relation to the variety tested. Variety Pantera had higher plants in variants with Zeolite for 11.80 cm (9.27%), while the variety Galina had more plants in other variants of 16.76 cm (19.20%) compared to the control, table 1 graph. 2.Largest mass of plants (19.82 g), height of first pod (10.10 cm), and the mass of pods (13.05 g), had a variety Galina compared to the tested varieties under table 1.

Table 1. Morpho-productive characteristics of soybean plants

Parameter	Genotype	NS Kaća	NS Pantera	Galina	Average
Plant mass, g					
Variant	Control	16.43	19.75	17.33	17.84
	Zeolite	17.90	19.03	22.30	19.74
	Average	17.17	19.39	19.82	18.79
Plant height, cm					
Variant	Control	85.63	127.27*	87.27	100.05
	Zeolite*	85.76	139.07*	104.03*	109.62*
	Average	85.70	133.17*	95.65*	104.62
First pod height, cm					
Variant	Control	7.73	8.63	7.60	7.99
	Zeolite	7.50	9.47	12.60	9.85
	Average	7.62	9.05	10.10	8.92
Pod mass, g					
Variant	Control	11.26	13.30	11.70	12.09
	Zeolite	12.87	12.57	14.40	13.28
	Average	12.07	12.93	13.05	12.68

LSD	Plant mass			Plant height			First pod height			Pod mass		
	G	V	G x V	G*	V*	G x V*	G	V	G x V	G	V	G x V
0.5	2.55	3.71	6.43	7.72	6.31	10.92	3.94	3.22	5.57	3.45	2.82	4.88
0.1	6.04	4.93	8.54	10.26	8.38	14.52	5.24	4.28	7.41	4.58	3.74	6.48

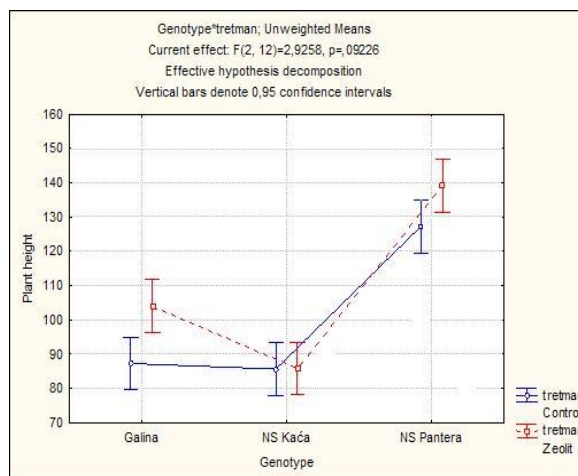
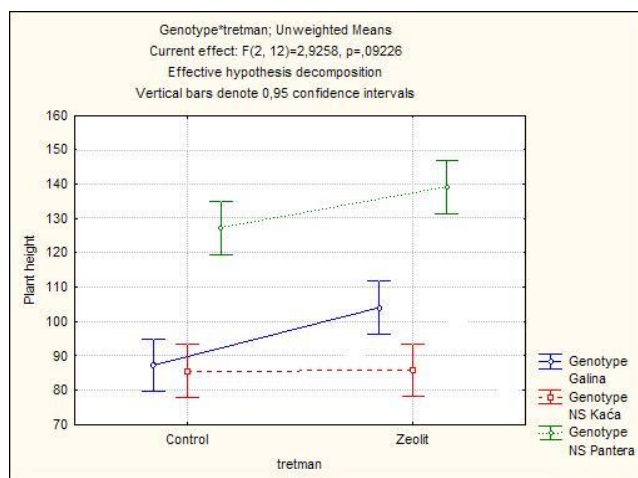

Graph 1. The effect of genotype and nutrient at the height of the soybean plants

Variety Galina had a largest mass of plants (19.82 g), followed by variety NS Pantera (19.39 g), and variety NS Kaća (17.17 g), table1, graph 1.

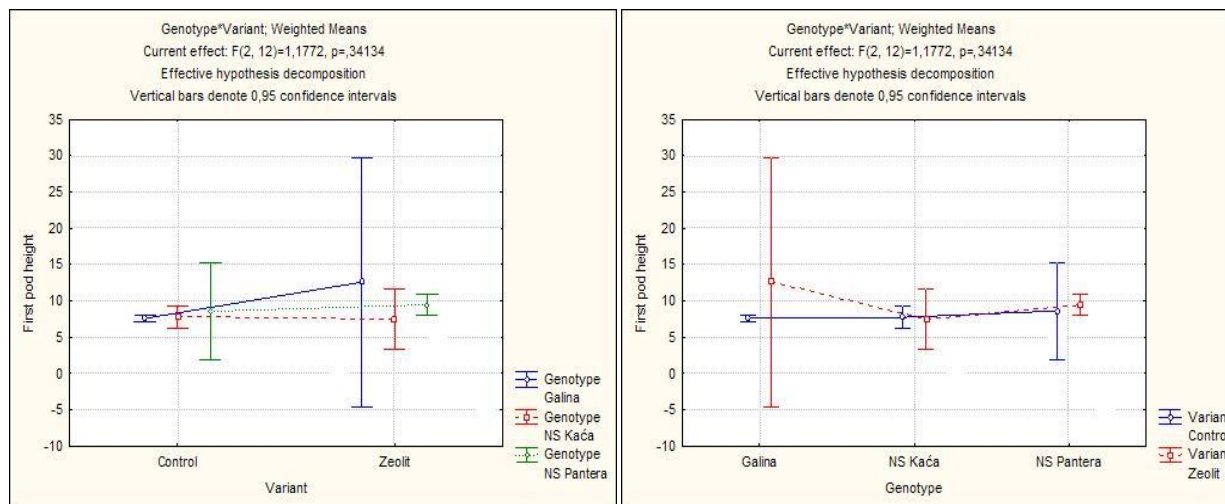

Graph 2. The effect of genotype and nutrient at the height of the first pod of soybean

The average of the first pod height of all tested cultivars was higher in variants with zeolite up to 23.28% compared to the control, table 1, graph 3.

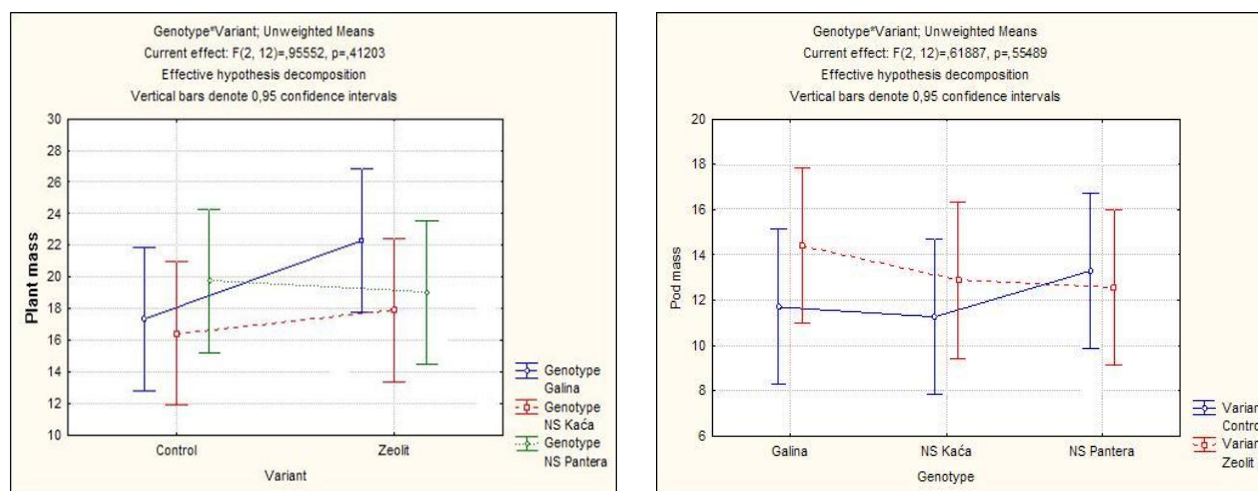

Graph 3. The effect of genotype and nutrient on the mass soybean plants

The average of pods weight for all tested cultivars was higher in variants with zeolite up to 9.84% compared to the control, table 1, graph 4.

The application of Zeolite prevents rinsing of nutrients and by that better morpho-productive characteristics of soybeans which is of great importance from the economic as well as ecological aspect.

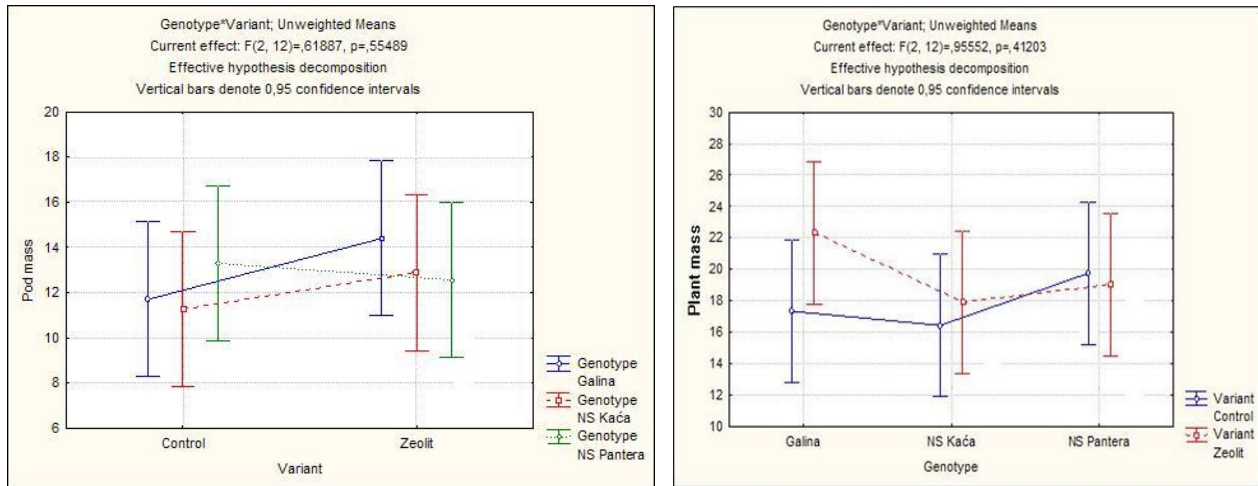

Graph 4. The effect of genotype and nutrient on the mass pods

With adequate potassium nutrition, yield, oil percentage and protein contents increased per unit area. Cost of production decreased and yield and profit increased (Epstein and Bloom, 2005, Khan et al., 2010, Djekic et al, 2013).

Correlations investigated traits

Correlations represent the interconnectedness between different occurrences presented values of two variables. Genotypic correlation coefficient enables an insight into correlation of properties and indicates the properties that may be useful as indicators of the behavior of some important properties (Johnson et al., 1955). Authors report that the correlation may help to identify characteristics that have little importance in the breeding program and provide important information for plant breeding. The link between the two parameters - variables means that the value of one variable can be predicted with a certain probability based on the knowledge of the value of other variables.

Strong, highly significant positive (direct) correlation was achieved between the weight of the plants and mass of pods. The correlation coefficient between these two parameters was 0.93, Table 2.

Table 2. Correlations investigated traits

Variable	Plant mass	Plant height	First pod height	Pod mass	Variant
Plant mass	1.00	0.30 ^{ns}	-0.01 ^{ns}	0.93**	0.27 ^{ns}
Plant height	0.30 ^{ns}	1.00	0.26 ^{ns}	0.19 ^{ns}	0.22 ^{ns}
First pod height	-0.01 ^{ns}	0.26 ^{ns}	1.00	-0.08 ^{ns}	0.30 ^{ns}
Pod mass	0.93**	0.19 ^{ns}	-0.08 ^{ns}	1.00	0.24 ^{ns}

^{ns} – nonsignificant; significant at 0.1

Among others tested parameters achieved positive insignificant correlations, except for the mass of plants and first pod height where he was recorded poor negative correlation, Table 2.

Positive genotypic correlations between the two properties means that the selection of one can automatically achieve the progress in breeding for other (Johnson et al., 1955).

Conclusions

Based on the research of zeolite applications in soybean crops, we can conclude the following:

- ✓ The genotype and nutrition had a statistically significant effect on plant height.
- ✓ The height of plants by an average of all tested varieties was significantly higher in variants with Zeolite compared to the control.
- ✓ Average plant weight, plant height, first pod height and weight of pods of soybean plants was higher in variants with zeolite compared to the control.
- ✓ A significantly higher average plant height had variety NS Pantera of all tested varieties. Variety Pantera had higher plants in variants with Zeolite for 11.80 cm (9.27%), while the variety Galina had more plants in other variants of 16.76 cm (19.20%) for compared to the control.
- ✓ The largest plant mass (19.82 g), height of first pod (10.10 c), and the mass of pods (13.05 g), had a variety Galina compared to the tested varieties.
- ✓ Variety Galina had the greatest plant mass (19.82 g), followed by NS Pantera (19.39 g), and NS Kaća (17.17 g).
- ✓ First pod height by an average of all tested cultivars was higher in variants with zeolite up to 23.28% compared to the control.
- ✓ The weight of pods on average for all tested cultivars was higher in variants with zeolite of 9.84% compared to the control.
- ✓ A strong, highly significant positive (direct) correlation was achieved between the weight of the plants and the mass of pods. The correlation coefficient between these two parameters was 0.93.
- ✓ Application of Zeolite inhibits rinsing of nutrients. It is of great importance both from the economic as well as the ecological aspect and also for achieves bigger productivity soybeans.

Acknowledgements

This work is a result of the projects TR 31022 and TR 1661021 financed by the Ministry of Education, Science and Technological Development of Republic of Serbia.

References

- Agarwal, A.K. 2007. Biofuels (alcohols and biodiesel) applications as fuels for internal combustion engines. *Prog. Energy Combust. Sci.* 33 :233-271
- Anonymous, A., 2009. Agricultural Statistics of Pakistan. Ministry of Food, Agriculture and Live Stock (Economic Wing), Islamabad. 65-66.
- Armbruster, T, (2001): *Studies in Surface Science and Catalysis 135, Zeolites and Mesoporous Materials at the Dawn of the 21st Century*, A, Galarnau, F, Di Renzo, F, Fajula i J, Vedrine (editori), Elsevier.
- Glamočlija, Đ., Janković, S., Popović, V., Kuzevski, J., Filipović, V., Ugrenović, V.(2015): *Alternatively crop plants in conventional and organic growing systems. Monograph. IPN Belgrade* 1-355, 175-180.
- Essa, T. and D. Al-Ani. 2001. Effect of salt stress on the performance of six soybean genotypes. *Pak. J. Biol. Sci.* 4:175-177.
- Epstein, E. & A. Bloom. 2005. *Inorganic components of plants. Mineral nutrition of plants: principles and perspectives*, 2nd Ed. Sinauer Associates, Inc., Massachusetts, 44-45.
- International Zeolite Association – IZA; www.iza-structure.org, 1970 .
- Johnson, H. W., Robinson, H. F. and Comstock, R. E.: Genotypic and phenotypic correlations in soybeans and their implications in selection. *Agron. J.*, 47. (IO), 477- 483, 1955.

- Khan, M.W., L.K. Almas and B.A. Stewart. 2010. Effects of Macronutrients on Seed Quality and Profitability Analysis of Sunflower Production in Northwest Pakistan. Paper read at 2010 Annual Meeting, February 6-9, 2010, Orlando, Florida.
- Krishnan, H.B. 2001. Biochemistry and molecular biology of soybean seed storage proteins. J. New Seeds. 2 :1-25.
- Misra, N. and U. Dwivedi. 2004. Genotypic difference in salinity tolerance of green gram cultivars. Plant Sci. 166 :1135-1142
- Mumpton, F A, (1999) La roca majica: uses of natural zeolites in agriculture and industry Proc. Natl. Acad. Sci. 96 (1999) pp. 3463–3470.
- Đekić, V., Staletić, M., Jelić, M., Popović, V., Branković, S. (2013): The stability properties of wheat production on acid soil. 4th International Symposium "Agrosym 2013", Jahorina, 84-89.
- Polat, E, Karaca, M, Naci, Onus, A, Demir, H,(2004): Use of natural zeolite (clinoptilolite) in agriculture, Journal of Fruit and Ornamental Plant Research;12, 183-189.
- Popović, M.Vera (2010): Influence of Agro-technical and Agro-ecological practices on seed production of wheat, maize and soybean. Doctoral thesis, University of Belgrade, Faculty of Agricultural, Zemun-Belgrade, p. 145, 62-65.
- Popović, M. V., Tatić, M., Đekić, V., Kostić, M., Ilić, A. (2012a): Productivity and quality of the newly developed NS soybean varieties and lines in Pancevo region, Serbia. Bilten za alternativne biljne vrste, 2012, 44, 85, 21-27.
- Popovic, M. Vera, Sikora, V., Glamoclija, Đ., Cervenski, J., Vasic, M., Gvozdanic-Varga, J., Maksimovic, L. (2012b): Effect of soil conditioner on yield and quality of organic soybean. Proceeding of Third International Scientific Symposium "Agrosym Jahorina 2012", 435-440.
- Popović, V., Malešević M., Miladinović J., Marić V., Živanović Lj. (2013): Effect of agroecological factors on variations in yield, protein and oil contents in soybean grain. No. 30, DII 2067-5720 RAR 2012-207.
- Popović M. Vera (2015): The concept, classification and importance of biological resources in agriculture. Editor. Milovanovic Jelena, Đorđević Slađana: Conservation and enhancement of biological resources in the service of ecoremediation. Monograph. Futura. Belgrade. ISBN 978-86-86859-41-9; 1-407. 29-51
- Rakić, V, Simić A, Živanović, I., Rac V., Rajić N. (2015):The application of natural zeolites in agriculture. Institute of PKB Agroekonimik, Belgrade, UDC: 633.12+631.95:622.12+676.014.8, p. 2015,
- Shi, G. and Cai,Q. (2010): Zinc tolerance and accumulation in eight oil crops. J. Plant Nutr. 33:982-997
- Zivanović, Lj. & Popović, V.(2016):Production of soybean (*Glycine Max.*) in the World and in the Republic of Serbia. SoB, XXI Savetovanje o biotehnologiji, Čačak, Vol. 21 (23) 129-135.

THE EFFECT OF STAND DENSITY ON CONFECTIONARY SUNFLOWER SEED QUALITY

Jovan CRNOBARAC¹, Igor BALALIĆ², Nenad DUŠANIĆ², Goran JAĆIMOVIĆ¹, Dragana LATKOVIĆ¹

¹University of Novi Sad, Faculty of Agriculture, Sq. D. Obradovica 8, 21000 Novi Sad, Serbia

²Institute of Field and Vegetable Crops, Maksima Gorkog 30, 21000 Novi Sad, Serbia

*Corresponding author: jovanc@polj.uns.ac.rs

Abstract

A two year (Y) field plot was conducted on experimental fields of Institute of field and vegetable crops in Novi Sad (Serbia). The effect of stand density on the most important quality criteria in commercial production of confectionary sunflower: oil content (OC) the protein content (PC) and 1000 seed mass (TM) was researched. Three hybrids (H) of NS Seed Company were used (NS-goliat, NS-slatki, NS-gricko). There were six stand densities (D), from 20000-70000 plants per hectare with increasing step of 10000. According to F-test all factors (Y, H, D) and some their interaction had highly significant influence on all quality traits of confectionary sunflower. According to partitioning in total of sum squares off all treatments the most important factor for oil content is hybrid, for protein content is year and for 1000 seed mass is stand density. There were high significant correlations between stand density and OC, PC and TM, +0,99, -0,90 and -0,98, respectively. By increasing stand density by each 10000 plants OC regularly increase by +1,06%, while PP and TM contrary regularly decreases by -0,37% and -8,29g, respectively. Concerning hybrids in average for two years and all stand densities, significantly the lowest OC of 28,03% had hybrid NS-goliat, the highest PC of 16,79% hybrid NS-gricko and the highest TM of 126,03g again hybrid NS-goliat.

Keywords: *confectionary sunflower, plant density, oil and protein content, 1000 seed mass.*

Introduction

Although sunflower is the main oil crop in Serbia, unfortunately production of confectionary sunflower is very low. Non-oil type or confectionary sunflower is distinguished from standard oil type by bigger size of plants and seed, higher protein and lower oil content, better seed hull ability because of thicker hull which is loosely connected to the kernel, as well as by different shell colour and seed shape. Larger size of seeds is especially desirable, because they have higher market value (Crnobarac et al. 2014). There are only a few research about confectionary sunflower. Zubriski and Zimmerman (1974) found that seed yield of nonoil sunflower increased with increase in plant density from 28200 to 47800 plants ha⁻¹. Robinson et al. (1980) found that the minimum plant density required for maximum yield of nonoil sunflower ranged from 25 000 to 62 000 plants ha⁻¹, depending on location. They attributed the differing effects of plant density on yield among the six locations to soil, temperature and rainfall. Also optimum plant density is influenced by sunflower ability to compensate different plant densities through the number of seeds per head and seed weight. Robinson et al. (1980) found that nonoil and oilseed sunflower generally required the same plant densities for maximum yield, while Zubriski and Zimmerman (1974) found that plant density for maximum yield of oilseed sunflower was greater than for nonoil sunflower. In deciding on an optimum plant density for nonoil sunflower, both seed yield and size must be considered. Since

seed size decreases as plant density increases, it is desirable to aim for the plant density that will produce enough large seed without severely reducing overall yield (Gubbels and Dedio, 1986). The aim of this study was to research hybrid specificity of confectionery sunflower to plant density and its influence on quality criteria oil content (OC) the protein content (PC) and 1000 seed mass (TM)

Materials and Methods

Field plots were conducted in 2011-2012 on experimental field of the Institute of Field and Vegetable Crops, Novi Sad, Serbia. The soil type was the chernozem. The effect of plant density on next quality criteria was researched: oil content (OC), protein content (PC) and 1000 seed mass (TM). Three hybrids (H) of NS Seed Company were used (NS-goliat, NS-slatki, NS-gricko). The hybrids were sown on six plant densities (D), from 20000-70000 plants per hectare with increasing step of 10000. Design of trial was a split plot, where hybrids were on whole plot and density on subplot level. Individual experimental plots were 10 by 4,2 m, with six rows in every plot. Planting was done manually with 2-3 seed per hill; at 70 cm between rows. At stage of 2-3 pair of leaves the plots were thinned at one plant per hill. Harvesting was done manually at maturity by harvesting the two inner rows in each plot. Even there we did not harvest first and last plant in those rows, because of edge effects. Sunflower seeds were threshed on a stationary thresher and further cleaned by hand to remove any broken seed or impurities. Seed oil content (%) was determined from absolutely clean and air dried seed on the NMR-analyzer and seed protein content was determined by Kjeldahl method. Mass of 1000 seeds (g) was measured on a random sample of an absolutely clean and air dried seed. Data was processed by ANOVA and regression analysis. The ANOVA was completed using the Mstat C software and model 'Two Factor Randomized Complete Block Design with Split Plot Combined over Locations'.

Results and Discussion

The influence of year on all traits was high significant ($p < 0.01$) and accounted from 10-69% of total of sum squares of all treatments variability (Tab.1). The lowest part of variability was on oil content and the highest on protein content. The influence of genotype on all traits also was highly significant and accounted from 8-51% of variability. The lowest influence of genotype was on 1000 seed mass and the highest on oil content. The influence of plant density also was highly significant for all traits. The lowest influence of density was on protein content (11%) and the highest on 1000 seed mass (69%). Partition of each double interaction in variability for all traits were low and the highest were H x D interaction, 7% and 5% for OC and PC respectively. Triple interactions were also low and significant in oil and protein content, while in 1000 seed mass triple interaction was nonsignificant.

Table 1. Partitioning of treatments sum of square and significances, derived from ANOVA

Source of variation	df	Oil content	Protein content	Mass of 1000 seed
Year (Y)	1	10 **	69 **	20 **
Hybrid (H)	2	51 **	11 **	8 **
Y x H	2	0 ^{ns}	1 *	1 ^{ns}
Plant density (D)	5	24 **	11 **	69 **
Y x D	5	4 **	0 ^{ns}	1 *
H x D	10	7 **	5 **	1 ^{ns}
Y x H x D	10	4 **	3 **	1 ^{ns}

** Indicates significance at $p < 0,01$, * at $p < 0,05$, ^{ns} – non significant.

Level of oil content in seed was pretty low, what is appropriate for confectionery type of sunflower (Tab. 2). Between two research years there is significant difference in oil content, in 2012 was higher for 2,38%. On average for two years and six plant densities, hybrid NS-gricko had significantly the highest (34,16%) and NS-goliat the lowest oil content (28,05%). On average for two years and three hybrids the oil content regularly increased with higher density, and those differences were significant between each step of plant density. There were strong linear regression ($r = +0,99$) and oil content regularly increase 1,06% for each increasing density for 10000 plants (Graph. 1). Similar influence of plant density was in both researched year and same rule was at each hybrid. In both research year and in each plant density hybrid NS-goliat had significantly lower oil content then another two hybrids. (Tab. 2).

Table. 2. The effect of plant density and hybrids, on oil content of confectionery sunflower

Year: Y	Hybrid: H	Plant density: D						Av.: YH	Av.: Y
		20	30	40	50	60	70		
2011	NS Goliat	22,02	24,21	27,68	28,46	28,92	31,17	27,08	30,58
	NS Slatki	30,56	31,24	29,15	32,22	33,08	34,06	31,72	
	NS Gricko	34,04	33,79	34,22	29,86	31,94	33,75	32,94	
	Average: YD	28,87	29,75	30,35	30,18	31,31	33,00		
2012	NS Goliat	24,54	26,86	27,96	30,32	31,39	33,08	29,02	32,96
	NS Slatki	30,51	33,30	33,56	35,42	36,84	37,22	34,47	
	NS Gricko	31,58	33,75	35,08	36,97	37,33	37,54	35,38	
	Average: YD	28,87	31,30	32,20	34,24	35,19	35,95	Av.: H	
HD	NS Goliat	23,28	25,53	27,82	29,39	30,16	32,13	28,05	
	NS Slatki	30,53	32,27	31,35	33,82	34,96	35,64	33,09	
	NS Gricko	32,81	33,77	34,65	33,42	34,64	35,64	34,16	
	Average: D	28,87	30,52	31,28	32,21	33,25	34,47		

Factor	Y	H	D	YH	YD	HD	YHD
LSD _{0,01}	0,87	1,06	0,92	1,50	1,40	1,72	2,43
LSD _{0,05}	0,62	0,76	0,69	1,07	1,06	1,30	1,84

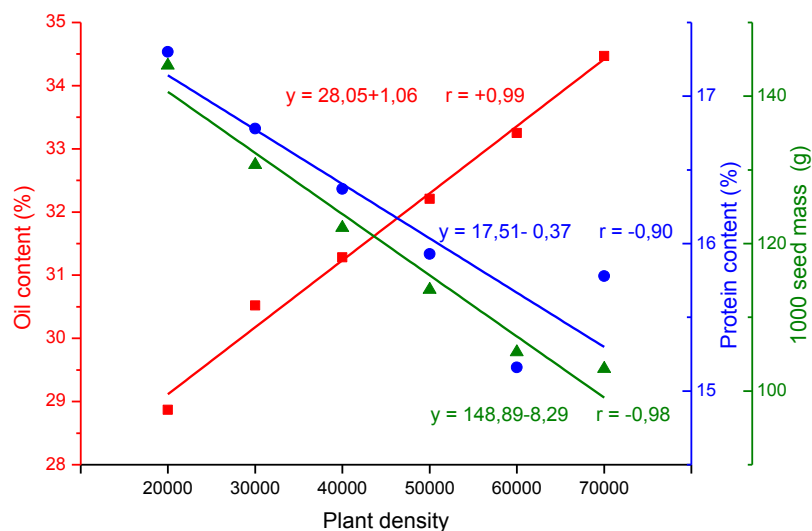

Graph. 1. Regression of confectionary sunflower plant density with of oil and protein content and 1000 seed mass

Like oil content for common oil type of sunflower, for confectionary sunflower protein content is main quality indicator. In average for all other treatments if we look only year, in 2011 was significantly higher protein content than in 2012, difference was 3,29% (Tab.3) and it was opposite to oil content. In average for all others treatments if we look only hybrid, the significantly lowest content of 15,25% had hybrid NS-goliat, after are hybrids NS-slatki and NS-gricko which are similar to each other. In both investigated year order of hybrids was the same like on average. In average for all others treatments if we look only plant density protein content significantly decrease with increasing plant density till to 60000 plants per hectare. At 20000 plants per hectare was 17,30% and at 60000 plants only 15,16%. There were strong linear regression ($r = -0,90$) and protein content regularly decrease 0,37% for each increasing density for 10000 plants (Graph. 1). Similar influence of plant density was in both researched year. In two way interactions of density and hybrid, there were similar influence of plant density in each hybrid.

Table 3. The effect of plant density and hybrids, on protein content of confectionery sunflower

Year: Y	Hybrid: H	Plant density: D						Av.: YH	Av.:Y
		20	30	40	50	60	70		
2011	NS Goliat	17,58	18,02	16,91	17,49	16,18	17,57	17,29	17,96
	NS Slatki	17,99	18,65	20,09	18,27	16,66	17,83	18,25	
	NS Gricko	20,78	19,16	17,63	17,12	17,67	17,67	18,34	
	Average: YD	18,79	18,61	18,21	17,63	16,83	17,69		
2012	NS Goliat	14,08	13,11	13,33	13,03	12,76	12,91	13,20	14,48
	NS Slatki	16,39	16,24	14,82	15,11	13,34	14,08	15,00	
	NS Gricko	16,98	15,47	15,46	14,57	14,38	14,61	15,24	
	Average: YD	15,82	14,94	14,54	14,24	13,50	13,87	Av.: H	
HD	NS Goliat	15,83	15,57	15,12	15,26	14,47	15,24	15,25	
	NS Slatki	17,19	17,45	17,45	16,69	15,00	15,95	16,62	
	NS Gricko	18,88	17,31	16,54	15,85	16,02	16,14	16,79	
	Average: D	17,30	16,78	16,37	15,93	15,16	15,78		

Factor	Y	H	D	YH	YD	HD	YHD
LSD _{0,01}	0,28	0,34	0,41	0,48	0,58	0,71	1,00
LSD _{0,05}	0,20	0,24	0,31	0,34	0,44	0,53	0,76

In average for all others treatments if we look only year, in 2011 was significantly higher 1000 seed mass than in 2012, difference was 15,5 g (Tab. 4) and it was opposite to oil content. In average for all others treatments if we look only hybrid, all hybrids had average 1000 seed mass higher than 100g and even hybrid NS-goliat had 126,4 g. It was significantly higher values than hybrids NS-slatki and NS-gricko which are similar to each other. In both years the were similar relation between hybrids.

In average for all others treatments if we look only plant density seed mass significantly and regularly decrease with increasing plant density till to 60000 plants per hectare. The biggest seed of 144,2g was at 20000 plants per hectare and the lowest of 103,0 was at the highest plant density of 70000 plants. There were strong linear regression ($r = -0,98$) and regression coefficient was 8,29, it means that seed mass regularly decrease 8,29g for each increasing density for 10000 plants (Graph. 1). Similar trend was in both researched year. Because of non significant influence of interactions hybrid x density all hybrids had significant decreasing of seed mass with increasing plant density were till to 60000. It means that confectionary sunflower hybrids are more sensitive to higher plant density, but hybrids NS-goliat and NS-gricko had market requested seed mass over 100g even at the highest plant density of 70000 plants per hectare.

Table 4. The effect of plant density and hybrids on 1000 seed mass of confectionery sunflower

Year: Y	Hybrid: H	Plant density: D						Av.: YH	Av.:Y
		20	30	40	50	60	70		
2011	NS Goliat	158,7	147,5	136,3	128,7	116,9	116,1	134,0	127,6
	NS Slatki	145,4	133,5	124,6	117,0	103,0	103,0	121,1	
	NS Gricko	157,7	142,5	123,8	119,6	112,1	111,1	127,8	
	Average: YD	153,9	141,2	128,2	121,8	110,7	110,1		
2012	NS Goliat	143,4	126,6	119,9	111,3	109,1	102,9	118,9	112,1
	NS Slatki	133,4	118,0	115,0	105,7	94,2	90,7	109,5	
	NS Gricko	126,6	116,1	113,4	100,1	96,5	94,3	107,8	
	Average: YD	134,4	120,2	116,1	105,7	99,9	96,0	Av.: H	
HD	NS Goliat	151,0	137,0	128,1	120,0	113,0	109,5	126,4	
	NS Slatki	139,4	125,8	119,8	111,4	98,6	96,8	115,3	
	NS Gricko	142,1	129,3	118,6	109,9	104,3	102,7	117,8	
	Average: D	144,2	130,7	122,2	113,7	105,3	103,0		

Factor	Y	H	D	YH	YD	HD	YHD
LSD _{0,01}	4,1	5,0	3,6	7,1	5,9	7,3	10,3
LSD _{0,05}	2,9	3,6	2,8	5,1	4,5	5,5	7,7

Conclusions

According to the quality criteria of domestic confectionery sunflower hybrid we find out that: Oil content like qualitative traits in confectionery hybrids were pretty low, in all average around 32 % and all investigated factors had significant influence on it, but the highest had hybrid.

- In 2012 oil content was higher, in average for 2,38%
- In both year the lowest oil content achieved with hybrid NS-goliat (28,05%)
- Oil content regularly increased with increasing plant density.

Protein content like main quality traits of confectionery sunflower was influenced by all investigated factors , bat the highest influence had year.

- In 2011 protein content was higher, in average for 3,29%
- In both year the highest protein content achieved with hybrid NS-gricko (16,79%)
- Protein content regularly decreased with increasing plant density.

Seed size or 1000 seed mass was significantly influenced by all investigated factors , but the highest influence had plant density

- In 2011 seed size was higher for 15,5 g.
- In both year hybrid NS Goliat (126,4 g) had the highest 1000 seed mass.
- Seed size regularly decreased with increasing plant density.

Generally, with increasing plant density protein content and 1000 seed mass linearly decrease while oil content increase, for each 10000 plant they changes were -0,37% -8,29g and +1,06%, respectively. The highest influences on and protein content had year, while genotype had on 1000 seed mass. Plant density had the highest influence on 1000 seed mass. According to quality criteria optimal density for confectionary hybrids is around 40000-50000 plants per hectare.

Acknowledgements

This work was supported by the Ministry of Science and Technological Development of the Republic of Serbia (Research Grant: TR-31025)

References

- Crnobarac J., Balalić I., Marinković B., Jaćimović G., Latković D. (2014). Influence of stand density on yield and quality of ns sunflower confectionary hybrids, vol. 46, 2, pp. 61-66
- Gubbels G. H., Dedio W. (1986). Effect of plant density and soil fertility on the performance of nonoil sunflower. *Can. J. Plant Sci.* 66, 801-804
- Robinson R. G., Ford J. H., Lueschen W. E., Rabas D. L., Smith L. J., Warners D. D., Wieresma J. V. (1980). Response of sunflower to plant population. *Agron. J.* 72, pp. 869-871 .
- Zubriski J. C., Zimmerman D. C. (1974). Effects of nitrogen, phosphorus, and plant density on sunflower. *Agron. J.* 66, pp. 798-801.

PRELIMINARY DATA ON GENETIC VARIATION BETWEEN NATURAL POPULATIONS OF *Salvia officinalis* L OF NORTHERN ALBANIA BASED ON RAPDs

Stela PAPA*, Ariola BACU

Department of Biotechnology, Faculty of Natural Sciences, University of Tirana, Albania. Blv "Zogu I", Tirana, Albania

*Corresponding author: stelapapa@yahoo.com

Abstract

Garden sage (*Salvia officinalis* L.) which grows naturally in Albania, is also one of the most economically important aromatic plants cultivated in some areas of the country. In the last decades, molecular markers have been successfully used to assess genetic relationships and genotype identification with great impact on plant breeding programs, germplasm management, and biodiversity preservation. In this study, in order to evaluate the natural biodiversity of populations of northern Albania, eight populations were analyzed based on RAPDs. Genomic DNA was isolated based on a modified CTAB protocol and PCR amplification was completed, using five decameric random primers from Operon Technologies, performed in a volume of 25 µl. Amplified profiles were visualized in agarose gels and genetic polymorphic distances were analyzed based on PCoA and R-software. A dendrogram of similarity for the eight populations was produced as well. RAPDs markers proved to be an efficient marker system in detecting polymorphisms among *Salvia officinalis* populations and work will continue with more populations and decameric primers, in order to have these preliminary data enriched and reliable.

Key words: *common sage, molecular markers, genetic variability, RAPDs*

Introduction

Salvia officinalis L. is one of the most important representatives of *Lamiaceae* family. It has been known for its medicinal and culinary uses since ancient times. These species have been investigated mainly for the content and composition of the essential oil, since this has proved to be responsible for most of the pharmacological effects attributed to the plant (Penso, 1983). Sage is valued because of its antiseptic, anti-inflammatory, antioxidant, carminative, cholagogue and diaphoretic properties. Common sage is widespread in the Mediterranean, South-East Africa, as well as in Central and South America, where it is largely cultivated both for culinary and medicinal purposes (Farkas, 2008; Echeverrigaray, 2006; Edris, 2007; Vera *et al.*, 1999). Sage is also used as spice and flavoring agent in perfumery and cosmetics (Delamare *et al.*, 2007; Skoula, 1999; Karousou, 2000). Meanwhile, Sage (*Salvia officinalis*), which is grown naturally in Albania, is studied and used extensively for trade. Also it is cultivated in a number of private companies for the high quality of the essential oils. Previous works have demonstrated that, based on morphological and chemical content of their essential oils, Albania is rich in natural populations of sage.

Molecular markers provide another powerful tool for proper characterization of plant germoplasm and their management. Among developed genetic markers, RAPDs, AFLPs and SSR have been widely used for diversity analyses (Thimmappaiah *et al.*, 2009; Adhikari S. 2013; Grepts, 1993; Khali, 2005). RAPDs markers have been used widely because they don't require DNA

probes and no sequence information for the design of specific primers. RAPD analysis can be used to identify genetic variation (Bered 2001; Taghian 2003), genetic diversity analysis (Zheng, 2001; Maric, 2004) and phylogenetic relationships (Tsuji, 2000; Goriunova, 2004).

A number of studies have addressed the diversity of the sage populations of Central and Southern Albania (Bacuet *et al.*, 2005; Bacuet *et al.*, 2009; Kongjikaet *et al.*, 2014; etc). However, the populations of north of the country are less exploited. Considering that they are grown in geographically isolated areas, with specific climatic and pedological conditions, we expect polymorphisms not only in botanical characteristics but in DNA level as well. The aim of the study is to evaluate the natural biodiversity of eight populations of northern Albania based on RAPDs.

Material and Methods

Plant material: Fresh young leaves from eight natural populations of *Salvia officinalis* of Northern Albania, 10 plants from each population, were used to extract total genomic DNA (Table 1).

Table 1. Sage germplasm used in this study, their source and origin.

Natural populations	Source	Origin
<i>Salvia officinalis</i>	Ulza 1	Albania
<i>Salvia officinalis</i>	Ulza 2	Albania
<i>Salvia officinalis</i>	Kruje	Albania
<i>Salvia officinalis</i>	Lezhe	Albania
<i>Salvia officinalis</i>	Valbona 1	Albania
<i>Salvia officinalis</i>	Shengjini 1	Albania
<i>Salvia officinalis</i>	Shengjini 7	Albania
<i>Salvia officinalis</i>	Shiroke mix	Albania

Isolation of genomic DNA: Equal amounts (0.1 g) of leaf tissue were placed in a mortar chilled with liquid nitrogen and were ground to fine powder. Total genomic DNA was extracted as described by Doyle and Doyle (1987). Quality and quantity of DNA was measured according to Sambrook *et al.*, 1989.

PCR amplification:

Five arbitrary RAPD primers were used, OPA06, OPA 14, S2134, OPA02, OPB06 (Cinnagen, Tehran, Iran). Primers were chosen from Scoulaet *et al.*, 1999 (Table 2).

The PCR amplifications were carried out in Veriti 96-Well Thermal Cycles (Applied Biosystem) in a total volume of 25 µl containing Master mix (Cinnagen, Tehran, Iran), genomic DNA (30 ng), 50 pmoles of decameric primer and ddH₂O. The PCR program started with an initial phase of 1 minute at 95°C, followed by 45 cycles of 30 s at 95°C, 30 s at 39°C, 2 min at 72°C and 10 min final elongation at 72°C.

Table 2. RAPD primers sequences according to Scoulaet *et al.*, 1999.

Primer	Primer sequence (5'-3')
OPA02	TGATCCCTGG
OPA06	GGTCCCTGAC
OPA14	TCTGTGCTGG
OPB06	TGCTCTGCCC
S2134	GACCAGCCCA

The amplified products were separated by electrophoresis in horizontal 1.2% agarose gels in 10X TBE. Gels were stained with 2 μ l ethidium bromide, and visualized under UV light. Fragments were scored as a binary variable, (1) for the presence, and (0) for the absence of each band. The most distinct well-resolved stable bands were considered for statistical analysis.

Statistical analysis: RAPDs gels were analysed by Principle Correspondance Analysis (PCoA) to infer the phylogeographic pattern of polymorphism distribution using R-software and “adgenet” library.

Results and Discussions

The RAPDs based analysis of eight populations of sage of northern Albania displayed a variable level of similarity for different primers used to amplify arbitrary primed regions. Three, random primers out of five gave best stable polymorphic profiles, which were further processed, respectively OPA14, OPA02 and S2134(Fig 1).

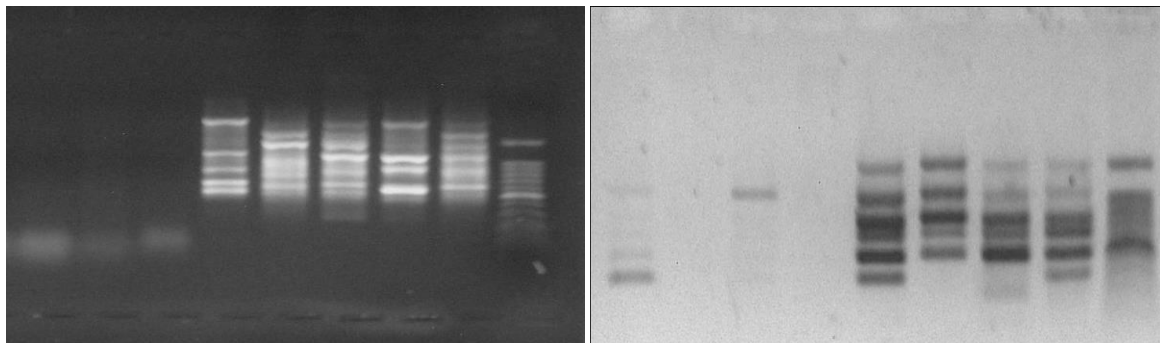

Fig 1. RAPDs profiles from eight sage populations generated from amplification with primers S2134 (right) and OPA02 (left). From left to right populations of Ulza 1; Ulza 2; Kruje; Lezhe; Valbona 1; Shengjin 1; Shengjin 7; Shiroke mix; 100bp marker.

Primer S2134 gave 12 bands from which 10 polymorphic, and primer OPA02 gave 13 bands from which 12 polymorphic. Reproducibility of banding patterns was good, and these bands were used for further processing in order to build clusters of similarity among the populations (Fig 2, 3, 4).

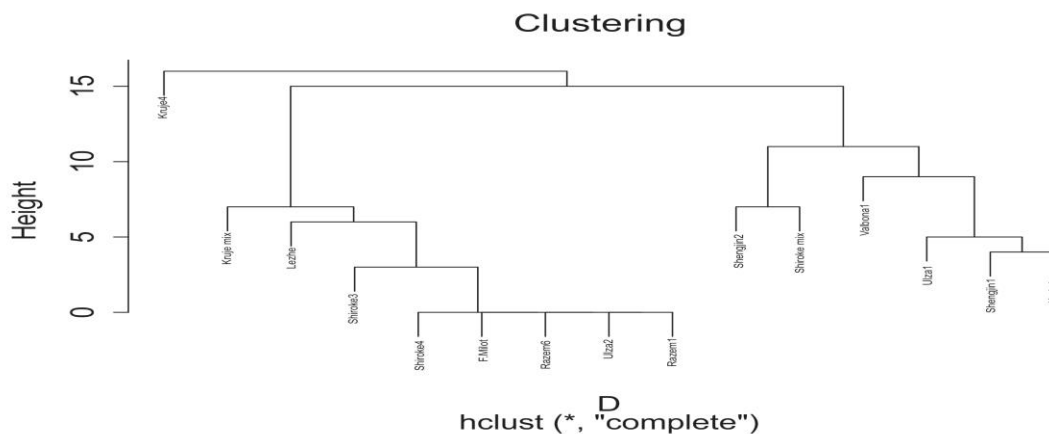

Fig 2.Dendrogram of polymorphic distances between analyzed samples, constructed by a complete linkage method.

The complete linkage method showed that populations are clustered in two main groups made of four populations each, with population of Kruja as a distinct one.

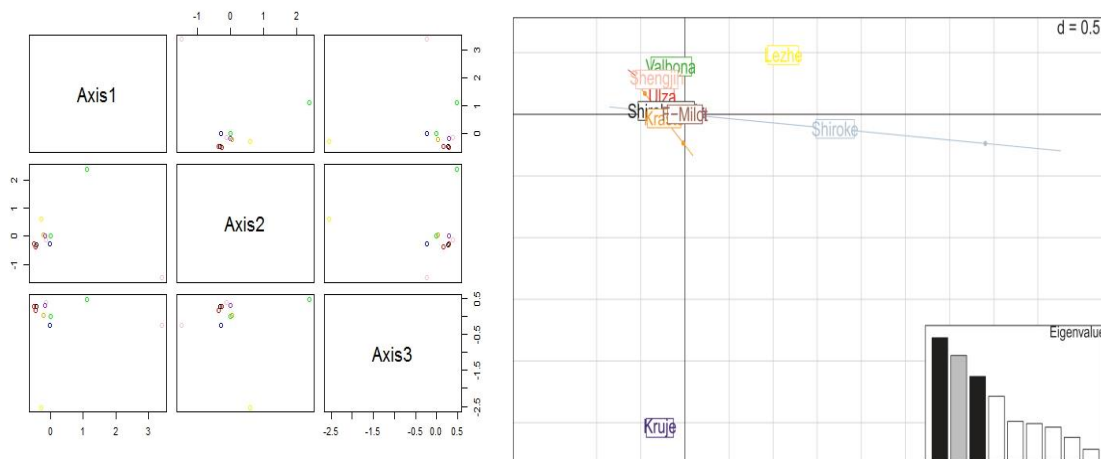

Fig 3/4.Clustering of populations of *Salvia officinalis* based on three principal components (PC).

Principle Correspondence Analysis (PCoA) of eight *Salvia officinalis* populations from the Northern Albania, which is plot by PC weight, shows that the most distant populations are Kruja, Shiroka, and Lezhe.

Conclusions

1. The RAPDs reactions showed that three out of five random primers (OPA14, OPA02 and S2134) are able to distinguish polymorphism between *Salvia officinalis* populations.
2. The PCoA suggests a high genetic distance among Lezha, Shiroka and Kruja populations with the rest, based on polymorphism of randomly amplified bands.
3. RAPDs analysis is a valuable tool to distinguish diversity at population level for *Salvia officinalis* populations, and can be implemented successfully to assess even the diversity among genotypes within populations.

References

- Adhikari S., Bandopadhyay T.K., Ghosh P.D. (2013). Assessment of genetic diversity of certain Indian elite clones of *Cymbopogon* species through RAPD analysis. *Indian Journal of Biotechnology* Vol 12; January 2013; pg 109-114.
- Bered F., Barbosa-Neto J.F., da Rocha B.M. de Carvalho F.I.F. (2001); Genetic variability in common wheat based on morphological traits, coefficients of parentage and RAPDs. *J New Seeds*; 3 (2001); pg 73-87.
- Delamare APL, Moschen-Pistorello IT, Artico L, Atti-Serafini L, Echeverrigaray S (2007) Antibacterial activity of the essential oils of *Salvia officinalis* L. and *Salvia triloba* L. cultivated in South Brazil. *Food Chem* 100(2):603–608.
- Doyle, J.J., and J.L. Doyle, 1987: A rapid DNA isolation procedure for small quantities of fresh leaf tissue. *Phytochem. Bull.* v. 9: 11-15, 1987.

- Echeverrigaray, S.; Agostini, G.(2006). Genetic relationships between commercial cultivars and Brazilian accessions of *Salvia officinalis* L. based on RAPD markers. Rev. Bras. Pl. Med., Botucatu, v.8, n.esp., p.13-17.
- Farkas A., Papp N., Horvath G., Nemeth T.S., Szabo*, Nemeth T. (2008) RAPD based genetic diversity among *Salvia officinalis* L. populations. FARMACIA, 2008, Vol.LVI, 3 pg 339-343.
- Gepts, P. (1993). The use of molecular and biochemical markers in crop evolution studies.Evol. Biol. v.27: 51-95, 1993.
- Goriunova S V., Kochieva E Z., Chikida N N., Pukhal'skii V A. (2004). Phylogenetic relationships and intraspecific variation of D-genome Aegilops L. as revealed by RAPD analysis.Genetica, 40. Pg. 642-651.
- Javan Z.S., Rahmani F., Heidari R. (2012). Assessment of genetic variation of genus *Salvia* by RAPD and ISSR markers.Australian Journal of Crop Science; AJCS. 6(6); Pg 1068-1073.
- Karousou R., E. Hanlidou, S. Kokkini, (2000). The sage plant of Greece: distribution and intraspecific variation, in Sage the genus *Salvia*, Ed. S. E. Kintzios, Amsterdam, Harwood Academic Publishers, 2000, pp. 27–46.
- Khalil A., Dhia S., Hassawi.,Kharma A. (2005). Genetic relationship among *Salvia* species and antimicrobial activity of their crude extract against pathogenic bacteria. Asian Journal of Plant Sciences 4 (5): 544-549, 2005. ISSN 1682-3974.2005 Asian Network for Scientific Information. Pg. 544-549.
- Maric S., Boloric S., Mortincic J., Pejic I., Kozumplik V. (2004).Genetic diversity of hexaploid wheat cultivars estimated by RAPD markers, morphological traits and coefficient of parentage. Plant Breed, 123, Pg 366-369.
- Penso G (1983) Index PlantarumMedicinaliumTotius Mundi EorumgueSynonymorum. Milano: OEMF.
- Sambrook, J., Fritsch, E. F., &Maniatis, T. (2000).*Molecular Cloning: A Laboratory Manual*. 2nd ed. Cold Spring Harbor: Cold Spring Harbor Laboratory Press, ISBN 0-87969-309-6.
- Skoula M., El Hilali I., Makris A. M., (1999). Evaluation of the genetic diversity of *Salviafruticosa*Mill. clones using RAPD markers and comparison with the essential oil profiles. Pergamon Biochemical Systematics and Ecology V. 27 (1999) Pg. 559-568
- Shasany A. K., Darokar M.P., Dhawan S., Gupta A.K. , Gupta S., Shukla A. K. , Patra N.K. , S. P. S. Khanuja S.P.S. (2005). Use of RAPD and AFLP Markers to Identify Inter- and Intraspecific Hybrids of *Mentha*. Journal of Heredity 2005:96(5):542–549 doi:10.1093/jhered/esi091; Advance Access publication August 31, 2005; Pg 542-549.
- Taghian A.S., Abo-Elwafa A., (2003).Multivariate and RAPD analyses of draught tolerance in spring wheat (*Triticumaestivum* L.).Assiut J AgrilSci, 34, Pg 1-25.
- Thimmappaiah, Santhosh WG, Shobha D, Melwyn GS (2009) Assessment of genetic diversity in cashew germplasm using RAPD and ISSR markers. Scientia Hortic 120:411–417.
- Tsuji K., Ohnishi O., Xiu P. (2000). Origin of cultivated Tatar buckwheat (*Fagopyrumtataricum*Gaertn.) revealed by RAPD analyses. Genet Resour Crop Evol, 47.Pg 431-438.
- Vera, R.R.; Chane-Ming, J., Fraisse, D.J. (1999) Chemical composition of the essential oil of sage (*Salvia officinalis* L.) from Reunion Island. J. Essent. Oil Res.v.19: 399-402.
- Zheng Y. L. Chen Y. O. Wei Y M., Zhou Y H., Zhang Z. O. (2001). Esterase, gliadins and RAPD variations among Siuchan wheat (*Triticumaestivum*) cultivars. Wheat InfServ, 92. Pg 5-8.

COMPARATIVE EXTRACTION PROTOCOLS FOR AN EFFICIENT GENOMIC DNA FROM *Salvia officinalis* L.

Stela PAPA*, Ariola BACU

Department of Biotechnology, Faculty of Natural Sciences, University of Tirana, Albania. Blv "Zogu I", Tirana, Albania

*Corresponding author: stelapapa@yahoo.com

Abstract

Studies on plants genetics generally and those on aromatic-medicinal species, including sage, particularly start with establishing of protocols for high quality DNA extractions. Different protocols have been reported, including CTAB based and commercially available kits. DNA from medicinal and aromatic plants such as common sage (*Salvia officinalis*, L.), as a result of the high content of secondary metabolites, which interfere with DNA isolation, need to be extracted with protocols modified in order to produce a DNA of good quality. In this study, two protocols were compared. DNA was isolated from fresh and dried leaf materials of 6 populations of *Salvia officinalis* of Northern Albania and quantity and quality in each case were determined based on spectrophotometry. Results show that for a good quality and quantity of genomic DNA the samples should be fresh young leaves and that both CTAB modified protocol and Plant Genomic DNA Kit (SIGMA) protocol avoid contaminants as carbohydrates and phenolics.

Key words: *genomic DNA, CTAB, Salvia officinalis*L.

Introduction

Medicinal plants have been used as natural remedies for thousands of years and in our days they are attracting more attention for researchers. Medicinal plants have a great diversity of bioactive components, which have been studied from many aspects (Leone *et al.* 2007; Ramawat and Merillon, 2008; Arora, 2011). These plants contain exceptionally high amounts of polysaccharides, polyphenols, and other secondary metabolites, which are often responsible for their therapeutic and pharmacological properties (Abu-Romman, 2010).

Garden sage (*Salvia officinalis* L.) has a very long tradition as a medicinal and aromatic herb with a broad range of applications. Sage is an important member of the mint family (*Lamiaceae*) used in medicine for treating many diseases (Lu and Foo, 2000). Common sage is characterized by a high content of polysaccharides, polyphenols, flavonoids, alkaloids, carbohydrates and diterpenoids (Kintzios, 2000), and so may be a recalcitrant target for isolation of large quantities of pure genomic DNA. Several studies have shown sage to be one of the sources of some potent antioxidants and antimicrobial agents (Cuvelier *et al.*, 1996). The application of molecular technology would increase and will as well facilitate the production of these substances (Stöckigt *et al.*, 1995) and help save natural resources (Pirttilä *et al.*, 2001).

These same substances that make the aromatic plants worthy of different studies may also be an impediment for isolation of large quantities and efficient genomic DNA. Phenols and polysaccharides bind firmly to nucleic acids during DNA isolation and interfere with subsequent reactions. Polyphenols released from vacuole during the cell lysis process are oxidized by cellular oxidases and undergo irreversible interactions with nucleic acids causing browning of the DNA

thus making the DNA resistant to restriction enzymes and polymerases (Abu-Romman, 2010; Aleksic, 2012).

The aim of this study was to establish an efficient DNA isolation protocol to obtain large amount of high quality DNA. The procedure of Doyle and Doyle (1987) and Plant Genomic DNA Kit (SIGMA) protocol were tested for ten sage plants of natural populations; Additional modifications were used to simplify the isolation procedure and to improve both DNA yield and purity. DNA isolates were used for specific PCR amplification of one nuclear region (26S rDNA), and one MTPs specific region, which can be potentially informative for future studies in common sage.

Material and Methods

Plant materials

Fresh young leaves were obtained from six populations of *S. officinalis* grown naturally in northern Albania region (populations of Rubik, Balldren, Lohe, Kruje, Fushe-Milot, Razem). Before proceeding with DNA extraction, leaves were placed in a mortar pre chilled with liquid nitrogen. Frozen sample was ground with a pestle and liquid nitrogen was added to prevent thawing, and two protocols were followed.

A) Modified Doyle & Doyle DNA extraction

All reagents and chemical used for optimization of DNA extraction has been manipulated in different combination for obtaining pure DNA from the leave sample.

- Doyle and Doyle(1987) protocol were followed up to the dilution of the DNA pellet in TE;
- Then were added 50mg of PVPP and 5µl of Proteinase K in order to rapidly inactivate nucleases that might otherwise degrade the DNA or RNA during purification.
- RNase treatment were followed in order to definitely degrade the RNA traces possibly present at samples.

B) GenElute™ Plant Genomic DNA Kit (SIGMA) protocol G2N-70; LOT 094K6032

After the extraction procedure described according to the manufacturer of Plant Genomic DNA Kit (SIGMA), a second purification procedure was followed using phenol-chloroform-isoamylalcohol according to Sambrook *et al.* (1989).

Measurement of quality and quantity of DNA was completed following Sambrook *et al.*, (1989) using the spectrophotometer ACTGene ASP-3700. Results are given at table 1.

PCR Analysis: In order to verify the quality of the genomic DNA extracted with both methods, two specific PCR amplification reactions were prepared: One for the direct amplification of the approximately 300bp region, a control DNA fragment, with Phire Plant Direct PCR Kit F-130, according to Demesure *et al.* (1995), and the second for the amplification of a central region of MTPs coding genes;

Amplification of the control DNA fragment according to Demesure et al. (1995):

50ng of genomic DNA were used as a template for PCR amplification.

The amplification was carried out in a 20 µl reaction mixture containing 2X Phire Plant PCR buffer (includes dNTPs and MgCl₂) 10µl, 25 µM Control Primer mix (Forward Primer 5'-AGTTCGAGCCTGATTATCCC-3' and Reverse primer 5'-GCATGCCGCCAGCGTCATC-3'), 0.4 µl Phire Hot start II DNA Polymerase and 7,2 µl ddH₂O. Cycling conditions consisted of an initial 5 min at 98°C followed by 5 sec denaturing at 98°C, 5 sec annealing at 62°C and 20 sec elongation at 72°C repeated for 40 cycles and with 1 min extension at 72°C.

Amplification of the central region of MTPs coding genes:

To test the suitability of the extracted DNA for enzymatic reactions, PCR was carried out using specific primers, Forward primer Sbs350 (5' TTCAACAGTTGGAGTTGATTGATGA 3') and reverse primer Sbs1010 (5' ATTCCACAATCCTATCTCTCACAAA 3'), designed to amplify a 720 bp amplicon for *S. officinalis* gene. The amplification was carried out in a 25 µl reaction mixture containing 1x PCR reaction buffer, 0.2 mM dNTPs, 100 pmol forward and reverse primers, 3 µM MgCl₂, and 0.5 U of *Taq* DNA polymerase. Cycling conditions consisted of an initial 3 min at 94°C followed by 0.5 min denaturing at 94°C, 1 min annealing at 66°C and 30 sec elongation at 72°C repeated for 35 cycles and with 5 min extension at 72°C.

Genomic DNA extracted using the two protocols was used as template for PCR amplification.

Results and discussions

This research was focused on comparing two types of DNA extraction protocols in order to establish the most suitable one for the isolation of nucleic acids from *Salvia officinalis* leaf tissue. The establishment of suitable nucleic acid isolation protocols that can produce high yield of genetic material with minimal contaminant from this plant is an important starting point for subsequent molecular genetic studies. A good quality and quantity of isolated DNA is crucial for molecular techniques such as polymerase chain reaction (PCR), Southern blotting and other genomic analysis. The modified CTAB protocol was efficient and so did the CTAB based method, however both were modified with additional steps. The first DNA extraction protocol was based on Doyle and Doyle (1987). CTAB, a strong ionic detergent, has been used to facilitate the separation of proteins from nucleic acids in extractions of biological materials. There were made some modifications to the original protocol such as the additional steps of PVPP and Proteinase K as well as the treatment with RNase in order to improve the extracted DNA. Based on Krizman *et al.*, (2006) this modification works well with aromatic plants, and our results prove this as well. The second protocol was the GenElute™ Plant Genomic DNA Kit (SIGMA). Without a second purification based of phenol:chlorophorm:isoamylalcohol, the quality of DNA was much lower (Graphic 1).

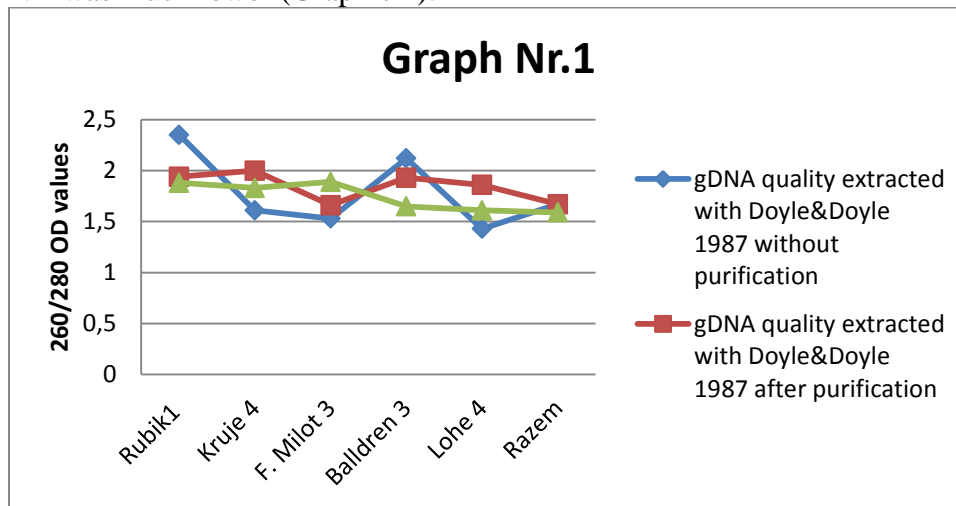

Graphic1. Comparative data of gDNA quality extracted with Doyle and Doyle (1987) without the second purification (blue line) with phenol:chlorophorm:isoamylalcohol and the data of purified gDNA quality extracted with Doyle and Doyle (1987) (red line) and with GenElute™ Plant Genomic DNA Kit (SIGMA) protocol (green line), both after purification steps with phenol:chlorophorm:isoamylalcohol.

Table 1 shows the yield and quality of sage DNA isolated using both methods and suggests that the first based on Doyle and Doyle(1987) modified, gives better results on the quality of the DNA.

Table 1. Quality and Quantity results measured spectrophotometrically.

Sample ID	Abs260	Abs280	Abs230	260/ 280	260/ 230	concentration(ng/ul)	Sample Type	Protocol used
Rubik1	0.293	0.151	0.136	1.94	2.15	14.6	dsDNA	CTAB (Doyle&Doyle) modified
								PLANT GENOMIC DNA SIGMA kit
Kruje4	0.996	0.53	0.702	1.88	1.42	49.7	dsDNA	CTAB (Doyle&Doyle) modified
	0.685	0.342	0.112	2	6.12	34.2	dsDNA	CTAB (Doyle&Doyle) modified
F. Milot 3								PLANT GENOMIC DNA SIGMA kit
	0.064	0.035	0.042	1.83	1.52	3.1	dsDNA	CTAB (Doyle&Doyle) modified
Balltren 3	0.078	0.047	0.074	1.66	1.05	3.9	dsDNA	CTAB (Doyle&Doyle) modified
								PLANT GENOMIC DNA SIGMA kit
Lohe 4	0.125	0.066	0.052	1.89	2.4	6.2	dsDNA	CTAB (Doyle&Doyle) modified
	0.11	0.057	0.072	1.93	1.52	5.5	dsDNA	CTAB (Doyle&Doyle) modified
Lohe 4								PLANT GENOMIC DNA SIGMA kit
	0.132	0.08	0.255	1.65	0.52	6.6	dsDNA	CTAB (Doyle&Doyle) modified
Lohe 4	0.067	0.036	0.072	1.86	0.93	3.35	dsDNA	CTAB (Doyle&Doyle) modified
								PLANT GENOMIC DNA SIGMA kit
	0.087	0.054	0.098	1.61	0.89	4.3	dsDNA	SIGMA

Razem	3.757	2.25	2.015	1.67	1.86	187.8	dsDNA	kit CTAB (Doyle& Doyle) modified
	3.619	2.272	1.955	1.59	1.85	180.9	dsDNA	PLANT GENOMI C DNA SIGMA kit

The DNA yield obtained via the modified protocol varied from 6-100 ng/μl DNA of leaf tissue (Table 1).

Specific PCR results

Figure 1 (left) illustrates the amplification of the 297 bp control DNA fragment from the gDNA of two populations of sage. Figure 2 (right) illustrates the amplification of the MTP coding region from six populations of sage. Population of Razem in MTPs primers (Fig 2) amplification did not give an amplicon (first line after the marker). These results indicate that the two protocols of DNA extraction were able to produce a relatively good quality DNA suitable for PCR amplification, however, there are differences in the quantity.

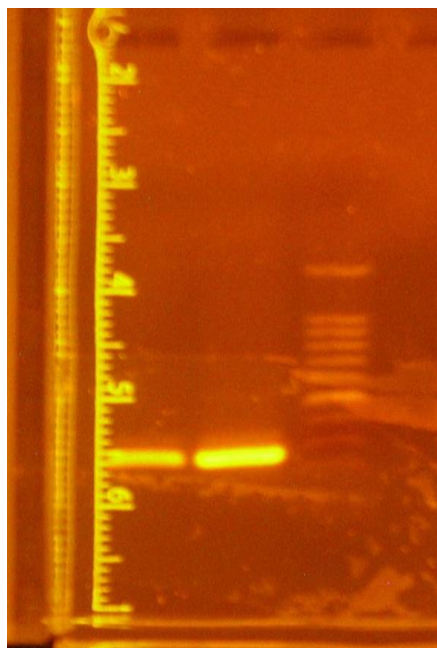

Fig 1. Two populations of sage Rubik 1, Kruje 4, 100bp marker (from left to right), amplified of the 297bp control DNA fragment with FINNzymes protocol.

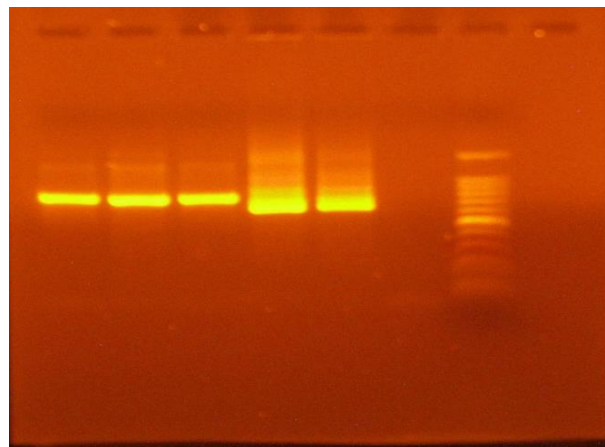

Fig 2. Six populations of sage, Rubik1, Kruje4, F.Milot 3, Balldren 3, Lohe4, Razem 100bp marker (from left to right), amplified with specific primers for MTPs.

Conclusions

Summing up, the two methodologies tested in this study were shown to be adequate for molecular studies in common sage. However, the modified CTAB methodology is recommended due to lesser costs especially and SIGMA kit is recommended due to the practicability of the method, especially considering DNA extraction from fresh plant leaves.

References

- Abu-Romman S. (2010). Comparison of methods for isolating high quality DNA from sage (*Salvia officinalis*). Journal of Medicinal Plants Research Vol. 5(6), pp. 938-941, 18 March, 2011 Available online at <http://www.academicjournals.org/JMPR> ISSN 1996-0875 ©2011 Academic Journals. Pg 938-941.
- Aleksic J. M. ´ Stojanovic D. Banovic B. Jancic R. (2012). A simple and efficient DNA isolation method for *Salvia officinalis*. Biochem Genet (2012) 50:881–892 DOI 10.1007/s10528-012-9528-y. pg 881-892.
- Arora R (2011) Medicinal plant biotechnology. CABI, Oxfordshire
- Cuvelier ME, Richard H, Berset C (1996). Antioxidative activity and phenolic composition of pilot-plant and commercial extracts of sage and rosemary. J. Am. Oil Chem. Soc., 73: 645-652.
- Demesure B. *et al.* (1995) Molecular Ecology 4: Pg 129-131.
- Doyle JJ, Doyle JL (1987) A rapid isolation procedure for small quantities of fresh leaf tissue. Phytochem Bull 19:11–15
- Lade B. D., Patil A.S. and Paikrao H. M. (2014). Efficient genomic DNA extraction protocol from medicinal rich passiflora foetida containing high level of polysaccharide and polyphenol. Lade et al. SpringerPlus 2014, 3:457 <http://www.springerplus.com/content/3/1/457>. pg 1-7
- Leone A, Grillo S, Monti L, Cardi T (2007) Molecular tailoring and boosting of bioactive secondary metabolites in medicinal plants. In: Ranalli P (ed) Improvement of crop plants for industrial end uses. Springer, Dordrecht, pp 471–507\
- Lu Y, Foo LY (2000). Flavonoid and phenolic glycosides from *Salvia officinalis*. Phytochem., 55: 263-267.
- Kintzios SE (2000) Medicinal and aromatic plants, industrial profiles: sage, the genus *Salvia*, vol 14. Harwood Academic Publishers, Amsterdam
- Krizman M, Jakse J, Baricevic D, Javornik B, Prosek M (2006). Robust CTAB-activated charcoal protocol for plant DNA extraction. Acta Agric. Slovenica, 87: 427-433.
- Pirttilä AM, Hirsikorpi M, Kamarainen T, Jaakola L, Hohtola A (2001). DNA isolation methods for aromatic and medicinal plants. Plant Mol. Biol. Rep., 19: 273a-273e.
- Ramawat KG, Merillon JM (2008) Bioactive molecules and medicinal plants. Springer, Berlin
- Sambrook J, Russel DW (2001). Molecular cloning: a laboratory manual. Third Edition. Cold Spring Harbor Laboratory Press. New York.
- Stöckigt J, Obitz P, Falkenhagen H, Lutterbach R, Endress S (1995). Natural products and enzymes from plant cell cultures. Plant Cell Tissue Organ Culture, 43: 97-109.
- Tan H., Huang H., Tie M., Ma J. & Li H. (2013) Comparative analysis of six DNA extraction methods in cowpea (*vigna unguiculata* l.walp. Journal of Agricultural Science; Vol. 5, No. 7; 2013 ISSN 1916-9752 E-ISSN 1916-9760 Published by Canadian Center of Science and Education, pg 82-90.

ALLELOPATHIC EFFECTS OF OREGANO AND ROSEMARY ESSENTIAL OILS ON GERMINATION AND SEEDLING GROWTH OF DURUM WHEAT

Mehmet ATAK^{1*}, Kazım MAVİ², İlhan ÜREMİŞ³

¹Department of Field Crops, Faculty of Agriculture, Mustafa Kemal University, Hatay, Turkey

²Department of Horticulture, Faculty of Agriculture, Mustafa Kemal University, Hatay, Turkey

³Department of Plant Protection, Faculty of Agriculture, Mustafa Kemal University, Hatay, Turkey

*Corresponding author: matak@mku.edu.tr

Abstract

Some allelochemical compounds secreted by variety plants parts may cause allelopathic effects on other organism. The aim of this study was to investigate the effect of *Origanum onites* L. (*Ori*) and *Rosmarinus officinalis* L. (*Ros*) essential oils on durum wheat germination and seedling growth. Doses of 0, 2, 4, 8 and 16 µL per petri dishes were applied, and five durum wheat cultivar seeds were allowed to germinate at 20 ± 2 °C in the dark for 10 days. Germination percentage (GP), germination index (GI), mean germination time (MGT), seedling shoot length (SL), seedling root length (RL), and seedling fresh weight (SFW) of cultivars were measured. Results showed that the significant allelopathic effect of essential oils was depended on cultivars, oil types and oil practiced doses. Both *Ori* and *Ros* essential oil caused a generally reducing effect on GR, GI, SL, RL, and SFW of the tested genotypes. Inhibition rates related to tested traits was increased with the increasing doses. When control and lowest oil doses and control and highest oil doses were compared, *Ori* oil caused 46.2 to 98.3 % GP inhibition, 60.3 to 94.6 % GI inhibition, 25.1 to 90.8 % SL inhibition, 47.8 to 95.6 % RL inhibition, 21 to 84 % SFW inhibition, respectively. When *Ros* oil was concerned inhibition rate range of GP was from 15.1 to 91.5 %, GI from 31.8 to 96.6 %, SL from 22.1 to 88.2 %, RL from 24.2 to 91.9 %, and SFW from 14.4 to 68.5 %. There was a delay on MGT of cultivars as the oil dose was increased. *Ori* oil had higher allelopathic effect than did *Ros* oil on seed germination and seedling growth of durum wheat. The result of the study also demonstrated that essential oil of *Ori* and *Ros* had allelopathic potential and should be evaluated as allelopathic agents if it will be used for control of weeds and volunteer wheat species.

Key words: *Durum wheat, oregano, rosemary essential oils, germination and seedling growth*

Introduction

Being a leading crop, bread wheat (*Triticum aestivum* L.), durum wheat (*Triticum durum* Desf.), and soft wheat (*Triticum compactum* Host.) cultivars or landraces are grown varying geographical conditions of Turkey; such that 15 - 12% of the wheat produced in Turkey belongs to durum wheat (Anonymous, 2013). When wheat species are grown there are varied environmental constraints that affect wheat yield and yield components. Weeds are one of the main constraints that negatively affect wheat yield loss across the wheat growing areas of the world as well as Turkey since they deprive the plants from limited available nutrients, light and moisture. More specifically, weeds are responsible for 23% wheat yield reduction in the worldwide (Oerke, 2006). Some weeds are also shown for their allelopathic or toxic effect on the wheat germination and seedling growth (Fragasso et al., 2013). Accurate weed control is needed for wheat based food security for every country of the world. To achieve weed control, increased amount of herbicides have been used. In long run chemical weed control will be facing some

challenges such as herbicide resistance in weeds, negative impact of herbicides on environment, human and animal health and increasing management cost for herbicide. This has resulted in increased consideration to alternative strategies for development of new environmental friendly biodegradable compounds especially in organic farming (Jabran et al., 2015).

Some allelochemical compounds secreted by variety plants parts may cause allelopathic effects on other organism or plants (Angelini et al., 2003; Bonanomi et al., 2006; Jabran et al., 2015). Allelopathic effect of some essential oil crops has been investigated in various oil or ornamental plants or crops by varying different parts. Different chemical components of essential oils have varying effect on crop plants. Germination inhibition caused by essential oils, as applied to the germinated seed of various crops and weeds has been reported by the previous works (Azirak and Karaman, 2008; Mutlu and Atıcı, 2009; Uremis et al., 2009; Gitsopoulos et al., 2013)

In Turkey, durum wheat cultivars' products frequently are used as a homemade food such as bulgur, macaroni, eriste (noodle), cakes, breads etc. For making healthy homemade food products, organic durum wheat is highly preferred by the consumers. By using plant biodegradable agents in weed and insect control is an indispensable component of organic durum wheat farming. For these aims different essential oils, doses and different durum wheat cultivars should be tested and investigated for potential weed control agents or volunteer wheat.

To the best of our knowledge, there were not much previous reports on cultivar based allelopathic effects of essential oil. The aim of this study was to evaluate essential oils of *Origanum onites* L. (*Ori*) and *Rosmarinus officinalis* L. (*Ros*) as an allelopathic agent on five durum wheat cultivars germination and seedling growth.

Materials and Methods

This study was conducted at the Faculty of Agriculture, Mustafa Kemal University, Hatay (Turkey) in 2015. Registered durum wheat cultivars seeds of Turkey namely 'Ankara-98 (A), Ç-1252 (Ç), İmren (İ), Kızıltan-91 (K), and Yelken-2000 (Y)' were provided by the Field Crops Central Research Institute (Ankara, Turkey). Germination and early seedling growth (10 days) of the cultivars were studied using distilled water (control) and essential oil doses of 2, 4, 8, 16 µL / petri dish containing *Ori* or *Ros*.

The essential oil was extracted from shade dried shoots and leaves of *Ori* and *Ros* samples. The GC-MS analysis were also performed by using a gas chromatograph HP 6890 (Agilent Technologies, Palo, Atla, USA) with electron impact ionization (70 eV) to determine yield of oils. Detailed information and procedure about used plant material, oil extraction and yield of essential oil can be seen in our previous work (Atak et al., 2016).

For each wheat cultivar surface sterilized seeds, 0, 2, 4, 8 and 16 µL essential oil per petri dishes (9 cm) were tested for seed germination and seedling growth with four replicates. To test the effect of the essential oils, 25 seeds were put on two layered filter paper (Whatman no 1.) in a petri dishes moistened with 6 mL distilled water. Aforementioned amount of essential oils was applied on the small piece of filter paper attached inside the petri dishes caps. Petri dishes were closed immediately and tightly sealed with parafilm to prevent loss of moisture, essential oil and avoid contamination and then incubated in a germination cabinet (SANYO FOC 225 İ, Refrigerated-Incubator, JAPAN). The wheat seeds were allowed to germinate at 20 ± 2 °C in the dark for 10 days (ISTA, 1996). A seed was considered as germinated when the emerging radicle elongated to 2 mm. Germination percentages were recorded every 24 h for 8 days.

Mean germination time (MGT) was calculated to assess the rate of germination (Ellis and Roberts, 1980). Germination index (GI) was calculated by using Maguire's (1962) procedure. The seedlings were thinned to 10 plantlets per petri dish after the eighth day. Fresh root and shoot

length and seedling fresh weights were measured on the tenth day of the experiment (Atak et al., 2016). A completely randomized design was used with a factorial arrangement of treatments (Oil (O), cultivar (G) and essential oil concentration (D)) with 4 replications and 25 seeds in each replicate. Data were analyzed by 2-way analysis of variance using statistical package MSTAT-C, and differences among the means were compared using Duncan's multiple range test ($P < 0.05$).

Result and Discussion

Analyses of variance (ANOVA) showed that tree ways interactions of tested treatments were highly significant except SL and SFW. All main effects of G were significant for all the treatments. Main effects of O were significant for all the tested treatments but not for the SL. Main effects of D were significant for all the tested treatments.

Performed ANOVA indicated that GP was significantly affected by O x G x D interaction (Figure 1). The essential oil of *Ori* and *Ros* significantly inhibited GP of wheat genotypes compared to respective control. The GP inhibition was higher for the essential oil of *Ori* and it was more pronounced at increasing dose of the respective oil (Figure 1). When 16 μ L and 2 μ L *Ori* was used 98.3% and 46.2% GP, respectively, inhibition was noted in durum wheat cultivars. The wheat cultivars' germination inhibition rate of *Ros* was ranged 91.3% (16 μ L) to 15.1% (2 μ L). The GP inhibition effect of *Ori* essential oil was more apparent as the dose increased. More specifically, at the highest dose of *Ori* there was no germination in other cultivars but cv. İmren showed 8% GP. On the other hand, all cultivars GP were not totally inhibited at 16 μ L of *Ros* (Figure 1). GP of cultivars was ranged 5 to 12% at the highest dose of *Ros*. These results showed that essential oil dose of *Ori* and *Ros* had inhibition effect on seed GP of the durum wheat cultivars, but inhibition effect of *Ori* oil was more remarkable (Figure 1). It was reported that terpenoids, in particular monoterpenes and sesquiterpenes were the main components of essential oils responsible for inhibitory effects on weeds and crops (Gitsopoulos et al., 2003; Uremis et al., 2009). Dudai et al. (2004) informed that monoterpenes such as Carvacrol had very powerful seed germination inhibitors for wheat. Our experiment result also reveals that carvacrol had negative effect on the germination of durum wheat cultivars in varying proportions since *Ori* oil had more carvacrol rate than *Ros*. Our previous experiment results showed that *Ori* oil had more inhibition effect than the *Ros* oil had on bread wheat and some weed species germinating and seedling growth (Atak et al., 2016).

Mean germination time (MGT) was delayed as the dose of essential oil increased (Figure 1). When the genotypes exposed to *Ori* oil MGT ranged 2.79 to 6.29 days. But the MGT for the genotypes exposed to *Ros* oil ranged 1.97 to 6.93 days (Figure 1). There are no previous experimental results representing essential oil effect on MGT in durum wheat. Our results showed that interested essential oils affected MGT in durum wheat cultivars variably depending on concentration of type of essential oil and cultivars.

Germination index (GI) was decreased as the dose of oil increased. GI for the genotypes exposed to *Ori* oil ranged 14.6 to 0.78. But the GI for the genotypes exposed to *Ros* oil ranged 15.5 to 0.52 (Figure 1). There were no previous experimental results representing essential oil effect on GI in durum wheat. Our results showed that respective essential oils affected GI in durum wheat cultivars variably depending on dose, type of essential oil and cultivars. Higher GI represents the higher seed vigor of crops. Our results showed that when used *Ori* seed vigor of the genotypes were more affected as compared to *Ros* oil.

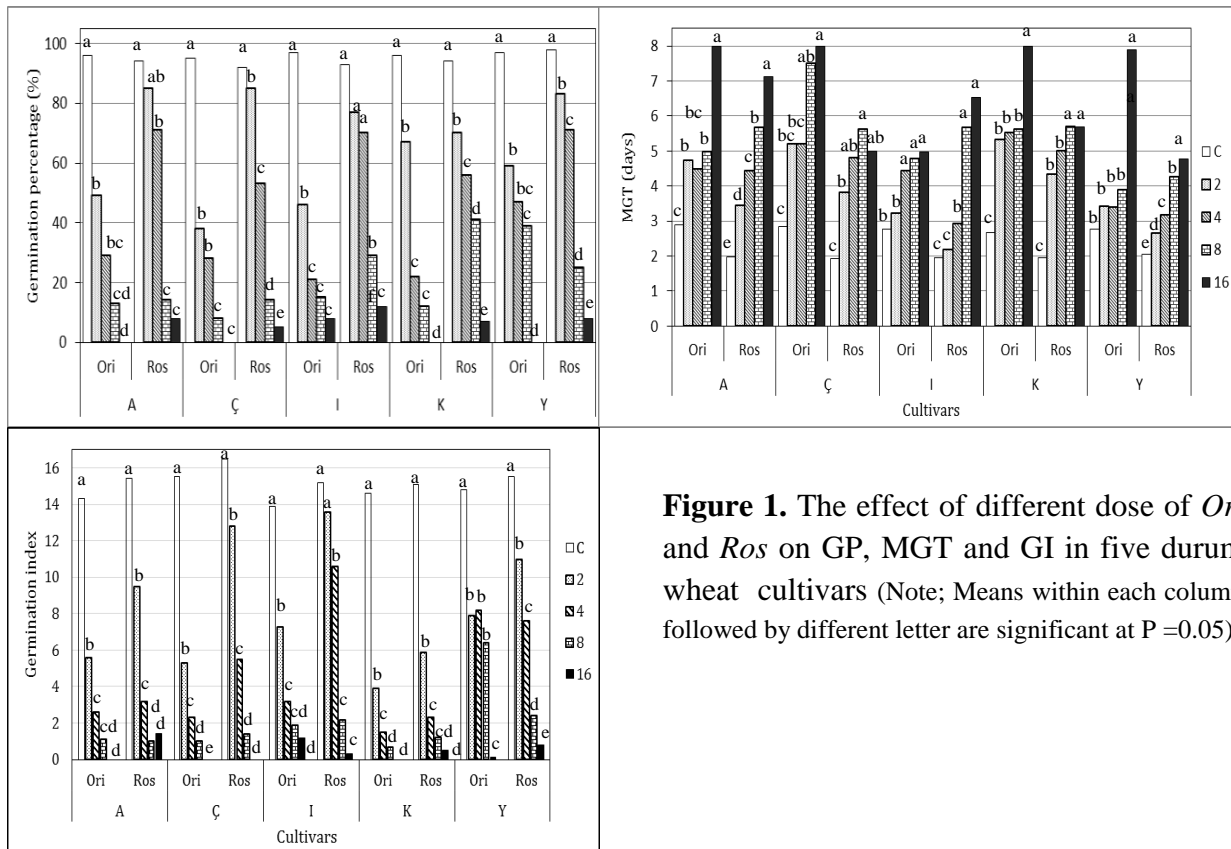

Figure 1. The effect of different dose of *Ori* and *Ros* on GP, MGT and GI in five durum wheat cultivars (Note; Means within each column followed by different letter are significant at $P = 0.05$).

Essential oil of *Ori* and *Ros* not-significantly reduced seedling shoot length (SL) of durum wheat cultivars compared to respective control treatments (Table 1). But, the reduction rate of SL was relatively increased with the increasing dose of both essential oil types. The essential oil of *Ori* proved more powerful allelopathic effect compared to the essential oil of *Ros*. Both oil dose of 2 μL and 16 μL when compared, shoot length of genotypes ranged 72.5 to 9mm and 79.6 to 12.0mm using *Ori* and *Ros*, respectively. Cultivars showed the varying inhibitory effect with increasing oil doses of essential oil type (Table 1).

Essential oil of *Ori* and *Ros* significantly reduced the seedling root length (RL) of durum wheat genotypes compared to respective controls (Table 1). The inhibition rates were relatively increased with the increasing dose of both essential oils. But RL inhibition rate caused by *Ori* was higher than the inhibition rate of *Ros*. Previous experiments reported that essential oil effect on various cereal crops (Dudai et al., 1999; 2004) including bread wheat germination inhibition (Atak et al., 2016).

Essential oil of *Ori* and *Ros* significantly decreased the seedling fresh weight (SFW) of durum wheat genotypes compared to respective controls (Table 3). The inhibition rate was relatively increased with the increasing dose of both essential oils. The SFW of durum wheat genotypes were inhibited by 84% and 68.5%, by application of highest dose of *Ori* and *Ros* oil, respectively (Table 1). This study results confirmed allelopathic activity (inhibition) of essential oils extracted from *Ros* and *Ori* on the investigated durum wheat cultivars. The essential oil of *Ori* exhibited the more powerful allelopathic effect compared to *Ros* essential oil on the tested durum wheat cultivars in terms of germination and seedling growth.

Table 1. The effect of different dose of essential oil on shoot length, root length and seedling fresh weight of five durum wheat genotypes

Shoot length (mm)							
Genotype	E.Oils	Control	2µL	4µL	8µL	16µL	Mean
A	ORI	97.8 a	78.6 a	58.5 b	34.8 b	0.0 c	55.3
	ROS	103.8 a	67.6 b	51.3 bc	28.6 cd	19.7 d	
Ç	ORI	113.0 a	68.2 b	44.4 bc	26.9 cd	0.0 d	53.5
	ROS	99.5 a	83.6 b	51.9 b	38.5 b	09.0 c	
İ	ORI	85.9 a	78.9 a	42.6 b	33.8 b	20.7 b	53.2
	ROS	101.1 a	66.4 b	58.0 b	29.9 c	14.5 c	
K	ORI	93.8 a	54.9 b	48.5 b	40.6 b	24.2 c	55.1
	ROS	108.3 a	90.9 b	49.8 c	28.0 c	12.0 d	
Y	ORI	96.9 a	81.3 a	72.2 a	44.7 b	0.0 c	59.3
	ROS	98.2 a	89.4 ab	67.5 bc	37.9 c	5.0 d	
	ORI	97.5	72.4	53.2	35.9	9.0	
	ROS	102.2	79.6	55.7	32.6	12.0	
Root length (mm)							
A	ORI	110.3 a	43.9 b	31.2 bc	12.6 cd	0.0 d	47.7
	ROS	113.7 a	72.5 b	54.2 b	22.8 c	15.3 d	
Ç	ORI	113.3 a	41.1 b	22.2 c	6.1 c	0.0 c	45.9
	ROS	107.3 a	90.3 a	46.8 b	24.3 b	7.0 c	
İ	ORI	86.6 a	49.5 b	19.7 c	5.3 c	4.8 c	44.9
	ROS	107.8 a	76.8 b	71.9 b	19.1 c	7.6 c	
K	ORI	95.3 a	60.0 b	17.5 c	16.3 c	15.6 c	50.1
	ROS	106.9 a	95.9 a	53.6 b	31.9 b	8.0 c	
Y	ORI	93.0 a	65.0 b	33.6 c	22.3 c	13 d	48.7
	ROS	110.5 a	78.9 a	51.7 c	23.5 d	6.0 d	
	ORI	100.1	52.0	24.9	12.6	4.3	
	ROS	109.3	82.8	55.6	24.2	8.8	
Seedling fresh weight (mg/seedling)							
A	ORI	0.203 a	0.151 ab	0.136 ab	0.118 c	0.0 d	0.140
	ROS	0.232 a	0.176 ab	0.169 bc	0.121 bc	0.097c	
Ç	ORI	0.183 a	0.141 a	0.130 a	0.129 a	0.0 b	0.113
	ROS	0.203 a	0.183 a	0.139 ab	0.063 b	0.061 b	
İ	ORI	0.169 a	0.125 b	0.102 b	0.099 b	0.067 b	0.125
	ROS	0.195 a	0.163 ab	0.161 ab	0.091bc	0.078 c	
K	ORI	0.186 a	0.158 b	0.112 bc	0.079 c	0.061 c	0.132
	ROS	0.2206 a	0.191 ab	0.145 bc	0.111c	0.048 d	
Y	ORI	0.155 a	0.128 a	0.126 a	0.088 b	0.014 b	0.115
	ROS	0.171 a	0.159 a	0.155 a	0.109 b	0.051 c	
	ORI	0.179	0.140	0.122	0.108	0.028	
	ROS	0.204	0.175	0.154	0.099	0.064	

*) Means within each line followed by different letter are significant at P=(0.05).

The results also revealed significant difference in the inhibitory effect of the two essential oil types and doses against durum wheat genotypes. This different response can be attributed to different rates of allelochemical metabolism (Gitsopoulos et al., 2013). The higher phytotoxicity of *Ori* may be attributed to Carvacrol as the main constitute that had a negative effect on germination of wheat genotypes (Dudai et al., 2004; Azirak ve Karaman, 2008; Atak et al., 2016). The amount of metabolize certain monoterpenes responsible for inhibition effect on germinated seed (Dudai et al., 1999). The essential oils are believed to be secure since they breakdown quickly in the natural environment and show low toxicity (Mutlu ve Atıcı 2009; Uremis et al., 2009; Gitsopoulos et al., 2013). In this regard they differ from synthetic herbicides. They can be used as an environment friendly tool for weed or pest control in field crops; however, they must act selectively, giving no damage to crops that are intended to grow (Azirak ve Karaman, 2008).

For this intention, the herbicidal effect of the essential oil should be evaluated both at field level by using various cultivars and relevant harmful weed species.

Our previous work results showed that bread wheat genotypes were affected less compared to weed species showing proper dose of these essential oils could be used as a bio-herbicide for weed control. Dudai et al. (1999) and Gitsopoulos et al. (2013) revealed variable essential oil responses among cereal crops. In present study, the essential oil of *Ori* exhibited the higher phytotoxic effect compared to *Ros* oil on durum wheat germination and seedling characters.

Conclusion

More knowledge about bio-degradable herbicides or pesticides would help to decrease man made environmental damages. The present study results showed that the essential oil of *Ori* and *Ros* could be considered as potential allelopathic agents in durum wheat cultivars. Using dose of 16 μ L / petri or more will also be useful to suppress or control the volunteer durum wheat species in organic crop areas.

References

- Angelini, L.G., Carpenese, G., Cioni, P.L., Morelli, I., Macchia, M., Flamini, G. (2003). Essential oil from Mediterranean Lamiaceae as weed germination inhibitors. *J.Agric. Food Chem*, 51(21), 6158-6164.
- Anonymous. (2013). Available: <http://www.tuik.gov.tr/> Access time, December, 2015.
- Atak, M., Mavi, K., Uremis, I. (2016). Bio-herbicidal effects of oregano and rosemary essential oils on germination and seedling growth of bread wheat cultivars. *Romanian Biological Letters*, 21, (1), 11149-11159.
- Azirak, S., Karaman, S. (2008). Allelopathic effect of some essential oils and components on germination of weeds species. *Acta Agric. Scand. Sect-B- Soil Plant Sci*, 58 (1), 88-92.
- Dudai, N., Ben-Ami, M., Chaimovich, R., Chaimovitch, D. (2004). Essential oils as allelopathic agents: Bioconversion of monoterpenes by germinating wheat seeds. *Acta Hort*, 629, 505-508.
- Dudai, N., Mayer, A.M., Poljakoff-Mayber, A., Putievsky, E., Lerner, H.R. (1999). Essential oil as allelochemicals and their potential use as bio-herbicides. *J.Chem.Ecol*, 25, 1079-1089.
- Ellis, R.H., Roberts, E.H. (1980). Towards a rational basis for seed testing seed quality. In: Hebblethwaite P., ed. *Seed Production*. Butterworths, London, pp. 605-635.
- Fragasso, M., Iannucci, A., Papa, R. (2013). Durum wheat and allelopathy: towards wheat breeding for natural weed management. *Front. Plant Sci*, 4, 1-8.
- Gitsopoulos, T., Chatzopoulou, P., Georgoulas, I. (2013). Effects of essential oils of *Lavandula x hybrida* Rev, *Foeniculum vulgare* Mill and *Thymus capitatus* L. on the germination and radical length of *Triticum aestivum* L., *Hordeum vulgare* L., *Lolium rigidum* L. and *Phalaris brachystachys* L. *J. Essent. Oil Bear. Pl*, 16 (6), 817-825.
- ISTA. (1996). International rules for seed testing. *Seed Sci. Technol.* 24. Supplement.
- Jabran, K., Mahajan, G., Sardana, V., Chauhan, B.S. (2015). Allelopathy for weed control in agricultural system. *Crop Protec*, 72, 57-65.
- Mutlu, S., Atici, Ö. (2009). Allelopathic effect of *Nepeta meyeri* Benth. extract on seed germination and seedling growth of some crop plants. *Acta Physiol. Plant*, 31, 89-93.
- Oerke, E.C. (2006). Crop losses to pests. *Journal of Agricultural Sciences*, 144, 31-43.
- Uremis, I., Arslan M., Sangun, M.K. (2009). Herbicidal activity of essential oil on the germination of some problem weeds. *Asian J. Chem*, 21(4), 3199-3210.

THE EFFECTS OF SOME POSTHARVEST TREATMENTS AND MODIFIED ATMOSPHERE PACKAGING (MAP) ON QUALITY AND POSTHARVEST LIFE OF BABY CUCUMBERS

Jasmina SABOTIC, Adem DOGAN, M. Seckin KURUBAS, Mustafa ERKAN*

Akdeniz University, Faculty of Agriculture, Department of Horticulture, 07059, Antalya, Turkey

*Corresponding author: erkan@akdeniz.edu.tr

Abstract

In this study, the effects of 1% Disper Cu Max and 5% sodium hypochlorite treatments on postharvest quality and decay control of baby cucumbers were evaluated. After Disper Cu Max and sodium hypochlorite applications, cucumbers were packaged in modified atmosphere packaging (MAP). Packed baby cucumbers were stored at 8°C temperature with 90-95% relative humidity (RH) for 28 days. Samples were taken at 7 day intervals from different storage conditions and various physical and chemical analyses such as weight loss, flesh firmness, titratable acidity, pH, soluble solids, skin color (L*, C*, h°), percentage of physiological disorders and decays were determined. Furthermore, the changes in O₂ and CO₂ levels in the MA bags were recorded. Experimental results showed that the lowest weight loss, decay and disorder development were determined on the baby cucumbers treated with sodium hypochlorite + MAP combination. Dipping the cucumbers in Disper Cu Max solution had the highest titratable acidity and soluble solids content at the end of the storage. The highest L*, C* and pH values were obtained from Disper Cu Max + MAP treated cucumbers. It can be concluded that baby cucumbers were successfully stored at 8°C temperature and 90-95% RH in Disper Cu Max + MAP combination for 28 days with minimal quality losses.

Keywords: *Baby cucumber, storage, MAP, fruit quality.*

Introduction

The production of vegetables in Turkey is on the fourth place in the world after China, India and the USA. Turkey produced 28 million tons of vegetables in 2013 (FAO, 2013).

Cucumber is one of the most economically important vegetables belonging to the Cucurbitaceae family (Jeffery, 1980). Total world production of cucumber in 2012 was 65.1 million tons, of which over 73.7% was produced in China (FAO, 2012). However, the quality of cucumbers rapidly decline after harvest and the fruit have very limited shelf-life as well. The main factors limiting shelf-life of cucumbers are fruit yellowing, disease development and excessive water loss (Zhang et al., 2014).

New techniques for reducing undesired microbial contamination, spoilage and decay, as well as maintaining the product's visual quality, textural and nutritional quality are required at all steps of the production and distribution chain (Marcin et al., 2014). Chlorine has been widely used primarily to wash agricultural produce due to its low cost and proven efficacy against bacterial pathogens (Adams et al., 1989). The frequently used forms of free-chlorine are liquid chlorine and hypochlorites (Parish et al., 2003). It is typically used in the range of 50 – 200 ppm free chlorine, usually having contact time of 5 min (Rico et al., 2007).

MAP is used to prolonged the storage duration and shelf-life of different fruits and vegetables (Sandhya, 2010). By creating higher CO₂ and lower O₂ concentrations in the surrounding atmosphere of the commodities decay development, respiration rate, ethylene production, and enzymatic activity can be controlled, resulting in an increase in postharvest quality of different commodities (Kader and Watkins, 2000; Caleb et al., 2012). MAP may also prevent weight loss and fruit shriveling by creating a higher relative humidity in the surrounding environment of the products (Zagory et al., 1989).

The objective of this research was to find out the effects of MAP, 1% Disper Cu Max and 5% sodium hypochlorite treatments on postharvest quality and decay control of baby cucumbers.

Materials and methods

Fruit material

Freshly harvested baby cucumbers (cv. Silor) at commercial harvest maturity were obtained from a local farm in Antalya (Turkey), and transported to the Postharvest laboratory of Department of Horticulture, Akdeniz University within 3 h after harvest. On the same day, samples were selected for uniformity in size, shape and color. Fruit with signs of mechanical damage, sunburn, blemishes, disease and pest damage were discarded.

Postharvest treatments and storage

After sizing and selecting, baby cucumbers were randomly divided into five groups of 120 fruits from each group. The first group of cucumbers was dipped in 1% Disper Cu Max solution for 60 sec. The second group of cucumbers was first dipped in 1% Disper Cu Max solution for 60 sec. then packed in MAP. The third group of cucumbers was treated in 5% sodium hypochlorite solution for 60 sec. The fourth group of cucumbers was first dipped in 5% sodium hypochlorite solution for 60 sec. then packaged in MAP. The fifth group of cucumbers was not treated and considered as control. Treated baby cucumbers were stored at 8°C with 90-95% RH for 28 days.

Weight loss

For weight losses, at harvest, individually numbered fruit were weighed, and at the end of each storage period the cucumbers were re-weighed again and weight losses was determined and expressed as percent loss from initial weight.

Fruit firmness

Fruit firmness was measured by a manual penetrometer (Model FT 011) with a 3 mm diameter flat probe. The flat probe was inserted to a depth of 5 mm. While measuring the firmness, peel of the cucumbers was not removed. The results were expressed as kg/cm².

Titrateable acidity and pH

For titrateable acidity (TA) and pH, juice from baby cucumbers is squeezed by using a blender. TA was determined by titrating 5 mL of fruit juice in 35 mL of distilled water with 0.1 N NaOH to an end point of pH 8.1 and expressed as percent of citric acid equivalents. pH measurements of the cucumbers were carried out by using a digital pH meter.

Total soluble solids content

For total soluble solids (TSS) content, fruit samples taken from fresh baby cucumbers and the juice obtained by using a blender. TSS content of the cucumbers was determined by using a digital refractometers and expressed as % Brix.

Skin color (L^ , C^* , h°)*

The skin color of the cucumbers was assessed by using a MINOLTA CR-200 Chromameter, (MINOLTA Camera Co, LTD Ramsey, NJ). Skin color of the cucumbers were presented as lightness (L^*), hue angle (h°), and chroma (C^*) by conversion from a^* and b^* values. The h° indicates how green or yellow a fruit is, and C^* describes the vividness to dullness of the color (Selcuk and Erkan, 2015).

Changes in oxygen (O_2) and carbon dioxide (CO_2) levels in the MA bags

O_2 and CO_2 levels inside the MA bags were monitored during the storage by using an O_2 and CO_2 gas analyzer (Dansensor CheckPoint 2014, Denmark). Measurements were taken at 2 different sides of the each MAP. Total of 6 measurements were made at 3 packages for each treatment. The results were represented as O_2 and CO_2 kPa.

Statistical analysis

The experimental design of the research was completely randomized. Groups of three replicates of 24 fruit per treatment for the cold storage period were established. The data were analyzed using the Statistical Analysis System software program, version 9.0 (SAS Inst., Cary, N.C. U.S.A.) and treatments means were statistically compared using the Duncan's multiple range test ($P \leq 0.05$).

Results and discussion

Skin color (L^ , C^* , h°)*

One of the most important quality parameters for marketing of fruit and vegetables is fruit colour. The effect of sodium hypochlorite, Disper Cu Max and MAP on the fruit color of baby cucumbers was determined by monitoring the changes in L^* , C^* and h° color values. In terms of skin color there were no statistical differences among treatments. The L^* values of the cucumbers progressively increased with prolonging the storage duration. Reduction in h° was also observed during the storage (Table 1). The degradation of chlorophyll causes yellowing phenomenon, shortens shelf life and affects quality of horticultural crops as well as cucumbers (Fukasawa et al., 2010). Roji and Uday (2015) also reported that a combination of sodium hypochlorite dipping and MAP treatment was the most effective and promising treatment for colour retention of fresh-cut cilantros during storage.

Table 1. The effects of different postharvest treatments and storage durations on skin color of (L^* , C^* , h°) baby cucumbers during storage at 8°C

Testing index	Treatments	Storage time (days)					Overall
		Day 0	Day 7	Day 14	Day 21	Day 28	
Chroma (C^*)	Control	22.46	25.62	28.34	28.34	30.90	27.19b ^b
	Sodium hypochlorite	22.46	27.07	28.00	31.94	32.35	28.36bc
	Sodium hypochlorite + MAP	22.46	27.13	28.92	32.26	33.73	28.90ab
	Disper Cu Max	22.46	26.29	27.56	30.04	32.21	27.62cd
	Disper Cu Max + MAP	22.46	27.54	28.61	33.03	36.05	29.54a
	Overall	22.46e ^a	26.73d	28.29c	31.12b	33.05a	
Hue (h°)	Control	121.91	121.75	120.93	118.93	118.24	120.31a
	Sodium hypochlorite	121.91	121.96	120.88	118.40	108.60	118.27a
	Sodium hypochlorite + MAP	121.91	122.04	120.85	119.34	117.72	120.28a
	Disper Cu Max	121.91	122.11	120.88	118.98	116.02	119.92a
	Disper Cu Max + MAP	121.91	121.91	120.72	118.46	115.90	119.70a
	Overall	121.91a	121.95a	120.85ab	118.82b	115.29c	
Lightness (L^*)	Control	38.32	40.66	41.40	42.99	43.97	41.54ab
	Sodium hypochlorite	38.32	40.81	40.64	42.62	44.08	41.29ab
	Sodium hypochlorite + MAP	38.32	39.13	39.24	42.40	44.97	40.81b
	Disper Cu Max	38.32	40.15	41.68	41.93	42.98	41.01b
	Disper Cu Max + MAP	38.32	40.44	39.73	44.09	47.00	41.91a
	Overall	38.39d	40.24c	40.54c	42.81b	44.60a	

^a Means in the same row with different letters are significantly different at $P \leq 0.05$ by Duncan's multiple range test.

^b Means in the same column with different letters are significantly different at $P \leq 0.05$ by Duncan's multiple range test.

Total soluble solids, Titratable acidity and pH

Total soluble solids (TSS) content, titratable acidity (TA) and pH are the most important factors that give the taste and flavor to the fruits and vegetables (Selcuk and Erkan, 2016).

TSS content of the cucumbers slightly declined with prolonging the storage duration. At the end of the storage, the highest TSS content was in Disper Cu Max treated cucumbers and the lowest was in Disper Cu Max + MAP treated cucumbers (Table 2).

TA content of the cucumbers increased significantly with prolonging the storage duration in all treatments during storage. The initial value of TA at harvest was 0.088% and it increased to 0.115% at the end of the storage. The highest TA content was in the treated with Disper Cu Max and the lowest was in group Disper Cu Max + MAP (Table 2).

Changes in the pH values of baby cucumbers along the storage period were determined to be statistically significant ($P \leq 0.05$). At harvest the initial pH was 5.96 and it decreased to 5.70 at the end of the 28 days of storage period. In terms of pH minimal changes occurred in Sodium hypochlorite + MAP and Sodium hypochlorite + MAP treated groups (Table 2).

Contrary to our findings Jose-Neptali et al. (2012), reported that there were no effect of Sodium hypochlorite on TA, TSS and pH of tomatoes.

Table 2. The effects of different postharvest treatments and storage duration on total soluble solids, titratable acidity and pH of baby cucumbers during storage at 8°C.

Testing index	Treatments	Storage time (days)					Overall
		Day 0	Day 7	Day 14	Day 21	Day 28	
TSS	Control	4.40	4.30	4.30	3.97	3.83	4.16 ^b
	Sodium hypochlorite	4.40	4.35	4.05	4.05	3.70	4.11 ^b
	Sodium hypochlorite + MAP	4.40	4.40	4.00	3.90	3.40	4.02 ^c
	Disper Cu Max	4.40	4.35	4.40	4.15	3.95	4.25 ^a
	Disper Cu Max + MAP	4.40	4.25	4.10	3.60	3.60	3.99 ^c
	Overall	4.40 ^a	4.33 ^a	4.17 ^b	3.93 ^c	3.70 ^d	
TA	Control	0,088	0,078	0,101	0,103	0,126	0,096 ^c
	Sodium hypochlorite	0,088	0,103	0,101	0,101	0,126	0,104 ^b
	Sodium hypochlorite + MAP	0,088	0,105	0,092	0,089	0,094	0,094 ^{cd}
	Disper Cu Max	0,088	0,102	0,106	0,113	0,135	0,109 ^a
	Disper Cu Max + MAP	0,088	0,103	0,090	0,079	0,095	0,091 ^d
	Overall	0,088 ^c	0,098 ^b	0,098 ^b	0,097 ^b	0,115 ^a	
pH	Control	5.96	6.16	5.57	5.48	5.54	5.74 ^b
	Sodium hypochlorite	5.96	5.62	5.53	5.52	5.54	5.63 ^c
	Sodium hypochlorite + MAP	5.96	5.56	5.75	5.67	6.08	5.80 ^a
	Disper Cu Max	5.96	5.67	5.54	5.53	5.53	5.64 ^c
	Disper Cu Max + MAP	5.96	5.64	5.71	5.88	5.83	5.80 ^a
	Overall	5.96 ^a	5.73 ^b	5.62 ^c	5.61 ^c	5.70 ^b	

^a Means in the same row with different letters are significantly different at $P \leq 0.05$ by Duncan's multiple range test.

^b Means in the same column with different letters are significantly different at $P \leq 0.05$ by Duncan's multiple range test

Weight loss (%)

Weight loss of fresh produce contains the dry matter and moisture which is related to respiration and transpiration rates (Roy et al.,1995; Varoquaux et al.,1999). Similar to most of the vegetables water loss is a common storage problem occurred during long term storage of cucumber as well.

Weight losses of cucumbers in all groups increased with prolonging the storage duration. As expected, the weight loss of baby cucumbers was the highest in Disper Cu Max (13.01%), Sodium hypochlorite (11.79%) and control group (10.48%). MAP lowered the weight loss of the cucumbers and Disper Cu Max + MAP (2.21%) and Sodium hypochlorite + MAP (1.19%) treatments was the least weight losses occurred group in the experiment (Table 3).

Similar to our results Roji and Uday (2015) reported that Sodium hypochlorite + MAP combination was the most effective treatment in reducing weight loss of fresh-cut cilantros.

Fruit firmness

Firmness is the key factor in determining postharvest deterioration of fruit and vegetables. It is the rate of softening, which influences shelf life and is infected by postharvest pathogens. Generally speaking, the most obvious sign of it is firmness (Brummell and Harpster, 2001).

In this study, firmness of baby cucumber slowly increased. The biggest change was recorded in control group, from 22.24 to 26.06 kg/cm². In Disper Cu Max + MAP combination occurred the smallest changes, to the 23.61 kg/cm², (Table 3). However, no obvious differences existed among treatments or controls. Ji Heun and Kenneth (1997) reported the similar results and Sodium hypochlorite had no effect on firmness of tomatoes.

Table 3. The effects of different postharvest treatments and storage duration on weight losses and fruit firmness of baby cucumbers during storage at 8°C.

Testing index	Treatments	Storage time (days)					Overall
		0	Day 7	Day 14	Day 21	Day 28	
Weight loss (%)	Control	-	1.88	8.08	11.88	20.08	10.48 ^a
	Sodium hypochlorite	-	4.00	8.01	14.26	20.90	11.79 ^a
	Sodium hypochlorite + MAP	-	0.55	0.92	1.41	1.87	1.19 ^b
	Disper Cu Max	-	6.15	9.71	14.90	21.27	13.01 ^a
	Disper Cu Max + MAP	-	0.49	0.80	2.96	4.60	2.21 ^b
	Overall	-	2.61 ^d	5.50 ^c	9.08 ^b	13.74 ^a	
Firmness (kg/cm ²)	Control	2,27	2,64	2,52	2,65	2,66	2,55 ^a
	Sodium hypochlorite	2,27	2,27	2,56	2,40	2,53	2,40 ^b
	Sodium hypochlorite + MAP	2,27	2,28	2,31	2,12	2,51	2,30 ^c
	Disper Cu Max	2,27	2,26	2,62	2,33	2,47	2,39 ^{bc}
	Disper Cu Max + MAP	2,27	2,31	2,40	2,20	2,41	2,32 ^{bc}
	Overall	2,27 ^b	2,35 ^b	2,48 ^a	2,34 ^b	2,51 ^a	

^a Means in the same row with different letters are significantly different at P≤0.05 by Duncan's multiple range test.

^b Means in the same column with different letters are significantly different at P≤0.05 by Duncan's multiple range test

Changes in O₂ and CO₂ concentrations in the MA bags

The levels of O₂ inside the packages decreased and CO₂ levels increased during storage due to the continuous process of respiration after harvest. Our results showed that the concentration of O₂ in the Sodium hypochlorite + MAP combination decreased slightly, from 20,05 kPa to 18.2 kPa, and CO₂ levels increased from 0.05 kPa to 2.3 kPa until the end of the 14th day of the storage. On the 28th day of storage the O₂ levels in MA bags increased slightly, 19.2 kPa, and CO₂ is decreased to 16.6 kPa, and CO₂ levels in MA bags increased to 4.6 kPa. The concentration of O₂ levels in Disper Cu Max + MAP combination decreased until the end of the third week from 20.01 kPa to the 16.2 kPa, then increased to the 17.6 kPa on the 28th day of storage. The levels of CO₂ increased to during the 21st day of storage then there were a decline (Fig. 1).

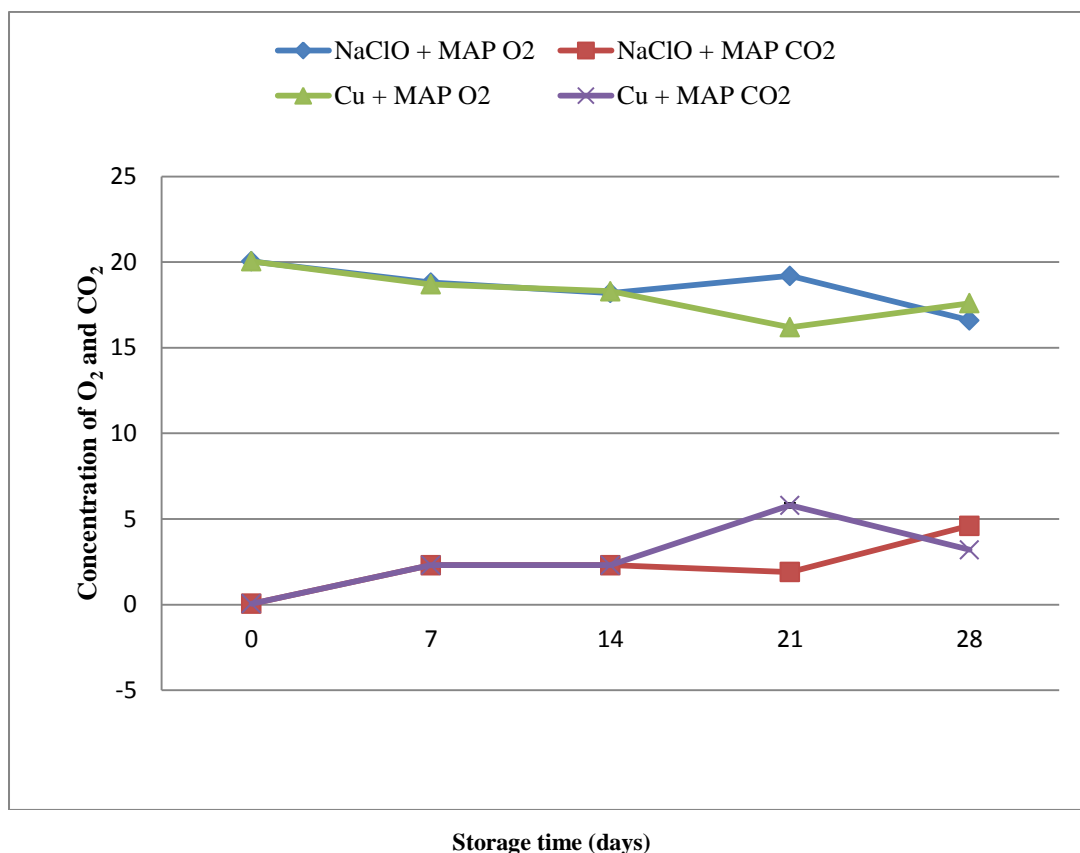

Fig. 1. Changes in CO₂ and O₂ levels inside MAPs during storage at 8 °C.

Conclusions

This study is one of the first reports about quality and postharvest life of baby cucumbers. Results showed that the lowest weight loss, disease and disorder development were determined on the baby cucumbers treated with Sodium hypochlorite + MAP combination. Dipping of cucumbers in Disper Cu Max solution had the highest titratable acidity and soluble solids content at the end of storage. The highest L*, C* and pH values were obtained from Disper Cu Max + MAP treated baby cucumbers. It can be concluded that baby cucumbers were successfully stored at 8°C temperature and 90-95% RH in Disper Cu Max + MAP for 28 days with minimal quality losses.

References

- Adams, M. R., Hartley, A. D. and Cox, L. J. 1989. Factors affecting the efficiency of washing procedures used in the production of prepared salads. *Food Microbiology*, 6, 69–77.
- Brummell, D.A. and Harpster, M.H. 2001. Cell wall metabolism in fruit softening and quality and its manipulation in transgenic plants. *Plant Mol. Biol.* 47, 311–340.
- Caleb, O. J., Opara, U.L. and Witthuhn, C.R. 2012. Modified atmosphere packaging of pomegranate fruit and arils: a review. *Food Bioprocess Technol* 5: 15-30.
- FAOSTAT, 2012. FAOSTAT. <http://faostat.fao.org>. Cucumber Production.
- Fukasawa, A., Suzuki, Y., Terai, H. and Yamauchi, N. 2010. Effects of postharvest ethanol vapor treatment on activities and gene expression of chlorophyll catabolic enzymes in broccoli florets. *Postharvest Biol Technol.* 55, 97–102.

- Jeffery, C. 1980. A review of the Cucurbitaceae. *J. Bot. Linn. Soc.* 81, 233–247.
- Heun-Hong, J. and Gross, C.K. 1997. Surface sterilization of whole tomato fruit with sodium hypochlorite influences subsequent postharvest behavior of fresh-cut slices. *Postharvest Biol Technol.* 13, 51–58.
- Jose-Nepali H.-Y., Maria-Jose, H. and, Maria-Teresa, S. 2012. Effect of different prepackaging treatments on the physical/chemical quality of margariteño tomatoes during postharvest storage at room temperature, *Journal of Food Quality* ISSN 1745-4557.
- Kader, A.A. and Watkins, C.B. 2000. Modified atmosphere packaging – toward 2000 and beyond. *HortTechnology* 10: 483-486.
- Marcin, G., Richard, C. and Deborah, R. 2014. Influence of continuous exposure to gaseous ozone on the quality of red bell peppers, cucumbers and zucchini, *Postharvest Biol Technol.*99: 1–8.
- Parish, M.E., Beuchat, L.R., Suslow, T.V., Harris, L.J., Garrett, E.H. and Farber, J.N. 2003. Methods to reduce/eliminate pathogens from fresh and fresh-cut produce. *Comprehensive Reviews in Food Science and Food Safety*, 2, 161–173.
- Rico, D., Martin-Diana, A. B., Barat, J. M. and Barry-Ryan, C. 2007. Extending and measuring the quality of fresh-cut fruit and vegetables: A review. *Trends in Food Science and Technology*, 18, 373–386.
- Roy, S., Anantheswaran, R. C. and Beelman, R. B. 1995. Fresh mushroom quality as affected by modified atmosphere packaging. *Journal of Food Science*, 60, 334–340.
- Roji, B. W. and Uday, S.A. 2014. Integrated effect of sodium hypochlorite and modified atmosphere packaging on quality and shelf life of fresh-cut cilantro. *Food Packing and Shelf life* 3, 62 – 69.
- Selcuk, N. and Erkan, M. 2015. Changes in phenolic compounds and antioxidant activity of sour-sweet pomegranates cv. Hicaznar during long-term storage under modified atmosphere packaging. *Postharvest Biol Technol.*109, 30-39.
- Varoquaux, P., Gouble, B., Barron, C. and Yildiz, F. 1999. Respiratory parameters and sugar catabolism of mushroom (*Agaricus bisporus*). *Postharvest BiolTechnol.*, 16, 51–61.
- Zagory, D., Ke, D. and Kader, A.A. 1989. Long term storage of ‘Early Gold’ and ‘Shinko’ Asian pears in low oxygen atmospheres. In: Fellman JK, editor. *Proceedings of the Fifth International Controlled Atmosphere Research Conference*, pp. 353-357.
- Zhang, N., Zhao, Y., Aiqliang, C. and Songsong Z. 2014. Effects of intermittent heat treatment on sensory quality and antioxidant enzymes of cucumber, *Scientia Horticulturae* 170, 39–44.

EFFECTS OF SALT AND OSMOTIC STRESS ON GROWTH AND GERMINATION OF DOMESTIC WHEAT CULTIVARS (*Triticum aestivum* L.)

Branka GOVEDARICA, Igor ĐURĐIĆ, Tatjana IGNJIĆ, Maja MITROVIĆ, Vesna MILIĆ

University of East Sarajevo, Faculty of Agriculture, Vuka Karadzica 30, Bosnia and Herzegovina

*Corresponding author mail: vesnamlc@yahoo.co.uk

Abstract

Three winter-type cultivars of wheat (Jelena, Bosanka and Nova bosanka), selected in the Agricultural Institute of the Republic of Srpska in Banja Luka, were examined for resistance to osmotic and salt stress in the period of early germination. The trial was set up in the laboratory of the Faculty of Agriculture in East Sarajevo. The seeds were sterilized in 96 % alcohol and 50 uniform and healthy seeds for each type and treatment were put into Petri dishes. Filter papers soaked in the solution of a certain concentration (of mannitol and salt) and water potential of 0, -0.3 and -0.6 MPa, were put into the dishes. The seedlings were incubated for 7 days at a temperature of 20°C, or until the first leaves appeared. On the seventh day of the trial, or when the first leaves appeared, the measurement of a fresh coleoptile and root mass was conducted by an analytical balance (Adventurer). By drying the samples in a drying oven (Mettler) for 24 hours at 80°C and by weighing them, dry root and shoot weight was specified as well. The calculated dry root/shoot weight ratio is a significant indicator for the screening of genotypes for the resistance to drought-stress in the germination stage. Examination of germination in different conditions (concentrations of salt and mannitol) showed that the type Nova Bosanka is the most resistant to stress conditions. Stress conditions affect coleoptile forming in type Bosanka, and root forming in type Jelena. The usual border line of mannitol and salt concentration for germination is at -0.3 MPa.

Key words: *type, resistance, mannitol, salt, root, coleoptile*

Introduction

In their lifetime in nature, plants are exposed to various environmental factors which affect their growth, metabolism and crop. Temperature extremes, salinity, water supply changes, high light intensity and different kinds of pollutants are stress factors which limit plant productivity (Lawlor, 2002). The prolonged water deficit is called the drought. The drought is one of the most important abiotic stress factors for plants and it represents a complex form of stress which affects different metabolical processes (physiological, biochemical and molecular) of the whole plant, in almost all plant organs and cell parts (Yordanov *et al.*, 2000). Saline soils are a common limiting factor for agricultural productivity in semi-arid and dry areas of the world. Seed vigour and shoot length are the most sensitive to drought stress, followed by root and coleoptile length (Dhanda *et al.*, 2004). Wheat coleoptile is a specialised protective tissue for first leaves until they reach a certain length, or appear above the ground. Water access affects coleoptile growth and germinating. The distinction between the coleoptile length and drought tolerance index in stress-exposed wheat is significant, which is why it is recommended that the coleoptile length can be used as a drought tolerance indicator for screening the tolerant genotypes in wheat. Barley, maize and wheat are more sensitive to salinity during the germination, so crops get more harmed by salinity in earlier stages of growth (Anonymous, 2005).

Materials and methods

The tests included examination of three winter-type cultivars of wheat (Jelena, Bosanka and Nova bosanka) under controlled conditions. The seeds were selected at the Agricultural Institute of the Republic of Srpska. The experiment was set up in the laboratory of the Faculty of Agriculture in East Sarajevo. Only completely healthy and clean seeds were picked out for testing. The seeds were sterilized in 96 % alcohol for 30 seconds, then washed using distilled water several times, and 50 uniform and healthy seeds were put into sterile Petri dishes. Doubled filter papers soaked in the solution of a certain concentration (of mannitol and salt), were put into the dishes and dissolved with water potential close to 0, which was a control state, then with -0.3 and -0.6 MPa (*Braccini et al.*, 1996). Each Petri dish was filled with 15 ml of solution. Alcohol mannitol is used to induce water stress and sodium chloride to induce salt stress. Every treatment and type was replicated four times. The seedlings were incubated in an incubator (Binder) for 7 days at a temperature of 20°C, or until the first leaves appeared. On the seventh day of the trial, or when the first leaves appeared, the measurement of fresh and dry root mass (g) and fresh and dry coleoptile mass (g) was conducted.

The root and coleoptile were carefully split apart by fingernails and weighed separately. Fresh coleoptile and root mass was measured by an analytical balance (Adventurer). Dry root and shoot weight was also specified in the trial by drying the samples in a drying oven (Memmert) for 24 hours at 80°C and then by weighing them. Dry root/shoot weight ratio was established as well, which is a significant indicator for the screening of genotypes for the resistance to drought-stress in the germ stage.

All data were statistically processed using Analysis of variance (ANOVA). Differences between treatments in each type and differences between types within treatments were tested with the test of Least significant difference (LSD).

Results and discussion

Germination and early seedling growth are affected by genetic and environmental factors. Different types have developed distinctive mechanisms for adjusting to unfavorable conditions. Sodium chloride is a strong osmotic agent and it affects the growth when there is an increased concentration of it in a medium. Salt stress affects many physiological aspects of plant growth. Increased salt concentration in a medium increases the breathing of the root and shoot. When winter-type crops are concerned, including the winter-type wheat, sowing soil can contain more salt in the sowing period because of the evapotranspiration during the previous summer, in which case the salt migrates upwards to the surface, so the sowing layer is the richest in salt. In order for a seed to germinate under these conditions, it has to have a strong vigour, so it can break through the layer of salt to the surface and to survive in general (*Huang et al.*, 1995). The effects of different salt concentration to the fresh and dry root and coleoptile mass of three types, created at the Agricultural Institute of the Republic of Srpska, are shown in the table 1 and figure 1, 2, 3 and 4.

Table 1. Effects of type and salt to the fresh root mass, dry root mass, fresh coleoptile mass and dry coleoptile mass

Type	NaCl (MPa)	Fresh root mass (g)	Dry root mass (g)	Fresh coleoptile mass (g)	Dry coleoptile mass (g)	Dry root/coleoptile mass (g)
Bosanka	0	0,8068	0,0804	0,8710	0,0955	0,8418
	-0,3	0,5208	0,0516	0,6490	0,0573	0,9005
	-0,6	0,3241	0,0332	0,4730	0,0475	0,6989
	Average	0,5495	0,0571	0,6643	0,0667	0,8560
Nova Bosanka	0	0,9540	0,1440	1,4060	0,1486	0,9690
	-0,3	0,8640	0,1085	1,0660	0,1140	0,9517
	-0,6	0,6620	0,0838	0,9920	0,0953	0,8793
	Average	0,8266	0,1121	1,1546	0,1193	0,9396
Jelena	0	0,8621	0,0807	1,2119	0,1450	0,5566
	-0,3	0,3780	0,0599	0,8710	0,1067	0,5613
	-0,6	0,2600	0,0464	0,4520	0,0708	0,6553
	Average	0,5000	0,0623	0,8440	0,1075	0,5798
Average NaCl (MPa)	0	0,8576	0,1017	1,1629	0,1297	0,8257
	-0,3	0,5876	0,0757	0,8620	0,0926	0,8174
	-0,6	0,4153	0,0544	0,6390	0,0712	0,7640

LSD	Fresh root mass			Dry root mass			Fresh coleoptile mass		
	A	B	AxB	A	B	AxB	A	B	AxB
0,05	0,166	0,166	0,288	0,017	0,017	0,029	0,123	0,123	0,213
0,01	0,226	0,226	0,391	0,023	0,023	0,039	0,165	0,165	0,287
LSD	Dry coleoptile mass			Dry root/coleoptile mass					
	A	B	AxB	A	B	AxB			
0,05	0,018	0,018	0,032	0,148	0,148	0,256			
0,01	0,025	0,025	0,043	0,198	0,198	0,344			

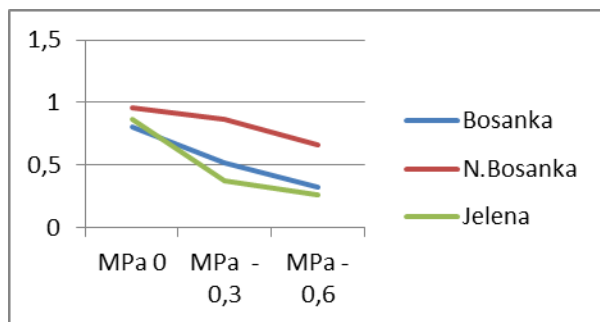

Figure 1. Effects of type and salt to the fresh root mass

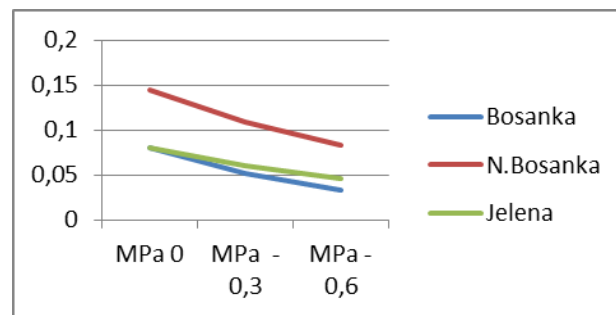

Figure 2. Effects of type and salt to the dry root mass

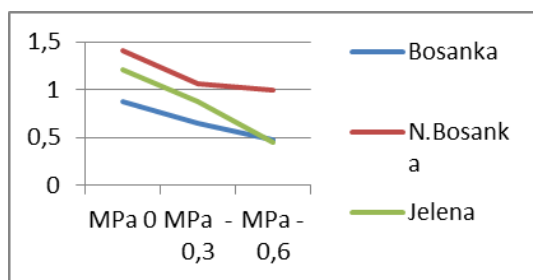

Figure 3. Effects of type and salt to the fresh coleoptile mass

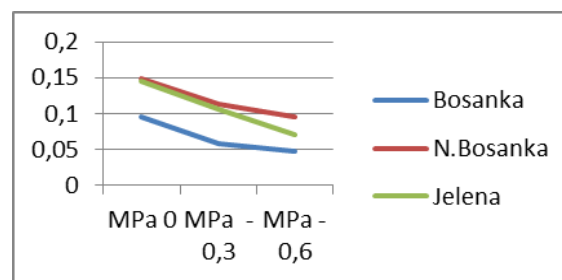

Figure 4. Effects of type and salt to the dry coleoptile mass

Placed statistically high, type Nova Bosanka had a significantly greater fresh and dry root mass, compared to the types Bosanka and Jelena, while the distinction between the latter two types was not established. Increased salt concentration led to a significant reduction of fresh and dry root mass, which is in accordance with the results of *Begum et al.* (1992). Type Jelena turned out to be the most sensitive because with the increased salt concentration, fresh root mass was significantly reduced, while in dry root measurement, type Bosanka displayed the lowest results. This is in accordance with the results of *Wang et al.*, (2011), which reported that the fresh root and coleoptile mass of two types of lucerne were inhibited by 200 mM NaCl and that with the further salt increase, the germination was stopped. Capability of a seed to germinate in salinity conditions does not depend only on the salt concentration, but also on the other biological factors, seed age, dormancy, seed coat thickness, seed vitality.

Placed statistically high, types Nova Bosanka and Jelena had a significantly greater fresh and dry coleoptile mass, compared to the type Bosanka. Increased salt concentration led to a significant reduction of fresh and dry coleoptile mass. Type Bosanka turned out to be the most sensitive because with the increased salt concentration, fresh and dry root mass was significantly reduced.

Measurement results of a dry root/shoot ratio in different types of wheat under different water deficit conditions, were maximized in controlled state and minimized at the water potential of -0.6 MPa. Type Bosanka was the most sensitive at water potential of -0.3 MPa, while type Jelena of -0.6 MPa.

The effects of different mannitol concentration to the fresh and dry root and coleoptile mass of three types, created at the Agricultural Institute of the Republic of Srpska, are shown in the table 2 and figure 5, 6, 7 and 8. Alcohol mannitol is used to induce water stress (*Chen et al.*, 2010), as an osmoticum in the germination test and it is an impenetrable solution, i.e. it leaves the embryo intact (*Almansouri et al.*, 2001), which induces germination inhibition by affecting water absorption.

Placed statistically high, types Nova Bosanka and Bosanka had a significantly greater fresh and dry root mass, compared to the type Jelena, while the type Nova Bosanka also had a significantly greater dry root mass than type Bosanka, but both types Bosanka and Jelena significantly differed in dry root mass as well. Increased mannitol concentration led to a significant reduction of fresh and dry root mass. Type Jelena turned out to be the most sensitive because with the increased mannitol concentration, fresh and dry root mass was significantly reduced.

Placed statistically high, types Nova Bosanka and Jelena had a significantly greater fresh and dry coleoptile mass, compared to the type Bosanka. Fresh and dry coleoptile mass in type Nova Bosanka was significantly greater compared to the fresh and dry coleoptile mass in type Jelena. Increased mannitol concentration resulted in significant fresh and dry coleoptile mass reduction.

Reduction of dry root and coleoptile mass was greater in type Bosanka, while in types Nova Bosanka and Jelena, it was lower. In type Jelena, increased osmotic stress with water potential of -0.6 MPa, led to increased values of the examined parameter, in type Nova Bosanka with water potential of -0.3 MPa compared to -0.6 MPa and controlled state, and in type Bosanka with the controlled state compared to water potentials of -0.3 MPa and -0.6 MPa, as well as with comparing water potentials of -0.3 MPa and -0.6 MPa. Determined differences in type Bosanka were of statistical importance, while in types Nova Bosanka and Jelena were not. Our results are in accordance with the trials conducted by *Pratap i Sharma (2010)*. High root/shoot ratio during germination in a number of winter-type wheat examined, is a reliable indicator for wheat drought resistance (*Baalabaki et al., 1999*).

Table 2. Effects of type mannitol to the fresh root mass, dry root mass, fresh coleoptile mass and dry coleoptile mass

Type	Mannitol (MPa)	Fresh root mass (g)	Dry root mass (g)	Fresh coleoptile mass (g)	Dry coleoptile mass (g)	Dry root/coleoptile mass (g)
Bosanka	0	0,4476	0,0798	0,7602	0,0643	1,2410
	-0,3	0,3104	0,0454	0,5601	0,0530	0,8566
	-0,6	0,3274	0,0269	0,4445	0,0416	0,6466
	Average	0,3618	0,0507	0,5882	0,0529	0,9584
Nova Bosanka	0	0,5997	0,1004	1,3824	0,1826	0,5498
	-0,3	0,3918	0,0857	1,1135	0,1400	0,6121
	-0,6	0,2420	0,0646	0,6640	0,1129	0,5721
	Average	0,4111	0,0835	1,0533	0,1451	0,5754
Jelena	0	0,3230	0,0394	1,1502	0,1495	0,2635
	-0,3	0,2113	0,0317	0,8846	0,1202	0,2637
	-0,6	0,1008	0,0271	0,3924	0,0868	0,3122
	Average	0,2117	0,0327	0,8090	0,1188	0,2752
Average NaCl (MPa)	0	0,4560	0,0732	1,0976	0,1321	0,5541
	-0,3	0,3043	0,0542	0,7527	0,1044	0,5191
	-0,6	0,2234	0,0395	0,5003	0,0804	0,4912

LSD	Fresh root mass			Dry root mass			Fresh coleoptile mass		
	A	B	AxB	A	B	AxB	A	B	AxB
0,05	0,075	0,075	0,130	0,009	0,009	0,017	0,137	0,137	0,238
0,01	0,101	0,101	0,175	0,013	0,013	0,023	0,185	0,185	0,320
LSD	Dry coleoptile mass			Dry root/coleoptile mass					
	A	B	AxB	A	B	AxB			
0,05	0,014	0,014	0,024	0,165	0,165	0,286			
0,01	0,018	0,018	0,032	0,222	0,222	0,384			

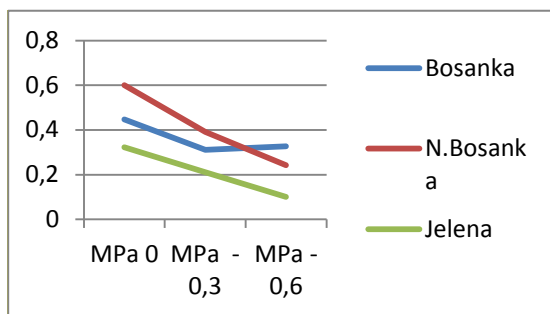

Figure 5. Effects of type and mannitol to the fresh root mass

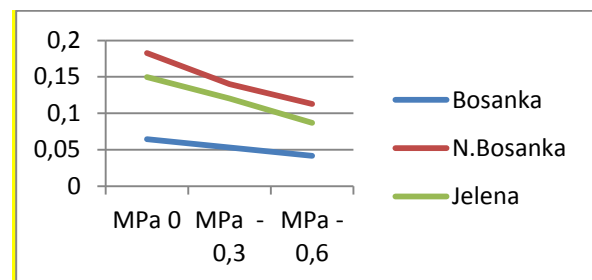

Figure 8. Effects of type and mannitol to the dry coleoptile mass

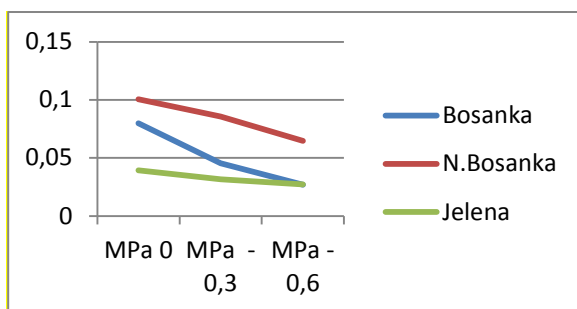

Figure 6. Effects of type and mannitol to the dry root mass

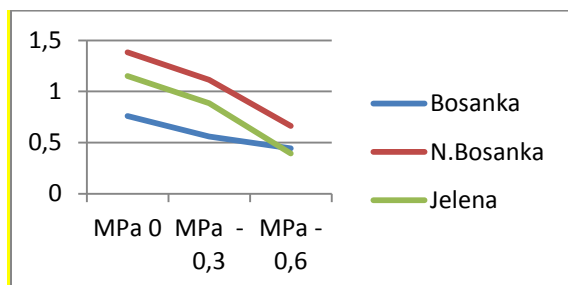

Figure 7. Effects of type and mannitol to the fresh coleoptile mass

Conclusion

The results show that the osmotic and toxic effects of salt had an impact on germination at early stages of development in all examined types of wheat. Based on the examination of stress condition effects, of different osmotic potential and salinity intensity, it can be concluded that in all types there was a reduction of examined germination parameters starting with water potential of -0.3MPa, and that could be one of the indicators of their sensitivity to stress conditions. Germination was reduced less with water potential of -0.3MPa, more with -0.6 MPa. Osmotic stress and specific ions equally affected both fresh and dry root and coleoptile mass, although it is considered that mannitol and sodium chloride work through different mechanisms in a seed and in a plant. Based on the trial results, conclusion is that the border line of water potential, under the effects of mannitol and sodium chloride, with the possibility for all types to germinate successfully, is -0.3 MPa, i.e. under lower intensity stress.

Acknowledgements

This work is the result of the project 'Resistance variety of some domestic field crops on stress caused by drought', which is supported by the Ministry of Science and Technology of the Republic of Srpska.

References

- Almansouri, M., Kinet, M., Lutts, S. (2001), Effect of salt and osmotic stresses on germination in durum wheat (*Triticum durum* Desf.). *Plant and Soil*, 231, 243-254.
- Anonymous (2005). Efficient input management. The Hindu survey Indian Agriculture: 47-49.
- Baalbaki, R.Z., R. A. Zurayk, R. A. Bleik and S. N. Tabouk (1999). Germination and seedling development of drought tolerant and susceptible wheat under moisture stress. *Seed & Science and Technol.*, 27:291-302.
- Braccini, A. L., Ruiz, H. A., Braccini, M.C. L., Reis, M. S. (1996): Germinação e vigor de sementes de soja sob estresse hídrico induzido por soluções de cloreto de sódio, manitol e polietilenoglicol. *Revista Brasileira de Sementes*, 18: 10-16.
- Begum F., Karmoker J.L., Fattah and Maniruzzaman A.F.M. (1992): The effect of salinity on germination and its correlation with K, Na, Cl accumulation in germinating seeds of *Triticum aestivum*. *Plant Cell Physiol.* 33, 1009-1014.
- Chen, K., Arora, R., Arora, U. 2010. Osmopriming of Spinach (*Spinacia Oleracea* L. Cv. Bloomsdale) Seeds and Germination Performance under Temperature and Water Stress. *Seed Sci. Technol.* 38: 36-48.
- Dhanda SS, Sethi GS, Behl RK (2004). Indices of drought tolerance in wheat genotypes at early stages of plant growth. *J Agron Crop Sci* 190: 6–12.
- Lawlor D.W. (2002): Limitation to photosynthesis in water-stressed leaves: stomata vs. metabolism and the role of ATP. *Annals of Botany* 89: 871–885.
- Livne, A., Levin, N. (1996): Energy metabolism of salt-affected pea seedlings. *Israel J. Botany*, 15.
- Pratap, V., Sharma, Y.K. 2010. Impact of Osmotic Stress on Seed Germination and Seedling Growth in Black Gram (*Phaseolus Mungo*). *J. Environ. Bio.* 31:721-726.
- Huang, J., Reddman, R.E. (1995): Salt tolerance of *Hordeum* and *Brassica* species during germination and early seedling growth. *Can. J. Plant Sci.*, 75: 815-819.
- Yordanov I., Velikova V. & Tsonev V. (2000). Plant response to drought, acclimatation and stress tolerance. *Photosynthetica.* 30: 171-186.

Wang, K., Liu, Y., Dong, K., Dong, J., Kang, J., Yang, Q., Zhou, H., Sun, Y. (2011): The effect of NaCl on proline metabolism in *Saussurea amara* seedlings. *Afr. J. Biotechnol.*10: 2886-2893.

THE EFFECT OF VARIETY AND WATER DEFICIENCY ON PRODUCTIVE QUALITIES OF POTATO

Branka GOVEDARICA*, Tanja JAKIŠIĆ, Igor ĐURĐIĆ

University of East Sarajevo, Faculty of Agriculture, Vuka Karadzica 30, Bosnia and Herzegovina

*Corresponding author: brankacg89@gmail.com

Abstract

As a result of global climate changes, in the past years, during summer months, more or less expressed rainfall deficit is occurring, which has negative effects on potato production. Some varieties, thanks to their ability of fast growth, good land coverage and early tuber seeding, endure some of the stressful situations easier than others. The goal of this paper was to examine, in controlled environment, the reaction of five varieties on moisture deficit, and also to determine if the productivity of potato will be affected by application of biostimulators. Three factorial experiments were set on 02.04.2016. in the greenhouse of the Faculty of Agriculture in East Sarajevo (Entity of Republic of Srpska, Bosnia and Herzegovina). The research included variety reaction (factor A – five varieties: A₁ - Agria, A₂ - Faluka, A₃ - Kenebek, A₄ - Kurada and A₅ - Dezire) and biostimulators (factor B: B₀ – without foliar top dressing and B₁ – foliar top dressing – three treatments with Isabion) on moisture deficit in the soil (factor C water deficit – C₀ – draught was created by stopping the substrate irrigation in the phase of tuber seeding and C₁ – optimal irrigation during the vegetation – substrate was watered every day until optimal water capacity, until water content in substrate was in field water capacity of 36%) on potato plant productivity. Faluka variety had the largest percentage of small and the smallest percentage of large tubers, while the Kenebek variety had the largest percentage of large and the smallest percentage of small tubers. The application of Isabion positively affected on yield increase at varieties: Agria, Kenebek and Dezire, as well as its application in varieties where there was a brake in irrigation during the phase of tuber seeding. The drought effect influenced the process of organic compounds synthesis and their translocation, which was notable for understanding the effect of drought on potato yield.

Key words: *variety, foliar top dressing, irrigation, yield, tuber.*

Introduction

Due to its importance as a food source and for existence of a large number of population, the potato is, on a global level, increasingly considered to be the food of the future and an ideal cultivar for crisis situations (*Jovović et al.*, 2013). In the times where a large global food shortage is expected, many scientists believe that potato is the cultivar that can ease the hunger. The potato is a worldwide plant, being grown throughout the world because of its great polymorphism, that is existence of a large number of varieties that can adapt to different ecological conditions. Modern approach in research of grown plants production is primarily based on studies of photosynthesis, growth and watering regime as the basic physiological processes which determine the plants productivity. Knowledge about these processes can contribute to overcoming the effects of stress factors, particularly drought, and to achieving the fertility potential of agricultural cultivars in certain agroecological conditions (*Passioura*, 2007). At the beginning of the vegetation period, potato plants usually have sufficient amounts of water

(significant amounts are accumulated through rainfall during the winter), so the drought is very rare in that period. As a result of global climate changes, in the past years, during summer months, more or less expressed rainfall deficit is occurring, which has negative effects on potato production. Soil water deficit in the periods of stolons formation and tuber seeding plays a crucial role in yield forming. (Tomasiewicz *et al.*, 2003).

Larger genetic variability enables wider spread area and better ability of adaptation to different environmental changes, including new diseases, vermins and climate changes (Hamer and Teklu, 2008). Larger variability also provides better basis for production of new genotypes with numerous desirable properties. With correct choice of assortments, unfavorable effects of environment would be significantly reduced (Jovović, 2010; Bugarčić *et al.*, 2000). Some varieties, due to their fast growth abilities and early tuber seeding, can endure stressful situations easier. The goal of this paper was to examine, in controlled conditions, reaction of five varieties on moisture deficit, and also to determine will the productivity of potato be affected by application of biostimulators.

Materials and methods

Three factorial experiments with six repetitions were set on 02.04.2016 in the greenhouse of the Faculty of Agriculture in East Sarajevo (Entity of Republic of Srpska, Bosnia and Herzegovina). The research included variety reaction (factor A – five varieties: A₁ - Agria, A₂ - Faluka, A₃ - Kenebek, A₄ - Kurada and A₅ - Dezire) and biostimulators (factor B: B₀ – without foliar top dressing and B₁ – foliar top dressing – three treatments with Isabion) on moisture deficit in the soil (factor C water deficit – C₀ – draught was created by stopping the substrate irrigation in the phase of tuber seeding and C₁ – optimal irrigation during the vegetation – substrate was watered every day until optimal water capacity, until water content in substrate was in field water capacity of 36%) on potato plant productivity (tubers number, tubers mass, yield by dish and percentage participation of individual fractions – calibrating <35 mm, 35-55 mm and >55 mm). Germinating tubers were planted in dishes (30x35 cm) which were filled with Pot ground H substrate (Klasmann-Deilmann, Germany). Removing of the potato tubers was done by hand in their full physiological maturity.

Research results were processed by variation-statistical analysis and the evaluation of differences significance in LSD test is depicted in tables. During the experiment, temperature and relative air humidity were measured by electronic thermo-hygrometer (model THG312, Oregon Scientific). Potato has moderate requirements regarding temperature, relative air humidity and slightly increased requirements regarding rainfall during tuber bulking phase, full inflorescence and later after flowering in the phase of yield formation and bulking.

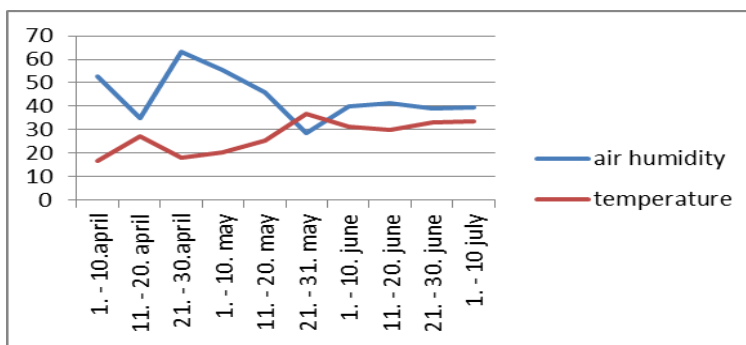

Chart 1. Temperature and air humidity in the greenhouse during the experiment

Ecological conditions during the experiment (temperature and air humidity) are depicted in chart 1. The formation of root system occurred in soil temperatures above 7°C. Above – ground vegetation part was formed on temperatures between 15-20°C. These temperatures are biological optimum for above – ground assimilative part (trunk and leaves) and below –ground vegetative organs (stolons and tubers) formation. Higher air (>25°C) and soil (>20°C) temperatures slow down tubers formation. Largest yield was achieved in average daily temperatures of around 21°C. Potato has also moderate requirements regarding air humidity, with optimum being 75-80% (Bašović, et al., 1980).

Results and discussion

The number of newly formed tubers per plant is a variety feature, but it greatly depends on the number of above-ground sprouts per plant, size of tubers used as seed, agroecological conditions and technology in potato production (Barkley, 2005). It is considered that for most varieties optimal number of tubers per plant is 12-14, which enables achieving high potato yield. In our research (table 1) it's determined that Faluka variety formed the biggest number of tubers compared to other varieties. Determined differences were highly significant, as were the differences between varieties Kurada and Kenebek. In our research variety Faluka confirmed tolerance to high temperatures and moisture deficiency which had no effect on number of tubers formed per plant. The number of tubers formed per plant was not significantly affected by application of biostimulators and watering interruption.

Table 1. Average number of tubers per plant

Variety (A)	Foliar top dressing (B)	Watering		Average			
		Watering interruption C ₀	Regular watering C ₁	AB	A		
Agria	B ₀	11,5	13,7	12,6	12,7		
	B ₁	13,3	12,2	12,8			
	AC	12,4	12,9				
Faluka	B ₀	22,5	19,8	21,2	19,9		
	B ₁	18,5	18,7	18,5			
	AC	20,5	18,3				
Kenebek	B ₀	10,3	10,7	10,5	11,4		
	B ₁	12,8	11,8	12,3			
	AC	11,6	11,2				
Kurada	B ₀	13,3	17,2	15,3	14,7		
	B ₁	13,2	15,0	14,1			
	AC	13,3	16,1				
Dezire	B ₀	14,2	14,7	14,5	13,0		
	B ₁	11,5	11,8	11,4			
	AC	12,8	13,2				
BC		14,4	15,2	14,8	B		
		13,9	13,9	13,9			
C		14,1	14,6		14,4		
LSD test	A	B	C	AB	AC	BC	ABC
0,05	2,104	1,331	1,331	2,976	2,976	1,882	6,655
0,01	2,777	1,755	1,755	3,937	3,937	2,489	8,805

Average tuber mass is property of a certain variety, but it depends a lot on influence of agroecological factors, applied agrotechnics, way of garden bed forming, size of seed tuber, number of above-ground sprouts per plant, number of tubers per plant, and length of stolons (Tadesse *et al.*, 2001; Bussan *et al.*, 2007). Kenebek variety, compared to other varieties, had the largest average tuber mass and that difference was highly significant, compared to average tuber mass in varieties Faluka, Kurada and Dezire, as well as the difference in tuber mass between Faluka variety and other varieties, because Faluka variety had the smallest tuber mass. Average tuber mass per plant decreases when the number of tubers per plant increases. Mišović and Šušić (1985) came to similar conclusions. Treatments with biostimulator (Isabion) had positive effect on tuber mass. In the part of the experiment where the treatment with Isabion was conducted, average tuber mass was 65, 13 g, which is significantly higher compared to average tuber mass (56,21g) in the part of the experiment where the treatments were not conducted. The application of the biostimulator proved to be especially effective when applied to Kenebek variety because the average tuber mass of this variety ranged from 64,14 g (without biostimulator application) to 80,06 g (treated with biostimulator). Biostimulator also had positive effects on tuber mass on the part where watering was interrupted because tuber mass ranged from 53, 89 grams (without Isabion application) to 65, 09 grams (with Isabion application).

Table 2. Average tuber mass (g)

Variety (A)	Foliar top dressing (B)	Watering		Average			
		Watering interruption C ₀	Regular watering C ₁	AB	A		
Agria	B ₀	53,65	68,32	60,98	65,92		
	B ₁	67,37	74,35	70,86			
	AC	60,51	71,33				
Faluka	B ₀	38,04	50,84	44,44	47,03		
	B ₁	51,15	48,11	49,63			
	AC	44,59	49,47				
Kenebek	B ₀	63,00	65,28	64,14	72,1		
	B ₁	83,96	76,17	80,06			
	AC	73,48	70,72				
Kurada	B ₀	61,55	52,47	57,01	59,74		
	B ₁	58,80	66,15	62,47			
	AC	60,17	59,31				
Dezire	B ₀	53,24	55,95	54,59	58,62		
	B ₁	64,18	61,14	62,66			
	AC	58,71	58,54				
BC		53,89	58,57	56,21	B		
		65,09	65,18	65,13			
	C	59,49	61,88				
LSD test	A	B	C	AB	AC	BC	ABC
0,05	8,338	5,273	5,273	11,792	11,792	7,458	16,677
0,01	11,032	6,977	6,977	15,602	15,602	9,866	22,065

Yield of every plant species is the most important quantitative property, which is very variable and dependent on strong influences of agroecological and agrotechnical factors. Yield increase is one of the most important tasks to which the modern intensive agriculture strives. Those varieties which have high and sustainable yield potential in different agroecological conditions are favored. When choosing the assortment, yield is considered to be one of the most important features. Average yield of tubers per dish (table 3) ranged between 696, 67 grams in Dezire variety and 903, 95 grams in Faluka variety. Dezire variety compared to other varieties had the smallest yield which was very statistically significant, while the differences between other tested varieties did not have statistical significance. Highly significant differences were determined in variety B, where, with foliar top dressing, average yield was 861, 98 grams, while in varieties without foliar top dressing with Isabion, yield was 783, 81 grams. Watering interruption affected the yield with high significance, which ranged from 786, 18 grams (watering interruption) to 865, 98 grams (watering). The application of Isabion positively affected the yield increase in varieties: Agria, Kenebek and Dezire, as well as its application in varieties with watering interruption in tubers forming phase. Water deficit in the tubers initiation phase and phase of their early development increased the number of rough and deformed tubers which significantly decreases potato yield, while the water deficit in the period of tuber bulking, negatively affected not only the quantity, but also the quality. (King and Stark, 2011). Steyn *et al.* (1998) established that there was significant reduction in potato yield and tubers size, caused by water reduction, but they also pointed out the influence of the genotype as a response to water stress. Water deficit in the early phase of growth led to yield reductions and development of small tubers (Hasasan *et al.*, 2002), which is in accordance with our results.

Table 3. Potato yield (g per dish)

Variety (A)	Foliar top dressing (B)	Watering		Average			
		Watering interruption C ₀	Regular watering C ₁	AB	A		
Agria	B ₀	616,97	935,98	776,47	839,00		
	B ₁	896,02	907,07	901,54			
	AC	756,49	921,52				
Faluka	B ₀	845,63	998,95	922,29	903,95		
	B ₁	876,78	894,46	885,62			
	AC	861,20	946,70				
Kenebek	B ₀	648,90	698,49	673,69	830,22		
	B ₁	1074,68	898,81	986,74			
	AC	861,79	798,64				
Kurada	B ₀	808,88	899,06	853,97	860,56		
	B ₁	742,98	991,34	867,16			
	AC	775,93	945,20				
Dezire	B ₀	651,59	733,66	692,62	696,67		
	B ₁	699,43	702,02	700,72			
	AC	675,51	717,84				
BC		714,39	853,23	783,81	B		
		857,98	878,74	861,98			
	C	786,18	865,98				
LSD test	A	B	C	AB	AC	BC	ABC
0,05	76,098	48,129	48,129	107,619	107,619	67,377	150,656
0,01	100,594	63,684	63,684	142,404	142,404	89,377	201,386

Table 4. Tubers faction structure (%)

Variety (A)	Foliar top dressing (B)	<35 mm		35-55 mm		> 55 mm	
		Watering		Watering		Watering	
		Watering interruption C ₀	Regular watering C ₁	Watering interruption C ₀	Regular watering C ₁	Watering interruption C ₀	Regular watering C ₁
Agria	B ₀	5,67	9,48	29,98	21,68	64,34	68,83
	B ₁	9,75	6,72	28,12	27,74	62,63	65,54
	Average	7,71	8,10	29,05	24,71	63,48	67,18
Faluka	B ₀	20,03	11,75	30,23	35,16	49,74	54,11
	B ₁	12,09	12,98	28,74	56,25	59,16	30,76
	Average	16,06	12,36	29,48	45,70	54,45	42,43
Kenebek	B ₀	5,39	6,62	25,15	18,87	69,45	74,51
	B ₁	10,85	8,56	19,13	18,87	69,98	72,56
	Average	8,12	7,59	22,14	18,87	69,72	73,53
Kurada	B ₀	13,09	12,53	28,41	39,95	58,50	47,52
	B ₁	13,06	10,90	33,34	33,96	53,59	55,14
	Average	13,07	11,71	30,87	36,95	56,04	51,33
Dezire	B ₀	14,41	13,37	44,47	44,69	41,10	41,94
	B ₁	7,65	13,65	43,99	23,91	48,36	62,43
	Average	11,03	13,51	44,23	34,30	44,73	52,18
Total watering		11,20	10,65	31,15	32,11	57,68	57,33

The achievement of high number of certain sized tubers in total yield is imperative for every potato grower. Physiological processes which determine the number and size of the tubers are numerous and there are a lot of agronomic and physiological factors which are included in those processes (*Bus and Dustman, 2007*). Size of the potato tubers, especially its percentage in the total yield is feature of a variety, which also depends on level of agrotechnics, climate conditions, soil type and its structure, the way the garden bed was formed, number of tubers per plant, and stolons length. Early and mid-early sorts usually have short stolons with small number of big tubers, while the mid-late and late sorts form longer stolons with larger number of small tubers. *Mackerron et al. (1988)*, *Dwyer and Boisvert (1990)* and *Walwort and Carling (2002)* concluded that the water deficit in the soil caused increase in number of smaller faction tubers.

Largest percentage of small faction (20,03%) had the variety Faluka, where the foliar top dressing was not applied and watering was interrupted in the phase of tuber initiation, and the smallest percentage of the small faction had the variety Kenebek (5,39%) in the variety without the foliar top dressing and with watering interrupted in the phase of tuber initiation. Faluka variety had also the largest percentage of middle tubers faction (56, 25%) and that was in the variety with foliar top dressing and with regular watering. The largest percentage of big tubers (74, 51%) had the Kenebek sort in the variety without foliar top dressing and with regular watering. The most desirable faction structure had the Kenebek sort, because in the production of market tubers, it is desirable to produce as few as possible of small tubers, and as many as possible of big tubers.

Conclusion

Based on the gathered results, these conclusions can be derived:

- The Faluka variety formed the biggest number of tubers, while the Kenebek variety had the smallest number of tubers. Number of formed tubers affected the average mass, as well as faction structure, so the Faluka variety had the smallest tuber mass, while the Kenebek variety had the largest. Faluka variety had the largest percentage of small and the smallest percentage of large tubers, while the Kenebek variety had the largest percentage of large and smallest percentage of small tubers.
- Foliar application of Isabion had significant influence on average tuber mass and potato yield. Application of Isobion positively affected yield increase in following varieties: Agria, Kenebek and Dezire, as well as its application in the parts of the experiment where the watering was interrupted in the phase of tubers formation.
- The drought effect influenced the process of organic compounds synthesis and their translocation, which is significant for understanding the effects of drought on potato yield.

References

- Barkley S. (2005): Botany of the Potato Plant. Agriculture, Food and Rural Development, Government of Alberta: 1-6.
- Bašović, M., Velagić-Habul, E. I Čmelik, Z. (1980): Contents of some elements in the aboveground part, root and tuber varieties of potatoes Eba. Archive for the agricultural teachings V.41. (141) 5-16.
- Bugarčić, Ž., Bugarčić, R.A., Đekić, R., Ivan, J. (2000): A study of yields of Duch potato varieties in different agro-ecological conditions in Serbia. Journal of Scientific agricultural research. Vol. 61, No 215, 143–150, Belgrade.
- Bus C.B. and Wustman, R. (2007): The Canon of Potato Science: 28. Seed Tubers. Potato Research Vol. 50: 319-322.
- Bussan A.J., Mitchell P.D., Copas M.E., Drilias M.J. (2007): Evaluation of the effect of density on potato yield and tuber size distribution. Crop Sci. Vol. 47: 2462-2472.
- Dwyer L.M. and Boisvert J.B. (1990): Response to irrigation of two potato cultivars (*Solanum tuberosum* L.) Kennebec and Superior. Can. Agric. Engr. Vol. 32: 197-203.
- Hammer, K. and Y. Teklu (2008): Plant Genetic Resources: Selected Issues from Genetic Erosion to Genetic Engineering. Journal of Agriculture and Rural Development in the Tropics and Subtropics. Volume 109, No. 1, 15–50.
- Hassan A., Sarkar A.A., Hazi M. (2002): Effect of deficit irrigation at different growth stages on the yield potato. Pak.J.Biol.Sci. 5, 128-134.
- Jovović, Z., Stešević, D., Meglič, V. and Dolničar, P. (2013): Old potato varieties in Montenegro. University of Montenegro, Biotechnical faculty Podgorica
- Jovović, Z. (2010): The influence of the tuber size on yield and other productivity features of potatoes. Studii și Cercetări, Biologie, Vol 18, 33-37. Romania.
- King B.A. and Stark J.C., (2011): Potato irrigation management. University of Idaho, College of Agriculture, <http://www.cals.uidaho.edu/edcomm/pdf/bul789>, Pristupljeno 10.09.2011.
- Mackerron D,K,L., Marshall B., Jefferies R.A. (1988): The distributions of tuber sizes in droughted and irrigated crops of potato. Relation between size and weight of tubers and the variability of tuber –size distributions. Journal Potato reserch 31, 279-288.
- Milić S., Bošnjak Đ., Maksimović Livija., Vasin J., Ninkov Jordana, Zeremski-Škorić Tijana (2009):

- Dynamics of potato vine yield formation and biological yield as affected by pre-irrigation soil moisture. Proceedings, Volume 46, 25-32. Institute of Field and Vegetable Crops, Novi Sad.
- Mišović M. i Šušić S. (1985): The impact on germination of seed potato yield and starch content. Zornik works. Institute for potatoes, Guča, 1: 17-23.
- Passioura J. (2007): The drought environment: physical, biological and agricultural perspectives. Journal of Experimental Botany, Vol. 58, No 2, 113-117.
- Steyn J.M., H.F. DU Plessis and P.S. Hammes (1998): Yield response of potato genotypes to different soil water regimes in contrasting seasons of a subtropical climate. Journal of potato research, 41, 239-254.
- Tadesse M., Lommen W.J.M., Struik P.C. (2001): Development of micropropagated potato plants over three phases of growth as affected by temperature in different phases. Netherland Journal of Agricultural Science, 49: 53-66.
- Tomasiewicz D, Harland M, Moons B (2003): Guide to Commercial Potato Production on the Canadian Prairies, Western Potato Council. Adapted for internet.
- Walworth J.L., Carlimg D.E. (2002): Tuber initiation and Development in irrigated and Non-irrigated Potatoes, Amer. J. Of Potato Res. 79: 387-395.

EFFECT OF GROWTH REGULATORS AND THEIR MIXTURES ON WINTER WHEAT GROWTH, COLD RESISTANCE AND PRODUCTIVITY

Virgilija GAVELIENĖ, Lina PAKALNIŠKYTĖ, Leonida NOVICKIENĖ

Institute of Botany, Nature Research Centre, Akademijos 2, Vilnius, Lithuania

E-mail: virgilija.gaveliene@botanika.lt

Abstract

This study was aimed to investigate the effect of growth regulators containing free amino acids, macro- and micro-elements on winter wheat freezing resistance, growth and productivity formation; and to test mixtures of regulators retardant and herbicide activity on wheat growth and productivity. Effect of regulators was established in controlled cold conditions and natural field experiments in 2012–2015. The tested regulators applied to wheat 'Skagen' at BBCH 13–14 stage in controlled cold stress conditions actively restored wheat seedlings growth after freezing at -5°C and -7°C temperature. Under the impact of Ruter AA (1 ml/100 ml), Terra Sorb (1 ml/100 ml) and Razormin (0.1/100 ml) seedlings survival, compared with control, increased by 28, 17 and 11%, respectively. In natural field experiments tested regulators produced stimulating effect on wheat plants growth in autumn, plants overwintering, vegetation renewal and productivity elements formation. At full maturity stage, it was revealed that Ruter AA (2 l ha^{-1}), Terra Sorb (2 l ha^{-1}) and Razormin (200 ml ha^{-1}) increased the number of productive stems and grain number per ear as well as grain weight per plant. 1000 seed weight differed among the test variants and was significantly highest after treatment with Terra Sorb (2 l ha^{-1}). Investigation of Razormin, Terra Sorb in mixture with herbicide Sekator (200 ml ha^{-1}) and retardant Cykocel (1.5 l ha^{-1}) applied at BBCH 31-32 stage on wheat showed that herbicide and more retardant did not damage the activity of the tested regulators on plants growth and productivity.

Keywords: *amino acids, Triticum aestivum L., overwintering*

Introduction

At present the world population constantly increases and therefore the global food productivity shows a decreasing trend due to the accumulating negative effects of abiotic-biotic stresses. For all that the agriculture production in the world is rapidly increasing; it strongly depends on the use of modern agrochemistry agrotechniques, as well as the use of suitable growth regulators, their mixtures and combinations. European agrometeorological conditions, particularly in periods of winter crops hardening-preparation for wintering, overwintering and vegetation renewal, are unfavourable and varying. So the search for tools regulating plant growth, development and productivity is important. In the above-mentioned regulation process synthetic plant growth regulators of various chemical structures participate: physiological analogues of phytohormones, compounds of contrary action – retardants, herbicides regulating weed management, and amino acids products (Auškalnienė, 2005; Rademacher, 2000). Latter are established growth regulators or so-called special fertilizers, containing free amino acids, macro and micro elements (Velini *et al.*, 2010). Free amino acids have a lower molecular weight, so they are quickly absorbed by plants, especially through leaves, and only small amount through roots. Several different amino acids: lysine, glutamine, glicine have been tested for their effects on nitrate and ammonium

influx, transcription, and for these process glutamine was most effective (Miller *et al.*, 2007). As well as exogenously applied amino acids, glutamine and especially proline increased free proline content and is involved in the response to cold stress. So proline level may be an indicator of plants cold hardening and freezing tolerance (Haya *et.al.*, 2012). (Gaveliene *et al.*, 2014). Glutamic and aspartic acids are very important acids for synthesis of other amino acids. The absence of one amino acid, which participates in individual protein structure, hindered protein synthesis (Nikiforova *et al.*, 2006). Plants themselves synthesize amino acids from inorganic nitrogen (N). During this process nitrate is assimilated via conversion to nitrite, then ammonium ions into amino acids (Miller *et al.*, 2007). So the scientific investigation and employment of the products – growth regulators with optimal ratio of amino acids is perspective. Even the practices of using multi-component mixtures (growth regulators, herbicides) of various combinations are spreading (Auškalnienė, 2005). Many plants can deactivate or metabolize plant growth regulators, including herbicides. Wheat and barley tolerate 2,4-D and MCPA, because they can metabolize these chemicals faster than broad-leaved plants. Some cultivars of wheat are tolerant while others are susceptible to the herbicide difenzoquat. This difference is due to specific genes within the plants (Gunsolus, 2013 (<http://www.extension.umn.edu/>)). From the practical point of view the multi-component mixtures of growth regulators save money and time, fields are less damaged by vehicles, but the knowledge of what products can be mixed in order to regulate plant growth, development and productivity formation processes in the desired direction and be efficient against weeds, are insufficient.

Therefore the main task of this research was to investigate the effect of growth regulators containing free amino acids, macro- and micro-elements on winter wheat freezing resistance, crops autumnal growth, vegetation renewal, productivity formation in laboratory and field conditions; to test some regulator mixtures with compounds of retardant and herbicide activity on winter wheat in natural field conditions.

Material and Methods

The investigation of the action of different growth regulators and their mixtures on winter wheat (*Triticum aestivum* L.) growth and development was carried out in controlled conditions at the Laboratory of Plant Physiology and in natural field conditions at the Field Experimental Station of the Institute of Botany of Nature Research Centre (Lithuania) in 2012-2015. The tested products were: Ruter AA containing (%) total free amino acids 8.4, N - 6.6, P₂O₅ - 6.0, K₂O – 4.2, Fe-0.04, Mn-0.06, Mo-0.12, Zn-0.08 and 18 % organic matter; Terra Sorb containing (%) free amino acids 9.3, total N 2.1, organic N 2.1, B-0.02, Mn-0.04, Zn-0.07 and organic matter 14.8; Razormin containing (%) free amino acids 7, N – 4, P₂O₅ – 4, K₂O – 3, Fe-0.4, Mn-0.1, Zn-0.085, B-0.1, Cu-0.02, Mo-0.01 and organic matter-25.0; For experiments we used winter wheat genotype 'Skagen' tolerant to cold, produced in Germany by the Nordic A/S seed growing company. *In laboratory conditions* wheat seedlings were germinated for 20 days in soil (6 growing dishes 16 seedlings in each) in the Climacell plant growing chamber at 18±2°C temperature, under illumination of 60 μmol m²s⁻¹ and photoperiod 16/8 h. At BBCH-13-14 stage (Meier, 2001) plants were treated with water solutions of tested growth regulators. After 24 hours seedlings were acclimated at 4°C for 96 h in the Friocell chamber. After hardening the seedlings were held at temperature –1°C, –3°C, –5°C and –7°C for 24 h. After freezing the seedlings were transferred into a plant growing chamber, at a temperature of 18±2°C for 7 days and after that the survived seedlings were noted and estimated.

The growth regulators with amino acids investigated in controlled laboratory conditions, were further studied in *natural field conditions*. Field experiments were performed in sixfold repetition on light loamy Endocalcari-Epihypogleic Combisol. The main agrochemical parameters of the arable soil layer: pH - 7.0-7.3; P₂O₅ – 769.8-770 mg kg⁻¹, K₂O – 214-214.6 mg kg⁻¹. Plants were cultivated using standard agrochemical and agrotechnical technology for these crops (Liakas *et al.*, 2000). Experiments were set in the 2nd week of September. Fertilization of wheat (N₁₀₀P₉₀K₆₀) plants was performed as follows: P, K and N₃₀ were used before soil autumn ploughing, whereas in spring N₉₀ kg ha⁻¹ were used before the renewal of plant vegetation period. The test products were applied on plants foliar spread of water solutions, 100 ml for each plot at BBCH- 22-25 stage (tillering phase). In order to assess the success of plants overwintering, the number of plants was calculated in autumn and in spring in six plots (1 m⁻² each) of test products and of control. The morphometrical parameters of plant growth (the stem height, leaf number, plant fresh and dry weight) were estimated in autumn at BBCH 30-32 stage and in spring, at the vegetation renewal period, from 30 plants for each investigated product (regulator) and control. From each plot 5 plants were randomly rooted out and sampled in all – 30 plants. For investigation of growth regulators Ruter AA (2 l ha⁻¹), Terra Sorb (2 l ha⁻¹) and Razormin (200 ml ha⁻¹) in mixture with herbicide Sekator (200 ml ha⁻¹) and retardant Cykocel (1.5 l ha⁻¹) on winter wheat growth and productivity, plants was applied in spring at BBCH-31-32 stage. At full maturity stage the wheat yield structural elements: number of productive stems, number of grain per ear, grain weight per plant, 1000-grain weight and grain weight from each plot (1m-2x6) in all variants were determined.

The data were processed statistically Data was performed using STATISTICA 10.0 for Windows, one-way analysis of variance (ANOVA) at the confidence level $p \leq 0.05$. Data was processed using software MS Excel (version 7.0).

Results and Discussion

At present it is known that free proline and glutamine play a significant role in the cold acclimation and freezing tolerance processes of the wintering plants (Dörffling *et al.*, 2009; Gaveliene *et al.*, 2014). Therefore it becomes interesting to study the effect of growth regulators, containing free amino acid on plants freezing tolerance.

Experiments in controlled laboratory conditions. The evaluation of wheat freezing resistance under the impact of the tested regulators revealed that wheat seedlings are resistant at temperature -1°C. The most significant differences in the effects of growth regulators were determined at -5°C temperature. Under the impact of Ruter AA (1 ml/100 ml), Terra Sorb (1 ml/100 ml), and Razormin (0.1/100 ml) seedlings survival, compared with control, increased by 28%, 15%, and 11%, respectively (Table 1).

Table 1. Effect of growth regulators on winter wheat 'Skagen' seedlings' resistance to freezing

Test variant	Freezing temperature, °C			
	-1	-3	-5	-7
	Resistant seedlings %			
Control	95.2±6.3	88.0±2.3	35.7±2.3	4.1±0.1
Ruter AA (0.5 ml 100 ml ⁻¹)	98.0±5.8	95.3±6.3	38.9±2.0	4.5±0.0
*Ruter AA (1 ml 100 ml ⁻¹)	100.0±7.7	96.7±4.0	45.8±2.4	5.7±0.1
Terra Sorb (0.5 ml 100 ml ⁻¹)	99.5±6.1	98.5±5.2	37.0±5.2	4.8±0.8
*Terra Sorb (1ml 100 ml ⁻¹)	97.1±5.0	100.5±4.2	41.2±2.8	6.4±2.1
*Razormin (0.1 ml 100 ml ⁻¹)	98.1±3.3	97.3±6.0	39.7±3.6	5.7±0.3
Razormin (0.25 ml 100 ml ⁻¹)	100.3±6.3	90.0±7.1	36.7±2.2	4.8±0.2

Note. Each data represent the mean ± SE of three biological and thirty morphometrical replicates; * – differences are statistically significant based on t test at P≤0.05.

The represented data for the first time showed that products containing free amino acids in cold stress conditions increased seedlings' freezing tolerance. This data supplemented studies about the role of amino acids proline and glicine betaine in response to environmental stresses. There are data on proline being supplied exogenously and at low concentrations enhancing tolerance to cold stress (Gaveliene *et al.*, 2014). But in order to investigate the effect of growth regulators on autumnal growth, vegetation renewal, productivity elements formation of winter crops, the experiments should be carried out in natural field conditions.

Field experiments. The meteorological conditions of winter wheat growing season in Lithuania coincide with growth and development conditions of this plant. But some growth regulators may be able to optimize plants physiological and morphological processes related with wheat growth and productivity formation (Novickienė *et al.*, 2007). Study of the effect of tested growth regulators on wheat growth and development in autumn revealed the most active products and their doses: Ruter AA (2 l ha⁻¹), Terra Sorb (2 l ha⁻¹), Razormin (200 ml ha⁻¹), Terra Sorb (1 l ha⁻¹). After application of these compounds plants formed the optimal number of shoots, plants were on average by 6-21% higher in comparison with control. Positive effect of these growth regulators on fresh and dry weight accumulation was noted too. In spring, after vegetation renewal, in trial plots treated with Ruter AA (2 l ha⁻¹), Terra Sorb (2 l ha⁻¹) and Razormin (200 ml ha) the number of overwintered plants was by 10-20 % higher than control (Fig.).

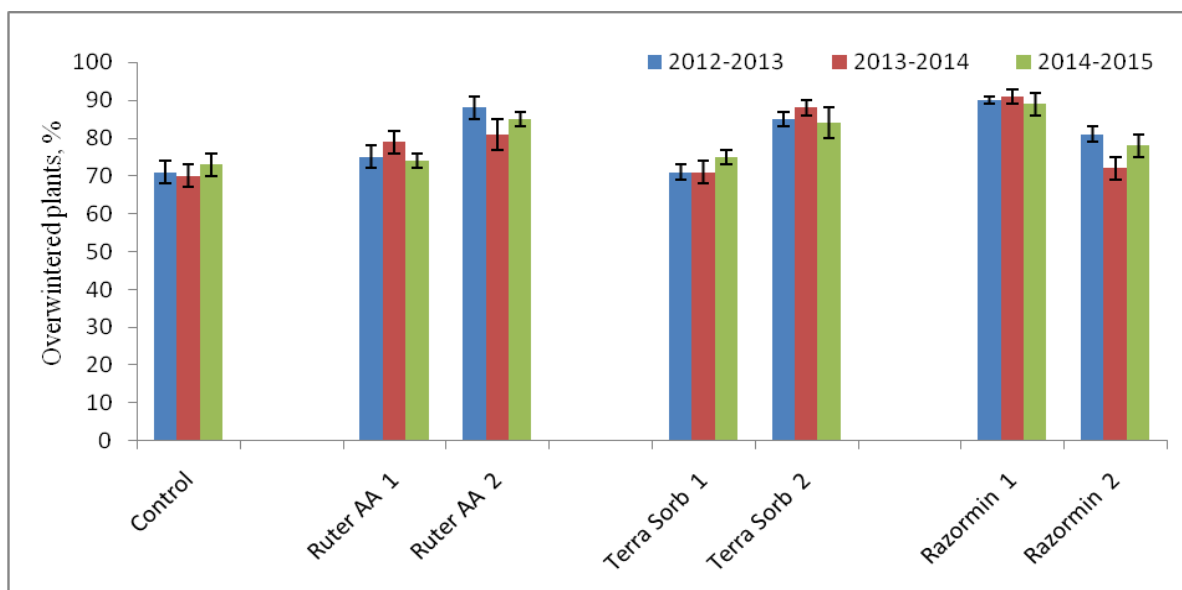

Figure. Effect of growth regulators on winter wheat 'Skagen' plants overwintering, 2012-2013; 2013-2014 and 2014-2015. Ruter AA 1 – 1 l ha⁻¹; 2 – 2 l ha⁻¹; Terra Sorb 1 – 1 l ha⁻¹; 2 – 2 l ha⁻¹; Razormin 1 – 200 ml ha⁻¹; 2 – 500 ml ha⁻¹. Each data represent the mean ± SE. * – differences are statistically significant at P≤0.05.

At full maturity stage (BBCH 97-99) the effect of tested regulators on wheat linear growth and productivity formation was estimated. It was found that all tested products more or less stimulated stems linear growth. Evaluation of the effect of tested compounds on number of productive stems, number of grain per ear, grain weight per plant and 1000 grain weight of wheat revealed that Ruter AA (1 l ha), Razormin (200 ml ha), increased productive stems formation. Terra Sorb (2 l ha) and Razormin (200 ml ha⁻¹) stimulated 1000 grain weight formation. Employing the data obtained in laboratory and in small-plot field experiments we revealed that products containing amino acids are promising to modify winter wheat growth and productivity elements formation. At present the use of growth regulators and pesticides mixtures is widely spread (Lydy et al., 2004; Auškalnienė, 2005). Bearing that in mind, we investigated the impact of the mixture of Razormin (200 ml ha⁻¹), Terra Sorb (2 l ha⁻¹), Ruter AA (2 l ha⁻¹) with herbicide Sekator and retardant Cykocel on winter wheat 'Skagen' stem growth and productivity formation. The morphometrical measurement at full maturity stage BBCH 96-97 showed that under the effect of Sekator stem height was close to control, but under effect of Sekator and Cykocel mixture stem growth significantly decreased, about 30% in comparison with control. Analysis of the impact of the tested herbicide Sekator on productivity elements formation showed that under the impact of Terra Sorb (2 l ha⁻¹) in mixture with Sekator O and Cykocel significantly increased the number of productive stems per plant. Cykocel and Ruter AA in mixture with Sekator O increased the number of productive stems only by 5%. Grain number per ear increased under all tested regulators, even Sekator O. Statistically reliable data on 1000 grain weight have been obtained under the effect of Terra Sorb (2 l ha⁻¹), Razormin (200 ml ha) in mixture with Cykocel (1.5 l ha⁻¹) (Table 2).

Table 2. Effect of growth regulators mixture on winter wheat 'Skagen' productivity elements formation at full maturity stage (BBCH96-97), 2014-2015.

Test variant	Number of productive stem	Grain number per ear	Grain weight per plant	1000 grain weight
	n		g	
Control	5.7±0.26	38.6±0.85	6.90±1.01	77±0.25
Sekator O (200 ml ha ⁻¹)	5.6±0.25	40.7±1.04	6.90±1.00	77±0.16
Sekator O (200 ml ha ⁻¹)+Cykocel (1.5 l ha ⁻¹)	5.8±0.37	41.0±1.24	6.98±1.33	72±0.08
Sekator O (200 ml ha ⁻¹) +Cykocel (1.5 l ha ⁻¹)+Ruter AA (2 l ha ⁻¹)	6.0±0.27	41.9±1.39	7.02±1.52	75±0.42
Sekator O (200 ml ha ⁻¹)+Cykocel (1.5 l ha ⁻¹)+Terra Sorb (2 l ha ⁻¹)	6.5±0.31	40.8±1.56	7.08±1.50	78±0.65
Sekator O (200 ml ha ⁻¹)+Cykocel (1.5 l ha ⁻¹)+Razormin (200 ml ha ⁻¹)	6.2±0.29	41.7±1.28	7.12±1.52	79±0.33

Note. Each data represent the mean ± SE of forty replicates, for 1000 grain weight of four replicates.

It is important that tested herbicide Sekator did not damage regulators with amino acids activity. Some authors indicated that herbicides act on pathways or processes, crucial to plants, in an inhibitory or stimulatory way, low doses of any herbicide might be used to beneficially modulate plant growth and development (Velini et al., 2010). But in general pesticides are chemical stressors in that they are designed to have biological activity, but are intentionally placed into the environment in large quantities (Lydy et al., 2004).

Conclusion

In conclusion, we can state that growth regulators, containing free amino acids, micro-and macro-elements, applied to wheat cv. 'Skagen' at BBCH 14-15 stage in controlled cold stress conditions significantly increased seedlings' freezing tolerance. Ruter AA (1 ml/100 ml), Terra Sorb (1 ml/100 ml), Razormin (0.1 ml/100 ml) more actively restored wheat seedlings growth at -5°C temperature. In natural field conditions the tested growth regulators produced significant stimulating effect on wheat growth in autumn, acclimation to the cold, over wintering, vegetation renewal in spring and productivity elements. Growth regulators Ruter (2 l ha⁻¹), Terra Sorb (2 l ha⁻¹), Razormin (200 ml ha⁻¹), in mixture with herbicide Sekator and retardant Cykocel showed, that herbicide and more retardant did not damage the activity of tested regulators on winter wheat on growth and productivity formation

References

- Auškalnienė O. (2005). Augalų augimo reguliatoriaus Modus mišinių įtaka žieminių kviečių derliui ir jo struktūros elementams (The influence of Modus mixtures with other plant growth regulators on the grain yield and productivity of winter wheat). Žemdirbystė. Mokslo darbai, Vol. 2, No. 90, pp. 48-60 (in Lithuanian).
- Dorffling K., Dorffling H., Luck E. (2009). Improved frost tolerance and winter hardiness in proline over accumulating winter wheat mutants obtained by in vitro-selection is associated

- with increased carbohydrate soluble protein and abscisic acid (ABA) levels. *Euphytica* Vol. 165, pp. 545-556.
- Gavelienė V., Pakalniškytė L., Novickienė L. (2014). Regulation of proline and ethylene levels in rape seedlings for freezing tolerance. *Central European Journal of Biology*, Vol. 9, No. 11, pp. 1099-1107.
- Gunsolus L.J. (2013). Herbicide resistant weeds. <http://www.extension.umn.edu/>
- Hayat Sh., Hayat Sh., Hayat Q., Alyemeni M.N., Wani A.Sh., Pichtel J. and Ahmad A. (2012). Role of proline under changing environments: a review. *Plant Signalling - Behavior*. Vol. 7, pp. 1456-1466.
- Liakas V., Rauckis V., Krivelis V. (2000). Physiological features of yield formation in winter wheat. *Sodininkystė ir daržininkystė*, Vol. 19, pp. 128-134.
- Lydy M., Belden J., Whellock C., Hammock B., Denton D. (2004). Challenges in regulating pesticide mixtures. *Ecology and Society*, Vol. 9, N.6. [Online/URI]
- Meier U., Growth stages of mono- and dicotyledonous plants. *BBCH Monograph*. 2. Edition, 2001 Edited by Uwe Meier
- Miller Anthony J., Fan Xiaorong, Shen Qirong, Smith Susan J. (2007). Amino acids and nitrate as signals for the regulation of nitrogen acquisition. *Journal of Experimental Botany*, Vol. 59, No. 1, pp. 111-119
- Nikiforova V.J., Bielecka M., Gakiere B., Krueger S., Rinder J., Kempa S., et al. (2006). Effect of sulfur availability on the integrity of amino acid biosynthesis in plants. *Amino Acids*, Vol. 30, No. 2, pp. 173-183.
- Novickienė L., Merkys A., Miliuvienė L., Gavelienė V., Kazlauskienė D., Pakalniškytė L. (2007). Physiological principles of modification of cereal crops growth and productivity. *The Third International Scientific Conference Rural development–2007. Proceedings II*, p. 178-184.
- Rademacher W. (2000). Growth retardants: effect on Gibberellin Biosynthesis and other metabolic pathways. *Annual Review of Plant Physiology and Plant Molecular Biology*, Vol. 51, pp. 501-531.
- Tein B., Ereemeev V., Keres I., Selge A., Luik A. (2010). Effect of different plant production methods on field and quality of winter wheat 'Portal' in 2009. *Annual 16th International Scientific Conference Proceedings of Agricultural Science*, Vol. 1, pp. 17–21.
- Velini A.K., Trindade M.L.B., Barberis L.R.M., Duke S.O. (2010). Growth regulation and other secondary effects of herbicides. *Weed Science*, Vol. 58, No 3, pp. 351-354.

ETHYL METHANE SULFONATE AND ITS EFFECT ON MUTAGENESIS IN RICE CROP IMPROVEMENT

Hamid DOROSTI¹, Peiman ZANDI^{2*}, Saikat Kumar BASU³, Shahram Khademi CHALARAS²

¹Rice Research Institute of Iran (RRII), P.O. Box 1658, Rasht, Iran

²Institute of Crop Science, Chinese Academy of Agricultural Sciences, Beijing 100081, P. R. China

³Department of Biological Sciences, University of Lethbridge, Lethbridge, AB, Canada

*Corresponding author: z_rice_b@yahoo.com

Abstract

The main purpose for inducing mutation in rice crops is to increase the mutation rate in a short period of time and to develop new plant varieties with useful agronomical traits in order for sustainable food production to become a possibility. The occurrence of a spontaneous mutation frequency rate is very rare and exceptional, making it difficult for plant breeders to exploit. Mutations are commonly induced by chemical (*e.g.* ethyl methane sulfonate) and physical (*e.g.* gamma radiation) mutagen treatment of both seed and vegetatively propagated crops. Here, more than 10,000 seeds of the rice variety Gohar were initially subjected to mutagenesis using ethyl methane sulfonate (EMS). The EMS-treated seeds were rinsed with deionized water, and then sown in the seedbed. A population of about 5,250 M1 plants was developed. At maturity, a single panicle was picked from each plant. The following year, to achieve 3,510 M2 plants, the seedlings selected from the nursery grown panicles were grown in the field. Then, one panicle was chosen from each mature plant in M2 to get the M3 population. In the M4 population, the selection criteria were early maturity, high fertility rate, dwarf growth habit, and plant type. Eventually, six plants possessing early maturing traits were selected for commercial release.

Keywords: *Chemical mutagen, early maturity, rice, mutation, ethyl methane sulfonate*

Introduction

The rice cultivation system in Iran is completely irrigated, and the production level in 2015 was quite impressive, with 3.5 million tons from approximately 0.550 million hectares of harvested rice area (Karbalaee Aghamolki *et al.*, 2015). Increasing Iranian rice production within limits in available land, water resources and challenges of climate change is a difficult task (Dorosti *et al.*, 2016). Hence, it is important to maintain rice diversity in the production areas for improved varieties as well as traditional landraces in equitable proportions. Induced genetic variation is a basic requirement for crop improvement to gain a long term sustainable food production (Jain, 2010). Plant breeders have successfully recombined the desired genes from the existing available gene pool with the related plant species through crossing (hybridization). Hybridization successfully obtained new varieties of a crop with desirable characteristics, such as high yield, biotic and abiotic stress tolerant.

The foremost goal of induced mutations is to enhance the mutation frequency rate in order to select appropriate variants for the purpose of breeding crops efficiently (Jain, 2010; El-Degwy, 2013). Induced mutations have played a pivotal role in the development of superior crop varieties over the past 50 years (Jain, 2005; Kharkwal and Shu, 2010), and are effective in enhancing world food security. Mutation breeding tools are the best method through which mutants with multiple traits can be identified (Till *et al.*, 2007; Jain, 2010; Kharkwal and Shu, 2010). Although

mutation is a random event (or sudden heritable change) in the genotype of an organism, some specific traits which are found in mutated plants are very desirable. In order to obtain new property /character, we need to have a large population for screening for the most desired mutants. The mutation frequency rate of spontaneous mutations is rather low and is therefore difficult to exploit by plant breeders (Jain, 2010). Mutagenesis is used by physical (*e.g.* gamma radiation) and chemical (*e.g.* ethyl methane sulfonate) mutagen treatment of seed crops (Chopra, 2005; Till *et al.*, 2007; Jain, 2010; Kharkwal and Shu, 2010). Short growing seasons and late season heavy rains are the main challenges to rice cultivation in the Northern part of Iran. Thus, the isolation of novel mutants with a higher yield, shorter growing period (earlier maturation date), and higher grain quality is necessary. Chemical agents can be beneficial since they provide high mutation rates to produce variants for tolerance to biotic/abiotic stress conditions (Jain, 2010). The dose assessment for chemicals is characterized by altering the duration and concentration of treatment; the solvent used (*e.g.* dimethyl sulfoxide); or the pH of the solution (Jain, 2005). Gohar is a high yielding variety with slender grains and good cooking quality. The variety is *late in maturing*, requiring a growing period of 135 to 140 days (seed to seed) under local conditions. Therefore, it is of particular importance to improve the variety in order to have early maturing varieties with a growing period of less than 115 days (seed to seed). The aim of *this work has been to select* new lines of rice (Gohar variety) that are high yielding, early maturing and with good grain cooking quality.

Materials and Methods

Mutation breeding on rice (Gohar variety) was conducted with ethyl methane sulfonate (EMS) targeting higher yield, early maturity and dwarf morphology. Initially, the best dose of EMS was calibrated for LD50% (data not shown). Indeed, one of the first steps in mutagenic treatment is the estimation of the most appropriate dose to apply. Almost, 10,000 seeds of Gohar variety were rinsed with deionized water and then treated with EMS concentrations 0.5%, 1%, 1.5% and 2% (V/V), pre soaked and kept on shaker for 18 hours at room temperature. All treated seeds were eluted and sown on the seedbed to grow. After 25 days, seedlings were transplanted in to the paddy field with spacing 25 × 25cm. Plants were followed from M1 to M4 populations following a strict selection criteria. The M2 population was around 3,510 plants selected for agronomic traits like early flowering and plant type. Only a few plants with visible good agronomic/ stable phenotypic characters were selected in M3 generation. In the M4 population, selection was made only on plants with stable characteristics like early flowering, good plant type, high panicle fertility and semi dwarf nature. Following EMS treatment on M0 seeds, 5,250 numbers of seeds germinated and the seedlings were investigated under field condition (M₁ population). One panicle from each plant was chosen at the ripening stage. Those panicles were grown under field condition and 3,510 plants were selected in M2. One seedling per hill was exploited in all generations from M1 to M4. Five seeds from each plant were selected and grown in seedbed; and were later transplanted to the paddy field. These plants were marked based on early flowering, and 34 plants were selected (M3). For the next year, five plants were transplanted from these materials (M4). In this generation only plants with early flowering and some other agronomic traits in comparison to the base population (Gohar) were selected and harvested. The total number of plants was 16, which flowered earlier by around 1-3 weeks than the maternal parent-Gohar. Six plants were chosen based on early maturity, leaf structure, grain quality, panicle fertility and high grain yield and were named Mutants 1 to 6.

Results and Discussion

Mutant1: Early flowering was the major character for selection. The characteristics of amylose content and fertility percent in mutant 1 were both better than the maternal parent. This mutant had long and slender grain, brick color paddy and at least flowered one week earlier than its maternal parent and was susceptible to lodging.

Table 1. Comparative performance of Mutant 1 with its maternal variety-Gohar

Characteristics	Mutant 1	Gohar (mother variety)	Percent increase or decrease related to Gohar (%)
Days to flowering*	114	121	-6.1
Plant height* (cm)	112	114	-1.8
Average productive tillers	18	18	0
Filled grain per panicle	123	126	-2.4
Fertile percent*	70.8	65	8.2
1000-grain weight (g)	23.4	23.6	0
Head rice yield (%)	58.1	57.8	1.5
Amylose*content (%)	22.8	24	-5.3
Standard heterosis for fertility (%)	6.63	-	-

*= Characters that were important for selecting mutants

Mutant 2: High yielding, early flowering (by 10 days), filled grain per panicle (19.7%) and good architecture were major criteria for selection. Fertility percent (13.9%) was also better than the maternal parent.

Table 2. Comparative performance of Mutant 2 with its maternal variety-Gohar

Characteristics	Mutant 2	Gohar (mother variety)	Percent increase or decrease related to maternal variety (%)
Days to flowering *	112	121	-8
Plant height (cm)	114	114	0
Average productive tillers	18	18	0
Filled grain per panicle	157	126	19.7
Fertile percent*	75.6	65	13.9
1000-grain weight (g)	23.7	23.6	0
Head rice yield (%)	54.9	57.8	-5.2
Amylose content (%)	24.3	24	-1.2
Standard heterosis for fertility (%)	12.36	-	-

*= Characters that were important for selecting mutants

Mutant 3: It was the best selected line. The selection was made on the basis of early flowering (by nearly 3 weeks), filled grain per panicle (171), high fertility rate (91.2%), long panicle length

(28.5cm) as well as medium amylose content (22.3%). Mutant 3 had tall and erect flag leaves and the standard heterosis for this mutant was also high (34.2 %) as compared to the mother variety.

Table 3. Comparative performance of Mutant 3 with its maternal variety-Gohar

Characteristics	Mutant 3	Gohar (mother variety)	Percent increase or decrease related to maternal variety (%)
Days to flowering*	104	121	-17.3
Plant height (cm)	115	114	0.8
Panicle length(cm)*	28.5	25.5	10.5
Average productive tillers*	12	18	-50
Filled grain per panicle*	171	126	26.3
1000-grain weight (g)	23.5	23.6	0
Fertile percent*	91.2	65	29.4
Head rice yield (%)	59	57.8	2
Amylose* content (%)	22.3	24	-7.6
Standard heterosis for fertility (%)	34.2	-	-

*= Characters that were important for selecting mutants

Mutant 4: This mutant had characteristics such as early flowering (at least 10 days earlier than the maternal parent), semi-dwarf plant height (104.5cm), panicle length (28.6cm), filled grain per panicle (155) and high fertility rate (91.2%). This mutant also had good taste/ aroma and cooking quality.

Table 4. Comparative performance of Mutant 4 with its maternal variety-Gohar

Characteristics	Mutant 4	Gohar (mother variety)	Percent increase or decrease related to maternal variety (%)
Days to flowering*	111	121	-9
Plant height* (cm)	104.5	114	-9
Panicle length* (cm)	28.6	25.5	10.9
Average productive tillers	16	18	-12.5
Filled grain per panicle*	155	126	18.7
1000-grain weight	23.5	23.6	0
Fertile percent*	91.2	65	40.7
Head rice yield (%)	59.2	57.8	-
Amylose*content (%)	23.6	24	-1.7
Standard heterosis for fertility (%)	34.8	-	-

*=Characters that were important for selecting mutants

Mutant 5: It had long slender grains and was early flowering (107 days to flowering) with higher number of productive tillers (18.7) than the maternal parent. In spite of low head rice yield (48.8%), this mutant had good cooking quality. This variety can grow well in saline condition, which is above the threshold range for rice (EC 0.3–3.6 mmhos/cm) and could be suitable for growing in regions affected by salinity (Baloch *et al.*, 2006; Deepa Sankar *et al.*, 2011).

Table 5. Comparative performance of Mutant 5 with its maternal variety-Gohar

Characteristics	Mutant 5	Gohar (mother variety)	Percent increase or decrease related to maternal variety (%)
Days to flowering*	107	121	-13
Plant height (cm)	93	114	-22.6
Panicle length (cm)	27.3	25.5	6.6
Average productive tillers	18.7	18	3.4
Filled grain per panicle	112	126	-12.5
1000-grain weight (g)	23.7	23.6	0
Fertile percent*	78.3	65	17
Head rice yield (%)	48.8	57.8	-18.4
Amylose content (%)	25.8	24	6.9
Standard heterosis for fertility (%)	2.26	-	-

*= Characters that were important for selecting mutants

Mutant 6: Six characteristics of this mutant were found to be more appropriate for selection. Criteria for selection were days to flowering (108 days), plant height (106.3cm), panicle length (28.4cm), number of fertile tillers (17), grain per panicle (178) and fertile percent (93.7%). The quality characteristic of mutant 6 was better than the maternal parent. The data suggest that mutagenic material did not modify 1000-grain weight. Our findings are in agreement with results of rice researchers using EMS to evolve high yielding mutant rice varieties (Baloch *et al.*, 2001, 2005; Bughio *et al.*, 2007; Jain, 2005, 2010; Talebi *et al.*, 2012).

Table 6. Comparative performance of Mutant 6 with its maternal variety-Gohar

Characteristics	Mutant 6	Gohar (mother variety)	Percent increase or decrease related to maternal variety (%)
Days to flowering*	108	121	-12
Plant height* (cm)	106.3	114	-7.2
Panicle length* (cm)	28.4	25.5	10.2
Average productive tillers*	17	18	-5.8
Filled grain per panicle*	178	126	29.2
Fertile percent*	93.7	65	30.6
1000-grain weight (g)	23.6	23.6	0
Head rice yield (%)	54.6	57.8	-6
Amylose content (%)	24.3	24	-1.2
Standard heterosis for fertility (%)	9.35	-	-

*= Characters that were important for selecting mutants

Conclusion

As mentioned earlier, induced genetic variation is essential for crop improvement for long term food production and securing food security. Hence, we conclude that for maintaining rice diversity and generating improved varieties; our attempts in inducing chemical mutation on rice seeds on the base population of Iranian rice variety Gohar using EMS has been successful. Our mutation breeding efforts in selecting successive mutants by managing populations across M1 to M4; was successful in identifying six desirable mutants with multiple traits suitable for Iranian agronomic conditions. The mutants were selected for traits such as dwarfness, early maturity, high fertility rate and plant type.

References

- Baloch A.W., Soomro A.M., Javed M.A., Bughio M.S., Bughio H.R. (2001). Genetic improvement in rice (*Oryza sativa* L.) through mutagenesis. *Pakistan Journal of Biological Sciences*, vol. 1, pp. 18-19.
- Baloch A.W., Soomro A.M., Naqvi M.H., Bughio H.R., Bughio M.S. (2006). Sustainable Enhancement of Rice (*Oryza sativa* L.) Production Through the Use of Mutation Breeding. *Plant Mutation Reports (Pakistan)*, vol. 1, no 1, pp. 40-42.
- Baloch A.W., Soomro A.M., Naqvi M.H., Bughio H.R., Bughio M.S., Abbasi S.J., Mastoi N.N. (2005). Sustainable rice production achieved by mutation breeding. PAWEES 2005, International Conference on management of paddy and water environment for sustainable rice production, Kyoto, Japan (Sept. 07–08, 2005), pp. 163-167.
- Bughio H.R., Asad M.A., Odhano I.A., Bughio M.S., Khan M.A., Mastoi N.N. (2007). Sustainable rice production through the use of mutation breeding. *Pakistan Journal of Botany*, vol. 39, no. 7, pp. 2457-2461.
- Chopra V.L. (2005). Mutagenesis: Investigating the process and processing the outcome for crop improvement. *Current Science*, vol. 89, no 2, pp. 353-359.
- Deepa Sankar P., Arabi Mohamed Saleh M.A., Immanuel Selvaraj C. (2011). Rice breeding for salt tolerance. *Research in Biotechnology*, vol. 2, no. 2, pp. 1-10.
- Dorosti H., Zandi P., Siavoshi M., Chalaras S.K. (2016). Effect of foliar feeding of Urea on yield and yield components of Iranian Hybrid rice 'Bahar 1'. *Journal of Plant Nutrition* (in press).
- El-Degwy I.S. (2013). Mutation induced genetic variability in rice (*Oryza sativa* L.). *International Journal of Agriculture and Crop Sciences*, vol. 5, no. 23, pp. 2789-2794.
- Jain S.M. (2005). Major mutation assisted plant breeding programs supported by FAO/ IAEA. *Plant Cell, Tissue and Organ Culture*, vol. 82, no. 1, pp. 113-123. doi:10.1007/s11240-004-7095-6
- Jain S.M. (2010). Mutagenesis in crop improvement under the climate change. *Romanian Biotechnological Letters*, vol. 15, no. 2, pp. 88-106.
- Karbalaei Aghamolki M.T., Khanif Yusop M., Zee Jaafar H., Kharidah S., Hanafi Musa M., Zandi P. (2015). Preliminary analysis of growth and yield parameters in rice cultivars when exposed to different transplanting dates. *Electronic Journal of Biology*, vol. 11, no. 4, pp. 147-153.
- Kharkwal M.C., Shu Q.Y. (2010). The role of induced mutations in world food security. In Shu, Q.Y. (ed.), "Induced Plant Mutations in the Genomics Era. Food and Agriculture Organization of the United Nations, Rome, 2009"; pp. 33-38.
- Talebi A.B., Talebi A.B., Shahrokhifar B. (2012). Ethyl Methane Sulphonate (EMS) Induced Mutagenesis in Malaysian Rice (cv. MR219) for Lethal Dose Determination. *American Journal of Plant Sciences*, vol. 3, no. 12, pp. 1661-1665. doi: 10.4236/ajps.2012.312202
- Till B.J., Cooper J., Tal T.H., Colowit P., Greene E.A., Henikoff S., Comal L. (2007). Discovery of chemically induced mutations in rice by TILLING. *BMC Plant Biology*, vol. 7, pp.19. doi: 10.1186/1471-2229-7-19

EFFECTS OF HYBRIDES AND SALT CONCENTRATION ONTO GROWTH AND DEVELOPMENT OF SPROUTING EMBRYO

Igor ĐURĐIĆ, Branka GOVEDARICA, Tanja JAKIŠIĆ

University of East Sarajevo, Faculty of Agriculture, Vuka Karadjica 30, Bosnia and Herzegovina

*Corresponding author: i_djurdjic@yahoo.com

Abstract

Salinity of soil has adverse impact on germination, growth and yield of maize. Hybrids show larger or smaller tolerance onto saline stress. Thus tests were conducted in laboratory of the Faculty of Agriculture of the University of East Sarajevo (Entity of Republic of Srpska, Bosnia and Herzegovina), to examine tolerance of four hybrids (BL-43, ZP- 427, Cisco and Maverick) maize (*Zea mays L.*) to different concentration of NaCl (0, -0,3 i -0,6 MPa). The tests included % of germination energy, % of seeds' germination, cotyledon and coleoptile length, fresh mass of cotyledon and coleoptile, dry mass of cotyledon and coleoptile, ratio of dry mass of the root and coleoptile. Based on statistically processed results the significant differences between the hybrids were determined in stress level as well as their interaction for most of the tested characteristics, the most resistant and most sensitive hybrid to saline stress. For the most of tested features, the most resistant hybrid determined is Cisco and the most sensitive is Maverick.

Key words: *maize, hybrid, stress, salt, germination, root, coleoptile.*

Introduction

During the vegetation period plants are exposed to various stress conditions within their environment, which have unavoidable effect on the development, thus significantly reducing the yield and the quality of their products. Stress tolerance indicates the plants' ability to adapt to sudden and unfavorable conditions, should those occur, and not become too damaged in the process. Mechanisms that enable the plant to survive the stress are called resistance or immunity. Salinity of the soil often occurs close to coastline areas but it can also result from irrigation process. There are two types of salinity of the soil: soils with high concentration of NaCl – sodicity, and soils with high concentration of different salts-salinity. High concentration of NaCl not only harms the plants (Zaki, 2011), but also impairs favorable soil structure (the base) thus becoming less permeable to water. Soil salinity can produce external, osmotic potential that limits the seeds' absorption of water or sodium ions and chloride ions can uptake into seeds that germinates, which has a toxic effect. Germination is first critical period in a plant production (Figueiredo-e-Albuquerque and Carvalho 2003; Misra and Dwivedi, 2004). Ability of seeds to germinate in soils with high concentration of salt is of a key significance for survival of numerous plant species. Although the salt stress mostly reduces the germination ratio and delays the germination start, its effect can be lessened under influence of other environment factors (Bojović et al., 2010). Since salt stress affects germination, growth and the crops' yield, it presents one of limiting factors in agriculture production in arid and semiarid regions (Yohannes and Abraha, 2013).

It has been determined that, when growing maize in saline soils, it results in slow plants growth and reduced yield (Ouda et al., 2008). In comparison to other grains, corn is has higher sensitivity to salt stress (Maas et al., 1986; Ouda et al., 2008), thus it is very important to pay

particular attention to development of hybrids that are tolerant to salt and water stress (Janmohammadi *et al.*, 2008). Aim of the research was to compare four hybrids grown in the area and select the hybrid most tolerant to salt stress.

Materials and methods

Researches included monitoring of germination in seeds of maize hybrids (BL-43, ZP- 427, Cisco and Maverick) in controlled environment. The experiment was set in laboratory of of the Faculty of Agriculture of the University of East Sarajevo (Entity of Republic of Srpska, Bosnia and Herzegovina). After received in laboratory, the seeds were subjected to manual separation of damaged and unhealthy seeds. Only completely healthy and pure seed were chosen for the test. The seeds were sterilized in 96% alcohol for 30 seconds, then washed several times with distilled water and 25 the same size seed were placed in sterile petri dishes (diameter: 9cm), with cover, to prevent moisture loss. Seeds of each hybrid for each treatment were placed in petri dishes. The dish contained double layer of filter paper soaked in NaCl solution with water potential 0, -0.3 and -0.6 MP (*Braccini i sar.*, 1996). Each petri dish contained 15ml of the solution. Controlled petri dish contained distilled water. The experiment was set with four repetitions for each treatment and for each hybrid separately. Sprouting embryo were incubated in the incubator (Binder) for period of 9 days, under temperature of 25 °C. The day when primary root reached length of 2mm marked the germination start. During the experiment, the following parameters were measured: germination energy (4th day of the experiment included counting all seeds germinated up to then and presented the amount in per cent, in relation to total number of seeds). On ninth day of the experiment, when the first leaf appeared, the following measurements were conducted: germination percentage or total seeds germinated in proportion to total number of seeds of one variant of the experiment, then separated 10 germinated seeds and measured length of coleoptile and cotyledon (the longest cotyledon was measured) with elastic meter, measuring the length of sprouts of each seed. Using fingernail the root was separated from coleoptile and their weight measured separately. Fresh mass of coleoptile and the root were measured by analytic scale (Adventurer). Dry mass of the root and the sprout were determined by drying in the dryer (Memmert) on 80°C for period of 24 hours, the weight measured as well as proportion of dry mass of the root/ dry sprout, an important indicator for genotype screening for resistance to drought during the sprouting embryo phase.

All data were statistically processed using Statistics analysis of variance (ANOVA). Differences between treatments within each cultivar and differences between varieties within treatments were tested with the test of least significant difference (LSD).

Results and discussion

Sodium chloride is a strong osmotic agent and affects the growth when increased concentration in medium. Salt stress affects numerous physiological aspects of plant growth. Impact of different salt concentrations on % of germination energy, % of total germination, root and coleoptile length, fresh and dry mass of the root and coleoptile, as well as proportion of dry mass of the root/coleoptile in four hybrids (BL – 43 produced on Institute of Agriculture of Republika Srpska, ZP-427 produced in Institute for Maize Zemun Polje, and two Syngentina hybrids Cisco and Maverick) presented in table 1.

The highest germination energy of 92% was in hybrid BL-43, and the lowest was in Maverick (74%). Hybrids BL-43 and Cisco, in comparison to other tested hybrids, had significantly higher germination energy, speaking in terms of statistics, as well as hybrid ZP-427 in comparison to hybrid Maverick. With increase of water potential, the percentage of germination energy reduced.

With water potential -0,3 MP hybrids ZP-427 and Cisco had higher germination energy in comparison to the control variant, while hybrids BL-43 and Maverick with increased water potential NaCl resulted in decreased percentage of germination energy. That the change of water potential toward more negative results in reduced germination energy was proven by *Pratap and Sharma* (2010) in research of vigna, where germination energy and germination percentage were inhibited with increase in osmotic potential.

Hybrid Cisco had the highest germination in total, and the lowest was in hybrid Maverick. Hybrid Maverick had the lowest germination in comparison to other hybrids examined, and the differences recorded were of high significance. With increased water potential the total seed germination was reduced in all hybrids, except in hybrid ZP-427 where salt and water potential did not impact the reduction of total germination greatly. Similar results were found in sugar beet, where seed germination and growth of the sprouting embryo was inhibited with NaCl (*Wang et al.*, 2011). *De Lima and Torres* (2009) published similar results and concluded that salt stress depends on plant species. Our results are in accord with *Moezel and Bell* (1987) where NaCl affected germination as ion effect, when ion reach toxicity level in the cell.

Hybrid BL-43 had the longest roots in comparison to other hybrids, while hybrid Maverick had the shortest root, in comparison. Determined differences were of high significance. Maximum values of the root length in all hybrids were controlled and with -0.3 MP applied the value has declined. Higher salt stress applied (-0.6MP) in hybrid ZP-427 and Maverick resulted in significant reduction of the root length, while in hybrid BL-43 and Cisco it resulted in significant reduction of the root length with lower level of salt stress applied. *Shalhevet et al.*, (1995) published that in soybeans and maize, elongation of the root is directly connected to cell elongation. In tests of *Maghsoudi and Maghsoudi* (2008) conducted on winter wheat it was determined that salt stress inhibits coleoptile growth more than of the root. Similar results were found during coleoptile measurements. Hybrid BL-43 had the smallest length in coleoptile, in comparison to other hybrids. With increase in salt concentration the length of coleoptile reduced. Exception was hybrid Cisco with water potential of -0,6 MP, which produced longer coleoptile in comparison to water potential of -0,3 MP. Similar results were found by *Machado Neto et al.*, (2004) in tests on soybeans where maximum values were controlled and with increase of water potential the length of coleoptile has reduced. *Katerji et al.*, (1994) found the close connection between percentage of germination reduction and that of plant growth under salt stress in sunflower and maize and their yield in controlled environment.

Table 1. Impact of hybrids and salts on growth and development of the sprouting embryo

Hybrid	NaCl (MPa)	Germination energy (%)	% total germination	Root length (cm)	Length of coleoptile (cm)	Fresh mass of root (g)	Fresh mass of coleoptile (g)	Dry mass of root (g)	Dry mass of coleoptile (g)	Dry mass of root/coleoptile (g)
BL-43	0	98,00	98,00	5,80	1,02	2,65	1,29	0,46	0,32	1,41
	-0,3	88,00	92,50	3,44	0,94	2,44	0,95	0,39	0,31	1,22
	-0,6	90,00	92,00	5,16	0,75	0,50	0,36	0,15	0,18	1,24
	Average	92,00	94,16	4,80	0,90	1,86	0,87	0,43	0,25	1,70
ZP-427	0	88,00	96,00	4,74	1,99	2,39	1,55	0,52	0,39	1,35
	-0,3	95,00	96,50	3,61	1,84	2,17	1,71	0,42	0,35	1,21
	-0,6	83,00	93,50	2,92	0,96	1,62	1,31	0,29	0,26	1,38
	Average	88,66	95,33	3,76	1,59	2,06	1,52	0,41	0,33	1,24
Cisco	0	90,00	100,0	3,92	1,90	2,78	0,81	0,69	0,28	2,49
	-0,3	96,00	97,50	3,12	0,95	2,66	0,64	0,58	0,38	1,52
	-0,6	88,50	89,00	3,77	1,45	2,34	0,59	0,48	0,33	1,45
	Average	91,50	95,50	3,60	1,43	2,59	0,68	0,58	0,33	1,77
Maverick	0	86,00	90,50	3,69	1,82	0,76	2,73	0,16	0,14	1,02
	-0,3	81,00	84,00	2,66	1,59	0,58	2,62	0,10	0,39	0,26
	-0,6	55,00	55,00	1,40	1,49	0,18	0,92	0,04	0,33	0,11
	Average	74,00	76,50	2,58	1,63	0,51	2,09	0,10	0,29	0,46
Average for NaCl	0	90,50	96,12	4,54	1,95	2,11	1,59	0,46	0,28	1,62
	-0,3	90,00	92,62	3,20	1,33	1,96	1,48	0,37	0,36	1,04
	-0,6	79,12	82,37	3,31	1,16	1,16	0,79	0,32	0,33	0,96

LSD	Germination energy			Total germination			The root length		
	A	B	A x B	A	B	A x B	A	B	A x B
0,05	2,709	2,346	4,198	2,811	2,471	4,870	0,577	0,499	0,894
0,01	3,677	3,136	5,610	3,755	3,253	6,507	0,769	0,666	1,193
LSD	Coleoptile length			Fresh mass of the root			Fresh mass of coleoptile		
	A	B	A x B	A	B	A x B	A	B	A x B
0,05	0,211	0,183	0,366	0,182	0,159	0,316	0,159	0,137	0,267
0,01	0,281	0,244	0,488	0,244	0,210	0,421	0,213	0,183	0,367
LSD	Dry mass of the root			Dry mass of coleoptile			Dry mass the root/coleoptile		
	A	B	A x B	A	B	A x B	A	B	A x B
0,05	0,176	0,149	0,298	0,121	0,105	0,210	0,230	0,179	0,399
0,01	0,229	0,199	0,396	0,162	0,135	0,280	0,307	0,264	0,533

Results of dry mass of the root and sprout show maximum values controlled and the reduction with negative water potential. Statistics of significant reduction in fresh mass of the root and coleoptile was in hybrid BL-43, Cisco and Maverick. This is in accord with results of Wang *et al.*, (2009) which published that fresh mass and length of the root and of coleoptile in 2 alfalfa cultivars were inhibited 200mM of NaCl and with further increase of salt the germination process stopped. Exception was in hybrid ZP-427 where, with mild increase of concentration, there was increase in fresh mass of coleoptile and in comparison to control variant. Significant differences were recorded in fresh mass of the root and of coleoptile among the tested hybrids. The lowest fresh mass of the root was found in hybrid Maverick, while the lowest was in Cisco. Ability of seed to germinate in saline conditions does not exclusively depend on salt concentration but on other biological factors, age of seed, dormination, seed coat thickness, seed viability of seed.

Hybrid Maverick, in comparison to other hybrids, had the lowest dry mass of the root and these differences were of high significance, while differences in dry mass of coleoptile in each hybrid examined were not of statistics' significance. In all hybrids, the increase of salt concentration resulted in significant reduction of dry mass of the root. Begum *et al.*, (1992) concluded that increase of salt concentration produces decline of dry mass of the root, which is in accord with our results. When salt concentration increased in hybrid BL-43 and ZP-427 it was recorded that dry mass of coleoptile reduced while in hybrid Cisco with increase of salt concentration the mild increase of dry mass of coleoptile occurred with controlled variant and in hybrid Maverick, the increase of dry mass of coleoptile was significant in mild increase of salt concentration (-0,3MP). Maximum values of proportion of dry mass of the root/sprout were in controlled variant and in comparison to water potential of -0,3 MP and -0,6 MP was of high statistics' significance. Maximum values of proportion of dry mass of the root/sprout were found in hybrid BL-43 and Cisco and those are highly significant in comparison to hybrids ZP-427 and Maverick, as well as the differences between hybrid ZP-427 and Maverick. In hybrid ZP-427 with increase in salt concentration it came to the increase of proportion the root/sprout, which is in accord with results of Magsoudi and Maghsoudi (2008).

Conclusion

For most of characteristics tested, the best results were achieved in controlled variant. Exceptions are recorded only in dry mass of coleoptile because the lowest mass was found in controlled variant. Increased salt concentration had negative impact on germination energy, total

germination, length of the root and coleoptile, fresh mass of the root and coleoptile and the dry mass of the root, while increase of salt concentration resulted in the increase of dry mass of coleoptile but increase of salt concentration from -0,3 MP on -0,6 MP resulted in formulation of longer maize root. Significant variations in tolerance on salt stress were recorded in all hybrids tested. Hybrid BL-43 had the highest germination energy and longest root. Hybrid ZP-427 had the best dry mass of coleoptile and the highest total germination when higher salt concentration applied, which is extremely significant for arid and semiarid soils exposed to salt stress. Hybrid Cisco had the best total germination, fresh mass of the root, fresh mass of coleoptile and maximum value of proportion of dry mass of the root, dry mass of coleoptile and maximum value of proportion of dry mass of the root/coleoptile. Hybrid Maverick had the longest coleoptile. Hybrid Cisco appeared as the most tolerant on salt stress and the lowest tolerance was recorded in hybrid Maverick.

Acknowledgements

This work is the result of this project „Resistance varieties of some domestic field crops on stress caused by drought, which is supported by the Ministry of Science and Technology of the Republic of Srpska.

References

- Begum F., Karmoker J.L., Fattah and Maniruzzaman A.F.M. (1992): The effect of salinity on germination and its correlation with K, Na, Cl accumulation in germinating seeds of *Triticum aestivum*. *Plant Cell Physiol.* 33, 1009-1014.
- Bojović B., Đelić G., Topuzović M., Stanković M. (2010): Effects of NaCl on seed germination in some species from families Brassicaceae and Solanaceae, *Kragujevac Journal of Science*, 32: 83-87.
- De Lima B.G. and Torres S.B. (2009): Water and Saline Stresses on the Germination of *Zizyphus Joazeiro* Mart. (Rhamnaceae) Seeds. *Revista Caatinga*, 22: 93-99.
- Janmohammadi M, Moradi Dezfuli P, Sharifzadeh F (2008): Seed invigouration techniques to improve germination and early growth of inbred line of maize under salinity and drought stress. *Gen. Appl. Plant Physiol.* 34(3-4): 215-226.
- Katerji, N., Van Hoorn, J.W., Hamdy, A., Karam, F. and Mastrorilli, M., (1994): Effect of salinity on emergence and on water stress and early seedling growth of sunflower and maize. *Agric. Water Manage.* 26: 81-91.
- Maas EV, Hoffman GJ, Chaba GD, Poss JA, Shannon MC (1986): Salt sensitivity of corn at various growth stages. *Irrigation Sci.* 4: 45-57.
- Machado Neto N.B., Saturnino S.M., Bomfim D.C., Custódio C.C. (2004): Water stress induced by mannitol and sodium chloride in soybean cultivars. *Braz Arch Biol Tech* 47:521–529
- Maghsoudi Moud A, Maghsoudi K (2008): Salt stress effects on respiration and growth of germinated seeds of different wheat (*Triticum aestivum* L.) cultivars. *World J Agric Sci* 4: 351–358.
- Misra N, Dwivedi UN (2004): Genotypic differences in salinity tolerance of green gram cultivars. *Plant Sci.* 166: 1135-1142.
- Ouda SAE, Mohamed SG, Khalil FA (2008): Modeling The Effect of Different Stress Conditions on Maize Productivity Using Yield-Stress Model. *Int. J. Natural Eng. Sci.* 2(1): 57-62.
- Pratap, V., Sharma, Y.K. (2010): Impact of Osmotic Stress on Seed Germination and Seedling Growth in Black Gram (*Phaseolus Mungo*). *J. Environ. Bio.* 31:721-726.

- Figueiredo-e-Albuquerque, De MC, De Carvalho NM (2003): Effect of type of environmental stress on the emergence of sunflower (*Helianthus annuus* L.), Soybean (*Glycine max* (L.) Merrill) and maize (*Zea mays* L.) seeds with different levels of vigor. *Seed. Sci. Tech.* 31: 465-469.
- Shalhevet, J., Huck, M.G. and Schoeder, B.P. (1995): Root and shoot growth responses to salinity in maize and soybean. *Agronomy Journal*, 87:512-517.
- Van der Moezel P. G. and Bell D. T. (1987): The effect of salinity on the germination of some Western Australian Eucalyptus and Melaleuca species. *Seed Science and Technology*, 1, 239-246.
- Zaki F. (2011): The Determinants of Salinity Tolerance in Maize (*Zea mays* L.). University of Groningen. 11-15 pp .
- Yohannes G., Abraha B. (2013): The role of seed priming in improving seed germination and seedling growth of maize (*Zea mays* L.) under salt stress at laboratory conditions. *African Journal of Biotechnology*, 12, 46: 6484-6490.
- Wang K., Liu Y., Dong K., Dong J., Kang J., Yang Q., Zhou H., Sun Y. (2011): The effect of NaCl on proline metabolism in *Saussurea amara* seedlings. *Afr. J. Biotechnol.* 10: 2886-2893.

EFFECT OF DIFFERENT DOSES OF NAA (0, 125, 250, 500 AND 1000 PPM) ON MOUNTAIN THYME (*Thymus kotschyanus* Boiss. & Hohen.) ROOTING

Amir_RAHIMI^{1*}, Mohammad Reaza ZARDASHTI¹, Sadegh TGHIPOUR¹, Dogan ARSLAN²

¹Department of Agronomy, Faculty of Agriculture, Urmia University, Iran

²Department of Agronomy, Faculty of Agriculture, Siirt University, Siirt Turkey

*Corresponding author: emir10357@gmail.com

Abstract

In Mountain Thyme (*Thymus kotschyanus* Boiss. & Hohen.) the mating system is mostly cross pollination which can cause a high level of genetic polymorphism. In terms of uniformity, vegetative propagation as stem cuttings is an accessible and inexpensive method. Stem cuttings have the ability to form adventitious roots, and root cuttings can regenerate a new shoot system. The aim of this trial was to determine the effect of NAA on rooting of mountain thyme cuttings. The trial was established as a randomized block design with 3 replications during 2015, in greenhouse of the Agronomy Department, Faculty of Agriculture of Urmia University, Iran. At first, one stock plant was selected from Baba Hasan Valley, Sulduz region, West Azerbaijan province. Stem cuttings were taken from the stock plant. Before placing in the media the cuttings were treated with NAA (0, 125, 250, 500 and 1000 ppm). According to the results the average of stem height ranged 4.27-6.17 (cm); number of nodes ranged 3.27-5.20 (pcs); number of leaves ranged 6.53-10.40 (pcs); number of roots ranged 7.00-9.47 (pcs); the highest root length ranged 2.43-5.70 (cm); root fresh weight ranged 0.007-0.017 (g); shoot fresh weight ranged 0.031-1.106 (g); total fresh weight ranged 0.042-0.088 (g); root dry weight ranged 0.004-0.008 (g); shoot dry weight ranged 0.011-0.033 (g); total dry weight ranged 0.016-0.038 (g); ratio of root fresh weight /shoot fresh weight ranged 0.119-0.324; ratio of root dry weight /shoot dry weight ranged 0.154-0.429. In terms of root number, shoot fresh weight, root fresh weight, shoot dry weight and total dry weight, NAA 500 ppm; in terms of leaf number, nod number, stem height and total fresh weight, NAA 125 ppm and in terms of highest root height and root dry weight NAA 125 ppm were the best.

Keywords: *Mountain Thyme, NAA, Propagation, Stem Cutting.*

Introduction

Iranian medical schools are accounted for as one of the oldest and richest in the world. Numerous innovations have been offered in this medicine by Iranian scientists, for instance, in the 9th century (3rd Hegira), spinal cord injuries (SCI) with various treatments on them have been touched in the book entitled al-Hawi, compiled by Razi, an Iranian scientist (Abolghasemi, 2013). Worldwide use of medicinal plants has risen significantly over the past two decades, fueling development of an important agricultural market valued at over US \$ 60 billion annually (World Health Organization, 2004). At present, 80 percent of the population in developing countries relies largely on plant-based drugs for their health care needs, and the WHO has estimated that in coming decades a similar percentage of the world population may well rely on plant-based medicines. Thirty percent of the drugs sold worldwide contain compounds derived from plant material. The expanding interest in medicinal and aromatic plants, new income-generating opportunities are opening up for rural populations. This rapid rise in demand,

however, has not been matched by equal increases in cultivation. With many of the medicinal and aromatic plants gathered from the wild, the collection and sale of medicinal and aromatic plants is providing a complementary source of cash for many extremely poor rural households. However, despite the fact that the products collected can have very high value in the final products, the collectors typically receive only a small share of the final value, either because they are unaware of the real value, are unable to market it in the form wanted by buyers or are unable to market to these buyers (Pagliarulo *et al.*, 2004; FAO, 2010).

The pharmaceutical industry is largely dependent upon the wild populations for supply of these plant species for the extraction of their intrinsic bioactive component. Because the land sources of wild medicinal plants are limited, attempts to allow the replenishment or cultivation of this important flora is more necessary and there is an urgent need to develop effective propagation methods for cultivation of these important medicinal plants which will ultimately lead to their conservation as well as supply for commercial use. More often, plant species are hard to propagate sexually and they also show complexities and undesirable characters (Tiwari and Das, 2010; Johnston *et al.*, 1959).

Sexual reproduction has been responsible for the wide genetic diversity observed in many plants. While vegetative propagation of plants is essentially the reproduction of plant material from vegetative organs so that the offspring will contain the exact characteristics of the parent plant with regards to genotypes and health status. Cuttings are severed uninodal leafy shoot or root fragments that can develop adventitious roots and shoots respectively. Uninodal leafy shoot cuttings are usually placed into a suitable rooting substrate and kept under high humidity in propagators until roots and shoots are formed. Propagation by cuttings is a relatively easy method and can provide a large number of propagules in a very short time. Thus, vegetative propagation as stem cutting is the most vital and sole method to reproduce these plants species (Macdonald, 1996; Nanda, 1970; Tiwari and Das, 2010). In vegetative propagation, the rooted plants by cottage have many advantages, such as faster growth rate (Ooyamma and Toyoshima, 1965), greater stock stand uniformity, better site matching and true-to-type planting material production (Fielding, 1969). Cutting can be categorized into three groups; easy to root, difficult to root and obstinate to root (Nanda, 1970; Mumtaz *et al.*, 2009).

The family Lamiaceae is one of the most important plant families in which *Thymus* with about 215 species, is a significant genus (Zaidi and Crow, 2005). The medicinal properties of the genus *Thymus* have made it one of the most popular medicinal plants (Nickavar *et al.*, 2005). The genus *Thymus* L., is a well-known aromatic perennial herb originated from Mediterranean region. Among 215 species of this genus grown in the world, 18 species are distributed in Iranian flora, and 4 of these species are endemic (Jalas, 1982; Stahl-Biskup & Saez, 2002). *Thymus* species are well known as medicinal plants because of their biological and pharmacological properties. In traditional medicine, leaves and flowering parts of *Thymus* species are used. In Iran, *T. daenensis* Celak., *T. kotschyanus* Boiss. and Hohen. Are more widely used as herbal tea, flavoring agents (condiment and spice) and medicinal plants. Infusion and decoction of aerial parts of *Thymus* species are used as tonic, carminative, digestive, antispasmodic, anti-inflammatory, antitussive, expectorant and for the treatment of colds in Iranian traditional medicine ((Amin, 2005; Zargari, 1990). *Thymus kotschyanus* Boiss. & Hohen. Common name: (thyme) belongs to the Lamiaceae family. The plant is an aromatic and medicinal plant that grows wild in Iran (Azerbaijan, Gilan, Mazandaran, Qazvin and Tehran provinces). The essential oil chemical composition of the plant was identified Thymol (38.0%), Carvacrol (14.2%) and 1, 8-Cineole (13.2%) as the main components of the oil of the species collected from Dizin in Iran. In Iraqi folk medicine, the whole plant is anthelmintic, antioxidant, strongly antiseptic, antispasmodic, carminative,

deodorant, diaphoretic, disinfectant, expectorant, sedative and tonic. Internally, it is taken in the treatment of bronchitis, catarrh, laryngitis, flatulent indigestion, painful menstruation, colic and hangovers. Externally, it is applied to minor injuries (wound-healing), mastitis, mouth, throat and gum infections (Rustaiyan, R., 1999; Rechinger, 1982; Al-Rawi and Chakravarty, 1988).

Sato *et al.* (2005) reported that 8.8 μmol BAP and 11.42 μmol IAA caused to increase proliferation rate in shoot tip explants in the plant. The multiplication rate was the highest (3.44 ± 0.25 cm) when BAP was used in combination with NAA (naphtalic acetic acid). Presence of NAA promotes shoot elongation as reported by Barrueto *et al.* (1999). Root formation required the presence of NAA in culture medium (Tavares *et al.*, 1996). The rooting ability of the plant was inhibited in medium containing activated charcoal. After 25 days of treating plants with 1 mg/L NAA, 96% rooting was obtained while the same concentration of IBA induced 64% rooting of shoots (Meftahizade *et al.*, 2010). In the present study, the effect of NAA (0, 125, 250, 500 and 1000 ppm) on rooting of Mountain Thyme stem cuttings were evaluated.

Materials and Methods

At first, one stock plant was selected from Baba Hasan Valley, Sulduz region (Naghadeh), West Azerbaijan province, Iran. Sulduz region ($36:57^{\circ}$ E , $45:22^{\circ}$ N), is a district of West Azerbaijan province that is located on the north west of Iran. Sulduz takes its name from watery and flat in Azeri language. The region is surrounded by Urmia city and Urmia Lake from the north, Mahabad city from the south, Miyandoab city from the east, Piranshahr from the west, and Oshnaviyeh city (located in the border of Turkey and Iraq) from North West. The altitude is 1000 m at the foot and 2100 m at the summit of the mountain. The annual average temperature of the region is $11.3\text{-}13.71^{\circ}\text{C}$; the summer average is 22.76°C , and the winter average is 2.45°C . The coldest months are December-January ($-0/3^{\circ}\text{C}$) and the warmest are July-August (24.21°C). Average precipitation is 326.43 mm (Rahimi *et al.*, 2012). Stem cuttings were taken from the stock plant. Vegetative propagation of the plant was carried out in green house at the Department of Field Crops, Faculty of Agriculture, Urmia University, Urmia, Iran during the period from 25. 05. 2015 till 26.06.2015. The stem cuttings were prepared at same size each as 0.2 cm diameter and 8 cm long. Plant cuttings were planted in plastic pots filled with sand substrate as a material to root. Before placing in the media the cuttings were treated with NAA (0, 125, 250, 500 and 1000 ppm). After placing the cuttings were irrigated regularly by hand depending on weather conditions and development stage of plants. Cuttings were harvested 31 days after planting and evaluated for different properties such as stem height, number of nods, number of leaves, number of roots, the longest root length, root fresh weight, shoot fresh weight, total fresh weight, root dry weight, shoot dry weight, total dry weight, the ratio of root fresh weight/shoot fresh weight and the ratio of root dry weight/shoot dry. Stem height and longest root length were measured. Fresh and dry weight of shoot, roots and total were weighed. The number of leaves and roots were counted. The ratio of root fresh weight / shoot fresh weight and ratio of root dry weight / shoot dry weight were calculated.

Results and Discussion

The average of stem height, number of nods, number of leaves, number of roots, the longest root length, root fresh weight, shoot fresh weight, total fresh weight, root dry weight, shoot dry weight, total dry weight, the ratio of root fresh weight/shoot fresh weight and the ratio of root dry weight/shoot dry in different treatments are shown in Table 1.

Table 1. Some properties of Mountain Thyme rooted cuttings

properties	0 ppm	125 ppm	250 ppm	500 ppm	1000 ppm
stem height (cm)	5.87	4.30	6.17	4.73	4.27
number of nods (pcs)	4.73	4.13	5.20	4.20	3.27
number of leaves (pcs)	10.40	8.13	10.40	8.40	6.53
number of roots (pcs)	7.00	8.93	8.13	9.47	7.00
the longest root length (cm)	5.47	5.70	3.53	2.43	2.57
root fresh weight (g)	0.007	0.013	0.014	0.017	0.010
shoot fresh weight (g)	0.056	0.060	0.074	0.106	0.031
total fresh weight (g)	0.062	0.073	0.088	0.066	0.042
root dry weight (g)	0.004	0.008	0.006	0.005	0.005
shoot dry weight (g)	0.029	0.024	0.022	0.033	0.011
total dry weight (g)	0.034	0.032	0.028	0.038	0.016
root/shoot (fresh)	0.119	0.220	0.185	0.162	0.324
root/shoot (dry)	0.154	0.319	0.265	0.160	0.429

According to the results the average of stem height ranged 4.27-6.17 (cm); number of nods ranged 3.27-5.20 (pcs); number of leaves ranged 6.53-10.40 (pcs); number of roots ranged 7.00-9.47 (pcs); the highest root length ranged 2.43-5.70 (cm); root fresh weight ranged 0.007-0.017 (g); shoot fresh weight ranged 0.031-1.106 (g); total fresh weight ranged 0.042-0.088 (g); root dry weight ranged 0.004-0.008 (g); shoot dry weight ranged 0.011-0.033 (g); total dry weight ranged 0.016-0.038 (g); ratio of root fresh weight / shoot fresh weight ranged 0.119-0.324; ratio of root dry weight / shoot dry weight ranged 0.154-0.429. In terms of root number, shoot fresh weight, root fresh weight, shoot dry weight and total dry weight, NAA 500 ppm; in terms of leaf number, nod number, stem height and total fresh weight, NAA 125 ppm and in terms of highest root height and root dry weight NAA 125 ppm were the best.

Conclusion

Results show a positive effect of NAA on rooting and vegetative growth of mountain thyme cuttings in terms of stem height, number of nods, number of leaves, number of roots, root length, root fresh weight, shoot fresh weight, total fresh weight, root dry weight, shoot dry weight and total dry weight. However, effect was dependant on NAA concentration. The best results were obtained with NAA 500 ppm in cases of root number, shoot fresh weight, root fresh weight, shoot dry weight and total dry weight while the best positive effect on leaf number, nod number, stem height, total fresh weight, root height and root dry weight was obtained with NAA 125 ppm.

Acknowledgement

The authors acknowledge the help of green house and agricultural laboratory of Urmia University, Urmia, West Azerbaijan province, Iran for his help.

References

- Abolghasemi, R., Mousavi Heris, A., and Saberi Esfeedvajani, M., 2013. Some Iranian medicinal plants to treat paralysis caused by spinal cord injury (SCI), *Journal of Medicinal Plants Research*, Vol. 7(39), pp. 2933-2939.
- FAO, 2010. Trade in Medicinal Plants, Raw Materials, Tropical and Horticultural Products Service Commodities and Trade Division Economic and Social Department Food and Agriculture Organization of the United Nations, Rome, pp.1-2.

- World Health Organization (2004). WHO Guidelines on Good Agricultural and Collection Practices (GACP) for Medicinal Plants. Geneva, Switzerland.
- Pagliarulo CL, Hayden AL, Giacomelli GA (2004). Potential for greenhouse aeroponic cultivation of *Urtica dioica* L. *Acta Hort.* p. 659.
- Johnston JC, Opits KW, Frolich EF (1959). Citrus propagation. Calif. Agric. Exp. Station Circ. p. 475.
- Tiwari RKS, Das K (2010). Effect of stem cuttings and hormonal pre-treatment on propagation of *Embelia tsjeriam* and *Caesalpinia bonduc*, two important medicinal plant species. *J. Med. Plants Res.* 4(15):1577-1583.
- Zaidi MA, Crow SA. 2004. Biologically active traditional medicinal herbs from Balochistan, Pakistan. *Journal of Ethnopharmacology* 96, 331-4.
- Nickavar B, Mojab F, Dolat-abadi R. 2005. Analysis of the essential oils of two *Thymus* species from Iran. *Food chemistry* 90(4), 609–611.
- Amin G. 2005. Popular medicinal plants of Iran. Tehran, Iran: Tehran University of Medical Sciences Press.
- Zargari A. 1996. Medicinal Plants, Tehran University Publications, Tehran, Iran, 4th ed.
- Stahl-Biskup E, Saez F. 2002. Thyme, The genus *Thymus*. Taylor and Francis, 331.
- Jalas J. 1982. *Thymus*. In K. H. Rechinger (Ed.). *Flora Iranica*. New York: Springer 150, 536–538.
- Al-Rawi A, Chakravarty HL. 1988. Medicinal Plants of Iraq. Ministry of Agriculture and Irrigation, State Board for Agricultural and Water Resources Research, National Herbarium of Iraq, Baghdad 93.
- Rechinger, KH., 1982. *Flora Iranica*. Akademische DruckU. Verlagsanstalt, Graz-Austria, No. 150, pp 540-546.
- Rustaiyan, R., 1999. T Lajevardi; M Rabbani; M Yari, and Sh Masoudi. *DARU*, 7(4): 27-28.
- Sato A, Dasilva S, Celso LSL, Rosane ASSG, Maria AE (2005). Essential Oil Composition of *Melissa officinalis* L. in vitro Produced under the Influence of Growth Regulators. *J. Braz. Chem.*, 16: 1387-1390.
- Barrueto CLP Adriane CMG, Silvia BRC, Ana CM (1999). Plant regeneration from seedling explants of *Eucalyptus grandis* E.urophylla. *Plant Cell, Tissue and Organ Cult.*, 56: 17-23.
- Tavares A.C., pimento M.C., Goncalves M.T., 1996. Micropropagation of *Melissa officinalis* L. through proliferation of axillary shoots. *Plant cell Rep.*, 15: 441-444.
- Meftahizade H., Lotfi M., Moradkhani H., 2010. Optimization of Micropropagation and establishment of cell suspension culture in *Melissa officinalis* L. *Afr. J. Biotechnol.*, 9(28), pp. 4314-4321.
- Rahimi, A., Aghaalinejad, M. and Arslan, N., 2012. Geophytes of Sulduz Region, West Azerbaijan Province, Iran and Their Characteristics, *Pure Appl. Bio.*, 1(1): 18-21.

CANADA GOOSE (*Branta canadensis* L.): AN ICONIC SYMBOL OF WILD CONTINENTAL NORTH AMERICA

Saikat Kumar BASU¹, Peiman ZANDI^{2*}, Shahram Khademi CHALARAS²

¹Department of Biological Sciences, University of Lethbridge, Lethbridge AB Canada

²Institute of Crop Science, Chinese Academy of Agricultural Sciences, Beijing 100081, P. R. China

*Corresponding author: z_rice_b@yahoo.com

Abstract

Canada goose (*Branta canadensis* L.) is one of the iconic species representing wild America; and is a native of the continent of North America, northern Europe and Far Eastern Asia. The range of the species stretches from Canada, through continental US to some parts of Central America. Within continental North America the species is widely distributed within several ecosystems from the Pacific on the west to the Atlantic in the east. It is a truly pan American avian species for its widespread distribution in the continent of North America stretching from northern Canada across the US to northern parts of Mexico. Canada goose is a grandeur symbol of the North American life, nature and eco-environmental values and is being currently reviewed based on popular voting organized by the famous Canadian Geographic magazine as one of the top five contending species for being considered as the National Bird of Canada. The majestic migratory avian species has several sub species reported across the west to east stretch of the continent of North America. The species usually travel to southern US, northern Mexico and some other parts of Central America during winter and returns to their northern breeding grounds in US and Canada during summer for nesting and breeding purposes. Although the exact number of sub species is debated; but researchers consider around 8-10 distinct sub-species. The species is related to the socio-cultural and ethnic history of the continent and the migrating flocks to the south during fall is considered to be an important iconic symbol of continental North America.

Key words: *Canada goose, eco-environmental, eco-sociological, North America, species*

Introduction

Canada goose (*Branta canadensis* L.) is one of the iconic avian species from continental North America, parts of Northern Europe and Far East (Krohn and Bizeau, 1980). Several introduced species are also known from several parts of the planet including New Zealand. The range of distribution for the Canada geese extends from Canada, through the United States to some warmer parts of the Central America; and the species is reported along both the Pacific coast on the west as well as the Atlantic in the east, being a truly pan American iconic avian species (Chapman et al., 1969; Basu, 2015a-d). Canada goose is also a grand symbol of the Canadian life, nature and eco-environmental values and is being currently reviewed based on popular voting organized by the famous Canadian Geographic magazine as one of the top five contending species for being considered as the National Bird of Canada (Basu, 2015a-d). This majestic species has trans-continental distribution (North America) with several sub species reported along a west to east stretch of the continent. Although the exact number of sub species is debatable among researchers; but, generally accepted varying somewhere between eight to ten (Shields and Wilson, 1987; Basu, 2015a, c). New molecular studies are providing further insights into the complex separation of close related sub species or geographic variants or morphological variants.

Sub species diversification

The commonly reported Canada goose sub species across the continental North America are mentioned as follows: Atlantic Canada Goose (*B. canadensis canadensis*) breeding in Labrador & Newfoundland (Eastern Canada), while wintering in Florida (US); Interior Canada Goose (*B. canadensis interior*) breeding in Canada; winters to Florida & Louisiana (US), Vancouver Canada Goose (*B. canadensis fulva*) is a predominantly resident species that breeds from coastal parts of southern Alaska (US) to British Columbia (Canada), Giant Canada Goose (*B. canadensis maxima*) used to be found in great numbers in the Great Plains of North America, but their numbers have fallen considerably and are now restricted to wildlife reserves of both Southern Canada and the Northern US; Lesser Canada Goose (*B. canadensis parvipes*) breeding from Central Alaska (US) to Alberta, Saskatchewan and Manitoba (Canada), while wintering in southern US; Dusky Canada Goose (*B. canadensis occidentalis*) predominantly breeds around South Western Alaska, wintering in mainland US; and Moffitt's Canada Goose (*B. canadensis moffitti*) breeding in areas in and around the Great Northern Plains and the Great Basin (US) and also in southern Canada, while wintering in South and South Western US (Chapman et al., 1969; Krohn and Bizeau, 1980; Shields and Wilson, 1987; Paxinos, et al. 2002; Basu, 2015a-d).

Biological behaviors

The number of sub-species of the Canada goose varies according to various research reports; and there is serious confusion and taxonomic debates around them (Shields and Wilson, 1987; Paxinos et al., 2002; Basu, 2015a-d). The geese are known to lay between 2-12 eggs depending on the seasonal weather patterns, quality of food supply and the levels of predation of eggs and chicks by predators such as coyotes, foxes, badgers and raptors. The Canada geese are devoted parents and dedicated partners raising their chicks together; and are known to be extremely territorial and highly aggressive in defending their nests, eggs, chicks and roosting areas (Krohn and Bizeau, 1980). They are predominantly dependent of aquatic vegetations, crustaceans, insects and also on grains and other available plant parts as their regular or standard diet (Sedinger, 1986; Sedinger and Raveling, 1988). They are gregarious species and usually like assembling or flocking together on the ground in between their long, exhausting flights often following together in close knit family groups as giant flocks (Hanson and Eberhardt, 1971). Canada geese are commonly seen in and around water bodies, marshes, bogs, swamps, lakes, ponds, parks and agricultural fields across the continent of North America. Many sub species of Canada geese prefer laying their eggs and raising their chicks within the safe boundary of agricultural fields throughout the Prairies of North America for easy access to food and nesting materials and protection from predators (Basu, 2015b, c).

Canada goose has become a symbol of environmentalism

Canada goose represents a unique eco-sociological symbol of nature and is very a well known migratory species of geese. The famous “v-shaped” flying pattern of trumpeting and migrating Canada geese flocks are seen as one of the most well known and symbolic signs of the change of season across the range of this beautiful species (Hanson and Eberhardt, 1971). Many aboriginal communities from North America consider this as a sign of good luck and fortune and there are numerous references of this majestic species in different indigenous folklores, legends, songs and indigenous stories and thereby constitute an essential part of the rich Canadian heritage from a sociological and historical perspective (Basu, 2015b). The majestic species is consider to be an important symbol of the majestic wildlife and grandeur wilderness of the continent of North America as well as a dynamic symbol of the socio-ecological heritage of the world’s second

largest country, Canada (MacInnes and Misra, 1972; Basu, 2015a,c,d). The V-shaped flight formations by huge flocks of Canada geese trumpeting across the horizon is a mesmerizing frame of natural beauty marking the change of seasons. The precisely organized and highly disciplined flight pattern of the majestic avian species literally represents the underlying strength, unity and solidarity among the coherent flock members. It is a legendary, socio-cultural and eco-ethnic symbol of numerous aboriginal communities from the continent of North America stretching across the frozen North to the dry Southern reaches of the vast continent. The large water bird with its wide flashy, black wings widely stretched while flying overhead is a poetic representative of the free spirit of eco-environmentalism across the continent of North America (Basu, 2015a, b).

The North American life is intricately interwoven with this natural wild icon. The species has been once inscribed on a one Canadian dollar coin to commemorate the spirit of winter Olympic held in Canada; and has regularly found spots in the circulating postage stamps of both Canada and the US. This commonly visible species is used as an important model in developing eco-environmental education, consciousness and awareness among local kids from the very foundation of formal education to help them grow up as responsible and eco-sensitive citizens of future. All these demonstrate that the environmental eco-sociological engagement with the species has been historical in this continent. It may have played a significant underlying role in the eco-environmental awareness, consciousness and successful eco-sociological conservation of the majestic species across the entire continent. This is a classical example of pan continental eco-environmental engagement, cooperation and conservation initiative that has resulted into a successful protection for this majestic avian species and can easily serve as a global model for successful eco-sociological conservation effort. The species is currently considered as Least Concern by the International Union of Conservation of Nature (IUCN) (Basu, 2015a, d).

Conclusion

Canada goose is grandeur, iconic symbol of wild North America and a native of the continent. The species is distributed from the Pacific to the Atlantic coast across the entire breadth of continental America. The distribution of the species stretches from Canada across the US to northern Mexico. The migratory species has several sub species reported across continental North America. This species migrates to southern US, northern Mexico and other parts of Central America to avoid harsh North American winter and returns to their breeding and nesting grounds in US and Canada during summer. Currently considered as a Not Threatened species with wide distribution reported across the continent in different ecosystems. Canada goose is as a species reflects to the eco-environmental dynamics of North America and is deeply connected to the socio-cultural life and history of several ethnic groups inhabiting the continent of North America and constitutes parts of several folklores, legends, stories and poems of indigenous communities as well as both rural and urban citizens of the continent.

References

- Basu, S.K. (2015a). Canada goose: Advocacy for the National Bird Project, Canada. Birds.com, New Media Holdings Inc., Seattle, USA.
- Basu, S.K. (2015b). Feature: Canada goose. The Global Newlight of Myanmar. Vol II (181): 8. Yangon, Myanmar. October 19, 2015.
- Basu, S.K. (2015c). Feature: Canada goose-A pan American species. Manipur Chronicle. 4(74): 8. Imphal, Manipur, India, September 4, 2015.

- Basu, S.K. (2015d). Letter to Editor: Online support needed to make Canada goose the National Bird. The Prairie Post. Published by the Lethbridge Herald, Lethbridge, Alberta, Canada, October 16, 2015.
- Chapman, J.A., Henny, C.J., Wight, H.M. (1969). The status, population dynamics, and harvest of the dusky Canada goose. *Wildlife Monographs*, 18: 1–8.
- Hanson, W.C., Eberhardt, L.L. (1971). A Columbia River Canada goose population, 1950–1970. *Wildlife Monographs*, 28: 3–61.
- Krohn, W.B., Bizeau, E.G. (1980). The Rocky Mountain population of the western Canada goose: its distribution, habitats, and management. No. 229. Washington, D.C.: U.S. Dept. of the Interior, Fish and Wildlife Service.
- MacInnes, C.D., Misra, R.K. (1972). Predation on Canada goose nests at McConnell River, Northwest Territories. *Journal of Wildlife Management*, 36(2): 414–422.
- Paxinos, E.E. James, H.F., Olson, S.L., Sorenson, M.D., Jackson, J., Fleischer, R.C. (2002). mtDNA from fossils reveals a radiation of Hawaiian geese recently derived from the Canada goose (*Branta canadensis*). *Proceedings of the National Academy of Sciences of the United States of America*, 99(3): 1399–1404.
- Sedinger, J.S. (1986). Growth and development of Canada goose goslings. *Condor*, 88:169–180.
- Sedinger, J.S., Raveling, D.G. (1988). Foraging behavior of cackling Canada goose goslings: implications for the roles of food availability and processing rate. *Oecologia*, 75(1): 119–124.
- Shields, G.F., Wilson, A.C. (1987). Subspecies of the Canada goose (*Branta canadensis*) have distinct mitochondrial DNA's. *Evolution*, 41: 662–666.

FORAGE FENUGREEK (*Trigonella foenum-graecum* L.) PRODUCTION: A BOON FOR SEMI-ARID AGRICULTURAL REGIONS

Saikat Kumar BASU¹, William CETZAL-IX², Peiman ZANDI^{3*}

¹Department of Biological Sciences, University of Lethbridge, Lethbridge AB Canada

²Instituto Tecnológico de Chiná, Calle 11 entre 22 y 28, Colonia Centro Chiná 24050, Campeche, México

³Institute of Crop Science, Chinese Academy of Agricultural Sciences, Beijing 100081, P. R. China

*Corresponding author: z_rice_b@yahoo.com

Abstract

Fenugreek (*Trigonella foenum-graecum* L.sp.) is one of the oldest reported medicinal plant, spice herb and forage crop in the world. The plant is believed to be native to the Mediterranean region. Indigenous species of fenugreek have been reported from Asia, North Africa, Europe and Australia. Over 25 species of fenugreek are reported across the globe. Currently grown widely across the Indian subcontinent, China, some parts of SE Asia and the Far East; in West Asia and North Africa; Mediterranean Europe and Russia; Australia and recently in parts of Western Canada, the United States and Argentina in the Americas. Fenugreek is an annual forage legume with appreciable genetic diversity and is suitable for the low input agricultural regions of Asia, Africa and Latin America as a forage crop, medicinal herb, spice as also an industrial crop for the nutraceutical and functional food industry.

Keywords: *Fenugreek, Trigonella foenum-graecum* L., *forage, spice, medicinal. Phytochemicals*

Introduction

Fenugreek (*Trigonella* sp.) is one of the oldest reported medicinal plant, spice herb and forage crop in the world (Acharya et al., 2006; Basu & Prasad, 2011; Zandi et al., 2015). The plant is believed to be native to the Mediterranean region. Indigenous species of fenugreek have been reported from Asia, North Africa, Europe and Australia (Acharya et al., 2006). Over 25 species of fenugreek are reported across the globe; however, the most popular species is *Trigonella foenum-graecum* L (Basu et al., 2008a, b; 2009; Zandi et al., 2011a,b). The term “*foenum-graecum*” means ‘Greek hay’ indicating its use as a forage crop in the past (Basu et al., 2008a, b; 2009; Zandi et al., 2013). Currently grown widely across the Indian subcontinent, China, some parts of SE Asia and the Far East; in West Asia and North Africa; Mediterranean Europe and Russia; Australia and recently in parts of Western Canada, the United States and Argentina in the Americas (Solorio-Sánchez et al., 2014). The plant belongs to the legume family (Fabaceae) like alfalfa (*Medicago sativa* L.); and can be easily identified by its dark green trifoliolate leaves with ovate leaflets, cream to white small leguminous flowers and hard textured golden yellow coloured seeds. On an average, 20 seeds are produced in each sickle-shaped, glabrous, slender, greenish to light brown or partly purplish pods varying in length between 12-18 cm (Acharya et al., 2006; Basu et al., 2008a, b; 2009; Zandi et al., 2013). Plants are indeterminate in growth habit; and hence continue to flower until frosting or till any desiccant is applied. Fenugreek being a self-pollinated crop; does not need the use of pollinators (Acharya et al., 2006; Basu et al., 2008a, b; 2009; Zandi et al., 2013).

Fenugreek seed and leaves contain a number of medicinally important phytochemicals including the galactomannans, steroidal saponinins such as diosgenin, tigogenin, yamogenin;

dihydroxysapogenins like gitogenin; spirostanol saponins such as graecunin; triterpenoids; alkaloids; flavonoids; and amino acids like 4-hydroxy-isoleucine (Zandi et al., 2015). Galactomannan helps in reducing glucose intake thereby providing efficient control of blood glucose levels in diabetic patients (Zandi et al., 2013). The amino acid isoleucine has similar role by regulating the release of insulin from the pancreatic cells (Acharya et al., 2011). The steroidal sapogenins are important sources of synthetic sex steroids and are used in the treatment of hypercholesterolemia. Furthermore, the plant has been reported to have antioxidant, antimicrobial, anti-leukemic and anti-neoplastic properties to mention only a handful (Acharya et al., 2008, 2010). However, the amount and nature of these phytochemicals have been found to vary under different environmental conditions and also with the change in the genotype demonstrating Genotype X Environment interaction (Zandi et al., 2015). Hence, locally adapted cultivars of fenugreek are suggested for optimal production of different agronomic and/or biochemical traits of the crop (Basu & Prasad, 2011). Currently fenugreek is also actively used in the global nutraceutical and functional food industries due to its rich medicinal properties (Basu et al., 2007). India is the largest global producer of fenugreek seeds where the plant is also used as a traditional spice in preparing traditional curries. The seeds are also used in producing artificial maple syrup. Fenugreek seeds are reported as an important galactagogue; and helps in promoting milk flow both in lactating women and animals (Acharya et al., 200, 2010).

Crop benefits

Fenugreek has nitrogen fixing ability thereby restricting the need for application of costly synthetic nitrogenous fertilizers and hence environment friendly by nature; and could be used in Organic Farming for soil nitrogen enrichment (Acharya et al., 2006; Basu et al., 2008a,b; 2009; Basu & Prasad, 2011; Zandi et al., 2011a,b). It is suitable for short term rotations (Acharya et al., 2008; Basu et al., 2008a, b; 2009; Zandi et al., 2013) and also suited to dry land as well as rainfed conditions suitable for semi-arid regions; and hence cuts down irrigation expenses (Acharya et al., 2006; Basu et al, 2007 a,b; Zandi et al., 2010). *In vitro* dry matter disappearance and crude protein level in fenugreek has been found to be higher than that of alfalfa; however, *in vitro* gas production and volatile fatty acid content are almost similar. The forage quality (protein and fibre content) of mature fenugreek is comparable to prime cut alfalfa; and hence can be easily utilized at any growth stage (Acharya et al., 2006; Zandi et al., 2010; Basu & Prasad, 2011). Reasonably high yield of forage fenugreek is reported from semi-arid regions (Acharya et al., 2008). The crop is known to be bloat free unlike alfalfa (Acharya et al., 2011; Basu & Prasad, 2011; Zandi et al., 2010, 2013).

The fenugreek phytochemicals reduces the need for application of synthetic steroids in the cattle (Acharya et al., 2007; Basu et al, 2007 a,b; Basu et al., 2008a, b; 2009; Basu & Prasad, 2011). Fenugreek promotes muscle growth and hence supports higher carcass weight in animals (Acharya et al., 2014). Fenugreek seed is an important galactagogue (Acharya et al., 2011). Being comparable to alfalfa in most forage properties along with additional attributes as mentioned above have led to the potential increase in the global forage, nutraceutical and functional food markets for fenugreek (Zandi et al., 2010). However, due to presence of the phytochemicals fenugreek seed has a characteristic odour and could possibly taint the milk and meat, if fed exclusively to animals. Fenugreek mixed with alfalfa and/or sainfoin (*Onobrychis* sp.) has better end results (Acharya et al., 2010; Basu et al., 2008a, b; 2009; Basu et al, 2007 a,b).

Agronomy

Tristar is an annual forage legume cultivar of fenugreek developed by the Agriculture and Agri-Food Canada Research Centre in Lethbridge, AB. This particular cultivar has the ability to maintain high yield consistently over years and at different locations and is suitable for the semi-arid regions of North America (Basu & Prasad, 2011). The production is consistent at a particular location over years; however, production sometimes varies from one location to another (Basu et al., 2014). Tristar can be used as hay, silage, straight grazing or swath grazing. Addition of phosphate rich fertilizers in optimum amounts to phosphate deficient soil boosts Tristar growth. But, no effect was observed in soils already rich in phosphorus. Well drained loamy soil with a pH of 8-8.5 is preferred for cultivation. Tristar, a dryland crop responds reasonably well to irrigation for both forage and seed production (Basu & Prasad, 2011). The crop is quite easy for establishment and can be conveniently harvested using conventional hay cutting or cereal combine equipment. The crop is extremely suitable for agronomic productions in the dry and semi-arid areas of Asia, Africa and Latin America (Zandi et al., 2010; Basu and Agoramoorthy, 2014; Basu et al., 2014; Zandi et al., 2015).

Tristar seedlings like other fenugreek cultivars do not develop canopy to reduce weed growth until several weeks post seeding; and hence yield could be reduced by the annual grasses and broadleaf weeds common in the Prairies (Basu et al., 2008a, b; 2009). However, Tristar has been reported to demonstrate appreciable level of tolerance to herbicides such as trifluralin, ethalfluralin and imazamox/ imazethapyr. Attempts are under way to get minor use registration for some of the herbicides (Acharya et al, 2007). Application of gibberellic acid to the seeds prior to sowing improve seed yield. Application of chemicals like ethyl methane sulphonate or dimethyl sulfoxide or cholchicine on the seeds have resulted in plants with determinate growth habit, bigger seed sizes and higher seed oil contents under experimentation (Basu et al, 2007 a,b; Basu & Prasad, 2011).

Several bacterial, viral, fungal and insect diseases of fenugreek are reported globally impacting forage production (Basu et al., 2008 a,b). However, the two most common fungal diseases are the Leaf Spot caused by *Ascochyta* sp and the Powdery Mildew caused by *Oidopsis* sp in wet years and if the crop is irrigated beyond August in Western Canada (Basu et al., 2014; Chakraborty et al., 2014). Tristar is particularly susceptible to the Powdery Mildew. Conditions favouring Powdery Mildew are relative humidity between 95-97 %, temperature within a range of 23-30 °C and annual precipitation between 350-400 mm with warm days and cool nights (Acharya et al., 2007). *Pseudomonas syringae* infection is a common bacterial infection. Potential insect pests of fenugreek in southern AB include *Lygus* sp. and *Adelphocoris* sp. However, the plant being new to the North American continent does not have significant insect pest load reported as of now (Basu et al., 2006).

Tristar has been reported to be suitable for intensive silage and hay production in Western Canada particularly for regions having warmer summer (Basu et al., 2008 a,b). Tristar biomass yield is 2 and 11% higher compared to the check cultivar Amber under dryland (rainfed) and irrigated conditions, respectively. Tristar has 26% higher seed yield compared Amber under irrigated condition of southern AB. Field trials demonstrated Tristar having higher forage yield (t DM ha⁻¹) compared to Amber under both irrigation and dryland (rainfed) conditions (6.0 vs 5.4 and 5.8 vs 5.7, respectively); and higher seed yield (t ha⁻¹) than Amber under both irrigation and dryland (rainfed) conditions (1.26 vs 1.0 and 0.78 vs 0.77, respectively) (Acharya et al., 2007). Mature golden brown seeds of Tristar are smaller in size (14.3 g 1000 seed⁻¹) compared to that of check cultivar Amber (15.5 g 1000 seed⁻¹) (Acharya et al., 2007).

Concluding remarks

Fenugreek (*Trigonella foenum-graecum* L.) is an annual forage legume with appreciable genetic diversity and is suitable for the low input agricultural regions of Asia, Africa and Latin America as a forage crop, medicinal herb, spice as also an industrial crop for the nutraceutical and functional food industry. The plant has been known since ancient times for its yellowish brown, angular seeds that are rich in gum, fiber, alkaloids, flavonoids, saponins, volatile substance and other nutritional contents. Possessing high concentration of fiber, fenugreek herb could be effectively considered as a food stabilizing, emulsifying and adhesive agent so as to change the food texture for specific purposes. In regard with nutraceutical properties, fenugreek might also be favored by nations as a means for providing medicinal or health benefits in many cases involving carcinogenic, diabetic, and bacterial illnesses. It can also work as antioxidant, anti-anorexia agent, gastric stimulant and effective cure for hypoglycemia and hypercholesterolemia.

References

- Acharya, S.N., Blade, S., Mir, Z. and Moyer, J.S. (2007). Tristar fenugreek. *Can. J. Plant Sci.* 87: 901–903.
- Acharya, S.N., Acharya, K., Paul, S. and Basu, S.K. (2011). Variation in the antioxidant and anti-leukemic properties among different Western Canada grown fenugreek (*Trigonella foenum-graecum* L.) genotypes. *Can. J. Plant Sci.* 91 (1): 99–105.
- Acharya, S.N., Basu, S.K., Datta Banik, S. and Prasad, R. (2010). Genotype X environment interactions and its impact on use of medicinal plants. *The Open Nutraceuticals Journal*, 3: 47–54.
- Acharya, S.N., Thomas, J.E. and Basu, S.K. (2006). Fenugreek: an “old world” crop for the “new world”. *Biodiversity*, 7(3&4): 27–30.
- Acharya, S.N., Thomas, J.E. and Basu, S.K. 2008. Fenugreek (*Trigonella foenum-graecum* L.) an alternative crop for semiarid regions of North America. *Crop Sci.* 48: 841–853.
- Basu A., Basu, S. K., Kumar, A., Sharma, M., Chalghoumi, R., Hedi, A., Solorio-Sánchez, F.J., Ramírez-Avilés; L., Balogun, M.O., Hafez, E.E. and Cetzal-Ix, W. (2014). Fenugreek (*Trigonella foenum-graecum* L.), a potential new crop for Latin America. *AJSIH.* 4(3): 148–162.
- Basu, S.K. and Agoramoorthy, G. (2014). Fenugreek (*Trigonella foenum-graecum* L.): Production Challenges and Opportunities for Asia, Africa and Latin America. *AJSIH. Fenugreek Special Issue (March/April)*: 1–2.
- Basu, S.K. and Prasad, R. (2011). Trends in new technological approaches for forage improvement. *Aust J Agric Eng.* 2(6): 176–185.
- Basu, S.K., Acharya, S.N. and Thomas, J.E. (2006). A report on powdery mildew infestations caused by *Erysiphe polygoni* D.C. in North America grown fenugreek. *J. Mycopathol. Res.* 44(2): 253–256.
- Basu, S.K., Acharya, S.N. and Thomas, J.E. (2007a). Colchicine treatment produces genetic improvement in fenugreek seed size and yield. *Proc. Multi. Grad. Res. Conf.*, 1(1): 37–43.
- Basu, S.K., Acharya, S.N. and Thomas, J.E. (2007b). Foliar spray to improve fenugreek seed yield and reduce maturity duration. *Proc. Multi. Grad. Res. Conf.* 1(1): 44–50.
- Basu, S.K., Acharya, S.N. and Thomas, J.E. (2008a). Application of phosphate fertilizer and harvest management for improving fenugreek (*Trigonella foenum-graecum* L.) seed and forage yield in a dark brown soil zone of Canada. *KMITL Sci. & Tech. J.* 8(1): 1–7.

- Basu, S.K., Acharya, S.N. and Thomas, J.E.(2008b). Genetic improvement of fenugreek (*Trigonella foenum-graecum* L.) through EMS induced mutation breeding for higher seed yield under prairie conditions of western Canada. *Euphytica*, 160:249–258.
- Basu, S.K., Acharya, S.N., Bandara, M.S., Friebel, D. and Thomas, J.E. 2009. Effects of genotype and environment on seed and forage yield in fenugreek (*Trigonella foenum-graecum* L.) grown in western Canada. *Aust. J. Crop Sci.* 3(6): 305–314.
- Basu, S.K., Acharya, S.N., Cárcamo, H.A., and Thomas, J.E.(2006). Study on the potential insect pests of fenugreek (*Trigonella foenum-graecum* L.) in North America with particular emphasis on the western flower thrips (*Frankliniella occidentalis* Pergande) in the greenhouse and plant bugs (*Lygus* and *Adelphocoris*, Miridae, Hemiptera) in the field. *J. Environ. & Sociobiol.* 3(1):1–7.
- Basu, S.K., Thomas, J.E. and Acharya, S.N.(2007). Prospects for growth in global nutraceutical and functional food markets: a Canadian perspective. *Aust. J. Basic Appl. Sci.* 1(4):637–649.
- Chakraborty, N., Chatterjee, S.Basu, S.K. and Acharya, K. (2014). Fungal diseases of fenugreek. *AJSIH. Fenugreek Special Issue (March/April)*:171–185.
- Solorio-Sánchez, F., Solorio-Sánchez, B., Basu, S.K., Casanova-Lugo, F., Sarabia-Salgado, L., Ku-Vera, J., Aguilar-Pérez, C., Ramírez-Avilés, L., Noguera-Savelli, E., Cetzal-Ix, W., Infante-Cruz, Á., Petit-Aldana, J. and Ayala-Basulto, A. (2014). Opportunities to grow annual forage legume fenugreek (*Trigonella foenum-graecum* L.) under Mexican silvopastoral system. *AJSIH. Fenugreek Special Issue (March/April)*: 86–95.
- Thomas, J.E., Basu, S.K. and Acharya, S.N.(2006). Identification of *Trigonella* accessions which lack antimicrobial activity and are suitable for forage development. *Can. J. Plant Sci.* 86(3):727–732.
- Zandi, P., Basu, S.K., BazrkarKhatibani, L., Balogun, M., Aremu, M.O., Sharma, M., Kumar, A., Sengupta, R., Li, X., Li, Y., Tashi, S., Hedi, A., Cetzal-Ix W. (2015). Fenugreek (*Trigonella foenum-graecum* L.) seed: a review of physiological and biochemical properties and their genetic improvement. *Acta Physiologia Plantarum*, 37:1714. doi:10.1007/s11738-014-1714-6
- Zandi, P., Daneshian, J. and ShiraniRad, A.H. (2010). Determination of Ideal Nitrogen Fertilizer Rate and Plant Density in Fenugreek under Dry Farming Conditions: The Regional Congress on Modern Results in Agronomy and Nanotechnology, QudsAzadUniversity, Quds city, Iran.
- Zandi, P., ShiraniRad, A.M. andBazrkarKhatibani L. (2011a). Agronomic study of fenugreek grown under different in-row spacing and nitrogen levels in a paddy field of Iran, *Amer-Eurasian J Agri & Environ Sci.* 10 (4): 544–550.
- Zandi, P., ShiraniRad, A.H., Daneshian, J. andBazrkarKhatibani, L. (2011b). Agronomic and morphologic analysis of Fenugreek (*Trigonella foenum-graecum* L.) under nitrogen fertilizer and plant density via factor analysis. *African Journal of Agricultural Research*, 6(5): 1134–1140.
- Zandi, P., ShiraniRad, A.H.,Daneshian, J. andBazrkarKhatibani, L. (2013). Evaluation of nitrogen fertilizer and plant density effects on yield and yield components of Fenugreek in double cropping. *Journal of Plant Production (ChamranUniversity, Ahvaz)*, 35 (4): 81–91.

2. PLANT PROTECTION AND FOOD SAFETY

DETERMINATION METHODOLOGY OF PENCONAZOLE AND MYCLOBUTANIL RESIDUES IN APPLES

Edlira SHAHINASI^{1*}, Ferdi BRAHUSHI², Vjollca VLADI³

¹Department of Chemistry, Faculty of Biotechnology and Food, Agricultural University of Tirana, Kodër-Kamëz, 1029 Tirana, - Albania

²Department of AgroEnvironment and Ecology, Agricultural University of Tirana, Kodër-Kamëz, 1029 Tirana, - Albania

³Food Safety and Veterinary Institute. Tirana, Albania

*Corresponding author: eshahinasi@ubt.edu.al

Abstract

Among many fruit trees, apples are the most cultivated trees in Albania, and the region of Korça is the main market supplier with apple fruits. This specie represents around 70% of total fruit trees. The increase of production and the quality of this fruit are related not only with Good Agricultural Practice but even with the use of pesticides. The fruit trees are in the second place regarding to the used amount of pesticides per hectare. In this study we have been focused on the evaluation of penconazole and myclobutanil residues in apple based on QuEChERS method. The experiments are performed with two types of apple cultivars (Golden Delicious and Starking). The apples trees were treated with the minimum and maximum doses of pesticides penconazole and myclobutanil that are required. The number of treatments according to European Union (EU) did not exceed 4 treatments for season. For determination of penconazole and myclobutanil residues from each apple variety 10g homogenated sample were weighted. Then, the sample was placed in a centrifuge tube test 50mL, when 10 ml acetonitrile and 100µl solution of 20ppm TPP was added. The centrifuge tube test was closed and mixed in a vortex. After that, a mixture of magnesium sulfate anhydrous, sodium chloride, trisodium citrate dehydrates and disodium hydrogen citrate sesquihydrate was added. Then, extract was centrifuged for 5 minutes in a centrifuge with speed 3500rpm. A small quantity of supernatant was added in e centrifuge tube that contained 150 PSA and 900 mg magnesium sulfate anhydrous and undergoes the mixture with vortex and centrifugation. The supernatant was placed in a vial and kept in refrigerator to be ready for chromatography analyses.

Keywords: *apples, pesticides residues, penconazole, myclobutanil.*

Introduction

Fruits are an essential component of our diet due to their nutritional value. They serve as supplementary sources of carbohydrates, lipids, vitamins, minerals, antioxidants which play an important role in the metabolic pathways and inhibit the abnormal growth of cells. A high intake of fruit has been encouraged not only to prevent consequences due to vitamin deficiency but also to reduce the incidence of major diseases such as cancer, cardiovascular diseases and obesity (Wattenberg, 1992; WHO, 2002; Latif *et al.*, 2012). According to The World Health Report 2002, high fruit and vegetable intake is estimated to reduce about 31% of ischemic heart disease and 11% of stroke worldwide.

Among many fruit trees, apples are the most cultivated trees in Albania, which represents around 70% of total fruit trees, and the region of Korça is the main market supplier with apple fruits.

Unfortunately, not all farmers follow legal practices, and by using tremendous number of pesticide applications they make this agricultural product a subject of contamination, which often leads to the presence of pesticide residues in fruit after harvest (Food and Drug Administration, 1999; Fillion *et al.*, 2000; Lehotay, 2000; Abdulrauf *et al.*, 2012)

A number of analytical methods are designed to determine multiple pesticide residues (Lehotay, 1996), but the usual methods for isolating pesticides from fruit samples are: Liquid-Liquid Extraction (LLE), Pressurized Liquid Extraction (PLE), Liquid-Liquid Microextraction (LLME), Microwave-assisted Extraction (MAE) and Ultrasound-assisted Extraction (UAE). Extract clean-up techniques are the most commonly employed Solid-phase Extraction (SPE), Solid-phase Micro-extraction (SPME), Stir Bar Solvent Extraction (SBSE) and Gel Permeation Chromatography (GPC) (Blasco *et al.*, 2002; Sanusi *et al.*, 2004; Sanchez *et al.*, 2006). Currently, the Solid Phase Extraction (SPE) is the most popular extract clean-up technique (Stajnbaher and Zupancic-Kralj, 2003).

Anastassiades *et al.* (2003) described the “Quick, Easy, Cheap, Effective, Rugged, low solvent consumption, wide pesticide range (Polar, pH – dependent compounds) and Safe” (QuEChERS) method for pesticide residues analysis, which provides high quality results in a fast, easy, an inexpensive approach. Since that time, the QuEChERS method using MeCN for extraction has been successfully validated in several laboratories and in interlaboratory trials. The method (with minor modification differences) has become an Official Method of Association of Analytical Communities (AOAC) International and the European Standard Organization (CEN) (Lehotay, 2007).

The most common techniques in modern multi-residue target pesticide analysis are gas chromatography, liquid chromatography coupled to mass spectrometry (GC-MS, LC-MS) and/or tandem mass spectrometry (GC-MS/MS, LC-MS/MS). Núñez *et al.*, 2012 have noticed in their study that liquid chromatography coupled with mass spectrometry (LC-MS) or with tandem mass spectrometry (LC-MS-MS) or with time-of-flight (LC-TOF-MS) has lately become a powerful analytical technique for the identification and quantification of pesticides residues in fruits such as apples.

Materials and methods

Experimental Field

In this study we have chosen two species of apple trees; Golden Delicious and Starking Delicious, because these species are the most affected by diseases. The field experiment was performed at the Korça region (Albania). The application of the pesticides on the trees was done through a tractor in which two sprays were mounted. In the Table 1 are listed the commercial name, active substances and some other characteristics of pesticides (fungicides) that are used in this study.

The apple orchard was divided into four plots. Golden Delicious were placed on the first and second plots, while Starking Delicious were placed on the third and fourth plots. During the treatment two doses were used, one with minimum and the other one with maximum of optimum level needed for the disease treatment. The doses (%) for myclobutanil and penconazol are listed on the Table 2.

Table 1 *Some characteristics of fungicides used in experiment*

Commercial name	Active substance	Mode of action	Group Name	Chemical group	FRAC Code
Chorus50 WG	Cyprodinil	Amino acid and protein synthesis	AP - fungicides (Anilino-Pyrimidines)	anilino-pyrimidines	9
Captan 80 WG	Captan	Multi-site contact activity	phthalimides	phthalimides	M4
Stroby WG	Kresoxym methyl	Respiration	QoI-fungicides (Quinone outside Inhibitors)	Oximino-acetates	11
Brik 24	Myclobutanil	Sterol biosynthesis in membrane	DMI-fungicides (DeMethylation Inhibitors)	Triazoles	3
Zato 50 WG	Trifloxystrobin	Respiration	QoI-fungicides (Quinone outside Inhibitors)	Oximino-acetates	11
Delan 700WG	Dithianon	Multi-site contact activity	quinones (anthraquinones)	quinones (anthraquinones)	M9
PEN 10 EC	Penconazol	Sterol biosynthesis in membrane	DMI-fungicides (DeMethylation Inhibitors)	Triazoles	3

(Source: FRAC list code 2016)

Table 2. Treatment scheme, schedule of application and doses for myclobutanil and penconazole

Nr.	Schedule of application	Type of treatment	Dose (%)	
			Min.	Max.
1	26.04.2015	Captan 80 WG + Chorus 50WG		
2	02.05.2015	Brik 24	0.015	0.025
3	10.05.2015	Stroby + Delan 700WG		
4	19.05.2015	Zato 50WG + Captan 80 WG		
5	28.05.2015	Pen 10 EC	0.025	0.04
6	12.06.2015	Stroby + Delan700WG		
7	20.07.2015	Captan 80 WG + Chorus 50WG		
8	30.07.2015	Stroby + Delan 700WG		
9	20.08.2015	Brik 24	0.015	0.025
10	10.09.2015	Pen 10 EC	0.025	0.04

Sampling procedure

The first samples were taken for analysis on 21th August 2015 one day after the treatment of trees with Brik 24 and then into intervals (see the Table 3).

Sampling was performed by hand-picking of the apples (around 1kg of fruit). The apple samples were taken in accordance with European Commission Directive 2002/63/EC. The transportation of apples to the laboratory was done through cooling boxes. The temperature inside the boxes did not exceed 5-6^oC.

Table 3. The last treatments and sampling data

Data of Treatment	Type of treatment	Sampling Data
20.08.2015	Brik24	21.08.2015
		26.08.2015
		03.09.2015
10.09.2015	PEN10 EC	11.09.2015
		17.09.2015
		22.09.2015
		29.09.2015

Sample preparation

The acetate-buffered QuEChERS sample preparation method for pesticides (UNI EN 15662:2009) was applied to all the samples. After homogenization of 1 kg apples with a domestic blender, a 10 gr portion of homogenized sample was placed in a centrifuge tube test 50mL, when 10 ml acetonitrile and 100µl solution of 20ppm TPP were added. The centrifuge tube test was closed and mixed in a vortex. After that, a mixture of magnesium sulfate anhydrous, sodium chloride, trisodium citrate dehydrates and disodium hydrogen citrate sesquihydrate was added. Then, extract was centrifuged for 5 minutes at 3500rpm. A small quantity of supernatant was added in e centrifuge tube that contained 150mg PSA and 900 mg magnesium sulfate anhydrous and undergoes again the mixture with vortex and centrifugation. The supernatant was placed in a vial and kept in refrigerate to be ready for LC-MS/MS analysis.

Results and Discussion

Chromatography analysis data

Chromatography analysis data of myclobutanil and penconazole residues in apple are presented in the Table 4. These data are taken by using QuEChERS methods and LC-MS/MS apparatus.

Table 4. *The parameters of method for residues analysis of myclobutanil and penconazole in apple*

No.	Parameters	Pesticides	
		Myclobutanil	Penconazole
1	Recovery (%)	80,0	86,2
2	Limit of Detection (LOD) (mg/kg)	0,005	0,005
3	Limit of Quantification (LOQ) (mg/kg)	0,01	0,01
4	Reproducibility (%)	≤ 10	≤ 10

The obtained data showed that applied method is suitable for analysis of myclobutanil and penconazole residues in apple as the LOQ are lower than the Maximum Residues Limit (MRL) for myclobutanil and penconazole in apple, which are 0,6 and 0,2 mg/kg, respectively. Furthermore, recoveries and reproducibility parameter of the methods were satisfactory, as they are above required limits. Therefore, this method can be applied for further analysis of myclobutanil and penconazole residues in apple. According to Vladi, 2015 this method can be applied even for other pesticides residues in fruits and vegetables.

Conclusion

The used method in this study is available for the analysis of pesticide residues as myclobutanil and penconazole in apple. The evaluated parameters of method showed good reproducibility and were in required interval for pesticide residues analysis. Thus, QuEChERS methods is simple, fast phase extraction sample, with the largest number of pesticides determined at the same time, higher reliability and simultaneously lower costs.

References

- Abdulrauf, L.B., Chai, M.K. and Tan, G.H. (2012) "Applications of solid-phase microextraction for the analysis of pesticide residues in fruit and vegetables: A review". *Journal of AOAC International*, 95, 1272-1290.
- Anastassiades, M.; Lehotay, S.J.; Stajnbaher, D.; Schenck, F.J. (2003) "Fast and easy multiresidue method employing acetonitrile extraction/proportioning and dispersive solid phase extraction for the determination of pesticide residues in produce". *Journal of AOAC International*, 86(2), 412-431.
- Blasco C., Font G. and Pico Y. (2002) "Comparison of microextraction procedure to determine pesticides in oranges by liquid chromatography mass spectrometry" *Journal of Chromatography A*, vol. 970, pp. 201–212.
- Fillion J, Sauv e F, Selwyn J (2000). "Multiresidue method for the determination of residues of 251 pesticides in fruits and vegetables by gas chromatography/mass spectrometry and liquid chromatography with fluorescence detection". *J. AOAC Int.*, 83: 698-713.
- Food and Drug Administration (1999). Pesticide Analytical Manual Volume I: Multiresidue Methods, 3rd Edition, U.S. Department of Health and Human Services, Washington, DC.

- FRAC. (2016) Fungicide Resistance Action Committee. (FRAC) code list 2016. Fungicides sorted by mode of action (including FRAC Code numbering). <http://www.frac.info/docs/default-source/publications/frac-code-list/frac-code-list-2016.pdf?sfvrsn=2>
- Latif Y, Sherazi ST, Bhangar MI., (2012) “Assessment of pesticide residues in commonly used vegetables in Hyderabad, Pakistan” *Ecotoxicol. Environ. Saf.*, 74(8), 2299-2303
- Lehotay, S.J. (1996) “Supercritical fluid extraction of pesticide residues in fruit and vegetables”. *Seminars in Food Analysis*, 1, 73-84
- Lehotay, S.J. (2007) “Determination of Pesticide Residues in Foods by Acetonitrile Extraction and Partitioning with Magnesium Sulfate” *Collaborative Study. J. AOAC mt.*, 90, 485-520.
- Núñez, H., Gallart-Ayala O., Ferrer I, Moyano E., and Galcerana M. T, (2012). “Strategies for the multi-residue analysis of 100 pesticides by liquid chromatography–triple quadrupole mass spectrometry,” *Journal of Chromatography A*, vol. 1249, pp. 164-180.
- Sanchez A. G. Martos N. R. and Ballesteros E. (2006). “Multiresidue analysis of pesticides in olive oil by gel permeation chromatography followed by gas chromatography-tandem mass-spectrometric determination,” *Analytica Chimica Acta*, vol. 558, pp. 53–61
- Sanusi A., Guillet V. and Montury M. (2004). “Advanced method using microwaves and solid-phase microextraction coupled with gas chromatography-mass spectrometry for the determination of pyrethroid residues in strawberries,” *Journal of Chromatography A*, vol. 1046, pp. 35-40, 2004.
- Stajnbaher D. and Zupancic-Kralj, L. (2003). “Multiresidue method for determination of 90 pesticides in fresh fruit and vegetables using solid phase extraction and gas chromatography-mass spectrometry,” *Journal of Chromatography A*, vol. 1015, pp. 185-198.
- Vladi V. (2015) PhD thesis: “Evaluation of analytical methods for analysis of some pesticide residues, and determination of pesticide residues levels in our country”
- Wattenberg, L.W. (1992) “Inhibition of carcinogenesis by minor dietary constituents”. *Cancer Research*, 52, 2085- 2091.
- World Health Organization (WHO, 2002). The World Health Report: Reducing risks, promoting health. Geneva, World Health Organization.

ENTOMOFAUNA OF PEARS IN EAST SARAJEVO AREA (BOSNIA AND HERZEGOVINA)

Dejana TEŠANOVIĆ^{1*}, Radoslava SPASIĆ², Radenko RADOVIĆ³

¹University of East Sarajevo, Faculty of Agriculture, Vuka Karadžića 30, East Sarajevo, Bosnia and Herzegovina

²University of Belgrade, Faculty of Agriculture, Nemanjina 6, Belgrade, Serbia

³Administration Bosnia and Herzegovina for Planth Health Protection, Maršala Tita, 9a, Sarajevo

*Corresponding author: dejanatesanovic@yahoo.com

Abstract

Entomofauna of pears in region of East Sarajevo (entity of Republic of Srpska, Bosnia and Herzegovina) was examined in 2011 and 2012 in intensive orchards in the locations Vojkovići and Kula, in semi-intensive orchards in locations Tilava and Petrovići, and in extensive orchard in the location Kasindo. Using entomological methods, collecting before adult and adult stadium phytophagous and entomophagous-predators species, taking a sample of infested plants organs, cultivation before adult eclosion and determination of collected and newly hatched insects was carried out. Total number of determined insect's species is 44, of which 35 are phytophagous, 8 entomophagous - predators and one with mixed feeding regiment. The largest number of phytophagous insect species trophic related to pear was in semi-intensive orchards, 29 species in the Tilava and 23 species in the Petrovići. In intensive orchards, 13 species was found in Kula, 9 in Vojkovići, while in extensive orchard in the Kasindo, there was 17 species. The most numerous of entomophagous insects - predators was found in intensive orchards in the Vojkovići (8 species) and lowest in extensive orchard in the Kasindo (2 species).

Key words: *Entomofauna, Pear, East Sarajevo region*

Introduction

The total world production of continental fruit, according to the FAO, pear (*Pyrus communis* L.) is in second place, right after the apple, with an average production of 19 million tons. (Mratinić, 2000; Milatović, 2009). In Bosnia and Herzegovina (BiH), pear is on the third place, after the plums and apples, but with a tendency to increase surface area.

During a growing season, the pear is exposed to many pests' attacks, where important place belong to insects from different insects order. Some insect species are present on pears during whole year and hibernate in different stages, but some of them occur only in a certain period of the vegetation, depending on development stages of a plant and bionomy insect species. Feeding by different parts of plants, insects cause physiological weakening of a plant, deformation of plant organs, reduced fruiting or defoliation, while species which damage the fruits, often can cause their prematurely falling, reducing the market value, and sometimes even complete destruction of the plant.

In countries around the world, some species are economically very important, such as psyllid species: *Cacopsylla pyri* L., *Cacopsylla pyrisuga* Foerster and *Cacopsylla pyricola* Foerster (Jerinić – Prodanović, 2010). In addition, important pests of pear are *Cydia pomonella* L. and *Cydia pyrivora* Danilevskij, which causing damage of fruits, their prematurely falling, and reducing their market and the value in use in many parts of Europe and Asia (Lacey *at al.*, 2002).

In addition to harmful species, on pear are present many beneficial insects, particularly pollinators and many entomophagous species or predators and parasitoids, from different insect orders (Heteroptera, Neuroptera, Diptera, Dermaptera and Coleoptera). They are very important in the regulation harmful insects (Maceljki, 2002; Almaši *et al.*, 2004; Jerinić-Prodanović, 2010; Tamaš, 2012). In the region of Sarajevo and BiH, there is not enough literature data about harmful and beneficial insects on pear. In the middle 60's in the XX century, leaf miners were studied in this region (Dimić, 1964). Since then the important examination was not until 2004, when the area of Sarajevo and the other locations in Bosnia and Herzegovina on pear, discovered Phytoplasmatic disease "Pear decline" (Trkulja *et al.*, 2004; Delić *et al.*, 2005), transmitted by *C. pyri* and *C. pyricola* (Garcia - Chapa *et al.*, 2005). The main objective of this paper was to examine insects' fauna diversity on pear in the area of East Sarajevo, in different rearing systems.

Materials and methods

The examination was realized in 2011 and 2012 in the orchards (locations Vojkovići, Kula, Tilava, Petrovići, Kasindo) and in the laboratory of the Faculty of Agricultural in East Sarajevo. Method of visual examination of randomly selected trees was determined the presence of insects, their number and symptoms of damage. Visual examination of trees was done during the vegetation season at intervals of 10-15 days, and during the winter. It was done overview of plants for the presence of overwintering form of insects and collecting material by sampling at different insect stages. Winter examination of plants was done by the two samples of the total length of 2 m of two- or three-year branch were survey (from different places was taken of the 10 branches of length 20 cm) and examined in detail in the laboratory under the dissecting microscope. In the locations Petrovići, Tilava and Vojkovići, were examined of 20 trees, while in the Kula and Kasindo examination included of 10 trees. Predators were collected together with the sample plant material.

By method of shaking branches, using entomological meshes and exhauster, all stages of insects which lived freely in the plant organs, were collected. In the locations Vojkovići, Kula, Tilava and Petrovići, one sample was a 100 strokes with 100 branches, of which the two branches of the same trees, at different heights and positions. In the locations Kasindo and Kula, one sample was 100 strokes with 10 of different branches on each of 10 trees.

By method of sampling of 100 different plant organs (leaf and flower buds, leaves, fruits) with a randomly selected tree, the presence of insect pests and their development stage was determined. All sampled infested plant material was observed in laboratory. All collected eggs, larvae and pupa of phytophagous and entomophagous insects, were reared in the lab to adult stadium. In this purpose was used plastic containers and Petri dishes. In the bottom placed a layer of cellulose wadding occasionally misted in order to maintain the freshness of the leaf. The rearing of psyllid species was by the method Hodkinson & White, 1979, (cit. Jerinić-Prodanović, 2010). Also, the collected and reared insects were fixed in 70% alcohol; some of them were prepared, making microscopic preparations or the entomological collection.

Determination of species was based on morphological characteristics of the adults and before adult stadium, followed by keys and appropriate entomological literature (Balachowsky 1966; Hering, 1957). For determination to psyllid species, were done microscopic preparations of whole insect or body parts essential for determination.

Results and discussions

Two-year research of entomofauna on pears in the area of East Sarajevo, in the intensive, semi-intensive and extensive orchards, resulted in 44 detected species from orders Hemiptera, Neuroptera, Coleoptera, Lepidoptera and Diptera. Obtained results are according to the literature data (Ciglar, 1998; Alston and Murray, 2007). The most numerous species was in semi-intensive orchards, 39 species in the Tilava, and 31 species in the Petrovići. The following intensive orchards with 20 species in the Kula and 17 species in the Vojkovići. In extensive orchard, in the Kasindo, it was found 19 species. Of the total number of detected species, 35 were phytophagous, 8 species were entomophagous-predatory, and one species *Cantharis decipiens* was with mixed feeding regiment (Table 1).

Of the total number of determined species, nine species of insects have been determined in all localities: *Cacopsylla pyri* L., *Cacopsylla pyrisuga* Forster, *Phyllobius oblongus* L., *Anthonomus pomorum* L., *Adalia bipunctata* L., *Harmonia axyridis* Pallas, *Cydia pyrivora* Danilevskij, *Cydia pomonella* L. and *Stigmela malella* Stainton. Eight species (*Aphis pomi* De Geer, *Lepidosaphes ulmi* L., *Pulvinaria vitis* L., *Anthocoris nemorum* L., *Ptycholoma lecheana* L., *Leucoptera malifoliella* Costa, *Aporia crataegi* L. and *Contarinia pyrivora* Ribey) were present in only one location, usually in semi-intensive pear orchard in the Tilava.

During our research, by method of winter examination woody parts of plants were found: *Q. perniciosus* Comstock, *L. ulmi* L., *E. leperii* Signoret and *P. vitis* L., according to the literature data (Cean *et al.*, 2012).

By methods of review of plant organs, were found three species: *C. pyri*, *C. pyrisuga* and *C. pyricola*, according to many authors about their distribution and harmfulness in all areas where pears are grown (Sestras *et al.*, 2009; Maceljski, 2002). Among of them, the most numerous species was *C. pyri*, especially in the intensive orchards in locations Vojkovići and Kula, while *C. pyrisuga* and *C. pyricola* were more present in semi-intensive and extensive orchards, according to literature data about their more presence in the less-tended orchards (Jerinić-Prodanović, 2010).

Among of dangerous defoliators, included leaf miners which in the former Yugoslavia, occurred in the late 70's in XX century, when they became a serious problem. In the area of Sarajevo and the environment on pear, five species were found: *L. corylifoliella* Haworth, *L. mespiliella* Frey, *Lyonetia clerkella* L., *Cemiostoma scitela* Costa and *C. hemerobiella* Scopoli of which the most numerous was *L. corylifoliella* (Dimić, 1964). Our research resulted in six species of leaf miners: *L. malifoliella*, *L. blancardella*, *L. corylifoliella*, *S. malella*, *C. denticulella* and *Coleophora hemerobiella* (Table 1).

Buds and leaves of pears in this area were damaged by *Hibernia defoliaria* L. and *Cheimatobia brummata* L., but without important damage, according to literature data (Ciglar, 1998; Almaši *et al.*, 2004). In addition to these species, in locations Tilava and Petrovići were found *Pasiphila* (= *Chloroclystis*) *rectangulata* L. which except the pears, damage and the other plants from fam. *Rosaceae* (apple, cherry, etc.), but didn't cause important damage (Maier, 2009). Also, the leaf and flower buds were damaged tortricid moth (*Hedya nubiferana* Haworth, *Archips rosana* L., *Archips podana* Scopoli), especially in the semi-intensive orchards (Tilava and Petrovići). In contrast to literature data about dominance *A. rosana* in Bosnia and Herzegovina (Ciglar, 1988; Maceljski, 2002), during our research both species of the genus *Archips* were found as individual specimens in the semi-intensive orchards. Very important pests of fruit pears are *C. pomonella* and *C. pyrivora* (Aghdam, 2010), but our research showed the presence of individual damaged fruits.

The semicircular damage on the leaves was done by species from the genus *Phyllobius* which didn't consider economically important pest, except in the orchards near to the forest (Almaši *et al.*, 2004). In our examination, these species were present in small number and located in the orchards near the forest, in the locations Kula, Tilava and Petrovići, without important damage.

Table 1. The presence of insects in orchards pears in the area of East Sarajevo in 2011 and 2012 year

	Order	Familia	Species of insects	Locations				
				Vojko vići	Kula	Tilava	Petrovići	Kasindo
1.	HEMIPTERA	Aphididae	<i>Dysaphis pyri</i>	+	+	+	-	+
2.			<i>Aphis pomi</i>	-	-	+	-	-
3.		Diaspididae	<i>Quadraspidiotus perniciosus</i>	-	-	+	+	+
4.			<i>Lepidosaphes ulmi</i>	-	-	-	-	+
5.			<i>Epidiaspis leperii</i>	-	-	+	+	+
6.		Coccidae	<i>Pulvinaria vitis</i>	-	-	-	+	-
7.		Psyllidae	<i>Cacopsylla pyri</i>	+	+	+	+	+
8.			<i>Cacopsylla pyrisuga</i>	+	+	+	+	+
9.			<i>Cacopsylla pyricola</i>	-	-	+	+	-
10.		Pentatomidae	<i>Graphosoma lineata</i>	-	+	+	+	-
11.		Anthocoridae	<i>Anthocoris nemorum</i>	+	-	-	-	-
12.	NEUR O-PTERA	Chrysopidae	<i>Chrysoperla carnea</i>	+	+	+	+	-
13.			<i>Chrysopa septempunctata</i>	+	+	+	+	-
14.	COLEOPTERA	Curculionidae	<i>Phyllobius oblongus</i>	+	+	+	+	+
15.			<i>Phyllobius pyri</i>	-	+	+	+	-
16.			<i>Phyllobius argentatus</i>	-	+	+	-	-
17.			<i>Anthonomus pomorum</i>	+	+	+	+	+
18.			<i>Anthonomus pyri</i>	-	-	-	-	+
19.		Coccinellidae	<i>Adalia bipunctata</i>	+	+	+	+	+
20.			<i>Coccinella septempunctata</i>	+	+	+	+	-
21.			<i>Harmonia axyridis</i>	+	+	+	+	+
22.		Scarabaeidae	<i>Epicometa hirta</i>	-	-	+	+	-
23.		Cantharidae	<i>Cantharis decipiens</i>	-	-	+	+	-
24.		Chrysomelidae	<i>Gynandrophthalma cyanea</i>	-	-	+	+	-
25.	LEPIDOPTERA	Tortricidae	<i>Cydia pyrivora</i>	+	+	+	+	+
26.			<i>Cydia pomonella</i>	+	+	+	+	+
27.			<i>Hedya nubiferana</i>	-	-	+	+	+
28.			<i>Archips rosana</i>	-	-	+	+	+
29.			<i>Archips podana</i>	-	-	+	+	-
30.			<i>Ptycholoma lechearna</i>	-	-	+	-	-
31.		Nepticulidae	<i>Stigmela malella</i>	+	+	+	+	+
32.		Lyonetiidae	<i>Leucoptera malifoliella</i>	-	-	+	-	-
33.		Lithocolletidae	<i>Lithocolletis blancardella</i>	-	+	+	+	+
34.			<i>Lithocolletis corylifoliella</i>	-	-	+	+	-
35.			<i>Calisto denticulella</i>	-	-	+	+	+
36.		Coleophoridae	<i>Coleophora hemerobiella</i>	-	-	+	+	-
37.		Geometridae	<i>Hibernia defoliaria</i>	-	-	-	+	+
38.			<i>Cheimatobia brummata</i>	-	+	+	+	-
39.			<i>Pasiphila (=Chloroclystis) rectangulata</i>	-	-	+	+	-
40.		Pieridae	<i>Aporia crataegi</i>	-	-	+	-	-
41.	DIPTE-RA	Cecidomyiidae	<i>Dasyneura pyri</i>	+	+	+	-	-
42.			<i>Contarinia pyrivora</i>	-	-	+	-	-
43.		Syrphidae	<i>Episyrphus balteatus</i>	+	+	+	-	-
44.			<i>Syrphus ribesii</i>	+	-	+	-	-
Total number of species				17	20	39	31	19

Harmfull species Entomophagous species Mixed feeding regiment

Except harmful insects, in pear orchards were collected 8 entomophagous species of insects - predators. From order Coleoptera and fam. Coccinellidae three species were found: *Adalia bipunctata* L. and *Coccinella septempunctata* L. as predators psyllid species according to literature data (Jerinić-Prodanović, 2010), and *Harmonia axyridis* Pallas, which with these two species, were reared from the colonies of aphids *Dysaphis pyri* Boyer de Fonscolombe, according to literature data (Vuković, 1990). All these species have already been identified in the area of East Sarajevo as predators of aphids on apple (Tešanović *et al.*, 2010). Besides these species, from order Neuroptera and fam. Chrysopidae, two species were found: *Chrysoperla carnea* Stephens and *Chrysopa septempunctata* Westmael as predators of aphids and psyllid species, in all localities except the Kasindo, according to literature data (Vuković, 1986, cit. Tamaš, 2012). The important predatory species were from the order Diptera and fam. Syrphidae (*Episyrphus balteatus* De Geer, *Syrphus ribesii* L., *Metasyrphus colorae* Fabricius, *Sphaeroforia scripta* L., *S. menthastri* L., *Scaeva pyrastris* L., *Syrphus latifasciatus* Macquart (Vuković, 1990). Our examination showed the presence of two species (*E. balteatus* and *S. ribesii*), determined in locations Vojkovići and Tilava, while in the locality Kula identified only *E. balteatus*. Their larvae were feeding of colonies of *D. pyri*, according to literature data (Vuković, 1990; Tamaš, 2012). From the order Hemiptera, *Anthocoris nemorum* L., was determined in the locality Vojkovići. According to many authors, this species was present one of the most important predatory species, which feeds by psyllid species, *C. pyri* and *C. pyrisuga* (Jerinić-Prodanović, 2010).

Conclusion

In the area of East Sarajevo, in intensive, semi-intensive and extensive orchards of pears, in 2011 and 2012 year, 44 species were found. They belong to different orders: Hemiptera, Neuroptera, Coleoptera, Lepidoptera and Diptera. Among of them, 35 species were phytophagous, 8 entomophagous and one with mixed feed regime. From 35 phytophagous species, 31 were related to the trophic pear.

From the order Hemiptera were determined: *Dysaphis pyri*, *Aphis pomi*, *Quadraspidiotus perniciosus*, *Lepidosaphes ulmi*, *Epidiaspis leperii*, *Pulvinaria vitis*, *Cacopsylla pyri*, *Cacopsylla pyrisuga* and *Cacopsylla pyricola*.

Order Coleoptera was represented with species: *Phyllobius oblongus*, *Phyllobius pyri*, *Phyllobius argentatus*, *Anthonomus pyri*, *Anthonomus pomorum* and *Epicometis hirta*. From order Lepidoptera was found: *Cydia pyrivora*, *Cydia pomonella*, *Hedya nubiferana*, *Archips rosana*, *Archips podana* and *Ptycholoma lecheana*, *Lithocolletis blancardella*, *Lithocolletis corilifoliella*, *Calisto denticulella*, *Stigmella malella*, *Leucoptera malifoliella* and *Coleophora hemerobiella*, *Hibernia defoliaria*, *Cheimatobia brummata* and *Pasiphila* (= *Chloroclystis*) *rectangulata*.

Order Diptera was represented with species: *Dasineura pyri* and *Contarinia pyrivora*. The most numerous species to trophic related to pear was in semi-intensive orchards, in Tilava 29 species, and Petrovići, 23 species. In intensive orchard in the Kula, 13 species were found and 9 species in the Vojkovići, while in extensive orchard in the locality Kasindo, 17 species were found.

From entomofagous – predators species were found: *Anthocoris nemorum*, *Chrysoperla carnea*, *Chrysopa septempunctata*, *Adalia bipunctata*, *Coccinella septempunctata*, *Harmonia axyridis*, *Episyrphus balteatus* and *Syrphus ribesii*.

The most numerous entomofagous species was in intensive orchard in the Vojkovići (8), and the least was in extensive orchard in the Kasindo (2).

References

- Aghdam, R., Y. Fathipour (2010). First report of parasitoid wasps, *Ascogaster quadridentata* and *Bassus rufipes* (Hym.: Braconidae) on codling moth (Lep.: Tortricidae) larvae from Iran. *Journal of Entomological Society of Iran* 55, 2010, 30(1), 55-58.
- Almaši, R., Injac, M., Almaši, Š. (2004). Štetni i korisni organizmi jabučastih voćaka, Univerzitet u Novom sadu, Poljoprivredni fakultet.
- Alston, D.G., Murray, M. (2007). Pear *Psylla*. Utah State University Extension, Extension Entomology Ent-62-07: 1-4.
- Balachowsky, A. S. (1966). *Entomologie appliquée a agriculture*, Tome II Lepidoptères: 493-893. Paris.
- Cean, I. Cean, M., Stănică, F. (2012). The harmfulfauna of pear in ecological conditions Oľbucharestin 2012. *Scientific Papers, Series B, Horticulture*, Vol. LVI, 2012.
- Ciglar, I. (1998). Integralna zaštita voćnjaka i vinograda. Zrinski d.d., Čakovec.
- Delić, D., Martini, M., Ermecora, P., Myrta, A., Carraro, L. (2005). Fitoplazmoze jabučastog voća i lisne buve kao njihovi vektori u Bosni i Hercegovini. VII Savetovanje o zaštiti bilja, Zbornik rezimea, Društvo za zaštitu bilja Srbije, Soko Banja, 15-18. novembar, 2005 godina, 101-102.
- Dimić, N. (1964). Prilog poznavanju minera voćaka na području Sarajeva, Poljoprivredni fakultet Univerziteta u Sarajevu.
- Garcia-Chapa, M, Sabate, J., Lavina, A., Batlle, A. (2005). Role of *Cacopsylla pyri* in the epidemiology of pear decline in Spain. *European Journal of Plant Pathology*, 111:9-xx.
- Hering, M. (1957). *Bestimmungstabellen der Blattminen von Europa*. Band II, 848-854. Uitgeverij Dr.W. Junk-s-gravenhage.
- Hodkinson, I. D. & White I. M. (1979). Homoptera, Psylloidea. *Handbooks for the Ident. Brit. Insects*. Vol. II, Part.5 (a): Roy. Ent. Soc. Of London. 101 pp.
- Jerinić-Prodanović, R.D. (2010). Diverzitet lisnih buva (Homoptera: Psylloidea) i njihovih prirodnih neprijatelja u Srbiji sa posebnim osvrtom na vrste značajne u poljoprivredi, Doktorska disertacija, Univerzitet u Beogradu, Poljoprivredni fakultet Beograd-Zemun.
- Lacey, L. A., Vail P.V., Hoffmann, D.F. (2002). Comparative activity of baculoviruses against the codling moth *Cydia pomonella* and three other tortricid pests of tree fruit. *Journal of Invertebrate Pathology* 80 (2002) 64–68.
- Maceljiski, M. (2002). Poljoprivredna entomologija, II dopunjeno izdanje, Zrinski, Čakovec.
- Maier, T.C. (2009). Hosts, Pattern of Seasonal Emergence and Flight, and New Distributional Records of Palearctic *Pasiphila rectangulata* (Lepidoptera: Geometridae) in the Northeastern United States. "Department of Entomology, Connecticut Agricultural Experiment Station, P.O. Box 1106, New Haven.
- Milatović, D. (2009). Dostignuća u oplemenjivanju kruške u svijetu. Zbornik radova II Savetovanja „Inovacije u voćarstvu“, Beograd, 11-12. februar, 2009, 25-37. Univerzitet u Beogradu, Poljoprivredni fakultet, Katedra za voćarstvo.
- Mratinić, E. (2000). Kruška, Veselin Masleša, Beograd.
- Sestras, R., Botez, C., Ardelean, M., Oltean, I., Sestras, A. (2009). Response of Pear genotypes to *Psylla* sp. Attack in Central Transylvania, Romania, 2009. ISHS ACTA Horticulturae 814: XII Eucarpia Syposium on fruit Breeding and Genetics.
- Tamaš, N. (2012). Osjetljivost zelene vaši jabuke (*Aphis pomi* De Geer) i predatora iz familije Cecidomyiidae na insekticide različitih mehanizama delovanja, Doktorska disertacija, Univerzitet u Beogradu, Poljoprivredni fakultet Beograd, 2012. godina.

- Trkulja, V., Duduk, B., Botti, S., Ivanović, M., Stojčić, J., Bertaccini, A. (2004). Pear decline phytoplasma – novi patogen kruške u Bosni i Hercegovini. Zbornik rezimea, V Kongres o zaštiti bilja, Zlatibor, 140-142.
- Tešanović, D., Spasić, R., Makera, A. (2010). Predatori lisnih vaši na jabuci u lokalitetu Kula (Istočno Sarajevo), Međunarodni naučni simpozijum agronoma „Agrosym 2010”, 455-461.
- Vuković, M. (1990). Biologija afidifagne mušice (*Aphidoletes aphidimyza* Rond., Diptera, Cecidomyiidae. Doktorska disertacija, Poljoprivredni fakultet, Novi Sad.

CONTROL OF HIGHLY BLENDED WEEDING AT MAIZE (*ZEA MAYS L.*)

Tonyo TONEV², Miroslav TITYANOV¹, Anyo MITKOV², Mariyan YANEV², Nesho NESHEV^{2*}

¹Summit Agro Company, Bulgaria

²Agricultural University of Plovdiv, Bulgaria

*Corresponding author: n_neshev85@abv.bg

Abstract

The experimental work was carried out during 2013-2015 in the training and experimental base for implementation of the Agricultural University of Plovdiv. In the trail the maize (*Zea mays L.*) hybrid “Florence” (FAO group 480) was used. The plant density was 6500 plants da⁻¹. In the experiment three herbicide tank mixtures during the vegetation were applied. In each of the herbicide combinations, the product Nishin 4 OD (40 g/l nicosulfuron) at dose of 130 ml da⁻¹ was used. Against the broad leaf weeds, the herbicides Flurostar 200 EC (200 g/l fluroxypyr) at dose of 70 ml da⁻¹, Mustang 306.25 SC (florasulam + 2.4 D) at dose of 60 ml da⁻¹ and Kalisto 480 SC (480 g/l meotrione) at dose of 20 ml da⁻¹ were applied. All products were studied together with one and two mechanized intercrop soil tillages. On one third of the treated experimental plots the soil tillages were not applied. The three herbicide mixtures were highly effective against the weeds and selective for maize. They effectively protect the crop free of weeds for more than 60 days. The highest efficacy against weeds and maximum yield was obtained after the combined usage of the herbicides Flurostar 200 EC + Nishin 4 OD. In the conditions of highly blended weeding, the mechanized soil tillage complemented the herbicide efficacy in the weed management very well.

Key Words: *maize, herbicides, soil tillages, weeds*

Introduction

Maize (*Zea mays L.*) is main grain-forage crop with adaptive ability to different geographical and climatic conditions. That is the reason for the successful growing of this culture in many regions around the globe. In Bulgaria it is strategical field crop. Maize has the highest energy value in comparison to the others forage crops (Tomov and Yordanov, 1984). The quality of maize grain is the main factor for the wealthy nutrition of the farm animals (Ivanov, 2007). One of the main negative factors for agricultural production is the weeds. They decrease the yields and the quality of maize grain (Spasov, 1995; Masgood *et al.*, 1999; Tonev, 2000; Werner *et al.*, 2004; Changsaluk *et al.*, 2007). Weeds are annually emerging all over the fields and are causing great damage of the maize production (Tonev *et al.*, 2007). There are a lot of publications that indisputably prove the harmful effects of the weeds in the crops. There is large number of possibilities to control the weeds by mechanical tilth and chemical applications (Fetvadzieva, 1982; Spasov, 1995; Fetvadzieva *et al.*, 1991). Meotrione for example is a member of the benzoylcyclohexane-1,3-dione herbicides, which are chemically derived from a natural phytotoxin of *Callistemon citrinus* (Curtis) plants. Meotrione has been shown to be effective for both pre- and postemergence control of weeds in maize (Sutton *et al.*, 1999; Armel *et al.*, 2003). Nicosulfuron is a postemergence sulfonyleurea herbicide that even in low rates can control many difficult to manage monocotyledonous weeds at maize (Green and Hale, 2005). Integrating the intercrop tillage with contemporary herbicides at maize is a perspective way for obtaining high

efficacy of weed control and decreasing the harmful after-effect of the products for plant protection (Ljubenov, 1988; Tonev, 2006).

The objective of the study is to determine the alone and combine effect of systemic leaf herbicides applied together with three different intercrop tillages and their influence on maize grain yields.

Material and Methods

The experimental work was carried out during the period from 2013 to 2015 in the training and experimental base for implementation of the Agricultural University of Plovdiv. The trail was conducted by the split plot method with 12 variants in 4 replications. The size of the experimental plots was 60 m².

Table 1. Variants of the trail

X ₁ Flurostar 200 EC - 70 ml da ⁻¹ + Nishin 4 OD - 130 ml da ⁻¹	250 g/l fluroxypyr + 40 g/l nicosulfuron
X ₂ Mustang 306.25 SC - 60 ml da ⁻¹ + Nishin 4 OD - 130 ml da ⁻¹	6.25 g/l florasulam + 300 g/l 2.4 D ester + 40 g/l nicosulfuron
X ₃ Kalisto 480 SC - ml da ⁻¹ + Nishin 4 OD - 130 ml da ⁻¹	480 g/l meotrione + 40 g/l nicosulfuron
T ₁ (a)	Without mechanized tillage
T ₂ (b)	With one mechanized tillage
T ₃ (c)	With two mechanized tillages

The herbicide efficacy was compared with the untreated controls. Each of the treated 60 m² plots was divided into three different 20 m² plots. On one of these plots two mechanized tillages were done - first tillage in phenophase 3rd – 4th leaf and second tillage in 7th – 8th leaf of maize. On the second of these plots only one tillage in phenofase 3rd – 4th leaf of the crop was accomplished. On the third plot the weeds were controlled only with the evaluated herbicides and no tillage was performed. The herbicides were sprayed just before the tillage was done. The expense of spray solution was 25 l da⁻¹.

In the trail the maize (*Zea mays L.*) hybrid “Florence” (FAO group 480) was used. Plants were grown under irrigated conditions and the plant density was 6500 plants da⁻¹. Herbicides were applied with back sack sprayer for plot trails (brand “Solo”).

The tillage during the vegetation was done with cultivator for intercrop dredging. The second tillage was combined with earthing up of the maize.

Predecessor of maize in the crop rotation was winter wheat. After the wheat harvest deep plowing at 30-32 cm depth was done. Before this tillage fertilization with 16 kg P₂O₅ and 12 kg K₂O da⁻¹ was applied (the fertilizer rates are in active substance). Before maize sowing, fertilization with nitrogen at rate of 22 kg da⁻¹ was applied.

The herbicide efficacy was reported on the 14th, 28th and 56th day after treatment. The weed species were observed by the visual scale of EWRS (European Weed Research Society), and the degree of weeding was evaluated by the quantitative method (number of weeds per 1 m²).

The maize grain yield was recorded on the base of experimental plot for the four replications. The standard grain humidity was 14 %. For disperse statistical analyses of the collected data, the software package of Biostat 5.1 was used (Penchev, 1998).

Results and Discussion

According to Tonev *et al.* (2008) maize is highly sensitive to weeding especially in the early development stages. That is observed especially in the cases when the germination is delayed because of unfavorable conditions. It is proved by a lot of experimental work that at high weed infestation the maize grain yield could be decreased from 77 to 91 % (Tonev *et al.*, 2008). For the current study natural background of weeding of the maize field of the experimental base of the Agricultural University of Plovdiv was used. The weed associations that prevailed on the field during the experimental period were 12 annual species: Common amaranth (*Amaranthus retroflexus L.*), Thorn apple (*Datura stramonium L.*), Rough cocklebur (*Xanthium strumarium L.*), Black nightshade (*Solanum nigrum L.*), Fat-hen (*Chenopodium album L.*), Velvetleaf (*Abutilon theophrasti L.*), Purslane (*Portulaca oleraceae L.*), Wild raddish (*Raphanus raphanistrum L.*), Charlock (*Sinapis arvensis L.*), Barnyard grass (*Echinochloa crus gali L.*), Yellow bristle-grass (*Setaria glauca L.*) and Red finger-grass (*Digitaria sanguinalis L.*). From the perennial weed species, with highest density were Johnson grass (*Sorghum halepense L.*), followed by Field bindweed (*Convolvulus arvensis L.*), Bermuda gras (*Cinodon dactylon L.*) and Creeping thistle (*Cirsium arvense L.*). The examined herbicide mixtures were with closer spectrum of action. The studied herbicide combinations controlled mostly the annual broad leaf and grass weeds, as well as the Johnson grass (*Sorghum halepense L.*) developed from seeds and rhizomes and also the root-sprouted species. As leaf herbicides, their efficacy against the weeds was not highly influenced by the soil moisture at the time of the treatment, as well as the net precipitation and its distribution. On table 2 is shown the efficacy against weeds after the alone and combined effect of herbicide application and intercrop tillage at maize 56 days after treatments.

Table 2. Efficacy against weeds after the alone and combined effect of herbicides application and intercrop tillage average for the period of the study (2013-2015)

V a r.	Herbicide / tillage	Average weed number per 1 m ² – 56 days after treatment				Total weed number
		Monocoty ledonous	Di- cotyledonous	Annual	Perennial	
X ₁ Flurostar 200 EC - 70 ml da ⁻¹ + Nishin 4 OD - 130 ml da ⁻¹						
1.	Without mechanized tillage	5.6	5.2	10.8	11.8	22.6
2.	With one mechanized tillage	3.4	2.6	6.0	8.8	14.8
3.	With two mechanized tillage	1.4	1.4	2.8	5.6	8.4
X ₂ Mustang 306.25 SC - 60 ml da ⁻¹ + Nishin 4 OD - 130 ml da ⁻¹						
4.	Without mechanized tillage	4.8	5.0	9.8	16.2	26.0
5.	With one mechanized tillage	1.8	3.2	5.0	10.6	15.6
6.	With two mechanized tillage	1.0	1.8	2.8	6.4	9.2
X ₃ Kalisto 480 SC - 20 ml da ⁻¹ + Nishin 4 OD - 130 ml da ⁻¹						
7.	Without mechanized tillage	3.8	7.6	11.4	18.6	30.0
8.	With one mechanized tillage	2.0	4.4	6.4	13.2	19.6
9.	With two mechanized tillage	1.4	3.2	4.6	8.6	13.2
Without herbicide application						
10.	Without mechanized tillage	42.6	65.6	108.2	25.6	133.8
11.	With one mechanized tillage	19.4	38.8	58.2	19.4	77.6
12.	With two mechanized tillage	11.6	21.8	33.4	8.8	42.2

The highest total weed number on the 14th day after the treatments was 141.2 specimens per 1 m² at the untreated control (without herbicide application and without tillage). On the same date, after the application of the studied herbicides, at the variants without applied tillage, the total weed number was as follows: At variant X₁ (Flurostar 200 EC - 70 ml da⁻¹ + Nishin 4 OD - 130 ml da⁻¹) – 29.5, at variant X₂ (Mustang 306.25 SC - 60 ml da⁻¹ + Nishin 4 OD - 130 ml da⁻¹) – 32.8 and at variant X₃ (Kalisto 480 SC - 20 ml da⁻¹ + Nishin 4 OD - 130 ml da⁻¹) – 37.0 specimens per 1 m². At the second report of the herbicides efficacy (on 28th day after treatments) the total number of unaffected weeds was again for the untreated control - 138.4 specimens per 1 m². The number of unaffected weeds at the treated plots was as follows: At variant X₁ – 25.4, at variant X₂ – 29.6 and at variant X₃ – 33.2 specimens per 1 m².

The highest total weed number on the 56th day after treatments was for the untreated control – 133.8 per 1 m² (Table 2). After the usage of the herbicides without application of tillage there were a number of weeds that remained in the field. The number of the existing specimens after the treatments were: At variant X₁ – 22.6 specimens per 1 m², at variant X₂ – 26.0 specimens per 1 m² and at variant X₃ – 30.0 specimens per 1 m². The main part of not influenced or recovered weeds after the treatments were mostly from the perennial species.

Variants		Yields			Average
		2013	2014	2015	
X ₁ Flurostar 200 EC - 70 ml da ⁻¹ + Nishin 4 OD - 130 ml da ⁻¹					
1.	1 a	900	802	728	912
2.	1 b	944	888	904	988
3.	1 c	1000	922	1042	1036
X ₂ Mustang 306.25 SC - 60 ml da ⁻¹ + Nishin 4 OD - 130 ml da ⁻¹					
4.	2 a	880	894	962	810
5.	2 b	1002	932	1030	912
6.	2 c	1034	962	1112	988
X ₃ Kalisto 480 SC - 20 ml da ⁻¹ + Nishin 4 OD - 130 ml da ⁻¹					
7.	3 a	800	776	788	788
8.	3 b	956	846	766	856
9.	3 c	1002	922	908	944
Without herbicide application					
10.	4 a	296	274	234	268
11.	4 b	486	456	390	444
12.	4 c	730	636	512	626
GD 5% =		22.26	24.58	28.64	
GD 1% =		30.44	36.48	36.40	
GD 0,1% =		44.42	40.22	44.68	

The highest efficacy of the examined herbicide tank mixtures was recorded at the combination of Flurostar 200 EC - 70 ml da⁻¹ + Nishin 4 OD - 130 ml da⁻¹ (Table 2). The supremacy of the herbicide compilation with Mustang 306.25 S + Nishin 4 OD - 130 ml da⁻¹ was observed at the high density of the weed Fat-hen (*Chenopodium album L.*) in 2014. The superiority of Flurostar 200 EC was strongly revealed at the fields infested with Field bindweed (*Convolvulus arvensis L.*). That could be explained with the fact that the active substance of this herbicide (fluroxypyr) have very high efficacy against this weed.

By the one or especially two intercrop tillages more than the half of the unaffected from the herbicides weed plants, were temporarily cut. That was inhibiting their growth and development. At the conditions of highly blended weeding with different species, the intercrop tillage successfully supplemented the herbicide effect of the used products. The tillage complemented maize to use fully the resources like water, light, soil nutrients and air. The tillages contributed for the statistically proved increase of the maize grain yields when compared with any of the variants with applied herbicides without any performed tillage.

Table 3. Maize grain yields (kg da⁻¹)

Variants		Yields			Average
		2013	2014	2015	
X ₁ Flurostar 200 EC - 70 ml da ⁻¹ + Nishin 4 OD - 130 ml da ⁻¹					
1.	1 a	900	802	728	912
2.	1 b	944	888	904	988
3.	1 c	1000	922	1042	1036
X ₂ Mustang 306.25 SC - 60 ml da ⁻¹ + Nishin 4 OD - 130 ml da ⁻¹					
4.	2 a	880	894	962	810
5.	2 b	1002	932	1030	912
6.	2 c	1034	962	1112	988
X ₃ Kalisto 480 SC - 20 ml da ⁻¹ + Nishin 4 OD - 130 ml da ⁻¹					
7.	3 a	800	776	788	788
8.	3 b	956	846	766	856
9.	3 c	1002	922	908	944
Without herbicide application					
10.	4 a	296	274	234	268
11.	4 b	486	456	390	444
12.	4 c	730	636	512	626
	GD 5% =	22.26	24.58	28.64	
	GD 1% =	30.44	36.48	36.40	
	GD 0,1% =	44.42	40.22	44.68	

Pandey (1989) conduct field trials in Bihar and recorded that the earthing up at the 25th or 25th and 45th days after sowing as well as the application of metribuzin at dose of 0.5 kg ha⁻¹ and pendimethalin at 1.0 kg ha⁻¹ (at pre-emergence), and spraying with 2.4-D at 0.8 kg ha⁻¹ after emergence led to increasing of maize yield and suppressed the Wild hemp (*Canabis sativa* L.) growth. The best results in the study were recorded after usage of metribuzin and pendimethalin + two times earthing up. The highest yield average for the period in our study was achieved after the combined application of Flurostar 200 EC - 70 ml da⁻¹ + Nishin 4 OD - 130 ml/da + two intercrop tillages – 1036 kg da⁻¹ (Table 3). At the variants treated with herbicides plus one intercrop tillage the maize grain yield was increased from 68 to 102 kg da⁻¹. The two intercrop tillages together with herbicide spraying contributed for even higher yield increase – from 124 to 178 kg da⁻¹.

The selectivity of the studied herbicides to maize on the 10th and on the 20th day after the treatment was reported. There were not visually observed symptoms of fitotoxicity on the crop in any of the three years of the trail.

Conclusions

The three examined tank mixtures of the products Nishin 4 OD with Flurostar 200 EC, Mustang 306.25 SC and Kalisto 480 SC were herbicide combinations with strong effect against the broadleaf and grass weeds. The products had also continuous influence on weeds that was observed on the 56th day after treatments.

The studied herbicide mixtures were highly selective for the maize crop.

The highest herbicide efficacy and the highest maize grain yields were obtained after the use of Flurostar 200 EC + Nishin 4 OD. The active substance of the product Flurostar 200 EC (fluroxypyr) had excellent control of the broadleaf weed - Field bindweed (*Convolvulus arvensis L.*).

At the conditions of highly blended weeding with different species the intercrop tillage successfully supplemented the herbicide effect of the used products that lead to increasing of the maize grain yields.

References

- Armel G.R., Wilson H.P., Richardson R.J., Hines T.E. (2003). Mesotrione, acetochlor, and atrazine for weed management in corn (*Zea mays*). *Weed Technol.* 17 (2): 284–290
- Changsaluk S., Pornprom T., Waramitr N., Suwanmakkha R., Pathom N., Lim-aroon S., (2007). Effect of weed densities of fresh corn yield. In proceedings of the 45th Kasetsart University, Annual Conference, Bangkok, Thailand, 30 January – 2 February, on CD
- Fetvadzieva N. (1982). Agrotechnique weed control. *Journal of Plant protection.*
- Green J., Hale T. (2005). Increasing and decreasing pH to enhance the biological activity of nicosulfuron. *Weed Technology*, Volume 19 (2), 468–475.
- Fetvadzieva N., Zhelev A, Dechkov Z., Pavlov P., Dimov A., Spasov V., Topalov V., Kondarev R. (1991). *Herbology*. Publisher “Zemizdat” Sofia. (In Bulgarian)
- Ljubenov Ya. (1988). *Integrated weed control – 1st and 2nd Volume*. Publisher “Zemizdat” Sofia. (In Bulgaraen).
- Maqsood M., Akbar M., Yousaf N., Mahmood M., Ahmed S. (1999). Studies on weed–crop competition in maize. *International Journal of Agriculture & Biology*, 4, 270–272.
- Pandey J. (1989). Effect of Cannabis sativa infestation on yield of rabi maize. *Indian Journal of Agronomy* 34 (1), 109-110.
- Penchev E. (1998). Software product for dispersion analyses. PhD dissertation. (In Bulgarian)
- Spasov V. (1995). Habilitation for the academic title „Professor”. (In Bulgarian)
- Sutton P., Foxon G., Beraud J-M., Anderdon J., Wichert R. 1999. Integrated weed management systems for maize using mesotrione, nicosulfuron and acetochlor. The BCPC Conference – Weeds 1: 225–230.
- Tomov N., Yordanov Yo. (1984). *The maize in Bulgaria (Book)*. Publisher: “Zemizdat”, Sofia. 315 pages. (In Bulgarian).
- Tonev T. (2000). *Integrated weed control and proficiency of agriculture*. VSI Plovdiv. (In Bulgarian)
- Tonev T. (2006). New excellent alternatives for weed control at maize. *Plant protection Journal*. Volume 4.

- Tonev T., M. Dimitrova M., Zhalnov I., Kalinova Sht., Spasov V. (2007). Herbology (Textbook). Academic publisher of Agricultural University of Plovdiv. (In Bulgarian).
- Tonev T., Krasteva H., Bakardzieva N., Malinova S., Zarkov B., Tsankova G., Dekov O., Iliev I., Chavdarov L., Grigorova P. (2008). Guide for integrated control of the pests at the cereal crops. Ministry of Agriculture and Foods. Publisher: "D. Blagoev", Sofia. 191 pages (In Bulgarian).
- Ivanov s., 2007. Grain yield, protein and oil content of experimental high oil maize hybrids Plant Genetic Stocks – The Basis of Agriculture of Today. Volume 2 and 3, 191-193.
- Werner E., Curran W., Harper J., Roth G., Knievel D., (2004). Velvetleaf (*Abutilon theophrasti*) interference and seed production in corn silage and grain. *Weed Technology*, 18 (3): 779-783.

EVALUATION OF WATER CONTAMINATION USING PHYTOINDICATORS

Antonije ŽUNIĆ¹, Slavica VUKOVIĆ¹, Sanja LAZIĆ¹, Maria Fátima ALPENDURADA²,
Dragana ŠUNJKA¹

¹University of Novi Sad, Faculty of Agriculture, Novi Sad, Serbia

²Water Institute of the Northern Region, Porto, Portugal

*Corresponding author: zunictoni@gmail.com

Abstract

Agriculture is a significant user of water resources through irrigation but it also has considerable effect to the quality of water, especially in view of the effects caused by pesticides and fertilizers that end up dissolved in rivers and ground waters. In addition to agricultural production, major pollutants of aquatic ecosystems are: industry, municipal wastewater, waterway traffic, accidents, etc. The analyzed water was taken from two locations of the River Lesa in Portugal. By using biological assay in the laboratory, quality and impact of water were tested regarding the following test plants: barley (*Hordeum vulgare*) and radish (*Raphanus sativus*). Physiological and morphological parameters of the test plants were used for evaluation of water quality by the filter-paper method ISTA (2013) and according to the Regulations on the seed quality for agricultural plants in Serbia. Results for physiological parameters are expressed in percentages. The values of morphological parameters are shown as average values and are processed using the ANOVA and Duncan's multiple comparison tests, with confidence interval of 95%. Physico-chemical analysis of water indicates that nitrates, nitrites and ammonium were detected in values exceeding maximum allowable concentration, according to Portuguese regulations of water quality. Also, in the analyzed water samples cadmium (Cd) and iron (Fe) were found in quantities that exceed the MAC values, as well as some pesticidal substances (MCPA, fonofos). In the tested samples, long list of pharmaceuticals were detected. The obtained results indicate differences in tolerance of test plants towards water quality. The expressed variability of parameters reveal their potential as possible bioindicators.

Key words: *Lesá, water pollutants, phytoindicators, barley, radish.*

Introduction

Agriculture is one of the main sources of diffuse water pollution. Problems occur due to improper use of chemical agents in agricultural production, which is unprofessionally used by farmers. The use of chemical resources is necessary on a large scale production but it is crucial to use them at the right time and in an appropriate concentration. In addition to agriculture the major polluters are: industry, municipal wastewater, waterway traffic, accidents, etc. To prevent and reduce environmental pollution, it is essential to carry out the continuous monitoring of water quality. Quality assessment and detection of pollution of waterways, involves the use of various methods (physical, chemical, biological) in order to include the characterization of pollution, but also the effects on wildlife. For the quality assessment of the environment and detection of contamination, biological methods are increasingly being used. Methods that involve the use of cultivated plants as test organisms are extremely important for assessing the contamination of water used in agricultural production, because its results reflect the benefits of the area for cultivation of plants and the use of water for irrigation.

Material and Methods

In 2014, water sampling was conducted by experts from "Northern Region Water Institute"-IAREN (Instituto da Água da Região do Norte) from Portugal. Water was sampled from two sites along the River Lesa in Portugal.

The sampling sites and coordinates:

- Lesa I - Rio Leça (Ponte do Carro) (N 41°12'52.2"; W 8°40'05.35),
- Lesa II - Rio Leça (Ponte Teófilo) (N 41°12'27.6"; W 8°40'14.10).

Physico-chemical analysis of water was also conducted in Portugal and includes the following parameters: general parameters of water quality, organic compounds, heavy metals, pesticides, pharmaceuticals. For chemical analysis, the following techniques were used: Atomic Adsorption Spectrometry-Flame Technique (EPA Method 7000B), Liquid Chromatography-Tandem Mass Spectrometry (LC-MS-MS), Gas Chromatography Mass Spectrometry (GC-MS) and Inductively Coupled plasma Mass spectrometry (ICP-MS).

For the extraction that preceded detection of the presence of pollutants Solid Phase Extraction (SPE) and Accelerated Solvent Extraction (ASE) were used. The maximum allowable quantities (MAC) used in this experiment are stipulated by Portuguese regulations Decreto-Lei nº 103/2010, D.-Lei nº 236/1998 and the EU Directive 2008/105/EC.

Test plants were barley (*Hordeum vulgare*) and radish (*Raphanus sativus*). Water quality was evaluated using physiological (germination energy and germination %/%) and morphological parameters (length of roots and shoots of seedlings /cm/, fresh and dry weight of roots and shoots of seedlings /g/) of the test plants.

A filter-paper method by ISTA (International rules for seed testing) for 2013 and the Regulations of the seeds quality for agricultural plants („Sl. List SFRJ“, no. 47/87, 60/87, 55/88 and 81/89 and „Sl. List SRJ“, no. 16/92, 8/93, 21/93, 30/94, 43/96, 10/98, 15/2001 and 58/2002, „Sl. List RS“, no. 23/2009, 64/2010, 72/2010 and 34/2013) was used.

Results for physiological parameters are expressed in percentages. The values of morphological parameters are shown as average values and are processed using the Analysis of Variance and Duncan's multiple comparison test, in the statistical software R ver. 3.2.2.

Results and Discussion

According to the results of the physico-chemical analysis (Tab. 1.), in water sample Lesa I a high concentration of ammonia nitrogen (exceeding MAC for 126x) and nitrite (3x) was established, while the other test parameters were in allowable limits. In water sample Lesa II was found that nitrate values exceed the MAC for 2.5x and ammonia nitrogen (184x), so this water sample is also polluted and does not meet the required quality for irrigation.

Water containing a high concentration of nitrogen and nitrogen compounds can adversely affect the yield and quality of barley, sugar beet and some vegetable crops, causing excessive growth of vegetative organs (Bauder et al., 2014). The results indicate that the length and fresh weight of root and shoot of barley was significantly stimulated by water from the sample Lesa I and Lesa II (found to have a high concentration of nitrate, nitrite and ammonia nitrogen) which is consistent with the allegations of Bauder et al. (2014).

Table.1. Physico-chemical analysis of the general parameters in analyzed water samples

Location	Detected values of general parameters							
	pH	EC (mS/cm) at 20°C	t°C	NO ₃ ⁻ mgN/l	NO ₂ ⁻ mgN/l	NH ₃ mgN/l	P mgP/l	B mgB/l
Lesa I	7.5	463	21.4	0.6	3.0	6.3	<0.1	<0.1
Lesa II	7.3	423	22.3	25.0	0.7	9.2	0.9	<0.1
MAC	5-9	≤1000	30.0	10.0	1.0	0.05	1.0	1.0

The results from analysis of heavy metals and other elements from the list of priority pollutants indicate an extremely high amount of cadmium (Cd), three times higher than the MAC and also the increased amount of molybdenum (Mo) and magnesium (Mg) in the water sample Lesa I. Iron (Fe) is found in high quantities in a water sample Lesa II (2.5x more than the MAC). In the sample Lesa II a higher concentration of manganese (Mn) was also detected, but values were below the MAC (Tab. 2).

Heavy metals are very harmful because of their non-biodegradable nature, long biological half-lives and their potential to accumulate in different body parts. Most of the heavy metals are extremely toxic due to their solubility in water (Arora et. al., 2008).

Cadmium is toxic to many plant species. High concentrations of cadmium cause the inhibition of plant growth, development and to the occurrence of deformities. The shoots are shortened, the root is reduced and becomes brown, stiff (Rascio & Navarre-Izzo, 2011).

Iron is one of 16 essential elements for plant growth and reproduction. Although required by plants in small amounts, Fe is involved in many important compounds and physiological processes in plants. Toxicity of iron has not been reported under most aerobic plant production systems (Hochmuth, 2011).

Table. 2. The content of heavy metals and elements from the list of priority pollutants in water samples

Location	Detected values of heavy metals and other elements									
	Cd (µg/l)	Se (µg/l)	As (µg/l)	Mo (µg/l)	Cr (µg/l)	Pb (µg/l)	Mn (µg/l)	Fe (µg/l)	Zn (µg/l)	Mg (mg/l)
Lesa I	16	<2.5	<1.0	33	<0.5	<0.2	<1.0	<0.1	<10.0	75
Lesa II	<0.5	<2.5	<1.0	<0.01	5	<0.2	72	250	24	9,6
MAC	5	10	10	50	50	50	100	100	500	50

Chemical analysis of pesticide content in the tested waters showed the presence of pesticide substances MCPA and fonofos. The highest concentration of these substances was found in water sample Lesa I. In the sample Lesa II listed pesticides were below the limit of detection (Tab. 3.).

Fonofos represents a highly toxic organophosphate insecticide. In plant tissues it is rapidly metabolized to non-toxic compounds. It is extremely dangerous and toxic to bees, birds, fish and other aquatic organisms (Wagner, 1983).MCPA is a selective herbicide for control of broadleaf weeds. Applied in small quantities, it stimulate growth like natural hormones. Moderate amounts stimulate cell division and elongation, while large amounts inhibit grow (Konstantinović, 2008). The research results are consistent with this these, as the test plants (barley and radish) had a growth stimulation in the treatment with water from sample Lesa I, where it is detected an increased amount of MCPA.

Table 3. The content of pesticides and organic compounds in water samples

Location	Parameters ($\mu\text{g/l}$)						
	Endosulfan	MCPA	Alachlor	Simazin	Fonofos	Aldrin	Benzene
Lesa I	<0.009	5.9	<0.01	<0.05	670.0	<0.01	<0.28
Lesa II	<0.009	<0.05	<0.01	<0.05	<0.01	<0.01	<0.28
MAC	0.01	0.5	0.7	4.0	10.0	30.0	50.0

Chemical analysis of the content of pharmaceuticals in tested water samples showed that the drugs such as paracetamol, naproxen, ibuprofen, hydrochlorothiazide, azithromycin, diclofenac, furosemide and ciprofloxacin were over the limit of detection (Tab. 4). Water sample Lesa II contained the highest concentrations of these drugs, so it can be considered more polluted compared to Lesa I.

The main sources of pollution of surface and ground-waters with these compounds are urban and agricultural waste waters or households, hospitals and agricultural lands (Robinson et al., 2007). Also, the significant source of drugs for the environment are wastewaters from the pharmaceutical industry and the farms, on which they are used extensively for livestock and poultry treatments (Grujić, 2009). On the most farms antibiotics are used as prevention or for infection treatments, as well as a food additive that favors the growth of animals (Hirsch et al. 1999). By using manure, antibiotics can still be transferred to agricultural land and then, due to leaching, reach groundwaters (Heberer, 2002).

Table 4. The content of detected pharmaceuticals in water samples

Location	Parameters (ng/l)							
	Paracetamol	Naproxen	Ibuprofen	Hydrochloro-thiazide	Azithro-mycin	Furo-semide	Cipro-floxacin	Diclofenak
Lesa I	<0.02	<0.04	<0.17	<0.03	<0.01	<0.17	<0.03	<0.01
Lesa II	550.0	100.0	400.0	180.0	150.0	150.0	150.0	100.0

Bioassay results - test plant barley

Germination energy and germination. Barley seeds were not influenced by the quality of the water and all values are on the same level of significance with each other and with the control ($F=0.46$ ns, $p>0.05$; $F=0.46$ ns, $p>0.05$).

Length of root. Root was significantly stimulated by Lesa I and Lesa II water samples (by 28% and 34%, respectively, compared to control). Differences between the treatments are statistically significant ($F=20.23^*$, $p<0.05$).

Fresh weight of root. The highest average value of fresh weight was recorded in the sample Lesa II (94% higher, compared to the control) and in water from sample Lesa I it was higher for 40%. Differences between the treatments are statistically significant ($F=63.38^*$, $p<0.05$).

Dry weight of root. Dry weight was stimulated by the samples Lesa I and Lesa II (by 31% and 21%, respectively, compared to control). Differences between treatments are statistically significant ($F=11.17^*$, $p<0.05$).

Length of shoot. Shoot was significantly stimulated by Lesa I and Lesa II samples (by 37% and 35%, respectively, compared to control). Differences between the treatments are statistically significant ($F=8.56^*$, $p<0.05$).

Fresh weight of shoot. Fresh weight was stimulated by the samples Lesa I and Lesa II (by 21% and 23%, respectively, compared to control). Differences between the treatments are statistically significant ($F=14.09^*$, $p < 0.05$).

Dry weight of shoot. This parameter has not been affected by water quality and all values are on the same level of significance. ($F=2.73$ ns, $p > 0.05$).

Bioassay results - test plant radish

Germination energy and germination. Radish seeds were not influenced by the quality of water and all values are on the same level of significance with each other and with the control ($F=2.55$ ns, $p > 0.05$; $F=1.90$ ns, $p > 0.05$).

Length of Root. Root has not been influenced by the water and all values are on the same level of significance with each other and with the control ($F=1.55$ ns, $p > 0.05$).

Fresh weight of root. Fresh weight has not been influenced by water and all values are on the same level of significance with each other and with the control ($F=0.05$ ns, $p > 0.05$).

Dry weight of root. Dry weight was not under the influence of water and all values are on the same level of significance with each other and with the control. ($F=1.03$ ns, $p > 0.05$).

Length of shoot. Length of shoot was significantly stimulated by water from Lesa I (by 21%) as compared to control, and from Lesa II by 25%. Differences between the treatments are statistically significant ($F=11.78^*$, $p < 0.05$).

Fresh weight of shoot. Fresh weight was stimulated by the samples Lesa I and Lesa II (by 14% and 18%, respectively, compared to control). Differences between the treatments are statistically significant ($F=4.57^*$, $p < 0.05$).

Dry weight of shoot. Dry weight was not under the influence of water and all values are on the same level of significance with each other and with the control. ($F=0.72$ ns, $p > 0.05$).

The achieved results indicate that physiological parameters of barley and radish are not good indicators of water quality, and therefore, some morphological parameters may be considered more reliable (Tab. 5.,6.,7.).

Table. 5. Water quality influence on physiological parameters

Parameters	Water sample	Barley	Radish
Germination energy (%)	Lesa I	94.25 ±1.89 a	97.75 ±0.50 a
	Lesa II	94.50 ±1.00 a	97.25 ±1.26 a
	Control	96.00 ±4.32 a	98.75 ±0.96 a
	F value	0.46 ns	2.55 ns
Germination (%)	Lesa I	95.50 ±1.29 a	98.25 ±0.96 a
	Lesa II	95.50 ±1.73 a	97.75 ±0.96 a
	Control	96.75 ±2.99 a	99.00 ±0.82 a
	F value	0.46 ns	1.90 ns

Table. 6. Impact of water quality on morphological parameters - Root

Parameters	Water sample	Barley	%	Radish	%
		Values		Values	
Length of root (cm)	Lesa I	12.37 ±0.39 a	128	4.80 ±0.59 a	89
	Lesa II	13.00 ±0.50 a	134	4.95 ±0.69 a	91
	Control	9.70 ±1.19 b	100	5.45 ±0.37 a	100
	F value	20.23*		1.55 ns	
Fresh weight of root (g)	Lesa I	1.42 ±0.11 a	140	0.15 ±0.02 a	95
	Lesa II	1.58 ±0.10 a	194	0.14 ±0.05 a	92
	Control	0.81 ±0.10 b	100	0.16 ±0.07 a	101
	F value	63.38 *		0.05 ns	
Dry weight of root (g)	Lesa I	0.16 ±0.011 a	131	0.016 ±0.002 a	52
	Lesa II	0.15 ±0.008 a	125	0.015 ±0.001 a	48
	Control	0.12 ±0.015 b	100	0.031 ±0.003 a	100
	F value	11.17 *		1.03ns	

Table. 7. Impact of water quality on morphological parameters – Shoot

Parameters	Water sample	Barley	%	Radish	%
		Values		Values	
Length of shoot (cm)	Lesa I	11.70 ±0.56 a	137	6.50 ±0.35 a	121
	Lesa II	11.50 ±1.22 a	135	6.72 ±0.40 a	125
	Control	8.55 ±1.60 b	100	5.38 ±0.47 b	100
	F value	8.56 *		11.78 *	
Fresh weight of shoot (g)	Lesa I	2.79 ±0.05 a	121	1.98 ±0.19 a	114
	Lesa II	2.84 ±0.06 a	123	2.05 ±0.14 a	118
	Control	2.31 ±0.26 b	100	1.73 ±0.14 b	100
	F value	14.09 *		4.57 *	
Dry weight of shoot (g)	Lesa I	0.23 ±0.011 a	116	0.09 ±0.003 a	113
	Lesa II	0.22 ±0.021 a	111	0.09 ±0.006 a	113
	Control	0.20 ±0.025 a	100	0.08 ±0.041 a	100
	F value	2.73 ns		0.65 ns	

Conclusions

Based on the conducted tests and the results achieved on the impact of water quality (Lesa I, Lesa II) on the test plants (barley, radish) the following can be concluded:

- In water sample from Lesa river site I, detected pollutants, in the quantities exceeding MAC according to the Regulations, are: nitrites, ammonia, cadmium, fonofos and MCPA, and none of the tested pharmaceuticals. Based on the biological test of water quality on phyto-indicators, plants reacted in a significant stimulation of the length, fresh/dry weight of root (barley) and length and fresh weight of shoot (barley, radish), which can be attributed to the presence of ammonia, nitrites and MCPA;

- In a sample of water from the site Lesa II in quantities exceeding MAC, nitrates, ammonia and iron were registered. The pharmaceuticals such as: paracetamol, naproxen, ibuprofen, hydrochlorothiazide, azithromycin, diclofenac, furosemide and ciprofloxacin, were also detected. Water significantly stimulated length, fresh/dry weight of root (barley) and length and fresh weight of shoot (barley, radish). These effects can be attributed to the presence of ammonia, nitrates and iron in a greater amount in this water sample;

Bioassay test results indicate the different susceptibility of tested plant species and parameters as well as their validity in assessing water contamination. Different plant species and parameters responded in dissimilar manner to the quality of the sampled water. An expressed variability of parameters indicates their potential as possible bioindicators.

Acknowledgement

This study was part of the project III43005, funded by the Ministry of Education, Science and Technological Development of the Republic of Serbia.

References

- Arora, M., Kiran, B., Rani, S., Rani, A., Kaur, B., Mittal, N. (2008): Heavy metal accumulation in vegetables irrigated with water from different sources. *Food Chemistry Journal*, 111, 811–815.
- Bauder, T.A., Waskom, R.M., Sutherland, P.L and Davis, J.G. (2014): *Irrigation Water Quality Criteria*. Colorado State University, 1-5.
- Grujić, S. (2009): Determination of traces of drugs in water by method of liquid chromatography with tandem mass spectrometry. Faculty of Technology, Belgrade, 4-10.
- Heberer T. (2002): Occurrence, fate, and removal of pharmaceutical residues in the aquatic environment: a review of recent research data, *Toxicol. Lett.*, 131, 5–17.
- Hirsch R., Ternes T., Haberer K. and Kratz K-L. (1999): Occurrence of antibiotics in the aquatic environment, *Sci. Total Environ.*, 225, 109–118.
- Hochmuth, G. (2011): *Iron Nutrition of Plants*. University of Florida, IFAS Extension, 1-7.
- Konstantinović, B. (2008): *Weeds and their control*. Faculty of Agriculture, Novi Sad, 220-226.
- Rascio N. & Navari-Izzo F. (2011): Heavy metal hyperaccumulating plants: How and why do they do it? *Plant Science* 180, 169–181.
- Robinson I., Junqua G., Van Coillie R. and Thomas O. (2007): Trends in the detection of pharmaceutical products, and their impact and mitigation in water and wastewater in North America, *Anal. Bioanal. Chem.*, 387, 1143–1151.
- Wagner, S.L. (1983): *Clinical Toxicology of Agricultural Chemicals*. Noyes Data Corp. 1983., 205-246.

DIAPORTHE ERES AS A PATHOGEN OF QUINCE FRUIT (*CIDONIA OBLONGA*) IN SERBIA

Danijela RISTIĆ^{1*}, Miloš STEVANOVIĆ¹, Stefan STOŠIĆ², Ivan VUČUROVIĆ¹, Katarina GAŠIĆ¹, Veljko GAVRILOVIĆ¹, Svetlana ŽIVKOVIĆ¹

¹Institute for Plant Protection and Environment, Belgrade, Serbia

²Scholar of Ministry of Education, Science and Technological Development, Serbia

*Corresponding author: risticdaca@yahoo.com

Abstract

Species in the genus *Diaporthe* and their *Phomopsis* asexual states are responsible for diseases on a wide range of plant hosts, some of which are economically important worldwide, causing root and fruits rots, stem cankers and leaf spots. In December 2015, quince fruit (cv. Asenica) with symptoms of brown rot were collected from storage in the area of Šabac. The isolates formed white mycelium, with dark pigmentation developing in the centre of the colony grown on a potato dextrose agar (PDA). Alpha conidia were abundant, aseptate, hyaline, ovate to ellipsoidal. Based on the morphological characteristics of the colony, shape of conidia and conidiomata as well as sequences of internal transcribed spacer regions (ITS), the fungus was identified as *Diaporthe eres*. Total DNAs were extracted directly from the fungal mycelium with a DNeasy Plant Mini Kit (Qiagen, Hilden, Germany) and PCR amplification was performed with primers ITS1/ITS4. The sequence analysis of ITS region revealed that representative isolate 7-16 (GenBank Accession No. KX274026) shared 100% identity (100% query coverage) with sequences of 13 *D. eres* isolates deposited in the GenBank. A pathogenicity test was conducted and Koch's postulates were fulfilled by re-isolation of the fungus from the diseased tissues. To our knowledge, this is the first report of *D. eres* causing fruit rot on quince in Serbia.

Keywords: *Quince, Diaporthe eres, ITS region*

Introduction

The genus *Diaporthe* Nitschke (syn. *Phomopsis* (Sacc.) Bubák) represents a cosmopolitan group of fungi occupying diverse ecological niches as saprobes, endophytes and plant pathogens (Rossman et al. 2007; Udayanga et al. 2011). *Diaporthe* species are responsible for some important crop diseases worldwide including root and fruit rots, dieback, cankers, leaf spots, blights, decay and wilt (Mostert et al. 2001; Santos et al. 2011; Thompson et al. 2011).

Diaporthe eres has been regarded as a minor pathogen causing leaf spots, stem cankers and diseases of woody plants in diverse families including the *Ericaceae*, *Juglandaceae*, *Rosaceae*, *Sapindaceae*, *Ulmaceae*, *Vitaceae* and others, mostly in temperate regions worldwide (Vrandečić et al. 2010; Anagnostakis 2007; Thomidis and Michailides 2009; Baumgartner et al. 2013). In addition, it is considered a pathogen with plant health inspection and quarantine significance (Cline and Farr, 2006). Post-harvest losses in fruits can be attributed to several factors, the most important of which is post-harvest disease. *Diaporthe* species has also been reported to be associated with post-harvest rots of fruit. However, post-harvest diseases cause severe losses during storage, transportation, marketing, and in retail stores during shelf-life (Luongo et al. 2011).

Consequently, the objectives of this study were to identify *D. eres* of quince fruits for the first time in Serbia based on morphological and molecular characteristics.

Materials and methods

Sampling and morphology

In December 2015, quince fruits (cv. Asenica) produced on a farm located at Šabac area showing post-harvest symptoms of brown rot were investigated with the aim of identifying the disease agent.

Representative fruit rot samples were brought to the laboratory for isolation of the associated fungal pathogens (Dhingra and Sinclair, 1985). Samples were cut into small pieces (3-5 mm) and surface sterilized with 1% sodium hypochlorite solution for 2-3 min followed by two washes with sterile distilled water. Samples were blotter dried and placed on potato dextrose agar (PDA) medium and incubated for 7 days at 25°C under a 12 h light/dark cycle. Fungal colonies expressed after 7 days of incubation were identified based on macro and micro-morphology of vegetative structures, pycnidia and conidia.

Pathogenicity test

The Koch's postulates were applied using the basic principles of the methodology described in other investigations (Xiao and Rogers, 2004; Mari et al. 2012). Inoculation was performed on quince fruits (cv. Asenica) sterilized in 70% ethanol. Quince fruits were inoculated with 50 µl of a spore suspension (1×10^6 conidia/ml) from the cultures grown 7 days on PDA on 3 mm deep. The control fruit was inoculated with 50 µl of sterile distilled water. After inoculation the quinces were placed in sterile plastic boxes on the wet paper towel and incubated at 25°C up to 10 days. After incubation reisolation of the pathogenic fungi was performed and these were identified according to the morphological characteristics.

DNA extraction, PCR amplification and sequencing

Genomic DNA was isolated from mycelium scraped from the surface of a 7 days old culture with DNeasy Plant Kit (Qiagen, Hilden, Germany), following the manufacturer's instructions. The universal primers ITS1 and ITS4 (White et al. 1990) were used to amplify the ITS region of the ribosome genes. PCR reaction was performed in a total volume of 25 µl with 12.5 µl 2 X PCR Master mix (K071, Fermentas, Lithuania), 9 µl RNase-free water, 1.25 µl each of both forward and reverse primers (100 pmol/µl, Metabion International, Deutschland) and 1 µl template DNA. DNA amplification was performed in a Thermal Cycler PCR system 2720 (Applied Biosystems). Cycling parameters were 94°C for 2 min, followed by 35 cycles of 2 min at 94°C, 30 sec at 57°C, 1 min at 72°C, and a final extension for 10 min at 72°C.

Amplified products were analyzed by 1% agarose gel electrophoresis, stained with Midori Green DNA Stain (Nippon Genetics), and visualized under a UV transilluminator. Sequencing in both directions was performed on an automated sequencer (ABI 3730XL Automatic Sequencer Macrogen, Korea). Sequence generated in this study was subjected to a Megablast search analysis at NCBI's GenBank nucleotide database for sequence similarity. Sequence of Serbian representative isolate (7-16) was aligned by using ClustalW algorithm implemented in MEGA 5 (Tamura et al. 2011).

Results and discussion

Although *D. eres* has been previously reported as causal agent of fruit rots in other plant species, such as *Prunus persicae* (Ko and Sun, 2003), *Malus domestica* (Arsenijevic and Gavrilovic, 2005) and *Actinidia deliciosa* (Luongo et al. 2011), to our knowledge, this is the first report of occurrence of this pathogen on quince in Serbia, causing fruit rot. Necrotic lesions appeared on stylar end and quickly expanded on other parts of the fruit, followed by occurrence of whitish mycelium mass (Fig. 1). A total of 12 samples of fruit rot were collected from one storage in the area of Šabac, three samples were infected by *D. eres* evident on PDA isolation.



Fig. 1. Symptom of fruit rot of quince caused by *Diaporthe eres*

Colonies of *D. eres* isolates on PDA were white, aerial, reverse centre dark pigmentation developing in centre, producing abundant, black stromata at maturity (Fig. 2a). Pycnidia were globose, embedded in tissue, erumpent at maturity, with a long, black, elongated neck. Conidia were extruded from ostioles in yellowish masses (Fig. 2b). Two types of conidia (alpha and beta) were observed. Alpha conidia were abundant, aseptate, hyaline, ovate to ellipsoidal ($6.2-8.7 \times 2.5-3.7\mu\text{m}$) (Fig. 2c). Beta conidia were filiform, curved, hyaline and aseptate ($20-27.5 \times 1.2-2.5\mu\text{m}$) (Fig. 2d). Colony and conidial morphology were consistent with those of a *D. eres* (Udayanga et al. 2014).

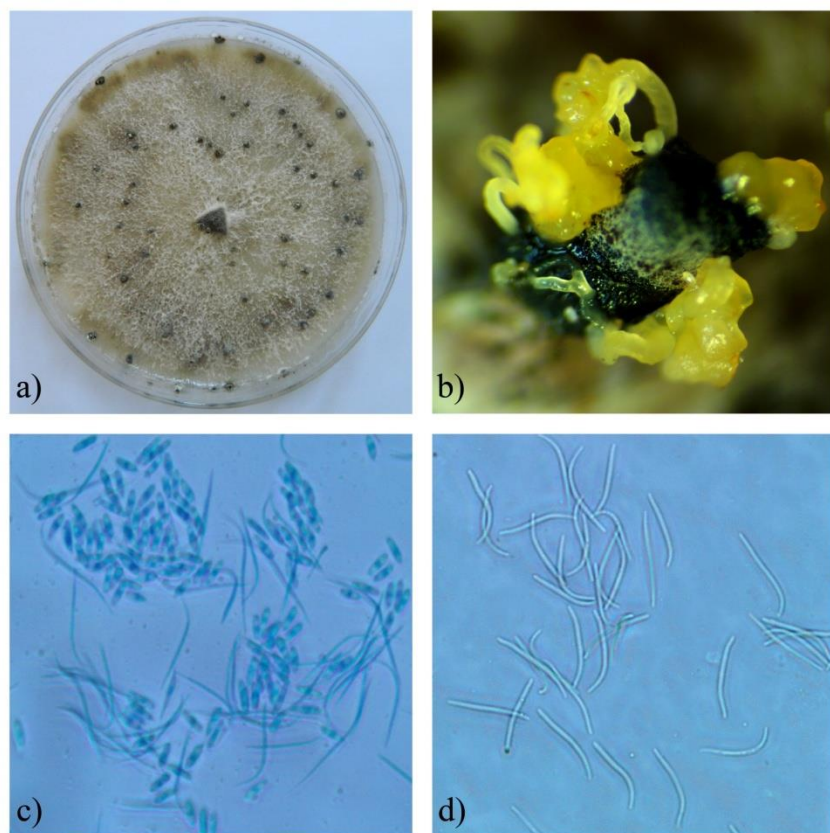

Fig. 2. Morphology of *Diaporthe eres*: **a)** colony cultured on PDA; **b)** sporulating pycnidia with yellowish masses; **c)** aseptate, ellipsoidal alpha conidia and beta conidia; **d)** aseptate, slightly curved beta conidia

A total of three isolates of *D. eres* obtained from naturally infected fruits of quince were tested for pathogenicity. Within 10 days, inoculated fruits developed typical brown rot symptoms. No symptoms were observed on any of the control fruits. Koch's postulates were fulfilled by re-isolating colonies from fruit rots and by obtaining the same morphological characters as the isolates used for inoculation.

To confirm morphological identification, sequence analysis of 550 bp of the ITS region of nuclear ribosomal DNA was performed. Since all the ITS sequences of the *D. eres* isolates from quince fruit were 100% identical (100% query coverage), the sequence of a single isolate (7-16) was used for comparison and deposited in GenBank (Accession No. KX274026). The representative isolate 7-16 shared the highest identity with sequences of 13 *D. eres* isolates deposited in the GenBank. DNA sequence data were effectively used for identification of *D. eres* in this study. For a majority of groups of fungi, the nuclear ribosomal internal transcribed spacer (ITS) region is the predominantly available sequence in public databases (Nilsson et al. 2008, 2014; Kõljalg et al. 2013). To date, different gene sequences species limits of *D. eres*, actin (ACT), DNA-lyase (Apn2), translation elongation factor 1- α (EF1- α), beta-tubulin (TUB), calmodulin (CAL), 60s ribosomal protein L37 (FG1093) and histone-3 (HIS), can be used for the detection of *Diaporthe* at species level and have been successfully applied in the characterization of closely related species (Udayanga et al. 2014). Molecular identification of *D. eres* species was conducted for the first time in our country, and represents introduction in molecular

characterization of this important species in Serbia. Results of sequencing of ITS region showed the need for detailed analyses of genetic structure of Serbian population of this pathogen, including sequencing of other informational parts of genom.

Management of storage conditions may delay disease development and retain fruit quality. Cold storage of fruit immediately after harvest may be a method to control the postharvest occurrence of *Phomopsis* fruit rot (Eguchi and Hara, 2005). According to the results of Thomidis and Michailides (2009) that showed that artificially inoculated peach fruit with *D. eres* did not develop any symptoms of rot when they were stored at 10°C or lower temperatures. This is basis may be good starting point for investigation postharvest control measures.

Conclusion

Knowledge of the composition of populations of *Diaporthe* species of quince fruit in Serbia is of great importance due to their ability to reduce quality, and provides the base for development of effective disease management strategies. This is the first detailed report of *D. eres* associated with fruit rot on quince diseases in Serbia with morphology, pathogenicity and molecular data. Further characterization and research on diversity of pathogens causing fruit rot on quince in Serbia are needed. Possible emergence of new pathogenic isolates and species could lead to a higher incidence of the disease and economically even more significant yield losses.

Acknowledgements

This research was supported by the projects TR31018, funded by the Ministry of Education, Science and Technological Development, Republic of Serbia.

References

- Anagnostakis, S. L. (2007). *Diaporthe eres* (*Phomopsis oblonga*) as a pathogen of butternut (*Juglans cinerea*) in Connecticut. *PlantDisease* 91:1198.
- Arsenijevic, M., Gavrilovic, V. (2005). *Phomopsis pernicioso* grovec-ausal agent of apple rot in storage fruits. *Pesticides and Phytomedicine* 20:189-194.
- Baumgartner, K., Fujiyoshi, F., Travadon, R., Castlebury, L. A., Wilcox, W. F., Rolshausen, P. E. (2013). Characterization of Species of *Diaporthe* from Wood Cankers of Grape in Eastern North American Vineyards. *Plant Disease* 97:912-920.
- Cline, E. T., Farr, D. F. (2006). Synopsis of fungi listed as regulated plant pests by the USDA animal and plant health inspection service: notes on nomenclature, disease, plant hosts, and geographic distribution. *Online Plant Health Prog.* doi:10.1094/PHP-2006-0505-01-DG
- Dhingra, O. D., Sinclair, J. B. (1985). *Basic Plant Pathology Methods*. CRC Press, Boca Raton, FL.
- Eguchi, N., Hara, H. (2005). Influence of preservation temperature on rot extent of fruit core rot of Japanese pear caused by *Phomopsis* spp. *Annual Report of the Kanto-Tosan Plant Protection Society* 52:51-52.
- Kõljalg, U., Nilsson, R. H., Abarenkov, K., Tedersoo, L., Taylor, A. F. S., Bahram, M. et al (2013). Towards a unified paradigm for sequence-based identification of fungi. *Molecular Ecology* 22:5271-5277.
- Ko, Y., Sun, S. K. (2003). *Phomopsis* fruit rot of subtropical peach in Taiwan. *Plant Pathology Bulletin* 12:212-214.
- Luongo, L., Santori, A., Riccioni, L., Belisario, A. (2011). *Phomopsis* sp. associated with post-harvest fruit rot of kiwifruit in Italy. *Journal of Plant Pathology* 93 (1):205-209.

- Mari, M., Guidarelli, M., Martini, C., Spadoni, A. (2012). First report of *Colletotrichum acutatum* causing bitter rot on apple in Italy. *Plant Disease* 96 (1):144.
- Mostert, L., Crous, P. W., Kang, J. C., Phillips, A. J. L. (2001). Species of *Phomopsis* and *Libertella* occurring on grapevines with specific references to South Africa: morphological, cultural, molecular and pathological characterization. *Mycologia* 93:146-167.
- Nilsson, R. H., Kristiansson, E., Ryberg M., Hallenberg, N., Larsson, K. H. (2008). Intraspecific ITS variability in the kingdom Fungi as expressed in the international sequence databases and its implications for molecular species identification. *Evolutionary Bioinformatics* 4:193-201.
- Nilsson, R. H., Hyde, K. D., Pawłowska, J., Ryberg, M., Tedersoo, L. et al. (2014). Improving ITS sequence data for identification of plant pathogenic fungi. *Fungal Diversity* In Press, doi:10.1007/s13225-014-0291-8.
- Rossmann, A. Y., Farr, D. F., Castlebury, L. A. (2007). A review of the phylogeny and biology of the *Diaporthales*. *Mycoscience* 48:135-144.
- Santos, J. M., Vrandečić, K., Ćosić, J., Duvnjak, T., Phillips, A. J. L. (2011). Resolving the *Diaporthe* species occurring on soybean in Croatia. *Persoonia* 27:9-19.
- Tamura, K., Peterson, D., Peterson, N., Stecher, G., Nei, M., Kumar, S. (2011). MEGA5: Molecular Evolutionary Genetics Analysis using Maximum Likelihood, Evolutionary Distance, and Maximum Parsimony Methods. *Molecular Biology and Evolution* 28: 2731-2739.
- Thomidis, T., Michailides, T. J. (2009). Studies on *Diaporthe eres* as a new pathogen of peach trees in Greece. *Plant Disease* 93:1293-1297.
- Thompson, S. M., Tan, Y. P., Young, A. J., Neate, S. M., Aitken, E. A., Shivas, R. G. (2011). Stem cankers on sunflower (*Helianthus annuus*) in Australia reveal a complex of pathogenic *Diaporthe* (*Phomopsis*) species. *Persoonia* 27:80-89.
- Udayanga, D., Liu, X., McKenzie, E. H. C., Chukeatirote, E., Bahkali, A. H. A., Hyde, K. D. (2011). The genus *Phomopsis*: biology, applications, species concepts, and names of common phytopathogens. *Fungal Diversity* 50 (1):189-225.
- Udayanga, D., Castlebury, L. A., Rossmann, A. Y., Chukeatirote, E., Hyde, K. D. (2014). Insights into the genus *Diaporthe*: phylogenetic species delimitation in the *D. eres* species complex. *Fungal Diversity* 67:203-229.
- Vrandečić, K., Jurković, D., Ćosić, J. (2010). *Phomopsis* vrste na vinovoj lozi u istočnoj Hrvatskoj [*Phomopsis* Species on Grapevine in Eastern Croatia, in Croatian]. *Glasilo biljne zaštite* 4:246-252.
- White, T. J., Bruns, T., Lee, S., Taylor, J. (1990). Amplification and direct sequencing of fungal ribosomal RNA genes for phylogenetics, In: Innis MA, Gelfand DH, Sninsky JJ, White TJ (eds), *PCR Protocols: A guide to methods and applications*: 315-322. Academic Press, San Diego, USA.
- Xiao, C.L., Rogers, J. D. (2004). A postharvest fruit rot in d'Anjou pears caused by *Sphaeropsis pyriputrescens* sp. nov. *Plant Disease* 88 (2):114-118.

OZONE FUMIGATION FOR QUARANTINE AND PRE-SHIPMENT TREATMENTS AS ALTERNATIVES TO METHYL BROMIDE

Ali Arda IŞIKBER*, Hasan TUNAZ, Mehmet Kubilay ER

¹Kahramanmaraş Sutcu Imam University, Agriculture Faculty, Plant Protection Department, Avsar Campus, 46100, Kahramanmaraş, Turkey

*Corresponding author: isikber@ksu.edu.tr

Abstract

Dried fruits and nuts production are important agricultural activity in Turkey. From a phytosanitary point of view, storage pests infesting dried fruits and nuts, especially during drying and storage period, may cause significant problems in dried fruits and nuts sector. Objective of this study is to test gaseous ozone for rapid disinfestations of dried fig and hazelnut as an alternative to methyl bromide by evaluating its toxicity against major insect pests of stored dried fruits and nuts. Gaseous ozone at low concentrations (1-2, 5-6 and 10-11 ppm) for short exposure periods (1, 2 and 4 hour) resulted in very low mortalities of against all life stages of *Ephestia cautella* (Walker) and *Plodia interpunctella* (Hubner). Ozone flush treatment at 30 minute intervals for 6 hours resulted in almost complete mortality of adults and pupae of *E. cautella* and *P. interpunctella* placed in top position of 1.3 kg of dried fig and hazelnut whereas eggs and larvae of *E. cautella* and *P. interpunctella* placed in top position of 1.3 kg of dried fig and hazelnut were hard to kill. The results indicated that gaseous ozone cannot be alternative to methyl bromide for rapid disinfestations of dried fruits and nuts (quarantine treatment) since it did not provide the complete mortality of all life stages of *E. cautella* and *P. interpunctella* on dried fig, and hazelnut even at its high concentrations.

Keywords: *Gaseous ozone, Methyl bromide, Alternative, Quarantine, Ephestia cautella, Plodia interpunctella*

Introduction

Dried fruits and nuts production is an important agricultural activity in Turkey. The annual Turkish dried fig production is around 55 to 60 000 tones and comes from a single cultivar, (*Ficus carica* Sarilop (= Calimyrna)), grown in the western part of Turkey, making Turkey the leading country of the world in dried fig and nut production. Nearly 90% of the production goes to the export market, with the main period of marketing being between late September and December (Aksoy *et al.*, 2008). Storage pests infesting dried fruits and nuts especially during drying and storage period may cause significant problems in dried fruit and nut sector. The fig moth (*Ephestia cautella* (Walker) and Indianmeal moth (*Plodia interpunctella* (Hubner) reduce fruit quality by feeding and damaging the fruit and contaminating by leaving its excretions and other residues as silky net weaves (Damarlı *et al.*, 1997). Large populations can develop before being detected and severe damage may occur rapidly (Jarratt, 2001). Moreover, from a phytosanitary point of view, during export, the presence of insects, or their fragments, has cost inestimable losses, due to cargo returns.

Ozone is a triatomic form of oxygen (O₃) and is referred to as activated oxygen, allotropic oxygen or pure air. It is an unstable gas and its life span lasts about 20 minute, depending on the temperature. Electrical generation of ozone eliminates the handling, storage, and disposal

problems of conventionally used post-harvest pesticides. Attractive aspect of ozone is that it decomposes rapidly (half-life of 20-50 min) to molecular oxygen without leaving a residue. These attributes make ozone an attractive candidate for controlling insects and fungi in stored products. Ozone in its gaseous form has been also considered to have potential to kill insect pests in commodities and was subjected of several research studies (Erdman, 1980; Mason *et al.*, 1997; Kells *et al.*, 2001). High mortality was achieved for adults of the maize weevil, *Sitophilus zeamais* (Motsch.), and the red flour beetle *Tribolium confusum* (Jacqueline de Val), and the larval stage of the Indian meal moth, *P. interpunctella* exposed to lower ozone concentrations ranging from 5 to 45 ppm (Erdman, 1980; Kells *et al.*, 2001).

Methyl bromide has frequently used as a fumigant for disinfestations of other stored agricultural commodities such as nuts, cereals and fruits since it kills the insects rapidly, has a wide spectrum of activity and relatively low-cost (Fields and White, 2002). However it had been banned in developed countries since 2005 and scheduled for worldwide withdrawal from routine use as a fumigant in 2015 under the directive of the Montreal Protocol on Substances that Deplete Ozone Layer (Schneider *et al.*, 2003) except quarantine, laboratory and pre-shipment purposes. As a consequence, There is a critical need to develop new fumigants for quarantine purposes, where rapid insect mortality is required (exposure time less than 1 day). Objective of present study was to test gaseous ozone for rapid disinfestation of dried fruits and nuts as a replacement for methyl bromide by evaluating its toxicity against major insect pests of stored dried fruits and nuts.

Materials and Methods

Test insects:

Tests were carried out on all life stages (adult, larva, pupa and egg) of *E. cautella* and *P. interpunctella*. All life stages of *E. cautella* were obtained from stock cultures reared at $26 \pm 1^\circ\text{C}$ and $65 \pm 5\%$ r.h. at the incubator on a standard diet of wheat flour mixed with brewer's yeast (17:1, wt:wt) using standard culture techniques. *P. interpunctella* was reared on diet of a 10:2:1 mixture of wheat flour: wheat germ: dried brewer's yeast at the same environmental conditions described for *E. cautella*. Eggs aged 1-2 days in 9 cm Petri dishes were placed in 3 liter jars and then were exposed to ozone treatments. Larvae were removed from culture jars and exposed to the treatments 21 days after oviposition. Two days old pupae were obtained by daily separation from culture jars and were exposed to ozone treatments. Seven day old adults were placed in culture jars and then were exposed to ozone treatments.

Commodity:

In-shell hazelnuts with moisture content (m.c.) of $10.5\% \pm 0.5$ and dried figs at m.c. of $21\% \pm 0.5$ were used in the tests. In order to minimize the reaction of microbial loads in the commodity with ozone the hazelnuts and dried figs used in the tests were sterilized under high pressurized steam.

Fumigation chambers:

Test chambers consisted of 3 liter glass jar, each capped with a metal stopper equipped with entry and exit tubing. Two pieces of rubber tubing, 5 cm long, 6.2 mm ID, were attached to the tubing and sealed with pinch-clamps.

Ozone fumigation procedures:

Ozone generator in laboratory scale was provided from the company Ozomax Inc., Ozone gas was generated using a laboratory corona discharge ozone generator (Model OZO-1VTT) from purified extra dry oxygen feed gas. Ozone was introduced as gaseous into the exposure jars using a ozone generator. The 100 mm Hg measure referred to herein is absolute pressure, with 760 mm

Hg considered as atmospheric pressure. Prior to each test, twenty larvae, pupae or adults were placed, separately, inside 3 cm diameter by 8 cm long wire-mesh cages. For eggs, fifty eggs placed in opened Petri dishes were used per fumigation.

For application of low ozone concentrations, ozone concentrations 1-2, 5-6 and 10-11 ppm were exposed to the eggs, pupae, larvae and adults of *E. cautella* and *P. interpunctella* for short exposure periods (1, 2 and 4 hour). The insects were first placed in exposure jars and then, constant ozone concentrations of 1-2, 5-6 and 10-11 ppm were continuously flushed into exposure jar and were exposed to the insects for 1, 2 and 4 hours. For intermittently repeated ozone treatment in presence of commodity, each desiccators was loaded separately with 1.3 kg of dried fig and in-shell hazelnut, and then 50 eggs, 25 pupae, 25 adults and 25 larvae placed inside the wire-mesh cages were inserted into top and bottom position of the commodity the desiccators were briefly evacuated to 760 mm Hg. Afterwards gaseous ozone at concentrations of 8.35 mg/l (3895 ppm) and 33.33 mg/l (15545 ppm) was flushed into exposure jar until reaching atmospheric pressure and it was repeated every half an hour for 6 hours. Untreated control insects were exposed to atmospheric conditions. Each test was replicated at three times. For all ozone fumigations, r.h. and temperature were maintained at $65\pm 5\%$ at atmospheric pressure and $26\pm 1^\circ\text{C}$, respectively.

Data processing and analysis:

After each ozone treatment, larvae, pupae, and adults were transferred to 250-mL jars containing standard diets and were held at $26 \pm 1^\circ\text{C}$ and $65 \pm 5\%$ r.h. until examined for mortality. The eggs were transferred into "pits" drilled into Perspex exposure slides, each slide containing 50 pits. They were held under the same conditions until the oviposition sites were examined for egg hatch. Mortality data was subjected to Arcsine transformation and then, were analyzed using one-way analysis of variance (ANOVA). The means were separated using the LSD method at 5% level.

Results and Discussion

Mortality rates (%) of all life stages of *P. interpunctella* and *E. cautella* exposed to low concentrations of gaseous ozone are given in Table 1 and 2, respectively. Gaseous ozone at low concentrations (1-2, 5-6 and 10-11 ppm) for short exposure periods (1, 2 and 4 hour) resulted in very low mortalities of against all life stages of both tested species. The mortality rate of all life stages of *P. interpunctella* and *E. cautella* exposed to low ozone concentrations for short exposure periods varied from 6.7% to 28.3% and 3.8% to 46%, respectively.

Table 1. Mortality rates of all life stages of *Plodia interpunctella* exposed to low concentrations of gaseous ozone

Ozone concentration	Exposure period (h)	Mortality rate (%) ± S. error			
		Pupa	Adult	Egg	Larva
1-2 ppm	1 h	10±0	15±2.89	28.33±1.67	6.67±1.67
	2 h	11.67±1.67	18.33±3.33	25±2.89	10±0
	4 h	10±0	18.33±3.33	25±2.89	6.67±1.67
5-6 ppm	1 h	11.67±1.67	21.67±1.67	26.67±1.67	8.33±1.67
	2 h	13.33±1.67	20±2.89	26.67±1.67	10±0
	4 h	11.67±1.67	25±2.89	28.33±1.67	10±0
10-11ppm	1 h	11.67±1.67	21.67±1.67	26.67±3.33	8.33±1.67
	2 h	15±2.89	26.67±1.67	25±2.89	11.67±1.67
	4 h	11.67±1.67	28.33±4.41	30±0	18.33±1.67
Control	1 h	6.67±1.67	20±2.89	25±2.89	5±0
	2 h	6.67±1.67	18.33±1.67	18.67±1.67	6.67±1.67
	4 h	13.33±1.67	18.33±4.41	21.67±1.67	5±0
<i>P</i> value ^a	-	<i>P</i> =0.055	<i>P</i> =0.06	<i>P</i> = 0.061	<i>P</i> = 0.08
<i>P</i> value ^b	-	<i>P</i> =0.38	<i>P</i> =0.44	<i>P</i> =0.13	<i>P</i> =0.48

Table 2. Mortality rates of all life stages of *Ephestia cautella* exposed to low concentrations of gaseous ozone

Ozone concentration ^a	Exposure Period (h) ^b	Mortality rate (%) ± S. error			
		Pupa	Adult	Egg	Larva
1-2 ppm	1 h	11.6±1.6	36±5.3	26.6±1.6	9.4±3.6
	2 h	13.3±1.6	35±6.7	26.6±1.6	3.1±3.1
	4 h	11.6±1.6	46±3.0	26.6±1.6	10.5±2.7
5-6 ppm	1 h	11.6±1.6	35±6.3	28.3±1.6	23.3±11.4
	2 h	13.3±1.6	8±3.8	28.3±1.6	4.3±4.3
	4 h	13.3±1.6	24±6.1	30±2.8	3.1±3.1
10-11 ppm	1 h	13.3±1.6	31±10.9	31.6±1.6	4.1±2.4
	2 h	15±0	3.8±2.1	30±2.8	3.1±1.8
	4 h	13.3±1.6	5±2.4	31.6±1.6	3.7±2.1
Control	1 h	8.3±1.6	3.3±2.1	23.3±1.6	4.3±2.4
	2 h	8.3±1.6	22±8.6	20±2.89	4.8±2.1
	4 h	8.3±1.6	38.7±8.5	23.3±1.6	3.1±1.9
<i>P</i> value ^a	-	<i>P</i> =0.06	<i>P</i> <0.001*	<i>P</i> = 0.1	<i>P</i> = 0.36
<i>P</i> value ^b	-	<i>P</i> =0.54	<i>P</i> =0.099	<i>P</i> =0.68	<i>P</i> =0.15

Mortality rates (%) of life stages of *E. cautella* and *P. interpunctella* placed at top and bottom position against 6-h exposure intermittently gaseous ozone treatment in presence of 1.3 kg of hazelnut are given Table 3 and 4, respectively. The results of biological tests indicated that ozone treatment at 33.33 mg/l concentration resulted in % 100 or nearly % 100 mortalities of only adult

and pupa stage of *E. cautella* and *P. interpunctella* placed at top position of the hazelnut. However, ozone treatments at lower concentration (8.35 mg/l) caused nearly % 100 mortalities of only pupa stage of *P. interpunctella* at placed at top position of the hazelnut. It was clear that ozone treatments at low concentration (8.35 mg/l) resulted in significantly lower mortalities of all life stages of *E. cautella* and *P. interpunctella* that those at high concentration (33.33 mg/l). Generally, in all ozone treatments the mortalities of tested insects placed at top position of the hazelnut were higher than those placed at bottom position of the hazelnut. Notably, it was hard to kill the larvae and eggs of *E. cautella* and *P. interpunctella* placed at bottom position of the hazelnut.

Table 3. Mortality rates of life stages of *Ephestia cautella* placed at top and bottom position against 6-h exposure intermittently gaseous ozone treatment in presence of 1.3 kg of hazelnut

Ozone concentration	Insect Position	Mortality rate (%) ± S. error			
		Adult	Larva	Pupa	Egg
8.35 mg/l (3895 ppm)	Top	68.3±4.4 B	18.3±3.3 AB	81.7±3.3 B	52.7±2.9 B
	Bottom	1.7±1.7 C	8.3±1.7 BC	61.7±6 C	24.7±2.4 D
33.33 mg/l (15545 ppm)	Top	98.3±1.7 A	30±2.9A	95±2.9 A	84±3.1 A
	Bottom	75±5 B	11.7±1.7 C	68.3±1.7 BC	39.3±2.4 C
Control	Top	0±0 C	6.7±4.4 C	8.3±1.7 D	6.7±1.8 E
	Bottom	0±0 C	6.7±4.4 C	8.3±1.7 D	6.7±1.8 E
F and P value	-	F _{5,12} =149 P<0.0001	F _{5,12} =4.1 P=0.022	F _{5,12} =71.4 P<0.0001	F _{5,12} =100 P<0.0001
LSD value	-	9.455	12.679	9.405	5.865

Table 4. Mortality rates of life stages of *Plodia interpunctella* placed at top and bottom position against 6-h exposure intermittently gaseous ozone treatment in presence of 1.3 kg of hazelnut

Ozone concentration	Insect Position	Mortality rate (%) ± S. error			
		Adult	Larva	Pupa	Egg
8.35 mg/l (3895 ppm)	Top	78.3±4.4 B	33.3±3.3 B	96.7±3.3 A	33.3±5.8 B
	Bottom	71.7±1.7 B	21.7±1.7 B	75±5 B	14.7±1.8 C
33.33 mg/l (15545 ppm)	Top	100±0 A	88.3±6.0 A	100±0 A	73.3±4.4 A
	Bottom	96.7±3.3 A	23.3±1.7 B	91.7±6.0 A	38.3±5.1 B
Control	Top	0±0 C	1.7±1.7 C	3.3±1.7 C	4±2.3 D
	Bottom	0±0 C	1.7±1.7 C	3.3±1.7 C	4±2.3 D
F and P value	-	F _{5,12} =198.2 P<0.0001	F _{5,12} =34.6 P<0.0001	F _{5,12} =57.14 P<0.0001	F _{5,12} =27.68 P<0.0001
LSD value	-	8.733	13.348	15.103	11.234

Mortality rates (%) of life stages of *E. cautella* and *P. interpunctella* placed at top and bottom position against 6-h exposure intermittently gaseous ozone treatment in presence of 1.3 kg of dried fig are given Table 5 and 6. Ozone treatment at 33.33 mg/l concentration resulted in % 100 or nearly % 100 mortalities of egg, adult and pupa stage of *E. cautella* and only adult and pupa stage of *P. interpunctella* placed at top position of the dried fig. However, ozone treatments at

lower concentration (8.35 mg/l) caused nearly % 100 mortalities of only pupa stage of *E. cautella* and *P. interpunctella* at placed at top position of the dried fig. Thus, ozone flush treatment at 30 minute intervals for 6 hours resulted in almost complete mortality of eggs, adults and pupae of *E. cautella* placed in top position of 1.3 kg of dried fig whereas larvae of *E. cautella* placed in top position of 1.3 kg of dried fig and hazelnut were hard to kill. Similar to the results obtained from ozone treatment on the hazelnut, low ozone concentration (8.35 mg/l) resulted in significantly lower mortalities of all life stages of *E. cautella* and *P. interpunctella* that high ozone concentration (33.33 mg/l). Generally, in all ozone treatments the mortalities of tested insects placed at top position of the hazelnut were higher than those placed at bottom position of the hazelnut.

Table 5. Mortality rates of life stages of *Ephestia cautella* placed at top and bottom position against 6-h exposure intermittently gaseous ozone treatment in presence of 1.3 kg of dried fig

Ozone concentration	Insect Position	Mortality rate (%) ± S. error			
		Adult	Larva	Pupa	Egg
8.35 mg/l (3895 ppm)	Top	76.7±4.4 B	26.7±3.3 BC	93.3±4.4 AB	64±2.3 B
	Bottom	41.7±4.4 C	10±2.9 CD	91.7±3.3 B	49.3±0.7 B
33.33 mg/l (15545 ppm)	Top	96.7±1.7 A	71.7±0.7 A	100±0 A	96±0 A
	Bottom	93.3±1.7 A	45±2.9B	100±0 A	97.3±2.7 A
Control	Top	0±0 D	6.7±4.4 D	1.7±1.7 C	0±0 C
	Bottom	0±0 D	6.7±4.4 D	3.3±3.3 C	1.3±1.3 C
F and P value	-	F _{5,12} =207 P<0.0001	F _{5,12} =18.6 P<0.0001	F _{5,12} =89.7 P<0.0001	F _{5,12} =165.6 P<0.0001
LSD value	-	7.754	13.259	13.232	8.608

Table 6. Mortality of life stages of *Plodia interpunctella* placed at top and bottom position against 6-h exposure intermittently gaseous ozone treatment in presence of 1.3 kg of dried fig

Ozone concentration	Insect Position	Mortality rate (%) ± S. error			
		Adult	Larva	Pupa	Egg
8.35 mg/l (3895 ppm)	Top	78.3±3.3 B	43.3±3.3 B	100±0 AB	63.3±2.9 B
	Bottom	53.3±4.4 C	38.3±6.7 CD	95±.9 B	51.3±2.7 B
33.33 mg/l (15545 ppm)	Top	100±0 A	68.3±1.7 A	100±0 A	87.3±1.8 A
	Bottom	96.7±3.3 A	46.7±10.1 B	100±0 A	70.7±4.8 A
Control	Top	0±0 D	11.7±4.4 D	8.3±1.7 C	3.3±2.4 C
	Bottom	0±0 D	11.7±4.4 D	8.3±1.7 C	3.3±2.4 C
F and P value	-	F _{5,12} =207 P<0.0001	F _{5,12} =18.6 P<0.0001	F _{5,12} =89.7 P<0.0001	F _{5,12} =165.6 P<0.0001
LSD value	-	7.754	13.259	13.232	8.608

Conclusion

The results indicated that gaseous ozone cannot be alternative to methyl bromide for rapid disinfestations of dried fruits and nuts (quarantine treatment) since it did not provide the complete mortality of all biological stages of *E. cautella* and *P. interpunctella* on dried fig and hazelnut even at its high concentrations.

Acknowledgments

This study was partially funded by The Scientific and Technological Research Council of Turkey (TÜBİTAK) with project number 109O802

References

- Aksoy U., Can H.Z., Meyvacı K.B., Şen, F. (2008). Turkish Sultans. In: Dried Fig (Ed.: U. Aksoy), Can Digital Publishing Center, İzmir, pp. 61-62.
- Damarlı E., Gün H., Özay G., Bülbül S., Oechsle P. (1997). An alternative method instead of methyl bromide for insect disinfestations on dried figs: controlled atmosphere. *Acta Horticulturae*, vol.480, pp. 209-215.
- Erdman H.E. (1980). Ozone toxicity during ontogeny of two species of flour beetles, *Tribolium confusum* and *T. castaneum*. *Environmental Entomology*, vol. 9, pp. 16-17.
- Fields P.G., White N.D.G. (2002). Alternatives to methyl bromide treatments for stored-product and quarantine insects. *Annual Review of Entomology*, vol. 47, pp. 331-359.
- Jarratt J.M. (2001). Pest management principles: Industrial, institutional and structural pest control. <http://msucares.com/publications/p2247ch7.pdf>.
- Kells S.A., Mason L.J., Maier D.E., Woloshuk C.P. (2001). Efficacy and fumigation characteristics of ozone in stored maize. *Journal of Stored Products Research* vol. 37, pp. 371-382.
- Mason L.J., Woloshuk C.P., Maier D.E. (1997). Efficacy of ozone to control insects, moulds and mycotoxins. In: Donahaye, E.J., Navarro, S., Varnava, A. (Eds.), *Proceedings of the International Conference on Controlled Atmosphere and Fumigation in Stored Products*. Nicosia, Cyprus Printer Ltd., Nicosia, pp. 665-670.
- Schneider S.M., Roskopf E.N., Leesch J.G., Chellemi D.O., Bull C.T., Mazzola M. (2003). Research on alternatives to methyl bromide: pre-plant and post-harvest. *Pest Management Science*, vol. 59, pp. 814-826.

FUMIGANT TOXICITY OF GARLIC ESSENTIAL OIL AND THEIR ACTIVE COMPONENTS AGAINST LIFE STAGES OF CONFUSED FLOUR BEETLE, *TRIBOLIUM CONFUSUM* Jacquelin du Val.

Ali Arda IŞIKBER^{1*}, Hasan TUNAZ¹, Mehmet Kubilay ER¹, Özgür SAĞLAM²

Kahramanmaraş Sutcu Imam University, Agriculture Faculty, Plant Protection Department, Avsar Campus, 46100, Kahramanmaraş, Turkey

²Namik Kemal University, Agriculture Faculty, Plant Protection Department, Tekirdag, Turkey

*Corresponding author: isikber@ksu.edu.tr

Abstract

This study was carried out to determine fumigant toxicity of garlic essential oil, its active compounds (diallyl sulphide and diallyl disulphide) and mixture (diallyl sulphide+diallyl disulphide) against life stages of *Tribolium confusum* du Val. Garlic essential oil, its active components and mixtures showed different fumigant toxicity against life stages of *T. confusum*. On the basis of LC90 values, toxicity of vapour of treatments to *T. confusum* eggs and adults in descending order was: diallyl sulphide > diallyl disulphide > garlic essential oil and diallyl sulphide+diallyl disulphide > diallyl disulphide > garlic essential oil ≥ diallyl sulphide, respectively. Garlic essential oil, their active compounds and mixture required less than $\mu\text{l l}^{-1}$ to kill 90% of the eggs. Garlic essential oil, diallyl disulphide and mixture diallyl sulphide+diallyl disulphide required less than 6 $\mu\text{l l}^{-1}$ to kill 90% of the pupae. Garlic essential oil, diallyl disulphide and mixture diallyl sulphide+diallyl disulphide required less than 20 $\mu\text{l l}^{-1}$ to kill 90% of the adults. On the other hand, garlic essential oil, its active compounds and mixture required the doses ranging from 6.44 to 23.31 $\mu\text{l l}^{-1}$ to kill 90% of the larvae. Bioassay tests indicated that the adults and larvae were the most tolerant stages while the eggs and pupae were the most susceptible stages to treatments of garlic essential oil, its active compounds and mixtures. Toxicity tests indicate that garlic essential oil and their active components can be used as possible alternative bio-fumigants in controlling stored grain insects.

Keywords: *Garlic, Essential oil, Diallyl sulfide, Diallyl disulfide, Fumigant toxicity, Tribolium confusum*

Introduction

The application of various synthetic insecticides and fumigants to grain storage over the years has led to a number of problems, including the development of insecticide resistance in stored grain insect pests in various parts of the world (Champ and Dyte, 1976). Another concern is the accumulation of pesticides (including fumigant) residues in treated grain (Snelson, 1987). These problems have highlighted the need for the development of natural products derived from plants as an alternative to conventional insecticides. Many types of spices and herbs are known to possess insecticidal activities (Tripathi *et al.*, 1999) especially in the form of essential oils (Shaaya *et al.*, 1991). They do not leave residues toxic to the environment and have medicinal properties for humans with lower toxicity to mammals (Duke, 1985).

Essential oils are among the best-known substances tested against insects. These compounds act as fumigants (Regnault-Roger and Hamraoui, 1995; Shaaya *et al.*, 1997), contact insecticides (Schmidt and Streloke, 1994), repellents (Plarre *et al.*, 1997), antifeedants (Harwood *et al.*, 1990)

and may affect some biological parameters such as growth rate, life span and reproduction (Regnault-Roger and Hamraoui, 1995). Essential oils are potential sources of alternative compounds to currently used fumigants. Various studies have demonstrated fumigant activity of various essential oils against various stored product insects (Shaaya *et al.*, 1997; Tunç *et al.*, 2000; Lee *et al.*, 2003). Karcı (2006) tested toxicity of various essential oils and their volatile constituents against all life stages of the flour beetle, *Tribolium confusum* (du Val.) (Coleoptera: Curculionidae) and reported that two essential oils, garlic and onion had potent fumigant activities on *T. confusum*. Gözek (2007) reported that the adults and larvae of *T. confusum* were the most tolerant stages and the eggs and pupae were the most susceptible stages to treatments of garlic essential oil, their active compounds and mixture. The present study was carried out to investigate fumigant toxicity of garlic essential oil, its active compounds (diallyl sulphide and diallyl disulphide) and their mixtures (diallyl sulphide+diallyl disulphide) against life stages of *T. confusum*.

Materials and Methods

Insect culture:

Biological tests were carried out on all life stages (egg, larva, pupa and adult) of *T. confusum*. *Tribolium confusum* were obtained from cultures reared in 1 l glass jars at $25 \pm 1^\circ\text{C}$ and $65 \pm 5\%$ relative humidity (RH) on a diet of wheat flour mixed with dry brewer's yeast (17:1, wt:wt) (Donahaye 1990). Eggs were daily separated from oviposition jars by sieving (60 mesh, 250 μm sieve). Eggs for exposure to treatments were transferred into the glass vials (2.5 cm diameter and 5 cm long). The 10 ml glass tube (18 cm height \times 18 cm width \times 12 cm diameter), each containing 50 eggs 1–2 days old, was exposed to each treatment. Larvae were removed from culture jars and exposed to the treatments 25-30 days after oviposition. Two day-old pupae were obtained by daily separation from culture jars and held in wheat flour for 24 h before the exposure. Newly emerged adults were held in pre-exposure jars containing wheat flour, and were exposed to treatment 7-10 days after emergence.

Garlic Essential Oil and Their Main Compounds:

Essential oil from garlic (*Allium sativum* L.) and its main compounds, diallyl disulphide and diallyl sulphide were tested against all life stages of *T. confusum*. Essential oil extracted by stem distillation method was provided commercially from ATL Canada Company. Diallyl disulphide (Sigma-Aldrich, 317691, 80 %) and diallyl sulphide (Sigma-Aldrich, 35801, 97%) were provided commercially by Sigma-Aldrich. After purchase, garlic essential oil and their main compounds were collected in sealed glass containers and refrigerated in the dark at 4°C until their use.

Bioassay Tests and Experimental Procedures:

Tested stages of *T. confusum* were collected from the cultures and placed in the glass vials covered with a fine mesh to allow penetration of any volatiles emanating from garlic oil, its main compounds (diallyl sulphide and diallyl disulphide) and mixture (diallyl sulphide + diallyl disulphide). Fifty eggs and twenty five larvae, pupae and adults were used for each replicate. Bioassays were carried out in 3 l glass jars closed with metal screw-on lids, which served as fumigation chambers and were kept at $25 \pm 1^\circ\text{C}$ and $65 \pm 5\%$ RH at the incubator. The single-dose biological tests were carried out to determine the effective doses of essential oil and each compound against the all life stages of *T. confusum*. Each tested stages were exposed to a constant concentration of $25 \mu\text{l l}^{-1}$ air of garlic oil, diallyl sulphide, diallyl disulphide and mixture diallyl sulphide + diallyl disulphide (each compound at $12.5 \mu\text{l l}^{-1}$ air) for 24 h. Garlic oil, diallyl sulphide, diallyl disulphide and diallyl sulphide + diallyl disulphide were applied on

filter paper (2 cm x 5 cm) attached to the under-side of the lids of fumigation chambers by using 50 µl micropipette. After eggs, larvae, pupae and adults were transferred separately into fumigation chambers, they were closed with screw-on lids, which were made air-tight. Each treatment and control was replicated three times. For the control treatment, all life stages of *T. confusum* were exposed to atmospheric conditions and were kept at $25 \pm 1^\circ\text{C}$ and $65 \pm 5\%$ RH at the incubator.

Garlic essential oil, diallyl sulphide, diallyl disulphide and diallyl sulphide + diallyl disulphide were subjected to lethal concentration tests to determine their LC_{50} and LC_{90} values. Four to seven dose levels ranging from 0.5 to 25 µl l^{-1} for garlic oil, from 0.5 to 50 µl l^{-1} for diallyl sulphide, from 0.5 to 18 µl l^{-1} for diallyl disulphide and from 5 to 25 µl l^{-1} for diallyl sulphide + diallyl disulphide were used for life stages of *T. confusum*. The dose levels were selected for each stage of *T. confusum* on basis of the single-dose biological tests. Three replicates were set up for each dose and control. Fumigation procedures were the same as in above mentioned bioassay tests.

Data Processing and Analysis:

After each treatment, the eggs in their Perspex slides were held at $26 \pm 1^\circ\text{C}$ and $65 \pm 5\%$ r.h. until the oviposition sites were examined for egg hatching. It was checked 7 days after treatment for mortality counts. Mortality counts for adults were done 4-5 days after exposure; for larvae they were based on those individuals that had failed to pupate 9 days after exposure; pupal mortality was based on those pupae that failed to develop in adults 9 days after exposure. Mortality data obtained from bioassay tests were corrected by using Abbott's formula (Abbott, 1925). Mortality data obtained from preliminary bioassay tests were normalized using arcsine transformation and then were analyzed using two-way analysis of variance (ANOVA). The means were separated using the Duncan's test at the 5 % level (SAS Ins., 1989). Data obtained from each zero dose control and exposure time-mortality responses were subjected to probit analysis by using maximum likelihood program software (POLO-PC) (LeOra Software, 1987) to determine $\text{LC}_{50\text{S}}$ (Lethal Concentration₅₀), $\text{LC}_{90\text{S}}$ (Lethal Concentration₉₀) and their respective 95% confidence intervals. Differences in toxicity were considered significant when 95% confidence intervals did not overlap.

Results and Discussion

Percent mortalities of *T. confusum* eggs, larvae, pupae and adults exposed to 25 µl l^{-1} dose of garlic essential oil, its main compounds and their mixture for 24 h are given in Table 1. Preliminary bioassay tests indicated that both vapours of tested compounds and the insect stage had a significant effect on mortality of the life stages of *T. confusum* when exposed to a dose of 25 µl l^{-1} for 24 h (for compounds $F_{4, 40} = 513.17$, $P < 0.0001$; for insect stages $F_{3, 40} = 34.09$, $P < 0.0001$). According to results of single-dose biological tests, garlic essential oil, diallyl disulphide and mixture diallyl sulphide + diallyl disulphide resulted in 100% or almost 100% mortality of all life stages of *T. confusum*. Diallyl sulphide achieved 100% or almost 100% mortality of eggs, larvae and pupae while resulted in low mortality of adults (3.9%). Single-dose tests indicated that all tested compounds (garlic essential oil, diallyl sulphide, diallyl disulphide and diallyl sulphide + diallyl disulphide) at a dose of 25 µl l^{-1} for 24 h had high fumigant activity on all life stages of *T. confusum* except diallyl sulphide for adults (Table 1). Compared with the investigation of Karcı (2006) for garlic essential oil and Gözek (2007) for garlic essential oil and their components our results indicated a similar toxicity of garlic oil and their main compounds against all life stages of *T. confusum*.

Table 1. Percent mortalities of *Tribolium confusum* eggs, larvae, pupae and adults exposed to 25 $\mu\text{l l}^{-1}$ dose of garlic essential oil, its main compounds and their mixture for 24 h

Compounds	Mortality (%) \pm S.E.				F and P value
	Egg	Larva	Pupa	Adult	
Garlic oil	100 \pm 0 Aa	94.3 \pm 3.9 Aa	100 \pm 0 Aa	96.8 \pm 1.9 Aa	F _{3,8} =2.24 P=0.1607
Diallyl sulphide	100 \pm 0 Aa	100 \pm 0 Aa	94.7 \pm 5.3 Aa	3.9 \pm 2.3 Bb	F _{3,8} =72.19 P< 0.0001
Diallyl disulphide	100 \pm 0 Aa	100 \pm 0 Aa	100 \pm 0 Aa	100 \pm 0 Aa	F _{3,8} =- P-
Diallyl sulphide+ Diallyl disulphide	100 \pm 0 Aa	98.7 \pm 1.3 Aa	100 \pm 0 Aa	100 \pm 0 Aa	F _{3,8} =1.00 P= 0.4411
Control	8.7 \pm 0.7 B	12.9 \pm 2.1 B	3.9 \pm 2.2 B	1.4 \pm 1.4 B	-
F and P value	F _{4,10} =144.5 P< 0.0001	F _{4,10} =349.9 P< 0.0001	F _{4,10} =92.4 P< 0.0001	F _{4,10} =168.7 P< 0.0001	

Two-way ANOVA was applied to the data. Means within a row with the same lower-case letter and a column with the same upper-case letter do not differ significantly (Duncan test at 5% level) The results of probit analysis (LC₅₀ and LC₉₀ values) for all life stages of *T. confusum* exposed to various doses of garlic essential oil, its main compounds and their mixture for 24-h are given in Table 2. Probit mortality regression data indicated a remarkable difference in toxicity of tested compounds against all life stages. Garlic essential oil, diallyl sulphide, diallyl disulphide and mixture diallyl sulphide + diallyl disulphide against *T. confusum* eggs had 2.47, 1.35, 1.39 and 1.80 $\mu\text{l l}^{-1}$ of LC₉₀ value respectively. Therefore, it appears that diallyl sulphide was the most toxic to *T. confusum* eggs, followed by diallyl disulphide, diallyl sulphide + diallyl disulphide and garlic oil, respectively. LC₉₀ values for diallyl sulphide and diallyl disulphide against larval stage of were significantly lower than those for garlic oil and diallyl sulphide + diallyl disulphide, since 95 % confidence intervals (CLs) of diallyl sulphide and diallyl disulphide did not overlap those for garlic oil and diallyl sulphide + diallyl disulphide (Table 2). Garlic oil, diallyl disulphide and diallyl sulphide + diallyl disulphide were more toxic to pupae with LC₉₀ values of 5.03, 3.96 and 5.25 $\mu\text{l l}^{-1}$ respectively than diallyl sulphide with LC₉₀ value of 20.14, 42.26. Diallyl sulphide + diallyl disulphide were more toxic to adults with LC₉₀ values of 8.72 $\mu\text{l l}^{-1}$ than garlic oil and diallyl disulphide with LC₉₀ value of 19.05 and 16.61, respectively. Considering all results obtained from lethal concentration tests, diallyl disulphide was the most toxic compound to all life stages of *T. confusum* except adults. Likewise, Huang *et al.* (2000) reported that main components of garlic oil, diallyl trisulphide, diallyl disulphide and methyl allyl trissulphide, had high fumigant toxicity against *Tribolium castaneum* (Herbst) and *Sitophilus zeamais* Motschulsky and can be considered as potential alternative fumigant for controlling stored product insects.

Toxicity data for garlic essential oil, its active compounds and mixtures indicated a remarkable difference in susceptibility between life stages of *T. confusum* (Table 2). Bioassay tests indicated that the adults and larvae were the most tolerant stages while the eggs and pupae the most susceptible to treatments of garlic essential oil, its active compounds and mixtures. LC₅₀ values for the adult was significantly different from those of the eggs, pupae and larvae, since 95 %

confidence intervals (CLs) of the adult did not overlap those of its egg, pupa and larva. LC₅₀ values for the egg was also significantly different from those of the larvae, pupae and adult, since 95 % CLs did not overlap.

Table 2. Probit analysis data of garlic essential oil, its main compounds and their mixture for *Tribolium confusum* eggs, larvae, pupae and adults following 24-h laboratory fumigation

Life stage	Compounds	N ^a	Slope ^b ± S.E.	LC ₅₀ (µl l ⁻¹) (Fiducial limit) ^c	LC ₉₀ (µl l ⁻¹) (Fiducial limit) ^c	χ ² ^d
Egg	Garlic oil	900	3.1±0.29	0.96 (0.84-1.08)	2.47 (2.15-2.96)	7.03
	Diallyl sulphide	750	4.58±0.39	0.71 (0.62-0.79)	1.35 (1.18-1.62)	15.99
	Diallyl disulphide	750	3.58±0.33	0.61 (0.54-0.67)	1.39 (1.24-1.61)	3.05
	Diallyl sulphide+ Diallyl disulphide	900	3.46± 0.32	0.77 (0.65-0.88)	1.80 (1.55-2.23)	18.34
Larva	Garlic oil	900	2.87±0.65	7.98 (4.40-10.41)	22.33 (18.15-32.66)	9.86
	Diallyl sulphide	1050	2.27±0.25	1.76 (1.35-2.22)	6.47 (4.95-9.24)	8.27
	Diallyl disulphide	900	2.69±0.32	2.15 (1.68-2.67)	6.44 (5.02-9.04)	11.31
	Diallyl sulphide+ Diallyl disulphide	900	2.49 ± 0.39	6.69 (4.14-8.81)	21.85 (16.89-33.35)	15.57
Pupa	Garlic oil	900	2.53±0.35	1.56 (1.11-1.99)	5.03 (3.87-7.13)	2.88
	Diallyl sulphide	1050	2.02±0.19	4.66 (3.55-5.82)	20.14 (16.03-26.81)	12.75
	Diallyl disulphide	900	2.24± 0.26	1.06 (0.803-1.32)	3.96 (3.09-5.53)	3.93
	Diallyl sulphide+ Diallyl disulphide	900	2.36±0.25	1.51 (1.19-1.83)	5.25 (4.16-7.18)	2.05
Adult	Garlic oil	900	5.49±0.66	11.13 (9.21-12.69)	19.05 (16.62-23.41)	20.79
	Diallyl sulphide	1200				
	Diallyl disulphide	900	5.65±0.95	9.85 (7.29-11.52)	16.61 (14.18-22.55)	21.76
	Diallyl sulphide+ Diallyl disulphide	1050	4.93±0.82	4.79 (3.49-5.63)	8.72 (7.39-12.09)	26.69

^a : Number treated, excluding controls, ^b : Slopes are non-parallel and unequal where noted,

^c : Value in parentheses refers to the 95% confidence range, ^d : Chi-square,

^e : Calculated LC₅₀ ve LC₉₀ values were found to be far beyond tested application dose ranges

Conclusion

Toxicity tests in this study indicate that garlic essential oil, its active compounds (diallyl sulphide and diallyl disulphide) and mixtures (diallyl sulphide + diallyl disulphide) provided the complete mortality of all life stages of *T. confusum* at relatively low concentrations and short exposure period. In conclusion, present study showed that garlic essential oil, its active compounds and mixtures would be potential as an alternative to conventional fumigants.

References

- Abbott W.S. (1925). A method for computing the effectiveness of an insecticide. *Journal of Economical Entomology*, vol. 18, pp. 265-267.
- Champ B.R., Dyte C.E. (1976). Report of the FAO Global Survey of Pesticide Susceptibility of Stored Grain Pests. FAO Plant Production and Protection Series No. 5, Rome.
- Donahaye E. (1990). Laboratory selection for resistance by the red flour beetle, *Tribolium castaneum* (Herbst) to an atmosphere of low oxygen concentration. *Phytoparasitica*, vol. 18, pp. 189-202.
- Duke J.A. (1985). *Handbook of Medicinal Herbs*, CRC Press, New York, pp. 378-383.
- Gözek N. (2007). Fumigant Toxicity of Garlic and Onion Essential Oils and their Active Components Against Life Stages of Confused Flour Beetle, *Tribolium confusum* du Val. Master Thesis. University of Kahramanmaraş Sütçü Imam Institute of Natural and Applied Sciences, Department of Plant Protection, 46 pp. (Only Abstract in English)
- Harwood H.S., Moldenke F.A., Berry E.R. (1990). Toxicity of monoterpenes to the variegated cutworm (Lepidoptera: Noctuidae). *Journal of Economical Entomology*, vol. 83, pp. 1761-1767.
- Huang Y., Xing C.S., Hung H.S. (2000). Bioactivities of methyl allyl disulfide and diallyl trisulfide from essential oil of garlic to two species of stored-product pests, *Sitophilus zeamais* (Coleoptera: Curculionidae) and *Tribolium castaneum* (Coleoptera: Tenebrionidae). *Journal of Economic Entomology*, vol. 93, pp. 537-543.
- Karcı A. (2006). Fumigant Toxicity of Some Plant Derived essential Oils against all Life Stages of Confused Flour Beetle, *Tribolium confusum* Duval, (Col.: Tenebrionidae). Master Thesis. University of Kahramanmaraş Sütçü Imam Institute of Natural and Applied Sciences, Department of Plant Protection, 45 pp. (Only Abstract in English)
- Lee S., Peterson C.J., Coats J.R. (2003). Fumigation toxicity of monoterpenoids to several stored product insects. *Journal of Stored Products Research*, vol. 39, pp. 77-85.
- LeOra Software. (1987). *POLO-PC: A Users' Guide to Probit or Logit Analysis*. LeOra Software, Berkeley, CA.
- Plarre R., Reichmuth C. (1997). Toxic effects of carbonyl sulfide (COS) on *Sitophilus granarius* (L.) (Coleoptera: Curculionidae), *Fusarium culmorum* and *Fusarium avenaceum* (Saac.) (Deuteromycatina: Hypomycetes), and corrosion on copper. *Proceedings of International Conference on Controlled Atmosphere and Fumigation in Stored Products*, 21-26 April 1996, Nicosia Cyprus. Caspit, Jerusalem.
- Regnault-Roger C., Hamraoui A. (1995). Fumigant toxic activity and reproductive inhibition induced by monoterpenes on *Acanthoscelides obtectus* (Say) (Coleoptera), a brucid of kidney bean (*Phaseolus vulgaris* L.). *Journal of Stored Products Research*, vol. 31, pp. 291-299.
- SAS Institute Inc. (1989). *SAS / STAT^R User's Guide*, Version 6, 4th Ed. SAS Institute Inc., Cary, NC.

- Schmidt H.G., Strelake M. (1994). Effect of *Acorus calamus* (L.) (Araceae) oil and its main compound β -asarone on *Prostephanus truncatus* (Horn) (Coleoptera: Bostrichidae). *Journal of Stored Products Research*, vol. 30, pp. 227-235.
- Shaaya E., Kostjukovski M., Eilberg J., Sukprakarn C. (1997). Plant oils as fumigants and contact insecticides for the control of stored-product insects. *Journal of Stored Products Research*, vol. 33, pp. 7-15.
- Snelson J.T. (1987). *Grain Protectants* (ACIAR Monograph No. 3). Canberra Publishing and Printing Co, Fyshwick, ACT, 448 pp.
- Tripathi A.K., Prajapati V., Gupta R., Kumar S. (1999) Herbal material for the insect-pest management in stored grains under tropical conditions. *Journal of Medicinal and Aromatic Plant Sciences*, vol. 21, pp. 408-430.
- Tunç İ., Berger B.M, Erler F., Dağlı F. (2000). Ovicidal activity of essential oils from five plants against two stored-product insects. *Journal of Stored Products Research*, vol. 36, pp.161-168.

MICROBIAL CONTAMINANTS AT VARIOUS STAGES OF BREWING PROCESS

Linda LUARASI¹, Rozana TROJA², Luljeta PINGULI²

¹Department of Biotechnology, Faculty of Natural Sciences, University of Tirana, Albania

²Department of Industrial Chemistry, Faculty of Natural Sciences, University of Tirana, Albania

*Corresponding author: linda.luarasi@gmail.com

Abstract

Beer may contain microbial contaminants which originate from different sources such as the raw materials, manufacture equipment, and those introduced during bottling. The raw materials including malt, water and hops contain their own microflora. The brewing yeast should be stored and propagated with maximal hygienic condition in order to avoid contamination. At the bottling process, the contamination can occur in the filling sector as well as in the sealing sector. The airborne microorganisms are a significant problem in all the breweries. The spoilage microorganisms which are mostly encountered in the whole brewing process are molds, wild yeasts and lactic acid and acetic acid bacteria. Species of *Alternaria*, *Cladosporium* and *Fusarium* are field fungi, while *Aspergillus* and *Penicillium* are grown during barley storage. The non-*Saccharomyces* wild yeasts include *Brettanomyces*, *Hanseniaspora*, *Pichia*, *Torulaspora*, *Zygosaccharomyces* etc. The contamination of brewing yeast from bacterial strains may be a serious problem to the fermentation process. The most isolated bacterial contaminants are lactic acid and acetic acid bacteria. The paper presented here is an introduction of a study related to the determination of environmental contaminant strains and other spoilage microorganisms of beer in Albania. A number of critical points were identified in the technological process taking into consideration the most probable polluted areas of production. The cultivation methods were performed. Isolated and identified strains detected during the microbiological control belonged mainly to the genera of *Penicillium*, *Aspergillus* and *Rhodotorula*. Spontaneous strains were very few in number and were not considered problematic for the indigenous microbial population.

Keywords: *contaminants, beer, microorganisms, fermentation*

Introduction

The microbiological stability of beers relies on three basic aspects, including the microbiological quality of the raw materials used for brewing – malt, water, hops and yeast - the nature of the process and product, taking into consideration whether or not the pasteurization is applied and the sanitary condition of the beer-contact surfaces, including the cleaning processes of the brewing equipment and the plant. These three factors serve as indicators of the sanitary and microbiological quality of all beers, whether they may be brewed in industrial scale or in microbreweries (Priest *et al.* 2003).

This paper presents some aspects of the research work on the microbiology of brewing process. Some beers are typically more susceptible to microbial spoilage, especially those which are not pasteurised or sterile filtered. Further, some beer companies usually lack a well-established quality control laboratory, and in some cases the cold storage is not guaranteed throughout the distribution chain (Moretti, 2013). So this research work allowed to determine some critical control points of the process, especially investigating the microbiological control of equipment

used; management of the yeast and the management of cleaning and sanitizing; as well as the microbiological control of beer sampled from different types of packages.

Processing areas. The environment where beer is produced is quite variable, ranging from modern equipment established in well maintained buildings, to outdated equipment and old buildings that are sometimes historic places. Thus testing the airborne microorganisms is recommended in the brewing industry. The impurity of the environmental air surrounding the processing area is high affected by the seasons. Some studies have shown that the different periods of the year have had an effect on total number of aerobic airborne microorganisms with the spring months being five times higher than other months (Miller, 2011). Routine microbiological environmental air testing is a good indicator of overall brewery hygiene.

Bottling. Most microbreweries use new, nonreturnable bottles. These are rinsed and sanitized with specific kinds of detergents. The finished beer in bottles is finally analyzed microbiologically. The canning line in the brewery was found to be contaminated with beer spoiling bacteria on average 75% of the time. Critical areas in the brewery, such as the bottling and canning lines, should be routinely tested for airborne microorganisms as they could lead to final product contamination (Miller, 2011).

Wild yeasts must have been a problem in beverage fermentations throughout history, and have been the subject of numerous reviews since their microbiological nature became understood. It is important to practice testing for the absence of undesirable yeasts at each sensitive stage of the brewing process (Priest *et al.* 2003). The microbiological CCPs of the brewing industry have been identified in the Recommended Methods of the Institute of Brewing and American Society of Brewing Chemists (Vaughan, 2005). Contamination of pitching yeast, even if initially pure, is probably inevitable after a number of fermentations and repitching in traditional open vessels, although the contaminant may stabilize at a relatively low and therefore harmless level.

The focus of this paper work is the detection of spoilage microorganisms at various stages of brewing process during the investigation of the most probable critical areas.

Material and Methods

Samples were selected from a private company of beer production in Tirana, during April and May, 2016. Sampling involved selection of some critical control points in the brewery.

Microbiological quality of filtered beer

The filtered beer in this case means beer without any kind of sterilization. The sampling point was the pressure tank. 50 ml of filtered beer was taken for plating in selective media, wort agar and PCA. The methods are described in EBC Analytica Mibrobiologica 3.3.4.1.

Microbiological quality of beer during fermentation

Samples were taken in a sterile manner 4 days after pitching of the yeast, from the main fermentation unit. Cultivation methods were performed using the pour plate technique in WA and PCA. The methods are described in EBC Analytica Microbiologica 3.3.2.

Microbiological quality of beer in kegs

The same technique was followed for the microbiological testing of beer in kegs. The procedure of sampling was carried out in sterile manner.

As noted previously, there is no selective medium that suppresses brewery or distillery culture yeasts and supports the growth of all contaminants that could be present. However, wild yeast contaminants of the genus *Saccharomyces* will probably form spores and can be selected by their marginal heat resistance in comparison with nonsporulating culture yeasts (Campbell, 2003).

Results and Discussion

Microbiological controls, focused on the quality of the final product, demonstrated the presence of some specific microorganisms, most of them non harmful bacteria, yeast and molds. The risk of a microbial contamination was related not only to the microflora of the raw materials but also to the operating conditions in the processing environment.

The microbiological test of different beer samples showed the following results.

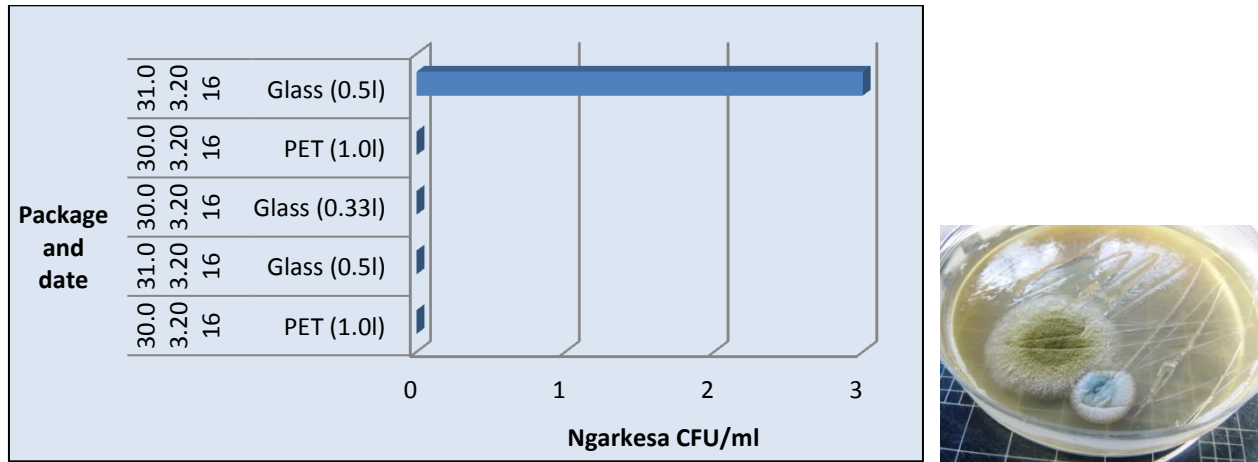

Figure 1. Total count of microorganisms in PET and glass bottles of finished beer (wort agar) The obtained results showed a few spontaneous strains, which is believed to come from the surrounding environment. The strains belonged to *Penicillium* genera.

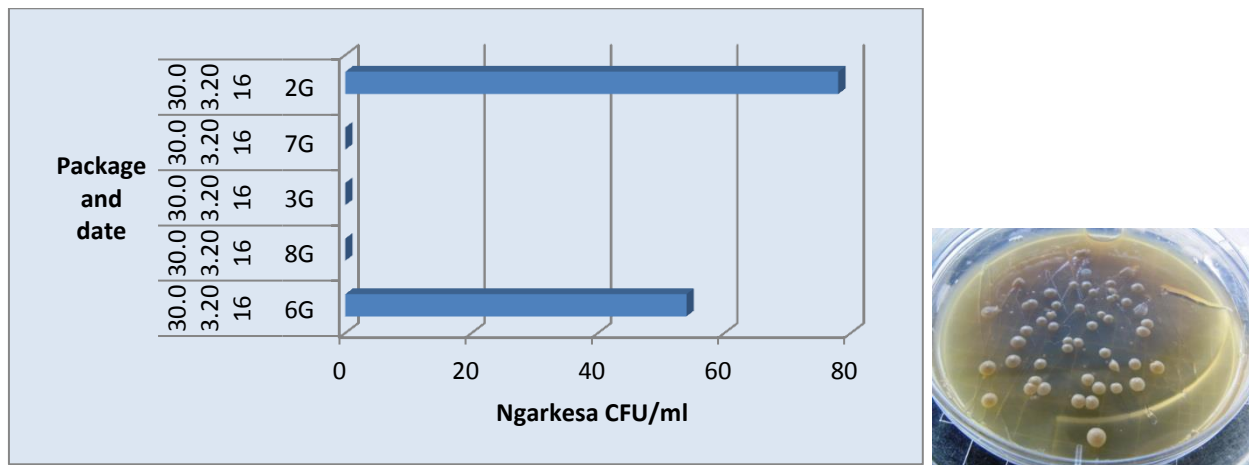

Figure 2. Total count of microorganisms in filtered beer incubated in wort agar
The total count of microorganisms in filtered beer during the growth in wort agar belonged to the yeast culture *Saccharomyces uvarum*.

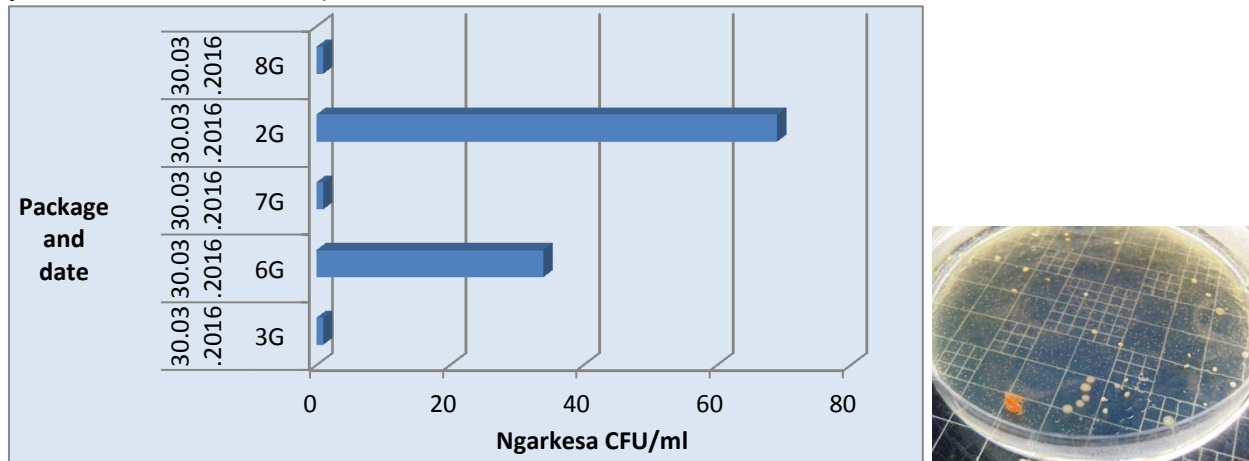

Figure 3. Total count of microorganisms in filtered beer incubated in PCA

Considering the total count in filtered beer in PCA, it is noted the presence of the pink yeasts, *Sporobolomyces* and *Rhodotorula*.

According to the other studies, it is believed that these wild yeasts belonging to the *non-saccharomyces* family originate from the raw materials. Yeast numbers in finished malt have been reported to lie in the range 7.2×10^2 - 1.1×10^4 /g, with the pink yeasts in the genera *Sporobolomyces* and *Rhodotorula* often being abundant (Wiles, 1953).

Other related studies provided a comprehensive survey of culture media for detection and isolation of wild yeasts, which they defined as 'yeasts not playing a significant part in a normal fermentation.' In the earlier reviews of wild yeasts it is used the definition 'yeasts not deliberately used and under full control' which indicates the accidental nature of wild yeast contamination.

The results obtained in samples of beer during the fermentation showed an uncountable total charge in PCA medium. Meanwhile the microbiological control of beer in keg containers showed no growth of microorganisms.

Conclusions

The general evaluation of the total count of microorganisms in different stages of beer production has shown the presence of some specific strains which are not considered pathogenic or harmful. However, brewing companies apply good hygienic practices, it is inevitable the presence of airborne microorganisms as well as those microorganisms encountered in the storage environment. The mold colonies including *Penicillium* and *Aspergillus* are frequently found in the storage sector of malt grains. The wild yeasts belonging to the *non-sacharomyces* family, *Sporobolomyces* and *Rhodotorula* are common environmental basidiomycetous yeasts, frequently found in brewing processing areas. During the evaluation of total count of microorganisms in the fermentation process, no specific strains were noted. Concerning the control points, the most problematic and of increased importance are beer leavening the filter, pressure tank, beer entering filler, empty bottles, and beer before crowning. The bottles washing process is also considered a delicate process being a potential source of microorganisms' growth.

References

- Berry D. R., Russell I., Stewart G.C. (1987). Yeast Biotechnology. Part I, Ch. 2, p. 36. ISBN 978-94-010-7903-7
- EBC Analytica Microbiologica – Method 3.3.4.1 (1984). *Journal of the Institute of Brewing* Volume 90, Issue 4, pages 273
- EBC Analytica Microbiologica – Method 3.3.2 (1984). *Journal of the Institute of Brewing* Volume 90, Issue 4, pages 272–276
- EBC Analytica Microbiologica – Method 2.4.7 (1981). *Journal of the Institute of Brewing* Volume 87, Issue 5, pages 303–321
- Campbell, I. (2003). Microbiological methods in brewing analysis. *Brewing Microbiology* 3rd edition 12, 367-378, ISBN 0-306-47288-0
- Miller A. L. (2011). PhD Assessment of airborne microorganisms in a craft brewery. Colorado State University.
- Moretti E. (2013). PhD Development of guidelines for microbiological control in microbrewery. University of Bologna.
- Priest, F. G. Campbell, I. (2003). *Brewing Microbiology* 3rd edition. Kluwver Academic/Plenum Publishers, New York. ISBN 0-306-47288-0
- Vaughan, A. O’Sullivan, T. Van Sinderen, D. (2005). Enhancing the microbiological stability of beer – A review. *Journal of the Institute of Brewing* 111(4), 355–371
- Wiles, E. (1953). Identification and significance of yeasts encountered in the brewery. *Journal of the Institute of Brewing* Volume 59, Issue 4, pages 265–284
- The Brilliant Beer Company (2010). Section 13: Beer quality – microbiological contamination http://www.mycology.adelaide.edu.au/Fungal_Descriptions/Yeasts/Rhodotorula/

PHYSICAL AND CHEMICAL CHARACTERISTICS OF FLORAL, MEADOW AND FOREST HONEY IN THE AREA OF GORAZDE MUNICIPALITY (BOSNIA AND HERZEGOVINA)

Amna BIJEDIĆ¹, Alma MIČIJEVIĆ¹, Harun KURTAGIĆ¹, Hanadija OMANOVIĆ^{1*}

¹Agro Mediterranean faculty, Dzemal Bijedic University of Mostar

*Corresponding author: hanadija.omanovic@unmo.ba

Abstract

The goal of this paper is to conduct a comparative analysis of physical and chemical characteristics of honey in the area of Gorazde municipality, Bosnia and Herzegovina. Sampling of honey was carried out by random selection of three producers of honey from Gorazde. Physical and chemical analyses were conducted on three types of honey: floral, meadow and forest honey. Physical and chemical analyses have included following parameters: level of water by drying method, level of ashes, conductometric level of reduced sugar according to Luft-Schoorl, level of sucrose according to Luft-Schoorl and level of free acids in terms of volumetry. All parameters were given in percentages and they are compared with the existing Rulebook. The obtained results show that all three analyzed samples of honey have the necessary quality. The conclusion is that, in the period of analysis, the controlled samples have shown the necessary safety and they are in accordance with the regulations of existing Rulebook on honey and other bee products (Official Gazette of Bosnia and Herzegovina, No 37/09).

Keywords: *Honey, physical and chemical analyses, quality.*

Introduction

Since the beginning of man to this day, his diet includes honey as a foodstuff but as well as a medicine. Men have always had great respect for the bee products. With time, scientific achievements have enabled organized honey production based on contemporary processes with permanent presence of development and progress in the quality of final bee product.

Honey is a foodstuff that cannot be produced artificially. Honey is completely natural product what can be used directly from the beehive in its natural form in which it was made from bees. The main chemical ingredients of honey are: 38.19% fructose, glucose 31.28%, 1.31% sucrose, maltose and disaccharides 7.31%, 17.20% water, acid 0.57%, 0.26% protein, ash 0.17% and the other the different components of 2.21%. (Čondić, 2003)

In many European countries, the average consumption of honey is 7-10 grams per day(Wong, 2001).

Honey is also functional food. These characteristics are based on its antibacterial quality, i.e. it has bactericidal and bacteriostatic effect on the majority gram positive bacteria. Antibacterial quality of honey depends on its botanic origin. High content of sugar in honey and low quality Ph are increasing antibacterial quality in honey.

Gorazde is a suitable area for development of vegetable and fruit growing, animal husbandry, farming and beekeeping based on its geographical position, hydro graphic, relief and other characteristic.

There are significant conditions in the area of Gorazde municipality for development of

beekeeping thanks to its rich flora and honey plants on big meadows and there is a significant number of beehives at this location. The production of honey is very important in Gorazde municipality and 104 tons were produced only in 2013. The placement of honey is difficult and uncertain due to nonexistence of organized purchase and sale. Therefore the placement is reduced to individual attempts and activities. The area of Gorazde municipality had cca 8050 beehives in 2013.

The goal of this paper was to examine physical and chemical characteristics of three different types of honey produced by three different producers from the area of Gorazde and compare the results with parameters given in the existing Rulebook and assess its acceptability for future potential consumers on free market with the presentation of the results of chemical analysis in tables.

Material and Methods

The sampling was carried out by the producers of three different types of honey. Sample no. 1 was floral honey, sample no. 2 meadow honey and sample no. 3 forest honey in 2015 in the area of Gorazde. The physical and chemical analyses included the following parameters:

Water content (%) - the method of drying,

Ash content (%) - conductometric method,

Content of reducing sugars %, -method by Luft-Schoorl,

Content of sucrose in% - the method by Luft-Schoorl and

Content of free acids in millimoles/kg by volumetric method

The analyses were carried out according to the methods in Rulebook on methods for control of honey and other bee products. The content of moisture was determined by gravimetric drying method on 100°C – 105°C. The measuring was carried out on analytic beam balance Sartorius BP 110S.

Electric conductivity at 20°C was determined with conductometre Eutech Instruments Con 110) by using a water solution of honey (the amount of honey was equivalent to 20 grams of dry honey matter dissolved in 100 ml of distilled water).

The content of mineral material was determined in solution, right after measurement of electric conductivity, by transferring in TDS (Total dissolved solids) way of working on Eutech Instruments – Cyberscan con 110 instrument.

Determination of sugar was carried out by using Luff – Schrool method. The method is based on the principle that in a certain conditions reduced sugar (natural invert) transforms Cu^{2+} ions into Cu^{+} ions. Unused amount of Cu^{2+} ions rerites with the solution of sodium tiosulfate. From the difference of spent for blind experiment and the real test, we can see the amount of sugar from the table that shows correlation between the reagent spent and the amount of sugar. Non-reduced disaccharide (sucrose) must be previously inverted, i.e. hydrolysed to reduced monosaccharide with acid, after we re-determine the sugars with Luff reagent. In this way, we receive the data regarding the total amount of sugar in the analysed sample.

Method principle to determine reduced sugar is based on reduction of Fehling' solution at the boiling point by titration with solution of reduced honey sugar and by using methylene blue as an indicator.

Determining the sucrose was carried out according to the Rulebook on methods for control of honey and other bee products and it is calculated as a difference in content of reduced sugar before and after hydrolyse, multiplied by factor 0,95.

The free acidity is determined by titration of a standard solution of sodium hydroxide with phenolphthalein as an indicator.

Third year students of Agro Mediterranean faculty in Mostar carried out organoleptic analysis. A commission, that meets the conditions foreseen for analysis of raw material, was formed i.e. they were all introduced to the material they were analysing, theoretically – what conditions honey must meet in terms of foodstuff on the market. They were all in good health and mentally stable. They formed the commission of nine members.

Results and Discussion

Physical and chemical analyses on samples of meadow, floral and forest honey from the area of Gorazde were carried out at federal Institute for agriculture in Sarajevo and Agro Mediterranean faculty of Dzemal Bijedic University of Mostar. The obtained analyses results of content of sugar, ash, sucrose and free acids are compared to the parameters in existing Rulebook on honey and other bee products (Official Gazette of Bosnia and Herzegovina No. 37/09) and in that way we have created the complete image regarding the quality of the very product.

Table 1. Results of the physical and chemical analyses – sample no. 1 (Floral honey)

Parameter	Analysis result	Rulebook value
Water content (%)	13,38	< 20
Ash content (%)	0,420	< 0,6
Reduced sugar content (/%)	73,56	>60
Sucrose content (%)	5,32	< 5
Free acids content (milimol/kg)	20,0	< 50

In Table 1, the obtained results of chemical analysis are compared to allowed parameters according to existing Rulebook. They show that the content of water, ash, reduced sugar and content of free acids within the allowed parameters.

Analysed parameter of sucrose content shows a deviation from the allowed level of sucrose content i.e. the obtained results are somewhat increased (for 0,32%)

Table 2. Results of the physical and chemical analyses – sample no.2 (Meadow honey)

Parameter	Analysis result	Rulebook
Water content (%)	13,93	< 20
Ash content	0,339	< 0,6
Reduced sugar content	72,48	>60
Sucrose content	2,57	< 5
Free acid content	26,0	< 50

Obtained results of physical and chemical analysis carried out on sample no. 2 show that all analysed parameters are in keeping with existing Rulebook on honey and other bee products (Official Gazette of Bosnia and Herzegovina No. 37/09)

Table 3. Results of the physical and chemical analyse – sample no.3(Forest honey)

Parameter	Analysis results	Rulebook
Water content	13,97	< 20
Ash content	0,478	< 0,6
Reduced sugar content	70,86	>60
Sucrose content	5,83	< 5
Free acid content	28,0	< 50

Obtained results of physical and chemical analysis carried out on sample no. 3, similar to sample no. 1 show that analysed parameters of content of water, ash, reduced sugar and free acids are within the allowed concentrations while there is a deviation from the existing Rulebook with content of sucrose that should not be higher than 5 while the obtained result is 5,83%

Organoleptic analysis of all three analysed honey samples we have determined the colour, consistency and taste. We have reached the following conclusions:

- They have thick – liquid consistency
- That it is ripe and it is not in condition of fermentation or mouldiness
- That it has an aroma and taste characteristic to honey without an outside aroma or taste
- That it has no outside ingredients
- That it is not infected by insects or their parts

Conclusions

The results obtained with sample no. 1 and sample no. 3 show a mild deviation in terms of sucrose content what is not in line with the allowed foreseen concentrations stipulated by the Rulebook, while all other analysed parameters (content of water, ash, reduced sugar and free acids) were in line with the existing Rulebook.

Obtained results of physical and chemical analyses of all analysed parameters with sample no. 2 were in line with existing Rulebook and as such it can be placed on the market and made available to consumers as a high quality product in both chemical and organoleptic terms.

All three analysed honeys are a product of self-organized producers in the area of Gorazde. obtained results show that all three analysed samples in the majority of examined parameters are within allowed concentration limits. Sample no. 2 stands out in terms of quality i.e. all technological processes production of honey are in line with existing Rulebook.

Refernces

- Batinić K. (2014) Rulebook on honey, Federal agro Mediterranean institute Mostar
- Čondić, Z. (2003): The bees returned me back health, treat by bee products Tuzla
- Rulebook on honey and other bee products Official Gazette of Bosnia and Herzegovina No. 37/09,
- Trajković J. (1983). Analysis of foodstuff Technology and food science faculty, Belgrade
- Wong J.L.G., Thornber K., Baker N. (2001) Resource assesment of non-wood forest products: Experience and biometric principles / CD-Rom inside.-Rome: FAO, 109 pp.-(Non-Wood Forest Products N13).

VARIABILITY OF GRAIN MASS PER SPIKE IN CULTIVARS OF TRITICALE (*X TRITICOSECALE* WITTM.)

Desimir KNEZEVIC¹, Gordana BRANKOVIC², Danijela KONDIC³, Sretenka SRDIC³,
Veselinka ZECEVIC⁴, Mirela MATKOVIC⁴, Srdjan ATANASIJEVIC⁵

¹University of Pristina, Faculty of Agriculture, Kosovska Mitrovica- Lešak, Kosovo&Metohia, Serbia,

²University of Belgrade, Faculty of Agriculture Belgrade, Serbia

³University of Banja Luka, Faculty of Agriculture, Republic of Srpska, Bosnia and Herzegovina

⁴University "John Naisbitt" Belgrade, Faculty of Biofarming, Bačka Topola, Serbia

⁵Technical College of Professional Studies, Dept. Inform., R. Domanovica 12, Kragujevac, Serbia

*Corresponding author: deskoa@ptt.rs

Abstract

Triticale is a cereal species created by crossing the wheat and rye species. It is characterized by good quality and high yielding capacity which is specific for wheat and high tolerance to abiotic and biotic stress factors which is specific for rye. The high yield potential of triticale is determined by genetics and influenced by environmental factors. The aim of the paper is to present the results obtained at different triticale varieties under different climatic conditions regarding the grain mass spike⁻¹. Five triticale (*xTriticosecale* Wittm.) cultivars (KG 20, Bolero, Rtanj, Odisej and Bogoj) were investigated in field experiment which was conducted as a randomised block design in five replications on 5m² size of unit plot, during three years period (2010-2013). In full stage of maturity 100 plants (20 plants per replication) were used for analysis of grain mass spike⁻¹. Obtained results for grain mass spike⁻¹ showed significant differences among studied triticale cultivars, years of experiment and interaction genotype/year. The average value of grain mass spike⁻¹ for all three years and all five tested cultivar of triticale was 2.28g. The cultivar Bolero had the lowest average value (2.15g) and Odisej the highest value (2.52g) of grain mass spike⁻¹ in average for three years period.

Keywords: *grain mass, spike, triticale, cultivars*

Introduction

Triticale is highly productive cereal species which use for planting as alternative to other cereals in region where growing conditions are unfavorable or in low-input systems (Erekul and Köln, 2006; Jelić et al., 2007). Triticale is, in general, more tolerant to environmental stresses than wheat and barley. Breeding for marginal areas (acidic or alkali soils), phosphorus deficiency, micro-elements deficiencies (Cu, Zn, Mg) or toxicity (boron) and drought stress in the arid and semi-arid zones is the important task of breeding programs in the world (Oettler, 2005; Knezevic et al., 2010). By breeding was increased grain yield, improved resistance to disease and optimized morphological traits and grain protein composition (Hernández, 2001). Triticale can be used for different purpose as animal and human food (Zečević et al., 2007; Martinek et al., 2008). Flour of triticale very often use to replace soft wheat flour in mixtures for breads, cakes or cookies (Bağcı, 2005; Zecevic et al. 2005). The grain mass spike⁻¹ is important factor for grain yield which have positive association with grain number spike⁻¹ and with yield (Yanbeyi et al., 2006). Except, grain mass spike⁻¹, the numerous morphometric components (plant height, tillering, grain number spike⁻¹, thousand grain mass, hectoliter mass, etc.) have contribute to total

grain yield. Response of genotypes on different environmental conditions is a good way for estimation which genotypes is more adaptive to specific area for growing (Kirchev et al., 2014). The formation of grain yield varied under the influence of environmental factors (temperature, precipitation). Grain yield depends of variations of precipitation in critical months. Triticale breeding programs are focused on increasing grain yield, biomass yield, earliness, grain filling percentage as well nutritional quality (Grabovets and Popova, 2015; Moskalets et al., 2016). The strong interaction between genotype/environment require the creation of varieties with specific adaptability to climatic conditions both favorable and unfavorable (Zečević et al., 2010). For improvement of spike traits, grain yield and yield components depends on the amount of nitrogen nutrition (Kirchev et al., 2006; Madic et al., 2015) and that require study to optimize measure of technology growing (Jelić et al., 2007) in different area of triticale production, considering the climate change. The changes of environmental conditions as well climate in recent years emphasized the extreme variations, with consequences on the agricultural production (Zečević et al., 2010).

The aim of this paper is study of variability of grain mass spike-1, in five genetically divergent winter triticale cultivars influenced by different environmental conditions.

Material and Methods

The five cultivars of triticale (KG 20, Bolero, Rtanj, Odisej and Bogo) were included for investigation variability of grain mass spike⁻¹. Field experiment was set up as a randomised block design in five replications on 5m⁻² size of unit plot, which carried out in three growing season (2010/11, 2011/2012 and 2012/2013). The experiment conducted on the soil type pseudogley which characterized acidic pH (pH_{H2O} = 4.1) and the following content: humus 2.36%, readily available phosphorus 7.8 mg 100⁻¹ g soil and potassium 14.3 mg 100⁻¹ g soil. In full stage of maturity of 100 plants (20 plants per replication) were used for analysis of grain mass spike⁻¹. The analysis of variance was computed according to randomize complete block design with two factors: A (cultivars), B (year) and using ANOVA (MSTAT-C program, 1989). The significant differences among the means were estimated by least significant difference (LSD) test (Hadživukovic, 1991). Components of variance (genetic, interaction and environment) were computed by Falconer (1981).

Climatic conditions during growing seasons

In the years of experiment the values of temperature and precipitation were different. Also, those values in comparison with computed average values for 10 previous years were different (tab. 1). In the first year the average temperatures (8.74°C) were similar to average of ten years period (9.08°C) and in second (8.13°C) were in average slightly lower than in first year and ten year period, while in third year of experiment (2012/13) average value of temperature (9.73°C) was higher than in other year of experiment and average temperature for ten years period. In the first year 2010/11 the amount of precipitation (520.5mm) was higher than in second 2011/12 (474.7mm) year, while in the third year 2012/13 was the highest amount of precipitation (611.5mm). The average value of precipitation in the first and second year of experiment was lower, while in the third year was higher than average value of precipitation for ten year period (2000-2010). Amounts of precipitation in the first and third years was higher and suitable up to the June in the stage of ripening plant. The precipitation in the second year in the period of emerging (November) was extremely low, while from December to June distribution of precipitation was suitable at each stage of development, while the low amount of precipitation in June (17.8mm) at the stage of grain filling. This precipitation was suitable for seed maturity

phase, and was lower for 52.9mm than in first year, 136.85mm than in the third year and for 74.4mm lower than in ten years average values.

Table 1. Monthly and mean temperatures and monthly and cumulative precipitation

Month	Temperature °C				Precipitation (mm)			
	2010/11	2011/12	2012/13	2001-2010	2010/11	2011/12	2012/13	2001-2010
October	9.2	10.4	13.7	12.2	93.6	30.4	56.7	64.3
November	11.1	3.2	9.1	7.0	34.1	1.7	11.1	57.4
December	2.7	3.3	0.4	2.0	64.9	63.7	97.6	48.5
January	0.3	-0.1	2.9	0.9	28.1	107.1	62.4	42.8
February	0.6	-4.2	4.0	2.4	59.2	54.9	84.3	44.7
March	6.6	8.8	6.4	7.6	48.9	24.5	102.0	52.5
April	12.2	12.7	13.3	12.0	37.1	69.1	41.2	66.6
May	15.6	16.0	18.0	17.2	82.9	105.5	70.8	74.9
June	20.4	23.1	19.8	20.4	71.7	17.8	85.4	92.2
Average	8.74	8.13	9.73	9.08	57.8	52.7	67.94	60.4
Total	78.7	73.2	87.6	81.7	520.5	474.7	611.5	543.8

Results and discussion

The analysis of grain mass spike-1 showed differences among cultivars as well for the same cultivars depends of year. Under specific environmental conditions of experimental season 2010/11 the grain mass spike-1 varied between 2.12g (KG 20) and 2.49g (Odisej) with an average value for five investigated cultivars of 2.29g. The values for grain mass spike-1 in 2011/12 varied between 2.08g (Bolero) and 2.26g (Odisej and KG20) with average value for all five cultivars of 2.20g. In the climatic year conditions of 2012/13 grain mass spike-1 varied between 2.13g (KG20) and 2.81g (Odisej) with an average value for five investigated cultivars of 2.34g. The average value of grain mass spike-1 for all three years and all five tested cultivar of triticale was 2.28g and variation value of grain mass spike-1 was between 2.15g (Bolero) and 2.52g (Odisej) table 2.

The results for grain mass spike-1 in this research were similar to obtained value of grain weight (ranged from 1.94 to 2.58g) for triticale lines, reported by Dogan et al., (2009) and similar to research (Giunta et al., 2004; Kociuba et al., 2010). However, values of grain mass spike-1 in this study is higher to obtained values in investigation (Pochișcanu, et al., 2013; Gerdzikova, 2014). Also, different values of grain mass spike-1 in comparison to our investigation were found in other studies Atak et al. (2006), Yanbeyi et al. (2006) and Akgun et al. (2007). These differences may arise from different ecological conditions in which different researcher were conducted.

The better climatic conditions of 2012/13 compared to 2011/12, especially concerning the much better water supply from precipitation, determined a significant increase in the grain mass spike-1 at analyzed triticale cultivars. Except of genotype specificity, higher amount of precipitation in first (520.5mm) and third (611.5mm) year in relation to second year of experiment (474.7mm) have influence to efficient grain filling as well higher grain mass spike-1.

The investigation (Hernández, 2001) showed that under good rainfed condition (~ 700mm) triticale has 15% higher grain yield than wheat, or approximately three fold higher than under low (~300mm) rainfed condition. This advantage is much larger under dry and marginal conditions. Also, physiological-genetic variable have influence on the variations of yield among crop plant genotypes and has been linked to stomatal conductance and assimilation. Productive genotypes which also sustain growth and yield under variable moisture and temperature conditions express higher stomatal conductance and gas exchange (Horie et al. 2006; Blum 2011; Reynolds et al., 2012; Blum, 2013; Wang et al., 2014).

Table 2. Mean values for grain mass spike⁻¹ of triticale cultivars in different growing seasons

Genotype	grains mass spike ⁻¹ (g)			
	Year			Average
	2010/11	2011/12	2012/13	
KG 20	2.12gh	2.26cde	2.13fgh	2.17c
Bolero	2.19efgh	2.08h	2.20defg	2.15c
Rtanj	2.34c	2.20defg	2.24cdef	2.26b
Odisej	2.49b	2.26cde	2.81a	2.52a
Bogo	2.31cd	2.20defg	2.34c	2.28b
Average	2.29	2.20	2.34	2.28

Distinct letters in the row indicate significant differences according to LSD test ($P \leq 0.05$).

Through the analysis of variance highly significant differences were determined among grains mass spike⁻¹ of different genotypes ($F=59.017^{**}$), then among years of research ($F=23,523^{**}$), and their interactions as well ($F=16.406^{**}$), table 3. Differences among cultivars of triticale according to grain mass spike⁻¹ influenced with genetic specificity and different regime of temperature and precipitation during vegetative period in experimental years. It means that grain mass spike⁻¹ is highly depended on genetic and interaction genetic/environmental factors.

Table 3. Analysis of variance for grain mass spike⁻¹ (g)

Source of variance	Degree of freedom (DF)	Mean square (MS)	F-test	LSD		Components of variance	
				0.05	0.01	σ^2	%
Repetitions (R)	4	0.002	0.401 ^{ns}	-	-	-	-
Genotypes (G)	4	0.326	59.017* *	0.0785	0.1302	0.016	39.03
Year (Y)	2	0.130	23.523* *	0.0943	0.2174	0.002	4.88
Interaction (GxY)	8	0.091	16.406* *	0.1130	0.1644	0.017	41.46
Error	56	0.006	-	-	-	0.006	14.63
Total	74	-	-	-	-	0.041	100.00

* Significant at $P = 0.05$ level; ** significant at $P = 0.01$ level

The investigated genotypes of triticale expressed significant differences for the average values of grain mass spike⁻¹ in different year of growing that indicates on diversity of examined genotypes. Variability of grain mass spike⁻¹ depended on investigated genotypes and year as well what is in agreement of investigation. These findings are in agreement with previous study (Knezevic et al., 2010; Kondić et al., 2012; Madic et al., 2015). For increasing grain mass spike⁻¹ the important role have morphological and anatomical structure of plants and their organs (Kondić et al., 2012).

Conclusion

The analyzed triticale cultivars showed differences in average values of grain mass spike⁻¹ what indicates that these genotypes are specific. The cultivars examined in this study had different

values of grain mass spike⁻¹ in the years of examination what indicates different reaction of a investigated cultivars to different conditions during its development. The expression of variability of grain mass spike⁻¹ were influenced by genetic and environmental factor. The effect of genetic factor and interaction of genetic/environmental was highly significant. The largest impact of environmental factor (annual and monthly average value of temperature, precipitation) with 41.46% and the genotypes with 39.03% of variance. Promising genotypes for use in the breeding process are those that have expressed the stability of mass of spike in different climate with high average values, and among them are the cultivar Odisej and Bogo. The grain mass spike⁻¹ was different for the analyzed triticale cultivars and play important role in forming of grain yield. However, increasing of genetic potential of grain yield is achievable through improvement of other quantitative characteristics, as well as increase of the size and capacity of spike as well as improvement of anatomical structure of spike. The phenotypic variability is possible to identify which genotype could be involved in future triticale breeding programs.

Acknowledgements

This investigation supported by Ministry of Education, Science and Technology Development of Republic of Serbia, Project TR 31092.

References

- Akgun, I., Kaya, M., Altindal, D. (2007). Determination of yield and yield components in some triticale lines/genotypes under isparta ecological conditions. J Fac. Agric., Akdeniz Univ. 20(2), 171-182.
- Atak, M., Kaya, M., Ciftci, C. Y., Unver, S. (2006). Effect of seeding rates on yield and some yield components of Triticale (X *Triticosecale* Wittmack) genotypes. J.Nat.Appl.Sci.10(1), 40-47
- Bagci, S. A., M. Keser, S. Taner and T. Tasyurek, (2004). Triticale in Turkey, Triticale improvement and production, FAO Plant Production and Protection Paper, pp.149-154
- Blum, A. (2011). Plant Breeding for Water Limited Environments. Springer, NY, USA, 258 pp.
- Dogan, R., Kacar, O., Nazan Coplu, N., Azkan, N. (2009). Characteristics of new breeding lines of triticale. African Journal of Agricultural Research Vol. 4 (2), pp. 133-138.
- Ereku O, Kohn W (2006). Effect of weather and soil conditions on yield components and bread-making quality of winter wheat (*Triticum aestivum* L.) and winter triticale (*Triticosecale* Wittm) varieties in North-East Germany, J. Agron. Crops Sci. 192, 452- 464.
- Falconer D. S. (1981): Introduction to quantitative genetics. Longwan, London and New York.
- Grabovets, A. I. and Popova, O. G. (2015). Breeding of winter triticale for use in confectionery production. Russian Agricultural Sciences, 41(6), 411-414.
- Gerdzhikova, M. (2014). Influence of N fertilization and predecessors on Triticale yield structure characteristics. Turkish J. of Agricultural and Natural Sciences Spec Issue: 2, 1922-1932.
- Giunta, F. and Motzo, R. (2004). Sowing rate and cultivar affect total biomass and grain yield of spring Triticale (x *Triticosecale* Wittmack) grown in a Mediterranean-type environment. Field Crops Res. 87, 179-193.
- Hernández, S.A. (2001). Experiencias en el mejoramiento y difusion del triticale desde 1996 en el INIA CIMMYT, INIFAP e ICAMEX.
- Hadživukovic S. (1991): Statisticki metodi. Drugo prošireno izdanje. Radnicki univerzitet "Radivoj Cirpanov", Novi Sad.

- Horie, T., Shoji, M., Toshiyuki, T., Kouhei, K., Akihiro, O., Tatsuhiko, S. (2006). Genotypic difference in canopy diffusive conductance measured by a new remote-sensing method and its association with the difference in rice yield potential. *Plant Cell Environ.* 29, 653–660.
- Ion, V., Temocico, G., Băşa, A.G. (2016). Influence of different factors on some biometrical traits at triticale. *Scientific Papers Series Management, Economic Engineering in Agric. and Rural Develop.* 16(1), 221-226.
- Ivanova, A. and Kirchev, H. (2014). Agronomy performance of new triticale varieties (*xTriticosecale* Wittm.) grown under different regions. *Global J. of Sci. Res.*, 2(3), 71-75.
- Jelić, M., Đalović, I., Savić N., Knežević, D. (2007). Influence of seed rate and dose of nitrogen fertilizer on yield and quality of grain in forage winter barley and oats. *Review of research work of the Institute of Field and Vegetable Crops, Novi Sad* 44(1), 481-486./in Serbian/
- Kociuba, W., Mađry, W., Kraamek, A., Ukalski Kryzsztof, Studnicki, M. (2010). Multivariate diversity of Polish winter triticale cultivars for spike and other traits. *Plant Breeding and Seed Science*, 62, DOI:10.2478/v10129-011-0003-4.
- Kirchev, H., Penkov, D., Terziev, G., Tonev T. (2006). Energy productivity of triticale varieties depending on growing conditions and nitrogen fertilization. *Field Crops Studies*, 3, 289-295 (Bg).
- Kirchev, H., Delibaltova, V., Matev, A., Kolev, T., Yanchev, I. (2014). Analysis of productivity of triticale varieties grown in Thrace and Dobrudja depending on nitrogen fertilization. *Journal of Mountain Agriculture on the Balkans*, 17(2), 328-335.
- Knezevic, D., Zecevic, V., Jelic, M., Paunovic, A., Madic, M. (2010). The effect of mineral nutrition on weediness and grain yield of triticale. *Növénytermelés, suppl.* 59, 513-516
- Kondic, D., Knežević, D., Paunovic, A. (2012). Grain weight of genotypes of triticale (*X Triticosecale Wittmack*) in agroecological conditions of Banja Luka. *Genetika*, 44(2), 419 -428
- Madic, M., Đurovic, D., Paunovic, A., Jelic, M., Knežević, D., Govedarica, B. (2015). Effect of nitrogen fertilizer on grain weight per spike in triticale under conditions of central Serbia. *Sixth International Scientific Agricultural Symposium "Agrosym 2015", Jahorina, Bosnia and Herzegovina, October 15-18, 2015. Book of Proceedings 2015*, 483-487.
- Moskalets, T. Z., Vasykivskiy, S. P., Morgun, B. V., Moskalets, V. I., Moscalets, V. V., Rybalchenko, V. K. (2016). New genotypes and technological indicators of winter triticale. *Biotechnologia Acta*, 9(1), 79-86.
- Martinek, P., Vinterová, M., Burešová, I., Vyhnánek, T. (2008). Agronomic and quality characteristics of triticale (*X Triticosecale* Wittmack) with HMW glutenin subunits 5+10. *J. of Cereal Sci.*, 47, 68-78.
- Oettler G (2005). The fortune of a botanical curiosity – Triticale : past, present and future. *J. Agric. Sci.* 143, 329-346.
- Pochișcanu, S.F., Buburuz, A., Pomohaci, T., Leonte, A., Naie, M. (2013). Behavior of some romanian triticale varieties in the climatic conditions of the center of Moldavia, Romania. *Cercetări Agronomice în Moldova*, XLVI, 4 (156), 13-20.
- Reynolds, M.P., Pask, A.J.D., Mullan, D.M. (eds) (2012). *Physiological Breeding I: Interdisciplinary Approaches to Improve Crop Adaptation*. CIMMYT, Mexico, D.F.
- Zecevic, V., Knezevic, D., Micanovic, D. (2005). Bread making quality of wheat-triticale flour blends. *Journal of Yugoslav society for power machines, tractors and maintenance - Tractors and machinery* 10 (2), 448-453.
- Zečević, V., Knežević, D., Mićanović, D. (2007). Technological quality of triticale. „Multifunctional agriculture and rural development“- saving of rural values. *Thematic review*, 2, 1151-1159. /in Serbian/

- Zečević, V., Knežević, D., Bošković, J., Milenković, S. (2010). Effect of nitrogen and ecological factors on quality of winter triticale cultivars. *Genetika-Belgrade*, 42 (3), 465-474.
- Yanbeyi S, Sezer, I. (2006). A research on yield and yield component of some Triticale lines in Samsun ecological conditions. *J. Fac. Agric. OMU*, 21(1), 33-39.
- Wang, Y., Noguchi, K., Ono, N., Inoue, S-I., Terashima, I., Kinoshita, T. (2014). Overexpression of plasma membrane H⁺-ATPase in guard cells promotes light-induced stomatal opening and enhances plant growth. *Proc. Nat. Acad. Sci.* 111, 533–538.

APPLICATION OF MEASURING TECHNIQUES IN TESTING MACHINES FOR THE PROTECTION OF PLANTS IN THE REPUBLIC OF SERBIA

Dragoslav DJOKIĆ^{1*}, Jordan MARKOVIĆ¹, Jasmina MILENKOVIĆ¹, Dragan TERZIĆ¹, Rade STANISAVLJEVIĆ², Saša BARAĆ³, Ranko KOPRIVICA⁴

¹Institute for Forage Crops, 37251 Globoder-Kruševac, Serbia

²Institute for Plant Protection and Environment, 11000 Belgrade, Teodora Draljzera 9, Serbia

³University of Priština, Faculty of Agronomy - Priština/Lešak, 38219, Kopaonička bb, Serbia

⁴University of Kragujevac, Faculty of Agronomy 32000 Čačak, Cara Dušana 34, Serbia

*Corresponding author: dragoslav.djokic@ikbks.com

Abstract

The main task of modern agriculture is the production of safe food. Testing of plant protection machines began in the late nineties in the European Union (EU). Using correct and adjusted machines for the application of pesticides, in favorable weather conditions, increases the effect of protection, and reduce losses of pesticides and toxic contamination of environment. The adoption of relevant legislation in this field is expected in the future because of the desired entry of Serbia into the EU. Current situation in Serbia is such that the percentage of sprayers in operation over ten years is 82%. Crop protection machines are not tested, and also testing of new machines in operation are mostly not implemented. Mostly operate machinery manufacturers that did not have some sort of the training. Plant Protection Department of the Ministry of Agriculture and Environment of the Republic of Serbia, in accordance with European Parliament Directive 2009/128 / EC and 2006/42 / EC, establishes a framework for the control of sprayers and mistblowers. These directives are becoming significant in Serbia, with joining Serbia to the EU. The introduction of Hazard Analysis Critical Control Points (HACCP) and Global Good Agricultural Practices (Global G.A.P.) standards in agricultural production guarantees the health safety of products, as well as the absence of pesticide residues. This is important especially for fresh fruits and vegetables. This allows farmers to export their health safe products on the EU market, which should fulfill all the conditions set by the "Global G.A.P." standards.

Key words: *measurement techniques, sprayers, mistblowers, plant protection.*

Introduction

In agriculture pests and diseases of agricultural crops, as well as weeds, every year cause significant losses in yield, quality, and sometimes can completely destroy agricultural products. In practice, there are many ways and methods to control harmful organisms, weeds and diseases. One of the most effective ways to fight both for preventive protection against disease, and pest and weed control is chemical way. This method is used by numerous and different chemical compounds, which are called by the general name of pesticides (Urošević, 2001). In modern agriculture the chemical method of protection is now the primary means of plant protection. The quality of treatment machines for pesticides application is closely related to adjustment, technical solution and modernity machines, which affect the accuracy of distribution, dosing accuracy and size of losses (Bugarin et al., 2010;. Srivastava, 2014). The main task of mechanizing protection, which is performed on larger areas with sprayers is to provide a uniform vertical distribution of fluids with precise dosing of individual zones with the least possible losses on land in the air, in

order to preserve the environment (Bugarin et al., 2008). In recent years in Serbia have increased the area under orchards. Particular attention in the care of orchards deserves the protection against diseases and pests. Chemical protection of orchards is usually performed with mistblowers. Class and type of mistblowers affects the quality of work, but also the efficacy of pesticides. If pesticides are not applied appropriately in 60% of cases may be the cause of the inefficiency of the preparation and of the same harmful effects on operator, animals and the environment (Sedlar et al., 2008; Sedlar et al., 2014). On the uniformity of sprayers distribution affect the way the disintegration of the working fluid. Uniformity of distribution describes the coefficient of variation expressed in percentages and it is very important for the quality and efficiency of plant protection from diseases and pests and desiccation (Višacki et al., 2014). The most important factor in machine protection products are nozzles. They perform important functions such as failure to specify the quantity of liquid per unit time, making disperse liquid droplets of appropriate size and form (Tadić et al., 2014; Bajkin et al., 2014). In the Republic of Serbia in the category "attachable unit" there was a total of 138.084 sprayers and 17.281 mistblowers (Radivojević, 2014). In 1999., in the Republic of Serbia adopted the Law on the provision of services in the field of plant protection which provides for mandatory verification sprayer and mistblowers, as well as the Plant Protection Act. The adopted laws are in accordance with EU 91/414 EEC and refer to control sprinklers mandatory and assisted sprayers (Koprivica et al., 2015). The EU introduced regulations, required inspection of technical means of plant protection directive 2009/128 / EC and 2006/42 / EC, which is the basis of the standard EN 13790 (Banaj et al., 2014; Djokic et al., 2015). Three main arguments for periodic inspection testing machine for the application of pesticides in use are: improving the safety of workers who apply pesticides (operators) and other workers (those who enter treated areas to perform certain activities); reducing the potential risk of environmental pollution by pesticides; efficient control of harmful organisms, with minimal application of pesticides. Equipment for pesticide application must meet all the important aspects that have achieved a high level of environmental and human health. Full effectiveness of the application ensured proper handling and operation of equipment. Control sprayer and assisted sprayers that are used in EU member states is required since 2009, with the entry into force of the Directive on the sustainable use of pesticides (2008/128 EC).

In the Republic of Serbia in 2015. and 2016. control is voluntary and free, and in 2017 began regular review. Testing accuracy of machines for plant protection products is carried out in accordance with the norm EN 13790, which prescribes methods and equipment for control. Control stations in Serbia are equipped with the latest technology to control. In Serbia there are two central laboratories in agricultural universities in Belgrade and Novi Sad, as well as 31 other regional laboratories in universities, institutes, agricultural stations and schools. Institute for forage crops in Globoder-Kruševac is responsible for testing the protection of plants in Rasina district.

The aim of this study was to carry out a practical test sprayer and measuring the pressure and flow to multiple types of agricultural sprayer to determine the accuracy and uniformity of flow nozzles.

Experiment was done during the month of June in the Rasina region and a control station in Institute for forage crops in Kruševac-Globoder (Serbia). Testing of sprayer, nozzles, manometers, and the uniformity of flow to nozzles with flow measurement, was carried out. Testing was done in three repetitions, three different types of sprayers (I, II, III), and the two modes of operation. Flow measurement is carried out at a pressure of 3 bar and PTO speeds of 540 min^{-1} . Also, the flow at lower rpm PTO 300 min^{-1} , which corresponding to 840 min^{-1} engines

for tractors IMT 539. Sprayer tip I is mounted sprayer manufacturer "Agromehanika" from Kranj. The capacity of the pump sprayer was 60 l min^{-1} , a tank volume of fluid was 400 l. Sprayer type II is mounted by "Morava" from Požarevac tank volume was 330 l. Sprayer type III is carried crop sprayer with capacity of 400 l from manufacturer "Fischer" from Switzerland. Number of nozzles is different and depends on the type of sprayer. Ranged from 19 (I) 16 (II) 22 and (III). We used measurement equipment manufacturer AAMS Salvarani: examiner individual nozzles S001, control pressure gauge "Wika" and the examiner pumps. AAMS Salvarani Nozzle Flow Rate Tester S001 (Figure 1) is a device that defines the flow of all types of nozzles, accuracy class 1%. It is used as a handheld portable device, and it is designed for fast and precise control characteristics of the nozzles. If measurement determines that the flow nozzles deviate by more than $\pm 10\%$ of tablet value in a particular operating pressure, according to EU standards, such nozzles should be removed from use.



Figure 1. Nozzle Flow Rate Tester S001- AAMS-SALVARANI

AAMS Salvarani Pumptester and flowmeter (Figure 2) is used to determine the actual capacity of the pump at different pressures. It is equipped with inductive flow sensor and an electronic pressure sensor. Both sensors are connected to the monitor that continuously displays the pressure and flow rate.



Figure 2. Pumptester and flowmeter- AAMS-SALVARANI

Results and discussion

The Table 1 shows the average value of three repetitions and three different types of sprayers (I, II, III). Overall, sprayer type I had the lowest average value of the flow of fluids (at 300 min⁻¹ 0.779 l min⁻¹ and at 540 min⁻¹ 0.846 l min⁻¹) with the smallest variations in both RPM PTO as indicated by the lowest coefficient of variation (CV = 5,662% and in the average value of flow rate of 0.846 l min⁻¹ CV = 6.587%). It is evident that the type sprayers III had the highest average value in both RPM PTO rate (at PTO 300 min⁻¹ 1,253 l min⁻¹ and at 540 min⁻¹ 2,437 l min⁻¹). Sprayer type II as measured by these indicators had the biggest variation (CV = 57.16% for speed revolution of 300 min⁻¹ and CV = 57.95% for 540 min⁻¹).

Table 1. The flow of the working fluid crop sprayers

Number of nozzles	The flow of the working fluid crop sprayers (l min ⁻¹)					
	The type of sprayers					
	I		II		III	
	Number of PTO (min ⁻¹)					
	300	540	300	540	300	540
1.	0,769	0,826	0,521	0,750	1,389	3,355
2.	0,856	0,997	0,711	0,881	1,193	1,323
3.	0,754	0,774	0,601	0,695	0,529	1,023
4.	0,751	0,807	0,760	0,816	1,158	2,068
5.	0,803	0,850	1,512	1,939	1,251	2,056
6.	0,865	0,915	0,599	0,708	0,534	1,998
7.	0,796	0,857	0,797	0,904	1,234	2,002
8.	0,797	0,870	0,603	0,692	1,228	1,884
9.	0,774	0,800	0,615	0,674	1,371	1,897
10.	0,768	0,803	1,949	2,386	1,914	4,135
11.	0,797	0,920	0,665	0,770	1,881	2,736
12.	0,788	0,887	1,392	1,547	1,756	2,874
13.	0,769	0,804	1,964	2,255	1,749	2,831
14.	0,655	0,793	0,482	0,567	1,229	2,762
15.	0,809	0,856	0,631	0,752	0,642	2,969
16.	0,770	0,839	0,466	0,562	1,297	2,859
17.	0,747	0,830	-	-	0,780	2,786
18.	0,749	0,784	-	-	1,336	2,883
19.	0,790	0,868	-	-	1,305	2,293
20.	-	-	-	-	1,162	2,058
21.	-	-	-	-	1,368	2,851
22.	-	-	-	-	1,257	1,967
Average	0,779	0,846	0,892	1,056	1,253	2,437
CV %	5,662	6,587	57,16	57,95	30,41	28,47

For all three types of sprayer by increasing the number of revolutions PTO increases the amount of chemical agent for plant protection (Tab. 1).

Conclusion

By analyzing the work of three different types of sprayers (I, II, III) in two different modes engine, and RPM PTO (300 min^{-1} and 540 min^{-1}) can be concluded that all three sprayers showed different results. The better work quality had sprayer I ("Agromehanika" Kranj), which had the lowest average value of liquid flow and the smallest variation from the average value in both modes. Sprayer II ("Morava", Požarevac) had the greatest variation. Sprayer III ("Fischer", Switzerland) had the highest average value of the flow of fluids in both RPM PTO. Quality of work sprayers depends on the proper setting mode sprayers, as well as the choice of nozzles, and the quality and type of nozzles. Defective nozzles represent the biggest problem for the proper functioning of machines for plant protection. By reducing the quantity of chemical mixture reduces overall costs, and also increases the profit in agricultural production. All this justifies the use of measuring equipment for testing the safety of the device for the application of pesticides, because measuring the exact set up any deviation and irregularity in work.

Acknowledgment

This study was supported by the Ministry of Education, Science and Technological Development of the Republic of Serbia, Project No TR – 31057, as well as Ministry of Agriculture and Environment of the Republic of Serbia and the Ministry of Agriculture, Food and Forestry Policy of the Republic of Italy.

References

- Bajkin, A., Ponjičan, O., Sedlar, A., Zoranović, M., Turan, J. 2014. Ekološki i energetske parametri primene poljoprivredne mehanizacije, Poljoprivredni fakultet, Novi Sad, Srbija. (Environmental and energy parameters agricultural mechanization application, Faculty of Agriculture, Novi Sad, Serbia).
- Banaj, Đ., Tadić, V., Petrović, D., Knežević, D., Banaj, A. 2014. Vertikalna raspodjela zračne struje raspršivača AGP 200 ENU. Zbornik radova 42. međunarodnog simpozijuma iz područja mehanizacije poljoprivrede. Aktualni zadaci mehanizacije poljoprivrede. Sveučilište u Zagrebu, Agronomski fakultet, Zavod za mehanizaciju poljoprivrede, Zagreb, Hrvatska, 167 – 177. (Vertical distribution of air current with AGP 200 ENU mistblower. Proceedings of the 42nd. International Symposium on Agricultural Engineering, Actual Tasks on Agricultural Engineering, University of Zagreb, Faculty of Agriculture, Department of Agricultural Engineering, Zagreb, Croatia, pp.167 – 177).
- Bugarin, R., Đukić, N., Sedlar, A. 2008. Činioci efikasne aplikacije u zaštiti višegodišnjih zasada orošivačima, Savremena poljoprivredna tehnika, Novi Sad, Srbija, 34(3-4): 236-243. (Efficient application factors in protection of perennial seedlings by air assistance sprayers, Contemporary Agricultural Engineering, Novi Sad, Serbia, 34(3-4): pp. 236-243).
- Bugarin, R., Đukić, N., Sedlar, A. 2010. Uticaj tehnike za aplikaciju pesticida na zagađenje zemljišta. Savremena poljoprivredna tehnika, Novi Sad, Srbija, Vol. 36, No 2, 107- 116. (Influence of pesticide application technique on soil pollution, Contemporary Agricultural Engineering, Novi Sad, Serbia, Vol. 36, No 2, pp. 107-116).
- Đokic, D., Vasic, T., Milenkovic, J., Terzic, D., Stanisavljevic, R., Barac, S., Koprivica, R. (2015): The system of regular technical device control for the application of pesticides in the Republic of Serbia. Book of Proceedings, Sixth International Scientific Agricultural Symposium "Agrosym 2015", 15th-18th October, mountain Jahorina, Bosnia and Herzegovina. pp. 930-935.

- Koprivica, R., Veljković, Biljana, Barać, S., Đokić, D. 2015. Značaj atestiranja uređaja za aplikaciju sredstava za zaštitu bilja. Zbornik naučnih radova, XX Savetovanje o biotehnologiji sa međunarodnim učešćem. Univerzitet u Kragujevcu, Agronomski fakultet, Čačak, Vol. 20, (22), 601 - 605. (Importance attesting device for applications plant protection products. Book of Proceedings, XX Conference on Biotechnology with international participation. University of Kragujevac, Faculty of Agronomy, Čačak, Vol. 20, (22), pp. 601 – 605).
- Radiojević, D., 2014. Poljoprivredna mehanizacija, oprema i objekti. Republički zavod za statistiku, Beograd, Srbija. (Agricultural mechanization, equipment and facilities, Statistical Office of the Republic of Serbia, Belgrade, Serbia).
- Sedlar, A., Đukić, N., Bugarin, R. 2008. Savremena tehnička rešenja i mere poboljšanja efikasnosti orošivača u cilju primene malih i srednjih normi pri orošavanju voćnjaka. Savremena poljoprivredna tehnika, Novi Sad, Srbija, 34(3-4), 117 –128. (Modern technical solution and means of improving the efficiency of air assistance sprayers in the purpose of applying small and medium application rates by spraying the orchard. Contemporary Agricultural Engineering, Novi Sad, Serbia, 34(3-4), p. 117 –128).
- Sedlar, A. Bugarin, R., Đukić, N. 2014. Tehnika aplikacije pesticida, Univerzitet u Novom Sadu, Poljoprivredni fakultet, Novi Sad, Srbija. (Technique pesticide application, University of Novi Sad, Faculty of Agriculture, Novi Sad, Serbia).
- Srivastava, M. 2014. Pesticides as pollutants of environment and use of botanicals as an alternate management strategy. Fifth International Scientific Agricultural Symposium "Agrosym 2014". Jahorina, October 23-26, 2014, Bosnia and Herzegovina, pp. 473–477.
- Tadić, V., Banaj, Đ., Petrović, D., Knežević, D., Seletković, N. 2014. Testiranje tehničkih sustava u zaštiti bilja u Republici Hrvatskoj, Zbornik radova 42. međunarodnog simpozijuma iz područja mehanizacije poljoprivrede, Aktualni zadaci mehanizacije poljoprivrede. Sveučilište u Zagrebu, Agronomski fakultet, Zavod za mehanizaciju poljoprivrede, Zagreb, Hrvatska, 161-166. (Testing technical system in plant protection in Republic of Croatia, Proceedings of the 42nd. International Symposium on Agricultural Engineering, Actual Tasks on Agricultural Engineering, University of Zagreb, Faculty of Agriculture, Department of Agricultural Engineering, Zagreb, Croatia, pp. 161-166).
- Urošević, M. 2001. Mašine i aparati za primenu pesticida, Poljoprivredni fakultet Beograd, Institut za poljoprivrednu tehniku, Beograd, Srbija. (Machines and apparatus for the application of pesticides, Faculty of Agriculture, Belgrade, Institute of Agricultural Engineering, Belgrade, Serbia).
- Višacki, V., Sedlar, A., Turan, J., Bugarin, R., Burg, P. 2014. Ujednačenost aplikacije pesticida pri najčešćim parametrima eksploatacije. Savremena poljoprivredna tehnika, Vol. 40, No. 3, 125-134. (Pesticide application uniformity with most frequent parameters of exploitation. Contemporary Agricultural Engineering, Novi Sad, Serbia, Vol. 40, No. 3, pp. 125-134).

HAZELNUT KERNEL DEFECTS AND ASSOCIATED FUNGI IN THREE PROVINCES IN TURKEY

Arzu SEZER^{1*}, Fatma Sara DOLAR²

¹Hazelnut Research Institute, Giresun, 28200, Turkey

²Department of Plant Protection, Faculty of Agriculture, Ankara University, 06110 Ankara, Turkey

*Corresponding author: arsezer@gmail.com

Abstract

Hazelnut (*Corylus avellana* L.) is one of the most important tree nut crops in Turkey. As having the 80% of world production area, it has the leading position in production and export of hazelnuts. Although there are 16 licensed provinces for growing hazelnut in Turkey, the majority of production is carried out in six provinces including Ordu, Giresun and Trabzon. This study was conducted in 2008 in hazelnut growing areas in provinces Ordu, Giresun and Trabzon in Black Sea Region in order to determine hazelnut kernel defects and associated fungi. Survey was carried out on 221 hazelnut orchards in July-August, near harvest time. Total of 5886 nuts derived from 1750 fruit clusters were dried and stored at room temperature in open air and then examined for kernel defects. The main observed defects were blank, blank and moldy, decayed or moldy kernel, brown spot in internal cavity and spotted kernel. Fungi from these defected kernels were isolated, counted and their incidence was calculated as a percent of total isolated fungi. Total of 65 fungal isolates belonging to 9 genera were isolated from defected kernels. The incidence of *Cladosporium* spp. (24.62%) had the highest rate, and was followed by *Penicillium* spp. (20.00 %) and *Trichothecium roseum* (18.46%). The incidence of *Aspergillus* spp. was relatively low with 7.69%.

Keywords: *Hazelnut, Kernel defects, fungi, Black Sea Region*

Introduction

Hazelnut (*Corylus avellana*) is one of the most important tree nut crops in Turkey. As having the 80% of world production area, it has the leading position in production and export of hazelnuts (Anonymous, 2015a). It is not only one of the most important export crops for Turkey, but also the main economical activity for near 400000 households under the form of family farmer in the Black Sea Region (Tanrıvermiş *et al.*, 2006). Hazelnut production in Turkey extends along the Black Sea region, from Georgia border at east, to Istanbul at west. In terms of provinces, although 33 provinces have hazelnut growing areas, 16 of them are licensed for growing hazelnut. Almost all production (90 %) is carried out in six provinces: Ordu, Giresun, Trabzon, Samsun, Sakarya and Düzce (Anonymous, 2015b).

Insect pests, diseases, environmental factors and growing techniques can be major constraints for hazelnut production. Many fungal, bacterial and viral diseases cause crop losses in hazelnut orchards when environmental condition favours disease development and spread. Main fungal hazelnut fruit diseases in the world are brown rot caused by *Monilia fructigena* and *M. laxa*, anthracnose caused by *Gloeosporium coryli*, fruit rot caused by *Botrytis cinerea* (Belisario and Santori, 2009), gray fruit necrosis caused by *Fusarium lateritium* (Santori *et al.*, 2010). In Turkey, *Botrytis cinerea*, *Monilia fructigena* or *M. coryli* were previously determined as hazelnut fruit diseases agents in Bolu, Zonguldak and Bartın provinces (Yürüt *et al.*, 1994). *B. cinerea* was

the most important and the most prevalence disease for hazelnut fruit clusters during 2008-2009 surveys conducted in Ordu, Giresun and Trabzon provinces (Sezer and Dolar, 2012).

There are several types of defects for nut of hazelnut including blank, moldy kernels, black tips, doubles, shrivelled kernels, poorly filled nuts, brown stain, brown stain in kernel cavity, kernel spot. While some of them are considered as physiological disorders, certain are associated with some fungi and some insect pests (Mehlenbacher and Pscheidt, 2002; Doster *et al.*, 2002; Romero *et al.*, 2001; Romero *et al.*, 2009; Maness, 2005; Tuncer *et al.*, 2009). The severity of kernel decay varies from year to year with average 0.5-1% and losses in individual hazelnut orchards. In Oregon (USA) frequently reach 3-10% (Doster *et al.*, 2002).

The objective of this research was to determine hazelnut kernel defects and associated fungi in provinces Ordu, Giresun and Trabzon, which are important as hazelnut growing areas in Turkey.

Materials and methods

Survey, sample collection and preparation for examination

Survey was carried out in 221 hazelnut orchards in July-August in 2008, near harvest time, in 19 district in Ordu, 12 district in Giresun and 11 district in Trabzon provinces in Black Sea Regions (Figure 1). Total of 1750 healthy-looking fruit clusters externally were picked up from trees. Nuts (total 5886) were separated from husk by hand and dried at room temperature in open air for several days. Nuts were stored the same condition until examination.



Figure 1. Survey area in Turkey: provinces Ordu, Giresun and Trabzon

Determination of defects

Whole nuts were manually shelled using wooden hammer and kernels aseptically removed and evaluated for defects. After detection of blank, blank and moldy, decayed or moldy kernels, other kernels were cut for internal defects such as brown spot in internal cavity, spotted kernel, black tip etc. Nuts were scored for frequency of observed defects.

Fungal isolation and identification

Nuts with defects were surface-sterilized with 0.5-1% (w/v) sodium hypochlorite for 1-2 min before placed on potato dextrose agar (PDA, Merck) that contained streptomycin. Fungal parts (spores or hyphae) were plated directly to the same medium from kernels with obvious fungal growth on. Single spore isolates from fungal cultures were incubated at $23\pm 1^{\circ}\text{C}$ with a 12-h photoperiod for 3-5 days and stored on PDA slant tubes at 4°C .

For identification at the genus level culture morphology and conidial morphology were observed from 7-10 day-old cultures grown on PDA (Booth, 1971; Ellis, 1976; Sutton, 1980; Nelson *et al.*, 1983; Anonymous, 2011c).

Pathogenicity tests

At pathogenicity tests inoculations were performed using both mycelial culture disk and conidial suspension of fungi. After disinfecting their surface with a cotton ball with 70% ethanol (Merck), good looking kernels were divided in half and placed in 9 cm petri dishes containing sterile filter paper moistened. Each kernel part was inoculated by placing a mycelial disc (3 mm) from an actively growing edge of the 10-day-old fungal culture or dropping 10 µl conidial suspension (1×10^3 - 1×10^6 conidia/ml) on center of each half. PDA discs or sterile distilled water were used as controls. After incubation at $25 \pm 2^\circ\text{C}$, for 7 days and 12 h photoperiod, symptoms were assessed and re-isolations were performed.

Results and discussion

A total of 1750 fruit clusters were picked up from 221 hazelnut orchards in provinces Ordu, Giresun and Trabzon in 2008. In total 5886 nuts derived from these fruit clusters were examined for kernel defects. The main noticed defects were blank means a nut containing no kernel or a kernel filling less than one-fourth the capacity of the shell. Some of these blanks had visible fungal growth on, categorized as blank and moldy while some not and were blank. Decayed or moldy kernel, brown spot in internal cavity and spotted kernel were found as other defects (Figure 2). Rate of blanks and kernel with brown spot in internal cavity were 15.85% and 2.36% respectively. Rate of the others were less than 1% (Table 1).

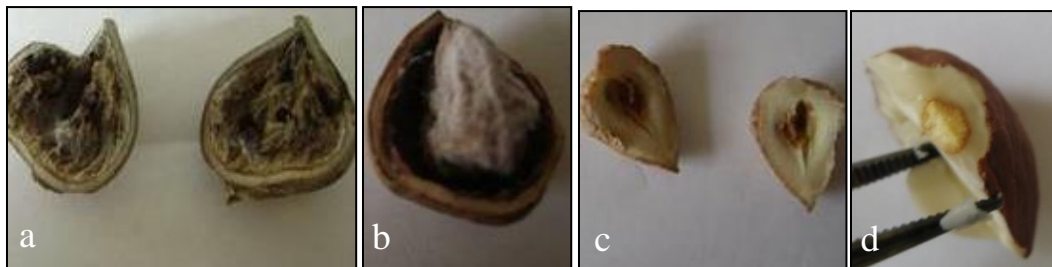

Figure 2. Kernel defects in hazelnut: a. Blank and moldy, b. decayed/moldy kernel, c. brown spot in internal cavity, d. spotted kernel

A total of 65 isolates belong to 9 fungal genera (*Acremonium*, *Aspergillus*, *Cladosporium*, *Fusarium*, *Penicillium*, *Pestalotiopsis*, *Phomopsis*, *Rhizopus* and *Trichothecium*) were isolated from defective kernels. Identification was made at genus level except *Trichothecium roseum*. *Cladosporium* spp. were the most common isolated fungi from defective kernels with 24.62% frequency. It is isolated from all defect types. According frequency of appearance *Cladosporium* spp. was followed by *Penicillium* spp. (20.00%) and *T. roseum* (18.46%). Fortunately, the incidence of *Aspergillus* spp., (some of them may produce aflatoxin) was relatively low with frequency of 7.69%. The rates for *Fusarium* spp. and *Pestalotiopsis* spp. were the same, 9.23%. The fungi belongs to genera *Phomopsis*, *Rhizopus* and *Acremonium* were isolated in very low level (6.15% for *Phomopsis*, 3.02% for *Rhizopus* and 1.54% for *Acremonium*, respectively). *Cladosporium* spp., *Penicillium* spp. and *T. roseum* were isolated from all defects. Although these three were isolated from kernels with brown spot in internal cavity symptom, this symptom

is considered as a physiological disorder and the main cause agent is not known yet. It seems that the disorder could be related to some enzymatic process that could be affected by temperature (Romero *et al.*, 2009). Regarding spotted kernel, in this study a total of 22 isolates belong to 6 fungal genera (*Aspergillus*, *Cladosporium*, *Fusarium*, *Penicillium*, *Phomopsis* and *Trichothecium*) were isolated. This symptom is associated generally with bugs mostly belong to Pentatomidae, Coreidae and Acanthosomatidae families of the order Heteroptera (Tuncer *et al.*, 2005; Tuncer *et al.*, 2009). On the other hand, in Italy and Oregon (USA) it is stated that the same symptom was consistently associated with *Nematospora coryli*, an ascomycetous yeast (Doster *et al.*, 2002).

Table 1. Numbers and percentage of kernel with different defects

Provinces	Number of Examined Nut	Number of Blank	Rate (%)	Number of Blank and Moldy	Rate (%)	Number of Decayed or Moldy Kernel	Rate (%)	Number of Brown Spot in Internal Cavity	Rate (%)	Number of Spotted Kernel	Rate (%)
Ordu	2838	366	12.9	6	0.21	13	0.46	91	3.21	27	0.95
Giresun	2170	457	21.06	20	0.92	12	0.55	37	1.71	10	0.46
Trabzon	878	110	12.53	1	0.11	10	1.14	11	1.25	11	1.25
Total /Average Values	5886	933	15.85	27	0.46	35	0.59	139	2.36	48	0.82

Table 2. Fungi isolated different symptoms, numbers of isolates, total numbers and isolation rates (%)

Fungi	Symptoms				Total Numbers of Isolates	Total Isolation Rate (%)
	Blank and Moldy	Decayed or Moldy Kernel	Brown Spot in Internal Cavity	Spotted Kernel		
<i>Acremonium</i>	0	1	0	0	1	1.54
<i>Aspergillus</i>	0	1	1	3	5	7.69
<i>Cladosporium</i>	1	5	4	6	16	24.62
<i>Fusarium</i>	2	2	0	2	6	9.23
<i>Penicillium</i>	1	2	4	6	13	20
<i>Pestalotiopsis</i>	4	2	0	0	6	9.23
<i>Phomopsis</i>	2	1	0	1	4	6.15
<i>Rhizopus</i>	1	1	0	0	2	3.08
<i>Trichothecium roseum</i>	1	2	5	4	12	18.46
Total	12	17	14	22	65	100

In Turkey *T. roseum*, *Dothiorella* sp. and *Cryptostictis* sp. was determined in a past on decaying hazelnut fruits (Bremer 1948). Eke (1984) stated that *T. roseum* is one of the most frequently encountered species inside the shell during harvest, drying and storage of hazelnut. In addition to its mycotoxigenic character, it produces enzyme lipase which hydrolyses fat to produce free fatty acids which causes bitterness and effects badly the quality and taste of hazelnut (Sipahioglu and

Heperkan 2000). While Karahan *et al.*, (1978) have found hazelnut kernel contaminated with *Aspergillus* spp. and *Penicillium* sp. at high rate, they determined *Cladosporium* spp., *Cephalosporium* spp., *Alternaria* spp., *Rhizopus* spp., *Mucor* spp., *Trichothecium roseum*, *Fusarium* spp., *Pestalozzia* spp., *Verticillium* spp., *Oospora* spp., *Macrosporium* sp., *Botryodiplodia* sp., *Glomerella* sp., on kernels also.

Pathogenicity tests were conducted in this study with most isolated fungi: *Cladosporium* sp., *Penicillium* sp. and *T. roseum*. In both methods (either using mycelial culture disk or conidial suspension of fungi) from the second day on, fungal growth was visible. Almost all fruit surface was covered with mycelium on the seventh day and rot in inner tissue was found (Figure 2). However, symptoms similar to original symptoms like spotted kernel or brown spot in kernel cavity were not detected in this experiment. It is difficult to decide certainly if these fungi (*Cladosporium* sp., *Penicillium* sp. and *T. roseum*) were causal agents or not for spotted kernel or brown spot in kernel cavity. Regarding hazelnut kernel decay, it is known that *Ramularia* sp., has been associated with necrosis of kernel tips, *Phomopsis* sp., *Septoria ostryae* are associated with internal discoloration and *Nematospora coryli* with kernel spot, but their pathogenicity has not been proved yet (Doster *et al.*, 2002).



Figure 2. Symptoms caused by: *Trichothecium roseum* (a), *Penicillium* sp. (b), *Cladosporium* sp., control (d) at pathogenicity test

Conclusion

In the study conducted in provinces Ordu, Giresun and Trabzon in order to determine kernel defects and associated fungi, the main detected defect was blank. The others were brown spot in internal cavity, spotted kernel, decayed or moldy kernel, and blank or moldy kernel, respectively. Total of 65 associated fungal isolates belonging to 9 genera were isolated from defected kernels. *Cladosporium* spp., *Penicillium* spp. and *T. roseum* were most common isolated fungi. The incidence of *Aspergillus* spp., was relatively low. Pathogenicity of fungi associated with brown spot in internal cavity and spotted kernel was not proved with pathogenicity test. Therefore, more comprehensive studies started in the orchard are needed in future.

Acknowledgement

This study was supported by the Scientific Research Projects Office of the Ankara University and Ministry of Food, Agriculture and Livestock of Turkey.

References

- Anonymous.(2015a). Food and Agriculture Organization of the United Nations. <http://faostat3.fao.org/download/Q/QC/E> accessed on 14/06/2015.
- Anonymous.(2015b). Turkish Statistical Institute. www.tuik.gov.tr accessed on 14/06/2015.

- Anonymous. (2015c). Mycobank Database, Fungal Databases, Nomenclature & Species Banks. <http://www.mycobank.org/> accessed on 14/06/2015.
- Belisario A., Santori A. (2009). Gray Necrosis of Hazelnut Fruit: A Fungal Disease Causing Fruit Drop. *Acta Hort. (ISHS)* 845:501-506.
- Booth, C. (1971). The genus *Fusarium*. Commonwealth Mycological Institute, 237 p., Kew, Surrey, England.
- Bremer, H. (1948). Türkiye Fitopatolojisi (Phytopathology of Turkey). Special Issue. Ministry of Agricultura Publications. No: 657, 237 p., Ankara.
- Doster M.A., Johnson, K.B., Michailides, T.J., Stone, J.K. and Teviotdale B.L. (2002). Kernel Decay. In: *Compendium of Nut Crop Diseases in Temperate Zones*. Teviotdale, B.L., Michailides, T.J. and Pscheidt, J.W. (eds). American Phytopathological Society, pp. 2-3, St. Paul, MN.
- Eke D. (1986). Aflatoxin Production in hazelnut. Ph.D.Thesis. Ege University, Turkey.
- Ellis M.B. (1976). More Dematiaceous Hypomycetes. *Commonwealth Mycol. Ins.*, 505 p., Kew, England.
- Karahan O., Barış M., Kocatürk S., Maden S., Dündar F., Altınyay N., Ünal A., Çakır B., Güvener A., Türker O., Dinç N., Biçici M., Öztuna F., Bilgin A. and Sezgin S. (1978). Investigations of the aflatoxin producing fungi on hazelnut, pistachionut and groundnut and determination of the causal factors with their prevention measures. *T.C. Gıda Tarım ve Hayvancılık Bakanlığı, Zir. Müc. ve Zir. Kar. Gn. Md. Teknik Bülten no: 41*, 154 p., Ankara.
- Maness N.O. (2005). Filbert: Postharvest Quality Maintenance Guidelines. In K. Gross, M. Saltveit and C.Y. Wang (eds.) *The Commercial Storage of Fruits, Vegetables, and Florist and Nursery Stocks*, 4th Edition, USDA, ARS Agriculture Handbook No. 66. Edited by Kenneth C. Gross, Chien Yi Wang, and Mikal Saltveit.
- Mehlenbacher S.A., Pscheidt J.W. 2002. Blanks, Brown Stain, and Catkin Blast. In: *Compendium of Nut Crop Diseases in Temperate Zones*. Teviotdale, B.L., Michailides, T.J. and Pscheidt, J.W. (eds). American Phytopathological Society, pp. 50, St. Paul, MN.
- Nelson P.E., Toussoun T.A., Marasas W.F.O. (1983). *Fusarium species: An illustrated manual for identification*. Pennsylvania State University Press, 193 p., University Park and London.
- Romero A., Tous J., Rerran X., Rius M., Sentis X., Plana, J. (2001). The Brown Spots in Kernel Cavity Disorder of Hazelnut. *Acta Hort. (ISHS)*, 556; 397-401.
- Romero A., Tous J., Marti E. (2009). White Spots in hazelnut Kernel: Symptoms, Causes and Quality Loss. *Acta Hort. (ISHS)*, 845; 607-612.
- Santori A., Vitale S., Luongo L., Belisario A. (2010). First Report of *Fusarium lateritium* as the Agent of Nut Gray Necrosis on Hazelnut in Italy. *Plant Dis.*, 94(4); 484.
- Sezer A., Dolar F.S. (2012). Prevalence of *Botrytis cinerea* Pers. ex Fr. causing disease on fruit clusters in hazelnut growing areas of Ordu, Giresun and Trabzon provinces and determination of the reactions of some cultivars against pathogen. *Bitki Koruma Bülteni*, 52(1):93-110.
- Sipahioğlu H.N., Heperkan D. (2000). Lipolytic activity of *Trichothecium roseum* on hazelnut. *Food Microbiology*, 17 (4), 401-405.
- Sutton B.C. (1980). *The Coelomycetes. Fungi Imperfecti with Pycnidia, Acervuli and Stromata*. Commonwealth Mycological Institute, Kew, Surrey, England: 696 p.
- Tanrıvermiş H., Gönenç S., Terzioğlu S.B. (2006). Socio-Economic Structure of Hazelnut Production in Turkey, The possibilities of development for supplementary income resources and impact assessment. Council of 3rd National Hazelnut pp. 125-144, Giresun.
- Tuncer C., Saruhan İ., Akça İ. (2005). The insect pest problem affecting hazelnut kernel quality in Turkey. *Acta Hort. (ISHS)*, 686; 367-375.

- Tuncer C., Saruhan I., Akça I. (2009). Chemical control of true bugs (Heteroptera: Pentatomidae, Acanthosomatidae and Coreidae) to prevent kernel damage in hazelnut orchards of turkey. *Acta Hortic.* 845, 487-494.
- Yürüt H.A., Erkal Ü., Gürer M. (1994). Hazelnut diseases in Bolu, Düzce and Bartın. 9th Congress of the Mediterranean Phytopathological Union, Kuşadası, Aydın, Turkey: Turkish Phytopathological Society Publications. No: 7, pp. 417-419.

THE COMBINE EFFECTS OF EICOSANOID BIOSYNTHESIS INHIBITORS AND TWO NATIVE ISOLATES OF *BEAUVERIA BASSIANA* ON MORTALITY OF *SPODOPTERA LITTORALIS* LARVAE

Hasan TUNAZ*, Ali A. IŞIKBER, Mehmet Kubilay ER

Department of Plant Protection, Faculty of Agriculture, University of Kahramanmaraş Sütçü İmam, Kahramanmaraş, Turkey

*Corresponding author: htunaz@ksu.edu.tr

Abstract

In this study, the effect of *B. bassiana* isolate (6646) was expressed in a time dependent manner on mortality of the larvae although the effect of *B. bassiana* (3288) isolate on mortality was lower. When *B. bassiana* (6646) isolate was co-injected with the eicosanoid biosynthesis inhibitors (phenidone dexamethasone, naproxen, indomethacin, esculetin, ibuprofen) with different modes of action it caused an increased and faster mortality of the larvae. Similarly, increasing phenidone (eicosanoid biosynthesis inhibitor) dosages were associated with increasing mortality of the larvae co-injected with *B. bassiana* (6646) isolate. These findings support that virulent effects of entomopathogen, *B. bassiana* (6646) can be increased when *S. littoralis* immune systems were suppressed and that increased effects of microbial control of pest insects.

Keywords: *Nodulation; eicosanoid; Beauveria bassiana; Spodoptera littoralis.*

Introduction

Two categories of immunity to microbial infections, humoral and hemocytic were expressed by insects (Gillespie *et al.*, 1997; Stanley, 2000). Humoral immune reactions involve induced biosynthesis of anti-bacterial proteins (Leulier *et al.*, 2003; Stanley and Miller, 2006). Hemocytic immune reactions involve direct interactions between circulating hemocytes and infecting microbes (Stanley and Miller, 2006). These immune functions are well known and the contemporary research frontiers reveal information on the signal mechanisms responsible for mediating and coordinating insect immunity.

Stanley-Samuelson *et al* (1991) first suggested that eicosanoids mediate one or more cellular reactions responsible for clearing bacterial infections from hemolymph circulation. This suggestion prompted more detailed research meant to determine which of the several cellular defense reactions depend on eicosanoid biosynthesis. Because nodulation is the predominant cellular immune reaction to bacterial infections, it has been hypothesized that eicosanoids mediate nodulation reactions to bacterial infections (Miller *et al.*, 1994). On the basis of these findings, Stanley and his colleagues developed the hypothesis that eicosanoids mediate nodulation reactions to bacterial infections in most, if not all, insect species, now known as the eicosanoid hypothesis (Stanley, 2000). Several research groups have tested the hypothesis for about 20 insect species, as summarized in reviews (Stanley, 2006; Stanley and Miller, 2006). All experimental work has strongly supported the idea.

Connick *et al* (2001) tested role of eicosanoid biosynthesis inhibitors (EBIs) when co-applied with the pathogenic bacterium, *Serratia marcescens* for insect pest control. They reported increased mortality of the termites; *Coptotermes formosanus* when the bacteria were co-applied with eicosanoid biosynthesis inhibitors. Similarly, Tunaz (2006) tested influence different fungal

species on nodule formation and on mortality of *P. brassicae* larvae and to determine whether injecting *P. brassicae* larvae with EBIs plus fungus would influence larval mortality. Again his result showed that increased and faster mortality of *P. brassicae* larvae was seen when the fungi were co-applied with eicosanoid biosynthesis inhibitors. To continue developing the idea that EBIs can influence mortality in infected insects, the objectives of this study were to determine the influence two native isolates of *B. bassiana* on mortality of *S. littoralis* larvae and to determine whether injecting *S. littoralis* larvae with EBIs plus *B. bassiana* would influence larval mortality.

Materials and Methods

Organisms

S. littoralis were reared on a culture (38 g agar, 2600 ml distil water, 300 g corn flour, 120 g wheat embryo, 100 g yeast, 20 g casein, 14 g wesson salt, 8 g sorbic acid, 4 g nipagin, 600 mg streptomisin, 18 g ascorbic acid and 80 mg vitamin complex) and maintained in the laboratory at 25 ± 2 °C and $65 \pm 5\%$ relative humidity (RH). The larvae (5. instars) were tested for each bioassays at 25 ± 2 °C and 65 ± 5 % RH. The entomopathogenic fungus, *B. bassiana* (3288, 6646) isolates were used in this study. The isolates were grown at 25 °C on potatoe dextrose agar (PDA) for 30 days. Conidia were harvested from these plates in sterile distilled water containing 0.1 % Tween 80 and vortexed vigorously.

Reagents

The phospholipase A₂ (PLA₂) inhibitor dexamethasone {(11β, 16α)-9- fluoro-11,17,21-trihydroxy-16-methylpregna-1,4-dione}, the cyclooxygenase inhibitors naproxen, indomethacin and ibuprofen {O-2-(6-methoxy-naphthyl) propionic acid}, the dual cyclooxygenase and lipoxygenase inhibitor phenidone {1-pheny-3-pyrazolidinone}, and the 5- and 12-lipoxygenase inhibitor, esculetin {6,7-dihydroxycoumarin} were all purchased from Sigma Chemical Co. (St. Louis, MO).

Influence of two different isolates of *B. bassiana* on mortality of *S. littoralis* larvae

Larvae were applied with individual isolates (1×10^7 conidiospor/ml for each isolates). Control insects were applied with 0.021 % Tween 80 solution. After application, the larvae were kept on room temperature. Mortality was assessed at selected times after injections.

Effects of eicosanoid biosynthesis inhibitors on mortality of *S. littoralis* larvae when co-injected with *B. bassiana* isolate (6646)

S. littoralis larvae were divided into groups and individuals in each group were injected with either the phospholipase A₂ (PLA₂) inhibitor dexamethasone, three of the cyclooxygenase inhibitor, naproxen, ibuprofen and indomethacin, the dual cyclooxygenase and lipoxygenase inhibitor phenidone, or the lipoxygenase inhibitor esculetin, all in standard dosages of 104 µg in 4 µl EtOH. Control insects were injected with 4 µl EtOH. Following injections, the larvae were injected with 1×10^7 conidiospor/ml in 5 µl 0.021 % Tween 80 solution. After injection the larvae were kept on room temperature as described. Mortality was assessed at selected times after injections as described above.

Influence of phenidone (eicosanoid biosynthesis inhibitor) dosages on mortality of *S. littoralis* larvae when co-injected with *B. bassiana* isolate (6646)

Individuals in five groups of larvae were injected with 4 µl of ethanol, or 52, 104, 156, 208 µg of phenidone in 4 µl ethanol, then infected with a standard concentration of *B. bassiana* isolate (6646). At 24 hpi, mortality was assessed.

Results and Discussion

Effects of different isolates of *B. bassiana* on mortality of *S. littoralis* larvae

Table 1 indicates that compared to control, two isolates of *B. bassiana* caused higher mortality of *S. littoralis* larvae at each time. At day 9, control caused no mortality of larvae of *S. littoralis* whereas the isolate (6646) of *B. bassiana* caused approximately 67 % mortality of the larvae.

Table 1. The influence of two different isolates of *B. bassiana* on mortality of *S. littoralis* larvae

<i>B. bassiana</i> Isolates	Time (days)			
	3	5	7	9
6646	33,33±3,33 ^a	60,00±0,00 ^a	66,67±3,33 ^a	66,67±3,33 ^a
3288	6,67±3,33 ^b	26,67±6,67 ^b	33,33±8,82 ^b	33,33±8,82 ^b
Control	0,00±0,00 ^c	0,00±0,00 ^c	0,00±0,00 ^c	0,00±0,00 ^c

^aMean number in a column followed by different letters are significantly different (P <0.05)

Effects of co-injected *B. bassiana* isolate (6646) and EBIs on mortality of *S. littoralis* larvae

EBIs strongly enhanced absolute mortality and the speed of kill due to *B. bassiana* isolate (6646) challenge (fig. 1). Higher mortality obtained in larvae treated with the all inhibitors except dexamethasone plus the concentration (1x10⁷ spor/ml) of *B. bassiana* isolate (6646) by 72 h PI. Lower mortality was recorded in the control and the inhibitor, dexamethasone at 72 h PI.

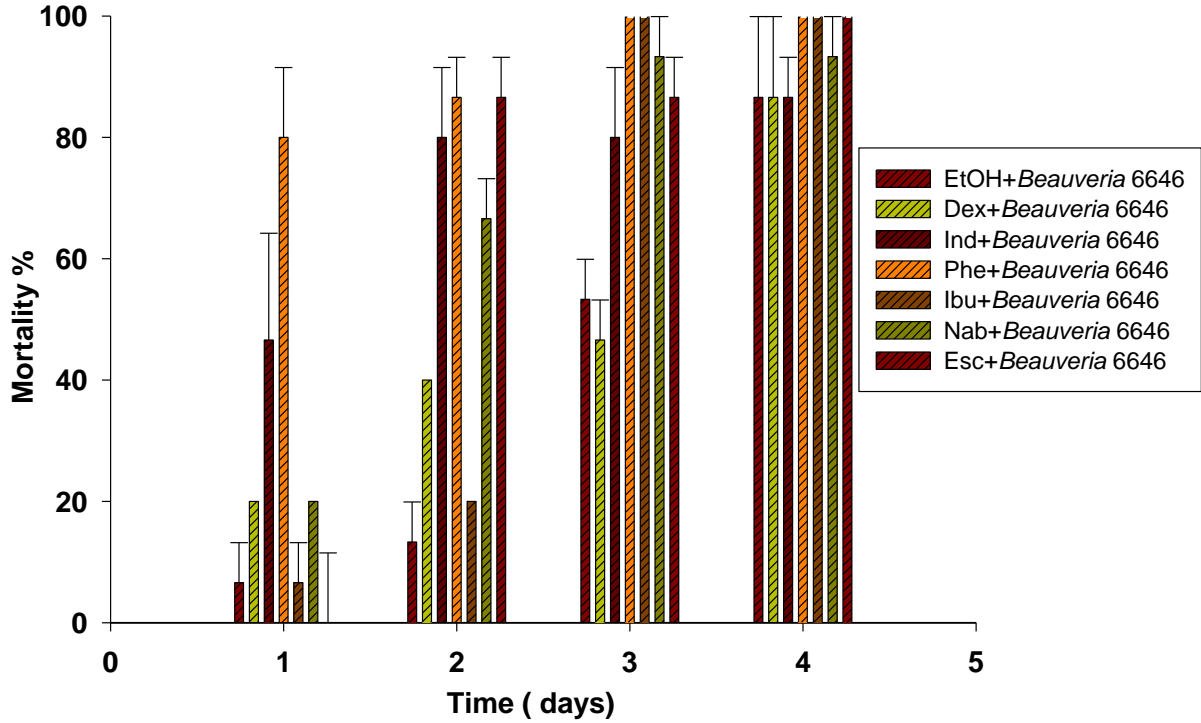

Figure 1. Effect of eicosanoid biosynthesis inhibitors on mortality *S. littoralis* larvae infected with of *B. bassiana* isolate (6646)

Influence of phenidone (eicosanoid biosynthesis inhibitor) dosages on mortality of *S. littoralis* larvae when co-injected with *B. bassiana* isolate (6646)

Figure 2 indicates that the mortality due to phenidone was express in a dose-dependent manner. Increasing phenidone (eicosanoid biosynthesis inhibitor) dosages were associated with increasing mortality activity of the larvae co-injected with *B. bassiana* (6646) isolate.

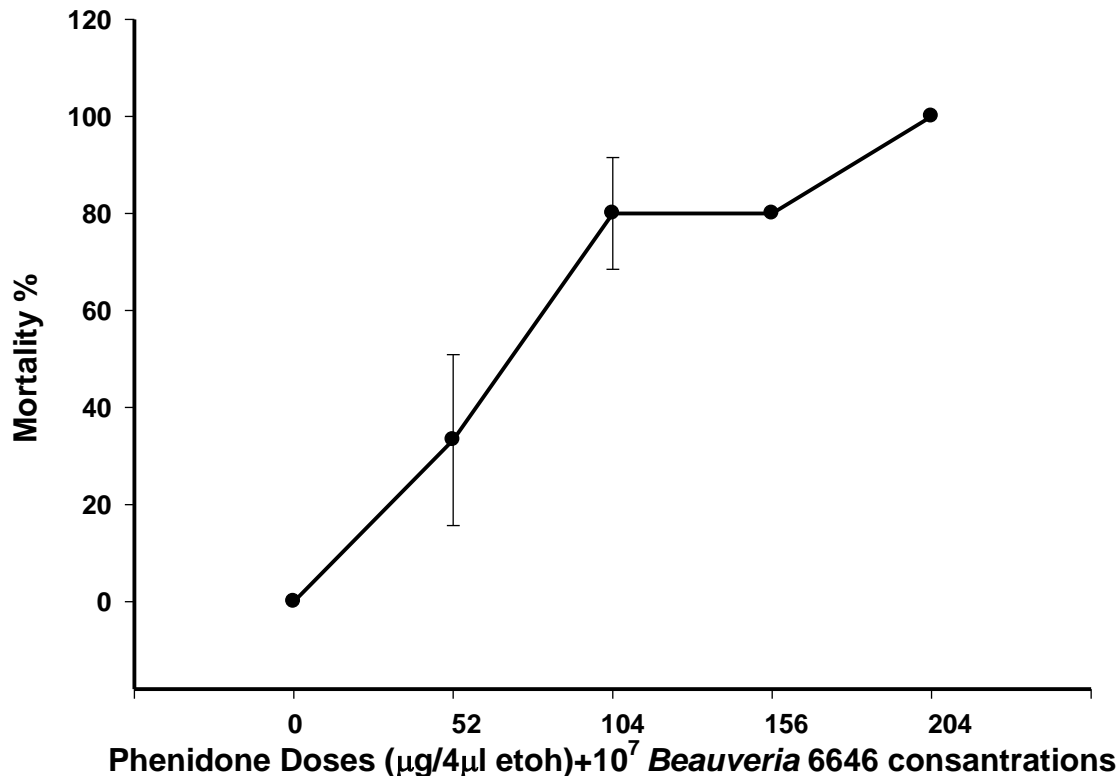

Figure 2. Influence of phenidone dosages on mortality of *S. littoralis* larvae when co-injected with *B. bassiana* isolate (6646)

The data reported in this work support the idea that EBIs significantly increased insect larval mortality due to the pathogenic fungal challenge. First, compared to control, two isolates of *B. bassiana* caused higher mortality of *S. littoralis* larvae at each time. Second, treating the larvae with any of six EBIs except dexamethasone substantially increased mortality due to the fungal challenge. Third, increasing phenidone (eicosanoid biosynthesis inhibitor) dosages were associated with increasing mortality activity of the larvae co-injected with *B. bassiana* (6646) isolate. We infer from these data that disabling immune signaling by inhibiting eicosanoid synthesis renders insects unable to protect themselves from fungal challenge and that the lack of immune protection is lethal. The idea that eicosanoids mediate insect cellular immunity was first suggested by Stanley-Samuels et al (1991). They showed that when eicosanoid biosynthesis is inhibited by EBIs, *M. sexta* larvae could not clear the pathogenic bacterium, *S. marcescens* from their hemolymph. More important, this situation increased insect mortality. Since this first paper, several laboratory groups have indicated eicosanoids are involved in nodulation formation (Stanley, 2006; Stanley and Miller, 2006). There is now considerable evidence for the involvement of eicosanoids in insect immune reactions to bacteria, fungal, protozoan and parasitoid challenge in a wide range of insects. Tunaz (2006) tested influence of different fungal species on nodule formation and on mortality of *P. brassicae* larvae and tried to determine whether injecting *P. brassicae* larvae with EBIs plus fungus would influence larval mortality. The result showed that increased and faster mortality of *P. brassicae* larvae was seen when the

fungi were co-applied with eicosanoid biosynthesis inhibitors. Similar to this work, we suggested that there were synergistic effects of EBIs with the fungus, *B. bassiana* (6646) isolate on mortality of *S. littoralis* larvae. The pharmacological chemicals we used inhibit different eicosanoid biosynthetic pathways in mammals. Dexamethasone inhibits phospholipase A₂ which releases arachidonic from membrane phospholipids; naproxen inhibits cyclooxygenase; esculetin inhibits lipoxygenase; and phenidone inhibits both cyclooxygenase and lipoxygenase (Stanley, 2000). Hence, because all the inhibitors we tested enhanced the susceptibility of *B. germanica* to the injected bacteria, it is possible that both cyclooxygenase and lipoxygenase pathways are involved in mediating the immunomodulatory effects of eicosanoids in this insect.

Conclusion

Virulent effects of entomopathogenic fungi, *B. bassiana* (6646) can be increased when *S. littoralis* immune systems were suppressed by EBIs and that increased effects of microbial control of pest insects. From these data, we can conclude that disabling immune signaling by inhibiting eicosanoid synthesis renders insects unable to protect themselves from fungal challenge and that the lack of immune protection is lethal.

Acknowledgement

This study was supported by The Scientific and Technological Research Council of Turkey (TUBITAK Project no: 110O159).

References

- Connick W.J., Osbring W.L.A., Wright M.S., Williams K.S., Daigle D.J., Boykin D.L., Lax A.R. (2001). Increased mortality of *C. formosanus* (Isoptera: Rhinotermitidae) exposed to eicosanoid biosynthesis inhibitors and *Serratia marcescens* (Eubacteriales: Enterobacteriaceae). *Environ. Entomol.* Vol. 30, pp. 449-455.
- Gillespie J.A., Kanaost M.R., Trenzcek T. (1997). Biological mediators of insect immunity. *Annu. Rev. Entomol.* Vol. 47, pp. 611-643.
- Leulier F., Parquet C., Pili-Floury S., Ryu J.H., Caroff M., Lee W.J., Mengin-Lecreux D., Lemaitre B. (2003). The *Drosophila* immune system detects bacteria through specific peptidoglycan recognition. *Nature Immunology* Vol. 4, pp. 478-484.
- Miller J.S., Nguyen T. Stanley-Samuelson D.W. (1994). Eicosanoids mediate insect nodulation responses to bacterial infections. *Proc. Nat. Acad. Sci. USA* Vol. 91, pp. 12418-12422.
- Stanley-Samuelson D.W., Jensen E., Nickerson K.W., Tiebel K., Ogg C.L. Howard R.W. (1991). Insect immune response to bacterial infection is mediated by eicosanoids. *Proc. Nat. Acad. Sci. USA* Vol. 88, pp. 1064-1068.
- Stanley D.W. (2000). *Eicosanoids in Invertebrate Signal Transduction Systems*. Princeton University Press, Princeton, NJ.
- Stanley D.W. (2006). Prostaglandins and other eicosanoids in insects: biological significance. *Annu. Rev. Entomol.* Vol. 51, pp. 25-44.
- Stanley D.W., Miller J.S. (2006). Eicosanoid actions in insect cellular immune functions. *Entomologia Experimentalis et Applicata*. Vol. 119, pp. 1-13.
- Tunaz H. (2006). Eicosanoid Biosynthesis Inhibitors Influence Mortality of *Pieris brassicae* Larvae Co-Injected With Fungal Conidia. *Arc. Ins. Biochem. Physiol.* Vol. 63, pp. 93-100.

EFFECTS OF POST-HARVEST DIPPINGS OF CALCIUM OXIDE ON AROMA VOLATILE COMPOUND OF PINK LADY APPLE CULTIVAR

Neslihan EKİNCİ¹*, Murat ŞEKER², Mehmet Ali GUNDOĞDU³

¹Lapseki Vocational School, Çanakkale Onsekiz Mart University, Çanakkale, Turkey

²Department of Horticulture, Faculty of Agriculture, Şırnak University, Şırnak, Turkey

³Department of Horticulture, Faculty of Agriculture, Çanakkale Onsekiz Mart University, Çanakkale, Turkey

*Corresponding author: nekinci@comu.edu.tr

Abstract

The aim of this work was to assess the profile of volatile compounds changes during the cold storage in ‘Pink Lady’ apples. Six-year-old Cripps Pink (Pink Lady) apple trees grafted onto M9 rootstock were used as a plant material for this study. The trees were in a commercial orchard in Çanakkale-Turkey. Fruits were carefully picked up by hand at the commercial harvesting time. The fruits were dipped into calcium oxide solutions (concentrations of 2 and 4%) during three minutes. Control fruits were exposed to distilled water. Fruits were stored at 0 °C and 90% relative humidity for 6 months. The aroma volatile content of apples determined by GC/MS (Gas Chromatography/Mass Spectrometry) analysis followed by liquid-liquid extraction. Stored fruits were analyzed immediately for their volatile contents at the 2nd, 4th and 6th months. Fresh fruits at the initial stage contained 15 aroma volatile content in total. However, higher levels of aroma volatile compounds were detected after 6 months of cold storage. According to the chromatography results, control fruits had 24 volatiles, 2% CaO treated fruits had 25 volatiles and 4% CaO treated fruits had 27 volatiles at the end of 6 months of cold storage. Apples at the initial stage produced an abundance of hexyl acetate (4.56%), butyl acetate (3.83%), and hexanoic acid hexyl ester (1.68%), which confer typical apple aroma characteristics. Mostly, ester production exhibited a fairly broad peak, declining as fruit aged. Propanoic acid 2-methyl-2-propenyl acetate (initial 0.548%) was lower at the beginning of the storage compare to the end of storage (control fruits 0.064%, 2%CaO 0.127%, 4% CaO 0.203%). CaO applications especially 4% concentration had deformation effect on epidermal layer cells on fruit surface. As a result, CaO applications had a significant effect on aroma enhancement in Pink Lady apples.

Key Words: *Pink Lady, Apple, Calcium oxide (CaO), Aroma volatile, GC/MS*

Introduction

Production of aroma volatile compounds is an important factor determining quality of fruit produce and is directly influenced by fruit maturity (Mattheis *et al.*, 1991). Flavor is one of the most important criteria of fruit quality. The formation of flavor and aroma compounds in fruits is a dynamic process, volatile substances are continuously synthesised and developed during fruit growth and ripening. Volatile composition changes qualitatively and quantitatively (Amira, 2011). Aroma compound analysis plays an important role in the process of quality apple breeding. The aroma of a fruit is the result of a complex mixture of esters, alcohols, aldehydes, terpenoid compounds, etc. (Nie *et al.*, 2006).

Increment in tissue Ca content by postharvest Ca treatment reduces disorders and maintains storage quality of whole fruit including apple (Saftner *et al.*, 1998), ethylene production (Conway and Sams, 1987), to inhibit respiration and ethylene production rates and to persistent inhibitory

effect on volatile production (Brackmann, 1993), the factor considered most likely responsible for diminished apple flavor (Knee and Hatfield, 1981). Postharvest injection of CaNO₃ solution into the core of apples has been shown to nonsignificantly inhibit quality-associated volatile production (Wills, 1972). Genotype is a major factor accounting for the phenotypic differences in the composition of the volatile fraction emitted by fruit, as significant qualitative and quantitative variation is found among apple and pear cultivars (Young *et al.*, 2004).

'Pink Lady', is very popular, late maturing apple (*Malus × domestica* Borkh.) cultivar increasingly grown in many apple-producing areas of the world owing to its excellent flavor and sensory attributes. Commercial interest is thus focused on developing suitable criteria for harvest maturity as well as appropriate storage procedures in order to assure quality of final produce (Villatoro *et al.*, 2008). It is firm, has fine dense flesh, is crisp and juicy, excellent flavor (Corrigan, 1997). Production of aroma volatile compounds is an important factor determining final sensory quality of fruit produce and hence consumer satisfaction and influenced by maturity (Mattheis, 1991). Whereas deficient aroma volatile production in immature fruit, suggested to arise from low rates of precursor synthesis, is gradually overcome as fruit approach the optimal harvest date (Song and Bangerth, 1994),

In this study, 2% and 4% CaO treated fruits are stored at the cold storage during the 6 month. 2nd, 4th and 6th month aroma volatile compounds were detected by GC-MS. It is investigated differences aroma volatile content among treatments and storage period.

Materials and Methods

Fruit source

Six year old Cripps Pink (Pink Lady) apple trees which grown in a commercial orchard (40°24'04" N and 26°24'35" E, just 35 m above sea level) in Çanakkale (Turkey), were used as plant materials for this study. The trees were randomly selected from unblemished trees showing general characteristics of the apple cultivar. The fruits were carefully harvested by hand. Starch content of the harvested apples was determined by standard procedures using a starch index (1 to 8, Generic Starch Iodine Index Chart for Apples). When the average starch index reached 5, the fruits were picked up for the experiment.

Control fruits of Pink Lady apple cultivar were exposed to distilled water. Experiment fruits were dipped into solutions of calcium oxide (both at the concentrations of 2 and 4%). The fruits stored later at 0°C and 90% relative humidity for 6 months. Aroma volatiles contents were analyzed on the fruits taken out of at the 2nd, 4th and 6th months.

Aroma volatile content

The aroma volatile content of the stored apples was determined by GC/MS analysis followed by liquid-liquid extraction. Liquid-liquid extraction was performed by use of diethyl ether solvent. Each extraction included two replications and each replication contained 100 g apple puree obtained by using a liquidizer (homogenizer). 100 mL diethyl ether solvent was added into the Erlenmeyer flask with 100 g apple puree. After solvent treatment, the extract was concentrated to 1 mL with a centrifuge and concentrator. Then the solvent was directly injected into a gas chromatograph for α volatile compound (Solis-Solis *et al.*, 2007).

The amount of the aroma volatile determined with a gas chromatograph-mass spectrometer (Shimadzu QP2010 GC/MS) fitted with a DB-WAX column (30 m x 0.25 mm ID, 0.25 μ m film thickness; J & W, USA). Identification of volatile content was carried out by mass spectrometry using a mass spectrometer set at 280 °C of capillary direct interface temperature,

the ionization energy of the mass spectrometer was programmed for 70 eV. Also the ion source temperature was set at 250 °C and 40-350 amu of mass interval and 666 amu s⁻¹ scan rate. WILEY and NIST libraries were used for identification of compounds. One microliter samples were injected in 1:50 split ratio (with 280 °C injection temperature) by an auto injector. Firstly, the column temperature was set at 40 °C for 2 min. After the column reached at 280 °C by 10 °C min⁻¹ and held for 10 min

Results and Discussion

15 volatile compounds were detected at harvest stage of apples (Table 1). The compounds were consisting of 5 alcohols (61.06 %), 6 esters (11.679%), 1 aldehyde compound (0.540%), 1 alkane (0.848%), 2 other compounds (25.869%). The alcohols were ethyl alcohol (0.040%), 1-propanol (0.0687%), 1-hexanol (5.414%), 1,3-Octanediol (2.321%), and 10-nonadecanol (52.602%). The esters were buthyl ester of hydroxyacetic acid (0.677%), buthyl acetate (3.862%), hexyl acetate (4.604%), 2-methyl-2-propenyl ester (0.548%), propanoic acid 1-methyl ester (0.309%), hexanoic acid hexyl ester (1.680%). The aldehyde was trans-4-hexenal (0.541%) and the other compounds were toluene (1.027%) and alpha farnasene (24.842%).

According to the obtained results of storage periods, volatile compounds were changed in both of qualitative and quantitatively. While initial alcohol content was around 61.06%, its content decreased at the 2nd month of storage. Control fruits were more alcohols levels than CaO treatments (Table 1). Total alcohol content increased at the end of 4th and 6th month storage. However, among the treatments resulted similarly. Ethyl alcohol has increased significantly, during the storage period. Especially, 4th and 6th month resulted higher level of ethyl alcohol. Control fruits were resulted 64.192% while 2% CaO 63.106%, 4% CaO 56.784% showed the lowest content of ethyl alcohol. Initially, nonadecanol was observed at very high amounts. But, according to analysis 2nd month were not detected for nonadecanol. 4th and 6th month increased too slight. Alcohol precursors paralleled that of the corresponding esters for 'Gala' (Fellman, 2000) and Fuji (Lara, 2006).

Ester compounds were largely predominant in the aroma profile. In this research ethyl acetate were not determined at harvest time. 2nd and 4th month increased. But, end of the 6 month haven't observed. The maximum level of ester compounds obtained at 4% CaO (3.790%) end of the 4th month. Control fruits (3.320%) and % CaO (3.106%) were lower. 1-chloroethyl acetate is determined only, end of the storage. 4% CaO, 2% CaO and control (0.117%, 0.104% and 0.089%) fruits were given respectively.

The beta-oxidation pathway provides alcohols and acyl co-enzyme, acyl (CoA), which are the main precursors for volatile ester production. Acyl CoAs are reduced by acyl CoA reductase to produce aldehydes, which in turn are reduced by alcohol dehydrogenase (ADH) to form alcohols that are converted to esters via the action of aspartate amino transferase (AAT) (Song and Bangerth, 1994)

At harvest time, individual straight chain 2-methylbutyl acetate were high (3.862%). During the cold storage, buthyl acetate content slightly decreased. 2nd and 4th month 4% CaO higher than 2% CaO and control fruits. End of the storage, 2% CaO more than, 4% CaO and control fruits (Table 1). CaO treatments have not effective on reducing of buthyl acetate. On the contrary, it caused increasement of ester. 3-methyl-buthyl acetate was not determined at harvest time. 2nd and 4th month was seen in the experiment. 2nd month 4% CaO, 4th month 2% CaO applications were higher compound.

2-methyl-butyl ester was not determined at harvest time. 2nd month only 4% CaO application gave a low level of compound (0.246%). 4th month 4% CaO (0.337%), 2% CaO (0.242%) and control fruits (0.234%) were given 2-methyl-butyl ester respectively.

2-propenyl ester, at harvest time hasnt determined. 2nd month, 2% CaO and 4% CaO 4th month, only 2% CaO treatments gave to 2-propenyl ester.

Hexyl acetate, at harvest time determined 4.604%. 2nd month increased of compound. 4% CaO treatment gave to high percentage (5.817%), control fruits (5.206%), 2% CaO (4.668) treatments respectively. 4th month, ester content decreased, 6th month, hasnt determined to hexyl acetate.

At harvest 2-hexenyl acetate hasn't determined. 2nd month 4% CaO higher compound content. 4th and 6th month, control fruits gave to higher 2-hexenyl acetate.

Propanoic acid hexyl ester was not determined at harvest time. 6th month, 4% CaO the highest compound propanoic acid hexyl ester determined. 2% CaO and control fruits gave to lower content. propanoic acid 1-methyl ester is determined only at initial.

Hexanoic acid buthyl ester was not determined at harvest time and 6th month. Second month 2% CaO, 4th month, 4% CaO treatments determined higher ester.

Butanoic acid hexyl ester was not determined at harvest time and 6th month. 2nd and 4th month control fruits were given higher ester.

Butyric acid 2-methyl-hexyl ester was not determined at harvest time and 6th month. 2nd month control fruits, 4th month, 4% CaO treatments gave to higher butyric acid 2-methyl-hexyl ester.

At the harvest time, 1.680% hexanoic acid hexyl ester determined. 2nd month 2% CaO (3.053%), 4th month, 4% CaO (4.011%), 6th month, 2% CaO (0.569%) treatments were higher than 4% CaO (0.533%) and control fruits (0.274).

Iso buthyl caprylate determined end of the 2nd month, only 4% CaO treatments and 4th month, control and 2% CaO treatments.

Octanoic acid hexyl ester, 2nd month, 4% CaO, 4th month, control fruits were higher than 4% CaO and 2% CaO treatments. 6th month only control fruits showed to octanoic acid hexyl ester.

Cyclohexanol, 2-methyl, propionate has determined only end of the cold storage.

Total ester content examined in this research. 2nd month gave the 4% CaO, 4th month, control fruits, 6th month 2% CaO showed to higher content os esters during the cold storage.

Aldehydes examined totally in this research. At the harvest time, 0.541% aldehyde determined. 2nd month, 4% CaO treatments (2.193%), 2% CaO (0.883), control (0.832) fruits were given respectively. 6th month, 2% CaO (9.902%), control (6.533%), 4% CaO (4.370%) showed respectively. The higher concentration of aldehydes was found to correspond with increased green/grassy odor of apple juice (Komthong *et al*, 2007). (E)-2-hexenal and the increased content of acetate esters which were well corresponded with the green and sweet aroma intensity, respectively (Komthong *et al.*, 2006).

Initially alkane content was too low (0.848%). End of the storage, total alkane, 4% CaO (15.051%), 2% CaO (6.260%), control fruits (4.898%).

Other compounds are toluene, xylene and alpha farnesene. Especially, alpha farnesene was determined too high (25.868%). Its concentration was reduced during the storage. 2% CaO (4.484%), control fruits (3.257%), 4% CaO (2.665%) at the end of 6th month.

Conclusions

CaO solutions were not resulted in reduced total volatile levels. 2% CaO and 4% CaO treatments beyond 6 months storage, cause higher total volatile levels as those in the corresponding control fruit. The two concentrations of CaO used in this study had a similar effect on total volatile levels during cold storage. It can be concluded that CaO applications especially 4% concentration had

deformation effect on epidermal layer cells on fruit surface. As a result, CaO applications had a significant effect on aroma enhancement.

Table 1. Post-harvest dippings of calcium oxide on aroma volatile compound of pink lady apple cultivar

Ret Time	Aroma Volatiles	2'nd Month				4'rth Month			6'th Month		
		Initial	Cont.	2% CaO	4% CaO	Cont.	2% CaO	4% CaO	Cont.	2% CaO	4% CaO
3.47	Ethyl alcohol	0,04	1,22	0,64	1,03	20,87	13,76	19,36	64,19	63,11	56,78
5.86	1-Propanol	0,69	0,95	0,59	0,82	0,74	0,86	0,76	0,06	0,11	0,11
6.21	1-Hexanol	5,41	0,00	0,00	0,00	0,00	0,00	0,00	2,09	2,87	3,06
7.24	2-Butanol	0,00	0,00	0,53	0,59	0,33	0,38	0,51	0,00	0,00	0,00
8.49	1-Butanol	0,00	8,79	8,00	7,46	4,12	3,34	5,06	0,00	0,00	0,00
9.18	3-Phenylbutan-2-ol	0,00	0,00	0,26	0,00	0,26	0,00	0,00	0,00	0,00	0,00
9.80	2-Methylbutan-1-ol	0,00	2,57	2,22	2,24	0,93	0,79	1,02	0,00	0,00	0,00
10.50	2-Pentanol	0,00	0,00	0,36	0,00	0,00	0,04	0,00	0,00	0,00	0,00
10.65	1-Pentanol	0,00	0,00	0,26	0,18	0,00	0,07	0,00	0,00	0,00	0,00
12.43	1-Hexanol	0,00	14,44	11,53	12,33	5,86	3,77	4,36	0,00	0,00	0,00
13.26	2-Hexen-1-ol	0,00	1,30	1,04	1,20	0,37	0,12	0,00	0,05	0,03	0,03
17.82	3-Hexanol	0,00	0,00	0,00	0,00	0,23	0,12	0,36	0,07	0,03	0,07
20.69	1-Undecanol	0,00	0,00	0,00	2,01	0,00	0,00	0,00	0,09	0,08	0,08
22.12	1,3-Octanediol	2,32	17,63	13,46	14,88	18,11	12,61	17,76	0,00	0,00	0,00
23.83	Phenol,2,6-bis(1,1-dimethylethyl)-4-methyl	0,00	0,00	0,67	0,00	0,36	0,00	0,00	8,25	2,56	5,13
23.92	1-Hexen-3-ol	0,00	0,00	0,00	0,00	0,00	0,00	0,00	0,00	0,00	1,04
24.08	Phenol	0,00	0,00	0,00	0,00	0,00	0,00	0,00	1,67	2,67	2,62
24.29	Farnesol	0,00	0,00	0,60	0,00	0,00	0,00	0,00	0,00	0,00	0,00
25.00	1-Hexanol	0,00	0,00	0,00	0,00	0,42	0,00	0,00	0,46	0,17	1,01
27.33	Tridecanol	0,00	1,24	1,82	1,75	1,74	2,16	0,71	0,00	0,00	0,00
32.35	10-Nonadecanol	52,60	0,00	0,00	0,00	1,04	0,00	2,87	1,62	0,48	0,81
	Total Area	61,06	48,14	41,98	44,49	55,38	38,02	52,77	78,55	72,11	70,74
Ret. Time	Ester	Initial	Cont.	2% CaO	4% CaO	Cont.	2% CaO	4% CaO	Cont.	2% CaO	4% CaO
2.61	Ethyl Acetate	0,00	3,35	2,88	3,61	3,32	3,11	3,79	0,00	0,00	0,00
3.84	Butyl ester of hydroxyacetic acid	0,68	0,00	0,00	0,00	0,00	0,00	0,00	0,14	0,10	0,16
4.02	Propyl acetate	0,00	0,33	0,39	0,30	0,00	0,00	0,00	0,00	0,00	0,00
5.16	1-Chloroethyl acetate	0,00	0,00	0,00	0,00	0,00	0,00	0,00	0,09	0,10	0,12
6.19	Propanoic acid	0,00	0,00	0,00	0,00	0,00	0,00	0,00	0,00	0,18	0,06
6.66	Butyl acetate	3,86	1,37	1,72	2,09	1,06	1,36	1,51	0,11	0,36	0,28
7.88	3-methyl-butyl acetate	0,00	0,87	1,02	1,16	0,43	0,44	0,34	0,00	0,00	0,00
10.00	2-methyl- butyl ester	0,00	0,00	0,00	0,25	0,23	0,24	0,34	0,00	0,00	0,00
10.26	2-propenyl ester	0,00	0,00	0,20	0,10	0,00	0,05	0,00	0,00	0,00	0,00
11.01	Hexyl acetate	4,60	5,21	4,67	5,82	2,85	2,40	2,48	0,00	0,00	0,00
11.96	2-methyl- 2-propenyl ester	0,55	0,00	0,00	0,00	0,00	0,00	0,00	0,06	0,13	0,20
12.08	2-Hexenyl Acetate	0,00	0,33	0,32	0,54	0,14	0,04	0,00	0,63	0,36	0,18
12.18	Propanoic acid hexyl ester	0,00	0,37	0,53	0,51	0,14	0,10	0,00	2,37	4,59	4,66

12.69	Propanoic acid 1-methylethyl ester	0,31	0,00	0,00	0,00	0,00	0,00	0,00	0,00	0,00	0,00
13.36	Hexanoic acid butyl ester	0,00	0,68	0,79	0,68	0,74	0,87	0,91	0,00	0,00	0,00
13.40	Butanoic acid hexyl ester	0,00	1,15	1,03	1,01	0,94	0,77	0,94	0,00	0,00	0,00
13.58	Butyric acid 2-methyl-, hexyl ester	0,00	2,13	1,78	1,44	0,59	0,62	0,66	0,00	0,00	0,00
16.15	Hexanoic acid hexyl ester	1,68	2,93	3,05	2,90	3,29	3,79	4,01	0,27	0,57	0,53
16.20	Iso butyl caprylate	0,00	0,00	0,00	0,35	0,44	0,41	0,00	0,00	0,00	0,00
18.63	Octanoic acid hexyl ester	0,00	0,00	0,00	0,43	0,49	0,41	0,48	0,15	0,00	0,00
Ret. Time	Ester	In.	Cont.	2% CaO	4% CaO	Cont.	2% CaO	4% CaO	Cont.	2% CaO	4% CaO
22.44	Propanoic acid, pentyl ester	0,00	1,61	1,19	1,18	1,22	0,85	1,25	0,00	0,00	0,00
25.41	11,13-Tetradecadien-1-ol acetate	0,00	0,00	0,00	0,00	0,52	0,00	0,00	0,00	0,30	0,81
27.58	Ethyl linoleate	0,00	0,00	0,00	0,00	0,60	0,00	0,00	0,00	0,00	0,00
27.76	Cyclohexanol, 2-methyl-, propionate	0,00	0,00	0,00	0,00	0,00	0,00	0,00	2,92	0,56	0,18
	Total Area	11,68	20,33	19,57	22,37	17,00	15,46	16,71	6,74	7,25	7,18
Ret Time	Aldehit	Initial	Cont.	2% CaO	4% CaO	Cont.	2% CaO	4% CaO	Cont.	2% CaO	4% CaO
5.91	trans-4-hexenal	0,54	0,00	0,00	0,00	0,00	0,00	0,00	0,00	0,00	0,00
6.83	Hexanal	0,00	0,52	0,83	1,85	0,88	0,76	1,37	0,00	0,00	0,00
21.73	2-Hexyl-2-decenal	0,00	0,00	0,00	0,34	0,00	0,00	0,00	0,15	0,07	0,08
26.95	13-Tetradecenal	0,00	0,00	0,00	0,00	0,00	0,00	0,00	6,10	0,00	2,67
29.41	Pentadecanal	0,00	0,00	0,00	0,00	0,00	0,00	0,00	0,00	9,48	1,26
35.68	14-Heptadecenal	0,00	0,00	0,00	0,00	0,00	0,00	0,00	0,29	0,36	0,36
	Total Area	0,54	0,52	0,83	2,19	0,88	0,76	1,37	6,54	9,91	4,37
Ret Time	Alkane	Initial	Cont.	2% CaO	4% CaO	Cont.	2% CaO	4% CaO	Cont.	2% CaO	4% CaO
3.33	2-Butanone	0,00	0,00	0,00	0,00	0,00	16,53	0,00	0,00	0,00	0,00
29.26	Hexatriacontane	0,85	0,00	19,36	8,63	0,00	0,00	9,12	0,00	0,00	0,28
29.72	Dotriacontane	0,00	11,05	0,00	0,00	9,36	7,74	0,00	4,90	6,26	14,77
	Total Area	0,85	11,05	19,36	8,63	9,36	24,27	9,12	4,90	6,26	15,05
Ret Time	Others	Initial	Cont.	2% CaO	4% CaO	Cont.	2% CaO	4% CaO	Cont.	2% CaO	4% CaO
5.63	Toluene	1,03	1,59	2,17	2,32	0,81	0,78	0,94	0,00	0,00	0,00
8.20	Xylene	0,00	0,87	1,17	1,49	0,00	0,21	0,27	0,00	0,00	0,00
17.88	Alpha-Farnesene	24,84	17,50	14,94	18,53	16,57	20,53	18,84	3,26	4,48	2,67
	%total identified	25,87	19,96	18,28	22,34	17,38	21,52	20,05	3,26	4,48	2,67

*Percentage obtained by FID peak area normalization.

References

- Amira, E.A., Guido, F., Behija, S.E., Manel, I., Nesrine, Z., Ali, F., Mohamed, H., Noureddine, H.A., and Lotfi, A. (2011). Chemical and aroma volatile compositions of date palm Haider, Khan, Naqvi, Jaskani, Nafees, Maryam & Pasha 582 (*Phoenix dactylifera* L.) fruits at three maturation stages. *Food Chem.* 127:1744-1754.
- Brackmann, A., Streif, J., Bangerth, F. (1993). Relationship between a reduced aroma production and lipid metabolism of apples after long-term controlled-atmosphere storage. *Journal of the American Society for Horticultural Science*, 118, pp. 243–247.

- Conway, W.S. and Sams, C.E. (1987). The effects of postharvest infiltration of calcium, magnesium, or strontium on decay, firmness, respiration, and ethylene production in apples. *Journal of the American Society for Horticultural Science*. 112:300-303.
- Corrigan, V.K., Hurst, P.L., Boulton, G. (1997). Sensory characteristics and consumer acceptability of 'Pink Lady' and other late- season apple cultivars ISSN: 0114-0671 (Print) 1175-8783
- Fellman, J.K., Miller, T., Mattinson, D., Mattheis, J. (2000). Factors that influence biosynthesis of volatile flavor compounds in apple fruits. *HortScience* 35: 1026-1033.
- Knee, M., Hatfield, S.G.S. (1981). The metabolism of alcohols by apple fruit tissue. *J.Sci. Food Agric.* 32:593.
- Komthong P, Katoh T., Igura N., Shimoda M. (2006). Changes in the odours of apple juice during enzymatic browning. *Food Qual. Pref.*, 17, 497-504.
- Komthong, P., N. Igura and Shimoda, M. (2007). Effect of ascorbic acid on the odours of cloudy apple juice. *Food Chem.* 100: 1342–1349.
- Lara, J., Graell, M.L., López, G., Echeverría. (2006). Multivariate analysis of modifications in biosynthesis of volatile compounds after CA storage of 'Fuji' apples. *Postharvest Biology and Technology*, 39 , pp. 19–28.
- Mattheis, J.P., Fellman, J.K., Chen, P.M., Patterson, M.E. (1991). Changes in headspace volatiles during physiological development of 'Bisbee Delicious' apple fruit. *J. Agr. Food Chem.* 39:1902–1906.
- Nie, L. C., Sun, J. S., Chen, H. J., Zou, X. W. (2006). Study on fruit aroma of different apple cultivars. *Scientia Agricultura Sinica*, 39, 641-646. (in Chinese)
- Saftner, R.A., Conway, W.S., Sams, C.E. (1998). Effects of postharvest calcium and fruit coating treatments on postharvest life, quality maintenance, and fruit-surface injury in 'Golden Delicious' apples. *J. Am. Soc. Hort. Sci.* 123, 294–298.
- Solis-Solis, H.M., Santoyo, M.C., Golindo, S.S., Solano, G.L. and Sanchez, J.A.R. (2007). Characterization of aroma potential of apricot varieties using different extraction techniques. *Food Chemistry*, 105:829-837.
- Song, J., Bangerth, F. (1994). Production and development of volatile aroma compounds of apple fruits at different times of maturity. *Acta Horticulturae*. 368: 150-159.
- Villatoro, C., Altisent, R., Echeverria, G., Graell, J., Lopez, M.L., Lara, I. (2008). Changes in biosynthesis of aroma volatile compounds during on-tree maturation of 'Pink Lady®' apples. *Postharvest Biol.Technol.* 47, 286-295.
- Wills, R. B. H. (1972). Effect of calcium on the production of volatiles by apples. *J. Fd. Agr.* 23:1131-1134.
- Young, J.C., Chu, C.L.G., Lu, X.W., Zhu, H.H. (2004). Ester variability in apple varieties as determined by solid-phase microextraction and gas chromatography-mass spectrometry. *J Agric Food Chem* 52 8086–8093.

**TOXICITY OF SPINOSY INSECTICIDE, SPINOSAD AGAINST COWPEA WEEVIL,
(*CALLOSOBRUCHUS MACULATUS* (F.) (COLEOPTERA: BRUCHIDAE))**

Özgür SAĞLAM^{1*}, Mert SULAR¹, Ali Arda IŞIKBER²

¹Namık Kemal University, Agriculture Faculty, Department of Plant Protection, Tekirdağ, Turkey

²Sütçü İmam University, Agriculture Faculty, Department of Plant Protection, Kahramanmaraş, Turkey

*Corresponding author: osaglam@nku.edu.tr

Abstract

In present study, residual toxicity of Spinosyn group insecticide, Spinosad solution was evaluated on chickpeas against adult of *Callosobruchus maculatus* (F.) under laboratory condition. In laboratory bioassay, *C. maculatus* adults on chickpeas were exposed to Spinosad at 6, 12, 24, 48, 72 and 108 ppm (mg active substance/l water/ 0.5 kg product) concentrations for 7 days. The concentration of spinosad suspension and the exposure period had a significant effect on paralysis and mortality rate of *C. maculatus* adults on chickpeas. %100 paralyze and mortality rate of *C. maculatus* adults were recorded on surface treated chickpeas at 48 ppm concentration of spinosad for 7 day of exposure. At 72 and 108 ppm of spinosad concentrations no progeny production was observed while at 48 ppm concentration progeny production was only 1 adult. These results indicated that spinosad treatment at 48 ppm and above concentrations achieved complete mortality and completely suppressed the progeny production of *C. maculatus*. In conclusion, surface treatment of spinosad would be potential of controlling major stored legume pest, *C. maculatus* and be an alternative to conventional synthetic insecticides.

Keywords: *Spinosad, Callosobruchus maculatus, chickpeas, residual toxicity*

Introduction

Cowpea weevil, *Callosobruchus maculatus* (Fab.) is the principal pest of stored chickpea (Iturralde-Garcia *et al.*, 2016) and major pest for grain legumes in many tropical and subtropical countries (Singh, 1997). *C. maculatus* females lay about 50 eggs on each seed coat. Embryo development takes approximately 6 days, when larvae cross the seed coat and penetrates the cotyledons, where it feeds intensively to complete development. Adults emerge 25-30 days after oviposition (Credland, 1987; Southgate, 1979) and rapidly engage in reproduction and egg laying. The larvae of *C. maculatus* feed on the grain, causing considerable damage, which produces qualitative and quantitative losses. Estimated annual losses caused by *C. maculatus* in West Africa alone exceed \$ 50 million (Shade *et al.*, 1986). At present, control of stored product insects is mainly based on the use of fumigants and residual insecticides, both of which pose serious hazards to mammals and the environment (Shaaya *et al.*, 1997; Ren *et al.*, 2008). Fumigation is still one of the most effective methods for prevention of storage losses. Phosphine and methyl bromide (MB) are the most common fumigants used for stored-product protection throughout the world. However, MB was phased out at end of the 2015 in all over the world and for phosphine insect resistance problem is a global issue now and control failures have been reported in field conditions in some counties (Taylor, 1989; Collins *et al.*, 2002; Opit *et al.*, 2012; Saglam *et al.*, 2015). One of the potential alternative insecticides for controlling stored product insects is spinosad which is member of the spinosyn group insecticides. Spinosad is an insecticide

product from Dow AgroSciences (Indianapolis, Indiana, U.S.A.), derived via fermentation from a naturally-occurring soil actinomycete, *Saccharopolyspora spinosa* Mertz and Yao (Bacteria: Actinobacteridae). Spinosad contains two insecticidal factors, spinosyns A and D, present in an approximately 85:15 % ratio in the final product (Mertz and Yao, 1990; Kirst *et al.*, 1992; Sparks *et al.*, 1999)

Spinosad is highly active by both contact and ingestion to numerous pests in the orders Lepidoptera, Diptera, Thysanoptera, Coleoptera, Orthoptera, Hymenoptera, and others (Sparks *et al.*, 1995; Bret *et al.*, 1997). It affects nicotinic acetylcholine and gamma amino butyric acid (GABA) receptors sites of the insect nervous system (Salgado and Sparks, 2005). Some of the most important properties of spinosad are low mammalian toxicity and a highly favorable environmental profile (Cleveland *et al.*, 2001). Spinosad is also considered as a natural product and thus approved for use in organic agriculture by numerous national and international certification bodies (Racke, 2007). In present study, residual toxicity of spinosad solution was evaluated on chickpeas against *Callosobruchus maculatus* (F.) adults under laboratory condition.

Materials and methods

Insect culture: Insects were reared on *Cicer arietinum* L. var. *kocbasi* chickpea seeds in glass jars at 26 ± 1 °C temperature, 65 ± 5 % RH at laboratory condition. Insect cultures were maintained in on chickpeas in 1 liter glass jars under continuous darkness. New subcultures were established weekly, by removing approximately 100 beetles from each of the two oldest jars, the oldest then being discarded. In biological tests 2-3-day old adults were used.

Commodity: Uninfested and untreated chickpea (*Cicer arietinum* L. var. *kocbasi*) with 8 ± 0.5 % of moisture content was used for the bioassays and insect rearing. The chickpeas was placed a freezer at -18 °C for one week to destroy any remaining insects before the seed was used for insect rearing and laboratory trials.

Insecticide and insecticide treatment: A suspension concentrate (SC) formulation of Spinosad (Laser 480 SC) that contained 480 g of active ingredient (AI) per liter and was supplied by Dow AgroSciences, UK was used for bioassays. 500 g of chickpea was sprayed with spinosad at seven concentration levels: 0 (control), 6, 12, 24, 48, 72 and 108 ppm (mg active substance/ l water/ 0.5 kg product). The spinosad SC formulation was suspended with distilled water to prepare each concentration and 1 ml of the appropriate suspension was sprayed in each lot. The insecticide application was made by using HSENG Airbrush AS18 model (Ningbo Haosheng Pnömatik Machinery Co., Zhejiong, China). To achieve even distribution of the insecticide, the bean was spread into a plastic tray (48 x 33 x 8 cm) providing a thin mono layer as a spraying surface. Then, the sprayed bean lots in the plastic tray were shaken manually for approx. 1 min to enhance the insecticide distribution. Additional lots of 500 g of chickpeas were sprayed with distilled water as a control treatment. After spinosad treatment, commodities were left one day for drying under laboratory conditions.

Bioassays: Cylindrical glass vials with 330 ml of capacity were used as the experimental units for bioassays. For each spinosad concentration, five samples, each of 100 g, were taken from each jar of treated bean and placed in vials. Then, 20 one to three-day old and mixed-sex adults of *C. maculatus* were introduced into each vial (separate vials for each concentration). All these vials were placed in incubators set at 25 ± 1 °C, 65 ± 5 % RH and continuous darkness. Dead (no motion) and paralysis (only moving antenna and legs) of the exposed individuals were recorded

after 1, 3, 5 and 7 day of exposure in the treated and untreated substrate. After the 7 day of exposure, all adults (dead or alive) were removed and the jars returned to the experiment conditions. Forty-two days later (Rees, 2004), adult progeny emergences (F₁) were counted in treated and untreated vials.

Data analysis: For each exposure time, mortality rate and paralysis rate of *C. maculatus* adults were calculated. Since control mortality was generally low, no correction was considered necessary. Arcsine transformation was applied to mortality and paralysis data and then were subjected by two-way ANOVA (factors: exposure time and concentration) (Proc GLM: Univariate, SPSS, 2009). For progeny production, one-way ANOVA was performed, by using the same software, with number of progeny as the response variable, and concentration as main effect. In this case, the number of progeny in the control vials was also included in the analysis. The means were separated using Duncan test at the 5% level (Proc CM: One-way ANOVA, SPSS Statics 18, 2009).

Results and discussion

Biological tests indicated that concentration and exposure time had significant effect on mortality (for concentration; $F_{6,172}=587.1$, $P<0.0001$ and for exposure time; $F_{3,172}=120.5$, $P<0.0001$) and paralysis rate of *C. maculatus* when exposed to spinosad solution (For concentration; $F_{6,172}=50.2$, $P<0.0001$ and for exposure time; $F_{3,172}=85.7$, $P<0.0001$). Generally, mortality of *C. maculatus* adults increased with increasing of concentration at each exposure time. At the highest concentration (108 ppm) 80 % mortality rate was obtained after 1 day of spinosad treatment while at 48 ppm concentration 100 % mortality rate was achieved after 3 days of exposure time. The lowest mortalities were achieved at 0.1 ppm concentration for each exposure time.

Table 1. Mean mortality (%±SE) of *Callosobruchus maculatus* on chickpeas treated by spinosad at the different concentrations for 1, 3, 5 and 7 day of exposure time.

Concentration (ppm)	Mortality rate (%)*±S.E.				F and P value
	1 st day	3 rd day	5 th day	7 th day	
6	2.0±1.2 Ea*	5.5±1.7 Ca	6.6±1.9 Ca	13.5±4.6 Da	$F_{3,16}=2.0$ $P=0.153$
12	15.0±5.5 Db	35.8±9.8 Ba	40.3±6.2 Ba	41.6±5.7 Ca	$F_{3,16}=3.35$ $P<0.045$
24	19.3±5.3 Dc	37.2±7.4 Bb	55.3±4.7 Bab	68.8±5.9 Ba	$F_{3,16}=11.9$ $P<0.0001$
48	32.2±6.2 Cb	98.8±1.1 Aa	98.8±1.1 Aa	100±0 Aa	$F_{3,16}=97.7$ $P<0.0001$
72	50.7±5.1 Bb	100±0 Aa	100±0 Aa	100±0 Aa	$F_{3,16}=224.0$ $P<0.0001$
108	80.7±7.0 Ab	100±0 Aa	100±0 Aa	100±0 Aa	$F_{3,16}=24.2$ $P<0.0001$
Control	0.2±1.8 Eb	1.1±1.2 Ca	3.2±1.2 Ca	5.1±1.0 Ea	$F_{3,76}=7.9$ $P<0.0001$
F and P value	$F_{6,43}=75.8$ $P<0.0001$	$F_{6,43}=161.8$ $P<0.0001$	$F_{6,43}=200.7$ $P<0.0001$	$F_{6,43}=177.8$ $P<0.0001$	

(*Two-way ANOVA was applied to the data. Means within a row with the same lower-case letter and a column with the same upper-case letter do not differ significantly (Duncan test at 5% level).

High levels of paralysis were observed during 1st day of exposure time and then decreased on following exposure times. Spinosad treatments at 48 and 72 ppm for 1 day of exposure had significantly higher paralysis levels of *C. maculatus* than those at other spinosad concentration. However, very low paralysis levels were obtained at same concentrations after 3 day of exposure (Table 2).

Table 2. Mean paralysis levels (%±SE) of *Callosobruchus maculatus* on chickpeas treated by spinosad at the different concentrations for 1, 3, 5 and 7 day of exposure time.

Concentration (ppm)	Paralysis rate (%)*±S.E.				F and P value
	1 st day	3 rd day	5 th day	7 th day	
6	4.2±1.8 Da	4.4±1.1 Ba	4.3±2.6 Aa	12.7±4.6 Aa	F _{3,16} =1.9 P=0.167
12	5.1±2.4 Da	5.5±1.9 Ba	1.8±1.1 BCa	9.6±2.0 Aa	F _{3,16} =2.5 P=0.092
24	21.4±2.4 Bca	17.1±2.0 Aab	9.0±4.0 Abc	5.7±3.3 Bc	F _{3,16} =0.018 P<0.0001
48	42.6±6.6 Aa	0±0 Cb	0±0 Cb	0±0 Cb	F _{3,16} =109.4 P<0.0001
72	32.1±5.2 Aba	0±0 Cb	0±0 Cb	0±0 Cb	F _{3,16} =109.6 P<0.0001
108	17.3±7.7 Ca	0±0 Cb	0±0 Cb	0±0 Cb	F _{3,16} =109.6 P<0.0001
Control	0±1.9 E	0±0 C	0±0 C	0±0 Ca	F _{3,76} = - P= -
F and P value	F _{6,43} =40.9 P<0.0001	F _{6,43} =53.6 P<0.0001	F _{6,43} =5.5 P<0.0001	F _{6,43} =24.2 P<0.0001	

(*Two-way ANOVA was applied to the data. Means within a row with the same lower-case letter and a column with the same upper-case letter do not differ significantly (Duncan test at 5% level).

There were significant differences in progeny production between spinosad concentrations and control treatment. At 72 and 108 ppm, no progeny of *C. maculatus* was produced, whilst progeny production was observed at the lowest concentrations (6, 12 and 24 ppm). These results indicated that spinosad treatment at 72 and 108 ppm would completely suppress the progeny production of *C. maculatus* (Table 3).

Table 3. Mean number of adult progeny of *Callosobruchus maculatus* on chickpea treated by spinosad at the different concentrations

Concentrations (ppm)	Mean numbers of adult progeny ± S.E.
6	14.8±4.8 B*
12	5.4±1.9 B
24	7.6±1.8 B
48	1.0±0.4 B
72	0±0 B
108	0±0 B
Control	29.4±4.5 A
F and P value	F _{6,38} = 8.8, P<0.0001

*(Means followed by the same upper case letter at each concentration are not significantly different; Duncan test at 0.05).

Conclusion

Based on the results obtained from the biological tests, the concentration of spinosad suspension and the exposure period had a significant effect on paralysis and mortality rate of *C. maculatus* adults on chickpeas. The highest efficacy of dust treatment of spinosad was achieved at 0.7 to 1.44 ppm concentrations against some stored product insects (*R. dominica*, *S. zeamais* and *P. truncatus*) (Subramanyam 2006; Mutambuki *et al.*, 2012). Sadat *et al.* (2006) also reported LC₅₀ value as 149 ppm of spinosad against *C. maculatus*. In present study, spinosad treatment at 48 ppm and above concentrations achieved complete mortality and completely suppressed the progeny production of *C. maculatus*. Differences in the results obtained from present study can be attributed to different test methods and insect populations. In conclusion, surface treatment of spinosad would be potential of controlling major stored legume pest, *C. maculatus* and be an alternative to conventional synthetic insecticides

Acknowledgements

This study was supported by Namık Kemal University MS research grant (NKUBAP.00.24.YL.15.07).

References

- Bret B.L., Larson L.L., Schoonover J.R., Sparks T.C., Thompson G.D. (1997). Biological properties of spinosad. *Down to Earth* 52, 6-13.
- Cleveland C.B., Mayes M.A., Cryer S.A. (2001). An ecological risk assessment for spinosad use on cotton. *Pest Management Science* 58, 70-84.
- Credland P.F. (1987). Effects of host change on the fecundity and development of an unusual strain of *Callosobruchus maculatus* (F.) (Coleoptera: Bruchidae). *J. Stored Prod. Res.* 23, 91–98.
- Collins, P.J., G.J. Darglish, H. Pavic, T.M. Lambkin, Kapittke R. (2002). Combating strong resistance to phosphine in stored grain pests in Australia. *Proceedings of the Australian Postharvest Technical Conference on Stored Grain in Australia, 2000 Aug 1-4 CSIRO Canberra, Australia*, pp.109-112.

- Iturralde-García R.D., Borboa-Flores J., Cinco-Moroyoqui F.J., Riudavets J., Del Toro-Sanchez C.L., Rueda-Puente E.O., Martínez-Cruz O., Wong-Corral F.J. (2016). Effect of controlled atmospheres on the insect *Callosobruchus maculatus* Fab. in stored chickpea. *Journal of Stored Products Research* 69:78-85.
- Kirst H.A., Michel K.H., Mynderse J.S., Chao E.H., Yao R.C., Nakatsukasa W.M., Boeck L.D., Occlowitz J., Paschel J.W., Deeter J.B., Thompson G.D. (1992). Discovery, isolation and structure elucidation of a family of structurally unique fermentation-derived tetracyclic macrolides. In: Baker, D.R., Fenyes, J.G., Steffens, J.J. (Eds.), *Synthesis and Chemistry of Agrochemicals*, Vol. 3. American Chemical Society, Washington, D.C., pp. 214-225.
- Mertz E.P., Yao R.C. (1990). *Saccharopolyspora spinosa* sp. nov. Isolated from soil collected in sugar rum still. *Intern. J. Syst. Bacteriol.*, 40: 34-39.
- Mutambuki K, Ngatia CM, Mbugua JN, Likhayo P. (2012). Evaluation on the efficacy of spinosad dust against major storage insect pests. *Journal of Stored Products and Postharvest Research* Vol. 3(2), pp. 19–23.
- Opit G.P., Phillips T.W., Aikins M.J., Hasan M.M. (2012). Phosphine resistance in *Tribolium castaneum* and *Rhyzopertha dominica* from Stored wheat in Oklahoma. *Journal of Economic Entomology*, 105: 1107-1114.
- Racke K.D. (2007). A reduced risk insecticide for organic agriculture. In: Felsot, A.J., Racke, K.D. (Eds.), *Certified Organic and Biologically-Derived Pesticides: Environmental, Health, and Efficacy Assessment*. Symposium Series. American Chemical Society, Washington D.C., pp. 92-108.
- Rees D. (2004). *Insects of Stored Products*. CSIRO publishing, Collingwood, Australia, 192 pp.
- Ren Y.L., Mahona J.V.S., Gravera Head M. (2008). Fumigation trial on direct application of liquid carbonyl sulphide to wheat in a 2500 t concrete silo. *Journal of Stored Products Research*, 44: 115-125.
- Saglam O., Edde P.A., Phillips T.W. (2015). Resistance of *Lasioderma serricorne* (Coleoptera: Anobiidae) to fumigation with Phosphine. *Journal of Economic Entomology*, 108 (5): 2489-2495.
- Salgado V.L., Sparks T.C. (2005). The spinosyns: chemistry, biochemistry, mode of action, and resistance, In: *Comprehensive Insect Molecular Science* (Ed: L.I. Gilbert, K. Iatrou & S.S. Gill), vol. 6, Control, Elsevier, New York, pp.137-173.
- Sadat K.M., Asghar P.A. (2006). The influence of post-exposure temperature on the toxicity of spinosad against adults of *Callosobruchus maculatus* Fabricius (Coleoptera: Bruchidae). *Proceedings of the 9th International Working Conference for Stored Product Protection*, 15-18 October 2006. ABRAMOS, Campinas, Sao Paulo, Brazil, pp.258-262.
- Shaaya E., Kostjukovski M., Eilberg J., Sukprakarn C. (1997). Plant oils as fumigants and contact insecticides for the control of stored-product insects. *J. Sci. Food Agric.* 33, 7–15.
- Shade R.E., Murdock L.L., Foard D.E., Pomeroy M.A. (1986). Artificial seed system for bioassay of cowpea weevil (Coleoptera: Bruchidae) growth and development. *Environ. Entomol.* 15, 1286–1291.
- Singh S.R. (1997). Cowpea cultivars resistant to insect pests in world germplasm collection. *Trop. Grain Legume Bull.* 9, 3–7.
- Southgate B.J. (1979). Biology of the Bruchidae. *Annu. Rev. Entomol.* 24, 449–473.
- Sparks T.C., Thompson G.D., Larson L.L., Kirst H.A., Jantz O.K., Worden T.V., Hertlein M.B., Busacca J.D. (1995). Biological characteristics of the spinosyns: new naturally derived insect control agents. In: *Proceedings of the Beltwide Cotton Conference*, San Antonio, Texas, 4-7 January, 1995. National Cotton Council of America, Memphis, TN, pp. 903-907.

- Sparks T.C., Thompson G.D., Kirst H.A., Hertlein M.B., Mynderse J.S., Turner J.R., Worden T.V. (1999). Fermentation-derived insect control agents: the spinosyns, pp 171-188, In: *Biopesticides: Use and Delivery* (Ed: F.R. Hall, & J.J. Menn), Humana Press, Totowa, NJ, 626 pp.
- SPSS (2009). *SPSS Statistics 18 Data Analysis with Comprehensive Statistics Software*, Brother Soft, WA, USA.
- Subramanyam B. (2006). Performance of spinosad as a stored grain protectants, pp.250-257. In *Proceedings of the 9th International Working Conference for Stored-Product Protection*, Campinas, Brazil. Brazil: ABRAPOS- Brazilian Post-harvest Association.
- Taylor R.W.D. (1989). Phosphine a major fumigant at risk. *International Pest Control*, 31:10-14.

HERBICIDE CONTROL OF WILD HEMP (*CANNABIS SATIVA L.*) AT SUNFLOWER GROWN BY "EXPRESS SUN" TECHNOLOGY

Chavdar DOCHEV¹, Anyo MITKOV², Mariyan YANEV², Nesho NESHEV^{2*}, Tonyo TONEV²

¹DuPont Pioneer Company, Bulgaria

²Agricultural University of Plovdiv, Bulgaria

*Corresponding author: n_neshev85@abv.bg

Abstract

The Wild hemp (*Cannabis sativa L.*) is relatively rare weed in Bulgaria. Its presence in high density in the sunflower fields makes the production difficult and sharply decreases yields. To solve this problem a field trail in sunflower (*Helianthus annuus L.*) field infested with the weed Wild hemp in high density was conducted. The experiment was carried out during the vegetation periods of the sunflower from 2010 to 2014. The trail was stated on the agricultural land of village Krumovo, near Plovdiv, Bulgaria. The sunflower plants were grown by "ExpressSun" technology. The primly used herbicide is Express 50 SG (containing 500 g/kg tribenuron-methyl). For better Wild hemp control as partner products in our study, the adjuvant Trend 90 and the herbicide Pledge 50 WP (containing 500 g/kg flumioxazine) in dose of 7 g/da were used. The trail was conducted in four replications and the size of the plots was 28 m². The evaluated herbicides were applied in three different dates and in different doses. The obtained data for the efficacy of the herbicides were compared with the untreated dredged and not dredged controls. The efficacy of the herbicides against the weeds by the quantitative method (number of weeds per 1 m²) and the percentage of efficacy (%) by the visual scale of EWRS (European Weed Research Society) were reported three times annually. The influences of the examined factors on the sunflower seed yields were also studied. The results from the study showed that the wild hemp control is extremely difficult and for the best way to control this weed, a system of herbicide application in the correct time is required.

Keywords: *wild hemp, sunflower, herbicides, efficacy, yields*

Introduction

The Wild hemp (*Cannabis sativa L.*) is late spring weed and is observed mainly in spring field crops and in orchards (Small *et al.*, 2003). This weed species has aboveground biomass reaching 2 - 3 m of height, as well as powerful and deep root system. The Wild hemp infests a lot of different crops. At the rice fields in the northern part of western Bulgaria it is very aggressive weed that makes great economic damages (Duary and Mukherjee, 2003). The existence of Wild hemp as secondary emerged weed in unevenly topped winter wheat crop is also observed. Reisinger *et al.* (2005) reported that the Wild hemp is significantly more competitive compared to the culture. That leads to ineffective use of the present soil moisture and available nutrients. Ved Prakash *et al.* (2000) recorded that at the onion (*Allium cepa L.*) fields in the North-west Himalia the main weed species are Wild hemp (*Cannabis sativa L.*), Java grass (*Cyperus rotundus*) and Gallant soldier (*Galinsoga parviflora*). The weeding is decreasing the yields with 81,2 %. The Wild hemp is relatively rare weed in Bulgaria. Its presence in high density in the sunflower fields makes the production difficult and sharply decreases yields (Osman *et al.*, 2014). For the Wild hemp control different methods are applied. Many authors recommend the biological control by

using mycoherbicides. For this aim several virulent strains of *Fusarium oxysporum* f. sp. *cannabis* are studied and evaluated (Noviello et al., 1990; Tiourebaev et al., 2001). Páli *et al.* (2007) established that through fiercely burning the seeds of the wild hemp (*Cannabis sativa* L.) significantly decreases their viability. The information about the chemical control of the Wild hemp at sunflower as well as at the other crop is still limited. Pandey (1989) established that the infestation with Wild hemp at maize is controlled by usage of metribuzin at dose of 0.5 kg/ha, pendimethalin at dose of 1.0 kg/ha and two times earthing up on the 25th and on the 45th day after sowing. At the conventional technology of sunflower growing, none of the registered herbicide products cannot control the Wild hemp. Weed control at sunflower should be performed at the optimal phases of the crop before the critical period for decreasing the morphological parameters is reached (Simic et al., 2011). The introduction of the "Express sun" technology marks a new stage at weed control at sunflower production (Delchev and Georgiev., 2015). The aim of the present study was to establish the possibilities for herbicide control of Wild hemp (*Cannabis sativa* L.) at sunflower grown by "ExpressSun" technology.

Materials and Methods

The experiment was carried out during the vegetation periods of the sunflower from 2010 to 2014 (without 2013), on field infested with Wild hemp in high density. The sunflower plants were grown by "ExpressSun" technology. The trail was stated on the agricultural land of village Krumovo, near city of Plovdiv, Bulgaria. The primarily used herbicide was Express 50 SG, containing 500 g/kg tribenuron-methyl. For better hemp control as partner products in our study, the adjuvant Trend 90 and the herbicide Pledge 50 WP (active substance - flumioxazine 500 g/kg) in dose of 7 g/da were used. At variant 6 the herbicide Pledge 50 WP was applied immediately after sowing, and Express 50 SG was sprayed at phenophase from the emergence of 2-4 leaves of the sunflower (at variants 3 to 6) and from the emergence of 6-8 leaves (at variants 5 and 6). In the first three years of the study the sunflower hybrid "PR64 E83" was grown, and in the last experimental year (2014) the hybrid "PR64 LE25" was sowed.

The trail was conducted in four replications with size of the harvesting plot 28 m². The evaluated herbicides were applied in three different dates and in different doses (2 и 4 g/da). The obtained data for the efficacy of the herbicides were compared with untreated dredged two times controls (variant 2), as well as untreated not dredged controls. The efficacy of the herbicides against the weeds by the quantitative method (number of weeds per 1 m²) and the percentage of efficacy (%) by the visual scale of EWRS (European Weed Research Society) were reported three times annually. The influence of the tested factors on the yield of sunflower was also evaluated. In the trail intercrop tillage during the vegetation was not performed. The fields for the experiment were selected so that the prevailing weed infestation to be from the weed Wild hemp. The control of the single specimens from the other existing weeds on the field was accomplished by their removal by hand. The removing of the weeds was done to phenophase 8-10 leaves of the plants. Statistical analysis of collected data was performed by using Duncan's multiple range test (1955) of SPSS program. Statistical differences were considered significant at $p < 0.05$.

Results and Discussion

The number of the Wild hemp specimens in the untreated control varied from 17,3 to 50,9 per m² in the different years (Table 1). This variant showed the enormous competitive abilities of Wild hemp in its uncontrolled coexistence with sunflower. In comparison to the untreated control, in the twice dredged control (variant 2) the number of the Wild hemp plants was 4 times lower and varied from 3,9 to 9,4 specimens per 1 m² (Table 1). The most unsatisfied herbicide effect on the

examined weed was observed at variant 3 (Express 50 SG at dose of 4 g/da). According to Jursik *et al.* (2011), by applying adjuvants together with herbicides, the biological efficacy and crop selectivity of the used product is going to be improved. This statement was proved in our study. The adding of the adjuvant Trend 90 significantly improved the efficacy against the Hemp. In a study performed by Delchev (2013), the herbicide tank mixture of Express + Stratos Ultra by "ExpressSun" technology led to complete control of all annual and perennial grass and broadleaf weeds. In our experiment, by the application of Express 50 SG at dose of 2 + 4 g/da in combination with the adjuvant Trend 90 twice during the vegetation, over 90 % efficacy against Wild hemp was achieved. By the system of twice treatment the just emerged specimens of the weed were affected in maximum rate. After the second treatment, the secondary emerged weed plants were significantly affected. The highest herbicide effect against the Wild hemp was recorded at variant 6 (Pledge 50 WP + Express 50 SG + Trend 90, applied tree times) (Table 1). The results were the highest at phenophase cotyledons to 2-4 leaves of the plants. After the treatment of the sunflower plants with Express 50 SG at the time when the Wild hemp was at phenophase "rosette", the efficacy of the studied herbicide was sharply decreased.

The observations and reports for selectivity in the first three years of the study showed that the examined herbicide products had limited signs of fitotoxicity for sunflower. The visible indication of stress at the crop was expressed in meaningful lightening of the leaves that was continuing for 7-10 days. After this period the fitotoxicity signs completely disappeared. Between 2 and 5 % from the heterozygous hybrid "PR64 E83" did not form normal sunflower heads after the treatment with Express 50 SG. With implementation of the new homozygous hybrid "PR64 LE25" in 2014, any visible indications of fitotoxicity were not observed.

The highest yields in the experiment were obtained in 2014 (Table 2). The reasons for this fact were complex. On the first place, the summer of the concrete year was with the highest precipitation (the total precipitation for the period from April to August was 361,7 mm). On the second place was the implementation of the hybrid "PR64 LE25" that have high productivity potential and higher resistance to the applied herbicide in comparison to the hybrid used in the previous three years of the study ("PR64 E83"). The Plants of the new generation of hybrids do not undergo a state of stress after the application of Express 50 SG. At the older generation heterozygous hybrids the stress is expressed in short-term yellowing of the leaves after the treatment, a slight development delay, as well as blocking of the flowering of up to 5 % of sunflower plants.

Yield generally decreased with increased duration of weed interference (Elezovic *et al.*, 2012). In our trail the average yield for the period of investigation from the untreated and undredged controls was with 2,49 to 3,67 times lower in comparison to the variants with applied herbicides. During every experimental year, with statistically proved lowest yields among the treated variants, was the variant with single application of Express 50 SG without the adjuvant Trend 90 (Table 2). The epicuticular wax is the most significant barrier to the penetration of watersoluble herbicides (DiTomaso, 1999). The presence of epicuticular wax on the Wild hemp's leaves should be overwhelmed so the herbicide can get into the plant tissues. Our observations showed that with the aging of the Wild hemp, the weed was becoming more resistant to Express 50 SG and the necessity of the adjuvant application was more obvious. The lowest yield from the untreated control in 2011 corresponds to the highest level of weed infestation with Wild hemp (Table 2). Another important factor was undoubtedly the precipitation in this season. The total precipitation for the period April-August 2011 was 184.1 mm.

Table1. Efficacy of the studied herbicides

Variants	Doses g(ml)/da	2010		2011		2012		2014		2010/2014	
		Num./ m ²	Efficacy (%)	Num./ m ²	Efficacy (%)	Num./ m ²	Efficacy (%)	Num./ m ²	Efficacy (%)	Num./ m ²	Efficacy (%)
1. Untreated control	-	38,4	0	50,9	0	17,3	0	34,8	0	35,4	0
2. Earthed up control	-	5,0	90,0	9,4	89,3	3,9	87,3	5,5	90,0	6,0	89,2
3. Express 50 SG	4	13,4	70,0	17,6	65,3	10,4	70,0	13,7	69,0	13,8	68,6
4. Express 50 SG + Trend 90	4 + 25	9,6	74,7	14,3	75,7	7,1	80,7	9,5	76,7	10,1	77,0
5. Express 50 SG + Trend 90 (Applied two times)	(2+25) + (4 + 25)	6,1	90,3	6,9	87,7	3,8	90,7	4,9	88,3	5,4	89,3
6. Pledge 50 WP + Express 50 SG + Trend 90 (Applied tree times)	7+(2+25) +(4+25)	3,1	93,7	3,3	92,0	0,8	96,3	2,8	94,3	2,5	94,1

Table 2. Comparative analyses of the sunflower yields for the period 2010-2014 (kg/da)

Herbicides	Doses g(ml)/da	2010		2011		2012		2014		2010/2014	
		With U.c.	By Duncan's multiple range test	With U.c.	By Duncan's multiple range test	With U.c.	By Duncan's multiple range test	With U.c.	By Duncan's multiple range test	With U.c..	By Duncan's multiple range test
1. Untreated control	-	76	a	68	a	99	a	107.5	a	87.63	a
2. Earthed up control	-	260.00*	c	285.00*	e	285.00*	e	360.00*	c	297.50*	d
3. Express 50 SG	4	218.00*	b	119.00*	b	160.00*	b	298.50*	b	218.88*	b
4. Express 50 SG + Trend 90	4 + 25	255.00*	b	217.00*	c	207.00*	c	311.00*	b	247.50*	c
5. Express 50 SG + Trend 90 (Applied two times)	(2+25) + (4 + 25)	288.00*	d	243.50*	d	253.00*	d	368.50*	c	288.25*	d
6. Pledge 50 WP + Express 50 SG + Trend 90 (Applied tree times)	7+(2+25)+(4+25)	328.00*	e	292.00*	e	298.00*	e	370.00*	c	322.00*	e

Legend: All variants with * (star) are with proved difference compared with the untreated control. The values that are in one column and that have different letters (a, b, c etc.) are with proved difference at $p < 0.05$; U.c. = Untreated control

Conclusions

The results from the trails showed that the control of the Wild Hemp (*Cannabis sativa L.*) by the “ExpressSun” technology was extremely difficult and for the best way to control this weed, a system of herbicide application in the correct time is required. The Wild Hemp could decrease sunflower seed yields from 2,49 to 3,67 times in comparison to the variants with herbicide application.

When the product Express 50 SG was applied alone the herbicide control of the Wild Hemp was insufficient that had negative effect on sunflower yields.

The adding of the adjuvant Trend 90 to Express 50 SG increased the efficacy of the product during the fourth experimental years. The combined usage of the herbicide and the adjuvant led to increase of the yields over 13 % when compared with the alone herbicide spraying.

The application of Express 50 SG twice during period of 10 - 14 days increased the herbicide efficacy against Wild hemp with 10 - 15 % when compared with the alone application. As a result, there was yield increase on average over 16,5 %.

The highest and stable efficacy against the Wild hemp and the highest yields were achieved after the application of the herbicide combination of Pledge 50 WP + Express 50 SG + the adjuvant Trend 90 applied three times during the vegetation.

References

- Delchev G. (2013). Efficacy and selectivity of vegetation-applied herbicides and their mixtures with growth stimulator Amalgerol premium at oil-bearing sunflower grown by conventional, Clearfield and ExpressSun technologies. *Agricultural Science and Technology*, Vol. 5, No 2, p. 200-205.
- Delchev G., Georgiev M. (2015). Achievements and problems in the weed control in oil-bearing sunflower (*Helianthus annuus L.*). *Scientific Papers A, Agronomy* 58 Bucharest, 168-173.
- DiTomaso J. (1999). Barriers to Foliar Penetration and Uptake of Herbicides. *Proceedings of the California Weed Science Society*. Volume 51, p. 150-155.
- Duary B., Mukherjee A. (2013). Distribution pattern of predominant weeds in wet season and their management in West Bengal, India. The role of weed science in supporting food security by 2020. *Proceedings of the 24th Asian-Pacific Weed Science Society Conference, Bandung, Indonesia, October 22-25, 2013 Bandung: Weed Science Society of Indonesia, 2013, 191-199.*
- Duncan, B. (1955). Multiple range and multiple F tests. *Biometrics* 11, p. 1–42.
- Elezovic I., Datta A., Vrbnicanin S., Glamoclija D., Simic M., Malidza G., Knezevic S. (2012). Yield and yield components of imidazolinone-resistant sunflower (*Helianthus annuus L.*) are influenced by pre-emergence herbicide and time of post-emergence weed removal. *Field Crops Research*. 128, p. 137–146.
- Jursic M., Soucup J., Janku J., Holec J. (2011). Důležité aspekty herbicidní ochrany – Adjuvanty (Important aspects of herbicide protection – adjuvants) (In Czech). *Listy cukrovarnické a řepářské*. 127:384-388.
- Noviello C., McCain A., Aloj B., Scalcione M., Marziano F. (1990). Biological control of *Cannabis sativa* by *Fusarium oxysporum* f.sp. *cannabis*. *Annali della Facoltà di Scienze Agrarie della Università degli Studi di Napoli, Portici*. 24, 33-44.
- Osman A., El-Habieb R., Elkhawad, M. (2014). Herbicidal efficacy of oxyfluorfen (Sharoxy 24 EC) for pre-emergence weed control in sunflower. *Persian Gulf Crop protection* 3 (4) Dezful: Islamic Azad University, Plant Protection Department, 37-44.
- Páli O., Pomsár P., Reisinger P. (2007). Thermal method to control dangerous weeds. *Cereal Research Communications* 35 (2) Budapest: Akadémiai Kiadó, 885-888.

- Pandey J. (1989). Effect of *Cannabis sativa* infestation on yield of rabi maize. *Indian Journal of Agronomy* 34 (1), 109-110.
- Reisinger P., Lehoczyk É., Komives T. (2005). Competitiveness and precision management of the noxious weed *Cannabis sativa* L. in winter wheat. *Communications in Soil Science and Plant Analysis* 36 (4/6) Washington: Taylor & Francis, 629-634.
- Simic M., Dragičević V., Dolianovic Z., Jug D., Brankov M., Stipešević B. (2011). Effect of applied herbicides (fluchloridone + s-metolachlor) on weeds in different stage of sunflower growth. 46th Croatia and 6 th International Symposium on Agriculture, Opatija, Croatia, 14-18 February, 2011. *Proceedings Zagreb: University of Zagreb Faculty of Agriculture*, 704-708.
- Small E., Pocock T., Cavers P. (2003). The biology of Canadian weeds. 119. *Cannabis sativa* L. *Canadian Journal of Plant Science* 83 (1) Ottawa: Agricultural Institute of Canada, 217-237.
- Tiourebaev K., Semenchenko G., Dolgovskaya M., McCarthy M., Anderson T., Carsten L., Pilgeram A., Sands D. (2001). Biological Control of Infestations of Ditchweed (*Cannabis sativa*) with *Fusarium oxysporum* f.sp. *Cannabis* in Kazakhstan. *Biocontrol Science and Technology* 11 (4) Basingstoke: Carfax Publishing, Taylor & Francis Ltd, 2001, 535-540.
- Ved Prakash P., Singh R., Mani V. (2000). Integrated weed management in winter onion (*Allium cepa*) under mid-hill conditions of north-western Himalayas. *Indian Journal of Agronomy* 45 (4) New Delhi: Indian Society of Agronomy, 816-821.

THE VALIDATION OF (ALTAIR AGRAR) MODEL AS A DECISIONS TOOL OF IPM PROGRAMES IN COTTON FIELDS

Ahmed ABDO HAMED AMIN

Emeritus Professor Plant Protection Res. Institute, ARC, MOA
7, Nady El-Sayied Street, Dokki, Giza 12311, Egypt
Corresponding: aahakaa@gmail.com

Abstract

A physiologically based model has been developed for use in addressing crop and pest management decisions in processing cotton (ALTAIR AGRAR). Field studies were conducted during 2014-2015 cotton growing seasons in Fayum Governorate (Egypt), to detect the adult population of the pink bollworm (*Pectinophora gossypiella*), cotton leaf worm (*Spodoptera littoralis*), cotton aphid (*Aphis gossypii*), white fly (*Bemisia Tabaci*) and red mite (*Tetranychus Urticae*). Field generation numbers, life table parameters for field, thermal requirements and heat unit's accumulation were used. Cotton plant phenology was recorded as well as weather factors. The relationships in cotton complex were detected. The interaction of pest (5 pests), plant (phenology) and weather (four Factors) were tested by (ALTAIR AGRAR) Model, on cotton varieties (Giza 90). A comparison was made between the expected and observed data. Most of the validations produced results that were in reasonable agreement with the observed data. The forecasts were more accurate, when the phenology of the population peaks was compared than when actual population densities were compared. In general, no computer model can make perfect forecasts; however, we can use (ALTAIR AGRAR) Model successfully to help to take the decisions in cotton fields.

Keywords: ALTAIR AGRAR, Model, Plant phenology, cotton, Egypt.

Introduction

Modelling techniques that applied to agriculture can be useful to define research priorities and understanding the basic interactions of the plant-atmosphere system. by Using the models could estimate the importance and the effect of certain parameters, that could be most useful. Beginning the mid-1960 through the present, a considerable effort has been directed at development of computer models of agricultural systems.

Cotton in Egypt, is subjected to yield and quality losses by insect pests. The Pink bollworm (PBW), *Pectinophora gossypiella* and Cotton Leafworm, (CLW), *Spodoptera littoralis* are remaining the most destructive pests causing significant losses to the yield. Most economic losses caused by these pests due to larval feeding within boll basis. Since the larvae penetrate the bolls soon after hatching, efficient control by insecticides is hard to achieve. In addition, application of toxic insecticides may result in increased pest resistance to insecticides, interference with the activity of beneficial insects, environmental pollution, and hazards to public health. The reduction of insecticide applications in cotton is, therefore, of great correspondence. Cotton bollworm has a number of difficult problems regarding sampling techniques, i. e. (A)- Larvae feed inside the green bolls causes' special difficult in estimation the population density in the developmental stages of these insect pests. (B)- PBW and CLW have variable numbers of annual generations. Amin et al. (1994) found that PBW showed four generations. CLW found to has seven overlapping generations annually by many authors (Bishara, 1926; Abdel-Badie, 1977; Dahi, 1997). The indiscriminate use of insecticides has caused

a number of problems to various ecological niches around the world including Egypt. Hence there is a growing necessity and interest in the use of Ecological approaches for management these pests. The rates of development in insects under natural conditions are largely determined by temperature. In most microenvironments, temperature is characterized by daily and seasonal cyclic variations with superimposed irregular fluctuations. However, studies of insect development rate most often involve experiments performed under constant temperatures (Howe, 1967). In the development and application of development-rate models, it is always assumed that development rate at a given temperature is independent of thermal regime, whether the model is linear or nonlinear in relation to temperature. This assumption is also inherent in efforts to derive development-rate models from data obtained under varying temperatures, such as the work by Dallwitz & Higgins (1978) Babasaheb et al (2014), Marc Sporleder et al (2004). According to this assumption, development rate follows a definite function with respect to temperature, when other factors are equal, and the amount of development can be calculated by ac-cumulating the fraction of development per unit time; i.e., rate summation (Kaufmann 1932). The procedure may be expressed as:

$$D = \int r [T (t)] DT$$

Where development D is a function of temperature, T , which in turn is a function of time, t , and the development rate, r ; adjusts instantaneously to temperature. The above assumption is fundamental to the formulation of development-rate functions for phenological models. Life table studies are fundamental to not only demography but also to general biology. In such studies, development times and survival rates of each stage, longevity of adults, and the daily fecundity of females are recorded for every individual. Using elementary statistics, means and standard deviations can be calculated. In traditional life-table analysis, these means are used to calculate age-specific survival rates and age-specific fecundity using either the Leslie matrix (Leslie 1945) or Birch's method (Birch 1948). These procedures have been widely used by researchers in many different fields (Laing 1969, Shib et al. 1976, Cave & Gutierrez 1983, Vargas et al. 1984, Carey & Vargas 1985). However, variation in development rate is well known, even when a population is kept under constant laboratory conditions. The range of variation depends on many factors (for example, temperature and food). To assume that all individuals have the same development rate is biologically unrealistic and may be misleading. Therefore, ignorance of such variation when using either the Leslie matrix or Birch's method should be carefully considered. The method of incorporating this variation is the use of distributed delay theory in modelling (for example, Gutierrez et al. 1984, Plant & Wilson 1986). On the other hand, Chi & Liu (1985) developed an age-stage life table theory for both sexes, incorporating variable developmental rates among individuals. In comparison with the distributed delay models, Chi & Liu's model is different in that both sexes were included, and variation in development rates was integrated sequentially for all stages and expressed in the form of a stage distribution. The stage structure of a population can also be calculated in Chi & Liu's model. Furthermore, most life-table analyses have been concerned only with the "female" population. Most lepidopteran, coleopterans, and orthopteran pests are not parthenogenesis, however, and both males and females are economically important. Moreover, the development rate may differ between the sexes. Susceptibility to either chemical or biological control agents may be quite variable among stages and sexes. These and many other differences among stages and sexes explicitly point out the inadequacy of the female age-specific life table. In addition, whether to calculate the intrinsic rate of increase of a "female" population or of the population as a whole is a central question in ecology. In the theoretical model of Chi & Liu (1985), the population parameters are calculated with respect to both sexes and incorporating variable developmental rates among individuals. However, the major obstacle in taking the variable developmental rates and the male population into account is the difficult and tedious work of applying the age-stage, two-sex life table theory to the raw data analysis (Jean-Francois(1999)).

The number of days between observable events, such as cotton seedling emergence and first squares of the duration of insect generations can characterize the growth and development of plants and insects. The number of days between events, however, may be misleading because growth rates vary with temperatures. The measurement of events can be improved by expressing development units in terms of the temperature and time. The deviation between events is then based on accumulated degrees per unit time above a lower temperature re-presenting a threshold of growth. The goal of this study is to test the accuracy of pest-plant-weather components of (ALTAIR AGRAR) with cotton variety for short and long predictions to forecast the density and timing of cotton pest's populations.

Material and Methods

(ALTAIR AGRAR) is a temperature driven model with development based on cumulative heat above a lower developmental threshold (Wilson and Barnett, 1983). Unlike simple phenology models, however, biological rates are not strictly linearly proportional to heat above the lower threshold; factors such as solar intensity, water deficit stress, and so on regulate these temperature dependent rates. The linear approximation to physiological time, however, serves as a useful parameter for estimating potential rates of structural production (numbers) and biomass accumulation, which is in turn modified by the feedback mechanisms incorporated into the model.

The crop model consists of four parallel interacting subpopulations of seedlings, leaves, flowers, and bolls. Each subpopulation has its own birth rates, death rates, and growth rates.

The interface for (ALTAIR AGRAR) consists of a series of screens enabling a user to modify any of several default parameters at the start of a simulation. Key parameters for the crop currently include planting date, cotton Variety, planting date, and geographical location of the simulated field.

(ALTAIR AGRAR) validation data were collected from Fayum Governorate cotton fields (90 Km south Cairo) in Middle Egypt. Data were collected throughout two successive cotton-growing seasons (2014-2015). Giza 90 was the variety that cultivated in 2014 and 2015 seasons. Data was collected on: 1-pests numbers 2-injured fruit numbers, 3-cotton fruit numbers, 4- predator numbers, and 5- weather. Protocol was as follows: 1- pheromone traps: Six PBW and CLW pheromone delta traps were placed from February 15th to the end of October. The gossyplure baits were replaced with new one every 2 weeks or less depending on the weather. Adult males from each pheromone trap were checked twice per week.

Yellow sticky traps were used for aphids and white fly. Visual examination for red mite was made on all plants found in 25 m quadrat randomly selected.

2- Cotton fruit: Twenty-five meters of canopy were examined weekly for: a) No. of squares (pinhead to matched, matched to 1/4 inch and 1/4 inch to > 1/4 in diameter).

b) No. of bolls (<3/4 inch, >3/4 inch in diameter), and open bolls. c) No. of plants count (plants in each m² multiply by 4.047 to obtain the absolute number per acre). d) Plant height/m. 3-Crop injury. Samples of 100 bolls collected weekly. Small, medium and large bolls were taken randomly from each field and the infestation percentages were estimated in the lab.

Results and Discussion

I - Prediction of cotton phenology

Data were collected from three different planting dates in Fayum Governorate cultivated with cotton Giza 90. The three planting dates are: 15/2/2014, 1/3/2014 and 15/3/2014. The Cultivation Dates for 2015 cotton growing season for Giza 90 variety were: 20/2/2015, 7/3/2015 and 16/3/2015.

Table (1) illustrated the plant phenology; planting date, seedling emergence, Cotyledons stage, first true leaf, first fruiting branch, first bud, first flower, first boll and bolls maturation for the nine cultivation dates. The table shows deviation between the observed data that collected from the fields

and the predicted that obtained after applying the (ALTAIR AGRAR) model, by means of heat units.

The careful examination of date in the table reveal that the general average of deviation of DD's for the six cultivation dates for the eight plant stages tested ranged from 4 to -108.9 (first flower) and from -3.6 to 3.8 (first bud) DD's .

Data in Table (2) demonstrate the deviation of means between observed and predicted cotton phenology by days. As it could be seen the average ranged between -1 and -12 (boll maturation) and from 6 to -4 (seedling emergence) days.

As it could be concluded from the obtained results, the growth development curves observed actually did not differ significantly than those obtained by (ALTAIR AGRAR) model as all observed curves demonstrated a similar growth rate curve prior to the (ALTAIR AGRAR) model.

Table (1) Deviation between observed and predicted cotton phenology by (ALTAIR AGRAR) model, by means of heat units (2014-2015), Fayum, Middle Egypt

Planting Dates	Seedling emergence	Catyledons stage	First true leaf	First fruiting branch	First bud	First flower	First boll	Bolls maturation
15/02/2014	-3.3	6.6	1.4	-1.1	-3.6	-101.1	-18.5	-3.4
01/03/2014	-0.7	2.1	1.4	2.4	1.4	-117.6	5.6	1.7
15/03/2014	4.1	0	-1.6	0.1	3.8	-108.9	-3.1	-4
20/02/2015	-3	-5	1	-1	-6	4	0	1
07/03/2015	0	2	-3	-3	-1	2	-6	7
16/03/2015	5	3	1	-7	2	2	-8	1
General average	0.35	1.45	0.03	-1.60	-0.57	-53.27	-5.00	0.55
± S. D	3.51	3.83	1.87	3.18	3.70	61.50	8.16	3.99
99 % Confidential limit	5.77	6.31	3.08	5.24	6.09	101.23	13.44	6.57
95 % Confidential limit	3.68	4.02	1.96	3.34	3.88	64.54	8.57	4.19

Table (2) Deviation between observed and predicted cotton phonology by (ALTAIR AGRAR) model, by means of days (2015-2014), Fayum, Middle Egypt

Planting Dates	Seedling emergence	Catyledons stage	First true leaf	First fruiting branch	First bud	First flower	First boll	Bolls maturation
15/02/2014	6	5	-4	-3	-1	-3	-6	-2
01/03/2014	-2	-2	0	-1	0	-13	-2	-1
15/03/2014	2	1	-5	1	-1	-13	-2	-1
20/02/2015	-1	0	8	1	-2	1	-1	-9
07/03/2015	-4	-4	-5	-5	-5	-3	-5	-12
16/03/2015	-3	-5	-2	-5	-3	-3	-5	-12
General average	-0.33	-0.83	-1.33	-2.00	-2.00	-5.67	-3.50	-6.17
± S. D	3.72	3.66	4.97	2.76	1.79	5.89	2.07	5.42
99 % Confidential limit	6.13	6.02	8.18	4.54	2.94	9.69	3.41	8.92
95 % Confidential limit	3.91	3.84	5.21	2.89	1.88	6.18	2.18	5.69

II – Prediction of Cotton key pests

Cotton in Egypt, is subjected to yield and quality losses by insect pests. The Pink bollworm (PBW), *Pectinophora gossypiella* and Cotton Leafworm, (CLW), *Spodoptera littoralis* are remaining the most destructive pests causing significant losses to the yield. Most economic losses caused by these pests due to larval feeding within boll basis. Early season sucking pests; *Aphis gossypii*, white fly, *Bemisia Tabaci* and red mite, *Tetranychus Urticae*. also play an important role in reducing the yield quality and quantity. The proposed model ((ALTAIR AGRAR)) predicate the occurrence of these insect pests, consequently the goals of this work is to make the validation of that model.

Simulated and observed cotton tested insect pests densities are depicted in Table (3). (ALTAIR AGRAR) explained only 69.55 % of the variability in the field data of aphid as an average for the two seasons, 83.45% for red mite, 84.65% for the white fly, 77.95% for the cotton Leafworm and 79.1 % for the pink bollworm. The predicted trend of population peaks is closed to the actual population peaks, the general average for pest component as whole reached to 78.94 %.

However, the (ALTAIR AGRAR) model could be successfully used for cotton insect pest's predictions in Fayum, Middle Egypt.

Table (3): Simple correlation of Log observation and prediction curves of some cotton insect pests during two successive cotton growing seasons (2014-2015) at Fayum Governorate, Middle Egypt

Pest	R ²		% Accuracy
	Observed	Expected	
Aphid 2014	0.0121	0.0088	72.7
Aphid 2015	0.4225	0.2805	66.4
Average			69.55
Red Mite 2014	0.0322	0.0287	89.1
Red Mite 2015	0.5118	0.3983	77.8
Average			83.45
White Fly 2014	0.0078	0.0066	84.6
White Fly 2015	0.0144	0.0122	84.7
Average			84.65
Cotton Leafworm 2014	0.0031	0.0026	83.9
Cotton Leafworm 2015	0.3278	0.2361	72
Average			77.95
Pink Bollworm 2014	0.35	0.2726	77.9
Pink Bollworm 2015	0.1135	0.0911	80.3
Average			79.10
General Average			78.94

References

- Abdel-Badie; A. H. G. (1977). Ecological studies on certain cotton pests in Dakahlia Province. M. Sc. Thesis, Alexandria University.
- Amin, A. H. and M. A. Abdel-Meguid. (1994). Heat accumulation for timing pink bollworm, *Pectinophora gossypiella* (Saund.) control measures in Menoufia Governorate cotton complex. Egypt. J. Appl. Sci. Sci.; 9 (11) 71-78
- Babasaheb B. Fand a, , Henri E.Z. Tonnang b, Mahesh Kumar a, Ankush L. Kamble a, Santanu K. Bal (2014). A temperature-based phenology model for predicting development, survival and population growth potential of the mealybug, *Phenacoccus solenopsis* Tinsley (Hemiptera: Pseudococcidae). Crop Protection 55 , 98-108
- Birch; L. C. (1948). The intrinsic rate of increase of insect populations. J. Anim. Ecol. 17: 15-26.
- Bishara; I. (1926). The cotton leafworm, *Prodenia laticlavia* in Egypt. Bull. 92 Tech. and Sci. Service, Min. Agric. Egypt.
- Chi, H & H. Liu (1985). Two new methods for the study of insect population ecology. Acad. Sin., Carey; J. R. & R. I. Vargas (1985). Demographic analysis of insect mass rearing: a case study of three tephritids. J. Econ. Entomol. 78: 523-527.
- Cave, R. D. & A. P. Gutierrez (1983). *Lygus hesperus* field life table studies in cotton and alfalfa. Can. Entomol. 115: 649-654.
- Dahi, H. F. (1997). New approach for management the population of cotton leafworm, *Spodoptera littoralis* and pink bollworm, *Pectinophora gossypiella* in Egypt. M. Sc. Thesis, Cairo University.
- Gutierrez, A. P., J. U. Baumgaertner & C. G. Summers (1984). Multitrophic models of predator-prey energetics II: A realistic model of plant-herbivore-parasitoid-predator interactions. Can. Entomol. 116: 923-963.

- Jean-Francois Briere, , Pascale Pracros, Alain-Yves Le Roux, And Jean-Sebastien Pierre (1999). A Novel Rate Model of Temperature-Dependent Development for Arthropods. *Environ. Entomol.* 28(1): 22-29
- Leslie, P. H. (1945). On the use of matrices in certain population mathematics. *Biometrika* 33: 183-212.
- Marc Sporleder, Juergen Kroschel, Maritza R. Gutierrez Quispe, And Aziz Lagnaoui(2004). A Temperature-Based Simulation Model for the Potato Tuberworm, *Phthorimaea operculella* Zeller (Lepidoptera; Gelechiidae). *Environ. Entomol.* 33(3): 477-486
- Plant, R. E. & L. T. Wilson (1986). Models for age structured population with distributed maturation rates. *J. Math. Biol.* 23: 247-262.
- Shib, C. I., S. L. Poe & H. L. Cromroy. (1976). Biology, life table, and intrinsic rate of increase of *Tetranychus urtica* Koch. *Ann. Entomol. Soc. Am.* 69: 362-364.
- Vargas, R. I., D. Miyashita & T. Nishida (1984). Life history and demographic parameters of three laboratory-reared tephritids. *Ann. Entomol. Soc. Am.* 77: 651-656.
- Wilson, L. T., and Barnett, W. W., 1983. Degree-days: an aid in crop and pest management. *Calif. Agric.* 37:4-7.

EFFICIENCY OF BIOLOGICAL AGENTS IN CONTROLLING OF SEEDS AND ROOTS DISEASES OF EGGPLANT

Nadeem A. RAMADAN*, Peris T. AKRAWI

Biology Department, College of Science, Mosul University-IRAQ
Salahaldeen University, College of Agriculture, Plant Protection Department

*Corresponding author: nadeem.ramadan53@yahoo.com

Abstract

The effectiveness of alcoholic extract of Oak gall and Neem seeds on the integrity of eggplant seeds was examined. Five different seed samples were collected from the northern provinces of Iraq and used in this study. The result of our examination showed presence of various fungi including *Aspergillus*, *Aurobasedium*, *Botrytis*, *Cladosporium*, *Fusarium*, *Phoma* and *Rhizoctonia* in the examined seeds and roots samples. Isolation rate of fungi ranged from 1% to 17%. Fungi that were isolated from studied roots included *Alternaria*, *Botrytis*, *Chaetomium*, *Cladosporium*, *Drechslera*, *Fusarium*, *Geotrichum*, *Macrophomina*, *Phytophthora*, *Pythium*, *Rhizoctonia*, *Sclerotium* and *Stemphyllium*. Alcoholic extract of Oak gall showed inhibitory effect of 8% and 10% against *F. oxysporum* and *F. semitectum* respectively. Whereas, Alcoholic extract of Neem seeds showed inhibitory effect of 64% and 61.77% against *R. solani* and *F. oxysporum* respectively. The soil-borne fungus *Trichoderma harzianum* showed an antagonistic activity, and it had antifungal effect against several pathogenic fungi, especially *F. solani*, with antibiosis level of 1.66. *Bacillus subtilis* also showed high inhibitory activity of 100% against *F. semitectum* and 92.66% against *F. solani*.

Key words: *Eggplant, Biological Control, Fungi, Neem, Oak gall.*

Introduction

Biological control is an effective method against diseases transmitted by seeds. It is well known that, this method positively affect the activity of most microorganisms, and it improves soil conditions and sustainability of agriculture (Papavizas and Lewis, 1989). Biological control method is also proven to cause no harm to environment, and it reduces human health risks.

It is believed that, Eggplant, *Solanum melongena L.*, is originated in China and India. It grows as a wild plant (Chen and Li, 1996), and it usually needs a warm climate for growth. Generally, eggplant is economically important vegetable crop, and it ranks third after potatoes and tomatoes in terms of world production.

The plant is cultivated in tropic and subtropics region of Iraq, and the total area of planting is 21,665 ha and production is 24,321.84 kg /ha (anonymous, 2001). The plant is grown seasonally in open fields in spring, to produce fruit during summer months and autumn. Due to its importance and increased demand in winter and early spring, cultivation of this crop in protected facilities began in 1980s in Iraq to enhance and extend its production capacity (Bozorgi, 2012). The available information on the most producing countries of eggplant in descending order are: China (18 million tons), India (8.4 million tons), Egypt (1.2 million tons), Turkey (813 thousand tons), Indonesia (389 thousand tons), Iraq (380 thousand tons), Japan (371 thousand tons), Italy (321 thousand tons), and Sudan (230 thousand tons) (FAO, 2008).

However, eggplant is susceptible to many diseases, particularly fungal infections. Seeds play a vital role in transferring and spreading of these diseases. The damaging effect of diseases to crops, and massive economic loss as a result was indicated in a previous study, where the study stated a

substantial economic loss (up to 100%) which was related to vascular wilt diseases (Alabouvette et al., 1996).

This study aimed to investigate seeds and roots diseases of eggplants that were collected from three Northern provinces in Iraq, and to determine the efficiency of two different biological methods in controlling of such diseases.

Material and Methods

Isolation and diagnosis of fungi associated with seeds:

Five samples of eggplant seed lots were collected from several local companies and farmers in three provinces Akrae in Dohuk, Erbil, and Koya in Sulaimani (Iraq)..

The samples were kept in polyethylene bags in the refrigerator at 5°C until use. Fungi were isolated from seeds using agar plate method that was described by the International Seed Testing Association (ISTA, 1976). A 200 seeds were surface-sterilized by immersion in 1% sodium hypochlorite (NaOCL) for three minutes. Distilled water was used to wash the seeds thoroughly, and then seeds were dried between two layers of the Whatman filter paper. The treated seeds were distributed in separate dishes. Each ten seeds were placed in a dish containing 15 ml of PDA with streptomycin sulfate (50 mg /L). Plates were kept at 25°C for 12 h under light and 12 h under dark regime for one week. After the incubation period, plates were examined for the presence of fungal growth, and the detected fungal colonies were identified according to (Booth, 1971; Toussaun and Nelson, 1976; Pitt and Hocking, 1997; Leslie and Summerell, 2006). The isolated colonies were purified by using single spore or hyphal tip technique, and preserved on PDA slant at 5°C until used.

Isolation and diagnosis of fungi associated with roots:

Several field-infected plants were transferred to Plant Protection laboratory at the Faculty of Agriculture, University of Salahaldeen. Isolation of fungi from the infected plants was performed according to the method described by Agnihorti, (1971). Following a week of incubation, the colonies were examined and prepared as mentioned in the preceding paragraph and preserved on PDA slant tubes at 5°C.

Pathogenicity of isolated fungi:

Pathogenicity of the isolated fungi from the infected seeds and seedlings was tested. The PDA medium was used for cultivation of fungi, and cultivated plates incubated at 25°C±2. The grown fungi colonies were used in inoculation of sandy loamy soil. For this experiment 2 kg sandy loamy soil was used. The soil then inoculated with the fungi colonies grown on one half of the PDA plate. The added fungi growth mixed thoroughly with the surface layer of the soil (Saydam et al., 1973). Following mixing, the soil distributed in 1% formalin sterilized 20 cm-diameter pots. The experimental pots were placed in the canopy of wood for three days. Eggplant seeds that had been obtained from Erbil were used for the experiment at rate of 10 seeds per pot. Prior to spreading of seeds on the pots, seeds were sterilized with 1% sodium hypochlorite solution for three minutes. After sterilization, the seeds washed with sterilized distilled water, and spread on contaminated soil.

Biological control:

a) Plant extracts:

Two types of forest tree extracts were tested to assess their effectiveness against pathogenic fungi. Oak gall was obtained from Akrae, and Neem seeds were obtained from Sami Abdul Rahman Park in Erbil. Both Oak gall and Neem seeds washed with distilled water, and then placed on a filter paper at room temperature to dry. Each dried plant was kept in a labeled polyethylene bag until use. A twenty gram of each oak gall powder and Neem seed powder was separately added to 200 ml of 95% ethanol in 400 ml flasks. The mixtures left in shaking condition in water bath (Karlsruhe Company-Germany) for 1 hour, and then kept in refrigerator at 4°C for 24 hours. The extract was filtered through two layers of gauze, filtrate placed in a petri dish and left to dry at room temperature. The alcoholic plant extracts then collected in glass bottles and stored at -20°C in deep freezer until use (Alnoman, 1998).

One gram amount of alcoholic extract was added to 5 ml of dimethyl sulfoxide (DMSO) (BioSolve BV, Netherlands). The mixture then filtered using Millipore filters (0.2 micrometer). A 10 mg/ml of the above substance were added to 500 ml sterile PDA medium, and the medium poured into sterile glass petri dishes. The same procedure was followed in preparation the other concentrations (8, 6, 4, and 2 mg/ml). Freshly prepared disc (0.5 cm diameter) of pathogenic fungal colonies was placed over the prepared plates. Each treatment was repeated three times, control containing medium without alcoholic plant extract was also included in the experiments (Riso et al, 1987).

b) With fungi and bacteria:

Antagonism activity test carried out by using the bio-agent *T. harzianum* against pathogenic fungi that were grown on PDA plates. The plate was divided into two parts, a disk (0.5 cm diam.) containing colonies of *T. harzianum* was placed on the first half of the medium. While another disk (0.5 cm diam.) containing colonies of pathogenic fungi was placed on the second half of the medium. The distance between both microorganisms was almost 4 cm. The experiment repeated three times. Control was also included in the experiment, where, *T. harzianum* was used to inoculate a centre of a medium plate, and a disk containing pathogenic fungi was used to inoculate a different plate. The results obtained after a week of incubation at 25°C, and evaluated according to Bell et al., (1982).

Antagonism test of *Bacillus subtilis* against fungal pathogens:

Each PDA plate was inoculated with 0.5ml of *B. subtilis* at rate of 2.5×10^8 cfu/ml. The bacterial culture was grown in a nutrient broth at 37 °C for 24 hours, and 0.1ml of a fresh culture aseptically spread on the surface of the plate. Inoculated disks with fungal cultures were placed at the center of PDA plates, and plates were incubated at 25 °C. Experiment for each fungi culture was repeated three times. Results of grown fungal colonies on plates were recorded and the ratios of Qatrin perpendicular and the percentage of inhibition were calculated. Generated data was statistically analyzed using the Statistical Analysis System-SAS (Anon, 2005), and validated by Duncan's multiple range test.

Results and Discussion

Isolation and diagnosing of fungi associated with seeds

The testing result of seeds integrity of five eggplant samples that were obtained from Erbil, Dohuk, and Sulaimani is shown in (Table 1). The table shows that *R. solani* was found in 7% of examined seeds, with the highest rate (63.6%) of frequency which was recorded in seeds collected from Arbil. This finding is agreed with the findings of (Ismail, 2010), who indicated isolation of fungi from eggplant seeds. In addition to *R. solani*, *Aspergillus* sp. was also found, and the later fungus

presence was recorded in all examined samples at a range between 2-5%. The highest debut (100%) was found in seeds obtained from Sulaimani, and the lowest (20%) was found in seeds obtained from Akrae. A similar result was showed in a previous study by (Al-Kassim and Monawar, 2000), who also stated isolation of these fungi from seeds of eggplant. Moreover on fungal isolation from eggplant seeds, *F. oxysporum* was also isolated from the seeds obtained from Akrae at rate of 10%. A similar result regarding isolation the latter fungi from seeds were also reported by Ismail (2010). However, it is noteworthy to mention that *F. oxysporum* can cause a significant loss in production through causing diseases such as wilt disease. Symptoms of the disease usually occur on mature plants and unilateral gestures. Yellowing may appear on one side of infected plant then extend to all parts followed by wilt (Siva et al., 2008).

In a recent study, researchers were able to isolate both *F. oxysporum* and *F. solani* from seed embryos of eggplant (Habib *et.al.*, 2007). The occurrence of *F. solani* in soil is common, and contaminated seeds are the main route of transmission. This fungi can cause root rot diseases and stem ulceration in various plants (Gordon, 1960), and it considered one of the most dangerous pathogenic fungi that can cause wilting (Chakraborty and Chatterjee, 2008).

Table 1: Fungi isolated from the seeds of eggplants.

Governorates	Fungi	% Isolation	% Frequency
Erbil	<i>Aspergillus spp</i>	3	27.3
	<i>Phoma sp</i>	1	9.1
	<i>Rhizoctonia solani</i>	7	63.6
Sulaimani	<i>Aspergillus spp.</i>	5	100
Dohuk	<i>Aspergillus spp</i>	4	57.1
	<i>Botrytis cinnerea</i>	3	42.9
Akrah	<i>Aspergillus spp</i>	2	20
	<i>Aurobasidium pullulans</i>	1	10
	<i>Cladosporium cladosporioides</i>	1	10
	<i>Fusarium oxysporum</i>	1	10
	<i>Fusarium solani</i>	1	10
	<i>Rhizoctonia solani</i>	4	40
Koya	<i>Aspergillus spp.</i>	3	100

(ISTA, 1976)

Isolation of fungi from roots of eggplant:

Our data in Table 2 shows presence of *Fusarium sp.* in all samples that were collected from all studied sites in the regions of Erbil with repetition rate of 66.66%. However, information of the conducted field survey demonstrated isolation of *F. solani* from several studied sites especially in Shmamk, Khabat, and Ainkawa at rate of 4.76%, 3.57%, and 1.47% respectively. In addition to what we have explained earlier, as these fungi are commonly found in soil and can be transmitted through seeds, they can also penetrate plants through wounds on lateral roots or through the exposure to undesired conditions. Because its parasitic nature, it can cause root-rot diseases to many plants (Gordon, 1960), and subsequently the infected plants develop symptoms such as taproot and lateral roots browning. The later description of fungal root infection was also indicated in another study were the researchers stated that, the infection that had been occurred in the root reflected first on the aerial parts then yellowing and drought without discoloration of the vascular vessel (Ahmad and Al-Moussalli, 1987). In addition to *Fusarium sp.*, *R. solani* was also isolated from all of the

surveyed sites with the highest incidence found in Ainkawa 22.05%, Khabat 17.85%, and Shmank 9.52%. However, its occurrence may be due to the contamination of soils in these sites with this fungus, which is considered as one of the most causal agents of rot and seedling death to its wide range host that may exceed 230 plant species. Especially when we conclude that, *R. solani* can remain in the case of vegetative growth in the wet soil for the rest of the year (Parameter, 1970). However, during the infection process; the fungus affects seeds and seedlings in the soil before and after emergence. At the final stage, the disease attacks the roots and aerial parts of affected pots, fruits, leaves and stems (Anne et al., 2002).

Table 2: Fungi isolated from the roots of eggplants in areas of the province of Erbil.

Fungi	Khabat		Ainkawa		Shmank		Total	
	*% Iso	**% Freq	% Iso	% Freq.	% Iso.	% Freq.	% Iso	% Freq.
<i>Alternaria alternata</i>	7	8.33	1	1.47	1	2.38	9	4.6
<i>Botrytis cinnerea</i>	5	5.95	-	-	-	-	5	2.7
<i>Chaetomium herbarium</i>	-	-	-	-	1	2.38	1	0.5
<i>Cladosporium cladosporioides</i>	-	-	-	-	1	2.38	1	0.5
<i>Drechslera spp.</i>	6	7.14	2	2.94	-	-	8	4.1
<i>Fusarium compactum</i>	1	1.19	-	-	1	2.38	2	1.0
<i>Fusarium miscanthi</i>	1	1.19	-	-	-	-	1	0.5
<i>F. semetictium</i>	1	1.19	1	1.47	-	-	2	1.0
<i>F. solani</i>	3	3.57	1	1.47	2	4.76	6	3.1
<i>Fusarium spp.</i>	39	46.4	33	48.52	28	66.66	100	51.7
<i>Geotrichum candida</i>	-	-	1	1.47	-	-	1	0.5
<i>Macrophomina phasiolina</i>	-	-	-	-	1	2.38	1	0.5
<i>Phytophthora spp.</i>	-	-	1	1.47	2	2.38	3	1.5
<i>Pythium spp.</i>	3	3.57	3	4.41	1	2.38	7	3.6
<i>Rhizoctonia solani</i>	15	17.9	15	22.05	4	9.52	34	17.6
<i>Sclerotium spp.</i>	3	3.57	4	5.88	-	-	7	3.6
<i>Stemphyllium herbarum</i>	-	8.33	6	8.82	-	-	6	3.1
Total of Positive samples	84		68		68		194	
Total of negative samples	16		32		32		106	

- Non-appearance of fungi. Isolation, ** Freq. = Frequency. = Iso. = *

Pathogenicity of fungi isolated from eggplant:

Seed rot and seedling death of eggplant.

Results regarding seed rot and seedling death of eggplant collected from the region of Erbil are shown in Table 3. *F. solani* and *F. oxysporum* were the most virulent fungi isolated from seeds at a rate of (63.3%) without showing any significant differences between the species of fungi except control treatment. Our result also shows the contribution of *F. semetictum*, *F. compactum* and *R. solani* in causing seed rot that reached 53.3% and 43.3% respectively. However, *A. alternata* caused pre-emergence damping-off to a lesser extent of 26.7%. And, *R. solani*, *F. miscanthi*, and *F. solani* caused post-emergence damping-off at rates of 36.3%, 16.7%, and 13.3% respectively. Meanwhile, *F. miscanthi* did not cause death of seedlings and the surviving percentage of the infected plants with

F. miscanth was 63.3%, which indicates a weak pathogenicity of these fungi. While, surviving percentage the infected plants with *R. solani* reached 20.3%, which refers to high pathogenicity.

Biological Control

Effect of alcoholic extract of Oak galls on fungal growth:

The effect of alcoholic extract of Oak gall in inhibition growth of pathogenic fungi is shown in Table 4. The inhibition rate of the extract at 10% concentration against *F. compactum* found to be 61.4% with no significant differences between the treatments and the control plants. On the other hand, testing the impact of alcoholic extract of Oak gall on *F. miscanthi* showed the highest inhibition rate of 10% of the extract was 64.9%, and the

Table 3: Effect of some fungi isolated from seeds and roots of eggplant rot in the Preemergence damping-off and seedling death Post-emergence damping-off of seeds obtained from the province of Erbil.

Fungi	% Pre- emergence damping-off	%Post- emergence damping-off	% Survival plants
Control	13.3 b	3.3 de	83.3 a
<i>Alternaria alternata</i>	26.7 ab	6.7 cde	66.7 ab
<i>Drechslera spp.</i>	33.3 ab	10.0 bcd	56.7 abcd
<i>Fusarium compactum</i>	43.3 ab	10.0 bcd	46.7 abcd
<i>F. miscanthi</i>	36.7 ab	0.0 e	63.3 abc
<i>F. oxysporum</i>	63.3 a	10.0 bcd	26.7 cd
<i>F. semetictium</i>	53.33 ab	16.66 b	30.0 bcd
<i>F. solani</i>	63.33 a	13.33 bc	23.33 d
<i>Rhizoctonia solani</i>	43.33 ab	36.33 a	20.33 d

Numbers that bear similar letters do not differ significantly at 0.05 probability level using Duncan multiple range test (vertically). * Each number represents the average of three replicates .

lowest inhibition rate of 2% of the extract was 35.1%. When the influence of Oak gall extract was tested against *F. oxysporum*, a significant inhibiting action (100%) of the extract on the fungus was obtained. Although, there were no significant differences among the concentrations used, but a difference was found between control plates and the extract at 2% concentration, where the lowest inhibition rate 76.6% was observed. Moreover, the 10% alcoholic plant extract also had a significant inhibition action (100%) on the growth of *F. semitectum*. Meanwhile, the 2% extract showed the lowest inhibition rate of 62.5% with no significant differences among tested concentrations. The differences were only found with the control. However, *F. solani* was found to be the most susceptible to the plant extract treatment. Similar conclusion was also stated by Yamunarani, et.al.,(2005),who indicated inhibition of fungi growth by protein extracted from Oak. Söhreto et al., (2007) also mentioned the impact of alcoholic extract of Oak galls on mycelium growth of these pathogenic fungi.

Table 4: Effect of alcohol extract of oak galls in the growth of *Fusarium* species pathogenic to eggplants.

Pathogenic Fungi	Control (Cm)	Concentration				
		2%	4%	6%	8%	10%
		%Inhibition				
<i>F. compactum</i>	7.3 a *	28.4 a	46.7 a	52.3 a	55.7 a	61.4 a

<i>F. miscanthi</i>	6.2 b	35.1 b	50.0 b	60.9 b	62.2 b	64.9 b
<i>F. oxysporum</i>	6.8 a b	76.6 c	80.3 c	85.3c	100.0 c	100.0 d
<i>F. semitectum</i>	6.7 ab	62.5 c	80.0 c	81.2 c	100.0 c	100.0 d
<i>F. solani</i>	6.0 b	32.0 b	37.5 ab	59.8 b	65.3 b	73.7 c

Numbers that bear similar letters do not differ significantly at 0.05 probability level using Duncan multiple range test (vertically).

* Each number represents the average of three replicates.

Effect of alcoholic extract of Neem seeds on fungal growth:

The effect of alcoholic extract of Neem seeds in inhibiting growth of pathogenic fungi is shown in Table 5. The inhibition level of alcoholic extract of Neem seeds on *F. solani* was found to be 64.0% with no significant differences between treatments. A similar finding was also indicated by other researchers (Carpinella et al., 2003). Increasingly, *F. oxysporum* was also negatively impacted by this seed extract; the inhibition level was 61.8%. The highest inhibition level was observed at concentration of 8 and 10%. This particular result was in contrast with the result obtained by Hassanein et al., (2008) who found the inhibition rate of Neem plant extract at 20% concentration on the growth of *F. oxysporum* and *F. solani* to be 7%. But the inhibition rate of the same concentration on the growth of *F. semitectum* was 60.1%. The impact of 8 and 10 % extract concentration was found to be significantly different from the rest of the treatments. On the impact of the extract on the growth of *F. miscanthi*, the extract's inhibition rate was 58.1% with no significant differences between all treatments. Effectiveness of the alcoholic extract of Neem seeds may be attributed to its content of paraisine, which is one of the alkaline substances that inhibit fungi growth. It may also due to its combination with the dynamic biological processes, including the precipitation of the amino acid in the proteins synthesis (AL-Rawi and Chakravaraty, 1964). Another reason it could be containing materials effective against fungi including Vanillin and 4-hydroxy-3- methoxycinnam aldehyde and Pinoresinol (Carpinella et al., 2003).

Table 5: Effect of alcoholic extract of neem seeds in inhibition the growth of *Fusarium* species pathogenic to eggplants.

Pathogenic Fungi	Control cm	Concentration				
		2%	%4	6%	8%	10%
		% Inhibition				
<i>F. compactum</i>	7.33 a*	14.7 a	27.28 a	30.7 a	46.7 a	53.5 a
<i>F. miscanthi</i>	6.16 b	17.5ab	17.53 a	22.9 ab	44.6 a	58.1 a
<i>F. oxysporum</i>	6.75a b	44.4 b	48.14 b	48.1 b	55.6 a	61.8 a
<i>F. solani</i>	7.33 a*	9.8 ab	27.28 a	26.5 ab	50.0 a	60.1 a

Numbers that bear similar letters do not differ significantly at 0.05 probability level using Duncan multiple range test (vertically).

* Each number represents the average of three replicates.

Biological control using bacteria and fungi:

Efficiency of *Trichoderma harzianum* against pathogenic fungi.

The result presented in Table 6 indicates the high antagonism ability of *T. harzianum* against pathogenic fungi that infected eggplants. The antagonism level against *F. solani* found to be 1.7 degree, followed by *Drechslera* spp. Our results were in line with the results observed by other researchers, (Küçük and Merih, 2003) emphasized the ability of different bio- control such as *T. harziurum* in inhibiting growth of *Drechslera sorokiniana*, *F. oxysporum* and *R. solani*. In regard to *F. miscanthi*, *F. oxysporum* and *F. semitectum* the degree of antagonism level was found to be 2.0, while the degrees of antagonism against *A. alternate*, *F. compactum* and *R. solani*, were 2.3, 2.2, and 2.3 respectively. These results are consistent with the results reported by Wahgunde and Patil, (2009) in relation to the antagonism ability of the fungi *T. viride* and *T. harziurum* in inhibiting the growth of *A. alternate*. The antagonism ability of bio-control *T. harzianum* can be attributed to the production of B-1-3-glucanase enzyme, which weakens the pathogenic fungi and releasing cellulose enzymes in small quantities. However, this may assist in the penetration process of the bio-controls to pathogenic fungi cells and production of antibiotic, which degrades fungal thread (Benhamon and Chet, 1993).

Table 6: The efficiency of biocontrol *Trichoderma harzianum* against fungal pathogens of eggplants.

Fungi	Degree of Antagonism *
<i>Alternaria alternata</i>	**2.3
<i>Drechslera</i> spp.	2.00
<i>Fusarium compactum</i>	2.2
<i>Fusarium miscanthi</i>	2.0
<i>Fusarium oxysporum</i>	2.0
<i>Fusarium semetictium</i>	2.0
<i>Fusarium solani</i>	1.7
<i>Rhizoctonia solani</i>	2.3

* According to the world peace quintet Bell et al., (1982).

** Each number represents the average of three replicates.

Proficiency test of bacterial antagonism activity against pathogenic fungi:

The bacterial antagonism activity against pathogenic fungi was tested by using *B. subtilis*. The results in table 7 show that the inhibitory affect of *B. subtilis* was highest (100%) on *F. miscanthi*. On the other hand, it showed no effect on the growth of *Drechslera* sp. However, in a previous study of Korston and de Jager, (1995) the authors found a remarkable antagonism activity of this bacterium on spores growth and mycelia of *Drechslera setariae*. While, the inhibition rate reached up to 92.7% against *F. solani*. In another previous study, Kim, et.al., (1994) have also reported a potential antagonism activity of same bacteria on the growth of *F. solani*. Where the authors concluded the following, treated eggplant seedlings with *B. subtilis* prior to planting in contaminated soil reduced seedling infection rate from 68 % to 76 % by *F. solani*, and 90.8% by *F. oxysporum* within 25 to 30 days after treatment. However, this antagonism activity may be due to the ability of these bacteria in secretion group of antibiotics which include Difficidin, Prydifficidin, Bactracin, and Bacillomyin. It may also attribute to their ability in producing volatile organic compounds.

Table 7: Effect of biocontrol (*Bacillus subtilis*) against fungal pathogens of eggplants

Fungi	% of Inhibition
<i>Alternaria alternata</i>	59.3
<i>Drechslera spp.</i>	0.0
<i>Fusarium compactum</i>	83.3
<i>Fusarium miscanthi</i>	100.0
<i>Fusarium oxysporum</i>	90.8
<i>Fusarium semitectum</i>	66.7
<i>Fusarium solani</i>	92.7
<i>Rhizoctonia solani</i>	63.0

Diameter of colony control (9 cm).

Conclusion

Based on the presented results and discussions can be determined the following results:

- 1- The result of our examination showed presence of various fungi including *Aspergillus*, *Aurobasedium*, *Botrytis*, *Cladosporium*, *Fusarium*, *Phoma* and *Rhizoctonia* in the examined seeds and roots samples.
- 2- Isolation rate of fungi ranged from 1% to 17%. Fungi that were isolated from studied roots included *Alternaria*, *Botrytis*, *Chaetomium*, *Cladosporiu*, *Drechslera*, *Fusarium*, *Geotrichum*, *Macrophomina*, *Phytophthora*, *Pythium*, *Rhizoctonia*, *Sclerotium* and *Stemphyllium*
- 3- The soil-borne fungus *Trichoderma harzianum* showed an antagonistic activity, and it had antifungal effect against several pathogenic fungi, especially *F. solani*, with antibiosis level of 1.66. *Bacillus subtilis* also showed high inhibitory activity of 100% against *F. semitectum* and 92.66% against *F. solani*.

References

- Al-Ahmed, M. and N. Moussalli (1987). Wilt disease and root rot in lentil - Lens. Scientific Bulletin 14: 27-31.
- Alnoman, A.Y. (1998). The molecular effect of some plant extracts on the growth and metabolism of G + &G -Bacteria. PhD Thesis, College of Sci, Mosul Univ. IRAQ.
- Anonymous (2001). Yearbook of Agricultural Statistics Arabic. Vol. No.21.
- Anonymous, (2005). Statistics Users Guide for Personal Computer, SAS Institute Inc. , Cary, N.C., U.S.A.
- Al-Hammadi, M, F. (1990). Protected Agriculture. Ministry of Higher Education and Scientific Research. University of Baghdad, 399 pages.
- Agnihorti, V.P. (1971). Plant Pathology. 3rd. ed. Copy Right©. By Academic Press. 1451 pp
- Alabouvette, C.; Hoepfer, H.; Lemanceau, P. and Steinberg, C. (1996). Soil suppressiveness to disease induced by soil borne plant pathogens. pp 371- 413 .cited by :Stotzky, G. and Bollage, J.M.(ed). Soil Biochemistry, Vol.9. Marcel Pekker, INC. New York.
- Al-Kassim, M.Y. and Monawar, M.N. (2000). Seed-borne Fungi of Some Vegetable Seeds in Gazan Province and Their Chemical Control. Saudi. J. Biol. Sci. 7(2): 179-185.
- Al-Rawi, A. and Chakravarty, H.L. (1964). Medical Plants of Iraq. Technical Bulletin. No.5, 109 pp.
- Anne, E.D.; Patrick, E.L. and Dennis, R.M.(2002). *Rhizoctonia* damping off and stem rot of bean. Ohio state University extension fact sheet Plant Pathology.

- Bell, D.K.; Wells, H.D. and Markham, C.R.(1982).The *In Vitro* antagonism of *Trichoderma* species against six fungi plant pathogens.Phytopathology.72:379-382.
- Benhamon, N. and Chet, I. (1993). Hyphal interaction between *Trichoderma harzianum* and *Rhizoctonia solani* Ultrastructure and gold cytochemistry of the mycoparasitic process. Phytopathology 83:1062-1071.
- Booth, C. (1971). The Genus *Fusarium* Kew, Surry England. Commonwealth Mycol. Inst. 237 pp.
- Bozorgi,H.R.(2012). Study effects of nitrogen fertilizer management under nano iron chelate foliar spraying on yield and yield components of eggplant (*Solanum melongena* L.). ARPN J. of Agric. and Biol. Sci. 7(4):233-237.
- Carpinella, M.C.; Giorda, L.M.; Ferrayoli, C.G.; Palacios,S.M. (2003). Antifungal effects of different organic extracts from *Melia azedrach* L. on phytopathogenic fungi and their isolated active components J. Agric. Food Chem. 51(9):2506-2511.
- Chakraborty, M.R.and Chatterjee, N.C.(2008). Control of *Fusarium* wilt of *Solanum melongena* by *Trichoderma* spp. Biologia Plant Arum 52(3) : 582-586.
- Chen, N.C. and Li, H. M.,(1996). Cultivation and seed production of eggplant 1-12pp.cited by: Asian Vegetable Research and Development Center.
- F.A.O. (2008). Food and Agricultural Organization of the United Nations, 2008. www.Faostat.fao.org.
- Gordon, W. L.(1960). The taxonomy and habitats of *Fusarium* species from tropical and temperate regions. Canadian Journal of Botany 38: 643-658.
- Habib, A.; Sahi, S.T.; Ghazanfar M.U. and Ali, S. (2007). Location of seed-borne Mycoflora of Eggplant (*Solanum melongena* L.) in different seed components and impact on seed Germinability. Seed-borne Flora of Eggplant. Int. J. Agri. 9 (3) : 514-116 .
- Hassanein, N.M.; Abou Zeid, M.A.; Youssef, K.A and Mahmoud, D.A. (2008). Efficacy of leaf of neem (*Azadirachta indica*) and hinbeery (*Melia azadrach*) against early blight and wilt disease of tomato. Australian Journal of Basic Applied Science.2(3):763- 772.
- Ismael, J. H.S (2010). Isolation and identification of some fungi from certain solanaceous seeds in Sulaimania and Germian regions and their exudate effects on germination rate. Agric. Biol. J. N. Am.1 (4): 615-619.
- I.S.T.A. (1976). Proceeding of the International Seed Testing International Rules of seed testing. Wogeningen, Netherlands. 152pp.
- Kim, Y.; Ho-Seong,I.and Sang-dal ,K.(1994).*Bacillus subtilis* YB-70 as a Biocontrol Agent of *Fusarium solani* causing plant Root-Rot. J. of Micro and Biotech. 4(1):68-74.
- Küçük, Ç.and Mirih, K.(2003). Isolation of *Trichoderma* spp. and determination of their antifungal, biochemical and physiological features. Turk.J. Biol.27:247-253.
- Korston, L. and De Jager, E.E. (1995). Mode of action of *Bacillus subtilis* for control of Avocado post- harvest pathogens. South African Avocado Growers Association Year book. 18:124-130.
- Lesil, J.F. and Summerell,B.A.(2006).The *Fusarium* Laboratory Manual. Blackwell Publishing Asia.Australia.388 pp.
- Mahammad,S.and Amusa, N.A.(2003). *In-Vitro* inhibition of growth of some seedling blight inducing pathology by compost inhibiting microbes. African.J. Biotech. 2(6). 161-164.
- Parameter, J.R.(1970). *Rhizoctonia solani*, Biology and Pathology. University of California Press.Berkeley, Loss Angeles and London.
- Papavizas, G.C. and Lewis, J.A. (1989). Effect of *Gliocladium* and *Trichoderma* on damping-off and blight of snap bean caused by *Sclerotinia rolfisii* in the green house. Plant Pathol.38: 277-286

- Pitt, J.I. and Hoching, A.D. (1997). *Fungi and Food Spoilage*, 2nd ed. Gaithersburg. Maryland "Chapman and Hall", 593pp.
- Rios, J.L.; Recio, M.C. and Villar, A. (1987). Antimicrobial activity of selected plant employed in the Spanish Mediterranean area. *J. of Ethno Pharmacology*. 21:135-144
- Saydam, C.; Copeu, M. and Sezgin, E. (1973). Studies on inoculation techniques of cotton wilt caused by *Verticillium dahliae* Kleb. Investigation on the laboratory inoculation techniques. *Journal.Tur.Phytopathology*. 2:69-75.
- Siva, N.; Ganesan, N. and Muthuchelian (2008). Antifungal effect of leaf extract of some medicinal plant against *Fusarium oxysporum* causing wilt disease of *Solanum melongena* L. *Ethnobotanical leaflets*. 12:156-163.
- Söhreto, D.Ü.; Melike E.Ü.; Ekrem, K. and Koray, M.S. (2007). Antibacterial and Antifungal Activities of Some *Quercus* species in Turkey. *Fabad.J.Sci*. 32:127-130
- Tousson, T.A. and Nelson, P.E. (1976). A pictorial guide to the identification of *Fusarium* species according to taxonomy system of Snyder and Hansen 2th Ed. The Pennsylvania state university Press. University Park and London. 43pp.
- Wahgunde, R.R. and Patil, R.K. (2009). Antagonistic effect of bioagents on *Alternaria* fruit rot (*A. alternata*) of aonla. *J.Green Farming*. 2(11):783-784.
- Yamunarani, K.; Jaganathan, R.; Bhaskaran, R.; Govindaraju, P. and Velazhahan, R. (2005). *In vitro* Antifungal activity of a 29-kDa Glycoprotein purified from the Galls of *Quercus infectoria*. *Acta phytopathologica et Entomologica. Hungarica*. 40(1-2):43-54 .

ANTAGONISTIC EFFECT OF *TRICHODERMA HARZIANUM* AND *BACILLUS* SP. AGAINST THE LETTUCE PATHOGEN *SCLEROTINIA SCLEROTIUM*

Svetlana ŽIVKOVIĆ^{1*}, Veljko GAVRILOVIĆ¹, Katarina GAŠIĆ¹, Danijela RISTIĆ¹, Ivica DIMKIĆ², Slaviša STANKOVIĆ², Đorđe FIRA²

¹Institute for Plant Protection and Environment, Belgrade, Serbia

²University of Belgrade, Faculty of Biology, Belgrade, Serbia

*Corresponding author: zivkovicsvetla@gmail.com

Abstract

Sclerotinia sclerotiorum is a major pathogen of many economically important vegetable crops worldwide. Plants can be infected at any stage of their development. The pathogen survives in crops as sclerotia in soil or as mycelium in infected plant debris. This study was conducted in order to: a.) reveal trends of the disease occurrence on lettuce in Serbia, and etiological aspects of the causal agent *Sclerotinia* spp., and b.) evaluate the antagonistic effect of *T. harzianum* and *Bacillus* sp. against *Sclerotinia* spp. Lettuce with symptoms of basal rot were collected between 2012 and 2014 in the area of Lazarevac. All *Sclerotinia* isolates obtained from the diseased lettuce were identified as *Sclerotinia sclerotiorum*, based on morphological and cultural characteristics. *Trichoderma harzianum* (DSM 63059) and three bacterial biocontrol agents: *Bacillus* sp. strains SS 12.6, SS 13.1, and SS 51.1, were evaluated *in vitro* for their antagonistic potential against *S. sclerotiorum*, isolated from the lettuce plant. *T. harzianum* and the cell-free culture filtrate of *Bacillus* strains SS 12.6 and SS 13.1 showed the greatest potential for controlling *S. sclerotiorum* and these agents will be further tested in field trials.

Key words: *Sclerotinia sclerotiorum*, morphology, antagonistic effect, *Trichoderma harzianum*, *Bacillus* sp.

Introduction

The genus *Sclerotinia* contains a number of soil borne plant pathogenic fungi that occurs widely in temperate and subtropical areas of the world. The disease name was recorded as *Sclerotinia* drop rot, drop, decay, or watery soft rot depending on the hosts (Farr et al., 1989). The fungus survives in the soil as sclerotia, which are long-term survival and dissemination structures that can withstand adverse environmental conditions such as extreme temperature, UV light, desiccation, or antagonistic organisms (Ben-Yephet, et al., 1993). Germination of sclerotia can either be myceliogenic (forming mycelium) or carpogenic (forming apothecia). Regardless of the type, both germination methods results in initiation of disease (Clarkson et al., 2004).

It has been reported that *Sclerotinia sclerotiorum* (Lib.) de Bary and *S. minor* Jagger cause sclerotinia rot on some composite vegetable crops (Farr et al., 1989). Lettuce drop, caused by these two pathogens, is one of the most destructive lettuce diseases, causing severe yield losses worldwide (Subbarao, 1998; Kim et al., 2002; Bolton et al., 2006). The third species which also causes lettuce drop symptoms was detected in China is *S. nivalis* (Li et al., 2000).

Controls of *Sclerotinia* spp. are currently limited to the use of cultural and chemical control methods. In search of alternatives, biological control has emerged as a way of managing these pathogens. Numerous antagonistic and mycoparasitic fungi that belong to the genera, *Acrostalagmus*, *Aspergillus*, *Fusarium*, *Gliocladium* *Hormodendrum*, *Mucor*, *Penicillium*, *Stachybotrys*, *Trichoderma*, *Ulocladium* and *Verticillium* have proved to be effective against *S. sclerotiorum* (Bedi, 1961; Adams and Fravel, 1990; Li et al., 2003).

Trichoderma species have been shown to attack both sclerotia and mycelia of *Sclerotinia* species and have been used in the field with varying degrees of success (Chitrampalam, 2008). The mechanisms for the suppression of pathogens by *Trichoderma* include mycoparasitism, competition for space and resources, and antibiosis. The extracellular cell wall degrading enzymes produced by many strains of *Trichoderma* are traditionally included in the concept of mycoparasitism, due to their integral role in direct physical interactions (Howell, 1998; Monte and Llobell, 2003). Also, bacteria particularly those which produce antibiotics, such as *Pseudomonas fluorescences*, *P. putida*, and *Bacillus* spp., may have a direct or indirect impact on the survival of sclerotia (Tu, 1997). *Bacillus* spp. have special characteristics that make them good candidates as biological control agents (BCAs). The strains of this genus are ubiquitous, possess a resistant spore stage and produce several kinds of antifungal compounds (Yoshida et al., 2001; Leelasuphakul et al., 2008). This study was conducted in order to: a.) reveal trends of the disease occurrence on lettuce in Serbia, and etiological aspects of the causal *Sclerotinia* spp., and b.) evaluate the antagonistic effect of *T. harzianum* and *Bacillus* sp. against *Sclerotinia* spp.

Material and methods

Fungal isolation

The lettuce plants with symptoms of basal rot were collected between 2012 and 2014 in the area of Lazarevac. Isolation was achieved by cutting the small pieces on the margin of healthy and diseased tissue. The pieces were surface sterilized with 10% sodium hypochlorite solution for 2 min, rinsed several times with sterile distilled water, and plated on potato dextrose agar (PDA). The Petri plates were incubated at 25°C for 7 days.

Morphological and cultural characteristics

Fungi were identified based on morphological and cultural characteristics. The four representative isolates were cultured on PDA at 25°C for two weeks for production of sclerotia. Sclerotia produced on the medium were examined for the morphological characteristics and preserved in a low temperature incubator at 0°C. After one month of incubation, the sclerotia were put in 250 ml flasks with sterile wet sand and incubated at 15°C for five months in alternating cycles of 12 hr fluorescent light and 12 hr darkness. Apothecia produced from the sclerotia during the incubation were collected and examined for the morphological features.

In vitro inhibition of *Sclerotinia* spp.

T. harzianum (DSM 63059), employed for *in vitro* antimicrobial assay was obtained from German Collection of Microorganisms and Cell Cultures (DSMZ). Three strains of antagonistic bacteria: *B. licheniformis* SS-12.6, *B. amyloliquefaciens* SS-13.1, and *Bacillus* sp. SS-51.1 were obtained from cultural collection of Faculty of Biology.

a.) *T. harzianum* was screened for their antagonistic activity against isolates of *Sclerotinia* spp. using dual culture tests based on the percent growth inhibition (PGI). A 5 mm diameter mycelial agar disc was cut from the margin of 7 day old culture of *Sclerotinia* spp. and placed on one side of a 9 cm Petri plate containing PDA medium. Another 5 mm mycelial agar disc from 7-day old culture of *T. harzianum* was placed 6 cm away from the disc of *Sclerotinia* spp. on the same plate. Plates inoculated only with pathogens served as controls. The cultures were incubated at 25°C. Hyphal interaction and morphology were examined under a light microscope.

b.) The mycelial growth inhibitory effects of the extracellular metabolites from culture extract of *Bacillus* sp. SS-12.6, SS-13.1 and SS-51.1 were estimated by using the radial growth inhibition assay. For the production of antimicrobial substances, *Bacillus* sp. strains were grown in 200 ml of Luria-Bertani (LB) broth at 30°C in a shaker at 200 rpm over the night. The cells were harvested by centrifugation at 13,000 x g for 15 min, and the culture supernatant was tested. The agar disc of each tested isolates of *Sclerotinia* spp. was transferred to the surface of PDA, previously inoculated with 0.5 ml of bacterial cultures extract. Plates inoculated only with test pathogens served as controls.

In both tests, PGI of isolates of *Sclerotinia* spp. was calculated after 7 days using the formula: $\text{KR-R1/KR} \times 100$, where KR is the colony diameter in control plate without antagonist, and R1 is the colony diameter in treated plate.

Results and discussion

Morphological and cultural characteristics

The morphological characteristics of isolates are presented in Table 1. Colonies of *Sclerotinia* spp. on PDA consisted of white mycelia and globose to irregular and black sclerotia. All isolates obtained from the diseased lettuce were identified as *S. sclerotiorum*, based on morphological and cultural characteristics. The morphological characteristics of our isolates of *S. sclerotiorum* are similar to those reported by other researchers (Kohn, 1979, Willetts and Wong, 1980).

Table 1. Morphological characteristics of *S. sclerotiorum* isolated from lettuce.

Morphology	Isolates				
	LS-1	LS-2	LS-3	LS-4	
Sclerotium	Color	black	black	black	black
	Shape	irregular	irregular	globose	globose
	Size (mm)	5.0×7.0	4.5×6.5	7.5×8.0	8.0×8.5
Apothecium	Size of disk (mm)	0.5-7.3	0.5-7.5	1.0-8.5	1.0-8.0
	Length of stalk (mm)	2.0-10.5	2.0-8.0	2.5-14.0	2.0-14.0
Ascus	Shape	cylindrical	cylindrical	cylindrical	cylindrical
	Size (µm)	100-180×8-11	100-200×8-11	100-180×8-11	100-200×8-11
Ascospore	Shape	ellipsoid to ovoid	ellipsoid to ovoid	ellipsoid to ovoid	ellipsoid to ovoid
	Size (µm)	10-18×5-8	10-16×5-8	10-18×5-8	9-16×5-8

In vitro inhibition of *Sclerotinia* spp.

a.) *T. harzianum* is a saprophytic fungus which is generally used as a BCA against a wide range of economically important aerial and soil borne plant pathogens (Papavizas, 1985). Results from the dual culture test showed that *T. harzianum* exhibited the strong antagonism against isolates LS-1, LS-2, LS-3 and LS-4 of *S. sclerotiorum* with a high PGI value (71%, 68%, 65%, and 63% respectively). No distinct inhibition zones were observed between antagonistic fungus and pathogens. Microscopic examination of dual culture assay showed alternation of the mycelium of pathogen where it was in contact with antagonist. *T. harzianum* induced abnormal stunted, highly

branched hyphal tips, swollen hyphae and the vacuolar appearance of the mycelium of all tested fungal pathogens (Figure 1). Beside competition for resources and space, the invasive mechanism of *Trichoderma* includes lysis, mycoparasitism, antibiosis and local or systemic induced resistance (Howell, 2003; Harman, 2005). Similarly, in this study it was observed that the mechanisms of antagonism for all tested isolates of *S. sclerotiorum* were through competition, lysis, and mycoparasitism. *In vitro* test showed that *T. harzianum* (DSM 63059) had the capacity to recognize the fungal host by the formation of “hook-like” and “appressorial” structures around the hyphae of *S. sclerotiorum*.



Figure 1. Malformed and swollen hyphae of *S. sclerotiorum* (isolate LS-3) parasitized by *T. harzianum*.

b.) The result of mycelial growth inhibition assay showed that a culture extracts of *Bacillus* sp. SS-12.6 and SS-13.1 inhibited the growth of all tested isolates (LS-1, LS-2, LS-3 and LS-4) of *S. sclerotiorum* by 100% in comparison with control (Figure 2). Bacterial extract of strain SS 51.1 did not showed inhibitory effect on the growth of the tested isolates of *S. sclerotiorum*. *Bacillus* spp. are known to produce antibiotics (iturin, surfactin and fengycin), cell wall-degrading enzymes (chitinase, and β -1,3 glucanase), and antifungal volatiles which are effective against various pathogens (Knox et al., 2000). Ethyl acetate extracts of cell-free supernatants of *Bacillus* sp. SS 12.6 and 13.1, showed the presence of PCR products related to genes involved in synthesis of iturins and surfactins, and exhibit strong antimicrobial activity against a wide spectrum of postharvest fungal pathogens (Dimkić et al., 2013).



Figure 2. *In vitro* effect of bacterial extract of *Bacillus* strains SS 51.1, SS 13.1 and SS 12.6 on mycelial growth of *S. sclerotiorum*; K+ control without bacterial extract (isolate LS-3).

Conclusion

Biological control of *S. sclerotiorum* has been considered a more natural and environmentally acceptable alternative to the existing chemical treatment methods. The results of the present study suggest the need for further experiments on the antagonistic activity of *T. harzianum* and *Bacillus* strains, SS 12.6 and SS 13.1 against *S. sclerotiorum* using *in vivo* assays with plants under controlled greenhouse conditions.

Acknowledgment

This study was supported by the Ministry of Education, Science and Technological Development of the Republic of Serbia, Projects OI 173026 and TR 31018.

References

- Adams, P. B., and Fravel, D. R. (1990). Economical biological control of Sclerotinia lettuce drop by *Sporidesmium sclerotivorum*. *Phytopathology*, 80, 1120-1124.
- Bedi, K.S. (1961). Factor affecting the viability of sclerotinia of *Sclerotinia sclerotiorum* (Lib.) de Bary. *Indian Journal Agric. Sci.*, 31, 236-245.
- Ben-Yephet, Y., Genizi, A., and Siti, E. (1993). Sclerotial survival and apothecial production by *Sclerotinia sclerotiorum* following outbreaks of lettuce drop. *Phytopathology* 83, 509-513.
- Bolton, M.D., Thomma, B.P., and Nelson, B.D. (2006). Pathogen profile: *Sclerotinia sclerotiorum* (Lib.) de Bary: Biology and molecular traits of a cosmopolitan pathogen. *Molecular Plant Pathology*, 7, 1-16.
- Chitrampalam, P., Figuli, P. J., Matheron, M. E., Subbarao, K. V., and Pryor, B. M. (2008). Biocontrol of lettuce drop caused by *Sclerotinia sclerotiorum* and *S. minor* in desert agroecosystems. *Plant Disease*, 92, 1625-1634.
- Clarkson, J.P., Phelps, K., Whipps, J.M., Young, C.S., Smith, J.A., and Watling, M. (2004). Forecasting Sclerotinia disease on lettuce: toward developing a prediction model for carpogenic germination of sclerotia. *Phytopathology*, 94, 268-279.

- Dimkić, I., Živković, S., Berić, T., Ivanović, Ž., Gavrilović, V., Stanković, S., and Fira, Đ. (2013): Characterization and evaluation of two *Bacillus* strains, SS-12.6 and SS-13.1, as potential agents for the control of phytopathogenic bacteria and fungi. *Biological Control*, 65(3), 312-321.
- Farr, D. F., Bills, G. F., Chamuris, G. P. and Rossman, A. Y. (1989). *Fungi on Plants and Plant Products in the United States*, APS Press. The American Phytopathological Society, St. Paul, Minnesota, USA, pp. 1252.
- Harman, G.E. (2005). Overview of mechanisms and uses of *Trichoderma* spp. *Phytopathology*, 96, 190-194.
- Howell, C.R. (1998). The role of antibiosis in biocontrol. In: *Trichoderma and Gliocladium*, Harman, G.E., Kubicek, C.P. (Eds.), Taylor and Francis Ltd., UK, pp. 173–184.
- Howell, C.R. (2003). Mechanisms employed by *Trichoderma* species for the biological control of plant diseases: the history and evolution of current concepts. *Plant Disease*, 87, 1-10.
- Kim, W.G., and Cho, W.D. (2002). Occurrence of Sclerotinia Rot on Composite Vegetable Crops and the Causal *Sclerotinia* spp. *Mycobiology*, 30 (1), 41-46.
- Knox O.G.G., Killham K., Leifert C., 2000. Effects of increased nitrate availability on the control of plant pathogenic fungi by the soil bacterium *Bacillus subtilis*. *Applied Soil Ecology*, 15, 227-231.
- Kohn, L. M. (1979). A monographic revision of the genus *Sclerotinia*. *Mycotaxon*, 9, 365-444.
- Leelasuphakul W., Hemmanee P., and Chuenchitt S. (2008). Growth inhibitory properties of *Bacillus subtilis* strains and their metabolites against the green mold pathogen (*Penicillium digitatum* Sacc.) of citrus fruit. *Postharvest Biology and Technology*, 48, 113-121.
- Li, G., Wang, D., Jiang, D., Huang, H.C., Laroche, A. (2000). First report of *Sclerotinia nivalis* on lettuce in central China. *Mycol. Res.*, 104, 232–237.
- Li, G.Q., Huang, H.C., and Acharya, S.N. (2003). Antagonism and biocontrol potential of *Ulocladium atrum* on *Sclerotinia sclerotiorum*. *Biological Control*, 28, 11–18.
- Monte, E., and Llobell, A. (2003): *Trichoderma* in organic agriculture. *Proceedings V World Avocado Congress*, 725-733.
- Papavizas, G. C. (1985). *Trichoderma* and *Gliocladium*: Biology, ecology and the potential for biocontrol. *Annul. Rev. Phytopathol.*, 23, 23–54.
- Subbarao, K.V. (1998). Progress toward integrated management of lettuce drop. *Plant Disease*, 82, 1068-1078.
- Tu, J.C., (1997). Control of white mold of beans. *Bot. Bull. Acad. Sci.*, 38, 73-76.
- Willettts, H. J. and Wong, J. A. L. (1980). The Biology of *Sclerotinia sclerotiorum*, *S. trifoliorum*, and *S. minor* with emphasis on specific nomenclature. *The Botanical Review* 46, 101-165.
- Yoshida, S., Hiradate, S., Tsukamoto, T., Hatakeda, K., and Shirata, A. (2001). Antimicrobial activity of culture filtrate of *Bacillus amyloliquefaciens* RC-2 isolated from mulberry leaves. *Phytopathology*, 91, 181-187.

FIRST RECORD OF AN EGG PARASITOID FOR İĞDIR PROVINCE, TURKEY ELM LEAF BEETLE, XANTHOGALERUCA LUTEOLA (MULLER 1766) (COLEOPTERA: CHRYSOMELLIDAE)

Celalettin GÖZÜAÇIK^{1*}, Pınar SOYCAN²

¹İğdir University, Faculty of Agriculture, Department of Plant Protection, İğdir, Turkey

²Republic of Turkey Ministry of Food, Agriculture and Livestock, Kocaeli, Turkey

*Corresponding author: cgozuacik46@gmail.com

Abstract

The Elm tree (*Ulmus* spp.), is a tree which grows as both natural and ornamental in warm regions of Europe and Asia. It grows naturally and is also grown as ornamental plant in İğdir province. This study was conducted to determine egg parasitoids and parasitism rates of Elm Leaf Beetle, *Xanthogaleruca luteola* (Müller 1766) (Coleoptera: Chrysomellidae) feeding on Elm leaf (*Ulmus* spp.) in Central, Aralık, Karakoyunlu ve Tuzluca districts of İğdir provinces in the Eastern Anatolia region (Turkey) in the years 2013-2014. In each two years, the total 12.697 eggs were collected and cultivated at 25±1°C and 65±5% RH in glass tube (2x10 cm) in the laboratory. As a result of study, *Oomyzus gallerucae* (Fonsocolombe, 1832) (Hymenoptera, Eulophidae) was obtained. This species was recorded for the first time for the fauna of İğdir province, East Anatolia, Turkey. The average parasitism rates in elm plantations were 39.9% and 48.3% in İğdir provinces in 2013-2014 years, respectively.

Keywords: *Elm*, *Ulmus* spp., *Xanthogaleruca luteola*, *Egg parasitoid*, *Oomyzus gallerucae*, *Parasitism rates*

Introduction

Elms (*Ulmus* spp) are huge trees that drop their leaves in winter, prevail in warm regions of Europe and Asia (Anonymous, 2016). It belongs to Ulmaceae family *Ulmus* L. genus, it is a forest tree and it is generally used as park, garden and road tree (Dutkuner and Avcı 2000). It is widely grown starting from North and Eastern Europe, Western Asia and all the forested areas in Turkey especially in Black sea. The Elm tree (*Ulmus* spp.), is a tree which grows as both natural and ornamental and has become the symbol of İğdir province. So far many harmful insects have been determined which harm the Elms. *Xanthogaleruca luteola* (Müller) one of these insects is one of the most harmful ones. *X. luteola* was first discovered in the east of USA, Baltimore (Maryland) in 1830s (Glover, 1871; Riley 1883). This harmful insect exists in almost all the places where the elms are grown in North America (Davidson, 1979). The first record about this harmful insect was kept by Çanakçioğlu (1993). Luck and Scriven (1976) determined *Tetrastichus brevistigma* Gahan (Hymenoptera, Eulophidae) as the egg parasitoid of *X. luteola* in the research the made in the years between 1973-1974 in South California. Hall and Johnson (1983) first determined *Oomyzus gallerucae* (Fonsc.) as the egg parasitoid of *X. luteola* in USA in 1982. They presented the first time that this parasitoid spent the winter as adult. Graham (1985), determined the *O. gallerucae* and *Tetrastichus suevius* (walker) as the egg parasitoid of *X. luteola*.

This research was carried out the first time to determine the egg parasitoid of *X. luteola*, the harmful insect of the Elm in İğdir and parasitism rates in period 2013-2014.

Materials and methods

To determine the egg parasitoid of *X. luteola*, the eggs were collected in the dates between–08/06/2013 - 08/05/2014 and 02/05/2013-20/06/2014 when the eggs are seen as the first and the last time, in the years between 2013-2014 in the districts Tuzluca (Üçkaya - 39°56'58.0"N, 43°39'49.0"E and Turabi - 40° 04'41.0"N, 43°45'51.0"E), Aralık (Karasu neighborhood - 39°51'52.1"N, 44°32'01.6"E), and Karakoyunlu (39°58'25.4"N, 44°10'43.5"E), the center of Iğdır (the city forest - 40°02'04.2"N, 43°49'53.6"E). The collected eggs were taken in tubes sized 2x8 cm and label information have been added. These eggs were brought to the laboratory in ice container and were taken in the 25±1 °C and 65±5% R.H. culture. The eggs were checked daily and the parasitoid adults that leave have been protected being involved in 70 % alcohol. The identification of these insects was made by Dr. Miklat DOĞANLAR. At the end of research the parasitism rates have been determined by counting the eggs which are parasited and not parasited.

Results and discussion

In the study carried out in 6 locations in Iğdır, 12 597 eggs of *X. luteola* were collected and as egg parasitoid; *Oomyzus gallerucae* (= *Tetrastichus gallerucae*) Fonsolombe, 1832 (Hymenoptera, Eulophidae) were obtained. *O. gallerucae* was added in Iğdır fauna. Luck and Scriven (1976), determined *Tetrastichus brevistigma* (Hymenoptera, Eulophidae) as the egg parasitoid of *X. luteola* in the research they made in the years between 1973-1974. Hall and Johnson (1983) determined *O. gallerucae* as egg parasitoid of *X. luteola* in USA in 1982 the first time. Graham (1985) determined the species *O. gallerucae* (Fonsc) and *Tetrastichus suevius* (Walker). To determine the rates of parasitism, in 6 different locations where Elms are grown widely 6981 eggs of *X. luteola* (Table 1), were collected in 2013 and 5716 eggs were collected in 2014. In the first year, the adult parasitoids obtained 2786 of these eggs and in the second year 2776 of the eggs. The parasitoids obtained parasitism rates have been found as respectively 39.9 %, 48.3 %. On the table 1 and 2 the parasitism was observed mostly in the rate 46,95 % in 2013 in the locations where the researches are made in the City forest, in 2014 73.63 % rate in Sarıçoban. Puttler and Bailey (2003) determined the parasiting rate 26.3–51.7 % in the research they have made in Columbia, Missouri in the period 1999-2000.

Table 1. The number of collected eggs and parasitism rates of *Xanthogaleruca luteola* in Iğdır province in 2013 year

Location		The number of collected eggs	The number of parasitized eggs	Parasitism rate (%)
Central	Sarıçoban	312	56	17,9
	City forest	4440	2085	46,95
Aralık	Central	378	69	18,2
	Ortaköy	693	186	26,83
Tuzluca	Üçkaya	16	0	0.0
	Turabi	1142	390	34,15
Total		6981	2786	39,9

Table 2. The number of collected eggs and parasitism rates of *Xanthogaleruca luteola* in Iğdır province in 2014 year

Location		The number of collected eggs	The number of parasitized eggs	Parasitism rate (%)
Merkez	Sarıçoban	349	257	73,63
	City forest	2037	1293	63,47
Aralık	Central	28	0	0,0
Tuzluca	Turabi	2659	1104	41,51
Karakoyunlu	Central	671	122	18,18
Total		5744	2776	48,3

Conclusion

The studies are made in 2013 and 2014 and Elm Leaf Beetle, *X. luteola* and egg parasitoid *O. gallerucae* was found in all the areas where the elms are grown in Iğdır. Parasitism was recorded as the rate 39.9 % and 48.3 % as a result of two years of studies. The parasitism rates are denser in natural areas away from the settlements and are less densely found in the elms which are grown park and ornamental plants near the settlements. The reasons of this fact are considered to be the pest control efforts of the municipality for other insects on elm, the fumes coming out of the exhaust pipes and the dust appearing by the sides of the road.

Acknowledgement

We are grateful to Prof. Dr. Miktat DOĞANLAR (Mustafa Kemal University, Faculty of Agriculture, Department of Plant Protection (Antakya/Turkey) for identifying the specimen.

References

- Anonymous, 2016. <http://www.agaclar.net/forum/genis-yaprakli-agaclar/13927.htm> (Access to: 3.03.2016)
- Çanakçıoğlu H., (1993). The Forest Entomology. Publications of İstanbul University, İstanbul University Publications and Film Center. Publication No.: 3623, 458p.
- Davidson R., (1979). Insect Pests of Home, Garden and Orchard. New York, USA: Wiley and Sons, New York.
- Dutkuner İ., Avcı, M., (2000). Burdur-Göhlhisar Yöresinde Karaağaç (*Ulmus minor* Miller. supsp. *minor*) Ölümleri, SDÜ Fen Bilimleri Enstitüsü Dergisi, Cilt 4, Sayı 1.
- Glover T, (1871). Report of the Commissioner of Agriculture for the Year 1870. Washington, DC, USA: Government Printing Office, 65-91.
- Graham, M.W.R. de V., (1985). *Tetrastichus* species (Hymenoptera, Eulophidae), parasitizing the elm-leaf beetle *Pyrrhalta luteola* (Mull.) and allied hosts. Journal of Natural History 19(6):1059-1071.
- Hall R.W., Johnson, N.F., (1983). Recovery of *Tetrastichus gallerucae* (Hymenoptera: Eulophidae), an introduced egg parasitoid of the elm leaf beetle (*Pyrrhalta luteola*) (Coleoptera: Chrysomelidae). J. Kans. Entomol. Soc. 56, 297–298.
- Luck R.F., Scriven, G.T., (1976). The elm leaf beetle, *Pyrrhalta luteola*, in southern California: its pattern of increase and its control by introduced parasites. Environ. Entomol. 5, 409–416.

- Puttler B, Bailey W.C., (2003). Establishment of *Oomyzus gallerucae* (Hymenoptera: Eulophidae), an egg parasite of the elm leaf beetle (Coleoptera: Chrysomelidae), in Missouri and adjacent states. *Biological Control*, 27(1):20-24.
- Riley C.V., (1883). Report of the entomologist. In: Report of the Commissioner of Agriculture for the Year 1883. Washington, DC, USA: Government Printing Office, 159-170.

WHEN SHOULD THE FRUIT BE CONSUMED IN TERMS OF NUTRITION?

Kazim GUNDUZ*, Safder BAYAZIT, Oguzhan CALISKAN

Mustafa Kemal University, Horticulture Department of Agricultural Faculty, Antakya, Hatay, Turkey

*Corresponding author: kgunduz44@gmail.com

Abstract

Today, the idea of eating healthy food for a healthy life is becoming worldwide popular. The consumption of fruit rich in bioactive compounds is very important for health as it is known for their characteristics such as anticancer, antimutagenic and antioxidant. Fruit is consumed by people at the fully ripen stage. In some studies, it can be seen that fruit has a few times less bioactive compounds at the fully ripen stage when compared to the previous stages. For example: according to analysis results of the samples of cornelian cherry (*Cornus mas* L.) taken at four different stages (light yellow, blush, light-red and dark red) it is found that at light-red stage, the fruit has about 1.7 times more phenolic, 3.48 times more antioxidant and 2.32 times more tannin when compared with the fully ripen stage (dark red). Similar result was taken for *Ziziphus jujuba* Mill., *Vaccinium macrocarpon* Ait., and *Phoenix dactylifera* L.. In terms of anthocyanin, the values are similar. For this reason, the most important time of consuming fruit in terms of nutrition is not fully ripen stage but the stages before it.

Keywords: *Fruit, time of consuming, nourishment, phytochemicals.*

Introduction

Recent interest in food phenolics has greatly increased on account of the antioxidant and free radical-scavenging abilities associated with some phenolics and their potential effects on human health (Hamid et al., 2011). Agronomic research has set priorities to obtain high yield, better resistance to disease and transportation and longer shelf-life of fruit. Thus, fruit breeding programs have been aimed at improving yield and fruit size, resistance to disease and pests, adaptation to particular growing systems and rate of ripening. Most recently, research has been focused on the quality of fruit (Capocaso et al., 2008). Particularly small fruits constitute a good source of natural antioxidant substances. Fruits are a good source of natural antioxidants, containing many different radical scavenger components that provide protection against harmful-free radicals and consequently are associated with lower incidence of cancer and heart diseases in addition to number of other health benefits (Shui and Leong, 2006; Hamid et al., 2011). Antioxidants reduce oxidative damage to cells that can lead to cancer, heart disease, and other degenerative diseases. Especially the anthocyanin compounds, that give red berry their red color, are powerful antioxidants (Prior, 2003; Zafra-Stone et al., 2007). Among natural compounds phenolics and, in particular, flavonoids have been found to be an important part of human diet and are considered to be the active component in many medicinal plants (Cooper-Driver, 2001). Genotype-variety is the major factor in determining fruit nutritional quality. Nutritional quality is also affected by crop conditions, ripening season, pre-harvest and post-harvest conditions, shelf-life and processing (Connar et al., 2002; Capocaso et al., 2008). Maturity or ripening index is another important factors which can strongly influence the nutritional value as well as physiological properties such as development of colour and texture of fruits (Ali et al., 2004; Schweiggert et al., 2011). According to some researchers, the changes in antioxidant properties were found to be varied among different fruits such as *Olea europaea* L., orange, *Solanum lycopersicum* L., and *Ziziphus jujuba* Mill. (Castrejón et

al., 2008; Huang et al., 2007; Ilahy et al., 2011; Wu et al., 2012). Various factors (climatic, agronomic, genomic, pre- and postharvest conditions, and processing) may affect the chemical composition of plant foods and may have a significant role in determining the phenolic composition and the bioactivity of these compounds (Imeh and Khokhar, 2002). Maturity stage is another important factor that may influence the compositional quality of fruit and vegetables. In fact, during fruit ripening, several biochemical, physiological, and structural modifications happen and these changes determine the fruit quality attributes. Harvesting at the proper maturity stage is essential for optimum quality and often for the preservation of this quality after harvest and storage (Amira et al., 2012).

The aim of this compilation is to pay attention on consumption time of fruit species in respect to nutritional ingredients. Fruit species are generally consumed in their full ripe stages.

Studies on the Changes Made in the Stages of Fruit Ripening

In recent years, a great number of researches are carried out about fruit quality change effect of ripeness stages of fruit and vegetables. The reason of this is phytochemicals which exist with high levels in fruit and vegetable ingredients. Therefore, it is a necessity to determine consumable fruit ripeness of useful bioactive substances which exist with high amounts in fruit and vegetables.

Gündüz et al. (2013) was evaluated at chemical properties and antioxidant characteristics of cornelian cherry fruits at four ripeness stages (Table 1). The stages were light yellow, blush, light red and red. TPC and TEAC averages gave similar patterns: the highest averages were recovered at the light yellow (8033 µg GAE/g fw) and 55.0 µmol TE/g fw) and blush (8206 µg GAE/g fw and 55.3 µmol TE/g fw) stages; and the averages were reduced at the light red (7110 µg GAE/g fw and 27.1 µmol TE/g fw) and red stages (4162 µg GAE/g fw and 7.8 µmol TE/g fw). A reverse pattern was observed for TMA and tannins. TMA was lowest at the light yellow stage and reached to 65.0 and 65.8 µg cy-3-glu/g fw at the red and red light stages. Tannin content was reduced from 4.45% to 1.58% from the light yellow to red stages.

Table 1. Mean and mean separations for total phenolic content (TPC), antioxidant capacity (TEAC), anthocyanin (TMA) and tannins of cornelian cherries fruits sampled from four maturation stages

Stage	Weight (g)	TSS (%)	TPC (µg GAE/g fw)	TEAC (µmol TE/g fw)	TMA (µg cy-3-glu/g fw)	Tannins (%)
Light yellow	3.9 d	11.3 c	8033 a	55.0 a	4.9 c	4.45 a
Blush	4.2 c	12.2 b	8206 a	55.3 a	16.5 b	3.79 b
Light Red	5.0 b	16.0 a	7110 b	27.1 b	65.8 a	3.66 b
Red	6.4 a	16.5 a	4162 c	7.8 c	65.0 a	1.58 c
Mean	4.9	14	6878	36.3	38	3.37
SD _{5%}	0.4	0.6	350	1.9	2.2	24

Some of the chemical properties and antioxidant capacity of cranberry (*Vaccinium macrocarpon* Ait. cv. Pilgrim) fruits were investigated at light green, blush, light red and dark red maturation stages (Celik et al., 2008). The berry size progressively increased during the fruit maturation (Table 2). Similarly, the Brix values increased from 6.0 to 9.3% (Table 2). Total phenolic and total anthocyanin contents of each maturation stages were statistically different (Table 2). During maturation, from green to dark red stage, the total phenolic content was decreased from 7990 to

4745 mg GAE/kg fw, while total monomeric anthocyanin content was increased from 0.8 to 111.0 mg/kg fw from green to dark red stage. The highest antioxidant capacities were recovered from green stage followed by blush. The lowest antioxidant capacities were determined at light red (Fig 1). The results clearly demonstrated that some of the chemical properties and antioxidant capacities of some fruits are affected by maturation stages. Significant variability was found for overall total phenolic, anthocyanin, organic acids and antioxidant capacity of different maturation stages. Total phenolic and anthocyanins content affected the antioxidant capacity. Green stage of some fruits had the highest antioxidant capacity.

Table 2. Mean and significances for several pomological and chemical parameters of cranberry fruits sampled from four maturation stages

Stage	Weight (g/100 berries)	TSS (%)	TPC (μ g GAE/g fw)	TMAc (μ g cy-3-glu/g fw)	Total Organic Acids (g/100g)
Green	67.3 c	6.0 d	7990 a	0.8 c	1.50 c
Blush	87.6 b	6.8 c	6853 b	6.6 c	1.71 b
Light Red	135.3 a	8.7 b	4901 c	50.2 b	1.81 b
Dark Red	141.8 a	9.3 a	4745 c	111.0	2.04 a
Mean	108	7.7	6122	42.2	1.76
HSD5%	11.8	0.4	218	7.6	0.14

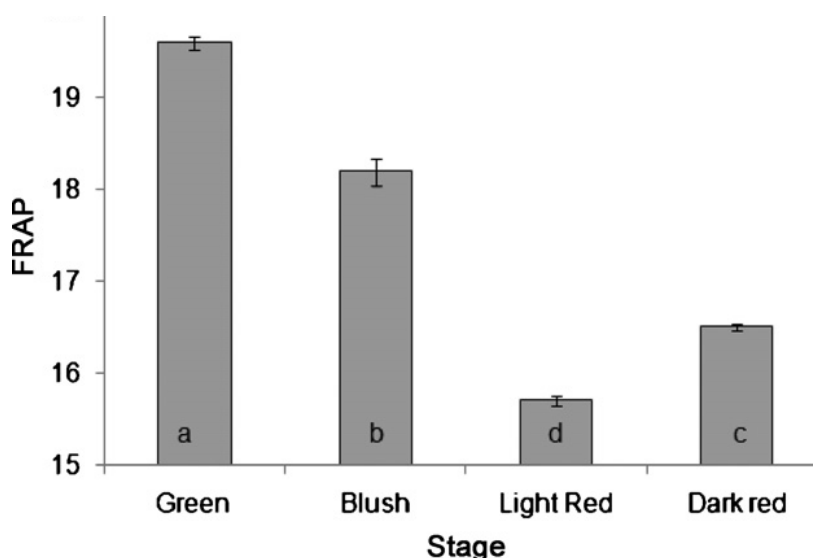

Fig. 1. Total antioxidant capacities of the cranberry fruits sampled from four maturation stages. The values are expressed as mmol of trolox equivalents/kg fw.

In another study some of the chemical properties and antioxidant capacity of jujube (*Ziziphus jujuba* Mill.) fruits were investigated at four maturation stages (Gündüz et al., 2014). The maturation stages were classified by degree (%) of dark color formation on the fruit surface (Stage (S1), 1-10% (S2), 11-50% (S3), 51-100% (S4). According to findings, TSS increased from 12.8% to 18.3% from the S1 to the S4 fruit stage, respectively. S3 had the highest TPC (6518 mg GAE/g fw). The highest AOC were recovered from S2 (TEAC; 74.4 μ mol TE/g fw, FRAP; 50.9 μ mol TE/g fw), followed by S3 (TEAC; 63.6 μ mol TE/g fw, FRAP; 37.6 μ mol TE/g fw). The average AOC measured was 59.5 and 37.9 mmol TE/kg fw by TEAC and FRAP methods. The main organic acid was citric acid

determined by the HPLC method. Average glucose and sucrose was similar among stages. Fructose content tended to be more stable than glucose and sucrose. As a result, significant variability was found for overall fruit characteristics tested in the study, phytochemical accumulation, antioxidant activity and types of sugars of jujube at four different maturity stages. S3 stage had highest TPC and AOC. Therefore, to recover the highest anti-oxidant capacity, fruit should be harvested at the S3 stage (Table 3).

Table 3. Means and mean separations for specific and total sugars and acids of jujube fruits sampled from for maturation stages

Stage	Weight (g/)	TSS (%)	TPC (μ g GAE/g fw)	TEAC (μ mol TE/g fw)	Total Organic Sugar (g/100g)	Total Organic Acids (g/100g)
S1 (0% dark)	6.4 b	12.8 d	5138 b	49.8 b	14.8 b	0.54 a
S2 (1-10% dark)	6.6 b	14.5 c	4742 b	74.4 a	12.7 c	0.38 d
S3 (11-50% dark)	7.3 a	16.7 b	6518 a	63.6 a	21.1 a	0.45 c
S4 (51-100% dark)	6.8 b	18.3 a	5451 b	50.2 b	21.8 a	0.48 b
Mean	6.7	15.6	5462	59.5	17.6	0.46
LSD _{5%}	0.5	1.2	809	10.9	1.26	0.15

In another study changes in total phenolic content (TPC), total flavonoid content (TFC), individual phenolic compound content, DPPH radical scavenging activity and antioxidant capacity were investigated in jujube fruits during three edible maturity stages and measured by FRAP assay of four phenolic fractions (free, esterified, glycosided and insoluble-bound) (Wang et al., 2016). The maturity stages of jujubes were established as white maturity (WM), half-red maturity (HM) and red maturity (RM). The free fraction in jujube at WM stage had the highest TPC, TFC, total phenolic acid contents, and antioxidant capacities. The phenolic contents and their activities greatly decreased with the increasing maturity stage. Caffeic acid was the most predominant in all detected phenolic compounds at WM stage, while rutin dominated at HM and RM stages. Even though most of phenolic compounds with antioxidant activity in jujube existed at the WM stage as the free form, the insoluble-bound fractions also contained a large number of phenolic compounds.

Amira et al. (2012) analyzed four cultivars of Tunisian date palm fruits (*Phoenix dactylifera* L.) (Gondi, Gasbi, Khalt Dhahbi, and Rtob Ahmar) at three different maturation stages according to the pollination date: besser, rutab, and tamr for their antioxidant activities (AA) using 2,2'-azino-bis (3-ethylbenzothiazoline-6-sulfonic acid) and 2,2-diphenyl-1-picrylhydrazyl radicals cation, and reducing power (RP) methods. The total phenolic (TPC), total flavonoid (TFC), and condensed tannins (CTC) contents were measured. Results showed that all samples have the highest TPC, TFC, CTC, and AA at besser stage. The results presented in this work clearly demonstrate that the amounts of phenolic compounds and the antioxidant capacities of date fruits were affected by maturation stages. Date cultivars have different levels of TPC, TFC, CTC, and AA during ripening most of which were present at besser stage.

Singha et al., (2015) investigated phytochemical changes in aril and pulp of *Momordica subangulata* ssp. Renigera (G. Don) de Wilde fruit during ripening process. Aril had higher lycopene (57.0 μ g/g), carotenoids (149.8 μ g/g), flavonoids (396.0 mg/100 g), phenolics (297.7 mg/100 g), tannin (495.4 mg/100 g), and xanthophylls (111.8 mg/100 g) than pulp at stage-1. Carotenoids, lycopene and xanthophylls in aril fraction increased from turning yellow to ripe stage by 205.0%, 524.5%, and 303.7%, respectively while in pulp by 633.2%, 557.4%, and 1113.2%,

respectively. Flavonoids (18.3%, 16.5%), tannins (24.4%, 26.8%), phenolic (20.2%, 19.5%), β -carotene (87.4%, 70.6%), and chlorophyll (55.1%, 82.0%) were decreased in aril and pulp. The ABTS and DPPH activities reduced in both fractions with ripening.

Almeida et al. (2013) investigated the chemical composition the bioactive compounds and antioxidant potential of the *Ximenia. Americana* in different stages of maturation. The fruits at green maturity stage showed higher content of yellow flavonoids (22.07 mg/100 g), anthocyanins (1.92 mg/100 g), polyphenols (3051.62 mg/100 g), starch (4.22%), antioxidant activity (489.40 g fruit/g DPPH and 198.77 mmol Trolox/g) and activity of antioxidant enzymes; the antioxidant activity allocated to the fruit was shown to be related to the contents of extractable polyphenols, yellow flavonoids, total anthocyanins and antioxidant enzymes.

Fawole and Opara (2013) was conducted to investigate changes in physico-chemical, elemental and antioxidant capacity of pomegranate fruit cultivar ‘Ruby’ at different maturity stages were investigated to provide useful information regarding quality changes during fruit development. Results obtained showed that major compositional changes in the fruit are developmentally regulated. Significant increase in total soluble solids (TSS), sugars (glucose and fructose) and anthocyanins, coupled with significant decline in titratable acidity (TA) and organic acids as well as total phenolics was observed along the days after full bloom.

In the study Zainudina et al. (2014) the variations in bioactive compounds and antioxidant activity of carambola (*Averrhoa carambola* L.) fruit (cv. B17) at different ripening stages were investigated. The carambola fruit was harvested from week 9 until week 13. Bioactive compounds such as TPC, TFC, β -carotene, γ - and δ -tocopherol were found to be dominant in unripe fruit while those of sugar (sucrose, glucose and fructose), TCC, α - and β -tocopherol were prominent in the ripe fruit. The findings of this study advocate harvesting of carambola fruit at an appropriate stage to get maximum nutritional benefits.

Wolfberry (*Lycium barbarum* L.) fruits of three cultivars (‘Damaye’, ‘Baihua’ and ‘Ningqi No.1’) were harvested at five different ripening stages and evaluated for sugars and organic acids. Fructose, glucose and total sugar contents increased continually through development and reached their maxima at 34 days after full bloom (DAF). Fructose and glucose were the predominant sugars at maturity, while sucrose content had reduced by maturity (Zhao, et al. 2015). Sugar ingredients are increasing along with ripeness. Therefore it has been stated that fruit sugar is harmful in respect to human health.

Conclusion

People generally consume fruit when they are fully ripened or when their phenolic content drops and when their sugar content rises. In terms of health, it is important to consume fruit when phenolic and antioxidant content is high; but, when they are at edible ripening stage. The conducted compiled studies show that phenolic content (excluding anthocyanin) and antioxidant capacity of fruit drop and sugar content rises at fully ripening stage. It is stated that glucose content is harmful for a healthy diet. It is possible to suggest that people for a healthy diet should eat fruit one stage before fully ripening stage. On the other hand, studies on the changes of food content of fruit types when they are at ripening stage should be carried out.

References

- Ali, Z.M., Chin, L.-H., Lazan, H., 2004. A comparative study on wall degrading enzymes, pectin modifications and softening during ripening of selected tropical fruits. *Plant Sci.* 167 (2), 317–327.
- Almeida, MLB., Freitas, WES., Dantas de Moraes, PL., Sarmiento, JDA., Alves, RE., 2016. Bioactive compounds and antioxidant potential fruit of *Ximenia americana* L., *Food Chemistry* 192 (2016) 1078–1082.

- Amira, E.A., Behija, S.E., Beligh, M., Lamia, L., Manel, I., Mohamed, H., Lotfi, A. 2012. Effects of the Ripening Stage on Phenolic Profile, Phytochemical Composition and Antioxidant Activity of Date Palm Fruit, *J. Agric. Food Chem.*, 60, 10896-10902.
- Capocasa, F., Scalzo, J., Mezzetti, B., Battino, M. 2008. Combining quality and antioxidant attributes in strawberry: The role genotype. *Food Chemistry*, 111, 872-878.
- Castrejón, A.D.R., Eichholz, I., Rohn, S., Kroh, L.W., Huyskens-Keil, S., 2008. Phenolic profile and antioxidant activity of highbush blueberry (*Vaccinium corymbosum* L.) during fruit maturation and ripening. *Food Chem.* 109 (3), 564–572
- Celik, H., Ozgen, M., Serce, S., Kaya, C. 2008. Phytochemical accumulation and antioxidant capacity at four maturity stages of cranberry fruit. *Scientia Horticulturae* 117: 345–348
- Connor, A.M., Luby, J.J., Hancock, J.F., Berkheimer, S., Hanson, E.J. 2002. Changes in fruit antioxidant activity among blueberry cultivars during cold-temperature storage *J. Agric. Food Chem.*, 50: 893–898.
- Cooper-Driver G.A., 2001. Contribution of Jeffrey Harborne and co-workers to the study of anthocyanins. *Phytochemistry* 56, 229–236
- Fawole, O.A., Opara, U.L. 2013. Changes in physical properties, chemical and elemental composition and antioxidant capacity of pomegranate (cv. Ruby) fruit at five maturity stages. *Scientia Horticulturae* 150: 37–46.
- Gunduz, K., Saracoglu, O., Ozgen, M., Serce, S. 2013. Antioxidant, physical and chemical characteristics of cornelian cherry fruits (*Cornus Mas* L.) at different stages of ripeness, *Acta Scientiarum Polonorum Hortorum Cultus* , 59-66 pp.
- Gunduz, K., Saracoglu, O., 2014. Changes in Chemical Composition, Total Phenolic Content and Antioxidant Activities of Jujube (*Ziziphus Jujuba* Mill.) Fruits at Different Maturation Stages, *Acta Scientiarum Polonorum Hortorum Cultus (ISI)*, 13(2): 187-195.
- Hamid H., Yousef H., Jafar H., Mohammad A., 2011. Antioxidant capacity and phytochemical properties of cornelian cherry (*Cornus mas* L.) genotypes in Iran. *Sci. Hort.* 129, 459–463.
- Huang, R., Xia, R., Hu, L., Lu, Y., Wang, M., 2007. Antioxidant activity and oxygenscavenging system in orange pulp during fruit ripening and maturation. *Sci. Hort.* 113 (2), 166–172.
- Ilahy, R., Hdider, C., Lenucci, M.S., Tlili, I., Dalessandro, G., 2011. Antioxidant activity and bioactive compound changes during fruit ripening of high-lycopene tomato cultivars. *J. Food Compos. Anal.* 24 (4–5), 588–595.
- Imeh, U.; Khokhar, S. Distribution of conjugated and free phenols in fruits: Antioxidant activity and cultivar variations. *J. Agric. Food Chem.* 2002, 50, 6301–6306.
- Prior, R.L., 2003. Absorption and metabolism of anthocyanins: potential health effects. *Phytochemicals: mechanisms of action.* CRC Press, Inc., Boca Raton, FL.
- Schweiggert, R.M., Steingass, C.B., Mora, E., Esquivel, P., Carle, R., 2011. Carotenogenesis and physico-chemical characteristics during maturation of red fleshed papaya fruit (*Carica papaya* L.). *Food Res. Int.* 44 (5), 1373–1380.
- Shui, G., Leong, L.P., 2002. Separation and determination of organic acids a phenolic compounds in fruit juices and drinks by high-performance liquid chromatography. *Journal of Chromatography A* 977, 89–96.
- Singha, S., Swainb, S., Nishac, M., Shajeeda Banuc, V., Singha, D.R., Dam Royd, S. 2015. Changes in lycopene, total carotenoid and anti-radical activity in teasel gourd [*Momordica subangulata* ssp. renigera (G. Don) de Wilde] fruit fractions at different stages of maturity. *Industrial Crops and Products* 73:154–163.
- Wang, B., Huang, Q., Venkitasamy, C., Chai, C., Gao, H., Cheng, N., Cao, W., Lv, X., Pan, Z. 2016. Changes in phenolic compounds and their antioxidant capacities in jujube (*Ziziphus jujuba* Miller) during three edible maturity stages. *LWT - Food Science and Technology* (66), 56-62.

- Wu, C.-S., Gao, Q.-H., Guo, X.-D., Yu, J.-G., Wang, M., 2012. Effect of ripening stage on physicochemical properties and antioxidant profiles of a promising table fruit 'pear-jujube' (*Zizyphus jujuba* Mill.). *Sci. Hortic.* 148, 177–184.
- Zafra-Stone, S., Yasmin, T., Bagchi, M., Chatterjee, A., Vinson, J.A., Bagchi, D., 2007. Berry anthocyanins as novel antioxidants in human health and disease prevention. *Molecular Nutrition & Food Research* 51, 675–683.
- Zainudina, MAM., Hamida, AA., Anwarb, F., Osmana, A., Saari, N. 2014. Variation of bioactive compounds and antioxidant activity of carambola (*Averrhoa carambola* L.) fruit at different ripening stages. *Scientia Horticulturae* 172 (2014) 325–331
- Zhao, J., Li, H., Xi, W., An, W., Niu, L., Cao, Y., Wang, H., Wang, Y., Yin, Y., 2015. Changes in sugars and organic acids in wolfberry (*Lycium barbarum* L.) fruit during development and maturation. *Food Chemistry* (173): 718–724.

RESISTANCE OF SOME WHEAT VARIETIES TO *BLUMERIA GRAMINIS TRITICI* IN SERBIA

Mirjana STALETIĆ*, Vera ĐEKIĆ, Milivoje MILOVANOVIĆ

Small Grains Research Centre, Save Kovacevica 31, Kragujevac, Serbia

*Corresponding author: staleticm@kg.ac.rs

Abstract

This paper presents the results of study on the resistance of wheat varieties to *Blumeria graminis tritici*. During the 2010-2011 period, in the Small Grains Research Centre in Kragujevac, investigations were performed of resistance at 140 commercial wheat varieties in the field conditions. Sowing was carried out in rows length of 1 m, catch variety in one row, with distance of 20 cm. In the period of maximal development of parasites estimations of reaction of investigated cultivars were carried out by determination of types of infection from 0 to 4 and intensity of infection from 0 to 100%. Majority of them belong to average susceptible category (60.35%), than to susceptible (23.92%) and intermediate (9.64%). Consideration of results demonstrated that majority of varieties were susceptible to *B. graminis tritici* (84.22%), while limited number of varieties were resistant (5.73%). In season 2010, varieties Jasenica, Fortuna and Nera were very resistant, while in 2011 the most resistant were varieties Fortuna, Pesma and Dina, with coefficient of infection 0. At some varieties (Fortuna, Dina and Pesma) differences in resistance were established depending of season of investigation. These investigations underlines the importance of work on creation of new wheat cultivates.

Keywords: *Blumeria graminis tritici*, resistance, variety, wheat, Serbia

Introduction

The fungus epiphytous *Blumeria graminis tritici* is a cosmopolitan species, which appears widespread of world in wheat growing areas (Newton and Cherewick, 1947; Dikson, 1956; Smiljaković, 1996). It is one of the most widespread diseases of wheat in Serbia. Influence of powdery mildew on grain yield of wheat in Serbia depends of variety, at some varieties this influence was significant, and in some of the, the decrease of grain yield was small (Bošković et al., 1983). Intensity of powdery mildew infection depends on resistance of cultivars too, which can be different in diverse growing areas. Infection intensity varies in dependence of wheat variety, climate conditions and agricultural practices. Although there have been no epiphytotics in Serbia yet, this disease can play a significant role in yield formation. Successful wheat breeding for resistance to the causal agent of powdery mildew is based on the identification of virulence and changes in the pathogen population (Jevtić et al., 2004).

The most efficient and the most economic suppression of powdery mildew causers in wheat achieves by creation and growing of resistant cultivars. But, creation of such cultivars is long term and complex activity, because it is very complex relation of two live organisms. The pathogens exchange continuously in the nature, forming new virulent genotypes to which, existing resistant varieties the becomes sensitive. Because of that many of our genes and their introgression in new cultivars.

The goal of this paper was to point out the resistance of some important wheat cultivars to causer of powdery mildew, with the aim of introduction in cultural practice the most resistant ones.

Materials and methods

During the 2010-2011 period, in the Small Grains Research Centre in Kragujevac (Serbia), investigations were performed of resistance at 140 commercial wheat varieties in the field conditions. Sowing was carried out in rows length of 1 m, catch variety in one row, with distance of 20 cm. The artificial inoculations were performed by mixture of prevalent pathotypes of parasites, by transplant of previous inoculated plants of susceptible variety Little Club in the rows of protective belt.

In the period of maximal development of parasites, reaction estimations of investigated cultivars were carried out by determination of infection types from 0 to 4 (Mains and Dietz, 1930) and intensity of infection from 0 to 100%. Types of infection have the next meaning: 0-very resistant; 1-resistant; 2-average resistant; 3-average susceptible; 4-very susceptible.

On the basis of type of infection and intensity of infection, coefficients of infection were calculated. According to values of coefficients of infection, investigated varieties were divided in few categories (Levine and Vasile, 1960): 0-5%-immune; 6-10%-very resistant; 11-25%-average resistant; 26-40%intermediate; 41-65%-average susceptible and 66-100%-very susceptible.

Results and discussion

From data presented in the Table 1. it can be noticed that number of cultivars per categories of resistance was different. Majority of them belong to average susceptible category (60.35%), than to susceptible (23.92%) and intermediate (9.64%). Only few varieties belong in category of immune ones (1.08%), very resistant (1.08%) and average resistant (3.57%). Majority of cultivars were in categories of susceptible (84.22%), and small number-resistant (5.73%). Intermediate category was present in 9.64% of varieties. Obtained results comply with data of Stojanović and Stojanović (1992) which pointed out that small number of cultivars were in category of resistant, majority in categories of susceptible, while some cultivars were intermediate.

Table 1. Summary review of varieties and resistant

Category	Year				Total	
	2010		2011			
	No	%	No	%	No	%
0-5	0	0.00	3	2.14	3	1.08
6-10	3	2.14	0	0.00	3	1.08
11-25	4	2.85	7	5.00	11	3.57
26-40	16	11.42	11	7.85	27	9.64
41-65	85	60.71	84	60.00	169	60.35
66-100	32	22.85	35	25.00	67	23.92
Total	140	100.00	140	100.00	280	100.00

These results demonstrate that the work on breeding of resistant varieties to causer of powdery mildew in Serbia must be more intensive. In accordance to this, great number of new very resistant lines were created, some of which will recently find place in agricultural practice. However, the fact, that resistance of variety can be changed in addition to changes of parasites virulence must be considered. That is the reason of continuing nature of the work on creation of resistant varieties.

The resistance of some more important commercial varieties was shown in Table 2, as well as those which could be used in breeding programs as donors of genes for resistance.

Table 2. Resistance of some wheat varieties to powdery mildew

VARIETY	2010			2011		
	T.i.	I	K	T.i.	I	K
KG 56	4	60	60	4	60	60
KG 56S	4	70	70	4	60	60
JASENICA	3	10	10	3	20	16

RAVANICA	4	50	50	4	40	40
KG 78	4	60	60	3	20	16
SRBIJANKA	4	50	50	4	50	50
STUDENICA	4	50	50	4	50	50
TAKOVČANKA	4	40	40	4	60	60
NS RANA NISKA	4	70	70	4	70	70
PARTIZANKA	4	50	50	4	80	80
ZVEZDA	3	20	20	4	50	50
ZELENGORA	3	20	20	2	50	20
ŽITNICA	4	50	50	4	50	50
BALKAN	4	50	50	4	70	70
JUGOSLAVIJA	4	40	40	4	50	50
RODNA	4	60	60	4	50	50
LASTA	4	50	50	4	50	50
NS RANA 2	4	60	60	4	70	70
BISERKA	4	50	50	4	70	70
FRANCUSKA	4	60	60	4	70	70
EVROPA	4	50	50	4	70	70
EVROPA 90	4	50	50	4	50	50
DANICA	4	50	50	4	70	70
LEPA	4	60	60	4	60	60
MAJA	4	50	50	3	30	24
NERA	3	10	8	4	50	50
POBEDA	4	60	60	4	50	50
PROTEINKA	4	50	50	4	70	70
JELICA	3	20	20	4	30	30
NS RANA 5	4	50	50	4	50	50
MILICA	4	50	50	4	60	60
DIČNA	4	60	60	4	60	60
FORTUNA	3	10	10	0	0	0
ITALIJA	4	50	50	4	60	60
SREMKA	4	40	40	4	50	50
RUSIJA	4	60	60	4	60	60
RENEANSANSA	4	50	50	4	60	60
NS 6902	3	30	30	4	50	50
DINA	4	50	50	0	0	0
TIHA	4	70	70	3	50	40
PESMA	4	40	40	0	0	0
JAREBICA	4	50	50	4	40	40
DEJANA	4	50	50	4	50	50
PRIMA	4	50	50	4	50	50
SLOGA	4	30	30	3	50	50
KREMNA	4	70	70	4	50	50
RANKA	4	80	80	4	60	60
KRAJINKA	4	50	50	4	70	70
KRALJEVICA	4	60	60	4	70	70
PAHULJA	4	70	70	4	70	70
ZA 75	4	50	50	4	70	70
ZA 16/94	4	40	40	3	30	24
PANORAMA	4	60	60	4	60	60

T.i.-the type of infection; I-the intensity; K-the coefficient of infection

In varieties Jasenica, Fortuna and Nera with the coefficient of infection 8 were very resistant season in 2010. Average resistance expressed varieties Zvezda, Zelengora, Jelica and NS 6902 with coefficients of infection from 16 to 24. Great numbers of varieties were intermediate as Takovčanka (40), Jugoslavija (40), Sremka (40), Pesma (40), Sloga (40) and ZA 16/94 (40). Rest varieties were average or very susceptible.

In 2011 season, immune were varieties Fortuna, Pesma and Dina, with coefficient of infection 0, and varieties Jasenica, Kg 78, Zelengora, Maja and ZA 16/94 were average resistant with coefficients ranking from 16 to 24. Intermediate were varieties Ravanica (40), Jelica (30), Tiha (40) and Sloga (40). Rest varieties expressed high susceptibility.

In season 2010, variety Fortuna was very susceptible, Dina-average susceptible, and Pesma-intermediate, while in season 2011 these three varieties were immune. This demonstrates, that depending on structure of parasites virulence, variety in one location can express different degree of resistance, pointing out the need of more seasons of investigation of variety resistance.

Results of many studies (Kostić and Ribaković, 1985; Jevtić, 1993), point out the high variability of *Blumeria graminis tritici* population in Serbia. The greatest pressure on structure of virulence and changes in pollution of this fungus make varieties included in agricultural practice (Powers and Sando, 1957).

Obtained results demonstrate that in the both seasons of examination, the greatest resistance expressed varieties Jasenica and Zelengora. Majority of commercial wheat varieties were very susceptible, which points out the need for future work of creation of resistant varieties to cause of powdery mildew.

Conclusion

On the basis of these investigations it could be concluded that:

-Resistance of some varieties of wheat to *Blumeria graminis tritici* was different. Small number of varieties (5.73%) was in category of resistant, and majority (84.22%) in category of susceptible, while as intermediate appeared 9.64% of varieties.

-In season 2010 varieties Jasenica, Fortuna and Nera were very resistant, and in season 2011-varieties Fortuna, Pesma and Dina.

-At some varieties (Fortuna, Dina and Pesma) differences in resistance were established depending of season of investigation. Reason for that were specific conditions in ecological factors and virulence of parasites.

-In both seasons of investigations, the greatest resistance and varieties Fortuna, Jasenica and Zelengora.

-Majority of commercial varieties of wheat were very susceptible, which points out the need for intensive work on breeding of resistance wheat cultivars.

References

- Bosković, M., Kostić, B., Momčilović, V., Pribaković, M. (1983): Effect of powdery mildew and leaf rust on the yield of some varieties of wheat. *Plant protection*, 164:181-192.
- Dickson, J. (1956): *Diseases of field crops*. New York, Toronto, London, 30-34:235-236.
- Jevtić, R. (1993): Structures virulence full and sexless population (*Erysiphe graminis tritici*). Doctoral dissertation, Faculty of Agriculture, Novi Sad.
- Jevtić, R., Jerković, Z., Stojanović, S., Staletić, M. (2004): Screening for virulence of *Blumeria graminis tritici* using mobile nurseries. International Conference on Sustainable Agriculture and European Integration Processes. September 19-24, Novi sad, 101-102.
- Powers, H.R., Sando, W.J. (1975): Genetics of host-parasite relationship in powdery mildew of wheat. *Phytopathology*, 47:453.
- Kostić, B., Pribaković, B. (1985): Virulence frequency of physiological races of *Erysiphe graminis* f. sp. *tritici* in the southeastern part of the country from 1978 to 1982. *Plant Protection*, 171: 5-12.
- Levine, M., Basile, R. (1960): A review and appraisal of thirty years research on cereal uredinology in Italy. *Stazione di patologia vegetale*, Anno, 1:1-35.
- Mains, E.B., Dietz, M.S. (1930): Physiologic forms of barley mildew, *Erysiphe graminis hordei* Marchal. *Phytopathology*, 3:229-239.
- Newton, M., Cherewick, W. (1947): *Erysiphe graminis* in Canada. *Cann. J. of Res.*, No 2.
- Smiljaković, H. (1966): The study of biology, ecology and combating *Erysiphe graminis* D.C., parasites wheat Sr Serbia. Doctoral dissertation, Proceedings of the Institute for Small Grains in Kragjevcu, 1: 5-76.
- Stojanović, S., Stojanović, J. (1992): The importance of wheat breeding for resistance to diseases as part of its integrated protection. XVI Seminar of Plant Protection, Serbia: 14-17.

THE VIRULENCE SPECTRUM OF *PUCCINIA GRAMINIS TRITICI* FROM DIFFERENT *BERBERIS* SPECIES

Mirjana STALETIĆ*, Vera ĐEKIĆ, Milivoje MILOVANOVIĆ, Vladimir PERIŠIĆ, Kristina LUKOVIĆ

Small Grains Research Centre, Save Kovacevica 31, Kragujevac, Serbia

*Corresponding author: staleticm@kg.ac.rs

Abstract

The paper presents the virulence spectrum of the *Puccinia graminis tritici* populations from *Berberis* spp. The investigations were carried out at the Small Grains Research Centre in Kragujevac over 2011 and 2012. The aecidiospore samples were collected from 24 species of *Berberis* spp. from the Kragujevac collection. Then most widespread was the pathotypes with virulence's formula (V/A): / 5, 21, 9e, 7b, 11, 6, 8a, 9g, 36, 9b, 30, 17, 13, 22, 24, 25, 26, 27, 29, 31, 32, 33, 37 (50%) that did not contain virulence alleles for the Sr wheat resistance genes studied. The maximum total number of spots with aecidia on the leaf was recorded on May 14, 2011 and on May 18, 2012, being 2053 and 2322, respectively. The aecidia formation rhythm differed between the years. Pathotype BBB was the most widespread (50%) whereas the rest of the pathotypes were present at considerably lower level (4.55-18.19%). Twelve virulence formulas were identified and the highest frequency was recorded with the virulence genes V5, V7b and V6 (45.46%). Resistance genes Sr36, Sr31 and Sr33 were 100% effective. Although *Berberis* spp. is not a necessary precondition for the rust incidence and spreading, the intensity of the disease is known to be higher in the presence of this intermediate host.

Keywords: *Berberis* spp., *Puccinia graminis tritici*, virulence spectrum

Introduction

Wheat, barley and certain number of the *Poaceae* family species serve as primary and additional hosts of the causal agent of wheat stem rust (*P. graminis tritici*). The completion of the parasite's development cycle requires the presence of an intermediate host *Berberis* spp. (Barberry). As early as 1920, Craige (1981) experimentally proved the parasite hybridization on *Berberis* spp; later to be confirmed by Stakman (1944). Convincing data on the abundance of the physiological races formed on *Berberis* spp. were given by Johnson and Green (1957). They identified seventeen physiologic races from ten samples collected from *Berberis* spp. The population of *P. graminis tritici* on *Berberis* spp. was composed of 12 virulence formulae were established (Staletić et al., 2004).

The subject matter of this investigation as well as the role of *Berberis* spp. in the life cycle of the fungus and the virulence spectrum of the pathotypes produced.

Berberis spp. is important mostly from the point of view of the parasite hybridization taking place on it and resulting in the evolution of new fungus pathotypes that may disturb the existing balance in the parasite-plant system. The goal of these investigations was therefore to study the pathotypes of *P. graminis tritici* derived from *Berberis* spp. and determine their virulence.

Materials and methods

The investigations were carried out at the Small Grains Research Centre in Kragujevac (Serbia) over 2011 and 2012. The aecidiospore samples were collected from 24 species of *Berberis* spp. from the Kragujevac collection (Table 1). The aecidia formation on the shrubs of *Berberis* spp. was observed

and samples were collected at the time of their full development. Every seven days during the months of May and June, the sampling of *Berberis* spp. leaves with aecidia was performed, the collected samples being the average ones considering the highly variable number of aecidia on the leaves. For that reason, the samples were taken from different sides and heights on the *Berberis* spp. shrubs. One hundred leaf samples were collected from each species of *Berberis* spp. The leaves were dried at room temperature and then kept in refrigerator at +4°C till the beginning of the examination.

During the aecidia sampling, observation was also made on the following morphological traits in different *Berberis* species (*B. ilicifolia*, *B. gilgiana*, *B. francisci ferdinandi*, *B. Fischeri*, *B. chinensis*, *B. candidula*, *B. bidentata*, *B. atropurpurea*, *B. aridocalida*, *B. amurensis*, *B. angulosa*, *B. aquifolium*, *B. purpurea*, *B. vulgaris* var. *atropurpurea*, *B. vulgaris*, *B. virescens*, *B. verna*, *B. thunbergii*, *B. provincialis* var. *serrata*, *B. oblonga*, *B. mutabilis*, *B. lyceum*, *B. latiflora* var. *oblanceolata*, *B. cunawurensis*): the full flowering time, the number of inflorescence on the 30-cm-long shoot, the number of flowers per inflorescence as well as the number of leaves per nodus. The thorn length (mm) was measured and thorn number on the 30-cm-long shoot was identified. The average of the leaves of *Berberis* spp. was taken and the average leaf length and breadth expressed in cm were measured. The shrub development was estimated visually using the following attributes: stunted, moderately vigorous, vigorous and very vigorous.

The artificial wheat inoculation was carried out during winter in the greenhouse using the isogenic wheat line seedlings. The isogenic line multiplication and inoculation method was described in detail by Kostić (1962) and is therefore not presented there. One day prior to the inoculation the leaves with aecidia were placed into Petri dishes containing wet filter paper for the purpose of fructification or releasing as many aecidiospores as possible. The susceptible wheat cultivar Little Club plants were inoculated by the aecidiospores. When the parasite on the susceptible cultivar had been fully developed, individual pustules were taken and multiplied. Pure parasite cultures used for the later inoculation of the isogenic wheat lines were obtained in this way. Twenty grains of each isogenic line were planted in flowerpots. During the first leaf full development stage, their inoculation was performed. 10-12 days later, the plant reaction was estimated by determining the infection types 0-4 (Stakman et al., 1962).

Based upon the results obtained by determining the types of the infection, the pathotypes and virulence spectrum of *P. graminis tritici* were identified.

The pathotype identification was done using Sr lines classified into three groups (Roelfs and Mc Vey, 1974). The lines containing the genes Sr5, Sr9d, Sr9e and Sr7b belong to the first group, those with the genes Sr11, Sr6, Sr8 and Sr9a and Sr36, Sr9b, Sr13 and Sr10 belong to the second and third groups, respectively.

The isogenic wheat lines with known Sr resistance genes (Sr5, Sr6, Sr7b, Sr8a, Sr9b, Sr9e, Sr9g, Sr11, Sr13, Sr17, Sr21, Sr22, Sr24, Sr25, Sr26, Sr27, Sr29, Sr30, Sr31, Sr32, Sr33, Sr36 and Sr37) were used for determining the virulence formulas *P. graminis tritici*.

The isogenic line plants can react in two ways: by resistant (R) types of infection (0-2) and susceptible (S) types of infection (3-4) reactions. Parasite can be virulent (V) or avirulent (A) to the isogenic lines of wheat. Based upon these interactions, the virulence formulas (V/A) as well as virulence groups, being formulas for each isolate studied, were obtained (Green, 1981).

Results and discussion

During the observations, from April 23 to June 24, 2011, a total of 94 aecidiospore samples was collected. In 2012, during seven observations, from April 23 to June 9, 64 samples were collected. Although *Berberis* spp. is not a necessary precondition for the occurrence and spreading of wheat rust, the intensity of the disease incidence is known to be higher in the presence of this intermediate host. The role of *Berberis* spp. in the *P. graminis tritici* epidemiology is primarily connected with the

development and occurrence of new parasite pathotypes, due to which 158 samples were examined during 2011 and 2012.

The onset of the *Berberis* spp. leaving in the conditions of Sumadija is in the first days of April. With this in mind, the observations in both years mentioned started in the second half of April, which is in accordance with the results of Kostić et al. (1970). In this period, the leaf size is such that permits infection by basidiospores. In the course of the first observation (April 23) in 2011, only traces of spermatia were identified, the number of which increased rapidly by the time of the second observation. It was only in the course of the third observation (May 7) that the first aecidia were identified. It is noteworthy that the first spermatia in the second study year were also identified on April 23. Seven days later, the first aecidia occurred on the leaves. These investigations confirmed the previous findings on the volume and time of aecidia formation in our climatic conditions (Kostić, 1960).

Table 1. *Morphological traits of the Berberis spp.*

<i>Berberis</i> spp.	A	B	C	D	E	F	G	H	I
<i>B. amurensis</i>	7.V	2	13	9	17	20	3.70	1.79	very vigorous
<i>B. angulosa</i>	7.V	8	14	11	17	27	3.55	1.49	very vigorous
<i>B. aridocalida</i>	-	-	-	7	59	17	1.65	0.59	stunted
<i>B. atropurpurea</i>	7.V	19	17	8	25	8	2.63	1.14	stunted
<i>B. aquifolium</i>	14.V	1	13	9	53	24	2.24	1.40	stunted
<i>B. bidentata</i>	7.V	15	18	9	42	7	3.38	1.48	moderate
<i>B. candidula</i>	7.V	7	18	9	36	15	3.91	2.12	moderate
<i>B. chinensis</i>	7.V	13	15	9	47	23	4.29	1.98	vigorous
<i>B. cunawurensis</i>	-	-	-	9	19	11	3.24	1.44	moderate
<i>B. Fischeri</i>	7.V	3	15	9	35	23	2.85	1.44	very vigorous
<i>B. francisci ferdinandi</i>	-	2	15	9	38	10	-	-	stunted
<i>B. gilgiana</i>	14.V	7	11	7	18	20	3.92	1.64	moderate
<i>B. ilicifolia</i>	7.V	10	13	9	39	15	3.35	1.77	vigorous
<i>B. latiflora</i> var. <i>oblanceolata</i>	7.V	3	16	8	12	5	4.12	1.95	moderate
<i>B. lycium</i>	7.V	14	15	10	24	18	2.51	1.01	moderately
<i>B. mutabilis</i>	7.V	15	17	7	18	10	2.90	1.42	vigorous
<i>B. oblonga</i>	-	-	-	7	35	20	2.92	1.17	moderate
<i>B. provincialis</i> var. <i>serrata</i>	7.V	11	14	9	20	20	3.34	1.27	vigorous
<i>B. purpurea</i>	14.V	15	17	11	22	14	2.66	1.14	stunted
<i>B. thunbergii</i>	30.IV	11	9	11	18	11	2.60	1.37	moderate
<i>B. verna</i>	7.V	23	24	11	14	17	4.24	1.75	very vigorous
<i>B. virescens</i>	7.V	9	15	8	32	19	3.28	1.96	moderate
<i>B. vulgaris</i>	7.V	4	14	8	28	28	3.73	2.03	vigorous
<i>B. vulgaris</i> var. <i>atropurpurea</i>	7.V	6	18	10	15	13	3.44	1.77	very vigorous

(*A-flowering time; B-the number of inflorescences per shrub on the 30-cm-long shoot; C-number of flowers per inflorescences; D-then number of leaves per nodes; E-then number of thorns on the 30-cm-long shoot; F-thorn length in mm; G-average leaf length in cm; H-average leaf breadth in cm; I-shrub development)

The maximum total number of spots whit aecidia on the leaf was recorded of May 14, 2011 and on May 18, 2012 being 2053 and 2322, respectively. From the mentioned data it could be concluded that the time difference in the aecidia occurrence between the years was not high, being only there days. The termination of aecidia formation takes place at different periods of time. In 2011 it was on June 18 and in 2012 of June 2. Aecidia formation in 2011 and 2012 lasted 61 and 46 days, respectively. The aecidia formation rhythm differed between the years. More intense aecidia formation was registered in 2011 characterized by fluctuating dynamics but in the following year the aecidia formation was somewhat less intense having no sudden rises.

Data on the presence of the pathotypes in 2011 are not shown because no aecidiospores infection of the sensitive wheat cultivar was registered, the primary reason for that being unfavorable climatic conditions during the sampling period. The incessant rain caused washing off and decay of the aecidiospores. Optimal temperature for teleutospore and basidiospore germination ranged from 20-22°C and from 15-20°C, respectively (Vennot-Bourgin, 1949). Humidity necessary for spore germination was positively affected by evenly distributed precipitations as well as by dew.

Although the aecidia were present almost more than two months, the aecidiospores did not exert almost any effect on the occurrence of *P. graminis tritici* on wheat in the observation region. The reason for this should be sought in low virulence of the pathotypes obtained from *Berberis* spp. as well as in unfavorable conditions for the development of the infection. Early infection and numerous uredopustules occurred on some *Poaceae* spp. and particularly on *Agropyron repens* growing under or by the shrubs of *Berberis* spp.

All *Berberis* spp. species are characterized by uniform flowering onset time. In all species it started around April 7 on average. Then number of flowers per shrub on the 30-cm-long shoot highly varied ranging from the absence of inflorescence (*B. aridocalida*, *B. oblonga* and *B. cunawurensis*) to 23 inflorescences (*B. verna*). Besides having the highest number of inflorescences, the species *B. verna* had also the highest number of flowers per inflorescence, being 24 on average. Then number of leaves per nodes was rather uniform ranging from 7 to 11. In the species *B. francisci ferdinandi* leaving was not recorded. The average leaf length was greatest in *B. chinensis* species (4.29 cm) and smallest in *B. aridocalida* (1.65 cm). *B. aridocalida* species had also the smallest average leaf breadth (0.59 cm). The highest being recorded in *B. candidula* species (2.12 cm). The vigor of shrubs of the *Berberis* spp. species ranged from very vigorous (*B. Fischeri*, *B. amurensis*, *B. angulosa*, *B. vulgaris* var. *atropurpurea* and *B. verna*) to stunted species (*B. francisci ferdinandi*, *B. atropurpurea*, *B. aridocalida*, *B. aquifolium* and *B. purpurea*), (Table 1).

In 2012 by the analysis of 22 isolates of *P. graminis tritici* from *Berberis* spp.; twelve virulence formulas were detected. Then most widespread was the pathotypes with virulence`s formula (V/A): / 5, 21, 9e, 7b, 11, 6, 8a, 9g, 36, 9b, 30, 17, 13, 22, 24, 25, 26, 27, 29, 31, 32, 33, 37 (50%) that did not contain virulence alleles for the Sr wheat resistance genes studied. The rest of the pathotypes were represented by one isolate each or 4.55%. The number of virulence genes in then ranged from 1 to 15 (Table 2).

Table 2. Virulence formulas of *P. graminis tritici* from *Berberis spp.* in 2012

Virulence formula (V/A)	Num. of isolate	%	V/A
/ 5 21 9e 7b 11 6 8a 9g 36 9b 30 17 13 22 24 25 26 27 29	11	50.00	0:23
5 21 7b 11 6 9g 9b 30 17 13 22 25 27 29 37 / 9e 8a 36 24	1	4.55	15:8
5 21 7b 11 6 9g 9b 30 17 13 22 27 32 37 / 9e 8a 36 24 25	1	4.55	14:9
5 21 7b 11 6 9g 9b 30 17 13 22 27 29 37 / 9e 8a 36 24 25	1	4.55	14:9
5 21 7b 11 6 9g 9b 30 17 13 22 / 9e 8a 36 24 25 26 27 29	1	4.55	11:12
5 21 7b 6 30 13 22 27 / 9e 11 8a 9g 36 9b 17 24 25 26 29	1	4.55	8:15
5 21 7b 11 6 8a 9g 9b 17 13 22 24 27 29 / 9e 36 30 25 26	1	4.55	14:9
5 21 7b 11 6 13 22 26 27 / 9e 8a 9g 36 9b 30 17 24 25 29	1	4.55	9:14
7b / 5 21 9e 11 6 8a 9g 36 9b 30 17 13 22 24 25 26 27 29	1	4.55	1:22
5 7b 11 6 13 22 27 / 21 9e 8a 9g 36 9b 30 17 24 25 26 29	1	4.55	7:16
5 9e 6 9g 17 37 / 21 7b 11 8a 36 9b 30 13 22 24 25 26 27	1	4.55	6:17
5 9e 7b 6 9g 22 25 27 / 21 11 8a 36 9b 30 17 13 24 26 29	1	4.55	8:15
Total:			107:169

From the data in Table 3. it could be seen that the highest frequency in the population of parasite *P. graminis tritici* in 2012 was registered with virulence genes V5, V7b and V6 (45.46%) and the lowest one with the genes V36, V31 and V33 (0%). The frequency of other genes ranged from 4.55% to 40.91%.

The Sr gene effectiveness against the isolates of *P. graminis tritici* from *Berberis spp.* in 2012 is shown in Table 3. The most effective genes were the genes Sr36, Sr31 and Sr33 which did not have virulence alleles in the parasite population, followed by genes Sr9e, Sr8a, Sr24, Sr26 and Sr32, their effectiveness being 95.46%. The rest of the genes were more or less ineffective.

Table 3. The effectiveness of Sr genes against isolates of *P. graminis tritici* from *Berberis* spp. in 2012

Sr genes	R		S	
	Number of isolates	%	Number of isolates	%
5	12	54.55	10	45.46
6	12	54.55	10	45.46
7b	12	54.55	10	45.46
8a	21	95.46	1	4.55
9b	17	77.28	5	22.73
9e	21	95.46	1	4.55
9g	15	68.19	7	31.82
11	15	68.19	7	31.82
13	14	63.64	8	36.37
17	16	72.73	6	27.28
21	15	68.19	7	31.82
22	13	59.09	9	40.91
24	21	95.46	1	4.55
25	20	90.91	2	9.09
26	21	95.46	1	4.55
27	14	63.64	8	36.37
29	19	86.37	3	13.64
30	17	77.28	5	22.73
31	22	100.00	0	0.00
32	21	95.46	1	4.55
33	22	100.00	0	0.00
36	22	100.00	0	0.00
37	18	81.82	4	18.19

Although *Berberis* spp. is not unnecessary precondition for the rust incidence and spreading, the intensity of the disease is known to be higher in the presence of this intermediate host. Relatively low variability of *P. graminis tritici* is caused by low presence in nature of the intermediate host *Berberis* spp. where the sexual stage of the life cycle of the fungus takes place. Barberry destruction was performed with the aim of preventing the hybridization of races and therefore the virulence gene recombination. However, the spreading of the disease and incidence of novel pathotypes have not been stopped.

Conclusion

Based upon the results obtained of the study of the *P. graminis tritici* population structure in accordance with the research goal, the following conclusions may be drawn:

-The maximum total number of spots whit aecidia on the leaf was recorded of May 14, 2011 and on May 18, 2012 being 2053 and 2322, respectively. The aecidia formation rhythm differed between the years. More intense aecidia formation was registered in 2011 characterized by fluctuating dynamics but in the following year the aecidia formation was somewhat less intense having no sudden rises.

-In 2012 bay the analysis of 22 isolates of *P. graminis tritici* from *Berberis* spp.; twelve virulence formulas were detected. The most widespread was the pathotype with the virulence formula (V/A): /5, 21, 9e, 7b, 11, 6, 8a, 9g, 36, 9b, 30, 17, 13, 22, 24, 25, 26, 27, 29, 31, 32, 33, 37 (50%) that did

not contain virulence alleles for the Sr wheat resistance genes studied. The rest of the pathotypes were represented by one isolate each or 4.55%. The number of virulence genes in the ranged from 1 to 15.

-The highest frequency in the population of the parasite in 2012 was registered with virulence genes V5, V7b and V6 (45.46%) and the lowest one with the genes V36, V31 and V33 (0%). The frequency of other genes ranged from 4.55% to 40.91%.

-In the some year, the most effective genes were the genes Sr36, Sr31 and Sr33 which the not have virulence alleles in the parasite population, followed by genes Sr9e, Sr8a, Sr24, Sr26 and Sr32, their effectiveness being 95.46% the rest of the genes were more or less ineffective.

-Although *Berberis* spp. is not unnecessary precondition for the rust incidence and spreading, the intensity of the disease is known to be higher in the present of this intermediate host.

References

- Craigie, J. H. (1931): An experimental investigation of sex in the rust fungi. *Phytopathology*, XXI, 11: 1001-1040.
- Green, G. J. (1981): Identification of physiologic races of *Puccinia graminis* f. sp. *tritici* in Canada. *Can. J. Plant Pathol.* 3: 33-39.
- Johnson, T., Green, G.J. (1957): Physiologic specialization of wheat stem rust in Canada, 1919 to 1955. *Can. Journ. Of Plant Sci.*, 37.
- Kostić, B. (1960): Creating ecidia *Puccinia graminis* (Pers.) Erikss. et Henn. on *Berberis vulgaris* L. and their epidemiological significance. *Plant Protection* 62: 117-130.
- Kostić, B. (1962): Fiziološke rase *Puccinia graminis tritisi* Erikss. et Henn. u jugoistočnom delu FNRJ. *Zaštita bilja*, 69-70: 1-81.
- Kostić, B., Joksimović, S., Stojanović, S. (1970): The role of *Berberis* (*Berberis vulgaris* L.) in the creation of primary inoculum *Puccinia graminis* Press. *Plant Protection* 108: 113-118.
- Roelfs, A.P., Mc Vey, D.V. (1974): Races of *Puccinia* f. sp. *tritici* in the U.S.A. during 1973. *Plant. Dis. Rep.*, 58:608-611.
- Stakman, E. C., Stewart, D. M., Loegering, W. Q. (1962): Identification of Physiological races of *Puccinia graminis* var. *tritici*. U. S. Agric. Res. Serv., ARS E 617: 1-53.
- Stakman, E. C., Lewine, M.N., Loegering, W.Q. (1944): Identification of physiologic races of *Puccinia graminis tritici*. U.S. Dept. Agr. Res. Admn. Bur. Ent. Pl. Quar., E-617.
- Staletić, M., Stojanović, S., Jevtić, R. (2004): The aecia formation of *Puccinia graminis* persoon on *Berberis* species. 3th International Eco-Conference on Safe food, Novi Sad, 347-352.
- Vennot-Bourgin, G. (1949): Parasitic fungi cultivated plants. Tome II, Paris.

EFFECT OF RAINFALL AND HUMIDITY DURING SHOOTING AND GRAIN FILLING PERIOD ON YIELD AND QUALITY IN BREAD WHEAT (*Triticum aestivum* L.) CULTIVARS

*İrfan ÖZTÜRK¹, Turhan KAHRAMAN¹, Remzi AVCI¹, Vedat Çağlar GİRGIN¹, Orhan Onur AŞKIN², Buket AŞKIN², Bülent TUNA¹, Adnan TÜLEK¹

¹Trakya Agricultural Research Inst., Edirne, Turkey

²Kırklareli Uni. Fac. of Engineering, Food Engineering Kırklareli, Turkey

*Corresponding author: ifanozturk62@hotmail.com

Abstract

Rainfall and humidity is one of the abiotic environmental factors may influence bread wheat quality during grain filling period in Trakya region (Turkey). It was investigated effect of the rainfall and humidity, in April May and June, to quality of the bread wheat cultivars. Rainfall and humidity from shooting up to grain filling period were taken in experimental area. This research was established with 25 genotypes in RCBD with 4 replications in Edirne, between 2005 and 2015 growing seasons. Aldane, Selimiye, Pehlivan and Gelibolu were selected from this experiment. Grain yield, TKW, TW, protein ratio, gluten, hardness and sedimentation and relationship amongst these traits were investigated. There were various relations among investigated parameters. The rainfall in shooting stage positively affected and increased protein ratio, gluten, hardness, sedimentation, and grain yield. Rainfall during heading and grain filling period significantly affected and increased TKW, test weight, while negatively affected and decreased protein ratio, gluten value and sedimentation ($r = -0.670$). The rainfall in late stage of grain filling negatively affected test weight and grain hardness. Grain yield and sedimentation was positively correlated. Mean humidity from shooting up to grain filling positively and significantly affected and increased gluten index. Also, there was highly significant correlation between protein with gluten ($r = 0.976^{**}$), hardness ($r = 0.589$), and sedimentation ($r = 0.780$). There was negative relation between TKW with protein ratio, gluten, index, hardness and sedimentation, while positive relation between yields. The rainfall in April and June positively affected yield potential of the cultivar. During heading and grain filling period high amount of rainfall and humidity decreased grain quality except TKW and test weight.

Key Words: *Bread wheat, cultivar, rainfall and humidity, yield, quality characters*

Introduction

Trakya region is located in the Northwestern part of Turkey. Mostly bread wheat cultivars are grown and it covers 5-6% of the total wheat area of Turkey. Average wheat yield is almost 5.0 tons/ha and production 3 million tons per year (Anonymous, 2011). Although the average annual rainfall is 560 mm this precipitation ranges between 350 mm to 850 mm. During the growing season (October-June) the distribution of this rainfall is not regular. Due to this fluctuation of rainfall in some growing year causes decrease in grain yield and quality (Anonymous, 2011). Almost all breeding programs in the world aim to improve varieties with stable yields (Pfeiffer and Braun, 1989). Environmental factors play a main role in the expression of genotype characteristics (Peterson et al., 1998). In wheat, grain yield and baking quality are dependent on the environment, genetic factors and the interaction between them (Yan and Holland, 2010; Coventry et al., 2011). Both the quality and content of the wheat protein are affected by the climatic conditions during

wheat maturation (Johnson et al., 1972; Johansson and Svensson, 1998). Increasing yield potential without affecting negatively the quality of the grain is difficult, mainly because increases in grain yield are generally accompanied by a decrease in the grain's protein content, which is strongly associated with bread-making quality (Pena 2002). Grain protein content in the mature grain is largely determined by environmental and farm management factors, with genetics playing a minor role in being either low or high in protein content. By contrast, protein quality is determined by the genetic composition of the wheat variety and also how the environment influences genetic expression (Blakeney et al., 2009). Environmental factors, such as nitrogen fertilization, water and temperature, influence protein content (Sissons et al., 2005). In contrast, protein quality is largely under genetic control (Lerner et al., 2006; Rogers et al., 2006). The physical characteristics of grain are important as they are indicative of potential processing quality. Grain hardness, which is largely genetically determined (Pena, 2008). Also grain hardness is a grain quality trait associated with the milling properties of wheat (Miller et al., 1982). Success of a wheat breeding program depends on the regional adaptability of the cultivars improved and adaptability of such cultivars in the target environments determined by its tolerance to biotic and abiotic stresses. The most important abiotic stress factor is the shortage of rainfall in the region. There are three critical periods of rainfall; fall rains during the early vigor and tillering, early spring rains during the tiller survival and stem elongation, and late spring rains during grain filling period (Altay, 2012). The purpose of the study was to investigate and comparison grain yield with the major quality characteristics of four widely cultivated varieties under varied rainfall and humidity condition in in Trakya region, Turkey.

Materials and Methods

The experiment was conducted in Trakya Agricultural Research Institute experimental area during 2005-2015 growing seasons. Twenty five winter wheat genotypes were examined under field condition with randomized complete block design with four replications. Four cultivars which are Pehlivan, Gelibolu, Aldane and Selimiye were selected from these experiments. All plots were sown into 6 rows, and plot sizes were 6 m² at harvesting. It was used 500 seeds/m² at planting. Sowings were performed by using a plot drill in October and in November, and nitrogen was applied at tree times, and for weed control chemical was used.

Grain yield, thousand kernel weights and test weight, (Blakeney et al., 2009), protein ratio, grain hardness, gluten, gluten index, and sedimentation (Köksel ve ark., 2000; Perten H. 1990; Anonymous, 2002; Anonymous, 1990) were investigated. The quality analysis of Zeleny sedimentation test and wet gluten content were determined according to ICC standard methods No. 116/1 and 106/2, respectively (Anonymous, 1972; Anonymous, 1984).

The rainfall and mean humidity in April (Z31-Z47), May (Z49-Z75) and June (Z77-Z90) from shooting up to ripening period were taken from 2005 up to 2015 growing years in experimental field (Table 1). The Zadoks Decimal Code (Z) was used to describe plant growth stages of cereals. The described plant development stages are; April: Zadoks Z31 (first node detectable) from up to Z47 (flag leaf sheath opening), May: Z49 (first awns visible) from up to Z75 (medium milk), June: Z77 (late milk) from up to Z90 (ripening). Also, regression graphs are used to predict comparison of characters. The statistical analyses of measurements were performed by using statistics program for and the differences among the means were compared with LSD (Least Significant Differences) at a 5% significant level (Kalaycı 2005).

Table 1. The rainfall (mm) and mean humidity (%) scored in April, May and June

Year	RAPR	RMAY	RJUNE	MHA	MHM	MHJ
2005	17.6	55.4	15.1	62.2	67.2	61.9
2006	24.0	36.5	57.8	65.8	63.8	64.3
2007	17.0	122.0	8.2	59.2	67.4	56.1
2008	44.1	33.4	45.7	71.2	62.7	62.1
2009	15.8	27.7	25.9	68.8	66.1	62.5
2010	17.8	16.0	30.8	76.0	68.6	72.3
2011	47.4	12.4	32.4	78.9	74.9	68.6
2012	55.7	104.6	0.4	72.5	75.8	64.1
2013	51.0	11.0	26.6	67.5	66.7	70.1
2014	36.8	61.7	68.8	81.6	76.6	73.8
2015	44.4	45.2	31.0	70.9	68.4	68.2
Average	33.8	47.8	31.2	70.4	68.9	65.8

Note: RAPR: Rain April (Z31-Z47); RMAY: Rain May (Z49-Z75); RJUNE: Rain June (Z77-Z90); MHA: Mean Humidity April (Z31-Z47); MHM: Mean Humidity May (Z49-Z75); MHJ: Mean Humidity June (Z77-Z90)

Results and Discussion

According to mean yield and other investigated traits there were significant differences among years. The highest average yield was 863.6 kg in 2008, and in 2014 with 824.4 kg/da. The lowest yield was obtained in 2009 due to environmental condition. Test weight is the weight of a specific volume of grain and is an indication of the bulk density of the grain. It reflects the extent of grain filling and the potential for flour yield (Blakeney et al., 2009). There were significant differences among years, so test weight ranged from 79.9 kg in 2013 to 85.2 kg in 2015. Mean test weight was 82.1 kg. Grain or kernel weight is the mass of a given number of kernels and is a useful measure of grain size (Blakeney et al., 2009). The highest TKW was measured in Pehlivan (46.6 g). TKW ranged from 34.5 g in 2011 to 51.6 g in 2005 among years and mean value was 43.8 g. (Table 2 and 3). There were significant differences among years according to protein ratio and ranged from 9.8% in 2014 up to 14.5% in 2011 year. Mean protein ratio was 12.0%. Wheat hardness is influenced especially by genetic factors, but can be influenced also by environment and factors like moisture and protein content (Turnbull and Rahman 2002). In this study there were significant differences among years according to grain hardness and ranged from 46.0 in 2010 up to 55.0 in 2011 year. Mean of the grain hardness was 49.4 (Table 2 and 3).

Statistically significant differences for wet gluten content were found among genotypes, and years. According to years, the highest wet gluten content was measured in 2011 year (42.3%), while the lowest with 25.9% in 2014 year. Mean gluten content was 33.9%. Also, there was a significant difference for gluten index. Gluten index ranged from 74.9% in 2012 up to 93.0% in 2014 year. Analysis of variance showed highly significant differences among genotypes investigated years for sedimentation value. Average sedimentation value ranged from 33.0 ml (in 2017) to 64.3 ml (in 2011). Genotypes reacted differently on investigated years. The highest sedimentation value achieved in Aldane cultivar (59.1 ml), while the lowest in Pehlivan (41.9 ml). The mean sedimentation value was 48.5 ml (Table 2 and 3).

Table 2. Determined mean yield and quality parameters based on years

Years	GY	TKW	TW	PRT	GLT	IND	HARD	SED
2005	751.5 b	51.6 a	85.2 a	11.6 de	32.3 de	82.2 b-e	49.8 bc	42.5 e
2006	711.7 bc	48.7 ab	82.9 b	13.4 b	37.7 bc	86.3 abc	49.5 bc	55.5 bc
2007	662.6 cd	42.5 def	80.2 d	10.0 f	26.4 g	80.4 b-e	46.5 cd	33.8 f
2008	863.6 a	43.9 cd	83.2 b	13.2 bc	37.5 bc	76.2 de	51.3 b	51.3 cd
2009	611.6 d	38.6 fg	80.5 cd	13.1 bc	37.9 bc	78.2 cde	51.0 b	45.8 de
2010	671.9 c	39.5 ef	80.8 cd	11.0 e	28.9 fg	91.7 a	46.0 d	50.5 cd
2011	666.0 cd	34.5 g	82.7 b	14.5 a	42.3 a	87.8 ab	55.0 a	64.3 a
2012	694.7 bc	47.0 bc	85.3 a	12.5 bcd	39.1 ab	74.9 e	51.5 b	44.5 e
2013	719.8 bc	44.9 bcd	79.9 d	10.7 ef	29.9 ef	78.6 b-e	46.8 cd	43.3 e
2014	824.4 a	48.3 ab	80.7 cd	9.8 f	25.9 g	93.0 a	46.5 cd	41.3 e
2015	688.5 c	42.9 cde	81.9 bc	12.3 cd	35.5 cd	85.0 a-d	49.8 bc	61.0 ab
Mean	715.2	43.8	82.1	12.0	33.9	83.1	49.4	48.5
LSD (0.05)	58.2	4.26	1.44	0.93	3.32	9.4	3.42	5.87
F	**	**	**	**	**	**	**	**

Note: Significance at **: P<0.01; * :P<0.05; GY: Grain yield (kg/da), TKW: 1000-kernel weight (g), TW: Test weight (kg), PRT: Protein ratio (%), GLT: Gluten (%), IND: Gluten index (%), HARD: Hardness (PSI), SED: Sedimentation (ml)

Analysis of variance showed highly significant differences among genotypes (G) investigated years (Y) for all quality parameters and year 2011 was very favourable for protein ratio, gluten value, grain hardness, gluten index and sedimentation value. It was very favourable year of 2012 for 1000-kernel weight and test weight.

Table 3. Based on year mean yield and quality characters of the tested genotypes

Cultivars	GY	TKW	TW	PRT	GLT	IND	HARD	SED
Pehlivan	723.6 a	46.6 a	82.4 ab	11.5 c	35.9 a	61.7 c	50.7 a	41.9 c
Gelibolu	740.4 a	41.5 b	81.4 c	11.1 c	26.8 b	94.2 a	45.5 b	42.8 c
Aldane	650.1 b	43.6 b	81.6 bc	12.3 b	36.5 a	92.4 a	49.8 a	59.1 a
Selimiye	746.3 a	43.7 b	83.0 a	13.1 a	36.6 a	84.0 b	51.5 a	50.2 b
Mean	715.2	43.8	82.1	12.0	33.9	83.1	49.4	48.5
LSD (0.05)	35.1	2.57	0.86	0.55	1.99	5.69	2.06	3.52
F	**	**	**	**	**	**	**	**

The four cultivars, Pehlivan, Gelibolu, Aldane and Selimiye, selected from this study and for the comparison rainfall and mean humidity with their yield, quality parameters. The results of variance analysis showed that there was statistically difference among genotypes according to yield and quality parameters. Selimiye was the highest yielding cultivar with 746.3 kg/da. The highest value of the TW, protein ratio, gluten value and hardness was determined in Selimiye cultivar. Aldane have highest gluten index and sedimentation (Table 3).

In order to find, relationship and effect of the rainfall, from Z31 (first node detectable) up to Z47 (flag leaf sheath opening) plant growth stage on some quality parameters was investigated (Figure 1). Rainfall from Z31 to Z47 plant growth stage affected positively gluten value, grain hardness and

sedimentation value. A positive correlation was found between rainfall and gluten content ($R^2=0.136$), hardness ($R^2=0.344$) and slightly relation with sedimentation value (Figure 1). Also, it was investigated, relationship and effect of the mean humidity, from Z31 up to Z47 plant growth stage on some quality parameters (Figure 1). Mean humidity from Z31 to Z47 plant growth stage affected positively gluten index value, grain hardness and sedimentation value and negatively affected 1000-kernel weight. A positive correlation was determined between mean humidity with gluten index ($R^2=0.522$), and sedimentation value ($R^2=0.261$), while a negative correlation existed between the mean humidity and the 1000-kernel weight ($R^2= -0.214$) (Figure 1).

Relationship rainfall and mean humidity with yield and quality parameters from Z49 (first awns visible) up to Z75 (medium milk) plant growth stage was given in Figure 2. The increasing in rainfall during Z49 up to Z75 (booting, heading and grain filling period (from Z49 to Z75) positively affected and increased TW, TKW and gluten index, also negatively affected and decreased protein ratio, gluten value and sedimentation. A positive correlation was found between rainfall and test weight ($R^2= 0.182$), 1000-kernel weight ($R^2=0.237$), while a negative correlation existed between the rainfall and sedimentation value ($R^2=0.449$), protein ratio ($R^2=0.180$) and gluten value ($R^2=0.113$). The mean humidity during Z49 up to Z75 positively affected gluten index ($R^2= 0.376$) (Figure 2).

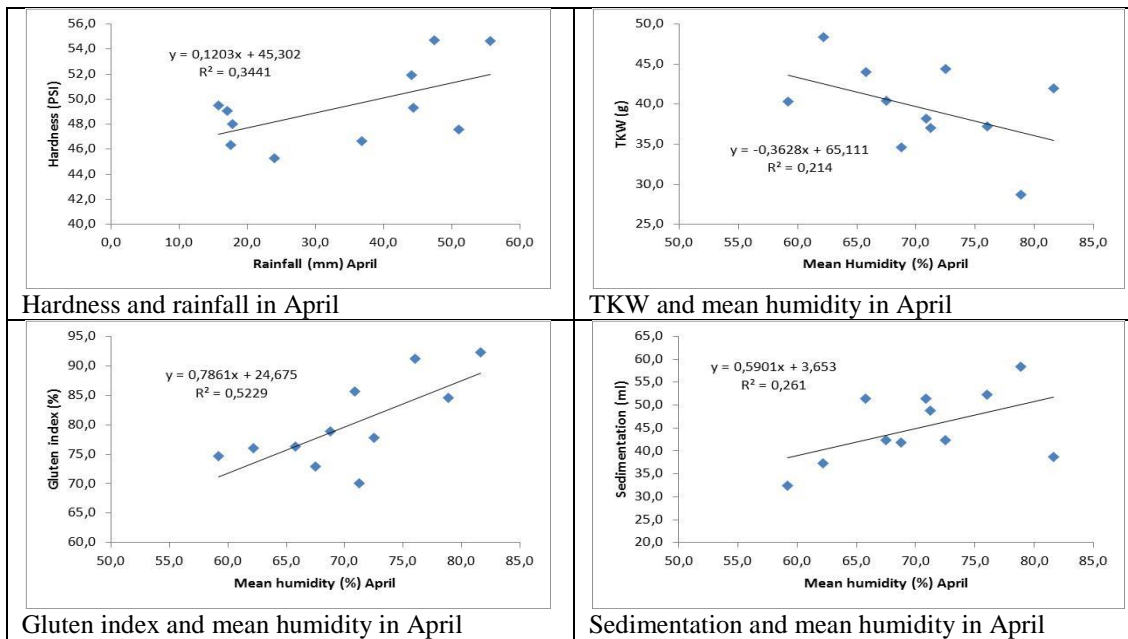

Figure 1. Relationship rainfall and mean humidity with yield and quality parameters from Z31 (first node detectable) up to Z47 (flag leaf sheath opening) plant growth stage

During Z77 with Z90 relationship among rainfall with yield and quality parameters was investigated. The rainfall positively affected and increased TW, TKW and gluten index, also negatively affected and decreased protein ratio, gluten value and sedimentation. There was negatively relation rainfall with test weight ($R^2=0.166$), and grain hardness ($R^2=0.169$), while a positive correlation founded between rainfall and the grain yield ($R^2=0.216$) and gluten index. The mean humidity during Z77 up to Z90 was positively correlated with gluten index and sedimentation value with R^2 values of 0.536 and 0.191 respectively (Figure 2). Also, mean humidity during Z77 up to Z90 was slightly negatively correlated with test weight.

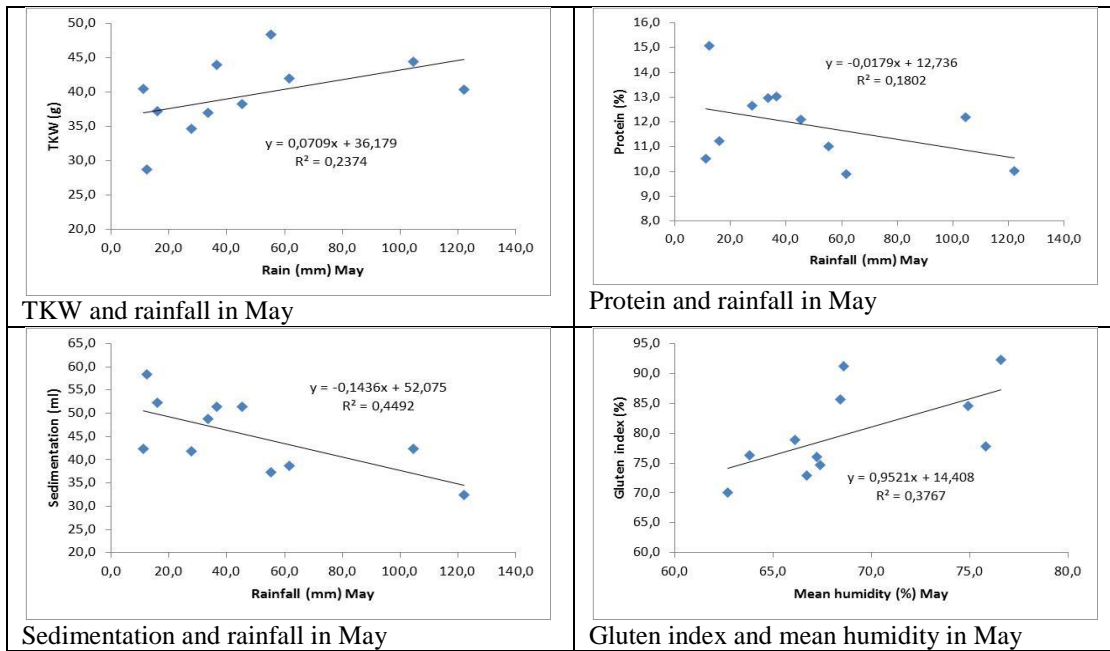

Figure 2. Relationship rainfall and mean humidity with yield and quality parameters from Z49 (first awns visible) up to Z75 (medium milk) plant growth stage

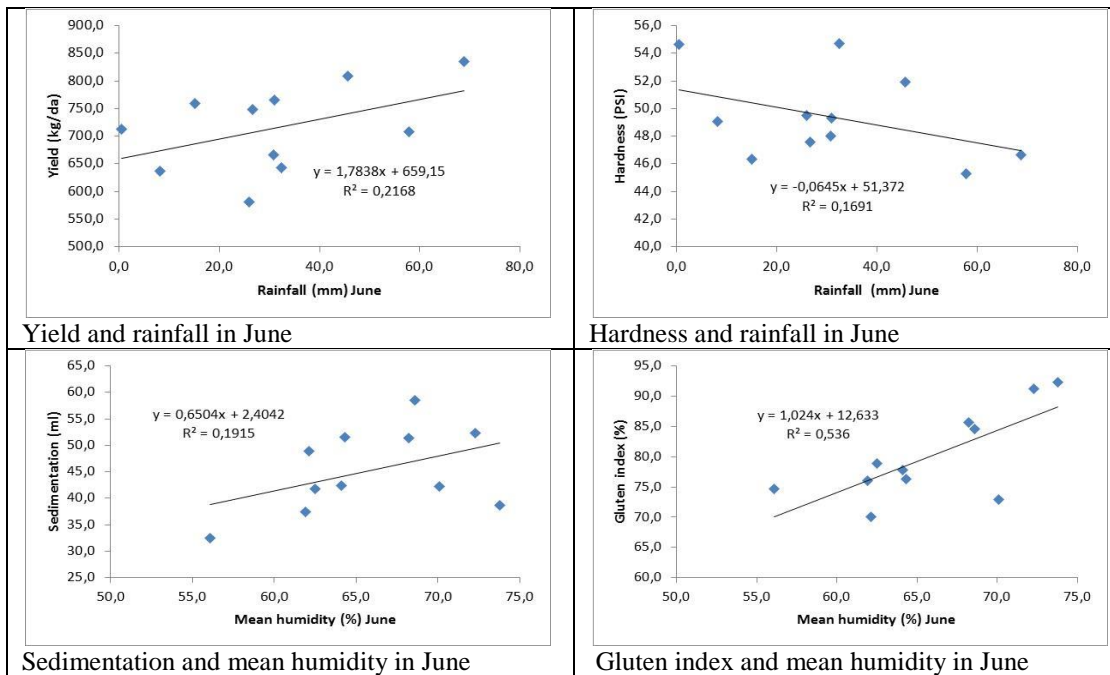

Figure 3. Relationship rainfall and humidity with yield and quality parameters from Z77 (late milk) from up to Z90 (ripening) plant growth stage

Table 4. Correlation coefficients among tested characters by rainfall and mean humidity of cultivars under field conditions

Traits	RAPR	RMAY	RJUNE	MHA	MHM	MHJ	TKW	TW	PRT	GLT	IND	HARD	SED
RMAY	-0,069												
RJUNE	0,004	-0,448											
MHA	0,441	-0,371	0,484										
MHM	0,416	0,264	-0,056	0,652									
MHJ	0,346	-0,555	0,509	0,798	0,460								
TKW	-0,159	0,487	-0,118	-0,463	-0,091	-0,203							
TW	0,108	0,427	-0,408	-0,169	0,183	-0,241	0,666*						
PRT	0,273	-0,425	0,080	0,272	-0,017	-0,048	-0,589	0,024					
GLT	0,370	-0,337	-0,028	0,201	-0,019	-0,121	-0,473	0,166	0,976**				
IND	-0,073	-0,166	0,342	0,723*	0,614*	0,732*	-0,244	-0,173	-0,080	-0,219			
HARD	0,587	0,122	-0,411	0,336	0,411	-0,127	-0,527	0,151	0,589	0,651*	-0,087		
SED	0,314	-0,670	0,330	0,511	-0,006	0,438	-0,585	-0,155	0,780**	0,713*	0,287	0,322	
GY	0,435	0,008	0,466	0,234	0,073	0,345	0,449	0,206	-0,312	-0,263	0,025	-0,233	-0,073

Note: Significance at **: $P < 0.01$ and * : $P < 0.05$; RAPR: Rain April (Z31-Z47); RMAY: Rain May (Z49-Z75); RJUNE: Rain June (Z77-Z90); MHA: Mean Humidity April (Z31-Z47); MHM: Mean Humidity May (Z49-Z75); MHJ: Mean Humidity June (Z77-Z90); GY: Grain yield (kg/da), TKW: Thousand kernel weight (g), TW: Test weight (kg), PRT: Protein content (%), GLT: Gluten (%), IND: Gluten index (%), HARD: Hardness, SED: Sedimentation (ml)

Correlation coefficients among the tested characters were given in Table 4. It was found various relations among investigated parameters based on rainfall and humidity with yield and quality parameters. The rainfall in April (Z31-47) positively affected and increased protein ratio ($r = 0.273$), gluten ($r = 0.370$), hardness ($r = 0.587$), sedimentation ($r = 0.314$), and grain yield ($r = 0.435$). Rainfall in May (Z49-75), during heading and grain filling period, significantly affected and increased TKW ($r = 0.487$), test weight ($r = 0.427$), but negatively affected and decreased protein ratio ($r = -0.425$) gluten value ($r = -0.337$), and sedimentation ($r = -0.670$). The rainfall in June (Z77-90) positively affected sedimentation and grain yield, while negatively affected test weight and grain hardness. Mean humidity in April ($r = 0.723$), May ($r = 0.614$) and June ($r = 0.732$) positively and significantly affected and increased gluten index. Also, there was highly significant correlation between protein and gluten ($r = 0.976^{**}$), hardness ($r = 0.589$), and sedimentation ($r = 0.780$). There was negative relation between TKW with protein ratio, gluten, gluten index, hardness and sedimentation, but positive relation between grain yields.

The rainfall in April and June positively affected yield potential of the cultivar. During heading and grain filling period high amount of rainfall and humidity decreased grain quality except 1000-kernel weight and test weight.

Conclusion

Environmental factors over years strongly influenced the grain yield and quality parameters. This large difference in variance between environmental and genotypic influences clearly demonstrates the importance of growing season weather impact on quality for adapted bread wheat genotypes. There were various relations among investigated parameters. The rainfall during shooting stage positively affected and increased protein ratio, gluten, hardness, sedimentation, and grain yield. Rainfall during heading and grain filling period significantly affected and increased TKW, test weight, while negatively affected and decreased protein ratio, gluten value and sedimentation. The rainfall in late stage of grain filling negatively affected test weight and grain hardness, also positively affected gluten index and sedimentation. The mean humidity from shooting up to grain filling period positively affected and increased protein ratio, gluten, gluten index, hardness and sedimentation. During heading and early grain filling period mean humidity increased TKW, hardness and gluten index.

Also, there was highly significant correlation between protein with gluten, grain hardness, and sedimentation value. There was negative relation between TKW with protein ratio, gluten, index, hardness and sedimentation, while positive relation between test weight and yields. During heading and grain filling period high amount of rainfall and humidity decreased grain quality except 1000-kernel weight and test weight.

References

- Altay F. 2012. Yield stability of some Turkish winter wheat (*Triticum Aestivum* L.) genotypes in the western transitional zone of Turkey. *Turkish Journal Of Field Crops*, 2012, 17(2): 129-134
- Anonymous. 1972. ICC. Standard methods of the international association for cereal chemistry (ICC). Methods No. 106/2. Vienna Verlag Moritz Schafer. Detmold, Germany.
- Anonymous. 1984. ICC. Standard methods of the international association for cereal chemistry (ICC). Methods No. 116/1. Vienna Verlag Moritz Schafer. Detmold, Germany.
- Anonymous, 1990. AACC Approved Methods of the American Association of Cereal Chemist, USA.
- Anonymous, 2002. International Association for Cereal Sci. and Technology. (ICC Standart No: 110, Standart No: 105, Standart No: 106, Standart No: 155, Standart No: 116, Standart No: 115).
- Anonymous, 2011. Trakya Tarımsal Araşt. Enst. Araştırma Projeleri Raporu. Edirne. (unprinted) (Trakya Agr. Res. Inst. Report of the Research Project. Edirne, Turkey)
- Atlı A. 1999. Buğday ve Ürünleri Kalitesi. Orta Anadolu'da Hububat Tarımının Sorunları ve Çözüm Yolları Sempozyumu, s; 498-506. Konya. (Quality of Wheat and Production. Symposium of the Cereals Production, p: 498-506. Konya).
- Balla K, Veisz O. 2007. Changes in the quality of cereals in response to heat and drought stress. *Acta Agronomica Óvariensis*, 49: 2. 451-455.
- Blackman J.A, Payne P.I. 1987. Grain quality. *Wheat Breeding*. Cambridge Uni. p:455-484.
- Blakeney A.B., Cracknell R.L., Crosbie G.B., Jefferies S.P., Miskelly D.M., O'Brien L., Panozzo J.F., Suter D.A.I., Solah V., Watts T., Westcott T., Williams R.M. 2009. *Understanding Wheat Quality*. p:8. GRDC, Kingston, Australia.

- Coventry D. R, Gupta R. K, Poswal R. S, Chhokar R. S, Sharma R. K, Yadav V. K, Gill S. C, Mehta A, Kleemann S.G.L, Bonamano A, Cummins J. A. 2011. Wheat quality and productivity as affected by varieties and sowing time in Haryana, India. *Field Crops Research*, v. 123, n. 3, p. 214-225.
- Johnson J.A, Khan M, Sanchez C.R. 1972. Wheat cultivars, environment and bread-making quality. *Cereal Sci. Today*, 17, 323–326.
- Johansson E, and Svensson G. 1998. Variation in bread making quality: Effect of weather parameters on protein concentration and quality in some Swedish wheat cultivars grown during the period 1975–1996. *J. Sci. Food Agric.* 78, 109–118.
- Kalaycı M. 2005. Örneklerle Jump Kullanımı ve Tarımsal Araştırma için Varyans Analiz Modelleri. *Anadolu Tarımsal Araştırma Enst. Müd. Yayınları*. Yayın No: 21. Eskişehir. (Example for Jump Use and Variance Analysis Model for Agricultural Research. *Anatolia Agr. Res. Inst, Pub. No: 21 Eskişehir, Turkey*).
- Köksel H, Sivri D, Özboy O, Başman A. ve Karacan H.D. 2000. *Hububat Laboratuvarı El Kitabı*. Hacettepe Üni. Müh. Fak. Yay. No:47, Ankara. (Handbook of the Cereal Laboratory. Hacettepe Uni. Fac. of Eng. No: 47, Ankara, Turkey).
- Lerner S.E, Seghezzo M.L, Molfese E.R, Ponzio N.R., Cogliatti M, Rogers W.J. 2006. N- and S-fertilisers effects on grain composition, industrial quality and end-use in durum wheat. *Journal of Cereal Science*, 44, 2–11.
- Miller B.S, Afework S, Pomeranz Y, Bruinsma B, and Booth G.D. 1982. Measuring the hardness of wheat. *Cereal Foods World*, 27: 61-64.
- Pena R.J. 2002. Wheat for bread and other foods. *FAO Plant Production and Protection Series*. No:30. Bread Wheat Improvement and Production. Rome.
- Pena R.J. 2008. Improving or preserving bread making quality while enhancing grain yield in wheat. *International Symposium on Wheat Yield Potential: Challenges to International Wheat Breeding*. Mexico, D.F.: CIMMYT. p: 171-174.
- Perten H. 1990. Rapid Measurement of Wheat Gluten Quality by the Gluten Index, *Cereal Foods World*, 35: 401-402.
- Pfeiffer W.H, Braun H.J. 1989. Yield stability in bread wheat. In J.R. Anderson and P.B Hazel, eds. *Variability in Grain Yields*. Washington D.C.: John Hopkins Univ. and the Int. Food Policy Res. Inst.
- Rogers W.J, Cogliatti M, Lerner S.E. 2006. Effects of nitrogen and sulfur fertilizers on gliadin composition of several cultivars of durum wheat. *Cereal Chemistry*, 83, 677–683.
- Sissons M.J, Egan N.E, Gianibelli, M.C. 2005. New insights into the role of gluten on durum pasta quality using reconstitution method. *Cereal Chemistry*, 82, 601–608.
- Turnbull K.M., Rahman S. 2000: Endosperm texture in wheat. *J. Cereal Sci.*, 36: 327-337.
- Yan W, Holland J.B. 2010. A Heritability-adjusted GGE biplot for test environment evaluation. *Euphytica*, v. 171, n. 3, p. 355-369.
- Peterson C.J., Graybosch R.A., Shelton D.R., and Baenziger P.S. 1998. Baking quality of hard red winter wheat: Response of cultivars to environments in the Great Plains. *Euphytica* 100 (1-3): 157-162.

WEED CONTROL IN SUNFLOWERS WITH *CLEARFIELD PLUS* TECHNOLOGY

Todor MANILOV*, Ivan ZHALNOV

Department of Agronomy, Agricultural University, Plovdiv, Bulgaria
Corresponding author: t.manilov@yahoo.com

Abstract

Field trial experiments were set up in a region close to the town of Pazardzhik (Bulgaria) in the period 2013 - 2015. The object of the experimental work was *Clearfield Plus* technology, which included soil herbicides. The sunflower hybrid that was used during three years of the experiment was *EC Candimis CL Plus*. The main aim of the experiment was to determine the selectivity of imazamox-based herbicides to the sunflower and herbicidal efficacy of the combinations of pre and post emergence herbicides against economically important weeds in the sunflower. Reported herbicide tolerance to crop in three years, which is characterized by slightly lightening the leaves on some of the treatments. The phytotoxicity disappeared within 14 – 21 days after the application of postemergence herbicides. The trial results over the last three years showed that the most significant differences were in the efficacy of *Pulsar 40* against perennial weeds. Solely application of herbicide *Pulsar 40* without *Dash*, significantly reduced its effectiveness against *Sorghum helepense* L., *Cirsium arvense* L. and *Chenopodium album* L. However, against annual broadleaf species – *Amaranthus* spp, *Sinapis arvensis* L, *Raphanus raphanistrum* L, *Solanum nigrum* L. and others – its efficiency was 100%. The pre-emergence herbicides- used immediately after sowing showed great at controlling over some economically important annual weeds in early stages of crop development.

Keywords: *Selectivity, efficacy, herbicides, sunflower*

Introduction

Sunflower is one of the most important oil-bearing crops in the world due to its high adaptation capacity, mechanization and also the fact that it is preferred by customers as a vegetable oil. The areas where sunflower is grown are not very large worldwide owing to the fact that the profits are lower because as a summer crop it is influenced by the conditions of the environment. In order to increase the production, it is important to reduce the effect of factors decreasing the seed yield by using techniques that boost production and also by developing cultivars giving higher yield (Skoric, 2012; Kaya, 2014b).

The fight against weeds in sunflower must be initiated during the earliest phenophases of the crop because when it enters the stage of intensive growing of the stems, the crop itself is capable of successfully coping with the competition of the weeds. The weeds that are most widespread in sunflower are *Amaranthus* spp, *Sinapis arvensis* L., *Echinochloa crus-galli* L., *Setaria* spp, *Chenopodium album* L., *Cirsium arvense* L., *Sorghum helepense* L., *Orobanche cumana* W. and others. During the conventional growing of sunflower, what is crucial for the successful outcome of the fight against weeds is the early deep ploughing after gathering the previously grown plants and the additional summer and autumn cultivation. Thus, we obtain a bed for sowing sunflower which is relatively better cleaned from weed seeds (Tonev, 2000, Jocić, *et al.*, 2011).

The most important thing in the pre-sowing spring cultivation is the early initial cultivation by means of harrowing, which eliminates all the weeds that have survived the winter and triggers the

germination of new weed seeds. Sunflower is a crop that can stand both pre-germination and post-germination harrowing using light weed spike-tooth or rotary harrows. The timely harrowing, which has to coincide with the period of mass germination of the weeds, has a substantial anti-weed effect (Mitkov and Stoychev, 2014).

When sunflower plants become overgrown with weeds, two or three inter-row cultivations must be performed, reaching a depth of 6-8 cm. During the last cultivation, it is recommended to earth up the sunflower plants slightly. Thus, a large number of shoots of the late-growing weeds will be covered with soil and will die as a result. The need to conduct vegetation cultivation of sunflower is reduced depending on the level of cleaning of the soil from weeds after the successful application of herbicides (Tonev, *et al.*, 2010; Tonev, *et al.*, 2015).

Considering the fact that with the conventional sunflower hybrids the selective herbicides do not show effectiveness regarding *Xanthium strumarium* L and *Cirsium arvense* L, whose density over the last years has been too high, a good alternative is offered by the technologies „Sun” and „Clearfield” in sunflower. In order to fight all types of *Orobanche cumana* W. in sunflower, we use the technology *Clearfield* (Tóth *et al.*, 2004; Suresh and Reddy, 2010, Tonev, *et al.*, 2009).

The inclusion of sunflower in appropriate and scientifically substantiated crop rotations, in which it is usually alternated with densely sown crops, facilitates the fight against the perennial and the late-spring weeds (Malidža *et al.*, 2011; Reis *et al.*, 2014).

The purpose of this research is to:

- Conduct comparative testing in order to establish the selectivity of the imazamox-containing herbicides towards the new generation of sunflower hybrids based on the *Clearfield* technology.

- Establish the effectiveness of various doses of imazamox-containing herbicides with added adjuvant *Dash* and also in combination with soil herbicides against the most economically significant weeds in sunflower which is grown based on the technology *Clearfield Plus* considering the conditions in Bulgaria.

Material and Methods

In the period 2013-2015, we conducted a field experiment on areas sown with sunflower in the region of the village of Chernogorovo, district of Pazardzhik. The subject of the experiment was the technology *Clearfield plus* and during the three years of the experiment we used the sunflower hybrid ES *Candimis CL Plus*. The tested soil herbicides *Stomp Aqua* (455g/l pendimethalin) and *Gardoprim Plus Gold* (312.5 g/l S-metolahlor + 187.5 g/l Terbutilazin) were applied right after the sunflower was sown and all the other herbicides were applied during the 4th-6th leaf phenophase of the sunflower, the rosette stage of the main broadleaves weeds and the tillering stage of the grass weeds.

Field trial has 6 treatments plots and each plot was with size of 21m² made in four replications. The untreated area were included in the randomization in each replication. We also included an additional control sample which had undergone mechanical treatment once (Dimova, D., *et al.*, 1999).

As a result of the experiments, we determined the selectivity of the herbicides towards sunflower and the effectiveness against weeds on the 14th, 28th and 56th days (in % based on the EWRS scale) upon the application of the vegetation herbicides. The experiments were conducted in accordance with the EPPO standards of the European Union.

Table 1: Treatment information and time of application

№	Treatments	Dose rate of application	Time of application
1	Untreated		
2	<i>Pulsar 40</i>	1.2 l/Ha	A2
3	<i>Pulsar 40 + Dash</i>	1.0 l/Ha + 1.0 l/Ha	A2
4	<i>Pulsar 40 + Dash</i>	1.2 l/Ha + 1.2 l/Ha	A2
5	<i>Stomp Aqua + Pulsar 40</i>	3.5 l/Ha + 1.2 l/Ha	A1 + A2
6	<i>Gardoprim Plus Gold + Pulsar 40</i>	3.5 l/Ha + 1.2 l/Ha	A1 + A2

Application A1- application pre-emergence of crop BBCH 00-09.

Application A2- application post-emergence of crop BBCH 12-16.

Pulsar 40 (40 g/l Imazamox)

Stomp Aqua (455 g/l Pendimethalin)

Gardoprim Plus Gold 500 SC (312.5 g/l S-metolahlor + 187.5 g/l Terbutilazin)

Table 2: Trial Map Design

❖ 101/1	❖ 201/5	❖ 301/2	❖ 401/4
❖ 102/2	❖ 202/4	❖ 302/6	❖ 402/1
❖ 103/3	❖ 203/6	❖ 303/5	❖ 403/3
❖ 104/4	❖ 204/3	❖ 304/1	❖ 404/2
❖ 105/5	❖ 205/1	❖ 305/3	❖ 405/6
❖ 106/6	❖ 206/2	❖ 306/4	❖ 406/5

Results and Discussion

The manifestations of phytotoxicity on cultivated crops are an important element of the effectiveness of a certain herbicide used to control weeds. We registered the phytotoxicity towards the crop of the herbicides used to fight weeds in sunflower during two stages – on the 14th and 28th days upon the application of herbicides. The results showed that upon the application of vegetation herbicides, there is slight phytotoxicity in variants 4 and 5 which is manifested as slight lightening of the treated sunflower plants. These symptoms of the sunflower plants completely disappear after the 28th day upon the application of the vegetation herbicides.

The effectiveness of the herbicides regarding the main weed types growing among the sunflower plants are shown in Tables 3, 4 and 5. The results from the experiments show that the most significant differences are to be observed in the effectiveness of *Pulsar 40* against perennial weeds. The individual use of *Pulsar 40* without the adjuvant *Dash* significantly reduces its effectiveness against *Sorghum helepense* L., *Cirsium arvense* L., *Xanthium strumarium* L., *Chenopodium album* L. and *Portulaca oleracea* L. Regarding the effectiveness against annual

broadleaf types – *Amaranthus retroflexus* L., *Sinapis arvensis* L., *Raphanus raphanistrum* L., *Solanum nigrum* L. and others – it is 100% and there are no differences between the various doses applied – 1.0 and 1.2 l/Ha. The individual application of the herbicide *Pulsar 40* in a dose of 1.2 l/Ha, without the adjuvant *Dash*, makes it as effective against the most resistant weeds as the herbicide applied in a dose of 1.0 l/Ha in combination with 1.0 l/Ha of the adjuvant *Dash*. The use of the soil herbicides *Stomp Aqua* and *Gardoprim Plus Gold* applied in a dose of 3.5 l/Ha after sowing and before the germination of the crop controls the annual weeds, with the exception of *Xanthium strumarium* L., *Sorghum helepense* L., *Cirsium arvense* L.. At the time of applying the vegetation herbicides during the 4th-6th leaf stage of the crop, the density of the annual grass and broadleaf weeds is significantly lower compared to the untreated area.

Table 3: Averages of selectivity for sunflower (in % on a scale of EWRS) and averages of efficacy (in % on a scale of EWRS) against major weeds on the 14th day from the date of submission of vegetation herbicides

№	Treatment	Dose rate l/Ha	Selectivity (%) Scale EWRS	<i>Sorghum helepense</i> . L	<i>Cirsium arvense</i> .L	<i>Amaranthus retroflexus</i> . L	<i>Solanum nigrum</i> . L	<i>Abutilon theophrasti</i> . L	<i>Sinapis arvensis</i> . L	<i>Xanthium strumarium</i> . L	<i>Chenopodium album</i>	<i>Portulaca oleracea</i> . L	<i>Raphanus raphanistrum</i> . L
1	Untreated		100	0	0	0	0	0	0	0	0	0	0
2	Pulsar 40	1.20	100	70	65	82.5	77.5	85	85	65	60	55	70
3	Pulsar 40+ Dash	1.00+ 1.00	100	72.5	67.5	85	82.5	82.5	82.5	60	57.5	50	65
4	Pulsar 40+ Dash	1.20+ 1.20	95	77.5	70	90	85	87.5	90	67.5	62.5	60	70
5	Gardoprim Plus Gold Pulsar 40	3.50 1.20	95	82.5	60	96.2	100	97.5	91.2	62.5	92.5	77.5	87.5
6	Stomp Aqua Pulsar 40	3.50 1.20	100	85	62.5	98.7	100	95	97.5	62.5	97.5	80	95
Average number of weed per square meter in Untreated				8.2	1.4	2.7	4.6	2.1	2.7	4.1	3.1	8.4	3.7

Table 4: Averages of selectivity for sunflower (in % on a scale of EWRS) and averages of efficacy (in% on a scale of EWRS) against major weeds on the 28th day from the date of submission of vegetation herbicides

№	Treatment	Dose rate l/Ha	Selectivity (%) Scale EWRS	<i>Sorghum helepense</i> . L	<i>Cirsium arvense</i> .L	<i>Amaranthus retroflexus</i> . L	<i>Solanum nigrum</i> . L	<i>Abutilon theophrasti</i> . L	<i>Sinapis arvensis</i> . L	<i>Xanthium strumarium</i> . L	<i>Chenopodium album</i>	<i>Portulaca oleracea</i> . L	<i>Raphanus raphanistrum</i> . L
1	Untreated		100	0	0	0	0	0	0	0	0	0	0
2	Pulsar 40	1.20	100	85	85	100	100	100	100	75	87.5	87.5	100
3	Pulsar 40+Dash	1.00+ 1.00	100	100	87.5	100	100	100	100	90	90	90	100
4	Pulsar 40+Dash	1.20+ 1.20	100	100	95	100	100	100	100	95	95	92.5	100
5	Gardoprim Plus Gold Pulsar 40	3.50 1.20	100	100	85	100	100	100	100	77.5	95	82.5	100
6	Stomp Aqua Pulsar 40	3.50 1.20	100	100	82.5	100	100	100	100	82.5	100	98.7	100
Average number of weed per square meter in Untreated				11.8	2.4	3.8	5.6	2.9	4.2	6.3	4.6	9.6	4.8

Table 5: Averages of selectivity for sunflower (in % on a scale of EWRS) and averages of efficacy (in % on a scale of EWRS) against major weeds on the 56th day from the date of submission of vegetation herbicides

№	Treatment	Dose rate l/Ha	Selectivity (%) Scale EWRS	<i>Sorghum helepense</i> . L	<i>Cirsium arvense</i> .L	<i>Amaranthus retroflexus</i> . L	<i>Solanum nigrum</i> . L	<i>Abutilon theophrasti</i> . L	<i>Sinapis arvensis</i> . L	<i>Xanthium strumarium</i> . L	<i>Chenopodium album</i>	<i>Portulaca oleracea</i> . L	<i>Raphanus raphanistrum</i> . L
1	Untreated		100	0	0	0	0	0	0	0	0	0	0
2	Pulsar 40	1.20	100	90	85	100	100	100	100	82.5	90	88.7	100
3	Pulsar 40+Dash	1.00+ 1.00	100	96.2	90	100	100	100	100	90	91.2	91.2	100
4	Pulsar 40+Dash	1.20+ 1.20	100	100	96.2	100	100	100	100	96.2	96.2	93.7	100
5	Gardoprim Plus Gold Pulsar 40	3.50 1.20	100	90	87.5	100	100	100	100	80	98.7	87.5	100
6	Stomp Aqua Pulsar 40	3.50 1.20	100	95	85	100	100	100	100	83.7	100	98.7	100
Average number of weed per square meter in Untreated				12.5	3.7	4.2	6.8	3.8	5.3	7.7	7.5	10.2	5.7

Conclusion

In order to exercise effective control over the resistant types *Sorghum helepense* L., *Xanthium strumarium* L., *Chenopodium album* L., *Portulaca oleracea* L. and *Orobanche cumana* W., it is necessary to apply *Pulsar 40* in the highest tested dose of 1.2 l/Ha, with the compulsory addition of the adjuvant *Dash*.

In case of weeds that are highly sensitive to the herbicide *Pulsar 40* such as *Sinapis arvensis* L. *Solanum nigrum* L., *Myagrum perfoliatum* L. and others, *Pulsar 40* can be applied in the lowest tested dose of 1.0 l/Ha, without adding the adjuvant *Dash*.

In case of areas significantly overgrown with *Sorghum helepense* L from rizoms, the herbicide *Pulsar 40* must be used in a dose of 1.2 l/Ha, in combination with adjuvant *Dash* in a dose of 1.0 l/Ha.

The use of soil herbicides in combination with *Pulsar 40* is justified in those cases when there are areas significantly overgrown with annual grass and broadleaves weeds and later application of the herbicide *Pulsar 40*.

References

- Malidža G., Elezović I., Simić M., Glamočlija Đ. (2011). Critical periods for weed control and obtaining yield increase in Vegetation-applied herbicides Goal, Raft and Pledge combined sunflower (*Helianthus annuus* L.) tolerant to imidazolinones. 11th treatment with the soil applied herbicide Pelican provide good control of Conference about Plant Protection, Zlatibor, Serbia, 111-112.
- Mitkov, A., Stoychev, D. 2014. Integrated weed control in sunflower. Journal Plant Protection, 2, pp. 30 -34.
- Reis, R. M.; Souza, M. F.; Queiroz, G. P.; Siebert, I. G.; Silva, D. V.; Fereira, E. A.; Silva, A. A. Tolerance of sunflower to herbicide application in post-emergence. State University of Maringa, Umuarama, Brazil. Journal of Herbicides, 2014, 13, 1, pp 15-22.
- Suresh G and Reddy B, 2010. Effect of weed control practices on Herbicide tank mixtures Pulsar + Stomp by Clearfield weed dry matter, production potential and nutrient uptake of technology and Express + Stratos ultra by Express Suntechnology sunflower (*Helianthus annuus*) in Vertisols. Indian Journal of completely destroyed all annual and perennial grassy and Agricultural Sciences, 80, 1, 33-37.
- Tonev, T., 2000. Handbook for integrated weed control and culture for farming. Color Atlas of the 100 most economically important weed in Bulgaria. Library Agricultural Education, vol. 2 VSI Plovdiv.
- Tonev, T., Mitkov A., 2015. Chemical weed control in major field crops. Agriculture Plus, 2, 33-44.
- Tonev, T., Mitkov A., Dochev Ch., Tityanov M., 2009. Opportunities Sun technologies for effective weed control in sunflower. Journal Plant Science, 2, 161-166.
- Tonev, T., Tityanov M., Mitkov A., 2010. Integrated weed control in sunflower. Scientific papers of Agricultural University Plovdiv, Bulgaria LV, 2, 127-132.
- Tóth, E.; Molnár, I.; Somlyay, I.; Popovics, I.; Gulyás, A.; Kara, B. A new possibility for postemergence weed control of sunflower: Application of Granstar 75 DF in Granstar tolerant sunflower. Debreceni Egyetem, Agrártudományi Centrum, Mezőgazdaságtudományi Kar, Debrecen, Hungary, 9. Tiszántúli Növényvédelmi Fórum, 20-21 October 2004, Debrecen, Hungary, 2004, pp 351-355
- Wanikorn N, 1991. Weed competition and chemical weed control in Joci Č S, Malidža G, Cveji Č Hladni N, Mikli Č V and Škori Č D, 2011. sunflower (*Helianthus annuus*(L.). Thesis for

PhD, Kasetsart Development of sunflower hybrids tolerant to tribenuron methyl. University, Bangkok.

Dimova D., Marinkov E., 1999. Experimental work and biometrics, Academic Publishing of VSI
Kaya Y. (2014b). Sunflower. A. Pratap. (Ed) Alien Gene Transfer in Crop Plants, Vol. 2. Springer Press. 281-315.

HARMFUL ORGANISMS OF GRAIN AS POTENTIAL RISKS TO HUMAN HEALTH

Vesna ĐUROVIĆ¹, Snežana TANASKOVIĆ^{1*}, Dragutin A. ĐUKIĆ¹, Leka MANDIĆ¹, Desimir KNEŽEVIĆ²

¹University of Kragujevac, Faculty of Agronomy, Cara Dušana 34, Čačak, Serbia

²University of Pristina, Faculty of Agriculture, Kosovska Mitrovica-Lešak, Kopaonička bb, Kosovo and Metohija, Serbia

*Corresponding author: stanasko@kg.ac.rs

Abstract

One of the main imperatives of agriculture and processing industry is the production of safe food of high nutritional quality free of biological, physical and chemical contaminants. Cereals are an essential part of human nutrition. Microorganism represents permanent microflora elements of cereals and fruits. The most frequent moulds are *Aspergillus*, *Penicillium*, *Fusarium*, *Claviceps* and *Alternaria*. Some of them biosynthesizes and excrete mycotoxins (aflatoxins, ochratoxins, sterigmatocystin, zearalenone, fumonisin, deoxynivalenol, ergot alkaloids). Data testify that about 25% of the total world production of grain is contaminated with at least one mycotoxin. Among the raw materials that are usually contaminated with mycotoxins are cereals, maize, oilseeds, dry and stone fruits. Mycotoxins in humans and animals cause mycotoxicosis and manifest mutagenic, teratogenic, embryo-toxic, hepatogenic, nephrotoxic, dermatogenic and carcinogenic effect. Stored products are also attacked by storage pests. The most important insect storage pests are *Sytophilus granaries*, *Rhyzopertha dominica*, *Tribolium* sp., *Pyralis farinalis*, *Sitotriga cerealella*, *Plodia interpuctella*, *Ephestia kuehniella* and *Tinea granella*. Contamination by insects, their metabolites and excrements reduces the quality of the food and makes it unsuitable for consumption. Many insect species are hosts and vectors of pathogens of man and/or animals. Carcinogenic and teratogenic substances are produced only by *Tribolium* sp. Professional exposure to the infested dust of grains is associated with changes in the type of allergic conjunctivitis, dermatitis or asthma. From rodents as storage pests and vectors of infectious diseases emphasize *Ratus norvegicus*, *Mus musculus* and *Rattus rattus*. Contaminants of food are global problem, they cause economic damage and have a negative impact on food and feed i.e. human and animal's health.

Keywords: *mycotoxins, insects, health risks.*

Safe food means good health

Imperative of agriculture and processing industry is the production of safe food of high nutritional quality without the biological, physical and chemical contaminants. For secure safe final product is very important production and quality of raw materials i.e. "from farm to fork". Cereals and cereal products are very present in the nutrition of humans and animals (Perši *et al.*, 2011). It is necessary to minimize the presence of contaminants in grain weight. Permanent companions of grain and grain mass are microorganisms. Contamination by microorganisms and their metabolites occurs in the fields, during the harvest, then during transport and storage (Coffey *et al.*, 2009). They pose a major problem especially expressed during the rainy weather (Pepeljnjak *et al.*, 2008; Mitak *et al.*, 2011).

Fungi and mycotoxins as a serious danger

Fungi are ubiquitous plant pathogens that are major spoilage agents of foods and feedstuffs. The infection of plants by various fungi in the same time having results in reduction in crop yield and quality with significant economic losses. Also the fungi contribute contamination of grains with poisonous fungal secondary metabolites called mycotoxins. The ingestion of such mycotoxin contaminated grains by animals and humans has enormous public health significance. These toxins can cause diseases in human and animals (Makun, 2013). The disease produced by mycotoxins is termed as "mycotoxicosis" (Pal, 2007). Acute mycotoxicoses can cause serious and sometimes fatal diseases. The possibility of mycotoxin intoxication should be considered when an acute disease occurs in several persons when there is no evidence of infection with a known etiological agent, and no improvement in the clinical picture following treatment. Most of the outbreaks of mycotoxicoses described are a consequence of the ingestion of food that is contaminated with mycotoxins. The thorough control of food quality, in both industrialized and developing countries, is therefore necessary to avoid such outbreaks (Pal, 2015). According to Ožegović and Pepeljnjak (1995) - the most common molds are of genus *Aspergillus*, *Penicillium*, *Fusarium*, *Claviceps* and *Alternaria* and they are classified into field molds (*Alternaria*, *Helminthosporium*, *Fusarium* and *Cladosporium*) and storage molds (*Penicillium* and *Aspergillus*). Species of the genus *Penicillium*, *Fusarium* and *Alternaria*, as well as teleomorph class Ascomycetes (*Aspergillus alliaceus*, *Aspergillus nidulans*, etc.) are most often cited as potential producers of mycotoxins (Samson *et al.*, 2004). *Aspergillus*, *Penicillium* and the *Eurotium* are "storage" fungi that develop within water activity (aw value) of 0.85 or lower, so that they can be isolated from spices, dried fruits, vegetables, sunflower seeds and similar products. Types from genus *Fusarium* and *Alternaria* are the "field" fungi and their development requires a higher moisture content in the substrate and lower temperature. These types are often found in/on grain cereals and cereal products (Kocić-Tanackov and Dimić, 2013). Mycotoxins are toxic byproducts (secondary metabolites) produced by fungi. Namely, aflatoxins, ochratoxin A, fumonisins, certain trichothecenes, and zearalenone are considered the most serious threat to human and animal health due to their carcinogenic potential of hepatogenic, teratogenic, and mutagenic effects (Pal, 2015).

Alternaria toxins biosynthesize different species of genus *Alternaria*, the frequent causal agents of plant diseases. These types of fungi are the main contaminants of wheat, sorghum, barley, sunflower, canola, tomatoes, apples, citrus fruits, olives (Desphande, 2002).

Zearalenone - zearalenone are like fumonisine derivatives polyketides. They are natural contaminants of harvested and stored grain and their derived products around the world (Kocić-Tanackov, 2004; Zinedine *et al.*, 2007; Weidenbörner, 2008; Rhyn and Zoller, 2003).

Sterigmatocystine (STC) is a secondary metabolite of some species of the genus *Aspergillus* and as the most important producer of this toxic metabolite is cited *A. versicolor* (Veršilovskis and De Saeger, 2010).

Aflatoxins are highly toxic coumarin derivatives mainly biosynthesized by *A. flavus* and *A. parasiticus*. The most important mycotoxins from this group are aflatoxins B1 (AB1), B2 (AB2), G1 (AG1), G2 (AG2), M1 (AM1) and M2 (AM2) (Samson *et al.*, 2004; Park *et al.*, 2000). These mycotoxins fungi biosynthesize in/on a number of substrates, such as oil seeds, cereals and their products, stone fruits, subtropical fruits, spices (Weidenbörner, 2008). Most often they are found in products that are not sufficiently dried after harvest or during storage at relatively high temperatures. From this group of mycotoxins AB1 is the strongest carcinogen, followed AG1, AM1 and AB2. At mammals aflatoxins cause acute aflatoxicosis, which are manifested primarily

through liver damage, although the kidneys, lungs and spleen may be damaged. AB1 is described as the strongest potential hepatocarcinogenic (Fink-Gremmels, 2008).

The high average temperatures and a long drought cause heat stress in plants, causing a plant contamination with fungi of the genus *Aspergillus*, especially in the period of flowering and tanning corn silk (Marsh *et al.*, 1984; Kocić-Tanackov *et al.*, 2013).

Fusarium growth often implies production of mycotoxins (e.g. trichothecenes, zearalenone, fumonisins, moniliformin, etc) which pose a threat to human or animal health (Krsmanović *et al.*, 2005).

One of the first known mycotoxicosis is ergotism. Ergotism was responsible for the deaths of thousands in medieval Europe (Duraković *et al.*, 2003; Diaz, 2005).

Ergot alkaloids are compounds produced as a toxic mixture of alkaloids in the sclerotia of species of *Claviceps*, which are common pathogens of various grass species. Modern methods of grain cleaning have significantly reduced ergotism as a human disease. However, it is still an important veterinary problem (Bennett and Klich, 2003).

The most important in the transmission of mycotoxins are grains because they consume humans and animals. It is assumed that even 25 to 40% of the world grains are contaminated with mycotoxins (Pittet, 1998; Peraica and Domijan, 2001, Surai *et al.*, 2008). Although there are more than 300 isolated mycotoxins (Betina, 1984), studies mainly refer to those who threaten the health of people, domestic animals and pets. In recent years numerous studies have been conducted on the impact of mycotoxins on human health and the emergence of certain diseases of unclear etiology. Since 1993, "World Health Organization International Agency for Research on Cancer" estimated potential carcinogenic and mutagenic effects of certain mycotoxins on humans (WHO-IARC, and WHOIARC 1993a, 1993b). Comprehensive negative effect on people (Peraica *et al.*, 1999) and animals (D'Mello and MacDonald, 1997) gave in their review articles.

Crop rotation (Jaime Garcia and Cotty, 2010) is one way to reduce the risk of contamination by molds and mycotoxins in the field. Also, the storage conditions after harvest are of great importance for the prevention of occurrence of mycotoxins. Sorting and drying kernels are important parameters to prevent subsequent contamination of grain mycotoxins (Jaime Garcia and Cotty, 2007; Birck *et al.*, 2006).

Insects as vectors of disease

Stored products of agricultural and animal origin are attacked by more than 600 species of beetle pests, 70 species of moths and about 355 species of mites causing quantitative and qualitative losses (Rajendran, 2002). Insect contamination in food commodities is an important quality control problem of concern for food industries. In industrialized countries like Canada and Australia there is zero tolerance for insects in food grains (White, 1995; Pheloung and Macbeth, 2002). The fact is that a reduction in quality and contamination of food by insects, their metabolites and excrements makes food unsuitable for human consumption. The most common insects as food contaminants negatively affect the quality of the food itself, but also on human health (Orris and Whitehead, 2000). Insects cause physical, chemical and microbiological contamination of products in warehouses. Physical contamination represent occurrence of different parts of the insect body or insect stage (eggs, larvae, exuviae or excrements). Many insect species in warehouses are hosts and vectors of pathogens of man and/or animals. In that way become leading agents in microbial contamination of stored food products (Olsen, 1998). The most common contaminants are the insects with hidden development - within the stored grains such as *Rhyzopertha sp.* and *Sitophilus sp.* (Tanasković *et al.*). *Sitophilus oryzae* (L.), *S. granaries* (L.) or *Rhyzopertha dominica* (F.) are the main source of physical contamination in

flour (Pedersen, 1992; Perez-Mendoza *et al.*, 2003). The major storage pests of milled rice are *Sitophilus spp.* and *Tribolium castaneum*, with *Corcyra cephalonica*, *Ephestia kuehniella*, *Rhyzopertha dominica* and some other secondary pests causing minor damage (Sidik *et al.*, 1985). Carcinogenic and teratogenic substances are produced only by *Tribolium spp.* (El-Mofty *et al.*, 1989, 1992). Namely, in secretion of these species (*T. castaneum*) were identified 13 different quinone (Howard, 1987). These ingredients give an unpleasant flavor in storage products and at some small vertebrates can cause cancer of the liver and spleen (El-Mofty *et al.*, 1988; 1989; 1992). Although quinones may endanger the health of animals for experiments, the level of contamination *T. castaneum* in warehouses of finished products is low or normal, however cumulation quinone may endanger human health (Hodges *et al.*, 1996). Insects of ranks Blattodea, Coleoptera, Lepidoptera and Psocoptera can cause allergic reactions in humans. Sources of allergies are body parts or secretions of insects and mites. Continuous exposure to insects and mites can cause occupational diseases in farmers, millers and bakers (Revsbech and Dueholm, 1990). Exposure of infested grain dust is associated with a number of allergic reactions to a type of conjunctivitis, rhinitis, dermatitis, and asthma (Jeebhay *et al.*, 2001).

Rodents attacks for humans and animals health

Since the Middle Ages is known that rodents can contribute to human disease, as black rats were associated with distribution of plague. However, also in modern times rodents form a threat for public health (Meerburg *et al.*, 2009). Rodent-related problems exist in public health due to their role as vectors and reservoirs for bacterial diseases such as leptospirosis, murine typhus and salmonellosis, in addition to plague. As humans and livestock are in regular contact with rodents, the potential for transmission of zoonotic diseases is high (Gratz, 1994; Webster and Macdonald, 1995). Because of their adaptable characteristics, types of commensal rodents, house mouse (*Mus musculus*) and the brown rat (*Rattus norvegicus*) have adapted to the conditions of storage areas, which are easily accessible shelters and food (Vukša, 2010). Except with their nutrition, rodents contaminate up to nine times more food than they need for food with their feces, urine, hair, and many other impurities (Drummond, 2001; Brown *et al.*, 2007).

Detection of contaminants

Mycotoxins in feeds, milk, urine, blood, bile, and faeces can be detected by several techniques such as TLC, GLC, HPCL, ELISA, RIA, and RFLP (Pal, 2015).

To identify a physical contamination by insects may be used flotation fragments, immunochemical methods (ELISA), molecular methods (PCR) and infrared spectroscopy - NIRS (Perez-Mendoza *et al.*, 2005).

Acknowledgement

This work is part of Projects TR 31092 and TR 31057 financed by Ministry of education, science and technological development.

References

- Bennett J. W., and Klich M. (2003). Mycotoxins, Clin. Microbial. Rev. July 2003, vol. 16. no. 3 497-516 1 American society for microbiology.
- Betina V. (1984). Biological effects of mycotoxins. In: V. Betina, Editor, Mycotoxins- Production, Isolation, Separation and Purification, Elsevier, Amsterdam, The Netherlands, 25–36.

- Birck N. M. M., Lorini I., Scussel V.M. (2006). Fungus and mycotoxins in wheat grain at post harvest, 9th International Working Conference on Stored Product Protection, Brazil, PS2-12 – 6281, pp. 195–205.
- Brown P. R., Huth N. I., Banks P. B. and Singleton G. R. (2007): Relationship between abundance of rodents and damage to agricultural crops. *Agriculture Ecosystems & Environment*, 120: 405-415.
- Coffey R., Lummins E., Ward S. (2009). Exposure assessment of mycotoxins in dairy milk. *Food control* 20, 239–249.
- Cotty P. J., Jaime-Garcia R. (2007). Influences of climate on aflatoxin producing fungi and aflatoxin contamination, *Int. J. Food Microbiol.* 119, 109–115.
- Desphande S.S. (2002). *Handbook of Food Toxicology: Fungal Toxins*, Marcel Dekker Inc., New York, pp. 387—456.
- Diaz D. (2005). *The Mycotoxin Blue Book*, Nottingham University Press, Nottingham
- D'Mello J. P. F., MacDonald A. M. C. (1997). Mycotoxins. *Anim. Feed Sci. Technol.* 69, 155–166.
- Duraković S., Duraković L. (2003). *Mikologija u biotehnologiji*. Kugler, Zagreb
- Drummond D. C. (2001): Rodents and biodeterioration. *International Biodeterioration & Biodegradation*, 48: 105-111.
- El-Mofty M. M., Khudoley V. V., Sakr S. A., Fatala N. G. (1992). Flour infested with *Tribolium castaneum*, biscuits made of this flour, and 1, C benzoquinone induce neoplastic lesions in Swiss albino mice. *Nutrition and Cancer* 17, 97-104.
- El-Mofty M. M., Sakr S. A., Osman, S. I., Toulan B. A. (1989). Carcinogenic effect of biscuits made of flour infested with *Tribolium castaneum* in *Bufo regularis*. *Oncology* 46, 63-65.
- El-Mofty, M. M., Osman S. I., Sakr S. A., Toulan B. A. (1988). Carcinogenicity of flour infested by *Tribolium castaneum* using Egyptian toad *Bufo regularis* as a biological test. *Oncology* 45, 65-67.
- Fink-Gremmels, J. (2008). The role of mycotoxins in the health and performance of dairy cows. *The Veterinary journal* (1): 84-92 <http://dx.doi.org/10.1016/j.tvjl.2007.12.034>
- Gratz N.G.(1994): Rodents as carriers of disease, in Rodent pests and their control, Buckle, AP, and Smith, RH, Eds, Oxford, CAB International, 85.
- Hodges R. J., Robinson R., Hall D. R. (1996): Quinone contamination of dehusked rice by *Tribolium castaneum* (Herbst) (Coleoptera: Bostrichidae). *Journal of Stored Products Research* 32, 31-37.
- Howard R. W. (1987). Chemosynthetic studies of the Triboliini (Coleoptera; Tenebrionidae): phylogenetic inferences from the defensive chemicals of eight *Tribolium* spp., *Palorus ratzeburgi*, and *Latheticus oryzae*. *Annals of the Entomological Society of America* 80, 389-405.
- Jaime-Garcia R., Cotty P. J. (2010). Crop rotation and soil temperature influence the community structure of *Aspergillus flavus* in soil, *Soil Biol. Biochem.* 42, 1842—1847.
- Jeebhay M.F., Robins T.G., Lehrer S.B., Lopata A.L. (2001). Occupational seafood allergy: a review. *Occup. Environ Med.* 58, 553-562.
- Kocić-Tanackov S. (2004). Rast toksigenih *Fusarium* vrsta i sinteza zearalenona u ječmu namenjenom proizvodnji pivskog slada, Magistarska teza, Tehnološki fakultet, Univerzitet u Novom Sadu.
- Kocić-Tanackov S. D., Dimić G. R. (2013). Gljive i mikotoksini – kontaminanti hrane, *Hem. Ind.* 67 (4) 639–653 (2013) doi: 10.2298/HEMIND120927108K ,UDK 579.67:543:616.

- Krsmanović V., Klapac T., Velić N., Milaković Z. (2005). Contamination of malt barley and wheat by *Fusarium graminearum* and *Fusarium culmorum* from the crop years 2001–2003 in eastern Croatia: Microbiological Research, Volume 160, Issue 4, Pages 353–359.
- Lević J. T., (2008). Vrste roda *Fusarium*, Institut za kukuruz “Zemun Polje” i Društvo genetičara Srbije, Cicero, Beograd.
- Makun H.A., Atanda O., Foluwabamiwo., Ogara M.I., Idahor K.O., Eshiett M.E., Edema M., (2013). Fungal and mycotoxin contamination of nigerian foods and feeds, publisher Intech Open access Publisher.
- Marsh S. F., Payne G. A. (1984). Preharvest infections of Corn silks and kernels by *Aspergillus flavus*, *Phytopathology* 74, 1284–1289.
- Meerburg B. G., Singleton G. R., Kijlstra A. (2009): Rodent-borne diseases and their risks for public health, *Critical Reviews in Microbiology*; 35(3): 221–270 REVIEW ARTICLE.
- Mitak M., Pleadin J., Perši N., Vulić A., Zadarvec M. (2011). Mikotoksini u krmnim sirovinama i smjesama tijekom 2009. i 2010. godine. *Vet. stn.* 42, 139-145.
- Olsen A.R. (1998). Regulatory action criteria for filth and other extraneous materials II. Allergenic Mites: An emerging food safety issue. *Regulatory toxicology and farmacology* 28, 190-198.
- Orris G.D., Whitehead A.J. (2000): Hazard analysis and critical control point (HACCP) as a part of an overall quality assurance system in international trade. *Food Control* 11, 345-351.
- Ožegović L., Pepeljnjak S. (1995). Mikotoksikoze. Školska knjiga. Zagreb.
- Pal M. (2007): *Veterinary and Medical Mycology*. Indian Council of Agricultural Research, New Delhi, India. Pp. 266-271.
- Pal M., Gizaw F., Abera F., Kumar Shukla P., Hazarika R. A. (2015). Mycotoxins: A Growing Concern to Human and Animal Health, *Beverage and food world - Vol. 42 - No. 5*.
- Park L. D., Ayala E. C., Guzman-Perez S. E., Lopez- Garcia R., Trujillo S., in: K. C. Winter Ed. (2000). *Food Toxicology: Microbial Toxins in Foods: Algal, Fungal and Bacterial*, CRC Pres, Boca Raton- London - Washington, pp.15–20.
- Pres, Fink-Gremmels, J. (2008). The role of mycotoxins in the health and performance of dairy cattle. *Vet. J.* 176:84-92. Boca Raton- London- Washington, pp. 15–20.
- Pedersen J.R. (1992). Insects: identification, damage, and detection. In: Sauer, D. B. (Ed.), *Storage of Cereal Grains and Their Products*. American Association of Cereal Chemists, St. Paul, MN, pp. 435-489.
- Pepeljnak S., Cvetnić Z., Šegović-Klarić M. (2008). Okratoksin i zearalenon: Kontaminacija žitarica i krmiva u Hrvatskoj (1977-2007) i utjecaj na zdravlje životinja i ljudi. *Krmiva* 3, 147-159.
- Peraica, M., Radić B., Lučić A., Pavlović M. (1999). Toxic effects of mycotoxins in humans. *Bull. World Health Org.* 77, 754–763.
- Peraica M., Domijan A.M. (2001): Contamination of food with mycotoxins and human health. *Arh. Hig. Rada Toksikol* 52, 23-35.
- Perez-Mendoza J., Throne J. E., Maghirang E. B., Dowell F. E., Baker J. E. (2005). Insect fragments in flour: relationship to lesser grain borer (Coleoptera: Bostrichidae) Infestation level in wheat and rapid detection using nearinfrared spectroscopy. *J. Econ. Entomology* 98, 2282-2291.
- Perši N., Pleadin J., Vulić A., Zadravec M., Mitak M. (2011): Mikotoksini u žitaricama i hrani životinjskog podrijetla, *Veterinarska stanica* 42 (4), 327-334.
- Pheloung P., Macbeth F. (2002). Export inspection: adding value to Australia’s grain. In: Wright, E.J., Banks, H.J., Highley, E. (Eds.), *Stored Grain in Australia 2000*. Proceedings of the

Australian Postharvest Technical Conference, Adelaide, 1–4 August 2000. CSIRO Stored Grain Research Laboratory, Canberra, Australia, pp. 15-17. Mycotoxin and Food Safety in Developing Countries, Edited by Hussaini Anthony Makun, (2013) p. cm. ISBN 978-953-51-1096.

- Pittet, A. (1998). Natural occurrence of mycotoxins in foods and feeds – an updated review. *Rev. Med. Vet.* 149, 479-492.
- Rajendran S. (2002). Postharvest pest losses. In: Pimentel, D. (Ed.), *Encyclopedia of Pest Management*. Marcel Dekker, Inc., New York, pp. 654–656.
- Revsbech P., Dueholm, M. (1990). Storage mite allergy among bakers. *Allergy* 45, 204-208.
- Rhyn P., Zoller P. (2003). Zearalenone in cereals for human nutrition: relevant data for the Swiss population, *Eur. Food Res. Technol.* 216 (316–322).
- Samson A.R., Hoekstra S. E., Frisvad C.J. (2004). *Introduction to Food-and Airborne Fungi*, Centraalbureau voor Schimmelcultures, Utrecht.
- Sidik M., Halid H., and pranata R.I. (1985). Pest problems and the use of pesticides in grain storage in Indonesia, *ACIR proceedings No 14*, 37-43.
- Soekarna et al. (1977). Recorded four species of rodents associated with stored products: *Rattus norvegicus*, *Mus musculus*, *Rattus rattus diardii*, and *Suncus murinus*. Rodent infestation of stored rice usually occurs when food becomes short in the surrounding fields.
- Surai P.F., Mezes S.D., Melnichuk S.D., Fotina T.I. (2008): Mycotoxins and animal health: From oxidative stress to gene expression. *Krmiva* 50, 35-43.
- Tanasković S., Solujić S., Pešić S., Inđić D., Zatežić Z. (2011): Insekti kao biokontaminanti hrane i alergeni. XVI Savetovanje o biotehnologiji; organizator: Univerzitet u Kragujevcu, Agronomski fakultet Čačak; Zbornik radova, vol.16, br.18, 417-422, Čačak; ISBN978-86-87611-15-3. CIP-63(082)60(082). [in Serbian]
- Veršilovskis A., De Saeger S., (2010). Sterigmatocystin: Occurrence in foodstuffs and analytical methods – An overview, *Mol. Nutr. Food Res.* 54, 136–147.
- Vukša M., Đedović S., Jokić G., Elezović I., Stojnić B. (2010): Zaštita uskladištenog žita od štetnih glodara primenom hlorofinona. *Pestic. Phytomed.* (Belgrade), 25(4), 343-347 Scientific paper DOI: 10.2298/PIF1004343V UDC: 632.934:632.958. [in Serbian]
- Webster J. P., Macdonald DW. (1995) :Parasites of wild brown rats (*Rattus norvegicus*) on UK farms, *Parasitol*, 111, 247.
- Weidenbörner M. (2008). *Mycotoxins in Foodstuffs*, Springer Science+Business Media, LLC, New York.
- White N.D.G. (1995). Insects, mites and insecticides in stored-grain ecosystems. In: Jayas, P., White, N.D.G., Muir, W.E. (Eds.), *Stored- Grain Ecosystems*. Marcel-Dekker, New York, pp. 123–167.
- WHO-IARC (1993a). World Health Organization International Agency for Research on Cancer (IARC), Toxins derived from *Fusarium moniliforme*: fumonisins B1 and B2 and fusarin C. IARC Monographs on the Evaluation of Carcinogenic Risks to Humans 56, 445–462.
- WHO-IARC (1993b). World Health Organization International Agency for Research on Cancer (IARC), IARC Monographs on the Evaluation of Carcinogenic Risks to Humans.
- Zinedine A., Soriano J.M. Molto J.C., Manes J. (2007): Review on the toxicity, occurrence, metabolism, detoxification, regulations and intake of zearalenone: an oestrogenic mycotoxin, *Food Chem. Toxicol.* 45 1–18.

EFFECTS OF MODIFIED ATMOSPHERE CONDITIONS ON BETA CAROTENE AND ANTHOCYANIN CONTENTS OF *ARBUTUS UNEDO* L. FRUITS

Neslihan EKINCI¹, Fatma AYDIN², Murat ŞEKER³

¹Çanakkale Onsekiz Mart University, Lapseki Vocational School, Çanakkale, Turkey

²Çanakkale Onsekiz Mart University, Faculty of Science and Art, Department of Chemistry, Çanakkale, Turkey

³Şırnak University, Faculty of Agriculture, Department of Horticulture, Şırnak, Turkey

*Corresponding author: nekinci@comu.edu.tr

Abstract

The fruits of strawberry tree (*Arbutus unedo* L.) species contain a higher amount of nutrients and bioactive compounds and a good source of antioxidants compared to many other cultivated species. *Arbutus* fruits are also good sources of beta carotenes and anthocyanines. However, consumption of those fruits is currently not widespread. This research was aimed to determine cold storage conditions for *A. unedo* berries and to prolong its shelf-life in the market and also to increase its use in the pharmaceutical industry. For this purpose, *Arbutus* fruits were collected from Şevketiye village of Lapseki sub-province of Çanakkale province (40°23' N, 26°52' E) at 92 m above sea level, which is located in the Northwestern part of Turkey in December 2010. The fruits were stored for 14 days at 0 °C and 90% relative humidity at modified atmosphere packaging (MAP) and normal atmosphere (NA) conditions. The β-carotene and anthocyanine contents of the fruits were determined in 7 days interval. The fruits were kept at 20 °C plus 2 days for shelf life at the end of the storage experiments. In this study, we presented the β-carotene content at initial day, 7th day, 14th day and plus 2 days at 20 °C modified atmosphere (MA) (85.00, 83.00, 78.00, 67.00 mg/100 g, respectively), and control fruits, (85.00, 80.10, 67.03, 55.78 mg/100 g, respectively). Anthocyanine contents were as follows; under MA conditions (37.00, 39.08, 29.76, 54.89 mg/100 g, respectively), and control fruits (37.00, 48.71, 44.84, 43.20 mg/100 g, respectively). Storage conditions are very important for fresh *A. unedo* fruits. MA packaging material preserved the physicochemical characteristics and sensory quality of the fruits during the storage period especially at 0 °C. However, unpackaged (control) *Arbutus* fruits were stored for only 7 days under NA conditions, and 14 days under MA conditions due to significant changes in their physical and sensory properties. Keeping fruits further at plus 2 days at 20 °C conditions did not yield any positive results, especially with the MA conditions. MAP should only be implemented under cold storage to best keep of the *A. unedo* fruits.

Key words: strawberry tree, *Arbutus unedo*, anthocyanins, β-carotene, MAP- Cold Storage Conditions

Introduction

In Turkey, important studies have been carried out to select the *Arbutus* genotypes for superior fruit quality from the Northwestern part of Turkey, as well as to prevent extinction and to allow extensive cultivation of the strawberry trees (Celikel *et al.*, 2008). Some researchers investigated the nutritional properties of fresh strawberry fruits (Ozcan and Haciosrefogulları 2007; Şeker and Toplu, 2013).

The strawberry tree (*Arbutus unedo* L.) belongs to the family Ericaceae, is an evergreen shrub or small tree, typical of the Mediterranean fringe and climate, and it is widely distributed in the

Mediterranean region and North Africa. In Turkey, *Arbutus* trees grow wildly especially in the Mediterranean region and it is found to grow on dry rocky slopes and hillsides, or in pine forests, particularly in the Taurus Mountains (Papoff *et al.*, 1993; Ayaz *et al.*, 2000; Barros *et al.*, 2010). Strawberry tree fruits are suitable for the production of alcoholic beverages, jams, jellies and marmalades (Alarcao-e-Silva *et al.*, 2001; Pallauf *et al.*, 2008). The fruits are frequently used in traditional medicine in some countries, such as Spain and Morocco (Tahraoui *et al.*, 2007). In several Portuguese regions, the fruits are eaten raw or made into liqueurs, as well as bark or roots decoctions, which are used as anti-inflammatory, laxatives, carminatives, digestives, odontalgics and cardiotonics (Barros *et al.*, 2010). Recently, important studies have been carried out to select the *Arbutus* genotypes for superior fruit quality from the Northwestern part of Turkey, and thus to prevent extinction and to allow extensive cultivation of the strawberry trees (Çelikel *et al.*, 2008). Fruits are an important part of human diet. They provide, not only the major dietary fibre component of our food, but also a range of micronutrients, including minerals, vitamins and antioxidant compounds, such as carotenoids and polyphenols. For example, carotenes act as a precursor for vitamin A, which can only be obtained from diet and which as an antioxidant, is known to play a role in the prevention of several diseases. Anthocyanines are the largest group of water-soluble pigments in the plant. Several studies have pointed out the anti-oxidant properties of anthocyanines and their positive role in our diet.

Postharvest practices such as modified atmosphere packaging (MAP) reduces undesirable physiological, chemical/biochemical and physical changes in foods, it controls microbial growth and it prevents product contamination. MAP extends the shelf-life of fresh fruits.

Arbutus fruits are highly perishable, non-climacteric and a short self-life. Loss of firmness, shriveled fruit surface, changing of fruit color, and development of decay are major problems shortening the shelf- life (Floros and Matsos, 2005).

The objective of this study was to determine cold storage conditions of *Arbutus* fruits, the effects of packaging materials (MAP) and during the storage on anthocyanine and β -carotene quality of *A. unedo* berries.

Material and Methods

Arbutus fruits were collected from Şevketiye village of Lapseki sub-province of Çanakkale province in Turkey (40°23' N, 26°52' E) at 92 m above sea level, which is located in the Northwestern part of Turkey in December 2010. The area has a subtropical climate conditions. The average annual rainfall is around 600 mm. August is the driest month. The mean temperature ranges from a minimum of -11.2 °C in February to a maximum of 39 °C in July according to long years data. Fully matured *Arbutus* fruits were harvested in fully red appearance period in November. The fruits were approximately 2.5 kg of freshly harvested fruits for each replication. The *Arbutus* berries were not selected for size, but reflected the typical size for the species. The experiment was established with four replications. The fruits were stored at normal atmosphere and modified atmosphere packaging (MAP) conditions for 14 days at 0 °C and 90% RH. The fruit anthocyanine and beta carotene content were determined in 7 days interval. The fruits were kept at 20 °C plus 2 days for shelf life at the end of storage experiment.

Quality analysis methods

Determination of total anthocyanine contents

Total anthocyanine content was measured with the pH differential absorbance method, as described by Cheng and Breen (1991), Gallik (2012). The absorbances were read at room temperature, using a Perkin-Elmer Win-Lab 25 UV-Vis spectrophotometer. Absorbance of the extracts were measured at 510 and 700 nm in potassium chloride buffer at pH 1.0 (hydrochloric acid-potassium chloride, 0.2 M) and sodium acetate buffer at pH 4.5 (acetic acid-sodium acetate, 1 M). The following equation was used for calculating the monomeric anthocyanine pigment concentration (C mg/L):

$$C(\text{mg/L}) = \left(A \times MW \times Df \times 1000 \right) / \left(\varepsilon \times l \right)$$

where A is absorbance = $[(A_{510} - A_{700})_{\text{pH } 1.0}] - [(A_{510} - A_{700})_{\text{pH } 4.5}]$; MW is the molecular weight for compound (cyanidin-3-glucoside = 449.2 g/mol; DF is the dilution factor; ε is the molar absorbance coefficient and l is the pathlength (1cm). The total monomeric anthocyanines content was expressed as cyanidin-3-glucoside equivalents (MW = 449.2 g/mol and $\varepsilon=26900$). Results were expressed as mg cyanidin-3-glucoside equivalents per 100 g fresh weight.

Determination of β -carotene

Total carotene content was determined using the modified method of Park (1987). Each analytical sample (Pulp, 30 g) added with %1 potassium hydroxide solution was extracted with a mixture of petroleum ether and ethanol (1:1, 25 mL). Celite was added in extract. The extracts were filtered through a Buchner funnel with Whatman No. 1 filter paper. The residue was re-extracted until it became colorless. The filtrates were combined in a separating funnel and washed with four times distilled water (15 mL). To remove the water in the petroleum ether solution, an amount of MgSO_4 (anhydrous) was added as desiccant. The petroleum ether phase was transferred to a volumetric flask. Spectra were collected in the range of 350-550 nm for each sample in petroleum ether as blank using Perkin-Elmer Win-Lab 25 UV-Vis spectrophotometer. The concentration of β -carotene in the solution was determined from the absorbance at 450 nm the standard curve for prepared β -carotene (Lichtenthaler and Buschmann 2001).

The following equation was used for calculating the carotenoid pigment concentration:

$$\text{Total carotenoid (mg/100g)} = \left(A \times Df \right) / \left(\varepsilon \times 1000 \right)$$

A is Absorption of extract, D_f is the dilution factor, ε is the molar absorbance coefficient and l is the pathlength (1 cm). The total content of carotenoids was expressed as β -carotene equivalents at 445 nm, by using $\varepsilon = 2370$.

Statistical Analysis

Data were evaluated in a two-way Anova analysis by using Minitab software (ver. 14).

Results and Discussion

The interest in berry fruits has increased worldwide because of their multiple health promoting phytochemicals. In addition to the usual nutrients, berry fruits are also rich in flavanols, anthocyanidins, proanthocyanidins, catechins, flavones, and glycosides. These components are capable of performing a number of antioxidant activity (Wang *et al.*, 2010).

Consumption of anthocyanins has been linked as protective agents against many chronic diseases, since several studies have shown that they provide powerful antioxidant, antiinflammatory and anticarcinogenic activities, and possess very strong antioxidant properties leading to a variety of health benefits (Welch *et al.*, 2008). It has long been known that plants containing colors are usually those that are of great benefit to human health. The absorption spectrum for 14th days is shown in Figure 1. As it can be seen, there are two different absorption peaks in the spectrum at pH 1.0 and 4.5 and all of them are identified as anthocyanins due to a variety of molecular transformations at the anthocyanidin system with pH changes (Fig. 1).

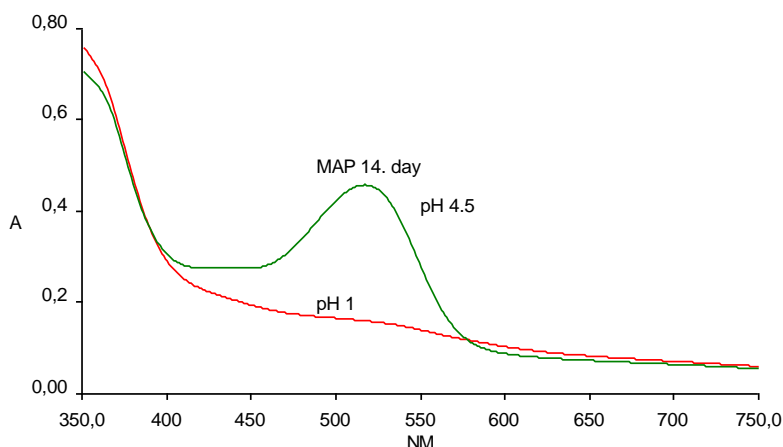
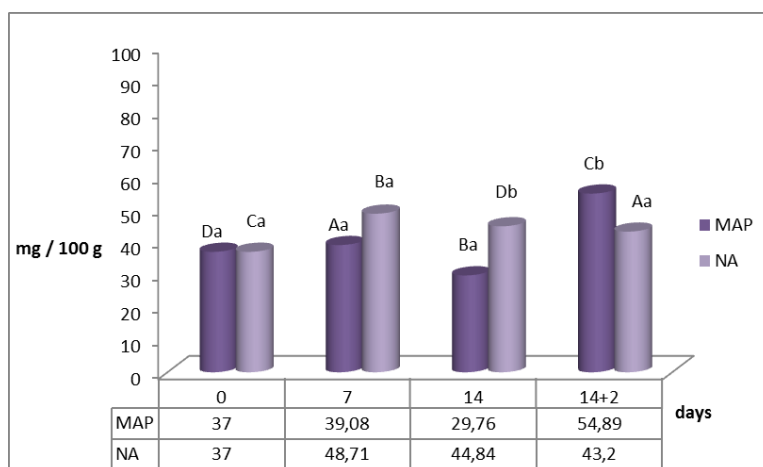

Fig 1. UV-Vis absorption spectrums for the anthocyanine profile of *Arbutus unedo* fruits at pH 1 and 4.5 on 14. days storage conditions.

The amount of quantitative of total calculated anthocyanine are found as 37.00, 48.71, 44.84, 43.20 mg/100 g (initial, day 7, day14 and day14+2 at NA) and 37.00, 39.08, 29.76, 54.89 mg/100 g (initial, day 7, day14 and day14+2 at MAP), respectively, at different store conditions (Fig. 2). According to data, It is seen that MAP conditions is observed to be better than NA condition due to humidity (wetness) values (Fig. 2).



** Means within columns not followed by the same small letter are significantly different at the $P < 0:01$ level by of application

Fig 2. Total anthocyanine content of *Arbutus unedo* fruits during the cold storage period Many factors, such like the pH, temperature, light, presence of other phenolic compounds, enzymes, metal ions, sugars, ascorbic acid, and oxygen have impact on the stability of

anthocyanins. In aqueous solution, carotenoids and anthocyanins to be coumarine derivatives undergo structural transformations that are pH-dependent. Therefore, processing and storage under low temperature can investigate to improve the stability (Rein, 2005).

As it can be seen at Figure 3, absorption of β -carotene in *Arbutus* berries observed as qualitative by UV-Vis spectral analysis. The β -carotene contents were determined from the standard curve for prepared β -carotene and found as 85, 83, 78, 67 mg/100 g (initial, 7th day, 14th day and 14+2nd day in MAP), respectively. 85.00, 80.10, 67.03, 55.78 mg/100 g (initial, 7th day, 14th day and 14+2nd day in NA) (Fig. 4).

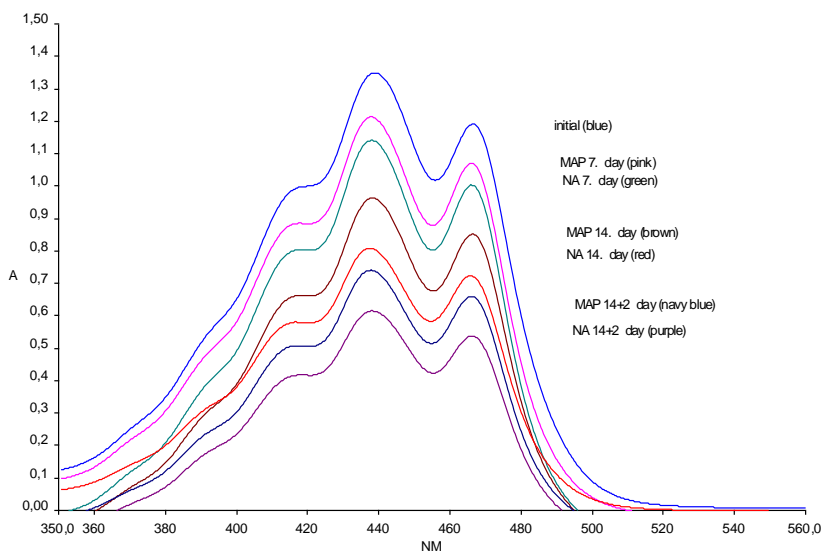
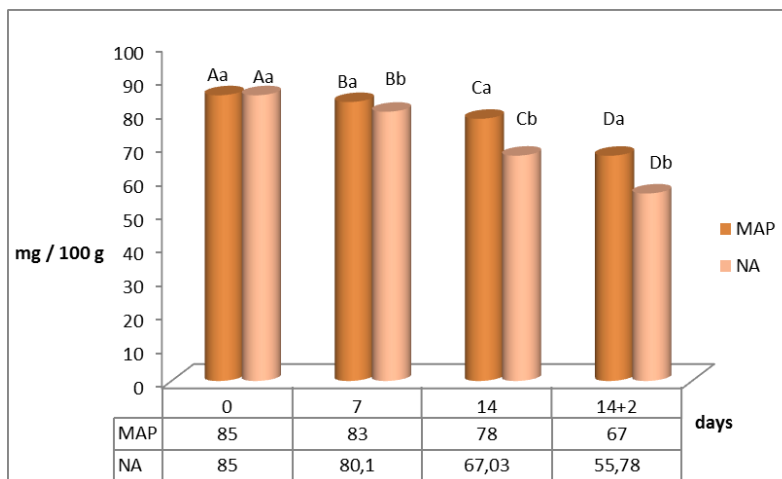

Fig 3. UV-Vis absorption spectrums for the carotene profile of *Arbutus unedo* fruits at initial, 7, 14 and 14+2 days according to MAP and NA storage conditions.



** Means within columns not followed by the same small letter are significantly different at the P <0:01 level by of application

Fig 4. UV-Vis absorption spectrums for the *Arbutus unedo* fruits during the cold storage period (0 °C)

More research is required to identify those storage conditions that will minimize nutrient and quality losses in these highly perishable products. The objective of our study was to assess a variety of *Arbutus unedo*, postharvest storage treatments including: modified atmosphere

packaging (MAP) and normal atmosphere (NA). Effects of packaging on β -carotene content investigated in *Arbutus* over 14-day storage at 0 °C. Relative to the initial level, total carotenoids were retained fully in MAP samples, but a dramatic loss (34%) in total carotenoid was observed in other NA treatments by 14+2 days. MAP resulted in the best retention of anthocyanin and β -carotene content on *Arbutus unedo* during post-harvest storage.

The data generally show that antioxidants and antioxidant capacity increase after harvest and can be sustained during low temperature storage. However, the rapid decline in fruit quality after cold storage is reflected in a loss in these properties. This suggests that as well as a need to prolong storage life, maintaining shelf-life quality should be a major target in developing this fruit as a commercial crop.

Conclusion

To our knowledge, there is no published article on *Arbutus* storage by using NA and MAP treatments. So, this study is particularly important for obtaining preliminary results of different storage treatments on *Arbutus* berries. MA packaging effectively reduced mass loss during the storage period. MA packaging material preserved the physicochemical characteristic and sensory quality during the storage period especially at 0 °C. However, unpackaged (NA) *Arbutus* fruits can be conserved for only 7 days due to significant changes in physical and sensory properties. However MAP has provided always better performance and extent twice the storage period. Therefore, suggested of *Arbutus* fruits were 7 days for control fruit and 14 days for MA treatments. Plus 2 days 20 °C, so dangerous for MA treatments. Those results could be used for fresh *Arbutus* berry storage especially for food and pharmaceutical drug industries.

References

- Alarcao-e-Silva M., AEB. Leitao, HG. Azinheira and MCA. Leiato. (2001). The arbutus berry: studies on its color and chemical characteristics at two mature stages. *Journal of Food Comp. Anal.* 14(1):27-35.
- Ayaz, F.A., M. Kucukislamoglu, M. Reunanen. (2000). Sugar, non-volatile and phenolic acids composition of strawberry tree (*Arbutus unedo* L. var. *ellipsoidea*) fruits. *J. Food Compos. Anal.* 13:171-177.
- Barros, L., AM. Carvalho, J. Sá Morais, ICFR. Ferreira. (2010). Strawberry-tree, blackthorn, and rose fruits: Detailed characterisation in nutrients and phytochemicals with antioxidant properties. *Food Chem.* 120:247-254.
- Cheng, G. W., Breen, P. J. (1991). Activity of phenylalanine ammonia-lyase (PAL) and concentrations of anthocyanins and phenolics in developing strawberry fruit. *Journal of the American Society of Horticultural Science*, 116, 865-869.
- Çelikel G, L. Demirsoy, H. Demirsoy.(2008). The strawberry tree (*Arbutus unedo* L.) selection in Turkey. *Sci. Hortic. Amsterdam* 118:115-119.
- Floros, J.D., K.I. Matsos.(2005). Introduction to modified atmosphere packaging. *Innovations in Food Packaging*. J. Han. New York, USA, Elsevier academic press, ISBN 0-12-311632-5, pp.159-172.
- Gallik, S. (2012). Determination of the anthocyanin concentration in table wines and fruit juices using visible light spectrophotometry. *Cell Biology*, 2:1-12.
- Ozcan, M.M., Haciseferogullari H.(2007). The strawberry (*Arbutus unedo* L.) fruits: Chemical composition, physical properties and mineral contents. *J. Food Engineering*, 78, 1022–1028.

- Lichtenthaler, H.K., Buschmann, C.(2001). Chlorophylls and Carotenoids: Measurement and Characterization by UV-VIS Spectroscopy. Current protocols in Food Analytical Chemistry. DOI: 10.1002/0471142913.faf0403s01.
- Pallauf K., J.C. Rivas-Gonzalo, M.D. Castillo, M.P. Cano, S. Pascual-Teresa.(2008). Characterization of the antioxidant composition of strawberry tree (*Arbutus unedo* L.) fruits. J. Food Compos. Anal. 21:273-281.
- Papoff CM, I. Floris, V. Vacca and G. Langiu. (1993). Dehydrating strawberry tree (*Arbutus unedo*) honey in a small dehumidifier. Apicoltore Moderno 84(3):97-103.
- Park, Y.W. (1987). Effect of Freezing, Thawing, Drying, and Cooking on Carotene retention in Carrots, Broccoli and Spinach. Journal of Food Science. Volume 52, Issue 4, pages 1022-1025.
- Rein, M. (2005). Copigmentation reactions and color stability of berry anthocyanins. University of Helsinki, Department of Applied Chemistry and Microbiology, Helsinki (PhD. Thesis).
- Şeker M. and C. Toplu. 2010. Determination and Comparison of Chemical Characteristics of *Arbutus unedo* L. and *Arbutus andrachnae* L. (fam: Ericaceae) Fruits. *Journal of Medicinal Food*, 13(4): 1013-1018
- Tahraoui A., J. El-Hilali, ZH. Israili, B. Lyoussi. (2007). Ethnopharmacological survey of plants used in the traditional treatment of hypertension and diabetes in the south-eastern Morocco (Errachidia province).
- Wang S.Y. (2010). Correlation of antioxidants and antioxidant enzymes to oxygen radical scavenging activities in berries. Berries and cancer prevention. Part 2, 79–97, DOI: 10.1007/978-1--4419-7554-6-4.
- Welch, C., Wu Q., & Simon J. (2008). Recent advances in anthocyanin analysis and characterization. *Current Analytical Chemistry* 4(2): 75–101.

THE CITRUS SANITATION PROGRAM IN TUNISIA

Asma NAJAR^{1*}, Kaouther BEN MAHMOUD¹, Nebiha METOUI², Emna JEDIDI¹, Rachida GHEZAL¹, Ahmed JEMMALI¹

¹Department of Plant Protection, National Institute of Agronomic Research of Tunisia, Ariana, Tunisia

²Technical Center of Citrus, Tunisia

*Corresponding author: asmanajara@yahoo.fr

Abstract

The total citrus growing area in Tunisia is about 24,000 ha mainly located in Cap Bon (Northwest region) with an average yield ranging from 15 to 18 tons/ha. This yield decrease is mainly attributed to biotic constraints. From these, viral diseases are known to seriously reduce the potential of the most cultivars. In fact, almost all of citrus trees in Tunisia are infected with one or more virus and virus-like diseases which induce high economic losses. The establishment of Citrus Sanitation Program was needed to solve this problem.

A National Virus Free Citrus Program was initiated in 1992. Selected trees of the commercially important varieties of sweet orange, clementine and lemon were indexed for several viruses, stubborn and viroids and subjected to shoot tip grafting and re-indexed. These virus free mother plants served as a starting foundation block that was enriched in 1996 by other varieties imported from the French Citrus Variety Improvement Program (National Institute of Agricultural Research of Corsica) in order to extend the list of marketed varieties. Actually, there are around 45 varieties in the foundation block. The pre-basic material increased from the mother plants was used for the multiplication of the basic material in 29 Citrus nurseries.

Keywords: *Citrus, Sanitation program, virus, Tunisia.*

Introduction

Citrus crop is an important agriculture activity in Tunisia. It covers 24 thousands hectares with 6.4 millions trees mainly located in Cap-Bon region (in the Northern east of Tunisia) that is characterized by its favorable climate for citrus cultivation (DGPA, 2014). Unfortunately, the level of citrus production remains low compared with the other citrus-producing countries. This low production is mainly related to viral infections of the nursery plants that were not subjected to any sanitation control. Indeed, these infections affected the source plant material belonging to the INRAT (Tunisian National Institute of Agronomic Research) collection located in Cap-Bon and the national foundation block installed in Sbikha (Central west of Tunisia) since 1974-1976. Propagation by grafting allowed large dissemination of graft-transmissible diseases caused by viruses, viroids or other pathogens. Vectors and farming practices also contributed to the spread of these diseases. Among these, concave gum, blind pocket and *impietratura* were frequently encountered in old citrus orchards and citrus psorosis virus was identified on Clementine (32%), Valentinia late (23%), Maltese orange (20%) and lemon (4%) (Khlijet *al.*, 2004). Infections with viroids such as *Citrus exocortis viroid*, *Citrus bent leaf viroid*, *Hop stunt viroid*, *Citrus dwarfing viroid* and *Citrus bark cracking viroid* have also been identified with respective infection rates 68%, 33%, 68%, 81% and 3% (Najar and Duran-Vila, 2004). Stubborn disease was identified since 1998 (Najar et al, 1998) but, no infection with citrus tristeza virus has been reported.

Regarding their incurability, virus and virus-like diseases need specific means for their eradication e.g. genetic resistance of rootstock-scion or *in vitro* techniques. These approaches constituted the best way for our national program based on the propagation of healthy and authentic source material. As a result, a national citrus conservatory has been installed since 1996 with virus free clones representing cultivars from the old INRAT collections and the newly introduced ones from INRA Corsica San Giuliano station.

This paper will report the main steps and the realized actions under auspices of the national program of citrus certification.

Material and methods

Practically, the real certification program started in 1992 with the aim to obtain virus-free budwood of all the major commercial citrus cultivars. It aimed to eliminate many viral diseases such as Citrus psorosis, Concave gum, blind pocket, *impietratura*, *Citrus exocortis viroid*, *Citrus bent leaf viroid*, *Hop stunt viroid*, *Citrus bark cracking viroid* and *Citrus dwarfing viroid*.

The citrus certification scheme in Tunisia is based on the same concepts as adopted in other citrus-producing countries in the world especially in Spain (Navarro, 1993) and Morocco (Zemzami, 2002).

Program design

Actions sequentially consisted in selecting, indexing cultivars, thermotherapy and *in vitro* shoot-tip grafting.

Initial foundation block

Because they were established in open and uncontrolled conditions, the initial foundation block (located in Sbikha region) and INRAT collections (located in Cap Bon region) are faced to all possible infections. In this field, two operations were made:

1. Selection of the best clones based on agronomic characters.
2. Indexing of these selected specimens for the following pathogens: tristeza, psorosis, concave gum, blind pocket, *impietratura*, citrus exocortis viroid, citrus bent leaf viroid, hop stunt viroid, Citrus bark cracking viroid and Citrus dwarfing viroid.

Indexing tests (biological, serological and molecular) revealed that these plants were infected by viral diseases. Then, they were subjected to sanitation techniques such as thermotherapy combined with shoots tip grafting. The shoot-tip grafted plants underwent re-indexing to verify their sanitary state. Healthy plants constituted a new foundation block.

New foundation block (mother plants)

The new foundation block, which consisted of 4 shoot-tip grafted plants onto sour orange rootstock and maintained under screen cover and indexed for the above mentioned diseases with trueness-to-type assessment.

Prebasic block (prebasic material)

It consisted of 12 potted trees propagated from the mother plants and maintained under screenhouse and indexed systematically for diseases as cited above.

Increase block (basic material)

It consisted of few hundred grafted on 2 types of rootstocks of trees propagated in the registered nurseries from the previous types of material and maintained for production of certified buds.

Certified nursery plants

It consisted in the production of certified plants using certified buds from basic material. They are inspected and tested at random.

Developed techniques

Indexing

Detection of graft-transmissible diseases of citrus is based primarily upon biological indexing, which is accomplished by grafting tissue of the budline onto citrus indicator seedlings. Specific indicator seedlings are used to detect specific diseases. Indicator varieties have been selected for sensitivity to diseases and ability to express symptoms. In each index, adequate positive controls, or disease-infected seedlings along with healthy control seedlings of each indicator variety, are held under the same environmental conditions as test seedlings. Controls are used as a comparison with the test source and also as confirmation that environmental conditions in the greenhouse are optimal for plant growth and symptom expression. Plant material is indexed with cedrat Etrog for viroids, Hamlin for virus-like disease (concave gum, blind pocket and *impietratura*) and Madame vinous for Stubborn disease.

Laboratory tests are also used for the disease diagnosis process. The enzyme linked immunosorbent assay (ELISA) is used for the detection of Tristeza using two types of antibodies: Spain monoclonal antibody 3DF1+3CA5 from Plant Print and a polyclonal antibody from Biroeba (Switzerland) and also for psorosis using monoclonal antibody from Agritest. Sequential polyacrylamide gel electrophoresis (sPAGE) (Iglío, 1983) and hybridization with specific probe (Palacio *et al.*, 2000) used for the detection of citrus viroids [(Citrus bent leaf viroid (CBLVd), Citrus exocortis viroid (CEVd), Hop stunt viroid (HSVd), Citrus dwarfing viroid (CDVc), Citrus bark cracking viroid (CBCVd)] and polymerase chain reaction (PCR) is used for the detection of stubborn (Bové, 1997). Pathogen detection or indexing occurs at different times and steps of the sanitation program. One small scale testing (pre-index) takes place at the time of introduction. The results of the pre-index indicate the need and type of therapy necessary (Navarro, 1993; Vidalakis *et al.*, 2010).

Thermotherapy and shoot-tip grafting

Thermotherapy or heat treatment is performed by taking buds from the infected budline and grafting them onto sour orange seedlings. The infected bud grafted onto each seedling is tightly and completely wrapped with budding tape so that the bud will not flush during thermaltherapy. The citrange seedlings, each with an infected bud grafted on it, are placed into a hot greenhouse with temperatures maintained at 28-40°C daytime and 25°C nighttime for preconditioning to high temperatures for 30 days. After that, the seedlings are placed into a controlled temperature chamber which is set for 16-hour days at 40°C and 8-hour nights set at 30°C. Plants are maintained in the thermotherapy chamber for a period of 3 months. Upon removal of the plants from the temperature chamber, the buds are unwrapped. The rootstock seedling is lopped over, and the top of the seedling is pushed into the potting soil such that the grafted bud will become the terminal bud. The plants are then placed in the greenhouse until sufficient budwood growth is produced from the grafted bud for further indexing. This method is effective against most citrus viruses; however, is not effective against viroids.

Shoot-tip-micrografting is the other form of disease clean-up therapy (Navarro *et al.*, 1975). This method has proven effective in recovering citrus cultivars free of tristeza, psorosis, concave gum,

exocortis pathogens (Roistacheret *al.*, 1976; Navarro *et al.*, 1975) and the resulting virus-free plants were shown to be non juvenile, and available for budwood increase in less than one year after *in vitro* grafting. The young growing flushes on field trees are used as the source of shoot tips, which are excised and grafted *in vitro* to appropriate rootstock seedlings, following the procedure of Navarro *et al.* (1975). Shoot tips are composed of the apical meristem plus two to three leaf primordia and measure 0.1 to 0.2 mm in height. A minimum of ten *in vitro* grafted plants are retained for growth, transplanting to soil, and subsequent indexing. Ten plants appear sufficient to assure at least one pathogen-free tree (Roistacheret *al.*, 1976).

Results and discussion

Varieties belonging the INRAT collection

Indexing tests (biological, serological and molecular), carried out on all cultivars belonging to INRAT and Sbikha collections, revealed that they were infected at least by one viral disease. Infected plants were subjected to thermotherapy and shoot tip grafting for sanitation. Shoot tip grafted plants underwent a re-indexing and healthy ones are maintained as replicates in the conservation repository under screenhouse. After assessing the trueness-to-type, the budwood is collected to produce mother block material (table 1). The prebasic material consisting of 12 plants from each mother tree grafted on sour orange rootstock, are planted in 40 L plastic containers and kept in a screenhouse. The basic material is propagated from the above materials grafted on two different rootstocks (Sour orange and *Citrangecarrizo*) under similar insect-proof conditions and used for production of certified budwood.

Table 1. Certified citrus varieties from INRAT collections and national foundation block of Sbikha

Varieties	Mother plants number	Pre-basic plants number
Washington navel	12	48
ClémentinierCassar	7	28
Maltaise demi-sanguine	7	28
Maltaisedouce	5	20
Maltaise blonde	2	8
Maltaisebarlerin	4	16
CitronnierLunari	5	20
Citronnier Eureka	5	20
Lime douce	3	12
Valencia late	3	12

Imported varieties from INRA Corsica San Giuliano station

47 citrus varieties belonging to orange, mandarin, lemon and grapefruit groups were imported from INRA Corsica San Giuliano station in the aim to enrich our varietal assortment (table 2). From each variety, 4 grafted plants that constituted mother plants were maintained under screenhouse. After that, these plants were subjected to indexing (biological, serological and molecular tests) in order to check their sanitary state. Virological tests revealed that all of them were free from viral diseases excepted one variety ‘Salustiana’ which was infected with exocortis. This variety underwent thermotherapy and shoot-tip grafting. Recovered plant material was subjected to indexing and healthy one constituted mother plants.

The prebasic material was constituted with 12 trees for each variety grafted from each mother plant. The basic material was multiplied on 2 types of rootstocks in the registered nurseries from the previous types of material and maintained for production of certified buds.

Nursery operations will be supervised by personnel of the Plant Protection Department of Agriculture with periodic indexing of foundation and grower mother block trees to assure freedom from certain pathogens.

Table 2. Mother foundation block of varieties imported from INRA Corsica

<p>Clementines Cassar Marisol Hernandina Nour MA3 Nules Caffin</p>	<p>Oranges Washington navel Maltaise barelin Maltaise petit pierre Lane Late New Hall Navelate Navelina Torocco Valencia Late Double Fine Améliorée RhodeRedvalentia Maltaise demi-sanguine Moro Salustiana Sanguinelli Sanguinello Boukhobza</p>
<p>Mandarins-hybrids Fortune Encore Ortanique Minneola Nova Fremont Fairchild Tangelo Mapo</p>	<p>Grapefruit Star Ruby</p>

Lemons Eureka Kudiken Santa Téréza Interdonato Monachello Feminello Panaché Lime Bearss Lime Mexicaine Cedrat de corse	Others Calamondin Kumquat Marumi Kumquat Nagami
---	---

The citrus certification program has a considerable impact on the development of the citrus industry at the national level. The yearly production of 29 registered nurseries in Tunisia has reached about 400,000 certified plants.

Conclusion

Besides efforts made to reach the expected objective, i.e. sufficient number of certified citrus plants covering the national need, the national sanitation program did not succeed to provide satisfactory results (less than 400,000 virus-free plants/year).

However, the national program planned two other actions in order to improve the sector productivity. On the one hand, the Tunisian Ministry of Agriculture is going to introduce new citrus varieties of orange, Clementine and lemon from **Instituto Valenciano de Investigaciones Agrarias (IVIA)** Spain with the aim to enrich the national varietal assortment. On the other hand, it incited the nursery gardeners to install new plant nurseries in new zones outside the Cap Bon region and to substitute gradually the sour orange rootstock by other rootstocks which are tolerant or resistant to tristeza virus (CTV) such as *Citrangecarrizo* and *Citrus volkameriana*.

References

- DGPA. (2014). Annual report of Ministry of Agriculture of Tunisia. General Direction of Agricultural Production. Tunisia
- Iglio G.L. (1983). A silver stain for detection of nanogram amounts of tRNA following two dimensional electrophoresis. *Analyt. biochem.* 134: 184-188.
- Najar A., Duran-Vila N. (2004). Viroid prevalence in Tunisia Citrus. *Plant. Dis.* 88: 1286.
- Najar A., Bouhachem S., Danet J.L., Saillard, C., Garnier M., Bove J.M. (1998). Présence en Tunisie de *Spiroplasma citri*, l'agent causal du stubborn des agrumes et de son vecteur, la cicadelle *Circulifer haematoceps*. Contamination de *C. haematoceps* et de *C. opacipennis* par *S. citri*. (Occurrence in Tunisia of *Spiroplasma citri*, casual agent of citrus stubborn and of its vector *Circulifer haematoceps* leafhopper. Contamination of *C. haematoceps* and *C. opacipennis* by *S. citri*.) *Fruits* 53: 391-396.
- Navarro L., Roistacher C.N., Murashige T. (1975). Improvement of shoot-tip grafting in vitro for virus-free citrus. *J. Amer. Soc. Hort. Sci.* 100: 471-479.
- Navarro L. (1993). Citrus sanitation, quarantine and certification programs, In: Proc. 12th Conf. IOCV. IOCV, Riverside, pp. 383-391.
- Palacio A., Foissac X., Duran Vila N. (2000). Indexing of citrus viroids by imprint hybridization. *Eur. J. Plant. Pathol.* 105: 897-903

- Roistacher C.N., Navarro L., Murashige T. (1976). Recovery of citrus cultivars free of several viruses, exocortis viroid and spiropasma citri by shoot-tip grafting in vitro. In: Proc. 7th Conf. Int. Organization citrus Virol., IOVC, Riverside, pp: 186-193.
- Vidalakis G., Da Graça J. V., Dixon W.N., Ferrin D., Kesinger M., Krueger R.R., Lee R. F., Melzer M.J., Olive J., Polek M.L., Sieburth P.J., Williams L.L., and Wright G. C. (2010). Citrus quarantine sanitary and certification programs in the USA. Prevention of introduction and distribution of citrus diseases. Citograph May-June, p:27-39.
- Zemzami M. (2002). The program for the production of certified citrus nursery trees at the agricultural domains in Morocco. In D'Onghia A.M., Djelouah K., Roistacher C.N. (ed.). Proceedings of the Mediterranean research network on certification of citrus (MNCC): 1998-2001. Options Méditerranéennes: Series B. Studies & Research; n. 43. pp. 49-55

NITROGEN CONTENT IN VEGETABLES AND NITROGEN EFFECT ON THEIR NUTRITIONAL VALUE

Mariola KODRA^{*}, Ariola DEVOLLI, Edlira SHAHINASI, Dhurata FETA

Agricultural University of Tirana, Faculty of Biotechnology and Food, Department of Chemistry, Albania

^{*}Corresponding author: marjola_mala@yahoo.com

Abstract

Nitrogen plays an important role in nutrition and functions in plants, but because of environmental pollution and uses of organic and inorganic liquid fertilizers it can be accumulated in edible parts of vegetables particularly if excessive nitrogen fertilizer has been applied. Nitrogen content in vegetables has always been a matter of interests. In our study we were focused on evaluating nitrogen content in some vegetables, specifically in tomatoes, cucumber and pepper grown in a glasshouse, without applying specific amounts of nitrogen fertilizers, but just the normal rate used by the farmer. Nitrogen content was assessed by combustion. In most cases, nitrogen content in tomatoes and pepper were in normal range from 1.12 to 4.49 % N and 1.08 to 4.6% N respectively. Even if these vegetables must contain 2.5-3% N, we also meet cases of high nitrogen content. Cucumbers generally contain up to 2.5-5% N and the data showed a low content of nitrogen varying from 0.9 - 5.65% N. Nitrogen cannot be dangerous by itself, but its metabolites and reaction products e.g., nitrate, nitrite and N-nitroso compounds are of a great concern because they are converted in more toxic forms. Nitrogen sources are air, soil, water and food (especially vegetables) so consuming these crops can harm human health; that is why it is important to control rates of nitrogen fertilizers used in agriculture, in order to have safe products since a reduction in nitrogen forms content can represent added value for vegetable products.

Key words: *nitrogen content, vegetables, nutritional value, nitrogen fertilizers*

Introduction

Nitrogen is one of the most important nutrients that plants need for their growth. It is a key element that takes part in essential biomolecules such as amino acids, vitamins, hormones, enzymes and nucleotides. Nitrogen is the fourth most abundant element found in plant tissues, behind carbon, oxygen and hydrogen and is an integral part of the nitrogen cycle, which interchanges nitrogen between organisms and the environment (Meah MN, Harrison N and Davis A, 1994). Although inorganic nitrogen compounds (i.e., NH_4^+ , NO_2^- , and NO_3^-) account for less than 5% of the total nitrogen in soil (EC, 1997), they are the main form of the element absorbed by most plants. Inorganic and organic fertilizers are applied to maintain the nutritional condition of different cropping systems. For an organic agricultural system, continuous application of manure increases the nitrogen (N), phosphorus (P), potassium (K), calcium (Ca) and magnesium (Mg) content in soil (Schuddeboom LJ, 1993). Once organic fertilizers are applied to soils and mineralization begins, inorganic nitrogen is released and absorbed by plants (Cheng-Wei Liu, Yu Sung, 2014) and so it is converted in NO_3^- and NO_2^- . Nitrate (Mensinga TT, Speijers GJA and Meulenbelt J, Health, 2003) *per se* is relatively nontoxic, but its metabolites, nitrite, nitric oxide and N-nitroso compounds, make nitrate of regulatory importance because of their potentially adverse health implications. On the other hand recent research shows that its conversion to nitrite plays an important antimicrobial role in the stomach (EC (European Commission), 2002) and

other nitrate metabolites also have important physiological/pharmacological roles (EC, 2001). Farmers may therefore use manure and nitrogen-based fertilizers to boost crop yields. A range of leafy vegetables can accumulate high levels of nitrate. The concentrations depend on a range of factors including season, light, temperature, growing conditions, fertilizer use, and storage of the crop. Once nitrogen fertilizers are applied to agricultural systems, the fertilizers are absorbed directly by plants or converted into various other forms through the oxidation process. Excess nitrogen is lost in ionic or gaseous form through leaching, volatilization, and denitrification (Cheng-Wei Liu, Yu Sung, 2014).

Objective of this study has been evaluation of nitrogen content in some vegetable, such as tomato, cucumber and pepper in order to evaluate their nutritional values according to this nutrient. This study was conducted in a glasshouse and vegetable were grown under fertilization rates randomly used in this glasshouse.

Materials and methods

In our study vegetable were grown under fertilization rates randomly used in this glasshouse by the producer; rates of approximately 100 kg/ha inorganic N fertilizers for an area of 0.5 ha and the vegetables were planted three times in a year. The tissues of the harvested vegetables were washed with tap water and DI water and oven dried at 65 °C for 72 h, and the dry tissues were further ground using a grinder to a particle size less than 1 mm and then digested using H₂SO₄ (EC, 1999). The total nitrogen concentration in the filtrate of the plants passed through filter papers and N was determined with an automatic distillation unit (Kejdahl method). The results were compared on their mean, minimal and maximal values.

Results and discussion

Not all the soils naturally possess all the nutrients that are needed to produce top quality yields, crop after crop (Diana Moigradean, 2007). That is why fertilizers are used in soils, to improve soil fertility. Fertilizers rate and efficacy depend on many factors such as climate, soil structure and chemistry and method of application. A fertilizer is complete when it contains nitrogen, potassium and phosphorous; these are macronutrients needed in high amounts by vegetables. Nitrogen is added as nitrate-nitrogen that is soluble in water and affects ripening of fruits. Fruits will not ripen properly in low nitrogen concentration than in high. Nitrate global level concentration in tomatoes in concordance with WHO Codex code VO 448 is 15 mg/kg. In our study tomatoes were collected thoroughly fruit maturity. Nitrogen affects growth, production and quality of vegetable's fruits (EC, 1999). Different vegetables have different nitrogen needs, depending on vegetable species, for example, tomato, cucumber, eggplant, bean, selectively prefer more nitrate ions (Dessureault-Rompré J. et al. 2009).

In our study we analyzed tomatoes fruits for nitrogen content. Tomatoes fruits were collected after fruit maturity and they contain 2-3% N. In Table 1 and Graph 1 are presented results of these analyses.

Table1. Nitrogen content (%) in tomato

N content %	1	2	3	4	5	6	7	8	9	10	Mean	Min	Max
	1.12	1.96	2.85	1.87	1.47	2.4	2.12	1.18	4.49	3.85	2.331	1.12	4.49

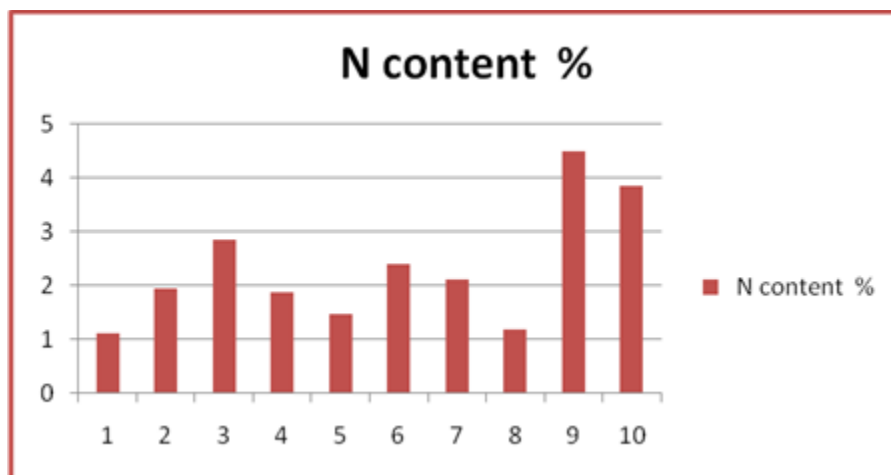

Graph 1. Nitrogen content in tomato (%)

These data show that in most cases N content in tomato fruits, is less than 2%, low than nitrogen content should be and that are considered as absence. But we also meet cases of more than 3% N that are considered as high level of nitrogen content.

In our study we also analyzed cucumber for nitrogen content. Cucumber fruits were collected after fruit maturity. Cucumbers contain 2 – 5% N. In Table 2 and Graph 2 are presented results of these analyses.

Table 2. Nitrogen content (%) in cucumber

N content %	1	2	3	4	5	6	7	8	9	10	Mean	Min	Max
	0.9	1.12	1.32	4.08	4.24	2.67	5.65	1.77	1.64	5.5	2.889	0.9	5.65

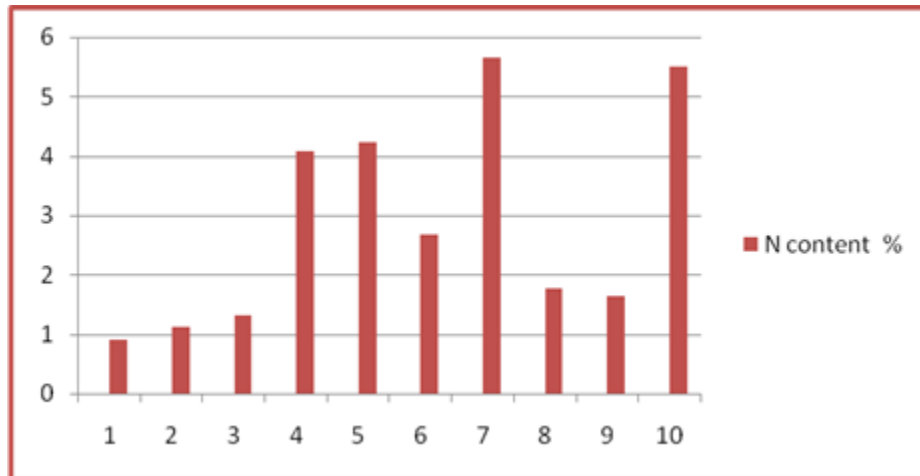

Graph 2. Nitrogen content (%) in cucumber

Most cases show a low content of N in cucumber (less than 2% N), other cases are of normal N content (2-5% N). High N content (more than 5% N) was observed only in some samples but these can't be considered as toxic N contents.

In Table 3 and Graph 3 below, are presented data obtained by analyses of pepper fruits. Pepper fruits were also collected after fruit maturity. Peppers contain 2 – 3 % N.

Table3. Nitrogen content (%) in pepper

N content %	1	2	3	4	5	6	7	8	9	10	Mean	Min	Max
	1.08	3.4	1.64	2.96	2.94	4.38	3.85	4.6	1.76	2.68	2.929	1.08	4.6

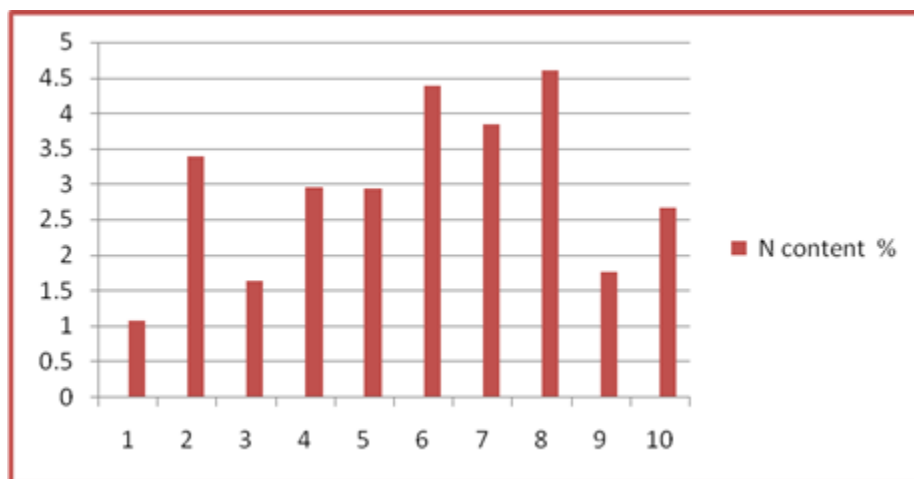

Graph3. Nitrogen content (%) in pepper

Most cases show a normal (2-3% N) or low (< 2% N) nitrogen content. But as we can see there are also cases of very high (4.6% N) nitrogen content (> 3% N) that are considered as toxic levels of nitrogen.

Nitrogen content in vegetable has a close relationship with the amount of N fertilizer applied. In our study vegetable were grown under fertilization rates randomly used in this glasshouse by the producer; rates of approximately 100 kg/ha inorganic N fertilizers for an area of 0.5 ha and the vegetables were planted three times in a year. Frequent planting and high rates of inorganic nitrogen fertilizers can influence nitrogen content in plant tissues and of the soil. That is why in our study we came across different levels of nitrogen content. In another study, Cheng-Wei Liu *et al.* (Cheng-Wei Liu, Yu Sung, 2014) have shown that applying inorganic fertilizers resulted in a high concentration of nitrate in lettuce than applying organic fertilizers.

Once adsorbed by vegetables nitrogen is converted in its metabolites and reaction products, nitrate, nitrite and ammonium. Previous studies indicate that vegetables are the major source of nitrate intake by humans and constitute approximately 40%–92% of the average daily intake (Turrini A, Saba A and Lintas C, 1991; Schuddeboom LJ, 1993).

According to Schuddeboom LJ, tomatoes and pepper are vegetables classified with a very low nitrate content ($< 200 \text{ mg kg}^{-1} \text{ fm}$) and cucumber with low nitrate content ($200\text{-}500 \text{ mg kg}^{-1} \text{ fm}$) and the vegetables fruits are plants part with low nitrogen content (Schuddeboom LJ, 1993; Mensinga TT, et al, 2003). Same results are shown in our study; N content in all the analyzed vegetable's fruit can be evaluated as normal.

To protect public health from nitrates in food, in 1997 the European Member States agreed an EC Regulation setting limits for nitrate in lettuce and spinach (EC Regulation No. 194/97) (EC, 1997) and adopted EC Regulation No. 1881/2006 [(EC (European Commission), 2002)]. The same regulation has been adopted in our country (Directive No. 1. 05/02/2016, Law "For Food" changed) (Regulation of Ministry of Agriculture, Rural Development and Water Administration, 2016). But beside a good law, farmers by themselves must do periodic soil and plant test, in order to provide a good product that can't harm human health.

Conclusion

The obtained results indicate that Nitrogen content in analyzed vegetables in most cases was low or normal. There were also cases of high and even toxic N content. According to N content, vegetable fruits analyzed in our study can't be harmful to human health and can serve as a good source of N.

But although most vegetables have normal N content, we must pay attention to the cases with low or high N content. In order to avoid low or high N content, preliminary soil test should be done and after that we can make the right decision in choosing the appropriate method and rate of fertilization to improve soil productivity and as result vegetable's quality.

References

- Cheng-Wei Liu, Yu Sung, Bo-Ching Chen, and Hung-Yu Lai Effects of Nitrogen Fertilizers on the Growth and Nitrate Content of Lettuce (*Lactuca sativa* L.) *Int J Environ Res Public Health*. 2014 Apr; 11(4): 4427–4440. Published online 2014 Apr 22. doi: 10.3390/ijerph110404427
- Dessureault-Rompré J., Zebarth B.J., Burton D.L., Sharifi M., Cooper J., Grant C.A., Drury C.F. Relationships among mineralizable soil nitrogen, soil properties, and climatic indices. *Soil Sci. Soc. Amer. J.* 2010;74:1218–1227. doi: 10.2136/sssaj2009.0213.
- Diana Moigradean, A. Lazureanu, I. Gogoasa, Mariana-Atena Poiana, I. Gergen, Nitrogen content in tomato fruit after NPK fertilization, *Lucrări Științifice – vol. 50, seria Agronomie* p 525-530, 2007

- EC (European Commission), Commission Regulation (EC) No 194/97 of 31 January 1997 setting maximum levels for certain contaminants in foodstuffs. Official J Eur Commun L31:48–50 (1997).
- EC (European Commission), Commission Regulation (EC) No 864/99 of 26 April 1999 amending Regulation (EC) No. 194/97 setting maximum levels for certain contaminants in foodstuffs. Official J Eur Commun L108:16–18 (1999).
- EC (European Commission), Commission Regulation (EC) No 466/2001 of 8 March 2001 setting maximum levels for certain contaminants in foodstuffs. Official J Eur Commun L77:1–13 (2001).
- EC (European Commission), Commission Regulation (EC) No 563/2002 of 2 April 2002 amending Regulation (EC) No 466/2001 setting maximum levels for certain contaminants in foodstuffs. Official J Eur Commun L86:5–6 (2002).
- Meah MN, Harrison N and Davis A, Nitrate and nitrite in foods and the diet. Food Add Contam 11:519–532 (1994).
- Schuddeboom LJ, Nitrates and nitrites in foodstuffs, ed by the European Commission, Council of Europe Press, Brussels, p 125 (1993).
- Turrini A, Saba A and Lintas C, Study of the Italian reference diet for monitoring food constituents and contaminants. Nutr Res 11:861–873 (1991).
- Udhëzim i Ministrisë së Bujqësisë, Zhvillimit Rural dhe Administrimit të Ujërave nr. 1, datë 5.2.2016 Për vendosjen e niveleve maksimale për disa kontaminues në produktet ushqimor (Regulation of Ministry of Agriculture, Rural Development and Water Administration, no 1, date 5.02.2016 On establishing maximal levels about some food contaminants)

ASSORTMENT OF EASTERN PERSIMMON AND THE WAYS OF ITS IMPROVEMENT

Sergey KHOKHLOV

Nikita Botanical Gardens, Yalta, Russian Federation

E-mail: ocean-10@mail.ru

Abstract

High-productive, frost-resistant, immune cultivars with different ripening periods have been selected in the result of the researches on determination of biological potential for eastern persimmon in the conditions of South Coast of the Crimea (Russia). The best cultivars of Nikita Botanical Gardens were obtained as a result of inter-species and intra-species crossings. The detailed study of this gene fund allows to classify the persimmon cultivars and select the most perspective ones according to their characteristics (productivity, fruit quality, resistance to diseases). The specification of biological and morphological characteristics of cultivars has been summarized. The data on phenological observations and evaluation of cultivars on fruits quality have been given. The most promising cultivars for using in breeding processes and laying of industrial plantations of intensive type have been selected.

Keywords: *persimmon, cultivars, group, crop, fruit quality*

Introduction

Eastern persimmon (*Diospyros kaki* Thumb.) according to complex of economically valuable characteristics takes the special place among fruit crops due to its valuable fruits, wide ecological range of growth and plant ornamentally. The determining factor in the expansion of the areal of this crop is the available source of genetic material, the basis for the obtaining highly adapted cultivars satisfied the growth conditions (Bellini, 1982, Zaretsky, 1934, Zhukovsky, 1971).

Eastern persimmon despite its name comes from China. Its cultural areal is quite wide and occupies practically all warm-temperate and subtropical zones of North hemisphere (Zhukovsky, 1971). In the Crimea persimmon as the fruit plant was known at the beginning of the XIX century (Kondaraky, 1872. But only in 1901 the first small plantation of persimmon was founded in Imperial Nikita Economic Botanical Gardens. It became the starting point of persimmon assimilation in horticulture of the peninsula (Pasenkov, 1973).

Persimmon is polymorphic, heterozygous species. Due to cross-pollination there are the wide spectrum of persimmon cultivars with significant variation of main morphological characteristics: form and size of fruits, form of their top and bottom, presence and absence of astringency in the pulp, color. The collected gene fund of persimmon in Nikita Botanical Gardens fully reflects the biological diversity of this species. The high level of natural inhomogeneity of the starting material used in breeding process provides a large selection of combination for deliberate hybridization and obtaining new forms with comparatively high viability and adaptability to environment conditions.

The aim of these researches: to study the existing gene fund of persimmon, to classify the cultivars, to select the most valuable specimen according to certain economically valuable characteristics (productivity, fruit quality, resistance to diseases) or their combinations, to estimate the adaptability of cultivars to growth conditions.

Materials and methods

Research was conducted organized in 2012-2015 at the collection plantation of eastern persimmon presented by 86 persimmon cultivars. Collection is located on two grounds Primorsky and terraces differed by steep slopes, protection from prevailing winds, mechanical soil composition and predecessors.

The plot Primorsky is located 200 meters from the sea coast at an altitude of 20-40 m above sea level, on gentle South-East exposure slope of 10-20°. Predecessors are roses and vines. The soils are brown-gray, gray, slightly calcareous, powerful, medium and heavy loamy, slightly and medium gravelly, trenching ones. This study was funded by a research grant # 14-5-00079 of the Russian Science Foundation

The plot is fully opened from the South; its west, north and north-east sides are protected by natural forest and park plantations; its east side is surrounded by rocky spur of Nikitskaya Yaila covered by juniper forest.

The Upper terrace of the Gardens is located 20-50 meters north and 5-10 meters higher than plot Primorsky on rather steep slope (up to 30°) of South-East and South exposition. Predecessor is mixed forest. The soil of terrace is the same as for plot Primorsky, but it differs by low power of root zone horizon and by larger content of skeletal particles in the profile.

For evaluation of comparative winter-resistance the quick method of direct artificial freezing of some branches with generative and vegetative organs in refrigerators at different temperatures (from -8° up to -25°C) has been used. The primary study was done using common method (Medov and Ogoltsova, 1999; Ereemeev, 1976) and methodological instructions worked out in Nikita Botanical Gardens (Pasenkov, 1973).

Results and discussion

Today new highly productive, regular fruiting cultivars, best adapted to growth conditions are urgently needed for industrial plantations of intensive type for horticulture of the Crimea and South regions of Russia. During last years the new cultivars of persimmon, surpassing the main characteristics not only of the foreign introduced cultivars but also the regionalized domestic ones have been obtained in Nikita Botanical Gardens as a result of intraspecific hybridization.

On the basis of a comparative analysis of collection evaluation data on main morphological characteristics the persimmon cultivars were combined in the following groups:

a) Presence or absence of astringency in fruits pulp

- constant not astringent cultivars (PCNA); their fruits become sweet after typical coloration irrespective of seeds and ripening level
- variable not astringent (PVNA) cultivars; firm, sweet fruits with three and more seeds
- variable astringent cultivars (PVA); seedless fruits, astringent in firm state
- constant astringent cultivars (PCA); fruits are astringent in firm state, it is possible to eat them only fully ripened in 10-30 days after harvesting.

The following cultivars belong to the first group (PCNA): Prevoskhodny, Fuyu, Kiara, Krymchanka 55, Nakhodka, Nadezhda, Prelestnaya, Triumf, Zolotistaya, Sharon.

The second group (PVNA) includes cultivars: Ukrainka, Sputnik, Zarya, Zorka, Shokoladnaya, Doch Saburozy, Konkurent, Opylitel 48, Rubinovaya, Tsyganochka, Tavrichanka, Zvezdochka, Yuzhnoberezhnaya, Urozhainaya, Vostochnaya, Hyakume, Zengy-Maru, Yankin-Tsuru, Kuro-Kuma, Shogatsu-Gaki, Merkheulis, Geily, Maru.

The third very small group (PVA) includes cultivars: Seedless, Suvenir Oseny, Vekovaya, Cibaca, Variruyushchaya.

The fourth group of cultivars (PCA): Rossiyanika, Nikitskaya Bordovaya, Kiara Konstantnaya, Adzhara, Pribrezhnaya, Mechta, Zolotaya Osen, Zamanchivy, Izobilnaya, Yaltinsky, Yuzhnaya Krasavitsa, Kostata, Nitary, Tanenashy, Aizumishirazu, Hiragaki, Yurogaki, Yamagaki, Orest Uzhgorod, Tone Wase, Rojo Brillante, Druzhba, Delishes, Skromnitsa, Kavabata, Zhuravlyenok.

b) mass of fruits

1.1. large-fruited cultivars; mass of fruits is more than 200 g

1.2. middle-fruited cultivars; mass is 150-500 g

1.3. small-fruited cultivars; mass is 100-150 g.

The first group includes cultivars: Hachiya, Hyakume, Zolotistaya, Rojo Brillante, Sharon, Konkurent, Batumsky II, Zamanchivy, Mechta, Yaltinsky.

The second group combines the following cultivars: Adzhara, Prevoskhodny, Yuzhnoberezhnaya, Ukrainka, Sputnik, Zarya, Zorka, Zvezdochka, Shokoladnaya, Doch Saburozy, Zenzhi-Maru, Yanki-Tsuru, Kuro-Kuma, Shogatsu-Gaki, Geily, Maru, Rojo Brillante, Sharon, Vekovaya, Kiara Konstantnaya, Adzhara, Pribrezhnaya, Mechta, Zolotaya Osen, Zamanchivy, Izobilnaya, Yaltinsky, Yuzhnaya Krasavitsa, Kostata, Nitari, Tanenashi, Aizumishirazu, Opylitel 48.

The following cultivars belong to the third group: Hiragaki, Yurogaki, Orest Uzhgorod, Tone Wase, Rossiyanika, Nikitskaya Bordovaya, Zhuravlyenok, Krymchanka.

c) periods of ripening and full coloration of fruits

very early (fruits color at the end of August - beginning of September) - Ukrainka, Izobilnaya, Yankin-Tsuru

early (coloration begins in the second decade - beginning of the third decade of September) - Hyakume, Sputnik, Shokoladnaya, Doch Saburozy, Rojo Brillante, Sharon, Mechta, Zolotistaya, Yuzhnaya Krasavitsa, Zvezdochka

middle period of ripening (fruits color up to the 10-th of October) - Yuzhnoberezhnaya, Batumsky II, Zamanchivy, Zarya, Zorka, Prevoskhodny, Rojo Brillante, Sharon, Hachiya, Suvenir Oseni, Mechta, Hiragaki, Yurogaki, Jiro, Yamagaki, Orest Uzhgorod, Tone Wase, Zhuravlyenok, Zengi-Maru, Kuro-Kuma, Shogatsu-Gaki, Merheulis, Geily, Opylitel 48

late (coloration of fruits begins at the end of October - beginning of November) - Rossiyanika, Nikitskaya Bordovaya, Zolotaya Osen, Pribrezhnaya, Izobilnaya, Adzhara

very late (ripening of fruits with coloration is in the second decade of November) - Yaltinsky, Konkurent, Vekovaya.

d) winter-resistance

resistant cultivars (single bud damage on annual shoots)

cultivars with resistance above average (up to 20% damaged buds)

cultivars with average resistance (20-40% damaged buds with partial damage of annual wood)

weakly resistant cultivars (40-80% damaged buds and wood of many last year shoots)

very weakly resistant cultivars (more than 80% damaged buds and partial damage of wood of 2-year and 3-year old shoots).

The main factors limited the areal of distribution of eastern persimmon in the Crimea and South regions of Russia are temperature parameters of winter-summer periods and winter-resistance of plants.

Ten cultivars bred in Nikita Botanical Gardens belong to the resistant group: Rossiyanika, Zolotistaya, Suvenir Oseni, Nakhodka, Zorka, Yuzhnoberezhnaya, Zolotaya Osen, Krymchanka, Nikitskaya Bordovaya and Yuzhnaya Krasavitsa. It accounts for almost 12% of the total number of plants in collection.

Cultivars having the level of resistance higher than average (26.6%) are combined into a group of 23 cultivars of domestic and foreign selection.

The largest group is the group with average level of resistance (55.8%) - 48 cultivars. Groups with weak (14%) and very weak (14%) resistance have 12 cultivars each.

Conclusions

The results of agrobiological study of collection fund of eastern persimmon allow to do the following conclusions:

1. The gene fund of persimmon in Nikita Botanical Gardens according to the varietal diversity is one of the largest in Russia, that allows to solve the selection problems relevant to modern fruit-growing.

2. The most part of studied persimmon cultivars of foreign selection after winter and early spring thaws instigated the plants for vegetation are damaged by slight negative air temperatures (from -9° up to -8°C). Wherein, some cultivars remain quite productive and profitable: Hyakume, Shagotsu-Gaki, Nitari, Seedless, Aizumishirazu, Batumsky II, Tamopan, Hiragaki, Yurogaki, Jiro, Yamagaki, Orest Uzhgorod.

3. Due to more deep period of winter rest persimmon cultivars bred in Nikita Botanical Gardens practically do not suffer from provocative influence of winter thaws. Thanks to that they bear fruits each year.

4. Cultivars can be divided to the following groups according to their economic use: the most perspective for industry: Zolotistaya, Suvenir Oseni, Nakhodka, Zorka, Yuzhnoberezhnaya, Yuzhnaya Krasavitsa, Krymchanka, Nikitskaya Bordovaya, Rossiyanika, Opylitel 48, Opylitel 87, Zamanchivy, Merchta, Zvezdochka and Zolotaya Osen for including in breeding process for obtaining large-fruited cultivars: Hachiya, Hyakume, Zolotistaya, Rojo Brillante, Sharon, Konkurent, Batumsky II, Zamanchivy, Mechta, Yaltinsky for early ripening period: Ukrainka, Izobilnaya, Yankin-Tsuru.

References

- Bellini E., 1982. Monograph of the main cultivars of Kaki introduced in Italy /Firenze, p.281.
- Eremeev G.N., 1976. Methods of evaluation of plants resistance to unfavorable environment conditions.- L.: Kolos, p. 54-60.
- Kondaraky V.H., 1872. Agriculture in the Crimea //Notes of the Imperial Society of Agriculture of South Russia.-Odessa, 1872.-V.1-2, p. 34.
- Medov Ye.N. and Ogoltsova T.P., 1999 Program and method of varietal study of fruit, berry and nut crops //Oryel: Pub. House VNIISGTK, p. 606.
- Pasenkov A.K., 1973. Methodological recommendation on primary varietal study of eastern persimmon. Yalta, p.30.
- Zaretsky F.Ya., 1934. Japanese persimmon. L.: Pub. House of All Union Institute of Plant Growing, p.54.
- Zhukovsky P.M., 1971. Cultural Plants and their relatives. - L.: Kolos, p. 543-547.

EVALUATION OF NEW APRICOT CULTIVARS INTRODUCED IN NIKITA BOTANICAL GARDEN

Valentina GORINA*, Vadim KORZIN, Natalya MESYATS

Nikita Botanical Garden, Yalta, Russian Federation

*Corresponding author: valgorina@yandex.ru

Abstract

During 2013-2015 we studied 19 new cultivars of apricot, introduced in Nikita Botanical Garden. The cultivar Kryimskij Amur was used as a control. In 2013-2014 the susceptibility of cultivars Kryimskij Amur, Kioto, Lanyhou Jim Mama, Lednicka and others to *Monilinia laxa* (Aderh. & Ruhland) Honey did not exceed 0.5-1 points. In epiphytotic year (2015) susceptibility of the same cultivars was rated with 3-5 points. Two genotypes were selected due to their *Monilinia laxa* resistance - Novyj 6357 and I-05-6. *Stigmina carpophila* (Lev.) M. B. Ellis damages did not exceed 3 points during the years of studies. Four cultivars demonstrated high resistance to the disease: Aurel, Lanyhou Jim Mama, Novyj 6357 and Sundrop. Increased resistance to both diseases was detected in three genotypes - Morava, Novyj 6357, Holovously and one form I-05-6. Morava and I-05-6 were selected since the plants bloom one week later than the control. There are 10 cultivars with early fruit ripening (24.06 - 5.07): Kioto, Lanyhou Jim Mama, Holovously, Sundrop and others. Cultivars Kryimskij Amur and Wesley-25 are of medium-late ripening July 23-24. The fruit quality of genotypes Aurel, Morava and others is not inferior to the control. In complex of signs (later flowering, increased resistance to fungal diseases, good fruit quality) cultivars Morava and Novij 6357 were dominant. Kioto cultivar is promising for breeding. Its plants have an average resistance to *Monilinia laxa* and *Stigmina carpophila*. Also, it is characterized by early fruit ripening and precocity, abundant yield and good fruit quality.

Keywords: *apricot, late flowering, disease resistance, fruit quality*

Introduction

An important task of fruit-growing is to ensure the population with fresh fruits and processed products. The advantage of the apricot (*Armeniaca vulgaris* Lam.) is the high-quality of fruit. Apricot plantations cover about 350 thousands hectares in 55 countries. Every year about 2.4 million tons of fruits are produced in the world. Production is mainly concentrated in southern Europe and Asia. In Europe, annually production is up to 750 thousand tons and in Asia - up to 950 thousand tons. Demand for apricot fruits is constantly increasing (Pedryc et. al., 1999; Witkowski, 2003). A variety of soil and climatic conditions of natural regions determines the requirements for cultivars. Particular importance is the adaptation of created genotype. The main indicators in this case are resistance to diseases, drought resistance, stability of fruiting, high-quality fruits and products (Smykov, 1999). Production needs new high-yielding, precocious and stable fruiting cultivars. Comprehensive assessment of cultivars will identify sources of economically valuable traits. The use of these genotypes in breeding will expand the amplitude of adaptation of new varieties to the environmental conditions.

The aim of the work was to determine the economic and biological value of new introduced cultivars of apricot in Nikita Botanical Garden.

Materials and Methods

The study included 19 introduced cultivars and forms of apricot. Investigations were carried out in the period 2013-2015. Widespread and released in Crimea cultivar Kryimskij Amur was used as a control. During the studies phenological observations, yield, fruit quality parameters, and plant disease resistance were investigated using conventional techniques (Sedov and Ogoltsova, 1999).

Under conditions of the Crimea apricot plants mostly affected with monilia infection, which is manifested in spring and results in rapid wilting of flowers bloomed and later young leaves and shoots, and *Stigmia carpophila* maximum damage of which appears in August. Estimation of monilia infection was made during the flowering period of apricot trees and *Stigmia carpophila* – at the stage of mature leaves. The rate of damage was assessed in points:

0 – no damages of flowers, leaves and shoots;

1 - up to 1% of the flowers, leaves or shoots are damaged;

2 –1-10% of the flowersleaves or shoots on the tree are damaged;

3 – 11-25% of the flowersleaves or shoots on the tree are damaged;

4 – 26-50% of the flowersleaves or shoots on the tree are damaged;

5 - more than 50% of the flowers, leaves or shoots on the tree are damaged.

Determination of drought resistance of cultivars and forms was carried out using the methodological guidelines of Eremeyev and Lishchuk (1974). Statistical analysis was made with the method of analysis of variance and differences between means were tested using LSD test at $P \leq 0.5$ (Zaitsev, 1984) using the Microsoft Office Excel program.

Results and Discussion

The studies of apricot cultivars and forms demonstrated variations of studied features. The rate of drought resistance of apricot cultivars is important for stability of fruiting. The analysis demonstrated that range of drought resistance in the most studied genotypes is not inferior to the control cultivar. The drought resistance of nine cultivars and forms exceeds the control cultivar and was 3.7-4.0 points (table 1).

Table 1. Biological features of introduced apricot cultivars (2013-2015 years).

Cultivar	Drought-resistance (1-5 scale)	Flowering time		Ripening periods of fruits		The damage of disease (0-5 scale)	
		Start	End	Start	Mass	<i>Monilinia laxa</i> , point	<i>Stigmata carpophila</i> , point
Kryimskij Amur (control)	3.6±0.1	20.03±1	28.03±1	23.07±0	25.07±0	2.0±1	2.0±1
Kioto	3.5±0	19.03±1	31.03±2	28.06±3	4.07±1	3.0±2	2.5±0
Aurel	3.6±0.2	16.03±4	29.03±8	15.07±0	18.07±0	4.9±1	1.0±0
Lanyhou Jim Mama	3.6±0.2	14.03±1	28.03±0	3.07±0	5.07±0	3.0±2	1.5±0
Morava	3.5±0.1	24.03±2	7.04±5	20.07±0	23.07±0	2.5±0.5	1.5±0.5
Kabaasi	3.6±0	18.03±1	28.03±1	6.07±4	10.07±5	4.0±1	2.0±0.5
Marculesti	3.8±0.2	18.03±1	27.03±2	8.07±0	12.07±0	3.0±0	2.0±0
Holovously	3.9±0.9	14.03±1	26.03±1	25.06±3	1.07±5	2.5±0.5	2.0±0
Bertiruch	3.7±0.2	15.03±3	25.03±2	25.06±3	29.06±3	4.9±0.1	2.0±1
Novyj 6357	3.8±0.1	21.03±1	31.03±2	16.07±0	19.07±0	1.5±1	1.5±0
K-604-19	3.7±0.1	5.03±2	20.03±7	18.06±6	21.06±6	5.0±0	3.0±0.5
Sundrop	3.8±0.1	13.03±1	23.03±2	24.06±0	28.06±0	5.0±0	1.5±0
Skaha	3.5±0.1	11.03±1	23.03±3	24.06±0	28.06±0	4.9±0.1	1.8±0.2
Sirena	4.0±0.2	20.03±2	30.03±1	1.07±0	3.07±0	3.0±1	2.0±0.5
3/6/3	3.2±0.2	4.03±2	18.03±4	5.07±0	7.07±0	3.0±2	2.5±0
Weslay-25	3.2±0.2	15.03±1	27.03±1	24.07±0	28.07±0	4.2±0.2	2.0±0.5
Harlayne	3.1±0.3	18.03±4	26.03±2	7.07±6	10.07±1	3.5±1.5	2.0±1
Lednicka	3.5±0.1	20.03±1	29.03±0	17.07±0	20.07±0	3.0±2	2.7±0.2
Nadezda	3.8±0	21.03±3	29.03±1	3.07±3	7.07±5	3.5±1	2.0±0.5
I-05-6	3.8±0.2	26.03±2	7.04±8	26.06±0	1.07±0	0.5±0	2.0±1
LSD05	0.4	-	-	-	-	2.0	0.8

Evaluation of the introduced cultivars let us to determine the rate of disease damages in plants. It varied greatly from year to year. So the damage caused by *Monilinia laxa* in 2013-2014 in the cultivars Kryimskij Amur, Kioto, Lanyhou Jim Mama, Lednicka did not exceed 0.5-1 points. In epiphytotic year (2015), the damage of the same cultivars was from 3 to 5 points. Two genotypes - Novyj 6357 and I-05-6 demonstrated higher resistance to *Monilinia laxa*.

Scientists from different countries investigated favorable conditions for fungal diseases, various approaches in apricot tree protection, works in revealing of resistant forms and cultivars were carried out for further breeding of new forms resistant to *Monilinia laxa* and other pathogens. Apricot collections in the North of California, Rumania and other countries were studied and the most resistant genotypes were marked out: Riland, Royal, A -105, Viceroy, King, Tonda di

Tossignano, K-55-39, Precoce de Italia, Vivagold, Sulmona, Mamaia, Baneasa 33/11, Sirena, Pike, Umberto and etc. (Balan et al., 1999; Brooks, 1942; Trandafirescu and Teodorescu, 2006).

Ivonne Liverani and Perfection are considered as donors of apricot resistance to *Monilinia laxa* with possible capacity to transmit this property. Fair quantity of resistant seedlings was a result of using these cultivars in crossing (54.0% and 45.5%) (Nikotraet et al., 2006).

Another disease widespread all over the Crimea, Russia and other countries is *Stigmia carpophila*, or spot blotch. This pathogen damages all drupaceous cultures and it is especially harmful for apricot plants. In the conditions of the Crimea disease development is more dangerous for leaves. Being extremely damaged leaves fall off, tree crown becomes lighter or even bare, that decreases tree productivity (Kropis et al., 1975).

The damage cause by *Stigmia carpophila* (Lev.) M. B. Ellis, in studied cultivars and forms did not exceed 3 points. Four cultivars - Aurel, Lanyhou Jim Mama, Novyj 6357 and Sundrop demonstrated high resistance to this disease and in some years - control cultivar Kryimskij Amur. Increased resistance to both diseases was detected in three cultivars -Morava, Novyj 6357, Holovousy and a form I-05-6.

Early flowering apricot cultivars often fall under the influence of spring frosts, which leads to decrease in yield or its complete loss. Therefore, in Nikita Botanical Garden works on the creation of apricot cultivars with late flowering is carried out. Selected genotypes Morava and I-05-6 start to bloom on March 24 - 26, nearly a week later compared to the control cultivar. The problems of generative buds winter hardiness, increasing resistance to other abiotic and biotic factors in combination with the quality of fruits are urgent tasks in the cultivation of apricot not only for Russia, but also all over the world. For example, in California (USA) scientists are trying to create strong winter-hardy and frost-resistant cultivars with the use of the Central Asian cultivars (Ledbetter, 2010).

The study of ripening terms of fruits in the studied genotypes of apricot showed 10 early cultivars: Kioto, Lanyhou Jim Mama, Holovousy, Sundrop, etc. (24.06 - 5.07). Cultivars Kryimskij Amur and Wesley-25 have medium-late ripening (23-24.07). 8 cultivars have medium ripening (6-20.07).

Comparing the quality of fruits to the control cultivar, it is found that 6 genotypes - Aurel, Morava, Holovousy and others are not inferior (table. 2). Fruits of these cultivars are of excellent appearance, characterized with large size (51-80 g), round or oval shape, bright blush colored flesh, high taste of fruits (tasting score 4.1 - 4.5 points). In the introduced cultivars Aurel, Bertiruch, Morava, Nadezda, Skaha, Sirena, 3/6/3, K-604-19 were found the largest fruits (65-102 gr). Taste of the fruits was the best in the cultivar Morava and the form – in 3/6/3 (4.4-4.5 points). The cover color of the fruit skin (up to 75%), was the most intensively expressed in Harlayne cultivar.

One of the main problems is adaptability of new cultivars to the conditions different from those of their origin. Fruiting regularity is a serious problem in several apricot cultivars. Work on the breeding of new apricot cultivars are carried out in different regions of the world (Krška et al., 2006; Polat, Caliskan, 2013).

Table 2. Pomological characteristics of apricot cultivars (2013-2015 years).

Cultivar	Mean weight of fruit (gr)	Fruit shape	The ground color of skin	Cover color of skin	Flesh color	Taste of fruit, points (scale 1-5)	Stone mass (gr)
Kryimskij Amur (st.)	54±2	flat-round	light-orange	no	orange	4.1±0	2.8±0
Kioto	54±18	round	light-orange	pink, 25%	orange	4.0 ±0	1.7±0.5
Aurel	65±0	widely-oval	orange	dark-red, 25%	orange	4.2±0	3.5±0
LanyhouJimMama	58±0	flat-round	yellow	pink, 25%	yellow	4.3±0	2.1±0
Morava	68±18	round	light-orange	pink, 50%	yellow	4.5±0	2.8±0.6
Kabaasi	61±7	triangular	yellow-orange	pink, 50%	orange	4.0±0	2.5±0.5
Marculesti	49±1	flat-round	orange	dark-red, 50%	orange	4.0±0	2.5±0
Holovousy	51±5	widely-oval	light-orange	pink, 25%	orange	4.2±0,1	3.0±0.5
Bertiruch	65±1	round	light-orange	pink, 50%	orange	4.1±0	2.4±1
Novyj 6357	41±9	oval	orange	dark-red, 25%	orange	4.0±0	1.9±0.1
K-604-19	102±0	round	orange	pink, 25%	orange	4.0±0	2.0±0
Sundrop	43±2	round	orange	pink, 50%	orange	4.0±0	2.2±0.4
Skaha	74±0	round	yellow	pink, 25%	orange	4.0±0	4.5±0
Sirena	79±21	widely-oval	yellow	pink, 50%	orange	4.0±0	2.5±0.5
3/6/3	80±0	round	orange	dark-red, 25-50%	orange	4.4±0	5.5±0
Weslay-25	48±0	widely-oval	yellow-orange	no	yellow-orange	4.0±0	3.0±0
Harlayne	30±0	round	yellow	pink, 75%	orange	4.3±0	2.0±0
Lednicka	38±3	oval	orange	dark-red, 25%	orange	4.0±0.2	2.6±0.1
Nadezda	66±7	round	yellow-orange	pink, 50%	orange	4.0±0	3.0±1
I-05-6	38±0	round	yellow	dark-red, 25%	orange	4.0±0	2.0±0
HCP05	14.3	-	-	-	-	0.1	0.7

Based on the complex of traits cultivars Morava and Novyj 6357 were selected. They are characterized by late flowering, increased resistance to fungal diseases, and the fruits of good quality. Also the cultivar Kioto is promising. Its plants have an average resistance to *Monilinia laxa* and *Stigmata carpophila*, early ripening of fruits, precocity, abundant yield and good fruit quality.

Conclusions

1. It was found that three cultivars - Morava, Novyj 6357 and Kioto are best adapted to the conditions of the South Coast of the Crimea and have a complex of valuable traits.
2. The following apricot cultivars are recommended as donors of valuable traits:
 - field resistance to *Monilinia laxa* and *Stigmata carpophila*: Morava, Novyj 6357, Holovousy, I-05-6;
 - late bloom: Morava and I-05-6;
 - early period of ripening: Kioto, Lanyhou Jim Mama, Holovousy, Bertiruch, Sundrop, Skaha, Sirena, 3/6/3, Nadezda, I-05-6;
 - good quality of fruit: Aurel, Lanyhou Jim Mama, Morava, Holovousy, Bertiruch, 3/6/3, Harlayne.
3. Evaluation of introduced cultivars let us to give needed information about their behavior in the local conditions and to develop adequate technology for them.

Acknowledgement

The study was funded by research grant №14-50-00079 of the Russian Science Foundation.

References

- Balan V., Toma S., Oprea M. (1999). Reaction of apricot phenotypes from national collection to *Monilinia laxa* (Aderh et. Ruhl) Honey inoculum. Acta Hort., 488: 667-670. http://www.actahort.org/books/488/488_108.htm
- Brooks R.M. (1942). Climate in relation to deciduous fruit production in California. Effect of the warm winter of 1940-1941 on apricot, plum, and prune varieties in northern California. Proc. Amer. Soc. Hort. Sci., 40: 209-211.
- Eremeyev G.N., Lishchuk A.I. (1974). The selection of drought resistant cultivars and rootstocks of fruit plants. SNBG, Yalta, Russia. 18 p.
- Kropis E.P., Smyikov V.K., Shafir G.M. (1975). Varietal *Clasterosporium carpophilum*-resistance of apricot crop. Selection and varietal study of seed, drupaceous, baccate and nut-bearing crops. I: 75-79.
- Krška B., Vachůn Z. and Nečas T. (2006) The Apricot Breeding Programme at the Horticulture Faculty in Lednice. Acta Hort., 717.29. http://www.actahort.org/books/717/717_29.htm
- Ledbetter, C.A. (2010). Apricot breeding in North America: Current status and future prospects. Acta Hort. 862, 85-91 http://www.actahort.org/books/862/862_12.htm
- Nikotra A., Conte L., Moser L. et al. (2006). Breeding programme for *Monilinia laxa* – resistance on apricot. Acta Hort., 701: 307-312. http://www.actahort.org/books/701/701_46.htm
- Sedov E.N., Ogoltsova T.P. (1999). Program and methodology of cultivar investigation of fruit, berry and nut crops. VNIISP, Orel, Russia. 608p.
- Smyikov V.K. (1999). Intensification of breeding of fruit crops. Proceedings of Nikit. botan. garden, 118:54-62.

- Pedryc A., Korbuly J., Szabo Z. (1999). Artificial frost treatment methods of stone fruits. *Acta Hort.*, 448:377-380. http://www.actahort.org/books/488/488_60.htm
- Polat A.A., Caliskan O. (2013). Yield and Fruit Characteristics of Various Apricot Cultivars under Subtropical Climate Conditions of the Mediterranean Region in Turkey. *International Journal of Agronomy*, 2013 (2013): 5. <http://dx.doi.org/10.1155/2013/687345>
- Trandafirescu M., Teodorescu G. (2006). Behaviour of some apricot and hybrids from National collection to the *Monilinia laxa* (AderhetRuhl.) Honey infection. *Acta Hort.*, 701: 371-375. http://www.actahort.org/books/701/701_61.htm
- Witkowski V.L. (2003). *WorldFruit plants*. Deer, Saint-Petersburg, Russia. 592 p.
- Zaitsev G.N. (1984). *Mathematical Statistics in Experimental Botany*. Science, Moscow, Russia, 424 p.

**OBSERVATIONS ON THE DISTRIBUTION, MORPHOLOGY AND SOME
BIOECOLOGICAL ASPECTS OF *CICADA MORDOGANENSIS* BOULARD
(HEMIPTERA: CICADIDAE) IN IZMIR, TURKEY**

Cevdet KAPLAN^{1*}, Serdar TEZCAN²

¹Siirt University, Faculty of Agriculture, Department of Plant Protection, Siirt, Turkey

²Ege University, Faculty of Agriculture, Department of Plant Protection, Izmir, Turkey

*Corresponding author: cevdetkaplan@siirt.edu.tr

Abstract

This study was conducted to determine the distribution, some morphological and bioecological aspects of *Cicada mordoganensis* Boulard (Hemiptera: Cicadidae) that damage fruit trees in Izmir province of Turkey in the period from 2005 to 2008. To determine the distribution of *C. mordoganensis*, investigations were carried out in 17 districts of Izmir and a total of 98 orchards were controlled. *C. mordoganensis* was found in 58,16 % of all orchards. For biology investigation, visual inspections were done in orchards in Kemalpaşa (Yukarıkızılcıca), Izmir, Turkey. In addition to the visual counting of adults in the shed skins of the nymphs, they were counted at the bottom of the trunk and under the canopy of 10 trees in that orchard. In addition, 10 wooden crates were put under 10 trees in this orchard and checked periodically to monitor the adult emergence. According to the results of these studies, the first adults of *C. mordoganensis* started to appear in the second week of June. The flying period finished at the mid of October. Flight duration of this species is about 110-115 days. The maximum adult emergence occurred between the end of June and mid of July. Population density changed from year to year. Most of the adults were observed in 2007 and least in 2006. Adults were observed on different fruit trees such as olive, cherry, peach, walnut, poplar, plane tree, fig, and pistachio. Females lay their eggs more on the bark of trunk of old trees and a dry stick of young plants. Some morphological characteristics of adult, last nymph instars and shed skins of last nymph of *C. mordoganensis* were also revealed.

Keywords: *Cherry, Cicada mordoganensis, Cicadidae, bioecology, morphology, Turkey*

Introduction

Cicadas (Hemiptera: Cicadidae) are insects drawing attention by the sounds they make during the summer months and the damages of which in agricultural areas are often unnoticeable. The cicadas that cause damage mostly in fruit trees spend most of their lives in the soil, around plant roots in the nymph period. Nymph periods take years in some species.

Females lay their eggs more into the holes they make on one-year shoots of fruit trees in groups. These holes in the shoots on which eggs are laid expand with the growth of the shoots, and wounds occur. These shoots wounded in the later years pave the way for the entry of other diseases and pests. They also cause shoot drying in weak shoots on which eggs are laid. Nymphs do the main damage of the cicadas. Nymphs suck sap in the roots of the host plants and cause shoots to be weak, internodes to be shortened, leaves to shrink, turn yellow and fall off.

There are a limited number of studies regarding the cicadas in Turkey. In these studies (Bodenheimer, 1958; Nizamlioğlu and Gökmen, 1964; Anbaroğlu, 1967; Kartal, 1974; Lodos,

1986), attention was drawn to the damage of cicadas to some cultivated plants by emphasizing the importance of cicadas. However, the information on this topic is not adequate.

There is a need for accurate identification of the species and accurate knowledge of its biology, damage, and density for accurate and successful management practices in cultivated plants. Therefore, the cicadas found in the cherry orchards in Izmir which is one of Turkey's most important cherry production areas were addressed and investigated, and the findings obtained in regard to the distribution, some morphological and bio-ecological characteristics of *Cicada mordoganensis* (Hemiptera: Cicadidae) species were assessed in this article.

Material and Methods

The samples of the *Cicada mordoganensis* Boulard (Hemiptera: Cicadidae) adult and pre-adult periods and the fruit trees constituted the material of this study.

To determine the distribution area of the pest, survey studies were carried out in all districts of Izmir (Turkey) in the months of May-October in 2005-2006. The studies related to the biology were carried out in an orchard which is located in Yukarıkızılcı town of Kemalpaşa and where this species exists in 2005-2008.

The samples delivered to the laboratory were examined in a stereoscopic microscope to reveal the morphological characteristics of the adult, last nymph instars and shed skins of last nymph of *C. mordoganensis*, and the necessary morphometric measurements were made on the color and design situations, head, thorax, abdomen, antennae and wing structures of them. Measurements were made over 20 male and 20 female individuals with caliper and micrometer. It was benefited from Motta (2003) in determining the distinctive features.

The observations regarding biology were made by going to the experimental orchard at least twice a week in the months of June-August during which the adult emergence density is high. To determine the adult emergence density in the orchard, 10 wooden crates covered with mosquito net which were 160x25x10 cm (0,4 m²) in size were put under the canopy projection of the each of 10 trees. By means of these crates, the adult emergences that occurred under tree canopy projection were checked and directly monitored. Moreover, 10 trees were marked before the first adult emergence in the same orchard by a second method, the shed skins of last nymph of the emerged adults were counted and removed from the environment by checking the under-canopy, trunk and leaves of the trees, and information about adult density was obtained. In addition, it was observed that the time of adult females laid eggs on which plants and plant parts.

Results and Discussion

Morphological characteristics of *Cicada mordoganensis*

Adult

The adult is gray-beige colored and has two black, big and round compound eyes and three red simple eyes on the head. Antennas are black, bristle-shaped and six segmented; the stylet is 10 mm long; the head width is 8.06±0.20 mm in males (n=20) and 8.15 ±0.29 mm in females (n=20).

Vertex, pronotum, and mesoscutellum are gray-brown patterned; mesoscutellum is swaged and there are two adjoining U-shaped brownish patterns on it; prothorax is gray and black, wings cover up the abdomen in the shape of roof; there are seven punctiform blackish spots and four bigger blackish spots on the upper wing; wing veins are greenish black, and the point where the wings are attached to the thorax is gray (Figure 1). In males, the wingspan is 75.61±2.57 mm and

the body length is 39.71 ± 2.12 mm. In females, the wingspan is 77.53 ± 4.47 mm and the body length is 40.53 ± 1.81 mm.

The forelimb femur has two dentiform prominences; there are a total of five thorny prominences, three of them inside the hind leg tibia and two of them in the outer side. There are 12 thorny prominences on the place where the hind tibia is connected to tarsus; the dorsal of the abdomen is line-shaped brown banded and 8 segmented.

Shed skins of last nymph

It is light cream, there are light brown bands in the dorsal of the abdominal segments. The length of the shed skin of nymph is 22.44 ± 1.07 mm in males (n=20) and 23.04 ± 1.12 mm in females (n=20); the width of the shed skin of nymph is 7.12 ± 0.26 mm in males and 6.55 ± 0.68 mm in females (Figure1).

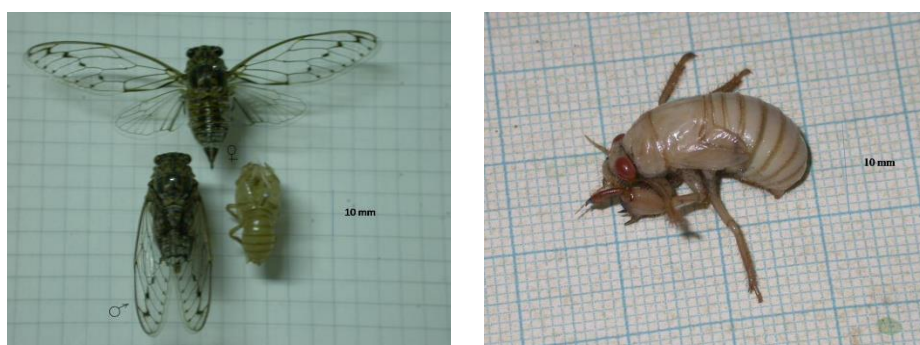

Figure 1. Adult, shed skin of last nymph and last nymph instars of *Cicada mordoganensis* Boulard.

Last nymph instars

The abdomen and mesothorax of last nymph instars are white, the bands between the wing extensions, prothorax, and abdomen segments are light brown; the compound eyes of the nymph turn red close to the adult emergence. The head capsule width of the last nymph instars (n=10) is 6.27 ± 0.25 mm, its body length is $21,77 \pm 1.43$ mm and the width is $8,10 \pm 0.58$ mm (Figure1).

Distribution

Cicada mordoganensis adults were found in all districts of Izmir province where the studies were carried out. They were not found in the cherry orchards in some districts (Beydağ, Dikili, Kınık and Menemen), but they were observed in the olive groves and pine trees near the orchards. They were found in 58.16% of 98 orchards controlled.

In the studies carried out previously, it was reported by (Lodos and Kalkandelen, 1981) that this species is an endemic species which is only found in Turkey around the world, and it is found in Antalya, Izmir and Mugla provinces in Turkey

Biology

Adult emergence time and duration

The first and latest observation dates of *C. mordoganensis* adults in nature in 2005-2008 and the period of their existence in nature (days) are determined.

In the four-year study carried out, it was determined that *C. mordoganensis* adults were observed in nature during the period from the second week of June to mid-October. Flight duration of this

species is about 110-115 days. Lodosand Kalkandelen (1981) reported that they collected *C. mordoganensis* adults from nature during the period from the beginning of June until the beginning of August.

Adult densities

The adult density of *C. mordoganensis* in the orchard in Yukarıkızılca in 2005-2008; while a total of 7 shed skins of last nymph were observed in 10 trees during the year of 2005, no adult could be obtained in 10 crates. In 2006, adult emergence was not determined in 10 trees and 10 crates. While 7 shed skins of last nymph were counted in 10 trees in the same orchard in 2007, 1 adult was obtained in 10 crates. In 2008, while a total of 2 shed skins of last nymph were determined in 10 trees all the year round, there was no adult emergence in 10 crates.

In the observations made in the orchards where the studies were carried out, it was observed that the adult density of *C. mordoganensis* in cherry orchards was 2-3 per orchard, but the adults were denser in olive groves near the cherry orchards.

The density of last nymph instars was observed to be very low in the orchards where the survey was carried out in Izmir province in 2005-2006, and the shed skin of nymph was found only in 9 orchards. The nymph density (1-25 shed skins of nymph/10 trees) was found to vary in these orchards. However, adults were determined in most of the orchards. From the orchards where the studies were carried out, a nymph belonging to this species was only found in one orchard in 2005. Their nymphs were found in olive trees within and around the cherry orchard. Adults were observed on different fruit trees such as olive, cherry, peach, walnut, poplar, plane tree, fig, and pistachio.

Egg-laying

Females were observed to lay their eggs on the bark of trunk of olive and cherry trees and the dry pine piles put into the soil to support olive seedlings while they were in the head up position. However, when the eggs were hatched could not be determined.

It was observed that *C. mordoganensis* adults were mostly found on the trunk and thick branches of the trees, and they flew to the nearest trees by zigzagging when being approached.

No information about the egg-laying behaviors and the hatch time of *C. mordoganensis* adults could be encountered in the literature.

Conclusions

When the results obtained from this study which was carried out in Izmir province in 2005-2008 were assessed as a whole, it was determined that *C. mordoganensis* was found in fruit production areas in all districts of Izmir province, their adults were observed during an 110-15-day period from the second week of June until mid-October, they were mostly observed on perennial plants such as olive, cherry, poplar, walnut, plane tree, pine, fig, peach and wild pistachio trees, and their eggs were laid on the flaked bark of the trunk of olive and cherry trees and the dry pine piles put into the soil to support olive seedlings. It was not possible to compare the findings obtained with the previous findings because there is not any biological and ecological study which was carried out previously on this species. This study is expected to contribute to future studies.

References

- Anbarođlu M. A.(1967). Asma ađustosböceđi (*Chloropsalta viridissima* Walker) üzerinde arařtırmalar [Investigations on *Chloropsalta viridissima* Walker]. *Bitki Koruma Bülteni*, 4: 145-154.
- Bodenheimer F. S. (1958). Türkiye’de Ziraata ve Ađađlara Zararlı Olan Böcekler ve Bunlarla Savař Hakkında Bir Etüt [A Survey on Pests Causing Damage to Agriculture and Trees in Turkey and Fighting Against Them]. 320 p.
- Kartal V. (1974). Ankara Çevresinde *Cicadatra persica* Kirk. (Homoptera: Cicadidae)’nın Ekolojisi Üzerinde Arařtırmalar [Investigations on the Ecology of *Cicadatra persica* Kirk. (Homoptera: Cicadidae) Around Ankara]. Ankara Üniversitesi Fen Fakültesi Sistematik Zooloji Kürsüsü, 87 p, (Basılmamıř doktora tezi).
- Lodos N., Kalkandelen A. (1981). Preliminary list of Auchenorrhyncha with notes on distribution and importance of species in Turkey, V families Flatidae, Ricaniidae and Cicadidae. *Türkiye Bitki Koruma Dergisi*, 5 (2): 67-82.
- Lodos N.(1986). Türkiye Entomolojisi II. Genel, Uygulamalı ve Faunistik (II.Basım) [Turkey Entomology 2nd General, Applied and Faunistic (2nd Edition)].Ege Üniversitesi Ziraat Fakültesi, Yayın No: 429: 93-104.
- Motta P.C.(2003), Cicadas (Hemiptera, Auchenorrhyncha, Cicadidae) from Brasilia (Brazil): exuviae of the last instar with key of the species. *Revista Brasileira de Zoologia*, 20 (1): 1-6.
- Nizamlıođlu, K.,Gökmen N. (1964). Türkiye’de Zeytine Zarar Veren Böcekler [Insects Causing Damage to Olives in Turkey].Yenilik Basımevi, İstanbul, 9-14.

CONTROL OF CYDIA POMONELLA L. IN APPLE ORCHARDS WITH ACETAMIPRID

Slavica VUKOVIĆ*, Sanja LAZIĆ, Srđana PETROVIĆ, Dragana ŠUNJKA, Antonije ŽUNIĆ

University of Novi Sad, Faculty of Agriculture, Novi Sad, Serbia

*Corresponding author: vukovic@polj.uns.ac.rs

Abstract

In Serbia, the codling moth (*C. pomonella* L.) occurs regularly in all apple orchards. It is one of the most important pests of apple. Damaged fruits mature and decline prematurely. Their market value is reduced, and during storage they are prone to decay. The pest also attacks pear, quince, peach, apricot, cherry and crab-apple fruits. Thus, exposure of the codling moth, as a target or non-target organism to insecticide effects increases selection pressure on the *C. pomonella*, which results in a decrease of its susceptibility, and finally the occurrence of resistance to the applied insecticides. During 2015, the trials were carried out according to the standard EPPO methods with the aim to establish the level of apple protection against the codling moth, by use of two products based upon acetamiprid (200 g a.i./L product) of SG formulations. In apple orchards at localities Sremski Karlovci, Kovilj and Tavankut, on varieties Idared and Granny Smith, the products based on acetamiprid were foliar applied at a concentration of 0.025%, by backpack sprayer. The experiment was set up in four replications in randomised block design. The efficiency of the insecticides was performed according to Abbott, and significance of differences (ANOVA) for the confidence interval of 95%. Nine days after application of the product based on acetamiprid, the efficacy at locality Sremski Karlovci was 88.9-91.6% and 27 days after the application, the product showed the efficacy 87.2-89.7%. Seven days after insecticides were applied at locality Kovilj, efficacy was 80.5-91.6%, while after 21 days was 93.1-94.8%. At locality Tavankut, 14 days after the treatment, the efficacy of the insecticide based on acetamiprid was 84.4%, and 24 days after the application 81.2%. The applied insecticides showed high efficacy in protection of apple fruits from *C. pomonella* in agricultural production conditions of Vojvodina province.

Key words: *Apple, C. pomonella, Acetamiprid, Efficacy.*

Introduction

Modern technology of apple production is highly intensive, very complex and requires a large investment of human labor and resources in economic terms, and also in terms of human health care it requires very high standards. In the Republic of Serbia apple is the most common fruit species after plum. According to the census of agriculture (2012) apple is produced on 23.737 ha (Anonymous, 2013). In Vojvodina, apple is the most common fruit species and is produced on 6.347 ha. Standard of apple production in developed countries is raising of dense high-intensity orchards with anti-hail nets, irrigation systems and also the introduction of quality standards (Global GAP and Integrated Production) (Keserović et al., 2013). However, traditional seedlings with the outdated assortment and wide distances between plants are still the most common in fruit growing in Serbia. In the last few years in our country, dense high-intensity apple orchards with cultivation technology based on the integral concept and Global GAP standard of food production were raised. Limiting factors for raising of modern orchards include: apple sensitivity to diseases

and pests, inadequate quality of soil, low winter temperatures, frequent spring frosts, lack of rainfall, windiness, etc. (Gvozdenović, 1998).

The apple is a species that requires the greatest number of treatments in control of pests and diseases. The most important pests on apples are codling moth (*C. pomonella* L.), apple aphid (*Aphis pomi* de Geer), woolly apple aphid (*Eriosoma lanigerum* Hausm.), San Jose scale (*Quadraspidiotus perniciosus* Comst.), apple ermine moth (*Yponomeuta malinellus* Zeller), leaf miners (round mines - *Lyonetia clerkella* L.; marble mines - *Phylonororycter blancardella* Fabr.; white mines - *P.corylifoliella* Hübner), rosy apple aphid (*Dysaphis plantaginea* Pass.) and others that occur occasionally (Almaši et al., 2004).

Codling moth occurs regularly every year. It is one of the most important pests in orchards, particularly in apple orchards. Permanent and often causes very high damages, that results in premature fruit drop, worm-eaten fruit and difficult preservation during storage, primarily due to untimely and inadequate protection without which apple cultivation is unimaginable. The fact is that the control of codling moth is difficult, primarily because of the long presence of moths in orchards, stretched and overlapping generations, to which, among other things, affects climate, not just in particular year, but in different localities (Graora, Jerinić-Prodanović, 2005).

In recent years, in a numerous orchards, a high number of damaged apples were detected, which endangered the profitability of production. Codling moth also damages fruit of pear, quince, peach, apricot, cherry and walnut. Therefore, codling moth exposure as a target or non-target organism to the effects of insecticides increases selection pressure which results in a reduction of the sensitivity, and finally with the occurrence of resistance to the applied insecticides. In the regions of Serbia changes in the efficacy of some insecticides have been recorded, but has not been permanent control or monitoring of susceptibility for this pest to insecticides. Due to the necessary application of insecticides for protection of the apple from *C. pomonella*, there are very good reasons to apply insecticides with favourable toxicological and eco-toxicological properties for its suppression.

The aim of this study was to determine the level of protection of apple orchards from *C. pomonella* using an acetamiprid based products.

Materials and methods

The experiments were carried out in 2015 at the localities of Vojvodina (Sremski Karlovci and Tavankut), according to the standard EPPO methods for design of experiments and data analysis (Anonymous, 2012); the efficiency of insecticides in the control of codling moth (Anonymous, 2004) and phytotoxicity (Anonymous, 2014). Acetamiprid Mospilan SG and SG 20 (acetamiprid 200 g/kg) preparations were applied at a concentration of 0.025%, a foliar spray, using backpack sprayer "Solo", with water consumption of 1000 L/ha. The apple varieties Idared and Granny Smith in the locality Sremski Karlovci are 14 years old and are planted at a distance of 3.6 x 1.6m. The same plant spacing of apple variety Idared is in 7 years old orchard in locality Tavankut.

For the suppression of the first generation codling moth the treatment was carried out in Sremski Karlovci on 19th May 2015 and in Tavankut on 23rd May 2015. Apples were in BBCH 74 phenophase (fruits were upright, with a diameter up to 40 mm). The experiment was set up in four replications with basic plot arrangement in a randomised block design. The size of the basic plot consisted of four apple trees. Before the experiment, at both sites, the number of captured codling moths in pheromone traps (Csalomon®) was monitored and identified.

The effect of the product was determined on the basis of the number of damaged fruits (accessed 300 fruits per repetition) caused by codling moth larvae. The first evaluation of the effects in

Sremski Karlovci was performed 9 days and the second 27 days after insecticide application. In Tavankut the first assessment was executed on 14 days and the second on 24 days after spraying. Results of the trial are shown through absolute and mean values for the number of damaged fruits, standard deviation of the average values (Sd), efficiency (E%) according to Abotty (Wentzel, 1963) and the significance of differences (ANOVA) for the 95% confidence interval.

Results and discussion

Results of the insecticide acetamiprid efficiency test in apple orchards applied to suppress population of *C. pomonella* are given in Tables 1 and 2. Nine days after insecticide application number of damaged apples, compared to the control, was significantly lower. The efficiency of the tested insecticides is 88.9-91.6%, all at the same level of significance (Table 1). After 27 days from the application, the number of damaged fruits was significantly lower compared to the control. The efficiency of the tested insecticides was 87.2-89.7 %, depending on the product. Both of the acetamiprid based insecticides, with the same content of active substance and the same formulation, achieved efficiency at the same level of significance.

In comparison to the control, 14 days after insecticide application, a number of damaged apples was significantly lower. The efficiency of the tested product was 84.4-86.7% (Table 2). After 24 days of treatment, the number of damaged apples was at a significantly lower level compared to the control with insecticides efficiency of 81.2-85.4%. During this study no phytotoxic effects were recorded in the apple varieties Idared and Granny Smith in both localities.

Table. 1 The average number of damaged apples and efficacy of insecticides in control of *C. pomonella* (Sremski Karlovci, 2015)

Insecticides (%)	9days after the treatment			27 days after the treatment		
	x	Sd±	E%	x	Sd±	E%
Acetamiprid SG (0,025)	1.0 b	1.41	88.9	1.25 b	0.81	87.2
Mospilan 20SG (0,025)	0.75 b	0.95	91.6	1.0 b	0.95	89.7
Control	9.0 a	2.83		9.75 a	1.26	
LSD (0,05%)	3.44			2.05		

x –average number; Sd± - standard deviation; E %- efficacy

Table. 2 The average number of damaged apples and efficacy of insecticides in control of *C. pomonella* (Tavankut, 2015)

Insecticides (%)	14 days after the treatment			24 days after the treatment		
	x	Sd±	E%	x	Sd±	E%
Acetamiprid SG (0,025)	1.50 b		86.7	1.75 b		85.4
Mospilan 20SG (0,025)	1.75 b	1.25	84.4	2.25 b	0.5	81.2
Control	11.25a	2.87		12.0a	3.91	
LSD (0,05%)	4.59			5.57		

x –average number; Sd± - standard deviation; E %- efficacy

Comparison of the number of affected and damaged fruits, depending on the location showed very uniform presence of damaged fruits in both locations, considering that the applied measures for *C. pomonella* control were carried out on a regular basis. Having in mind the possibility of changing the sensitivity of harmful species exposed to high selection pressure when suppressing,

the nature and mechanisms of action of registered insecticides that are in use, sensitivity monitoring of insects and prescribed strategies in the application of pesticides in the very near future will be the basis of measures for modern technologies of plant production.

Testing *C. pomonella* resistance to insecticides suggest that the codling moth showed resistance towards azinphos-methyl, phosmet, lambda-cyhalothrin, indoxacarb, but did not evolved resistance towards acetamiprid and spinosad (Mota-Sanchez et al., 2008). Laboratory tests Knight (2010) have shown that acetamiprid exhibits a high efficiency and significantly reduces the fertility of *C. pomonella*. Based on the assessment from response of newly hatched larvae of *C. pomonella* towards three insecticides (azinphos-methyl, acetamiprid and thiacloprid), and a role of cytochrome P450 monooxygenase in their toxicity Cichón et al. (2013) concluded that all the tested populations of *C. pomonella* in field conditions (Argentina) exhibited significantly lower mortality at discriminatory concentrations of azinphos-methyl and acetamiprid, while 13 of the 14 populations demonstrated a significantly lower mortality and also with the application of thiacloprid.

Conclusions

Based on the achieved results of field trials and the actions undertaken for codling moth control in 2015 at Sremski Karlovci and Tavankut, the following can be concluded:

- In the locality Sremski Karlovci, 9 and 27 days after application of products Acetamiprid SG and SG Mospilan 20, a number of damaged apples was at a significantly lower level compared to the control. The efficacy of Acetamiprid SG was 87.2 - 88.9%, and of Mospilan 20 SG was 89.7 - 91.6%;
- In Tavankut, 14 and 24 days from the application of insecticides, the number of damaged fruits was significantly lower compared to the control. The efficacy of Acetamiprid SG ranged from 85.4 - 86.7%, while the efficiency of the Mospilan 20 SG ranged between 81.2 - 84.4%.

Acknowledgement

This study was part of the project III46008, funded by the Ministry of Education, Science and Technological Development of the Republic of Serbia.

References

- Anonymous (2004). *Cydia pomonella* PP 1/7(3). EPPO Standards, Guidelines for the Efficacy Evaluation of Plant Protec. Products. Insecticide and Acaricides, OEPP/EPPO, Paris, Vol.3, 4-7.
- Anonymous (2012). Design and analysis of efficacy evaluation trials. PP 1/152(4), EPPO Bulletin, 42 (3), 367–381.
- Anonymous (2013). Statistical Yearbook of the Republic of Serbia 2013, Republic Institute of Statistics.
- Anonymous (2014). Phytotoxicity assessment, PP 1/135(4). EPPO Bulletin, Vol 44 (3), 265-273.
- Almaši R., Injac M., Almaši Š. (2004). Harmful and beneficial organisms of pome fruit. University of Novi Sad. Faculty of Agriculture.
- Cichón LB, Soleño J, Anguiano OL, Garrido SA, Montagna CM. (2013). Evaluation of cytochrome P450 activity in field populations of *Cydia pomonella* (Lepidoptera: Tortricidae) resistant to azinphosmethyl, acetamiprid, and thiacloprid. J. Econ Entomol., 106(2), 939-44.
- Graora D., Jerinić – Prodanović, D., (2005). The flight dynamics and harmfulness of codling moth (*C. pomonella* L.) Plant doctor, 615.

- Gvozdenović, D. (1998). Apple, University of Novi Sad. Faculty of Agriculture.
- Keserović Z., Magazin N., Injac M., Totis F., Milić B., Dorić M., Petrović J., (2013). Integrated production of apples. Faculty of Agriculture, Novi Sad.
- Knight A.L. (2010). targeting *Cydia pomonella* (L.) (Lepidoptera: Tortricidae) adults with low-volume applications of insecticides alone and in combination with sex pheromone. Pest Manag. Sci. DOI 10.1002/ps.1932.
- Mota-Sanchez D, Wise JC, Poppen RV, Gut LJ, Hollingworth RM. (2008). Resistance of codling moth, *Cydia pomonella* (L.) (Lepidoptera: Tortricidae), larvae in Michigan to insecticides with different modes of action and the impact on field residual activity. Pest Manag. Sci., 64(9), 881-900.
- Wentzel, H. (1963). The basic Principles of Crop Protection Field. Pflanzenschutz nachrichten Bayer.

Tymus vulgaris – ANTIMICROBIAL DRUG FROM NATURE

Vesna KALABA¹, Vesna GOJKOVIĆ², Željka MARJANOVIĆ BALABAN³, Dragana KALABA⁴

¹PI Veterinary Institute of the Republic of Srpska "Dr Vaso Butozan" Banja Luka Republic of Srpska, Bosnia and Herzegovina

² Faculty of Technology Zvornik, Republic of Srpska, Bosnia and Herzegovina

³Faculty of Forestry, University of Banja Luka, Republic of Srpska, Bosnia and Herzegovina

⁴Faculty of Medicine-Department of Pharmacy, Banja Luka, Republic of Srpska Bosnia and Herzegovina

*Corresponding author: vesna.kalaba@yahoo.com

Abstract

It is known that the essential oils of herbs possess antimicrobial activity against a broad spectrum of microorganisms. The subject of this study was to exam antimicrobial activity of essential oils of thyme and antimicrobial drugs against bacteria: *Escherichia coli* WDCM 00013, *Pseudomonas aeruginosa* WDCM00024, *Staphylococcus aureus* WDCM 00032, *Salmonella Typhimurium* WDCM 00031, *Salmonella enterica* WDCM 00030 coagulase positive staphylococcus *Providencia stuarti*, β haemolytic *Escherichia coli*, Streptococcus group D, *Staphulococcus aureus* and *Pseudomonas spp.* The essential oil of thyme had expressed an inhibitory effect on all tested pathogens. Zones of inhibition ranged in diameter from 5.00 mm in the case of *Pseudomonas aeruginosa* WDCMA 00024, up to 40.00 mm in the case of *Staphylococcus aureus* WDCMA 00034 and *Staphylococcus aureus* which is isolated from clinical materials (swabs of the nose). Because of these findings, the essential oil of thyme could find the extensive application in the food and pharmaceutical industries.

Key words: *Tymus vulgaris*, antimicrobial drugs, inhibition

Introduction

Thyme is a perennial, semi bushy plant, originating from the Mediterranean, where it grows in dry, sunny, rocky and little fertile soil.

A centuries-old knowledge and the use of thyme is evidenced by the many archaeological evidence and records. Since the ancient time it had been highly prized plant, which had been known and described by Hippocrates, Pliny the Elder and Hildegard of Bingen (Marković, 2013). In order to protect the food from rotting, in the Middle Ages thyme was used much as a spice, but due to the strong antiseptic effect it began to be used as antiseptic in hospitals and also from a traditional plant it became a drug that is widely used in modern phytotherapy. Germany Commission for drugs officially approved the use of this herb for treating bronchitis and catarrh of the upper airways. Thanks to the experience of tradicionale medicine thyme attributed analgesic, antiseptic and cardiotoxic properties and it is now widely used as stimulation of the cardiovascular system, encouraging secretion, urinary tract infections, as powerful vermicide (anti worms and larvae) (Rizk, 1986, Fayad *et al.*, 2013, Hanafi *et al.*, 2010).

Thyme is one of the most popular medicinal species. Depending of the place where it grows and small genetic differences can create different compounds. Depending on the chemical composition there are several chemotypes of thyme. Differences in chemotype is essential to the

process of distillation and of obtaining essential oils, while the dried plants are used as a tea drink these differences are not essential.

Some of thyme chemotypes as: thymol, carvacrol, geranyl/geranyl acetate, linalool 1.8 cineol/limonene, trans-tujanol, gamma-terpineol, alpha-terpineol, and names chemotypes come mainly from the dominant chemical compounds in certain essential oils.

The concentration of represented compounds is different. The main components, which are usually attributed to the role of the antibacterial properties of oils are present in a significant percentage, while some compounds found only in trace amounts.

Some of the components present in the oil act on the cellular membrane, which may cause certain changes and thus can be prevented further propagation of bacteria. The other component can operate on the other structure in the bacterial cell.

Many researches (researches conducted on the thyme, sage and oregano) have shown that components presented in small amounts have a critical role in the antimicrobial activity of essential oils of explored plants.

This appearance is attributed to the synergistic effect of these components of oil. Because of that essential oils in full composition show much more antimicrobial properties than their individual, the main components (Burt, 2004., Bakkal, 2008., Stojkovic *et al.*, 2013, Nazzaro 2013.).

Thyme essential oil contains thymol (20 to 50%) as a main component and carvacrol, which are known as compounds with strong antimicrobial and antioxidant activity (Feizi *et al.*, 2013, Janječić *et al.*, 2013.).

Many experiments have shown that some of the active compounds presented in the essential oil (carvacrol) can prevent the spread of *Salmonella spp.* in meat, as well as to reduce the number of aerobic bacteria in meat and meat products, and the antibacterial *E. coli*, *Staphylococcus aureus*, *Streptococcus pneumoniae*, *Mycoplasma gallisepticum*, *Clostridium perfligens*, *Salmonella enterica*, *Clostridium perfringens* (Janječić *et al.*, 2013., Feizi *et al.*, 2013.).

Application of essential oils is partly limited due to their intense taste and smell. However, thanks to the advancement of technology it is possible to combine successfully the microbiological stability and sensory quality (Fortino *et al.*, 2012, Tajkarimi *et al.*, 2010, LvF *et al.*, 2011, Hyldgaard *et al.*, 2012).

A growing problem of resistant bacteria on antibiotic, undesirable effects of the antimicrobial drugs, and interest in natural medicines, have led to a reevaluation and taking into consideration phytoterapy treatment of bacterial infections, because the essential oils have antitumor, anticancer, antiinflammatory, antispasmodic, sedative, analgesic, anticoagulant, antirheumatic, vasodilating, hypotensive, hypilipidemic and other effects (Bakkali *et al.*, 2008., Reichling *et al.*, 2009., Hieu *et al.*, 2010., Neira *et al.*, 2010., Hamid *et al.*, 2011.).

The aim of this research is to determine antimicrobial activity of various antimicrobial drugs to the increase of the reference culture *Escherichia coli* WDCMA 00013, *Pseudomonas aeruginosa* WDCM00024, *Staphylococcus aureus* WDCMA 00032, 00031 WDCMA *Salmonella Typhimurium*, *Salmonella enterica* WDCMA 00030 (BCCM™/LMG BACTERIA COLLECTION, Belgium), then, *Providencia stuarti*, coagulase-positive staphylococci, β -haemolytic *Escherichia coli*, streptococcus group D, *Staphulococcus aureus* and *Pseudomonas spp.* which werere isolated from clinical material. As well as to determine the effect of the essential oil of thyme on the growth of these pathogens and to determine whether the essential oil of thyme show bactericidal or bacteriostatic effect on them.

Material and Methods

In this paper commercially essential oil of thyme was used.

To test the antimicrobial activity of essential thyme oil, reference culture of *Escherichia coli* WDCMA 00013, *Pseudomonas aeruginosa* WDCM00024, *Staphylococcus aureus* WDCMA 00032, 00031 WDCMA *Salmonella Typhimurium*, *Salmonella enterica* WDCMA 00030 (BCCM™ / LMG BACTERIA COLLECTION, Belgium) were used, then *Providencia stuarti*, coagulase-positive staphylococci, β -haemolytic *Escherichia coli*, streptococcus from group D, *Staphylococcus aureus* and *Pseudomonas spp.* which were isolated from clinical material. Cultures were seeded in tryptone soy broth and incubated at 37 °C / 18h. Petri plates with the appropriate substrate (Mueller - Hinton agar) were seeded with 0.5 ml of the bacterial suspension in the concentration of 10⁵ cfu / ml.

To determine sensitivity of bacteria to reference antimicrobial drugs a method of antibiogram was used. As a standard to determine antimicrobial activity amoxicillin, streptomycin, bacitracin, cefotaxime, ceftazidime, doxycycline, norfloxacin, oxacillin, cefahlor and gentamicin ("Liofilchem" S.R. Italy) were used.

To test the effects of thyme oil to inhibit the growth of bacteria *Listeria monocytogenes* WDCMA 00020, *Pseudomonas aeruginosa* WDCM00024, *Escherichia coli* WDCMA 00090, 00031 WDCMA *Salmonella Typhimurium*, *Salmonella enterica* WDCMA 00030 and *Staphylococcus aureus* 00034 WDCMA agar diffusion method on solid sterile nutrient medium was used (Müeller- Hinton- agar-MHA) (Kirby Bauer, 1996). Cylinders, 9 mm in diameter were put on the surface of a solid culture medium on which a particular pure bacterial culture was previously seeded. 100 μ l of essential oil was instilled in the cylinder with micropipette. 100 μ l of 96% alcohol was instilled in the cylinder as a control. Ability of growth and reproduction of the strain depends on its resistance/sensitivity to tested extract, thus around the cylinder it is formed a clear, transparent zone in which there is no growth of microorganisms if the effect exists.

Besides the essential oil, discus slips of paper were placed on the plates as a reference antimicrobial drugs: amoxicillin, streptomycin, bacitracin, cefotaxime, ciprofloxacin, ceftazidime, doxycycline, norfloxacin, oxacillin, gentamicin and cefahlor.

Petri plates which were incubated 24 hours at a temperature of 37 °C



Fig. 1. Commercial thyme oil



Fig. 2 Antimicrobial drugs

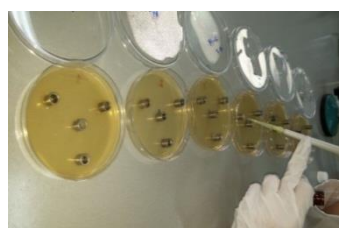

Fig. 3. Disk diffusion method

For the essential oil of thyme and the reference antimicrobial drugs three replication were carried out. The results were read as the diameter of the zone of inhibition of growth and expressed as the mean value in millimeters.

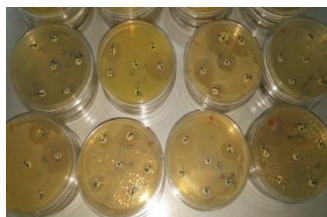

Figure 4. Reading the results
Type of activity

The type activity of essential oil was also determined. In order to see whether thyme oil has bactericidal or bacteriostatic effect, a small piece of agar was extracted from inhibition zone and added to the nutrient broth. Incubation was done at 37 ° C / 24 h. If, after the incubation, appears a turbidity of the broth, it is considered that the effect of oil is bacteriostatic, or if after the incubation broth remains clear, the effect of the oil is bactericidal.



Figure 5. Bactericidal and bacteriostatic effect of the essential oil of thyme

Results and Discussion

Table 1 shows the results which were obtained by testing the effects of different antimicrobial drugs on the growth of tested pathogenic bacteria.

Table 1. Zones of growth inhibition of tested pathogens achieved with antimicrobial drugs

Microorganisms	Antimicrobial drug (inhibition zone measured in mm)									
	AM.	STR.	BAC.	CEFO.	CEFT	DOX.	NORF.	OX.	CEF.	GEN.
<i>S. typhimurium</i> WDCM 00031	0,00	13,00	0,00	20,00	0,00	21,00	36,00	0,00	8,00	18,00
<i>L. monocytogenes</i> WDCM 00020	10,00	24,00	16,00	12,00	12,00	38,00	26,00	0,00	12,00	24,00
<i>E. coli</i> WDCM 00090	0,00	15,00	24,00	18,00	0,00	25,00	39,00	0,00	15,00	20,00
<i>St. aureus</i> WDCM 00034	15,00	16,00	18,00	13,00	0,00	30,00	34,00	0,00	13,00	21,00
<i>Ps. aeruginosa</i> WDCM 00024	0,00	12,00	25,00	0,00	0,00	0,00	34,00	0,00	0,00	20,00
<i>S. enterica</i> WDCM 00030	0,00	18,00	16,00	0,00	15,00	23,00	40,00	16,00	0,00	25,00
<i>Providencia</i> <i>stuartii</i>	0,00	0,00	0,00	0,00	0,00	0,00	0,00	0,00	0,00	0,00
<i>Coagu.pos.</i> <i>Staphylococcus</i>	0,00	15,00	20,00	0,00	0,00	13,00	38,00	0,00	0,00	24,00
β- haemolytic <i>E. Coli</i>	0,00	0,00	0,00	20,00	19,00	16,00	40,00	0,00	0,00	22,00
<i>S. aureus</i>	0,00	21,00	25,00	30,00	0,00	40,00	40,00	0,00	20,00	25,00
<i>Streptococcus</i> Group D	10,00	20,00	30,00	21,00	0,00	25,00	31,00	0,00	20,00	24,00
<i>Pseudomonas</i> spp.	0,00	0,00	21,00	20,00	0,00	0,00	40,00	0,00	20,00	0,00

AM-amoxicillin; STR-streptomycin; BAC-bacitracin; CEFO-cefotaxime; CEFTA ceftazidime; DOX-doxycycline; Norf-norfloxacin; OKS-oxacillin; CEF cefahlor; GEN-gentamicin

As it is evident that tested bacteria of *S. typhimurium* WDCMA 00031, *E. coli* WDCMA 00090, *Ps. aeruginosa* WDCMA 00024, *S. enterica* WDCMA00030, *Providencia stuarti*, coagulase-positive staphylococci, β hem. *E. coli*, *S. aureus* were resistant to amoxicillin and oxacillin. *Providencia stuartii* isolated from the clinical material was resistant to all antimicrobial tested

drugs. Also, it is evident that all tested pathogens showed multiple resistance. The antimicrobial drug with the mostly expressed zone of inhibition i.e. norfloxacin was used to compare the activity of essential oil of thyme. The results obtained by testing the influence of essential oil of thyme to different pathogens are shown in Table 2.

Table 2. Zones of inhibition on growth of tested pathogens achieved with essential oil of thyme

Microorganism	The zone of inhibition in mm
	The essential oil of thyme
<i>Salmonella typhimurium</i> WDCM 00031	31,00
<i>Listeria monocytogenes</i> WDCM 00020	35,00
<i>Escherichia coli</i> WDCM 00090	17,33
<i>Staphylococcus aureus</i> WDCM 00034	40,00
<i>Pseudomonas aeruginosa</i> WDCM 00024	5,00
<i>Salmonella enterica</i> WDCM 00030	19,33
<i>Providencia stuarti</i>	33,33
Coagulase positive <i>Staphylococcus</i>	32,00
β - hemolytic <i>Escherichia coli</i>	32,66
<i>Staphylococcus aureus</i>	40,00
Streptococcus Group D	38,00
<i>Pseudomonas spp.</i>	28,33

* The values shown are given in mm and the mean of inhibition zone in three measurements

As it is evident, the essential oil of thyme expressed antimicrobial activity against all tested bacteria. The zone of inhibition ranged in diameter from 5.00 mm in the case of *Pseudomonas aeruginosa* WDCMA 00024, up to 40.00 mm in the case of *Staphylococcus aureus* WDCMA 00034 and *Staphylococcus* isolated from clinical materials (swabs of the nose). If we present maximum inhibition zones of essential oil of thyme and compare to the inhibition zone the most effective antimicrobial drug norfloxacin, then results as in Figure 6 are obtained.

From the displayed graphic it is evident that the essential oil of thyme has more expressed antibacterial activity against *Listeria monocytogenes* WDCMA 00020, *Staphylococcus aureus* WDCMA 00034, *Providencia stuarti*, *Streptococcus* group D, than norfloxacin. It is also notable that the oil has the same effect as norfloxacin on *Staphylococcus aureus* isolated from clinical material.

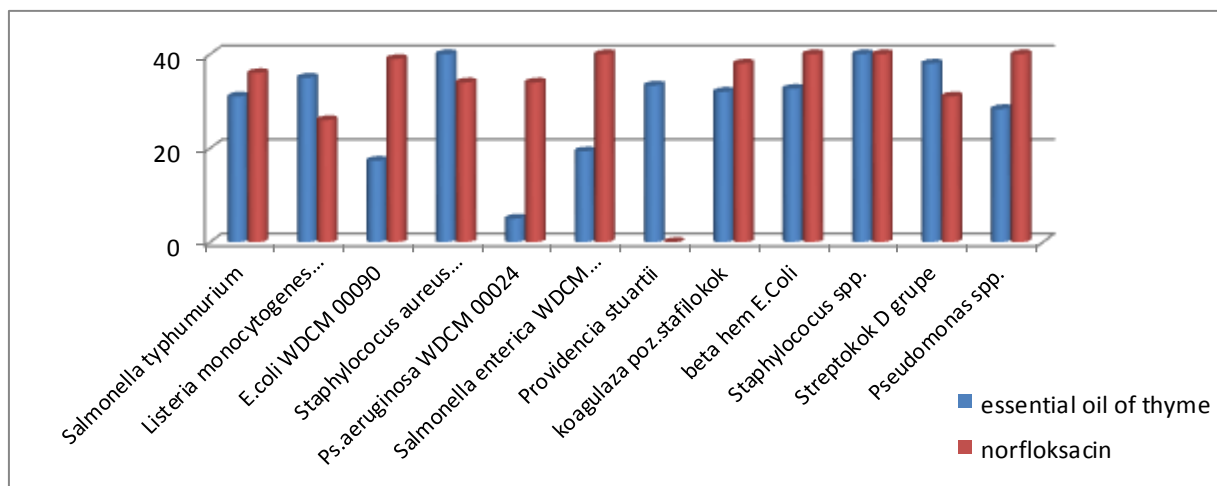

Figure 6. Comparison of maximal inhibition zones of essential oil of thyme and antimicrobial drug norfloxacin

Also, it is important to point out that the essential oil of thyme showed strong antibacterial activity against bacteria *Providencia stuartii* isolated from clinical material that was resistant to all antimicrobial drugs used in this paper.

The essential oil of thyme have bactericidal effect on all tested bacteria, except *Pseudomonas aeruginosa* WDCMA 00024, in which case it showed bacteriostatic effect.

The results of our research are in accordance with the results of the other researchers (Panizzi *et al.*, 1989., Griffin *et al.*, 1999, Kalaba *et al.*, 2014., Kalaba *et al.*, 2014a., Feizi *et al.*, 2013., Janječić *et al.*, 2013., Stojkovic *et al.*, 2013., Bajpai *et al.*, 2012., Jayasena, 2013., Basho *et al.* 2010., Lopez *et al.*, 2007., Lević *et al.*, 2011., Ahmad *et al.*, 2006., Stanković *et al.* 2011.,).

Even though many studies dealt with the antimicrobial activity of essential oil of thyme because of these characteristics, the essential oil of thyme deserves further, more detailed testing because it is necessary to establish the conditions in which the use of essential oil of thyme has positive effects. When testing the food it is important to take into account the interaction of biologically active components with components of food (fats, proteins, etc.) despite numerous advantages that essential oils provide, the use of essential oils can have negative consequences. Therefore, it is necessary to study which concentration and the amount are required to achieve the satisfactory effect.

Conclusion

Thyme as a plant species is a very rich in bioactive components that have found their application since the ancient times in traditional medicine and in the current medicine. It opens the field for new research and application of thyme and its isolated components in the treatment of many diseases (diseases caused by microorganisms resistant to antimicrobials, cancer, and many other infectious diseases) or in the food industry and as a food additive and as an excellent preservative.

References

- Ahmad, A.M., I.Khokhar, I. Ahmed, M.A.Kashmiri, A. Adnan, M.Ahmed (2006): Study of antimicrobial activity and composition by GC/MS spectroscopic analysis of the essential oil of *Thymus serpyllum*, *Internet Journal of Food Safety*, vol.5, 56-60
- Al-Kassie, A.M (2009): Influence of TwoPlant extracts derived from Thyme and Cinnamon on broiler performance *Pakistan Veterinary Journal*; 29:169-173
- Bakkali F, Averbeck D, Idaomar M (2008): Biological effects of essential oils-A review. *Food Chem Toxicol* 46(2): 446-475
- Burt S. (2004): Essential oils: their antibacterial properties and potential applications in foods—a review, *International journal of food microbiology*, vol. 94, 223-253
- Bajpai, V. K., Baek, K. H., Kang, S. C. (2012): Control of Salmonella in foods by using essential oils: A review. *Food Research International*, vol. 45, 722-734.
- Bassole, I. A. Lamien- Meda, B.Bayala, S.Tirogo, C. Franz, J. Novak, R. Nebie, M. Dicko (2010): Composition and antimicrobial activities of *Lippia multiflora* Moldenke, *Mentha x piperita* L and *Ocimum basilicum* L essential oils and their major monoterpene alcohols alone and in combination, *Molecules*, vol.15 (11):7825-7839

- Fayad, N.K.O.H.Obaidi, T.H.Noor,M.O.Ezzat (2013): Water and alcohol extraction of Tyme plant (*Tymus vulgaris*) and activity study against bacteria, tumors and used as anti-oxidant in margarine manufacture, *Innovative Systems Design and Engineering*, vol No 1: 41-51
- Feizi, A-, Bijanzad,P.,Kabali,K. (2013): Effects of thyme volatile oils on performance of broiler chiockens.*European Journal of Experimental Biology*, 3:250-254
- Fortino Solorzano- Santos, Maria Guadalupe Miranda- Novales (2012.): Essential oils from aromatic herbs as antimicrobial agents , *Food biotechnology-Plant biotechnology*,Vol. 23 Issue 2; 136-141
- Griffin S.G., S.G. Wyllie J.L. Markham, D.N.Leach (1999): The role of structure and molecular properties of terpenoides in determining their antimicrobial activity, *Flavour Frag. J.* 14; 322-332
- Hamid AA, Aiyelaagbe OO, Usman LA (2011): Essential oils: its medicinal and pharmacological uses *Int.J.Curr Res* 33(2)86-98
- Hanafi EM, Danial EN, Abd El Razik KA (2010): Antimicotic agent treatment of mycotic mastitis in goat *IJAR* 2(4) 307-313.
- Hieu TT, Kim S-I, Lee S-G, Ahn Y-j (2010): Repellency to *Stomoxys calcitrans* (Diptera: Muscidae) of Plant Essential Oils Alone or in Combination With *Calophyllum inophyllum* Nut Oil. *J. Med Entomol* 47(4):575-580
- Hyldgaard M. , Mygind T., Meyer R. L. (2012): Essential oils in food preservation: mode of action, synergies,and interactions with food matrix components. *Front. Microbio.* Vol. 3(12). doi: 10.3389/fmicb.2012.00012
- Janječić Z. Gabrić K. Karapandža N., Matanović S. (2013): Zamjena antibiotika biološki djelatnim tvarima u hranidbi peradi, *Krmiva*, 55: 47-55
- Jayasena D. D., Jo, C. (2013): Essential oilsas potential antimicrobial agents in meat and meat products: A review, *Trends in Food Science & Technology*, <http://dx.doi.org/10.1016/j.tifs.2013.09.002>
- Kalaba Vesna, Dragana Kalaba (2014): Comparative effects of essential oils on growth of *Escherichia coli* *Carpathian Journal of Food science and Technology* Vol. 6(2)
- Kalaba Vesna, Marijanovic Balaban Zeljka, Stijepic Milka, Glusac Jovana, Dragana Kalaba (2014a): Antimicrobial activity of selected essential oils against of *Staphylococcus aureus* compared with antimicrobial drugs, *II International Congress Food Technology Quality and Safety*, Novi Sad 434-4394
- Kirby-Bauer A (1996): Antimicrobial sensitivity testing by agar diffusion method *J.Clin Pathol.*, 44; 493
- Lević, J. I. Čabarkapa, G. Todorović, S. Pavkov, S. Sredanović, T. Galonja, Lj. Kostadinović (2011): In vitro antibacterial activity of essential oils from plant family Lamiaceae, *Romanian Biotechnological Letters*, vol. 16(1), 6034-6041
- Lopez, P.C. Sanchez, R. Battle, C.Neri (2007): Vapor-phase activites of cinnamon, t, and oregano essential oils and key constituents against foodberne microorganisms, *J. Agric. Food Chem.* Vol.55:4348-4356
- Lv F., Liang H., Yuan Q., Li C. (2011): In vitroantimicrobial effects and mechanism of action of selected plant essential oil combinations against four food-related microorganisms. *Food Research International*, vol. 44, 3057-3064
- Marković S. (2013): Timijan simbol za hrabrost, Vaše zdravlje, Oktal Pharma, 91www.vasezdravlje.com/izdanj/clanak
- Neiro LS, Olivero-Verbel J, Stashenko E (2010): Repellent activity of essential oils: A review. *Bioessour technol* ,101(1) 372- 378

- Nazzaro Filomena, Florinda Fratianni Laura De Martino, Raffaele Coppola, V. De Feo (2013): Effect of essential oils on pathogenic bacteria, *Pharmaceuticals (Basel)* 6 (12): 1451-1474 (www.ncbi.nlm.nih.gov/pmc/articles; Published online 2013 Nov.25)
- Panizzi, L. G.Flamini,P.L. Cioni, I. Morelli (1989): *J.Ethnopharm* 39; 167
- Reichling J., Schnitzlerb P., Sallerc R.,(2009): Essential Oils of Aromatic Plants with Antibacterial, Antifungal, Antiviral and Cytotoxic Properties- an Overview. *Forsch Komplementned* 16(2):79-90
- Rizk A.M. (1986): *The Phyto Chemistry of Flora of Qatar*, King Print of Richmond, Great Britian
- Stanković N., Ljiljana R.Čomić, Branislava D. Kocić, D.M. Nikolić, Tatjana M. Mihajlov-Krstev, B. S.Ilić, D.L. Miladinović (2011) Antibacterial activity chemical composition relationship of essential oils from cultivated plants from Serbia, *Hem.ind* 65 (5)583-588
- Stojković, D., Glamočlija, J.,Ćirić, A., Nikolić, M., Ristić, M., Šiljegović, J., Soković, M. (2013): Investigation on antibacterial synergism of *Origanum vulgare* and *Thymus vulgaris* essential oils. *Archives of biological sciences*, vol. 65 (2): 639-643
- Tajkarimi M. M., Ibrahim S. A., CliverD. O. (2010): Antimicrobial herb and spice compounds in food. *Food Control*, vol. 21, 1199-1218. 48 23. *Food Research International*, vol. 44, 3057-3064.
- Zhu,X., Yuan S., Chen, H (2014): The effect of different dietary levels of thyme essential oil on serum biochemical indices in mahua broilers chickens. *Italian Journal of Animal Science*, 13:576-581

IMPROVING THE VIRULENCE OF A NATIVE BEAVERIA BASSIANA ISOLATE AGAINST RHYZOPERTHA DOMINICA ADULTS

Mehmet Kubilay ER*, Hasan TUNAZ, Ali Arda IŞIKBER

Department of Plant Protection, Faculty of Agriculture, KahramanmaraşSütçü İmam University, Kahramanmaraş, Turkey

*Corresponding author: mker@ksu.edu.tr

Abstract

One of the important stored-grain pests is *Rhizopertha dominica* causing considerable grain loss once high level of population is established. A promising alternative to currently used chemicals is the use of entomopathogenic fungi for suppressing its populations. Several previous studies established the pathogenicity of *Beauveria bassiana* against *R. dominica*. After screening a series of native wild fungal isolates, one *B. bassiana* isolate (151138) was found promising (data not presented). This study was conducted to increase the virulence of the isolate against *R. dominica* in order to reduce the amount of fungal conidia to be used in microbial control practices. The fungus was re-isolated from dead *R. dominica* adults and five single spore colonies were established. They were used in a bioassay using 500ppm conidia and 60-76% mortalities within 14 days were found. Considering variation amongst repetitions, one was selected for a further re-isolation study and other five single spore colonies were obtained. The bioassay was repeated with latter isolates and 98.75-100% mortalities within 14 days were achieved. Similar increases in mortality levels on 7th day of incubation were also noticed. All the bioassays were conducted in centrifuge tubes with 40gr of wheat grains and 20 adults at 25°C and 65% relative humidity in darkness. As initial mortality rate was 50-65% in the same conditions with 500ppm concentration, almost two fold increase in the efficacy of the fungus was resulted. Although wild entomopathogenic fungal strains are good source for finding promising microbial control agents, selecting virulent once from wild strains is valuable for further investigations.

Keywords: *Microbial control, stored-product pest, lesser grain borer.*

Introduction

Cereals are commonly subjected to storage and during which infestations by pest insects can be a serious problem for both qualitative value and quantity of the commodity. One of such important stored-grain pests is *Rhizopertha dominica* causing considerable grain loss once high level of population is established. Currently, synthetic chemical insecticides are applied for its management. These chemicals can cause several problems like mammalian toxicity, residues on commodities, and increasing resistance by targeted pests (Arthur, 1996). Furthermore, consumer demands for residue free products and environmental concerns directed researchers for alternative means of controlling pests (Inglis *et al.*, 1997; Lomer *et al.*, 2001). The use of entomopathogenic fungi for suppressing pest populations was considered promising alternative to currently used chemicals (Shams *et al.*, 2011). Several previous studies established the potential of entomopathogenic fungi including *Beauveria bassiana* against stored product pests such as *R. dominica* (Searle and Doberski, 1984; Adane *et al.*, 1996; Hidalgo *et al.*, 1998; Moino *et al.*, 1998; Rice and Cogburn, 1999; Dal Bello *et al.*, 2001; Meikle *et al.*, 2001; Sheeba *et al.*, 2001; Cherry *et al.*, 2005). It is also noticed that isolates of the same fungal species vary considerably in

their effects on targeted hosts (Cherry *et al.*, 2005; Wakefield *et al.*, 2005). After screening a series of native wild fungal isolates, one *B. bassiana* isolate (151138) was found promising in our studies (data not presented). Increasing its effectiveness is one of our purposes and this study was conducted to increase the virulence of the isolate against *R. dominica* in order to reduce the amount of fungal conidia to be used in microbial control practices.

Materials and methods

Insect culture

Rhizopertha dominica cultures have been maintained in the laboratory of Department of Plant Protection at University of Kahramanmaraş Sutcu Imam on wheat, and originally obtained from insects collected from grain storages in Adana province in Turkey. In order to obtain adults at the same age, adults were left in clean wheat for two days for oviposition, and thereafter removed from jars. New generation adult emergence was monitored and 7-10 days old adults were used for experiments. Culturing conditions were $30\pm 2^{\circ}\text{C}$, $65\pm 5\%$ relative humidity in darkness.

Fungus culture

The *Beauveria bassiana* isolate (151138) was chosen from our entomopathogenic fungal culture collection. The fungus was originally isolated from an adult *R. dominica* and later found promising due to its high pathogenicity after a screening test (data not presented). All fungal cultures were grown on Potato Dextrose Agar (PDA) at $25\pm 2^{\circ}\text{C}$ in darkness.

Fungus re-isolation and establishing single spore cultures

Rhizopertha dominica adults were exposed to the fungus and incubated as described below (Pathogenicity tests). Dead insects were gathered, surface sterilised and placed within humidity chambers to promote fungal development and sporulation on the surface of the cadavers. Those with good sporulation were chosen to re-isolate the fungus. Spores from the surface of the cadavers were transferred to PDA including antibiotics. From the developing fungal cultures, a small amount of conidia was suspended into sterile 0.02% Tween 80 and 100 μl of the suspension was spread on PDA. After two days of incubation the plates were examined under a microscope to mark germinated single spores away from the others. Marked germinated-spores were transferred individually on new PDA plates to establish single spore cultures.

Pathogenicity tests

Five single spore colonies derived from re-isolated fungus from dead *R. dominica* adults were used for the first pathogenicity test. The bioassay was conducted by using 500ppm (w/w) conidia. Considering variation amongst repetitions, one was selected for a further re-isolation study and other five single spore colonies were obtained. In the second test, the bioassay was repeated with latter isolates. All the bioassays were conducted in centrifuge tubes (50ml in capacity) with 40gr of wheat grains and 20 adults at $25\pm 2^{\circ}\text{C}$ and $65\pm 5\%$ relative humidity in darkness. Insect mortalities were evaluated after 7 and 14 days.

Results and discussion

In the first test, after passing through the host and single spore isolation, mortalities were 33-51% and 60-76% after 7 and 14 days of incubation, respectively (Table 1). The culture number 5 was chosen for further investigation due to its higher mortality level and deviation. Five cadavers from this treatment were used to obtain other five single spore colonies for the second test.

According to the second test results the mortalities increased to 72.50-81.25% and 98.75-100% after 7 and 14 days of incubation, respectively (Table 2).

Table 1. Mortalities of *Rhizopertha dominica* adults caused by the first single spore cultures of *Beauveria bassiana* 151138 (n=5).

Mortalities (%) after 7 days of incubation						
Culture number	3	2a	1a	4b	5	Control
Overall mortality	46	33	46	51	41	0
Standart deviation	4.2	4.5	18.8	7.4	20.7	0
Mortalities (%) after 14 days of incubation						
Culture number	3	2a	1a	4b	5	Control
Overall mortality	76	60	69	72	76	6
Standart deviation	8.2	11.7	20.7	9.7	23.8	8.2

Table 2. Mortalities of *Rhizopertha dominica* adults caused by the subsequent second single spore cultures of *Beauveria bassiana* originated from the Culture Number 5 (n=4).

Mortalities (%) after 7 days of incubation						
Culture number	5-1	5-2	5-3	5-4	5-5	Control
Overall mortality	72.5	72.5	75	73.75	81.25	0
Standart deviation	25	12.6	5.8	10.3	21.7	0
Mortalities (%) after 14 days of incubation						
Culture number	5-1	5-2	5-3	5-4	5-5	Control
Overall mortality	100	100	100	100	98.75	1.25
Standart deviation	0	0	0	0	2.5	2.5

Pooled data of the first and the second test results were given in Figure 1. One week incubation mortality increased from $43.4 \pm 2.7\%$ to $75 \pm 3.4\%$, and two weeks incubation mortality increased from $70.6 \pm 3.2\%$ to $99.75 \pm 0.3\%$. As initial mortality rate of the fungus was 50-65% after two weeks of incubation in previous tests (data not presented) almost two fold increase in the efficacy of the fungus was resulted reaching to almost 100% mortality.

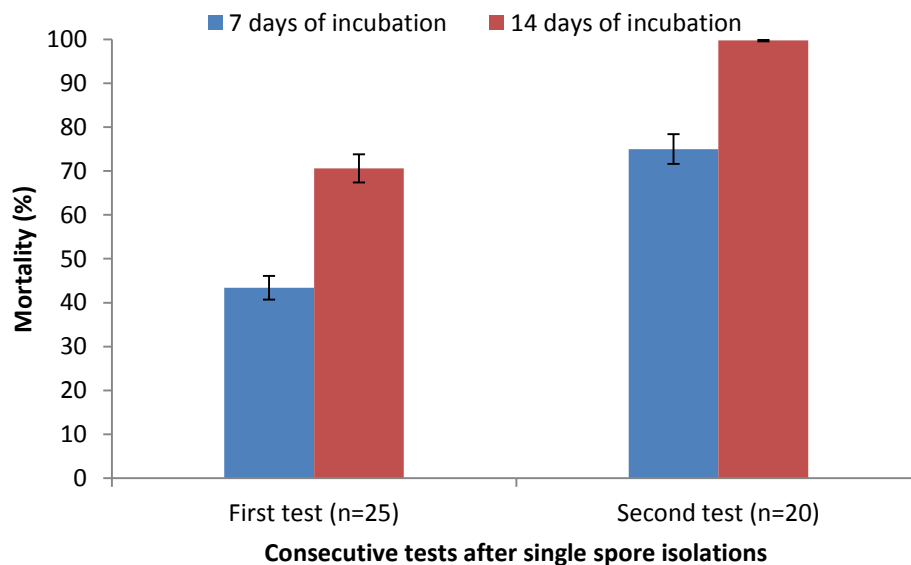

Figure 1. Pooled data of *Rhyzopertha dominica* adult mortalities after one and two consecutive single spore isolations from *Beauveria bassiana* 151138 (bars represent standard errors).

In previous studies, successive passages of entomopathogenic fungi through host insects have been shown to increase their virulence (Adames *et al.*, 2011; Quesada-Moraga and Vey, 2003; Santoro *et al.*, 2015; Song and Feng, 2011). The passages of the fungus through the targeted host in this study should have a great effect on increasing virulence; however the increase was quite fast reaching 100% only after two passages. This is possible due to isolation of a single spore after each passage speeding up the selection process. Adames *et al.* (2011) and Santoro *et al.* (2015) increased virulence of entomopathogenic fungi even after 7, 15 passages, respectively towards their targeted pests.

Conclusion

In the search for fungal biological agents for microbial control of insect pests, isolation of entomopathogenic fungi from targeted host or its surroundings is a common practice. These fungi have been useful for further investigations; however, wild fungi comprise genetic and adaptive diversity. This study presents the utility of selecting single spores from wild fungal isolates for studies towards developing microbial control agents. Although wild entomopathogenic fungal strains are good source for finding promising microbial control agents, selecting virulent once from these strains can increase their value.

References

- Adane K., Moore D., Archer S.A. (1996). Preliminary studies on the use of *Beauveria bassiana* to control *Sitophilus zeamais* in the laboratory. *Journal of Stored Products Research*, vol. 32, pp. 105-113.
- Adames M., Fernandez M., Pena G., Hernandez V.M. (2011). Effects of passages through a suitable host of the fungus, *Metarhizium anisopliae*, on the virulence of acaricide-susceptible and resistant strains of the tick, *Rhipicephalus microplus*. *Journal of Insect Science*, vol. 11:21 available online: insectscience.org/11.21.

- Arthur F.H. (1996). Grain protectants: current status and prospects for the future. *Journal of Stored Products Research*, vol. 32, pp. 293-302.
- Cherry A.J., Abalo P., Hell K. (2005). A laboratory assessment of the potential of different strains of the entomopathogenic fungi *Beauveria bassiana* (Balsamo) Vuillemin and *Metarhizium anisopliae* (Metschnikoff) to control *Callosobruchus maculatus* (F.) (Coleoptera: Bruchidae) in stored cowpea. *Journal of Stored Products Research*, vol. 41, pp. 295-309.
- Dal Bello G., Padin S., Lopez Lastra C., Fabrizio M. (2001). Laboratory evaluation of chemical-biological control of the rice weevil (*Sitophilus oryzae*) in stored grains. *Journal of Stored Products Research*, vol. 37, pp. 77-84.
- Hidalgo E., Moore D., Le Patourel G. (1998). The effect of different formulations of *Beauveria bassiana* on *Sitophilus zeamais* in stored maize. *Journal of Stored Products Research*, vol. 34, pp. 171-179.
- Inglis G.D., Johnson D.L., Goettel M.S. (1997). Field and laboratory evaluation of two conidial batches of *Beauveria bassiana* (Balsamo) Vuillemin against grasshoppers. *The Canadian Entomologist*, vol. 129, pp. 171-186.
- Lomer C.J., Bateman R.P., Johnson D.L., Langewald J., Thomas M. (2001). Biological control of locusts and grasshoppers. *Annual Review of Entomology*, vol. 46, pp. 667-702.
- Meikle W.G., Cherry A.J., Holst N., Hounna B., Markham R.H. (2001). The effects of an entomopathogenic fungus *Beauveria bassiana* (Balsamo) Vuillemin (Hyphomycetes), on *Prostephanus truncatus* (Horn) (Col.: Bostrichidae), *Sitophilus zeamais* Motschulsky (Col.: Curculionidae), and grain losses in stored maize in the Benin Republic. *Journal of Invertebrate Pathology*, vol. 77, pp. 198-205.
- Moino A., Alves S.B., Pereira R.M. (1998). Efficacy of *Beauveria bassiana* Vuillemin isolates for control of stored grain pests. *Journal of Applied Entomology*, vol. 122, pp. 301-305.
- Quesada-Moraga E., Vey A. (2003). Intra-specific variation in virulence and in vitro production of macromolecular toxins active against locust among *Beauveria bassiana* strains and effects of in vivo and in vitro passage on these factors. *Biocontrol Science and Technology*, vol. 13, pp. 323-340.
- Rice W.C., Cogburn R.R. (1999). Activity of the entomopathogenic fungus *Beauveria bassiana* against three coleopteran pests of stored grain. *Journal of Economic Entomology*, vol. 92, pp. 691-694.
- Santoro P.H., Zorzetti J., Constanski K., Neves P.M.O.J. (2015). Quality of *Beauveria bassiana* conidia after successive passages through *Alphitobius diaperinus* (Coleoptera: Tenebrionidae). *Revista Colombiana de Entomologia*, vol. 41, pp. 87-94.
- Searle T., Doberski J. (1984). An investigation of the entomogenous fungus *Beauveria bassiana* as a potential biological control agent of *Oryzaephilus surinamensis*. *Journal of Stored Products Research*, vol. 20, pp. 17-23.
- Shams G., Safaralizadeh M.H., Imani S., Shojai M., Aramideh S. (2011). A laboratory assessment of the potential of the entomopathogenic fungi *Beauveria bassiana* (Veauvarin) to control *Callosobruchus maculatus* (F.) (Coleoptera: Bruchidae) and *Sitophilus granarius* (L.) (Coleoptera: Curculionidae). *African Journal of Microbiology Research*, vol. 5, pp. 1192-1196.
- Sheeba G., Seshadri S., Raja N., Janarthanan S., Ignacimuthu S. (2001). Efficacy of *Beauveria bassiana* for the control of the rice weevil *Sitophilus oryzae* (L.) (Coleoptera: Curculionidae). *Applied Entomology and Zoology*, vol. 36, pp. 117-120.

- Song T.T., Feng M.G. (2011). In vivo passages of heterologous *Beauveria bassiana* isolates improve conidial surface properties and pathogenicity to *Nilaparvata lugens* (Homoptera: Delphacidae). *Journal of Invertebrate Pathology*, vol. 106, pp. 211-216.
- Wakefield M.E., Cox P.D., Moore D., Aquino de Muro M., Bell B.A. (2005). Mycopest: results and perspectives. Proceedings of the 6th Meeting of COST Action 842 Working Group IV, Locorotondo, Italy.

EFFECT OF SHORT TIME EXPOSURE OF RHYZOPERTHA DOMINICA ADULTS TO BEAUVERIA BASSIANA CONIDIA MIXED IN WHEAT GRAINS

Mehmet Kubilay ER*, Ali Arda IŞIKBER, Hasan TUNAZ

Department of Plant Protection, Faculty of Agriculture, KahramanmaraşSütçü İmam University, Kahramanmaraş, Turkey

*Corresponding author: mker@ksu.edu.tr

Abstract

Due to various problems of chemical insecticide use against pest insects of stored-grains, alternative control techniques have been investigated. One approach is utilization of entomopathogenic fungi for biological control of these pests and has commonly been considered promising. Previous experiments measured mortalities of insects kept in fungus treated cereals for 1-3 weeks or longer. This study was conducted to reveal the effect of shorter exposure time on *Rhyzopertha dominica* adults challenged with *Beauveria bassiana*. Adult insects (20 for each treatment) were left in wheat grains with fungal conidia(600ppm) for 15 mins, 1 h, 2hs, 6hs, 1 day and 2 days. Thereafter, they were transferred into clean wheat grains and incubated until mortality evaluations on the 7th and 14th days. One additional treatment (full time exposure) was to keep insects in wheat with fungal conidia throughout the experiment. Insects in control treatment were kept in untreated grains. The experiment had five repetitions and conducted at 25°C and 65% relative humidity in darkness. An expected general trend of increasing mortality with increasing exposure time was observed. However, statistical differences amongst mortalities after full time exposure (46%), 1 day (32%) and 2 days (58%) exposure treatments were insignificant in 7 days of incubation. Full time exposure treatment (83%) was also not statistically different from 2 days exposure treatment (64%) in 14 days of incubation. These findings are particularly important for protecting cereal bulks from new insect infestations, and in the cases of uneven distribution of fungal spores in cereal bulks in management of stored-grain pests.

Keywords: *Microbial control, stored-product pest, lesser grain borer.*

Introduction

Stored grains are frequently infested by various insect pests, and in the cases of their high populations, considerable qualitative and quantitative damage occurs. Although chemical insecticides are applied to suppress the populations, due to various problems of these insecticides (Arthur, 1996), such as undesirable chemical residues, their environmental threats, and resistance development of pests to the chemicals, alternative control techniques have been investigated (Inglis *et al.*, 1997; Lomer *et al.*, 2001). One approach is the use of entomopathogenic fungi in biological control approach and has been considered promising (Shams *et al.*, 2011). Some species of entomopathogenic fungi have been tested against several stored-grain pests, mostly coleopteran, with encouraging results (Meikle *et al.*, 2001; Sheeba *et al.*, 2001; Dal Bello *et al.*, 2001; Cherry *et al.*, 2005 Wakil and Ghazanfar 2010; Shams *et al.* 2011; Barra *et al.* 2013; Khashaveh and Chelav 2013; Sewify *et al.* 2014). Developing such biological agents to suppress pests of stored cereals can at least reduce the use of chemicals and thus their negative side effects. The previous experiments measured mortalities of insects kept in fungus-treated-cereals for 1-3

weeks or even longer. It can not be realized from their results whether insects die due to attached conidia in early period of time or throughout long exposure period. Clarifying this process can help developing entomopathogenic fungi for the control of stored-product pests. Therefore, shorter exposure of the insects needs to be investigated for better understanding the effects of these biological agents. This study was conducted to reveal the effect of shorter exposure periods on a stored-grain pest, *Rhyzopertha dominica*, when *Beauveria bassiana* was used as the biological control agent.

Materials and methods

Insect culture

Rhyzopertha dominica cultures were originally started with insects collected from grain storages in Adana province in Turkey and have been maintained in our laboratory on wheat. Adults at the same age were used in the experiments. They were obtained by leaving adults in clean wheat for only two days for oviposition and then by gathering new generation adults 7-10 days after the onset of adult emergence. All the cultures were kept in controlled conditions at $30\pm 2^{\circ}\text{C}$, $65\pm 5\%$ relative humidity in darkness.

Fungus culture

The *Beauveria bassiana* isolate (151138) was originally isolated from an adult *R. dominica*. It has been kept in our entomopathogenic fungal culture collection. All fungal cultures were grown on Potato Dextrose Agar (PDA) at $25\pm 2^{\circ}\text{C}$ in darkness. The cultures that completed sporulation were kept at room temperature with open lid to dry them for two days. Conidia were vacuumed and collected in small vials, and kept at $+4^{\circ}\text{C}$ until use. Before the experiment a small amount of conidia were incubated on PDA for 24 hours at $25\pm 2^{\circ}\text{C}$ in darkness for germination test. After incubation, spores were examined under microscope and those with a germ tube at least as long as the conidium were considered germinated. Spores with at least 95% germination ratio were used for the experiment.

Conducting the test

Centrifuge tubes of 50ml capacity with 40gr of wheat grains homogenously mixed with 600ppm (w/w) conidia were used. After placing 20 *R. dominica* adults, they were kept at 25°C and 65% relative humidity in darkness for various periods of exposure (15 mins, 1 h, 2hs, 6hs, 1 day and 2 days). The adults were transferred into clean wheat grains and incubated under the same conditions until mortality evaluations on the 7th and 14th days. One additional treatment (full time exposure) was set by keeping insects in wheat with fungal conidia throughout the experiment (14 days). Insects in control treatment were kept in untreated grains. The experiment had five repetitions. The obtained data were subjected to ANOVA and Tukey multiple comparison tests, after arcsine transformation by using Minitab statistics program.

Results and discussion

Rhyzopertha dominica adult mortalities varied between 11% and 58% at the end of 7 days of incubation (Figure 1). Although exposure time to fungal conidia significantly affected the mortality level ($F=14.12$; d.f.=5, 29; $P<0.000$), mortalities after 1-2 days of exposure were not statistically different from the full time continuous exposure treatment (Figure 1). Shorter exposure times (≤ 6 hours) however resulted with significantly lower mortalities. The results of 14 days of incubation were similar with the exception of 1-day exposure treatment (Figure 2). Mortalities were between 29% and 83% with significant differences ($F=17.11$; d.f.=5, 29;

P<0.000). The difference between the mortality after 2-days exposure and that of the full time continuous exposure was statistically insignificant while the mortalities of the other treatments were statistically lower. Insect exposure to the conidia for 15 mins – 1 day did not change the resultant mortality level. Considering the final mortality levels after two weeks of incubation, the results show that full time exposure of the insects to the fungal conidia can be better for pest control, but a 2-days exposure can give quite similar results in terms of pest suppression. Even short time exposure (15 mins – 1 day) to the fungus causes considerable mortalities, almost half the level obtained with full time continuous exposure.

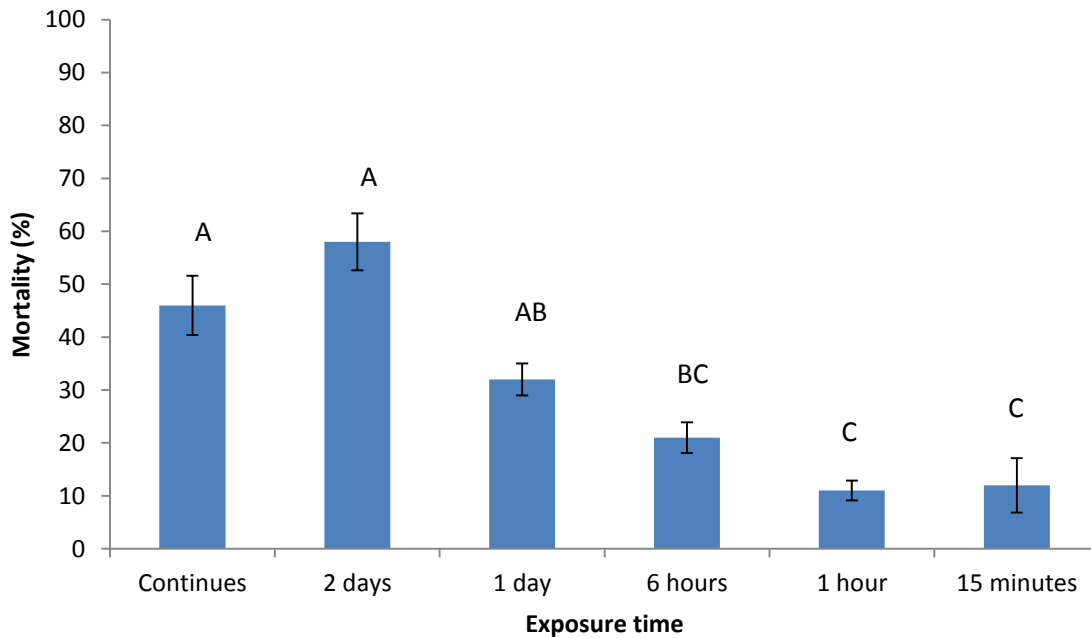

Figure 1. *Rhyzopertha dominica* adult mortalities seven days after exposure to *Beauveria bassiana* conidia (According to Tukey multiple comparison test, statistically significant differences are marked with different letters; control mortality=0%; bars represent standard errors; n=5)

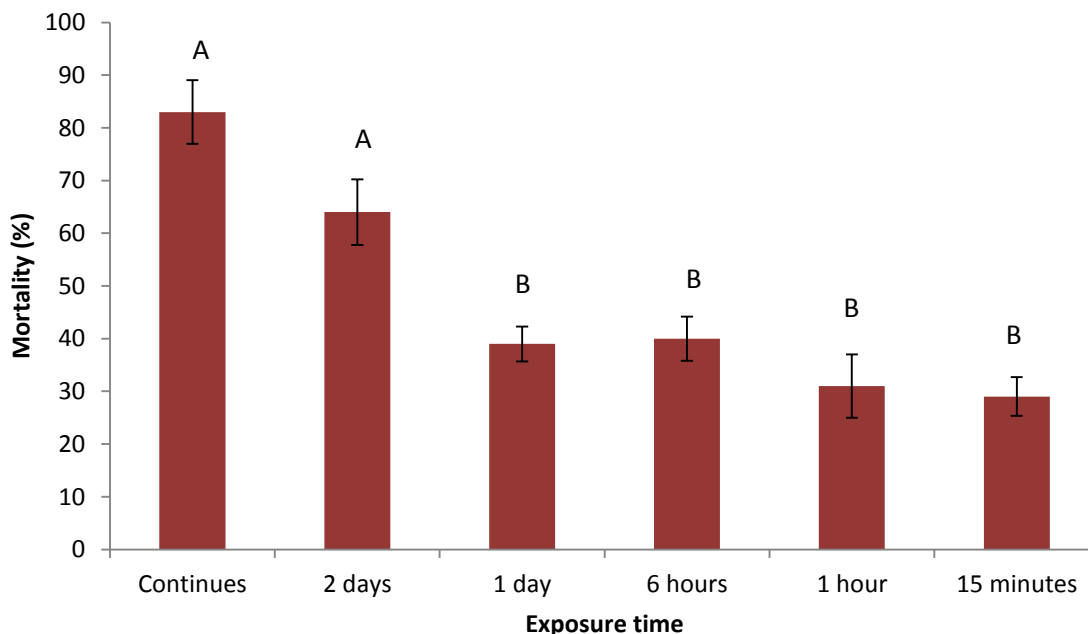

Figure 2. *Rhyzopertha dominica* adult mortalities 14 days after exposure to *Beauveria bassiana* conidia (According to Tukey multiple comparison test, statistically significant differences are marked with different letters; control mortality=2±1.2%; bars represent standard errors; n=5)

Conclusion

Although in previous studies targeted pests were kept in continuous contact with fungal conidia for the whole period of experiments, this results show that a much shorter exposure period can also be enough to yield high mortalities and to evaluate pathogenicity of entomopathogenic fungi. After shortening exposure period, however, fungi still require a period of time to kill. These indicate that entomopathogenic fungi can be more effective than expectations at suppressing pest populations in grain storages. According to the results, the conidia attached in early period of exposure time are mostly responsible for the mortalities even though the insects are exposed to conidia for a longer period. These findings are particularly important for protecting cereal bulks from new insect infestations, where they will be affected by early contacts with conidia leading to early mortalities with a possible result of faster management of stored-grain pests by using entomopathogenic fungi.

References

- Arthur F.H. (1996). Grain protectants: current status and prospects for the future. *Journal of Stored Products Research*, vol. 32, pp. 293-302.
- Barra P., Rosso L., Nesci A., Etcheverry M. (2013). Isolation and identification of entomopathogenic fungi and their evaluation against *Tribolium confusum*, *Sitophilus zeamais*, and *Rhyzopertha dominica* in stored maize. *Journal of Pest Science*, vol. 86, pp. 217-226.
- Cherry A.J., Abalo P., Hell K. (2005). A laboratory assessment of the potential of different strains of the entomopathogenic fungi *Beauveria bassiana* (Balsamo) Vuillemin and *Metarhizium anisopliae* (Metschnikoff) to control *Callosobruchus maculatus* (F.) (Coleoptera: Bruchidae) in stored cowpea. *Journal of Stored Products Research*, vol. 41, pp. 295-309.

- Dal Bello G., Padin S., Lopez Lastra C., Fabrizio M. (2001). Laboratory evaluation of chemical-biological control of the rice weevil (*Sitophilus oryzae*) in stored grains. *Journal of Stored Products Research*, vol. 37, pp. 77-84.
- Inglis G.D., Johnson D.L., Goettel M.S. (1997). Field and laboratory evaluation of two conidial batches of *Beauveria bassiana* (Balsamo) Vuillemin against grasshoppers. *The Canadian Entomologist*, vol. 129, pp. 171-186.
- Khashaveh A., Chelav H.S. (2013). Laboratory bioassay of Iranian isolates of entomopathogenic fungus *Metarhizium anisopliae* (Metsch.) Sorokin (Ascomycota: Hypocreales) against two species of storage pest. *Agriculturae Conspectus Scientificus*, vol. 78, pp. 35-40.
- Lomer C.J., Bateman R.P., Johnson D.L., Langewald J., Thomas M. (2001). Biological control of locusts and grasshoppers. *Annual Review of Entomology*, vol. 46, pp. 667-702.
- Meikle W.G., Cherry A.J., Holst N., Hounna B., Markham R.H. (2001). The effects of an entomopathogenic fungus *Beauveria bassiana* (Balsamo) Vuillemin (Hyphomycetes), on *Prostephanus truncatus* (Horn) (Col.: Bostrichidae), *Sitophilus zeamais* Motschulsky (Col.: Curculionidae), and grain losses in stored maize in the Benin Republic. *Journal of Invertebrate Pathology*, vol. 77, pp. 198-205.
- Sewify G.H., El Shabrawy H.A., Eweis M.E., Naroz M.H. (2014). Efficacy of entomopathogenic fungi, *Beauveria bassiana* and *Metarhizium anisopliae* for controlling certain stored product insects. *Egyptian Journal of Biological Pest Control*, vol. 24, pp. 191-196.
- Shams G., Safaralizadeh M.H., Imani S., Shojai M., Aramideh S. (2011). A laboratory assessment of the potential of the entomopathogenic fungi *Beauveria bassiana* (Veauvarin) to control *Callosobruchus maculatus* (F.) (Coleoptera: Bruchidae) and *Sitophilus granarius* (L.) (Coleoptera: Curculionidae). *African Journal of Microbiology Research*, vol. 5, pp. 1192-1196.
- Sheeba G., Seshadri S., Raja N., Janarthanan S., Ignacimuthu S. (2001). Efficacy of *Beauveria bassiana* for the control of the rice weevil *Sitophilus oryzae* (L.) (Coleoptera: Curculionidae). *Applied Entomology and Zoology*, vol. 36, pp. 117-120.
- Wakil W., Ghazanfar M.U. (2010). Entomopathogenic fungus as a biological control agent against *Rhyzopertha dominica* F. (Coleoptera: Bostrychidae) on stored wheat. *Archives of Phytopathology and Plant Protection*, vol. 43, pp. 1236-1242.

IMPORTANCE OF INSECT IMMUNITY FOR BIOCONTROL: INFECTIONS IN FIELD-TRAPPED INSECTS FROM OSMANIYE (TURKEY)

Hasan TUNAZ*, Mehmet Kubilay ER, Ali A. IŞIKBER

¹Department of Plant Protection, Faculty of Agriculture, University of Kahramanmaraş Sütçü İmam, Kahramanmaraş, Turkey

*Corresponding author: htunaz@ksu.edu.tr

Abstract

Insect immunology is an active research arena. However, the vast majority of research in the area is conducted on model species taken from laboratory cultures. In this study, the hypothesis tested is that insects are usually exposed to infections or invasions in nature and this paper reports on results of a field study designed to assess the extent of natural infections in insects collected in the fields around Osmaniye, Turkey. Specimens were dissected to assess numbers of nodules. Nodulation is one of the insect cellular to microbial infection, In about 600 tested insect specimens, at least some nodules were found in 99%. Number of nodules in each insect was from 1 to 105. From these data, we can speculate that insects are mostly challenged by microbial diseases from which they rescued themselves. Importance of our data is that insect immune systems may limit the host range and effectiveness of agents deployed in biological control programs. Knowledge of insect immune systems may contribute to increase use of biopesticides globally.

Keywords: *Insect immunology; Naturally occurring infections; Biological control.*

Introduction

Natural entomopathogen microbes are virulent insect pathogens, including viruses, fungi and bacteria. Some of these organisms can serve as important natural regulators of insect populations by invading insect bodies, often coming through the alimentary canal (Lacey *et al.*, 2001). Because of their actual or potential influence on insect populations, many insect pathogens are exploited as biological control agents (ref.). Commercially useful pathogens include viruses, fungi, bacteria, protozoans and nematodes, all deployed in as agents in biological control of insect pests,. The relative success and failures of microbial control of insect pests depends on a wide range of factors. One of them is biological issues in which successful microbial control products and processes will depend on them. These issues span a range of biological organization from the ecological level of microbe-host population dynamics to the molecular and cell biology of host defense mechanisms. One of the greatest barriers to increased deployments of microbial control agents may lie in insects' robust and complex innate immune effectors. Insect physiologically produce two different immunity to microbes which are cellular and humoral immunity. These cellular defense reactions begin immediately after an infection is detected within an insect. Some hours after an infection is detected, insects unleash an array of anti-microbial peptides that constitute the humoral immune system (Lemaitre and Hoffmann, 2007). The combined arsenal of immune effector mechanisms allows insects to overcome invasions, infections and wounds. And these mechanisms can limit the effectiveness of microbes deployed for biocontrol of insect pest populations. Therefore, it was hypothesized and tested that insects experience natural infections in fields and they recover and pass through their life.

Materials and Methods

Insects

Insects have been collected from fields of Osmaniye city area (Turkey) in 2012-2013. The collected species, collection sites, site altitudes, and biological stages are indicated in results. The specimens were transferred to the laboratory (20 ± 1 °C, RH 60 ± 5) at Kahramanmaraş Sütçü İmam University. Most individuals were identified to species.

Nodulation assay

Following identification, the extent of nodulation was assessed following the protocols formalized by Miller and Stanley (1998). Insects were anesthetized by chilling on ice and then their hemocoels were exposed. Melanized, brownish-black nodules were counted under a stereo microscope at 45x. The nodules were distinct, and direct counting reliably reflected the extent of the nodulation response to infections (Miller *et al.*, 1999). After the first counting, the alimentary canal was removed. Nodules in the previously unexposed areas and remaining internal tissues were then counted.

Statistical Analysis

Data on nodulation were analyzed using the General Linear Models procedure, and mean comparisons were made using Tukey test (SAS Institute Inc., 1989).

Results and Discussion

Two categories of defense responses to microbial infections were seen in insects, humoral and hemocytic defence reactions (Dunn, 1986; Gupta, 1991). Humoral reactions take quietly long time for their full expression, and involve induced synthesis of antibacterial proteins, such as cecropins, attacins, dipterocins, and defensins (Dunn, 1986). In the presence of these proteins, bacteria lose their cellular integrity because of the detergent properties of peptides. Insects also synthesize lysozymes, which enzymatically attack bacteria by hydrolyzing their peptidoglycan cell walls (Dunn, 1986; Russell and Dunn, 1996). Hemocytic reactions involve direct cellular interactions between circulating hemocytes and bacteria. In contrast to humoral defense reactions, hemocytic responses are very quick, typically occur within minutes of an infection cycle. Specific cellular defense mechanisms include phagocytosis, nodulation and encapsulation (Gupta, 1991). One of insect cellular or hemocytic defense actions is nodulation. Dunn and Drake (1983) indicated that following an injection of bacterial cells into tobacco hornworm *Manduca sexta*, the insects were capable to clear most bacterial cells from their hemolymph circulation by nodulation in the first 2 h following the artificial infection. Occurrence of nodulation involves more than one steps. First, insect granulocytes attaches to infecting microbe cells, second, the granulocytes are degranulated that causes attraction of insect plasmatocytes to the growing nodule, and the spreading of plasmatocytes around the nodule (Dean *et al.*, 2004). Finally, the darkened, melanized nodules attach to an internal organ or body wall, where they remain through the life of the insect.

From insect hemocoels, nodules are not easily moved away when insect has experienced a microbial infection. The presence of nodules in insect hemocoels indicates that the insect was infected with microbes in the past or has a past microbial infection. Many researchers report nodulation reactions in insects following infections of insects with microbes including bacteria, fungal spores and some viruses (Miller *et al.*, 1994; Dean *et al.*, 2002; Lord *et al.*, 2002; Büyükgüzel *et al.*, 2007; Durmuş *et al.*, 2008). Howard *et al.* (1998) also reported that some bacterial species evoked far more nodules than similar infections with other species

In this study, nodulation was assessed in a total of 60 insect species collected during 2012-2013. In the broadest description, we recorded nodules in 99% of the 600 specimens examined, although there was a very wide range of nodules/specimen (from 1 nodule/insect to >105 nodules/insect). We note a relatively small number of clear patterns in natural microbial infections. We usually determined more nodules in the insects associated with soil than in those collected from plants (Table 1). Specifically, we have seen higher number of nodules in orthopteran specimens and sunn pest adults. There were more nodules in orthopteran specimens and sunn pest adults associated with soil (Tables 1). It was also noted that the overwintered generations of *Eurygaster integriceps* had much more nodules compared to new generation adults (about 105 nodules for overwintered generations; about 8-12 nodules for new generation adults). Examining insect orders for nodulation assay, significantly more nodules were recorded from orthopteran species than lepidopteran, hemipteran and coleopteran species (Table 3), which is logical because orthopteran species were mostly collected from soil. There were no nodulation differences in number among biological stages of insects. It was recorded statistically similar numbers of nodules in larvae, nymphs and adults of insect species (Table 2). Putting together, insect orders in contact with soil are probably the main associations with higher number of nodules. However, the actual occurrence of natural infection may be a random event with no predominant patterns. On the other hand, the data indicate virtually all insects had experienced infection(s) in nature.

Table 1. A single-factor ANOVA across species for collection sources differences

Year	Collection sources	Nodules /insect ^a	Number of individuals
2012	Plant material	17.034±2.6 ^b	730
	Soil	61.338±7.2 ^a	60
2013	Plant material	9.3±0.81 ^b	1100
	Soil	59.5±4 ^a	200

^aMean number of nodules in a column followed by different letters are significantly different for each year ($F_{(1,77)} = 21.86, P < 0.0001$ for 2012) and ($F_{(1,128)} = 388.53, P < 0.0001$ for 2013)}

Table 2. A single-factor ANOVA across species for developmental stage differences

Year	Developmental stages	Nodules /insect	Number of individuals
2012	Adults	19.9±3.3 ^a	570
	Larvae	19.4±3.9 ^a	160
	Nymphs	14.8±5.1 ^a	40
2013	Adults	17.7±2.29 ^a	1060
	Larvae	16.6±3.14 ^a	130
	Nymphs	27.1±7.65 ^a	130

No significant differences were detected for each year ($F_{(2,74)} = 0.09, P=0.9109$ for 2012) and ($F_{(2,129)} = 1., P=0.3711$ for 2013)}

Table 3. A single-factor ANOVA across species for insect order differences

Year	Insect orders	Nodules /insect ^a	Number of individuals
2012	Lepidoptera	19.1±3.7 ^b	170
	Hemiptera	16.9±6.9 ^b	190
	Coleoptera	9.0±1.3 ^b	240
	Orthoptera	58.0±6.9 ^a	70
	Hymenoptera	4.5±1.3 ^b	30
	Diptera	5.9±2.9 ^b	30
2013	Lepidoptera	12.8±2.3 ^b	210
	Hemiptera	14.3±4.4 ^b	300
	Coleoptera	6.5±0.9 ^b	410
	Orthoptera	58.8±4.1 ^a	200
	Hymenoptera	8.4±2.2 ^b	50
	Diptera	10.4±2.0 ^b	70

^aMean number of nodules in a column followed by different letters are significantly different for each year { (F_(5,67) = 84.24, P<0.0001 for 2012) and (F_(5,118) = 34.97, P<0.0001 for 2013)

Conclusion

It was known that pest insects cause crop losses. Therefore understanding of insect immunity and pathogens on insect immunity are very important for controlling pest insect in agriculture, in which microbial insecticides are used. Insects have the ability to recover from infections in nature which is important for biological and agricultural implications. On the other hand, biologically, many microbes have the ability to overcome insect immune systems. Therefore, we need to understand evolutionary mechanisms of insect immunity and inhibitory actions of insect pathogens for getting effective result on insect pest management. It is known that insect immunity systems may limit use of biopesticides, which are environmentally friendly insecticide. Hence, in this paper, we tried to understand insect immune reactions in nature in which the insects were collected from Osmaniye Province of Turkey. We conclude that insect orders in contact with soil are probably the main associations with higher number of nodules. However, the actual occurrence of natural infection may be a random event with no predominant patterns. On the other hand, the data indicate virtually all insects had experienced infection(s) in nature.

Acknowledgement

This study was supported by The Scientific and Technological Research Council of Turkey (TUBİTAK Project no: 110O159).

References

- Büyükgüzel E., Tunaz H., Stanley D., Büyükgüzel K. (2007). Eicosanoids mediate *Galleria mellonella* cellular immune response to viral infection. *J Insect Physiol* vol. 53, pp.99-105.
- Dean P., Gadsden J.C., Richards E.H., Edwards J.P., Charnley A.K., Reynolds S.E. (2002). Modulation by eicosanoid biosynthesis inhibitors of immune responses by the insect *Manduca sexta* to the pathogenic fungus *Metarhizium anisopliae*. *J. Invert. Pathol.* Vol. 79, pp. 93-101.
- Dean P., Potter U., Richards E.H., Edwards J.P., Charnley A.K., Reynolds S.E. (2004). Hyperphagocytic haemocytes in *Manduca sexta*. *J Insect Physiol* Vol. 50, pp. 1027-1036.
- Dunn P., Drake D.R. (1983). Fate of bacteria injected into naive and immunized larvae of the tobacco hornworm, *Manduca sexta*. *J Invert Pathol.* Vol. 41, pp. 77-85.

- Dunn P.E. (1986). Biochemical aspects of insect immunology. *Annu Rev Entomol.* Vol. 31, pp. 321-339.
- Durmuş Y., Büyükgüzel E., Terzi B., Tunaz H., Stanley D., Büyükgüzel K. (2008). Eicosanoids mediate melanotic nodulation reactions to viral infections in larvae of the parasitic wasp, *Pimpla turionellae*. *J Insect Physiol.* Vol. 54, pp. 17-24.
- Gupta A.P. (1991). *Immunology of Insects and Other Arthropods*. CRC Press, Boca Raton, FL.
- Howard R.W., Miller J.S., Stanley D.W. (1998). The influence of bacterial species and intensity of infections on nodule formations in insect. *J. Insect Physiol.* Vol. 44, pp. 157-164.
- Lacey L.A., Frutos R., Kaya H.K., Vail P. (2001). Insect pathogens as biological control agents: Do they have a future? *Biol Control.* Vol. 21, pp. 230-248.
- Lemaitre B., Hoffmann J. (2007). The host defense of *Drosophila melanogaster*. *Annu Rev Immunol.* Vol. 25, pp. 697-743.
- Lord J.J., Anderson S., Stanley D.W. (2002). Eicosanoids mediate *Manduca sexta* cellular response to the fungal pathogen *Beauveria bassiana*: A role for the lipoxygenase pathway. *Arc. Ins. Biochem. Physiol.* Vol. 51, pp. 46-54.
- Miller J.S., Nguyen T., Stanley-Samuels D.W. (1994). Eicosanoids mediate insect nodulation responses to bacterial infections. *Proc. Nat. Acad. Scie. USA* Vol. 91, pp. 12418-12422.
- Miller J.S., Stanley D.W. (1998). The nodule formation reaction to bacterial infection: Assessing the role of eicosanoids. In: *Techniques in insect immunity* pp. 265-270. (A. Wiesner et al., eds.). SOS publications, Fair Haven, NJ.
- Russell V., Dunn P.E. (1996). Antibacterial proteins in the midgut of *Manduca sexta* during metamorphosis. *J Insect Physiol.* Vol. 42, pp. 65-71.
- SAS Institute Inc. 1989. *SAS/STAT User's Guide, Version 6, 4th Ed., vol 2*. SAS Institute Inc., Cary, NC.

MORPHOLOGICAL AND MOLECULAR IDENTIFICATION OF A NEW ALFALFA PARASITE - COLLETOTRICHUM LINICOLA IN SERBIA

Tanja VASIĆ^{1*}, Darko JEVREMOVIĆ², Snežana ANDJELKOVIĆ¹, Jordan MARKOVIĆ¹, Vladimir ZORNIĆ¹, Snežana BABIĆ¹, Aleksandar LEPOSAVIĆ²

¹Institute for Forage Crops, Kruševac, Serbia

²Fruit Research Institute, Čačak, Serbia

*Corresponding author: tanja.vasic@ikbks.com

Abstract

Alfalfa (*Medicago sativa* L.) is economically the most important forage crop in Serbia. During the period of 2005-2010, intense occurrence of alfalfa anthracnose was observed in Serbia (Srpska Crnja, South Banat District). Alfalfa plants showed characteristic symptoms of anthracnose disease (“shepherd’s crook”) including wilting and dying of the upper parts of the stems. Collected isolates formed light green to dark olive-green colonies on potato dextrose agar (PDA) and developed black acervuli around the center of the colony. In cultures on PDA medium acervuli were formed. Conidia were hyaline, aseptate, straight with one end pointed and the other slightly rounded, with dimensions 12.5 to 25.0 × 2.5 to 7.5 µm (mean 19.83 × 4.42 µm). In cultures on PDA medium after 5 days, numerous setae were formed. The setae were slightly darker at the bottom and lighter at the top, septate with 3 septa. Setae dimensions were with dimensions 100 to 185.5 × 2.5 to 5 µm (average 160.9 × 3.12 µm). PCR amplification using ITS1-ITS4, GSF1-GSR1, GDF1-GDR1 and T1-Bt2b primer pairs yielded fragments of approximately 495 base-pairs (bp), 900 bp, 200 bp and 750 bp, respectively. Based on the morphological characteristics and molecular characterization, the analyzed isolate Coll-44 from alfalfa was determined as *Colletotrichum linicola* Pethybr. & Laff.. According information we have on disposal this is the first report of *C. linicola* causing alfalfa anthracnose in Serbia.

Keywords: Anthracnose; Alfalfa; *Colletotrichum linicola*; PCR analysis

Introduction

Many diseases cause the dying of alfalfa plants, reduction of yield, and negative impact on quality of animal feed. Anthracnose of alfalfa is one of the most important diseases that reduce alfalfa yield (O'Neill et al., 1997; Vasić, 2013) and is caused by fungi of the genus *Colletotrichum*. Damage induced by presence and development of the pathogen causes the reduction of quality and quantity of fresh mass from 10-30% depending on the alfalfa cultivar, species of pathogen, climatic and edaphic factors (Latunde-Dada et al., 2007; Vasić, 2013). *C. trifolii* and *C. destructivum* spread rapidly during warm, wet weather. Conidia forms in the acervuli on stem lesions. Wind and rain splash carry conidia to the growing petioles and stems. Infected hyphae proliferate within susceptible host tissue and form oval-shaped lesions. In hot, dry weather, infected stems may wilt and die. The fungus grows down in infected stems into the crown and taproot, causing killing of tissue, predisposition to winter injury, wilting or plant dieback (Vasić, 2013). Anthracnose of alfalfa, caused by *C. destructivum* is prevalent on wide area in Serbia and the induced damages are of great economic importance (Vasić, 2013).

Material and methods

Morphological traits

The isolates studied in this survey were obtained from infected alfalfa plants collected from 2005-2010 in Serbia (Srpska Crnja, South Banat District). All samples were placed in paper bags and delivered to the phytopathological laboratory of the Institute for Forage Crops, Kruševac. The pathogen was isolated from the stem, the top of the root, and root of alfalfa. Potato dextrose agar (PDA) medium was used for the isolation of the pathogen (Dhingra and Sinclair, 1995). Petri dishes were incubated in thermostat at $24 \pm 2^\circ\text{C}$ in the dark.

Morphological traits of selected isolates of *Colletotrichum* sp. were studied on PDA and carnation leaf agar (CLA) (Waller et al. 1998) according to the method by Baxter et al. (1983). Hyphal appearance was prepared according to the method by Baxter et al. (1983) on PDA medium and in hanging drops over the glass according to the method described by Hawksworth (1974). Size of conidiomata was determined by measuring the diameter (10 fully formed acervuli on PDA) and calculating the mean values. The presence or absence of setae in the cultures was determined by the method of Smith and Black (1990) by observation of 10-day-old cultures under the light microscope. The form and dimensions of conidia in the selected isolates of *Colletotrichum* sp. were examined according to the method of Smith and Black (1990). Dimensions of conidia were determined by measuring the length and width of 30 randomly selected conidia in the selected isolates grown on PDA, using a light microscope (Olympus CX41). Morphological traits of appresoria of the studied isolates were determined using a modified method by Hawksworth (1974). The shape, color and dimensions of appresoria were studied in selected isolates. Twenty-five appresoria per isolate were observed and measured. To observe the formation of teleomorph stage, studied isolates were grown on PDA. Cultures were incubated at 25°C in the day and night cycle, and the formation of perithecia was observed on three occasions, after 30 days, 6 months and 12 months. Petri dishes were kept in a thermostat at 25°C . The trial was set to 10 repetitions per isolate.

Molecular detection and identification

Isolates were grown on PDA in the dark, at 25°C for 7 days. DNA extraction was done according to the method described by Day and Shattock (1997). Polymerase chain reaction (PCR) was done using four sets of primers. The 5.8S rDNA, ITS1 and ITS2 region (ITS) was amplified with the primer pair ITS1-ITS4; an intron region of the glutamine synthetase gene (GS) with GSF1-GSR1 primer pair; an intron region of the glyceraldehyde-3-phosphate dehydrogenase gene (GPDH) with the primer pair GDF1-GDR1; and 5' end of the β -tubulin gene (TUB2) with T1-Bt2b primer pair (Table 1).

Table 1. The list of primers used for the detection and identification of *Colletotrichum* sp.

Primers	Sequences 5'-3'	Fragment length	References
ITS1	TCCGTAGGTGAACCTGCGG	~495 bp	Freeman et al. (2000)
ITS4	TCCTCCGCTTATTGATATGC		
GSF1	ATGGCCGATACATCTGG	~900 bp	Liu et al. (2007)
GSR1	GAACCGTCGAAGTTCCAC		
GDF1	GCCGTCAACGACCCCTTCATTGA	~200 bp	
GDR1	GGGTGGAGTCGTACTTGAGCATGT		
T1	AACATGCGTGAGATTGTAAGT	~ 750 bp	O'Donnell and Cigelnik (1997)
Bt2b	ACCCTCAGTGTAGTGACCCTTGCC		

PCR tests were performed in a TPersonal thermocycler (Biometra, Germany). PCR products were analyzed by 1.5% agarose gel electrophoresis, stained with ethidium bromide and visualized under UV light on a transilluminator (Biometra, USA). The appearance of the fragment of the expected size was considered as a positive reaction.

Amplified products of the ITS and TUB2 regions of Coll-44 isolate were custom sequenced (Macrogen, the Netherlands). Obtained sequences were compared with the available sequences of *Colletotrichum* sp. from the NCBI GenBank database using BioEdit software (Hall, 1999).

Results and discussion

Morphological traits

On PDA medium, the isolate Coll-44 was characterized as *C. linicola*. It formed cottony colonies, velvety gray to light olive green in color. Analyzed isolate of *C. linicola* formed fruiting bodies - acervuli. Dimensions of acervuli were ranged from 100-280 μm . Similar results were earlier reported by Tunali et al. (2008), Vasić et al. (2014) and Damm et al. (2014). The Coll-44 isolate formed setae within conidiomata, slightly darker at the bottom and lighter at the top, having from 1 to 3 septae. Dimensions of septae were 100-185.5 x 2.5-5 μm (average 160.9 x 3.12 μm). The isolates identified as *C. linicola* formed cylindrical conidia, tapered at one end and rounded at the other, dimensions 10-25 x 2.5-7.5 μm . Our result is in accordance with Tunali et al. (2008) and Vasić et al. (2014). During this study it was found that *C. linicola* isolates form septa in the equatorial part of the conidia during germination, which is a characteristic trait of this species. Based on this characteristic traits, *C. linicola* differ from close related species which do not form septae. Latunde-Dada and Lucas (2007) and Tunali et al. (2008) noted that the species *C. linicola* forms septae during germination of conidia. The Coll-44 isolate formed numerous appresoria, dimensions 5-17.5 x 2.5-7.5 μm (average 11.8 x 5.9 μm). The results obtained from our study coincide with the results of Latunde-Dada and Lucas (2007), Tunali et al. (2008), Vasić et al. (2014) and Damm et al. (2014). During this experiment was performed the isolate Coll-44 from Serbia (Srpska Crnja, South Banat District) did not form perithecia. This result is in accordance with Baxter et al. (1983), Latunde-Dada and Lucas (2007). Pure culture of the tested isolate was deposited in the public collection of CBS-KNAW Fungal Biodiversity Centre, Utrecht, the Netherlands (specimen no. CBS 138125).

Molecular detection and identification

The polymerase chain reaction (PCR) has been successfully applied for the identification of the isolates from alfalfa, including *C. linicola* isolate Coll-44. Universal primer pair ITS1-ITS4 yielded a product of approximately 495 bp in all tested isolates (Figure 1).

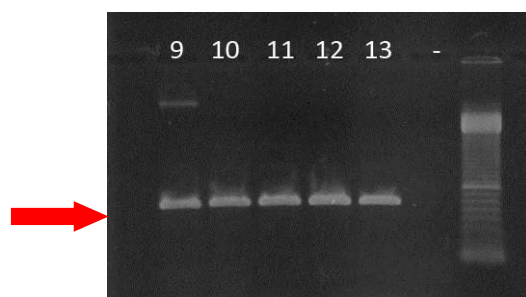

Figure 1. Electrophoretic analysis of PCR products with ITS1-ITS4 primer pair. Lines: 13- isolate Coll-44, (-) - negative control, M - 100-base pair ladder (Amersham Biosciences).

The presence of the fragment of approximately 900 bp was determined for most of the tested isolates using the primer pair GSF1-GSR1, an intron region of the GS gene had poor efficiency for Coll-44 isolate (Figure 2).



Figure 2. Electrophoretic analysis of PCR products with GSF1-GSR1 primer pair. Lines: 18 - isolate Coll-44, M- 100-base pair ladder (Amersham Biosciences).

PCR analysis with GDF1-GDR1 resulted in a positive reaction for tested isolates. Using these primer set, an intron region of the GPDH gene was successfully amplified for Coll-44 isolate (Figure 3).

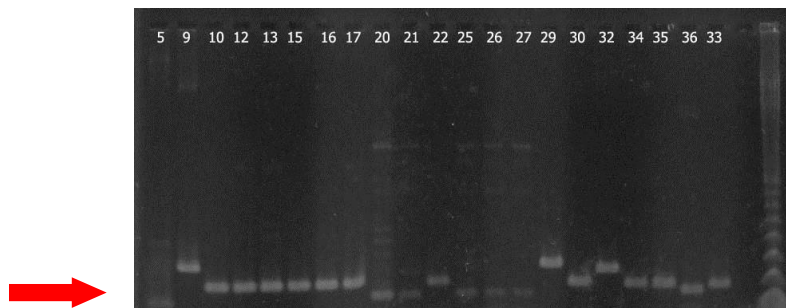

Figure 3. Electrophoretic analysis of PCR products with GDF1-GDR1 primer pair. Lines: 13 - isolate Coll-44, M - 100-base pair ladder (Amersham Biosciences).

In fourth PCR reaction with the primer pair T1-Bt2b the expected fragment of 750 bp was obtained for Coll-44 isolate (Figure 4).

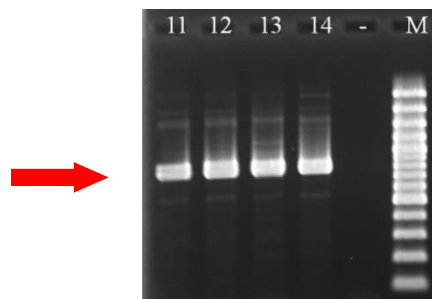

Figure 4. Electrophoretic analysis of PCR products with T1-Bt2b primer pair. Lines: 13 - isolate Coll-44, (-) - negative control, M- 100-base pair ladder (Amersham Biosciences).

The extracted fungal genomic DNA was of high quality and suitable for PCR amplification, allowing successful detection of isolates selected for this study. By using different primer pairs for PCR detection *C. linicola* isolate was successfully detected. Amplified PCR products of ITS and TUB2 regions of the isolate Coll-44 were sequenced and obtained sequences were deposited

in the NCBI Genbank under accessions numbers JX908364 and KJ556347, respectively. The sequences of Coll-44 isolate were compared with the available sequences from the GenBank database. Blast analysis confirmed 100% nucleotide identity of the Coll-44 ITS sequence with the GenBank accessions AB046609 and JQ005765 of *C. linicola*. Additionally, Coll-44 TUB2 sequence showed 99.6% nucleotide identity with the GenBank accession JQ005849 of *C. linicola* isolate CBS 172.51.

Freeman et al. (2000) have successfully distinguished 230 different isolates of *Colletotrichum* species using universal primers ITS1-ITS4 and sequencing PCR products of 450-490 bp of the tested isolates. Johnston and Jones (1997) used an analysis of LSU rDNA sequences of isolates derived from different crops in New Zealand. Moriwaki et al. (2002) successfully distinguished 236 isolates by studying ITS-2/LUS rDNA of *Colletotrichum* species in Japan using rDNA ITS1 region for sequencing products of size of approximately 157-190 bp. Liu et al. (2007) stated that the use of RFLPs of a intron regions in the glutamine synthetase (GS) gene has proved successful for the identification and characterization of closely related species within the genus *Colletotrichum* which were previously difficult to distinguish based on morphological traits. PCR reaction with GSF1-GSR1 primer pair had poor efficiency for Coll-44 isolate and gave product of not sufficient quality for further RFLP analysis. On the other hand, the intron region of the gene for GS is suitable for the detection and further characterization of Serbian *C. destructivum* isolates (Vasić, 2013). Detection of the isolates using the GDF1/GDR1 primers proved to be reliable and allowed the amplification of a portion of the second intron of the GPHD gene. These primers produced fragments of about 200 bp in all tested isolates. Talhinhos et al. (2002) performed the first multilocus phylogenetic analysis of the genus *Colletotrichum* by studying *C. acutatum* community on lupins (*Lupinus* sp.) using ITS, TUB2 and HIS4 sequences, while Guerber et al. (2003) used the intron region of a gene for GS and GPHD nucleotide sequences for the analysis of *C. acutatum*.

Conclusions

Based on morphological characteristics and molecular detection and characterization, the analyzed isolate from alfalfa was determined as *C. linicola*. Molecular detection with the primer sets targeting different genomic regions is useful tool for the detection of *C. linicola* in alfalfa, but sequence analysis is needed to distinguish this from other species.

According information we have on disposal this is the first report of *C. linicola* causing alfalfa anthracnose in Serbia.

Acknowledgment

Research was financed by the Ministry of Science and Technological Development, Republic of Serbia, project TR 31057.

References

- Baxter, A.P., Westhuizen, G.C.A. van der, Eicker, A. (1983): Morphology and taxonomy of South African isolates of *Colletotrichum*. South African Journal of Botany 2: 259-289.
- Damm, U., O'Connell, R.J., Groenewald, J.Z., Crous, P.W. (2014): The *Colletotrichum destructivum* species complex – hemibiotrophic pathogens of forage and field crops. Studies in Mycology, 79: 49–84.
- Day, J.P., Shattock, R.C. (1997): Aggressiveness and other factors relating to displacement of population of *Phytophthora infestans* in England and Wales. European Journal of Plant Pathology 103: 379–391.

- Dhingra, O.D., Sinclair, J.B. (1995): Basic Plant Pathology Methods, second edition. CRC Press, INC., Boca Raton, Florida, USA.
- Freeman, S., Minz, D., Jurkevitch, E., Maymon, M., Shabi, E. (2000): Molecular Analyses of *Colletotrichum* Species from Almond and Other Fruits. *Phytopathology* 90(6): 608-614.
- Glass, N.L., Donaldson, G.C. (1995): Development of primer sets designed for use with the PCR to amplify conserved genes from filamentous ascomycetes. *Applied Environmental Microbiology* 61: 1323–1330.
- Guerber, J.C., Liu, B., Correll, J.C., Johnston, P.R. (2003): Characterization of diversity in *Colletotrichum acutatum* sensu lato by sequence analysis of two gene introns, mtDNA and intron RFLPs, and mating compatibility. *Mycologia* 95: 872–895.
- Hall, T.A. (1999) BioEdit: a user-friendly biological sequence alignment editor and analysis program for Windows 95/98/NT. *Nucleic acids symposium series* 41: 95-98.
- Hawksworth, D.L., Graham, S.O. (1974): *Mycologists Handbook*. Commonwealth mycological Institute, Kew, England.
- Hyde, K.D., Cai, L., McKenzie, E.H.C., Yang, Y.L., Zhang, J.Z. and Prihastuti, H. (2009). *Colletotrichum*: a catalogue of confusion. *Fungal Diversity* 39: 1-17.
- Johnston, P.R., Jones D. (1997): Relationship among *Colletotrichum* isolates from fruit rots assessed using rDNA sequences. *Mycologia* 89: 420-430.
- Latunde-Dada, A.O., Lucas, J.A. (2007): Localized hemibiotrophy in *Colletotrichum*: cytological and molecular taxonomic similarities among *C. destructivum*, *C. linicola* and *C. truncatum*. *Plant Pathology* 56: 437–447.
- Liu, B., Wasilwa, L.A., Morelock, T.E., O'Neill, N.R., Correll, J.C. (2007): Comparison of *Colletotrichum orbiculare* and several allied *Colletotrichum* spp. for mtDNA RFLPs, intron RFLP and sequence variation, vegetative compatibility, and hostspecificity. *Phytopathology* 97: 1305-1314.
- Moriwaki, J., Tsukiboshi, T., Sato (2002): Grouping of *Colletotrichum* Species in Japan Based on rDNA Sequences. *Journal of General Plant Pathology* 68: 307-320.
- O'Neill, N.R., van Berkum, P., Lin, J.J., Kuo, J., Ude, G.N., Kenworthy, W., Saunders, J.A. (1997): Application of amplified restriction fragment length polymorphism for genetic characterization of *Colletotrichum* pathogens of alfalfa. *Phytopathology* 87: 745-750.
- O'Donnell, K., Cigelnik, E. (1997): Two divergent intragenomic rDNA ITS2 types within a monophyletic lineage of the fungus *Fusarium* are nonorthologous. *Molecular Phylogenetics and Evolution* 7(1): 103–116.
- Smith, B.J., Black, L.L. (1990): Morphological, cultural, and pathogenic variation among *Colletotrichum* species isolated from strawberry. *Plant Disease* 74: 69-76.
- Talhinhas, P., Sreenivasaprasad, S., Neves-Martins, J., Oliveira, H. (2002). Genetic and morphological characterization of *Colletotrichum acutatum* causing anthracnose of lupins. *Phytopathology* 92: 986–996.
- Tunali, B., Berner, D.K., Dubin, H. (2008): First report of leaf spot caused by *Colletotrichum* cf. *linicola* on field bindweed in Turkey. *Plant Disease* 92: 316.
- Vasić, T, Bulajić, A., Krnjaja, V., Jevremović, D., Živković, S., Andjelković, B. (2014): First report of anthracnose on alfalfa caused by *Colletotrichum linicola* in Serbia. *Plant Disease* 98: 1276-1276.
- Vasić, T. (2013): Characterization of *Colletotrichum* species, causing the anthracnose of alfalfa in Serbia and genotype susceptibility. Doctoral thesis. University of Belgrade, Faculty of Agriculture, Serbia, 1-178.
- Waller, J.M., Rithcie, B.J., Holderness, M. (1998): *Plant clinic handbook*. CAB International, Wallingford, Oxon.

**SUSCEPTIBILITY OF ONION THRIPS, THRIPS TABACI LINDEMAN
(THYSANOPTERA: THIRIPIDAE) TO OLD AND NEW GENERATION OF
SPINOSYN PRODUCTS UNDER LABORATORY CONDITIONS**

Sobhy A. TEMERAK

Plant Protection Department, Faculty of Agriculture, Assiut University, Egypt

*Corresponding author: stemerak@hotmail.com

Abstract

The spinosyn products are a large family that shows potent insecticidal effects against large scale of insect pests. Rapid development of resistance to old generation of insecticides has been established in onion thrips, *Thrips tabaci* production areas and being a key problem. Testing a new and relatively safe products may facilitate and help to find the best effective product.

The lethal effects of spinosad and spinetoram against nymphs and adults of onion thrips, *Thrips tabaci* Lindeman (Thysanoptera: Thripidae) were done under laboratory conditions, utilizing IRAC method no.10a and 10 b. The results revealed that nymphs were more susceptible than adults. Further, spinetoram (new generation) was 8.3- and 9.3- fold stronger than spinosad (old generation) against nymphs and adults, respectively. Application of spinetoram in conjunction with naturally occurring beneficial arthropods are an excellent example of a functional onion integrated pest management (IPM) program. Spinetoram will be an excellent and promising tool to the integrated pest management (IPM) programs and insect resistance management (IRM).

Key words: spinosyn products, *Thrips tabaci*, efficiency, toxicity.

Introduction

Onion thrips, *Thrips tabaci* Lindeman (Thysanoptera: Thripidae), is a key insect pest in most onion production regions of the world. Immature (nymphs) and adult thrips feed with a punch-and-suck behavior that removes leaf chlorophyll causing white to silver patches and streaks. Interestingly, thrips populations increase rapidly under hot, arid conditions and can lead to economic crop loss. However, the early bulb enlargement stage of onion growth is the most sensitive to thrips feeding. Consequently, insecticides are the most common tactic for onion thrips management. Despite their ease of use and availability of numerous classes or modes of action, rapid development of resistance to insecticides has been a key problem. The main reasons lay as follows:

- 1- In the life history characteristics of onion thrips: reproduction by parthenogenesis (eggs develop without male fertilization so females pass all of their genes to their offspring),
- 2- Highly reproductive potential and short generation time (Diane and Daniel, 2008).
- 3- Most currently available insecticides only kill the nymphs or adult, with no activity on eggs. As such, repeat applications are typically warranted to kill the life stages that were not affected by previous applications, such as nymphs that were in the egg stage and adults that were in the pupae stage (Kontsedalov et al., 1998; Diane and Daniel, 2008).
- 4- Recent research has shown that the majority of onion thrips on a plant are in the non-feeding egg stage (60- 75% of total population on an onion plant during late June to

August), and thus, not exposed to insecticides and other suppressive tactics (Diane and Daniel, 2008).

- 5- Widespread resistance across the western U.S. to organophosphate (e.g., azinphosmethyl, iazanon, methyl parathion) synthetic pyrethroid (e.g., cypermethrin, permethrin) and to new chemicals imidacloprid, abamectin and spinosad insecticides has been documented. (Immaraju et al., 1992, Zhao et al., 1995, Jenson 2000, Herron and James 2005; Bielza et al., 2007; Diane and Daniel, 2008; Wang et al., 2011; Chen et al., 2011; Gao et al., 2012).

The spinosyns have a unique mechanism of action (MOA) involving disruption of nicotinic acetylcholine receptors (nAChR). When compared with many other insecticides, the spinosyns generally show greater selectivity toward target insects and lesser activity against many beneficial predators as well as mammals and other aquatic and avian animals. Their insecticidal spectrum, unique MOA and lower environmental effect make them useful new agents for modern integrated pest management programs. As a result, this work has received U S Presidential Green Chemistry Challenge Awards. (Kirst, 2010; El-Geddawy et al., 2014; Ahmed et al., 2015a, b, c). There was possibility of resistance creation of thrips to spinosins in many areas of the world wide (Loughner et al., 2005; Zhang et al., 2008, Gao et al., 2012, Sparks et al., 2012). To prolong activity of the new novel insecticides such as spinosins (spinosad or spinetoram), the necessity of rotating insecticides and implementing alternative methods of managing is a potential requirement (Loughner et al., 2005; Dripos et al., 2010). Peterson et al (1997) indicated that application of spinosyns in conjunction with naturally occurring beneficial arthropods are an excellent example of a functional cotton integrated pest management (IPM) program. Cloyd and Sadof (2000) reported that spinosad and acephate were effective at controlling thrips on greenhouse-grown plants. Basically, Spinosad and spinetoram are classified by EPA as reduced-risk product and awarded the green chemical from the white house in USA in 1999 and 2008, respectively.

Rapid development of resistance to old generation of insecticides has been established in Onion thrips, *Thrips tabaci* production areas and being a key problem. Testing a new and relatively safe products may facilitate and help to find the best effective product.

Materials and Methods

Product used

Spinosad 24%SC (Tracer): is a metabolite of the Actinomycete, *Saccharopolyspora spinosa* Martz & Yao. It is a naturally occurring mixture of two active spinosyns (spinosyn A & D). It is a trademark of Dow AgroSciences Co. It is considered the 1st generation from the spinosyn group. Spinetoram 12% SC (Radiant): is the 2nd new generation of the spinosyn group with the same mode of action as spinosad. It is a mixture of two active spinosyns (spinosyn J & L). It is a trademark of Dow AgroSciences Co.

Laboratory tests (IRAC method no 10 a and b)

Thrips as adult and nymph, almost at same age, were collected using an aspirator from highly infested onion field, anaesthetized them with CO₂. The white leaves of onion bulb were separated and leaf discs as squares 2 x 2 cm was prepared. These discs were soaked for few seconds in different concentrations from the insecticides uses and left to be dry. The thrips were then

tapped into leaf discs .This almost in line with IRAC method no. 10 a and b discs were placed in petri dishes under room temperature 26 C and relative humidity as 55%. Spinosad concentrations as ppm were 100-1600 for nymph and 200-3200 for adult respectively. Radiant concentration was 10-80 ppm for nymph and from 20-160 pmm for adults, respectively. Similar technique was done by Thalavaisundaram et al. (2008), and by Dağh and Tunç (2007).

Results and Discussion

In laboratory test utilizing IRAC method no.10a and 10 b:

The lethal effects of spinosad and spinetoram against nymphs and adults of onion thrips, *T. tabaci* were done under laboratory conditions , utilizing IRAC method no.10a and 10 b (Table 1). Within spinosad or spinetoram treatments, nymphs were more susceptible than adult. The last may be attributed to the nymph eat more than adult in which more molecule was taken inside the target. Radiant was 8.3- and 9.3-fold stronger than tracer against nymph and adult, respectively. These results are in agreement with Srivastava et al 2008 who indicated that Spinetoram at 61 g ai/ha was as effective as spinosad at 140 g ai/ha against the western flower thrips and the other common thrips in Florida, *Frankliniella tritici* and *Frankliniella bispinosa*.(Spinetoram is compatible with the key natural enemy of *Frankliniella* species thrips in pepper. Also with Palumbo and Ichardson, (2008).

Table 1. Probit analysis of toxicity of spinosad and spinetoram against nymph and adult of *Thrips tabaci*, under laboratory conditions.

Insecticides	Slope \pm SE ^{1/}	LC ₅₀ (ppm) (95% FL)*	LC ₉₀ (ppm) (95% FL)*	Fold RR
Nymph stage				
Spinosad	0.92 \pm 0.37	282.84 (194.19-411.98) ^{3/}	1748.08 (929.54- 8269.62)	8.37
Spinotram	0. 60 \pm 0.38	33.76 (26.91-41.06)	112.92 (81.11-200.43)	
Adult stage				
Spinosad	1.02 \pm 0.37	422.51 (254.62-608.08)	2965.61 (1579.83-15415.44)	9.23
Spinotram	0.69 \pm 0.39	45.74 (32.57-60.89)	202.15 (129.47-504.71)	

* FL: fiducial limits,

In this interim, Lopez et al (2008) indicated adult vial technique (AVT) and spray table bioassays were conducted to evaluate toxicity of selected insecticides against immature and adult thrips, *Frankliniella* spp. (Thysanoptera: Thripidae). In AVT, technical insecticides compared with organophosphates (dicrotophos and methamidophos), spinosyn (spinosad) and neonicotinoids (thiamethoxam and imidacloprid) were used. The LC₅₀ values for contact with the insecticides were all significantly different, with spinosad being most toxic and imidacloprid being least toxic

to thrips. Furthermore, Cloyd and Sadof (2000) reported that, spinosad and acephate were effective at controlling thrips on greenhouse-grown plants. Radiant will be an excellent addition to our IPM programs, however because it has the same mode of action as tracer, it will not provide an additional rotational partner for our resistance management programs.

Table 2: Spinetoram was more effective than spinosad based on gram active

Targets	Lab. test	Field Test	Fold of stronger	References
<i>Phthorimaea operculelela</i> (Zeller)		field	3	Temerak and Rizk 2009
<i>Cadra</i> spp		field	4	Temerak and Sayed 2009
<i>Baterachedra amydraula</i> Meyrick		field	2.6	Temerak and Sayed 2009)
<i>Viracola livia</i> (Klug)		field	2	Sayed and Temerak 2009)
<i>Catantops axillaris</i> Thunburg		field	3 to 4	El-Gammal and Mohammed 2008
<i>Spodoptera littoralis</i> (Boisd)		field	5	Temerak 2007
<i>Spodoptera littoralis</i> (Boisd)	lab		7	Temerak 2008
<i>Arenipses (Aphomia) sabella</i> Hampson		field	5	Temerak ,under publication
<i>Tuta absoluta</i> (Merycik)		field	5	Temerak 2011
<i>Thrips tabaci</i> Lindeman	lab.		8.3-9.3	Temerak Current manuscript

In this regards, several published research were indicated that the new generation as Spinetoram (Radiant 12 SC) proved to be stronger than the old generation as spinosad (Tracer 24 SC) when gram active was considered (Table 2). It was 3-fold when Potato tuber worm *Phthorimaea operculelela* (Zeller) utilized in the field (Temerak and Rizk, 2009). It was 4-fold when the Almond Moth *Cadra* spp was tested in the field (temerak and sayed 2009). It was 2.6 fold when the Lesser date moth *Baterachedra amydraula* Meyrick was combated in the field (Temerak and Sayed, 2009). It was 2-fold when the Pomegranate fruit butterfly *Viracola livia* (Klug) was controlled in the field (Sayed and Temerak, 2009; Lysandrou et al., 2010). It was 3-4 times when the Grasshopper, *Catantops axillaris* Thunburg was faced in the field (El-Gammal and Mohammed, 2008) Spinetoram was 12 SC 3-4 times stronger than spinosad based on g.a.i/fed. It was 5 fold and 7 fold when cotton leaf worm *Spodoptera littoralis* was tested in the field and laboratory , repectively (Temerak, 2007). It was more than 5-fold when the greater date moth, *Arenipses (Aphomia) sabella* Hampson (Lepidoptera: Pyralidae) was tested in the field (Temerak unpublished data). It was 4 fold more active , The tomato borer, *Tuta absoluta* (Merycik) was tested in the field (Temerak, 2011). Further investigation should be conducted to illustrate in terms of molecular biology and biochemistry of spinosyn compounds, plus synthesis new spinosyn compounds are considered paramount.

Conclusion, Rapid development of resistance to old generation of insecticides has been established in Onion thrips, *Thrips tabaci* production areas and being a key problem. The last increase amount of insecticides with more cost and added pollution to the environment. Testing a new and relatively safe products may facilitate and help to find the best effective product.

Spinetoram is among the most efficacious insecticides against western flower thrips. This insecticide also tend to be compatible with natural enemies of thrips, making them highly valuable in IPM programs. (Gao et al 2012). Both spinosin products can not alternate to each other because having the same mode of action.

References

- Ahmed, M.A.I., Abdel-Galil, F.A., Temerak, S.A.H., Manna, S.H.M. (2015a). Bio-residual activity of selected biopesticides in comparison with the conventional insecticide dursban against cotton leafworm, *Spodoptera littoralis* (Boisd.) (Lepidoptera: Noctuidae). Am.-Eurasian J. Sustain. Agric. 9, 9-13.
- Ahmed, M.A.I., Temerak, S.A.H., Abdel-Galil, F.A., Manna, S.H.M. (2015b). Effect of selected host plants on the efficacy of spinosad pesticide on cotton leafworm, *Spodoptera littoralis* (Boisd.) (Lepidoptera: Noctuidae) under laboratory conditions. Adv. Environ. Biol. 9, 372-375.
- Ahmed, M.A.I., Temerak, S.A.H., Abdel-Galil, F.A., Manna, S.H.M. (2015c). Susceptibility of field and laboratory strains of cotton leafworm, *Spodoptera littoralis* (Boisd.) (Lepidoptera: Noctuidae) to spinosad pesticide under laboratory conditions. Plant Protection Science. In press.
- Bielza P, Quinto V, Contreras J, Torne M, Martin A and Espinosa PJ,(2007). Resistance to spinosad in the western flower thrips, *Frankliniella occidentalis* (Pergande), in greenhouses of south-eastern Spain. *Pest Manag Sci* 63:682–687 .
- Chen X, Yuan L, Du Y, Zhang Y and Wang J. (2011). Cross-resistance and biochemical mechanisms of imidacloprid resistance in the western flower thrips, *Frankliniella occidentalis*. *Pestic Biochem Physiol* 101:34–38 .
- Cloyd, R.A., Sadof. C. S. (2000). Effects of spinosad and acephate on western flower thrips inside and outside a greenhouse. Hort. Tech. 10 (2)359-362
- Dağh, F., İ. Tunç.(2007). Insecticide resistance in *Frankliniella occidentalis* (Pergande) (Thysanoptera: Thripidae) collected from horticulture and cotton in Turkey. Australian densities on cucumber and rose crops. J. Econ. Entomol., 100 (1):225-232.
- Diane G. Alston , Daniel Drost,(2008). Onion thrips (*Thrips tabaci*).Utah State Univ. and Utah Plant Pest Diagnostic Lab. Article of 7 pages
- Dripos JE, Gomez LE, Weiss AW, Funderburk J, Castro BA ., Paroonagian DL,(2010). Insecticide rotation as a component of thrips resistance management programs. *Resistant Pest Manag Newsl* 19:32–35.
- El-Gammal, A., Mohammed, M.T. (2008). Performance of two spinosyn products to combat the grasshopper, *Catantops axillaris* Thunburg, in comparison to a conventional insecticide in Baharia Oasis of Egypt. Egyptian Journal of Biological Pest Control., 18 (1) 215-220.
- El-Geddawy, A.M.H., Ahmed, M.A.I., Mohamed, S.H. (2014). Toxicological evaluation of selected biopesticides and one essential oil in comparison with indoxacarb pesticide on cotton leafworm, *Spodoptera littoralis* (Boisd.) (Lepidoptera: Noctuidae) under laboratory conditions. Am.-Eurasian J. Sustain. Agric 8, 58-64.

- Gao, Y., Zhongren L., Reitzb S. R. (2012). Western flower thrips resistance to insecticides: detection, mechanisms and management strategies. *Pest Manag Sci Hort. Tech.* 10(2):359-362.
- Herron GA., James TM. (2005). Monitoring insecticide resistance in Australian *Frankliniella occidentalis* (Pergande) (Thysanoptera: Thripidae) detects fipronil and spinosad resistance. *Aust J Entomol* 44:299–303
- Immaraju JA, Paine TD, Bethke JA, Robb KL, Newman JP. (1992). Western flower thrips (Thysanoptera: Thripidae) resistance to insecticides in coastal California greenhouses. *J Econ Entomol* 85:9–14.
- Jensen SE. (2000). Insecticide resistance in the western flower thrips, *Frankliniella occidentalis*. *Integrated Pest Manag Rev* 5:131–146.
- Kirst HA. (2010). The spinosyn family of insecticides: realizing the potential of natural products research. *J Antibiot* 63:101–111
- Kontsedalov S, Weintraub PG, Horowitz AR., Ishaaya I. (1998). Effects of insecticides on immature and adult western flower thrips (Thysanoptera: Thripidae) in Israel. *J Econ Entomol* 91:1067–1071
- Lopez, J.D, Jr., B. K. Fritz*, M. A. Latheef, Y. Lan, D. E. Martin, W. C. Hoffmann. (2008). Evaluation of toxicity of selected insecticides against thrips on cotton in laboratory bioassays. *The Journal of Cotton Science* 12:188–194
- Loughner RL, Warnock DF, Cloyd RA, (2005). Resistance of greenhouse, laboratory, and native populations of western flower thrips to spinosad. *Hortscience* 40:146–149.
- Lysandrou, M., Temerak S. A., Sayed A. A. (2010). The use of different insect control regimes using three green chemicals to combat *Batrachedra amydraula* Meyrick and *Cadra* spp. on date palm fruit in Egypt. *Acta Horticulturae* 882 : 481-489
- Palumbo, J., Richardson, J. (2008). Efficacy of RADIANT (Spinetoram) Against Western Flower Thrips in Romaine Lettuce. Proceedings of the 2nd Arab Conference of Applied Biological Pest Control, Cairo, Egypt, 7-10 April 2008.
- Peterson LG, Ruberson, J.R., Sprenkel, R.K., Weeks, J.R., Donahoe, M.C., Smith, R.M., Swart, J.S., Reid, D.J., Thompson, G.D. (1997): Tracer Naturalyte insect control and IPM. *Down To Earth*. 52 (1); 28-34.
- Sayed A.A., Temerak S. A., Lysandrou M. (2010). The use of different insect control regimes using three green chemicals to combat *Viracola livia* on date palm fruit in Egypt. *Acta Horticulturae* 882 : 471-479
- Sparks TC, Dripps JE, Watson GB and Paroonagian D. (2012). Resistance and cross-resistance to the spinosyns – a review and analysis. *Pestic Biochem Physiol* 102:1–10
- Temerak, S.A. (2011). Status of The tomato borer, *Tuta absoluta* (Merycik) in Egypt from 2009-2011. EPPO/IOBC/FAO/NEEPPO Joint international Symposium on management of *Tuta absoluta* (tomato borer). Agadir, Morocco, Nov. 16-18
- Temerak, S.A., Rizk A.M. (2009). Susceptibility of *Phthorimaea operculella* (Zeller) to old and new generation of spinosyn products on two potato varieties in Egypt. *Resistant Pest Management Newsletter* 19 (1) : 52-55
- Temerak, S.A. (2007). Susceptibility of *Spodoptera littoralis* to old and new generation of spinosyn products in five cotton governorates in Egypt. *Resistant Pest Management Newsletter*. 16 (2) : 18-21.
- Thalavaisundaram, S., Herron G., Clift A.D., Rose H. (2008). Pyrethroid resistance in *Frankliniella occidentalis* (Pergande) (Thysanoptera: Thripidae) and implications *The Journal of Cotton Science* 12:188–194 (2008).

- Wang ZH, Hou WJ, Hao CY, Wu QJ, Xu BY , Zhang YJ.(2011).Monitoring the insecticide resistance of field populations of western flower thrips, *Frankliniella occidentalis*, in the Beijing area (in Chinese). *Chin Bull Entomol* 48:542–547 .
- Zhang S-Y, Kono S, Murai T ., Miyata T.(2008). Mechanisms of resistance to spinosad in the western flower thrips, *Frankliniella occidentalis* (Pergande) (Thysanoptera: Thripidae). *Insect Sci* 15:125–132
- Zhao G, Liu W, Brown JM ., Knowles CO. (1995). Insecticide resistance in field and laboratory strains of western flower thrips (Thysanoptera: Thripidae). *J Econ Entomol* 88:1164–1170.

EFFECT OF HERBICIDES ON MAIZE (*ZEA MAYS* L.) LINES

Milan BRANKOV*, Milena SIMIĆ, Vesna DRAGIČEVIĆ, Branka KRESOVIĆ, Snežana MLADENOVIĆ DRINIĆ

Maize Research Institute „Zemun Polje“, Belgrade, Serbia

Corresponding author: mbrankov@mrizp.rs

Abstract

Herbicide application is one of the most important measures of weed control in maize production. In case of maize inbred lines herbicide use is even more present than in hybrid maize. On the other hand, many factors limit herbicide application, due to lines, herbicides or meteorological impacts. Five herbicides were applied to test their selectivity to 14 maize lines. Herbicides isoxaflutol + thien carbazon-methyl (Adengo), terbuthylazine + dimethenamid-p (Akris), mesotrione + terbuthylazine (Callaris Pro), thien carbazon-methyl + foramsulfuron (Monsoon active) and tembotrione (Laudis) were applied in recommended dose for use in maize hybrid. First two herbicides were applied in maize stage 11-12 (BBCH), while other three were applied in stage 15-16 (BBCH). Experiment was set up on Zemun Polje, Belgrade, Serbia in 2013 and 2014. With two opposite years in meteorological conditions (first one was with drought, second with high amount of precipitations) herbicides induced slight damages in the first visual evaluation, with no visible symptoms in the second evaluation. Also, maize grain yield was not affected by herbicides.

Key words: *herbicides, maize lines, phytotoxicity evaluation, grain yield*

Introduction

In maize field production herbicide application is one of the most important measures for achieving greater grain yield. When herbicides are not used in maize crop, grain yield can be reduced down to 50% (Spasojević, 2014), especially in seed production. On the other hand, one of the problems with herbicide is their selectivity to maize plants. It is known that maize seed crop is often more sensitive to herbicides than hybrid maize. One of the reasons could be maize line homozygosity what carry out smaller habit, slower growth and higher sensitivity towards stresses (Stefanović et al., 2007). Differences in herbicide selectivity are almost present with all herbicides in use, which is due to differences in maize genotypes. Great problems begin with introduction of sulfonylurea herbicides (Malidža, 2007; Stefanović et al., 2010). According to de Carvahlo et al. (2007) herbicides can cause temporary stress, with no influence to growing, while the permanent stress could lead to irreversible damages, yield loss and plant death. It is known that for activity of pre-emergence and early post-emergence herbicides the most important is precipitation amount. In seasons with higher amounts of rainfall, herbicides can negatively affect maize plants. The aim of this research was to evaluate herbicide fitotoxicity through visual plant damages and grain yield.

Material and Methods

Two years field experiment (2013 – 2014) was set up on chernozem soil type in experimental field of the Maize Research Institute „Zemun Polje“, Serbia (44° 52' N, 20° 19' E, 18 asl). Five

herbicides (Table 1) were applied to test their selectivity to 14 maize inbred lines (L1-L14). Herbicides were applied in recommended dose for use in hybrid maize.

Table 1. Herbicides applied in experiment

Active ingredient (a.i.)	Herbicide	a.i. in herbicides	Applied dose per ha
control	-	-	-
isoxaflutol thiencarbazono-methyl	+ Adengo (H1)	70 g/l + 225 g/l	0,44 l
dimethenamid-p terbuthylazine	+ Akris (H2)	280 g/l + 250 g/l	1 l
mesotrione terbuthylazine	+ Callaris Pro (H3)	50 g/l + 326 g/l	2 l
thiencarbazono-methyl + foramsulfuron	Monsoon active (H4)	10 g/l + 30 g/l	1,5 l
tembotrione	Laudis (H5)	420 g/l	1,5 l

First two herbicides (Adengo and Akris) were applied in early post emergence – in 1-2 leaf stage (11-12 BBCH) and other three in post emergence – 5-6 leaf stage (15-16 BBCH). In control (C), weeds were removed by hoeing. The four-replicate trial was set up according to split-plot arrangement. Herbicide phytotoxicity was evaluated twice: 2-3 weeks after herbicide application and 2-3 weeks after first evaluation. Damages were estimated according to the modified EWRC scale (FELDFERSUCHE MANUAL, 1975) following scale: 1- no damages, 9 – plant death. At the end of the vegetation cycle, grain yield was estimated and calculated at 14% of moisture. Obtained data were statistically processed by ANOVA and differences between means were tested by LSD test. Meteorological data for experiment are present in Table 2. In the first year weather conditions were optimal for maize production with proper distribution of precipitation, but in the second part of the season deficiency in precipitation was present. On the other hand, in the second year precipitation level was high during whole growing season. In May of 2014 in three days fall about 180 mm and the same sum was present in July.

Table 2. Precipitation and average air temperatures for the period April-September

Months	Precipitation (mm)		Temperature (°C)	
	2013	2014	2013	2014
April	14.9	84.8	14.9	13.7
May	93.9	192.5	19.7	17.4
June	37.8	71.2	21.9	21.1
July	16.0	187.4	23.8	23.2
August	12.7	41.0	23.7	22.6
September	70.1	75.6	16.9	18.0
Σ/Average	245.4	652.5	20.1	19.3

Results and Discussion

All applied herbicides did not cause significant phytotoxicity on maize lines plants (Table 3). Taking into consideration that applied herbicides belongs to different groups, and have diverse mode of action, they did not cause expected symptoms of phytotoxicity even on susceptible plants. Also, according to this test it can also be claimed that tested lines are tolerant to

application of recommended doses of these herbicides. Maize reaction to herbicides is strongly depended on meteorological conditions (Stefanović and Zarić, 1991), as well as on genotypes (Brankov et. al, 2015). In these two years there was enough precipitations after herbicide application that is needed for expression of activity to the first three herbicides (Adengo, Akris and Callaris Pro). It is known that higher amount of rainfall can cause herbicide rinse into deeper soil layers, what could have negative impact to cultivated plants. In this study such situation was not present, especially in 2014, when high amount of rainfall a lot of rain in May (in three days – 150 mm). Also, herbicide Monsoon active (H4) did not cause changes on maize plant, although it contain foramsulfuron, an active ingredient reported as problematic in maize seed crop (Brankov et al. 2012). Herbicide tembotrion (Laudis) belongs to triketone group that is known as good selectivity to maize (Gitsopoulos et al., 2010).

Table 3. Visual plant damages according to scale (1-9), averages values

	2013					2014				
	HERBICIDES					HERBICIDES				
	H1	H2	H3	H4	H5	H1	H2	H3	H4	H5
L1	1.25	1	1	1.5	1.25	1.5	1.25	1.75	2	2
L2	1	1	1	1	1	1.25	1.25	1.75	2.25	1
L3	1.75	1.75	1.75	1.75	2	1.5	1.25	2	2	1.5
L4	1.25	1	1	1	1.5	1.25	1	1	1	1
L5	1	1	1	1.25	1.25	1	1	1	1	1
L6	1.75	1.5	1	1	1	1	1	1	1	1
L7	1.25	1.5	1.25	1.25	1.25	1	1	1.25	1	1
L8	1	1	1	1	1	1	1	1	1	1
L9	1	1	1.25	1	1	1	1	1.25	1	1
L10	1	1	1	1	1	1	1	1	1	1
L11	1.25	1	1	1	1	1	1	1.25	1	1
L12	1	1	1	1	1	1	1	2	1.5	1.25
L13	1	1.5	1	1	1	1	1	1	1	1
L14	1	1	1	1.25	1	1	1	1	1.25	1

L1-L14 for H1-H5 $p>0,05$ – no significance differences for all treatments

Applied herbicides did not caused significant decrease in grain yield of tested maize plants. Maize grain yield differs significantly among years, but herbicides did not influence significant variations in maize yield, although in some treatments lower yield was observed but it wasn't significant. In 2013, lines L3, L8, L9 and L12 in all herbicide treatments achieved higher grain yields in comparison to control. Similar situation was observed in lines L2, L5, L8, L10, L11, L12 and L14 in 2014.

Table 4. Maize grain yield

	2013						2014					
	HERBICIDES						HERBICIDES					
	H1	H2	H3	H4	H5	C	H1	H2	H3	H4	H5	C
L1	2.14	2.37	1.99	2.10	2.42	2.22	2.45	2.12	1.85	3.09	2.26	2.14
L2	1.45	1.13	1.34	0.81	1.28	1.54	2.75	3.64	4.03	3.98	3.42	2.74
L3	0.53	0.65	0.58	0.43	0.64	0.40	4.46	5.31	6.36	6.11	6.00	4.94
L4	1.87	1.87	1.54	1.85	1.79	1.76	5.46	7.02	6.91	7.36	7.09	5.73
L5	1.90	2.07	2.02	1.74	2.10	1.95	6.30	5.60	6.40	6.25	6.84	5.43
L6	1.97	2.05	1.99	2.17	1.92	1.96	3.82	3.49	4.01	4.66	4.14	3.49
L7	4.30	4.69	3.99	4.48	4.67	4.22	9.22	8.91	10.0	10.5	9.51	8.95
L8	1.31	1.26	1.49	1.00	1.35	0.83	6.35	5.90	6.50	7.04	6.58	5.56
L9	0.55	0.63	0.54	0.98	0.67	0.42	5.17	5.08	5.50	5.42	5.16	5.27
L10	6.94	7.00	6.50	5.86	6.21	6.23	8.20	9.08	11.1	10.5	10.1	9.03
L11	1.02	1.06	1.22	1.27	1.30	1.11	2.65	2.47	2.13	2.46	2.94	2.00
L12	1.83	1.43	1.70	1.68	1.50	1.30	6.17	5.82	6.26	5.63	5.99	5.51
L13	3.81	4.51	4.44	3.68	3.99	3.68	6.99	8.56	7.68	8.27	7.69	7.55
L14	1.49	1.33	1.38	1.06	1.63	1.31	2.27	2.78	2.28	2.27	2.71	2.16

L1-L14 for H1-H5 $p > 0,05$ – no significance differences for all treatments

Conclusion

According to data obtained from our experiment it can be concluded that applied herbicides showed good selectivity to tested lines, so their application in recommended doses for weed control in maize lines crop is safe.

Acknowledgements

This study was supported by Ministry of Education, Science and Technological development of Serbia, Project TR 31068.

References

- Brankov, M., Simić, M., Dragičević, V., Vrbničanin, S., Spasojević, I. (2015): Genotype dependent tolerance to herbicides of maize (*Zea mays* L.) inbred lines. *Genetika*, 47 (1): 97-106.
- Brankov, M., Simić, M., Vrbničanin, S., Dragičević, V., Spasojević, I. (2012): The sensitivity of maize lines to different herbicides. International symposium on current trends in plant protection, 25-28 September, 2012, Topčider. 178-182.
- Carvalho, J. P., Nicolai, M., Rodrigues Ferreira, R., de Oliveira Figueira, A. V., Christoffoleti, P. C. (2009): Herbicide selectivity by differential metabolism: Considerations for reducing crop damages. *Science Agriculture*. (Piracicaba, Braz.), 66 (1): 136-142.
- FELDFERSUCHE MANUAL: Ciba-Geigy AD, Basel. Switzerland, 1975.
- Gitsopoulos, K. T., Melidis, V., Evgenidis, G. (2010): Response of maize (*Zea mays* L.) to post-emergence applications of topramezone. *Crop Protection*, 29 (10): 1091-1093.
- Malidža, G. (2007): Selectivity of sulfonylurea herbicides towards maize as affected by genotype and soil insecticide use. Doctoral dissertation, University of Belgrade, Faculty of Agriculture: 1-82.

- Spasojević I. (2014): The importance of the crop rotation for the increase of maize crop productivity and preservation of the agroecosystem. Doctoral dissertation, University of Belgrade, Faculty of Agriculture, 1-156.
- Stefanović L., Simić M., Dragičević V. (2010): Studies on maize inbred lines susceptibility to herbicides. *Genetika*, 42 (1): 155-168.
- Stefanović L., Simić, M., Rošulj M., Vidaković M., Vančetović J., Milivojević M., Misović M., Selaković D., Hojka Z. (2007): Problems in weed control in Serbian maize seed production. *Maydica* 52: 277-280.
- Stefanović, L., Zarić, Lj. (1991): The effects of herbicides and low temperatures on certain maize genotypes. *Plant Protection (Beograd)*, 42: 345-356.

EVALUTION OF PRECISION FARMING RESEARCH AND APPLICATIONS IN TURKEY

Bahattin AKDEMIR

Namik Kemal University Faculty of Agriculture Department of Biosystems Engineering, Tekirdag-Turkey

*Corresponding author: bakdemir@nku.edu.tr

Abstract

Precision farming as farm management system is very important for Turkey because Turkey has 24 million ha of arable land and Turkish farmers used 10.6 million tonnes of fertilisers and 39222 tonnes of pesticides for agricultural production in 2014. Optimal use of agricultural inputs is vital for environment, health and production cost. Objective of this paper is to summarize precision farming applications and research studies. Farmers' interest in precision farming has been getting increasing. Big private and state farms started to use steering assistance systems in tractors and Turkish Government bought 300 yield monitors for combine owners. In addition, General Directory of Agricultural Research has been started to support to Regional Research Institutes for carrying out National research projects and to join international projects related to precision farming. The universities has been developing control systems for variable rate applications and field scouting robots in order to collect data and measure spatial variability in the fields. There are a few representative companies of precision farming technologies in Turkey. They generally sell Global Position System (GPS) and steering assistance systems for tractors. Farmers are suspicious about profitability of precision farming. Companies look for market to sell precision agriculture systems. After adoption projects and decreasing cost of the system give encourage the farmers to apply precision agriculture. In addition, Turkish government should develop policies to support farmers for sustainable agriculture.

Keywords: *Precision farming, variable rate application, yield mapping, Turkey*

Introduction

Precision Agriculture (PA) is a farming management concept based upon observing, measuring and responding to inter and intra-field variability in crops, or to aspects of animal rearing (Anonymous, 2014). It is a management strategy that employs detailed, site specific information to precisely manage production inputs. This concept is sometimes called precision agriculture, prescription farming, or site-specific management. The idea is to know the soil and crop characteristics unique to each part of the field, and to optimize the production inputs within small portions of the field. The philosophy behind precision agriculture is that production inputs (seed, fertilizer, chemicals, etc.) should be applied only as needed and where needed for the most economic production (Searchy, 1997). Precision Agriculture: an integrated information- and production-based farming system that is designed to increase long term, site-specific and whole farm production efficiency, productivity and profitability while minimizing unintended impacts on wildlife and the environment (Anonymous, 2005). Precision farming (PF) is also defined as a holistic system approach to manage the spatial and temporal variability within a field in order to reduce costs, optimize yield and quality and reduce environmental impacts. This can be achieved by using appropriate technologies within a coherent management structure (Reichardt and Jurgens, 2009).

Turkey is the world's 7th largest agricultural producer and one of the biggest producers of large range of agricultural commodities, such as hazelnuts, apricots, lentils, cherries, figs, olives, tobacco and tea. About one third of Turkey's total land area is devoted to agriculture. There are approximately 3 million agricultural farms in Turkey most of which are family farms employing family labour, nearly two thirds of Turkish farms are less than 5.5 hectares. Although the share of agriculture in the economy has declined significantly, it is still important in both social and economic terms. In 2011 it represented 7.9 percent of GDP, 25.5 percent of employment (Giray, 2012). Turkey has 24 million hectares of arable land, Turkish farmers used 10.6 million tonnes of fertilisers and 39.22 tonnes of pesticides in 2014 (TUIK, 2016). Precision farming as farm management system is very important for Turkey because Optimal use of agricultural inputs is vital for environment, health and production cost. Objective of this study is to evaluate precision farming research and applications in Turkey. Information about research projects has been carried out by Universities and Research Institutes on precision agriculture will be summarized. In addition, precision farming applications, obstacles and possibilities in front of precision farming in Turkey will be discussed.

Precision farming research projects in Turkey

First precision agriculture research was about determination of spatial variability of soil texture, nutrients, weeds and yield. It was carried out by Ankara University and General Directory of Agriculture Research (Turker and Gucdemir, 2004, Turker, 2005)

A variable rate controller for centrifugal fertiliser developed by Tekin (2005), Tekin and Sindir (2013), In addition, different type variable rate controller was also developed by Akdemir et al. (2007). Step motors were used to realize variable rate application for these machines. A special electronic control system was designed for control step motors. A Differential Global Positioning System (DGPS) system was also used to determine positioning. Specific software was used to communicate variable rate system such as step motor, computer, DGPS. These systems were tested for determination of the performance (Tekin, 2004, Akdemir, et al., 2014)

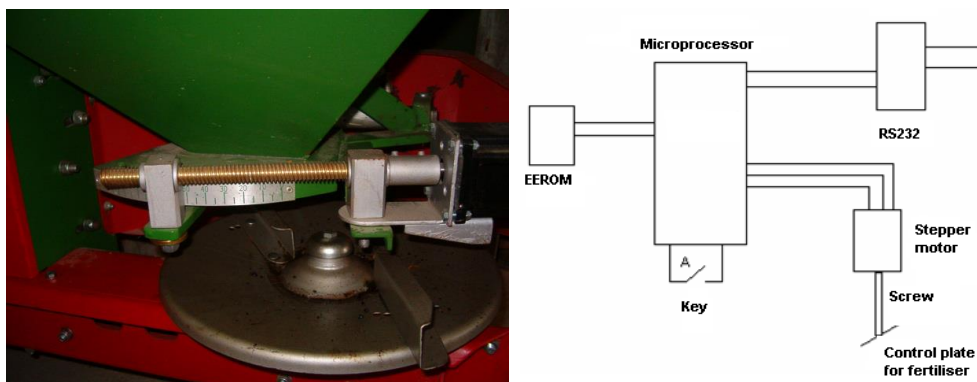

Figure 1. Variable rate controller for centrifugal fertiliser spreader

A variable rate controller was developed for combine cereal planting machines. This modular system was controlled by step motors. Elements of the control system were stepper motors, GPS antenna, and electronic control circuit. During laboratory tests any problem were found communication between stepper motors and control unit (Ozyuruyen and Akdemir, 2010).

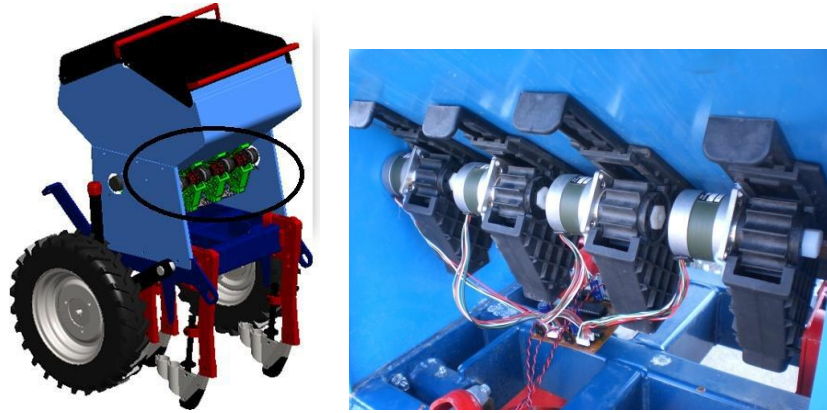

Figure 2. Variable rate controller for cereal sowing machine

An automatic steering system was developed by Akdemir et al., (2012), Altinkaradag, 2014 Akdemir et al. (2014). The system consists of a central control unit, touchable user interface, positioning system, and electro-hydraulic control unit. These subsystems will work simultaneously and whole system will work by developed software. Steering control unit includes a n electro-hydraulic valve and an electronic control circuit which controls the electro-hydraulic valve. The steering control system provides rotation of the steering wheel at required amount angle (?) according to the order of the central control unit. The routes and maps of the tractor can be loaded on Touchable User Interface, and it can create commands to realize these routes. The Touchable User Interface gives information about system working. In addition, it undertakes a duty as control panel which some adjustments can be on it. Positioning system is a system that can takes coordinate data from RTK-GNSS by using CORS-TR system which has 147 reference stations in Turkey and measurement errors will be approx. 3-4 cm. The positioning system will transfer data. The software consists of steering control software, graphic interface software, software for determination of positioning and motion, and system communication and integration software. The steering control software was developed by using Software Development.



Figure 3. Automatic steering system

All variable rate control systems require a prescription or application map software. Commercially available software can accept electronic communication protocol of nonregistered devices and generally companies doesn't give permission for this process. A special application map software was developed by Ungor and Akdemir (2010).

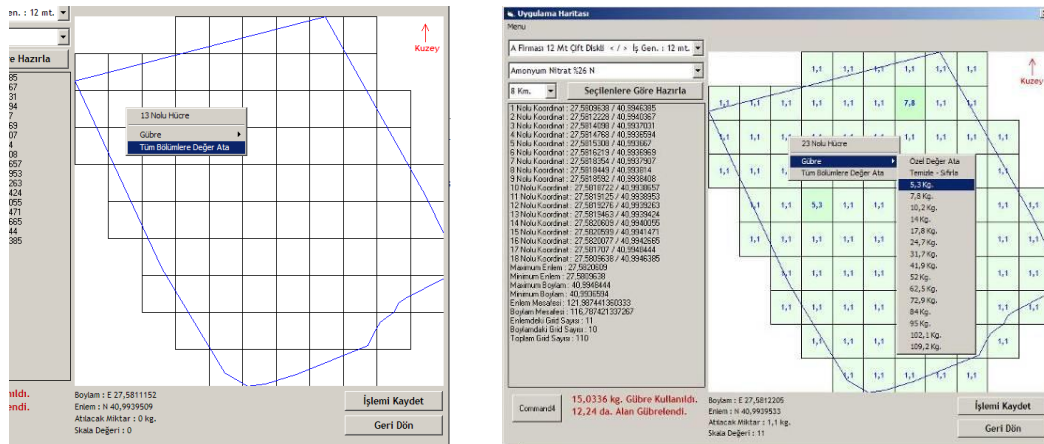

Figure 4. Prescription map software

A Test Software for Servo Motors And Electronic Control Unit Used In Variable Rate Controller was developed by Turen et al. (2014)



Figure 5. Laboratory test software for variable rate controllers

Soil sampling is one of the problems to get spatially variable data. Turkey has a large areas and it is not easy to take soil samples by simple tools. Turen (2013) and Dalmis et al., (2014) developed an automatic soil sample machine to take and make a package with geo reference data.

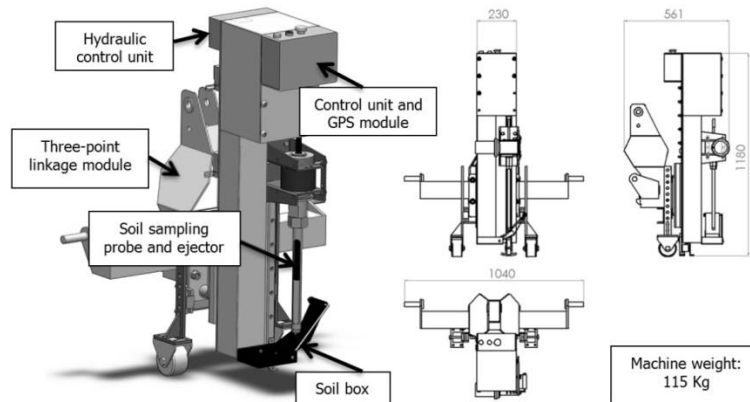

Figure 6. Automatic soil sampling machine

Spatial variability of the different crops were also worked for onions by Akdemir et al. (2005) and for olive Belliturk et al. (2010-a), Belliturk et al. (2010-b).

Albayrak (2010) developed a weight measurement system for tuber crops on a belt scale for dry onions and potatoes.



Figure 7. Weight measurement system of conveyor for tuber crops

Precision farming applications in Turkey

According to the representative companies of precision farming systems in Turkey, 105-110 automatic steering systems, 25 steering assistance systems and 310 yield monitors have been sold to the farmers. There are some imported variable rate applicators but their number is just less than 20. Some sensors such as Greenseeker, EM38, Spadmeter, UAV have been used by research institutes. According to the companies number of the Greenseeker is 45 in Turkey

Conclusions

Agriculture is important for Turkey. Turkish farmers generally apply conservative agricultural practices for production. A few of them apply for precision agriculture. Because cost of variable rate controllers, yield mapping systems and software are so high for small scale Turkish farmers. To solve this problem some software and variable rate controllers have been developed by Universities or Research Institutions but these systems are not available in the Turkish market. Some big farmer use precision agriculture technologies such as GPS, yield monitoring, automatic steering etc. but number of these systems is not so much. Turkish Government decided to support precision agriculture research and adoption projects to extend precision farming but it will take time. Farmers are suspicious about profitability of precision farming. Companies look for market to sell precision agriculture systems. After adoption projects and decreasing cost of the system give encourage the farmers to apply precision agriculture. In addition, Turkish government should develop policies to support farmers for sustainable agriculture.

References

- Akdemir, B., Urusan, A., Kesici, E., Karadag, A., A 2012. Project on development of agricultural tractor automatic steering (system architecture and laboratory tests), CIGR AGENG 2012 Conference, Proceedings of the 10-11 July 2012 Conference Automation technologies for off road equipment pp:21-26
- Akdemir, B., Bellitürk, K., Şişman, C. B., Blackmore S. 2005. Spatial Distribution in A Dry Onion Field (A Precision Farming Application in Turkey) Journal Of Central European Agriculture, Volume 6 Number 3, Pp211-222

- Akdemir, B., M.G. Ungor, Aydogdu, B., E.Kesici, K.Belliturk, Urusan, A., 2014. Development of a Precision Farming System for Turkish Farmers, *Acta Horticulturae*, 1054. Proc. International Conference on Agricultural Engineering, p:301-308
- Akdemir, B., Saglam, C., Belliturk, K., Makaracı, Z, Sener, M., Urusan, A.Y., Atik, M., 2015. Precision farming in olive production, The Joint International Conferences on Intelligent Agriculture, NERCITA ICIA 2015, 27-30 September 2015, Beijing, Proceeding Book
- Akdemir, B., Ungor, M.G, Saglam, N., B. Aydogdu, E. K. Belliturk, A. Altinkaradag, 2014. Development of a Precision Farming System for Turkish Farmers, *Acta Hort. 1054*, ISHS
- Akdemir, B., Sağlam, N., Bellitürk K., Aydogdu, B. 2007. Development a variable rate controller for centrifugal fertiliser (Design the system), 4th International Symposium on Intelligent information technology in Agriculture, 26-29 October 2007, Beijing, China.Proceedings Book, pp:49-54
- Albayrak, B., 2010. Developing a weight measurement system for tuber crops on A Belt Scale, University, Natural and Applied Sciences Institute, MSc Thesis, p:54
- Altinkaradag, A., 2014. Development of automatic steering system for tractors., Namik Kemal University, Natural and Applied Sciences Institute, PhD Thesis, p:135
- Anonymous, 2005. A General Introduction to Precision Agriculture, Australian Centre for Precision Agriculture, web page: www.usyd.edu.au/su/agric/acpa (Access date:14.08.2016)
- Anonymous, 2014. -Precision agriculture :an opportunity for EU farmers -potential support with the CAP 2014-2020, European Parliament Directorate -General For Internal Policies-Policy Department B: Structural And Cohesion Policies Agriculture And Rural Development, web page: [http://www.europarl.europa.eu/RegData/etudes/note/join/2014/529049/IPOL-AGRI_NT\(2014\)529049_EN.pdf](http://www.europarl.europa.eu/RegData/etudes/note/join/2014/529049/IPOL-AGRI_NT(2014)529049_EN.pdf)(access date: 14.08.2016)
- Belliturk, K., C. Saglam, B. Akdemir, C.B. Sisman, 2010. Determination of Spatial Variability in Olive Production Part I-Soil. *Bulgarian Journal of Agricultural Sciences*, Bulgaria, 16 (4)
- Belliturk, K., C. Saglam, B. Akdemir, C.B. Sisman, B. Sozubek, 2010. Determination of Spatial Variability in Olive Production Part II-Leaf. *Bulgarian Journal of Agricultural Sciences*, Bulgaria, 16 (6)
- Dalmis, I.S., Akdemir, B., Turen, N., Belliturk, K., 2014. Development and practical testing of an automatic soil sampling machine, 12th International Congress on Mechanization and Energy in Agriculture, 3-6 September 2014, Cappadocia, TURKIYE, Proceedings, p:20
- Giray, H. 2012. Turkish agriculture at a glance, *Journal of Food, Agriculture & Environment* Vol.10 (3&4): 292-295.
- Ozyuruyen, L. C., Akdemir, B., 2010. Development variable rate controllers for cereal sowing machines (Hububat ekim makinalarında değişken düzeyli kontrol sisteminin geliştirilmesi), 26. Tarımsal Mekanizasyon Ulusal Kongresi, 22-23 Eylül 2010, Mustafa Kemal Üniversitesi Ziraat Fakültesi Tarım Makinaları Bölümü, Bildiri kitabı, 114-117
- Reichardt M., Jurgens Æ C.. (2009). Adoption and future perspective of precision farming in Germany: results of several surveys among different agricultural target groups, *Precision Agric* (2009) 10:73–94
- Searcy, SW. (1997), Precision Farming-A new Approach to crop management, Texas Agricultural Extension Service, web page:http://lubbock.tamu.edu/files/2011/10/precisionfarm_1.pdf (Access date: 14.08.2016)
- Tekin, 2005. A study modifying a granule fertiliser applicator for variable rate fertiliser application, Ege University, Natural and Applied Sciences Institute, PhD Thesis, p:135

- Tekin, A. B., Sındır, K. O. 2004. "Application Accuracy And Distribution Uniformity Of Variable Rate Fertilizer Application "Proceedings Book, International Conference on the Energy Efficiency and Agricultural Engineering, 4-6 April 2004, Rousse, BULGARIA
- Tekin, A. B., Sındır, K. O. 2013. Variable Rate Control System Designed For Spinner Disc Fertilizer Spreader – “PreFer”. University of Belgrade, Faculty of Agriculture, Institute of Agricultural Engineering. Agricultural Engineering, No. 2, pp: 45 – 53.
- TUIK, 2016. Agriculture Statistics, <http://www.tuik.gov.tr/UstMenu.do?metod=kategorist> (Access date: 13/06/2016)
- Turen, 2013. Development of automatic soil sampling machine, Namik Kemal University, Natural and Applied Sciences Institute, MSc Thesis, p:33
- Turen, N., Akdemir, B., Sağlam, C., 2014. Developing A Test Software For Servo Motors And Electronic Control Unit Used In Variable Rate Controller, Tarım Makinaları Bilimi Derneği Dergisi, Vol:10(3), P:207-211
- Turker, U., Guçdemir, I., 2004. A Research on Assessing Small Scale Spatial Variability on Fallow-Wheat System in Atatürk Orman Çiftliği Using Precision Farming Technologies, Journal of Agricultural Sciences (Tarım Bilimleri Dergisi), 10 (3) 305-312
- Turker,U (2005). Determination of Spatial Weed Variability for Precision Farming, Journal of Agricultural sciences. Vol:11, No:4, pages:442-447. ISSN:1300-7580.
- Ungör, M. G., Akdemir, B., 2010. Development of a mapping programme for variable rate application, Journal of Agricultural Machinery Science, Vol 6(2), 121-126

SPATIAL AND TEMPORAL VARIABILITY OF NECROPHAGOUS DIPTERA IN AL-BALQA REGION IN JORDAN

Hazem S. HASAN

Department of Plant Production and Protection, Faculty of Agricultural Technology, Al-Balqa' Applied University, Al-Salt, 19117, Jordan. Email: Hazem@bau.edu.jo

Abstract

Necrophagous fly assemblages were surveyed in a three habitats from Al-Balqa governorate from residential to country- side regions using bottle traps technique from January 2008 to January 2009. From 81 sampling locations and 46048 collected insects from four dipteran families 9 species were identified as follows: family Calliphoridae: *Calliphora vicina* ROBINEAU-DESVOIDY, 1830, *C. vomitoria* (LINNAEUS, 1758), *Chrysomya rufifacies* (WIEDEMANN, 1819), *Lucilia cuprina* (WIEDEMANN, 1830), and *L. sericata* (MEIGEN, 1826); family Muscidae: *Musca domestica* LINNAEUS 1758 and *Muscina stabulans* (FALLEN, 1817); family Fanniidae: *Fannia scalaris* (FABRICIUS, 1791); family Sarcophagidae: *Sarcophaga carnaria* RHDENDORF, 1937. Rrelative abundance values of *Calliphora vicina*, *C. vomitoria*, *Chrysomya rufifacies*, *L. sericata*, *Musca domestica*, *Muscina stabulans*, *Fannia scalaris* and *Sarcophaga carnaria* were 28.7, 0.4, 2.6, 1.9, 35.0, 24.3, 2.7, 1.5, and 2.9%, respectively for species. No significant difference among these species in spatial distribution was detected, except for *Fannia scalaris* and *Lucilia sericata*. Both species showed a significant difference between Al Salt location habitat and Wadi Shabi location habitat.

Keyword: *Forensic entomology, Variability, Habitat association, Necrophagous Diptera, Jordan*

Introduction

Forensic entomology is the application of insects' study and other arthropods to legal issues (Benecke 2001, Kulshrestha and Satpathy 2001, Bajerlein *et al.* 2011, Bugajski *et al.* 2011). In fact, insects that attack animal corpse can be used as important source of data for forensic entomology application. These insects have high economic importance and important medical applications (Archer 2003, Abdel-Hafeez *et al.* 2015).

Necrophagous Diptera belongs to several taxonomic groups such as blowfly (Calliphoridae) flesh fly (Sarcophagidae). Necrophagous Diptera has important forensic uses such as estimation of Postmortem interval (PMI) (de Carvalho and Linhares 2001, Aballay *et al.* 2012) based on a composite of taphonomic factors that are affected by the geographic region or biogeoclimatic zone (Kulshrestha and Satpathy 2001, Arnaldos *et al.* 2005). In Jordan, the Necrophagous Diptera, mainly blow fly that attacks animal corpse, had been studied in recited area. However, further investigation is needed to identify necrophagous fly and its ecological abundance (Hasan 2008).

When a death is not witnessed, PMI is a crucial and fundamental step in any death scene investigation procedure (Poloz and O'Day 2009). PMI is defined as the length of time between death and corpse discovery. The medical parameters begin to degrade that are needed to establish the cause, manner, and death time at the onset of death, (Arnaldos *et al.* 2005, Tabor *et al.* 2005). Blowflies that are distributed worldwide cause medical problems and losses to the animal productivity (Ghandour 1988). There are some species of blowflies (*Chrysomya megacephala* (Fabricius) that are dangerous Dipteran vectors of enteric pathogens (Greenberg 1990, Greenberg 1991).

The objectives of this study are: collecting the common Necrophagous Diptera that are distributed in Al-Balqa governorate, identifying specimens, determining of relative abundance and habitat association patterns, studying the spatial and temporal variability of Necrophagous Diptera and establishing a data base for species of necrophagous diptera in Al-Balqa governorate.

Materials and Methods

Trapping methods using olfactory stimuli have been developed for sampling blow flies (Hall and Farkas 2000). To obtain specimens in good condition for identification a modified cone trap, based on a soft drink plastic bottle with a baited target was used (Hwang and Turner 2005). In total 81 bottle traps were made from two 1.5-L clear- plastic soft drink bottles of 8 cm in diameter. The bottle consists of two parts: the upper collection chamber and the lower, bait chamber, contains 30 g of lamb liver that is fixed to the inner bottom by tape. A 15 ml glass vial, contains 10 ml of a 30% sodium sulphide (Na₂S) solution and a 5 g piece of liver was fixed on the inner wall as a chemical attractant.

The study area (Al-Balqa) was categorized into three region according to the level of urbanization. Those regions are: Al-Salt (Urban), Al-Homra (Rural), and Wadi Shabi (Natural), (Table 1).

Table 1. Descriptions of the sampling sites study area

Place	Urbanization	Altitude (M)	Descriptions
Al-Salt	Urban	1100	High dense housing with private gardens, and commercial activities.
Al-Homra	Rural	400	Semi-natural habitat with little human interference.
Wadi Shabi	not residential area	-120	natural habitat without human interference

In total 27 traps were fixed approximately 1.5 m above the ground for each studied site. Shaded positions were selected for the traps to avoid thermal stress on the captured flies. The coordinates of the collection sites were determined and recorded using GPS. Traps were inspected twice a week for one study year. Larvae, pupae and adults that fed on the liver piece were collected and identified. The liver pieces represented a "dead body". Air temperatures and relative humidity were recorded every 1 hour using data loggers that was placed in the center point between the five traps of a site. Flies were killed by putting the trap in a -25°C freezer for 10 min. The flies was either preserved in 80% ethanol or oven dried. Identification was conducted using Taxonomical key (Buttiker *et al.* 1979, Borror *et al.* 1989, Rognes 2002).

Descriptive statistics such as, the number of species, and number of insects/month were calculated. The spatial and temporal activities of the commonest species were measured. Statistical analysis was conducted using SAS 9.4 software (Institute 2014).

Results and Discussion

A total of 46048 individuals belonging to 4 dipteran families were identified from 81 sampling occasions and 9 species confirmed; family Calliphoridae: *Calliphora vicina* ROBINEAU-DESVOIDY, 1830, *C. vomitoria* (LINNAEUS, 1758), *Chrysomya rufifacies* (WIEDEMANN, 1819), *Lucilia cuprina* (WIEDEMANN, 1830), and *L. sericata* (MEIGEN, 1826); family Muscidae: *Musca domestica* LINNAEUS 1758 and *Muscina stabulans* (FALLEN, 1817); family

Fanniidae: *Fannia scalaris* (FABRICIUS, 1791); family Sarcophagidae: *Sarcophaga carnaria* RHDENDORF, 1937, accounted of relative abundance 28.7, 0.4, 2.6, 1.9, 35.0, 24.3, 2.7, 1.5, and 2.9%, respectively for species (Figure 1).

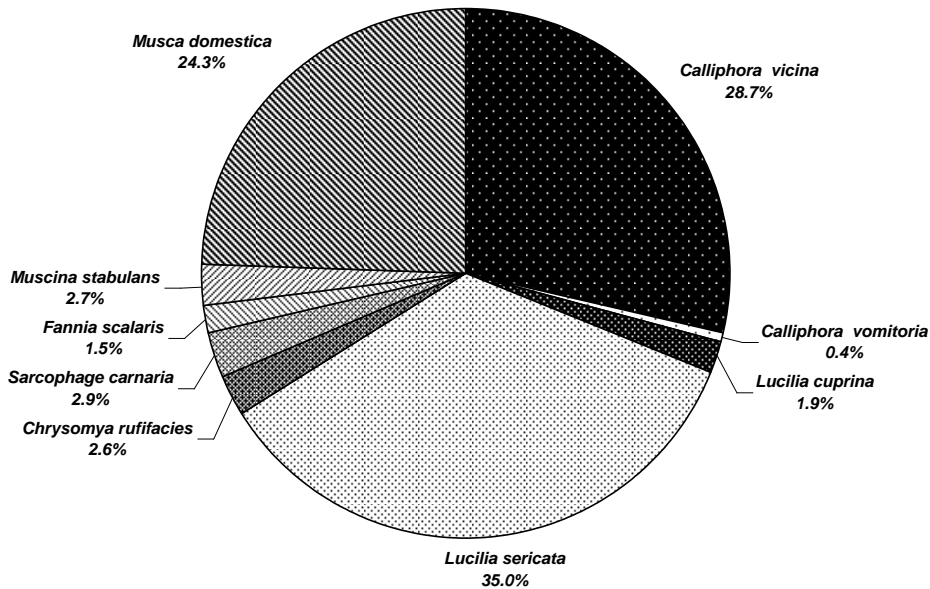

Fig. 1. Relative abundance of Necrophagous Diptera in Al Balqa governorate, Jordan during (2008-2009)

The highest monthly average captured numbers were for *Lucilia sericata* in Al Salt habitat (218.52) individuals followed by *Calliphora vicina* in the same habitat (178.96) individuals (Table 2). The lowest monthly average captured numbers were for *Calliphora vomitoria* Al Salt habitat (2.63) individuals. No significant difference was detected among *Calliphora vicina*, *C. vomitoria*, *Chrysomya rufifacies*, *Musca domestica*, *Muscina stabulans*, and *Sarcophaga carnaria*. *Fannia scalaris* and *Lucilia sericata* both showed a significant difference between Al Salt habitat and Wadi Shabi habitat.

Table 2. Monthly average captured numbers of necrophagous Diptera in Al Balqa area during 2008-2009

SITE	<i>Calliphora vicina</i>	<i>Calliphora vomitoria</i>	<i>Lucilia cuprina</i>	<i>Lucilia sericata</i>	<i>Chrysomya rufifacies</i>	<i>Sarcophaga carnaria</i>	<i>Fannia scalaris</i>	<i>Muscina stabulans</i>	<i>Musca domestica</i>
Al-Salt	178.96a*	2.63a	12.15a	218.52a	16.00a	18.03a	9.67a	16.74a	151.93a
Wadi Shabi	157.85a	3.78a	13.15a	147.96b	14.33a	13.78a	6.44b	12.00a	178.26a
Al-Homra	168.67a	3.48a	12.85a	183.59ab	15.41a	16.22a	8.37ab	14.56a	165.3a

*Means followed by different letters are significantly different according to LSD at (P<0.05)

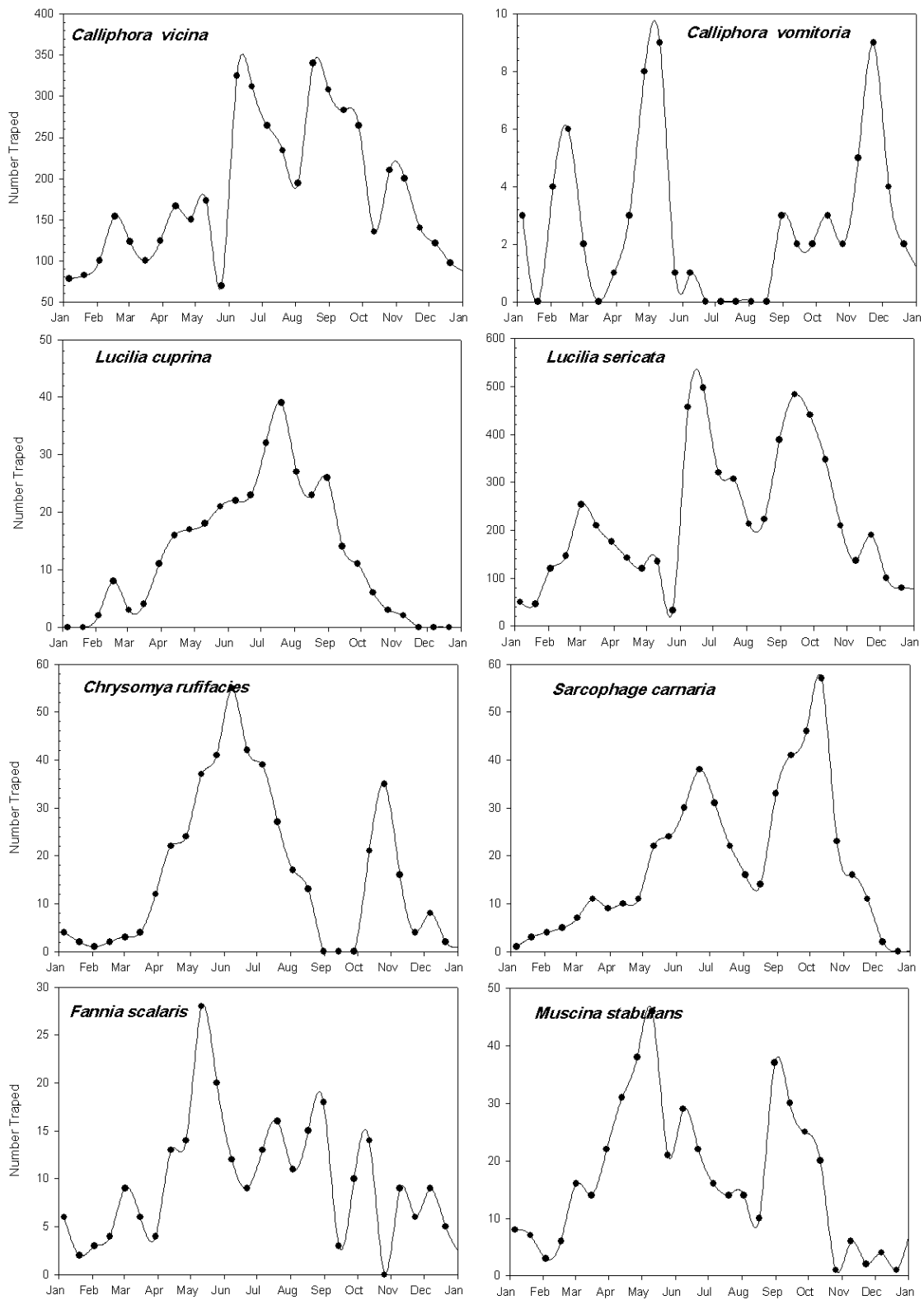

Fig. 2. Temporal variability of *Necrophagous Diptera* in Al-Salt region from 2008 to 2009

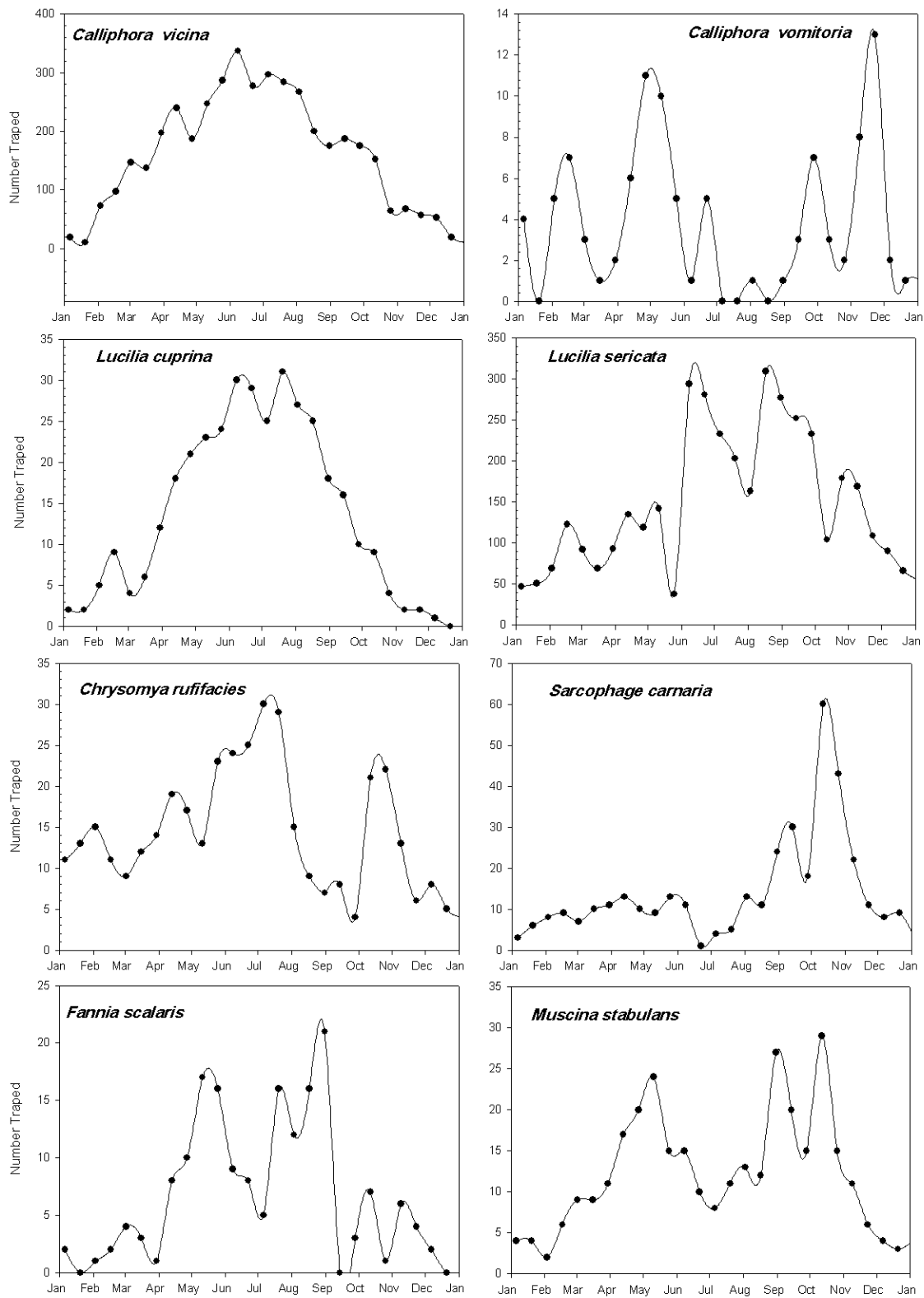

Fig. 3. Temporal variability of *Necrophagous Diptera* in Wadi Shabi region from 2008 to 2009

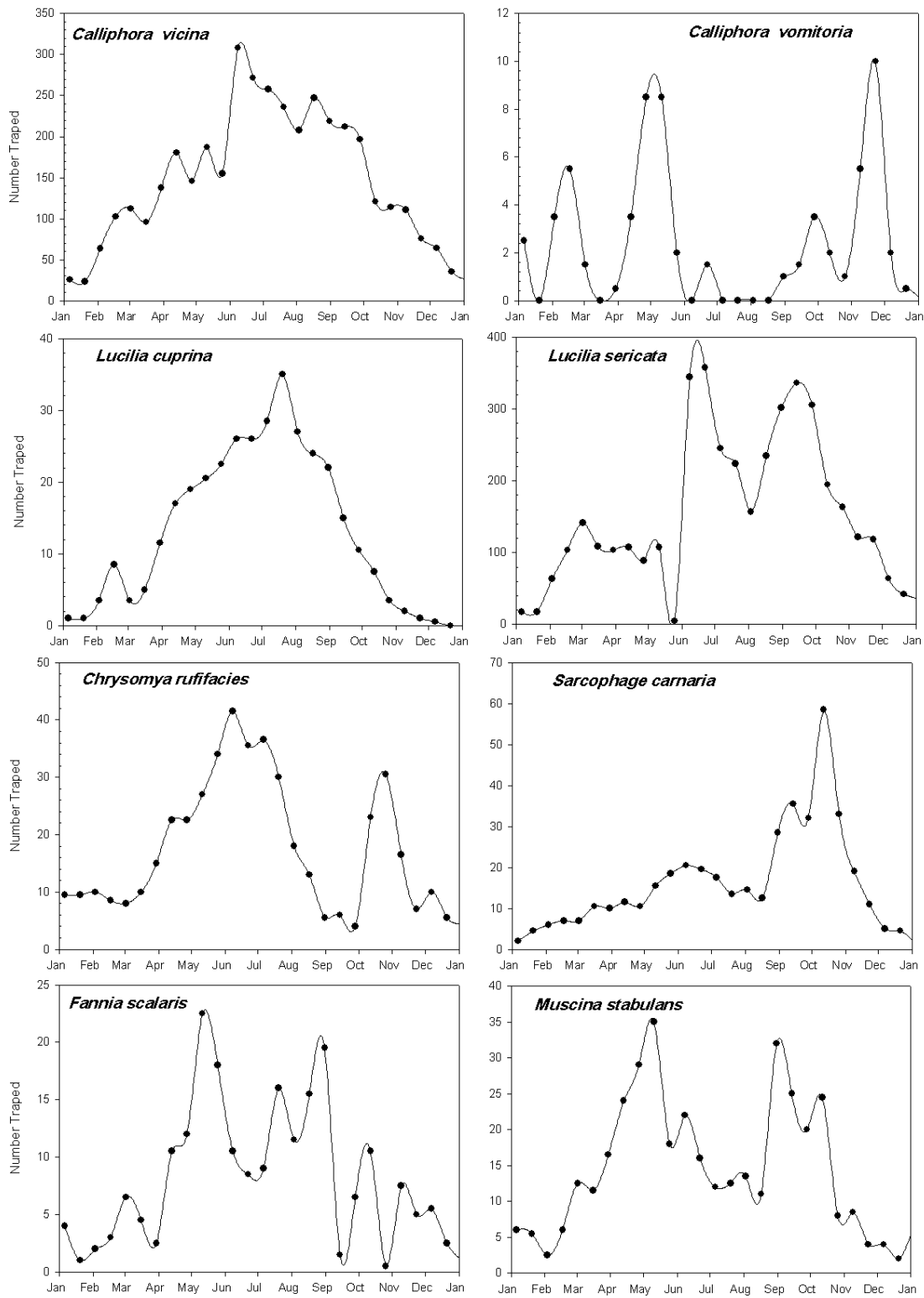

Fig. 4. Temporal variability of *Necrophagous Diptera* in Al-Homra region from 2008 to 2009

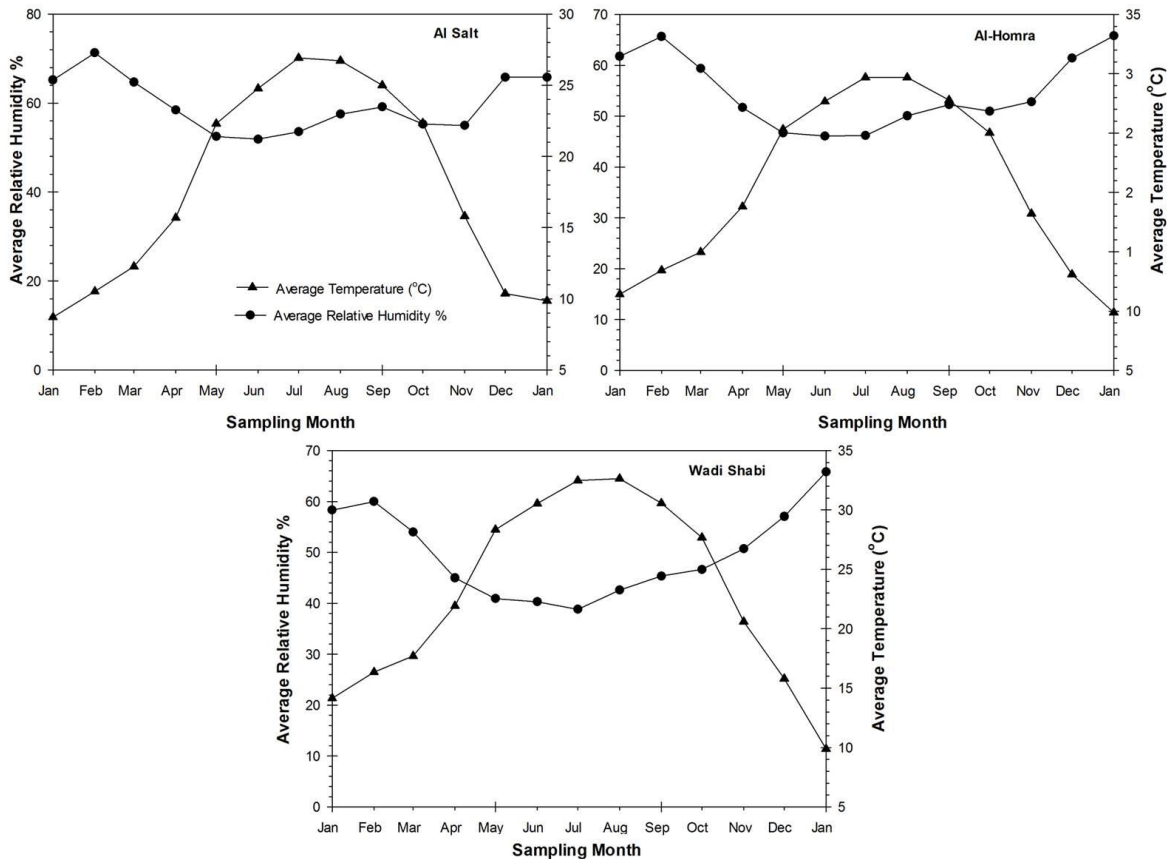

Fig. 5. Average temperature and relative humidity from 2008 to 2009

In Figures 2, 3, and 4 temporal variability of Necrophagous Diptera in Al-Salt, Wadi Shabi and Al-Hummra from 2008 to 2009 are presented. The most common Necrophagous species of Diptera were observed in May and July except *S. carnaria* and *L. sericata*, for which maximum captures were in October and November. This study show that the number of insects declined with the increase of the relative humidity and temperature (Figure 5). This indicates that increasing temperature and the relative humidity decreases the insect intensity.

Temperature and relative humidity influenced the stages of carcass decay and insect activity and abundance: This is in accordance with results of other researcher (de Carvalho and Linhares 2001, Barton *et al.* 2014). Results showed that nine species are forensic indicators in Al-Balqa governorate. Out of this five species are more important as forensic indicators due to their occurrence over long period of the year (*C. vicina*, *C. vomitoria*, *Chrysomya rufifacies*, *L. cuprina* and *L. sericata*).

Conclusions

I identified four dipteran families with nine species in three different habitats from Al-Balqa governorate, Jordan. *Calliphora vicina* species was the most abundant species, accounting for 28.7% of all the diptera specimens. In fact, temperature and relative humidity influenced, the population density of Necrophagous Diptera species, significantly. The average monthly number of *Lucilia sericata* was significantly different than the average monthly number of *Fannia scalaris* collected from the different habitats.

References:

- Aballay, F. H., Cecilia Dominguez, M. and Fernandez Campon, F. (2012) 'Adult Fanniidae associated to pig carcasses during the winter season in a semiarid environment: Initial examination of their potential as complementary PMI indicators', *Forensic Science International*, 219(1-3).
- Abdel-Hafeez, E. H., Mohamed, R. M., Belal, U. S., Atiya, A. M., Takamoto, M. and Aosai, F. (2015) 'Human wound myiasis caused by *Phormia regina* and *Sarcophaga haemorrhoidalis* in Minia Governorate, Egypt', *Parasitology Research*, 114(10), 3703-3709.
- Archer, M. S. (2003) 'Annual variation in arrival and departure times of carrion insects at carcasses: implications for succession studies in forensic entomology', *Australian Journal of Zoology*, 51(6), 569-576.
- Arnaldos, M. I., Garcia, M. D., Romera, E., Presa, J. J. and Luna, A. (2005) 'Estimation of postmortem interval in real cases based on experimentally obtained entomological evidence', *Forensic Science International*, 149(1), 57-65.
- Bajerlein, D., Matuszewski, S. and Konwerski, S. (2011) 'Insect Succession on Carrion: Seasonality, Habitat Preference and Residency of Histerid Beetles (Coleoptera: Histeridae) Visiting Pig Carrion Exposed in Various Forests (Western Poland)', *Polish Journal of Ecology*, 59(4), 787-797.
- Barton, P. S., Weaver, H. J. and Manning, A. D. (2014) 'Contrasting diversity dynamics of phoretic mites and beetles associated with vertebrate carrion', *Experimental and Applied Acarology*, 63(1), 1-13.
- Benecke, M. (2001) 'A brief history of forensic entomology', *Forensic Science International*, 120(1-2), 2-14.
- Borror, D., Triplehorn, C. A. and Johnson, N. (1989) 'Introduction to the Study of Insects. Edition No. 6. Brooks'.
- Bugajski, K. N., Seddon, C. C. and Williams, R. E. (2011) 'A Comparison of Blow Fly (Diptera: Calliphoridae) and Beetle (Coleoptera) Activity on Refrigerated Only versus Frozen-Thawed Pig Carcasses in Indiana', *Journal of Medical Entomology*, 48(6), 1231-1235.
- Buttiker, W., Attiah, M., Pont, A. and Wittmer, W. (1979) 'Insects of Saudi Arabia: Diptera: synanthropic flies', *Fauna of Saudi Arabia, Vol. 1*, 352-367.
- de Carvalho, L. M. L. and Linhares, A. X. (2001) 'Seasonality of insect succession and pig carcass decomposition in a natural forest area in southeastern Brazil', *Journal of Forensic Sciences*, 46(3), 604-608.
- Ghandour, A. (1988) 'Health hazards in humans and animals caused by imported livestock diseases in Saudi Arabia', *Fauna of Saudi Arabia, Vol. 9*, 468-477.
- Greenberg, B. (1990) 'NOCTURNAL OVIPOSITION BEHAVIOR OF BLOW FLIES (DIPTERA, CALLIPHORIDAE)', *Journal of Medical Entomology*, 27(5), 807-810.
- Greenberg, B. (1991) 'FLIES AS FORENSIC INDICATORS', *Journal of Medical Entomology*, 28(5), 565-577.
- Hall, M. and Farkas, R. (2000) 'Traumatic myiasis of humans and animals', *Contributions to a manual of palaeartic Diptera*, 1, 751-768.
- Hasan, H. S. (2008) *Taxonomical and Ecological Studies on Insects Associated with Animal Carcasses in Jordan*, unpublished thesis (PhD), University of Jordan.
- Hwang, C. and Turner, B. D. (2005) 'Spatial and temporal variability of necrophagous Diptera from urban to rural areas', *Medical and Veterinary Entomology*, 19(4), 379-391.
- Institute, S. (2014) *Base SAS 9.4 Procedures Guide*, SAS Institute.

- Kulshrestha, P. and Satpathy, D. K. (2001) 'Use of beetles in forensic entomology', *Forensic Science International*, 120(1-2), 15-17.
- Poloz, Y. O. and O'Day, D. H. (2009) 'Determining time of death: temperature-dependent postmortem changes in calcineurin A, MARCKS, CaMKII, and protein phosphatase 2A in mouse', *International Journal of Legal Medicine*, 123(4), 305-314.
- Rognes, K. (2002) 'Blowflies (Diptera, Calliphoridae) of Israel and adjacent areas, including a new species from Tunisia', *Insect Systematics & Evolution*, 3-+.
- Tabor, K. L., Fell, R. D. and Brewster, C. C. (2005) 'Insect fauna visiting carrion in Southwest Virginia', *Forensic Science International*, 150(1), 73-80.

OROBANCHE (OROBANCHE SPP.) AND PHELIPANCHE (PHELIPANCHE SPP.) IN LENTIL (LENS CULINARIS MEDIC.): IMPACTS ON YIELD, QUALITY AND MARKETING PRICES

Fethiye OZBERK¹, Irfan OZBERK², Abuzer YUCEL³, Imam MECCA⁴, Sengül ALTUNDAL⁵

¹Akçakale Vocational Collage, The Univ. Of Harran, Ş.Urfa, Turkey

²Department of Field Crops, Faculty of Agriculture, The University of Harran, S.Urfa, Turkey

^c Department of Plant Protection, Faculty of Agriculture, The University of Harran, S.Urfa, Turkey

⁴ Department of Agricultural Extension, Provincial Directorate of Ministry of Food, Agriculture and Animal Husbandry, Adıyaman, Turkey

⁵Department of Agricultural Extension, Township Directorate of Ministry of Food, Agriculture and Animal Husbandry, Viranşehir, S.Urfa, Turkey

*Corresponding author: ozberki@harran.edu.tr

Abstract

This study aimed to assess the impacts of severe parasitic plants (*O.crenata*, *P.ramosa*, *P.aegyptiaca*) on to grain yield, some quality characteristics and marketing price of red lentil in the South-east Anatolia. Farmer field trials were carried out in the Adıyaman and Viranşehir locations in 2010-11 and 2011-12 crop growing seasons respectively. Randomly distributed twin plots throughout the field relaying on required number of broomrape infestation in Adıyaman field trial in 2010-11 (1+ 1 m² each) as experimental units were nominated as follow; A₀B₀: control, A₁B₁: 30-39 broomrape flowering in twin plots; A₂B₂: 40-49 broomrape flowering twin plots; A₃B₃: 50-59 broomrape flowering plots and A₄B₄: over 60 broomrape flowering plots. (4 treatments) Twin plots (2 replications) in Viranşehir in 2011-12 (1+ 1 m² each) as experimental units were nominated as follow; A₀B₀: control, A₁B₁: 2-3 broomrape flowering in twin plots; A₂B₂: 4-5; A₃B₃: 6-7 and A₄B₄: 8-9 broomrape flowering plots. Grain yield, hectoliter weights and 1000 kernel weights were scored. All grain samples were presented to randomly chosen grain purchasers in local commodity market and marketing price offers were scored respectively. Results revealed that broomrape infestation under both low and high levels of epidemic reduced the grain yield ranging from 51.5% to 97.7% significantly. Some visual purchasing criteria such as hectoliter and 1000 kernel weights were not affected seriously. Purchasers offered very similar marketing prices for pulse grains with all severity levels. Economic losses were huge varying from \$396.77 to 678.50 ha⁻¹ It was concluded that regression equations derived from grain yield vs. infestation densities were found to be reliable with high coefficients of determinations and can be perfectly used for yield estimates under various levels of broomrape infestations

Key words: *Red lentil*, *Orobanche*, *Phelipanche*, grain yield, quality, marketing prices

Introduction

Lentil is a nutritious food legume; the seed has a relatively high content of protein (22%), carbon hydrate and calories (3250 kcal kg⁻¹) with fast cooking characteristic (Muehlbauer, 1985; Saskatchewan Agriculture and Food, 2005). Lentil (*Lens culinaris* Medic.) is a cool –season annual cash crop, classified as a grain legume or pulse in South East Anatolia (Ozberk et al., 2006).

Turkey is one of the major lentil producer after Canada and India with a 422.000 tons annual production at 216.000 ha acreage (Anonymous, 2010). Green lentil is grown in the central and transitional zones of Turkey while red lentil is grown in the South-east of Anatolia (Ozberk et al., 2006).

By far the most economically damaging root parasitic weeds in Europe and neighboring regions are member of the Orobanchaceae, mainly species belonging to the genera *Orobanche* and *Phelipanche* (broomrapes) (Joel et al, 2007a; Parker, 2009). In Turkey, 36 species of *Orobanche* have been recorded (Gilli, 1987). But only four of them result in a considerable damage to crops. *Phelipanche ramosa* (L) Pomel (syn.*O.ramosa* L.) *Phelipanche aegyptiaca* (Pers) Pomel (syn. *O. aegyptiaca* Pers.) (Joel et al, 2007; Parker, 2009) and *O crenata* Forsks. result in damage in lentil (Aksoy &Uygur, 2003). In legumes, the most intensive growth of *Orobanche* usually coincides with the flower and pot stage of the host. This results in flower dropping and low amount of podding due to increase competition from the parasitic sink. The wilting symptoms occur due to the reduced water uptake because of a deficiency of energy in the host roots, as a result of flow of carbon hydrates to the parasite (Anonymous, 1997).

Yield losses due to *Orobanche* ranged from 5 to 100% (Bulbul et al., 2009, Australian Department of Agriculture and Food, 1999, Anonymous, 1997). An economical loss of lentil of about 60 million Euros is estimated annually (Bulbul et al., 2009). Several strategies have been developed for the control of broomrape, from cultural practices to chemical control (Parker and Riches, 1993; Joel et al.,2007b), but none with unequivocal success. Good broomrape control can be achieved in faba bean by glyphosate at low rates. However, insufficient selectivity was found in lentil (Arjona- Berral et al., 1988). Lentil tolerates pre and post emergence treatment of other herbicides suitable for broomrape control, such as imazapic and imazetgapyr (Jurada-Exposito et al., 1997). Imazapic (10 g l⁻¹) is widely used in SE Anatolia. Phytotoxicity has been observed at higher doses of some herbicides and depends on the level of water stress and lentil cultivar (Henson and Hill, 2001). A number of cultural practices including delay sowing, hand weeding, no-tillage, nitrogen fertilization, intercropping, rotations can contribute to seed bank demise. Other strategies such as suicidal germination, activation of systematic acquired resistance, bio control or target site herbicide resistance are promising solutions that are being explored but are not yet direct application. The only methods currently available for farmers are the use of resistant varieties and chemical control (Rubiales &Fernandez-Aparicio, 2011). Resistance breeding is hampered by scarcity of proper source of resistance and of a reliable and practical screening procedure (Fernandez -Aparicio et al., 2007b).

This study aimed to assess the effect of broomrape damage on grain yield, some visual quality characteristics and marketing price of lentil in the local commodity markets.

Material and methods

This study was carried out in the farmer fields in Adiyaman and Viransehir locations (S.Urfa) in 2010-11 and 2011-12 growing seasons respectively. Wherein, broomrape infestations are common. *O. crenata* Forsk. (white flowering) , *P.ramosa* (pale blue flowering and branched) and *P.aegyptica* Pers. (blue flowering) were found to be wide spreading in lentil fields (75,51%) in Eastern Mediterranean region (Bulbul et al., 2009, Temel et al., 2012 and Aksoy, 2011a).

Preceding crop was tobacco in Adiyaman and barley in Viransehir. Adiyaman experiment was carried out under *Dolycoris* infestation. 8 ha in Adiyaman and 10 ha in Viranşehir were planted by drill with a 120 kg ha⁻¹ seed rate in both fields respectively. A50 kg ha⁻¹ di ammonium phosphate (DAP, 18 and 46% of N and P) was applied at sowing. All other necessary agronomical measures were taken for health crop production. Chemical weed control for narrow-leaf –weeds was employed but not pest control. Twin plots in Adiyaman in 2010-11 (1+ 1 m² each) as experimental units were nominated as follow; A₀B₀: control, A₁B₁: 30-39 broomrape flowering in twin plots; A₂B₂: 40-49 broomrape flowering twin plots; A₃B₃: 50-59 broomrape flowering plots and A₄B₄: over 60 broomrape flowering plots. Twin plots in Viranşehir in 2011-

12 (1+ 1 m² each) as experimental units were nominated as follow; A₀B₀: control, A₁B₁: 2-3 broomrape flowering in twin plots; A₂B₂: 4-5 broomrape flowering twin plots; A₃B₃: 6-7 broomrape flowering plots and A₄B₄: 8-9 broomrape flowering plots. Twin plots were assigned at flowering stage of broomrape and early pod stage of lentil. Five twin plots (surrounded by strip at the corners) possessing various amount of infestation were randomly selected throughout the broomrape infested field. Control twin plots have no broomrape infestation at the early pod stage of lentil crop. Numbers of broomrape flowers were counted in each twin plots at the flowering and pod filling stage of lentil. Each twin plots were harvested by hand and threshed for weighting grain yield. Highest yield loss was calculated as;

HYL%= (mean grain yield of A₄B₄ / mean grain yield of A₀B₀) x 100.

Hectoliter and 1000 kernel weights (Williams et al., 1986) of lentil grains were also scored. Seed samples of both year experiments with increasing amount of broomrape damage were presented to four randomly chosen grain purchasers in the local commodity market at mid-September in 2012. ANOVA and mean separation were performed for marketing price estimates. Coefficients of correlation among such characteristics were estimated Regression relation between grain yield, hectoliter weight and 1000 kernel weights vs. broomrape infestations were further investigated (Finlay & Wilkinson, 1963; Eberhard & Russel, 1966). Economic loss was calculated as;

EL= HYL% x mean grain yield of A₀B₀ marketing price of A₀B₀

SPSS statistical software (Efe et al., 2000) was employed for statistical analysis and figures.

Results and discussion

O. crenata Forsk. (white flowering) was dominating species in Adıyaman in 2010-11 while *P. ramosa* (pale blue flowering and branched) and *P. aegyptica* Pers. (blue flowering) were found to be complex in Viranşehir in 2011-12.

Adıyaman experiment (2010-11)

Annual rainfall and its distribution throughout the cropping season was adequate (676.5 mm). But field trial was carried out under sting bug (*Dolycoris baccarum* L.) and heavy broomrape infestation. No control measure was taken for sting bug. Broomrape infestation and. The grain yield of lentil crop is also given in Table 1.

Broomrape	A ₀ = 0	A ₁ =30	A ₂ =50	A ₃ =60	A ₄ =70
infestations	B ₀ =0	B ₁ =40	B ₂ =55	B ₃ =65	B ₄ =80
(no. m ⁻²)					
Grain yields	A ₀ =102.67	A ₁ =10.65	A ₂ =10.47	A ₃ =9.50	A ₄ =2.83
(g m ⁻²)	B ₀ =94.82	B ₁ =10.49	B ₂ =9.40	B ₃ =9.40	B ₄ =3.08
1000 Kernel	A ₀ =27.86	A ₁ =26.35	A ₂ =28.86	A ₃ =23.44	A ₄ =27.62
weights (g)	B ₀ =29.58	B ₁ =24.77	B ₂ =26.27	B ₃ =24.02	B ₄ =26.93

Grain yield reduction seems to be dramatic due to increasing amount of broomrape infestation (HYL=97.3%). There was no adequate amount of seed sample to score hectoliter weight. 1000 kernel weights ranged from 23.44 g (A₃) to 29.58 g (B₀). Hectoliter weight was only scored for plots of A₀ and B₀ giving 84.63 kg and 83.64 kg respectively. Coefficient of correlation between grain yield vs. broomrape infestation (r= -0.893**) and 1000 kernel weights vs. broomrape infestation (r=-0.695*) were found to be significant and negative.

Regression between grain yield vs. broomrape infestation turned out to be significant ($F=31.63^{**}$) indicating the presence of the effects of broomrape infestation onto grain yield clearly. Regression equation was estimated as $y=85.78^{**}-1.279x^{**}$ with a $R^2 \%=77.3$. Yield reduction due to increasing broomrape infestations is given in Figure1. Regression relation between 1000 kernel weights vs. broomrape infestation also turned out to be significant ($F=7.45^*$). Regression equation was found to be as $y=29.12^{**}-5.25x^*$ with a $R^2\%=41.8$. Analysis of variance (not given here) for marketing prices indicated that broomrape infestations were found to be significant ($F=24.52^*$) and the replications (purchasers) non-significant. Joint seed samples of A_0B_0 plots (controls) were received the highest marketing price offer ($\$ 412.99 \text{ ton}^{-1}$) and the others received same price offer ($\$330.39 \text{ ton}^{-1}$) (Table 2).

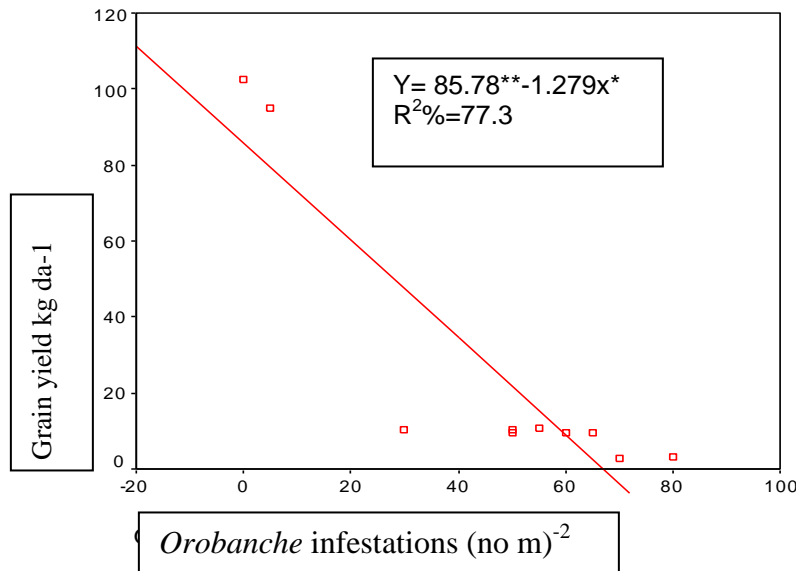

Figure1. Regression relation between broomrape infestation vs. yield in Adiyaman in 2010-11 cropping season.

Table 2. Means and groups for marketing price estimates for various broomrape infestations in Adiyaman in 2010-11.

Average Broomrape infest (no m ⁻²)	Marketing price estimates (\$ ton ⁻¹)	Groups
Control	412.99	a
35	330.39	b
52.5	330.39	b
62.5	330.39	b
75	330.39	b

Economical loss (EL) for the first year of experiment was approximately = $0.973 \times 0.9874 \times \$412.99 \text{ ton}^{-1} = \$ 396.77 \text{ ha}^{-1}$

Viransehir experiment (2011-12)

Farmer field was 10 km. northwest of Viransehir town of Sanliurfa province. Lentil variety of Firat-87 was planted in mid-November under barley- lentil crop rotation .Sowing time was quite early than common practice. Annual precipitation (351.4 mm) and distribution into cropping season was favorable for lentil production. Chemical weed control for broad leaves was employed for preceding barley crop. Number of broomrape m^{-2} for twin plots and grain yields are given Table 3.

Table 3.Field plan of Viransehir experiment (2011-12) and scored characteristics

Broomrape infestations (no. m^{-2})	A ₀ = 0	A ₁ =3	A ₂ =4	A ₃ =7	A ₄ =8
Grain yields (g m^{-2})	A ₀ =223.96	A ₁ =199.22	A ₂ =167.19	A ₃ =125.67	A ₄ =114.09
1000 Kernel weights (g)	B ₀ =41.38	B ₁ =42.42	B ₂ =41.25	B ₃ =41.94	B ₄ =42.24
Hectoliter weights (kg)	B ₀ =41.92	B ₁ =41.79	B ₂ =42.62	B ₃ =42.15	B ₄ =40.95
	A ₀ = 80.94	A ₁ =83.77	A ₂ =82.38	A ₃ =79.30	A ₄ =83.98
	B ₀ =77.69	B ₁ =80.54	B ₂ =80.49	B ₃ =82.56	B ₄ =81.52

Although being less than 10 m^{-2} , broomrape reduced grain yield approximately 50% comparing control (HYL=51.5%). Regression between grain yield vs. broomrape infestations turned out to be significant (F=286.92**). Coefficient of correlation was also found to be significant (r=-0.986**) and negative. Regression equation was estimated as $y= 228.96^{**}-14.39x^{**}$ with a $R^2\%=97.3$. (Figure 2) .

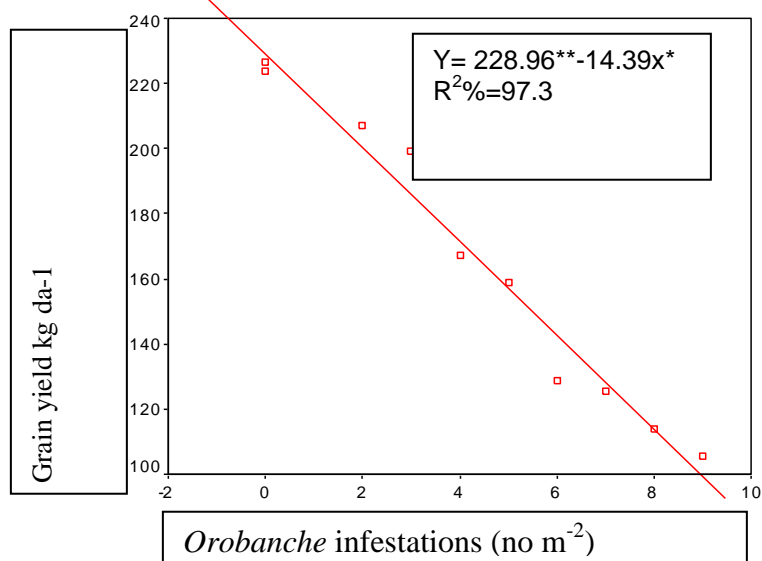

Figure 2. Regression relation between broomrape infestation vs. yield in Viranşehir in 20-11-12cropping season

1000 kernel weights (g) and hectoliter weights (kg) are also given in Table 3. Coefficients of correlation between broomrape infestations vs. hectoliter and 1000 kernel weights were found to be non-significant. Regression also between above characteristics turned out to be no significant indicating the absence of negative effects of broomrape on to such quality characteristics.

Analysis of variance for marketing price offers indicated that broomrape infestation and replications (purchasers) were found to be non-significant. Although being non-significant the means and the groups for marketing price offers depending upon increasing broomrape infestations are given in Table 4.

Table 4. Means and groups for marketing price estimates for various broomrape infestations in Viransehir in 2011-12

Average Broomrape infest (no m ⁻²)	Marketing price estimates (\$ ton ⁻¹)	Groups
Control	585.07	a
2.5	587.83	a
4.5	585.73	a
6.5	587.83	a
8.5	590.58	a

Although rainfalls were adequate and distributed regularly for lentil production in both years, grain yields were affected by some other factors giving less grain yield than expected. Early planting seems to be beneficial for broomrape competition. When lentil is planted into humid soil lately it cannot compete with parasitic broomrape and affected by severely. But there is a conflict between early planting vs. late planting. Late planting of early maturing types of lentil is recommended (Temel et al.,2012; Rubiales &Fernandez-Aparicio, 2011) whereas farmer practice in the region is to plant lentil relatively early for emergence and rapid vigorous seedling development. Therefore plant can compete with broomrape development as partially suggested by Silim et al., (1999). Grain yield reductions seem to be dramatic under low or high amount of broomrape infestations as indicated earlier (Australian Department of Agriculture and Food, 1999). Average a 75 broomrape m⁻² can reduce grain yield average 97% and an average 8.5 broomrape m⁻² can reduce the grain yield about 51.5% as pointed out (Anonymous, 1997). Hectoliter and 1000 kernel weights seem to be affecting slightly. Decrease in 1000 kernel weights in the first year experiments might also be due to severe sting bug infestation. This pest sucks lentil grain and results in chalky spot damage. Regression equations with high coefficients of determination indicated the presence of the effects of broomrape infestation on grain yield clearly. In the first year experiments, significant regression relation between 1000 kernel weights vs. broomrape infestation with moderate value of coefficient of determination showed the presence the importance of other factors rather than broomrape infestation only. But the non significant regression and correlation between above characteristics revealed the absences of broomrape infestation on such characteristics. Some negative influence of broomrape infestation on lentil quality was discussed by Australian Department of Agriculture and Food (1999). Broomrape infestations in first year affected marketing prices negatively. But the appearance of *Dolycoris* damaged lentil grains were the major factor for less marketing price offers. In second

year marketing price offers were not affected by infestation. Purchasers were found to be expert about identifying healthy grains offering the highest marketing prices. Economical losses were huge for two consecutive years. Economic losses show the importance of broomrape management in the red lentil growing belt of the country. Breeding resistance is the most economic, feasible and environment friendly method of control. However, resistance against broomrape is difficult to access, scarce of complex nature and low heritability, making breeding for resistance a difficult task (Rubiales, 2003). So far no source of resistance is available in lentil (Muehlbauer et al., 2006). But Fernandez-Aparicio et al., (2008) have observed a wide range of response to crenate broomrape resistance under field conditions. Low infection rates seemed to be based on a combination of various escape and resistance mechanisms. Moreover some in-vitro screening techniques may be used to rank and identify lentil accessions with potential broomrape resistance. There are numbers of cultural practices including delay sowing, hand weeding, no-tillage, nitrogen fertilization, intercropping, and rotations to contribute to seed bank demise. Taking into account simplicity in application, planting time modifications can be employed as an agronomical measure. Crop rotation and the use of trap plant such as *Linum usitatissimum* L. are other possible measures (Aksoy & Uygur, 2003).

Conclusion

Broomrape is one of major yield limiting factor in the red lentil belt of Turkey. This parasitic plant reduce grain yield severely even with a low infestations but not some quality characteristics and marketing prices. Economic loss due to the yield decrease is huge and control measures should not be neglected.

References

- Aksoy E. (2011a). Weed researches. National broomrape project result report. Annual program evaluation meeting, 21-25 March, 2011, Antalya, Project no: 105G080, General Directorate of Agr. Res., Yenimahalle, Ankara
- Aksoy E. (2011b). Weed Researches. The Use of trap plants against broomrape in lentil. Annual program evaluation meeting, 21-25 March, 2011, Antalya, Project no: 105G080, General Directorate of Agr. Res., Yenimahalle, Ankara
- Aksoy E., Uygur F.N. (2003). Distribution of *Orobanche* species in the eastern Mediterranean region of Turkey. In: Proceeding of 7th Mediterranean Symposium. Cuk.Univ. Adana, Turkey, 6-9 May, 2003, pp:1-189
- Anonymous (1997) Damage to host and economic importance. Training Manuel for International Training Course on Biology and Control of Parasitic Weeds, 77 p
- Anonymous (2010) TUIK <http://www.tuik.gov.tr> (28.03.2012)
- Arjona-Berral A., Mesa-Garcia J., Garcia-Torres L. (1988). Herbicide control of broomrapes in peas and lentil. *FAO Plant Protection Bulletin* 36, 175-178
- Australian Dept. of Agr. and Food (1999). Crop updates- The parasitic Orobanche. Noxious weed threats to the pulse, oilseed and vegetable industry. (http://www.agric.wa.gov.au/p.c_91469.html)
- Bulbul F., Aksoy E., Uygur S., Uygur N. (2009). Broomrape (*Orobanche spp.*) problem in the eastern Mediterranean region of Turkey. *Helia* 32.Nr.51, 141-152
- Eberhart S.A., Russel W.A. (1966). Stability parameters for comparing varieties. *Crop. Sci.* 6, 36-40
- Efe E., Bek Y., Sahin M. (2000). Statistical Methods II in SPSS. Computer Res. and App. Center, Pub.No:10, 215 p

- Fernandez-Aparicio M., Sillero J.L., Perez- De-luque A., Rubiales D. (2007). Identification of sources of resistance to crenate broomrape (*O.Crenata*) in Spanish lentil (*L.culinaris*) germplasm. *Weed Research* 48,85-94
- Fernandez-Aparicio M., Sillero J.C., Perez-de-luque A. (2008). Identification of sources of resistance to crenate broomrape (*O.crenata*) in Spanish lentil (*L.curinalis*) germplasm. *Weed Research* 48,85-94
- Finlay K.W., Wilkinson G.N. (1963). The analysis of adaptation in a plant breeding program. *Aust.J.Agr.Res.*,14,742-754
- Gilli A. (1982). *Orobanchaceae*, 1-23, In]Flora of Turkey and the east Aegean islands, :(eds , PH Devis ,Edinburg Univ.Press, Edinburg 7:1-947
- Henson B.D., Hill D.C. (2001). Effect of imazethapyr and pendimethalin on lentil (*L.curinalis*), pea (*P.sativum*) and a subsequent winter wheat (*T. aestivum*) crop. *Weed technology* 15, 190-194
- Joel D.M., Hershenhorn J., Eizenberg H.et al. (2007a).Biology and management of weedy root parasites. *Horticultural reviews* 33,267-349
- Joel D.M., Hershenhorn J., Eizenberg, H.et al. (2007b). Biology and management of weedy root parasites. In: *Horticultural Reviews* (ed. J.Jannik), Vol.33, 267-350. John Wiley and Sons Inc., Hoboken, NJ.
- Jurado-Exposito M., Garcia-Torres L. , Castejon-Munoz M. (1997). Broad bean and lentil seed treatments with imidazolinones for the control of broomrape (*O.crenata*). *Journal of Agricultural Science, Cambridge* 129, 307-314
- Muehlbauer F.J., Cubero J.I., Summerfield R.J. (1985). Lens (*Lens culinaris* Medic.) In: *Grain Legume Crops* , (eds RS Summerfield & EH Roberts.), Collins Grafton Street, London, UK, pp.266-311.
- Muehlbauer F.J., Cho S., Sarker A. (2006). Application of biotechnology in breeding lentil for resistance to biotic and abiotic stress. *Euphytica* 147,149-165
- Nandula V.K. (1998). Selective control of Egyptian broomrape (*O.aegyptiaca* Pers.) by glyphosate and its amino acid status in relation to selected hosts. Ph.D. Thesis. The Virginia State Univ. Blacksburg, Virginia, USA, 135 p ([http://www.scholar.lib.ut.edu/.](http://www.scholar.lib.ut.edu/))
- Ozberk I., Atlı A., Ozberk F., Yucel A. (2006). The effect of lygus bug (*Exolygus pratensis* L.) on marketing price of red lentil in Anatolia, Turkey. *Crop Protection* 25, 1227-1230
- Parker C. (2009). Observations on the current status of *Orobanche* and *Striga* problems worldwide. *Pest Management Science* 65,454-59.
- Parker,C., Riches C.R. (1993). *Parasitic weeds of the world: Biology and control*. CAB International Wallingford, UK.
- Rubiales D., Fernandez-Aparicio M. (2011). Innovations in parasitic weeds management in legume crops (A review). *Agron. Sustain Dev.* DOI 10.1007/s 13593-011-0045-x
- Saskatchewan Agriculture and Food (2005) *Lentil in Saskatchewan*. <http://www.agr.gov.sk.ca/docs/crops/pulses/production>
- Silim S.N., Saxena M.C., Erskine W. (1991). Effect of sowing date on the growth and yield of lentil in a rain fed Mediterranean environment. *Experimental Agriculture* Vol.27, 145-154
- Temel N., Eymirli S., Aksoy E., Arslan F. Tetik O. (2012). Determination of optimum sowing date and the cultivar to control broomrape (*Orobanche aegyptaca* Pers. and *Orobanche crenata* Forsk.) in lentil. *YYU J.Agr.Sci.*22 (2),99-107
- Williams P., El-Haramein F.J., Nakkoul H. Rihawi S. (1986). *Crop Quality Evaluation methods and Guideline* (Second ed., May, 1988), ICARDA, P.o.Box:5466, Aleppo, Syria,145 p

Zauhaier A., Kharrat M., Chabi N. (2008). Seed germination and tubercle development of *Orobanche feodita* and *Orobanche crenata* in the presence of different plant species. Tunisian J. of Plant Protection Vol.3, No:2, 101-108

DETERMINATION OF CYPRODINIL AND FLUDIOXONIL RESIDUES IN LETTUCE BY LIQUID CHROMATOGRAPHY/DIODE ARRAY DETECTION

Sanja LAZIĆ, Dragana ŠUNJKA*, Milica PANTELIĆ, Slavica VUKOVIĆ

University of Novi Sad, Faculty of Agriculture, Novi Sad, Serbia

*Corresponding author: draganas@polj.uns.ac.rs

Abstract

The objective of this study was to develop and validate analytical method for simultaneous determination of cyprodinil and fludioxonil residues in lettuce, based on QuEChERS sample preparation procedure and high performance liquid chromatograph (HPLC) equipped with diode-array detector as detection device. The validation of method was carried out in accordance with SANTE/11945/2015 guidelines. The accuracy of the method, evaluated by recovery studies at three fortification levels (0.1, 15 and 40 mg/kg) in blank lettuce samples, were 87.1% and 85.9%, with relative standard deviations (RSDs) of 1.1% and 2.4%, for cyprodinil and fludioxonil, respectively. Within a concentration range from 0.02-40.0 µg/ml, cyprodinil and fludioxonil showed linear calibration with correlation factor (R^2) of 0.994% and 0.995%, respectively. The detection and quantification limits of 0.02 and 0.05 mg/kg are below MRLs for cyprodinil and fludioxonil residues in lettuce, set by Serbian (15 mg/kg) and EU (15 mg/kg and 40 mg/kg) legislation. The results obtained in this study confirm that proposed method is easy and reliable for the determination of the analyzed fungicides residues in lettuce.

Keywords: *Cyprodinil, Fludioxonil, Lettuce, Residue.*

Introduction

Food production, with permanent demand for higher yields, represents an imperative of contemporary agricultural production (Lazić et al., 2014). According to the official FAO data, if pesticides had not be used in the course of the year, plant diseases, pests and weeds would reduce the world food production for 25-30%, and losses of stored foods would increase for additional 10-15% (Vuković et al., 2013).

However, pesticide use is often followed by a risk of environmental endangering, having in mind presence of pesticide residues. They can contaminate surface and groundwater, exhibit harmful effects on cultivated plants and useful organisms, cause the occurrence of resistance of biological agents, or can be found as residues in food (Lazić et al., 2013). The population is mostly exposed to pesticides through food, as certain quantities of these matters can remain in fruits or crops after harvesting, which particularly relates to fruits and vegetables that are mostly used fresh.

Nowadays, lettuce (*Lactuca sativa* L.) is frequently grown vegetable. In many countries, it is grown all year round, combining field and greenhouse production. However, lettuce production is obstructed by greater number of predominantly, fungi diseases. According to significance and frequency of occurrence, the most important pathogen of lettuce in our agro-ecological conditions is *Botrytis cinerea*, the agent of grey mould disease. Beside this, the disease that regularly occurs during lettuce growing in greenhouses is white mould, whose agent is *Sclerotinia sclerotiorum*. Lettuce is a plant of short vegetation period, which additionally hardens choice and dynamic of fungicide application, due to the necessity to respect the pre-harvest interval (PHI) of the applied products. The occurrence of resistant isolates of *Botrytis cinerea* toward fungicides that are used

for control of this pathogen represent a great problem. When to this issue are added increasingly strict criteria in relation to pesticide residues in food, as well as the fact that fresh leaves are directly used in nutrition, mainly immediately after harvesting, it is not hard to conclude that chemical protection of lettuce is to be approached with a lot of attention. Recently, for protection of lettuce against the named pathogens are introduced fungicides from groups of anilinopyrimidines (cyprodinil) and phenylpyrrole (fludioxonil).

Anilinopyrimidines are relatively new class of fungicides with protective and systemic action against several plant pathogens that belong to classes *Ascomycetes* and *Deuteromycetes*. A comprehensive field monitoring showed high efficiency of fungicide from this group in a several years lasting period, and cases of the resistance to all target pathogens, including *Botrytis* and *Venturia*, have not been detected. After foliar application, a plant uptakes anilinopyrimidin fungicide cyprodinil and it is transported by tissues and xylem. It inhibits penetration and development of fungi mycelia inside the leaf and on the surface; it controls a wide spectrum of pathogens such as *Tapesia yallundae* and *T. acuformis*, *Erysiphe* spp., *Pyrenophora teres*, *Rhynchosporium secalis*, *Botrytis* spp., *Alternaria* spp., *Venturia* spp. and *Monilinia* spp. (Savčić-Petrić, 2015).

On the other hand, phenylpyrroles are compounds with a wide spectrum of biological activity, especially against root rot and powdery mildew, caused by fungi from the classes *Ascomiceta*, *Basidiomiceta* and *Deuteromiceta*. They are primarily used for treatment of wheat seeds for control of seed pathogens (Roberts and Hadson, 1999). This class of fungicides includes fenpiclonil that is used as a fungicide for seed treatment and fludioxonil, that is used for seed treatment, as well as a fungicide for foliar application against *Botrytis cinerea*, the agent of grey mould disease.

In the European Union, including neighbouring countries, for control of the described pathogens in lettuce is applied the product SWITCH 62.5-WG (cyprodinil + fludioxonil 375 g/l + 250 g/l; Syngenta), which is still not registered in our country (Republic of Serbia). According to the Regulation of the European Union (Reg. No 2015/400) and the Republic of Serbia, the maximum residue level of cyprodinil (MRLs) in lettuce is 15 mg/kg, while according to the regulation of EU, the maximum allowed quantity of fludioxonil in lettuce is 40 mg/kg and according to Serbian regulation, MRL is 15 mg/kg.

In order to check presence of pesticide residues in agricultural products, and determine usually very low quantities of prescribed MRLs values, use of sensitive and reliable methods is needed. In this paper, a method for simultaneous determination of the fungicide cyprodinil and fludioxonil in lettuce was developed and validated, according with the requirements of SANTE/11945/2015 standard.

Material and methods

Chemicals and standard solutions

Certified reference standards of cyprodinil and fludioxonil of >98% purity were obtained from Dr Ehrenstorfer, Germany. Acetonitrile (MeCN; HPLC grade) and acetic acid (CH₃COOH) were purchased from "J.T.Baker" (Darmstadt, Germany), while ultrapure water was obtained from TKA apparatus (Germany). The dispersive SP extraction (Cat. No. 5982-5650) and clean-up (Cat. No. 5982-5356) kits for QuEChERS sample preparation were purchased as ready-to-use from Agilent Technologies (USA). A stock solutions of cyprodinil and fludioxonil were prepared in acetonitrile at a concentration of 100 µg/ml. Working standard solutions for HPLC analysis were prepared by appropriately diluting the stock solution with acetonitrile, achieving concentrations from 0.02 to 40.0 µg/ml. Stock solutions were stored at temperature of -20 ± 2 °C, and working standard solutions were stored in the dark at temperature of 4 °C.

Sample preparation

Extraction of cyprodinil and fludioxonil from the lettuce was accomplished by original QuEChERS method (Anastassiades et al., 2003). The analysis was carried out by use of untreated lettuce that was kept in the regime of deep freezing until the analysis. Untreated lettuce samples were previously grinded and homogenized. For the recovery experiment, to in this manner prepared sample (10 g) a corresponding quantity of cyprodinil and fludioxonil – of final concentration of 0.1, 15 and 40 mg/kg was added and left in the fridge over night. After that, 10 ml of acetonitrile was added, vigorously shaken by hand for 1 minute, than 1 minute on vortex and after that a prepared buffering mixture of salt (Agilent Cat. No 5982-5650) was added. It was instantly shaken by hand for 1 minute and 1 minute in vortex. Cuvettes were then placed in an ultrasonic bath for 10 minutes and centrifuged at 3000 rpm for 5 min (Figure 1).



Figure 1. The procedure of cyprodinil and fludioxonil extraction from lettuce

An aliquot of 6 ml was transferred from the supernatant to a clean-up tube with 855 mg of magnesium-sulphate, 150 mg of PSA and 45 mg of bulk carbograph. Afterward, centrifugation was carried out at 3000 rpm for 5 min. An aliquot (3 ml) from the supernatant was evaporated till volume of 1 ml, filtered through a 0.45 μm filter and analyzed by HPLC–DAD (Figure 2).



Figure 2. The purification process

Apparatus and chromatographic analysis

Pesticide residue analysis was performed with Agilent technologies 1100 Series high-performance liquid chromatographic system equipped with a diode array detector. The separation was performed on a C18 column (50 × 4.6 mm, 1.8 μm). The mobile phase was (0.5% acetic acid/MeCN, 40:60 v/v) with a flow rate of 0.9 ml/min and detection wavelength of 254 nm. Data analysis was performed using ChemStation software.

Results and discussion

The proposed method for cyprodinil and fludioxonil determination is based on reverse-phase high performance liquid chromatography and detection with a series of photo-sensitive diodes. Previously, those fungicides were determined using gas chromatography with a nitrogen-phosphorus detector (GC-NPD) (Marin et al., 2003). Also, HPLC-DAD method for determination of cyprodinil and fludioxonil in lettuce were described, while the separation was done with solid-phase microextraction (SPME) (Melo et al., 2012). However, the method allowed the determination of analyzed fungicides in lettuce at concentrations above 0.8 mg/kg.

Figures 3 and 4 present chromatograms of cyprodinil and fludioxonil standard mixture in acetonitrile and in a matrix of lettuce, as well as their spectra, obtained under previously given conditions.

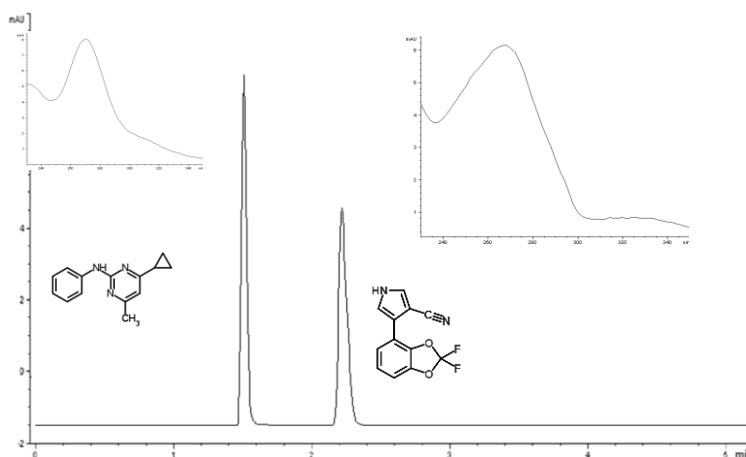

Figure 3. Chromatogram of cyprodinil and fludioxonil standard mixture and their spectras in acetonitrile

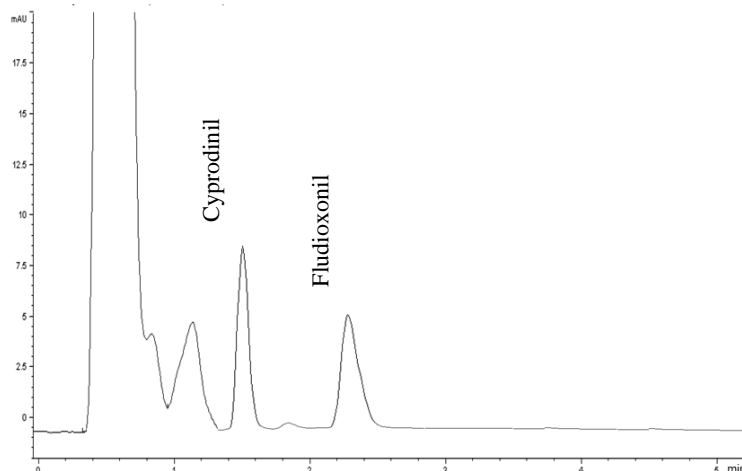

Figure 4. Chromatogram of cyprodinil and fludioxonil standard mixture in lettuce matrix

The analysis of analytical standards of cyprodinil and fludioxonil solution resulted in the maximum established peak of 265 nm, i.e. 275 nm, respectively. Chromatography of lettuce extract with added cyprodinil and fludioxonil standards, under the same conditions resulted with maximum of obtained peaks at the same wavelength.

The retention time of cyprodinil under the set conditions was found to be 1.507 min. The obtained chromatograms showed no interfering peak at the retention time of the cyprodinil, i.e., at 1.507 min showing good specificity of the method. Also, the retention time of fludioxonil was found to be 2.310 min, without interfering peak at that time.

The check of chromatographic conditions was carried out by linearity of the detector response, precision and accuracy of the method, and matrix effect, as well as determination of limits of detection (LOD) and quantification (LOQ).

The linearity of the detector responses was evaluated at a concentration range between 0.02–40.0 µg/ml using five calibration solutions prepared in acetonitrile. The calibration curve of analyzed fungicides showed a good linearity and strong correlation between concentrations and area in the studied range with correlation coefficient of 0.994 and 0.995, for cyprodinil and fludioxonil, respectively. The LOD and the LOQ for cyprodinil and fludioxonil in lettuce were 0.02 mg/kg and 0.05 mg/kg, respectively.

Precision value was evaluated through repeatability and expressed as relative standard deviation (RSD). The repeatability was checked by analysis of the cyprodinil and fludioxonil standard prepared in lettuce matrix (1.0 µg/ml) five times in the same day. RSD of the peak areas were 0.80 and 0.38%, respectively, fulfilling the criteria of $RSD \leq 20\%$.

A critical aspect of pesticide residue analysis is the purification process, which is required to isolate the residues from matrix components and to reduce matrix effects (Lehotay et al., 2005). The matrix effect, i.e., signal suppression or enhancement, of the studied fungicides in the lettuce matrix, was evaluated. For this study, matrix effects were examined comparing the slopes of calibration curve obtained for matrix-matched standards (MMC) and solvent-based standards (SC). Cyprodinil and fludioxonil standards were prepared in blank matrix extract in five concentrations between 0.02–40.0 µg/ml. The values of 105.9% and 104.9% indicate that the impact of the lettuce matrix on cyprodinil and fludioxonil determination can be ignored.

The accuracy of the method was carried out using blank sample spiked with a standard solution of cyprodinil and fludioxonil fungicides at three levels. Calculations were done using calibration curve of MMC standards. The mean recoveries for cyprodinil and fludioxonil were 87.1% and 85.9%, respectively. According to the EU validation guideline for pesticide residues, mean

recovery values should be within the range of 70–120%, which was achieved by this method. Results of the recovery achieved in this study confirmed that the optimal recovery was obtained for cyprodinil and fludioxonil in lettuce samples.

Conclusions

A relatively simple and fast HPLC-DAD method for the simultaneous determination of cyprodinil and fludioxonil fungicide residues in lettuce was developed. Reverse phase and isocratic elution conditions enable efficient separation and quantification of investigated fungicides. The proposed method has been validated with good recoveries and linearity, as well low LODs and LOQs values, lower than MRLs set by the EU and R. Serbia. Finally, the results obtained in this study confirm that proposed method can be applied for determination of cyprodinil and fludioxonil fungicide residues in lettuce.

Acknowledgement

The authors acknowledge the financial supports received from the Ministry of Education and Science, the Republic of Serbia, grant III46008.

References

- Anastassiades, M., Lehotay, S.J., Stajnbaher, D., Schenck, F.J., 2003. Fast and easy multiresidue method employing acetonitrile extraction/partitioning and ‘dispersive solidphase extraction’ for the determination of pesticide residues in produce, *Journal of AOAC International*, Vol. 86(2), 412-431.
- EU Commission Health and Consumer Protection Directorate-General. (2016). Guidance document on analytical quality control and method validation procedures for pesticides residues analysis in food and feed. SANTE/11945/2015.
- Lazić, S., Šunjka, D., Panić, S., Indić, D., Grahovac, N., Guzsvány, V., Jovanov, P., 2014. Dissipation rate of acetamprid in sweet cherries, *Pesticide and Phytomedicine*, Vol. 29(1), 75-82.
- Lazić, S., Šunjka, D., Pucarević, M., Grahovac, N., Vuković, S., Indić, D., Jakšić, S., 2013. Monitoring of atrazine and its metabolites in groundwaters of the Republic of Serbia, *Chemical Industry*, Vol. 67(3), 513-523.
- Lehotay, S.J., de Kok, A., Hiemstra, M., van Bodegraven, P., 2005. Validation of a fast and easy method for the determination of 229 pesticide residues in fruits and vegetables using gas and liquid chromatography and mass spectrometric detection. *J. AOAC Int.*, Vol. 88, 595-614.
- Marin, A., Oliva, J., Garcia, C., Navarro, S., Barba, A., 2003. Dissipation rates of cyprodinil and fludioxonil in lettuce and table grape in the field and under cold storage conditions, *J. Agric. Food Chem.*, Vol. 51(16), 4708-4711.
- Melo, A., Aguiar, A., Mansilha, C., Pinho, O., Ferreira, I., 2012. Optimisation of a solid-phase microextraction/HPLC/Diode Array method for multiple pesticide screening in lettuce, *Food Chemistry*, Volume 130(4), 1090–1097.
- Official gazette RS, 25/2010. Pravilnik o maksimalno dozvoljenim količinama ostataka sredstava za zaštitu bilja u hrani i hrani za životinje i o hrani i hrani za životinje za koju se utvrđuju maksimalno dozvoljene količine ostataka sredstava za zaštitu bilja.
- Roberts, T., Hadson, D., 1999, *Metabolic pathways of agrochemicals, Part two, Insecticides and Fungicides*, The Royal Society of Chemistry, UK.
- Savčić-Petrić, Lj.S. (Prir.) (2015). Plant protection products on the Serbian market (2015), *Plant Doctor*, No. 1-2.
- Vuković, S., Šunjka, D., Indić, D., Gvozdenac, S., Miletić, V., 2013. Botanical fungicides and herbicides of importance for plant protection, *Plant Doctor*, Vol. 41(4), 451-458.

RESPONSE OF THE PARLATORIA CITRUS SCALE INSECTS (HEMIPTERA, COCCOIDEA) TO COLOURED STICKY TRAPS

Hanan JENDOUBI*, Pompeo SUMA, Agatino RUSSO

Department of Agriculture, Food and Environment, University of Catania, Italy

*Corresponding author: hanan_bari@hotmail.com

Abstract

The black scale *Parlatoria ziziphi* (Lucas) and the chaff scale *Parlatoria pergandei* Comstock (Hemiptera, Diaspididae) are some of injurious scale insects to citrus crops. A better understanding of stimuli to which male adults respond is essential to develop more effective monitoring techniques and establish pest flight phenology to use in control programs. We sought to study relative attractiveness of coloured sticky traps to males of both citrus scale insects in citrus orchards, and to find a suitable coloured trap to estimate their populations in the field. Consequently, field tests on the colour and position response of *P. pergandei* and *P. ziziphi* males were conducted in two citrus orchards located in Eastern Sicily (Catania), using square coloured sticky traps (30 x 30 cm) placed in and outside the canopy of trees. Significantly high numbers of males of both species *P. pergandei* and *P. ziziphi* were caught with yellow traps. Adults were also attracted by white and green traps but less by red and blue ones. Few significant differences in the captured males were observed when the two trap positions were compared. In conclusion, the yellow traps represent a good tool for monitoring parlatoria citrus scale populations in the field and, correlating those data with the population density on fruits and leaves samples on the trees, their management in citrus orchards is possible.

Key words: *parlatoria citrus scale insects, coloured sticky traps, males, captures, monitoring.*

Introduction

The present study completes previous research carried out on citrus scale insects in Tunisia Jendoubi (2012). Authors reported two key pests of citrus in the northern region, the black scale *Parlatoria ziziphi* (Lucas) and the chaff scale *Parlatoria pergandei* Comstock. High infestations were related directly to the failure of management strategies applied by farmers due to the inefficient surveillance programs available for growers. In this context, a dedicated monitoring activity of citrus parlatoria scale insect species is presented in order to acquire useful information for the development of pest management programs in citrus orchards.

The black scale and the chaff scale are reported as important pests occurring on citrus in many citrus growing regions over the world. The black parlatoria scale or citrus parlatoria is one of the five species of *Parlatoria* known to infest citrus (Ben-Dov, 2016). Miller and Davidson (2005) reported this scale as the only truly monophagous species attacking citrus; plant hosts are apparently restricted to the family Rutaceae. From southern China (Asia), the species is established on all continents with a tropical or semi-tropical climate, but has also extended into temperate and Mediterranean regions. Many authors considered the black parlatoria scale as a serious world pest and one of the major pests of citrus in many countries. *P. ziziphi* was listed as economically important pest in Algeria, Morocco, Tunisia, and Southeast Asia (Talhouk, 1975; Jerraya, 2003; Pellizzari and Germain, 2010 and Bouazza and Guenaoui, 2015). Perhaps the most characteristic damage is the virtually irremovable black scale cover on the fruit. The chaff scale

or 'le pou gris' is considered a cryptogenic species of unknown origin by many authors (Pellizzari and Germain, 2010). Nowadays, it is widely distributed throughout the tropical and subtropical areas of the world. It occurs in Europe, Africa, Australasia, Pacific Islands, West Indies and America. It is a polyphagous species, reported in 36 plant families. Citrus is by far the most commonly reported host followed by Hibiscus, Jasminum and Viburnum (Heu, 2002 and Ben Dov, 2016). Miller and Davidson (1990) list this insect as a serious world and widespread pest. Since the 1970s, *P. pergandei* has become one of the main pests in all citrus-producing areas and has been recorded as such in several countries from the Mediterranean region (CABI, 1968). The infestation of the Chaff scale is generally relevant; a greenish blotch remains at the feeding point on mature fruit. Heavy infestations of both pests cause chlorosis and premature drop of leaves, die back of twigs and branches, deformations and premature drop of fruits. This reduces commercial value of fruits, causing rejection in most fresh fruit markets. In many countries worldwide, there are many studies on both of these scale insect species including excellent regional monographs and several articles treating bio-ecological features. However, few studies have so far been carried out on enhancing systems of monitoring citrus parlatoria populations within the integrated pest management strategies. The predicting infestation level is limited to visual scanning or sampling (growers and fieldsman) of sessile populations living on trees. This method reveals the presence of scale insects, but not the life stage distribution or population density. Catches of males by either chromatic or pheromone traps (as in the case of the citrus mealybug and the California red scale) should be used for monitoring these scale insects. Currently, coloured sticky traps have been widely used to monitor flying pests in many agro-ecosystems and are more preferable method in management systems. The use of yellow sticky traps is an effective tool in terms of pest management and this colour was proven to be the most effective one to screen flight activity of several insects as whiteflies, aphids, leafhoppers and thrips (Hill and Hooper, 1984; Hoback *et al.*, 1999; Wallis and Shaw, 2008 and Hazır and Ulusoy, 2012). Literature data on the male activity and colour preference are scarce or absent and there were no records on chromatic trapping for *P. pergandei* and *P. ziziphi*. A better understanding of the stimuli to which male adult respond is essential for the development of effective monitoring techniques to reliably estimate the dynamic population and flight phenology of these species.

This study aimed to determine the colour preference of parlatoria citrus scale males and to assess the utility of colour sticky trap catches in estimating their populations in the field. Consequently, the attractiveness of colour and placement of sticky traps on insect captures were examined. Our findings can be useful in the development of sampling techniques to support the growers in making management decisions against scale insects in citrus orchards.

Materials and methods

The colour and position preference of citrus Parlatoria males experiment were conducted in two citrus orchards located in Catania (Southern Italy) during summer 2010. Traps were designed by clear polypropalene card, square shaped and 30/30 cm in size, coated with Beetle-Glue®. Differently coloured traps were hanged on each citrus tree: yellow, blue, white, dark green, orange, red and black. The experimental design was a completely randomized block with three replications and the samples were collected each week (table 1). On each sampling date, two traps of each colour per tree were placed in exposed or shaded location. Placement and retrieval of traps required approximately half a day of labor per sampling date. At each time of collection, the single sticky trap was covered with cellophane wrapped and brought to the laboratory for the count of captured males under a stereoscope.

The data related to the males captures for each coloured traps were analyzed by analysis of variance (ANOVA) using the SAS software; means were separated using the Least Significant Difference (LSD) Multiple Comparison Tests.

Table 1: Experimental design of Colour traps trial

Block N°	Tree N°	01.06.10	08.06.10	15.06.10	22.06.10	29.06.10
A	1	W/BL	G/R	BK/Y	R/W	W/BL
	2	Y/R	Y/BL	G/W	BL/BK	R/Y
	3	BK/G	W/BK	R/BL	G/Y	BK/G
B	1	W/BL	BL/Y	G/W	BK/BL	Y/R
	2	R/Y	BK/W	BL/R	G/Y	BK/G
	3	BK/G	R/G	Y/BK	W/R	BL/W
C	1	Y/R	R/G	Y/BK	R/W	W/BL
	2	BK/G	BL/Y	W/G	BK/BL	Y/R
	3	BL/W	W/BK	BL/R	Y/G	BK/G
Colours	BK: black; BL: blue; G: green; R: red; W: white; Y: yellow					

Results and discussion

Trap colour and position

In figure 1, the different responses of the males of both parlatoria species to the tested coloured traps, were reported. The yellow (112 males) and white (93 males) traps were more attractive for *P. pergandei*. This was followed by red (72 males), green (72 males), and blue, with blue recording the lowest number of adults captured (57 males). For *P. ziziphi*, the yellow traps captured 38% of male catches followed by white 22%, green 20%, red 11%, and the lowest one was the blue 9%.

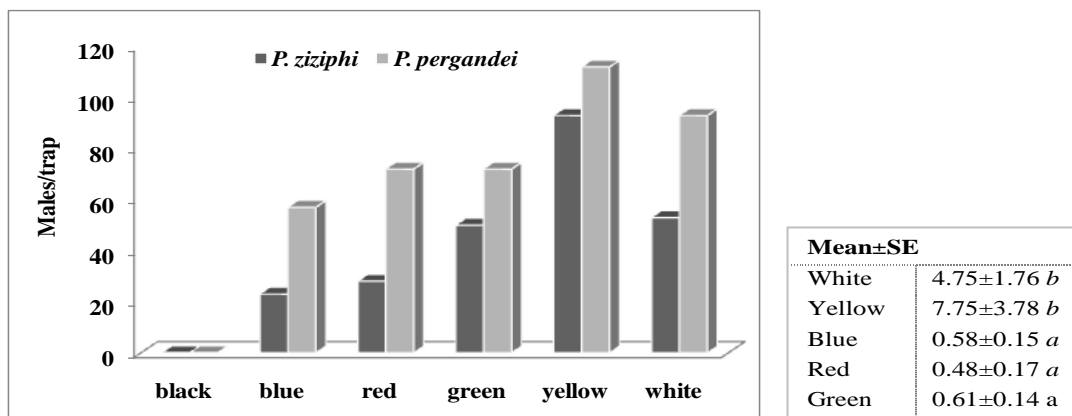

Figure 1: sticky trap colour preference of the chaff scale and black scale males in citrus orchards. a: capture means within a row followed by different letters were significantly different at $p < 0.05$ based on the LSD Multiple Comparison Tests.

Accordingly, from the statistical analysis of data, the yellow traps caught significantly more *P. pergandei* and *P. ziziphi* adults than other colours tested ($F=2.66$, $df=5$, 60 , $P=0.03$; $F=2.79$, $df=5$, 60 , $P=0.02$; $p < 0.05$) (table 2). The highest male captures reached a total of 186 males for both species on yellow sticky traps (7.75 ± 3.78). The second highest captures were obtained with the white trap (4.75 ± 1.76) capturing 146 males of *P. pergandei* and *P. ziziphi*. A previous study had also indicated yellow and white colours as being attractive to many hemipterans species including coccids group (Hoback et al., 1999). Compared with species belonging to the same genus, the

parlatoria palm scale males mostly preferred white traps. Whereas to parlatoria citrus scale, yellow was the most preferred colour and white ranked second in the order of preference (Abd El-Kareim, 1998). The black scale and the chaff scale share with the parlatoria palm scale the lowest response to green, red and blue colours. A similar low response to these colours was shown by males of *Aonidiella citrina* (Newstead) (Moreno *et al.*, 1974), which is an armoured scale insect considered as important citrus pest.

With the black cards, no captures were recorded in this study. Literature searches carried out on species level differences in colour preference demonstrated that most of insects are indifferent to black colour like *Parlatoria* species. In fact, only the *Ceratopogonidae* family was attracted to the black colour (Hill and Hooper, 1948).

It is necessary to point out as the males of others diaspidids (e.g. *Aonidiella aurantii* Maskell and *Lepidosaphes beckii* Newman) were found in glutted yellow cards, showing a positive response to chromatic traps.

No statistical significant differences in the captured males were observed comparing the two trap positions, which are indicative of microhabitat preferences (table 2). Male flights seem to be less affected by the location, sunny or shadow; but they are extremely dependant of yellow colour, recording high values.

Table 2: Summary of LSD Test results ($p=0.05$) of the response of citrus *Parlatoria* males to colour and position traps trial

	<i>df</i>	SE	<i>F</i>	<i>p-level</i>
Colour- <i>P. pergandei</i>	5	0.24	2.67	<0.03
Colour-<i>P. ziziphi</i>	5	0.23	2.79	<0.02
Position	1	0.24	0.48	0.49
Colour*position	5	0.24	0.59	0.71

Promoting results are recorded within this study, supporting the idea that the yellow trap represents a useful tool for pest management programs for *P. pergandei* and *P. ziziphi* and others armoured scale insects affecting citrus trees.

Efficiency of yellow traps on the population density

The yellow colour trap turned out to give indications on abundance of males but they can also provide interesting information on the pest population level of the monitored scale species. In fact in respect to the exposure time, high numbers, of males for both species *P. pergandei* (406 males) and *P. ziziphi* (247 males) were caught with the traps. Focusing on yellow cards, 112 males were counted for the chaff scale and less than the half (74 males) for the black scale. And so, the first one is much more abundant than the latter in the prospected citrus orchards, being both in an injurious status. This allows classifying *P. pergandei* as a key pest of citrus trees in those orchards, needing urgent intervention with systemic agro-chemical products. At the same time, this should prevent the spread of *P. ziziphi* populations and keep it under the economic threshold. Additionally, the yellow trap might affect the mating frequency chance for female copulations due to these high catches and the sexual reproduction model of most scale insect species. It will result in reduction of off-spring production and therefore it could be incorporated in an integrated management control program for the two pests.

Efficiency of yellow traps on the male flights

The yellow coloured trap may also be used as indicator of the population's flight activity of both parlatoria species, providing useful details when studying the phenology of male captures throughout the year.

In the figure 2, we tried to draw the male flights of *P. pergandei* and *P. ziziphi*, choosing best attractive colours, yellow and white. Accordingly, emergence of *P. pergandei* and *P. ziziphi* males start on 22 June, registering higher values or 'peaks' on 29 June. Data is clearly more expressed with the yellow sticky cards (186 males) which were more attractive to males than the white cards (146). If this type of trap is used for longer period, it will effectively detect the beginning of male activities and determine the flight peaks which are helpful in control practices timing. Hence, trapping by sticky yellow cards may be very helpful in the detection of first male flights of both citrus parlatoria scale insects.

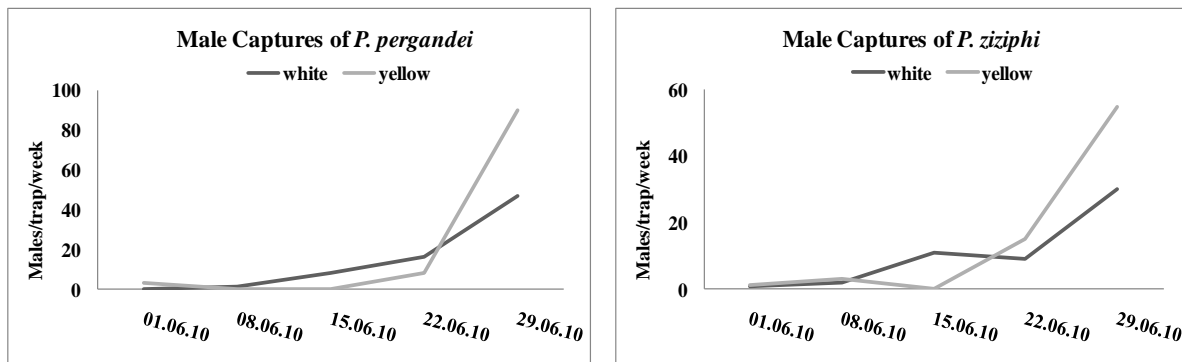

Figure 2: Monitoring male flights of *P. pergandei* and *P. ziziphi* using sticky coloured traps

At this step, a calendar (Informative Sheet) for growers and interested people, containing first preliminary data on how to use yellow sticky traps in monitoring males of citrus parlatoria scale insects and eventual others species from Diaspididae occurring in citrus orchards, can be proposed.

Informative sheet

Sticky trap color.

Yellow Traps is most recommended to be used in a monitoring program that will include citrus scale insects, belonging to Parlatoria genus.

Number of traps needed.

It can get a fairly good idea of males activity with 4 traps per 1ha. But, you need often to determine your main target pest(s) and then check with your state extension specialist.

Mode of sticky trap deployment.

The basic suggestion has been to hang traps vertically, at heights of 1,5m, slightly below the top of trees, where they will be most efficient. Also, place traps around orchard perimeters as well as within the orchard will detect pest injury before most other crops show symptoms.

Frequency and examination period.

Use sticky traps along with regular plant inspections: once a week would be ideal during spring and summer, twice a month in autumn and once a month in the Winter.

Learning pest Identification.

Males of diaspidids are generally winged, red with black eyes; but some particular differences for each species should be known by users. Perhaps, farmers can face some difficulties to identify

males but with using pictorial guides, hand lens, and attending grower meetings they will become acquainted with the major pest groups and will be able to easily identify them.

Insect counts.

Be certain to wrap the sticky traps in clear plastic. Insect count can be facilitated by using sticky traps with a background grid. Numbers should be written down in forms that should allow growers to start their monitoring process. we suggest correlating results of yellow cards to those of visual inspections before starting treatment.

Conclusion

This study reports first results dealing with the usefulness of the coloured sticky traps as tool for the monitoring activities of *P. pergandei* and *P. ziziphi* in citrus orchards.

Both male's species showed a strong preference for yellow colour, resulting in highest captures. Captures on sticky traps provided good informations on male abundance and revealed the pattern of adult flights to be considered of extreme importance for the early detection of male emergences and management of the black and the chaff scale in citrus orchards. Also, trap catches showed fluctuations in population sizes similar to visual counts attesting the overall reliability of the traps. Hence, the yellow sticky cards may be considered a practical, accurate and low cost technique for pest diagnostic, infestation level assessment or control practices timing of parlatoria citrus scale populations and other diaspidids occurring in citrus orchards. We encourage owners/growers to use these informations during monitoring periods. Moreover, we suggest conducting studies on economic thresholds based on male flights of scale insects using yellow glued cards in correlation with the sampling methods.

References

- Abd El-Kareim, A.I. (1998). Swarming activity of the adult males of parlatoria date scale in response to sex pheromone extracts and sticky color traps, *Archive Phytopathologie Pflanz*, Vol. (31.), pages (301-307).
- Ben-Dov, Y. (2016). ScaleNet: Find a Valid Name and Catalogue Query for a species, <http://www.sel.barc.usda.gov/scalenet/valid.htm>. Accessed on 01/06/2016.
- Bouazza, I. and Guenaoui, Y. (2015). Density infestations of parlatoria ziziphi (lucas) (Hemiptera: Diaspididae) on citrus in the Northwestern Algeria, *Sixth International Scientific Agricultural Symposium "Agrosym 2015"*, Jahorina, 793-799 pp.
- CABI. (1968). International Distribution Maps of Plant Pests, *Parlatoria pergandii*, <http://www.cababstractsplus.org/DMPP/Reviews.asp?action=display&openMenu=relatedItems&ReviewID=12800&SubjectID>. Accessed on 15/04/2015.
- Jendoubi, H. (2012). Current status of the scale insect fauna of citrus in Tunisia and biological studies on *Parlatoria ziziphi* (Lucas), Ph.D Thesis, University of Catania, Italy, 159 pp.
- Jerraya, A. (2003). Principaux nuisibles des plantes cultivées et des denrées stockées en Afrique du Nord : Leur biologie, leurs ennemis naturels, leurs dégâts et leur contrôle, *Climat Pub*, Tunisie, 225 pp.
- Hazır, A. and Ulusoy, M.R. (2012). Population fluctuation of thrips species (Thysanoptera: Thripidae) in nectarine orchards and damage levels in east Mediterranean region of Turkey, *Journal of Entomological Research Society*, Vol. (14.), pages (41–52).
- Heu, R.A. (2002). Distribution and Host Records of Agricultural Pests and Other Organisms in Hawaii, *Plant Industry Division-Department of Agriculture in Honolulu, Hawaii*. 69 pp.
- Hill, A.R. and Hooper, G.H.S. (1984). Attractiveness of various colors to Australian thephritid fruit flies in the field, *Entomological Express Applicata* Vol. (35.), pages (119–128).

- Hoback, W.W., Svatos, T.M. Spomer, S.M. and Higley, L.G. (1999). Trap color and placement affects estimates of insect family-level abundance and diversity in a Nebraska salt marsh, *Entomologia experimentalis et applicata* Vol. (91.), pages (393-402).
- Imad, B. and Yamina, G. (2015). Density infestations of *parlatoria ziziphi* (lucas) (Hemiptera: Diaspididae) on citrus in the Northwestern Algeria, Sixth International Scientific Agricultural Symposium “Agrosym 2015”, Jahorina, 793-799 pp.
- Miller, D.R. and Davidson, J.A. (1990). A list of the armoured scale insect pests, In. (eds.). Rosen, D. Armoured scale insects: their biology, natural enemies and control, *World Crop Pests*, Vol.(4B), Elsevier, Amsterdam, 299-306 pp.
- Miller, D.R. and Davidson, J.A. (2005). *Armoured Scale Insect Pests of Trees and Shrubs*, Cornell University, Ithaca (NY), 442 pp.
- Moreno, D.S., Carman, G.E., Fargerlund, J. and Shaw, J.G. (1974). Flight and dispersal of the adult male yellow scale, *Annals of Entomological Society of America*, Vol. (67.), pages (15-20).
- Pellizzari, G. and Germain, J.F. (2010). Scales (Hemiptera, Superfamily Coccoidea), *BioRisk*, Vol. (4.) (1), pages (475-510).
- Talhouk, A. M.S. (1975). *Citrus pests throughout the world*, Technical Monograph Vol. (4.), pages (1-21).
- Wallis, D.R. and Shaw, P.W. (2008). Evaluation of coloured sticky traps for monitoring beneficial insects in apple orchards, *New Zealand Plant Protection*, Vol. (61.), pages (328–332).

THE EFFICACY OF SOME ESSENTIAL OIL COMPONENTS AGAINST CONFUSED FLOUR BEETLE, *TRIBOLIUM CONFUSUM* DUVAL. (COLEOPTERA: TENEBRIONIDAE) AT DIFFERENT TEMPERATURES

Özgür SAĞLAM*, Nihal ÖZDER

Namık Kemal University, Agriculture Faculty, Department of Plant Protection, Tekirdag, Turkey

*Corresponding author: osaglam@nku.edu.tr

Abstract

Fumigant toxicity of essential oil components: α -pinene, *p*-cymene, eugenol, cuminaldehyde, linalyl acetate, linalool, α -terpinene, gamma terpinene, limonene, β -pinene, allyl isothiocyanate and diallyl disulphide against all life stages of Confused Flour Beetle, *Tribolium confusum* DuVal. at three different temperatures (20, 25, 30 °C) and 65±5 % R.H was determined. In preliminary biological tests all life stages of *Tribolium confusum* were exposed to 100 μ l/l concentration of compounds during 24 h. Results of preliminary tests were Cuminaldehyde, allyl isothiocyanate and diallyl disulphide showed highly toxicity to *T. confusum* eggs. Allyl isothiocyanate and diallyl disulphide had high fumigant toxicity to other life stages of *T. confusum*. The results obtained from effective components indicated that values of lethal concentration for effective compounds were decreased. However, toxicity increased with increasing temperature. According to results it can be concluded that Allyl isothiocyanate would be a potential compound in controlling stored-product insects, since it had high toxicity to all biological stages of *Tribolium confusum*.

Keywords: *Essential oil components, fumigant toxicity, Tribolium confusum, temperature*

Introduction

Insect control in stored products at present based on the use of gaseous fumigants and residual insecticides, both of which pose serious hazards to mammals and the environment (Shaaya et al. 1997; Ren et al. 2008). Fumigation is still one of the most effective methods for prevention of storage losses. Phosphine and methyl bromide (MB) are the most common fumigants used for stored-product protection throughout the world. MB phased out end of the 2015 in all over the world. Insect resistance to phosphine is a global issue now and control failures have been reported in field conditions in some counties (Taylor 1989; Collins et al. 2002; Opit et al. 2012, Saglam et al. 2015). Essential oils are potential sources of alternative compounds to currently used fumigants. Essential oils and components are among the best-known substance tested against insects. These compounds act as fumigants (Regnault-Roger and Hamraoui, 1995; Shaaya et al., 1997), contact insecticides (Schmidt and Streloke, 1994), repellents (Plarre et al., 1997), antifeedants (Harwood et al., 1990) and may affect some biological parameters such as growth rate, life span and reproduction (Regnault-Roger and Hamraoui, 1995). Various studies have demonstrated fumigant activity of various essential oils against various stored product insects (Shaaya et al., 1991; Shaaya et al., 1997; Tunç et al., 2000; Lee et al., 2003; Isikber et al. 2009). Furthermore, interest as been shown in plant products, i.e., essential oils and their components, for fumigants action since it is believed that natural compounds from plant sources may have the advantage over conventional fumigants in terms of low mammalian toxicity, since some of monoterpenoid compounds such as β -asarone, estragole, safrole, (+) - fenchone are known to be

carcinogenic (Kim and Ahn, 2001), rapid degradation and local availability (Isman, 2006). Previous laboratory evaluations of monoterpenoids on various insect pests have established their biological activity as ovicides, fumigants, and contact toxicants (Karr and Coats 1988; Rice and Coats 1994; Tsao et al. 1995; Saglam and Ozder, 2013). The present study was carried out to determine the fumigant toxicity of twelve monoterpenoids with different chemical groups; α -pinene, p-cymene, eugenol, cuminaldehyde, linalyl acetate, linalool, α -terpinene, γ -terpinene, limonene, β -pinene, allyl isothiocyanate and diallyl disulphide, against all life stages (adult, egg, larva and pupa) of confused flour beetle at three different temperatures.

Materials and methods

Insect culture:

Biological tests were carried out on all life stages (egg, larva, pupa and adult) of *T. confusum*. *Tribolium confusum* were obtained from cultures reared in 1 l glass jars at $25 \pm 1^\circ\text{C}$ and $65 \pm 5\%$ relative humidity (RH) on a diet of wheat flour mixed with dry brewer's yeast (17:1, wt:wt) (Donahaye 1990). The experiments were conducted with eggs (1-2 days old), old larvae (4-7th instar), pupae (1-2 days old) and adults (7-10 days old). Eggs were separated daily from oviposition jars by sieving (70 mesh, 210 μm sieve; Retsch, Germany). Eggs were transferred into the 10 ml glass tubes for exposure to treatments. 10 ml glass tube (2 cm diameter and 4.5 cm long), each containing 50 eggs 1–2 days old, were exposed to each treatment. Old larvae were removed from culture jars and exposed to the treatments 25-30 days after oviposition. Two day-old pupae were obtained by daily separation from culture jars and held in wheat flour for 48-h before the exposure. Newly emerged adults were held in pre-exposure jars containing wheat flour, and were exposed to treatment 7-10 days after emergence. Each glass tube, except of the egg stage, included 4 g wheat flour as food.

Tested monoterpenoid compounds:

Twelve monoterpenoid compounds; α -pinene (Aldrich, 147524, 98 %), p-cymene (Sigma-Aldrich, C121452, 99 %), eugenol (Fluka, 46129, Ph eur), cuminaldehyde (Fluka, 28210, 85 %), linalyl acetate (Fluka, 45980, 95 %), linalool (Fluka, 62140, 95 %), α -terpinene (Aldrich, 223182, 85 %), γ -terpinene (Fluka, 86478, 97 %), limonene (Sigma-Aldrich, 183164, 97 %), β -pinene (Aldrich, 112089, 99 %), allyl isothiocyanate (Merck, 800260, 95 %) and diallyl disulphide (Sigma-Aldrich, 317691, 80 %) were tested against all life stages of *T. confusum*. Experiments were carried out at 3 different temperature in laboratory condition. After purchase, the monoterpenoid compounds were collected in sealed glass containers with frangible septum which allows easy penetration by a syringe needle to permit withdrawal of the compounds. Containers were kept at refrigerator temperature (4°C) at dark until use.

Bioassay Tests and Experimental Procedures:

Tested stages of *T. confusum* were collected from the cultures and placed in the glass vials covered with a fine mesh to allow penetration of any volatiles emanating from the monoterpenoid compounds. Fifty eggs and twenty five larvae, pupae and adults were used in each replicate. Bioassays were carried out in 3-l glass jars closed with metal screw-on lids, which served as fumigation chambers and were kept at $20, 25, 30 \pm 1^\circ\text{C}$ and $65 \pm 5\%$ RH. An aqueous saturated magnesium nitrite solution ($\text{Mg}(\text{NO}_3)_2$) was placed in small glass petri dishes of 7 cm diameter to provide $60 \pm 5\%$ RH in the glass jar (Greenspan 1977). The single-dose biological tests were carried out to determine the effective concentrations of each compound against the all biological stages of tested species of *T. confusum*. Each tested stages were exposed to a constant concentration of 100 $\mu\text{l l}^{-1}$ air of each compounds for 24 h. Monoterpenoid compounds were applied on filter paper (2 cm x 5 cm) attached to the under-side of the lids of fumigation chambers

by using micropipette. The jars were immediately closed. After eggs, larvae, pupae and adults of *T. confusum* in glass vials were transferred separately into fumigation chambers, the fumigation chambers were closed with screw-on lids, which were made air-tight. Each treatment and control were replicated three times.

Monoterpenoid compounds that cuminaldehyde, diallyl disulphide and allyl isothiocyanate with high fumigant activity on biological stages of *T. confusum* in preliminary biological tests were subjected to lethal concentration tests to determine their LC₅₀ and LC₉₀ values. With diallyl disulphide a range of 6 concentration levels ranging from 0.25 to 10 µl l⁻¹ for the eggs, from 5 to 75 µl l⁻¹ for the pupae, from 1 to 75 µl l⁻¹ for the adults and 9 concentration levels ranging from 1 to 120 µl l⁻¹ for the larvae were used. With allyl isothiocyanate the ranges consisted of 6, 7, 8 and 5 concentrations, from 0.1 to 5 µl l⁻¹ for the eggs, from 0.25 to 5 µl l⁻¹ for the pupae, from 1 to 5 µl l⁻¹ for the adults and from 0.5 to 7.5 µl l⁻¹ for the larvae respectively. With cuminaldehyde the ranges consisted of 5 concentrations from 0.25 to 10.5 µl l⁻¹ for *T. confusum* eggs. Concentrations were selected for the eggs of insect species on basis of preliminary bioassay tests. Three replicates were set up for each concentration and control. Fumigation procedures were the same as in above mentioned bioassay tests.

Data processing and analysis:

After each treatment, larvae, pupae, and adults were transferred to clean 10 ml jars containing food medium and were held at 25 ± 1°C and 65 ± 5 % RH until examined for mortality. The eggs in their Perspex slides were held under the same conditions until the oviposition sites were examined for egg hatch. Mortality counts for adults were made 4-5 d after exposure; for larvae they were based on those insects that had failed to pupate 9 d after exposure; pupal mortality was based on those pupae that failed to produce adults 9 d after exposure, and egg hatch was counted 7 d after treatment. Mortality data obtained from bioassay tests were corrected by using Abbott's formula (Abbott, 1925). Mortality data obtained from preliminary bioassay tests were normalized using arcsine transformation and then were analyzed using two-way analysis of variance (ANOVA). The means were separated using the Duncan's test at the 5 % level (SPSS, 2009). Data obtained from each zero dose control and concentration- mortality responses were subjected to probit analysis by using maximum likelihood program software (POLO-PC) (LeOra Software 1987) to determine LC_{50s} (Lethal Concentration₅₀), LC_{90s} (Lethal Concentration₉₀) and their respective 95 % confidence intervals. Differences in toxicity were considered significant when 95 % confidence intervals did not overlap. The slopes and intercepts of concentration-mortality regressions for each tested insect were compared with the POLO-PC maximum-likelihood procedures (LeOra Software 1987).

Results and discussion

Preliminary bioassay tests indicated that percentage mortalities of all biological stages of *T. confusum*, exposed to a concentration of 100 µl l⁻¹ air of tested monoterpenoid compounds for 24 h are given in Table 1, Table 2 and Table 3. at different temperatures.

Table 1. Percent mortality of *Tribolium confusum* eggs, larvae, pupae and adults exposed to 100 $\mu\text{l l}^{-1}$ concentration of tested monoterpenoid compounds for 24 h at 20°C.

Compounds	Mortality (%) \pm S.E.				F and P value
	Egg	Larva	Pupa	Adult	
α -pinene	12 \pm 2.3 BC a *	2.7 \pm 1.3 FG b	20.8 \pm 5.33 AB a	0 \pm 0 B b	F _{3,8} = 12.6, P <0.002
<i>p</i> -cymene	8.7 \pm 0.6 CD b	9.3 \pm 3.5 CDEFG b	21.3 \pm 1.3 B a	0 \pm 0 B c	F _{3,8} = 9.9, P <0.005
Cuminaldehyde	100 \pm 0 A a	5.3 \pm 1.3 DEFG b	10.7 \pm 3.5 BCD b	0 \pm 0 B c	F _{3,8} = 137.9, P <0.0001
Linalool	8.7 \pm 1.7 CD a	6.7 \pm 1.3 EFG a	9.2 \pm 4.7 CD a	2.7 \pm 1.33 B a	F _{3,8} = 24.9, P <0.0001
β -pinene	12 \pm 1.1 BC a	4 \pm 2.3 C b	13.3 \pm 2.6 BCD a	0 \pm 0 B c	F _{3,8} = 5.2, P <0.027
Eugenol	13.3 \pm 1.7 BC a	18.7 \pm 2.6 CDEF a	22.7 \pm 3.5 B a	2.7 \pm 2.6 B b	F _{3,8} = 17.6, P <0.001
α -terpine	16.7 \pm 0.6 B a	11.5 \pm 3.5 DEFG a	14.7 \pm 4.8 BCD a	0 \pm 0 B b	F _{3,8} = 2.3, P=0.152
Linalyl acetate	7.3 \pm 2.9 DE a	8 \pm 4.6 B a	17.6 \pm 2.8 BC a	4 \pm 2.3 B a	F _{3,8} = 7.5, P < 0.01
Diallyl disulphide	100 \pm 0 A a	81.3 \pm 1.3 B b	100 \pm 0 A a	100 \pm 0 A a	F _{3,8} = 4.0, P= 0.05
Allyl isothiocyanate	100 \pm 0 A a	100 \pm 0 A a	100 \pm 0 A a	100 \pm 0 A a	-----**
γ -terpinen	6.7 \pm 0.6 DE ab	16 \pm 2.3 CD a	12 \pm 2.3 BCD a	2.7 \pm 2.6 B b	F _{3,8} = 4.9, P < 0.031
Limonene	10.7 \pm 0.6 CD a	13.3 \pm 4.8 CDE a	8 \pm 2.3 CD a	4 \pm 2.3 B a	F _{3,8} = 1.0, P=0.433
Control	4 \pm 1.15 E a	2.7 \pm 2.6 G ab	5.3 \pm 1.3 D a	0 \pm 0 B b	F _{3,8} = 2.1, P= 0.16
F ve P value	F _{12,26} =462.49 P < 0.0001	F _{12,26} =45.10 P < 0.0001	F _{12,26} =71.04 P < 0.0001	F _{12,26} =113.99 P < 0.0001	

* Two-way ANOVA was applied to the data., Means within a row with the same lower-case letter and a column with the same uppercase letter do not differ significantly (Duncan test at 5% level). **: F value didn't calculate because of Allyl isothiocyanate showed high toxicity.

Table 2. Percent mortality of *Tribolium confusum* eggs, larvae, pupae and adults exposed to 100 $\mu\text{l l}^{-1}$ concentration of tested monoterpenoid compounds for 24 h at 25°C.

Compounds	Mortality (%) \pm S.E.				F and P value
	Egg	Larva	Pupa	Adult	
α -pinene	17.3 \pm 4.6 BCD a* 5.4 \pm 1.3 CDE b	21.7 \pm 3.9 BC a	1.3 \pm 1.3 B b	F _{3,8} = 12.6, P <0.002	
<i>p</i> -cymene	12 \pm 1.1 CD a	6.8 \pm 1.3 CDE bc	9.5 \pm 1.5 DEF ab	4 \pm 0 B c	F _{3,8} = 9.9, P <0.005
Cuminaldehyde	100 \pm 0 A a	4.2 \pm 2.4 E b	6.7 \pm 2.6 EF b	1.3 \pm 1.3 B b	F _{3,8} = 137.9, P <0.0001
Linalool	27.3 \pm 1.7 B a	5.7 \pm 1.3 CDE b	4.1 \pm 2.3 F b	0 \pm 0 B c	F _{3,8} = 24.9, P <0.0001
β -pinene	14.7 \pm 2.8 CD a	5.3 \pm 2.6 DE bc	9.8 \pm 1.1 DEF a	1.3 \pm 1.3 B b	F _{3,8} = 5.2, P <0.027
Eugenol	16.7 \pm 3.5 BC a	18.7 \pm 3.5 C a	24 \pm 2.3 B a	0 \pm 0 B b	F _{3,8} = 17.6, P <0.001
α -terpine	15.3 \pm 3.7 CD a	14.1 \pm 1.6 CD a	17.3 \pm 5.8 BCD a	5.3 \pm 3.5 B a	F _{3,8} = 2.3, P=0.152
Linalyl acetate	16 \pm 4.1 CD ab	5.5 \pm 1.4 CDE bc	21.8 \pm 3.9 BC a	2.7 \pm 2.6 B c	F _{3,8} = 7.5, P < 0.01
Diallyl disulphide	100 \pm 0 A a	92 \pm 4 B b	100 \pm 0 A a	100 \pm 0 A a	F _{3,8} = 4.0, P= 0.05
Allyl isothiocyanate	100 \pm 0 A a	100 \pm 0 A a	100 \pm 0 A a	100 \pm 0 A a	-----**
γ -terpinen	8.7 \pm 1.3 DE bc	17.3 \pm 4.8 C a	12 \pm 2.3 CDE a	2.7 \pm 2.6 B b	F _{3,8} = 4.9, P < 0.031
Limonene	9.3 \pm 3.5 DE a	17.3 \pm 4.8 CD a	9.3 \pm 1.3 DEF a	8 \pm 4 B a	F _{3,8} = 1.0, P=0.433
Control	2.7 \pm 0.66 E a	1.4 \pm 1.4 E a	0 \pm 0 G a	2.7 \pm 1.3 B a	F _{3,8} = 2.1, P= 0.16
F ve P value	F _{12,26} =133.03 P < 0.0001	F _{12,26} =51.87 P < 0.0001	F _{12,26} =129.31 P < 0.0001	F _{12,26} =68.51 P < 0.0001	

* Two-way ANOVA was applied to the data., Means within a row with the same lower-case letter and a column with the same uppercase letter do not differ significantly (Duncan test at 5% level). **: F value didn't calculate because of Allyl isothiocyanate showed high toxicity.

Table 3. Percent mortality of *Tribolium confusum* eggs, larvae, pupae and adults exposed to 100 $\mu\text{l l}^{-1}$ concentration of tested monoterpenoid compounds for 24 h at 30°C.

Compounds	Mortality (%) \pm S.E.				F and P value
	Egg	Larva	Pupa	Adult	
α -pinene	9.3 \pm 0.66 BC ab	25.3 \pm 4.80 B a	24 \pm 2.3 BC a	4 \pm 4 B b	F _{3,8} =6.47 P< 0.016
p- cymene	16 \pm 4.61 B a	22.7 \pm 3.52 B a	22.7 \pm 2.66 C a	1.3 \pm 1.33 B b	F _{3,8} =14.22 P< 0.001
Cuminaldehyde	100 \pm 0 A a	21.3 \pm 2.66 B b	28 \pm 6.11 BC b	2.7 \pm 1.33 B c	F _{3,8} =86.53 P< 0.0001
Linalool	15.3 \pm 0.66 B a	17.3 \pm 1.33 B a	24 \pm 4.61 BC a	2.7 \pm 2.66 B b	F _{3,8} =10.47 P< 0.004
β -pinene	6.7 \pm 3.52 CD cd	20 \pm 2.30 B ab	34.7 \pm 3.52 B a	5.3 \pm 5.33 B c	F _{3,8} =6.24 P< 0.017
Eugenol	17.3 \pm 2.9 B a	24 \pm 4 B a	21.3 \pm 1.33 C a	0 \pm 0 B b	F _{3,8} =54.48 P< 0.0001
α -terpine	14.7 \pm 2.9 B ab	20 \pm 4 B a	25.3 \pm 3.52 BC a	5.3 \pm 1.33 B b	F _{3,8} =6.58 P< 0.015
Linaly acetate	10 \pm 3.05 BC ab	17.3 \pm 1.33 B b	22.7 \pm 3.52 C b	0 \pm 0 B b	F _{3,8} =4.90 P< 0.032
Diallyl disulphide	100 \pm 0 A a	100 \pm 0 A a	100 \pm 0 A a	100 \pm 0 A a	---**
Allyl isothiocyanate	100 \pm 0 A a	100 \pm 0 A a	100 \pm 0 A a	100 \pm 0 A a	---**
γ - terpinen	8.7 \pm 1.7 BC b	25.3 \pm 2.66 B a	25.3 \pm 3.52 BC a	6.7 \pm 4.8 B b	F _{3,8} =6.05 P< 0.019
Limonene	11.3 \pm 0.66 BC b	24 \pm 2.3 B a	25.3 \pm 4.80 BC a	2.7 \pm 1.33 B c	F _{3,8} =15.34 P< 0.001
Control	2 \pm 1.15 D b	6.7 \pm 1.33 C a	6.7 \pm 1.33 D a	0 \pm 0 B b	F _{3,8} =12.07 P< 0.002
F ve P value	F _{12,26} =146.42 P< 0.0001	F _{12,26} =89.54 P< 0.0001	F _{12,26} =108.87 P< 0.0001	F _{12,26} =49.41 P< 0.0001	

* Two-way ANOVA was applied to the data. Means within a row with the same lower-case letter and a column with the same uppercase letter do not differ significantly (Duncan test at 5% level). **: F value didn't calculate because of Allyl isothiocyanate showed high toxicity.

According to results of single-dose biological tests, cuminaldehyde, allyl isothiocyanate and diallyl disulphide resulted in 100% mortality of *T. confusum* life stages. And toxicity levels of essential oil components were increased with higher temperature levels. Huang et al. (2000) reported that main components of garlic oil, diallyl trisulphide, diallyl di sulphide ve metil allyl tris sulphide, had high fumigant toxicity on *Tribolium castaneum* (Herbst) and *Sitophilus zeamais* Motschulsky and can be considered as potential alternative fumigant for controlling stored product insects. According to some researcher already decribed that Diallyl disulfid and Allyl isothiocyanate components showed high toxicity life stages of *T. confusum* and *T. castaneum* (Gözek 2007, Karcı 2006, Wu et al. 2009, Işıkber et al. 2009).

The results of probit analysis (LC₅₀ and LC₉₀ values ($\mu\text{l l}^{-1}$)) for all biological stages of *T. confusum* exposed to various concentrations of cuminaldehyde (only egg stage), allyl isothiocyanate and diallyl disulphide for 24-h at three different temperatures are given in Table 4.

Table 4. Probit analysis data of garlic essential oil, its main compounds and their mixture for *Tribolium confusum* eggs, larvae, pupae and adults following 24-h laboratory fumigation at 3 different temperatures.

Life stage		Compounds	N ^a	Slope ^b ± S.E.	LC ₅₀ (µl l ⁻¹) (Fiducial limit) ^c	LC ₉₀ (µl l ⁻¹) (Fiducial limit) ^c	χ ² ^d
Egg	20 °C	Cuminaldehyde	900	2.47 ± 0.18	1.41 (1.19 – 1.62)	4.64 (4.0 – 5.53)	15.07
		Allyl isothiocyanate ^e	450	----	----	----	---
		Diallyl disulfid	750	5.33 ± 0.25	0.41 (0.37 – 0.44)	0.72 (0.64 – 0.80)	8.05
	25 °C	Cuminaldehyde	1350	2.78 ± 0.16	0.72 (0.64-0.80)	2.08 (1.82-2.44)	30.70
		Allyl isothiocyanate ^e	750	---	---	---	---
		Diallyl disulfid	900	4.04 ± 0.33	0.35 (0.31-0.40)	0.74 (0.65-0.89)	21.62
	30 °C	Cuminaldehyde	1050	2.67 ± 0.17	0.58 (0.5 - 0.67)	1.76 (1.50 - 2.16)	28.85
		Allyl isothiocyanate ^e	750	---	---	---	---
		Diallyl disulfid	900	5.39 ± 0.52	0.31 (0.29 - 0.34)	0.54 (0.49 - 0.62)	4.37
Larva	20 °C	Allyl isothiocyanate	516	2.46 ± 0.18	3.42 (2.51 – 4.61)	11.33 (7.75 – 21.52)	76.2
		Diallyl disulfide	597	2.08 ± 0.15	26.5 (23.03 – 30.21)	109.29 (90.18 – 139.04)	14.59
	25 °C	Allyl isothiocyanate	372	6.45 ± 0.83	3.79 (3.37-4.17)	5.99 (5.34-7.16)	14.63
		Diallyl disulfid	675	2.13 ± 0.27	24.64 (17.70- 30.95)	98.06 (79.84-130.28)	22.92
	30 °C	Allyl isothiocyanate	359	7.70 ± 1.35	2.96 (2.59 - 3.24)	4.35 (3.96 - 5.06)	12.42
		Diallyl disulfid	594	1.71 ± 0.18	19.27 (12.87 - 25.71)	108.17 (77.14 - 182.43)	34.29
Pupa	20 °C	Allyl isothiocyanate	447	2.73 ± 0.39	1.67 (0.83 – 2.31)	4.92 (3.63 – 8.84)	40.09
		Diallyl disulfid	448	3.07 ± 0.26	17.76 (14.98 – 20.62)	46.41 (38.48 – 59.9)	21.52
	25 °C	Allyl isothiocyanate	525	2.76 ± 0.25	0.92 (0.70- 1.14)	2.69 (2.19- 3.53)	30.95
		Diallyl disulfid	525	2.76 ± 0.26	14.56 (11.72 – 17.49)	42.26 (34.29-55.72)	21.34
	30 °C	Allyl isothiocyanate	519	2.79 ± 0.33	0.98 (0.52 - 1.33)	2.84 (2.09 - 5.44)	73.36
		Diallyl disulfid	520	2.60 ± 0.28	10.37 (8.2 - 12.43)	31.47 (26.48 - 39.14)	16.92
Adult	20 °C	Allyl isothiocyanate	450	7.25 ± 0.6	2.41 (1.97 – 2.78)	3.62 (3.11 – 4.72)	86.31
		Diallyl disulfid	599	2.59 ± 0.2	17.52 (15.15 – 20.10)	54.54 (45.2 – 69.44)	23.16
	25 °C	Allyl isothiocyanate	600	6.38 ± 0.44	2.20 (2.03 - 2.37)	3.50 (3.19 - 3.93)	36.99
		Diallyl disulfid	525	2.54 ± 0.17	14.90 (11.66 - 19.04)	47.57 (34.81 - 74.66)	49.65
	30 °C	Allyl isothiocyanate	599	7.58 ± 0.56	2.13 (1.91 - 2.36)	3.15 (2.78 - 3.85)	89.58
		Diallyl disulfid	598	4.15 ± 0.46	15,18 (13.08 - 17.11)	30.89 (26.44 - 39.24)	29.64

^a: Number treated, excluding controls, ^b: Slopes are non-parallel and unequal where noted,

^c: Value in parentheses refers to the 95% confidence range, ^d: Chi-square,

^e: Calculated LC₅₀ ve LC₉₀ values were found to be far beyond tested application dose ranges

It appears that allyl isothiocyanate was the most toxic to *T. confusum* eggs, followed by diallyl disulphide and cuminaldehyde respectively. LC₉₀ values for allyl isothiocyanate against larva, pupa and adult stages of *T. confusum* were significantly lower than those for diallyl disulphide, since 95 % confidence intervals (CLs) of allyl isothiocyanate did not overlap those for diallyl disulphide. Therefore, allyl isothiocyanate was more toxic to *T. confusum* larvae, pupae and adults at three different temperature conditions.

Conclusion

The results obtained from this study indicated that the toxicity of the most effective compounds (Cuminaldehyde, Allyl isothiocyanate ve Diallyl disulphide) to different biological stages of both species increased with increasing temperature. In conclusion, it was found that Allyl isothiocyanate would be a potential compound in controlling stored-product insects, since it had high toxicity to all biological stages of *T.confusum*.

Acknowledgements

This study was part of the PhD thesis of first author and also supported by TUBİTAK (108O596) and Namık Kemal University research grant (NKÜBAP00.24.DR.08.03).

References

- Abbott, W.S. (1925). A method for computing the effectiveness of an insecticide. *Journal of Economical Entomology*, 18: 265-267.
- Collins, P.J., G.J. Darglish, H. Pavic, T.M. Lambkin, Kapittke R. (2002). Combating strong resistance to phosphine in stored grain pests in Australia. *Proceedings of the Australian Postharvest Technical Conference On Stored Grain in Australia, 2000 Aug 1-4 CSIRO Canberra, Australia*, pp.109-112.
- Donahaye, E. (1990). Laboratory selection for resistance by the red flour beetle *Tribolium castaneum* (Herbst) to an atmosphere of low oxygen concentration. *Phytoparasitica*, 18: 189-202.
- Greenspan, L. (1977). Humidity fixed points of binary saturated aqueous solutions. *Journal of Research of the National Institute of Standards and Technology*, 8: 89-96.
- Gözek, N. (2007). Fumigant Toxicity of Garlic and Onion Essential Oils and their Active Components Against Life Stages of Confused Flour Beetle, *Tribolium confusum* du Val. Master Thesis. University of Kahramanmaraş Sütçü Imam Institute of Natural and Applied Sciences, Department of Plant Protection, 46 pp. (Only Abstract in English)
- Harwood, S.H., A.F. Modenke, Berry R.E. (1990). Toxicity of peppermint monoterpenes to the variegated cutworm (Lepidoptera: Noctuidae). *Journal of Economic Entomology*, 83: 1761-1767.
- Huang, Y., S.X. Chen, Ho S.H. (2000). Bioactivities of methyl allyl disulfide and diallyl trisulfide from essential oil of garlic to two species of stored-product pests *Sitophilus zeamais* (Col: Curculionidae) and *Tribolium castaneum* (Col: Tenebrionidae). *Journal of Economic Entomology*, 93: 537-543.
- Isman, M.B. (2006). Botanical insecticides deterrents and repellents in modern agriculture and an increasingly regulated world. *Annual Review of Entomology*, 51:45-66.
- Işıkber, A.A., Özder N., Sağlam Ö. (2009). Susceptibility of eggs of *Tribolium confusum*, *Ephestia kuehniella* and *Plodia interpunctella* to four essential oil vapors. *Phytoparasitica*, 37:231-239.

- Karacı, A. (2006). Fumigant Toxicity of Some Plant Derived essential Oils against all Life Stages of Confused Flour Beetle, *Tribolium Confusum* Duval, (Col.: Tenebrionidae). Master Thesis. University of Kahramanmaraş Sütçü Imam Institute of Natural and Applied Sciences, Department of Plant Protection, 45 pp. (Only Abstract in English).
- Karr, L.L., Coast J.R. (1988). Insecticidal properties of d-limonene. *Journal of Pesticide Science*, 13: 287-290.
- Kim, D.H. Ahn Y.J. (2001). Contact and fumigant activities of constituents of *Foeniculum vulgare* fruit against three coleopteran stored-product insects. *Pest Management Science*, 57: 301-306.
- Lee, S., C.J. Peterson, Coats J.R. (2003). Fumigation toxicity of monoterpenoids to several stored product insects. *Journal of Stored Product Research*, 39: 77-85.
- LeOra Software., 1987. POLO-PC: A Users' Guide to Probit or Logit Analysis. LeOra Software, Berkeley, CA.
- Opit, G.P., Phillips, T.W., Aikins, M.J., Hasan, M.M. (2012). Phosphine resistance in *Tribolium castaneum* and *Rhyzopertha dominica* from Stored wheat in Oklahoma. *Journal of Economic Entomology*, 105: 1107-1114.
- Plarre, R., Reichmuth, C. (1997). Toxic effects of carbonyl sulfide (COS) on *Sitophilus granarius* (L.) (Coleoptera: Curculionidae), *Fusarium culmorum* and *Fusarium avenaceum* (Saac.) (Deuteromycetina: Hypomycetes), and corrosion on copper. Proceedings of International Conference on Controlled Atmosphere and Fumigation in Stored Products, 21-26 April 1996, Nicosia Cyprus. Caspit, Jerusalem.
- Regnault- Roger, Hamraoui C. A. (1995). Fumigant toxic activity and reproductive inhibition induced by monoterpenes on *Acanthoscelides obtectus* (Say) (Coleoptera) a bruchid of kidney bean (*Phaseolus vulgaris* L). *Journal of Stored Product Research*, 31: 291-299.
- Ren, Y.L., D. Mahona, J.V.S. Gravera, Head M. (2008). Fumigation trial on direct application of liquid carbonyl sulphide to wheat in a 2500 t concrete silo. *Journal of Stored Product Research*, 44: 115-125.
- Rice, P.J., Coats, J.R. (1994). Insecticidal properties of several monoterpenoids to the housefly (Diptera: Muscidae), red flour beetle (Coleoptera: Tenebrionidae) and Southern corn rootworm (Coleoptera: Chrysomelidae). *Journal of Economic Entomology*, 87: 1172-1179.
- Saglam, Ö., Özder N. (2013). Fumigant toxicity of monoterpenoid compounds against the confused flour beetle, *Tribolium confusum* Jacquelin du Val. (Coleoptera: Tenebrionidae). *Turkish Journal of Entomology*, 37 (4), 457-466.
- Saglam, O., Edde P.A., Phillips T.W. (2015). Resistance of *Lasioderma serricornis* (Coleoptera: Anobiidae) to fumigation with Phosphine. *Journal of Economic Entomology*, 108 (5): 2489-2495.
- Shaaya, E., Ravid, U., Paster, N., Juven, B., Zisman, U., Pizarrev, V. (1991). Fumigant toxicity of essential oils against four major stored-product insects. *Journal of Chemical Ecology*, 17: 499-504.
- Shaaya, E., Kostjukovski, M., Eilberg, J., Sukprakarn, C. (1997). Plant oils as fumigants and contact insecticides for the control of stored-product insects. *Journal of Stored Products Research*, 33: 7-15.
- SPSS, (2009). SPSS Statistics 17 Data Analysis with Comprehensive Statistics Software, BrotherSoft, WA, USA.
- Tsao, R., Lee S., Rice P.J., Jensen C., Coats J.R. (1995). Monoterpenoids and their synthetic derivatives as leads for new insect control agents. In: Baker DR, Fenyes JG, Basarab GS (eds.)

Synthesis and Chemistry of Agrochemicals IV American Chemical Society, Washington, pp. 312-324.

Tunç, İ., Berger, B.M, Erler, F., Dağlı, F. (2000). Ovicidal activity of essential oils from five plants against two stored-product insects. *Journal of Stored Products Research*, 36: 161-168.

STUDY OF LEVEL FLUCTUATIONS OF THAUMETOPOEA PITYOCAMPA AND A BIOLOGICAL CONTROL TEST

Fatima Zohra BISSAAD^{1*}, Farid BOUNACEUR²

¹Laboratory Technologies Soft, Promotion, Physical Chemistry of Biological Materials and Biodiversity, Science Faculty, University M'Hamed Bougara, BP 35000 Boumerdes, Algeria.

²Laboratory of Agrobiotechnology and nutrition in semi-arid areas, Faculty of Agricultural and Veterinary Sciences, University Ibn Khaldoun Tiaret, Algeria.

*Corresponding author: bissaad@yahoo.com

Abstract

This study was performed in the national forest of Nador (Tiaret west of Algeria) on the population of pine processionary moth *Thaumetopoea pityocampa* Schiff.-. It highlighted infection rates by this pest because it varied greatly from one locality to another. It depends on several factors, among others, the forest structure and exposure. Three plots were established with an area of 1 are for each. They were exposed to different altitudes ranging from 1050m to the EzZeg station and 1250m of Chemekh station and 1150 m from the Hassi El Hadjel station. The emergence began on August 7 and was conducted over one month; egg laying began in late August to early September. Embryonal period lasted 30 to 45 days, the hatching occurred during the first decade of October. The damage to leaves increase with larval growth. The caterpillars of the 4th and 5th instars are the most dangerous and cause more damage. The last instar larvae leave their nest, following each other in long, head to tail processions to the end of March and seek out pupation sites in the soil in early of April. A biological control test by application of *Bacillus thuringiensis* in the field seems to be promising, because recorded larval mortality exceeded 32%. In the El Hassi Hadjel station, the weight of live caterpillars is 0.15g, while for dead caterpillars is 0.1g. While the measures of the lengths of live and dead caterpillars is almost the same is 2.3cm. However, in the station Chemekh it was noticed a difference in weight between live and dead caterpillars (0.5g to 0.1g for live larvae and dead larvae, respectively) and a variation between the measurement lengths of dead and live caterpillars which is 2.7cm to 2.4cm respectively.

Keywords: pine processionary, *Thaumetopoea pityocampa*, development cycle, Nador forest, *Bacillus thuringiensis*.

Introduction

Algerian forest covers an area of 4.1 million hectares preserved through afforestation. Plantation development caused increasingly attacked populations of insect pest species that can cause extensive damage when the population is not controlled (Maatoug 1992). Our forest still suffers from the same problems this is not only due to the absence of scientific studies and forestry research but the uncontrollable development of the Pests. Forestry area planted by Aleppo pine in our country each year suffer particularly severe attacks of insect pests including from the pine processionary *Thaumetopoea pityocampa*.

Therefore, a study of development cycle of this pest either in the field or laboratory conditions, allows to identify the conditions that favors development (Mezali, 2003). So, a better

understanding of a pest such as the pine processionary moth *T.pityocampa*, is essential for the implementation of a rational and effective control (Maatoug 1992).

Our study has focused on the development cycle of the pine processionary of Aleppo pine forest in Nador. Also, a biological control test using *Bacillus thuringiensis* was performed.

Material and methods

1. Sampling

1.1 Sample Selection

Systematic sampling is recommended in such cases. The inventory method in the truest straight line possible is that of straight transect of studying the environment, not on a given surface, but in a straight line (Rondeux, 1999).

1.2 Stations Study

Our study area is located in region of Tiaret; This allowed us to choose three experimental plots which differ in the exposure. We have chosen the following stations:

Plot 1: EzZeg with an area 700 ha, is characterized by a stand of Aleppo pine, whose average height is 2 m. This station in a Northern exposure, and 1,050 m of altitude.

Plot 2 : Chemekh with 1250ha area, it is composed of stand Nature reforestation of Aleppo pine, with an average height of 2.20 meters it is a East exposure and 1250 m altitude.

Plot 3: "Hassi Hadjel" composed of an Aleppo pine with an average height of 2.20 m. This resort to a South exhibition, located on flat land, the little rocky soil and 1150 m altitude.

1.3 Sampling Technique

The experiment lasted one year ((July 2010 à July 2011) in order to complete the development cycle of the insect. Sampling each development stage was performed 2-4 times per month. The samples were taken randomly. The each plots consisted of then trees for each station.

2. Observations of insect development cycle

2.1. Emergence of adults

Adult were caught using by pheromone trap composed of a plastic bag, a circular plate contains a sticky material and the capsule with pheromone to capture male. We have placed four traps per plot with aim to determine number of adults and duration of the flight period.

2.2. Egg laying

Egg hatching were observed simultaneously in the laboratory at the temperature $24\pm 2^{\circ}\text{C}$ and relative humidity $70\pm 4\%$ in the field. The Monitoring of hatching eggs was conducted between 26 September and 18 October. For this, a significant number of eggs was taken different plots.

2.3. Distribution of eggs on trees

The daily observation of laying eggs gave us the frequency curve of F. R. outbreaks (first hatched larvae for each egg). The distribution for average $x = 13.40$ (August 20) and standard deviation = 4.67. Note that we have grouped the data from classes 3 days for the calculation of the theoretical frequency (F.T.) (Demolin and Millet, 1981).

2.4. Larval hatching

From daily observation of egg laying, both in the field and in laboratory, we obtained the results of larval hatching taken from the station EzZeg. The egg mass were taken for ten trees.

2.5. Larval development

To determine the larval development period, track samples from the beginning of their hatching until their departure in procession were performed. Nests were taken randomly from each tree with pruning shears. Tweezers and a scalpel were used to open the nests and scale to weigh the samples.

3. Microbiological control against caterpillar

To assess the effectiveness of the biological control on field, was used for our experimentation, Chemekh plot and Hassi el Hadjel plot. Each plots consists of four small plots containing 3 trees. The first 3 plots are treated with the bacteria (*Bacillus thuringiensis*) while the fourth plot is treated with distilled water. After treatment that was performed on 19/01/2011), sampling was done on 27/01/2011. In each plot, we removed the nests each nest, count the number of dead larvae and the number of live larvae and makes length measurements and weight of larvae living and dead.

Mortality rate (%) = the number of dead larvae / total number of larvae x 100

4. Statistical Analysis

The results were reported as mean \pm standard deviation and compared by two-way ANOVA test (XL STAT software 6.0 -. ANOVA- of 95% confidence interval). The differences between averages are studied using the Newman-Keuls test and were considered significant at probability <0.05.

Results

1. Spatio-temporal dynamics of *T. pityocampa*

1.1 Dynamics of adult male *T. pityocampa* by pheromone by traps

There were significant differences ($p < 0,05$) of the population dynamics depending on the period. It appears that from August 7 to 31, the number of captured adult males is low at the beginning of August, and then begins to increase for decline at the end of this month. The peaks of emergence of adults males was in the middle of August, we have catch maximum from the beginning of August the emergence station for Hassi El Hadjel. The emergence of adults males, used to determinate the exact date that presents 50% of emergencies.

The emergence of butterflies, allow us to determine the precise date that presents 50% of emergencies. From that date, we can have an idea about the different period, larval stages of the pine processionary, knowing that the incubation period is 30 to 45 days (Figure 1).

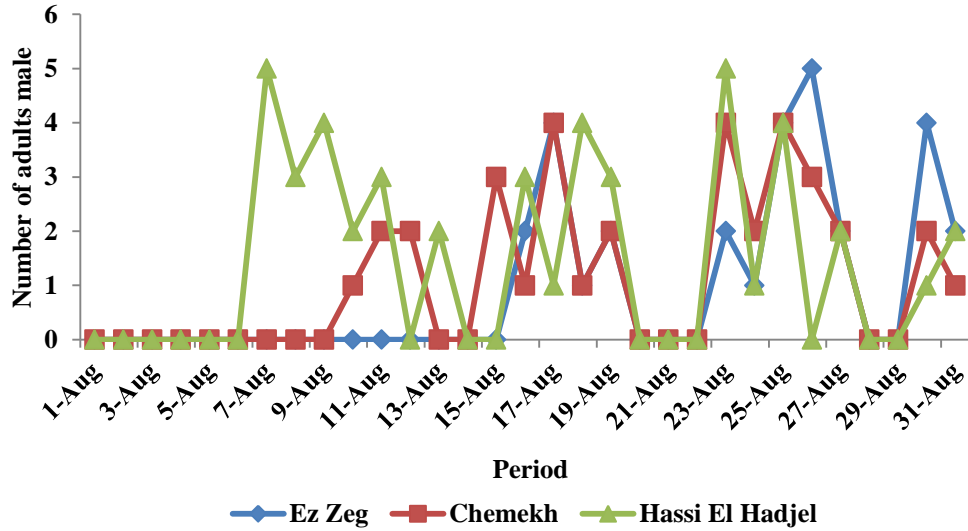

Figure 1: Number of male adults captured by pheromone traps

1.2 Distribution of eggs on trees

The analysis of results obtained on the distribution of layings on trees, shows that most layings are not deposited in a regular and similarly on the trees is especially trees, whose height is 1 to 2m and which are most sought after by processionary for issuing eggs. Indeed, it is at this height, that there is the largest percentage of the presence of laying on trees. Trees from 0 to 1m heights, are less affected (figure 2).

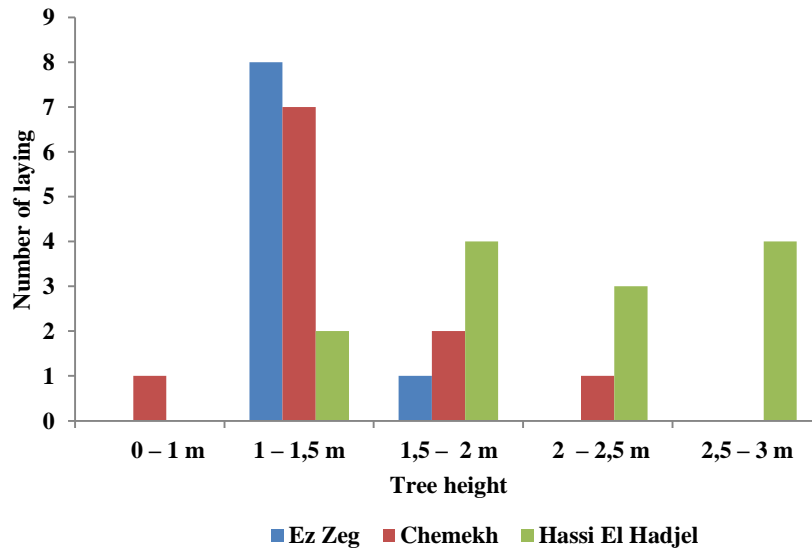

Figure 2: Distribution of eggs *T. pityocampa* according to the tree height

1.3 Hatching of eggs in the laboratory

Hatching of eggs laying in laboratory have started on 2 October 2011. The latest hatching were recorded 18 October 2011. Thus, the mean date of laboratory eggs hatching is recorded between

3 and 19 October for the pundits EzZeg plot, the incubation period of the eggs is from 16 to 25 days.

The hatching of eggs curve observed in the laboratory, Hatching are especially early (2 to 18 October), and it extends over the longest. From Figure 3 of hatching clutches, we can determine the date can be considered treatment.

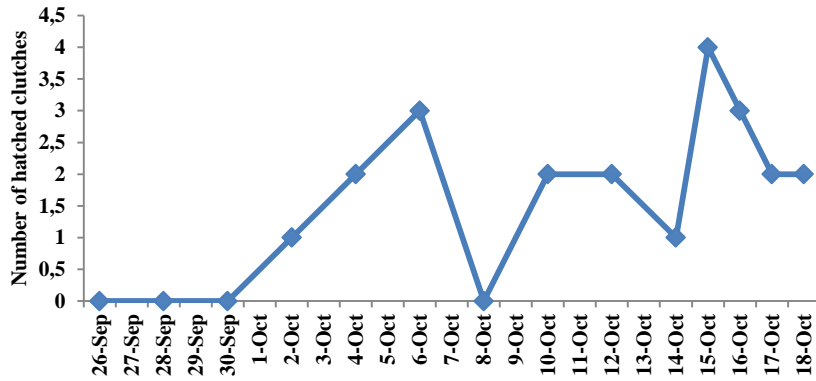

Figure 3: Number of hatched clutches in Ez Zeg station

1.3. Dynamics of numbers of nests of *T.pityocampa*

The number of nests is influenced by plots. Most nests were not deposited in a regular and identically in stations. Indeed, a high distribution of nests was obtained in the most infested Chemekh station where the number was between 3-8 nests per tree. By cons, in other stations EzZeg and Hassi El Hadjel we observe the number of nests are between 0-2 respectively for the first station and between 1-4 nests per tree to the second station (figure 4).

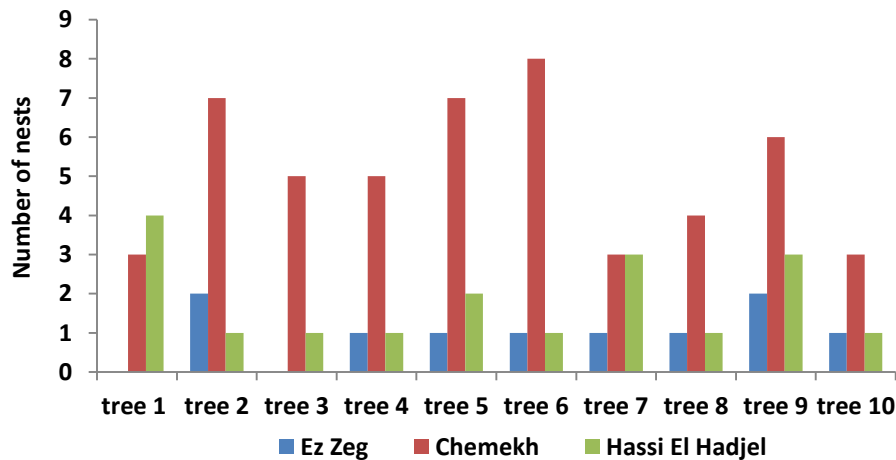

Figure 4: Number of nests in the three study sites

1.4. Dynamics of larval stages of *T.pityocampa*

The beginning of egg hatching were determined directly from the clutches previously taken and kept in the laboratory. The first larvae were observed on 26/09/2010 in Chemekh station, on 29/09/2010 in El Hassi El Hadjel station, and the station Ez 02/10/2010 Zeg. The larval period is dependent on the overwintering period, the average time to development of the larvae, varies from one site to another. Thus, this time in the three plots is 14 days for the 1st instar larvae, 17

days for 2nd instar larvae, L3 of 31 days for 3rd instar larvae, 82 days for the 4th instar larvae, and 55 days for the 5th instar larvae. It was found that the first two instars have a shorter development period. By cons, for the 4th instar larvae, we see a longer development period. There is also an overlap between the different larval stages (Figure 5).

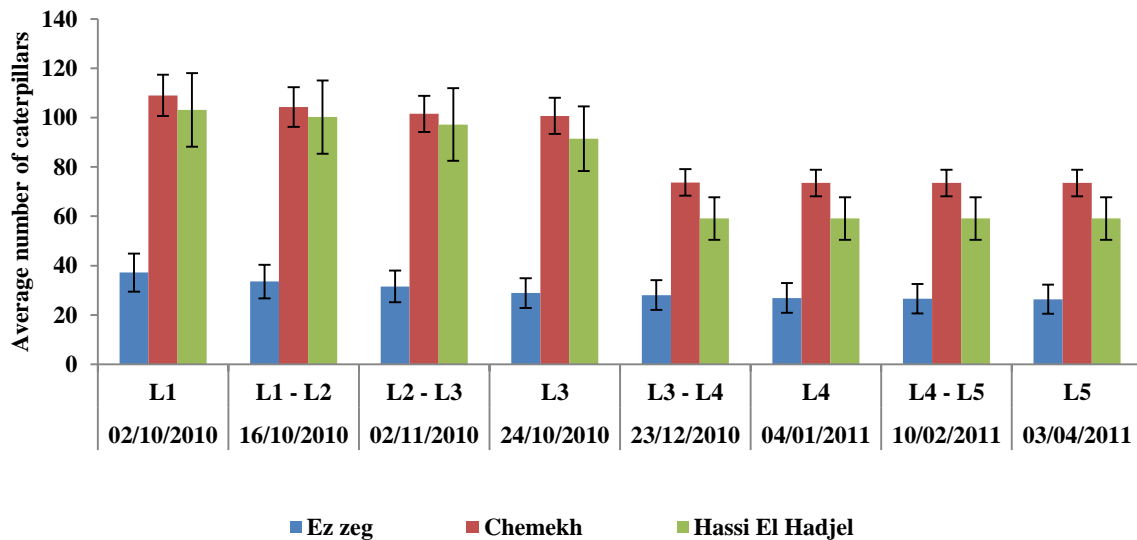

Figure 5: Population dynamics of the different stages of the larvae of *T. pityocampa* in the three plots (EzZeg, Chemekh, Hassi El Hadjel).

2. *Bacillus thuringiensis* effect on mortality of the *T. pityocampa*

2.1. Effect on mortality

The results from different samples showed very low mortality (23.5% dead larvae/nest to Chemekh plot, and 39% dead larvae/nest in Hassi El Hadjel plot). So that the number of live larvae are (73.5% larvae/nest for Chemekh plot and 51.9% larvae/nest for Hassi El Hadjel plot) (Figure 6).

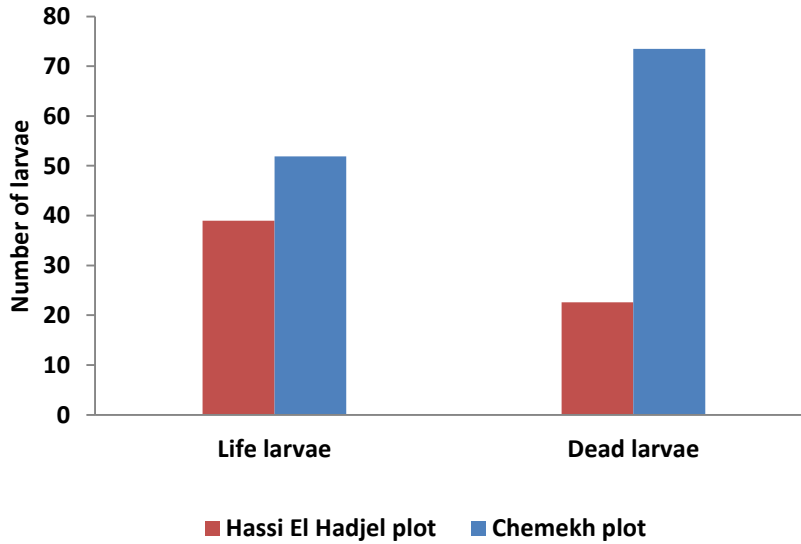

Figure 6: Mortality of larvae of *T.pityocampa* after biological treatment with *Bacillus thuringiensis* at stations Hassi El Hadjel and Chemekh.

2.2. Biometrics treated larvae

In the El HassiHadjel station the weight of live larvae is 0.15 g, while for dead caterpillars is 0.1g. However, By cons, the measurement of the lengths of live and dead caterpillars is almost identical is 2,3cm. But in the station Chemekh we noticed a clear difference in weight between the live and the dead caterpillars (0.5g to 0.1g for live caterpillars and dead caterpillar, respectively) and a variation between the measurement of the lengths of live and dead caterpillars followed respectively 2,7cm to 2,4cm respectively (Figure 7).

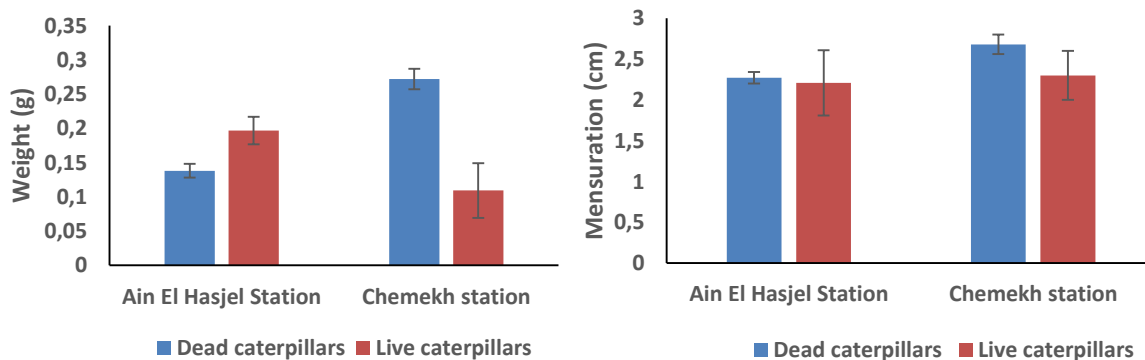

Figure 7: Effect of *Bacillus thuringiensis* on some weight and biometric parameters on track of *T.pityocampa* at Hassi El Hadjel and Chemekh plots).

Discussion

The population dynamics of *T.piyocampa* was studied during the period from July 2010 to July 2011 on the pine forest of Nador (Tiaret). The dynamics of male adult population using pheromone traps started from August in 2010 to 3 plots.

For Hassi el Hadjel plot, the first flight of the adult males was reported during the first decade of August. However, at the Chemekh plot it was recorded from the 10th of this month with a delay of 3 days compared to the first plot.

However, to the station EzZeg, the first flight was reported from 16 August, 9 days from the first station. Indeed, a cumulative of 45 males was recorded for the first station, while it is around 34 and 29 males for Chemekh and EzZeg stations.

The laying distribution of dynamic appears also vary from significantly between stations ($p = 0.000$). It is much more important in the station of Chemekh compared to the other two stations,. This is due to the forest stand that result is much more dense and abundant. Our data appear to be comparable to Zamoum *et al.* (2006) Tortricidae, They found that during spawning, the female may have to encounter in the wild more of its plants hosts "pine and cedar," one after the other. It probably compares sequentially involving a form of short-term memory (Singer, 1986; Courtney *et al.*, 1989).

Many authors (Wiklund, 1981; Thompson & Pellmry, 1991; Singer & Lee, 2000) considers that a preference for hierarchical laying between the various species composing the host range of an insect. It appears that under ideal conditions, many eggs were laid on the preferred species, and fewer eggs on the less preferred species, even fewer eggs on species that occupy a lower rank of preference. Theoretically, this preference laying should be correlated with the performance of the offspring on different host plants. However, in practice this is not always the case (Thompson, 1988; Degen *et al.*, 1999; Cunningham *et al.*, 2001).

Maher (1997), as part of a study on laying the choice of behavior *Lobesia botrana*, was able to establish a range of preferences between the bays of different plants, it also showed that the sensory equipment of the female eudemis has sensory receptors that mediate the role of tasting and mechanoreception in the choice of nesting site in this insect.

In this study it seems to us clearly that there is a difference between the plots studied. So they can be considered as a key criterion for selecting the nesting site. In this context, several hypotheses can be discussed. We can suggest that the increase in infestations of this resort is the result of two complementary attitudes: either the insect estimates the size of the needles, and other abiotic parameters (Zamoum, 1998). These two behaviors reflected that spawning is performed to reduce the competition between future larvae by spreading it according to the biotic and abiotic characteristics.

The review of the number of nests shows that it is relatively high at the Chemekh plot compared to the two other plots where we have counted 58 nests, whereas that of el Hadjel El Hadjel and Ez Zeg are respectively 28 and 18 nests (Demolin 1969 &1988).

The examination of the observed mortality appears to be relatively small compared to the desired results,. This is probably due to the leaching of the biopesticide by rain water that occurred the day of treatment, or the applied dose.

This new possibility of action on the 3rd and 4th instars larvae of *T. pityocampa* by microbiological preparations of *B. thuringiensis kurstasi* (Btk) offers prospects for integrated control against this pest. Indeed, the winter treatments as they were recommended by Demolin (1986) allow to avoid systematic aerial applications and intervene only in infestations while saving a zoocénose inactive at this time the year.

According noticed mortalities during the single *B. thuringiensis* tests are assumed to be due mainly to the effect of the ingestion of the crystals of this bipopesticide containing endotoxin.

Conclusion

The study carried out in Nador forest on pine processionary populations shows that the rate of pest infestation vary greatly from one location to another. It depends on several factors, among others the forest structure and exposure.

On the biology of this insect, the results show that since the emergence to to complete the cycle, we were allowed to distinguish five larval instars. The pupal stage period is 4 months. The duration of each stage was closely related to the action of climatic factors. It was found that *T. pityocampa* causes major damage in the Chemekh station with a total spawning nests 58. The most affected plot is that of the East with a percentage of 57.09% this is due by the presence of all the optimal conditions exist for its development.

One generation per year was obtained. The adult emergence began at 7 August 2010 and was conducted over one month. The egg laying began in late August - early September 2010. Incubation period lasted 30 to 45 days ; hatching occurred during the first decade of October. Damage to leaves increase with larval growth. The caterpillars of the 4th and 5th instars are the most dangerous and cause more damage. The fifth instar larvae, following each other in long, head to tail processions to the end of March and seek out pupation sites in the soil in early of April.

Biocontrol trials *Bacillus thuringiensis* seems to be s promising because C of mortality rates exceeding 32%.

References

- Courtney S.P., Chen G.K. & Gardner A., 1989. A general model for individual host selection. *Oikos*, 55: 55-65.
- Cunningham J.P., West S.A. & Zalicki M.P., 2001. Host selection in phytophagous insects: a new explanation for learning in adults. *Oikos*, 95:537-543.
- Degen T., Stadler E. & Ellis P.R., 1999. Host-plant susceptibility to the carrot fly, *Psila rosae*.1 Acceptability of various host species to ovipositing females. *Annals of Applied Biology*, 134:1-11.
- Demolin G., 1969. Incidence de quelques facteurs agissant sur le comportement social des chenilles de *Thaumetopoea pityocampa* en processsion de nymphose. Répercussion sur l'efficacité des parasites. Colloque de Pont-à-Mousson, Novembre 1969 : 360-390.
- Demolin G., 1986. Intensification de la protection phytosanitaire des forets en Algérie. Rapport scientifique, projet FAO n° DP-FO-ALG/82/013/27-30.
- Demolin G., Millet A., 1981. Essais insecticides contre la processionnaire du pin (*Thaumetopoea pityocampa* Schiff.). Action comparative de différentes spécialités commerciales de Bactospeine, Dipel, Thuricideet Dimilin. *Ann. Sci. Forest* 38(3), 389-404.
- Maatoug S., 1992. Bioécologie de la chenille processionnaire du pin et estimation des dégâts dans la forêt de Nador- Tiaret Mémoire d'Ingéniorat Université de Tiaret, 122p.
- Maher N., 1997. Etudes sur l'oviposition de l'eudémis, *Lobesiobotrana*, selon sa fécondité. Conséquences sur la répartition spatio-temporelle des œufs. Mémoire de DEA Œnologie et Ampélogie. Université de Bordeaux II, 41p.
- Mezali M., 2003. Forum des Nations Unies sur les forêts (3^{ème} session, Genève). Alger : Ministère de l'Agriculture et du Développement Rural et Direction Générale des Forêts, 9p.

- Rondeux J., 1999. La mesure des arbres et des peuplements forestiers. Gembloux, Les presses agronomiques de Gembloux.
- Scalo P., Charmillot D., Pasquier R., 1997. Comparaison de produits à base de *Bacillus thuringiensis* dans la lutte contre le vers de la grappe : du laboratoire au vignoble : 345-349.
- Singer M.C., 1986. The definition and measurement of oviposition preference in plant feeding insects. In: Insect Plant Interactions. (J.R.Miller&T.A Miller ed):65-94. New York (USA): Springer-Verlag 315p.
- Singer M.C. & Lee J.R., 2000. Discrimination within and between host species by a butterfly: implications for design of preference experiments. *Ecology Letters*, 3: 101-105.
- Thompson J.N., 1988. Evolutionary ecology of the relationship between oviposition preference and performance of offspring in phytophagous insects. *Entomologia Experimentalis et Applicata*, 47:3-14.
- Thompson J.N. & Pellmyr O., 1991. Evolution of oviposition behavior and host preference in Lepidoptera. *Annual Review of Entomology*, 36: 65-89.
- Zamoum, M., 1998. Donne ´es sur la bioécologie, les facteurs de mortalite ´ et la dynamique de populations de *Thaumetopoea pityocampa* Denis et Schiffermuller (Lep. Thaumetopoeidae) dans les pineraies subsahariennes de la région de Djelfa (Algérie), Thèse de doctorat Rennes I France.
- Zamoum, M., Démolin, G., & Bensidi, A., 2006. Complexe des ennemis naturels de la processionnaire du pin *Thaumetopoea pityocampa* (Lepidoptera: Thaumetopoeidae) au sud de son aire de répartition. Actes Congrès d'entomologie et de nématologie (pp. 140–152). Alger: Inst. Nat. Agro.

COMPARATIVE TESTING OF STOMP 33 EC AND WING P IN VINE NURSERY

Neli PRODANOVA-MARINOVA¹ *, Maya DIMITROVA², Iliyan ZHELYAZKOV²

¹Institute of Viticulture and Enology, Pleven, Bulgaria

² Agrarian University, Plovdiv, Bulgaria

*Corresponding author: neli_npm@abv.bg

Abstract

The impact of Stomp 33 EC (330 g/l pendimethalin) and Wing P (pendimethalin 250 g/l + dimethenamid P 212.5 g/l) on the vegetative growth of grafted vine cuttings of Bolgar X CO4 variety during their rooting was studied during 2011-2013 at IVE – Pleven (Bulgaria). Comparing the impact of Stomp 33 EC and Wing P, both on the annual weed species, infesting the nurseries, as well as on the grafted vine cuttings, the objective of this study was to establish the applicability of Wing P for maintaining the soil surface in the propagation material production.

The trial was conducted on leached chernozem soil type. The herbicides were introduced once, immediately after planting of the cuttings in the nursery.. Stomp 33 EC and Wing P were introduced in two doses and the trial variants were as follows: V1 Stomp 33 EC (4 l/ha), V2 Stomp 33 EC (6 l/ha), V3 Wing P (4 l/ha), V4 Wing P (6 l/ha) and an untreated, weeded out control - K. The tested herbicides reduced the germination rate in the first ten-day period after treatment. However that effect was overcome and it did not affect negatively the final value of that indicator. Contrary to Wing P, Stomp 33 EC caused specific symptoms of phytotoxicity. It was accounted minimal decrease in the yield of grafted rooted vines. The rate of obtained premium vine propagation material after treatment with Wing P was equal to the manually weeded out control. Stomp 33 EC and Wing P efficiently controlled the available annual weed species except *Solanum nigrum* and *Xanthium strumarium*.

Keywords: *germination, herbicides, phytotoxicity, vine cuttings, vine propagation material*

Introduction

Vine nurseries create optimal conditions for the development of a number of weed species. Their great competitiveness requires continuous development of methods for their control. The proper selection of herbicides and their timely inclusion into the scheme for harmful vegetation integrated control is of great importance. The main objective of the studies in this area is the identification of suitable active substances, combinations and doses that enable not only the soil surface to be maintained, but also to create optimal conditions for the biological processes going on in grapevines. It has been found that pendimethalin (in the form of various commercially available products under the name Stomp) at a dose of 3 – 4 l/ha controlled efficiently the annual gramineous and some broadleaf weeds for at least ten weeks, and may be applied in vineyards both on heavy and light soils (Tucker and Chambers, 1990; Prodanova-Marinoва, 2014). In some studies, the efficacy of Stomp 330 EC has reached 98-99% (Sarpe, 2011). Further to weed control in fruit-bearing plantations, studies of IVE - Pleven have demonstrated that pendimethalin was suitable for use in vine nurseries (Prodanova-Marinoва, 2012; Prodanova-Marinoва et al., 2014). In combination with dimethenamid (Wing P) it was recommended in various crops - maize, sunflower, etc. (Andr et al., 2014; Petcu et al. 2015). However, data on the application of this broad spectrum herbicide in the production of vine planting propagation material have not been available.

Comparing the impact of Stomp 33 EC and Wing P, both on the annual weed species, infesting the nurseries, as well as on the grafted vine cuttings, the objective of this study was to establish the applicability of Wing P for maintaining the soil surface in the propagation material production.

Material and Methods

The trial was carried out for three years (2011 – 2013) at the Institute of Viticulture and Enology – Pleven, Bulgaria. It was studied the efficiency of the herbicides Stomp 33 EC (330 g/l pendimethalin) and Wing P (250 g/l pendimethalin + 212.5 g/l dimetenamid P) for the annual weed species within the vine nursery. For finding out the effect of both products on the vegetative growth of grafted vine cuttings during their rooting it was used the variety – rootstock combination of Bolgar/Berlandieri x Riparia (CO4). The grafted and stratified cuttings were rooted by the technology adopted by IVE - Pleven (Dimitrova et al., 2007). The herbicides were introduced once, immediately after planting of the cuttings in the nursery. Spraying was carried after the treatment. Stomp 33 EC and Wing P were introduced in two doses and the trial variants were as follows: V1 Stomp 33 EC (4 l/ha), V2 Stomp 33 EC (6 l/ha), V3 Wing P (4 l/ha), V4 Wing P (6 l/ha) and an untreated, weeded out control - K. The trial was conducted on leached chernozem soil type. It was monitored the dynamics of the weed species density (plants/m²) on the thirtieth, sixtieth and ninetieth day after the treatment and the dynamics of germination of the grafted cuttings (%) to the fiftieth day after their planting in the nursery. The signs of phytotoxic response were determined visually. At the end of the vegetation the yield of standard rooted vines (%) was accounted. The data were processed by analysis of variance (Dimova and Marinkov, 1999).

Results and Discussion

During the examination of the trial plots throughout the three years of the study it was found eight annual species, representatives of the late spring weeds: red-root amaranth *Amaranthus retroflexus* L./, lamb's quarter *Chenopodium album* L./, European heliotrope *Heliotropium europaeum* L./, flower-of-an-hour *Hibiscus trionum* L./, pigweed *Portulaca oleracea* L./, hound's berry *Solanum nigrum* L./, common cocklebur *Xanthium strumarium* L./ and green foxtail *Setaria viridis* L./, Table 1 presented the data on their density on the average for the period of the study. Thirty days after the introduction of the herbicides in all treated variants the weed density was significantly lower compared to the control (22.3 plants / m²) as it was formed only by two species – common cocklebur and hound's berry. It was typical for them that they were not sensitive to pendimethalin (Fetvadzhieva et al., 1986; Tonev, 2000, Tonev et al., 2007). In the conditions of increased soil moisture typical of the vine nursery, the action of Stomp 33 EC weakened during the second month and apart from those two weed species, on the sixtieth day in V1 and V2 were reported respectively 0.1 plants / m² (V1) and 0.5 plants / m² (V2) of green foxtail. With Stomp 33 EC at a dose of 4 l/ha it was found presence of 0.1 plants / m² of amaranth. In the variants treated with Wing P the density of weeds had also increased (9 times in V3 and 2.7 times in V4), but no changes in the species diversity were observed. The increasing of the weed infestation was due to the rise in the number of common cocklebur and hound's berry. The persistence of both herbicides was strongly reduced after the sixtieth day of the treatment. Between the second and the third accounting, the weeds density had increased in times, both because of the growing number of the already found species in the plots, as well as because of the germination of the suppressed to that period lamb's quarter (V1, V3 and V4), amaranth (V3 and V4), European heliotrope (V3 and V4) and flower-of-an-hour (V3).

Table 1. Average density of the weeds during the period 2011-2013, (number/ m²)

Weed species	V1			V2			V3			V4			K		
	30 day	60 day	90 day	30 day	60 day	90 day	30 day	60 day	90 day	30 day	60 day	90 day	30 day	60 day	90 day
<i>Amaranthus retroflexus L.</i>	-	0.1	0.5	-	-	-	-	-	0.03	-	-	0.03	0.5	0.5	0.03
<i>Chenopodium album L.</i>	-	-	0.1	-	-	-	-	-	0.1	-	-	0.1	0.6	0.3	-
<i>Heliotropium europ. L.</i>	-	-	-	-	-	-	-	-	0.1	-	-	0.03	1.3	1.4	0.7
<i>Hibiscus trionum L.</i>	-	-	-	-	-	-	-	-	0.1	-	-	-	1.5	0.3	0.3
<i>Portulaca oleracea L.</i>	-	-	-	-	-	-	-	-	-	-	-	-	4.1	2.1	0.1
<i>Solanum nigrum L.</i>	0.3	1.0	1.0	0.3	0.5	1.0	0.05	0.1	0.5	0.01	0.1	1.2	0.4	0.1	0.5
<i>Xanthium strumarium L.</i>	1.2	1.5	1.5	1.0	1.5	1.5	0.1	1.3	0.1	0.1	0.2	0.2	1.8	0.6	0.2
<i>Setaria viridis L.</i>	-	0.1	1.2	-	0.5	0.8	-	-	1.2	-	-	0.03	12.1	8.0	0.5
<i>Total:</i>	<i>1.5</i>	<i>2.7</i>	<i>4.3</i>	<i>1.3</i>	<i>2.5</i>	<i>3.3</i>	<i>0.15</i>	<i>1.4</i>	<i>2.4</i>	<i>0.11</i>	<i>0.3</i>	<i>1.59</i>	<i>22.3</i>	<i>13.3</i>	<i>2.33</i>

In the variants treated with Stomp 33 EC (V1 and V2) weed infestation was more significant compared to those treated with Wing P (V3 and V4), however in V3 and V4 the increase of the density to the thirtieth day was greater. The total density in V3 went up from 0.15 to 2.4 plants /m², while in V4 - from 0.11 to 1.59 plants / m².

In monitoring the dynamics of weed infestation in the control it was seen that due to the cultivation practices, the density of the species decreased from the thirtieth to the ninetieth day. However, in the last accounting the number of weeds per m² did not differ significantly from that in the treated variants. The herbicides Stomp 33 EC and Wing P showed good efficiency against the annual species found in the trial plots.

The germination dynamics in the first fifty days after treatment was investigated for finding out the impact of the tested products on the vegetative manifestations of the grafted vine cuttings. The germination ratio was indicative for the cuttings response to the herbicide solution.

The most significant effect of the treatment was observed at the end of the first ten-day period. In all variants it was recorded a decrease in the ratio of germinated shoots compared to the untreated cuttings (57.25%) - Table 2. The most significant impact had Stomp 33 EC at a dose of 6 l/ha (V2). The indicator rate in this variant was the lowest (45.9%) and the analysis of variance showed significant difference from the control. In Wing P the higher dose (6 l/ha - V4) also resulted in a greater reduction in the germination ratio.

Over the next ten-day periods the negative impact of the herbicides was overcome and the ratio was growing smoothly. At the end of the fifth ten-day period the number of germinated cuttings in the treated variants became equal (in V1 and V4) or slightly exceeded (in V2 and V3) that of the control (74.75%). The decrease compared to the recorded rates at the end of the fourth ten-day period was due to the natural dying out of some cuttings with poor bond between the graft and the rootstock and was not caused by the action of the tested herbicides. The differences between the separate treated variants remained unproven in all ten-day periods and did not give reason to be believed that either of both herbicides inhibited the germination of the grafted cuttings to a greater degree than the other one.

Table 2. Germination dynamics of grafted cuttings during the period 2011 -2013, (% with respect to the planted cuttings)

V	Germination (%)						
	I ten-days		II ten-days \bar{X}	III ten-days \bar{X}	IV ten-days \bar{X}	V ten-days	
	\bar{X}	Proved				\bar{X}	Proved
K	57.25	*	70.34	78.37	77.36	74,75	*
V1	48.15	ns	67.75	74.73	74.71	74,23	ns
V2	45.9	-	71.62	79.02	79.19	77,41	ns
V3	50.8	ns	68.58	73.87	74.55	76,73	ns
V4	48.15	ns	68.09	74.00	74.00	73,99	ns
	GD 5% = 11.233 GD 1% = 16.343 GD 0.1% = 24.556					GD 5% = 9.397 GD 1% = 13.671 GD 0.1% = 20.541	

GD - border difference (GD = t.S_D; t - Student criteria; S_D - error of the difference)

It has been shown that pendimethalin in certain doses caused limited manifestations of phytotoxicity on the leaves, both in the grafted cuttings and young vines as well as in adult plants (Beuret and Niggli, 1990; Prodanova - Marinova, 2012). Yellowish spots of irregular shape were clearly visible on the leaf blades that were not found on the stems and shoots. However spotting was relatively weak and soon faded away. In some cases at higher doses it

was observed also deformation of the leaf blade - wrinkling and distortion of the edges. In this study a similar effect was found in the variants treated with Stomp 33 EC of both doses. Thirty days after planting of the cuttings and treatment of the plots it was reported presence of characteristic spots on the leaves, but necrosis and changes in shape were not observed.

The quantity of pendimethalin in Wing P composition was significantly lower (250 g/l) and the cuttings treated with it at doses of 4 and 6 l/ha did not exhibit signs of a phytotoxic response.

The relatively early overcoming of the herbicidal effect of Stomp 33 EC (about the sixtieth day after treatment) allowed the grafted cuttings to continue their development normally and did not result in significant reduction in the quantity and quality of the propagation material.

When analyzing the yield of standard rooted vines all treated variants had lower but close to the result obtained for the control (37.63%) - Fig. 1.

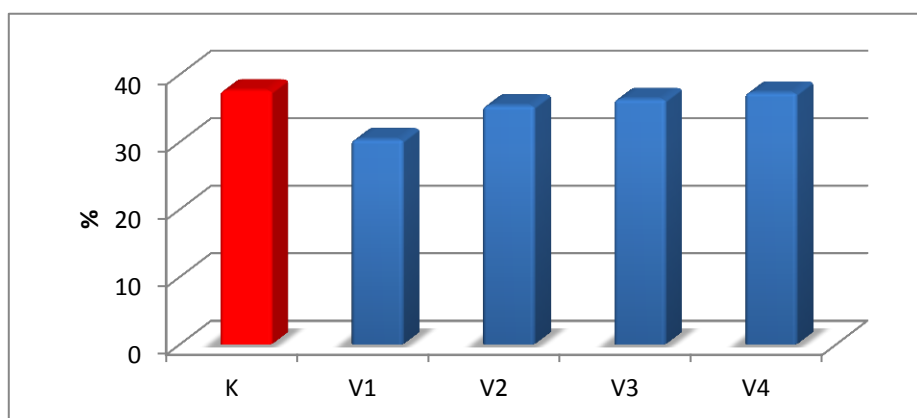

Figure 1. Average yield of rooted grapevines during the period 2011 - 2013 (% with respect to the planted cuttings)

The lowest rate of first-class propagation material throughout the three years of the study was obtained from V1 (Stomp 33 EC at a dose of 4 l/ha) – 30.38%. In the variants treated with Wing P (V3 and V4) the yield was higher compared to those treated with Stomp 33 EC, but the differences were insignificant. The ratio of standard rooted vine in V3 and V4 remained lower than in the control, but the differences were minimal (1.28% in V3 and 0.31% in V4). The analysis of variance did not prove the differences both in relation to the control, and between the separate variants (GD 5% = 10.072; GD 1% = 14.654; GD 0.1% = 22.018).

Conclusions

Stomp 33 EC and Wing P efficiently controlled the present annual weed species except *Solanum nigrum* and *Xanthium strumarium*. Their action decreased after the sixtieth day of treatment and it was determined by the dose of application and the specific soil conditions in the vine nursery.

The tested herbicides reduced the germination rate in the first ten-day period after treatment, however that effect was overcome and it did not affect negatively the final value of that indicator.

Unlike Stomp 33 EC, Wing P did not cause phytotoxic response after falling of the working solution on young shoots and leaves.

The treatment of the grafted cuttings of Bolgar variety with the tested herbicides did not affect significantly the yield of standard rooted vines. The ratio of first-class propagation material obtained after treatment with Wing P was equal to that of the manually weeded out control.

The study results showed that Wing P could be successfully applied for annual weed species control in the vine nursery.

References

- Andr, J, Hejnak V., Jursik M., Fendrychova V. (2014) Effects of application terms of the soil active herbicides on herbicide efficacy and reproductive ability for weeds in maize. *Plant Soil Environ*, 60, 10, 452 – 458.
- Beuret, E., Niggli U. (1990) Herbicide damage. *Swiss viticulture review, arboriculture and horticulture*. Vol. 22, 1, 43 – 46.
- Dimitrova, V., Peykov V., Tsvetanov E., Encheva H., Chelebiev M. (2007) Optimization of the technology for the production of grafted rooted vines. *Proceed. of scientific conference “Sustainable development of viticulture and enology, based on knowledge”*, Pleven, 99 – 106.
- Dimova, D., Marinkov E. (1999) *Experimental work and biometrics*. Academic Publishing House of HIA, Plovdiv, 263.
- Fetvadžieva, N., Straka F., Balinov I., Mihaylova P., Lyubenov Y., Karsova V., Pelov V., Balinova A. (1986) *Guide on pesticides*. Zemizdat. Sofia, 316.
- Petcu, V., Oprea G., Ciontu C., Stefanie G. (2015) Studies on the effect of some herbicides (single and different mixtures) on weeds control and soil quality in maize. *Romanian Agrocultural Research*, 32.
- Prodanova-Marinova. N. (2012) Study on the efficiency and selectivity of soil herbicides in vine nursery. *Dissertation thesis for award the degree of PhD*, 161.
- Prodanova-Marinova, N. (2014) Changes in the composition of weed association after three-year application of herbicides in vineyard. *Journal of mountain agriculture on the Balkans*, 17, 3, 751-761.
- Prodanova-Marinova. N., Dimitrova M., Tsvetanov E. (2014) Effect of pedimethalin on the production of propagation materials of Muscat Kaylashki variety grafted to different rootstocks. *Lozarstvo I Vinarstvo*, 4, 4-8.
- Şarpe, N. (2011) The No-tillage System Applied to Hybrid Grape Vine. *Journal of Horticulture, Forestry and Biotechnology*. V 15(1), 106- 108.
- Tonev, T. 2000. *Manual for integrated weed control and crop farming AU- Plovdiv*, vol. 2, 270.
- Tonev, T., Dimitrova M., Kalinova Z., Zhalnov I., Spasov V. (2007). *Herbology*. AU – Plovdiv, 227.
- Tucker, G., Chambers R. (1990) Stomp ® - a herbicide for pre-emergence control of weeds in deciduous orchard and vine crops. *Proceedings of the 9th Australian weeds conference*, Adelaide, South Australia, August 6-10, 1990, 535-539.

BIOLOGICAL CONTROL OF THE DATE PALM TREE BORERS, *ORYCTES* SPP. (COLEOPTERA: SCARABAIDAE: DYNASTINAE)

Mohammed KHALAF*, Hussain ALRUBEAI, Falah NAHER, Mustafa JUMAA

Integrated Pest Control Research Center, Agricultural Research Directorate, Ministry of Science & Technology,
Baghdad, Iraq

Corresponding author: mkhalaf34@yahoo.co.uk*

Abstract

The efficacies of the entomopathogenic nematodes (EPN), *Rhabdits blumi*, and the entomopathogenic fungi (EPF), *Beauveria bassiana* as a biocontrol agents were determined for the date palm tree borers, *Oryctes* spp. (Coleoptera: Scarabaeidae: Dynastinae) in laboratory and field trials, during 2015 season. Laboratory results demonstrated that direct spray of 1000 infective juveniles (IJs) per mL of *R. blumi* on Arabian Rhinoceros Beetle (ARB), *Oryctes agamemnon arabicus* caused 71.67% and 15% mortality in the larvae adults respectively. Treating the food source of the larvae (pieces of fresh tissue of the frond bases) with the same dose and period resulted in 48.33% mortality in larvae and 10% in the adults. Laboratory results also showed that using concentration 1×10^9 conidia/mL⁻¹ of *B. bassiana* as direct spray of the ARB larvae, led to 66.7% and 60% as treatment of the food source. Field experiments results showed that injection of 50 mL per palm tree with a concentration of 1000 IJs/mL of *R. blumi* inflicted about 42% mortality in ARB larvae infested the tree. Meanwhile, injection 50 mL of 1×10^9 conidia/mL⁻¹ of *B. bassiana* imposed 50% mortality in larvae. Results of this investigation illustrate the possibility of using *R. blumi* and, *B. bassiana* as a biocontrol agents against palm borers in IPM programs.

Key words: *Biocontrol*, *Endophyta*, *Palm borers*, *Oryctes* spp.

Introduction

Palm borers, especially *Oryctes* spp. are considered as an economically important insect pest of date palm trees in Iraq and most adapted to climatic conditions of the region (Khalaf *et al*, 2011; Khalaf, *et al*, 2014). Arabian Rhinoceros Beetle, *Oryctes agamemnon arabicus* caused severe damages to the bases of fronds and bunches making long tunnels inside tissue, which acting as weakening and breaking factors for these parts (Khalaf and Al-Taweel 2015). Entomopathogenic nematode (EPN) and fungi (EPF) have been used to enhance biological control measure of many insect pests (Ehier, 1990; Hazirs *et al*, 2003). France *et al* (2015) reported that the farmers usually based their pest management practices on chemicals pesticides, but the growing restrictions and concerns, encourage the use of microbial control agents, like EPF and EPN. Krell *et al* (2015) mentioned that the endophytic EPF like *Beauveria* spp. or *Metarhizium* spp were used in biological crop protection against many different insects. Eidt and Thurston (1995) and Simoes and Rosa (1996) reported the applications of EPN as a biocontrol agents against many insect pests especially soil insects. In Iraq, EPN *Steinernema* sp. isolated for the first time from the long horn date palm stem borer, *Jebusaea hammeschmidtii* and fruit stalk borer, *Oryctes elegans* in the date palm cultivation areas (Al-Jboory, 2007). Meanwhile Khudhair *et al* (2015) illustrated that the entomopathogenic fungi *Metarhizium anisopliae* and *Beauveria bassiana* were tested against Arabian Rhinoceros Beetle, *Oryctes agamemnon arabicus* larvae, and both were found to be effective. The aims of this study are to investigate the efficacy of EPN, *Rhabdits blumi*, and EPF, *Beauveria bassiana* as endophytic biocontrol agents against palm borers, *Oryctes* spp.

especially ARB, *Oryctes agamemnon arabicus* under laboratory and field conditions in date palm orchards.

Materials and Methods

Collection of Samples

Samples of ARB were collected from severely infested trees in date palm orchards at South of Baghdad. Borer's larvae were collected by using hand collection from tissues of the frond bases. While, adults were collected using light traps that distributed in the orchards during June to August, hence the high peak of adult activity. EPN, *R. blumi* was isolated from collected ARB larvae and reared on wax moth *Galleria mellonella* larvae under laboratory conditions. EPF, *B. bassiana* was isolated from both contaminated tree tissues and infected adult's borer.

Nematode and Fungal identification

EPN identified by Dr. Brian Darby, Nematology Department, University of North Dakota, USA using molecular biology of high quality sequence, and blast-matched them to the NCBI database, which classified the EPN as *R. blumi* (Personal communication). EPF isolates were identified by pathologist in the Directorate of Agricultural Research using microscopic characteristics which showed that the EPF isolated was *B. bassiana*.

Oryctes borer culture

O. agamemnon arabicus borer larvae (last instar) were kept in special plastic containers 30×20×22.5 cm supplied with small pieces of frond base tissue. Larvae were reared at 25±2°C, complete darkness and 65% RH. Fresh frond bases pieces were added regularly every two weeks to keep enough fresh food to the larvae. Larvae were kept until used for different experiments.

Experimental Design

The laboratory trials were conducted in Biological Control Dept. of IPM Center. Field trials were conducted in date palm orchard Global positioning system, GPS: latitude 33.12740, longitude 44.82124 located in Almadain district (30km South of Baghdad), planted with mature date palm trees of 25 -30 years old with 6-7 m high and 50 – 55 cm diameter.

Laboratory experiments include using four concentrations (0, 250, 500 and 1000 EJs per ml) of *R. blumi* and one concentration 1×10^9 conidia/mL⁻¹ of *B. bassiana* as direct spray on the larvae or their food (pieces of frond bases tissue). Fresh food pieces were added regularly every two weeks to keep enough fresh food to the larvae. Three replicates, 5 larvae each were used for each treatment as for laboratory experiments. Larval mortalities were counted in all treatments on daily basis through 4 weeks period.

For field experiments, injection of 50 mL solution of EPN 1000 EJs/mL or 1×10^9 conidia/mL⁻¹ of EPF were done through tree trunk using 50 mL syringes after drilling holes with a brad point drill- bit (diameter, 20mm and length, 200mm) 1m above the ground level. Three replicates (trees) were used for each treatment.

Larvae of ARB in trees crown were collected after four weeks of injection EPN or EPF, dead and live larvae were counted in each treatment and kept in plastic containers. In addition, fresh frond bases tissues were collected and healthy larvae of *G. mellonella* were added to test if it contains EPN, *R. blumi* in each treatment. Observations were taken pieces frond bases as a test of transfer EPN by plant tissues in each treatment. Observations were taken after 48, 72, 96 and 120 hr. of treatment. Larval mortalities that infected by EPN and EPF in each treatment were counted. The experimental designs implemented were complete randomized

design and complete randomized block design, and the results were analyzed according to the least significant differences (LSD) using GenStat 3 program.

Results and Discussion

Mortality percentages of ARB larvae after direct spray under laboratory conditions with EPN *R. blumi* revealed that the highest concentration used (1000 EJs/mL) inflicted the highest percentage reaching 71.67% after 120 hr., while the lower concentrations of 500 and 250 EJs/mL recorded mortality of 50.0% and 16.67% respectively (table 1). Meanwhile, mortalities reached 38.33%, 46.33% and 48.33% at concentrations of 250, 500 and 1000 EJS/mL respectively in experiments of using treated larval food (table 1). Adult mortality for direct spray and treated food were: 0%, 6.67%, 15.0% and 0%, 5.0%, 10.0% at concentrations 250, 500 and 1000 EJS/mL respectively (table 2). It is obvious from the results above that larvae of ARB were more sensitive to infection by EPN than the adults, and this could be due to that larvae have soft body wall compared to the hard cuticle of adults (Kaya and Gaugler, 1997). Moreover, direct spray treatment was more effective than treated food trail.

Table 1. Effect of entomopathogenic nematode *Rhbditis blumi* as biocontrol agent against palm borer, *Oryctes agamemnon arabicus* larvae under laboratory conditions.

Treatment method	Concentration of <i>R. blumi</i> (EJs/mL)	Total of larvae treated	%Corrected mortality(accumulation) After(hr)				
			48	72	96	120	Mean
Direct spray	Control (water)	15	0.0	0.0	0.0	0.0	0.0
	250	15	13.33	13.33	20.0	20.0	16.67
	500	15	40.0	53.33	53.33	53.33	50.0
	1000	15	66.67	73.33	73.33	73.33	71.67
	Mean	15	40.00	46.7	48.89	48.89	46.11
Treated diet (frond bases)	Control (water)	15	0.0	0.0	0.0	0.0	0.0
	250	15	33.33	40.0	40.0	40.0	38.33
	500	15	46.67	46.67	46.67	46.67	46.67
	1000	15	40.0	46.67	53.33	53.33	48.33
	Mean		40.0	44.44	46.67	46.67	44.44

LSD at 5% for Time: 5.27, for concentration: 13.01, for treatment method: 14.13, for concentration × Treatment method: 19.0, for time × Treatment method: 14.69, for concentration × time: 13.45, for time × concentration × Treatment method: 21.22

Table 2. Effect of entomopathogenic nematode *Rhbditis blumi* as biocontrol agents against palm borer, *Oryctes agamemnon arabicus* adults under laboratory conditions.

Treatment method	Concentration of <i>R. blumi</i> (EJs/mL)	Total of larvae treated	%Corrected mortality(accumulation)				
			48	72	96	120	Mean
Direct spray	Control (water)	15	0.0	0.0	0.0	0.0	0.0
	250	15	0.0	0.0	0.0	0.0	0.0
	500	15	0.0	0.0	13.33	13.33	6.67
	1000	15	6.67	13.33	20.00	20.00	15.0

	Mean	15	2.22	4.44	11.11	11.11	7.22
Treated diet (frond bases) method.	Control (water)	15	0.0	0.0	0.0	0.0	0.0
	250	15	0.0	0.0	0.0	0.0	0.0
	500	15	0.0	6.67	6.67	6.67	5.0
	1000	15	6.67	6.67	13.33	13.33	10.0
	Mean	15	2.22	4.44	6.67	6.67	5.0

LSD at 5% for Time: 3.68, for concentration: 11.49, for treatment method: 4.30, for concentration × Treatment method: 11.35, for time × Treatment method: 5.80, for concentration × time: 11.41, for time × concentration × Treatment method: 12.81

Field efficacy results (table 3) indicated that the mortality percentage of ARB larvae after direct spray of the tree grown with 1×10^9 conidia/ml⁻¹ of *B. bassiana* spore suspensions reached 66.7 while it reached 60.0% in injection of EPF spore suspension after 4 weeks of treatment.

Table 3 .Effect of direct spray and food treatment of entomopathogenic fungi (EPF) *Beauveria bassiana* as biocontrol agents against palm borer, *Oryctes agamemnon arabicus* larvae under laboratory conditions.

Treatment of EPF, <i>B. bassiana</i>	Total of larvae treated	Number of larvae after 28 day		% corrected Mortality
		life	dead	
Control	15	15	0	0.0
Direct spray	15	5	10	66.7
Food Treatment	15	6	9	60.0

LSD at 5% for concentration 11.33

Results in table 4 indicated that the field trials of EPN, *R. blumi* and EPF, *B. bassiana* revealed that trunk injection of 50 mL of each biocontrol agents inflict moderate mortality percentage of 41.7% and 50% among larvae of ARB reaching after 4 weeks in EPN and EPF treatments, respectively.

Table 4. Effect of entomopathogenic nematode (EPN) *Rhbditis blumi* and entomopathogenic fungi (EPF) *Beauveria bassiana* as biocontrol agents against on palm borer, *Oryctes agamemnon arabicus* larvae under field conditions.

Treatment (Trunk injection)	Number of larvae per three trees (in tree crown only)			%corrected mortality
	Before treatment	After 4 weeks of treatment		
		Live	dead	
control	20	20	0	0
50 mL per tree of EPN	12	7	5	41.7
50 mL per tree of EPF	10	5	5	50.0

LSD at 5% for treatment 8.01

The present results revealed that there was an acceptable efficacy of applying either of the two biocontrol agents, isolated locally from Iraqi date palm orchards ecosystem, EPN *R. blumi* and EPF *B. bassiana* reflected by the reducing survival percentage of ARB, *O. agamemnon arabicus* larvae and adults under laboratory and field trials. In addition, results indicated that the EPN and EPF solution could translocated through date palm tissue after injection. Ricaño *et al.* (2013) found that using more than one formula of *B. bassiana* can remarkably reduce survival and increase mortality rate among red palm weevil, *Rhynchophorus ferrugineus* larvae and adults. Abbas and Mahmoud (2009) reported that IJs of EPN, *Steinernema riobrave* caused 44-100% mortality in third instar larvae of *O. agamemnon* under laboratory conditions, and 33 – 78% mortality when applied to soil of fig orchard. Yang *et al.* (1993) have been successfully controlled banana weevil by injecting EPN suspensions directly into borer holes. In addition to the most common application method for EPN is to use the same type of equipments used for spraying chemical pesticides, nematodes could be applied to target site with most commercially available spray equipment such as hand or ground sprayers, mist blowers and aerial sprayers on helicopters (Georgis *et al.* 1995).

Conclusions

The results of this investigation depicted the possibility of using EPN, *R. blumi* and EPF, *B. bassiana* as effective biocontrol agents against ARB, *O. agamemnon arabicus* and probably to other palm borers species in date palm orchards either by direct spray or trunk injection through IPM program.

References

- Abbas M. S. T., Mahmoud B.(2009). The pathogenicity of entomopathogenic nematode, *Steinernema riobrave* on some economic insect pests. Egyptian J. of Biol. Pest Control, 19(1):49-53.
- Al-Jboory I. (2007). Survey and identification of the biotic factors in date palm environment and its application for designing IPM-program of date palm pests in Iraq. Aden Univ. J. of Appli & Natural Sci. Vol. 11(3):1-28.
- Ehier L. (1990). Some contemporary issues in biological control insects and their relevance to use of entomopathogenic nematodes. In: Gaugler R. and Kaya, H. eds. Entomopathogenic nematodes. Biological Control. CRC press. Boca Raton, FL. 1-9.
- Eidt D., Thurston G . (1995). Physical deterrents to infection by entomopathogenic nematods in wire worm (Coleoptera: Elateridae) and other soil insects. Can. Entomol. 127: 423-429.

- France A., Cisternas E., Urtubia I. (2015). Progress and uses of microbial control in Chilean Berries. Abstract book of XVIII. International Plant Protection Congress, Berlin, 2015, P.170.
- Georgis R., Dunlop D., Grewal P. (1995). Formulation of entomopathogenic nematode. In: Hall, F. Barry, J. eds. Biorational pest control agents: Formulation and Delivery. Washington, D. C; ACS; Symposium series No. 595. American Chemical Society: 197-205.
- Simoes N., Rosa J. (1996). Pathogenicity and host specificity of entomopathogenic nematods. *Biocontrol Sci. Technol.* 6:403-411.
- Hazir S., Kaya H. K., Stock S. P., Keskin N. (2003). Entomopathogenic nematodes (*Stenernamatidae* and *Heterohabditidae*) for biological control of soil pests. *Turk. J. Biol.* 27: 181-202.
- Kaya H., Gaugler R. (1997). Entomopathogenic nematodes. *Ann. Rev. Entomol.* 38:181-206.
- Khalaf M. Z., Shbar A. K., Al-Seria M. H., Sami R. A., Naher F. H. (2011). Some aspects of biology and control methods of Fruit Stalk Borer *Oryctes elegans* Prell (Coleoptera: Scarabaeidae). *Journal of Agricultural Science & Technology A* 1:142-147.
- Khalaf M. Z., Naher F. H., Khudair M. W., Hamood J. B., Khalaf H. S. (2014). Some Biological and Behavioral Aspects of Arabian Rhinoceros Beetle, *Oryctes agamemnon arabicus* Fairmaire (Coleoptera: Scarabaeidae: Dynastinae) under Iraqi Conditions. *Iraqi J. Agric. Res. (Special Issue) Vol. 19 (2):* 122-133.
- Khalaf M. Z., Al-Taweel, A. A. (2015). Palm Borers in Iraqi Environment: Species-Damages- Methods of Control. *J. of The Blessed Tree*, 07(01):54-64.
- Khudhair, M. W., Khalaf M. Z., Alrubeai H. F., Shbar A. K., Hamad B. S., Khalaf H. S. (2015). Evaluating the virulence of *Metarhizium anisopliae* (Deuteromycotina: Hyphomycetes) and *Beauveria bassiana* (Ascomycota: Hypocreales) isolates to Arabian rhinoceros beetle, *Oryctes agamemnon arabicus*. *J. of Entomological and Acarological Research* 47(5180): 117-122.
- Krell V., Jakobs-schonwandt D., Lohse R., Lemke P., Spieth P., Spieth L., Hettlage S., Patel A.V. (2015). Endophytic entomopathogenic fungi for biological crop protection: Novel integrated fermentation and formulation strategies. Abstract book of XVIII. International Plant Protection Congress, Berlin, 2015, P. 172.
- Ricano J., Guerri-Agullo B., Serna-Sarrias M. J., Rubio-Llorca G., Asensio L., Barranco P., Lopez-llorcal V. (2013) Evaluation of the pathogenicity of multiple isolates of *Beauveria bassiana* (Hypocreales: Clavicipitaceae) on *Rhynchophorus ferrugineus* (Coleoptera: Dryophthoridae) for the assessment of a solid formulation under simulated field conditions. - *Fla. Entomol.* 96: 1311-1324.
- Yang H., Zhang G., Zhang S. (1993). Biological control of tree borers (Lepidoptera: Cossidae) in China with the nematods *steinernema carpocapsae*. In: Beddy, R. Akhurst and Kaya, H. eds. *Nematodes and the Biological control of insects*. CSIRO publications. East Mebourne, Australia. 33-40.

**ANTITERMITIC ACTIVITIES OF PINUS ROXBURGHII WOOD EXTRACTIVES
AGAINST HETEROTERMES INDICOLA (WASMANN) (ISOPTERA:
RHINOTERMITIDAE)**

Babar HASSAN^{1*}, Sohail AHMED¹, Muhammad MISBAH-UL-HAQ², Mark E.
MANKOWSKI³, Nasir MEHMOOD¹

¹ Department of Entomology, University of Agriculture Faisalabad, Pakistan

² Nuclear Institute for Food and Agriculture (NIFA) Peshawar, Pakistan

³ USDA-FS Forest Products Laboratory, Wood Durability and Protection
201 Lincoln Green, Starkville, MS, USA

*Corresponding author: sialuaf@gmail.com

Abstract

Pinus roxburghii Sargheart wood extractives were examined for antitermitic activities against *Heterotermes indicola* (WASMANN). Heart wood extractives were removed from wood shavings by Soxhlet extraction by using ethanol: toluene(2:1) as the solvent system. Filter paper bioassay was conducted to observe concentration dependent feeding response and mortality of termites. Results indicated that the highest termite mortality was occurred at 10 mg/ml with an LC₅₀ at 6.48 mg/ml. *P. roxburghii* extractives showed maximum repellent activity after 12 hours of exposure of termites at the highest concentration (10 mg/ml). In choice and no-choice feeding bioassays with extracted and un-extracted *P. roxburghii* wood blocks, increased wood loss due to termite feeding was observed on extracted blocks compared to un-extracted blocks. More number of termites were found dead after feeding on un-extracted blocks compared to extracted blocks. Results also disclosed that extractives from *P. roxburghii* imparted resistance to vacuum-pressure treated Southern pine (SYP, *Pinus taeda* L.) and Cottonwood (CW, *Populus deltoides* W. Bartram ex Marshall) against *H. indicola*. The results of this study indicate that extractives from *P. roxburghii* may be potentially useful in the development of environment-friendly termiticides.

Keywords: *Pinus roxburghii*, extractives, antitermitic, *Heterotermes indicola*, repellent

Introduction

Heterotermes indicola (Wasmann) is considered a key termite pest species in South East Asia. It is a very common wood destroying termite, predominantly in zones north of 20°N latitude which comprises India, Pakistan, and Afghanistan (Maiti, 2006). In addition to causing substantial damage to wooden structures in houses, this species is also described to abolish paper, clothes and other stored products with cellulosic constituents. These termites feed internally within the wood but leave an outer shell intact to protect them from desiccation. In domestic infestations, termites create galleries which can be seen running along walls and ceilings to reach wooden materials (Roonwal and Chhottani, 1989). Out of 50 described species known to occur in Pakistan, 11 have been recorded damaging man-made wooden structures (Akhtar, 1983). One of the most important termites in urban and rural areas of Pakistan is *H. indicola*, which is extensively distributed throughout Pakistan (Sheikh et al., 2008).

Susceptible woods that are vulnerable to termite attack are usually well-preserved with synthetic chemicals/preservatives (Evans, 2003). These man-made compounds are expensive and often detrimental to the workers and the environment. This has impelled an increased interest in finding less toxic alternatives to wood protection use (Asamoah et al., 2011). The heartwood of numerous tree species has been publicized to be impervious to deprivation by biological agents, including fungi and termites. This opposition/resistance, or durability, is

mostly due to the accumulation of non-structural components/extractives in the heartwood (Kityo and Plumptre, 1997). Several studies have shown that after elimination of extractives, resistant/durable wood loses its natural resistance and makes them more prone to decay (Oliveira et al., 2010, and Kirker et al., 2013). Organically based wood extractives have a presumably less health risks and are very easy to depollute and dispose of without impairing the environment (Chen et al., 2004; Kirker et al., 2013). The practice of treating wood with natural extractives for the controlling of termites has been formerly studied. By eliminating extractives from a resistant wood species the durability could be relocated and distributed more uniformly into a non-durable species, such as southern yellow pine or cottonwood. It has been stated that the extractives exhibit toxicity and repellency against many species of termites (Dungani et al., 2012; Kirker et al., 2013; Kadir et al., 2014; Hassan et al., 2016). In the current study, extractives of *Pinus roxburghii* Sarg were used to treat two non-durable wood species, Southern Yellow Pine (SYP, *Pinus taeda* L.) and cottonwood (CW, *Populus deltoides*), and resistance against termite feeding were evaluated. Previous studies have indicated that the extractives of *P. roxburghii* contains α -pinene, longifolene, β -pinene, car-3-ene and careen (Kaushik et al., 2010). *P. roxburghii* Sarg is a staple wood species in Pakistan. It commonly found at lower elevations (500-2000m) than other pines in the Himalaya. *P. roxburghii* named after William Roxburgh is a native pine to the Himalaya. The range of this pine extends from northern Pakistan (North-West Frontier Province, Azad Kashmir), across northern India and Nepal to Bhutan. It has wide-ranging uses including building material, heating and has published medicinal value (Tewari, 1994). Though *P. roxburghii* is documented as non-resistant (class IV) to decay (Scheffer and Morrell, 1998) extractive of this species have been found to have medicinal and antibacterial properties. Heartwood extractives of *P. roxburghii* have been described to contain abietic acid, longifolene and low levels of several stilbenes which are known to have antifeedant activity against termites (Shuaib et al., 2013; Morimoto et al., 2006). The present work addresses the potential use of *P. roxburghii* heartwood extractives in improving the termite resistance property of southern pine and cottonwood.

Materials and Methods

Wood Material and Preparation of Extractives

Logs of *P. roxburghii* were obtained from the Timber Market located at Faisalabad, Pakistan. After air drying in USDA-FS Forest Products Laboratory, Starkville, Mississippi (USA), logs of *P. roxburghii*, southern pine, and cottonwood were cut into large boards from and evened with a planer then cut into 19×19×19 mm blocks. Shavings from this process were used for the preparation of extractives. Air dried wood shavings were soxhlet extracted using 300 ml of ethanol: toluene (2:1) as a solvent according to ASTM D1105-96 "Standard Test Method for Preparation of Extractive-Free Wood" with minor modifications (ASTM, 2015). Shavings (12 g) were added to soxhlets with a small amount of cotton placed below and above, to contain the shavings, and extracted for a total of six hours. The resulting aliquot was evaporated under reduced pressure using a rotary evaporator (BUCHI, Rotavapor R-114) and extraction yield was calculated per gram of wood shavings. Extractives were then prepared in stock solutions (100 mg/ml) and stored in small vials at 4°C.

Preparation of Extractive-Free Wood

Heartwood blocks of *P. roxburghii* were extracted according to ASTM D1105-96 with the following modifications. Conditioned blocks (33°C, 62±3%) were numbered and weighed before being placed in the soxhlets and extracted for six hours using ethanol: toluene (2:1). Blocks were then washed with alcohol to remove excess toluene and secondarily extracted for

six hours in ethanol (95%) alone. Ethanol-extracted blocks were air dried overnight and then boiled for six hours with 3L of distilled water and water was changed after every hour.

Toxicity and Repellency against Termites

Tests against *H. indicola* were conducted in NIFA (Nuclear Institute for Food and Agriculture) Peshawar, Pakistan. Oven dried (60°C) and weighed Whatman No. 1 filter paper (42.5 mm diameter) was treated with five different concentrations (1.25, 2.5, 5.0, 7.5, and 10.0 mg/ml) of extractives. Concentrations were prepared from stock solution using ethanol: toluene as a solvent and 200 µl of this solution was applied to each filter paper. Treatments were done in triplicate along with control treatment, which was treated with ethanol: toluene alone. A total of 50 worker termites (laboratory maintained) were released into jars containing 20 grams of sand, 3.6ml water and treated filter papers, and maintained in an incubator at 27°C and 75% RH for 15 days. At the end of the test, termite mortality was calculated by counting the number of live termites. ImageJ software (Developed by Wayne Rasband, Bethesda, Maryland) was used to calculate the area of filter paper consumed by the termites.

For repellency tests, the method outlined by Kadir et al. (2014) was used. Assessment of repellency was performed after 1, 2, 3, 4 and 12 h by counting some termites on treated and untreated filter paper. The following formula was used to calculate percent repellency:

Repellency (%) = $(N_c - N_t) / (N_c + N_t) \times 100$, where

N_c is the number of termites in control

N_t is the number of termites on the treated filter paper.

Antifeedant indices were determined by weight loss of the filter paper (Absolute coefficient of antifeedant (A), which was calculated using following formula:

A (%) = $[(K_k - E_e) / (K_k + E_e)] \times 100$, where

K_k is the weight loss of the filter paper in the control treatments

E_e is the weight loss of the treated filter paper. All treatments were divided into four classes according to antifeedant values (Dungani et al., 2012).

Choice and No Choice Test on Extractive-Free Wood

Extracted and un-extracted *P. roxburghii* heartwood blocks were subjected to choice and no-choice feeding tests according to a modified AWP A E1-15 standard (AWPA 2015). Screw top jars were filled with 150 grams sand along with 27 ml distilled water and held for two hours to equilibrate. For the no-choice test, extracted and un-extracted blocks were conditioned (33°C, 62±3%), weighed and placed on top of the damp sand with one block in each jar. For the choice test, each jar received one extracted and one un-extracted block. The experiment was replicated five times. A total of 400 termites (396 workers and 4 soldiers) were released in each jar and jars were kept in the conditioning chamber at 27°C and 75±2% relative humidity for 28 days. After four weeks, the number of live termites were counted. Blocks were brushed to remove sand, conditioned for one week, and re-weighed to determine weight loss. All blocks were rated visually using 0-10 scale as described in the AWP A standard.

Transfer of Durability Test

Weighed and conditioned (33°C, 62 ± 3% R.H.) SYP and CW sapwood blocks (19×19×19 mm) were pressure treated with different concentrations (2.5, 5 and 10 mg/ml) of *P. roxburghii* extractive. For controls, blocks were treated with solvent only (ethanol: toluene) or water. Blocks were pressure treated by placing five blocks in a 300 ml beaker containing the treatment solution in a vacuum-pressure chamber. Blocks were held under vacuum for 30 min and after that pressure was applied at 40 psi for 60 min. After pressure treatment, blocks were blotted dry using paper towels, weighed, and re-conditioned at 33°C and 62±3% RH.

A termite bioassay was conducted according to a modified AWPA E1-15 (AWPA, 2015). Modifications were the test block size of 19×19×19 mm and the amount of water added was 27ml. Screw top jars were filled with 150 grams sand along with 27 ml distilled water and left for two hours to equilibrate. After two hours, treated and control blocks were added to the jars so that each jar received only a single block. All treatments were replicated five times. A total of 400 termites (396 workers + 4 soldiers) were then added to each jar, and jars were placed in the conditioning room at 27°C and 75±2 %R.H. for 28 days. After four weeks, the number of live termites was counted. Test blocks were brushed to remove sand and conditioned for one week before being re-weighed to determine weight loss. All blocks were rated visually using 0-10 scale as described in the AWPA standard.

Results and Discussion

Termite mortality is one clue of antitermitic activity of extractives. Mortality of *H. indicola* was reliant on concentrations of *P. roxburghii* heartwood extractives (Fig. 1). All treatments were considerably different from one another ($F= 13.44$; $p < 0.005$; $df= 6$). *P. roxburghii* heartwood extractives showed antitermitic activity with an LC_{50} of 6.48 mg/ml ($n=50$; $\chi^2 = 1.74$; Slope $\pm SE = 2.53 \pm 0.17$; FL 95% = 6.15- 6.83) after 15 days of exposure. Maximum mortality was 80 % at the highest extractive concentration (10 mg/ml), while 10.8 % mortality was found at the lowest extractive concentration (2.5 mg/ml). The percentage of filter paper consumed was found to be lower in treated filter paper groups than the controls and results showed a strong correlation between the amount of filter paper consumption and termite mortality. Overall, all treatments were significantly different from the control treatments ($F=4.63$; $P < 0.005$; $df= 6$).

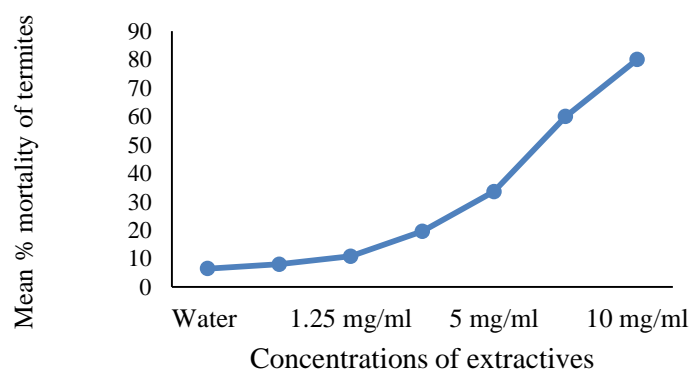

Fig. 1. Effect of different concentrations of *P. roxburghii* extractives on mortality of *H. indicola*

A similar trend was also found between mortality of termites and percent weight loss of filter paper. Minimum weight loss (3.67%) was found at the highest concentration (10 mg/ml) where there was maximum termite mortality (Fig. 2). While maximum weight loss was observed on the control filter paper which was treated with solvent and water.

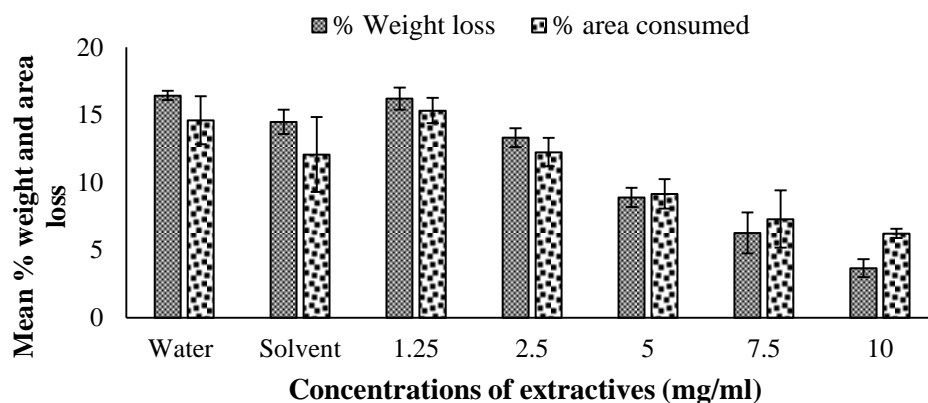

Fig. 2. Consumption (%) and weight loss (%) of filter paper treated with different concentrations of *P. roxburghii* extractives after 15 days exposure to termites

These results were similar to González et al. (2013) who found concentration dependent mortality and feeding rate of dry wood termites using aqueous extracts of *Enterolobium cyclocarpum*(Jacq.). They found a six-fold reduction in consumption of treated filter paper (10 mg/ml) compared to the control treatment (0 mg/ml). Several other researchers have found dose-dependent mortality of termites after feeding on extractive treated filter paper against *Incisitermes marginipennis* Latreille, *Coptotermes gestroi*(Wasmann) and *Coptotermes curvignathus* Holmgren (González et al., 2013; Se Golpayeganiet al., 2014; Kadir et al., 2014; Hassan et al., 2016).

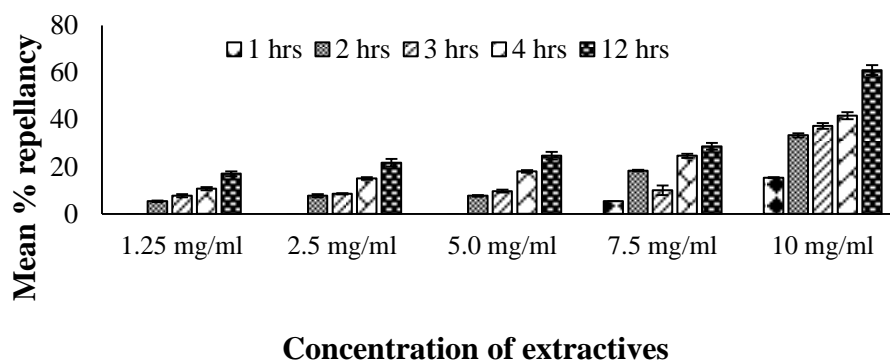

Fig. 3. Repellent activity of *P. roxburghii* heartwood extractives against *H. Indicola*

To determine the repellent properties of *P. roxburghii* heartwood extractives, a simple laboratory experiment was setup using similar methods to other repellency studies (Smith, 1979; Sharma et al., 1994). In this experiment heartwood, extractives did not show any repellent activities at lower concentrations even after 12 hours (Fig. 3). Maximum repellent activity was observed after 12 hours at highest concentrations. At the highest concentration (10 mg/ml) 61% of termites were repelled towards control filter paper section compared to lowest concentrations after 12 hours. There is no published literature on repellent activities of heartwood extractives of *P. roxburghii* except Pinus oil against the mosquito. The antifeedant activity of extractives obtained from *P. roxburghii* was 2 to 63% which was similar to an earlier study on Purkwakarta teak extracts (Dungani et al., 2012). The concentration of extractive is a vital factor for termite mortality and antifeedant (Dungani et al., 2012). This was most likely due to the presence of some phenolics compounds (Asima Chatterjee et al., 1977) in wood which are strong antioxidants (Kaushik et al., 2010; Salem et al., 2014) /

antifeedants. These compounds also act as natural protectants for the living tree (Ates et al., 2015).

The results of bioassays on un-extracted and extractive-free wood of *P. roxburghii* were examined by percent wood consumption and termite mortality (Fig. 4 a, b)

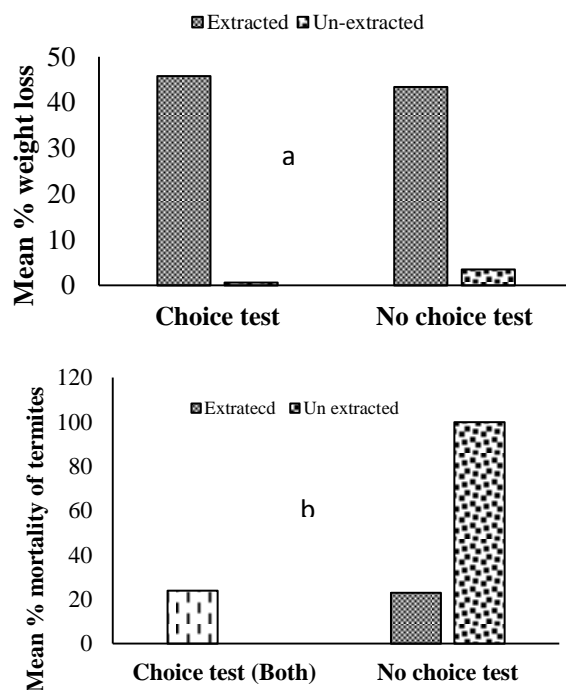

Fig 4 a, b Mean percent weight loss (a) and termite mortality (b) in choice and no-choice bioassay on un-extracted and extractive-free wood.

In the choice test, termites ignored the un-extracted block and consumed more of the extracted block (45.77%), while in the no-choice test weight losses for extracted blocks were almost similar (43%) to the choice test. In the case of un-extracted blocks, consumption was less than 1% in case of the choice test while under no choice test consumption of un-extracted wood was 3.5% after 28 days. All termites were dead in the no-choice test with un-extracted blocks, while in the case of the extracted blocks, mortality was 22.9 % which was similar to the choice test where both extracted and unextracted blocks were offered to termites.

P. roxburghii heartwood extractives were lethal to termites at each concentration and caused 100 % mortality of *H. indicola* at maximum concentration (10 mg/ml) after feeding on treated SYP. At lowest concentration-mortality was 54% ($F=5.84$, $P < 0.05$). A similar trend of mortality of termites was found after feeding on Cottonwood. At maximum concentration (10 mg/ml) there was maximum (81%) mortality of termites while at minimum concentrations there was less number of termites found dead in the jars (Fig. 5).

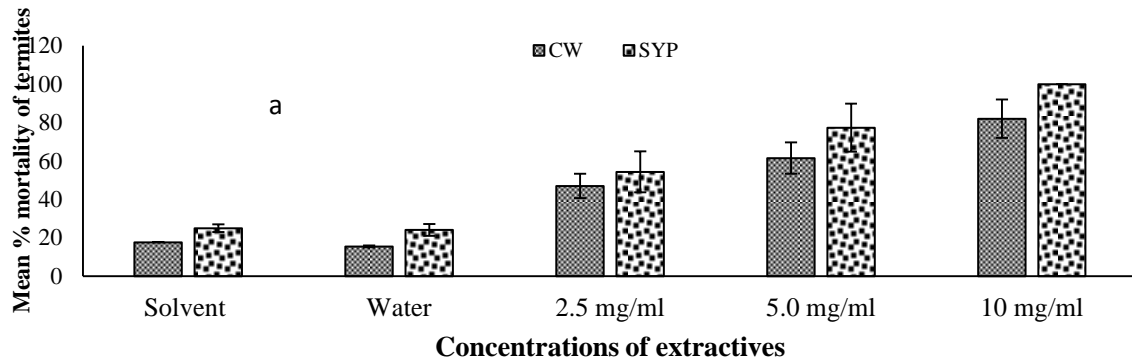

Fig. 5. Mean percentage mortality of termites after feeding on vacuum-impregnated SYP and CW blocks at 3 concentrations (mg/ml) of *P. roxburghii* extractives

All treatments differed significantly from each other and also from control treatments ($F=4.44$, $P<0.05$). Average weight loss of treated and untreated SYP and Cottonwood exposed to *H. indicola* is shown in Fig. 6. Solvent and water treated SYP controls lost 28 and 25% respectively, while cottonwood showed a weight loss of 42.5 and 42.2% respectively for solvent and water treated blocks

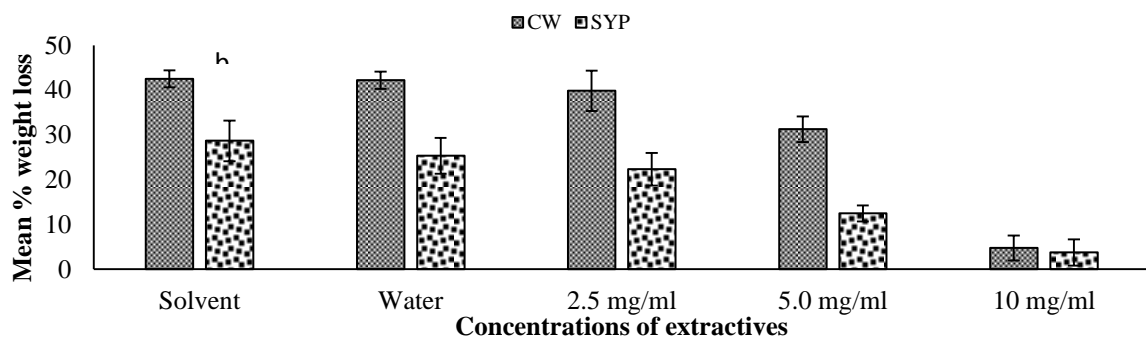

Fig. 6. Mean percentage weight loss of SYP and CW blocks vacuum impregnated with *P. roxburghii* extractives after termites feeding.

Conversely, SYP and CW treated with *P. roxburghii* extractives showed minimum weight loss (3.76 and 4.75% respectively) at the highest concentration (10 mg/ml). Weight loss was found to be inversely related to the extractive levels. Weight loss of control treatments of SYP was statistically higher than all other treatments ($F=53.08$; df 4, 20; $P<0.005$). A similar trend was found in Cottonwood ($F=142.03$; df 4, 20; $P<0.005$). Results from the current study are comparable to that reported by Yamaguchi *et al.* (2002) who found the treatment of sugi with mimosa tannin had lower weight loss and higher termite mortality. Similar results were also found by Tascioglu *et al.* (2012) who saw minimum feeding with highest mortality of termites for mimosa and quebracho extract-treated Scots pine at a 12% concentration level. Our results were also similar to Agatha *et al.* (2012) who found extractives from *Milicia excelsa*, *Albizia coriaria* and *Markhamia lutea* can increase termite resistance of susceptible woods up to 50% compared to control treatment.

Conclusion

Heartwood of *P. roxburghii* extracted with ethanol: toluene (2:1) yielded 7.40 % extractives. The results of this study showed a positive relationship between extractive contents and the resistance of termite which strongly proposes that these extractives can play a significant role in protecting not-durable woods from feeding by the subterranean termites. Moreover, this

also specifies that the durability can be relocated from a durable to a non-durable wood species. The maximum concentration was very efficient on both non-durable kinds of wood. Field trials of SYP and CW sapwood treated with *P. roxburghii* extractives are now under way

Acknowledgement

The authors wish to thank Craig Bell, USFS FPL Starkville, for the wood chunk and shaving preparation and Dr Hamid Borazjani, Mississippi State University, Nuclear Institute for Food and Agriculture (NIFA) for the use of laboratory facilities. The authors also appreciatively acknowledge the fiscal support of the Higher Education Commission of Pakistan (HEC) and the USDA-FS International Program, who approved a fellowship to conduct research.

References

- Agatha, S., Bananal, A.Y. and Nakabonge, G. (2012). Efficiency of natural wood extractives as wood preservatives against termite attack. *MaderasCiencia y Tecnología*. 14(2): 155–163.
- Akhtar, M.S. (1983). Wood destroying termites (Isoptera) of Pakistan: Key to the most important species their distribution and pattern of attack. *Materials and organisms*. 188: 277–291.
- American Wood Protection Association (2015). AWP A E1-15 Standard Method for Laboratory Evaluation to Determine Resistance to Subterranean Termites. AWP A Book of Standards pp.387–395. American Wood Protection Association. Birmingham, Alabama.
- Asamoah, A., Atta-Boateng, A., Frimpong-Mensah, K. and Antwi-Boasiako, C. (2011). Efficacy of extractives from parts of Ghanaian pawpaw, avocado and neem on the durability of *Alstonia*. *African Journal of Environmental Science and Technology*. 5(2): 131–135.
- Ates, S., Gur, M., Ozkan, O.E., Akça, M., Olgun, C. and Guder, A. (2015). Chemical contents and antifungal activity of some durable wood extractives vs. *Pleurotus ostreatus*. *BioRes.Technol.*10(2): 2433–2443.
- Chatterjee, A., Dhara, K.P., Rej, R.N. and Ghosh, P.C. (1977). Hexacosylferulate, a phenolic constituent of *Pinus roxburghii*. *Phytochemistry*. 16(3): 397–398.
- Chen, K., Ohmura, W., Doi, S. and Aoyama, M. (2004). Termite feeding deterrent from Japanese larchwood. *Bioresource Technology*. 95(2): 129–134.
- Dungani, R., Khalil, H.P.S.A., Naif, A. and Hermawan, D. (2012). Evaluation of antitermitic activity of different extracts obtained from Indonesian teakwood (*Tectona grandis*). *BioRes.Technol.* 7(2): 1452–1461.
- Evans, P. (2003). Emerging technologies in wood protection. *Forest Products Journal*. 53(1):142.
- Gonzalez, D.R., Martinez-Munoz, R.E., Ron-Echeverria, O.A., Flores-Garcia, A., MaciasRodriguez, L.I. and Pacheco, M.M.M. (2013). Dissuasive effect of an extract aqueous from *Enterolobium cyclocarpum* (Jacq) Griseb on the drywood termite *Incisitermes marginipennis* (Isoptera: Kalotermitidae) (Latreille). *Emirate Journal of Food and Agriculture*. 25(7): 524–530.
- Hassan, B., Mankowski, M.E., Kirker, G.T., Ahmed, S. Misbahulhaq, M. (2016). Antitermitic activities of Shisham (*Dalbergia sissoo* Roxb.) heartwood extractives against two termite species. 47th IRG Annual Meeting Lisbon, Portugal.
- Kadir, R., Ali, N.M., Soit, Z. and Khamaruddin, Z. (2014). Anti-termite potential of heartwood and bark extract and chemical compounds isolated from *Madhucautilis* Ridl.

- H.J. Lam and Neobalanocarpus heimii King P.S. Ashton. *Holzforchung*. 68(6): 713–720.
- Kaushik, D., Aggarwal, A., Kaushik, P., Mehra, R. and Rana, A. (2010). *Pinus roxburghii*-incredible gift in lap of himalayas. *Int. Journal of Pharmacognosy and Phytochemical Research*. 2(2): 29–35.
- Kirker, G.T., Clausen, C.A., Blodgett, A.B. and Lebow, S.T. (2013). Evaluating naturally durable wood species for repair and rehabilitation of above-ground components of covered bridges. General technical report FPL. 1–43 pp.
- Kityo, P. and Plumptre, R. (1997): The Uganda timber users' handbook: A guide to better timber use. Commonwealth Secretariat.
- Maiti, P.K. (2006). *Memoirs of the Zoological Survey of India*. 20 (4): 1-272.
- Morimoto, M., Fukumoto, H., Hiratani, M., Chavasiri, W. and Komai, K. (2006). Insect antifeedants, pterocarpol, in heartwood of *Pterocarpus macrocarpus* Kruz. *Bioscience Biotechnology Biochemistry*. 70: 1864–1868.
- Oliveira, L.S., Santana, A.L., Maranhão, C.A., Rita De Cássia, M., De Lima, V.L.A.G., Da Silva, S.I., Nascimento, M.S. and Bieber, L. (2010). Natural resistance of five woods to *Phanerochaete chrysosporium* degradation. *Int. Biodeterior. Biodegrad.* 64(8): 711–715.
- Roonwal, M.L. and Chhotani, O.B. (1989). *Zoological Survey of India*. 1 (8): 672.
- Salem, M.Z.M., Ali, H.M. and Basalah, M.O. (2014). Essential oils from wood, bark, and needles of *Pinus roxburghii* Sarg. From Alexandria, Egypt: Antibacterial and antioxidant activities. *BioRes.* 9(4): 7454–7466.
- Scheffer, T.C. and Morrell, J.J. (1998). Natural durability of wood: A worldwide checklist of species. Corvallis, Or: College of Forestry. Forest Research Laboratory. Oregon State University.
- Se Golpayegani, A., Thevenon, M.F., Gril, J., Masson, E. and Pourtahmasi, K. (2014). Toxicity potential in the extraneous compounds of white mulberry wood (*Morus alba*). *Maderas. Ciencia y Tecnologia*. 16(2): 227–238.
- Sharma, R.N., Tungikar, V.B., Pawar, P.V. and Vartak, P.H. (1994). Vapour toxicity and repellency of some oils and terpenoids to the termite *Odontotermes brunneus*. *Insect Science Application*. 15: 495–498.
- Sheikh, N., Manzoor, F., Ahmad, R., Naz, N. and Malik, S.A. (2008). Repellency and toxicity of insecticides against *H. indicola*. *Sociobiology*. 51(3): 749–764.
- Shuaib, M., Ali, M., Ahamad, J., Naquvi, K.J. and Ahmad, M.I. (2013). Pharmacognosy of *Pinus roxburghii*: A Review. *Journal of Pharmacognosy and Phytochemistry*. 2(1): 262
- Smith, V.K. (1979). Improved techniques designed for screening candidate termiticides in soil in the laboratory. *Journal of Economic Entomology*. 72: 877–879.
- Tascioglu, C., Yalcin, M., Troya, T.D. and Sivrikaya, H. (2012). Termiticidal properties of some wood and bark extracts used as wood preservatives. *BioRes. Technol.* 7 (3): 2960–2969.
- Tewari, D.N. (1994). A monograph on Chir Pine (*Pinus roxburghii* Sarg.). International Book Distributors.

EFFECT OF DEEP FREEZING AND AIR DRYING STORAGE ON CONTENT OF FATTY ACIDS OF ROSE HIP SEEDS

Mehmet GÜNEŞ^{1*}, Ümit DÖLEK², Göknur ŞAHİN³, Mahfuz ELMASTAŞ⁴

¹Gaziosmanpaşa University Agricultural Faculty Dep. of Horticulture, Tokat, Turkey

²Gökhöyük Vocational and Technical Anatolian High School, Amasya, Turkey

³Selçuk University Taşucu Vocational High School, İçel, Turkey

⁴Gaziosmanpaşa University Art and Science Faculty Dep. of Chemistry, Tokat, Turkey

*Corresponding author: mehmet.gunes@gop.edu.tr

Abstract

The aim of this study was to determine the effect of storage and time intervals on fatty acid composition of seeds of some promising genotypes belonging to different rose species. Study was carried out in research and treatment area of Horticultural Department of the Agricultural Faculty of the Gaziosmanpaşa University (Tokat/Turkey). Seeds of *Rosa dumalis*, *R. canina* and *R. villosa* rose hip species that selected as promising for domestication were used in the experiment. Mature fruits of rose hip genotypes were harvested then part of them dried and stored in dark room (20°C) and the other part of them stored in deep freezing (-20°C) conditions as fresh fruit. Fatty acid composition of the seeds of the species were analyzed three-month intervals during the full year. As a result; some changes occurred in fatty acids profile during storage period depending on species but it could not be determined any significant change depending on the storage media. Oleic, linoleic and linolenic acid contents were higher when compared to others in all the genotypes. However; it has been generally concluded that the protection methods do not have any important impact on the change of fatty acid ratios.

Key Words: *Rosa*, fatty acid profile, *dumalis*, *canina*, *villosa*.

Introduction

Another component of rose hip fruit needed to be utilized beside its pulp is its seeds. The seeds of rose hip constitute 30-40% of the weight of the fresh fruit. The seeds being removed away from the fruit in the process of retention are usually processed as waste product. However, the seeds of rose hip with fatty acids and other components they include both could be processed in the cosmetic industry and also be valued by being added into the feed of bovine and ovine as well as chicken (Nichita *et al.*, 1981; Macit *et al.*, 2003). In the process of storage, the change in the content of fatty acids of the seeds has importance in terms of cosmetics and nutritional value. Specifying of the chemical contents of the seeds of rose hip in parallel with the storage form and the storage process may contribute to more effective usage for different purposes. The essential fatty acids of the seeds of rose hip are linolenic, linoleic, oleic, stearic and palmitic acids. The fatty acid composition of the fat of the seeds of rose hip, showing change depending upon different factors, is generally in the proportion of 50% linoleic, 20% oleic, 15% linolenic, 6% palmitic, and 5% stearic acid (Ozcan, 2002; Ercisli *et al.*, 2007; Celik *et al.*, 2010a). Of these fatty acids, linoleic, linolenic, and oleic acids are unsaturated whereas palmitic and stearic ones are saturated fatty acids. It has been detected in a study conducted to determine the contents of fat and fatty acids of some species of rose hip belonging to the group ‘*Caninea*’ naturally growing in Poland that the results are quite different from each other; the average content of fat changes from 2,9% (*Rosa tomentosa*) to 5,9%. It has been determined that the fat of rose hip is high (59,5%) in terms of unsaturated fatty acids (PUFA), and is also low (0,3%) in terms of erucic acid. It has been detected that there is a strong correlation between the amount of erucic acid and linoleic acid (Adamczak *et al.*, 2011).

Rose hip cannot be processed immediately due to two important reasons. The first reason is the obligation of protection by freezing or drying in the period until the food factories or plants processing rose hip process their other raw materials. The second reason is that the substance of pectin existent in body of the fruit of rose hip causes to a more homogenous fracture after freezing and the attainment of

a more consistent product material. The reason for the mentioned consistency is due to the fact that a part of the cell juice is separated from the fruit after freezing and dissolution of the cell wall.

The main purpose of this study planned by taking into consideration the reasons for keeping the rose hip before processing is to determine the impact of drying rose hip in open air and storing it in deep freeze on the change of the fatty acid contents of its kernels.

Material and Methods

The study material consists of the seeds of hopeful genotypes belonging to the species of *Rosa dumalis* (MR-15), *Rosa canina* (MR-26) and *Rosa villosa* (MR-84) whose garden has been established in the research and implementation area at the Department of Horticulture of the Faculty of Agriculture (Gaziosmanpasa University) selected as the hopeful rose hip genotypes as a result of the study called "A Research on the Improvement of the Rose Hips (*Rosa spp.*) by Selection and Propagation With Cuttings, Wild Growing in Tokat Province" (Gunes, 1997). The study and implementation area of the Department of Horticulture of the Faculty of Agriculture (Gaziosmanpasa University) takes place in the city of Tokat (Turkey), campus of Tasliciftlik, in the northern latitude of +40° 20' 1.91" and in the eastern longitude of +36° 28' 38.44". The rose hip garden formed by the hopeful genotypes was established in 2000. The soil on which the garden was established has a slightly alkaline body. Genotypes were reproduced with cuttings, 3 plants belonging to each genotype were planted on condition that the order distance will be 3x3 m or more in the parcel. The garden was watered with drip irrigation system. The plants are regularly pruned in every year in January-February. No special breeding system has been applied in pruning; it has been carried out by combing out the branches which exceeded the pit, which was dry, which was competing with others and which had diseases. The garden was manured with farm and commercial manures in the establishment stage and in next years. The plants were disinfected with chemical struggle drugs in certain periods against the diseases, pesticides and especially the fruit worms every year.

Analysis has been made with the purpose of determining the phytochemical changes occurring during the conservation of rose hip genotypes by being frozen in deep freezer and dried in shadow environment under room conditions.

Fresh fruit samples having reached the technological crop maturation in rose hip genotypes have been taken and stored until the time of analysis as a part of them under dark ambience conditions at 20±2 °C by drying in shadow environment and the other part in the deep freezer at -18 °C. The analysis of fresh, frozen and dried fruits has been conducted for five times with the interval of three months. Analysis has three replications and the seeds of 20 fruits have been extracted in each replication and the analysis of fatty acids has been conducted.

The samples have been weighed as 5 grams and extracted with 10 ml hexane for 24 hours of duration in order to determine the fatty acid constituents of rose hip seed. At the end of this duration, the extract has been drained with vile filter paper and the filtrate has been evaporated at 40 °C. The obtained fatty has been kept at +4 °C till the analysis by being transferred to storage bottles of 5 mL.

The composition of fixed fatty acids has been done according to the method summarized in Turkekul *et al.*, (2006). Briefly, 30 mg has been weighed from the obtained fatty and it has been vortexed for 3 minutes by adding 1 M KOH solution prepared in 3 mL methanol. After waiting for 5-10 minutes in ambience conditions for the phases to separate, 1 mL hexane has been added and then analyzed with GC-FID directly after 0,5 mL has been taken from the supernatant. The proportion of each constituent in the fatty has been identified by the ratio of peak area. HP- innovax column as column 30m x 0,32 mm ID x 0.25µm film thickness), helium as carrier gas and FID as dedector (if needed MS) have been utilized. In the determination of fatty acids, standard fatty acids composition (*Supelco 37 Component FAME Mix*, 47885-U) .

The attained data have been exposed to statistical analysis in SPSS 15.0 as three replications. The differences between the averages in the variance analysis for the applications have been detected in %5 level ($P < 0.05$). The differences between the attained averages have been determined with Duncan multiple comparisons.

Results and Discussion

In the study; the analyses of the fatty acid contents of the fruits stored by freezing and drying have been conducted with the interval of three months during a year and they have been examined. As a result of the conducted analyses, the data belonging to the fatty acid ratios of the rose hip genotypes attained under various storage conditions and periods are submitted in Table 1, Table 2 and Table 3.

Linoleic acid has been determined as 48.74% and oleic acid has been determined as 39.40% in *Rosa dumalis*. While the ratio of oleic acid decreases depending on time, linoleic acid has increased. Both acid ratios have been found statistically important. Linolenic acid ratio has been determined between 13.60-19.40%, palmitic acid ratio has been determined between 3.47-8.44%, stearic acid ratio has been determined between 1.98-4.02%, arachidic acid ratio has been determined between 0.20-1.18%; cis-11.14-eicosadienoic acid ratio has been determined between 0.16-0.61%, benenic acid ratio has been determined between 0.01-0.25% and lignoseric acid ratio has been determined between 0.01-0.23% and they have been found statistically important (Table 1).

As it is in *Rosa dumalis*; oleic acid (40.33%) and linoleic acid (46.75%) have been attained in the highest ratio in *Rosa canina*. While the oleic acid ratio decreases depending on time when compared to fresh seed, linoleic acid ratio has increased depending on time. Both acid ratios have shown changes depending on time and this change have been found statistically important. Linolenic acid ratio has been determined between 11.79-14.25%, palmitic acid ratio has been determined between 3.70-9.21%, stearic acid ratio has been determined between 2.03-4.98%, arachidic acid ratio has been determined between 0.12-1.54%; cis-11.14-eicosadienoic acid ratio has been determined between 0.10-0.55%, benenic acid ratio has been determined between 0.01-0.20% and lignoseric acid ratio has been determined between 0.01-0.32% and they have been found statistically important (Table 2).

As it is in the other two species; oleic acid (38.19%) and linoleic acid (53.72%) have been attained in the highest ratio in *Rosa canina*. While the oleic acid ratio decreases depending on time when compared to fresh seed, linoleic acid ratio has increased depending on time. Both acid ratios have shown changes depending on time and this change have been found statistically important. Linolenic acid ratio has been determined between 13.04-17.30%, palmitic acid ratio has been determined between 3.59-5.59%, stearic acid ratio has been determined between 1.92-3.18%, arachidic acid ratio has been determined between 0.18-1.03%; cis-11.14-eicosadienoic acid ratio has been determined between 0.08-0.56%, benenic acid ratio has been determined between 0.06-0.23% and lignoseric acid ratio has been determined between 0.04-0.18% and they have been found statistically important (Table 3).

There are studies conducted in limited number both in our country and abroad regarding the fatty acids belonging to the kernel of rose hip. Among them; Yoruk *et al.*, (2008) have determined the linoleic acid content between 0.73-3.15 $\mu\text{g/g}$ and determined oleic acid content between 0.22-0.57 $\mu\text{g/g}$, Celik *et al.*, (2010a) have determined palmitic acid content between 4.25-5.15%, palmitoleic acid content between 0.22-0.89%, stearic acid content between 1.80-2.87%, oleic acid content between 20.35-23.03%, linoleic acid content between 41.14-51.06%, linolenic acid content between 19.66-23.03% and arachidic acid content between 0.94-1.29% $\mu\text{g/g}$. Adamczak *et al.*, (2011) have detected palmitic acid content between 2.72-4.08%, stearic acid content between 1.41-2.37%, oleic acid content between 11.12-16.28%, linoleic acid content between 33.54-41.01%, linolenic acid content between

12.72-25.65%, arachidic acid content between 0.20-0.51% and ve erucic acid content between 0,17-0,51%. In the analyses conducted in the kernels of some fruit species except for rose hip; as an example, Celik and Ercisli, (2009) have determined linoleic acid content in raspberry between 42.18-52.61% and linolenic acid content between 17.83-24.10%. In pistachio species; Dogan *et al.*, (2010) have detected the oleic acid content between 70.24%, linoleic acid content between 0.84-0.97%, palmitoleic acid content between 0.62-1.04%, arachidic acid content between 0.09-0.23% and gadoleic acid content between 0.15-0.25%. In different almond species growing in our country, it has been determined by Celik *et al.*, (2010b) that palmitic acid content is between 5.61-16.48%, palmitoleic acid content is between 0.32-0.69%, stearic acid content is between 1.23-3.89%, oleic acid content is between 68.99-81.71%, linoleic acid content is between 7.70-21.65%, linolenic acid content is between 0.08-0.21% and myristic acid content is between 0.22-0.91%. In another study conducted in different almond genotypes growing in our country; palmitic acid has been found between 6.29-6.48%, palmitoleic acid has been found between 0.41-0.64%, stearic acid has been found between 1.76-1.60%, oleic acid has been found between 72.02-76.41%, linoleic acid has been found between 18.92-21.65%, linolenic acid has been found between 0.07-0.09% and myristic acid has been found between 0.26-0.62% (Celik and Balta, 2011). Bayazit and Sumbul (2012) have reported in different walnut genotypes that palmitic acid is between 6.98-8.77%, stearic acid is 3.22-4.99%, oleic acid is between 19.33-36.76%, linoleic acid is between 41.55-59.89% and linolenic acid is between 8.44-11.0%. It has been expressed that the genotype and the environment and conditions of growing may cause to significant differences on the amount and ratios of the fatty acid (Sathe *et al.*, 2008). Yoruk *et al.*, (2008) have specified that the fatty acids may show differences depending on the ecological and environmental conditions and harvesting time. The values belonging to the fatty acids attained from the studies conducted on the rose hip and our findings have a general similarity. In our study; the difference between the fatty acid ratios of the species and genotypes grown under the same ecology has been found important. Oleic and linoleic fatty acid ratios have been found higher than other fatty acid ratios.

Conclusion

In general, fatty acid content has come out as decrease in the oleic, arachidic, eicosadienoic, benenic and lignoseric acid content and as increase in others during the protection process as of the commencement of storage (zero time). No important difference could be detected among the protection methods. The difference in fatty acids shows variability depending on the genotypes and acid species. Oleic, linoleic and linolenic acid contents are higher when compared to others in all the genotypes. However; it has been generally concluded that the protection methods do not have any important impact on the change of fatty acids.

Table 1. Effect of storage conditions and time intervals on fatty acid percentage of *Rosa dumalis*

Fatty Acid	Medium	0. month	3. month	6. month	9. month	12. month
Palmitic (c16:0)	Frozen	3.74b* ^A ^x	3.90bA	4.89bA	8.44aA	3.79bB
	Dried	3.74bA	3.48bB	6.88aA	5.69abA	3.76bB
Stearic (c18:0)	Frozen	1.98cA	2.63bcA	2.86bA	4.02aA	2.95bB
	Dried	1.98cA	2.52bcA	3.48aA	2.93abA	2.95abB
Oleic (c18:1n9c)	Frozen	39.40aA	24.41dA	27.66cA	30.12bA	26.99cA
	Dried	39.40aA	24.99cA	29.13bA	27.08bcB	26.92bcA
Linoleic (c18:2n6c)	Frozen	39.67bA	48.03aA	45.93aA	41.46bA	47.15aB
	Dried	39.67cA	48.09aA	43.13bcA	45.29abA	47.66aB
Linolenic (c18:3n3)	Frozen	13.60bA	19.40aA	17.99aA	14.51bB	18.54aA
	Dried	13.60cA	19.10aA	16.74bA	18.42abA	18.15abA

Arashidic (c20:0)	Frozen	0.83aA	0.89aA	0.25bA	0.44abA	0.33aA
	Dried	0.83aA	1.12aA	0.24bA	0.29bA	0.30bA
eicosadienoic (c20:2)	Frozen	0.40aA	0.37aA	0.22aA	0.61aA	0.16aB
	Dried	0.40aA	0.39aA	0.17bA	0.22bA	0.23bB
Behenic (c22:0)	Frozen	0.20aA	0.19aA	0.11aA	0.25aA	0.07aA
	Dried	0.20aA	0.16abA	0.15abA	0.05bcA	0.01cA
Lignoceric (c24:0)	Frozen	0.20abA	0.22aA	0.08abA	0.13abA	0.04bA
	Dried	0.20aA	0.16aA	0.08bA	0.03bA	0.02bA

*Difference between means in the same line with different small letters is significant at 0.05.

*Difference between means in column belonging the same character with different capital letters is significant at 0.05.

Table 2. Effect of storage conditions and time intervals on fatty acid percentage of *Rosa canina*

Fatty Acid	Medium	0. month	3. month	6. month	9. month	12. month
Palmitic (c16:0)	Frozen	3.70b* ^A ^x	4.13abA	8.89aA	9.21aA	4.12abA
	Dried	3.70bA	3.91bB	5.63abA	8.72aA	4.07bA
Stearic (c18:0)	Frozen	2.03cA	3.84bA	4.98aA	4.59abA	4.40abA
	Dried	2.03bA	3.86aA	4.16aA	4.43aA	4.46aA
Oleic (c18:1n9c)	Frozen	40.33aA	29.46cA	34.02bA	33.81bA	31.80bcA
	Dried	40.33aA	29.08cA	32.19bA	33.02bA	31.61bcA
Linoleic (c18:2n6c)	Frozen	38.74bA	46.40aA	39.59abA	39.81abA	46.03aA
	Dried	38.74cA	46.75aA	44.19abA	40.50bcA	45.98aA
Linolenic (c18:3n3)	Frozen	13.28abA	14.05aA	11.79bA	12.04bA	13.14abA
	Dried	13.28a,A	14.25a.A	13.29a.A	12.67a.A	13.32a.A
Arashidic (c20:0)	Frozen	1.01bA	1.54aA	0.12dA	0.25cA	0.36cA
	Dried	1.01bA	1.54aA	0.28cA	0.27cA	0.31cA
eicosadienoic (c20:2)	Frozen	0.55aA	0.32bA	0.10cA	0.16cA	0.12cA
	Dried	0.55aA	0.35bA	0.11cA	0.20cA	0.13cA
Behenic (c22:0)	Frozen	0.19abA	0.06abA	0.20aA	0.07abA	0.01bA
	Dried	0.19a,A	0.03b,A	0.14ab,A	0.10ab,A	0.08ab,A
Lignoceric (c24:0)	Frozen	0.17abA	0.20abA	0.32aA	0.06bA	0.03bA
	Dried	0.17abA	0.21aA	0.01cA	0.09bcA	0.06cA

*Difference between means in the same line with different small letters is significant at 0.05.

*Difference between means in column belonging the same character with different capital letters is significant at 0.05.

Table 3. Effect of storage conditions and time intervals on fatty acid percentage of *Rosa villosa*

Fatty Acid	Medium	0. month	3. month	6. month	9. month	12. month
Palmitic (c16:0)	Frozen	3.59b* ^A ^x	4.21bA	5.19aA	5.23aA	4.07bA
	Dried	3.59aA	3.91aA	4.47aA	5.59aA	4.13aA
Stearic (c18:0)	Frozen	1.92cA	2.51bB	2.84abA	3.06aA	2.92abB
	Dried	1.92cA	2.65abA	2.55bA	2.83abA	3.18aA
Oleic (c18:1n9c)	Frozen	38.19aA	21.28bA	23.27bA	23.92bA	23.08bA
	Dried	38.19aA	20.92cA	22.86bcA	22.98bcA	23.14bA
Linoleic (c18:2n6c)	Frozen	41.43bA	53.65aA	51.44aA	51.06aA	52.70aA
	Dried	41.43bA	53.72aA	52.66aA	51.08aA	52.50aA
Linolenic (c18:3n3)	Frozen	13.04cA	17.08aA	16.81abA	15.78bA	16.52abA
	Dried	13.04bA	17.30aA	17.00aA	17.07aA	16.26aA
Arashidic (c20:0)	Frozen	0.97aA	0.75aB	0.18bA	0.39bA	0.28bA
	Dried	0.97aA	1.03aA	0.19cA	0.20cA	0.29bA
eicosadienoic	Frozen	0.56aA	0.29abA	0.08bA	0.31abA	0.21bA

(c20:2)	Dried	0.56aA	0.28bA	0.11cA	0.15cA	0.23bcA
Behenic (c22:0)	Frozen	0.18aA	0.12aA	0.10aA	0.23aA	0.10aA
	Dried	0.18aA	0.06bA	0.12abA	0.09abA	0.10abA
Lignoceric (c24:0)	Frozen	0.14aA	0.12aB	0.12aA	0.04bA	0.13aA
	Dried	0.14aA	0.18aA	0.06aA	0.04aA	0.18aA

*Difference between means in the same line with different small letters is significant at 0.05.

^aDifference between means in column belonging the same character with different capital letters is significant at 0.05.

References

- Adamczak, A., Grys, A., Buchwald, W. and Zielinski, J., 2011. Content of Oil and Main Fatty Acids in Hips of Rose Species Native in Poland. *Dendrobiology* 2011, Vol. 66, 55-62.
- Bayazit, S. and Sumbul, A., 2012. Determination of Fruit Quality and Fatty Acid Composition of Turkish Walnut (*Juglans regia*) Cultivars and Genotypes Grown in Subtropical Climate of Eastern Mediterranean Region. *International Journal of Agriculture and Biology*, 14(3): 419-424.
- Celik, F. and Ercisli, S., 2009. Lipid and Fatty Acid Composition of Wild and Cultivated Red Raspberry Fruits (*Rubus idaeus L.*). *Journal of Medicinal Plants Research*, Vol. 3(8), 583-585.
- Celik, F., Balta, M.F., Ercisli, S., Kazankaya, A. and Javidipour, I., 2010a. Seed Oil Profiles of Five Rose Hip Species (*Rosa spp.*) From Hakkari, Turkey. *Journal of Food, Agriculture & Environment* Vol.8 (2):482-484.
- Celik, F., Balta, M.F., Javidipour, I. and Dogan, A., 2010b. Analysis of Oil Composition of Native Almonds From Turkey. *Asian Journal of Chemistry*, Vol. 22 (1): 818-820.
- Celik, F. and Balta, M.F., 2011. Kernel Fatty Acid Composition of Turkish Almond (*Prunus dulcis*) Genotypes: A Region Comparison. *Journal of Food, Agriculture & Environment*, Vol. 9(1): 171-174.
- Dogan, A., Celik, F., Balta, F., Javidipour, I. and Yavic, A., 2010. Analysis of Fatty Acid Profiles of Pistachios (*Pistacia vera L.*) and Native Walnuts (*Juglans regia L.*) From Turkey. *Asian Journal of Chemistry*, Vol 22 (1), 517-521.
- Ercisli, S. Orhan, E. and Esitken, A., 2007. Fatty Acid Composition of Rosa Species Seeds in Turkey. *Chemistry of Natural Compounds*, Vol. 43 No:5.
- Gunes, M., 1997. A Research on the Improvement of the Rose Hips (*Rosa spp.*) by Selection and Propagation With Cuttings, Wild Growing in Tokat Province. (Doktoral Thesis). Yuzuncu Yil University, Applied Science Institute, Van.
- Macit, M. Demirel M. Bakici, Y. and Erdogan, S. 2003. Determination of Rumen Degradability of Rosa Canina Seed by Nylon-Bag Technique. *Journal of Ataturk Univ. Agricultural Faculty*. 34 (3), 233-237.
- Nichita, G., Saradan, H., Padeanu, I., Casaleanu, I. and Gogoloiu, C., 1981. Eglantine (*Rosa canina*) Seeds For Feeding Broiler Chickens and Lambs. *Nutrition Abstr. and Reviews*, Series-B 1984 054-04651.
- Ozcan, M. 2002. Nutrient Composition of Rose (*Rosa canina L.*) Seed and Oils. *Journal of Medicinal Food*, Vol.5, (3):137-140.
- Sathe, S.K., Seram, N.P., Kshirsagar, H.H., Heber, D. and Lapsley, K.A., 2008. Fatty Acid Composition of California Grown Almonds. *Journal of Food Science* 73:603-614.
- Turkecul, I., Yilmaz, N., Sahin F. and Bayrak, O.F., 2006. Fatty Acid Composition of Six Mushroom Samples of Black Sea Region of Turkey. *Asian Journal of Chemistry*, 22 (2), 1479-1486.
- Yoruk, İ.H., Turker, M., Kazankaya, A., Erez, M.E., Battal, P., Celik, F., 2008. Fatty Acid, Sugar and Vitamin Contents in Rose hip Species. *Asian Journal of Chemistry* 20 (2), pp. 1357-1364.

SEASONAL OCCURRENCE OF THRIPS ON TABLE GRAPES IN NORTHERN ALGERIAN VINEYARDS

Sabah RAZI^{1*}, Farid BOUNACEUR^{2*}, Fatima Zohra BISSAAD³, Bahia DOUMANDJIMITICHE⁴

¹Laboratory of improvement of the phytosanitary techniques of protection in mountainous agro-system: case of Aures Mountain . Department of Agricultural Sciences, Science faculty, Mohamed Khider University, Biskra, Algeria

²Laboratory of Agrobiotechnology and nutrition in semi-arid areas, Faculty of Agricultural and Veterinary Sciences. University Ibn Khaldoun Tiaret. Algeria

³Laboratory Technologies Soft, Promotion, Physical Chemistry of Biological Materials And Biodiversity, Science Faculty, University M'Hamed Bougara, BP 35000 Boumerdes, Algeria.

⁴Agricultural Zoology Department, National School of Agronomy El Harrach, Algeria

*Corresponding authors: fbounaceur@yahoo.fr, sabah_razi@yahoo.fr

Abstract

Grape vine is an important crop in Algeria, it is harmed by many pests, thrips are among them. There is a lack of knowledge of pest thrips species of grape vine in this country. The aim of this study is to identify these species in some Algerian vineyards. A survey of thrips on grape vine was conducted during 2013 on three vineyards located in Mitidja, Tipaza and Isser areas (north Algeria). Leaves and flowers of grape vine were sampled for thrips, from March to November, each two weeks at the same day. Each vineyard was composed by 3300 grape vines, 6 plots, where 200 leaves are sampled from each plot; 50 plants are chosen aleatory, four leaves per plant are sampled following Bastide (1989) method. Thrips are separated, counted, mounted on slides, and identified using authors keys. The data shows the presence of four thrips species, three belonging to the Thripidae family (*Frankliniella occidentalis*, *Drepanothrips reuteri*, *Aeolothrips fasciatus*) and one species belongs to the Phlaeothripidae family (*Liothrips sp.*). The most abundant species are *Frankliniella occidentalis* and *Drepanothrips reuteri*.

Key words: *thrips, table grapes, occurrence, vineyards, Algeria*

Introduction

Grape vine culture is the fourth important perennial crop in Algeria in terms of surface occupation and it is ranked in the second place in terms of exportation (Anonymous, 2006). Vineyards are attacked by a number of pest organisms such as whiteflies, mites and thrips (Bounaceur, 2010).

Thrips are insect belonging to the order of Thysanoptera, with fringed wings, known as cosmopolitan insects. They are slender and tiny, measuring 0.1 to 15 mm in length, and have a singular buccal apparatus of which only the right mandible is fully developed (Mound and Marullo, 1986).

There are around 7400 thrips species worldwide, of which 1% is identified as agriculturally important pests, and most of these belong to the Thripidae (Mound and Marullo 1996; Mound 1997). This insect harms plant by feeding and piercing cells with their mouthparts and sucking out the cellular contents or by transmitting diseases.

Thrips are not commonly recognized as being a problem in Algeria. However, there is a lack of knowledge regarding the most common thrips species on Algerian crops and vineyards. The proper identification of insect pests is fundamental for their effective control and their ability to transmit phytopathogenic viruses makes necessary to identify the species associated with crops, as well as to describe the damage. The aim of this study was to determine the

species of thrips (Thysanoptera) present on vineyard crops in 3 zones (Mitidja, Tipaza and Isser) located in north Algeria.

Material and methods

The study was conducted in three vineyards; one vineyard is located in Mitidja plain, the second is located in Tipaza and the third one is located in Isser, from March to November 2013. Each vineyard was composed by 3300 grape vines, divided on 6 plots, 200 leaves are collected from each plot (50 plant are chosen aleatory, where four leaves per plant are sampled following Bastide (1989) method). Thrips are collected from flowers also, one flower is cut from the same vine where leaves are sampled. The samples were stored in labelled zip bag and transferred immediately to the laboratory of animal ecology at Tiaret university. Thrips were sampled each two weeks at the same day.

The leaves and flowers collected from the vineyards are washed for thrips extraction. These insects are removed using a fin brush into a labeled vials containing Ethanol at 70%.

All thrips collected were examined under dissecting microscope, counted and separated using their morphologic criteria for identification. Then, they are mounted on slides with Hoyer's medium (50ml water, 30g gum arabic, 200g chloral hydrate, 20ml glycerine), and identified under a compound microscope using published keys (e.g., Mound and Kebby, 1998; Moritz, 1994) at the laboratory of zoology of Biskra university

Results and discussion

Four thrips species are identified in the three vineyards. Two species (*Frankliniella occidentalis* and *Drepanothrips reuteri*) belong to the Thripidae family (at the rate of 82%), one (*Aeolothrips fasciatus*) specie to the Aeolothripidae (at the rate of 10%), and the last one to the Phlaeothripidae family (*Liothrips sp*) at the rate of 8% (Table 1).

Table 1. Taxonomy of thrips species found at the vineyard of the three sites and their occurrence

Species	Family	Occurrence
<i>Frankliniella occidentalis</i>	Thripidae	82%
<i>Drepanothrips reuteri</i>		
<i>Aeolothrips fasciatus</i>	Aeolothripida	10%
<i>Liothrips sp</i>	Phlaeothripidae	8%

A high part of thrips individuals were collected from flowers (95% of *F. occidentalis*, 85% of *D. reuteri* and 65% of *A. fasciatus*) (Table 2).

Table 2. Thrips species occurrence on the leaves and flowers

Species	Leaves (%)	Flowers (%)
<i>Frankiniellela occidentalis</i>	5	95
<i>Drepanothrips reuteri</i>	15	85
<i>Aeolothrips fasciatus</i>	35	65
<i>Liothrips sp</i>	45	55

Also the data shows that *F. occidentalis* presents an important population level from the beginning of sampling, until the end, with the total average of 120 thrips. The number of thrips is raising to show two peaks, the first one (with the average of 39 individual) during the second decade of April, and the second (with the average of 63,13 individuals) by the first

June. Afterwards, it falls to the end of the season, with an average of 25 individuals (Table 3). However, for *Drepanothrips reuteri* similar observations were taken with high population in April with 110 individuals to raise to 15 individuals in September.

Table 3: Evolution of Thrips *Frankiniellela occidentalis* and *Drepanothrips reuteri* populations on Table grapes in Mitidja vineyards

Species	March	April	May	Jun	July	August	Septembre
<i>Frankiniellela occidentalis</i>	39	120	117	95	65	35	25
<i>Drepanothrips reuteri</i>	29	110	92	78	62	28	15

This study shows the presence of four thrips species in grape vine at the north of Algeria, the same species are recorded on citrus plant by Belaam and Boulaehia-kheder (2012) in Tunisia, and by zur Strassen (1968) in Morocco. Lewis (1973) reported that Thrips are known as polyphagous pests, they can have several host plants and attack different parts of the vegetal (Mound, 1997).

The two important species *Frankliniella occidentalis* and *Drepanothrips reuteri* are phytophagous species, they are the more abundant in the three vineyards, and are responsible for serious damages (Bournier, 1957; 1983).

F.occidentalis is recorded in grapes vine at the Mediterranean region by Ciampolini *et al.*, (1990) ; Guarino and Laccone (1996) ; Moleas *et al.*, (1996) and Laccone and Guarino (2000) and also in South Africa by Allsop (2010). For *F. occidentalis*, this thrips breeds and feeds on leaves and also flowers, it is recorded in fava bean crop at an arid region of Algeria by Razi *et al.*, (2013). It can transmit tospovirus diseases. It is a highly polyphagous pest (Lewis, 1997).

For *Drepanothrips reuteri*, this species is known to be specific to vineyard table (Lacasa, 1989; Lacasa and Llorens, 1996). Recorded the first time from North America, it causes a scarring of the fruits resulting from feeding (Bailey, 1942). Damages on the leaves and the flowers were recorded by Bailey (1942), Bournier (1957), Roditakis and Roditakis (2007). For *Aeolothrips fasciatus* and *Liothrips sp* there are no recorded damages for this species; but the first one is recorded as predatory species (Bournier, 2002).

Conclusion

Various thrips species were found at table grapes in the vineyards of north Algeria, four phytophagous species are recorded: *Frankiniellela occidentalis*, *Drepanothrips reutei*, and *Aeolothrips fasciatus* and another unknown Phlaeothripidae (*Liothrips sp*).

Frankiniellela occidentalis and *Drepanothrips reuteri* are the most abundant species they may be classified as harmful organisms for this crop.

References

- Allespo E., 2010. Seasonal Occurrence of Western Flower Thrips, *Frankliniella occidentalis* (Pergrande), on Table Grapes in the Hex River Valley, South Africa. S. Afr. Ent. Viti. Vol.31.1 :49-57.
- Anonymous., 2006. Agricultural Statistics. 45p.
- Bailey, S. F., 1942. The grape or vine Thrips, *Drepanothrips reuteri*. J. Econ. Ent. 35, 382–386.
- Belaam I. & Boulaehia-kheder S., 2012. Inventory of Thrips Species in Citrus Orchards and Assessment of Scarring Fruits in two Citrus-Producing Regions of Tunisia. *Tunisian J. Plant. Prot.* Tunis. 7(1):34-35.
- Bounaceur F., 2010. Saptio- temporal dynamic and damages of *Lobesia botrana* (Denis & Schiffermuller, 1776) (Lepidoptera : Tortricidae), *Jacobisca lybica* (Bergerin & Zanon,

- 1922), (Hemiptera : Jassidae) and *Planococcus ficus* (Signoret, 1875) (Hemiptera : Pseudococcidae) in grape vine orchards at Mitidja . Doctorat Thesis in agricultural science. ENSA. El Harrach. Algeria, 134p.
- Bournier A., 1957. *Drepanothrips reuteri* Uzel. Thrips of grape vine . *Annales de l'Ecole Nationale d'agriculture de Montpellier*, 30:145-157.
- Bournier A., 1983. *Thrips, biology. agronomic importance*. Ed INRA, 128p.
- Ciampolini M., Perrini S. & Tumino S., 1990. Severe damage by thrips to table grapes in southern Italy. *Inf. Agrar*, 47:127-131.
- Guario A. & Laccone G., 1996. The defence of table grape from pests. *Inf. Agrar. Suppl.* 52 :31-40.
- Lacasa P.A., 1989. Thrips associated with protected crops southeast spanish. National Symposium on protected cultivars. Almeria, Spain 25p.
- Lacasa A. & Llorens J.M., 1996. Thrips and biological control. Tomo I.Ed. Council of Environment, Agriculture and Water. Series technical Divulagation, n°17.Murcia, Espana 9p.
- Laccone G. & Guario A., 2000. Plant health balance for dessert grapes in the year 2000. *Inf Agrar.Suppl.*56: 46-49.
- Lewis T., 1973. Thrips, their biology, ecology and economic importance, Academic Press London & New York Inc. 349p.
- Lewis T., 1997. Thrips as crop pests, Cab. International. UK, 740p.
- Moleas T., Baldacchino F. & Addante R., 1996. Integrated control of *Frankliniella occidentalis* (Pergande) on table grape in 1992-94. *Difesa Piante* 19: 41-48.
- Moritz G., 1994. Pictorial key to the economically species of Thysanoptera in central Europe. *Bull.OEPP\EPPO Bull.* 24, 181-208.
- Mound, L.A., Kibby G. & 1998. Thysanoptera, An identification guide. 2nd Ed.,CAB.INTERN, 70p.
- Mound L.A., 2007. Thysanoptera (Thrips) of the World – a Checklist. Commonwealth Scientific and Industrial Research Organization, Entomology, Canberra, Australia. <http://www.ento.csiro.au/thysanoptera/worldthrips.html>.
- Razi S. Lamari M. Ouamen S, & Bernard E.C. 2013 Thysanoptera survey on *Vicia faba* (broad bean) in the arid Biskra region of Algeria *Agriculture and Biology Journal of North America*.4(3):268.274
- Roditakis, E. & Roditakis, N. E., 2007. Assessment of the damage potential of three thrips species on white variety table grapes. In vitro experiments. *Crop Protection* 26, 476–483.
- Saxena MC., 1999. Status and scope for production of faba bean in the Mediterranean countries. *Options Méditerranéennes, Ser. Séminaires*; 10 : 15-20.
- Stockel J., 2000. The grape vine pests. (J.Stockel ed). Editons Féret. Bordeaux.

SEASONAL DYNAMICS OF AEROALERGENIC WEED POLLEN IN BANJA LUKA CITY AREA (BOSNIA AND HERZEGOVINA) DURING 2011-2015

Gordana BABIĆ*, Bojana ĆURKOVIĆ, Vojislav TRKULJA

Public institution „Agricultural institute of Republic of Srpska, Banja Luka“, Bosnia and Herzegovina

*Corresponding author: brkljacg@hotmail.com

Abstract

Around the world as well as in our area, in recent years, phytoallergens, which include taxa of various botanical families, present actual social and health problem. In that sense determination and monitoring the pollen types and pollen counts in the aero plankton of cities is of relevant medical importance. Considering the mentioned issues, as well as the results of monitoring carried out in previous years, the main objective of the study was to analyze the seasonal dynamics of aero allergenic weed pollen in Banja Luka area during the five- year period 2011-2015. Sampling of aero allergenic weed pollen during the pollination period 2011-2015 is conducted in urban, industrial part of Banja Luka in the Public Institution “Agricultural Institute of the Republic of Srpska, Banja Luka” (PI AIRS, BL) (N 44°47'41.0'', E 017°12'22.6'') with Hirst's pollenometer type (Hirst, 1952) using the method defined by the International Association for Aerobiology (IAA). Comparative analysis showed that among weed pollen the most dominant was ragweed pollen on an annual level during the five year monitoring of weed pollen in Banja Luka.

Keywords: *seasonal dynamics, pollen aeroallergens, weed, Banja Luka*

Introduction

Phytoallergens include taxon of various botanical families. According to their migration they are classified on anemophilous or entomophilous allergens. Anemophilous species, often causing allergic diseases, produce a huge quantity of readily airborne pollen grains (Bartkova-Ščevkova, 2003). It is now known that pollen grains of several plant groups such as *Alnus* spp., *Betula* spp., *Cupressaceae*, *Quercus* spp., *Platanus* spp., *Juglans* spp., *Moraceae*, *Pinus* spp., *Fraxinus* spp., *Acer* spp., *Corylus* spp., *Gramineae*, *Chenopodiaceae/Amaranthaceae*, *Urticaceae*, *Compositae*, *Plantago* spp., *Artemisia* spp., *Rumex* spp. and *Umbelliferae* cause allergic reactions in people (Levetin & Buck, 1980; Bousquet *et al.*, 1984; Eriksson *et al.*, 1984; D'Amato & Spiekma, 1990; Spiekma, 1990). Among these species, according to Hao *et al.* (2013), pollen from weeds is common source of allergens worldwide. The most well described wind pollinated genera are *Artemisia* (mugwort) and *Ambrosia* (ragweed) belonging to the family *Asteraceae*. The problem of human sensitivity to allergenic pollen around the world is characterized by increasing trend. A recent survey shows that in USA 2–10% of the residents were affected by pollinosis, in Europe the incidence has increased from 1% at the beginning of the 20th century to current 20% (Dai *et al.*, 2000), and will even be approximately 35% in the next two decades (Editorial, 1999). Research conducted in the ten-year period (2001-2010) in Clinical Center Banja Luka (B&H) pointed out to positive results of skin "Prick" test, where 88% of the surveyed population is allergic to plant pollen. From that percent 17.2% is allergic to trees pollen, 32.1% to grass pollen and 38.7% to weeds pollen, of which 28, 9% is allergic to the ragweed pollen (Balaban & Balaban, 2012). Considering the above mentioned issues, as well as that mugwort comprises several closely related species of which *A. vulgaris* is the most widespread across Europe (Oberhuber *et al.*,

2008), but also fact that on the annual level total amount of *Ambrosia artemisiifolia* pollen exceeds the amount of all other plants with the exception of grass (Medzinradsky *et* Jarai-Komlodi, 1995), the main aim of this study was to analyze the seasonal dynamics of aero allergenic weed pollen during five year period, from 2011 to 2015.

Material and method

Sampling of aero allergenic weed pollen during the pollination period 2011-2015 was conducted in urban, industrial part of Banja Luka in the PI Agricultural Institute of the Republic of Srpska, Banja Luka (N 44°47'41.0'', E 017°12'22.6'') with Hirst type sampler (Hirst, 1952), using the method defined by the International Association for Aerobiology (IAA). The trap brand Burkard (Burkard Manufacturing Co., Uxbridge, Middlesex, England) was calibrated for sampling 10 l/min of air through an orifice of 14 x 2 mm in diameter, that is always pointed in the direction of wind and protected from direct rainfall. As air passing through the orifice, pollen grains are fixed on glass slides coated with silicone gel, which moves at a speed of 2 mm/h. Visual identification of representative samples of aero allergenic weed pollen was performed daily during the pollination period, based on morphological characteristics under a light microscope Olympus BX51 at magnification x400. Just before reading, 24 hour segment of microscopic slide area was prepared by placing the substrate polyvinyl alcohol (Gelvatol), phenol, glycerol and color Fuxin that allows staining of pollen grains, and makes easier to distinguish pollen grains from the dust and fungi spores. After preparation and drying of microscopic preparation slides, determining the number of pollen grains is carried by the method of longitudinal lines at two hour intervals, by reviewing three horizontal lines, with the determination of ragweed pollen grains (p/m³) performed by translating obtained numbers with correction factor (F). The results are presented to the public media in the form of aero pallinological reports or so called "Pollen forecast" on the official web site of City of Banja Luka (Table 1).

Table 1. Number of ragweed pollen grains in the air with the corresponding percentage of persons in whose is possible occurrence of symptoms of allergic reactions Forsyth County Environmental Affairs Department Pollen Rating Scale, PRS)

Level of pollen	Number of pollen grains /m ³ air	Occurrence of symptoms of allergic reactions
	Weeds	
Not present	0	No symptoms
Low	1-10	Only in extremely sensitive individuals
Moderate	11-50	In 50% of sensitive individuals
High	51-500	Almost all allergic people
Very high	>500	In all allergic people

Results and discussion

During the five-year monitoring (2011-2015) of aeroallergen weed pollen in the city of Banja Luka seasonal dynamics, i.e. the beginning, duration and end of the pollination period with presenting daily low, moderate, high or very high concentrations, as well as a total weed pollen number on annual level (p/m³) was monitored. Among the types of aeroallergen weed pollen in the area of Banja Luka during the pollination period 2011-2015, monitoring included six weed species from five families: *Ambrosia artemisiifolia* (ragweed) and *Artemisia vulgaris* (mugwort) from *Asteraceae* family, *Chenopodium album* (moldweed) from *Amaranthaceae* family, *Plantago* sp. (plantain) from *Plantaginaceae* family, *Rumex* sp. (sorrel) from *Polygonaceae* family and *Urtica dioica* (nettle) from the *Urticaceae* family.

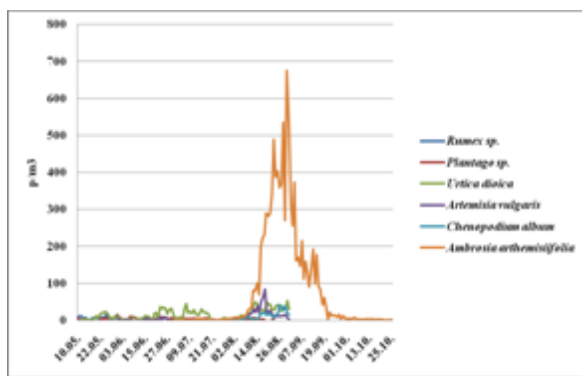

Photo 3. Seasonal dynamic of weed species pollination in 2011

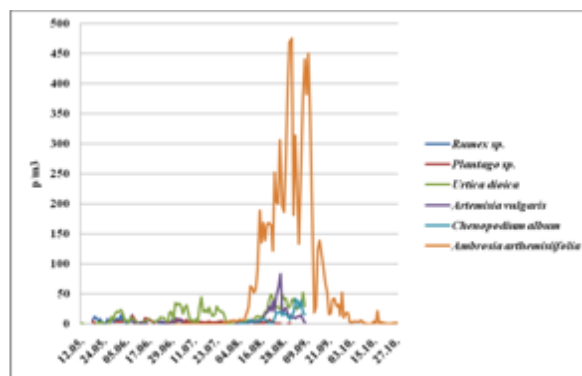

Photo 4. Seasonal dynamic of weed species pollination in 2012

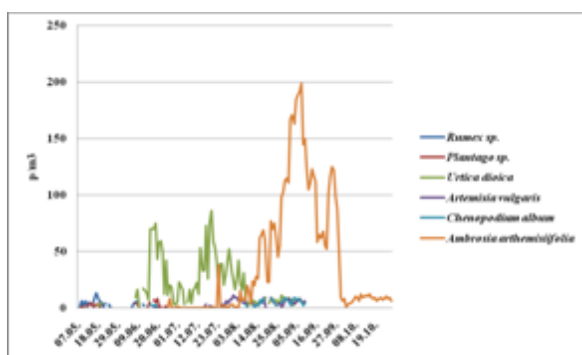

Photo 5. Seasonal dynamic of weed species pollination in 2013

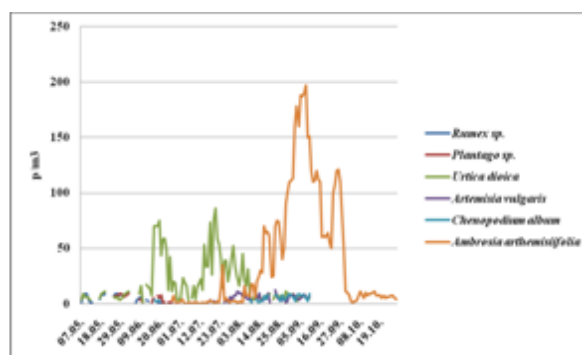

Photo 6. Seasonal dynamic of weed species pollination in 2014

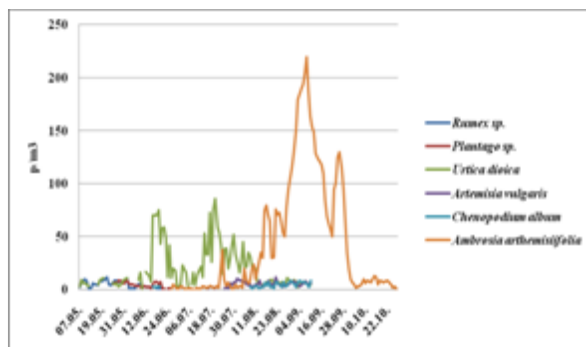

Photo 7. Seasonal dynamic of weed species pollination in 2015

During the five year monitoring, beginning of pollination season of aero allergenic weed species in Banja Luka has been recorded from the first decade of May with exception in 2012. In 2012 the beginning of weed pollination started in second decade of May, while the season of pollination lasted until third decade of October. Pollination season of *Rumex* sp. (sorrel) from *Polygonaceae* family, among the first aero allergenic weed pollen, lasted in average 60 days and it was characterized by low to moderate concentration. In case of *Urtica dioica* (nettle) from *Urticaceae* family, as well among the first aero allergenic weed pollen, pollination season lasted in average 105 days and it was characterized by low to moderate concentration during 2011 and 2012. From 2013 to 2015 high concentration was recorded during ten days period with high temperature. Aero allergenic pollen of *Plantago* sp. (plantain) from *Plantaginaceae* family was characterized by low to moderate concentration in five year monitoring. Pollination season lasted in average 49 days and during 2011 and 2013 first pollen grains were recorded in first decade of May, in 2012 in second decade of May and in 2014 and 2015 pollination season started in third decade of May. First

grain pollen of *Artemisia vulgaris* (mugwort) from *Asteraceae* family was recorded in the end of May in 2011, in the first decade of June in 2012, and during 2013 – 2015 in second decade of June. Pollination season lasted in average 55 days and it was characterized by low to moderate concentration. In case of *Chenopodium album* (moldweed) from *Amaranthaceae* family pollination season lasted in average 36 days and it was characterized by low to moderate concentration. The longest period of pollination season was recorded in *Ambrosia artemisiifolia* (ragweed) from *Asteraceae* family. In average it lasted 115 days. The highest concentration was recorded during second decade of August until the third decade of September. Very high concentration, above 501 p/m³, was recorded only in 2011 (photo 3-7). On annual level not only *Ambrosia artemisiifolia* (ragweed) had a longest pollination season, but monitoring results and comparative analysis showed also that the highest portion of weed pollen grains belongs to the ragweed pollen respectively (photo 8-12).

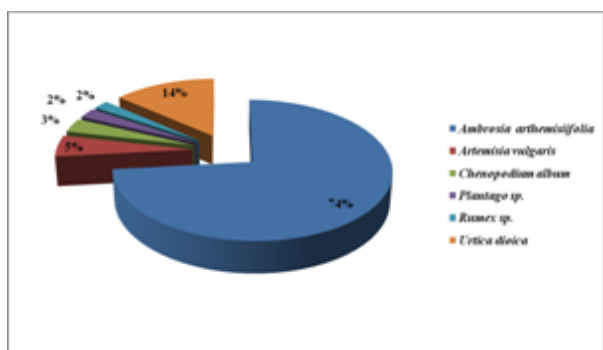

Photo 8. Comparative analysis of weed pollen grains in 2011

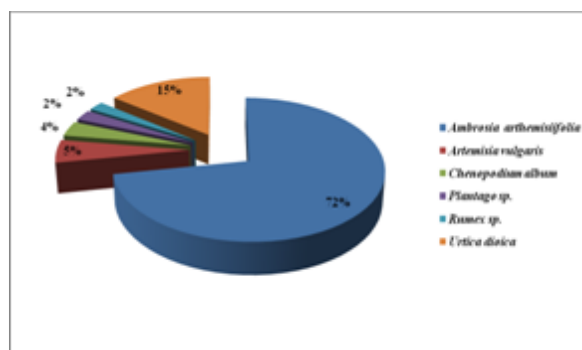

Photo 9. Comparative analysis of weed pollen grains in 2012

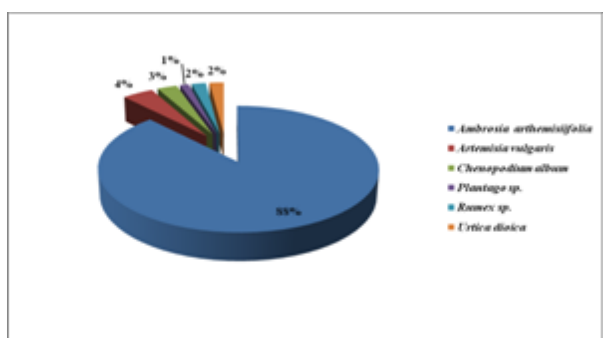

Photo 10. Comparative analysis of weed pollen grains in 2013

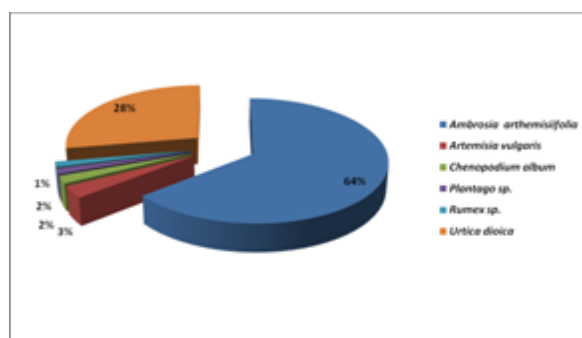

Photo 11. Comparative analysis of weed pollen grains in 2014

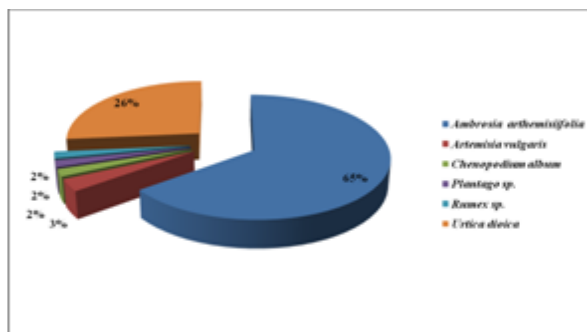

Photo 12. Comparative analysis of weed pollen grains in 2015

Conclusion

Regarding the current research in the studied region, conducted monitoring and comparative analysis of aero allergenic weed pollen in the period from 2011 to 2015 pointed out to a significantly domination of ragweed pollen. Hence *Ambrosia artemisiifolia* L. is considered as a biological pollutant responsible for severe allergic diseases (Déchamp *et* Méon, 2003), as well as facts that ragweed represents one of the most invasive weeds in our area, can move at up to 300 km (Jones, 1953; Comtois, 1998; Deen *et al.*, 1998, Genton *et al.*, 2005, Trkulja *et al.*, 2010) to large distance of 10 to 100 km, clinical thresholds that lead to the symptoms of allergy etc., further monitoring process for our area on local level is of a great social and medical importance.

References

- Balaban J., Balaban M. (2012). The pollen profile and patients pollen allergy in a Clinical center of Banja Luka. The first International Congress of Ecologists. Proceedings: University of Business Studies, Banja Luka, Ecological Spectrum, 1: 101–111.
- Bartkova-Ščevkova J. (2003). The influence of temperature, relative humidity and rainfall on the occurrence of pollen allergens (*Betula*, *Poaceae*, *Ambrosia artemisiifolia*) in the atmosphere of Bratislava (Slovakia). *Int J Biometeorol.* 48: 1–5.
- Bousquet J., Cour P., Guerin B. & Michel F.B. (1984). Allergy in the Mediterranean area. I. Pollen counts and pollinosis of Montpellier. *Clin Allergy* 14: 249–258.
- Comtois P. (1998). Ragweed (*Ambrosia* sp.) the Phoenix of allergophytes. 6th International Congress on Aerobiology. Satellite Symposium Proceedings, Ragweed in Europe, Perugia, Italy, ALK Abelló.
- Dai L. P., Lu C. (2000). Spring pollens and observation techniques. *Meteorological Monthly*, 26 (12): 49–52.
- D'Amato G. & Spiekma FThM (1990). Allergenic pollen in Europea. *Grana* 30: 67–70.
- Déchamp C., Méon H. (2003). *Ambrosia*, *Ambrosie*, polluants biologiques. Lyon, Edition ARPPAM, 238 pp.
- Deen W., Hunt A. L., Swanton J. C. (1998). Photothermal time describes common ragweed (*Ambrosia artemisiifolia* L) phenological development and growth. *Weed Science*, 46: 561–568.
- Eriksson N. E., Wihl J. A., Arrendal H., Strandhede S. O. (1984). Tree pollen allergy. *Allergy* 39: 610–617.
- Editorial (1999). Grass pollen: trends and prediction. *Clinical and Experimental Allergy*, 29: 735–738.
- Genton B. J., Shykoff J. A., Girand T. (2005). High genetic diversity in French invasive populations of common ragweed *Ambrosia artemisiifolia*, as a result of multiple sources of introduction. *Molecular Ecology*, 14: 4275–4285.
- Hao G., Zheng Y., Gjesing B., Kong X., Wang J., Song Z., Lai X., Zhong N., Spangfort M. D. (2013). Prevalence of sensitization to weed pollens of *Humulus scandens*, *Artemisia vulgaris* and *Ambrosia artemisiifolia* in Northern China. *J Zhejiang Univ-Sci B (Biomed & Biotechnol)*, 14 (3): 240–246.
- Hirst J. M. (1952). An automatic volumetric spore trap. *Ann Appl Biol*, 39: 257.
- Jones H. L. (1953). Frenching of ragweed (*Ambrosia artemisiifolia* L.). *Plant Physiology*, 28: 123–126.
- Levetin E., Buck P. (1980). Hay fever plants in Oklahoma. *Ann Allergy* 45: 26–32.
- Medzinradsky Z., Jaraji-KKlomodi M. (1995). I came from America – my name is *Ambrosia* – some feature of ragweed. Proc. 9 th Symp. EWRS, Budapest, 57–64.
- Oberhuber C., Ma Y., Wopfner N., Gadermaier G., Dedic A., Niggemann B., Maderegger B., Gruber P., Ferreira F., Scheiner O. (2008). Prevalence of IgE-binding to Art v 1, Art v 4

- and Amb a 1 in mugwort-allergic patients. *Int Arch Allergy Immunol*: 145 (2): 94–101. doi: 10.1159/000108134.
- Spijksma F. T. M. (1990). Pollinosis in Europe: new observations and developments. *Rev Paleobot Palynol*, 64: 35–40.
- Trkulja V., Ostojić I., Škrbić R., Herceg N., Petrović D., Kovačević Z. (2010). Ambrozija. Društvo za zaštitu bilja u Bosni i Hercegovini, Banja Luka.

HERBICIDE EFFICIENCY TESTING IN SOYBEAN DURING 2014 AND 2015– COOPERATIVE DANUBE-SOYA PROGRAM

Gordana BABIĆ*, Bojana ĆURKOVIĆ, Vojislav TRKULJA, Miloš NOŽINIĆ, Drago SPREMO, Jovo STOJČIĆ

Public institution „Agricultural institute of Republic of Srpska, Banja Luka“, Bosnia and Herzegovina

*Corresponding author: brkljacg@hotmail.com

Abstract

As participant of a cooperative Danube-Soya Program, Public institution „Agriculture Institute of Republic of Srpska, Banja Luka“ (PI AIRS) takes an active role in the implementation and the intensification of research Programme in the production of non-genetically modified soybean with the application of European Union (EU) standards and legal regulations. Speaking of the limiting factors of production, special emphasis, apart from others, is placed on effective weed management programs, since weed species as direct competitors have an extremely negative impact on the achievement of high and quality yield. Considering the mentioned, the main objective was to test the efficacy of a total 11 herbicide combinations on weed populations in soybean in the Banja Luka region. Efficiency test of 11 herbicide combinations was carried out during 2014 and 2015 on the experimental fields of PI AIRS, Banja Luka. In 2014, due to heavy rainfall, which caused constant emergence of weed species throughout the vegetation period of soybean, using similar, almost identical pre. em. combination achieved satisfactory efficiency. Compared with the previous year, in 2015, pre. em. combination with corrective treatments showed high efficiency, which indicates the importance of testing in different ecological conditions of production.

Keywords: *Danube-Soya Program, herbicide efficiency, soybean*

Introduction

By signing a cooperative Program B&H with the Danube Soya Association, Public institution „Agriculture Institute of the Republic of Srpska, Banja Luka“ (PI AIRS, BL) took an active role in the implementation and the intensification of research Programme in the production of non-genetically modified soybean. Among them crop protection program is of a great importance. Considering the limiting factors of production, especially when we are talking about direct competitors, increase the yield of soybean in addition to intensive crop management, optimized application of fertilizers and a more efficient protection against pests and diseases, always implies the effective protection against weeds. Not only that they: decrease yield, make harvest more difficult, reduce the quality of grain and increase the humidity, but also transmit a variety of diseases and pests. According to Öerke *et al.* (1994) grain yield can be reduced in average 13% or 10% (Maceljski, 1995).

In soybeans, as in the other row crops, there is a wide range of weed species of which are dominated broadleaved weeds (Konstantinović *et al.*, 1998). Beside the agronomic measures, key role in weed control has herbicide application. Selection of herbicide is of utmost importance that it is highly effective and selective, to avoid potential adverse effects on the cultivated plant (Konstantinović, 1999). As well, it is important to be familiar with the history field, in reference to predict the composition and abundance of weed flora in areas designated for planting, all in order to choose an effective combination for the dominant weed species (Bilandžić *et al.*, 1997; Ostojić, 2000). The density of weeds and spread of weeds in soybean depend on the type of soil, amount of rainfall during the growing season, soil and air temperatures (Vratarić *et al.*, 2007).

Therefore, in order to ensure high quality and yield of non-GMO soybean, primarily in order to strengthen the competitiveness of the EU market in relation to GMO soy producers, but certainly to intensify production on domestic manufacturers, the basic aim of this study was to investigate the efficacy of 11 different herbicides on weed populations in soybean in the Banja Luka area.

Material and method

The herbicide trial in 2014 and 2015 was conducted in the experimental field of the PI AIRS, Banja Luka according to the European and Mediterranean Plant Protection Organization guidelines (OEPP 1998; OEPP 1999; OEPP 2012). In 2014 herbicide efficiency trial was set up on 14th April in randomized block design, with elementary plots of 60 m² in 3 repetition in locality Maglajani. Weed control included one treatment before sowing and immediately after planting (pre.em.), while four others combinations were applied pre. em. (table 1).

Table 1. *Technical data and variants of applied herbicides in soybean during 2014 in Maglajani*

Herbicide variant	Active substances	Time of applications/date	Concentration/Unit
Zanat + Lord + Galolin mono	Pendimethalin +Metribuzin +Linuron	pre. sowing and pre. em	4 l/ha +0,5 kg/ha +1,5 l/ha
Galolin mono +Lord	Linuron +Metribuzin	pre. em	2,5 l/ha +0,5 kg/ha
Galolin mono + Lord	Linuron +Metribuzin	pre. em	2 l/ha +0,75 kg/ha
Frontier 900 EC +Lord	Dimethenamid-P +Metribuzin	pre. em	1 l/ha +0,75 kg/ha
Lord + Dual gold 960 EC	Metribuzin +S-metolachlor	pre. em	0,75 kg/ha +1,2 l/ha
Untreated variant			n/a

The basic plots were divided into two equal areas and on each were performed corrective treatments (table 2).

Table 2. *Technical details and variants of corrective treatments in soybean during 2014 in Maglajani*

Herbicide	Active substances	Time of applications/date	Concentration/Unit
Fusilade forte +Pulsar 40	Fluazifop-P-butyl +Imazamox	post. em.	2 l/ha +1,2 l/ha
Dynox +Harmony DF	Oxasulfuron +Thifensulfuron- methyl	post. em.	80 g/ha +10 g/ha

The herbicide efficiency trial conducted in 2015 with six herbicide combinations (4 pre. em. and 2 post.em.) was placed on the experimental field of PI AIRS, Banja Luka (Kalino Imanje), with elementary plots of 115 m² in 3 repetition (table 3).

Table 3. *Technical data and variants of applied herbicides in soybean during 2015 in Kalino imanje*

Herbicide variant	Active substances	Time of applications/date	Concentration/Unit
Zanat + Lord + Dual gold 960 EC	Pendimethalin +Metribuzin +S-metolachlor	pre. em	4 l/ha +1 kg/ha +1,2 l/ha
Galolin mono + Lord	Linuron +Metribuzin	pre. em	2 l/ha +0,75 kg/ha
Lord +Dual gold 960 EC	Metribuzin +S-metolachlor	pre. em	0,75 kg/ha +1,2 l/ha
Lord + Dual gold 960 EC	Metribuzin +S-metolachlor	pre. em	0,75 kg/ha +1l/ha
Pulsar 40	Imazamox	post.em.	1,2 l/ha
Dynox +Okvir	Oxasulfuron +Thifensulfuron- methyl	post. em.	80 g/ha +10 g/ha
Untreated variant			n/a

The basic pre. em. plots were divided into two equal areas and on each were performed corrective treatments (table 4).

Table 4. *Technical details and variants of corrective treatments in soy during 2015 in locality Kalino imanje*

Herbicide	Active substances	Time of applications/date	Concentration/Unit
Pulsar 40	Imazamox	post. em.	1,2 l/ha
Dynox +Okvir	Oxasulfuron +Thifensulfuron-methyl	post. em.	80 g/ha +10 g/ha

The weed population of each herbicide trial plot and untreated control was recorded in terms of numbers with absolute assessment. In terms of absolute assessment individual plants were counted for each weed species. These assessments were made on randomly selected marked quadrats in each plot. Based on the obtained data, the coefficient of efficiency C_e (%) of herbicides is calculated by the formula Dodelloc. cit. Janjic (1985) and represents a relative ratio between the number of destroyed weeds compared to the weeds number in the control.

Results and discussion

In 2014 during the evaluations of the herbicide variants efficiency revealed the presence of 11 weed species. Target organisms were presented in table 5.

Table 5. *Scientific names, EPPO Codes and common names of target weeds*

Scientific name	EPPO Code	Common name
<i>Agropyron repens</i>	AGRRE	Common couchgrass
<i>Amaranthus retroflexus</i>	AMARE	Common amaranth

<i>Ambrosia artemisiifolia</i>	AMBEL	Ragweed
<i>Cirsium arvense</i>	CIRAR	Canada thistle
<i>Convolvulus arvensis</i>	CONAR	Field bindweed
<i>Hibiscus trionum</i>	HIBTR	Venice mallow
<i>Matricaria chamomilla</i>	MATCH	Wild chamomile
<i>Polygonum aviculare</i>	POLAV	Prostrate knotweed
<i>Setaria</i> sp.	SETSS	Foxtail Grasses
<i>Sorghum halepense</i>	SORHA	Johnson grass
<i>Viola</i> sp.	VIOS	Wild Violet

The total number of weed population in control plots (photo 1) ranged from 109,3-162,4 plants/m², and among them the most dominant (63-75 plants/m²) was *Ambrosia artemisiifolia*, which was to be expected given that it is the most invasive weed species in our area. The high efficiency of 92.82% was achieved in the variant applied after sowing and before emergence of soybean (Galolin mono + Lord) at a dose of 2.5 l/ha + 0,5 kg/ha with a corrective treatment (photo 2), while satisfactory efficiency (>80%) achieved by applying of all other combinations (table 6).

Table 6. Efficiency of different weed control treatments in soybean in 2014

Herbicide variant	Ce %
Zanat + Lord+ Galolin mono + post.em. variant	84,17
Galolin mono + Lord + post.em. variant	92,82
Galolin mono + Lord+post.em. variant	88,59
Frontier 900 EC + Lord + post.em. variant	87,25
Lord +Dual gold 960 EC + post.em. variant	86,37

In 2015 during the evaluations of the herbicide variants efficiency revealed the presence of 9 weed species. Target organisms were presented in table 7.

Table 7. *Scientific names, EPPO Codes and common names of target weeds*

Scientific name	EPPO Code	Common name
<i>Ambrosia artemisiifolia</i>	AMBEL	Ragweed
<i>Chenopodium album</i>	CHEAL	Common lambsquarters
<i>Cirsium arvense</i>	CIRAR	Canada thistle
<i>Convolvulus arvensis</i>	CONAR	Field bindweed
<i>Hibiscus trionum</i>	HIBTR	Venice mallow
<i>Polygonum aviculare</i>	POLAV	Prostrate knotweed
<i>Setaria</i> sp.	SETSS	Foxtail Grasses
<i>Sorghum halepense</i>	SORHA	Johnson grass
<i>Xanthium strumarium</i>	XANST	Common cocklebur

The total number of weed population in control plots (photo 3) ranged from 125.3-173.4 plants/m² and among them, as in previous year, the dominant species (69-92 plants/m²) was *Ambrosia artemisiifolia*. High efficiency (>90%) was achieved in the variant applied after sowing and before emergence of soybeans with a corrective treatment, one of which is a variant Galolin mono+ Lord achieved the highest efficiency (94.82%), while satisfactory efficiency (>80%) was achieved by applying both post. em. combinations (table 8).

Table 8. *Efficiency of different weed control treatments in soybean in 2015*

Herbicide variant	Ce %
Zanat + Lord+ Galolin mono + post.em. variant	90,42
Galolin mono + Lord + post.em. variant	94,82
Lord+Dual gold 960 EC+ post.em. variant	91,36
Lord+Dual gold 960 EC+ post.em. variant	91,06
Pulsar 40	86,35
Dynox+Okvir	86,43



Photo 1. *Control untreated plots in 2014*



Photo 2. *Variant Galolin mono + Lordin 2014*



Photo 1. *Control untreated plots in 2015*



Photo 2. *Variant Galolin mono + Lordin 2015*

Conclusion

In 2014, due to heavy rainfall, which caused constant emergence of weed species throughout the vegetation period of soybean, pre.em.combination with corrective treatments achieved satisfactory efficiency. Compared with the previous year, in 2015, pre.em. combination with corrective treatments showed high efficiency, which point out the importance of testing herbicide efficiency in different ecological conditions of production. In that sense these studies have a great importance for agricultural producers as well as significant role in the selection of the most effective combination in the production of non-GMO soybeans in our area.

References

- Bilandžić M., Skender A., Vratarić M., Sudarić A., Buhiniček I. (1997). Investigation of efficacy of some new herbicides and their combination. *Eurosoya*, 11: 62–68.
- Janjić V. (1985). *Herbicidi /Herbicides/*. Naučna knjiga, Beograd.
- Konstantinović B., Štrbac P., Milošević N. (1998). *Zaštita soje od štetočina, bolesti i korova*. Poljoprivredni fakultet, Novi Sad.
- Konstantinović B. (1999). *Poznavanje i suzbijanje korova*. Stylos, Novi Sad.
- Maceljki M. (1995). Štete od štetočina u Hrvatskoj. *Glasnik zaštite bilja*, 6: 261–265, Zagreb.
- Örke E. C., Dehne H.W., Schöbeck F., Weber A. (1994). *Crop production and Crop protection- Estimated losses in major food and cash crops*. ECPA. Hamburg.
- Ostojić Z., Barić K. (2000). Učinak novog herbicida flufenaceta i metribuzina u soji. *Zbornik 36. Znanstvenog skupa hrvatskih agronoma*, pp. 189, Osijek.
- OEPP (1999). *Guideline for the efficacy evaluation of plant protection products, Phytotoxicity assessment, Introduction, General and Miscellaneous Guidelines, New and Revised Guidelines*, 135 (1): 31–36.
- OEPP (2012). *Guideline for the efficacy evaluation of plant protection products* 152 (4), *Design and analysis of efficacy evaluation trials*, 42 (3): 367–381.
- OEPP (1998). *Guideline for the efficacy evaluation of herbicides, OEPP/EPPO Standards for the efficacy evaluation of plant protection products, Herbicides and Plant Growth Regulators*, 1 (4): 42–46.
- Vratarić M., Sudarić A. (2007). *Tehnologija proizvodnje soje /Technology of Soya production/*. Poljoprivredni institut Osijek, Republika Hrvatska.

INTROGRESS OF *FOC 4* QTL LOCUS TO DEVELOP “SUPER ANNIGERI-1” CHICKPEA VARIETY RESISTANT TO FUSARIUM WILT THROUGH MABC

Durdanappa M. MANNUR^{1*}, S. B. YERI¹, M. MAHIBOBSA¹, I. SHANKERGOUDA², Mahendra THUDI³, R. K. VARSHNEY³, P. M. GAUR³, S. K. JAYALAKSHMI¹

¹Agriculture Research Station, Aland Road, Kalburagi (Karnataka), India

²University of Agricultural Sciences, Raichur (Karnataka), India

³CGIAR Generation Challenge Programme (GCP), International Crops Research Institute for the Semi-Arid Tropics (ICRISAT), Telangana State, India

*Corresponding author: dmmanur@rediffmail.com

Abstract

Chickpea is an important food legume cultivated and consumed across the Indian subcontinent. Fusarium wilt is the major constraint in chickpea production. The wilt race confined to Northern-Karnataka region is caused by soil borne fungus *Fusarium oxysporum* f. sp. *ciceris* (*foc 4*). Thus marker assisted backcrossing (MABC) was attempted to introgress the *foc 4* loci from WR-315 (wilt resistant) to elite cultivar Annigeri-1(A-1: wilt susceptible) (A-1 × WR-315). For MABC three markers TA96, TA27-F and TR19-V conferring the *foc 4* loci were used in foreground selection. Background selection was employed using 40 SSR markers that were evenly distributed on to all the 8 LG of chickpea genome. After two backcrosses and two rounds selfing, 67 families were found to be resistant to wilt under wilt sick garden and possessed good background genome recovery (78.85 – 94.83 %). Of the 67 BC₂F₃ families top ten elite families with recurrent parent genome recovery of 91.07 – 94.83 % were selected. The selected lines were homozygous and stable. Stringent phenotypic evaluation of advanced lines of BC₂F₃ families in wilt sick garden could confirm resistance to fusarium wilt Race-4. These elite lines are being evaluated for yield and yield attributing traits in multi-location trails to identify the best possible line as compared to local check for release and general cultivation in Northern-Karnataka region. The present investigation was accomplished with speedy development of elite “Super Annigeri-1” cultivar resistant to fusarium wilt, grain yield advantage that was otherwise susceptible, as early as in two backcrosses and selfing.

Keywords: Chickpea, Fusarium wilt, MABC, Foc 4, Super Annigeri-1

Introduction

Chickpea is commonly known as Bengal gram or Garbanzo (*Cicer arietinum* L.). It is an important food legume, cultivated and consumed across the globe. In India it is being cultivated throughout the semi arid-tropics. The crop occupies first position both in area and production among the pulses grown in Northern Karnataka state of India, especially in dry areas of Zone 2 and 3. In spite of its wide spread area in Northern Karnataka the yield levels are curtailed to greater extent by wilt disease. Fusarium wilt (FW), caused by *Fusarium oxysporum* Schlechtend: Fr. f. sp. *ciceris* (Padwick) Matuto & K. Sato, a soil-borne fungus is major constrain in chickpea cultivation and the pathogen race confined to Northern-Karnataka is *Fusarium oxysporum* f. sp. *ciceris* (Foc 4). The average annual losses to wilt have been estimated to the tune of 10 to 90% (Jimenez-Diaz et al., 1993; Cortes et al., 2000) under disease favourable conditions, epidemics can be devastating to individual crops and cause 100% loss (Halila and Strange 1996; Navas-Corte’s et al., 2000). The pathogen can survive in soil even in the absence of host plants for many years and build up the permanent disease inoculum (Haware et al., 1996) thus it is difficult to control. In this direction deployment of

host plant resistance by use of resistant cultivars is the preferred strategy for managing the wilt disease, as it is the most economic, effective and eco-friendly means of controlling chickpea wilt. Even then effectiveness of such a cultivar is further limited by the existence of different races of pathogens. Integration of genomic resources with conventional breeding approaches might enhance the precision and speed of developing resistant chickpea cultivars. Genomic resources including various mapping populations, linkage maps, QTL maps, markers linked to fusarium wilt have been developed in chickpea. Molecular markers associated with resistance to different races (0, 1A, 2, 3, 4, and 5) have been identified. Resistance genes for FW races 1 (*foc1*), 3 (*foc3*), 4 (*foc4*), and 5 (*foc5*), forming a cluster were located on CaLG02 (Mayer et al., 1997; Ratnaparkhe et al., 1998; Tullu et al., 1998; Winter et al., 2000; Sharma et al., 2004). Three simple sequence repeats (SSR) markers TA96, TA27-F and TR19-V conferring resistance to wilt were successfully employed for marker assisted backcross breeding (MABC) in chickpea (Varshney et al., 2014). Annigeri-1 is an elite chickpea variety with medium bold seeds, early maturing, tolerant to drought and recently accorded the status of national check for drought tolerance in frontier chickpea research. However, in recent past it is susceptible to wilt.

In this study, an effort was made to develop wilt resistant Annigeri-1 (Super Annigeri-1) by adopting MABC where WR315, a solitary source disease resistant to all the known races of fusarium wilt was used as the donor and markers associated with wilt resistance were employed for selection.

Material and methods

Annigeri-1 was used as the recurrent parent, while WR 315 was used as the donor parent in the MABC (Fig. 1). A crossing programs involving Annigeri-1 × WR315 was employed for generation of F₁ seeds. Three SSR markers TA96, TA27-F and TR19-V associated with resistance to FW on genomic region of LG 02 were employed for selecting hybrid plants and such plants were used for developing backcross progenies. Further, foreground selection (FGS) of target genomic regions and background selection (BGS) using SSR markers were employed for identification of plants for further backcrossing. After two rounds of backcrossing, selected plants were selfed twice (BC₂F₃) for making plants homozygous as well as for multiplication of improved seeds of Annigeri-1 (Super Annigeri-1) for FW. For molecular analysis, DNA extraction and genotyping was carried out at ICRISAT, Pattencheru Hyderabad (India). DNA was isolated from young leaves of 15-d-old seedlings of parental genotypes, F₁s, and backcross progenies using the modified cetyl trimethyl ammonium bromide (CTAB) extraction method, as described in Cuc et al. (2008). Quality and quantity of DNA were checked on 0.8% agarose gel and concentration was normalized to ~5.0 ng μl⁻¹. Polymerase Chain Reaction (PCR) of SSR markers for FGS and SSRs from complete genome (Varshney et al., 2014) for BGS was performed in 5.0 μl reaction volumes as mentioned in Thudi et al. (2011). PCR amplicon were separated by capillary electrophoresis using an ABI Prism 3730 DNA Sequencer and analyzed using GeneMapper software of Applied Biosystems, USA (Carlsbad, CA). Genotypes developed under MABC were screened against FW in sick plot developed at Agriculture Research Station, Kalaburagi (India). A field screening technique for wilt developed at ICRISAT (Nene et al., 1981) was adopted with wilt susceptible check (JG-62) sown intermittently after every five entries so as to monitor disease pressure. Observations on number of wilted plants was recorded at seedling stage (30 DAS), pod initiation stage (60 DAS) and physiological maturity stage (90 DAS). Per cent wilt incidence was calculated using the formula given below and wilt scoring scales developed by Nene et al. (1981). Data on FW reaction of the entries were classified as resistant (0-10%), moderately resistant (10-20%), moderately susceptible (20-30%), and susceptible (30-50%) and highly susceptible (above 50%)

$$\text{Per cent wilt incidence} = \frac{\text{Number of wilted plants}}{\text{Total number of plants}} \times 100$$

Result and discussion

Markers assisted backcrossing (MABC) for fusarium wilt: For introgressing *foc 4* locus conferring resistance to *race 4* of FW, three SSR markers (TA96, TA27-F and TR19-V) associated with resistance present on the linkage group LG 02 (Sharma and Muehlbauer, 2005; Varshney et al., 2014). All the three markers were polymorphic between parents (A-1 and WR 315), hence they were used for selection of target genomic region in segregating generations. MABC scheme used to introgress from WR 315 into Annigeri 1 is shown in Fig. 1.

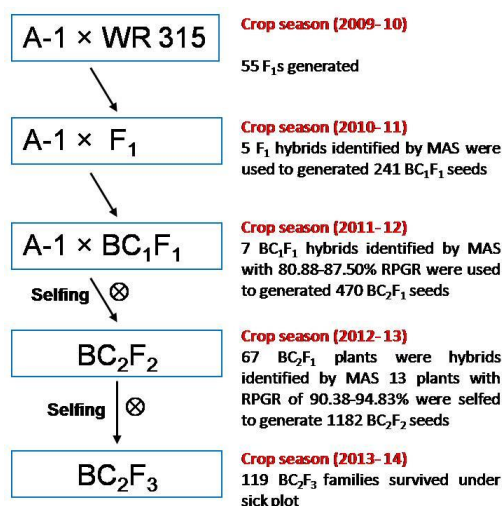

Figure1: MABC scheme for introgression of resistance to Fusarium Wilt race 4 (*foc 4*)

Backcrossing was initiated by hybridization of A-1 (recurrent and female parent) with WR 315 (donor) during the post rainy season of 2009-10. A total of 55 F₁ plants were produced. Of the 55 F₁ plants five hybrids were identified with the markers (TA96, TA27-F and TR19-V). As a result 241 BC₁F₁ seeds were obtained by pollinating A-1 with pollens collected from three F₁ plants. All the BC₁F₁ seeds rose in the crop season 2010-11 of which DNA from 188 BC₁F₁'s was isolated and used for FGS and BGS. FGS could yield 14 heterozygote plants at all the three marker loci. Due to the minimal polymorphism in the chickpea genome (Kazan Muehlbaure 1991; Ahmad and slinkard 1992; labdi et al 1996 Mayer et al 1997) a total of 38 SSR markers that were polymorphic for A-1 and WR 315 were used for BGS which showed a considerable genome recovery ranging from 76.39-87.50% among the heterozygote plant. Of the 14 BC₁F₁, seven plants with genome recovery of 80.88-87.50% were used for making second backcrossing to develop BC₂F₁ in the crop season 2011-12. Further, 470 BC₂F₁ were sown in the field during the crop season 2012-13. Of the 470 BC₂F₁, 376 plants that survived in the field were subjected for FGS and BGS. A total of 67 BC₂F₁ plants were confirmed with three makers in FGS. All the 67 plants were screened for BGS with 38 SSR markers that were found polymorphic. BGS could yield recurrent parent genome recovery (RPGR) of 74.85-94.83%. In the present study only round backcrossing was made and desired genotypes were selected with the aid of markers, followed by selfing. In a simulation study selection of backcross progenies with just two rounds of backcrossing would maximizes the recurrent parent genome faster as compared to additional third and/or four rounds of backcrossing provided negative linkage drag is not anticipated (Frisch *et al.*, 1999). Of the 67 BC₂F₁, 13

plants with highest RPGR of 90.38-94.83% selected selfed to produce 1181 BC₂F₂ seeds. The population size can be increased in order to recover the genetic background of the recurrent parent by only two backcrosses in the BC₂F₂ generation. If a small portion of the donor genome still persists, another backcrossing is usually needed to recover the recurrent parent genome by BC₃F₂. Otherwise, an additional selfing generation can also be used. Also, a large population size may not be required when the donor is an adapted, high yielding variety, and introgression of deleterious alleles would not be so likely (Iftekharruddaula *et al.*, 2011).

Screening MABC lines under wilt sick plot: Evaluation of chickpea lines for resistance to FW under the wilt sick plot with sufficient inoculum load ensures uniform infection of plants at same vegetative stage under well defined environmental conditions, thus helps in stringent screen of the test plants for FW. Since there are no linked markers for FW in chickpea that can be relayed upon for the effective MAS as in other crops, field screening of the MABC lines and selfed progenies would increase the precision of screening the plants carrying wilt resistance gene(s) which is complemented by MAS (Sharma *et al.* 2005; Sharma and Muehlbauer 2007). Thus in the present study, wilt sick plot prepared with heavy inoculum of FW (*foc 4*) was used to screen the selfed progenies of second backcross (BC₂F₂). Plant to progeny rows was followed for sowing all the 1181 BC₂F₂ seeds, 33 rows ranging from 1-5 rows were constituted during the cropping season of 2013-14 (Table 1).

Table 1. Evaluation of BC₂F₂ families against FW under wilt sick garden during 2013-14

Sl. No.	BC ₂ F ₂ Families	Seeds sown	TP	TWP	TRP	Per cent Wilt Incidence	BC ₂ F ₃ Seeds collected
1	I	11	11	11	0	100.00	0
2	II	60	39	36	3	92.30	168
3	III	50	35	35	0	100.00	0
4	IV	75	61	52	9	85.24	823
5	V	14	11	11	0	100.00	0
6	VI	12	11	9	2	81.81	132
7	VII	11	10	9	1	90.00	54
8	VIII	30	29	17	12	58.62	745
9	IX	195	161	161	0	100.00	0
10	X	90	64	23	41	35.93	3873
11	XI	185	129	116	13	89.92	1008
12	XII	180	146	126	20	86.30	1423
13	XIII	282	245	227	18	92.65	931
Total		1195	952	833	119	87.50	9157

TP: Total number of plants; **TWP:** Total number of wilted plants; **TRP:** Total number of resistant plants; **WI:** Wilt Incidence (per cent)

The observation on the incidence of wilt at different days after sowing (30, 60 and 90 DAS) was recorded, of the 952 total plants 833 showed the wilting symptoms at different stage and could not serve till harvest. Only 119 plants survived at 30, 60 and 90 DAS showing resistance towards FW. A total of 9157 BC₂F₃ seeds were collected from 119 BC₂F₂ plants. All the 119 BC₂F₃ families were sown again in the wilt sick plot during the cropping season of 2014-15. These 119 families were divided into eight groups based on their pedigree. Overall, there was high wilt incidence (87.55) facilitating proper selection of the MABC lines. Families screened at 30, 60 and 90 DAS could generate 71 resistant (R), 16 moderately resistant (MR), 6 tolerant (T) and 26 susceptible families. Data was also collected on seed yield/ family among the 71 resistant families from these eight groups. The families were categorized to know seed yield/family producing less than 100 gm, more than 100 gm, more

than 200 gm, 300 gm and 400gms. Over all, of the 71 resistant families constituted from eight classes could show nine families with more than 400 gm seed yield/ family, six families (>300 gm), 17 families (>200 gm), 21 families (>100 gm) and 18 (<100gm) (Table 2). The advanced families (Resistant, Moderately resistant or tolerant) constituted the BC₂F₄.

Table 2. Reaction of families against FW under wilt sick plot and seed yield during 2014-15

Sl. No.	FG	Wilt reaction				Total Families	Seed yield per family of Resistant lines (gm)					Total
		R	MR	T	S		< 100	>100	>200	>300	>400	
1	I	34	4	1	2	41	5	12	9	4	4	34
2	II	9	5	1	5	20	2	1	1	1	4	9
3	III	5	2	3	8	18	5	0	0	0	0	5
4	IV	1	1	1	10	13	1	0	0	0	0	1
5	V	10	3	0	0	13	2	4	4	0	0	10
6	VI	8	0	0	1	9	2	2	2	1	1	8
7	VII	3	0	0	0	3	1	1	1	0	0	3
8	VIII	1	1	0	0	2	0	1	0	0	0	1
Total		71	16	6	26	119	18	21	17	6	9	71

FG: Family Groups; **R:** Resistant; **MR:** Moderately Resistant; **T:** Tolerant; **S:** Susceptible

Conclusion

In the present study use of three markers associated with the FW race 4 (*foc 4*) enabled in selecting the proper genotype in MABC coupled with the stringent screening enabled us to precisely identify the resistant MABC plants/families. The mortality in the wilt sick condition of segregating plants with a variable genotypic constitution, expressing its race virulence in variable environment in different years cannot be disregarded. Environment influence the race to a greater extent, fortunately the dry spell prevailing for two consecutive years in the Northern-Karnataka region was highly favourable for FW. Therefore, proper expression of the pathogen and the host resistance was witnessed, this has led to identification of better MABC lines showing high resistance to FW. Stabilized families are being evaluated for their genetic potentiality for yield and yield attributing traits in station trails and multi-location trails this may yield us the Super Annigeri-1 in one or two years for release to farming community in Northern-Karnataka.

References

- Ahmad F., Slinkard A. E. (1992). Genetic relationship in the genus *Cicer* L. as revealed by polycarylamide gel electrophoresis of seed storage proteins. *Theor. Appl. Genet.* 84: 688-692
- Cortes J. A. N., Hav B., Jimenez-Diaz R. M. (2000). Yield loss in chickpea in relation to development of *Fusarium* wilt epidemics. *Phytopathology* 90, 1269-1278.
- Cuc L. M., Mace E., Crouch J., Quang V. D., Long T. D., Varshney R. K. (2008). Isolation and characterization of novel microsatellite markers and their application for diversity assessment in cultivated groundnut (*Arachis hypogaea* L.). *BMC Plant Biol.* 8:55-65.
- Frisch M., Bohn M., Melchinger A. E. (1999). Comparison of selection strategies for marker-assisted backcrossing of a gene. *Crop Sci.*, 39(5): 1295-1301.
- Halila M. H., Strange R. N. (1996). Identification of the causal agent of wilt of chickpea in Tunisia as *Fusarium oxysporum* f.sp. *ciceri* race 0. *Phytopath. Mediterr.*, 35:67-74
- Haware M. P., Nene, Y. L., Natarajan, M. (1996). Survival of *Fusarium oxysporum* f. sp. *ciceri* in the soil in the absence of chickpea. *Phytopathol. Mediterr.*, 35:9-12

- Iftekharuddaula K., Newaz M., Salam M., Ahmed H., Mahbub M., Septiningsih E., Collard B., Sanchez D., Pamplona A., Mackill D. (2011). Rapid and high-precision marker assisted backcrossing to introgress the SUB1 QTL into BR11, the rainfed lowland rice mega variety of Bangladesh. *Euphytica*, 178(1): 83-97.
- Jimenez-Diaz R. M., Alcalá-Jimenez, A. R., Hervás A., Trapero-Casas, J. L. (1993). Pathogenic variability and hosts resistance in the *Fusarium oxysporum* f. sp. *ciceris*/*Cicer arietinum* pathosystem. In: Proc Eur semin Fusarium mycotoxins, taxonomy, pathogenicity and host resistance, 3rd Hodowla Roslin Aklimatyzacjai Nasiennictwo. Plant Breeding and Acclimatization Institute, Radzikov, Poland, pp 87–94
- Kazan K., Muehlbauer F. J. (1991) Allozyme variation and phylogeny in annual species of *Cicer* (Leguminosae). *Plant system Evol.* 175:11-21
- Labdi M., Robertson L. D., Singh K. B., Charrier A. (1996). Genetic diversity and phylogenetic relationships among the annual *Cicer* species as revealed by isozyme polymorphism. *Euphytica* 88:181-188
- Mayer M. S., Tullu A., Simon C. J., Kumar J., Kaiser W. J., Kraft J. M., Muehlbauer F. J. (1997). Development of a DNA marker for Fusarium wilt resistance in chickpea. *Crop Sci.*, 37:1625-1629
- Navas-Cortés, J. A., Alcalá-Jiménez, A. R., Hau, B., Jiménez-Díaz, R. M. (2000). Influence of inoculum density of races 0 and 5 of *Fusarium oxysporum* f. sp. *ciceris* on development of Fusarium wilt in chickpea cultivars. *Eur. J. Plant Pathol.*, 106:135–146
- Nene Y. L., Haware, M. P., Reddy, M. V. (1981). Chickpea diseases: Resistance Screening Techniques. Information Bulletin No. 10, ICRIASAT, Patancheru, India. p.11
- Ratnaparkhe M. B., Santra D. K., Tullu A., Muehlbauer F. J. (1998). Inheritance of inter-simple sequence-repeat polymorphisms and linkage with a Fusarium wilt resistance gene in chickpea. *Theor. Appl. Genet.* 96:348–353. doi:10.1007/s001220050747
- Sharma, K. D. and Muehlbauer, F. J., 2005, Genetics mapping of *Fusarium oxysporum* f. sp. *ciceris* race-specific resistance genes in chickpea (*Cicer arietinum* L.). In: Abstract of the International food legume research conference-IV. Indian Agricultural Research Institute, New Delhi, pp 18–22
- Sharma, K. D. and Muehlbauer, F. J., 2007, Fusarium wilt of chickpea: physiological specialization, genetics of resistance and resistance gene tagging. *Euphytica*, 157:1–14
- Thudi M., Bohra A., Nayak S.N., Varghese N., Shah T.M., Penmetsa R.V., Thirunavukkarasu N., Gudipati S., Gaur P. M., Kulwal P. L., Upadhyaya H. D., KaviKishor P.B., Winter P., Kahl G., Town C.D., Kilian A., Cook D.R., Varshney R. K. (2011). Novel SSR markers from BAC-End sequences, DArT arrays and a comprehensive genetic map with 1291 marker loci for chickpea (*Cicer arietinum* L.). *PLoS ONE* 6:e27275. doi:10.1371/journal.pone.0027275.
- Tullu A., Muehlbauer F. J., Simon C. J., Mayer M. S., Kumar J., Kaiser W. J., Kraft J. M. (1998). Inheritance and linkage of a gene for resistance to race 4 of Fusarium wilt and RAPD markers in chickpea. *Euphytica* 102:227–232. doi:10.1023/A:1018373412281.
- Varshney, R. K., Mohan, S. M., Gaur, P. M., Chamarthi, S. K., Singh, V. K., Srinivasan, S., Swapna, N., Sharma, M., Singh, S., Kaur, L., Pande, S. (2014). Marker-Assisted Backcrossing to Introgress Resistance to Fusarium Wilt Race 1 and Ascochyta Blight in C 214, an Elite Cultivar of Chickpea. *The Plant Genome*, 7(1):1-11
- Winter, P., Benko-Iseppon A. M., Huttel B., Ratnaparkhe M., Tullu A., Sonnante G., Pfaff T., Tekeoglu M., Santra D., Sant V. J., Rajesh P.N., Kahl G., Muehlbauer F. J. (2000). A linkage map of the chickpea (*Cicer arietinum* L.) genome based on recombinant inbred lines from a *C. arietinum* . *C. reticulatum* cross: Localization of resistance genes for Fusarium wilt races 4 and 5. *Theor. Appl. Genet.* 101:1155–1163. doi:10.1007/s001220051592

THE EFFECTS OF GA₃ APPLICATION IN DIFFERENT ENVIRONMENTAL CONDITIONS ON THE SURVIVAL ABILITY OF THE SEEDS OF PISTACIA SPECIES AND CULTIVARS

Yusuf NİKPEYMA

Kahramanmaraş Sutcu Imam University, Agricultural Faculty, Department of Horticulture, Turkey

*Corresponding author: nikpeyma@ksu.edu.tr

Abstract

Pistacia species and cultivars have been placed among the important fruit trees of the world for consuming their nuts and using them as rootstocks. Along with the ecological factors, several practices performed during the plant growing causes a positive and sometimes negative effects. The purpose of this study is to hasten the growth of seedlings derived from the seeds of several *Pistacia* species and cultivars for a better growth in order to study their developments in different ecological conditions. This study has been conducted between the years of 2010 and 2011 at the greenhouse of Kahramanmaraş Sutcu Imam University Greenhouse. In the experiment, the seeds of *P. khinjuck* Stock., *Pistacia atlantica* Desf., *Pistacia terebinthus* L. and of three cultivars of *P. vera* L.. (Ohadi, Siirt, Kırmızı) were used. Seed vitality tests were performed using Triphenyl Tetrazolium Chloride (TTC). The vital seeds were kept in GA₃ solutions prepared with three concentrations (0-250-500 ppm) for 24 hrs. Then the seeds were divided into three groups. First group of seeds were sown in pots (8x8 cm in height and diameter) in a heated greenhouse; second group of seeds were sown in pots with the same size which were placed on the steel shelves in outdoor condition; third group seeds were sown into soil outdoor. The decrease in air temperature to -2 degree C in mid-February damaged to newly germinated seedlings. This damage was exaggerated with the increase in the concentration of GA₃.

Keywords. 2,3,5- Triphenyl Tetrazolium chloride, Gibberellic acid, Scarification, nursery tree.

Introduction

Pistachio (*Pistacia vera* L.) was first cultured during the Hitit Era in the southern part of Turkey. The Pistachio nut was on the table of ancient kings which indicates its value. *Plenchon* reported the antiquity of the pistachio nut. Since Anatolia is the center of origin of Pistachio, its culture is widely spread in Southern Anatolia where ecological conditions are suitable for economical production (Özbek, 1978; Bilgen *et al.*, 1994). Recently, pistachio culture has been gaining importance in many Mediterranean and MiddleEast countries as well as in USA and Australia. The reasons for this trend can be summarized as following: the nut has high nutritional value; the tree can thrive in dry and marginal lands and bring good income for farmers.

Pistachio belongs to *Anacardiaceae* family with 11 species which are cultured as nut trees or ornamental purposes. The all *Pistacia* spp trees as well as the crosses in the genus can be used as rootstocks, and the wild species grown in nature can be topworked to *Pistacia vera*, the edible nut (Mehanna *et al.*, 1995; Ak *et al.*, 1994). The Pistachio nut is an important part of agricultural economy, especially in the southern part of Turkey. However, there are many problems in nursery tree production. The number of nursery trees is relatively low. Traditionally farmers sow seeds directly to land or plant seedling for budding with *Pistacia vera* scions. Also some farmers topwork the wild *Pistacia* shrubs and trees around or in their properties. Wild *Pistacia* species have good characteristics for using as rootstocks, however the outer layer of their seeds should be worked for improving seed germination percentage

(Nikpeymaet *all.*, 1995; Xu, and Gu, 1984). The technic for this improvement needs suitable growing media and proper adjustment of chemicals. In this study, the effects of several plant growth regulators with different doses on the seed germination (Caini and Conticini, 1981; Crane and Forde, 1974) percentages, seedling growth, stem length and diameters, time for budding and propagation of healthy budded nursery trees were investigated.

Material and Method

This study was conducted between the years of 2010 and 2011 at the greenhouse of Kahramanmaraş Sutcu Imam University (Turkey). In the experiment, the seeds of *P. khinjuck* Stock., *Pistacia atlantica* Desf., *Pistacia terebinthus* L. and of three cultivars of *P. vera* L. (Ohadi, Siirt, Kırmız) were used. The outer layer of the shell of the seeds were carefully cracked. The seeds were placed in paper filters for an overnight and then the inner shell of the seeds were removed using grip pincer. Three seeds from each Pistachio cultivars and of *Pistacia* species were put in glass jars and then 0.05 % TTC were poured to glass jars covering the seeds completely. The glass jars were covered with aluminium paper and they were put in drying room at 27 °C for 24 hrs. The red stained seeds were accepted as vital ones, and low or non stained ones as non-vital. The scarification of exocarp, mesocarp and endocarp of the seeds from wild *Pistacia* species (*Pistacia khinjuck* Stock, *Pistacia atlantica* Desf., *Pistacia terebinthus*) were done with using H₂SO₄. The scarification period was 1 or 1.5 hrs. The seeds were then placed in water for 12 hrs; the water was refreshed at 4 hrs interval. The seeds were then treated with 0-250-500 ppm GA₃ in room temperature for 24 hrs. The seeds were then divided into three groups for determining germination percentages and seedling measurements as following: first group of seeds were sown in pots (8 x 8 cm in height and diameter) in a heated greenhouse; second group of seeds were sown in pots with the same size which were placed on the steel shelves in outdoor condition; third group seeds were sown in raised berms in field outdoor. The experiment was set up as a factorial design with 3 replication and each replication had 10 seeds,

Result and Discussion

The emergence and seedling growth of Pistachio cultivars and *Pistacia* spp. sown in three different growing media were first seen in heated greenhouse conditions 2 weeks after sowing and secondly in tubes in outdoor conditions 4 weeks after sowing and 6 weeks after sowing directly in open field. According to observations, seeds sown in tubes (8 x 8 cm) outdoor conditions made growth of 5-8 mm beneath the soil surface. However, since the air temperature suddenly dropped to below -2°C, the new growth of root tips were damaged from frost. Especially, in GA₃ treated seeds the higher the concentration the higher the frost damage on the root tips was observed. This damage was from radicle to cotyledone of newly germinated seeds. As seen in Table 1 when the temperature drop below -2°C in the highest frost damage was apparent in 500 ppm GA₃ treatment with 30.79 % germination. The seed germination rate of 250 ppm GA₃ treatment was highest with 65.67 % . When comparing the Pistachio cultivars and *Pistacia* spp, the germination of *P. terebinthus* was lowest with 35.67 % which was apparently most affected from frost, followed by Pistachio Kırmızı cv. with 37.94 % and Ohadi with 46.85%.

Table 1. The germination percentage of seeds of Pistachio cultivars and *Pistacia* spp grown in mini tubes outdoor.

Seed germination percentage (%)				
Pistachio cultivars and <i>Pistacia</i> spp.	0 ppm GA ₃	250 ppm GA ₃	500 ppm GA ₃	Mean
Kırmızı	66.83	26.83	20.16	37.94 cd
Ohadi	80.31	33.60	26.56	46.83 bc
Siirt	72.50	26.70	24.63	41.28 bc
<i>P. khinjuk</i>	60.60	46.70	40.10	49.13 ab
<i>P. atlantica</i>	66.80	46.50	46.63	53.31 a
<i>P. terebinthus</i>	47.03	33.33	26.66	35.67 d
Mean	65.67 a	35.61 b	30.79 b	

The highest seed germinating rate with 87.43 % was in control seeds (0 ppm) and lowest germination rate with 53.42 % was in 500 ppm GA₃ treatment (Table 2). In this part of experiment the seeds sown in field was less damaged from frost then ones grown in mini tubes. The soil might have partly protected seeds from frost. However, the seeds treated with 500 ppm GA₃ might have more cell division and much more water which made them highly sensitive to frost damage. When comparing the Pistachio cultivars and *Pistacia* spp, the highest germination rate was in Ohadi cultivar with 78.04 % and lowest in *P. terebinthus* with 55.59 %.

Table 2. The germination percentage of seeds of Pistachio cultivars and *Pistacia* spp grown in field conditions.

Seed germination percentage (%)				
Pistachio cultivars and <i>Pistacia</i> spp.	0 ppm GA ₃	250 ppm GA ₃	500 ppm GA ₃	Mean
Kırmızı	86.96	60.36	46.73	64.68 e
Ohadi	93.70	73.66	66.76	78.04 a
Siirt	100.00	60.40	46.66	69.02 c
<i>P. khinjuk</i>	86,86	60.43	53.43	66.90 d
<i>P. atlantica</i>	90.33	65.10	60.33	71.92 b
<i>P. terebinthus</i>	66.76	53.40	46.63	55.59 f
Mean	87.43 a	62.22 b	53.42 c	

As seen in Table 3, the best germination rate was obtained in greenhouse condition. The highest germination rate was in 500 ppm'lik GA₃ treatment with 87.84 % followed by 250 ppm treatment with 85.61 % and 0 ppm (control) treatment with 74.4 %. As a result 500 ppm treatment appears the best. And when comparing results from tubes outdoor and field sown seeds, the seeds in small pots grown outdoor was much affected from frost, closely followed by the seeds treated 500 ppm'lik GA₃ sown in field. The highest frost damages which resulted in low germinatin percentage were in Pistachio cultivars such as Ohadi, Siirt and Kırmızı

followed by . *Pistacia spp* such as *Pistacia atlantica* Desf., ,*Pistacia khinjuk* Stock, and *Pistacia terebinthus*

Table 3. The germination percentage of seeds of Pistachio cultivars and *Pistacia spp* in mini pots grown in greenhouse conditions.

Seed germination percentage (%)				
Pistachio cultivars and <i>Pistacia spp</i>.	0 ppm GA₃	250 ppm GA₃	500 ppm GA₃	Mean
Kırmızı	73.56	86.63	86.70	82.29 d
Ohadi	93.43	10.,00	100.00	98.81 a
Siirt	86.70	93.36	93.36	91.14 b
<i>P. khinjuk</i>	66.70	73.46	73.46	71.20 e
<i>P. atlantica</i>	73.43	86.70	93.43	84.52 c
<i>P. terebinthus</i>	56.76	73.53	80.10	70.13 e
Mean	79.09 c	85.61 b	87.84 a	

The growth of seedlings of Pistachio cultivars and *Pistacia spp* 7 weeks after sowing under field conditions was presented in Table 4. Under normal field conditions, the height and diameter of seedlings were better in Ohadi and Siirt pistachio cultivars, followed by others. When considering the mean values, the height and stem developments of seedlings were best with either 250 ppm or 500 ppm GA₃ treatments.

Table 4. The seedling growth of Pistachio cultivars and *Pistacia spp* 7 weeks after sowing under field conditions.

Pistachio cultivars and <i>Pistacia spp</i>.	0 ppm GA₃		250 ppm GA₃		500 ppm GA₃		Mean
	Seedling height (cm)	Seedling diameter (mm)	Seedling height (cm)	Seedling diameter (mm)	Seedling height (cm)	Seedling diameter (mm)	
Kırmızı	32	5.10	38	5.40	41	5.00	21.08 b
Ohadi	38	6.40	41	7.00	48	6.14	24.42 a
Siirt	35	6.11	39	6.30	37	6.14	21.59 b
<i>P. khinjuk</i>	23	4.21	26	4.70	29	5.11	15.33 bc
<i>P. atlantica</i>	32	4.43	35	5.30	30	5.61	18.72 c
<i>P. terebinthus</i>	22	4.00	24	4.20	25	4.00	13.86
Mean	30.33 c	5.04 c	33.83 b	5.48 a	35 a	5.33 b	19.16

As seen in Table 5. The seedling growth of Pistachio cultivars and *Pistacia* seeds sown in heated greenhouse conditions were better than the those of sown and grown in field conditions. The first ones came to budding height and diameter earlier with healthy conditions. The shorter time from seed sowing to budding is an important criteria in modern fruit growing and nursery technic. For that reason it is generally advised to use heated greenhouses for fast plant development. The height and diameter of seedlings were apparently better with especially 250 ppm and 500 ppm GA₃ treatments. The mean stem height in control treatments was 48,16 cm, however it was 54,66 cm with 250 ppm and 57,50 cm with 500 ppm treatment. When comparing the cultivars and *Pistacia spp*, Ohadi cultivar showed the

best seedling development with mean 68 cm height and 8.40 stem diameter, followed by cv Siirt, cv Kırmızı and *P. atlantica* seedlings.

Table 5. The seedling growth of Pistachio cultivars and *Pistacia* spp 7 weeks after sowing in pots in greenhouse.

Pistachio cultivars and <i>Pistacia</i> spp.	0 ppm GA ₃		250 ppm GA ₃		500 ppm GA ₃		Mean	
	Seedling height (cm)	Seedling diameter (mm)	Seedling height (cm)	Seedling diameter (mm)	Seedling height (cm)	Seedling diameter (mm)	B	C
Kırmızı	50	6.34	58	8.74	60	7.6	5600	7.38b
Ohadi	60	7.00	70	9.66	74	8.55	68.00	8.40a
Siirt	57	6.82	64	9.35	70	8.47	63.66	8.21a
<i>P. khinjuk</i>	46	5.3	46	7.00	50	6.39	47.33	6.23b
<i>P. atlantica</i>	46	5.33	54	7.00	58	6.46	52.66	6.26b
<i>P. terebinthus</i>	30	4.00	36	6.00	33	5.19	33.00	5.07c
Mean	48.16b	5.79b	54.66a	7.96a	57.5a	7.11a	53.22	6.78

Conclusion

In this study it appeared that many ecological factors could affect the generative and vegetative developments of Pistachio cultivars and *Pistacia* spp. In this study under different growing media with different GA₃ treatments, the developments from seed germination to budding stage were investigated. The seeds of all plants grown in mini pots outdoor conditions were much affected from frost with decreased air temperature below -2⁰C while increased the GA₃ concentration. In other words, cold air slowed the germination processes. However, generally the field sown seeds showed a better germination percentage than those sown in tubes outdoor. The germination difference was as much as two fold. The cold air did not affect the seeds 1-2 cm beneath the soil surface. However, the best result for germination during the experiment was obtained in heated greenhouse, also seedling development was best in this condition.

When considering fast plant development for reaching budding height and diameter of seedlings after 7 weeks, 250 ppm GA₃ treated seedlings were earliest in this respect. As a result of this study, in the case of early seed sowing, the fast plant development and shorter time for budding could be obtained in the heated greenhouse or normal field conditions. However, in the case of outdoor sowing in cold period, the bigger tubes or pots should be considered rather than small tubes (8 x 8 cm) for a successful nursery plant growing.

References

- Arawal P.K. (1986). Tetrazolium Test For Seed Viability In: J.P. Srivastona and C.T. Simarski (eds.) Seed Production Technology, ICARDA Aleppo, Syria, 287 s.
- AK, B.E., 1988, Bazı *Pistacia* Türleri Tohumlarının Çimlenmeleri Üzerinde Araştırmalar. Yüksek Lisans Tezi (unpublished) Adana, 109 s.
- AK, B.E., N. KAŞKA; A. I. ÖZGÜVEN and Y. NİKPEYMA., 1994, The Effects of GA₃ Applications on *Pistacia vera* Seed Germination and Seedling Growth. First International Symposium on Pistachio Nut. Department of Horticulture Fac. of Agric. University of Çukurova. September 20-24 Adana-Turkey, 67 p.

- BİLGİN, A. and N. KAŞKA, 1994, Nutrient Contents of Different Pistachio Varieties Budded on Different Species of Rootstocks Under Gaziantep Ecological Conditions. 1st International Symp. On Pistachio Nut., Sept., Adana Turkey 7/ s.
- CASINI, E. and L. CONTICINI, 1981, The Germinability Of Seeds Of *P. vera* And *P. terebinthus*. Rivistadi Agricoltura Subtropicalee Tropicale (1979) 73 (3/4): 233-240
- CRANE, J.C. and H. I. FORDE, 1974, Improved Pistacia Seed Germination. California Agriculture, Vol. 28, No 9 pp. 8-9.
- KAŞKA, N. B. E. A. K., Y. NİKPEYMA, 1992 b, Antepfıstığı Yetiştiriciliğinde Saçak Köklü Çöğür ve Fidan Yetiştirme Üzerinde Bir Araştırma (A study on the obtaining seedling and nursery trees with fibrous root system in pistachio). Türkiye 1. Ulusal Bah. Bit. Kon. Meyvecilik 13-16 Ekim, Ege Üni. Zir. Fak. Bornova – İzmir, s. 89-92
- MEHANNA, H. T., G. C. MARTİN AND C. NISHIJIMA, 1995, Effects of Temperature Chemical Treatments and Endogenous Hormone Content of Peach Seed Germination and Subsequent Seedling Growth. Soienti. Hort., 27:63-73
- ÖZGÜVEN A. I., Y. NİKPEYMA AND B. E. AK, 1994, The Effects GA3 on The Contents of ABA (Abscisic Acid) of Pistachia Seeds During Stratification 1st International Symposium On Pistachio Nut., Dept. Of Hort. Fac. of Agriculture University of Çukurova., September 20-24., Adana-Türkiye. S. 65.
- XU, B. ve Z. GU, 1984, Effect of GA3 On Seed Germination of Kiwi Fruit (*Actinidia chinensis* Planch Var.). Hispida G.F. Liang Soienotia Agriculture Sinica, No:3, 51-55
- MARINE, F. and D. N. GREENE, 1981. Involment of Gibberellins in the Biennial Bearing of “Early McIntosh” Apples. j. Amer. Soc. Hort. Sci. 106(5):593-596
- NİKPEYMA, Y ve N. KAŞKA, 1995: Antepfıstığı Yozları Buttum Atlantik Sakızı ve Melengiç Çöğürlerinde Tohum Ekiminden 26 Ay Sonraki Gövde Çap Büyüklükleri Üzerine Katlama, Çekirdek Kabuğu Aşındırmak ve Kök Ucu Kesmenin Etkileri (The effects of stratification, scarification and radicle pinching on the stem diameter growth of *P. terebinthus*, *P. atlantica*, *P. khinjuk* and *P. vera* seedlings up-rooted after 26 months of their seed sowing). Türkiye 2. Ulusal Bahçe Bitkileri Kongresi .Ç.Ü.Z.F. Bah. Bit. 3-6 Ekim, Adana., S. 418-423
- ÖZÇAĞIRAN, R., 1979. Bazı Erik Tohumlarının Çimlenme Yeteneği Üzerinde Araştırmalar (Investigation on the germination of some plum seeds). Ege Üni. Zir. Fak. Yayınları: 385, İzmir, 40s.

IDENTIFICATION OF LEAF RUST RESISTANCE GENES IN BL CULTIVARS AND BREEDING LINES OF WINTER WHEAT

Vojislav TRKULJA*, Jelena MIHIĆ SALAPURA, Dragana KOVAČIĆ JOŠIĆ, Gordana BABIĆ, Bojana VUKOVIĆ, Bojana ĆURKOVIĆ, Dragan MANDIĆ

Public Institution Agricultural Institute of Republic of Srpska, Banja Luka, Bosnia and Herzegovina

*Corresponding author: vtrkulja@blic.net

Abstract

Wheat leaf rust, caused by *Puccinia recondita* Dietele & Holw. is the most common rust disease of wheat (*Triticum aestivum* L.) and occurs world-wide. The fungus is an obligate parasite and can cause rust epidemics on a continental scale. Some BL cultivars and breeding lines of wheat from collection of PI Agricultural Institute of Republic of Srpska, Banja Luka showed very good to excellent resistance to *P. recondita* even during years that were favorable for disease development. These cultivars and breeding lines were sampled during tillering stage and analyzed in order to identify wheat leaf rust resistance genes by molecular markers. Extracted plant DNA was amplified by Polymerase Chain Reaction (PCR) and molecular markers were used to identify ten *Lr* resistance genes against the fungal pathogen of wheat *Puccinia recondita* (*Lr13*, *Lr19*, *Lr24*, *Lr26*, *Lr34*, *Lr35*, *Lr36*, *Lr37*, *Lr39* and *Lr46*) in Institute's 11 wheat breeding lines and four cultivars. Results showed that the most common genes in tested breeding lines and cultivars are *Lr34*, *Lr35*, *Lr39* and *Lr46* that are identified in all tested samples. Seven tested lines and cultivars (46.6%) had *Lr37* gen. *Lr13*, *Lr19*, *Lr24*, *Lr26* and *Lr36* genes weren't identified in tested samples. The objective of this study was to identify resistant wheat breeding lines that carry wheat leaf rust resistance genes and these breeding lines will be included in further selection and creation of new domestic wheat cultivars with higher genetic potential. All this should result in higher wheat yield as well as decreased import since wheat is very important grain for our country.

Keywords: *wheat leaf rust, leaf rust resistance genes, molecular markers*

Introduction

Wheat leaf rust, caused by *Puccinia recondita* Dietele & Holw. is the most common rust disease of wheat (*Triticum aestivum* L.) and occurs world-wide. It is also common disease in Europe and it is considered to be important in northwest, southern and southeast Europe (Zadoks & Bouwman, 1985), as well as in eastern Europe (Mesterhazy *et al.*, 2000). Hosts are winter and spring wheats equally, especially in wet and moderately wet areas of Central and Southern Europe, Russia, Australia, USA and Canada with losses ranging 5-50%. Besides affecting wheat yield, it also adversely affects wheat quality. The fungus is an obligate parasite capable of producing infectious urediniospores as long as infected leaf tissue remains alive. When conditions are favorable, urediniospores are formed every 7-17 days. Urediniospores can be wind-disseminated and infect host plants hundreds of kilometers from their source plant, which can result in wheat leaf rust epidemics on a continental scale.

The use of resistant cultivars offers the most effective and ecologically sustainable method of control of the disease; therefore, incorporating genetic resistance to this pathogen into adapted germplasm is a major goal in most wheat breeding programs (Vanzetti *et al.*, 2011). Growing resistant cultivars is probably the most efficient, cost-effective and environment-friendly method to control this disease (Singh *et al.*, 2004). More than 70 specific leaf rust resistance genes are known (KOMUGI, 2008). Resistance genes are expressed at seedling stage (qualitative resistance genes) than at adult plant (quantitative resistance genes). Certain adult

plant resistance genes like *Lr34* and *Lr46* are very important for breeding because they proved to confer durable resistance over a long period of time in different environments, as well as against diverse pathotypes of the fungus (Schnurbusch *et al.*, 2004). The molecular markers most closely linked to *Lr* genes are based on the PCR technique, as the majority of these can be applied relatively easily in wheat breeding programs. Molecular markers are used for two purposes in resistance breeding: (1) to monitor the incorporation of designated resistance genes or QTLs into elite wheat genotypes (i.e., MAS, marker-assisted selection) and (2) to identify resistance genes in varieties and lines where the genetic background is unknown (i.e., gene detection). DNA marker technology has been used in commercial plant breeding programs since the early 1990's and has proved helpful for the rapid and efficient transfer of useful traits into desirable cultivars and hybrids. Markers linked to disease resistance loci can now be used for marker assisted selection (MAS) programs, thus also allowing several resistance genes to be cumulated in the same genotype („pyramiding“ resistance genes).

Visual identification of cultivars or breeding lines, tolerant or resistant to leaf rust in field conditions and confirming the presence of resistance genes, allows greater certainty in breeding process. Certain number of our breeding lines showed very good to excellent resistance against leaf rust, even in years that were extremely favorable for the development of this disease, like it was 2014. Winter wheat breeding lines were selected for the identification of leaf rust resistance genes (*Lr* genes) using molecular markers, based on the visual assessment and previous results related to the yield. A better knowledge on the identity of effective *Lr* genes present in cultivars and breeding lines, that can be used as donors of resistance in wheat breeding programs, could greatly improve the efficiency of developing resistant cultivars by using these genes. The objective of this study was to identify *Lr* genes that condition leaf rust resistance in 15BL cultivars and breeding lines of wheat from Agricultural Institute's collection using molecular markers. Growing resistant wheat cultivars is the most economical and environmentally safe approach to eliminate the use of fungicides and to reduce crop losses due to leaf rust.

Material and method

A number of BL cultivars and breeding lines from collection showed very good to excellent resistance against leaf rust, even during years that were extremely favorable for disease development, like it was 2014. Infection rate of breeding lines and cultivars was scaled according to Stakman *et al.* (1962): 0 - nearly resistant; 1 - very resistant; 2 - medium resistant; 3 - medium resistant to medium sensitive; 4 - very sensitive. For evaluation of tolerance/resistance of winter wheat breeding lines and cultivars, i.e. presence of wheat leaf rust resistance genes, samples were collected in the field during tillering stage.

DNA was extracted using Qiagen DNeasy Plant Mini Kit according to manufacturer instructions. What we did first, was that we mechanically disrupted plant material and then added lysis buffer in order to chemically disrupt plant tissue. RNAase A from lysis buffer degraded RNA in the sample. After incubation proteins and polysaccharides were precipitated with salts. Cell debris was removed by centrifugation through QIAshredder column. Binding buffer and ethanol are added to a purified lysate in order to improve DNA binding to the DNeasy spin column. DNA bound to the membrane of the column while the contaminants such as protein and polysaccharide are efficiently removed in two washing steps. Purified DNA is diluted in a small amount of buffer with a low salt content. DNA concentration, as well as purity (A₂₆₀/A₂₈₀ ratio), is measured in the Eppendorf BioPhotometer. Extracted DNA of selected cultivars and breeding lines is analyzed using Polymerase Chain Reaction (PCR). Molecular markers for ten different *Lr* genes have been included in this study in order to identify wheat leaf rust resistance genes: *Lr13*, *Lr19*, *Lr24*, *Lr26*, *Lr34*, *Lr35*, *Lr36*, *Lr37*, *Lr39* and *Lr46* (Imbabi *et al.*, 2014). Polymerase chain reaction (PCR) was performed in 25 μ l

volumes with REDTaq[®] ReadyMix[™] PCR Reaction Mix-a (Sigma-Aldrich). This mix contains all PCR reagents including Taq polymerase. PCR mixture consists of PCR mix, primers in final concentration of 0.6 μ M, molecular biology grade water and sample DNA. Primer name and sequences, PCR annealing temperature, expected product size and references are shown in Table 1. Amplifications were performed in a Eppendorf Mastercycler ep gradient S. Amplification products were separated in microchip electrophoresis in MCE[®]-202 MultiNA (Shimadzu, Japan) using DNA-1000 kit. This system provides fast, accurate and easy separation of PCR products and results are analyzed in MultiNA Viewer software.

Table 1. Primer name, sequences, PCR annealing temperature, expected product size and references from *Lr* gene associated markers used in this study

<i>Lr</i> gene	Primer name	Primer sequence (5'-3')	Annealing temperature (°C)	Product size (bp)	Reference
13	13F 13R	GTGCCTGTGCCATCGTC CGAAAGTAACAGCGCAGTGA	55	324	Seyfarth <i>et al.</i> , 2000
19	19F 19R	CATCCTTGGGGACCTC CCAGCTCGCATAACATCCA	60	300	Prinset <i>et al.</i> , 2001
24	24F 24R	TCTAGTCTGTACATGGGGGC TGGCACATGAACTCCATACG	55	100	Schachermayer <i>et al.</i> , 1995
26	26F 26R	CATCCTTGGGGACCTC CCAGCTCGCATAACATCCA	63	260	Mohler <i>et al.</i> , 2001
34	34F 34R	GTGAAGCAGACCCAGAACAC GACGGCTGCGACGTAGAG	65	253	William <i>et al.</i> , 2003
35	35F 35R	AGAGAGAGTAGAAGAGCTGC AGAGAGAGAGCATCCACC	54	252	Gold <i>et al.</i> , 1999
36	36F 36R	GCTGCATGAGCTCTGCAAT TCTGTGAGGCATGACAGAA	57	282	Dadkhodaie <i>et al.</i> , 2011
37	37F 37R	AGGGGCTACTGACCAAGGCT TGCAGCTACAGCAGTATGTACACAAA A	55	199	Helguera <i>et al.</i> , 2003
39	39F 39R	CCTGCTCTGCCCTAGATACG ATGTGAATGTGATGCATGCA	64	180	Raup <i>et al.</i> , 2001
46	46F 46R	AGGGAAAAGACATCTTTTTTTTC CGACCGACTTCGGGTTTC	58	335	William <i>et al.</i> , 2003

Results and discussion

An important field in which molecular markers are used in wheat resistance breeding, is the determination of designated resistance genes in genotypes. Genetic background areas like breeding lines and commercial cultivars has not yet been clarified. Using this approach we screened four domestic wheat cultivars and 11 breeding lines by gene postulation for presence of 10 *Lr* genes (table 2), and five genes were detected. Results showed that the most common genes in tested breeding lines and cultivars are *Lr34*, *Lr35*, *Lr39* and *Lr46* that are identified in all tested samples. Seven tested lines and cultivars (46.6%) had *Lr37* gen. *Lr13*, *Lr19*, *Lr24*, *Lr26* and *Lr36* genes weren't identified in tested samples.

Table 2. shows results of visual assessment of resistance in BL winter wheat breeding lines and cultivars, as well as detected *Lr* genes. Some BL varieties (Bosanka, Jelena and Nova Bosanka) have already been present in production for a long time and can be used as standards. Detection of resistance of our breeding lines and cultivars using new technology provides the basis for incorporation of resistance to leaf rust. The table shows that breeding line BL 9875 is nearly resistant to *Puccinia recondita*. Most of our breeding lines is in the range of medium resistant to very resistant. From a total of 15 of BL cultivars and breeding lines that were analyzed, almost all are in this category. Only BL 225-11 and BL 121-11 showed very high susceptibility.

Table. 2. Resistance assessment and detected *Lr* genes

Cultivar / Breeding line	Resistance assessment						Identified <i>Lr</i> genes
	Sample	0 – nearly resistant	1- very resistant	2- medium resistant	3- medium resistant to medium susceptible	4- very susceptible	
BL 38-06	14			+			34, 35, 37, 39, 46
BL 45-10	16		+				34,35, 37, 39, 46
BL 12-10	17		+				34,35, 37, 39, 46
BL 52-10	18			+			34,35, 37, 39, 46
BL 69-10	19				+		34,35, 37, 39, 46
BL62-06	8				+		34, 35, 39, 46
BL 225-11	13					+	34,35, 37, 39, 46
BL 121-11	9					+	34,35, 39, 46
BL 9807	10		+				34,35, 39, 46
BL 9877	11			+			34,35, 39, 46
BL 9875	12	+					34,35, 37, 39, 46
Bosanka	3		+				34,35, 39, 46
Jelena	4				+		34,35, 39, 46
Orion	5			+			34,35, 37, 39, 46
Nova Bosanka	6			+			34,35, 37, 39, 46

In recent years developments in molecular marker techniques and marker identification have facilitated the spread of molecular-assisted selection (MAS). This is particularly true in the field of breeding wheat for leaf rust resistance, where PCR-based markers are already available for almost half of the designated resistance genes and alleles (Imbabi *et al.*, 2014).

Lr34 gene was found in all tested breeding lines and cultivars, although this gene alone is capable of reducing the level of infection to almost half, as reported by (Singh & Rajaram, 1992); resistance that is both excellent and durable can only be achieved if *Lr34* is combined with 2 or 3 other genes (Hysing *et al.*, 2006). Gene *Lr37* confers mainly adult plant resistance. Marker-assisted selection offers the opportunity to select desirable lines on the basis of genotype rather than phenotype, especially in the case of combining different genes in a single genotype. With the help of molecular marker, the pyramiding of leaf rust resistance genes which are active at the seedling and/or adult stage, should facilitate more efficient breeding for durable resistance against this disease. The mechanism for durable resistance to leaf rust is poorly understood, but durability appears to be enhanced when genes are combined (Long *et al.*, 1994).

Experience gained so far suggests that markers flanking *Lr* genes can be used simply and effectively in marker-assisted backcross programmers. Nevertheless, as the linkage between markers and resistance genes is not complete, regular phenotypic monitoring will be required if satisfactory parental genotypes are to be selected. However, molecular markers can prove the presence of the requested resistance gene in the genetic background and in the case of plants carrying adult plant resistance genes like *Lr35* and *Lr37* this is the only way to choose appropriate parents for crossing programmer. The use of MAS, whereby breeders select molecular markers linked to *Lr* genes, enable the pyramiding of more than one effective resistance gene. With the help of molecular markers, resistance genes are easy to detect in wheat varieties of unknown parentage. This information can then be used to design crossing programmers (Imbabi *et al.*, 2014).

Conclusions

The applied methods of molecular markers (marker assisted selection) enabled selection of the desired breeding line based on the genotype and not phenotype, which is significant especially in the case of combination of different genes in one genotype (breeding line or cultivar). With the help of molecular markers, identification of wheat leaf rust resistance genes facilitates efficient selection for permanent resistance to this pathogen. This allows selection of optimal breeding lines that will serve as a suitable material for the selection of new wheat cultivars resistant to *Puccinia recondita*. Also, molecular markers enable detection of resistance genes in BL cultivars and breeding lines of wheat, which is the most convenient and quickest way for the best selection of parents in crossbreeding programs.

References

- Dadkhodaie N. A., Karaoglou H., Wellings C. R., Park R. F. (2011). Mapping genes *Lr53* and *Yr35* on the short arm of chromosome 6B of common wheat with microsatellite markers and studies of their association with *Lr36*. *Theoretical and Applied Genetics*, 122 (3): 479–487.
- Gold J., Harder D., Townley-Smith F., Aung T., Procnier J. (1999). Development of a molecular marker for rust resistance genes *Sr39* and *Lr35* in wheat breeding lines. *Electronic Journal of Biotechnology*, 2 (1): 35–40.
- Helguera M., Khan I. A., Kolmer J., Lijavetzky D., Zhong-qi L., Dubcovsky J. (2003). PCR assays for the *Lr37-Yr17-Sr38* cluster of rust resistance genes and their use to develop isogenic hard red spring wheat lines. *Crop Science*, 43 (5): 1839–1847.

- Hysing S.-C., Singh R. P., Huerta-Espino J., Merker A., Liljeroth E., Diaz O. (2006). Leaf rust (*Puccinia triticina*) resistance in wheat (*Triticum aestivum*) cultivars grown in Northern Europe 1992–2002. *Hereditas*, 143: 1–14.
- Imbaby I. A., Mahmoud M. A., Hassan M. E. M., Abd-El-Aziz A. R. M. (2014). Identification of leaf rust resistance genes in selected Egyptian wheat cultivars by molecular markers. *The Scientific World Journal*, doi: 10.1155/2014/574285.
- KOMUGI (2008). Integrated wheat science Database KOMUGI. <http://www.shigen.nig.ac.jp/wheat/komugi/>
- Long D. L., Roelfs A. P., Leonard K. J., Roberts J. J. (1994). Virulence and diversity of *Puccinia recondita* f.sp. *tritici* in the United States in 1992. *Plant Disease*, 78 (9): 901–906.
- Mesterhazy A., Bartos P., Goyeau H. (2000). European virulence survey for leaf rust in wheat. *Agronomie*, 20: 793–804.
- Mohler V., Hsam S. L. K., Zeller F. J., Wenzel G. (2001). An STS marker distinguishing the rye-derived powdery mildew resistance alleles at the Pm8/Pm17 locus of common wheat. *Plant Breeding*, 120 (5): 448–450.
- Prins R., Groenewald J. Z., Marais G. F., Snape J. W., Koebner R. M. D. (2001). AFLP and STS tagging of *Lr19*, a gene conferring resistance to leaf rust in wheat. *Theoretical and Applied Genetics*, 103 (4): 618–624.
- Raupp W. J., Singh S., Brown-Guedira G. L., Gill B. S. (2001). Cytogenetic and molecular mapping of the leaf rust resistance gene *Lr39* in wheat. *Theoretical and Applied Genetics*, 102 (2-3): 347–352.
- Schachermayr G. M., Messmer M. M., Feuillet C., Winzeler H., Winzeler M., Keller B. (1995). Identification of molecular markers linked to the *Agropyron elongatum*-derived leaf rust resistance gene *Lr24* in wheat. *Theoretical and Applied Genetics*, 90, (7-8): 982–990.
- Seyfarth R., Feuillet C., Schachermayr G., Messmer M., Winzeler M., Keller B. (2000). Molecular mapping of the adult-plant leaf rust resistance gene *Lr13* in wheat (*Triticum aestivum* L.). *Journal of Genetics and Breeding*, 54 (3): 193–198.
- Singh R. P., Rajaram S. (1992). Genetics of adult-plant resistance of leaf rust in “frontana” and three CIMMYT wheats. *Genome*, 35 (1): 24–31.
- Singh R., Datta Priyamvada D., Singh S., Tiwari R. (2004). Marker-assisted selection for leaf rust resistance genes *Lr19* and *Lr24* in wheat (*Triticum aestivum* L.). *J. Appl. Genet.* 45 (4): 399–403.
- Stakman E.C., Stewart D.C., Loegering W.Q. (1962). Identification of physiological races of *Puccinia graminis* var. *tritici*. U.S. Dept. Agric., Agric. Res. Serv. E-617.
- Schnurbusch T., Bossolini E., Messmer M., Keller B. (2004). Tagging and validation of a major quantitative trait locus for leaf rust resistance and leaf tip necrosis in winter wheat cultivar Forno. *Phytopathology*, 94(10): 1036–1041.
- Zadoks J.C., Bouwman J.J. (1985). Epidemiology in Europe. In: Roelfs A.P., Bushnell W. R., eds. *The Cereal Rusts Vol II. Diseases, Distribution, Epidemiology, and Control*. Orlando, FL, USA: Academic Press, 329–369.
- William M., Singh R. P., Huerta-Espino J., Ortiz Islas S., Hoisington D. (2003). Molecular marker mapping of leaf rust resistance gene *Lr46* and its association with stripe rust resistance gene *Yr29* in wheat. *Phytopathology*, 93 (2): 153–159.
- Vanzetti L. S., Campos P., Demichelis M., Lombardo L. A., Aurelia P. R., Vaschetto L. M., Bainotti C. T., Helguera M. (2011). Identification of leaf rust resistance genes in selected Argentinean bread wheat cultivars by gene postulation and molecular markers. *Electronic Journal of Biotechnology*, 14 (3): 1–17.

**TESTING FOR THE PRESENCE OF GENETICALLY MODIFIED LIVING
PLANTS, PLANT PARTS AND PLANT PRODUCTS IN THE ENTITY OF
REPUBLIC OF SRPSKA (BOSNIA AND HERZEGOVINA) IN 2015**

Vojislav TRKULJA*, Jelena MIHIĆ SALAPURA, Dragana KOVAČIĆ JOŠIĆ, Bojana
ĆURKOVIĆ, Bojana VUKOVIĆ, Jelena VASIĆ, Gordana BABIĆ

Public institution „Agricultural institute of Republic of Srpska, Banja Luka“, Bosnia and Herzegovina

*Corresponding author: vtrkulja@blic.net

Abstract

Genetically Modified Organisms (GMO's) are organisms which undergo modification on their DNA structure that involves inserting external genes from one species in order to alter the property of another species which would otherwise not be achieved by conventional reproductive means. With the general public aware of the existence of genetically modified foods, consumers are concerned regarding the contents of the GMO in food products. This served as pretext for carrying out the research whether the food or feed that is used for human or domestic animals consumption are genetically modified or not. A total of 96 samples of food and feed are tested for the presence of genetic modifications. Samples have been collected by the Republic Phytosanitary Inspection Agency (RPIA) and Republic Food Inspection Agency as well as samples were taken in the field by the RPIA and several samples were submitted by farmers and food exporters. DNA was extracted according to CTAB method and Real Time analysis was performed using a Stratagene Mx3005P QPCR with MxProdata analysis system. Real time PCR system enables easy and reliable detection and amplification of specific DNA sequences in GM products. Samples have been tested on presence of specific GM elements such as: promoter 35S, NOS terminator, CP4epsps gene, CTP2-CP4epsps construct, pat gene and nptII gene. Results showed that 19 samples were positive: 4 samples of soybean meal and 6 samples of feed mixtures imported from abroad, as well as 9 samples of soybean that are taken from fields in the entity of Republic of Srpska. The other 77 samples were negative for all tested elements.

Key words: *GMO, GM plants, samples, analysis of GMO*

Introduction

Genetically Modified Organisms (GMO's) are organisms which undergo modification on their DNA structure that involves inserting external genes from one species in order to alter the property of another species which would otherwise not be achieved by conventional reproductive means. GM plants may be altered to provide better protection against insect pests or diseases, or to withstand herbicides to enable better weed control. As a result of the achievements in molecular biology techniques, these days, scientists are able to transfer genes for herbicide tolerance and insect and disease resistance into traditional cultivars of agricultural plants (Block *et al.*, 1987; Moellenbeck *et al.*, 2001; Trkulja *et al.*, 2014). The actual trait endowed on the plant can differ, but the one feature all GM plants have in common is addition of new genetic material, DNA, to complement the DNA already present in the plant.

In the last years, the number of GM events being commercialized worldwide has been increasing steadily (James, 2015; Stein *et Rodriguez-Cerezo*, 2009). Genetic engineering in crops is becoming more and more widespread; a cumulative hectareage of 2 billion hectares of biotech crops were cultivated globally in the 20-year period from 1996 to 2015. The 2.0 billion accumulated hectares comprise 1.0 billion hectares of biotech soybean, 0.6 billion hectares of biotech maize, 0.3 billion hectares of biotech cotton and 0.1 billion hectares of

biotech canola (James, 2015). In spite of the rapid adoption of these “transgenic” crops by farmers around the world, some people remain skeptical and even fearful of these plants, demanding strict controls on their cultivation, distribution and consumption. Considering that GMO is not allowed in our country, many genetically engineered plants, as well as the foods and feeds derived from them should be monitored for the presence of genetic modifications.

Material and method

Samples

A total of 96 samples of food and feed were screened for specific elements present in GM events: promotor 35S, terminator NOS, CP4epsps gene, CTP2-CP4epsps construct, pat gene and nptII gene. Samples were taken by the Republic Phytosanitary Inspection Agency (RPIA) and Republic Food Inspection Agency during 2015. Also, samples were taken in the field by the RPIA and several samples were submitted by farmers and food exporters.

DNA extraction

DNA extraction has been performed according to publicly available CTAB protocol. The basic principle of DNA extraction consisted of first releasing the DNA present in the sample into aqueous solution and further purification of the DNA from PCR inhibitors. CTAB-based method started with a lysis step (thermal lysis in the presence of CTAB and EDTA). About 200 g of sample were ground using a ZM 200 Retsch GmbH mill. A total amount of 2 g of each sample, 3 ml of dH₂O and 7 ml of CTAB buffer solution were lightly mixed and incubated at 65°C for 30 min. For positive controls 200 mg of reference material, 300 µl of dH₂O and 700 µl of CTAB buffer solution were used. After incubation 1.5 ml of the solution was transferred into new tubes and 10 µl of RNase A solution (10 mg/ml) was added in order to remove RNA; the mixture was heated at 65°C for 15 min. Afterwards, 10 µl Proteinase K (20 mg/ml) were added, and the mixture was heated at 65°C for 30 min. After centrifugation step supernatant was transferred to a new tube followed by removal of contaminants such as lipophilic molecules and proteins by two extractions with chloroform. After centrifugation the upper layer was mixed with 2 volumes of CTAB precipitation solution (under low salt conditions DNA precipitates in the presence of CTAB) and incubated at room temperature for an hour. The mixture was centrifuged for 10 min at 16000xg and 4°C. The precipitate was dissolved in 350 µl of 1.2 M NaCl solution, and then 350 µl chloroform were added, mixed and centrifuged for 10 min at 16000xg. The upper layer was mixed with 0.6 volumes of isopropanol and centrifuged for 10 min at 16000xg and 4°C. The precipitate was washed with ice-cold 70% ethanol and dissolved in TE buffer. Certified Reference Material (CRM) consisted of 0.05-2% GMO soybean was used as control and reference material. The quality and the quantity of the DNA solutions were determined by UV-spectroscopy (NanoPhotometer Pearl, Implen). The absorbance of the DNA solutions was measured using a spectrophotometer. The purity of the extracted DNAs was determined by the ratio of the absorbance at 260 and 280 nm.

Real Time PCR

Due to the increasing number of GMO, a screening approach using qualitative screening methods has become an integrated part of GMO detection. Real Time analysis was performed using a Stratagene Mx3005P QPCR system. Samples are analyzed for detection of specific elements present in GM events: promotor 35S, NOS terminator, CP4epsps gene, CTP2-CP4epsps construct, pat gene and nptII gene. All reactions of the real-time PCR were performed in duplicate using 2 wells. Reactions were performed in a final volume of 25 µl using 1X Taqman Universal Master Mix (Applied Biosystems, Foster City, CA). Primers and probes used in PCR reactions are shown in Table 1 and qPCR reaction conditions are shown in Table 2.

Table 1. Primers and probes used in PCR reactions

Target	Primers and probe	Sequences (5'-3')	Primer and probe concentration (nM)
Lectin	Lec For	CCA GCT TCG CCG CTT CCT TC	300
	Lec Rev	GAA GGC AAG CCC ATC TGC AAG CC	100
	Lec Pr	FAM-CTT CAC CTT CTA TGC CCC TGA CAC-TAMRA	
<i>35s promotor</i>	35S-F3 Fw	ATG CCT CTG CCG ACA GT	400
	35S-R	AAG ACG TGG TTG GAA CGT CTT C	200
	35S-TMP Probe	FAM-CAA AGA TGG ACC CCC ACC CAC G – TAMRA	
NOS terminator	5F Fw	GTA ATG CAT GAC GTT ATT TAT GAG A	300
	4R Rv	TAA TTT ATC CTA GTT TGC GCG C	200
	P1 Probe	FAM-TGC GGG ACT CTA ATC ATA AAA ACC CA- TAMRA	
<i>CP4EPSPS1 gene</i>	Sttmf3a Fw	GCA AAT CCT CTG GCC TTT CC	600
	Sttmr2a Rv	CTT GCC CGT ATT GAT GAC GTC	200
	Sttmpa Probe	FAM-TTC ATG TTC GGC GGT CTC GCG-TAMRA	
<i>CTP2-CP4EPSPS2 construct</i>	F6 Fw	CCA CGG CGT GCA TGC	300
	R6 Rv	ACC AGA GGA CTT ACG AGC AGT TG	100
	P Probe	FAM-TCA CGG TGC AAG CAG CCG TCC-TAMRA	
<i>pat gene</i>	KVM-5	TTG AGG GTG TTG TGG CTG GTA	400
	KVM-6	TGT CCA ATC GTA AGC GTT CCT	200
	Probe	FAM-CTT CCA GGG CCC AGC GTA AGC A-TAMRA	
<i>nptII gene</i>	NPTII F	CTA TGA CTG GGC ACA ACA GAC A	800
	NPTII R	CGG ACA GGT CGG TCT TGA CA	400
	Probe	FAM-CTG CTC TGA TGC CGC CGT GTT CCG-BHQ1	

Table 2. PCR reaction conditions for all elements.

Step	Stage	T (°C)	Time (sec.)	No of cycles
1	UNG (Uracil N-glycosylase) activation	50	120	1
2	Denaturation and activation of DNA polymerase	95	600	1
3a	Denaturation, annealing and elongation	95	15	50
3b		60	60	

Results and discussion

The DNA isolated by CTAB method was quantified using a spectrophotometer at the absorbance of 260 and 280 nm. The results show that the CTAB-based protocol produced optimum DNA yield. First, amplification of specific soybean gene, lectin, was done from isolated DNA. The results obtained showed that all tested samples had lectin gene. This result showed that the isolated DNAs were amplifiable and contained soy DNA (Figure 1). After PCR amplifications of the lectin gene, all samples were subjected to qualitative real time PCR amplification to determine the presence of GM plant specific sequences: 35S promoter, NOS terminator, CP4epsps gene, CTP2-CP4epsps construct, pat gene and nptII gene (Figure 2). Many available GMOs contain these genetic elements: 35S promoter from *Cauliflower mosaic virus* (CaMV), terminator of the nopaline synthase gene from *Agrobacterium tumefaciens* (T-NOS), 5-enolpyruvylshikimate-3-phosphate synthase gene from the strain CP4 of *Agrobacterium tumefaciens* (CP4epsps), CTP2-CP4epsps – junction region between the chloroplast transit peptide 2 (CTP2) and the synthetic version of 5-enolpyruvylshikimate-3-phosphate synthase gene from the strain CP4 of *Agrobacterium tumefaciens* (CP4-epsps), phosphinothricin N-acetyltransferase gene from *Streptomyces viridochromogenes* strain Tu 494 (pat gene) and neomycin phosphotransferase II gene from *Escherichia coli* (npt II gene).

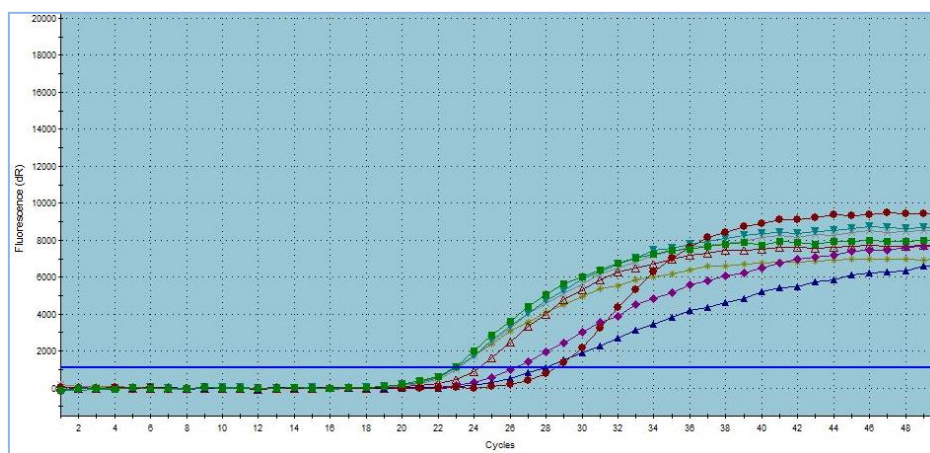

Figure 1. Real time PCR amplification of lectin gene.

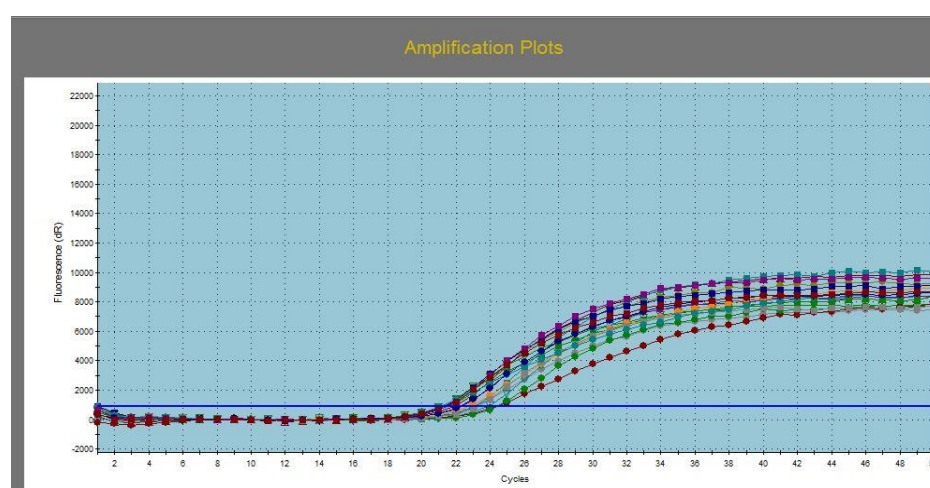

Figure 2. Real time PCR amplification of GM plant specific sequences.

Screening food and feed products for the presence of GMOs has been performed by real time PCR because the specific DNA sequences in GM products can be detected and amplified

easily and reliably. Detection of GMO in food and feed consists of two steps: extraction and purification of DNA and amplification of the inserted DNA by real time PCR. Very low concentrations of isolated DNA could be adequate for the detection of GMO material. In theory, PCR could determine a single target molecule in DNA mixture (Holst-Jensen & Berdal, 2004). Results showed that 19 samples were positive: 4 samples of soybean meal and 6 samples of feed mixtures from import, as well as 9 samples of soybean that are taken from fields in the entity of Republic of Srpska. The other 77 samples were negative for all screened elements.

Conclusions

Considering that from total number of analyzed samples, 19 were positive on genetic modification, as well as that according to legislation in Bosnia and Herzegovina GMO's in food and feed are not allowed and demands of consumers, it would be essential to continue this research to update and confirm the results.

References

- Block M. D., Botterman J., Vandewiele M., Dockx J., Thoen C., Gossele V., Movva N. R., Thompson C., Montagu M. V. & Leemans J. (1987). Engineering herbicide resistance in plants by expression of a detoxifying enzyme. *The EMBO Journal*, 6(9): 2513–2518.
- Holst-Jensen A., Berdal K. G. (2004). The modular analytical procedure and validation approach and the units of measurement for genetically modified materials in foods and feeds. *Journal of AOAC International*, 87(4): 927–936.
- James C. (2015): Global Status of Commercialized Biotech/GM Crops: 2015. ISAAA Brief No. 51. ISAAA: Ithaca, NY.
- Moellenbeck D. J., Peters M. L., Bing J. W., Rouse J. R., Higgins L.S., Sims L., Nevshemal T., Marshall L., Ellis R. T., Bystrak P. G., Lang B. A., Stewart J. L., Kouba K., Sondag V., Gustafson V., Nour K., Xu D., Swenson J., Zhang J., Czaplá T., Schwab G., Jayne S., Stockhoff B. A., Narva K., Schnepf H. E., Stelman S. J., Poutre C., Koziel M., Duck N. (2001). Insecticidal proteins from *Bacillus thuringiensis* protect corn from corn rootworms. *Nature Biotechnology*, 19 (7): 668–672.
- Stein A. J., Rodriguez-Cerezo E. (2009): The global pipeline of new GM crops. Implications of asynchronous approval for international trade (Rep. no. EU23864-EN). Luxembourg: European Communities.
- Trkulja, V., Bajrović, K., Vidović, S., Ostojić, I., Terzić, R., Ballian, D., Subašić, Đ., Mačkić, S., Radović, R., Čolaković, A. (2014): Genetički modifikovani organizmi (GMO) i biosigurnost /Genetically modified organisms (GMOs) and biosecurity/. Uprava Bosne i Hercegovine za zaštitu zdravlja bilja i Agencija za bezbjednost hrane Bosne i Hercegovine.

**PRESENCE OF AFLATOXIN B1 IN FOOD AND FEED SAMPLES IMPORTED TO
THE ENTITY OF REPUBLIC OF SRPSKA (BOSNIA AND HERZEGOVINA)
DURING 2013-2015**

Vojislav TRKULJA*, Bojana VUKOVIĆ, Jelena VASIĆ, Dragana KOVAČIĆ JOŠIĆ, Jelena MIHIĆ SALAPURA, Jovana PRIJIĆ

Public institution „Agricultural institute of Republic of Srpska, Banja Luka“, Bosnia and Herzegovina

*Corresponding author: vtrkulja@blic.net

Abstract

Extremely dry and warm weather conditions recorded during 2012 were favorable for intensive development of mold. As a result of these very stressful conditions unusually high contamination of corn with Aflatoxin B1 was established which caused huge economic losses in milk production in Republic of Srpska and in surrounding countries. The production of corn and other cereals in Bosnia and Herzegovina is not satisfactory and it is characterized by low average yields. In order to satisfy all needs, in terms of human and animal nutrition, we are forced to import food and feed from other countries. Considering the situation occurred in 2012, starting from 2013, a continuous control of imported food and feed has been carried out. During the three-year research 434 samples of imported food and feed were analyzed for the presence of Aflatoxin B1. Samples were analyzed by competitive enzyme immunoassay (ELISA) with microplate based kit produced by EuroProxima, the Netherlands. Results of the analysis showed that 91 analyzed samples (20.97%) was contaminated with Aflatoxin B1 according to Regulations of maximum level for certain contaminants in food.

Keywords: *Aflatoxin B1, food, feed, Entity of Republic of Srpska.*

Introduction

Wide variety of agricultural, food and feed products can be contaminated with secondary metabolites of moulds known as mycotoxins. Mycotoxins are considered to be one of the best known and most common chemical contaminants of food and feed which after ingestion can result in illness or death of animals and humans. Infection may occur in the field, particularly where the plant experiences water, temperature or nutrient stress and accumulation of mycotoxin may increase if harvested material is inappropriately stored (Moreno and Kang, 1999). Despite efforts to control fungal contamination of many cereal and other crops in the field or during storage, toxigenic fungi are present in agricultural products and occur regularly in worldwide food supplies. For that reason, monitoring for the presence of mycotoxins in food and feed is therefore needed at the global level. As these can never be completely removed from the food supply, many countries have defined levels in food (tolerances, guideline levels, maximum residue levels) that are unlikely to be of health concern (Magan and Olsen, 2004).

Aflatoxins are the main toxic secondary metabolites produced by *Aspergillus parasiticus* and *Aspergillus flavus* and have carcinogenic, hepatotoxic, teratogenic and mutagenic effects in human and animals when ingested, inhaled or adsorbed through the skin. A wide range of food commodities may be contaminated with aflatoxins, but the highest levels are usually found in commodities originating from areas with warmer climates. Since AFs could contaminate a wide variety of agricultural product, which presents an important part of food chain, indirectly it can cause a great number of toxic effects in human and animal organisms. Furthermore, the presence of AFs could also be a cause of great economical losses (EFSA, 2013). The liver is the main target organ, but high levels of aflatoxins have also been found in

other organs such as lungs, kidneys, brains and hearts of individuals dying from acute aflatoxicosis. From a food safety point of view, chronic toxicity is probably more important certainly in more developed countries. Low level ingestion over a long period has been implicated in primary liver cancer, chronic hepatitis, jaundice, cirrhosis and impaired nutrient conversion in many animals and therefore potentially in humans. The major members of aflatoxins are aflatoxin B1, B2, G1, G2 as well as two additional metabolic products M1 and M2. According to International Agency for Research on Cancer (IARC) AFB1 is listed as a group I carcinogen and is more frequently present in cereals than the B2, G1 and G2 type. Due to the extreme carcinogenic effects, significant adverse impacts on human and animal health, as well as a great influence on economic losses, aflatoxins make an enormous challenge for research around the world (Kos, 2014). The aim of this study was to monitor all imported samples of food and feed for the presence of Aflatoxin B1.

Materials and methods

During three-year period (2013-2015) 434 samples of food and feed intended for human and animal consumption were analyzed. Samples were taken on the borders by the representatives of the Republic administration for inspection affairs and analyzed in Laboratory for Plant Protection of Agricultural Institute of Republic of Srpska, Banja Luka. Each sample was dried at a temperature of 60°C for 72 h and a 100 g of each sample was ground and homogenized to a fine powder. 9 ml of methanol was added in each sample and the tubes were stirred for 10 min and then centrifuged for 10 minutes at 2000 xg. Further dilution were prepared by transferring 50 µl of the supernatant obtained after centrifugation with 150 µl of dilution buffer. For further testing 50 µl of the dilution is used, and each sample was tested in two replicates. Samples were analyzed by competitive enzyme immunoassay (ELISA) with microplate based kit produced by Euro Proxima, the Netherlands. The aflatoxin B1 ELISA is a competitive enzyme immunoassay based on antibodies which enables the detection and quantification of very low concentrations of aflatoxin B1. Standards and samples are pipetted into the wells of microtiter plate and according to protocol we added antibodies and conjugate in all wells except H1 and H2 wells. Microtiter plate was incubated for one hour at 37°C. After a washing procedure ready-to-use substrate is added and plate was incubated for 30 minutes at 20°C - 25°C. Photometric measurements were carried out on the Thermo Scientific™ Multiskan™ FC microplate photometer. The mean optical density (O.D.) of blank wells is subtracted from individual O.D. values of wells containing standards and samples. The O.D. value of six standards and the samples (value of the duplicates) are divided by the mean O.D. value of zero standard (wells A1 and A2) and multiplied by 16. Values (% maximum absorbance) calculated for the standards are plotted on the Y axis versus the aflatoxin B1 equivalents concentration (ng/ml) on a logarithmic X-axis. The amount of aflatoxin B1 in the samples has been expressed as aflatoxin B1 equivalents. The aflatoxin B1 equivalents in the extracts (ng/ml) corresponding to the % maximal absorbance of each extract can be read from the calibration curve. Calculated equivalents are multiplied by a factor 16. All these calculations were done using the Thermo Scientific™ SkanIt™ software.

Results and discussion

Results of the analysis of imported samples of food and feed from different countries to the Republic of Srpska during three years of survey have shown contamination levels of 60,5%. 34,3% of analyzed samples was contaminated with aflatoxin B1 in the amount of 2-5 µg/kg (ppb) while in 26,2% of the analyzed samples established aflatoxin B1 content was over 5 µg/kg. According to Regulations on maximum levels for certain contaminants in foods (Official Gazette B&H 68/14), cereals and all products obtained from cereals, dried fruits (except dried figs), nuts, peanuts and other oilseeds and their products intended for direct

human consumption with the content of aflatoxin B1 over 2 µg/kg, cannot be used for direct human consumption. According the same Regulation, corn and rice, which will be subjected to sorting or other physical treatment before human consumption or use as a component in food, hazelnuts and Brazilian nuts with the content of aflatoxin B1 above 5 µg/kg (ppb) cannot be used for direct human consumption. In Bosnia and Herzegovina content of aflatoxin B1 in animal feed is regulated by Regulations on undesirable substances in animal feed (Official Gazette B&H 72/11) and content of aflatoxin B1 in animal feed over 20 ppm (20 mg/kg) cannot be used for direct human consumption. All analyzed samples can be used for animal feed according to this Regulation. Analyzed by each year (Table 1, Graf. 1), in 2013 from total analyzed samples number of food and feed (220)25,0% was contaminated with aflatoxin B1. 8,6% analyzed samples was contaminated with aflatoxin B1 in the amount of 2-5 µg/kg. In 16,4% analyzed samples content of aflatoxin B1 was over 5 µg/kg. In 2014, from total analyzed samples number (139)12,9% was contaminated with aflatoxin B1. 7,1% of samples was contaminated with aflatoxin B1 in the range of 2-5 µg/kg while 5,8% analyzed samples had aflatoxin levels higher than 5µg/kg. From total analyzed samples number in 2015 (72)22,6% was contaminated with aflatoxin B1, 18,6% were contaminated with aflatoxin B1 in the range of 2-5 µg/kg and only 4% had aflatoxin B1 levels that exceeded 5 µg/kg.

Tab. 1. Review of analyzed samples number during the three-year survey.

Year	Total number of analyzed samples	% of samples with concentration of aflatoxin B1 2-5 µg/kg (ppb)	% of samples with concentration of aflatoxin B1 >5 µg/kg (ppb)	Total %
2013	220	8,6	16,4	25,0
2014	139	7,1	5,8	12,9
2015	72	18,6	4,0	22,6
TOTAL	431	34,3	26,2	60,5

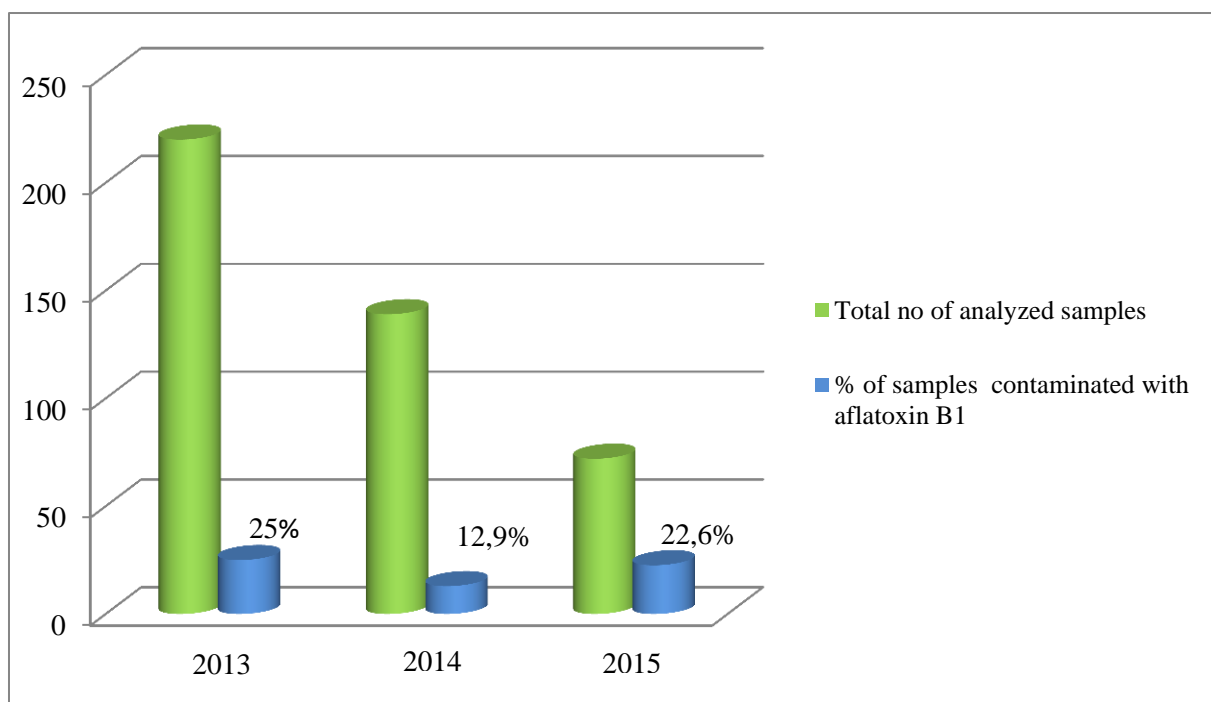

Graf 1. The total number of analyzed samples and % of samples contaminated with aflatoxin B1 per year.

Conclusion

The levels of contaminated food and feed samples reported in this study with AFB1 shown that monitoring of imported raw materials and feed samples is necessary to prevent human and cattle exposure to aflatoxin B1. Also, Aflatoxin B1 concentration in feed may result in excretion of AFM1 in milk and eventually causing human exposure through consumption of contaminated milk. Many countries monitor imported commodities that are susceptible to aflatoxin B1 contamination by sampling and analysis. However, moulds and aflatoxins in bulk food shipments tend to be highly heterogeneous and it is essential to ensure that an adequate sampling method is used to monitor imported materials.

References

- Amin A., AboGhalia H., Hamed A. (2010). Aflatoxin B1 and B2 in cereal – based baby foods and corn snacks from Egypt markets: Occurrence and estimation of the daily intake of AFB1. *The African Journal of Mycology and Biotechnology*, 15: 1–11.
- Cismileanu A., Voicu G., Ciuca V., Ionescu M. (2008). Determination of aflatoxin B1 in cereal-based feed by a high-performance chromatographic method. *Lucraristi intifice medicina veterinara*. Vol. XLI, Timisoara.
- EFSA, European Food Safety Authority (2013). Aflatoxins (sum of B1, B2, G1, G2) in cereals and cereal-derived food products. Supporting Publications, EN-406, The EFSA Journal, 1–11.
- Kos J. (2015). Aflatoksini: analizapojave, procena rizika i optimizacija metodologije odredivanja u kukuruzu i mleku. Doktorskadisertacija, Novi Sad.
- Kotinagu K., Mohanamba T., RathnaKumari L. (2015). Assessment of aflatoxin B1 in livestock feed and feed ingredients by high-performance thin layer chromatography. *Veterinary world*, EISSN: 2231–0916.
- Magan N., Olsen M. (2004). Mycotoxins in food. Woodhead Publishing and Food Science and Technology, 1st edition.
- Moreno O. J., Kang M. S. (1999). Aflatoxins in maize: the problem and genetic solutions. *Plant Breed*, 118: 1–16.

A NEW BACTERIAL ENDOSYMBIONT OF SUNN PEST, EURYGASTER INTEGRICEPS

Nurper GUZ

Ankara University, Insect Molecular Biology Laboratory, Department of Plant Protection, Faculty of Agriculture, Ankara, Turkey

Corresponding author: nurperguz@agri.ankara.edu.tr

Abstract

Most insect species harbor endosymbiotic bacteria that play key roles in their hosts' fitness by providing essential nutrients and manipulating their reproduction, also protecting them from natural enemies. Spiroplasmas, most commonly associated with arthropods, exhibit great diversity with respect to both their modes of transmission and effects on their hosts. In this paper we evaluated the prevalence of Spiroplasma infections in the field populations of Eurygaster integriceps, one of the most serious pests of wheat and barley. Whole genomic DNA was extracted from surface sterilized individual sunn pest samples from 16 different geographic localities in Turkey. PCR-based screening of DNA was undertaken by using the 16S rDNA locus in terms of Spiroplasma infection. To our knowledge, this study represents the first report of sunn pest naturally harboring Spiroplasma infection in Turkey. We detected widespread Spiroplasma infections whereas infection frequencies varied among different populations. The results obtained in this study showed that Spiroplasma infections in *E. integriceps* in Turkey had a higher frequency, indicating that symbionts appear to be an important tool in developing alternative control strategies against sunn pest populations.

Keywords: Sunn pest, endosymbiont, *Spiroplasma*, 16S rDNA

Introduction

Symbiotic bacteria are ubiquitous organisms that have major roles in supplying essential nutrients to their hosts such as essential amino acids, vitamins and other potentially beneficial compounds that restricted host diets typically lack (Buchner, 1965; Douglas, 2009; Hosokawa et al., 2010; Feldhaaret al., 2007). In addition to provisioning nutrients to the host they have also been implicated in the detoxification of dietary compounds and insecticides as well as contribute to resistance toward natural enemies, provide tolerance to heat shock or impact host transmission of viruses (Douglas, 2009; Wilkinson et al., 2007; Haine, 2008). Among these bacterial fauna, Spiroplasma is one of the most common microbial species found in insects. Spiroplasma is less studied than the other well-known bacteria, Wolbachia, hence the evolutionary consequences of harboring Spiroplasma are unclear. Wolbachia, is a member of α subdivision of the class Proteobacteria while Spiroplasmas are members of the class Mollicutes. Similar to Wolbachia, Spiroplasma is a heritable endosymbiont which is transmitted transovarially from mother to offspring however Wolbachia has been known to induce cytoplasmic incompatibility while Spiroplasma is famous as male killer in the fruit fly *Drosophila* spp. (Poulson and Sakaguchi 1961; Williamson et al. 1999), ladybird beetles (Hurst et al., 1999; Jiggins et al. 2000; Majerus et al. 1999; Tinsley and Majerus 2006), and a butterfly (Jiggins et al. 2000). On the other hand there are species of *Drosophila* harbor Spiroplasma that do not cause male-killing, and no obvious phenotypic effects of this infection have yet been found (Ota et al. 1979; Williamson and Poulson, 1979).

The sunn pest, *Eurygaster* spp., is one of the most devastating pests of wheat crops in the Near and Middle East, West and Central Asia, North Africa, Eastern and South Europe (Brown, 1962; Critchley, 1998; Parker et al., 2002) causing up to 90 % losses and seriously damaging the remaining grain quality. The current management strategy for this pest mainly relies on chemical control. In addition to the high cost, insecticides pollute the environment, as well as killing non-target insects, whilst resistance has developed to various types of insecticides in this species (Critchley, 1998; Bandaniet al., 2005; Sukhoruchenko&Dolzhenko, 2008). In recent years, bacteria-insect interactions have emerged as a promising area for development of novel methods to control insect pests. The infection density of endosymbionts is one of the most important factors for understanding the consequences of harboring endosymbionts. Objective of this paper was to learn the prevalence of *Spiroplasma* detected in sunn pest populations in Turkey.

Material and Methods

E. integriceps adults were collected from wheat fields between 2015 and 2016. Information about the collection sites and geographical coordinates of different sunn pest specimens are listed in Table 1.

Specimens were morphologically identified using recent taxonomic keys and confirmed by DNA barcoding (data not shown), as well.

Sunn pest adults were homogenized in lysis buffer (50 mM Tris, 50 mM EDTA, 0.4 M LiCl, 1% CTAB, 2% PVPP and 0.5% Tween 20) with a sterile pestle in order to isolate genomic DNA. The homogenate was incubated at 65°C for 15 min and extracted with chloroform-isoamyl alcohol (24: 1) followed by isopropanol precipitation. The pellet was washed with 70% ethanol and re-suspended in sterile water. The bacterial *16S rRNA* gene was amplified by PCR with the primers 16SA1 (5'-AGAGTTTGATCMTGGCTCAG-3') and TKSSspR (5'-TAGCCGTGGCTTTCTGGTAA-3') (Fukatsu *et al.*, 2000) under the temperature profile of 94°C for 10 min, followed by 35 cycles consisting of 94°C for 1 min, 55°C for 1 min, and 72°C for 1 min. The PCR product was electrophoresed in an agarose gel, excised, purified by using a Gel Extraction Kit (Promega), and cloned with the TA cloning vector pT7Blue (Novagen) and *Escherichia coli* DH5 α competent cells (Promega), in which ampicillin and X-Gal (5-bromo-4-chloro-3-indolyl-beta-D-galactopyranoside) were used for the blue-white selection system. Plasmids were purified by using a MiniElute kit (Promega). Sequencing reactions were performed by using the plasmids as template DNA with a GenomeLab DTCS Quick Start kit (Beckman Coulter). Sequencing analyses were performed with a GeXP Genetic Analysis System (Beckman Coulter). The following sequencing primers were used: M13M4 (5'-GTTTTCCAGTCACGAC-3') and M13RV (5'-CAGGAAACAGCTATGAC-3') in the flanking regions of the vector. The DNA and deduced amino acid sequences were analyzed using the BLAST tool at the National Center for Biotechnology Information (NCBI) (www.ncbi.nlm.nih.gov/BLAST) and EXPASY (<http://expasy.org/>). The sequences obtained with these general primers allowed us to design species specific primers. New primers were designed using Primer-BLAST program (Ye *et al.*, 2012). Sunn pest specific primers amplifying approximately 400bp fragment of bacterial 16S rRNA were as follows: EinSpiF: 5' TCT TCC CTT ACA ACA GAC CTT TAC 3' and EinSpiR: 5' CTG GCG GCA TGC CTA ATA 3'. PCRs were performed in a total volume of 50 μ l using 1 μ l of DNA template and GoTaq Flexi DNA polymerase (Promega) according to the manufacturer's instructions: 5 \times buffer, 10 mM each dNTP, 10 mM each primer and 1.25 u/ μ l DNA polymerase. A final primer set (12 SAI: 5' CTA GGA TTA GAT ACC CTA TT 3' and 12 SBI: 5' AAG AGC GAC GGG CGA TG 3') was used to assess the quality of the template DNA. 12S primers are considered universal for insect mtDNA amplifying an approximately 400 bp DNA fragment (Simon *et al.*, 1991). 2 μ l of PCR products were visualized by gel electrophoresis on 1.5%

agarose gels stained with ethidium bromide. In the case of negative amplification, PCRs were repeated with higher DNA template concentrations to ensure that the dilutions used were not below the sensitivity of the PCR technique. Data were excluded in cases in which the 12S control primers were unable to amplify a product from a given DNA extraction.

Results and Discussion

This study is the first report of the presence of *Spiroplasma* infection in *E. integriceps*. In total, 64 individual females belonging to *E. integriceps* species were screened for *Spiroplasma* by PCR assay using species specific *16SrDNA* gene primers (Figure 1). The infection status of each samples tested and the number of specimen screened are listed in Table 1. In total, 49 of 64 tested samples were PCR positive which means that 76.5% were infected with *Spiroplasma*. Results showed that infections could be detected in 100% of the individuals in İzmit, Sakarya, Gaziantep, Adıyaman, Adana, Balıkesir, Hatay and Kırklareli, whereas none of the populations from Mersin were found to harbor *Spiroplasma*. On the other hand half of the populations from Şırnak, Elazığ and approximately 75% of the populations from Ağrı, Çanakkale, Diyarbakır and Şanlıurfa were found to harbor *Spiroplasma*. Screening more samples will give more accurate infection frequencies of *Spiroplasma* in sunn pest populations.

Table 1. The *Spiroplasma* infection status of *E. integriceps* species collected from various sites. The values (+ve and -ve) refer to the number of sunn pests sampled by PCR analysis and found positive and negative for the presence of *Spiroplasma*, respectively.

# of Specimen	Collection sites	Co-ordinates	<i>Spiroplasma</i> infection status		# of Specimen	Collection sites	Co-ordinates	<i>Spiroplasma</i> infection status	
			+ve	-ve				+ve	-ve
1, 2, 3, 4	Ağrı, Turkey	39°55'50"N 40°39'39"E	3	1	33, 34, 35, 36	Şırnak, Turkey	37°13'49"N 42°29'48"E	2	2
5, 6, 7, 8	İzmit, Turkey	40°47'20"N 29°59'07"E	4	0	37, 38, 39, 40	Elazığ, Turkey	38°33'34"N 40°07'36"E	2	2
9, 10, 11, 12	Mersin, Turkey	36°52'57"N 34°51'20"E	0	4	41, 42, 43, 44	Adıyaman, Turkey	37°46'59"N 38°35'17"E	4	0
13, 14, 15, 16	Çanakkale, Turkey	40°25'37"N 26°39'53"E	3	1	45, 46, 47, 48	Adana, Turkey	37°15'41"N 35°04'19"E	4	0
17, 18, 19, 20	Sakarya, Turkey	41°01'53"N 30°18'49"E	4	0	49, 50, 51, 52	Şanlıurfa, Turkey	37°44'28"N 39°38'57"E	3	1
21, 22, 23, 24	Diyarbakır, Turkey	38°06'26"N 40°26'40"E	3	1	53, 54, 55, 56	Balıkesir, Turkey	39°55'15"N 28°08'23"E	4	0
25, 26, 27, 28	Tunceli, Turkey	38°51'42"N 39°19'30"E	1	0	57, 58, 59, 60	Hatay, Turkey	36°16'12"N 36°34'12"E	4	0
29, 30, 31, 32	Gaziantep, Turkey	37°24'59"N 37°41'19"E	4	0	61, 62, 63, 64	Kırklareli, Turkey	41°36'57"N 27°30'47"E	4	0

Figure 1. PCR screening for the presence of *Spiroplasma* in *E. integriceps* using species specific *16S rDNA* gene primers. GeneRuler 100 bp DNA Ladder used as marker. Lanes 1-64 represent sunn pest samples from the following areas: Lane 1-4: Ağrı, 5-8: İzmit, 9-12: Mersin, 13-16: Çanakkale, 17-20: Sakarya, 21-24: Diyarbakır, 25-28: Tunceli, 29-32: Gaziantep, 33-36: Şırnak, 37-40: Elazığ, 41-44: Adıyaman, 45-48: Adana, 49-52: Şanlıurfa, 53-56: Balıkesir, 57-60: Hatay, 61-64: Kırklareli

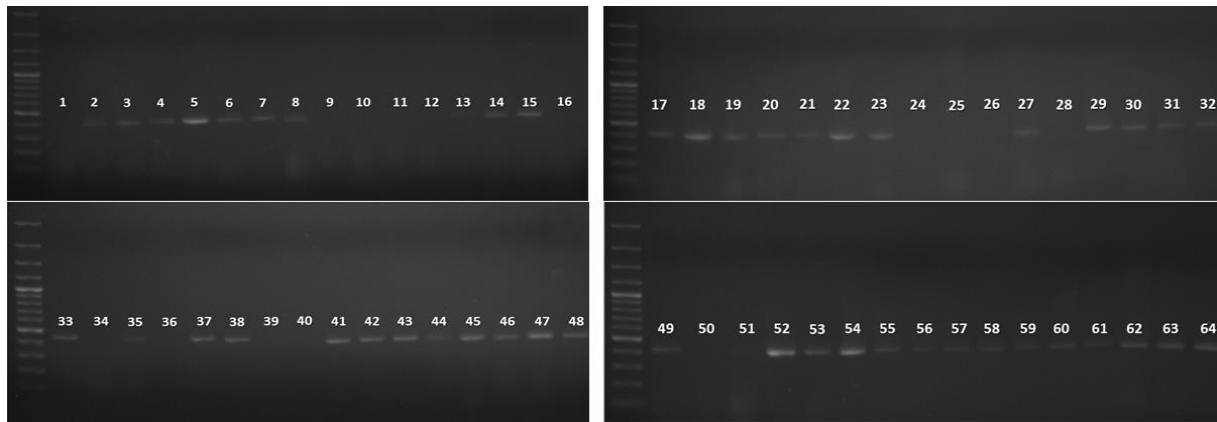

Most of our understanding of the critical parameters influencing the dynamics of symbiotic bacteria spread and maintenance in insect populations comes from studies of *Drosophila*. While the prevalence and fitness cost of *Wolbachia* have been widely studied in *Drosophila*, the incidence of *Spiroplasma* infections in *Drosophila* are far less clear (McGraw & O'Neill, 2004; Werren 1997). The highest levels of *Spiroplasma* infection rates 85% in certain populations of *D. mojavensis* and 66% of females from the field surveys from wild populations of *D. hydei* have been reported in previous studies (Watts *et al.*, 2009; Kageyama *et al.*, 2006). In contrast, infection of wild *D. willistoni* and *D. nebulosa* by male-killing *Spiroplasma* ranged from 1-6%, varying seasonally (Williamson and Poulson, 1979). Our initial analyses of the prevalence of *Spiroplasma* infections in sunn pest populations have shown that there is a heterogeneous infection profile with 76.5% infection rate in Turkey.

Spiroplasma is a male-killer in some species of *Drosophila* (Williamson & Poulson, 1979), however many other species of *Drosophila*, are infected with *Spiroplasma* that do not cause male-killing, and their fitness effects are unclear (Kageyama *et al.* 2006; Mateos *et al.* 2006; Watts *et al.* 2009). Some species of *Spiroplasma* are horizontally transmitted insect pathogens in the gut while many lineages exhibit vertical transmission via transovarially (i.e. from mother to offspring) and affect their hosts in different ways (Gasparich, 2002). The mode of transmission route of *Spiroplasma* in sunn pest populations and how sunn pest is affected from *Spiroplasma* infection is still unknown. On the other hand, sunn pest is a hemimetabolous univoltine species feeds and completes its development in grain fields during spring and summer and then migrates as an adult to the mountains in late summer where it enters an obligatory diapause. Due to its genetically programmed diapause and reproductive strategy it is difficult to measure the fitness effect of *Spiroplasma* in sunn pest populations.

Conclusions

In the present study, we assessed the prevalence of *Spiroplasma* in *E. integriceps* in sixteen different geographic localities in Turkey. Due to intensive sampling effort, we are able to test *Spiroplasma* presence by PCR analysis. Further experiments need to be conducted in order to detect the phylogenetic relationship and phenotypic effect of *Spiroplasma* in *Eurygaster* populations which will confer its potential in terms of suppressing sunn pest species in the future.

Acknowledgement

This research was funded by The Scientific and Technological Research Council of Turkey (TUBITAK-Grant no: 114O423).

References

- Bandani A.R., Alizadeh M., Talebi K. (2005). Toxicity of fenitrothion, an organophosphorus pesticides summer population of sunn pest, *Eurygasterintegriceps* Put. (Hemiptera: Scutelleridae). Commun. Agric. Appl. Biol. Sci.70: 775-777.
- Brown E.S. (1962).Notes on parasites of Pentatomidae and Scutelleridae (Hemiptera-Heteroptera) in Middle East countries, with observations on biological control.Bull. Entomol. Res.53: 241-256.
- Buchner P.(1965). Endosymbioses of animals with plant microorganisms.Wiley, Chichester, UK.
- Critchley B.R. (1998). Literature review of sunn pest *Eurygasterintegriceps* Put. (Hemiptera, Scutelleridae). Crop Prot. 17: 271-287.
- Douglas A.E.(2009).The microbial dimension in insect nutritional ecology.FunctEcol 23: 38-47.
- Feldhaar H., Straka J., Krischke M., Berthold K., Stoll S., Mueller M.J., Gross R. (2007).Nutritional upgrading for omnivorous carpenter ants by the endosymbiont *Blochmannia*. BMC Biol. 5, 48.
- Fukatsu T., Nikoh N., Kawai R. and Koga R.**(2000). The secondary endosymbiotic bacterium of the pea aphid *Acyrtosiphonpisum*(Insecta: Homoptera).Appl. Environ. Microbiol.66:2748-2758.
- Gasparich G.E. (2002). Spiroplasmas: evolution, adaptation and diversity. Front. Biosci. 7:d619-d640.
- Haine E.R.(2008).Symbiont-mediated protection. Proc BiolSci275:353-361.
- Hosokawa T., Koga R., Kikuchi Y., Meng X.Y., Fukatsu T. (2010).*Wolbachia* as a bacteriocyte-associated nutritional mutualist. Proc. Natl Acad. Sci. USA 107: 769-774.
- Hurst G.D.D., Jiggins F.M., Schulenburg J.H.G.V.D., Bertrand D., West S.A., Goriacheva H. (1999).Male-killing *Wolbachia* in two species of insect. Proc Biol Sci. 266:735-740.
- Jiggins F.M., Hurst G.D., Jiggins C.D., Schulenburg J.H., Majerus M.E. (2000). The butterfly *Danauschrypsippus* is infected by a male-killing *Spiroplasma* bacterium. Parasitology. 120:439-446.
- Kageyama D., Anbutsu H., Watada M., Hosokawa T., Shimada M., Fukatsu T. (2006).Prevalence of a non-male-killing *Spiroplasma* in natural populations of *Drosophila hydei*.Appl Environ Microbiol 72: 6667-6673.
- Majerus T.M., Graf von der Schulenburg J.H., Majerus M.E., Hurst G.D. (1999). Molecular identification of a male-killing agent in the ladybird *Harmonia axyridis*(Pallas) (Coleoptera: Coccinellidae). Insect Mol Biol. 8:551-555.
- Mateos M., Castrezana S., Nankivell B., *et al.* (2006). Heritable endosymbionts of *Drosophila*.Genetics.174: 363-376.
- McGraw E.A., O'Neill S.L. (2004).*Wolbachia* pipientis: intracellular infection and pathogenesis in *Drosophila*. CurrOpinMicrobiol 7: 67-70.
- Ota T., Kawabe M., Oishi K., Poulson D.F. (1979).Non-male-killing *Spiroplasma* in *Drosophila hydei*. J Hered 70:211-3.
- Parker B.L., Costa S.D., Skinner M., Bouhssini M.E. (2002).Sampling sunn pest (*Eurygasterintegriceps*Puton) in overwintering sites in northern Syria.Turkish J. Agric. Forestry26: 109-117.
- Poulson D.F, Sakaguchi B. (1961). Nature of “sex-ratio” agent in *Drosophila*.Science. 133:1489-1490.

- Simon C., Franke A., Martin A. (1991). The polymerase chain reaction: DNA extraction and amplification. In Hewitt G.M., Johnson A.W.B. & Young J.P.W. (eds): Molecular Techniques in Taxonomy. Vol. 57. Springer, Berlin, pp. 329-355.
- Sukhoruchenko G.I., Dolzhenko V.I. (2008). Problems of resistance development in arthropod pests of agricultural crops in Russia. EPPO Bull. 38: 119-126.
- Tinsley M.C., Majerus M.E. (2006). A new male-killing parasitism: *Spiroplasma* bacteria infect the ladybird beetle *Anisosticta novemdecimpunctata* (Coleoptera: Coccinellidae). Parasitology. 132:757-765.
- Watts T., Haselkorn T.S., Moran N.A., Markow T.A. (2009). Variable Incidence of *Spiroplasma* Infections in Natural Populations of *Drosophila* Species. PLoS ONE 4(5): e5703.
- Werren J.H. (1997). Biology of *Wolbachia*. Annu. Rev. Entomol. 42: 537-609.
- Williamson D.L., Poulson D.F. (1979). Sex Ratio Organisms (*Spiroplasma*) of *Drosophila* in The Mycoplasmas III: Plant and Insect Mycoplasmas, Academic Press, New York 3:176-206.
- Williamson D.L., Sakaguchi B., Hackett K.J., Whitcomb R.F., Tully J.G., Carle P., Bové J.M., Adams J.R., Konai M., Henegar R.B. (1999). *Spiroplasma poulsoni* sp. nov., a new species associated with male-lethality in *Drosophila willistoni*, a neotropical species of fruit fly. Int J Syst Bacteriol. 49:611-618.
- Wilkinson T.L., Koga R., Fukatsu T. (2007). Role of host nutrition in symbiont regulation: impact of dietary nitrogen on proliferation of obligate and facultative bacterial endosymbionts of the pea aphid *Acyrtosiphon pisum*. Appl Environ Microbiol. 73:1362-6.
- Ye J., Coulouris G., Zaretskaya I., Cutcutache I., Rozen S., Madden T. (2012). Primer-BLAST: A tool to design target-specific primers for polymerase chain reaction. BMC Bioinformatics. 13:134.

INTEGRATED PEST MANAGEMENT OF THE TOMATO LEAF MINER, *TUTA ABSOLUTA* (MEYRICK) (LEPIDOPTERA: GELECHIIDAE) IN TOMATO FIELDS IN EGYPT

Goda N. F., A. H. EL-HENEIDY, Djelouah K.¹, Hassan N.²

Plant Protection Research Institute, Agricultural Research Center, Giza, Egypt

²Instituto Agronomico Mediterraneo di Bari, Ciheam, Italy

³Russell IPM Ltd, England

*Corresponding author: nizarfahmi78@ymail.com

Abstract

Tomato (*Solanum lycopersicum* L) is universally one of the most important vegetable crops worldwide. In Egypt, the crop is cultivated annually in 2-3 plantations. The tomato leaf miner, *Tuta absoluta* (Meyrick) (Lepidoptera: Gelechiidae) is one of the recent devastating pests attacking tomato crop worldwide. It is a new exotic pest in Egypt in 2009. A study to evaluate the efficacy of integrated control methods against the pest was carried out at Fayoum Governorate, Egypt in the tomato Nili plantation (September – December) of 2014. The control methods tested based on the use of bio-rational solutions (use of biopesticides) or biological control agents in integration with mass trapping (use of sex pheromone). The evaluation was measured by counting the aggregation pheromone trap catches twice a week and the reduction rate of pest infestation (weekly inspection of no. of mines/plant). Based on the infestation reduction rate, release of the egg parasitoid, *Trichogrammatoidea bactrae* + mass trapping (plot B) showed best results, followed by the application with Biotrine and Fytomax + mass trapping (plot A) and lastly use of insecticides (control) (plot C). Respective seasonal rate of infestation was 9.2, 11.1 and 29.3%. Highest yield production was recorded (38 ton/hectare) in plot (B) (*T. bactrae* + mass trapping), whereas the loweerrone (33.5 ton/hectare) was recorded in plot (C) (control). The general means of cost benefit for plots A, B and C attained 6150.5, 6635 and 5630.5 Euro/ hectare, respectively.

Keywords: Tomato, *Tuta absoluta*, IPM, Cost benefit, Egypt.

Introduction

Tomato (*Solanum lycopersicum* L.) is universally considered one of the most important vegetable crops worldwide. This crop is subject to attack with scores of insect pests and diseases that affect its production. The tomato leaf minor (TLM), *Tuta (Scrobipal puloides) absoluta* (Meyrick) (Lepidoptera: Gelechiidae) is one of the major devastating insect pests attacking tomato in many of the tomato-producing regions worldwide. It is originated from south America, rapidly invaded various European countries and spread very fast along the Mediterranean Basin including Egypt (Desneux *et al.*, 2010). Tomato is known as the main host of *T. absoluta*, but it also feeds, develops and reproduces on other solanaceous plants such as potato, tobacco, eggplant, pepper, aubergines, black nightshade and several related weeds such as jimson weed (Pereyra and Sanchez, 2006). Severe infestation with *T. absoluta* can potentially result in significant damage by feeding on all aerial parts of tomato plant, causing economic losses of up to 80-100%, if the pest is not properly managed (Desneux *et al.*, 2010).

At present, depending on the cropping system and infestation intensity, the main control tools used against TLM rely too heavily on conventional insecticides that have led to the development of insecticide resistance (Haddi, 2012). Therefore, the use of insecticides has become subordinated to other control methods, such as biological control singly and/or in

integrated with other methods as use of aggregation pheromones and biopesticides that have gained more credibility in the last decades (Senior *et al.*, 2001; Agamy, 2003 and Mandour *et al.*, 2012). Biological control using natural enemies would be the concerted use as a major component of any integrated pest management (IPM) program for controlling TLM. Egg parasitoid species of family Trichogrammatidae are considered efficient biological control agents and are widely used commercially for the suppression and control of lepidopterous pests on many crops (Agamy, 2003). They are easy to rear and release either in open fields or protected crops (Chailleux *et al.*, 2012) mostly through innudative releases (Mills, 2010). Selection of the appropriate *Trichogramma* species for controlling a given insect pest is a crucial factor to the success of biological control program (Desneux *et al.*, 2010; Mills, 2010 and Chailleux *et al.*, 2012).

The present study aimed to testing an IPM package based on use of sex pheromone aggregation traps + use of biorational solutions or a biocontrol agent comparing with use of conventional pesticides. Cost-benefit of the package was also estimated. .

Materials and methods

Materials

Biorational solutions

The tested biorational solutions used in this study were Fytomax N and Biotrine produced by Russell IPM Company UK. These two products are highly recommended for controlling *T. absoluta* in vegetable crops.

1-Fytomax N: is a bio-rational solution based on Azadirachtin 1% (10000 ppm) extracted from the neem tree seeds *Azadirachta indica* in ULV formulation. Fytomax N prevents or interferes with an insect's development. It has an ovicidal effect and control target pests by contact as well as by ingestion. It acts as a repellent, antifeedant, and interference with the molting process of insect pest. Treated insects stop feeding and growing.

2-Biotrine: is a bio-rational solution based on a natural fermentation of the soil bacterium *Streptomyces avermitilis*. It is a broad spectrum in its action, killing insects through contact and as they feed on treated plants. Biotrine works by paralyzing the insect, contact, ingestion and by suffocation. It acts as an antifeedant product with residual protection for the crop.

Soapy water traps

Pheromone lures used in this study were obtained from Russell IPM Company, UK. Rubber septa dispenser of 120 days was used. Water traps were used for monitoring and mass-trapping program. Trap designs vary and can be as simple as deep plastic trays filled with soapy water and with the pheromone lure suspended over the center of the tray just above the water line attracted moths become trapped when they touch the soapy water.

Trichogrammatoidea bactrae Nagaraja and Nagarkatti

The egg parasitoid species *T. bactrae* was recommended to be used against the pest. Parasitoid cards, included parasitized *Sitotrogace* eggs, provided by El-Heneidy (Dept. of Biological Control, Agriculture Research Centre, Giza, Egypt), were kindly hanged directly in the field on the tomato plants.

Methodology and Experimental Design

An experimental area of one hectare (equal 2.5 feddan) (feddan = 4200 m²) located at Fayoum governorate in Egypt, cultivated with tomato plants, variety Gold stone (planted in the nursery on 20th of June and transplanted to the permanent field by early August), was subdivided into

three experimental plots. The experiment was carried out at the tomato plantation (September-January), which is so-called Nili plantation. Plot A (one feddan) was subdivided into 4 subplots (A1 – A4) as replicates and treated with Bio-rational solutions. Plot B (one feddan) was subdivided into 4 subplots (B1 – B4) as replicates and was treated by releasing *T. bactrae* (at two release rates; 60000 and 100000 parasitoids per feddan). Plot C (control) (½ feddan) was subdivided into 2 subplots (C1 and C2) as replicates and left for regular practices carried out by the grower himself, depends mainly on the use of pesticides. The pheromone-soapy water basin traps were placed at all the experimental plots. Meteorological data (minimum, maximum temperature and relative humidity (RH) in the region of the experiment throughout the experimental period was obtained from the meteorological station of Fayoum, located in the Agricultural Research Station, Fayoum, Egypt.

Monitoring of pest population

A total of 10 pheromone traps per hectare (4 per feddan), obtained and recommended by Russell IPM, UK was placed as 4, 4 and 2 traps in plots A, B and C, respectively, as mass-trapping. Trap catches were examined and counted twice a week throughout the tomato growing season that extended from early September 2014 to early January 2015.

Estimation of the rate of infestation with *T. absoluta*

A total of 100 plants (25 plants/ replicate)/ plot was examined weekly and rate of infestation (no. of mines in the leaves, stems and fruits/plant) were counted and recorded at the three experimental plots A, B and C, starting early September until harvesting.

Experimental plot A (Bio-rational solutions' trial)

Four pheromone–soapy water traps were placed, one trap/ replicate, at each of the subplots A1, A2, A3 and A4. By catching the first *T. absoluta* moth in any of the plot traps, the plot was treated weekly by one of the two tested compounds; Biotrine and Fytomax N, alternatively until harvesting.

Experimental plot B (Parasitoid's trial)

Four pheromone–soapy water traps were placed, one trap/ replicate, at each of the subplots B1, B2, B3 and B4. By catching the first *T. absoluta* moth in the plot traps, the plot was treated bi-weekly by releasing the egg parasitoid *T. bactrae* at two release rates; 60000 and 100000 parasitoids per feddan. The first rate (15000 parasitoids per subplot) was applied in subplots B1 and B2, while the second rate (25000 parasitoids per subplot) was applied in subplots B3 and B4. Each was considered as a replicate. Releases were applied until harvesting.

Experimental plot C (Control)

Half feddan (2100 m²) was subdivided into 2 subplots (2 replicates) (C1 and C2), each replicate (about 1000 m²). Two pheromone– soapy water traps were placed, one trap/ replicate at the subplots C1 and C2. The plot was sprayed by the grower himself using recommended pesticides in the region, without any interference. Pesticides names, rates and dates of application were recorded.

Cost-benefits of IPM packages

At the end of harvesting, cost-benefits of using each of the IPM packages; bio-rational solutions, biological control and pesticides application (control) were estimated. The costs included the costs of purchasing the traps, materials and labor cost at each plot.

Statistical analysis

Obtained data was subject to statistical analysis using the computer program one way ANOVA and T test. Means were compared by Duncan's Multiple Range test.

Results and discussion

Trap catches

Data of the trap catches of *T. absoluta* moths in the pheromone traps placed in the experimental field at Fayoum Governorate, Egypt in tomato Nili plantation of 2014 were summarized in table (1). By early September 2014, the beginning of the study in the permanent field, 2 pheromone traps was placed in plot C (control plot) for monitoring the pest population. The first catches (7 moths/ trap) were found on September 9th. Accordingly, other traps were placed in plots A and B (treatments) (4 traps/ plot = a rate of 10/ hectare) to serve for monitoring as well as mass-trapping control method. The first records 3.75 and 7.75 moths/ trap in plots A and B, respectively were recorded on September 12th. Occurrence of the moths continued throughout the whole study period September 2014 – January 2015. The month of October represented the highest mean numbers of moth catch/ traps (46.8 moths), followed by November (27.6 moths), while the months of September and December were the lowest (16 moths) (Table 1).

Table (9): Monthly mean numbers of *T. absoluta* moth catches/ trap in pheromone traps placed in different experimental plots at Fayoum Governorate, Egypt in the tomato Nili plantation of 2014

Date of Inspection	Trap Catches (No. of moths/trap)													Mean /trap
	Plot A (Plant extracts)					Plot B (Release of <i>Trichogrammatoidea</i>)					Plot C (Control)			
	A1	A2	A3	A4	Mean	B1	B2	B3	B4	Mean	C1	C2	Mean	
September	16.5	14.5	18.5	17.16	16.66	14.66	13.66	21.16	36	21.37	9.7	10.4	10.05	16.03
October	49.5	68	40.6	46.3	51.1	40.12	40.3	42.5	47.1	42.5	50.5	58.5	54.5	49.37
November	32.2	26.1	21.8	21.7	25.5	23.7	26.4	19.3	38.2	26.9	34.4	32.2	33.33	28.57
December	6.5	7.6	8.5	9	7.9	4.8	5.3	10.8	6.5	6.9	34.7	38	36.35	17.05
Grand mean	23.48	22.63	22.61	23.94	25.3	21.35	22.13	23.48	32.53	24.4	33.14	35.46	32.1	

The technique of mass trapping with pheromone has been widely used for the control of different insect species (Rodriguez-Saona and Stelinski, 2009). These findings agree with those reported earlier by Ltd (2009b) who mentioned that mass trapping can be used to reduce *T. absoluta* populations and it is particularly useful in production of greenhouse tomatoes. Also, Salas (2004) reported that water traps were the most common pheromone traps used for mass trapping of *T. absoluta*, as they are easier to maintain and less sensitive to dust than Delta or light traps and also have a larger trapping capacity than Delta traps. Cocco *et al.* (2012) stated that use of mass trapping alone for controlling male *T. absoluta* populations was not effective in reducing leaf and fruit damage.

Seasonal general mean of trap catches in plot C (control) was 23 and 27% higher than that in plots A and B, respectively. Total catch difference between plots A and B was 8% in favor of plot A. Number of moth catches in plot C was lower than that in plots A and B in September, while it was higher in the other three months, especially in December. Peak numbers of the moth catches (60, 82 and 84 moths/ trap) was recorded on October 27th, 19th and 19th in plots A, B and C, respectively. As well, the month of October represented the highest mean numbers of moth catches/ trap (43.6, 42.5 and 54.5 moths/ trap) in plots A, B and C, respectively (Table 1).

Percentages of infestation

Percentage of infestation with *T. absoluta* at Fayoum Governorate, Egypt in the tomato Nili plantation of 2014 was summarized in tables (2, 3 and 4).

Plot A: treated weekly with each of Biotrine and Fytomax N alternatively, started September 21st and ended November 23rd. Each compound was treated 5 times; Biotrine on 21/9, 5/10, 19/10, 2/11 and 16/11/2014 and Fytomax N on 28/9, 12/10, 26/10, 9/11 and 23/11/2014. The monthly rate of infestation started with (7.3%) in September, increased in the following months to reach (8.2%) in October, (16.3%) in November and then reduced to (12%) in December (Table 2). Rates of infestation have been always less, following the application with Biotrine than that following Fytomax, except the application practiced by early November (Table 2). Seasonal rate of infestation at plot A was 70% less than the control (pesticides treatments). Statistical analysis showed highly significant difference between the use of Bio-rational solutions ($t= 0.00111^{**}$) and the control.

Table (10): Monthly mean rates of infestation with *T. absoluta* (no. of mines/ plant) at Plot (A) (sprayed with biorational solution) at Fayoum Governorate, Egypt in the tomato Nili plantation of 2014.

Date of inspection	Mean				
	A1	A2	A3	A4	Mean
September	9.3	9.3	5.3	5.3	7.3
October	9.6	10.4	8	7.2	8.2
November	19	23	13	10	16.3
December	10	18	13	7	12
Grand mean	12	15.2	9.8	7.4	11.1

Current management of TLM in Egypt as a part of Mediterranean Basin is mainly based on treatment with chemical insecticides (González-Cabrera *et al.*, 2011). Nevertheless, few bio-rational solutions are effective against TLM and selective to beneficial insects at the same time. Obtained results revealed that it is possible to reduce the tomato leaf miner impact by applying Biotrine and Fytomax N alternatively + mass trapping combination which showed promising results in controlling the pest. The Azadirachtin based-bio-rational solution Fytomax N had great efficacy towards *T. absoluta*. These findings agree with those reported earlier by Servicio de Sanidad (2008) who recommended use of Azadirachtin as a preventive spray and for light infestations (< 30 adult catches per week) of *T. absoluta* in Spain. Abamectin based bio-rational solution Biotrine efficiency was also confirmed under field conditions. These findings are in agreement with those reported earlier by Zalom *et al.* (2008) who recommended abamectin for controlling the tomato pinworm in IPM programs. Moussa *et al.* (2013) mentioned that abamectin provided excellent control against *T. absoluta* in Egypt. Mass trapping and using of Biotrine alternatively with Fytomax N induced showed a better control of the pest. Generally, seasonal rate of infestation was much less than the control (pesticides' treatments).

Plot B: treated biweekly by 2 rates of the egg parasitoid, *T. bactrae*; 60000 (in subplots B1 and B2) and 100000 (in subplots B3 and B4) parasitoids/ feddan. Dates of releases were on 25/9, 9/10, 23/10, 6/11 and 20/11/2014. Releases started on September 25th and ended November 20th. Both release rates were applied 5 times. Monthly rate of infestation started with (5%) in September, increased in the following months to reach (8.6%) in October, (12%) in November and continued around the same level (11%) in December (Table 3). Rates of infestation were almost similar at the 2 different rates of releases in September, increased slightly in October at the high rate of release and then a vice versa was recorded in November

(Table 3). Total seasonal mean rate of infestation with *T. absoluta* at Fayoum in the Nili tomato plantation of 2014 was nearly equivalent in plots A and B (11.1 and 9.2%, respectively). Seasonal rate of infestation at plot B was 75% less than the control (pesticides' treatments) and 17% less than applying Biotrine or Fytomax. Statistical analysis showed highly significant difference between the use of *T. bactrae* ($t=0.003587^{**}$) and the control. Also, insignificant difference was found between the two rates of releasing *T. bactrae* ($t=0.086433$) in plot B.

Table (11): Monthly mean rates of infestation with *T. absoluta* at Plot (B) (release of *Trichogrammatoidea*) at Fayoum Governorate, Egypt in the tomato Nili plantation of 2014

Date of inspection	Mean				
	B1	B2	B3	B4	Mean
September	8	1.3	5.3	5.3	5
October	7.2	7.2	13.6	6.4	8.6
November	11	17	13	7	12
December	10	10	17	7	11
Grand mean	9.1	8.9	12.2	6.4	9.2

T. bactrae is one of the most effective parasitoid against TLM as indicated by the higher percentages of parasitism (Abd El-Hady, 2014). In the present study, obtained results revealed that these oophagous parasitoid would play crucial role for management of TLM. Abd El-Hady (2014) stated that increasing the number of released parasitoids caused significant increase of parasitization and the seasonal rate of infestation was obviously less than the control (pesticides' treatments) and relatively than the bio-rational solutions. Such result is evidence of the efficacy of the combining of mass trapping technique and release of *T. bactrae* in management of TLM.

Plot C: (control plot), treated 7 times by the grower, using three different pesticides; Nomolt 15% SC, Pleo 50% EC and Oshin 20% SG. Dates of application were as follow: Nomolt 15% SC on 18/10 and 22/11/2014 & Pleo 50% EC on 7 and 13/11/2014 & Oshin 20% SG on 22/10, 28/11 and 2/12/2014. The monthly mean rate of infestation with the pest increased from 13.3% in September to 26.8% in October, to 60.5% in November and then decreased to 29.3% in December (Table 4). Seasonal mean rate of infestation was obviously higher in plot C (29.3%) than in the other 2 plots, 11.1 and 9.2% at plots A and B, respectively. This indicates that application of either Biotrine or Fytomax or release of parasitoid achieved about 70-75% less rates of infestation than using pesticides.

Table (12): Monthly mean rates of infestation with *T. absoluta* at Plot (C) (control -sprayed with pesticides) at Fayoum Governorate, Egypt in the tomato Nili plantation of 2014

Date of inspection	Mean				Mean
	C1		C2		
	I	II	I	II	
September	18.7	0	8	0	13.3
October	24	0	29.6	0	26.8
November	60	0	61	0	60.5
December	46	10	47	14	20
Grand mean	37.2	10	36.4	14	29.3

I = < 3 mines/plant II = 4 -10 mines/plant III = > 11 mines/plant

Although plot C was treated 7 times by the pesticides (Nomolt 15% SC, Pleo 50% EC and Oshin 20% SG), the highest total rate of infestation (36.8%) was recorded in it. Percentages of infestation did not exceed a level one (< 3 mines/ plant) in plots A and B throughout the experimental period. Level 2 (4-10 mines/ plant) was recorded twice in the pesticide plot (C) in late December (Table 4). Highest monthly mean percentage of infestation (60.5%) was recorded in plot C (control) in November, while it was 16.3 and 12% in plots A and B, respectively in the same month (). Generally, the peak number of moths/ trap, recorded in the pheromone traps in October (46.8 moths), led to an increase in the pest's rates of infestation in the all experimental plots in November. Treatment with the parasitoid releases in plot B (5 times) showed least mean percentages of infestation (9.2%) compared with (11.1%) in the bio-rational solutions treatment (plot A) (treated 10 times).

Cost Benefits

Plot B showed 11.8 and 5.3% higher in yield production (ton/feddan) than plot C and A, respectively and correspondent less control costs 57.19 and 42.18%. Seasonal cost benefit achieved in the experimental plots was 15.14 and 7.31% higher in plot B than that in plot C and A, respectively.

In conclusion, applying an IPM packages depended upon mass trapping plus either release of the parasitoid, *T. bactrae* or applying Biotrine or Fytomax achieved best rates of reduction of *T. absoluta* infestation at Fayoum in the Nili tomato plantation of 2014. Further studies are needed for other tomato plantations as different rates of the pest population are expected.

Acknowledgement

Thanks are due to the Agronomic Mediterranean Institute from Bari (IAMB), Italy for funding and supervising this study as part of a M. Sc. in Integrated Pest Management Program.

References

- Abd El-Hady, M. 2014. Biollogical Control studies on some insect pests infesting tomato plants at Ismailia governorate, Egypt. M. Sc. Thesis, Faculty of Agriculture, Suez Canal University, 121pp.
- Agamy, E. A. 2003. The inundative release of *Trichogramma evanescenes* West. as biocontrol agent against the potato tuber moth, *Phthorimaea operculella*(Zeller). Egypt. J. Biol. Pest Control, 13(1-2): 101-104.
- Chailleux, A., Desneux, N., Seguret, J., Do Thi Khanh, H., Maignet, P. and Tabone, E. 2012. Assessing European egg parasitoids as a mean of controlling the invasive South America tomato pinworm *Tuta absoluta* PLOS ONE, 7(10): e48068 .
- Cocco, A., Deliperi, S. and Delrio, G. 2012. Potential of mass trapping for *Tuta absoluta* management in greenhouse tomato crops using light and pheromone traps. IOBC-WPRS Bulletin, 80: 319-324.
- Desneux, N., Wajnberg, E., Wyckhuys, K. A. G., Burgio, G., Arpaia, S., Narváez-Vasquez, C. A., González-Cabrera, J., Catalán Ruescas, D., Tabone, E., Frandon, J., Pizzol, J., Poncet, C., Cabello, T. and Urbaneja, A. 2010. Biological invasion of European tomato crops by *Tuta absoluta*: ecology, geographic expansion and prospects for biological control. Journal of Pest Science, 83(3): 197-215. <http://dx.doi.org/10.1007/s10340-010-0321-6>
- Gonzales-Cabrera J., Molla O. and Urbaneja A. (2009). Biological control of *Tuta absoluta* (Meyrick) (Lepidoptera: Gelechiidae) with *Bacillus thuringiensis* (Berliner). *Agricola Vergel: Fruticultura, Horticultura, Citricultura, Vid, Arroz*, 28(333): 476-480.
- Haddi, K. 2012. Studies of insecticide resistance in *Tuta absoluta* (Meyrick), with special emphasis on characterization of two target site mechanisms at Catania, Italy. PhD. thesis, Faculty of Agriculture, University of Catania., 148pp.
- Ltd R. I. 2009. *Tuta absoluta*-Insect Profile Russell IPM Ltd.
- Mandour, N., Sarhan, A. and Atwa, D. 2012. The integration between *Trichogramma evanescens* West.(Hymenoptera: Trichogrammatidae) and selected bioinsecticides for controlling the potato tuber moth *Phthorimaea operculella* (Zell.)(Lepidoptera: Gelechiidae) of stored potatoes. Journal of Plant Protection Research, 52(1): 40-46.
- Mills, N. 2010. Egg parasitoids in biological control and integrated pest management. In: (ed). Egg parasitoids in agroecosystems with emphasis on *Trichogramma*. Springer, pp.389-411.
- Moussa, S., Baiomy, F., Sharma, A. and El-Adl, F. E. 2013. The Status of Tomato Leafminer; *Tuta absoluta* (Meyrick)(Lepidoptera: Gelechiidae) in Egypt and Potential Effective Pesticides. Academic Journal of Entomology, 6(3): 110-115 .
- Pereyra, P. C. and Sanchez, N. E. 2006. Effect of two solanaceous plants on development and population parameters of the tomato leaf miner, *Tuta absoluta* (Meyrick) (Lepidoptera: Gelechiidae). Neotropical Entomology, 35(5): 671-676.
- Rodriguez-Saona, C. R. and Stelinski, L. L. 2009. Behavior-modifying strategies in IPM: theory and practice. In: (Ed). Integrated pest management: innovation-development process. Springer, pp.263-315 .
- Salas, J. 2004. Capture of *Tuta absoluta* (Lepidoptera: Gelechiidae) in traps baited with its sex pheromone. Revista Colombiana de Entomología, 30(1): 75-78.
- Senior, L., McEwen, P., McEwen, P., New, T. and Whittington, A. 2001. The use of lacewings in biological control. Lacewings in the Crop Environment: 296-302.
- Serviciode Sanidad, V.M. 2008. Control de la polilla del tomate (*Tuta absoluta*). Horticultural Internacional (64): 30-31.
- Silva, C. C. d., Jham, G., Picanço, M. and Leite, G. 1998. Comparison of leaf chemical composition and attack patterns of *Tuta absoluta* (Meyrick) (Lepidoptera: Gelechiidae) in three tomato species. Agronomia Lusitana, 46(2-4): 61-71.

Zalom, F. G., Trumble, J. T., Fouche, C. F. and Summers, C. G. 2008. UC Management Guidelines for Tomato Pinworm on Tomato . UC Statewide Integrated Pest Management System. System.<http://www.ipm.ucdavis.edu/PMG/r783300411.html>

NOZZLES APPLICATION QUALITY IN WHEAT: EFFECT OF SINGLE, DOUBLE AND TRIPLE FLAT FAN NOZZLES

Aleksandar SEDLAR, Vladimir VIŠACKI, Rajko BUGARIN, Jan TURAN, Lazar PAVLOVIC, Sanja LAZIĆ, Dragana ŠUNJKA

Faculty of Agriculture, University of Novi Sad, Trg D. Obradovića 8, 21000 Novi Sad, Serbia

*Corresponding author: vladimir.visacki@polj.uns.ac.rs

Abstract

Protection of wheat must be done in an efficient and economical way to protect against diseases and pests. The price of wheat prevents enough space for the calculation in the protection and further subsequent corrective walkthrough. The protection is usually done in two passes, one for weed control and the other for diseases and pests. For several years back, wheat pass through the critical period when flowering. High temperatures and humidity cause invasive attacks of several different diseases and pests. This protection is the most important because it directly affects the grain quality. For efficient protection, besides of respecting norm and dose, it is necessary to use adequate nozzles. Density of wheat and leaf surface is at a maximum. For good protection, it is necessary that the working fluid cover leaf and ear of wheat. During the experiment three types of nozzles were used. The common characteristic is that they have a flat T jet, spray angle of 110° and a flow rate of 1.6 l / min at 3 bar. They differ in the number of jets. Nozzles are used with one, two and three jets. The first nozzles have vertical jet, second have jets at 30 ° from the vertical on both sides and third, one jet is positioned vertically while the other two at an angle of 30 ° on the opposite side. Because they have two or three jets, expected result is to have better pesticide applications. This would achieve effective protection of wheat and thus ensure high yield and quality of grain.

Keywords: *nozzle, nozzle jet, pesticide application, wheat, sprayer.*

Introduction

Wheat is the most important raw material for the food and the animal population in Vojvodina province (Serbia). The sowing is performed on about 30% of arable land, depending on the year. Mainly winter wheat is sown. The protection is performed several times in the spring when the conditions are acceptable for the application of pesticides. These are the two most common treatments for weed and fungal diseases, insects rarely. The first was carried out in early spring, in March after fertilization, which was conducted in February, a second suppression of in May. The optimal deadline was in mid-May. In order to combat fungal diseases is very important to treat the entire surface to a pesticide application is uniform. In order to achieve uniform application of pesticides play an important role nozzles.

The most important and most critical point of the production of wheat and other cereals is to protect crops and pesticide application (Ágoston-pepo, 2005; Czövek et al., 2006). Chemical treatments are harmful to crops and the environment, and their efficiency should be at the maximum level. Weeds, insects and fungal diseases are in an environment that allows them to extremely rapid growth and development, and further threaten the crop. Control weeds and pests has great influence on the yield and therefore economic profit (Knežević et al. 2008). Accordingly, pesticides play a role to increase the protection of food production and an increase in living standards (Delcour et al., 2015). For the reduction of pests and diseases and increasing economic effects of agricultural production, farmers resort to using more pesticides (Nazarian et al., 2013). But the use of pesticides must be carried out at the right time with the

correct quantity and in the right way (Khan et al., 2010). Accordingly, the use of pesticides must be based on environmental conditions, the applied knowledge and current research in order to obtain a healthy safe and economically viable product (Yilmaz, 2015).

Task work represents pesticide application in wheat using three different types nozzles for different exploitation parameters. The paper determines flexibility of pesticide application using chemical tracer. Conducted research is needed to determine which nozzles utilization is the best for the application of pesticides in wheat.

Materials and methods

All trials are performed at open filed which is located in Vrsac. It was used tractor mounted sprayer Agromehanika AGS 800 which was aggregated tractor Case Farmal 115U (IH Farmall 115U). Capacity is 800 l sprayers a width of 15 m. Pivoting wings are coupled to the frame at one point and two springs were doing the leveling, and formed a mechanical system to copy field. Pump low pressure BM 105 the same manufacturer, type of piston-diaphragm with a capacity of 105 l / min at 20 bar and 540 o / min, serving 30 nozzles working fluid and performs the same mixing. Height applications was 0.5 m as recommended by the producers, set the height of the most common applications in Vojvodina province. Carriers nozzles can carry maximum of 3 nozzles, triplex carrier. The same number nozzles were used in the experiment. The first nozzles with flat jet, spraying angle of 120 °, red color by color marking, labels LU 120-04. The following nozzles are injector type with single jet of the same technical characteristics as the first, marks IDK 120-04. Last, was same characteristics as the previous one but instead of one has two jets, a mark is IDKT 120-04.

On tractor Case Farmal 115U set four-cylinder engine with a nominal output of 84 kW at 2300 min⁻¹ (ECE R120), water-cooled engine with over boost as turbo compressors. Maximum torque is achieved at 1500 min⁻¹ (ECE R120) in the amount of 463 Nm. Transmission semi-automatic with a choice of 12 + 12 speeds, permanent four-wheel drive with electro-hydraulic turning on and turning circle of 4.05 m. Force hydraulic lifters that the pump flow rate of 65 l / min which allows lifting 3190 kg at the rear linkage. A total length of 4161 mm and wheelbase of 2350 mm. Standard tire sizes are 480/65 R 24 front and 540/65 R38 ago.

Treatment norm amounted to 175 l / ha at the speed of the tractor aggregate of 9.5 km / h and pressure of 2 bar applications. Also, the norm of 200 l / ha and 235 l / ha were used in the test at a pressure of 3 bar 4 bar person respectively. Wind speed was 1-2 m / s. The temperature was 26 ° C and the humidity was about 60%. Environmental conditions did not change during the execution of the experiment. Wheat was the average height of about 1.3 m, the leaves were about 1 m. She was very good and high density planting.

Using tracer obtained more correct information on the amount of active substance due to the target surface. This method of measuring is a cheap and easy method unlike chemical methods for determining the deposits of chemical plant protection products on the treated surface, which are more expenses. Tracer is a compound that fluoresces under the influence of light of a certain wavelength. Most often it is sold as a solution, or in solid, powder form, with the content of 89% tatrazine. Under the influence of light, it starts to degrade and also react differently with a change in pH. Characteristic of this tracer is as easy to use, non-toxic when handling. The lack of the aforementioned degradation is due to the effects of sunlight. It was stirred directly into the spray tank with water. Do not react with chemicals that contaminated a sprayer in the application it is necessary to properly wash sprayer or machine protection products. Most often used for determining the quality of deposition, measurement drift or contamination level of the operator, or the environment in which it is applied. For determining the quality of the application used in was tracer Tatrazine concentration of 5 g / l. Petri dishes are set at 4 places. First place was with the class and leaves, the second position is below the

sheets (upper leaves), the third location in the lower part of the tree and the last position is close to the land-surface. Petri dishes after pesticide application, washed with 0.05 l of deionized water and then analyzed on a spectrophotometer Shimadzu UV-Vis 1100 a wavelength of 427 ± 2 nm. All tests were done with water whose pH was slightly acidic and it was 5.7.

Results and discussion

The research results are presented by following photos. They shows the concentration of tracer in petri dishes on all four points of measurement. The first point is the top part and the rest are on the lower parts, described above.

Fig. 1. The concentration of the tracer measured at places at norm of 165 l / ha.

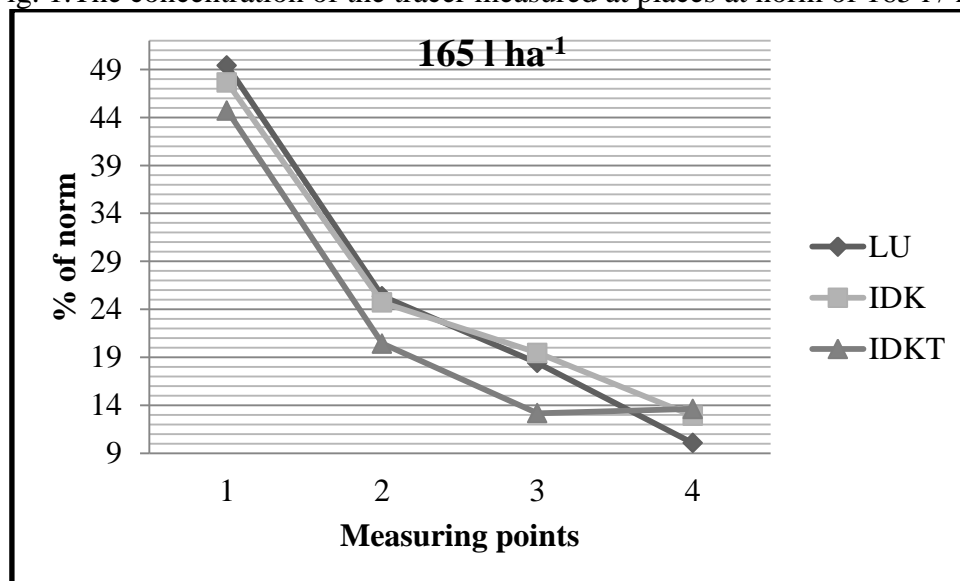

In the norms of 165 l / ha measured tracer concentration is the highest at the application of LU from 120 to 04 and the nozzles amounted to more than 49.4% relative to the concentration that has been in the working fluid. Something small amount was deposited nozzle IDK while the least deposited injector nozzle with two jets IDKT in the amount of over 44%. Double small amount of tracer was observed on the second measuring point, which was under the leaves of wheat. An average of less than 14% of the working fluid was deposited by all three nozzles at the lowest measuring point. Extracting the nozzle IDKT which recorded a smaller amount of liquid deposited on almost all counts except the lowest, for about 10.13% and 23.46% compared to the other two investigated.

Fig. 2. The concentration of the tracer measured at places at norm of 200 l/ha.

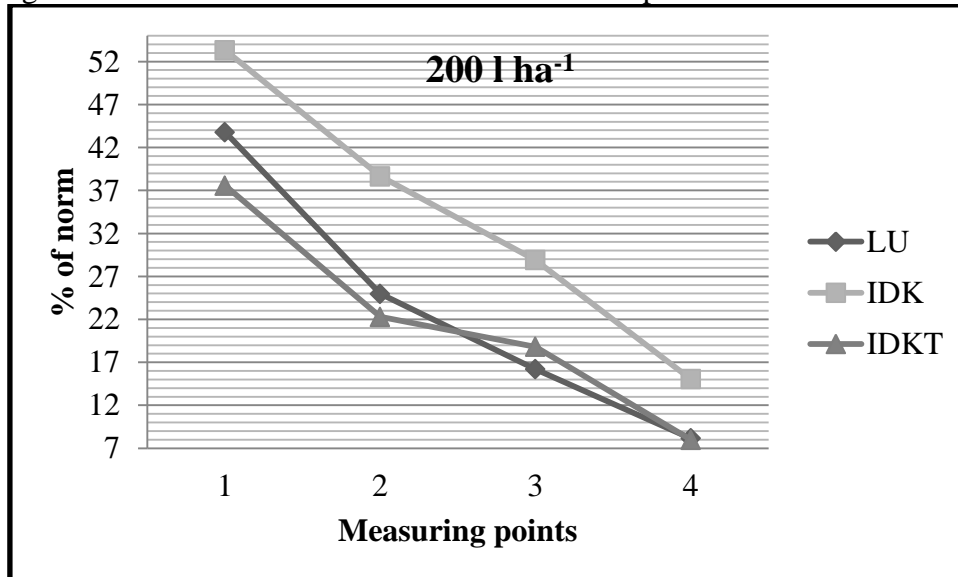

With increasing norm leads to reduced efficiency nozzles. In the norm of 200 l / ha, over 53% of the total amount of tracer nozzle IDK successfully distributed to the class and leaves of wheat. This is not the case with the other two where the injection nozzle with two jet retains the trend of distributed fluid at least the first two measuring points. These values range close from 43% up to 25% for nozzle with a flat jet of 37% and to 22% for IDKT nozzle. At the measuring points 3 and 4 the volume of distributed fluid both these nozzles is similar. An injection nozzle with a flat-jet recording of a greater amount of deposited nozzles of the examined in an amount of 22% to a high of 100%.

Fig. 3. The concentration of the tracer measured at places at norm of 235 l/ha.

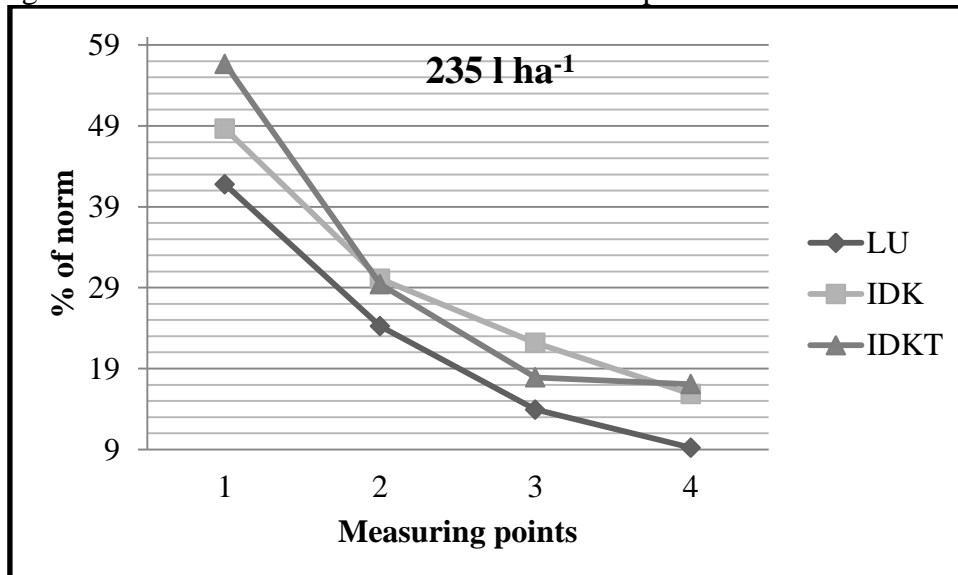

The photograph 3 is registered to both injector nozzles have better pesticides application with increasing standards and pressure in relation to the LU nozzle. This continues the trend of improving the quantity of liquid deposited with the increasing norm. So the top of the crop nearly 58% and 49% was deposited tracer injection nozzles. On counts 2 and 3 quantity is similar to the last measuring point 4. It is not case by the nozzle on point 4 where application quality is lower.

Conclusion

The method of measuring the quality of work of different nozzles using tracer provides reliable information. In examining the three nozzles can be concluded that the quality of the application of pesticides in wheat necessary to use the injector nozzles at high pressure applications.

Thus, the total quantity of liquid, more than 50% is due to the treated surface at application rates from 200 l ha⁻¹ and 235 l ha⁻¹. Higher pressures are not conducive to the nozzles applications with flat fan-shaped spray deposited because less than 45% of the working fluid. The rest misses the target or disappear as a drift.

It is necessary to do the effectiveness of treatment to determine the influence of pressure and type nozzles on the quality of apps, pesticides.

Acknowledgement

The work is part of the research project TR - 31025: "Development of new varieties and improving production technology oil plant species for different purposes", funded by the Ministry of Education and Science of the Republic of Serbia.

References

- Ágoston, T., Pepó, P. (2005): Őszi Búza-fajták ktermi képességének és betegség ellenállóságának vizsgálata / Examination of winter wheat varieties ktermi of capacity and disease resistance. . *Növénytermelés* 54 (5-6): 387-403.
- Czövek, P., Király, I., Páldi, E. (2006): Comparative analysis of stress tolerance in *Aegilops* accessions and *Triticum* wheat varieties to detect different drought tolerance strategies. *Acta Agronomica Hungarica*, 54 (1): 49-60.
- Knežević, M., Ranogajec, L., Šamota D. (2008): Effects of soil tillage and herbicides on weeds and winter wheat yields. *Cereal Research Communications* Vol. 36, Suppl. 1403-1406 pp.
- Delcour, I. Spanoghe, P. Uyttendaele, M. (2015). Literature Review: Impact of Climate Change on Pesticide Use. *Food Research International*, 68, pp.7–15.
- Nazarian, M. Ajili, A.A. Akbari, M. Rostami, F. (2013). Knowledge, Attitude and Environmental Safety Behaviours of Vegetable Farmers in use of Pesticides in South West of Iran. *International Journal of Agronomy & Plant Production*, 4(8), pp.1844-1854
- Khan, M.J.Zia, M.S. Qasim, M. (2010). Use of Pesticides and Their Role in Environmental Pollution. *International Journal of Environmental, Chemical, Ecological, Geological and Geophysical Engineering*, Vol:4, No:12, pp.621-627.
- Yilmaz, H. (2015). Farm Level Analysis of Pesticide Use in Sweet Cherry (*Prunus Avium* L.) Production in West Mediterranean Region of Turkey. *Acta Scientiarum Polonorum Hortorum Cultus*, 14(3), pp.115–129.

BREAD PRODUCTION LEFTOVERS AS POTENTIALLY VALUABLE RAW MATERIALS IN BIOTECHNOLOGY

Zvonko NJEŽIĆ^{1*}, Jasmina ŽIVKOVIĆ¹, Dragan PSODOROV²

¹University of Novi Sad, Institute for Food Technology, Novi Sad, Serbia

²College of Management and Business Communications, SremskiKarlovci, Serbia

*Corresponding author: zvonko.njezic@fins.uns.ac.rs

Abstract

The total production of bakery products in Serbia is around 800,000 tons per year, whereby the most frequently consumed product is wheat bread. The average consumption of bread per capita is about 106 kilograms. According to the statistics of this product consumption, regardless to the growth of prices, the total production has been increased in recent years. Increase of food production for humans and animals could be achieved through the application of new technologies in the food sector, i.e. in the bio-industry. Nowadays, there are many different ways for thermal processing of cereals: extrusion, hydrothermal processing, micronization, microwave treatment, while in Serbia, the most frequently used processes are extrusion and hydrothermal processing. Baking industry is highly developed in Serbia. Thus, bread consumption per capita in Serbia is far above average consumption in the EU. According to the survey conducted in January-February 2016 by The Institute of Food Technologies in Novi Sad, there is a significant amount of bread leftovers in Serbia. Bread leftovers represent an environmental problem. On the other hand, they are potentially valuable raw material for human food and animal feed. Therefore, bread leftovers could be considered as a potentially valuable raw material in the food industry. Corn grits (13 %) and bread crumbs (12.87 %) were used as the main ingredients of extrusion mixes. The result shows a significant increase of the total energy of mixes in comparison to the basic ingredients. Extruded mixes did not contain any of determinate pathogenic bacteria with an exception of an excessive number of microorganisms.

Keywords: *bakery products, food waste, raw materials, bread leftovers.*

Introduction

The food waste created in the bakery industry or in the large chains of supermarkets, hotels or other mass food storages, could become an excellent ingredient, in the case of the proper use. This paper suggests a solution for an application of stale bread, waste oil from the cold pressed soy bean, damaged corn grains in the production of proper healthy animal feed. In accordance with the results of the survey, conducted in January-February (2016) by The Institute of Food Technologies in Novi Sad (FINS), the amount of the stale bread in retail is in the interval between 5 and 20%, which is slightly more in comparison to results from the same survey conducted in 2010 (from 5 to 10%) (Nježić et al., 2010). Mentioned increase of the total amount could be attributed to the novel practice on the market, which implies the dump selling price from 10 to 25 dinars of the yesterday bread. However, the amount of wasted bread is still 10% of the total production. The question is: "How much bread we throw away on the daily basis?". The conclusion is that from one million and five hundred bread loaves produced in Vojvodina, a hundred thousand of them has been thrown away, which is almost fifty tons of bread on the daily basis. Depending on safety-health condition of the ingredient, we have either extremely attractive or potentially dangerous raw material (Nježić et al., 2010). It is possible with a good coordination to obtain a relative low price for the half of the total available samples. We have been managing to get a price of 10 dinars per kg of the stale bread, which is almost five times cheaper than ingredients created from flour T-500, and two times cheaper from wheat.

The price of the organized collecting of the stale bread would be certainly lower, thus we have a very commercial ingredient for the extrusion purposes for bread crumbs production. The solution to an increase of human and animal food production is an application of novel technologies in biotechnology, i.e. bio-industry (Lazarević et al., 2005). Basic orientation is presented by the new technological procedures. The objective of these procedures is an increase in the human and animal food nutritive value, also as a valorisation of byproducts in food and agricultural industry. Many methods for wheat and oilseed thermal processing were applied so far in the industry such as: extrusion, hydrothermal processing, micronization, microwave treatment, dialectical heat treatment (Marsman et al., 1998; Sakač et al., 2001), while in Serbia the most frequent processes are the extrusion and the hydrothermal processing (Filipović et al., 2008). An adequate operation of the thermal processes provides a reduction of a thermo-labile anti-nutrient content on the decent level, beside its effects on the increase of certain ingredients digestibility (protein, oil and carbohydrates), also as improving of sensorial characteristics and microbiological frame of the final product (Filipović et al., 2007). Considerable quantities of damaged corn grains were selected from the animal food factory silo. Furthermore, damaged grains were converted to corn grits. Corn is the basic ingredient for the most of feeds in the animal nutrition. By the application of corn extrusion process, as the basic ingredients in animal feeds, it could be obtained a better valorisation of food in the animal feed (Filipović et al., 2008). Along with the reduction of the antinutrient content, it is necessary to save the nutritive valued thermo labile components, therefore the process demands an achievement of compromise between these two efforts (Jensen et al., 1995). The mix of 50:50 corn grits and bread crumbs was created, before the extrusion process, with addition of wasted oil from soy cold pressing in quantity of 10%, which is the byproduct of the near locating factory. The objective was the increase of the final product energy value and resolving of the domestic waste problem. The extrusion process creates some changes of corn grits and bread crumbs carbohydrate complex structure, namely to decreasing of starch content until dextrans. Changes like that cause *in vitro* and *in vivo* digestion of starch, considering the fact that starch gelatinisation provides the increased availability of starch degradation enzymes, water and amylase inhibitor inactivation (Douglas et al., 1990). The aim of this work was to define the extrusion effect on the quality of corn grits and bread crumb mix, also as how extrusion affects health and hygiene condition of a product from the microbiological standpoint. Furthermore, was examined the effect of the soy cold pressed wasted oil on nutritive value of the product.

Material and Methods

Starch content as well as the total content of reducing sugars was defined in accordance to the physical and chemical analysis for the control of wheat, mill and bakery products, pasta and quick frozen dough manual (Rule Book, 1988), while the volumetric mass was conducted in accordance to the methods for taking samples and utilisation of physical, chemical and microbiological analysis of cattle feed (Rule Book, 1987). The basic chemical composition (moist, crude proteins, crude cellulose, crude fat and mineral content) of corn grits and bread crumb mix was determined in accordance to the Association of Official Analytical Chemists (A.O.A.C.) methods (Douglas et al., 1990). Corn grits with 13% and bread crumbs with 12.87% were used in corn grits and bread crumb mix extrusion process. The mix was assembled as 50:50 ratio in a counter current Homogenizer, besides the mix was moistened with 10% of the oil precipitate. Oil was the waste product of soy cold pressed oil process, grits were from damaged corn, and bread crumbs originates from stale bread and bread leftovers. Installed force of extruder electromotor was 85 kW. Temperature of extrusion was between 135°C and 145°C, and the diameter of nozzle with 4 holes was 10 mm. The total

number of microorganisms, yeasts and molds was determined in accordance to the methods for microbiological analysis and superanalysis of food manual (Rule Book, 1980).

Results and Discussion

Table 1 presents the chemical composition of corn grits, whereby the energy value, starch, protein and fat content are 1548 kJ, 72.93%, 6.88%, 1.14%, respectively. The obtained result implies that corn grits poses the potential for a protein cattle feed.

Table 1. Chemical composition and energy value of corn grits

Quality parameters	Content (%)
Moisture	13.57
Crude ash	0.24
Crude proteins	6.88
Total sugars	2.29
Reduced sugars	0.48
Starch	72.93
Fat	1.14
Energy value	1548kJ/100 g

One gram of the sample contains 80 molds and 500 microorganisms, which indicates the feed hygienic safety, according to the methods for microbiological analysis and superanalysis of food manual (Rule Book, 1980), number 25.

Table 2 shows the chemical composition and energy value of bread crumbs.

Table 2. Chemical composition and energy value of bread crumbs

Quality parameters	Content (%)
Moisture	12.87
Crude ash	2.24
Crude proteins	11.44
Total sugars	2.72
Reduced sugars	2.08
Starch	63.34
Fat	3.18
Energy value	1589 kJ/100 g

Bread crumbs are the food product created by the subsequent production process from bread leftovers. Mentioned product contains 63.34% of starch, 11.44% of proteins and 3.18% of fat. Furthermore, the total energy value is 1589 kJ/100 g, thus it could be used as a quality protein cattle feed. One gram of bread crumbs contains 30 microorganisms. Therefore, it is safe for the animal feed.

Chemical composition and energy value of corn grits and bread crumbs mix is shown in Table 3.

Table 3. Chemical composition and energy value of extruded mix

Quality parameters	Content (%)
Moisture	12.87
Crude ash	2.24
Crude proteins	11.44
Total sugars	2.72

Reduced sugars	2.08
Starch	63.34
Fat	3.18
Energy value	1817.38 kJ/100 g

By following results of the experiment, the decrease of moisture content in comparison to start samples is obvious, also as the decrease of starch content and the increase of reduced sugars, which is a consequence of thermal decomposition of starch, affects the digestibility of starch (Douglas et al., 1990). Increased sweetness or sensorial characteristics change is the result of physical-chemical changes of starch. Microbiological analysis of corn grits and bread crumbs extruded mix confirmed the total reduction of microorganisms, owing to mutual processing factors such as relatively low extrusion temperature (135–145°C), very short time of extrusion (6 -10 s) and very high pressure (30–40 bar) (Kormanjoš et al., 2007). Extruded mixes did not contain bacteria from *Salmonella ssp. genera, coagulase positive staphylococcus, sulfurreducens Clostridium, Proteus spp., Escherihia coli*. However, an exception is the total number of microorganisms, that is still in boundaries of legislation in accordance to the Maximum amount of harmful substances and ingredients in cattle feed manual (Rule Book, 2014). An increase of the total energy value of mixes in comparison to basic ingredients is significant.

Conclusion

Extruded mixes of corn grits (from damaged corn grains) and bread crumbs presents a highly valuable energy ingredient in animal feed industry. It has been determined that the main causes of wasted and returned bread are: bread is still a social category, a relatively low price of bread, a relatively low quality, the habit of consumers to buy more bread than is necessary, the tradition whereas the stale bread is not represented in the domestic menu. Extrusion process is responsible for a beneficial nutritive value of corn grits and bread crumbs mixes, due to increase of the total sugar and reducing sugar content, also as a positive change in the starch complex of the extrudate, which leads to increase of digestibility and utilization of food and feed. Thermal treatment that occurs in the cylinder and the screw of the extruder, along with the high pressure created during the friction process, results in the decrease of the total number of microorganisms in extruded product. Whereas, the temperature of 135°C in combination with the high pressure affects lethally on the most of microorganisms, while decreasing the total number of microorganisms contributes to food and feed safety. Extrusion of corn grits and bread crumbs along with the other mill waste could present a quality solution for the problem of stale bread increase in the bakery industry, furthermore reduces the mill waste as well as the amount of oilsprecipitate. The optimisation of oil waste will be conducted in the forthcoming period. Created extrusion mixes are recommended primarily for the nutrition of young animals, especially in the fish feed industry.

Acknowledgement

Researches are financed by the ProvincialSecretariatfor Science and Technological DevelopmentofVojvodina and they are part of research project number 114-451-2755/2015.

References

Douglas, A. Sullivan, J.H., Bond T.K., Struwe, F.J. (1990). Nutrient composition and metabolizable energy values of selected grain sorghum varieties and yellow corn, Poultry Sci., 698, 1147–1155.

- Filipović, S., Kormanjoš, Š., Sakač, M., Živančev, D., Filipović J., Kevrešan Ž. (2008). Corn extruding technological procedure, *Contemporary agriculture*, 57 (3-4), 144–148 (in Serbian).
- Filipović, S., Savković, T., Sakač, M., Ristić, M., Filipović, V., Daković, S. (2007). Supplemented and extruded corn cattle flour in broilers nutrition, *Faculty of Agronomy Čačak*, 12 (13), 171–175. (in Serbian).
- Jensen, S.K., Liu, Y.G., Eggum, B.O. (1995). The effect of heat treatment on glucosinolates and nutritional value of rapeseed meal in rate, *Anim. Feed Sci. Technol.*, 53 (1), 17–28.
- Kormanjoš, Š., Filipović, S., Plavšić, D., Filipović J. (2007). Extrusion effect on hygienic conditions of feed, *Contemporary agriculture*, 5-6, 143–146. (in Serbian).
- Lazarević, R., Mišević, B., Ristić, B., Filipović, S., Lević, J., Sredanović, S. (2005). Present and the future of livestock and feed production in Serbia, *Quality assurance, Vrnjačka Banja*, 12-18. (in Serbian).
- Marsman, G.J.P., Gruppen, H., Groot, J. De, Voragen, A.G.J. (1998). Effect of toasting and extrusion at different shear levels on soy protein interactions. *J. Agr. Food Chem.*, 46 (7), 2770–2777.
- Nježić, Z., Živković, J., Cvetković, B. (2010). Energy value of leftover bread as safe and quality food. *Chemical Industry & Chemical Engineering Quarterly*, 16 (4), 339–403.
- Sakač, M., Filipović, S., Ristić M. (2001). Full fat soy grits production by the application of dry extrusion process, *PTEP*, 5 (1-2), 64–68 (in Serbian).
- Rule book of methods for microbiological analysis and superanalysis of food ("Sl. list SFRJ", br. 55/80) (in Serbian).
- Rule book of methods for taking samples and utilisation of physical, chemical and microbiological analysis of cattle feed ("Sl. list SFRJ", br. 15/87)(in Serbian).
- Rule book of physical and chemical analysis for the control of wheat, mill and bakery products, pasta and quick frozen dough manual ("Sl. list SFRJ", br. 74/88)(in Serbian).
- Rule book of maximum amount of harmful substances and ingredients in cattle feed ("Sl. list SFRJ", br. 29/14) (in Serbian).

BIOLOGICAL CONTROL AGAINST SOILBORNE FUNGI OF CUCURBITS

Yosraben M'HENNI, Ibtissem SALEM, Naima BOUGHALLEB-M'HAMDI*

UR 13AGR03, Department of Biological Sciences and Plant Protection, High Institute of Agronomy of ChottMariem, University of Sousse, Tunisia

*Corresponding author: n.boughalleb@laposte.net

Abstract

In Tunisia, the incidence of cucurbits soil-borne diseases caused by *Fusarium* sp., *Monosporascus cannonballus* and *Macrophomina phaseolinae* is a yield limiting factor of these crops. Two bacteria species *Bacillus subtilis* (B27) and *Bacillus amyloliquefasciens* (B29) were tested against six isolates of *Fusarium* sp., two isolates of *Macrophomina phaseolinae* and one isolate of *Monosporascus cannonballus*. According to confrontation tests between these two bacteria and pathogens, a significant reduction of colony diameter of all species was observed with the lowest values by B29 (2.46 cm). To confirm the *in vitro* antagonism activities, both preventive and curative treatments were performed on melon and watermelon plants. The damage caused by different plant pathogens was tested based on rating scales symptoms of infestation. These results revealed that these treatments using bacteria strains B27 and B29 reduced the incidence of plants disease of melon and watermelon inoculated with all pathogens. For watermelon plants inoculated with *Fusarium solani cucurbitae* and *Monosporascus cannonballus*, both *Bacillus subtilis* and *Bacillus amyloliquefasciens* were more effective than the synthesis active ingredients (Mefenoxan and Azoxystrobin) and Hymexazol. The treatment with B27 seemed to be more effective than the active ingredients (Mefenoxan and azoxystrobin), reducing the incidence of disease caused by *Macrophomina phaseolina* with disease severity index of 1.76 and 2.23 compared to the synthetic product (2.43 and 2.46) according to preventive and curative treatments, respectively.

Keywords: *Antifungal activity, Bacillus subtilis, Bacillus amyloliquefasciens, soilborne fungi.*

Introduction

Fusarium oxysporum, *F. solani cucurbita*, *Macrophomina phaseolina* and *Monosporascus cannonballus* are the main soilborne pathogens affecting cucurbits (Stanghellini *et al.*, 1996; Boughalleb and ElMahjoub, 2006). Different soilborne bacteria and fungi are able to colonize the rhizosphere with different beneficial effects on plant growth and health. The use of plant growth-promoting (PGP) bacteria intended as biological control agents is an environmentally friendly alternative to agricultural chemicals and could be combined with other strategies in the integrated management of soilborne diseases such as *Monosporascus* root rot and vine decline (Pliego *et al.* 2011). Thus, the selection of antagonistic microorganisms should take into account the efficacy towards the target pathogen along with the conditions where the bioagent could develop (Alabouvette and Steinberg 2006). *Pseudomonas* and *Bacillus* spp. can promote plant growth directly by providing the plant with nutrients or growth hormones, or indirectly by decreasing the pathogens growth (Lugtenberg and Kamilova 2009). *Bacillus subtilis* is an ubiquitous bacterium that grows in diverse environments including soils, plant roots and within the animal gastrointestinal tracts (Earl *et al.*, 2008). Many *B. subtilis* isolates from different origins are considered as beneficial bacteria for their ability to produce antibiotics exerting antifungal and antibacterial activity (Stein, 2005) and to activate host resistance mechanisms (Kloepper *et al.*, 2004). For this reason *B. subtilis*, as well as other

Bacillus species is an ideal candidate for use as biocontrol agent in seed treatment programs against soilborne pathogens (Foldes *et al.*, 2000). *B. subtilis* and *B. amyloliquefasciens* are effective for controlling plant diseases caused by soil-borne agents, which are *Bacillus subtilis* and *Bacillus amyloliquefasciens* (Zhang *et al.*, 2008; Chen *et al.*, 2010; Antonelli *et al.*, 2012, 2013).

The use of a biological control approach through the antagonistic bacteria of the genus *Bacillus* which have antifungal properties in several pathogenic species causing soil-borne diseases could be proposed against *Fusarium* sp., *Macrophomina phaseolina* and *Monosporascus* sp. wilt and dieback affecting cucurbitacea. The objectives of the present work are to (i) study the inhibition of mycelial growth of *Fusarium oxysporum melonis*, *Fusarium solani cucurbitae*, *Monosporascus cannonballus* and *Macrophomina phaseolina* and (ii) evaluate the effectiveness of the use of antifungal agents on the *in vivo* disease incidence of these soilborne pathogens.

Materials and Methods

Bacterial strains

Two strains of *Bacillus subtilis* (B27) and *Bacillus amyloliquefasciens*(B29) are used in this study, which belongs to the collection of laboratory of Phytopathology in higher agricultural institute of Chott Mariem (Tunisia). Strains were cultivated in Nutrient Agar (NA) at 30°C and incubated at 4°C for experimental use.

Fungal strains

For this study, two isolates of *F. o.niveum* (FON1, FON2) and one isolate *Monosporascus cannonballus* (MT14) was collected from watermelon plants, three isolates of *F. o.melonis* (FOM1, FOM2 and FOM3) was isolated from root infected melon, were used. Moreover, two *F. s. cucurbitae* (FSC1 and FSC2) and two isolates of *M. phaseolina* (MP1 and MP2) were isolated from infected roots of watermelon and melon, and watermelon, respectively. All isolates were grown on Petri dishes containing PDA medium for 5 -7 days at 25°C. All strains were included in the collection of the laboratory of phytopathology (High Institute of Agronomy chott Mariem, Tunisia).

Plants material

Watermelon (*cv. Ananas d'Amérique*) and melon (*cv. Charleston Gray*) were used for the *in vivo* experiments.

In vitro* screening of antifungal activity of *B. subtilis* and *B. amyloliquefasciens

Dual culture

The efficiency of *B. subtilis* (B27) and *B. amyloliquefasciens*(B29) was evaluated *in vitro* by applying a dual culture technique. Petri dish containing PDA medium was divided into two compartments, which is placed a mycelial plugs of 5 mm in diameter of each pathogen fungi at each side of the bacterial strip. The distance between the two plugs was 2.5 cm. After incubation for 6 days at 26°C, the inhibition of fungal growth was evaluated by the reduction of mycelium percent using the formula adopted by Hmouni *et al.* (1996): $I \% = [(1 - C_n) / C_0] \times 100$ where I % is the percentage of growth inhibition, which C_n is the colony diameter of the pathogen in the presence of the antagonist and C_0 is the colony diameter of the pathogen without antagonist. The values were recorded as the means of three replicates. Experiments were repeated twice.

***In vivo* antagonism test**

Watermelon and melon plants were used to evaluate the biocontrol activity of strains B27 and B29 on enhancing the growth of roots and reducing the disease. The bacterial inoculum was

prepared in nutrient broth (NB) in a shaker at 15000 rpm for 2 days at 30°C. The fungal pathogens were prepared and the concentration was adjusted 2×10^7 conidia/ml. The experimental protocol was a randomized complete block. Ten plants of watermelon and of melon were used for each treatment, and the values were recorded as the means of three replicates for each treatment. Two *in vivo* essays were undertaken, preventive and curative treatments. Both tests are intended to assess the effectiveness of the use of antibacterial agents on the infestation of soilborne pathogens. Two controls were used in this trial, the negative control consist of the inoculation of watermelon and melon only by each pathogen and the positive control plants are inoculated and treated by a fungicide and depends on the pathogens; concerning *M. cannonballus* and *M. phaseolina* plants are inoculated and treated with F3OACM (Mefenoxan and azoxystrobin), and for the *Fusarium* species, plants are inoculated and treated with Tachigazol (Hymexazol).

Disease severity index

During the experiment, the plants were carefully removed from the pots at 45 days after inoculation. The root systems were gently washed in tap water. Each root system was rated for the severity of the pathogen as described in Table 1.

Table 1. Disease severity of watermelon plants inoculated with *F. oxysporum*, *F. solani*, *M. phaseolina* and *M. cannonballus*.

Fungi	Rating scale	Reference
<i>F. oxysporum</i>	0 = no symptoms; 1 = light vascular discoloration in the stem with or without stunting; 2 = vascular discoloration in the stem, stunting, wilting with or without yellowing of cotyledons; and 3 = dead seedlings.	Vakalounakis and Frangkiadakis (1999)
<i>F. solani</i>	0: healthy; 1: slight yellowing of leaves with slight rot pivot and lateral roots and crown rot; 2: significant yellowing in leaves with or without wilting, stunting of plants, severe rot at the pivot and lateral roots, significant rot and browning of vessels in the stem; 3: death of the plant.	Boughallebet <i>et al.</i> (2005)
<i>M. phaseolina</i>	0: symptomless, 1: 1 to 3% of shoot tissues infected, 2: 10% of shoot tissues infected, 3: 25% of shoot tissues infected, 4: 50% of shoot tissues infected and 5: more than 75% of shoot tissues infected.	Ravf and Ahmad (1998)
<i>M. cannonballus</i>	0 = no symptoms; 1 = few lesions (covering <10% of root), secondary root rot slight; 2 = rot of secondary roots or lesions covering approximately 25% of the root; 3 = lesions covering at least 50% of the root and dead secondary roots; and 4 = general root rot, most of the root affected.	Aegerter <i>et al.</i> (2000)

The Disease severity index was analyzed with the GENMOD procedure using the multinomial distribution and the cumulative logit as link function, and means of the values were separated by χ^2 test at $P < 0.05$ using SAS program (SAS Institute, Cary, NC). The variable was compared by analysis of variance (ANOVA) and means of the values were separated with Duncan test at $P < 0.05$ using SPSS 20.0 for Windows (SPSS Inc., Chicago, IL, USA).

Results and Discussion

In vitro effect of *Bacillus subtilis* and *Bacillus amyloliquefaciens* on cucurbits soilborne fungi

B. subtilis (B27) and *B. amyloliquefaciens* (B29) have significantly reduced the mycelial growth of *F. o.niveum*. The most important inhibition is obtained with B29 which caused a significant reduction in colony diameter of FON2 (2.16; control=3.45cm). B27 and B29 decreased the mycelial growth of the two *F.s. cucurbitae* isolates compared to control; For FSC1, B27 was more effective in reducing the colony diameter with 2.69 cm (control=3.93cm); FSC2 was more sensitive to the action of B29. The decrease of the growth inhibition of *M.*

phaseolina (MP1) with B29 was higher than B27; the diameter of the colonies is 2.73 and 3.15 cm (control=4.3cm), respectively. The two bacterial strains B27 and B29 reduced significantly the mycelial growth of *Monosporascus cannonballus* (MT14) with 1.9 and 0.85cm (control=4.16), respectively (Table 2).

Table 2. *In vitro* effect of different bacterial antagonists against some soil-borne phytopathogens.

Treatments	Potential antimicrobial activity <i>in vitro</i> ^a									
	<i>F. oxysporum niveum</i>		<i>F. solani cucurbitae</i>		<i>M. phaseolina</i>		<i>F. oxysporum melonis</i>			<i>Monosporascus cannonballus</i>
	FON1	FON2	FSC1	FSC2	MP1	MP2	FOM1	FOM2	FOM3	MT14
T0	4,04±0,51a ^b	3,45±0,37a	4,13±0,53a	3,93±0,43a	4,3±0,31a	4,3±0,56a	3,52±0,25a	2,75±0,75a	3,54±0,24a	4,16±0,61a
B27	3,16±0,30b	2,79±0,20a	3,44±0,32b	2,69±0,23b	3,15±0,71b	2,71±0,35b	3,06±0,56b	2,69±0,32a	2,75±0,55b	1,9±0,57 b
B29	2,87±0,2b	2,16±0,48b	2,28±0,34c	3,31±0,62b	2,73±0,65c	2,6±0,67b	2,85±0,37b	2,19±0,35b	2,83±0,53b	0,85±0,66 c
P value ^c	<0.05	<0.05	<0.05	<0.0	<0.05	<0.05	<0.05	<0.05	<0.05	<0.05

^aPotential antimicrobial activity *in vitro* by the formula of Hmouniet *et al.* (1996): $I (\%) = (1 - C_n/C_0) \times 100$

^b± Standard error, according to Duncan's Multiple Range Test, values followed by different superscripts are significantly different at $p \leq 0.05$.

^cProbabilities associated with individual F tests.

Many species in the *Bacillus* genus are considered as an important potential biocontrol agents that have induced a strong antifungal activity against some plant pathogens (Pretorius *et al.*, 2015). The *in vitro* results are consistent with several previous studies. Asaka and Shoda (1996) and Okigbo (2005) reported the antagonistic properties of different strains of *Bacillus subtilis*. In this sense, the antagonist activity of *B. subtilis* has been indicated by Antonelli *et al.* (2012), according to *in vitro* tests against *M. cannonballus*. Others investigations mentioned that *B. amyloliquefasciens* strains showed antifungal properties against plant pathogenic fungi based on the production of antimicrobial compounds such as cyclic lipopeptides (Yuan *et al.*, 2014; Ben Abdallah *et al.*, 2015). Koumoutsi *et al.* (2004) confirmed the inhibitory effect produced by *B. amyloliquefasciens* since this species revealed to be *in vitro* and *in vivo* efficient for controlling several plant pathogenic fungi.

Effect of *B. subtilis* and *B. amyloliquefasciens* on disease incidence

B. subtilis and *B. amyloliquefasciens* were assayed in the greenhouse to determine the ability to suppress *Fusarium* sp., *Marcrophomina* and *Monosporascus* sp. of melon and watermelon plants. The isolates of pathogens were selected from the results obtained previously *in vitro* test

Watermelon

The two selected strains B27 and B29 were tested for their biocontrol activity in the pathosystem watermelon-pathogen. On untreated control plants (negative control) and treated with fungicide (positive control), the pathogen caused severe root rots of lateral and tap rots. Preventive treatments by the two bacteria determined a significant reduction of the disease severity index of all pathogens ($p < 0.05$). Obtained results indicated that watermelon plants inoculated with *M. phaseolina* and *M. cannonballus* combined with each *Bacillus* strains showed less symptoms of root rot ($p < 0.05$) in comparison with the other pathogens. For *M. phaseolina*, *Bacillus subtilis* (B27) applied preventively recorded the lowest value of 1.76 (negative control=2.8). Concerning *M. cannonballus*, the same treatment showed more efficiency with a value of 2.07 (negative control=3.83).

Table 3. In vivo effect of different bacterial antagonists against *Macrophomina phaseolina*, *Fusarium oxysporum niveum*, *Fusarium solani cucurbitae* and *Monosporascus cannonballus* on watermelon plants.

Disease severity index ^a					
Watermelon	<i>Macrophominaphaseolina</i>				
Treatments	<i>Bacillus subtilis</i>	<i>Bacillus amyloliquefaciens</i>	Negative control	Positive control	P values ^c
Preventive	1.76±0.5c ^b	2.06±0.34b	2.8±0.55a	2.47±0.5b	<0.05
Curative	2.23±0.43d	2.37±0.49c	2.8±0.55a	2.43±0.5b	<0.05
<i>Fusariumsolanicucurbitae</i>					
Preventive	3.1±0.5c	2.47±0.5bc	3.97±0.32a	3.43±0.5b	<0.05
Curative	3.03±0.18c	2.73±0.52d	3.97±0.32a	3.26±0.52b	<0.05
<i>Fusariumoxysporumniveum</i>					
Preventive	1.97±0.55b	2.07±0.25b	2.83±0.38a	1.77±0.5b	<0.05
Curative	2.47±0.5b	2.17±0.38b	2.83±0.38a	2.23±0.43c	<0.05
<i>Monosporascuscannonballus</i>					
Preventive	2.07±0.78c	2.1±0.48c	3.83±0.38a	2.9±0.54b	<0.05
Curative	2.73±0.45c	2.6±0.5c	3.83±0.38a	3.23±0.45b	<0.05

^a Disease severity index: scale described by Ravf& Ahmad (1998), 0: symptomless, 1: 1 to 3% of shoot tissues infected, 2: 10% of shoot tissues infected, 3: 25% of shoot tissues infected, 4: 50% of shoot tissues infected and 5: more than 75% of shoot tissues infected. Disease severity index: 0 to 3 visual scale, in which 0 = no symptoms; 1 = light vascular discoloration in the stem with or without stunting; 2 = vascular discoloration in the stem, stunting, wilting with or without yellowing of cotyledons; and 3 = dead seedlings (Vakalounakis and Frangkiadakis, 1999). Disease severity index: a 0 to 3 scale adopted by Boughalleb *et al.* (2005), 0: healthy; 1: slight yellowing of leaves with slight rot pivot and lateral roots and crown rot; 2: significant yellowing in leaves with or without wilting, stunting of plants, severe rot at the pivot and lateral roots, significant rot and browning of vessels in the stem; 3: death of the plant. Disease severity index: 0 = no symptoms; 1 = few lesions (covering <10% of root), secondary root rot slight; 2 = rot of secondary roots or lesions covering approximately 25% of the root; 3 = lesions covering at least 50% of the root and dead secondary roots; and 4 = general root rot, most of the root affected (Aegerter *et al.*, 2000).

^b ± Standard error, according to Duncan's Multiple Range Test, values followed by different superscripts are significantly different at $p \leq 0.05$.

^c Probabilities associated with individual F tests.

Melon

Treating plants after the inoculation with pathogen and fungicide did reduce disease severity index compared to untreated plants (only pathogens). The results indicated that preventive and curative treatments differed significantly ($p < 0.05$) (Table 4). Concerning *M. cannonballus* both *Bacillus* strains showed antifungal activities as preventive treatment with values of 1.17 and 1.03 (negative control=3.33), respectively. *B. subtilis* B27 applied preventively and curatively generated an inhibitory effect against *F. o. melonis* (1.1 and 1.13 (negative control=2.23)), only curatively against *M. phaseolina* (1.13 (negative control=2.83)). *Bacillus amyloliquefaciens* (B29) applied preventively exhibited a significant reduction of disease severity index in presence of *M. phaseolina* (1.4) and *M. cannonballus* (1.03).

Table 4. *In vivo* effect of different fungal antagonists against *Macrophomina phaseolina*, *Fusarium oxysporum melonis*, *Fusarium solani cucurbitae* and *Monosporascus cannonballus* on melon plants.

Melon Treatments	Disease severity index ^a				
	<i>Macrophomina phaseolina</i>				
	<i>Bacillus subtilis</i>	<i>Bacillus amyloliquefaciens</i>	Negative control	Positive control	P values ^c
Preventive	1.77±0.43b ^b	1.4±0.5c	2.83±0.38a	1.7±0.53b	<0.05
Curative	1.13±0.39c	1.87±0.34b	2.83±0.38a	1.83±0.38b	<0.05
	<i>Fusarium solani cucurbitae</i>				
Preventive	2.47±0.5c	2.1±0.3d	3.67±0.48a	2.83±0.38b	<0.05
Curative	2.37±0.5c	3.13±0.34d	3.67±0.48a	2.9±0.3b	<0.05
	<i>Fusarium oxysporum melonis</i>				
Preventive	1.1±0.3b	1.17±0.38b	2.23±0.43a	1.17±0.5b	<0.05
Curative	1.13±0.34b	1.2±0.4b	2.23±0.43a	1.27±0.45b	<0.05
	<i>Monosporascus cannonballus</i>				
Preventive	1.17±0.38d	1.03±0.49c	3.33±0.48a	1.5±0.82b	<0.05
Curative	1.33±0.48d	1.73±0.74c	3.33±0.48a	2±0.66b	<0.05

^a Disease severity index: scale described by Ravf& Ahmad (1998), 0: symptomless, 1: 1 to 3% of shoot tissues infected, 2: 10% of shoot tissues infected, 3: 25% of shoot tissues infected, 4: 50% of shoot tissues infected and 5: more than 75% of shoot tissues infected. Disease severity index: 0 to 3 visual scale, in which 0 = no symptoms; 1 = light vascular discoloration in the stem with or without stunting; 2 = vascular discoloration in the stem, stunting, wilting with or without yellowing of cotyledons; and 3 = dead seedlings (Vakalounakis and Frangkiadakis, 1999). Disease severity index: a 0 to 3 scale adopted by Boughalleb *et al.* (2005), 0: healthy; 1: slight yellowing of leaves with slight rot pivot and lateral roots and crown rot; 2: significant yellowing in leaves with or without wilting, stunting of plants, severe rot at the pivot and lateral roots, significant rot and browning of vessels in the stem; 3: death of the plant. Disease severity index: 0 = no symptoms; 1 = few lesions (covering <10% of root), secondary root rot slight; 2 = rot of secondary roots or lesions covering approximately 25% of the root; 3 = lesions covering at least 50% of the root and dead secondary roots; and 4 = general root rot, most of the root affected (Aegerter *et al.*, 2000).

^b ± Standard error, according to Duncan's Multiple Range Test, values followed by different superscripts are significantly different at $p \leq 0.05$.

^c Probabilities associated with individual F tests.

The importance of the root microbiome in plant health is underlined by much experimental evidence and it is becoming increasingly clear that the plant is able to control the composition of its microbiome (Berendsen *et al.*, 2012). This research paper showed the antifungal activity of the two *Bacillus* species *in vivo* against some of the major soilborne pathogens of melon and watermelon. Indeed, *Pseudomonas* and *Bacillus* spp. can promote plant growth directly by providing the plant with nutrients or growth hormones, or indirectly by decreasing the growth of pathogens (Lugtenberg and Kamilova, 2009). Previous studies revealed that antibiosis was one of the primary mechanisms of *Bacillus* spp. against plant pathogens. Various antibiotics are produced by *Bacillus* spp. (Kilian *et al.*, 2000). *Bacillus amyloliquefaciens* and its close relative *B. subtilis* have been reported to be effective in controlling plant pathogens through the production of non-ribosomally synthesized antibiotics, mainly cyclic lipopeptides (Xuet *et al.*, 2013).

Conclusion

Our results indicate that *Bacillus* strains are beneficial to growth and health of melon and watermelon. Potentially, plant treatments with *B. subtilis* (B27) and *B. amyloliquefaciens* (B29) display a biocontrol against root rot and may provide a practical supplement to environmentally friendly disease management in combination with appropriate sustainable agricultural practices.

References

- Aegerter, B.J., Gordon, T.R., & Davis, R.M. (2000). Occurrence and pathogenicity of fungi associated with melon root rot and Vine decline in California. *Plant Disease*, Vol., (84), pages (224-230).
- Alabouvette, C., & Steinberg, C. (2006). The soil as a reservoir for antagonists to plant diseases. In: Eilenberg J, Hokkanen HMT (eds) *Ecological and Societal Approach to Biological Control*. Dordrecht, Springer, 123–144 pp.
- Antonelli, M., Reda, R., Aleandri, M., Varvaro, L., & Chilosi, G. (2012). Plant Growth-Promoting Bacteria from Solarized Soil with the Ability to Protect Melon against Root Rot and Vine Decline Caused by *Monosporascus cannonballus*. *Journal of Phytopathology*, Vol., (161) pages (485–496).
- Antonelli, M., Reda, R., Aleandri, M., Varvaro, L., & Chilosi, G. (2013). Plant Growth Promoting Bacteria from Solarized Soil with the Ability to Protect Melon Against Root Rot and Vine Decline Caused by *Monosporascus cannonballus*. *J. Phytopathol.*, Vol., (16), pages (485–496).
- Asaka, O., & M. Shoda. (1996). Biocontrol of *Rhizoctonia solani* damping-off of Tomato with *Bacillus subtilis* RB14. *Applied and Environmental Microbiology*, Vol., (62) pages (4081-4085).
- Ben Abdallah, D., Frikha-Gargouri, O., & Tounsi, S. (2015). *Bacillus amyloliquefaciens* strain 32a as a source of lipopeptides for biocontrol of *Agrobacterium tumefaciens* strains. *J. Appl. Microbiol.*, Vol., (119) pages (196–207).
- Berendsen, R.L., Pieterse, C.M., & Bakker, P.A. (2012). The rhizosphere microbiome and plant health. *Trends Plant Sci.*, Vol., (17), pages (478–486).
- Boughalleb, N., Armengol, J., & El Mahjoub, M. (2005). Detection of races 1 and 2 of *Fusarium solani* f. sp. *cucurbitae* and their distribution in watermelon fields in Tunisia. *J. Phytopathol.*, Vol., (153), pages (162-168).
- Boughalleb, N. & El Mahjoub, M. (2006). Watermelon sudden Decay in Tunisia / Identification of Pathogenic Fungi and determination of primary agents, *Pakistan Journal of Biological Science*, Vol., (9) pages (1095-1103).
- Chen, F., Wang, M., Zhang, Y., Luo, J., Yang, X., & Wang X. (2010). Quantitative changes of plant defense enzymes and phytohormone in biocontrol of cucumber Fusarium wilt by *Bacillus subtilis* B579. *World J. Microbiol. Biotechnol.*, Vol., (26), pages (675-684).
- Earl AM, Losick R, & Kolter R. (2008) Ecology and genomics of *Bacillus subtilis*. *Trends Microbiol.*, Vol., (16), pages (269–275).
- Foldes, T., Banhegyi, I., Herpai, Z., Varga, L., & Szigeti, J. (2000). Isolation of *Bacillus* strains from the rhizosphere of cereals and *in vitro* screening for antagonism against phytopathogenic, food-borne pathogenic and spoilage micro-organisms. *Journal of Applied Microbiology*, Vol., (89), pages (840–846).
- Hmouni, A., Hajlaoui, M.R. & Mlaiki, A. (1996). *Botrytis cinerea* resistance to benzimidazole and to dicarboximide in tomato protected culture in Tunisia. *EPPO. Bull.*, Vol., (26), pages (697-705).
- Kilian, M., Steiner, U., Krebs, B., Junge, H., Schmiedeknecht, G., & Hain, R. (2000). FZB241 *Bacillus subtilis*-mode of action of a microbial agent enhancing plant vitality. *Pflanzenschutz-Nachrichten Bayer*, Vol., (1), pages (72–93).
- Kloepper JW, Ryu C-M, & Zhang S. (2004) Induced systemic resistance and promotion of plant growth by *Bacillus* spp. *Phytopathology*, Vol., (94), pages (1259–1266).
- Koumoutsis, A., Chen, X.H., Henne, A., Liesegang, H., Hitzeroth, G., & Franke, P. (2004). Structural and functional characterization of gene clusters directing nonribosomal synthesis

- of bioactive cyclic lipopeptides in *Bacillus amyloliquefaciens* strain FZB42. *Journal of Bacteriology*, Vol., (186), pages (1084-1096).
- Lugtenberg, B., & Kamilova, F. (2009). Plant-growth-promoting rhizobacteria. *Ann. Rev. Microbiol.*, Vol., (63), pages (541–556).
- Okigbo, R. (2005). Biological control of post-harvest fungal rot of yam (*Dioscorea* Spp) with *Bacillus subtilis*. *International Journal of Vitmin, Nutriment Research*, Vol., (75), pages (161-168).
- Pliego C., Kamilova, F., & Lugtenberg, B. (2011). Plant growth promoting bacteria: fundamentals and exploitation bacteria in agrobiolology: crop ecosystems. In: Maheshwari DK (ed) *Bacteria in Agrobiolology Crop Ecosystems* ed. Berlin, Heidelberg, Springer, 295–343pp.
- Pretorius, D., van Rooyen, J., & Clarke, K.G., 2015. Enhanced production of antifungal lipopeptides by *Bacillus amyloliquefaciens* for biocontrol of postharvest disease. *New Biotechnol.*, Vol., (32), pages (243–252).
- Ravf, B.A., & Ahmad, I. (1998). Studies on correlation of seed infection to field incidence of *Alternaria alternata* and *Macrophomina phaseolina* in Sunflower. 13th Iranian Plant Protection Congress-Karaj, Iran, 113 pp.
- Stanghellini, M.E., Kim, D.H., & Rasmussen, S.L. (1996). Ascospores of *Monosporascus cannonballus*: germination and distribution in cultivated desert soils in Arizona. *Phytopathology*, Vol., (86), pages (509–514).
- Stein, T., 2005. *Bacillus subtilis* antibiotics, structure, synthesis and specific function. *Molecular Microbiology*, Vol., (56), pages (845–857).
- Vakalounakis, D.J., & Fragkiadakis GA. (1999). Genetic diversity of *Fusarium oxysporum* isolates from cucumber: differentiation by pathogenicity, vegetative compatibility and RAPD fingerprinting. *Phytopathology*, Vol., (89), pages (161–168).
- Xu, Z., Shao, J., Li, B., Yan, X., Shen, Q., & Zhang, R. (2013). Contribution of bacillomycin D in *Bacillus amyloliquefaciens* SQR9 to antifungal activity and biofilm formation. *Appl. Environ. Microbiol.*, Vol., (79), pages (808–815).
- Yuan, J., Zhang, F., Wu, Y., Zhang, J., Raza, W., Shen, Q., & Huang, Q. (2014). Recovery of several cell pellet-associated antibiotics produced by *Bacillus amyloliquefaciens* NJN-6. *Lett. Appl. Microbiol.*, Vol., (59), pages (169–176).
- Zhang, S., Raza, W., Ynag, X., Hu, J., Huang, Q., Xu, Y., Liu, X., Ran, W., & Sjen, Q. (2008). Control of fusarium wilt disease of cucumber plants with the application of bioorganic fertilizer. *Biol, Fertil. Soils*, Vol., (44), pages (1073-1080).

SCREENING OF SOME CUCURBITS CULTIVARS FOR TOLERANCE TO BACTERIAL FRUIT BLOTCH PATHOGEN *ACIDOVORAX CITRULLI* IN TURKEY

Nursen USTUN*, Neziha ARSLAN

Plant Protection Research Institute, Bornova, Izmir, Turkey

*Corresponding author: nursen.ustun@tarim.gov.com

Abstract

Bacterial fruit blotch of cucurbits, caused by *Acidovorax citrulli* is a devastating disease threatening the watermelon and melon industries all over the world. In this study the susceptibility of various commercial cultivars of cucurbits (Suha and Eyfel for squash, Aswan and Crimson Tide for watermelon, Golden West for melon, and Divan and Beith Alpha F1 for cucumber) commonly grown in Turkey was evaluated using seedling-inoculation assays. Emerging pot growing seedlings were grown in climatic room (25-28 °C, 60-70% RH and 16 hours daylight). Artificial inoculation was performed by spraying of two weeks old seedlings with bacterial suspension of two different melon strains of *A. citrulli* adjusted to 10⁶ CFU/L⁻¹. Ten plants per cultivar were inoculated with the same strain. Control plants from each cultivar were sprayed with sterile water. Following inoculation, plants were covered by plastic chambers in order to keep 90-100% humidity for the first 48 hours. Then the chambers were removed and plants were incubated at the 25-28°C and 70-80 % humidity for subsequent 12 days after inoculation. At the end of incubation, the severity of the disease for the strains was scored using 0-9 scale. Statistical analyses were performed by comparing mean severity index values according to Duncan multiple range test at P= 0.05 level. All of tested cultivars were found to be susceptible to the disease. However, some differences in the severity of the disease symptoms were observed.

Key words: *cucurbits, fruit blotch bacterium, cultivar susceptibility*

Introduction

Cucurbits are economically important vegetable crops commonly cultivated in the world. Turkey is among the biggest producers of cucurbits with world ranking 3rd for watermelons and also 3rd for melons (FAO, 2012). Many plant pathogens can limit productions of cucurbits by inducing serious disease epidemics.

Bacterial fruit blotch of cucurbits, caused by *Acidovorax citrulli* (*Ac*) is a devastating disease threatening the watermelon and melon industries all over the world. The disease first observed in the USA in areas of commercial watermelon production in 1989 (Hopkins, 1989; Latin & Rane, 1990) was reported from many different countries. Because of its seed-borne nature the pathogen has the great potential of spread across long distances and this evidence is of particular concern to the cucurbit industry.

Fourteen haplotypes of *Ac* determined on the basis of Pulsed Field Gel Electrophoresis DNA analyses (Walcot et al., 2000) fall into at least two distinct groups, Group I and Group II strains. Group I strains are isolated from different cucurbit crops, including muskmelons and watermelon, whereas Group II stains are predominantly associated with bacterial fruit blotch of watermelon (Walcott et al., 2004).

Ac was detected for the first time in 1995 in Turkey (Demir, 1996) only in some fields of Sultaniçi village, Enez town, Edirne province (Marmara Region) and then eradicated by taking some phytosanitary measures in the contaminated locality. The pathogen emerged

again in the Eastern Mediterranean Region (Cukurova) of Turkey in 2006 and caused severe losses in some watermelon fields (Mirik et al, 2006;). Horuz ve Aysan (2012) reported it not only from different watermelon cultivars (Blade, Zeugma, Crispy and Starburst) but also from Sürmeli melon cultivar. The bacterium listed in Plant Quarantine Regulation (Annex 2B) is under eradication in Turkey.

The management of watermelon fruit blotch is based primarily on seed disinfection, pathogen exclusion by seed health testing, cultural practices and regulation of environment in the transplant houses and application of copper compounds able only to reduce the disease in field/greenhouse but not to eliminate it. Using of resistant cultivars can be one of the most reliable approaches for the disease control. No complete resistance has been found in commercial cucurbit cultivars up to now. However differences in the disease response and relative tolerance were reported in some watermelon and melon cultivars or lines (Hopkins and Thompson, 2002; Hopkins and Levi, 2008).

In this study the susceptibility of various commercial cultivars of cucurbits commonly grown in Turkey was evaluated using seedling-inoculation assays.

Materials and Methods

Commonly grown cultivars in the Aegean Region of Turkey (Suha and Eysel for squash, Aswan and Crimson Tide for watermelon, Golden West for melon, and Divan and Beith Alpha F1 for cucumber) were selected for screening. For inoculation two different bacterial strains (Ac1 and Ac2) isolated from melon and identified previously were used.

Seeds of the cultivars were sown in pots (two seeds per pot) containing soil mixture with equal parts of perlite and peat. Emerging seedlings were grown in climatic room (25-28 ° C, 60-70% RH and 16 hours daylight. Two weeks old seedlings were artificially inoculated by spraying with bacterial suspension of 2 different melon strains of *A.citrulli* adjusted to 10⁶ CFU/L⁻¹. Ten plants per cultivar were inoculated with the same strain. Control plants from each cultivar were sprayed with sterile water. Following inoculation, plants were covered by plastic chambers in order to keep 90-100% humidity for the first 48 hours. Then the chambers were removed and plants were incubated at the 25-28°C and 70-80 % humidity for subsequent 12 days after inoculation. At the end of incubation, the severity of the disease for the strains was scored using 0-9 scale (1 = no symptoms; 2 = single, small necrotic lesions on less than 1% of the leaf; 3 = small necrotic lesions on 1% to 10% of the leaf; 4 = necrotic lesions on 11% to 20% of the leaf; 5 = necrotic lesions with chlorosis on greater than 20% to 40% of the leaf; 6 = necrotic lesions on 40% to 60% of the leaf; 7 = necrotic lesions on 61% to 80% of the leaf; 8 = large spreading lesions, greater than 85% of leaf; and 9 = dead plant) proposed by Hopkins and Thompson (2002) applied for true leaves instead of cotyledons. Statistical analyses were performed by comparing mean severity index values according to Duncan multiple range test at P= 0.05 level.

Results and Discussion

Two watermelon (Crimson Tide and Aswan), one melon (Golden West), two squash (Eysel and Suha) and two cucumber (Beith Alpha F1 and Divan) cultivars commonly grown in the Aegean Region of Turkey were screened for resistance to watermelon fruit blotch pathogen. In the seedlings-inoculation assay all of tested cultivars were found to be susceptible to the disease. However, some differences in the severity of the disease symptoms between the cultivars were observed. According to Duncan multiple range test at P= 0.05 level, compared the mean severity index values, the cultivars based on their reaction to Ac1 strain were grouped in 5 different statistical groups. Three statistical groups were formed for Ac2 strains (Table 1). The melon cultivar Golden West was the most susceptible cultivar to both tested strains followed by squash cultivar Eysel. Watermelon cultivars Crimson Tide and Aswan and squash cultivar Suha were less affected from Ac1 strain than other tested cultivars. In reaction

to another bacterial strain Ac2 cucumber cultivars Beith Alpha 1 and Divan, watermelon cultivar Aswan and squash cultivar Suha fell into same statistical group and were less affected than others.

Table1. Response of some cucurbits cultivars to watermelon fruit blotch pathogen *Acidovorax citrulli*

Cucurbits Plant species	Cultivar	Ac 1	Ac 2
melon	Golden West	7,7 a	8,2 a
cucumber	Beith Alpha	6,6 abc	5 b
	Divan	5,7 bcd	5,4 b
squash	Eyphel	6,9 ab	6,8 ab
	Suha	4,8 cd	5 b
watermelon	Crimson Tide	4,2 cd	5,2 ab
	Aswan	4,2 cd	6,4 b

Ac1, Ac2 –*Acidovorax citrulli* strains from melon; cultivars: Eyfel and Suha -squash; Beith Alfa 1 and Divan-cucumber, Golden West-melon; Aswan and Crimson tide-watermelon

Mean severity index values were calculated on the basis of 0-9 scale ((1 = no symptoms; 2 = single, small necrotic lesions on less than 1% of the leaf; 3 = small necrotic lesions on 1% to 10% of the leaf; 4 = necrotic lesions on 11% to 20% of the leaf; 5 = necrotic lesions with chlorosis on greater than 20% to 40% of the leaf; 6 = necrotic lesions on 40% to 60% of the leaf; 7 = necrotic lesions on 61% to 80% of the leaf; 8 = large spreading lesions, greater than 85% of leaf; and 9 = dead plant) proposed by Hopkins and Thompson (2002) and applied for true leaves instead of cotyledons. Mean severity index values were compared according to Duncan multiple range test at P= 0.05 level.

In general, the reaction of the cultivars was similar for the both tested strains. However some of the cultivars showed different reaction. For example watermelon cultivars Crimson tide and Aswan were more susceptible to Ac 2 strain. In contrast cucumber cultivar Beith Alfa-1 was more affected from Ac 1 strain. This results indicated that cultivars the susceptibility of the cultivars can be strain related and they can react differently to various strains.

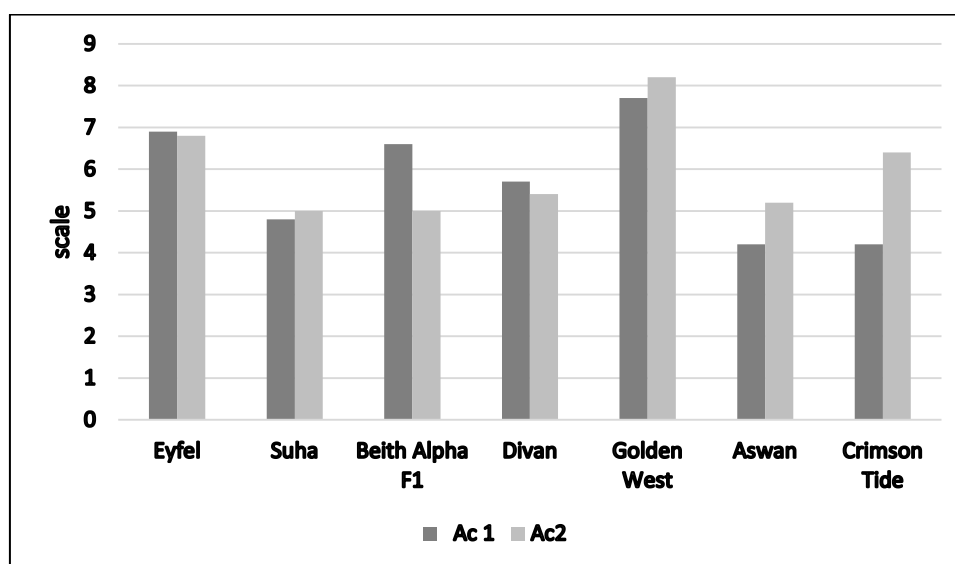

Figure 1. Strain related response of some cucurbits cultivars to watermelon fruit blotch pathogen *Acidovorax citrulli*

Ac1, Ac2 –*Acidovorax citrulli* strains from melon; cultivars: Eyfel and Suha -squash; Beith Alpha F1 and Divan-cucumber, Golden West-melon; Aswan and Crimson tide-watermelon

Conclusions

The study provide evidence that the tested cultivars of cucurbits (Eyfel and Suha -squash; Beith Alpha F1 and Divan-cucumber, Golden West-melon; Aswan and Crimson tide-watermelon) commonly grown in Turkey are susceptible at different degree to the watermelon blotch pathogen. However many cucurbits cultivars grown in Turkey (including cultivars of local origin) are not evaluated for their resistance in this study. Determination of the reactions of local cucurbits cultivars are recommended in the future studies in order to find the sources of the resistance.

References

- FAO (2012). Food and Agricultural commodities production.
<http://faostat.fao.org/site/339/default.aspx>
- Horuz S., and Aysan Y. (2012). Outbreak of bacterial fruit blotch disease on melon and watermelon in Çukuroba region, Turkey. Proceedings of the Xth EUCARPIA Meeting on Genetics and Breeding of Cucurbitaceae. 15-18 Ekim 2012, Antalya, p 763-766.
- Hopkins, D.L. 1989. Bacterial fruit blotch of watermelon: A new disease in the eastern USA, p. 74–75. In: Thomas, C.E. (ed.). Cucurbitaceae 1989. Proc. Evaluation and enhancement of Cucurbit germplasm. U.S. Vegetable Laboratory, Charleston, SC.
- Hopkins D.L., and Levi A. (2008). Progress in the development of Crimson sweet-type watermelon breeding lines with resistance to *Acidovorax avenae* subsp. *citrulli*. In: Pitrat, M. (ed.). Cucurbitaceae 2008. Proc. IXth EUCARPIA meeting on genetics and breeding of Cucurbitaceae. Institut National de la Recherche Agronomique, Avignon, France.
- Hopkins D.L., and Thompson C.M. (2002). Evaluation of *Citrullus* sp. germplasm for resistance to *Acidovorax avenae* subsp. *citrulli*. Plant Dis. 86:61–64.
- Latin R.X. and Hopkins D.L. (1995). Bacterial fruit blotch of watermelon: The hypothetical exam question becomes reality. Plant Dis. 79:761–765.
- Mirik M, Aysan Y, and Sahin F., (2006). Occurrence of bacterial fruit blotch of watermelon caused by *Acidovorax avenae* subsp. *citrulli* in the eastern Mediterranean Region of Turkey. Plant Disease 90 (6): 829.
- Walcott R.R., Fessehaie A., and Castro A.C. 2004. Differences in pathogenicity between two genetically distinct groups of *Acidovorax avenae* subsp. *citrulli* on cucurbit hosts. J. Phytopathol. 152:277–285.
- Walcott, R.R., Langston D.B., Sanders Jr. F.H., Jr. And Gitaitis R.D. 2000. Investigating intraspecific variation of *Acidovorax avenae* subsp. *citrulli* using DNA fingerprinting and whole cell fatty acid analysis. Phytopathology 90:191–196.

**STUDY OF THE LARVICIDAL ACTIVITY OF HYDRO-
ALCOHOLIC EXTRACTS OF *NERIUM OLEANDER* L. AND *RICINUS COMMUNIS* L.
ON *TUTA ABSOLUTAM*.**

Boualem MALIKA*, Osmane BADIAA, Saïah FARIDA

Plant Protection and Plant Biochemistry Laboratory, Department of Agronomy, University Abdelhamid Ibn Badis-
Mostaganem, Algeria

*Corresponding author: boualemmalika@yahoo.fr, bio.badi@gmail.com

Abstract

The use of synthetic pesticides is now in frequent use in crop protection. But they are considered as a major problem on the environment, the flora and fauna or human health. Biopesticides of botanical origin are a good alternative to remedy this evil. Our study aimed at assessing the toxicity of hydro-methanoic, hydro-ethanoic and synergistic extracts of two toxic plants, including *Nerium oleander* and *Ricinus communis* growing spontaneously in Mostaganem area, on larvae of the tomato leafminer *T. absoluta* (Meyrick), which is considered as a serious pest on tomato crop in Algeria. The extraction yields (Method of Soxhlet) obtained by the two hydro-methanoic and hydro-ethanoic extracts are (26%, 18%) for *N. oleander* and (35%, 29%) for *R. communis* respectively. However, the hydro-methanoic extract remains the most effective. These extracts were tested adopting the method of toxicity by direct contact or spray. The biological tests on the larvae of *T. absoluta* have shown that there is a difference between the toxicity of hydro-methanoic and hydro-ethanoic extracts within the same plant. The synergistic extract caused a remarkable mortality rate that exceeded 90%. *N. oleander* and *R. communis* presented a low toxicity not exceeding 30% for the hydro-ethanoic extracts and 40% for the hydro-methanoic extracts. After 24 hours of exposure to the test, the LD50 values were very high (above 50%) for hydro-ethanoic and hydro-methanoic extracts for the two plants used. However, the LD50 values were relatively low for the synergistic extract (19%). The results showed that L2 and L1 larvae are most sensitive to all extracts used. The L3 and L4 are the most resistant, except for the synergistic extract.

Key words: Bioinsecticides-*Tuta absoluta*- *Nerium oleander*- *Ricinus communis*-Toxicity-Hydro-alcoholic.

Introduction

The tomato borer *Tuta absoluta* (Meyrick) (Lepidoptera: Gelechiidae), a key pest of tomato invaded Algeria in March 2008, It is now devastating pest in tomato crops in Mediterranean basin and Maghreb. According to Gilardon *et al.* (2001) and Tropea *et al.* (2012), in most countries where *T. absoluta* occurs, the main control strategy consists of frequent sprays with chemical insecticides, because without control *T. absoluta* causes yield losses up to 100% and dramatically decreases fruit quality in both field and in greenhouse tomato crops. Both control *T. absoluta* population and care ecosystem, natural products are increasingly required for sustainable agriculture, the indiscriminate use of conventional synthetic pesticides have had a negative ecological and health impact (pest resistance, contamination of environment and ecosystems, loss of biodiversity, etc.).

The use of vegetable kingdom and molecule that allowed the plants to protect against natural enemies becomes indispensable (Regnault-Roger, *et al.*, 2008; Lacava and Azevedo, 2014). Plant derived insecticides and insect hormones are receiving significant interest as alternatives

to chemical pesticides and key components of integrated pest managements systems, which are cheaper, safer, and ecofriendly (Attathom, 2002; Adedire and Ajayi, 1996 in Adedire and Akinkurolere, 2005). We can cite as active elements of plants: phenols, flavonoids, tannins, anthocyanins, saponins, vitamins, and minerals glucosides (Chevallier, 2001).

Material and Methods

To improve the bio-insecticide effect of the natural plants substances, we have chosen two plants known for their toxicity and high content of active ingredients: oleander (*Nerium oleander* L.) and Ricin (*Ricinus communis* L.) in order to use it to control larval population of *T. absoluta* on tomato crop and to secure the production by reducing the damage caused by this pest; also for limiting the harmful effects of these on the environment and human Health. It is also important to encourage and promote the production of organic crops in Algeria. Other studies have highlighted the effectiveness of plant extracts on *T. absolutalarvae* (Da Cunha *et al.*, 2008; Nilahyaneet *al.*, 2012; Moreno *et al.*, 2011; De Brito *et al.*, 2015).The larvae sensitivity of extracts varies from one plant to another.

a) Extraction Method (The Soxhlet Extractor)

We treated 20g of Ricin fresh leaves by ether petroleum, and then allowed to dry for 10 minutes at room temperature. After, the solute is introduced in a cartridge placed in Soxhlet. Extraction solvents used are: a hydro-methanoic mixture and hydro-ethanoic (Jordan *et al.*, 2009).The flask contents (more solvent materials dissolve) are concentrated by rotary evaporator.

b) Larvicidal Activity (Test Contact)

The use of plant extracts to control *T. absoluta* larvae has been proposed by many authors. Moreira (2007) tested extracts of such toxic plants, *Datura stramonium* and *R. communis*.

In Algeria, the studies on the larvicidal activity of toxic plant extracts to the lepidopteran larvae are so limited. In this context we have been able to evaluate the larvicidal activity of the hydro-methanoic extracts and hydro-ethanoic of toxic plants (*N. oleander*, *R. communis*), and a synergistic extract.

The tests were carried out as of $T^{\circ}= 25\pm 3^{\circ}\text{C}$, $H^{\circ}= 48\pm 8\%$ and natural photoperiod. *T. absoluta* larvae were levied by a brush and placed in airy Petri dishes containing agar;each box carrying a healthytomato's leaflets that serve as food support for the larvae. The concentrations of each extract (hydro-methanoic, hydro-ethanoic, and synergistic of two plants used) were tested: at 10, 20, and 30%, then the control treated with distilled water. The mortality rate (%) is determined for each treatment after 24h, 72h, 48h, 7 days, and 15 days after spraying. The larval mortality rate depending on time contact is estimated with Abbott's formula (Busvine, 1981).

Results and Discussion

Humidity Rate of Plant Material

Plants are rich in water, the analysis of the samples showed a high humidity, between 39 and 50%, which means approximately half weight of fresh plant is constituted by water.*N. oleander*leaves gave us an approximate weight to equivalent proportions of dry matter and water (50%). whereas*R. communis* is very rich in dry matter (61%) and only 39% water.The results show a variability of the water content between different species (Fig. 1).

Extraction Efficiency

Hydro-methanoic extract noted a higher yield compared to hydro-ethanoic. Then it was recorded higher yield for *R. communis* compared with *N. oleander* (Fig. 2). Mohadjerani

(2012) showed that aqueous methanol and pure methanol were the most effective solvents for the extraction of phenolic compounds from the leaves and flowers of *N. oleander* in Iran. The difference between yields' extraction for the same plant is rated on the solvent used. The highest yield was observed by hydro-methanoic extracted with 26% and 35% for respectively *N. oleander* and *R. communis*, followed by hydro-ethanoic extract with 18% and 29% respectively for both plants tested (Fig. 2).

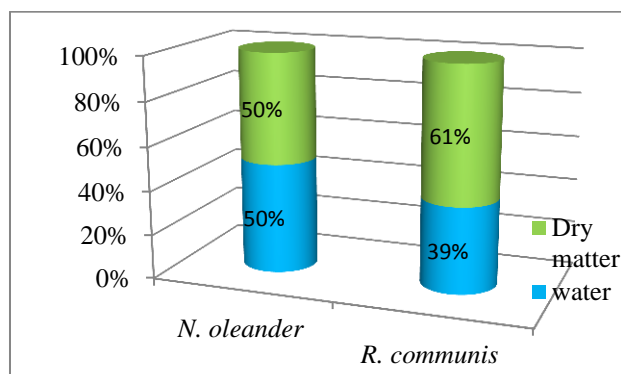

Figure 1. Humidity rate of *N. oleander* and *R. communis* *T. absoluta*

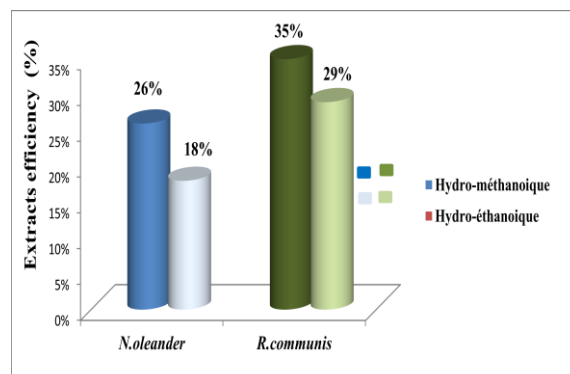

Figure 2. Comparison of *N. oleander* and *R. communis* hydro-alcoholic extracts fresh leaves

Larvicidal Activity

T. absoluta larvae were exposed to different treatments of hydro-methanoic and hydro-ethanoic extracts from fresh leaves of *N. oleander* and *R. communis* at different periods: 24, 48, 72 hours, 7, and 15 days. The results showed that the same mortality was obtained after 24 hours which is explained by the larvicidal activity that is not related to the duration of exposure to treatment but by the action of extracts that have had an immediate effect. Moreover, the live larvae were able to continue their development after 24 hours to reach pupation. No mortality was recorded in all control groups we tried even after 15 days (the development of larval instars was not unaffected).

Larvicidal Activity of *N. oleander* Extracts of *T. absoluta*

The results presented in Figure 3, indicate that the two hydro-alcoholic extracts of *N. oleander* caused more or less significant larvicide efficiency compared to the control. This activity increases proportionally with the concentrations tested and it varies from one sample to another for the same plant. For both *N. oleander* extracts, larval mortality lower rate reached 50% even for the highest concentration (30%).

The LD50 (dose causing the death of 50% of *T. absoluta* population) have been very high for both extracts of *N. oleander*, which values are 54% and 75% for hydro-methanoic and hydro-ethanoic extracts respectively. And for even extracts the LD90 obtained are exceeded 100%. All these lethal doses explain the low toxicity of the extract of this plant. A positive correlation was obtained between the dosages of the extracts and mortality with a correlation coefficient of 0.933 and 0.9 respectively for the two extracts.

Furthermore, the Sankarasubramanian *et al.* (2007) tests carried out onto *Bipolaris oryzae* have revealed that, in vitro studies of Nerium oleander leaf extract, was exerted a higher percent inhibition to mycelial growth (77.4%) and spore germination (80.3%).

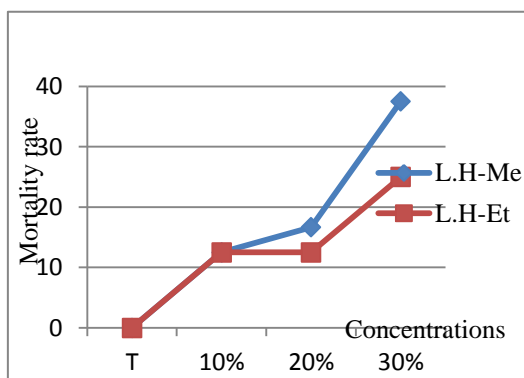

Figure 3. Larvicidal activity of hydro-methanoic and hydro-ethanoic extracts of *N. oleander*

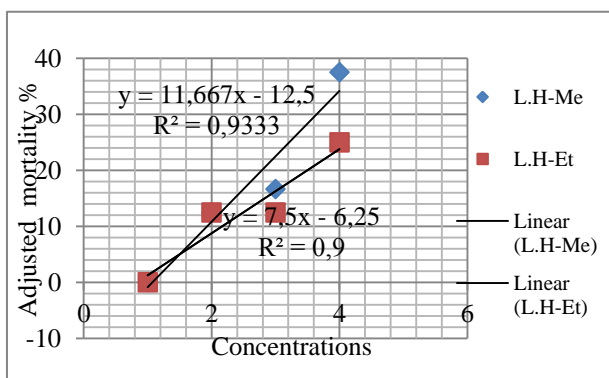

Figure 4. Mortality adjusted of hydro-methanoic and hydro-ethanoic extracts of *N. oleander*

Larvicidal Activity of *R. communis* Extracts on *T. absoluta*

The results shown in Figure 5, indicate that the two hydro-alcoholic extracts of *R. communis* illustrate a significant larvicidal efficacy compared to control. For both extracts of *R. communis* larval mortality reached rate below 50% even for the highest concentration (30%). The observations indicate that the hydro-methanoic extract has a higher mortality rate than hydro-ethanoic extract.

LD50 values were very high for both hydro-alcoholic extracts of *R. communis*. LD50 values obtained are 51% and 63% respectively for hydro-methanoic and hydro-ethanoic extracts. While the LD90 obtained were very important. We recorded 86% and 100% rates respectively for the two extracts raised; this explains the low toxicity of these extracts. A positive correlation obtained between doses extracts and mortality with respective correlation coefficients of 0.956 and 0.968 for both extracts.

The synergistic extract caused remarkable mortality rate exceeded 90% mortality. While *N. oleander* and *R. communis* showed only low toxicity not exceeding 30% for hydro-ethanoic extracts and 40% for hydro-methanoic extracts (Fig. 7).

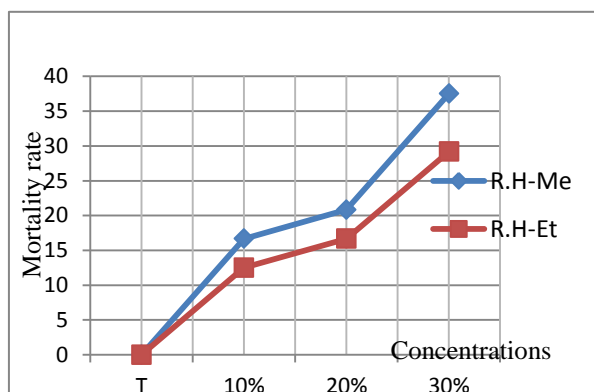

Figure 5. Larvicidal activity of hydro-methanoic and hydro-ethanoic extract of *R. communis* on *T. absoluta*

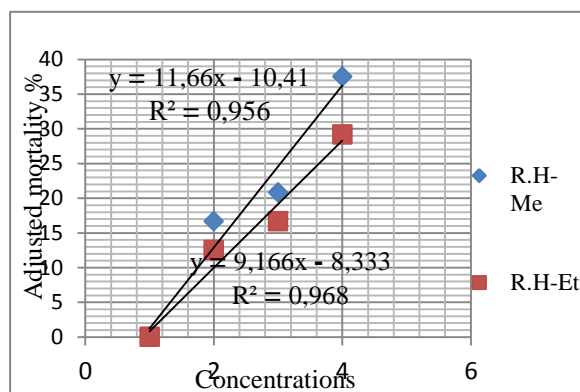

Figure 6. Mortality adjusted of hydro-methanoic and hydro-ethanoic extracts of *R. communis* on *T. absoluta*

The results of comparison between all the extracts used report that the best rate of mortality is caused by the synergistic extract; in fact, by a concentration of 10% it's caused the death of 87% to *T. absoluta* larvae. While at the same concentration, the other extracts showed only a low efficiency about 12 and 17% for *N. oleander* and *R. communis*.

The larvicidal activity of the extracts of *N. oleander* and *R. communis* remains low for both extracts even at 30% compared to the synergistic extract which presented a very high rate around 92% (Fig. 7).

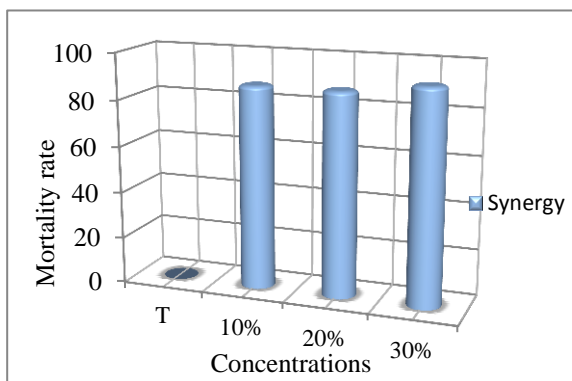

Figure 7. Evolution of the larvicidal synergistic extract activity on *T. absoluta*

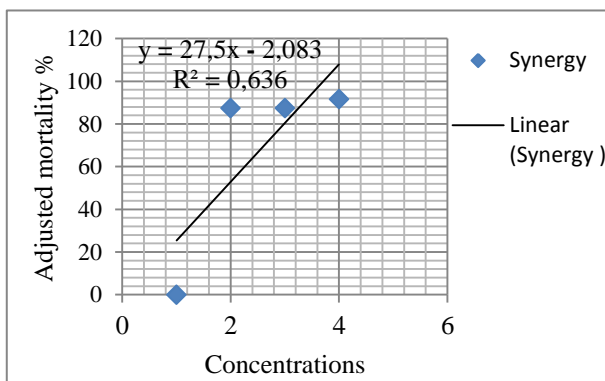

Figure 8. Mortality adjusted of synergetic extracts on *T. absoluta*

Table 1. Result of Lethal dose (50 and 90) for the different hydro-alcoholic extracts

Extracts Dose	N.H-Me	N.H-Et	R.H-Me	R.H-Et	Synergy
LD50	54%	75%	51%	63%	19%
LD90	88%	128%	86%	107%	33%

According to the results shown in Table 1, we observed that the hydro-methanoic extracts and hydro-ethanoic of *R. comminus* and *N. oleander*, require doses greater than 50 and 86% to cause a death 50 and 90% respectively. While the synergistic extract requires a low dose of 19 and 33% for the respective mortality rates of 50 and 90%. These indicate the high toxicity of the product after mixing the two plants' methanolic extracts.

Larvicidal Activity of Hydro-Alcoholic Extracts on *T. absoluta* Larval Instars

During *in vivo* assay should be taken into account mortality in the general population. The best way for using our extracts in biological control, is to define in the first the sensitivity *in vitro* of each instars.

The effect of different hydro-alcoholic extracts of the two plants tested on *T. absoluta* biological instars showed a high sensitivity of the first two instars (L1 and L2). While L3, L4 were more resistant. The synergistic extract showed a very interesting effectiveness on the four larval instars, it has been enabled us to record a 100% mortality for L1 and L2 and a respective rate of 83 and 67% for L3 and L4, for 10 and 20% of extract doses (Fig. 9-10).

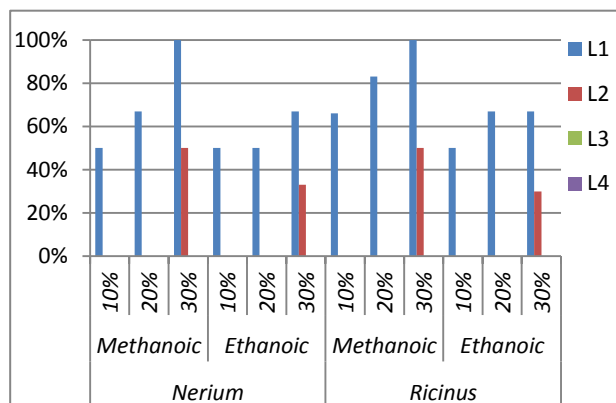

Figure 9. Larvicidal activity of hydro-alcoholic extracts on *T. absoluta* biological instars

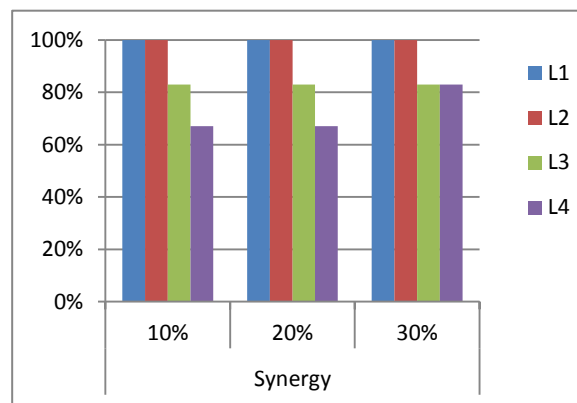

Figure 10. Larvicidal activity of synergistic extract on *T. absoluta* biological instars

Conclusion

The main objective of this work was to find an alternative to synthetic insecticides via insecticides solely of natural and organic compounds by testing the hydro-alcoholic extracts of medicinal plants. The tests were performed on tomato leafminer *Tuta absoluta* in order to control its population, by extracts of medicinal plants: *Nerium oleander* and *Ricinus communis* and their synergistic extract. The results obtained during this research note that hydro-alcoholic extracts of the two plants show insecticidal activity of *T. absoluta*. Hydro-methanoic extract was more efficiencies than a hydro-ethanoic extract. Further, the synergistic extract showed greater results compared to Ricin and oleander; indeed, very significant mortality rates were recorded for the synergistic extract by the different doses tested, 10, 20, and 30%, when a respective percent mortality 87, 87, and 92% was registered. The *T. absoluta* larval instars have showed the highest sensitivity to different extracts on the two first larval instars namely the L1 and L2 with greater sensitivity to the effect of the synergistic extract, where a mortality rate of 100% was recorded. These results need to be deepened by the various polyphenolic's study compounds of different substrates used for a better assessment of the quality of the solute.

References

- Attathom T. (2002). Biotechnology for pest control. Proc. Sat. Forum. "Sustainable Agricultural system in Asia". Nagaya June (2002): 73-84.
- Busvine J.R. (1981). Méthodes recommandées pour les mesures de la résistance des ravageurs aux pesticides. Etude F.A.O : Production végétale et protection des plantes. N : 21.
- Chevallier A. (2001). Encyclopédie des plantes médicinales. Identification, préparations, soins. Larousse, 335p.
- Da Cunha U.S., J.D. Vendramim, Rocha W.C., Viera P.C. (2008). Bioatividade de Moléculas isoladas de *Trichilia pallida* Swartz (Maliaceae) sobre *Tuta absoluta* (Meyrick) (Lepidoptera : Gelechiidae). Neotropical entomology. 37 (6) : 709-715 (2008).
- De Brito E.F., Baldin E.L.L., Silva R.C.M., Ribeiro L.P., Vendramim J.D. (2015). Bioactivity of piper extracts on *Tuta absoluta* (Lepidoptera: Gelechiidae) in Tomato. Pesq. Agropec. Bras. Brasília, V. 50, n.3, p. 196-202, mar. 2015.
- Gilardon E., Pocovi M., Hernandez C., Olsen A. (2001). Papel dos tricomas glandulares da folha do tomateiro na oviposição de *Tuta absoluta*. Pesquisa Agropecuária Brasileira. 36: 585-588.

- Jordan M.J., Martinez R.M., Martı́nez C., Moñino I., Sotomayor J. A., 2009. Polyphenolic extract and essential oil quality of *Thymus zygis*ssp. *gracilis*shrubs cultivated under different watering levels. *Industrial crops and products* 29; 145–153.
- Mohadjerani M. (2012). Antioxidant activity and total phenolic content of *Nerium oleander* L. grown in North of Iran. *Iran Journ. Pharm. Res.* 2012 Autumn, 11 (4): 1121-1126.
- Moreno S.C., Carvalho G.A., Picanço M.C., Morais E.G.F., Pereira R.M. (2011). Bioactivity of compounds from *Acmellaoleracea* against *Tutaabsoluta* (Meyrick) (Lepidoptera: Gelechiidae) and selectivity to two non-target species. *Pest manage. Sci* 68: 386-393.
- Nilahyane A., Bouharrou R., Hormatallah A., Ait Taadaouit N. (2012). Larvicidal effect of plant extracts on *Tutaabsoluta* (Lepidoptera: Gelechiidae). *Integrated control in protected crops, Mediterranean climate IOBC-WPRS Bulletin*. Vol. 80, 2012. Pp. 305-310.
- Regnault-Roger C., Philogene B.J.R., Vincent C. (2008). *Biopesticides' origine végétale*. 2ème édition augmentée. TEC et DOC Lavoisier, Paris. 565p.
- Tropea Garzia G., Siscaro G., Biondi A., Zappala L. (2012). *Tutaabsoluta*, an exotic invasive pest from south America now in the EPPO region: biology, distribution and damage. *EPPO Bulletin*, 42: 205-210.

HOW PLANT SILICA AFFECT ON MAIZE RESISTANCE TO THE EUROPEAN CORN BORER, *OSTRINIA NUBILALIS* (HÜBNER)

Ankica SARAJLIĆ^{1*}, Emilija RASPUDIĆ¹, Ivana MAJIĆ¹, Zdenko LONČARIĆ², Marko JOSIPOVIĆ³

¹Department for Plant protection, Faculty of Agriculture in Osijek, Josip Juraj Strossmayer Univeristy of Osijek, Croatia

²Department for Agroecology, Faculty of Agriculture in Osijek, Josip Juraj Strossmayer Univeristy of Osijek, Croatia

³Department for Agricultural Technique and Melioration, Agricultural institute, Osijek, Croatia

*Corresponding author: ankica.sarajlic@pfos.hr

Abstract

Silicon (Si) is not considered as an essential element but it is beneficial. It has been found to help improving tolerance against insects increasing stem strength, plays a very important role in drought tolerance, enhance nutrient deficiency. Tissue levels of Si vary within plant species or cultivars. The aim of this study was to determine silicon concentration in maize leaf under different levels of irrigation, nitrogen fertilization and various genotypes and relationship with ECB larvae damage. Field experiments were conducted during three years (2012-2014) at the Agricultural Institute in Osijek (Croatia) with natural infestation of European corn borer (ECB). At the end of each growing season ear weight (g), tunnel length (cm), ear shank damage (cm), the number of larvae in maize stalk, number of larvae in the ear shank, and total number of larvae in plant were determined. In silking stage, ten leaves (below the ear), from 10 maize plants were sampled on each variant (total 1,080 plants) and silicon concentration was determined (%). There was no statistically significant difference between irrigation levels in silicon concentration while the variant with the highest level of nitrogen fertilization had the lowest concentration of silicon and the greatest damage from ECB larvae ($P < 0.05$). Hybrid resistance didn't entirely depend on silicon concentration, even though damage was reduced with higher concentration of silicon at some hybrids. Silicon availability to plants is low in the soil and it is necessary to apply silicon fertilization to enhance plant resistance.

Keywords: *European corn borer, silicon, irrigation, nitrogen fertilization, hybrid*

Introduction

European corn borer, *Ostrinia nubilalis* (Hübner) (ECB) is major maize pest in Croatia. ECB larvae damage all above-ground part of maize plant so yield losses can vary between 2 and 25% (Maceljiski, 2002). According to Szőke et al. (2002) losses from ECB range from 250-1000 kg ha⁻¹ depending of the year and intensity of ECB attack. Some researchers found positive correlation between silicon content and plant resistance to ECB (Coors, 1987; Meyer and Keeping, 2005; Santiago et al., 2013). Silicon (Si) is classified as beneficial nutrient, not essential in plant biology. Plants contain silicon in concentrations from 1% of the dry matter to 10% in some plants or even higher (Epstein, 1994). Si improved insect resistance to stem borers, leaf spider mites, and various hoppers and also helps to protect plants from different disease and also from environmental stress (Heckman, 2013). Rojanaridpiched et al. (1984) negatively correlated second generation of ECB larval damage with silicon content, they also conclude that feeding activity of first generation of ECB depend of different levels of DIMBOA, silica and lignin. Resistance (higher Si concentration) has also been recorded in other crops such as vegetables (Chelliah, 1972; Puzyrkov et al., 1996), sugarcane (Keeping et al., 2014), rice (Hou and Han, 2010). Higher silicon concentration led to bigger leaf water

potential, leaf area index, the specific leaf weight, chlorophyll contents and the dry matter, increased root growth, improve the crop stand under stresses (Mukhtar et al., 2011). Increases in biomass production were also seen by Gong et al. (2003) in wheat. Decreased silicon concentrations in plant tissue can increase susceptibility to fungal diseases and pest injury (Volk et al., 1958; Buendgen et al., 1990). In spite of that, high concentrations of nitrogen in plants can increase susceptibility to pest attack and disease as observed by Slaton et al. (2003) where nitrogen rates with higher yields also increased percent of damaged plants. Deren (1997) reported decreases in nitrogen and phosphorus concentrations with increases Si concentration in rice plants. Soil water deficit significantly reduces agro-morphological and physiological properties of plants. Silicon applied with irrigation increase water use efficiency (Mukhtar et al., 2011). According to Kvedaras et al., (2007) stalk damage and reduction in borer numbers (*Eldana saccharina* Walker) in plants with higher Si concentration was greater for water-stressed cane than non-stressed cane.

The aim of this study was to determine silicon concentration in maize leaf under different levels of irrigation, nitrogen fertilization and various maize genotypes and also relationship with ECB larvae damage.

Material and methods

Field trials was set up during three years (2012 – 2014) at the Agricultural Institute in Osijek (45° 33' 27.11" N, 18° 40' 46.52" E). Maize was in rotation with soybean every year since 2000. Experiment variants were: A1- non-irrigated, A2– 60% - 80% field water capacity – FWC and A3– 80% -100% FWC), three nitrogen fertilizer levels (B1-0, B2-100 and B3-200 kg N ha⁻¹) and four different maize genotypes (C1-OSSK 596; C2–OSSK 617; C3–OSSK 602 and C4–OSSK 552). Field size was 0.5 ha. Basic plot planted with two rows of maize 10 m long (maize hybrids, 14 m² (10 m x 2 rows x 0.7 m = 14 m²)). On each variant were three rows of safety belt. Nitrogen introduced as urea (46% N) in the basic soil cultivation and pre-sowing. Top-dressing done with KAN (calcium-ammonium nitrate - 27% N) in phase 6-8 leavess and 8-10 leaves. At the end of each vegetation season dissection of maize stalk was done. From each variant of the experiment 10 maize plants were cut (total 1,080 plants) and tested tunnel length (cm) related to ECB feeding activity. In silking stage of maize plants, 10 leaves below the ear was taken and silicon and nitrogen concentration was determined.

The data of ECB larvae injury evaluated by analysis of variance using the SAS software (SAS Institute Inc., 2009) after normality data test. Log transformation (log (n+1)) used to normalize the data. Least square means with the Tukey adjustment for multiple comparisons were then calculated and reported for significance at the 95% confidence level. After that it was made back transformation to see original values.

Results and discussion

In drought-stressed plants silicon application significantly increased plant height, stem diameter, number of leaves, cob length, number of cob, grain yield along with improvement in photosynthetic rate and lowered transpiration rate, respectively (Muhammad et al., 2016). In our experiment, irrigation treatments didn't affect significantly on silicon concentrations except in 2013 where statistically differences between control variant (A1) and variant with higher level of irrigation (A3) were recorded (Table 1). Irrigation variant with longest tunnel length in maize stem was control variant (A1) and A3 variant had significantly the lowest damage from ECB larvae. Nitrogen fertilization had a huge impact on silicon concentration in maize plants. All tested years had statistically significant lower concentration of Si on variant with higher level of nitrogen fertilization (B3) compared to control (B1). Wallace (1989) showed that Si concentrations decrease in plant tissue with increasing nitrogen concentration. Differences between control variant of fertilization (B1)

and variant with lower level (B2) was not statistically significant. Significantly the highest damage from ECB larvae on nitrogen fertilization variants was recorded on B3 variant and same variant had the lowest Si concentration. Same results were published by Szulc et al. (2008). Similar studies were conducted by Setamou et al. (1993), they conclude that silicon applications reduced survival of stem borer larvae from 26% to 4% on maize at 0.56 g Si plant⁻¹. Hybrid C4 had significantly the lowest Si concentration in all tested years compared to other hybrids. In spite of small Si concentration hybrid C4 had the lowest damage from ECB larvae. That is contradictory to many studies (Marschner, 1986; Sétamou et al., 1993; Carvalho et al., 1999; Matichenkov et al., 2000.; Keeping and Meyer, 2002). This fact it could be explain by different genetic resistance to ECB larvae feeding especially in years with optimal or deficit water regime. Laing et al., (2006) showed that maize resistance to the second generation of ECB was significantly correlated with the silica content in the sheath and collar tissue. Rojanaridpichet et al. (1984) explained that maize genotype with 1.52% dry weight silica had 0.14 tunnels per plant and other genotype with 0.46% dry weight silica had 8.80 tunnels per plant.

Table 1 Differences in silicon concentration and tunnel length between treatments (2012. – 2014.)

Variant	2012		2013		2014		Si (%)	TL
	Si (%)	TL	Si (%)	TL	Si (%)	TL		
Irrigation								
A1	0.76 ^a	77.65 ^a	0.92 ^a	36.33 ^a	0.66 ^a	2.77 ^a	0.78 ^a	37.96 ^a
A2	0.69 ^a	69.51 ^b	0.76 ^b	23.95 ^b	0.70 ^a	2.78 ^a	0.72 ^a	32.01 ^{ab}
A3	0.82 ^a	49.10 ^c	0.81 ^{ab}	32.31 ^a	0.65 ^a	2.52 ^a	0.76 ^a	27.92 ^b
Nitrogen fertilization								
B1	0.89 ^a	51.65 ^b	0.93 ^a	22.17 ^c	0.71 ^a	2.20 ^b	0.83 ^a	25.34 ^b
B2	0.76 ^{ab}	71.16 ^a	0.84 ^{ab}	32.50 ^b	0.69 ^{ab}	2.74 ^a	0.76 ^a	35.47 ^a
B3	0.65 ^b	73.51 ^a	0.72 ^b	37.99 ^a	0.61 ^b	3.21 ^a	0.66 ^b	38.24 ^a
Maize hybrids								
C1	0.68 ^{bc}	79.21 ^a	0.80 ^b	35.93 ^a	0.61 ^{bc}	3.21 ^a	0.70 ^b	39.46 ^a
C2	0.95 ^a	62.95 ^b	1.04 ^a	27.01 ^b	0.87 ^a	3.29 ^a	0.96 ^a	31.11 ^{ab}
C3	0.81 ^{ab}	62.63 ^b	0.84 ^b	27.26 ^b	0.66 ^b	2.70 ^a	0.77 ^b	30.88 ^b
C4	0.56 ^c	56.94 ^b	0.64 ^c	33.32 ^a	0.53 ^c	1.61 ^b	0.58 ^c	30.64 ^b

A1 – control, A2 – from 60 to 100% WFC, A3 – from 80 to 100% WFC, B1 – control, B2 – 100 kg N ha⁻¹, B3 – 200 kg N ha⁻¹, C1- OSSK 596, C2 – OSSK 617, C3 – OSSK 602, C4 – OSSK 552; TL – tunnel length

In 2012, statistically significant negative correlation was determined at all irrigation variants between Si and N concentration but the stongest was on variant with higher level of irrigation (A3) (Table 2). Same parameters (Si and N) on nitrogen fertilization variants and different maize genotypes were statistically significant only at B2 variant and C3 hybrid. In 2013, three of four hybrids had statistically neagive medium correlation between Si and N concentration. In 2014, only variant with higher level of irrigation (A3) had significant positive correlation between tunnel lenght and Si concentration. Calatayud et al. (2016) reported that climate change can affect on Si concentration and also on insect distribution and abundance which coincides with our research. They also noted different susceptibility to Si presence between several maize pests and low temeratures at high altitudes were negatively correlated with Si assimilation by maize. According to Vilela et al. (2014) it was impossible determined the effects of silicon on the insect incidence due to the low infestation.

Table 2 Correlation coefficient between ECB feeding parameters and silicon concentrations among tested years and treatment variants

	Irrigation			Nitrogen fertilization			Maize hybrids			
	A1	A2	A3	B1	B2	B3	C1	C2	C3	C4
2012										
$R_{tl;Si}$	-0.04	0.22	-0.18	0.13	-0.15	0.02	-0.35	-0.46*	0.18	-0.27
$r_{Si;N}$	-0.36*	-0.35*	-0.51**	-0.25	-0.37*	-0.09	-0.16	-0.13	-0.46*	-0.06
2013										
$R_{tl;Si}$	-0.17	-0.18	-0.01	-0.10	0.17	-0.18	-0.04	0.15	-0.24	0.05
$r_{Si;N}$	-0.39*	-0.27	-0.39*	-0.07	-0.42*	-0.20	-0.07	-0.57**	-0.48*	-0.40*
2014										
$r_{tl;Si}$	0.01	0.01	0.33*	-0.19	0.28	0.21	0.21	0.13	0.04	-0.04
$r_{Si;N}$	-0.25	-0.21	-0.25	-0.26	-0.18	0.03	-0.11	-0.16	0.06	-0.01

A1 – control, A2 – from 60 to 100% WFC, A3 – from 80 to 100% WFC; B1 – control, B2 – 100 kg N ha⁻¹, B3 – 200 kg N ha⁻¹; C1- OSSK 596, C2 – OSSK 617, C3 – OSSK 602, C4 – OSSK 552; tl - tunnel length, N – nitrogen, Si – silicon

**ss P<0,05

*ss P<0,01

Maize hybrids was more or less susceptible on ECB injury independently on Si concentration. It was reported that Si provided greater protection for susceptible cultivars for borers than for resistant ones. Also different plant parts which accumulate Si can vary a lot in concentration so in fact it's important which part of plant is necessary for insect nutrition (Keeping et al., 2014).

Conclusion

Irrigation treatments did not significantly affect on silica concentration in maize leaves while nitrogen fertilization decreased silicon concentration. Genetic resistance had a significant role in ECB larval damage and resistance was not directly related to the concentration of silicon. It is necessary to provide additional studies with different levels of silicon fertilization in order to determine the effect of silicon in plants resistance on ECB damage.

References

- Buendgen, M.R., Coors, J.G., Grombacher, A.W., Russell, W.A. (1990): European corn borer resistance and cell wall composition of three maize populations. *Crop Science* 30: 505–510.
- Calatayud, P.A., Njuguna, E., Mwalusepo, S., Gathara, M., Okuku, G., Kibe, A., Musyoka, B., Williamson, D., Ong'amo, G., Juma, G., Johansson, T., Subramanian, S., Gatebe, E., Le RU, B. (2016): Can climate-driven change influence silicon assimilation by cereals and hence the distribution of lepidopteran stem borers in East Africa? *Agriculture, Ecosystems and Environment*. 224: 95–103.
- Carvalho, S.P., Moraes, J.C., Carvalho, J.G. (1999): Efeito do silício na resistência do sorgo (*Sorghum bicolor*) ao pulgão-verde *Schizaphis graminum* (Rond.) (Homoptera: Aphididae) (Effect of silicon resistance in sorghum (*Sorghum bicolor*) to the greenbug *Schizaphis graminum* (Rond.) (Homoptera: Aphididae)). *Anais da Sociedade Entomológica do Brasil*, 28, 505–510.
- Chelliah, S (1972): Some investigations in muskmelons *Cucumis melo* L. on resistance to the fruit fly, *Dacus cucurbitae* Coquillet (Diptera: Tephritidae). Ph.D. thesis, Annamalai University, Tamil Nadu, India.
- Coors, J.G. (1987): Resistance to the European corn borer, *Ostrinia nubilalis* (Hübner), in maize, *Zea mays* L., as affected by soil silica, plant silica, structural carbohydrates, and lignin. *Genetic aspects of plant mineral nutrition*. 445–456.
- Deren, C.W. (1997): Changes in nitrogen and phosphorus concentrations of silicon-fertilized rice grown on organic soil. *Journal of Plant Nutrition*. 20(6):765- 771.
- Epstein, E. (1994): The anomaly of silicon in plant biology. *Proceedings of the National Academy of Sciences of the USA*. 91: 11-17
- Gong, H., K. Chen, G. Chen, S. Wang, and C. Zhang (2003): Effects of silicon on growth of wheat under drought. *Journal of Plant Nutrition*. 26(5):1055-1063.
- Heckman, J. (2013): Silicon: A Beneficial Substance. *Better Crops*. 97 (4): 14-16.
- Hou, M., Han, Y. (2010): Silicon-Mediated Rice Plant Resistance to the Asiatic Rice Borer (Lepidoptera: Crambidae): Effects of Silicon Amendment and Rice Varietal Resistance. *Journal of Economic Entomology*. 103 (4): 1412-1419.
- Keeping, M. G, Meyer, J. H. (2002): Calcium silicate enhances resistance of sugarcane to the African stalk borer *Eldana saccharina* Walker (Lepidoptera: Pyralidae). *Agricultural and Forest Entomology* 4(4):265 – 274.
- Keeping, M. G., Miles, N., Sewpersad, C. (2014): Silicon reduces impact of plant nitrogen in promoting stalk borer (*Eldana saccharina*) but not sugarcane thrips (*Fulmekiola serrata*) infestations in sugarcane. *Frontiers in plant science*. 289 (5): 1-12.
- Kvedaras O.L., Keeping M.G., Goebel F.R., Byrne M.J. (2007): Water stress augments silicon-mediated resistance of susceptible sugarcane cultivars to the stalk borer *Eldana saccharina* (Lepidoptera: Pyralidae) *Bulletin of Entomological Research*. 97 (02): 175-183.
- Laing M. D., Gatarayiha M. C., Adandonon A. (2006): Silicon use for pest control in agriculture: a review. *Proceedings of the South African Sugar Technologists Association* 80: 278-286.
- Maceljiski, M., Igrc-Barčić, J. (2002): Poljoprivredna entomologija (Agricultural entomology) . Zrinski d.o.o. Čakovec: 290-300.
- Marschner, H. (1986): *Mineral Nutrition in Plants*. Academic Press, London.
- Matichenkov, V.V., Calvert, D.V., Snyder, G.H. (2000): Prospective of Silicon fertilization for citrus in Florida. *Proceedings - Soil and Crop Science Society of Florida* 59: 137-141.
- Meyer, J. H., Keeping, M. G. (2005): Impact of silicon in alleviating biotic stress in sugarcane in South Africa. *Sugarcane International* 23: 14-18.

- Muhammad A., Riaz A., Anser A., Iqbal H., Rashid M., Muhammad A., Dong J. L. (2016): Influence of Silicon Fertilization on Maize Performance Under Limited Water Supply. *Silicon*. 1-7
- Mukhtar A., Fayyaz H., Yasir K. (2011): Does silicon and irrigation have impact on drought tolerance mechanism of sorghum. *Agricultural Water Management*. 98 (12): 1808–1812.
- Puzyrkov, P.E., Dorozhkina, L.A., Dolgushkin, V.A. (1996): Application of tetraetoxisilane for increasing potato yield and for ecological safety of pesticides. *Izvestiya Timiryazevskoi Sel'skokhozyaistvennoi Akademii* 2: 135-144.
- Rojanaridpiched, C., Gracen, V.E., Everett, H.L., Coors, J.F., Pugh, B.F., Bouthyette, P. (1984): Multiple factor resistance in maize to European corn borer. *Maydica*. 14: 305-315.
- Santiago, R., Barros-Rios, J., Malvar, R. A. (2013): Impact of Cell Wall Composition on Maize Resistance to Pests and Diseases. *International Journal of Molecular Science*. 14(4): 6960–6980.
- Sétamou, MF, Schulthess, F, Bosque-Perez NA and Thomas-Odjo, A (1993): Effect of plant N and Si on the bionomics of *Sesamia calamistis* Hampson (Lepidoptera: Noctuidae). *Bulletin of Entomological Research* 83: 405-411.
- Slaton, N. A., Cartwright, R. D., Meng, J., Gbur, E. E., Norman R. J. (2003): Sheath blight severity and rice yield as affected by nitrogen fertilizer rate, application method, and fungicide. *Agronomy Journal*. 95: 1489–1496.
- Szöke, C., Zsubor, Z., Pók, I., Rác, F., Illés, O., Szegedi I. (2002): Significance of the European corn borer (*Ostrinia nubilalis* Hübn.) in maize production. *Acta Agronomica Hungarica*. 50 (4): 447-461.
- Szulc, P., Waligóra, H., Skrzypczak, W. (2008): Susceptibility of two maize cultivars to diseases and pests depending on nitrogen fertilization and on the method of magnesium application. *Nauka Przyroda Technologie*. 2(2): 1-6.
- Vilela, M., Moraes, J.K., Coelho, M., Françoso, J., Monteiro dos Santos-Cividanes, T., Sakomura, R. (2014): Response of moderate pest resistant and susceptible cultivar of sugarcane to silicon application. *American Journal of Plant Sciences*. 5(26): 3823-3828.
- Volk, R.J., Kahn, R.P., Weintraub, R. L. (1958): Silicon content of the rice plant as a factor influencing its resistance to infection by the blast fungus, *pyricularia oryzae*. *Phytopathology*. 48:179-184.
- Wallace, A. (1989): Relationships among nitrogen, silicon, and heavy metal uptake by plants. *Soil Science*. 147(6): 457-460.

**THE EFFICIENCY OF *Bt* CORN EXPRESSING ENTOMOCIDAL PROTEIN
CRY1AB ON BIOCHEMICAL PARAMETERS OF *SESAMIA CRETICA*
(LEDERER) (LEPIDOPTERA: NOCTUIDAE)**

Hassan F. DAHI^{1*}, Mohamed Z. Y. ALY², Mahmoud M. M. SOLIMAN³, Sherehan A. R. SALEM²

¹Plant Protection Research Institute, Agricultural Research Centre, Dokki, Giza, Egypt

²Department of Zoology, Faculty of Science, South Valley University, Egypt

³Department of Plant Protection, Faculty of Agriculture, South Valley University, Egypt

*Corresponding author: hassadahi@yahoo.com

Abstract

The present investigation aims to throw a light on the efficiency of *Bt* corn on biochemical parameters of 4th larval instar of pink corn borer *Sesamia cretica* (Led.) under laboratory conditions. The results showed that 24 h post feeding on *Bt* corn, caused a 36.05% increase in the larval protein content than their value in the control. Although, total carbohydrates was decreased by 49.13% in larvae than their value in the control. The disturbance in the carbohydrate level was expressed by impairment in the activity of carbohydrate enzymes in treated 4th instar larvae. In treated instar larvae there was a significant increase in the enzyme activity of alpha and beta esterase as well as in acetyl choline esterase. Also, a significant increase in the enzyme activities of both Glutamic pyruvic transaminase and glutathione S-transferase was recorded in treated larvae the values were 24.68% and 69.78% respectively. Meanwhile there was no significant in Glutamic oxaloacetic transaminase level in treated larvae.

Introduction

The pink stem borer *Sesamia cretica* is considered the most serious corn borer in Egypt and attacks young maize plants shortly after emergence devours the whorl leaves and may kill the growing points, causing dead hearts. It is capable of damaging older plants and excavating tunnels into the stem, ears and/ or cobs. This pest lays its eggs during March, so its larvae cause complete death of small maize plants in April and May causing drastic yield losses (Mostafa, 1981; Simeada, 1985; El-Metwally, 1987; El-Naggar 1991). These losses are mainly attributed to decrease in number of dead hearts, increase in plant lodging and ear drops and predisposing infested plants to disease organisms. Chemical insecticides are an effective mean for the control and prevention of major damage caused by this insect pest. However, the extensive and continuous use of traditional insecticides creates environmental contamination and could lead to development of insect resistance. Reduced pesticides risks are considered to be safer for human health and the environment and therefore are in constant demand as new control agents (Gamilet al., 2011). Genetically-engineered corn by *Bacillus thuringiensis* (*Bt*) genes which expressing *Cry* toxins is increasingly developed mainly against targeted pests. One type of *Bt* corn expressing *Cry1Ab* protects against the European corn borer *Ostrinia nubilalis* and the Mediterranean stalk borer *Sesamia nonagroides*. The widespread cultivation of *Bt* corn reduces many problems associated with the use of chemical pesticides, as the toxins are produced continuously within plant (Saxena et al., 2002). Transgenic maize engineered to express insecticidal proteins from the bacterium *Bacillus thuringiensis* (*Bt* maize) has become widely adopted worldwide with 51 million ha planted in 2011 (James, 2011). *Bt* maize cultivars based on the event MON810 (expressing *Cry1Ab*) have shown high efficacy for controlling corn borers. (Shelton et al., 2002; González-Cabrera et al., 2013).

The objective of the present work is to evaluate the efficacy of Bt corn which genetically modified by *Bacillus thuringiensis* (Bt) gene and non Bt corn on biochemical aspects of 4th instar larvae of *S. cretica*.

Materials and Methods

Test insect: Infested corn plants with *S. cretica* (larval stage) were collected from the field and transferred to the laboratory. The larvae of *S. cretica* were reared on maize pieces according to Aly *et al.*, 2011.

Biochemical bioassay

After 24 h following the feeding of 4th instar *S. cretica* larvae on Bt corn and non Bt corn, any surviving larvae exhibiting toxic symptoms were selected. The insects were prepared as described by Amin (1998). They were homogenized in distilled water (50 mg/ 1ml). Homogenates were centrifuged at 8000 r.p.m. for 15 min at 5°C in a refrigerated centrifuge. The deposits were discarded and the supernatant, which is referred as enzyme extract, can be stored at least one week without appreciable loss of activity when stored at 5°C.

Main metabolic contents

- (i) Total soluble protein according to Bradford (1976).
- (ii) Total carbohydrates according to Dubois *et al.*, (1956).
- (iii) Total lipids as described by Knight *et al.* (1972).

Enzymes assay

The following enzymes activity was determined:

- (i) Proteolytic activity was measured as described by Tatchell *et al.* (1972).
- (ii) Carbohydrates hydrolyzing enzymes; amylase, trehalase and invertase were determined according to the modifications of Amin (1998) to the method described by Ishaaya and Swiriski (1976) using trehalose, sucrose, and soluble starch as substrates for trehalase, invertase and α -amylase, respectively.
- (iii) Non-specific α and β esterase activity was measured as described by Van Asperen (1962) using α - naphthyl acetate and β - naphthyl acetate as substrates, respectively.
- (iv) Acetyl choline-esterase (AChE) activity was determined using acetylcholine bromide (AChBr) as substrate according to the method described by Simpson *et al.* (1964).
- (v) Glutamic pyruvic transaminase (GPT) and glutamic oxaloacetic transaminase (GOT) were determined calorimetrically according to the method of Reitman and Frankle (1957).
- (vi) Glutathione S-transferase activity (GST) was determined spectrophotometrically at 340 nm according to the method of Habiget *et al.* (1974).

Statistical analysis:

All experiments contained 3-4 replicates (insects homogenates), and the results of chemical determinations were pooled from the triplicate determinations. The variability degree of results was expressed as Means \pm Standard Deviation of means (Mean \pm S.D). The data were statistically analyzed T- test by using SPSS program.

Results and discussion

Biochemical effects

Effect on main contents

As seen in Table (1) 24h post feeding of 4th instar *S. cretica* larvae on *Bt* corn caused an increase in the total protein content from 25.8 to 35.1 mg/ml giving 36.05 % increase than their value in the control.

A marked reduction of 49.13% in total carbohydrates content, as its value was reduced from 9.77 in the control to 4.97 mg/ml.

Meanwhile, there is non-significant difference between the determined values of the total soluble lipids of *S. cretica* after feeding on *Bt* corn and non *Bt* corn. The values were 7.43 and 7.37 (mg/g).

Enzyme assay

Digestive Enzymes activities:

Protease activities of 4th instar *S. cretica* larvae feeding *Bt* corn and non *Bt* corn was presented in Table (2). Data revealed that the activity of protease values were 94.1 and 95.83 ug D, L alanine/ min./g.b.wt for *Bt* corn and non *Bt* corn respectively. These values show a slight elevation by 3.62 % after feeding on *Bt* corn. Statistically, there is non-significant difference between *Bt* corn and non *Bt* corn.

Carbohydrates hydrolyzing enzymes:

Effect on carbohydrate enzymes activity. As seen in Table (2), feeding of 4th instar larvae on *Bt* corn caused a significant 43.92% reduction in amylase activity than that in untreated larvae. Values were 40.0, 71.33 (ug glucose/min/g.b.wt). However, activity of invertase was significantly decreased by 14.49 % than the control, respectively. Meanwhile; a mild decrease of 4.23% in trehalase activity compared with that in untreated larvae.

Non-specific esterases, acetyl choline esterase, activities:

Effect on alpha, beta esterase and acetyl choline esterase activity. As seen in Table 2, The activity of alpha in 4th instar larvae 24 hours following feeding on *Bt* corn was 1262.0 ug α -naphthol /g /min, as compared to 1217.0ug α -naphthol /g /min in non *Bt* corn. Statistical analysis showed that there is a mild significant difference between *Bt* corn and non *Bt* corn. Meanwhile, the activity of beta esterase in 4th instar larvae of *S. cretica* after feeding on *Bt* corn caused a significant increase than those which fed on non *Bt* corn; values were 1284.0 and 1039.0 (ug β -naphthol /g/min.) respectively, being an increase by 23.58

Estimated acetyl choline esterase activity in 4th instar *S. cretica* larvae which fed on non *Bt* corn was 54.53 ugAchBr/ min/g.b.wt which was significantly lower than that recorded in those which fed on *Bt* corn. Where; feeding larvae on *Bt* corn led to a marked increase in acetyl choline esterase activity reached to 106.2 ugAchBr/ min/g.b.wt(i.e. 94.76% increase).

Effect on transaminase enzymes activities

The activity of GPT (ALT) as affect by feeding 4th instar *S. cretica* larvae on *Bt* corn and non *Bt* corn are shown in Table (2). Values were 55.77 and 44.73 U/g.b.wt respectively. Statistical analysis showed that there is significant difference between *Bt* corn and non *Bt* corn.

The effect of *Bt* corn and non *Bt* corn on AST(GOT) activity of *S. cretica* was presented in (Table 2) data revealed that the activity of GOT values were 72.67 and 73.5 U/g.b.wt for *Bt* corn and non *Bt* corn respectively. Statistically, there is non-significant difference between *Bt* corn and non *Bt* corn.

Glutathione S-transferase activity showed a significant increased following the feeding of 4th instar *S. cretica* larvae with *Bt* corn, where it was 54.5 m mole sub. conjugated/min/g.b.wt versus 32.1 m mole sub. conjugated/min/g.b.wt non *Bt* corn one giving a 69.78% increase than their value in the control.

Table 1. Enzyme activities in 4th instar larvae of *S. cretica* 24h post feeding with *Bt* corn

Dose	<i>Bt</i> Corn	Non <i>Bt</i> corn	% of change
Protease (ug D,L alanine/min/g.b.wt)	99.3 ± 2.0 ^{ns}	95.83 ± 1.39	3.62
Amylase (ug glucose/min/g.b.wt)	40.0 ± 1.53*	71.33 ± 1.86	- 43.92
Invertase(ug glucose/min/g.b.wt)	473.7 ± 7.45*	554.0 ± 8.19	- 14.49
Trehalase (ug glucose/min/g.b.wt)	488.7 ± 4.49 ^{ns}	510.3 ± 11.55	- 4.23
α – Esterase (ugα - naphthol/g/min)	1262.0 ± 28.67*	1217.0 ± 24.59	3.7
β – Esterase (ugβ - naphthol/g/min)	1284.0 ± 32.10*	1039.0 ± 30.99	23.58
Acetylcholinesterase(ugAchBr/min/g.b.wt)	106.2 ± 4.6*	54.53 ± 2.85	94.76
GPT (U/g.b.wt)	55.77 ± 2.17 *	44.73 ± 2.52	24.68
GOT (U/g.b.wt)	72.67 ± 2.77 ^{ns}	73.5 ± 1.19	- 1.13
GST(m mole sub. conjugated/min/g.b.wt)	54.5 ± 2.86 *	32.1 ± 1.61	69.78

% of change (% Increase or decrease than control)=treated - control / control * 100.
All values are mean ± S. E.

Table 2. Total carbohydrate, protein and lipid content in 4th instar larvae of *S. cretica* 24h post feeding with *Bt* corn

Dose	<i>Bt</i> Corn	Non <i>Bt</i> corn	% of change
Total soluble protein (mg/g)	35.1 ± 2.06*	25.8 ± 1.49	36.05
Total soluble carbohydrates (mg/g)	4.97 ± 0.33*	9.77 ± 0.2	- 49.13
Total soluble lipids (mg/g)	7.43 ± 0.09 ^{ns}	7.367 ± 0.29	0.81

% of change (% Increase or decrease than control)=treated - control / control * 100.
All values are mean ± S. E.

Bt maize cultivars based on the event MON810 (expressing Cry1Ab) have shown high efficacy for controlling corn borers. (Shelton *et al.*, 2002 and González-Cabrera *et al.*, 2013). In the present work, 4th instar *S. cretica* larvae were found to be more susceptible to *Bt* corn. Biochemical changes were measured in the 4th instar *S. cretica* larvae 24h post feeding on *Bt* corn. Total proteins, carbohydrates and lipids are major components necessary for an organism to develop, grow and perform its vital activities (Gamil *et al.*, 2011). A significant decrease in the quantities of total carbohydrates while a significant increase in total proteins was detected in 4th instars treated larvae. The disturbance in carbohydrates was expressed by impairments in the activity of carbohydrate enzymes in treated larvae. In the many studies, pesticides including *B.thuringiensis*, synthetic chemicals and botanical components significantly decreased the activity of α- amylase in the midgut of different insects (El-Gharet *et al.*, 1995; Shekari *et al.*, 2008; Zibae *et al.*, 2008; Zibae and Bandani, 2010, Soliman *et al.*, 2012). In treated instar larvae there was a significant increase in the activity of alpha, beta esterase and AchE. The results of *S. cretica* haemolymph enzymes after feeding *Bt* corn are in

harmony with those obtained by El-Gharet *al.* (1995) who determined the effect of *B. abamectin* and *thuringiensin* (beta-exotoxin of *B. thuringiensis*) on the main digestive enzymes and non-specific esterases in larvae of *Spodoptera littoralis*. Furthermore, glutathione S-transferase enzyme activity was increased in treated larvae, this enzyme plays a role in detoxification mechanism in insects, therefore maybe an over production of this enzyme occurred as a result of treatment. Glutamic pyruvic transaminase (GPT) activity increased in *Bt*-corn treatment while decreased in non *Bt*-corn. Results revealed that the activity of Glutamic oxaloacetic transaminase (GOT) not affected of *Bt*-corn compared with non *Bt*-corn. George and Gatehouse (2013) found that there was significant difference between GST activity for insects fed control plants and those fed *Bt* plants. Insects fed on 28 days control plants had lower (34%) activity than those fed on 28 days *Bt* plants. Glutathione S-transferase protects tissues against oxidative stress and oxidative damage. They expected insects fed *Bt* plants to be under more oxidative stress than those fed control plants hence more Glutathione S-transferase activity. However, the insects may not have been feeding on the *Bt* plants due to the effects of the toxin. *Bt* plants have been found to have anti-nutritive effects on insects.

Conclusion

Corn is the second most plentiful cereal grown for human consumption, and many cultures around the world have lived on this grain. Corn is a versatile crop, and everything on a corn plant is useable. A lot of insect pests attack the corn crop, specially corn borers. Chemical insecticides are an effective mean for the control and prevention of major damage caused by insect pests. However, the extensive and continuous use of traditional insecticides creates environmental contamination and could lead to development of insect resistance. Reduced pesticides risks are considered to be safer for human health and the environment and therefore are in constant demand as new control agents. The pink stem borer *Sesamia cretica* is considered the most serious corn borer in Egypt and attacks young maize plants shortly after emergence devours the whorl leaves and may kill the growing points, causing dead hearts. It is capable of damaging older plants and excavating tunnels into the stem, ears and/or cobs. Transgenic maize engineered to express insecticidal proteins Cry 1Ab from the bacterium *Bacillus thuringiensis* (*Bt* maize) has become widely adopted worldwide with 51 million ha planted around the world. *Bt* maize cultivars have shown high efficacy for controlling corn borers. The objective of the present work is to evaluate the efficacy of *Bt* corn which genetically modified by *Bacillus thuringiensis* (*Bt*) gene and non *Bt* corn on biochemical aspects of 4th instar larvae of *S. cretica*. In the present research, results revealed that feeding 4th larval instar of pink corn borer; *Sesamia cretica*, on *Bt* corn, has a direct influence on some physiological parameters of *S. cretica* under laboratory conditions. *Bt* corn makes a noticeable disturbance in the activities of main contents and enzymes of *S. cretica* larvae. Results also reveal that using *Bt* corn could give some promising results. This fact can help us in the future to minimize *S. cretica* number in corn fields.

References

- Aly, M. Z. Y.; Soliman; Ebrahim E.E. M.; Dahi, H. F. and Salem, S. A. R. (2011): Assessments the toxic effects of entomopathogenic bacterium, *Bacillus thuringiensis* subsp. *kurstaki* and methomyl insecticide on larval instars of the greater sugarcane borer; *Sesamia cretica* (Lederer). Egypt, Acad. J. Biolog. Sci. F. Toxi. & Pest Cont., 3 (1): 1 – 9.
- Amin, T. R. (1998): Biochemical and physiological studies of some insect growth regulators on cotton leafworm, *Spodoptera littoralis* (Biosd.). Ph.D. thesis, Faculty of science, Cairo Univ..

- El-Ghar, G. E. S. A.; Radwan, H. A. S.; El-Bermawy, Z. A. and Zidan, L. T. M. (1995): Inhibitory effect of *Bacillus thuringiensis* and abanectin on digestive enzymes and non specific esterases of *Spodoptera littoralis* (Boisd) (Lepidoptera: Noctuidae) larvae. J. Appl. Entomol., 119(5): 355-359.
- El-Metwally, M. F. (1987): Biological and ecological studies on some borer insects. Ph. D. Thesis, Fac. Agric., Al-Azhar Univ. 153 pp.
- El-Naggar, M. A. (1991): Ecological factors influencing some insects pests diversity in maize field. M. Sc. Thesis, Fac. Agric., Menofia Univ., Egypt. 161pp.
- Gamil, W. E., Mariy, F. M., Youssef, L. A. and Abdel Halim, S. M. (2011): Effect of Indoxacarb on some biological and biochemical aspects of *Spodoptera littoralis* (Boisd.) larvae. Annals of Agricultural Science 56(2), 121–126.
- González-Cabrera, J., García, M., Hernández-Crespo, P., Farinós, G. P., Ortego, F. and Castañera, P. (2013): Resistance to Bt maize in *Mythimna unipuncta* (Lepidoptera: Noctuidae) is mediated by alteration in Cry1Ab protein activation. Insect Biochemistry and Molecular Biology. Volume 43, Issue 8, Pages 635–643.
- George, D. G. M. and Gatehouse, A. M. R. (2013): Oxidative Stress Enzymes in *Busseolafusca*. Int.J.Curr.Microbiol.App.Sci 2(10): 485-495
- Habig, W. H.; Pabst, M. J. and Jakoby, W. B. (1974): Glutathione S-transferase the first enzymatic step in mercapturic acid formation. J. Biol. Chem., 249:7130-7139.
- Ishaaya, I. and Swirski, E. (1976): Trehalase, invertase and amylase activities in the black scale *Saissetia oleae*, and their relation to host adaptability. J. Insect Physiol. 22: 1025-1029.
- James, C. (2011): Global Status of Commercialized Biotech/GM Crops: International Service for the Acquisition of Agri-Biotech Applications. ISAAA Briefs No. 43, Ithaca, N.Y. Brief N_ 43.
- Mostafa, F. F. (1981): Biological and ecological studies on the pink stem borer *Sesamia cretica* Led. Ph.D. Thesis., Fac. Agric., Cairo Univ. Egypt. 360pp.
- Reitman, S. and Frankel, S. (1957): Colourimetric method for aspartate and alanine transaminases. Amer. J. Clin. Pathol., 28:56.
- Saxena, D.; Flores, S. and Stotzky, G. (2002): *Bt* toxin is released in root exudates from 12 transgenic corn hybrids representing three transformation events. Soil Biol. Biochem. (34) 133–137.
- Shekari, M.; Jalali Sendi, J.; Etenbari, K.; Zibae, A. and Shadparvar A. (2008): Effects of *Artemisia annua* L. (Asteraceae) on nutritional physiology and enzyme activities of elm leaf beetle, *Xanthogalerucaluteola* Mull. (Coleoptera: Chrysomellidae). Pestic. Biochem. Physiol. (91) 66-74.
- Shelton, A. M., Zhao, J. Z. and Roush, R. T. (2002): Economic, ecological, food safety, and social consequences of the deployment of Bt transgenic plants. Annu. Rev. Entomol., 47, pp. 845–881
- Simeada, A. M. (1985): Relative susceptibility of certain maize germplasm to infestation with greater sugarcane *Sesamia cretica* Led. (Lepidoptera: Noctuidae). M. Sc. Thesis Fac. Agric., Cairo Univ., Egypt. 82pp.
- Simpson, D. R.; Bull, D. L. and Linquist, D. A. (1964): A semimicrotechnique for estimation of cholinesterase activity in boll weevils. Ann. Ent. Soc. Amer., 57: 367-371.
- Soliman, M. M. M.; Aly, M. Z. Y.; Dahi, H. F.; Mohamed, E. E. E. and Salem, S. A. R. (2012): Biochemical and histopathological effects of *Bacillus thuringiensis kurstaki* and methomyl insecticide on larval stage of the greater sugarcane borer, *Sesamia cretica* (Lederer). 1st international conference on biotechnology applications in agriculture. Mostohor and Hurgada, Egypt. 253-260.

- Tatchell, R. I.; Araman, S.F. and Boctor, F. N. (1972): Biochemical and physiological studies of certain Ticks (Ixodoidea). Z. Parsitenk. 39: 345-350.
- Van Asperen, K. (1962): A study of house fly esterase by means of sensitive colourimetric method. J. Insect physiol., 8: 401- 416.
- Zibae, A. and Bandani, A. R. (2010): Effects of *Artemisia annua* L. (Asteracea) on the digestive enzymatic profiles and the cellular immune reactions of the Sunn pest, *Eurygaster integriceps* (Heteroptera: Scutellaridae), against *Beauveria bassiana*. Bull. Entomol. Res. 100: 185-196.
- Zibae, A.; Jalali Sendi, J.; Etenbari, K.; Alinia, F. and Ghadamyari, M. (2008): The effect of diazinon on some biochemical characteristics of *Chilo suppressalis* Walker (Lepidoptera: Pyralidae), rice striped stem borer. Munis. Entomol. Zool. (3) 255-264.

DO BUR CUCUMBER POPULATIONS EXHIBIT DIFFERENCES IN SEED DORMANCY?

Cumali OZASLAN^{1*}, Sonnur TAD², Huseyin ONEN², Shahid FAROOQ²

¹Department of Plant Protection, Dicle University, Diyarbakir, Turkey

²Department of Plant Protection, Gaziosmanpasa University, Tokat, Turkey

*Corresponding author: cumaliz@yahoo.com

Abstract

Bur cucumber (*Sicyos angulatus* L., SIYAN) is a troublesome invasive vine. Seeds of the plant possess a water-impermeable, hard seed coat exhibiting physical dormancy. Seed dormancy is employed by the invasive plants for persistence in soil seed bank, seedling recruitment and avoiding unfavorable environmental conditions. The seed dormancy differences among populations offer valuable insights for understanding biology and devising effective management practices against invasive plants through experimental studies. Therefore this study was carried out to evaluate the dormancy differences among 3 populations collected from Black Sea region of Turkey. Chemical scarification with H₂SO₄, wet and dry pre-chilling (for 2 weeks) and mechanical scarification (girdling with scalpel) were tested along with an untreated control for comparison. Seeds were dipped in concentrated (98%) H₂SO₄ solution for 1, 2, 3, 4 and 6 minutes for chemical scarification. Whereas, a small portion of the seed coat was removed with the help of scalpel in mechanical scarification. Experiments were incubated at 25 °C with 12 hours light and dark period for 30 days and repeated. Freshly harvested seeds exhibited higher dormancy with slight differences among populations. Chemical scarification and pre-chilling treatments were ineffective in overcoming the dormancy. Mechanical scarification significantly promoted the final germination percentage with slight differences (82-90%) among populations. The results of the mechanical scarification were consistent in both experimental runs. It is concluded that slight scarification of SIYAN seeds imparts water-permeability in seeds leading to higher germination. The persistence of the seeds in soil seed banks probably leads to the deterioration of seed coat till next growing season resulting in effective seedling recruitment. Mechanical scarification can be successfully employed to break the dormancy in SIYAN for experimental studies.

Keywords: *Sicyos angulatus*, Populations, Physical dormancy, Mechanical scarification, Chemical scarification.

Introduction

Biological invasions are considered as the most serious threat to native biodiversity throughout the world (Lee *et al.*, 2015). Among invasive plant species, vines are more dangerous as they readily get established in introduced ranges, spread and replace native biodiversity by blocking sunlight and competing for resources. *Sicyos angulatus* L. (Bur cucumber, SIYAN) is an annual vine, native to North-eastern USA and currently invades several regions of the world (Kurukowa *et al.*, 2009; Onen *et al.*, 2015a, b; Lee *et al.*, 2015;). It has been regarded as invasive plant in Europe as well and its range is continuously expanding (Hulina, 1996). SIYAN interferes with several crops, such as maize, soybean, hazelnut, and pumpkin etc. (Hulina, 1996; Shimizu, 1999; Esbenshade *et al.*, 2001; Watanabe *et al.*, 2002; Larché, 2004; Gibson *et al.*, 2005; Onen *et al.*, 2015a, b). SIYAN is also commonly observed along watercourses, forest sites and in other open spaces in the natural habitats where it suppresses native vegetation by completely covering the ground and

blocking sunlight (Watanabe *et al.*, 2002; Onen *et al.*, 2015a, b). The presence of the plant alongside rivers and streams restricts water flow and creates several problems for stream managers (Lee *et al.*, 2015). SIYAN is currently infesting considerable portion of Black Sea region in Turkey and exerted several negative effects on the native plant communities (Onen *et al.*, 2015a, b).

Different invasive plant species and/or even different populations of the same species successfully manipulate seed dormancy to persist and germinate under diverse range of environmental conditions. Dormancy influences the survival, colonization, adaptation, speciation and extinction both at population and species levels (Willis *et al.*, 2014). However, different life forms of plants exhibit different extent and type of seed dormancy (Willis *et al.*, 2014). The type and degree of dormancy strongly affects the germination especially in newly colonizing populations (Huang *et al.*, 2010). Therefore, seed dormancy is considered as the major determinant of species distribution as seeds first need to get germinated for the evolution of adaptive traits (Donohue *et al.*, 2010).

Environmentally cued seed dormancy through evolving specialized structures is known as physical dormancy. Physical dormancy has been documented in nine orders and 17 families of angiosperms (Baskin and Baskin, 2003; Baskin *et al.*, 2006). Cucurbitaceae is one of the families containing species which exhibit physical dormancy via developing water-impermeable seed coat. To date physical dormancy has been reported only in the two plants of genus *Sicyos* in the Cucurbitaceae family i.e., *Sicyos deppei* (Orozco-Segovia *et al.*, 2000) and *Sicyos angulatus* (Lim *et al.*, 1994). The existence of physical dormancy in SIYAN seeds and role of mechanical scarification in overcoming it is well documented (Qu *et al.*, 2010). However, seed dormancy differences among different populations of SIYAN have been less explored although, higher genetic diversity has been reported for the plant (Kurokawa *et al.*, 2009; Dlugosch *et al.*, 2015).

SIYAN can grow under different shade and water availability conditions indicating the presence of higher genetic diversity (Oh *et al.*, 2015). Therefore seed dormancy differences among different populations may help to infer the mechanisms of introduction and further spread (Kurokawa *et al.*, 2009; Dlugosch *et al.*, 2015). As described earlier, seed dormancy is the most initial trait expressed in the life history of plants, hence it is critical determinant of survival and colonization success (Willis *et al.*, 2014). Therefore a thorough understanding of seed dormancy differences among different populations might help to understand population dynamics and further invasion trends. Although invasion status of SIYAN is well studied in Black Sea region of Turkey however, no literature exists on the germination biology of different populations infesting the region.

The current study was therefore planned to infer the seed dormancy differences among different SIYAN populations and potential of different dormancy breaking techniques to overcome dormancy. The results of the study will help to better understand the germination biology of different populations infesting the region.

Materials and Methods

Seed Collection:

Sicyos angulatus have extensively infested the eastern parts of Black Sea region in Turkey and started to interfere with different agricultural crops. Seeds were collected from three different sites (Dernekpazar, Dereli and Camlihemsin counties) highly infested with the plant. Physiologically mature fruits were collected and brought to the laboratory where they were dried under shade and seeds were separated from fruit coats. Seeds were stored in glass jars until the start of experiments.

Experimental treatments

Mechanical and chemical scarification techniques along with pre-chilling were tested to evaluate their role in overcoming the dormancy of SIYAN seeds. A small proportion of the seed coat was removed with the help of a scalpel (girdling) in mechanical scarification treatment. Seeds of the tested populations were dipped in concentrated (98%) H₂SO₄ solution for different time intervals (1, 2, 3, 4 and 6 minutes). Seeds were then thoroughly rinsed, surface dried and used. Seeds were also stratified (pre-chilling) either wet (between moistened layers of filter paper) or dry at 4 °C for two weeks. The untreated seeds (control treatment) was also included in the study for comparison purpose.

Experimental Layout

Experiments were conducted in randomized complete block design with split plot arrangements. The SIYAN populations were taken as main plots whereas dormancy breaking techniques were randomized in sub plots.

Experimental procedure

Twenty five seeds were placed on the double layer of Whatman no. 1 filter paper in 5 replicates and the papers were moistened with deionized water. The moisture was supplied to the germinating seeds throughout the experimental duration according to the needs. The petri dishes were kept at 25 °C for 30 days with 12 hours light and dark period. The cool, while fluorescent lamps were used for the provision of light in the incubators and relative humidity was adjusted to 60%. The place of the petri dishes was changed every day within the incubators. Germination was observed on daily basis and germinated seeds were counted up to 30 days after the initiation of experiments. A seed with 2mm radicle prolonged was considered as “germinated”. The germinated seeds were removed from the petri dishes. Final germination percentage of the seeds was computed at the end of experiments and used in the statistical analysis.

Statistical Analysis

All of the tested seed dormancy breaking techniques except dry pre-chilling and chemical scarification for lesser time (i.e., 1, 2 and 3 minutes) improved final germination percentage compared to control. Therefore the treatments resulting higher germination than control were included in statistical analysis. A two way analysis of variance was used to test the significance for populations, treatments and their all possible interactions. Least significant differences test at 5% probability was used to separate means where ANOVA indicated significant differences. The SPSS computer program version 23 was used for the statistics analyses whereas graphical representation of the data was accomplished using Microsoft Excel version 2013.

Results and Discussion

The individual and interactive effects of SIYAN populations and dormancy breaking techniques proved significant in the current study (Table 1). Freshly harvested seeds of different SIYAN populations exhibited extensive dormancy (92.8 to 94.8% dormant seeds). Similarly, different seed dormancy breaking techniques significantly affected the final germination percentage of tested SIYAN populations (Table 1). Mechanical scarification with scalpel proved as the most effective in breaking dormancy. Chemical scarification with H₂SO₄ for 6 minutes also slightly stimulated the germination whereas chemical scarification for lesser time proved ineffective in this regard (Figure 1). Among the remaining seed dormancy breaking techniques, wet pre-chilling slightly stimulated the germination whereas dry pre-chilling proved ineffective. Therefore these treatments cannot be considered as potential

techniques for breaking dormancy of SIYAN seeds. Regarding interactions among populations and seed dormancy breaking techniques, highest final germination in all populations was observed with mechanical scarification while the untreated (control) seeds result in the lowest germination (Figure 2). The population collected from Dereli exhibited slightly higher final germination compared to the other SIAYN populations studied.

Seed dormancy delays or prevents germination under unfavorable conditions thus ensuring germination over the next growth season (Willis et al., 2014). It is evident from the results that SIYAN seeds exhibit physical dormancy as all the seed dormancy breaking techniques except mechanical scarification failed to promote germination of different tested populations. Physical dormancy allows the plants to colonize in novel environments by adjusting timing of germination (Donohue et al., 2005). The results of the study reveal that all of the populations undergo similar adaptations for persistence in the currently invaded region of Turkey. The development of water impermeability in SIYAN seeds soon after physiological maturity is well reported (Qu et al., 2010). Different weed populations exhibit high genetic variations among different populations or even within the same population (Dlugosch et al., 2015). Large scale genetic variations have been observed in different populations of SIYAN collected from Japan (Kurokawa et al., 2009). Therefore the difference in seed dormancy of different Turkish SIYAN populations are probably the result of genetic variations among populations.

Table 1. Two-way ANOVA different seed dormancy breaking techniques, bur cucumber populations and their interactions on final germination percentage.

Source	df	SS	MS	F value	P value
Populations (P)	2.00	187.55	93.77	10.33	0.00*
Treatments (T)	4.00	57117.65	14279.41	1572.62	0.00*
P × T	8.00	197.79	24.72	2.72	0.01*
Error	60.00	544.80	9.08		
Total	75.00	128336.00			

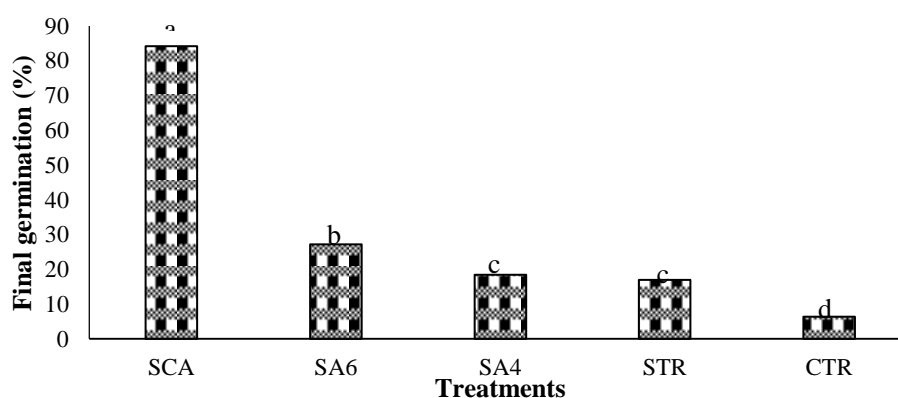

Figure 1. Effect of different seed dormancy breaking treatments on the final germination % of different populations (average of 3 populations). Here; SCA = mechanical scarification, SA4 and SA6 = chemical scarification with H₂SO₄ for 4 and 6 minutes, respectively, STR = wet pre-chilling at 4 °C for 15 days, and CTR = control treatment, (LSD 5% = 2.20).

Dormancy breaking requirements are highly specific for a given taxa which indicate that dormancy is developed by complex adaptations (Donohue et al., 2010). Physical dormancy due to the presence of water-impermeable seed coat have been widely cited in different studies (Lim et al., 1994; Qu et al., 2010). Seeds of SIYAN become water-impermeable after drying followed by physiological maturity (Qu et al., 2010). Since, the water imbibition is the

core requirement of the seeds for enzymatic activities during seed germination. Therefore, it was hypothesized that chemical scarification will impart the water permeability to SIYAN seeds and possibly overcome the seed dormancy. However, the results indicated that chemical scarification, even for longer time (6 minutes) almost failed to stimulate germination and hence proved ineffective for breaking dormancy. As chemical scarification slightly improved the germination with increasing exposure time, it is predicted that chemical scarification for longer time may possibly overcome dormancy.

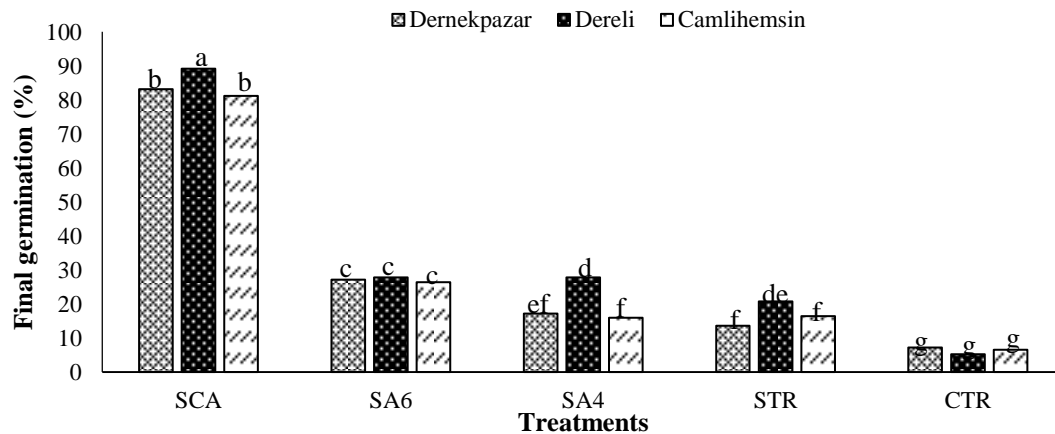

Figure 2. Effect of different seed dormancy breaking treatments and on the final germination % of different populations (effect on individual population). Here; SCA = mechanical scarification, SA4 and SA6 = chemical scarification with H₂SO₄ for 4 and 6 minutes, respectively, STR = wet pre-chilling at 4 °C for 15 days, and CTR = control treatment, (LSD 5% = 3.81).

Conclusion

It is concluded that SIYAN populations undergo similar adaptations to develop physical seed dormancy for persistence and colonization in novel environments. The presence of physical dormancy will help the plant to explore and invade novel environments in the country. Slight differences in the populations are owed to inherent genetic variations among populations. Secondly, the seed coat must be ruptured prior to germination which naturally happens due to longer burial time and presence of ample soil moisture in the currently invaded range of the plant in Turkey. It is recommended that proper management measures must be taken to tackle the existing populations and to prevent the further spread.

Acknowledgements

The current study was funded by the Scientific and Technological Council of Turkey (TUBITAK) with a Grant Number 113 O 790 as a part of the COST Action (FA 1209 - European Information System for Alien Species).

References

- Baskin JM., Baskin CC. (2003) Classification, biogeography, and phylogenetic relationships of seed dormancy. In: Smith R.D., Dickie J.D., Linington S.H., Pritchard H.W., Probert R.J. (eds). Seed Conservation: Turning Science into Practice. The Royal Botanic Gardens, Kew, pp. 517–544.
- Baskin JM., Baskin CC., Dixon KW. (2006) Physical dormancy in the endemic Australian genus *Stylobasium*, a first report for the family Surianaceae (Fabales). *Seed Science Research*, 16, 229–232.

- Dlugosch KM., Anderson SR., Braasch J., Cang FA., Gillette HD. (2015). The devil is in the details: genetic variation in introduced populations and its contributions to invasion. *Molecular Ecology*, 24(9), 2095-2111.
- Donohue K., de Casas RR., Burghardt L., Kovach K. and Willis CG. (2010). Germination, postgermination adaptation, and species ecological ranges. *Annual Review of Ecology, Evolution and Systematics*, 41, 293-319.
- Donohue K., Dorn L., Griffith C., Kim E., Aguilera A., Polisetty CR. and Schmitt J. (2005). Niche construction through germination cueing: Life-history responses to timing of germination in *Arabidopsis thaliana*. *Evolution*, 59(4), 771-785.
- Esbenshade WR., Curran WS., Roth GW., Hartwig NL., Orzolek MD. (2001). Effect of establishment date and crop competition on bur cucumber fecundity. *Weed Science*, 49, 524-527.
- Gibson KD., Johnson WG., Hillger DE. (2005). Farmer perceptions of problematic corn soybean weeds in Indiana. *Weed Technology*, 19, 1065-1070.
- Hulina N. (1996). New dangerous weed in Croatia: *Sicyos angulatus* L. (Cucurbitaceae). *Poljopr. Znan. Smotra* 61, 259-264.
- Kurokawa S., Kobayashi H., Senda T. (2009). Genetic diversity of *Sicyos angulatus* in central and north-eastern Japan by inter-simple sequence repeat analysis. *Weed Research*, 49(4), 365-372.
- Larché JF. (2004). *Sicyos angulatus*, a new weed for corn crops in SW France. *Phytoma* 571, 9-22 (in French with English summary).
- Lee CW., Kim D., Cho H., Lee H. (2015). The Riparian Vegetation Disturbed by Two Invasive Alien Plants, *Sicyos angulatus* and *Paspalum distichum* var. *indutum* in South Korea. *Ecology and Resilient Infrastructure*, 2(3), 255-263.
- Lim JH., Kwon TR., Kwon YS., Yoon JT., Choi BS. (1994) Studies on dormancy-breaking in seed of *Sicyos angulatus* L. *RDA Journal of Agricultural Science* 36: 395-399. (In Korean with English abstract and captions to tables)
- Oh D., Shim D., Song S., Oh J., Hong S., Shim S. (2015). Effects of Soil Moisture Condition and Shading on Growth of Invasive Plant Burcucumber (*Sicyos angulatus* L.). *Weed & Turfgrass Science*, 4(4), 315-320.
- Onen H, Ozaslan C, Tad S. (2015a) *Sicyos angulatus* L. In: Önen H (eds) Türkiye İstilacı Bitkiler Kataloğu, Ministry of Food, Agriculture and Livestock, Plant Health Research and General Policy Directorate, Ankara, Turkey (In Turkish) pp 458-472.
- Onen H, Tad S, Ozaslan C. (2015b) Current Status of *Sicyos angulatus* in Black Sea Region. *Turkish Journal of Weed Science*, 18(3):11-12.
- Orozco-Segovia A., Brechú-Franco AE., Zambrano-Polanco L., Osuna-Fernandez R., Laguna-Hernandez G., Sanchez Coronado ME. (2000) Effects of maternal light environment on germination and morphological characteristics of *Sicyos deppei* seeds. *Weed Research*, 40, 495-506
- Qu X, Baskin JM., Baskin CC. (2010). Whole-seed development in *Sicyos angulatus* (Cucurbitaceae, Sicyeae) and a comparison with the development of water-impermeable seeds in five other families. *Plant Species Biology*, 25(3), 185-192.
- Shimizu N. (1999). The level of damage by the foreign weed *Sicyos angulatus*. *Weed Science Society of Japan* 2, 2-3 (in Japanese).
- Watanabe O., Kurokawa S., Sasaki H., Nishida T., Onoue T., Yoshimura Y. (2002). Geographic scale distribution and occurrence pattern of invasive weeds. *Grassland Science*, 48, 440-450 (in Japanese with English summary).
- Willis CG., Baskin CC., Baskin JM., Auld JR., et al., (2014). The evolution of seed dormancy: environmental cues, evolutionary hubs, and diversification of the seed plants. *New Phytol.* 203(1), 300-309.

3. ORGANIC AGRICULTURE

EFFECT OF BIOPULS APPLICATION ON GROWTH AND YIELD OF TOMATO, CUCUMBER AND STRAWBERRY

Luiza DAWIDOWICZ^{1*}, Lidia SAS PASZT², Jerzy KRUK³

¹Department of Vegetable Crops, Faculty of Horticulture and Landscape Architecture, Poznan University of Life Sciences, Poland

²Department of Pomology, Research Institute of Horticulture in Skierniewice, Poland

³Microlife sp. z o.o., Poznan, Poland

*Corresponding author: loocy7@op.pl

Abstract

It is not possible to completely eliminate chemical protection and fertilization in horticulture. As a cost-effective alternative that could be used is limited NPK and application of microbial metabolites that are able to stimulate growth and yield of crops. One of the possibilities offered by the company, the BioPuls Microlife, is a line of products that based on the special composition of yeast *Yarrowia lipolytica* and their metabolites as bioactive substances and health-promoting nutrients for plants and soil. Use of beneficial microorganisms and bio-products have several advantages: (i) development of sustainable methods of horticulture, (ii) improvement of production quality and, (iii) protection of the environment and human health. The aim of this study is to comprehensively assess impact of the BioPuls on growth and yielding of three species of cultivated plants. Experiment was conducted in the Research Institute of Horticulture in Skierniewice (Poland) in 2013-2014. Experiment compared the growth and yielding of tomato (*Lycopersicon esculentum* Mill.), cucumber (*Cucumis sativus* L.) and strawberry (*Fragaria ×ananassa* Duchesne) var. 'Elkat'. Results shows that The BioPuls has a positive effect on the vegetative growth, develop and yield of tomato, cucumber and strawberry in greenhouse cultivation.

Keywords: *Yarrowia lipolytica*, yeast, plant biostimulation, microorganisms, bio-products

Introduction

Contaminated soils and an imbalances in the microbial rhizosphere population can be observe more often. The main reason is the technology of cultivation based on the excessive use of chemicals and artificial fertilizers. As a result, there is a condition in which the soil is completely devoid of useful microorganisms that mainly determine the normal processes within the soil. Restricting use of the plant protection products and mineral fertilizers carries the risk of fruit and vegetable production to become less attractive, thus leads to lower income of the farm. Nevertheless, is it not possible to completely eliminate chemical protection and fertilization. However, effective and economically viable alternative is to use limited NPK combined with application of microbial products that stimulate growth and yield of crops and protects the environment and health of consumers. It is possible to enrich orientation of biological life in the soil, thus the dominant species of microorganisms increased the fertility, better growth and development of plants (Barabasz and Smyk, 1997; Bashan, 1998; Barabasz et al., 1999; Doran et al., 2006; Jodelka et al., 2008; Dahm et al., 2010; Frąc and Jezierska-Tys, 2010).

The BioPuls Microlife, that is a line of products that based on special composition of yeast, *Yarrowia lipolytica*, and their metabolites, containing a high quality of protein-rich bioactive substances and health-promoting nutrients for plants and the soil. Use of the beneficial microorganisms and bioproducts, that are enriched microbiologically, presents several

opportunities: (i) development of sustainable methods of horticultural production, (ii) improvement of the quality in produced yields, and (iii) protection of the environment and human health.

Yarrowia lipolytica can be found in many plants and food products. This non-pathogenic microorganisms have the safety status of GRAS (Generally Recognized As Safe), awarded by the US Food and Drug Administration (FDA). *Y. lipolytica* has been identified in some kinds of cheeses, yogurts and dry sausage. Currently, it is used as an vaccine in the industrial production of cheese. Contrary to other yeast processing monosaccharides, *Y. lipolytica* is using fats as a source of carbon and energy, and does not occurs a fermentation process. Unofficially they are classified as a group of non-conventional yeasts. *Y. lipolytica* is a reservoir of valuable macronutrients, organic forms of micronutrients and trace elements, such as: selenium, chromium, iron, manganese, zinc, iodine, copper. Their metabolites – organic acids, hydrolytic enzymes, lipolytic enzymes and oxidoreductases – have positive effect on soil microflora, other organisms growth, process of germination and plant growth. It has been shown that the introduction of *Y. lipolytica* also favors plants rooting. These yeasts have a high survival rate in soil and high genetic and phenotypic stability. They also increase resistance of plants against some pathogens. Yeasts *Y. lipolytica* also have large assimilation capacities and it was used in bioremediation of contaminated water and soil, and detoxification of various harmful substances. Due to their lipolytic properties it was also used to treat waste from production of oil. Their specially selected and patented strain were used to develop a unique technology with the use of vegetable fats (Barth and Gaillardin, 1996; Barth and Gaillardin, 1997; Horn, 1997; Musiał et al., 2003; Fickers et al., 2005; Kordowska-Wiater, 2011; Krzyczkowska i Fabiszewska, 2015).

The aim of this study was to comprehensive assessment of impact of the BioPuls on growth and yielding of three species of cultivated plants: tomato, cucumber and strawberry.

Materials and methods

Experiment was conducted in greenhouse on three plant species: tomato (*Lycopersicon esculentum* Mill.), cucumber (*Cucumis sativus* L.) and strawberry (*Fragaria ×ananassa* Duchesne) var. ‘Elkat’, at the Research Institute of Horticulture InHort in Skierniewice (Poland), in 2013-2014.

Products of yeast *Y. lipolytica* were used in 3 combination with reduced to 30% NPK fertilizer. The control plants were fertilized with 100% dose of NPK. Yeast were used as a liquid form by spraying plants with an aqueous solution of 5% each of yeast products. Plants were sprayed three times at intervals of 1 month. Cucumber and tomato plants were sprayed first time on day of planting, the second spraying was performed after one month of growing, and the third after two months of growing. Planted cucumber plants were well developed and had approx. 12 cm high. Planted tomato plants had approx. 14 cm high. Strawberry plants were sprayed two weeks after planting, after the formation of roots and leaves. Next spraying was performed on a monthly basis.

In the experiment were used 4 combinations:

1. Control, standard fertilized with 100% NPK, the ground without yeast
2. Formula 1: 30% NPK + liquid yeast *Y. lipolytica* after cavitation 5%
3. Formula 2: 30% NPK + *Y. lipolytica* liquid yeast milk 5%
4. Formula 3: 30% NPK + *Y. lipolytica* forage yeast 5% + rhizosphere bacteria from the collection of Research Institute of Horticulture in Skierniewice.

During growth of plants and after completion of the experiments, the measurements and observations of: plant height, leaves width, average rate of plant growth, fresh and dry weight

of shoots and roots, surface area of plant shoots, root length, surface area, volume, diameter and number of vertices roots, fruit number and fruit yield per plant were performed.

Results and discussion

The BioPuls used in the first phase of tomato growth significantly influenced on plant height using a limited NPK fertilization – only 30%. All tomato plants on the time of planting had aligned height. The first treatment of the BioPuls, that was used on the day of planting, had a positive impact on young plants and increased plant growth by 80% after 15 days of growth. Average daily rate of the plants growth showed positive effects of the BioPuls on young plants. After one month of growth plants treated the BioPuls were higher than the control plants (Figure1). Dobromilska (2009) also confirms that the use of bio-stimulators has a positive effect on the vegetative growth of tomato plants and causes an increase of yielding. The plants which were treated with biostimulators were higher, had thicker stems and more leaves. The treatments significantly increased the yield of fruits. The stimulating influence of biostimulator treatment on fruit setting was also observed.

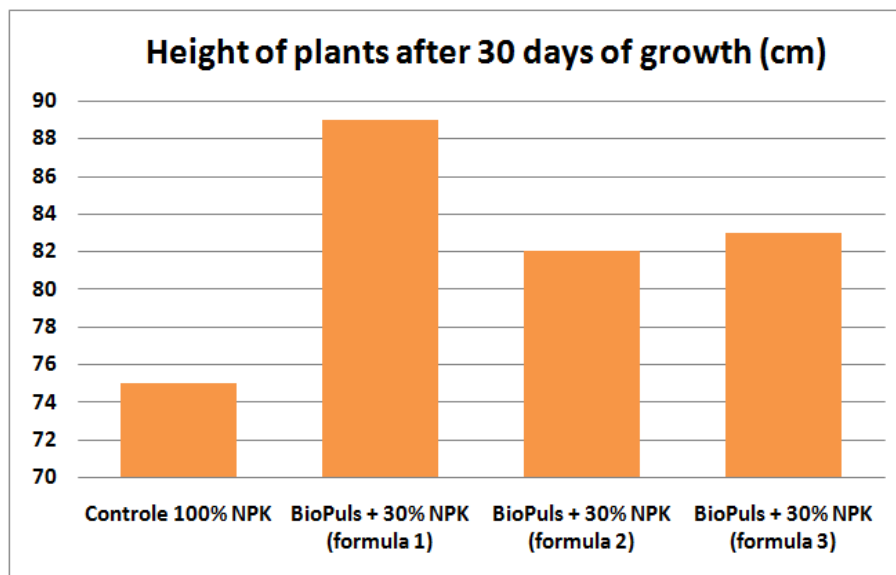

Figure 1. Height of tomato plants after 30 days of growth.

After two weeks of growth significant differences between height of cucumber plants treated the BioPuls and control plants were observed. Height of control plants (100% of NPK) was significantly lower than plants treated the BioPuls (+ 30% of NPK). During the first two weeks of growth plant sprayed with the BioPuls + 30% NPK had significantly higher average daily dynamics of growth than plants fertilized with 100% of NPK. The BioPuls significantly stimulated growth of cucumber plants. Impact of the BioPuls on width of the leaves was also tested. Results shows a significant increase of surface area of cucumber leaves after treatment with the BioPuls with combination of 30% of NPK compared to the control plants fertilized with 100% of NPK. Larger surface area of the cucumber leaves significantly increased photosynthetic activity in plants. It has been confirmed by growth dynamics in the initial phase of growth and development studied plants. Cucumber plants in the early phase of growth positively reacted to the BioPuls, that proved to be easily absorbed by plants and effective in the stimulation of vegetative growth. After first month of growth, cucumber plants treated with the BioPuls and 30% of NPK were significantly higher compared to the control. Application of the BioPuls, significantly stimulated growth of cucumber plants in early phase of development. Control plants fertilized with 100% of NPK had significantly lower daily

growth. Differences in plant height in favor of the BioPuls was also confirmed in fresh weight of cucumber plants after a month of growth. The results showed that cucumber plants fertilized reduced to 30% of NPK and the BioPuls were significantly higher mass (approximately 30-35%) compared to control plants. After one month of growth plants treated with the BioPuls + 30% of NPK had 21% more fruit in comparison to the control plants. Analyzing the whole period of growth of cucumber plants it has been shown higher mass plants treated with the BioPuls + 30% of NPK compared to control plants treated with 100% of NPK. The BioPuls treated plants had an average of 28% higher mass compared to control plants. Also the average height of cucumber plants treated with the BioPuls + 30% of NPK was significantly higher than the control plants. Based on the number of fruits and their mass was estimated commercial yield. The lowest yield trading characterized by control plants fertilized with 100% of NPK (Figure 2-3). Boehme et al. (2006) showed enhancing the cucumber root growth after the application of bio-stimulators. The results of Shevchenko (2010) showed that the cucumber plants treated with a biostimulators were more resistant to suboptimal growing conditions than the plants on variants without treatment. However Tomczyk and Elkner (2015) shown, that biostimulants was not significantly affected on yield of cucumber.

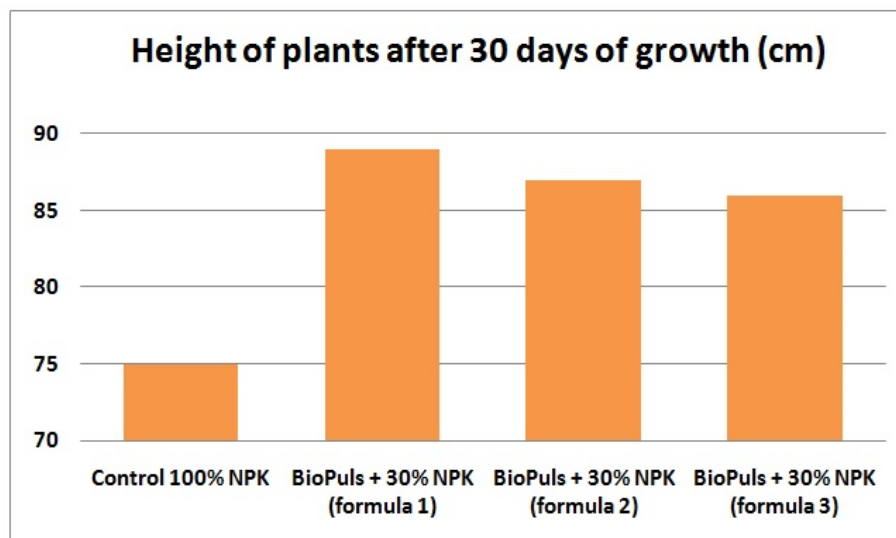

Figure 2. Height of cucumber plants after 30 days of growth.

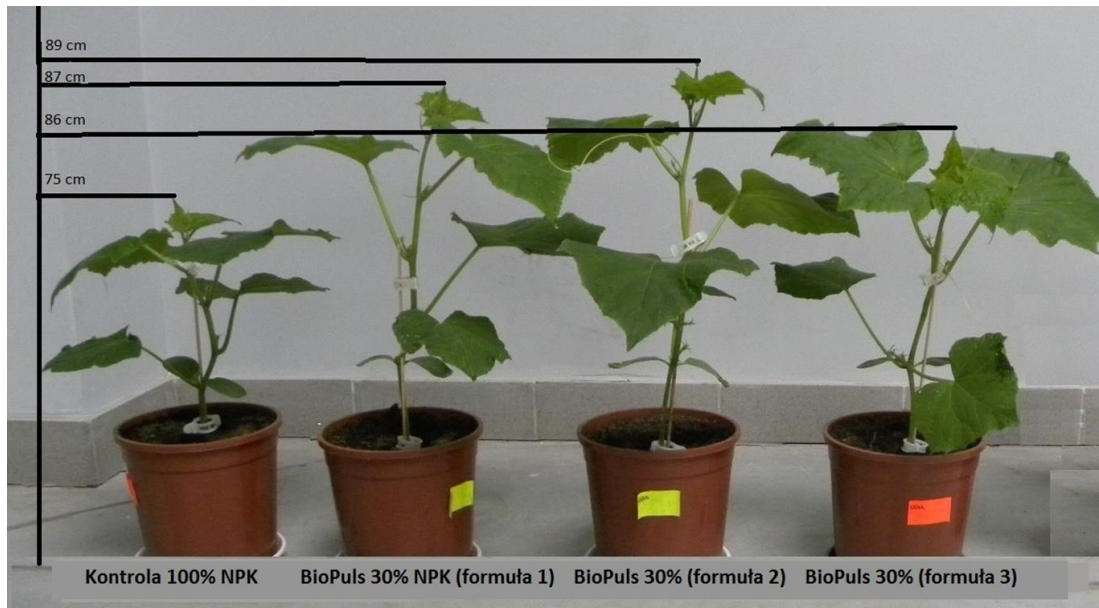

Figure 3. Height of cucumber plants after 30 days of growth.

Strawberry plants sprayed with the BioPuls + 30% of NPK had 100% higher number of leaves compared to control plants. The BioPuls + 30% NPK influenced for increasing more than 100% of fresh weight of leaves compared to the control (100% NPK). The BioPuls + 30% of NPK also affected on significant increase of surface area of leaves compared to control. Control plants had significantly lower fresh weight of root system than plants treated with the BioPuls + 30% of NPK. The BioPuls stimulated growth of roots and shoots of strawberry plants compared to the control. The BioPuls + 30% of NPK also influenced on significant increase of surface area of roots compared to the control. Control plants (100% NPK) had a smaller volume of root system compared to plants treated with the BioPuls + 30% of NPK. The BioPuls + 30% of NPK positive influenced on increasing the length of strawberry roots. The roots of control plants (100% NPK) were shorter (Figure 4). Results obtained by Glinicki et al. (2010) indicate the need for further research in field conditions to confirm the beneficial effects of use of bio-stimulators on growth, development and yield strawberry plant.

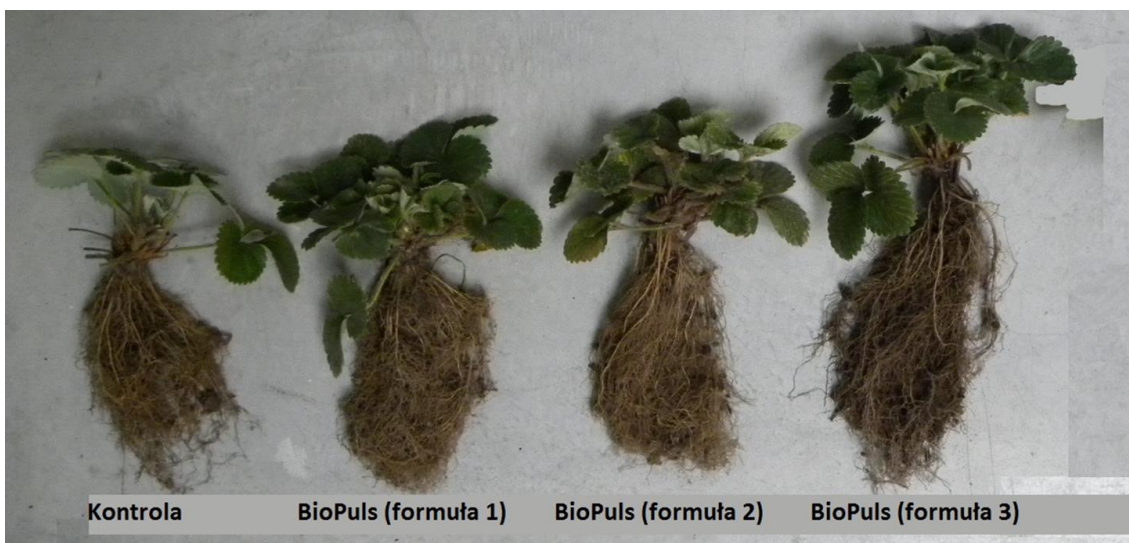

Figure 4. Strawberry plants treated with the BioPuls + 30% of NPK compared to control plants fertilized with 100% of NPK.

It has been shown intensity of flowering strawberry plants after application of the BioPuls. Due to the difficult pollination in greenhouses and autumn-winter period inflorescences were cut and counted to assess impact of the BioPuls on vegetative plants growth. Compared to control plants (100% NPK), foliar application of the BioPuls + 30% of NPK influenced increasing fresh weight and number of inflorescences per plant (Figure 5). Marjanska-Cichon and Sapieha-Waszkiewicz (2011) shown a slight tendency towards a positive influence of biostimulants on strawberry yielding. However Lisiecka et al. (2011) shown that application of biostimulant did not have a beneficial influence on number of strawberry runners, their length and diameter. Applied biostimulant did not also affect quantity of strawberry daughter plants, their crown diameter as well as number of leaves.

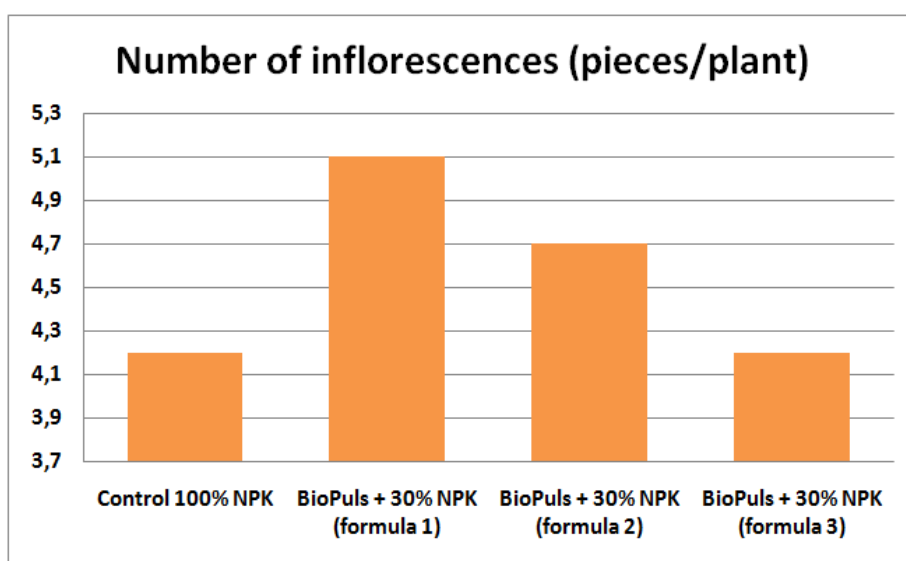

Figure 5. Strawberry plants treated with the BioPuls + 30% of NPK compared to control plants fertilized with 100% of NPK.

Conclusion

- Results shows that the effects of the BioPuls on growth and yield of tomato and cucumber have positive impact on production of seedlings, proper vegetative growth, development and yield of both species of tested plants in the greenhouse cultivation.
- Obtained results from the experiments shows effects of the BioPuls on vegetative growth of strawberry cultivar 'Elkat' and shows its positive impact on proper growth and development in the greenhouse cultivation.
- Based on the study it is possible to show positive effect of the BioPuls on vegetative growth and mass of strawberries inflorescences in greenhouse cultivation. Application of the BioPuls can help to obtain better yields and faster growth of strawberry plants in the early and later phase of development.
- In cultivation of cucumber and tomato could be observe reduction of NPK fertilization of 20-30% in conjunction with foliar or soil application of the BioPuls in order to stimulate the vegetative growth and yielding cultivated plants.

References

Barabasz W., Filipek Mazur B., Mazur K., Chmiel M. J., Grzyb J., Frączek K. (1999). Aktywność mikrobiologiczna gleby w 30-tym roku statycznego doświadczenia nawozowego w Czarnym Potoku koło Krynicy (Microbiological activity of the soil in the

- 30th year of the static fertilizer experiments in the Czarny Potok near Krynica). *Zeszyty Problemowe Postępów Nauk Rolniczych*, 465, 647-655.
- Barabasz W., Smyk B. (1997). Mikroflora gleb zmęczonych (Soil microflora). *Zeszyty Problemowe Postępów Nauk Rolniczych*, 452, 37-50.
- Barth G., Gaillardin C. (1996). *Yarrowia lipolytica*. Nonconventional yeasts in biotechnology, Springer Berlin Heidelberg, 313-388.
- Barth G., Gaillardin C. (1997). Physiology and genetics of the dimorphic fungus *Yarrowia lipolytica*. *FEMS microbiology reviews*, 19(4), 219-237.
- Bashan Y. (1998). Inoculants of plant growth-promoting bacteria for use in agriculture. *Biotechnol. Adv.*, 16(4), 729-770.
- Boehme M., Schevschenko Y., Pinker I. (2006). Use of biostimulators to reduce abiotics stress in cucumber plants (*Cucumis sativus* L.). In XXVII International Horticultural Congress-IHC 2006: International Symposium on Endogenous and Exogenous Plant Bioregulators 774 (pp. 339-344).
- Dahm H., Wrótniak-Drzewiecka W., Pauter A. (2010). Microbial biofertilizers. In: L. W. Szajdak, A. K. Karabanow (eds.). Physical, chemical and biological processes in soils, Prodruck, Poznań, 537-547.
- Dobromilska R. (2009). Wpływ stosowanie tytanitu na wzrost i plon pomidora drobnoowocowego (The influence of tytanit treatment on the growth and yield of small-sized tomatoes). *Rocz. AR Pozn. CCCLXXXIII, Ogrodn.* 41, 451-454
- Doran J.W., Saraantonio M., Liebiieg M.A. (1996). Soil health and sustainability. *Advances in Agronomy*, 56, 1-54.
- Fickers P., Benetti P. H., Wache Y., Marty A., Mauersberger S., Smit M. S., Nicaud J. M. (2005). Hydrophobic substrate utilisation by the yeast *Yarrowia lipolytica*, and its potential applications. *FEMS yeast research*, 5(6-7), 527-543.
- Frąc M., Jezierska-Tys S. (2010). Różnorodność mikroorganizmów środowiska glebowego (Microbial diversity of soil environment). *Post. Mikrobiol.*, 40, 1, 47-58.
- Glinicki R., Sas-Paszt L., Jadcuk-Tobjasz E. (2010). The effect of plant stimulant/fertilizer "Resistim" on growth and development of strawberry plants. *J. Fruit Orn. Plant Res.* vol. 18 (1), 111-124
- Horn G. (1997). The fungi in soil. In: J.D. van Elsas, J.T. Trevors, E.M.H. Wellington (eds.). *Modern soil microbiology*. Marcel Dekker, New York, 63-127.
- Jodelka J., Jankowski K., Jakubczak, A. (2008). Sezonowe zmiany liczebności drobnoustrojów w strefie ryzosferowej łąki nawożonej doglebowo i dolistnie (Seasonal changing of the microorganisms in the rhizosphere level of the meadow fertilized to the soil or as foliar). *Łąkarstwo w Polsce*, 11, , 67-76.
- Kordowska-Wiater M. (2011). Drożdże jako czynniki ochrony biologicznej roślin (Yeasts as biological control agents for plants). *Postępy Mikrobiologii*, 50 (2), 107-119.
- Krzyczkowska J., Fabiszewska A. U. (2015). *Yarrowia lipolytica* – niekonwencjonalne drożdże w biotechnologii (*Yarrowia lipolytica* –non-conventional yeast in biotechnology). *Post. Mikrobiol.*, 1(54), 33-43.
- Lisiecka J., Knaflowski M., Spizewski T., Fraszczak B., Kałużewicz A., Krzesiński W. (2011). The effect of animal protein hydrolysate on quantity and quality of strawberry daughter plants cv. 'Elsanta'. *Acta Sci. Pol. Hort. Cultus*, 10 (1), 31-40.
- Marjanska-Cichon B., Sapięha-Waszkiwicz A. (2011). Efekty stosowania kilku biostymulatorów w uprawie truskawki odmiany 'Salut' (Effect of the use of some biostimulants on the cultivated strawberry variety 'Salut'). *Prog. Plant Prot.*, 51 (2).
- Musiał I., Rymowicz W., Kramkowski R. (2003). Charakterystyka drożdży paszowych *Yarrowia lipolítica* suszonych metodą rozpyłową (Characteristic of spray-dried fodder yeast *Yarrowia lipolytica*). *Acta Scientiarum Polonorum Biotechnologia*, 2, 41-49.

- Shevchenko Y (2010). Effects of biostimulators on growth and physiological reactions of vegetables – tested on cucumber (*Cucumis sativus* L.). Dissertation, Humboldt-Universität zu Berlin, Landwirtschaftlich-Gärtnerische Fakultät , publiziert am 13.01.2010.
- Tomczyk A., Elkner J. (2015). Effect of biostimulants Asahi SL and Siapton 10 L on tolerance of cucumber plants to injury caused by western flower thrips (*Frankliniella occidentalis* Pergande). Progress in Plant Protection 55, 221-225.

LOSSES CAUSED BY DISEASES ATTACK QUINOA IN EGYPT

Tawfik H. ABD-ELMOITY, Ayat M. ALI

Central Lab of Organic Agriculture, Agriculture Research Center, Giza, Egypt

*Corresponding author: tawfikabdelmoity@yahoo.com

Abstract

Quinoa is a very recent crop was introduced to Egypt. Quinoa is considered as important crop due to it can grow and gives considerable yield in new reclaimed salty soil with salty water (1800 ppm) where wheat or many other crops cannot grow. This work was designed to illustrate different losses may occurred due to different diseases attack quinoa under Egyptian conditions. Obtained data show that soil borne pathogens *Fusarium solani*, *Rhizoctonia solani* and *M. phaseolina* were the most destructive pathogens for quinoa crop and caused more than 80% losses of yield. Foliage diseases came in the second rank causing about 65% in Egyptian variety. This work also included biological and chemical methods to control soil borne or foliage disease. Obtained data show that these losses can be reduced and yield increase six times in case of control soil borne pathogens. Foliage diseases were reduced to be 14 % using approved pesticides according to organic agriculture laws. Two different biocides were used to control soil borne pathogens. Obtained data indicated that product Clean root (a.i group of *Bacillus subtilis* isolates) was the most effective one compare with the other product Trichoderma (a.i isolates of *Trichoderma harzianum*). When downy mildew assessed use of Copiral max (Copper fungicide) show highest effects compare with the biocide Blight stop (contain *B. subtilis* and *T. harzianum*).

Keywords: *Quinoa- Diseases- Biological control- Losses*

Introduction

Quinoa is a very old crop belongs to the genus *Chenopodium quinoa*. Quinoa was used thousand years ago by Andean people (Rasmussen *et al.* 2003). It is grown for its edible seeds in some cases and places. Green leaves are eaten as vegetables. After harvest, the seeds must be processed to remove saponin which gives bitter taste for unprocessed seeds (Gee *et al.*, 2006). Quinoa was introduced to Egypt few years ago as pseudocereal crop. Quinoa requires cool temperature especially during flowering, for most genotypes, and short day length to flower and produce seeds. Therefore quinoa fits to the Egyptian winter climate (Oelke *et al.*, 2015).

Quinoa seeds contain essential amino acids, Calcium, Phosphorus, iron and high amount of protein. Due to these essential amino acids and high content of protein (Shukla and Ohri, 2006), quinoa can improve and replace part of animal protein, especially in poor rural area. Quinoa is attacked by numerous pathogens causing considerable losses. Danielsen (2001) announced that most attention is paid to downy mildew, caused by *peronospora farinose*. He also added there is scant knowledge about other quinoa pathogens that infect seeds or seedling and lead to decreased reduction in yield. These diseases are less widespread than downy mildew.

Recently, in 2015 Abd El-Moity *et al.* carried out complete survey for diseases and pests attack quinoa under Egyptian conditions. They stated that the most destructive diseases are soil borne diseases *i.e* damping off and root rot, these diseases can cause considerable losses under Egyptian conditions. Abd El-Moity *et al.* (2015) also, added that quinoa plants are susceptible to downy mildew.

Downy mildew reduces the photosynthetic area of the plant due to the development of chlorotic and necrotic spots in the leaves and lead premature leaf to fall. As declared by Danielsen and Munk, (2015) significant reduction in yield was registered in all cultivars due to downy mildew incidence. Late and semi-late maturing cultivar had the lowest yield loss of 33% and 35%, respectively, due to downy mildew, while the earliest maturing cultivars were heavily damaged with yield losses between 75% and 99%.

The purpose of this paper was to determine losses in yield caused by soil borne diseases and downy mildew. Also different approved fungicides, according to organic agriculture laws, were tested to illustrate their capacity on different disease control.

Materials and methods

To predict and measure losses may be occurred in quinoa due to diseases attack this crop, the five suggestions laid by Madden (1983) were considered and implemented during this work. These suggestions are:

- 1- "The experiments should be conducted in more than one location". All experiments in this work were conducted in two different locations (Fayium and Giza governorates) where this crop is normally grown and where the pathogens are exist.
- 2- "Experiments should be performed for more than one year". The experiments were preformed for two years in 2014/2015 and 2015/2016 in the same governorates.
- 3- "The experiments should be conducted in more than one cultivar represent a range of susceptibilities to the pathogens". Two quinoa cultivars were used, Egyptian white one and Rainbow cultivar.
- 4- "Multiple levels of treatment should be applied to potentially achieve levels of crop losses". Two different fungicides, approved according to organic agriculture rules, in addition to control treatment were used to control soil borne pathogens. These two fungicides were Clean-root (a.i. isolates of *Bacillus subtilis*, 30 x 10⁶c.f.u) produced by Central Lab of Organic Agriculture (CLOA), Agriculture Research Center, Giza, Egypt. Whereas the other fungicide is Trichoderma (a.i. isolates of *Trichoderma harzianum*, 30 x 10⁶c.f.u) produced by CLOA. Effects of these common commercial fungicides were tested in comparison with control treatment. On the other hand another two approved commercial fungicides were used to control downy mildew (Blight stop and Copiral max). Blight stop contain mixture of isolates *Bacillus subtilis* and *Trichoderma harzianum*. Copiral max, approved commercial fungicide contain 8 % Copper as Copper sulfate produced by CLOA).
- 5- Diseases intensity were determined and correlated with yield.

In addition to previously mentioned five suggestions, experiments were designed in randomized complete block as recommended by Hicks (1973).

Field experiments

General:

In all field experiments, unless otherwise indicated, plots each 12 m² were used. Eight plots were used for each treatment, and fifty plants were planted in each plot (replicates). Different treatments were distributed on plots in randomized complete blocks.

Losses due to soil borne diseases

To figure out losses occurred due to soil borne diseases, three groups of plots, each contains 8 plots, each plot 12 m² and contain 50 quinoa plants either Egyptian or Rainbow varieties were used. Different treatments were distributed on different group as follow.

The first group (8 plots):

In these plots all pests and diseases were intensively controlled to obtain ideal yield and the minimum percentage of diseases or pests. To achieve this target these plots received intensive program contain effective fungicides either against soil borne or foliage diseases. To avoid interference of different pests attack quinoa, an additional group of pesticides to control these pests was implemented, beside the main program to control soil borne and foliage diseases. The main and additional used programs include:

- 1- Seeds of quinoa were treated using Clean-root product at the rate of 10 gm / kg seeds. This product is used against soil borne pathogens {active ingredient (a. i) group of *Bacillus subtilis* isolates 30×10^6 }.
- 2- Spray every 10 days using the commercial insecticide (Antinsect) this product is approved to be used against sucking insects (Aphids, White fly and Mealy bug) in addition to leaf miner in organic farming.
- 3- Spray every week using the commercial product (B. t) contains *Bacillus thuringiensis* bacterium to control larvae of Lepidoptera.
- 4- Spray every 10 days using Blight Stop to control foliage diseases.

The second group (another 8 plots each contains 50 plants). This group of plots was used for the second treatment. This treatment is exactly the same as mentioned in previous group with only one exception the used fungicide against soil borne pathogens was Trichoderma product (a. i: isolates of *Trichoderma harzianum*, 30×10^6 c.f.u) instead of Clean-root.

The third group (another 8 plots): plots in this group received all treatment but without fungicide against soil borne pathogen to illustrate the size of damage can be occurred due to soil borne pathogens.

Losses due to foliage disease(downy mildew)

To determine losses occurred due to foliage disease another three groups of plots (each contain 8 plots) were used. The used strategy depends on removing any sources of losses except the target pathogen. To implement this strategy different treatments were distributed on the three groups as follow:-

Group one: all plots received sufficient plant protection program to protect quinoa against all soil borne and insects may attack quinoa exactly as mentioned in "first group in soil borne pathogens". Blight stop was used as an effective fungicide to control downy mildew.

Group two: another 8 plots were used. All treatments were exactly as previous group with one exception, where the Copper fungicide (Copiral max) was used instead of Blight stop.

Group three: in this group all pesticides and fungicides against pests and soil borne pathogens were used whereas no control against foliage disease (downy mildew) was taken to allow pathogen to attack quinoa to be able to determine the size of losses may be taken place if control of these diseases were ignored.

Losses assessments

1- Soil borne pathogens:

The three groups of plots used to determine damage occurred due to soil borne diseases (one group used Clean-root, another group used Trichoderma in addition to control treatment) using two quinoa cultivars during seasons 2014/2015 and 2015/2016 were examined periodically and percentage of damping off, either pre emergence or pest emergence were determined. At harvesting time quinoa plants were harvested by hand, throughout certain period. This is due to those quinoa panicles ripe at different times. At the end of harvesting process, yields of seeds were determined. On the other hand all plants were uprooted and percentages of root rot severity were determined in different treatment using disease index contain 10 rates of severity. Disease severity was calculated using following formula:

$$\% \text{ Disease severity} = \frac{\sum(\text{rating no.} \times \text{no. of plants in each rating}) \times 100}{\text{Total no. of plants} \times \text{highest rating}}$$

The relation between disease severity and yield per acre was put in linear relationship as illustrated by Larsson and Gerhardson (1991).

2- Foliage disease (downy mildew):

Downy mildew was the only disease appeared and attack quinoa in the two tested governorates. Downy mildew was assessed in the different groups of plots, one group where all soil borne and pests were controlled whereas downy mildew was controlled using Blight stop (*Trichoderma harzianum* + *Bacillus subtilis*). In another group downy mildew was controlled using Copper product (Copiral max).

In the third all pests and soil borne pathogens were controlled whereas no materials were used group to control downy mildew just to determine size of losses may be occurred due to downy mildew. At harvest time a disease index contain 10 rates was designed by author and formula mentioned by Whitney *et al.* (1983) was used to determine disease severity. Seed yield was harvested and yield per acre was calculated. Relation between disease severity and yield was but in diagram.

Results and discussions

Efficacy of used biocides on soil borne disease control and obtained yield:

Data in Table (1) indicate that use any of commercial biocides (Clean-root or Trichoderma) lead to clear reduction in disease severity compare with control treatment. Data also indicate that Rainbow variety show resistance against soil borne disease compare with the Egyptian variety. Percentage of disease severity in Egyptian variety reached 88 and 84.7% during 2014/2015 and 2015/2016 respectively compare with only 38 and 32.4 % in case of rainbow variety. When effects of the used biocides were compared, obtained data indicate that the product Clean-root was more effective than the other biocide Trichoderma. This may be due to Clean-root contains several isolates of *Bacillus subtilis*. *B. subtilis* produce many types of antibiotics and antifungal substances (Constantinescu, 2009). This broad spectrum in mode of action lead to inhibition of the pathogenic soil borne fungi. The pH of soil in Egypt is alkaline, which is favorable factor for *B. subtilis*.

Losses in quinoa yield due to soil borne disease:

Data obtained from replicates of the previous experiment, percentages of disease severity and obtained yield, were used to figure out a liner relation between percentage of disease severity and losses in yield (Fig.1).

Table (1): Correlation between percentage of soil borne disease severity and obtained yield in case of use two different quinoa varieties during two successive seasons

Treatment	variety	% of disease severity		Yield (Ton)	
		Season 2015	Season 2016	Season 2015	Season 2016
Clean root	Egypt	30.0	22.3	0.63	0.82
	Rainbow	15.3	14.0	1.52	1.5
<i>T. harzianum</i>	Egypt	42.0	34.7	0.46	0.61
	Rainbow	20.0	18.0	1.1	1.25
control	Egypt	88.0	84.7	0.23	0.25
	Rainbow	38.0	32.4	0.65	0.47

Correlation between percentage downy mildew severity and obtained yield:-

To estimate losses may be occurred due to different degrees of downy mildew severity, this experiment was conducted. Two fungicides were used to show different levels of disease also two quinoa varieties were used. Obtained data indicate that Copiral max and Blight stop showed highly significant effect in disease control compare with control treatment. Rainbow quinoa variety showed resistant to disease compare with the Egyptian one, and only 35% disease severity was recorded in case of Rainbow variety in 2015\2016 compare with 91.7% in Egyptian variety in the same season. Data also indicate that the fungicide Copiral max showed highest effect in downy mildew control and percentage of disease was only 25 % in Egyptian variety compare with 91.7% in control and 36% in case of use the biocide "Blight stop". This may be due to, Copiral contain chelated Copper sulfate. Copper as heavy metal negatively affect on the bioactivities of the pathogen cause downy mildew. Copper ions also can penetrate plant tissues and reach the pathogenic mycelium interplant cells causing inhibition for pathogen growth and development (Trdan, *et al.*, 2004).

Percentage of disease severity was correlated with obtained yield. The minimum yield 310 kg/acre was obtained in control treatment of Egyptian variety. Whereas the highest yield 2210 kg/acre was achieved when Copiral max was used with Rainbow variety. Egyptian variety also show highest yield 1820 kg/acre when Copiral max was used against downy mildew. Obtained data were put in liner relationship to estimate losses at any levels (Fig. 1).

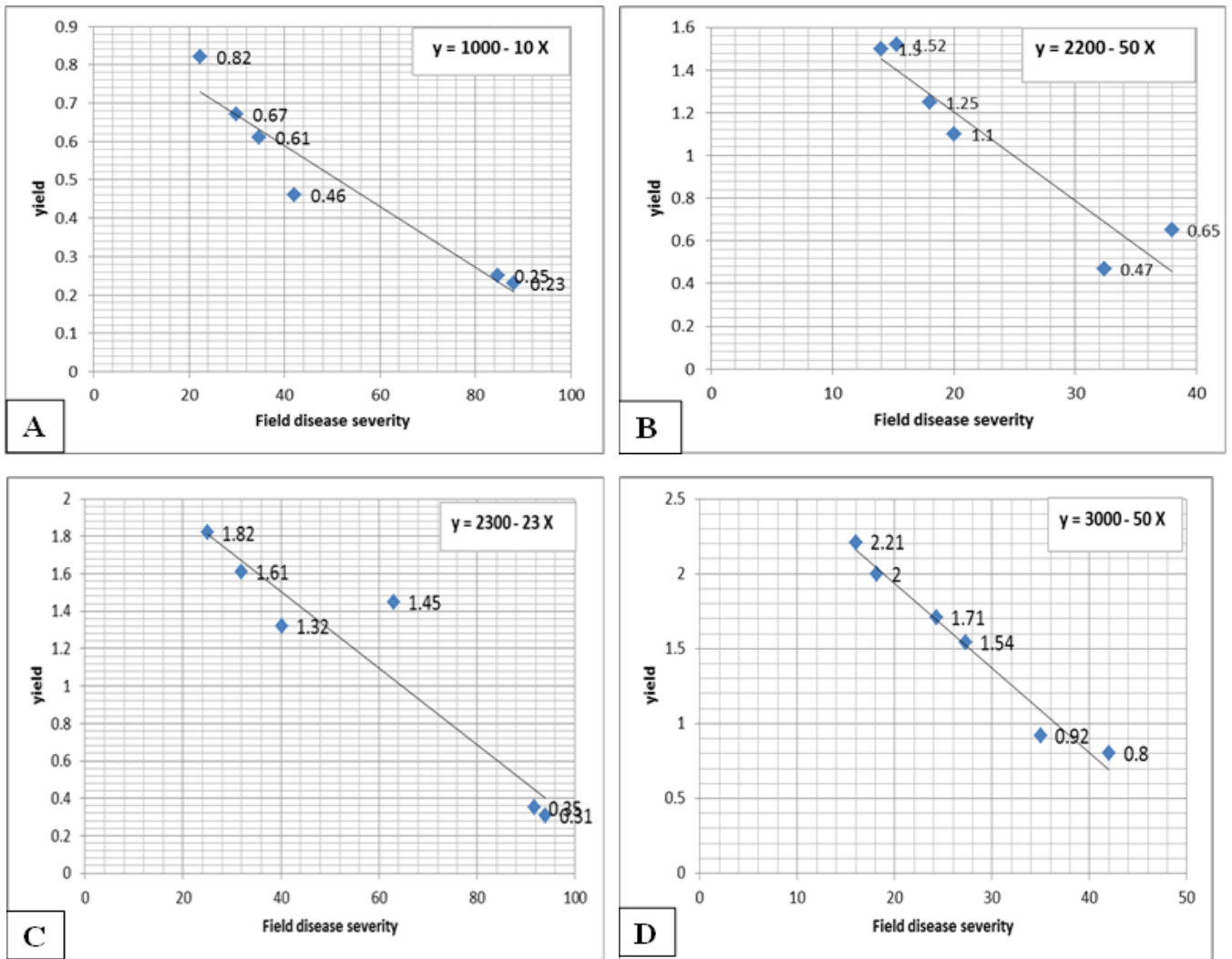

Figure (1): Relation between field disease severity and quinoa seed yield(Ton/Acre).

A) Relation between Quinoa Egyptian variety and soil borne.

B) Relation between Quinoa Rainbow variety and soil borne.

C) Relation between Quinoa Egyptian variety and Downy mildew.

D) Relation between Quinoa Rainbow variety and Downy mildew

Each value represent mean of 8 different values (replicates).

Table (2): Correlation between percentage of downy mildew disease severity and obtained yield in case of use two different quinoa varieties during two successive seasons

Treatment	variety	% of disease severity		Yield (Ton)	
		Season 2015	Season 2016	Season 2015	Season 2016
Blight stop	Egypt	36.0	40.2	1.45	1.32
	Rainbow	24.3	27.3	1.71	1.54
Copiral max	Egypt	25.0	32.0	1.82	1.61
	Rainbow	16.0	18.2	2.21	2.0
control	Egypt	91.7	94.0	0.35	0.31
	Rainbow	35.0	42.0	0.92	0.80

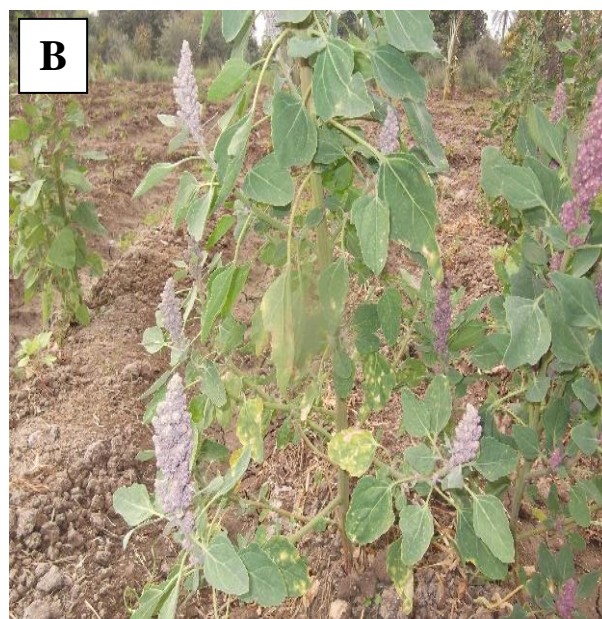
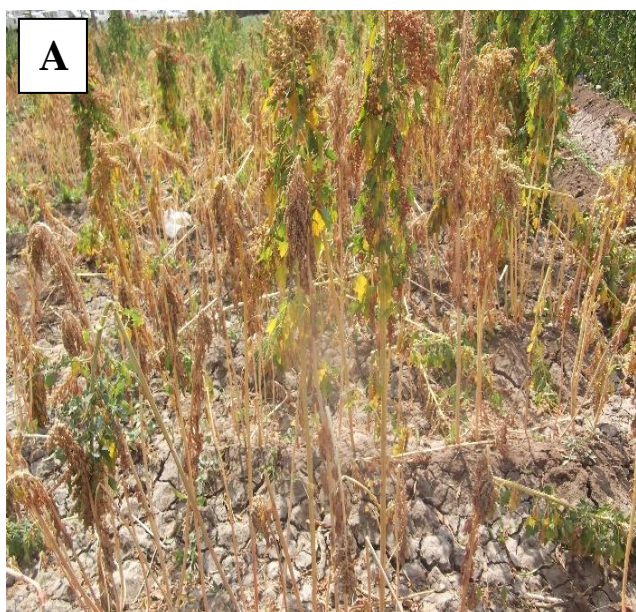

Fig. (2): Destruction of Quinoa plants due to soil borne diseases and downymildew.
 A) Quinoa plants at harvesting stages suffering from soil borne diseases.
 B) Quinoa plants show Downey mildew symptoms.

Conclusion

Soil borne diseases and downy mildew should be controlled at any level of infection. This control resultant in considerable yield can compensate cost of diseases control. Breeding for resistant or tolerant varieties must be considered.

Biological control can play very important role in quinoa protection against soilborne diseases and downy mildew.

By combination between biological control and approved chemical control, according to organic agriculture laws, it can be completely control all pathogens attack quinoa and produce high quality and quantity organic seed yield.

References

- Abd El-Moity, T. H.; Badray, H. B. M.; Ali Ayat, M. (2015). Survey on diseases and pests attack quinoa in Egypt. Six International Scientific Agricultural Symposium. Agrosym. Sarajevo, Bosnia. 868-876.
- Shukla, S. and Ohri, D. (2006). *Chenopodium quinoa*—An Indian perspective. Industrial Crops and Products. 23(1):73-87.
- Constantinescu, F.; Voshol, G. and Bloemberg, G. (2009). Mechanisms involved in biocontrol activity of *B. subtilis* B49b against *Fusarium oxysporum* f.sp. *radicis-lycopersici*. IOBC/WPRS Bulletin. 43: 113-116.
- Danielsen, S. (2001). Heterothallism in *Peronospora farinose* f.sp. *chenopodii*, the causal agent of downy mildew of quinoa (*Chenopodium quinoa*). J. Basic Microb. 41:305-308.
- Danielsen, S. and Munk, L. (2015). Evaluation of disease assessment methods in quinoa for their ability to predict yield loss caused by downy mildew. Crop Protection. 23: 219-228.
- Gee, J. M.; Price, K. R.; Wortley, G. M. and Jonson, I. T. (2006). Saponins of quinoa (*Chenopodium quinoa*): Effects of processing on their abundance in quinoa products and their biological effects on intestinal mucosal tissue. J. of the Science of Food and Agriculture. 63 (2): 201- 209.
- Hicks, C. R. (1973). Fundamental concepts in the design of experiments. Holt, Rinehart and Winston, New York. pp.349.
- Larsson, M. and Gerhardson, B. (1991). Disease progression and yield losses from root disease caused by soil borne pathogens of spinach. Ecology and Epidemiology. 82(4): 403-406.
- Madden, L. V. (1983). Quantification of disease progression. Prot. Ecol. 2:159-176.
- Oelke, N. D.; Suter, E. and Brown, C. V. (2015). Indicators and measurement tools for health system integration: a knowledge synthesis protocol. Systematic Reviews. 4:99-111.
- Rasmussen, C.; Lagnaoui, A. and Esbjerg, P. (2003). Advances in the knowledge of quinoa pests. Food reviews international. 19:61-75.
- Trdan, N. S.; Valic, J.; Jirman, D. and Znidarcic, L. (2004). Efficacy of three natural chemicals to reduce the damage of *Erysiphe cichoracearum* chicory in two meteorologically different growth seasons. J. phytopathol., 152: 567-574.
- Whitney, E. D.; Lewellen, R. T. and Skoyen, I. O. (1983). Reaction of sugar beet to powdery mildew: genetic variation, association among testing procedure and resistance breeding. Phytopathol. 73:182-185.

THE ORGANIC MILK PRODUCTION IN POLAND – ECONOMIC ASPECTS AND PROSPECTS FOR DEVELOPMENT

Marcin ŻEKAŁO

Institute of Agricultural and Food Economics – National Research Institute, Warsaw, Poland

*Corresponding author: zekalo@ierigz.waw.pl

Abstract

The production of organic milk shows a continuous growth in Europe but the market supply still does not meet the demand for organic milk and its products. In Poland, the organic milk production is conducted on a small scale, mainly due to an underdeveloped market of organic products. However, among the consumers the interest in such products is increasing, as well as for the farmers the organic milk production may be considered as a one of profitable agricultural production. The purpose of this article is to reflect the economic situation of organic milk production in Poland and the attempt to define prospects for further development. Accounting data for ‘dairy cows’ activity were collected since 2006 and processed according to the rules of the Agricultural Products Data Collection System (AGROKOSZTY). Surveyed farms were selected from a sample of Polish Farm Accountancy Data Network. Under the AGROKOSZTY system, the methodology of the gross margin was used (in accordance with the EU rules) which may give a full insight on actual direct costs and helps to determine the competitiveness of organic milk production. The income from ‘dairy cows’ activity account is based on the Polish FADN accounting data collected from the same farms. The survey indicate that the production results of organic dairy farms were significantly lower than an average results of dairy farms in Poland. In that case, the income of organic milk production strongly depends on the low level of production costs and the support of subsidies.

Keywords: *dairy cows, organic milk production, profitability.*

Introduction

According to the statistical data of Organic Data Network, in 2013 the organic production sector in the European Union covered 10.2 million ha of organic agricultural land (in 2002 it was about 5.7 million ha). Most organic agricultural land was situated in Spain, Italy, France, Germany and Poland (figure 1).

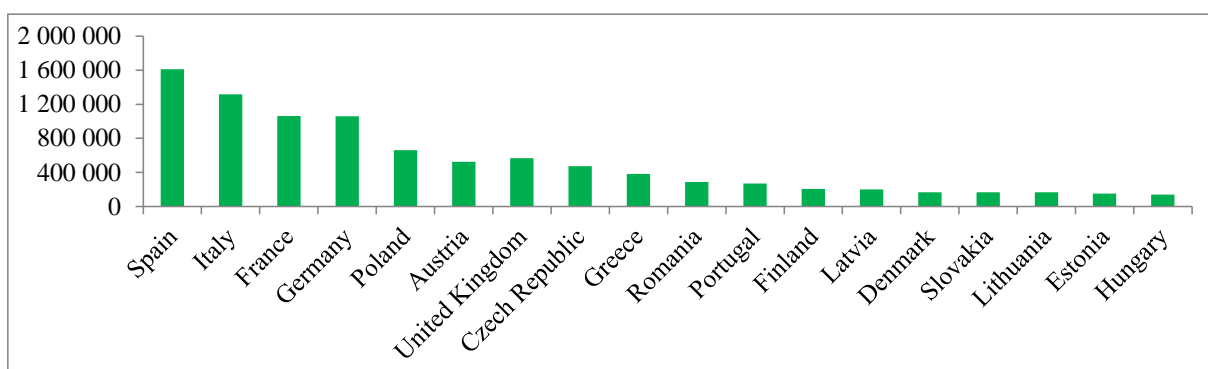

Figure 1. The area of organic agricultural land (in ha) in selected EU countries in 2013.

Source: own studies based on FiBL&IFOAM, The World of Organic Agriculture 2015.

Organic Farming and Market Development in Europe, Organic Data Network 2015.

However, it is worth noting that the area for the organic production amounted to only 5.7% of the total agricultural area in the EU. Among the organic crops, a significant part were grassland and permanent crops (together amounted to more than 60% of the area of organic

farming). One of the main activities of the organic livestock production is cattle rearing. According to by the European Commission report, in 2011 in organic farms around 28% of the population accounted for dairy cows as a part of the cattle production. In the EU countries, 0.7 million dairy cows were kept in organic farms which was about 3% of all dairy cows in the EU. In Poland, according to the statistics from 2011, the population of dairy cows in organic farms remains at the level below 20 thousand head, which accounted for only about 1% of the population of dairy cows in the country. The number of dairy cows in organic farms in the EU countries in 2011 is shown on the chart 2. The largest share of the organic milk production in the domestic market of agricultural products is held by Austria (18%), Sweden (13%), Denmark (about 11%) and United Kingdom (8%).

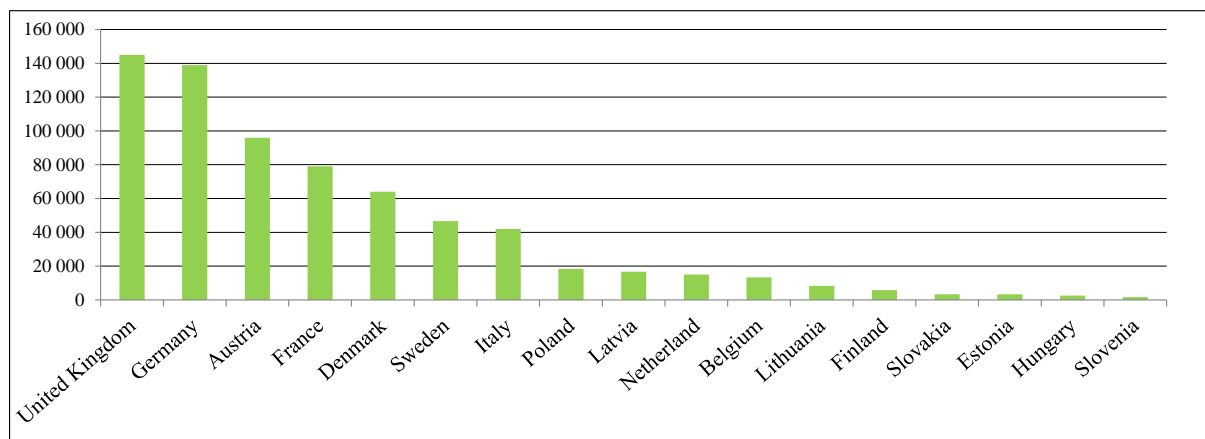

Figure 2. Number of dairy cows in organic farms in EU countries in 2011.

Source: own studies based on http://ec.europa.eu/agriculture/markets-and-prices/morereports/pdf/organic-2013_en.pdf.

In Poland, organic certified land and land under conversion covered in total 657.9 thousand ha which accounted for 6.38% of the area of EU organic land. It is worth noting that in the years 2013-2014, within the structure of organic agricultural area the largest share was held by fodder crops, meadows and pastures. Their total area in 2013 was 66.0% (in 2014 – 67.3%) of the total area of organic agricultural land in Poland. The high share of fodder crops, meadows and pastures could indicate to the popularity of the livestock production, including dairy cows, in organic farms. Unfortunately, the share of organic farms involved concurrently in the plant and livestock production is decreasing – only 19.3% of farms were involved in such simultaneous production in 2014 (in 2013 they accounted for 44.2% of all organic farms). When farmers quit the livestock production, including keeping dairy cows at the farm, the decreasing organic milk production in the country can be observed over the years. According to the statistical data, in 2011 the organic milk production amounted to 39.5 million liters while in 2014 it was only 25.2 million liters.

Organic farms involved in the milk production must provide feed from an organic farm, preferably from own farm, and for this purpose it is necessary to provide a sufficient fodder area. Pastures, from which roughage comes (forage, dried fodder or silage) are primarily used. Rearing and breeding of animals based on permanent grassland is beneficial for both the environment and from the point of view of the production economics [Radkowska 2012]. Organic feedstuffs purchased are relatively expensive, and their availability in the market is still very limited. On the other hand, the use of industrial concentrated feedingstuff in animal diet is strictly prohibited in organic farming.

Organic farms, conducting the extensive production mainly based on their own resources incur lower costs. However, the consequence may be lower production results and some limitations as regards the herd size of dairy cows. In case of farms keeping dairy cows in an extensive manner, we may observe the lower milk yield (lower by up to 30% than in conventional farms), however, we must point to a longer productive life of cows, which directly translates into the lower costs of herd replacement [Żukowski 2009]. Data provided for the EU countries show that the milk yield

of dairy cows in organic farms was very diverse. The highest milk yield was achieved in Sweden (more than 8,200 kg/cow), Finland (more than 7,000 kg), Denmark (6,700kg), the Netherlands (6,600kg). In Polish organic dairy farm (based on the group of organic farms in a survey in Agrokoszty system), the milk yield is only 75-80% of the milk yield achieved on average in the dairy farms in Poland (Figure 3).

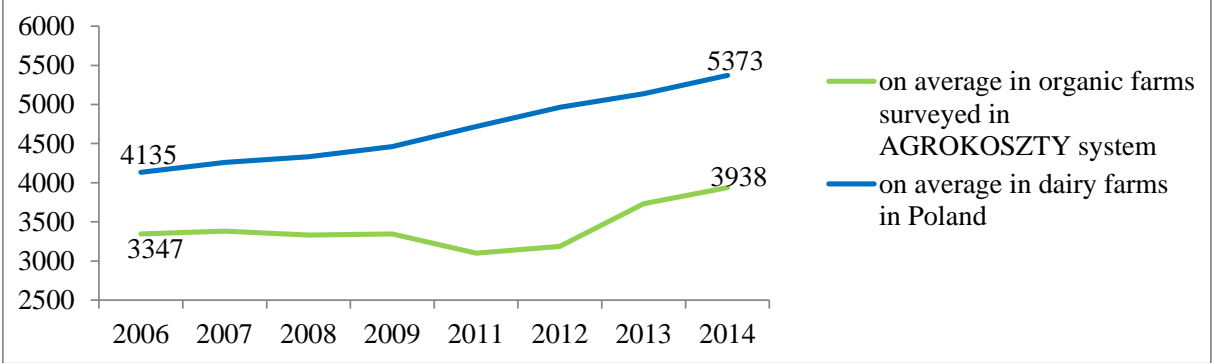

Figure 3. Milk yield (in liters) in organic farms surveyed in Agrokoszty system and on average in dairy farms in Poland in years 2006-2014.

Source: own studies based on Agrokoszty system database and CSO database.

The main product of the dairy cows activity is milk production (also calves weaned and cull dairy cows, to a small extent), and an important factor determining the obtained value of this production is the selling price of milk. Reports from the European market show that farmers often receive a higher price for the sale of organic milk when compared to milk from conventional farms [Offermann, Nieberg 2000]. The price premium for the sale of organic milk compared to the selling price of milk from conventional farms was often higher up to 30% (in Denmark), 20% (in Czech Republic, France, Great Britain), 13-14% (in Germany, Netherlands, Sweden). In a survey in Agrokoszty system, in Poland the selling price of organic milk was 8-16% lower than selling milk price achieved on average in the dairy farms in Poland (Figure 3).

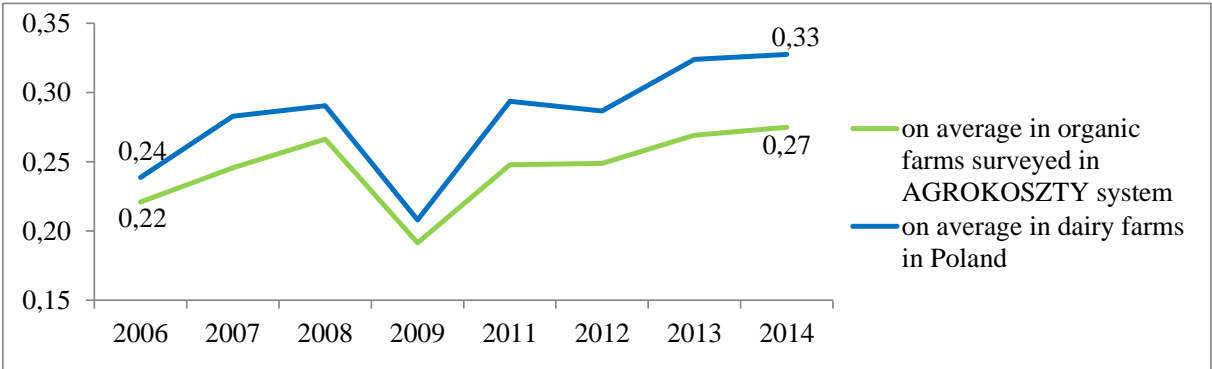

Figure 4. Selling milk price (in EUR) organic farms surveyed in Agrokoszty system and on average in dairy farms in Poland in years 2006-2014.

Source: own studies based on Agrokoszty system database and CSO database.

Farmers taking up activities in organic farming may also count on support in the form of payments addressed to this sector, which may significantly affect the level of income achieved from the agricultural activity. In addition, there are opportunities to acquire financial support from the animal genetic resources conservation programme. In the case of the type of activity of ‘dairy cows’ subsidies are calculated per forage area and include supplementary payments, agri-environmental payments and payments per animals.

The aim of this study is to present the production and the economic situation of organic dairy farms in Poland. An attempt has been made to assess the potential for the further development of the organic milk production in Poland, in the context of competitiveness in the domestic milk market, as well as with some regard to the EU market.

Materials and methods

Materials to study were the actual accounting data collected in the years 2006, 2009, 2012 and 2014 in organic farms participating in the studies of the Polish Farm Accountancy Data Network (FADN) and AGROKOSZTY system. The economic and production results of the analysed organic farms have been referred to the average milk results of conventional farms (selected farms with a similar scale of production i.e. number of dairy cows kept at the farm), participating in the studies in both systems, in the same years. All those farms were market-oriented and were economically stronger than production units, on average, in the country. For this reason (and due to low number of surveyed farms), the results obtained should not be directly translated into national average results for the organic farms. These are only average results for the surveyed sample of farms. However, multiannual surveys indicate, that the calculations carried out provide a reliable picture of the economic situation in organic dairy farms and correctly reflect milk price trends.

Accounting data were collected according to the methodological assumptions of the Agricultural Products Data Collection System AGROKOSZTY. For the researched type of activity 'dairy cows', the methodology of calculating the gross margin was used (Augustyńska-Grzymek et al. 2000). It is the first income category, calculated by deducting the direct costs incurred for producing the output from production value. In the case of dairy cows, the production value is calculated per one dairy cow. In estimating the price of production value, the average annual sales prices are used – the sales price of milk, the price of weaned calves and the price of culled dairy cows. The production value does not take into account the value of manure and slurry, which are produced at the farm. For dairy cows, direct costs include: livestock replacement, feedingstuff purchased and produced on the farm, rents paid for using forage area for less than 1 year, animal insurance, medicines and veterinary measures as well as specialised costs (including specialised expenses, services and employment of staff for specialised works). Moreover, a register of own and hired labour spent on works related to the type of activity 'dairy cows' is kept. Maintaining an account for income allows for obtaining information regarding activity (e.g. indirect costs, forage area, annual average number of animals), which comes from accounting data collected on the same farm for the Polish FADN system.

The calculation of income for agricultural production activities is given as follows:

Production value

– Direct costs

= Gross margin without subsidies

– Total indirect costs (actual indirect costs, depreciation, cost of external factors)

= Income from activity without subsidies

+ Subsidies

= Income from activity

On the basis of the obtained accounting data, it is also possible to define the profitability of production as a ratio of production value to total costs, in percent (Skarzyńska 2011). Subsidies per forage area were recognized as support to farmers income from activity of 'dairy cows'. The calculation of income from activity includes subsidies that have a direct impact on the discussed production activity, i.e. supplementary area payment for basic crops, the payment for animals, and in the case of organic farms – agri-environmental payments.

Results and discussion

Surveyed organic farms were conducting the extensive production mainly based on their own resources, mostly they had bigger permanent grass land area and the forage area involved in feeding of dairy cow. The average milk yield of dairy cows on surveyed organic farms was lower (up to 21%) than in the groups of conventional farms. It should be noted that the total amount of work on 1 cow remained at a similar level (190-250 hours) in both groups compared groups of farms (with a similar number of dairy cows in the herd). General informations about surveyed groups of farms were shown in table 1.

Table 1. General information of surveyed group of conventional and organic dairy farms.

Specification	on average in surveyed farms in years							
	2006		2009		2012		2014	
	Organic	Convent	Organic	Convent	Organic	Convent	Organic	Convent
Number of surveyed farms	29	35	20	31	15	40	22	49
Utilised agricultural area per farm [ha]	24,6	16,7	18,5	19,8	20,5	21,5	18,1	23,0
Permanent grassland area per farm [ha]	16,7	3,6	11,5	5,9	11,5	5,5	6,8	6,8
Forage area per dairy cow [ha]	0,77	0,68	1,03	0,75	0,87	0,68	0,86	0,61
Annual average number of dairy cows [heads per farm]	6,6	6,7	8,9	7,1	10,1	7,5	8,9	9,2
Milk yield [liter/cow]	3347	4164	3705	3881	3204	4060	3938	4513
Annual average selling milk price [EUR per liter]	0,22	0,22	0,20	0,18	0,25	0,36	0,27	0,29
Total labour input per dairy cow [hours]	259	250	227	242	219	224	220	192,9

Source: own studies based on Agrokoszty system database.

Generally, in organic farms a lower milk yield of cows and a less favorable selling milk price than in conventional farms, can be observed. This resulted in lower (on average by 10-16%), total production value obtained in organic farms (with the exception of research in 2009, in which organic farms received favorable sales price, and the milk yield remained at the same level as in the group of conventional farms) – table 2.

Table 2. General information of surveyed group of conventional and organic dairy farms.

Specification	on average (per 1 dairy cow) in surveyed farms in years								
	2006		2009		2012		2014		
	Organic	Convent	Organic	Convent	Organic	Convent	Organic	Convent	
Total production value	[EUR]	1025	1143	953	910	1049	1252	1335	1553
Direct costs total	[EUR]	260	482	306	438	328	610	355	646
Gross margin without subsidies	[EUR]	765	661	647	472	720	642	980	907
Indirect costs total	[EUR]	258	357	395	377	470	446	618	582
Income from activity without subsidies	[EUR]	507	304	252	95	250	196	362	325
Subsidies	[EUR]	130	55	223	84	138	47	146	0
Income from activity	[EUR]	636	359	475	179	388	242	508	325
Share of subsidies in income from activity	[%]	20,4	15,2	47,0	47,0	35,6	19,2	28,7	0
Milk production profitability index	[%]	197,8	136,2	135,9	111,6	131,3	118,5	137,2	126,4

Source: own studies based on Agrokoszty system database.

Milk production in both groups of farms allowed to generate income from this activity. However, the level of this income was much higher than the income obtained in conventional farms, taking into account the adopted scale of production in the considered groups.

The milk production profitability index in the group of organic dairy farms stood at a higher level compared to conventional farms – table 2. It should be pointed out that the total production costs in the group of organic farms were significantly lower than the earned value of production (costs accounted for 50-76% of the value of production), and in the case of conventional farms the total production costs were only slightly lower than total production value (accounted for 73-89%). What is important, the ratio of the amount of subsidy in relation to income from activity in the case of organic farms was relatively high (around 20-47%), which makes organic milk production more dependent on the financial support.

Conclusion

Among the EU countries, Poland has one of with the biggest organic land area, in which the permanent grassland have the largest share of. Despite good conditions for the development of animal production of ruminants the milk production is still a niche production in organic farms in Poland, only less than 1% of total number of dairy cows in Poland are keeping in organic farming system. In polish agricultural condition, farms with a small scale of milk production (especially in regions with lower intensity of agricultural production) may consider changing the method of farming to organic methods, which can greatly reduce production costs and increase income from activity due to subsidies to the organic sector. According to results of the survey in Agrokoszty system organic farms in a small scale of milk production achieved better economic results than in conventional farms at the same production scale, despite lower milk yields and lower selling milk prices, in general. In order to improve the price the milk production in organic farms should be more concentrated and then it could be a good conditions for the development for organic milk processing. Only in such cooperation the producers of organic milk can expect a premium prices for an organic milk (as in case other EU countries) and the dairies may expect a sufficient amount of organically produced milk for processing. In other way organic milk is sold to conventional dairies without any price premium. So far the organic production sector is still financially supported but producers of milk on organic farms should be aware of reliance only on supporting the income with subsidies.

References

- Augustyńska-Grzymek I. (editor) (2000). Metodyka liczenia nadwyżki bezpośredniej i zasady typologii gospodarstw rolniczych. FAPA, Warszawa. (Methodology of the calculation of the gross margin and the rules of the typology of agricultural holdings).
- EC raport (2013). Facts and figures on organic agriculture in the European Union, Agriculture and Rural Development, http://ec.europa.eu/agriculture/markets-and-prices/morereports/pdf/organic-2013_en.pdf [access on 04.2016].
- FiBL & IFOAM (2015): The World of Organic Agriculture 2015. Frick and Bonn, Europe: Current Statistics Organic Farming and Market Development in Europe.
- Offermann F., Nieberg H. (2000). Economic Performance of Organic Farms in Europe. Organic Farming in Europe: Economics and Policy, Stuttgart-Hohenheim.
- Radkowska I., Wpływ pastwiskowego systemu utrzymania na dobrostan krów mlecznych, Wiadomości Zootechniczne, Kraków 2012. (The impact of grazing system on the welfare of dairy cows).
- Skarżyńska A. (2011). Skala produkcji rolniczych działalności produkcyjnych a ich opłacalność. Roczniki Nauk Rolniczych, SERIA G, Warszawa. (The scale of production of agricultural production activities and their profitability).
- Żukowski K. 2009: Przyczyny wysokiego stopnia brakowania krów mlecznych. Wiadomości Zootechniczne, R. XLVII, 4: 67-86. (The reasons for the high degree of culling dairy cows).

USING MOISTURE CONTROLLING SUPERABSORBENTS FOR IMPROVEMENT OF BARLEY YIELD CAPACITY

Vyacheslav A. KUZNETSOV^{1*}, Maria. S. LAVLINSKAYA¹, Irina V. OSTANKOVA¹,
Victor N. SEMENOV¹, Vladimir F. SELEMENEV¹, Alexey L. LUKIN², Olga B.
MARAIEVA², Sergey N. SELYAVKIN², Denis E. SHEVTSOV¹.

¹Voronezh State University, Voronezh, Russia

²Voronezh State Agricultural University named after Emperor Peter I, Voronezh, Russia

*Corresponding author: dr.v.kuznetsov@gmail.com

Abstract

The article deals with an important issue of yield capacity improvement through using water retention agents. As a result of a laboratory experiment a special superabsorbent was developed as a moisture retention ingredient and successfully tested in the field conditions. The experimental part of the study focused on the development of cross-linked polymers including biodegradable nitrogen synthesized by free radical copolymerization, on polymers swelling kinetic and dependency of swelling rate versus cross-linking agent. The research describes the method and stages of obtaining superabsorbent containing microelements or humic acid. The superabsorbent was then tested in the laboratory and in an experimental micro plot in the territory of the Botanical Garden of the Voronezh State Agricultural University to verify its water retention characteristics and ecological efficiency. The sprouts and further development of the tested barley plants demonstrated a positive influence of the used superabsorbent. The obtained results clearly show the vivid advantages of the superabsorbent which can both contribute to sustaining the environment and enhance an increase in microorganisms promoting soil humification and mineralization. The research statistics show that using such type of absorbent definitely leads to growth in barley yield capacity without producing an undesirable impact on the local environment.

Keywords: *superabsorbent, humidity sorption, microbiological activity of the soil, barley yield.*

Introduction

One of the major objectives of the farmers of Black Earth Region is the further improvement of agrarian techniques and ensuring food safety in the region.

On account of the global climate changes we are faced with today, it seems extremely important to adapt the local arable farming to new natural and climatic conditions. These changes also require us to implement soil-protective and water-efficient farming techniques, involve using natural resources and consider using alternative crops, locally adapted species, high quality seeds, effective plant protection techniques, and apply complex fertilizers. This will ensure sustainable horticulture.

The major challenge for the regional farming, which is located in a risky zone, is that we enjoy favorable weather conditions only during three years out of five. Often, in the southern parts of the region snow melts at the beginning of March, and the soil is ready to be used only at the end of March. The moisture storage capacity before the sowing period starts is 70-80% of the required level. The lack of rainfall in May and June prevents crops from normal development, which badly affects plants in general. Consequently, spring crops have to be sowed in a very limited time period, so that the crops could effectively use the moisture supply in the soil (Lukin, et al., 2015, Malešević et al, 2010; Popović et al., 2011, Đekić et al, 2014).

Another problem farmers have to deal with is that field irrigation is often quite expensive and of little efficiency. Thus, one of the most effective ways to eliminate moisture deficiency in soil could be the application of water sorption materials, which are able to retain water. Such materials include polymeric superabsorbent, a great variety of which can be commercially obtained. However, all currently known polymeric superabsorbent are based on methacrylic acid derivatives, hence possessing a huge water sorption rate, which has significant disadvantages. First, they are characterized by longer half-life (up to 300 years). Also, the application of such products pollutes soil with some undesired components such as derivatives of polyethylene, which is the result of destruction of superabsorbent macrostructure. In order to decrease their polluting effects as well as anthropogenic influence on soil, it is important to obtain new eco-friendly polymeric materials, whose properties could both meet the needs of the farmers and contribute to the healthy environment rather than destroy it.

This study was aimed to obtain rare cross-linked polymer material based on biodegradable polymer which could both show superabsorbent properties and improve barley crop capacity.

Materials and methods

Synthesis of rare cross-linked polymer material is carried out by free radical copolymerization by ref. (Kuznetsov et al., 2016) with using redox initiator system ($\text{H}_2\text{O}_2\text{-Fe}^{2+}/\text{Ni}^{2+}/\text{Co}^{2+}$). In order to produce humic acids containing superabsorbent at the final step of polymerization, we added humic acids substance (4:1 mass ratio) to the reaction mixture.

FTIR spectra of the superabsorbent were recorded by Bruker Vertex 70 spectrometer. Swelling kinetic of all examples was carried out by gravimetric method. The sample of superabsorbent ($m=0.1$ g) was placed in flat-bottom flask containing 100 mL of water. The sample was removed from the flask every 15 minutes, then dried by filter paper and weighed during 5 hours.

To find out the effect of the superabsorbent on the soil characteristics and barley yield capacity, a micro-plot test was conducted in the territory of the Botanical Garden named after B.A. Keller (Voronezh State Agricultural University). The experimental variants were as follows: 1 – the control plot; 2 – the sorbent (the application rate - 200 kg/ha); 3- the sorbent (the application rate - 200 kg/ha).

The amount of ammonifying bacteria causing disintegration of proteins and their derivatives was defined on the basis of analysis of the bacteria colonies in meat-and-peptone agar (MPA). Starch-and-ammonia agar (SAA) was used to define the amount of amylolytic, or starch-splitting, microbiota involved in disintegration of non-nitrogenous compounds and at the same time providing for nitrogen. The catalase activity was analysed on the basis of well-established methods (Selyavkin, et al., 2015).

The experimental soil was leached medium-humic chernozem with a very higher containment of P and K, which classically makes it one of the most fertile soil types (Table 1).

Table 1. Agrochemical characteristics of the leached chernozem used in the experiment.

Amount of humus, %	pH KCl	mg-eq. per 100 g of soil		V, %	amount mg/kg	
		Hr	S		P ₂ O ₅	K ₂ O
3.25	5.53	5.6	27.3	80.2	165	94

Barley yield record was estimated on the basis of common methods (Maraeva et al., 2015).

Results and discussions

Polymeric materials with superabsorbent property containing biodegradable fragments were synthesized by free radical copolymerization with using redox initiator system. The ratio *biodegradable component: monomer: cross-linking agent* varied as follows: 0.05-0.2: 0.8-0.98: 0.05-0.005-0.1 mass. Rare cross-linked polymeric superabsorbent with different cross-linking degree was produced. The yield of polymerization products in all cases was quantitative. The wet products were dried in warm air flux.

In order to produce the superabsorbent type containing microelements Fe²⁺, Ni²⁺ and Co²⁺, metal salts were added to redox initiator system at the polymerization stage.

The structure of synthesized polymeric materials was confirmed by IR spectrum (Fig. 1). The IR spectrum contained absorption bands at 1647 и 1605 cm⁻¹ attributed to stretching vibrations C=O bond and bending vibrations of NH₂ group in amide fragment (Bellamy, 1964). The wide bands in range 3180-3300 cm⁻¹ showed the presence of OH and NH₂ groups of biodegradable fragment (Bellamy, 1964). We could observe the shifts of characteristic absorptions bands at adding microelements and humic acids to superabsorbent. It demonstrated the complexation between additives and functional groups of the polymeric materials.

Investigation of swelling kinetic was carried out by weight method. The swelling kinetic dependency versus cross-linking density can be seen in Fig. 2. It shows that as cross-linking density increases, the swelling decreases alongside swelling time rising. The swelling curves of polymeric materials with additives are represented in fig. 3. It was found that the presence of humic acids and microelements in polymer structure led to decreasing of swelling ability.

It should be also noted that synthesized hydrophilic superabsorbent preserves safe water uptaking properties at wide range of temperature from -40 to +40 °C, hence, it can be used in different climate zones.

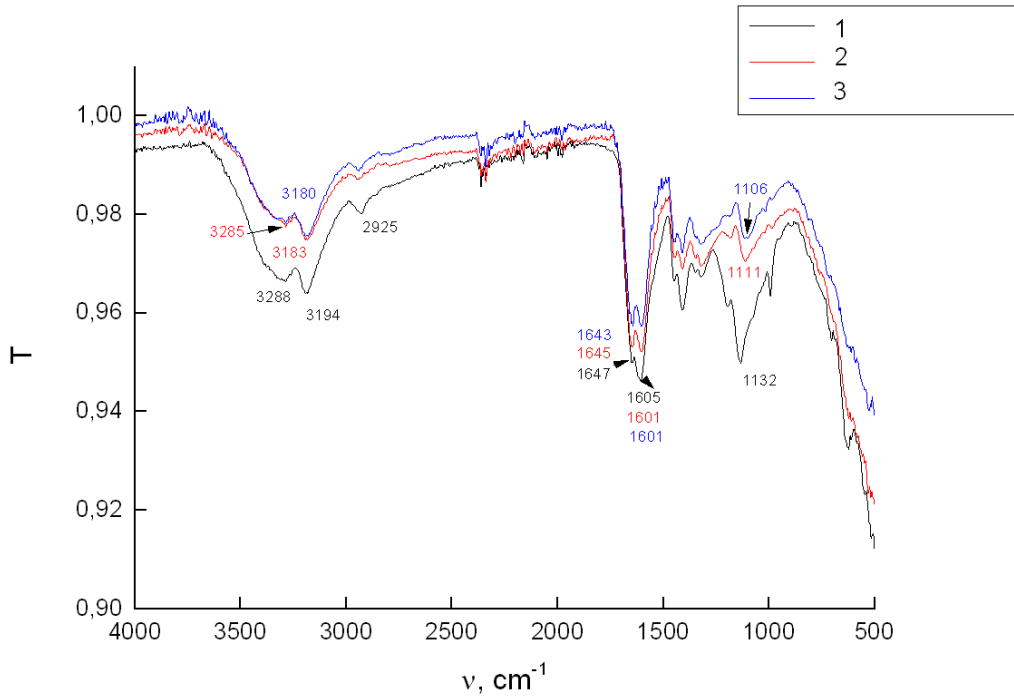

Fig.1. The IR-spectra of superabsorbent polymeric materials (1) with microelements (2) and humic acids (3).

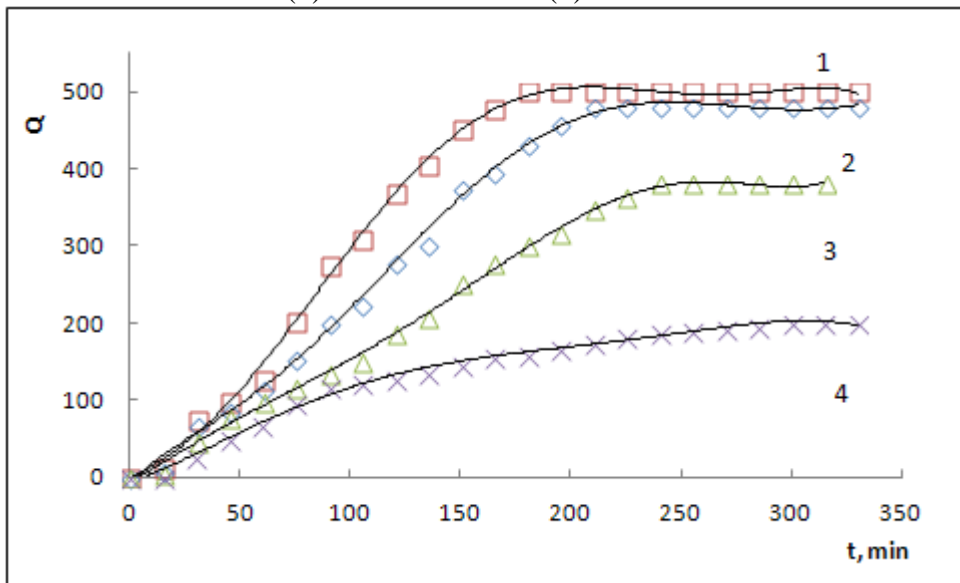

Fig. 2. The swelling kinetic dependency of polymeric material versus cross-linking density: 1 – 1% of cross-linking agent, 2 – 2 % of cross-linking agent, 3 – 5% of cross-linking agent, 4 – 10% of cross-linking agent.

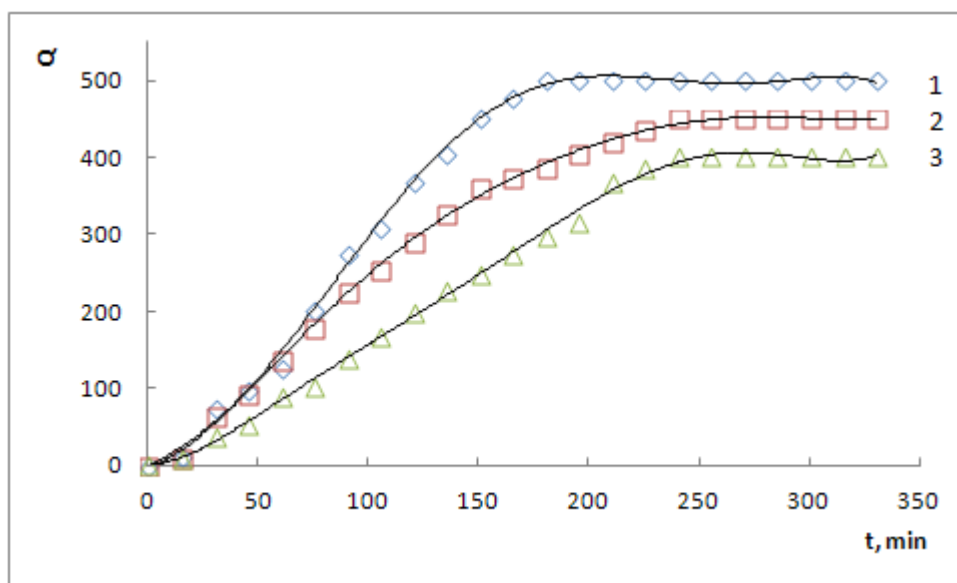

Fig. 3. The swelling curve of polymeric materials with additives: 1 – without additives, 2 – with microelements, 3 – with humic acids.

Having analyzed the super absorbent polymeric materials, we conducted a laboratory experiment aimed at defining its ability to retain water and give it off to the plant roots. The experimental amount of the superabsorbent was mixed with a sand substrate (200 kg/ha). Then the water was added at the actual ratio of water retention of 114% in regard to the control substrate sample. The figure below illustrates the results of seeds development on the 21st day.

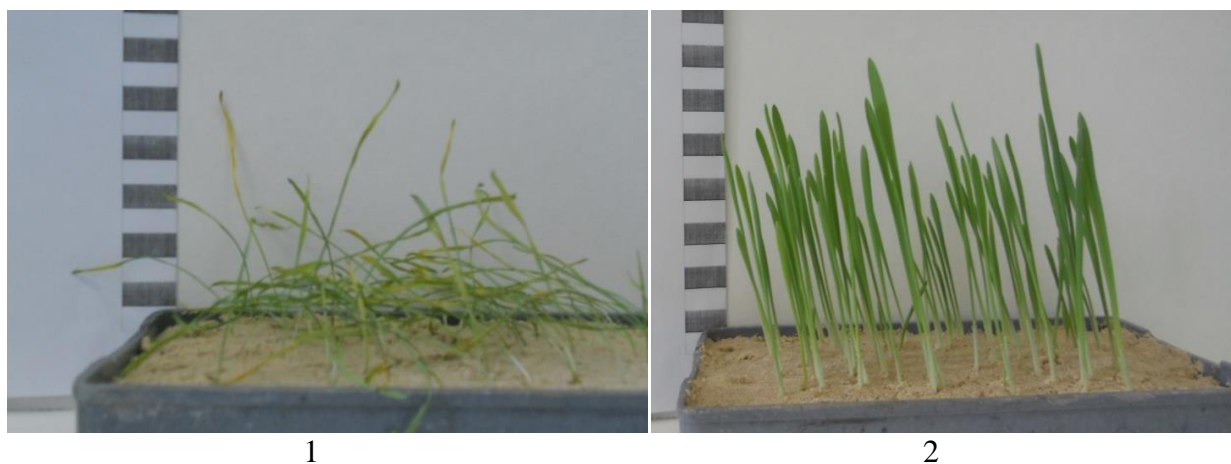

Fig 4. Barley plants on the 21st day: 1 – the control sample; 2 – substrate with the superabsorbent (200 kg/ha)

The obtained results clearly demonstrate that the superabsorbent undoubtedly contributes to the moisture retention, thus enabling the plants to resist unfavorable conditions. It was also discovered that the superabsorbent produces a non-toxic effect on soil. It neither pollutes the soil nor marshes it. At the end of their life the granules decompose into non-toxic components, releasing combined, fixed nitrogen, which then additionally functions as mineral fertilizer.

To evaluate possible toxic properties of the water extract from the experimental soil, we used a traditional method of phyto-testing. 100 g of fresh soil was weighed within an accuracy of 0.1 g, than placed into a 250 cm³ flask where 100 cm³ of distilled water was added. Next, the flask was shaken in a rotator for 2.5 hours. Finally, the ready suspension was filtered out, and

4 cm³ of the aliquot was taken for treatment of the prepared 165 seeds, all placed in special containers.

24 hours later 50 seeds, taken from each container, were placed in Petri dishes with three paper filters in each dish. 5 cm³ of distilled water was added to each dish. High quality seeds of garden radishes (the sort is called “French breakfast”) were used for the experiments, which were conducted in triplicate. The seeds were germinated in the environmental cabinet, or incubator, during 48 hours at 25°C.

Table 2 illustrates data on the effect of the soil extract on biometric characteristics of the radish seeds.

Table 2. Biological testing of soil

№	Variant	Replication	shoot	root
1	Water	1	0,74	2,70
		2	0,62	2,24
		3	0,58	2,23
		average	0,65	2,39
2	Sand	1	1,02	3,0
		2	1,18	2,92
		3	1,01	3,85
		average	1,07	3,25
3	Sand + superabsorbent	1	2,29	2,58
		2	2,42	2,62
		3	2,24	2,64
		average	2,31	2,61
HCP(0,5)			1,05	0,78

Table 2 demonstrates that the superabsorbent treatment of the seeds, as described above, produces a stimulating effect on them. The combination of the substrate with the superabsorbent increased the length of the shoots and roots by 1.66 mm and 0.22 mm, respectively, in comparison with the control sample.

In order to test the effect of the superabsorbent in the natural field conditions, it was placed in seed beds together with the barley seeds. The plants were not watered additionally. During different vegetation phases we collected samples to estimate the conventional degree of mineralization and then the amount of microorganisms (Table 2).

The variants treated with superabsorbent showed the increase in bacteria using mineral nitrogen. For example, during harvesting phase we could observe doubling of amylolytic microbiota (at the rate of 200kg/ha of the superabsorbent) in comparison with the control sample. There was also an increase in the amount of ammonifying bacteria in the soil treated with the superabsorbent. As is seen in Table 2, the value of the mineralization degree of the soil organics (SAA/MPA) is gradually decreasing in the phases of booting and harvesting. This indicates humification process and thus improvement of the soil productivity. As a result of application of the superabsorbent (200 tons/ha), the amount of the barley yield was 1,83 as high than the control yield.

Table 3. Microbiological soil activity (104 CFU\ 1g of absolutely dry soil) and barley yield capacity (tons/ha) during the period 2014-2015

N	Plant vegetation phase												YIELD CAPACITY
	tillering				booting				harvesting				
	MPA	SAA	SAA\MPA	CATALASE	MPA	SAA	SAA\MPA	CATALASE	MPA	SAA	SAA\MPA	CATALASE	
1	9	14	1,6	1,35	14	18	1,3	2,15	10	11	1,1	1,4	1,14
2	19	29	1,5	1,5	22	42	1,2	2,15	15	6	0,4	1,4	
3	7	23	1,3	1,5	20	23	1,2	2,3	23	24	1,0	1,45	2,10

Catalase - ml 0,1M KMnO4 per 1g of soil within 20 min

It is a well-known fact that catalase destroys hydrogen peroxide, which is toxic for plants and which is produced as a result of breathing and oxidation of organic compounds (Lukin, et al., 2015). The factors affecting catalase activity include organics, particularly, humus, temperature, moisture, etc. The obtained data show an increase in catalase activity at all stages of plant vegetation, especially during the booting phase (2.3). It is apparently connected with moisture retention in the root zone, due to which microorganisms can work more effectively. Naturally, the efficiency of the suggested techniques can be tested by estimating the yield capacity of the studied crops. The conducted experiment demonstrated the increase in the yield record, which was twice as much. That means an increase in nutrient availability for plants due to additional moisture retention in the soil.

Conclusions

The obtained data clearly show a highly positive effect of the application of hydrophilic superabsorbent. First, it contributes to moisture retention, which is extremely important for enhancing yield capacity. Also, it proved itself to be eco-friendly for developing plants. Finally, it enhances microbiological activity of the soil and thus the yield capacity of barley.

References

- Bellamy, L. (1964) The infra-red spectra of complex molecules. London: Methuen & Co. Ltd, New York: John Wiley & Sons, Inc.
- Đekić, V, Milovanović, M, Popović. V., Milivojević, J., Staletić, M, Jelić, M., Perišić, V. (2014). Effect of fertilization on yield and grain quality in winter triticale. Romanian Agricultural Research, Nardi Fundulea, Romania. Vol. 31, (2014) RAR.1-9. Print ISSN 1222-4227,
- Kuznetsov, V., Selemenev, V., Semenov, V., Bakalova, M. (2016) The method of producing hydrophilic cross-linked polymer with the superabsorbent properties. Patent of the RF № 2574722.
- Lukin, A., Maraeva O., Selyavkin S. (2015) Influence of plant organics on the fertility characteristics and biological yield of barley (case study) Ulyanov State Agricultural Academy Journal.. № 4 (32). p. 36-39.
- Malešević, M., Đ. Glamočlija, N. Pržulj, Vera Popović, S. Stanković, T. Živanović, Angelina Tapanarova (2010): Production characteristics of different malting barley genotypes in intensive nitrogen fertilization. „Genetika“ Belgrade, Vol. 42, No.2, 323-330. DOI:

- 10.2298/GENSR1002323M Maraeva O., Lukin A. (2015) Influence of the biological fertility on the barley yield
- Maraeva, O., Lukin A. (2015) The influence of microbiological fertility on barley yield. In the book: Genetic integration of procaryote and eykaryote: fundamental studies and modern technology in agriculture. p. 90.
- Popović, V., Đ. Glamočlija, M. Malešević, J. Ikanović, G. Dražić, M. Spasić, S. Stanković (2011): Genotype specificity in nitrogen nutrition of malting barley, Genetika Belgrade, . 43, 1, 197-204. DOI: 10.2298/GENSR1101197P
- Selyavkin S., Maraeva O., Lukin A. (2015) Microbial and enzymic activity used for evaluation of biological soil condition Voronezh State Agricultural University Journal. № 2 (45). p. 36-39.

HOMEOPATHIC EXTRACTS INFLUENCE ON FRUIT QUALITY OF TOMATOES (*SOLANUM LYCOPERSICUM* MILL.)

Rasa KARKLELIENĖ*, Danguolė JUŠKEVIČIENĖ, Audrius RADZEVIČIUS, Pranas VIŠKELIS, Audrius SASNAUSKAS

Institute of Horticulture, Lithuanian Research Centre of Agricultural and Forestry Science, Kaunas distr., Lithuania

*Corresponding author: r.karkleliene@lsdi.lt

Abstract

Investigation was carried out at the Institute of Horticulture, Lithuanian Research Centre for Agriculture and Forestry in 2012-2013. The object of investigation was tomato cultivars – Slapukai BS, Balčiai, Viltis. Plants were sprayed with homeopathic extracts – Silicea (two times in early plant growing stage) and Carbo vegetabilis (two times at the middle of plant vegetation) of different solution concentrations (dilution rate: *Si6 + CV6*; *Si30 + CV30*; *Si200 + CV200*). The solutions were sprayed every 10 days. The obtained results showed that the preparations influenced the yield and biochemical composition of tomato fruit. It was determined that plants sprayed with the homeopathic extracts *Si30+CV30* formed the highest yield (10.2-11.8 kg m⁻²). The average amount of soluble solids in the tomatoes fruit reached 4.3-4.5%. The highest amount of ascorbic acid (19.33 mg 100g⁻¹) was detected in the fruit of cultivar Balčiai, which was sprayed with homeopathic extracts *Si30+CV30* and *Si200+CV200*. Our results showed that the highest amount of lycopene (7.34 mg 100g⁻¹) and (1.034 mg 100g⁻¹) β-carotene was detected in fruits of cultivar Viltis. The highest amount of total sugar (5.01%) and less acidity (0.63%) were detected in cultivar Slapukai BS.

Keywords: *biochemical composition, extracts, yield, fruit, quality.*

Introduction

Tomato fruits are rich in soluble sugars, organic acids, minerals, carotenoids and other valuable substances (Johnson *et al.*, 1998; Radzevičius *et al.*, 2009). At present time, people are more interested in the environmental problems caused by agricultural activities; special attention is focused on the health risks related to the use of various chemical substances. Therefore, it is very important to choose the right plant growing technologies (Bettiol *et al.*, 2004). There are some research has been done according to different tomato growing techniques. Studies in Poland have shown that the organic tomatoes accumulated more total sugars and ascorbic acid but had less amount of lycopene compared to tomatoes growth under intensive growing technology (Hallmann and Rembalkovska, 2007). Yield quality of fruiting vegetables and are determined by the growing conditions and technology, cultivars resistance and other aspects (Dorais *et al.*, 2001; Survilienė and Duchovskienė, 2008). Fruiting vegetables, growth under Lithuanian climatic conditions, are more susceptible to various diseases, which leads to the harvest losses. Tomato cultivation becomes unprofitable, and researches are focused on the tomato yield and quality improvement using plants extracts. Influence of fertilization and growing condition to the tomato yield and biochemical composition were investigated in alternative cropping systems (Tample *et al.*, 2000). Klocke and Baumgartner (2009), Sakalauskiene *et al.* (2012) reported, that using various plant extracts may vary photosynthesis in plants and other processes. It is known that the effectiveness of photosynthesis process in plants depends on the optimal temperature conditions, but there is a lack of knowledge about the biochemical processes of

photosynthesis changes according to the use of homeopathic and botanical extracts. Homeopathic remedies acting whole symptoms at time heals organism. Such treatment helps the body to recover itself, to preserve the nutritional properties of the plants. Homeopathy is a promising alternative to the use of the chemical substances, because homeopathic material is non-toxic and does not pollute the environment (Kaviraj, 2006).

The aim of investigation is to evaluate homeopathic extracts impact on the tomato fruit quality and yield.

Material and Methods

Investigation was carried out at the Institute of Horticulture, Lithuanian Research Centre for Agriculture and Forestry in 2012-2013. Plants were sprayed with homeopathic extracts – Silicea (two times in early plant growing stage) and Carbo vegetabilis (two times at the middle of plant vegetation) of different concentration solutions (dilution rate: *SI6 + CV6*; *SI30 + CV30*; *SI200 + CV200*). Silicea - mineral homeopathic treatment made of *Acidum Silicicum* (silica, H_2SiO_3). Carbo vegetabilis - organic homeopathic treatment, made of birch wood charcoal. Solutions were sprayed 4 times in every 10 days; the first spray was performed after 15 days after planting. The object of investigation was tomato cultivars – Slapukai BS, Balčiai, Viltis.

Slapukai BS – fertile, moderately resistant to disease, medium early, deterministic type tomato cultivar. The fruits are red, flat round, medium-sized and good taste. Unripe fruits are dark green with a green shoulder on the peduncle.

Viltis – early deterministic type tomato cultivar. Ripen fruits are red coloured with a good (sweetish) taste, flat round, fleshy, multi seed-beds. Unripe tomato has a green shoulder.

Balčiai – medium early, deterministic type cultivar. The fruits are red, flat round, medium-sized and have a good taste. The unripe fruit is light green colour, without green shoulder at the base.

Seedlings were planted in natural soil in polyethylene non-heated greenhouse on the 5th of June in 2012 and on the 6th of June in 2013. Tomatoes were growing according planting system 0.3X0.7 m. Record field area was 2.1 m². The experiment was conducted in three replications. Biochemical analysis were performed with fully ripen fruits on the 18-21th of August. After assessment of total yield, the economic efficiency of homeopathic extract (Y) was calculated using the formula:

$$(Dabkevičius and Brazauskienė, 2007): Y = \frac{b - a}{a} \cdot 100;$$

b – yield of variant with homeopathic treatment; a – yield of variant without homeopathic treatment.

Biochemical parameters were established in fresh weight (f.w.) of tomatoes at the Laboratory of Biochemistry and Technology of LRCAF Institute of Horticulture. The amount of was determined total sugar by Bertrane method, soluble solids by a numeric refractometer and ascorbic acid (vitamin C) was determined by titration with the indicator 2,6-dichlorophenolindophenol sodium Natrium solution (AOAC, 1990). Carotenoids (β -carotene and lycopene) content was determined spectrophotometrically according to Scott (Scott, 2001). The results mathematically processed using Microsoft Excel (Tarakanovas and Raudonius, 2003). Reliability of the data was evaluated using statistical software "Anova".

Meteorological conditions. In 2012 y. June's average temperature was 1.3 °C lower and in 2013 - 2.1 °C higher than the standard rate of climate (SRC), so in 2013 tomato plants were stronger and had more bunches. In 2012-2013 July's average temperature was 17.6-19.6 °C (1.5-3 °C higher (SRC), and the sun shine duration reached 265-295 hours (which is 25-40 hours more than SRC). 2012 August's average temperature was 15.6-18.2 °C in 2013 -16.4-18.6 °C and were close to the standard climate rate (16.4-17.0 °C). In 2012 y. sunshine

duration decreased up to 25-40 hours compared with 2013 and SRC, so it caused prolonged tomato fruit ripening process and slightly reduced the amount of sugar in tomatoes. The average temperature of September in 2012 and 2013 was close to the standard climate rate (LHMT data base).

Results and Discussion

Two years investigation and evaluation of tomato total yield showed that the most productive variety was Balčiai, where produced total yield varied from 10.9 up to 11.8 kg m⁻². Meanwhile, total yield of variety Viltis varied from 9.9 up to 11.6 kg m⁻² and total yield of tomato variety Slapukai BS varied from 9.5 up to 10.9 kg m⁻². Previous research results confirm that the total tomato yield depend not only on the selected plant growing technology, but also is determined by the features of chosen cultivar (Radzevičius *et al.*, 2009). According to obtained data of this investigation, it was established positive effect of used preparations on total yield increase in all investigated cultivars. Tomato fruit yield depends on plant health. One of the most damaging plant diseases is *Phytophthora infestans*, which reduces tomato yield. For this purpose, in order to slow down negative effect of *Phytophthora infestans*, homeopathic extracts were used in this experiment. Researcher's data showed that this disease reduces harvest of different vegetables over 50 percent (Survilienė and Duchovskienė, 2008). It is very difficult to stop and control the spread of *Phytophthora infestans* due to the fungus biological characteristics – develops a resistant strain of the fungus (race) to fungicides. Particular attention must be paid to the greenhouse microclimate control, agro-technical and phyto-sanitary measures. The economic efficiency was calculated in order to evaluate effectiveness of homeopathic extracts. Tomato plants sprayed with Si30 + CV30 concentration solution provided maximum economic efficiency (4.72-11.71%) among all tested tomato cultivars (Table 1).

Table 1. Homeopathic extracts effectiveness on tomatoes, Babtai, 2012–2013

Years/Cultivar	Economical effectiveness of homeopathic extracts, %			
	Si6 + CV6	Si30+CV30	Si200+CV200	mean
Balčiai				
2012	4.72	4.72	0.94	3.46
2013	5.4	11.71	2.7	6.6
mean	5.06	8.22	1.82	5.03
Viltis				
2012	6.82	11.36	1.14	6.44
2013	1.82	5.45	1.82	3.03
mean	4.32	8.4	1.48	4.73
Slapukai BS				
2012	3.26	9.78	6.52	6.52
2013	5.1	8.16	7.14	6.8
mean	4.18	9.97	6.83	6.99
Mean cultivars	4.52	8.64	3.38	5.51

Biochemical composition is the most important feature of all the tomato quality attributes, because it determines fruit taste and aroma. Nutrition value of tomato fruit is mainly determined by environmental conditions and by cultivar features (Beckles, 2011). Tomato fruit colour essentially depends on content of lycopene and β-carotene, as well as their concentration and distribution also plant-growing conditions and genetic nature can have a significant impact on the lycopene content in tomato fruits (Tomlekova *et al.*, 2007). In investigation, red fruit colour cultivars were selected. In the red tomatoes, lycopene content consists up to 80-90 percent of the total carotenoids amount (Heinonen *et al.*, 1989). Our results showed that the highest amount of lycopene (7.34 mg 100g⁻¹) was detected in fruits of

cultivar Viltis. Meanwhile, lycopene amount in tomato fruits cultivar Slapukai BS varied from 5 up to 6.24 mg 100 g⁻¹ and in tomato fruits cultivar Balčiai – 5.83-6.9 mg 100 g⁻¹ (Fig. 1A). Similar results were obtained on other investigations, where average amount of lycopene in different tomato cultivars in different years varied from 7.8 up to 8.6 mg 100 g⁻¹ (Radzevičius et al., 2009). Plants sprayed by Si6+CV6 concentration solution showed positive effect on the amount of lycopene in all investigated varieties. According to our investigation, the amount of β-carotene content in tomato fruits ranged from 0.78 up to 1.13 mg 100 g⁻¹ (Fig 1B). Amount of this carotenoid is mainly determined by the plant genetic factors and cultivar characteristics, and usually it ranges from 0.33 up to 11.2 mg 100 g⁻¹ (Adalid *et al.*, 2010). Spraying plants Si6+CV6 concentration solution obtained β-carotene in the fruit. Various concentrations of homeopathic extracts increased β-carotene content of tomato fruit. Plants sprayed by Si6+CV6 concentration solution showed positive effect on the amount of β-carotene.

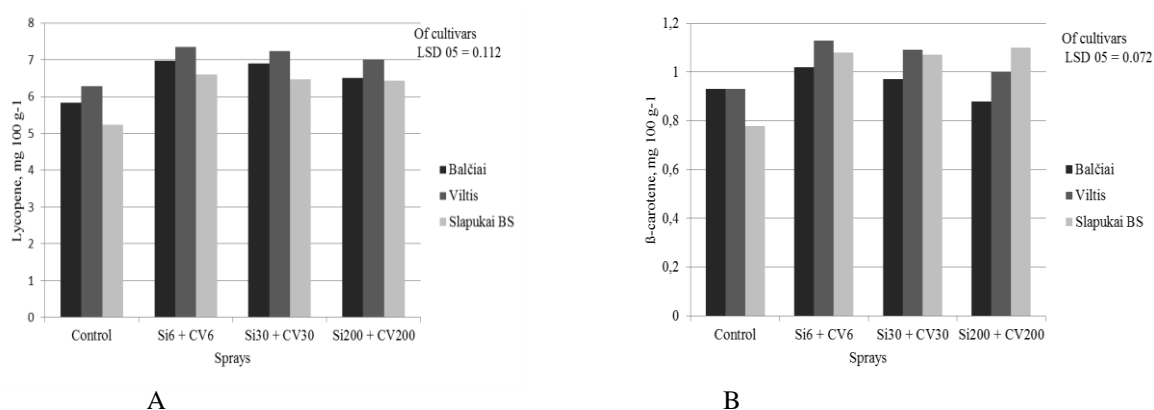

Fig 1. Amount of Lycopene (A) and β-carotene (A) in tomato fruit, Babtai, 2012-2013

Tomato fruit taste mainly depends on its content of sugar, acids and their ratio. The higher amount of sugars gives sweeter and more pleasant taste for tomato fruits (Malundo *et al.*, 1995). The highest amount of total sugar (5.01%) and less acidity (0.63%) were detected in cultivar Slapukai BS (Table 2). The lowest amount of total sugar was found in cultivar Viltis (4.63–4.74 %) and their titratable acidity reached 0.75–0.90%. Plants sprayed by Si6+CV6 solution showed positive effect on the amount of total sugar and reduced titratable acidity in tomato fruits.

Ascorbic acid and soluble solids content in tomato fruits are not constant; they are mostly determined by growing conditions and plant varieties. An average amount of ascorbic acid in tomato fruits varies from 10 up to 20 mg 100 g⁻¹. Many factors contribute to this variation, but environmental growing conditions and cultivar have been reported as having major effects on the ascorbic acid composition (Stern *et al.*, 1994; Radzevičius *et al.*, 2009). According to data of our investigation, the highest amount of ascorbic acid (17.29-19.71 mg 100 g⁻¹) was detected in fruits of cultivar Balčiai (Table 3). The similar results were obtained by the previous researches, where amount of ascorbic acid in tomatoes reached 18.8 mg 100 g⁻¹ (Radzevičius *et al.*, 2009). Our investigation showed that homeopathic extracts of different concentration had positive impact on the amount of ascorbic acid in tomato fruits. The soluble solids content determines vegetables nutritional value and affects their storage time and quality during storage (Radzevičius *et al.*, 2009; Karklelienė *et al.*, 2014). Soluble solids content is an important factor determining tomato fruit quality. The amount of soluble solids in ripe tomatoes range between 4 and 6% (Dorais *et al.*, 2001; Radzevičius *et al.*, 2016). That confirmed our results while the smallest quantity of these substances set out in a cultivar Balčiai - 4.02% and the largest amount was detected in cultivar Viltis - 4.56% (Table 3).

Homeopathic extracts had no reliable influence on the amount of soluble solids in all investigated variants.

Table 2. Amount of total sugar and titratable acidity in tomato fruit, Babtai, 2012-2013

Treatments	Cultivars							
	Balčiai		Viltis		Slapukai BS		Cultivar mean	
	total sugar, %	titratable acidity, %	total sugar, %	titratable acidity, %	total sugar, %	titratable acidity, %	total sugar, %	titratable acidity, %
I	4.68±0.02	0.76±0.02	4.63±0.02	0.90±0.03	4.77±0.02	0.70±0.05	4.69	0.79
II	4.83±0.04	0.64±0.02	4.74±0.03	0.75±0.02	5.01±0.03	0.63±0.02	4.86	0.67
III	4.76±0.03	0.72±0.03	4.72±0.03	0.85±0.02	4.96±0.03	0.66±0.03	4.81	0.74
IV	4.75±0.03	0.72±0.03	4.70±0.02	0.78±0.02	4.76±0.02	0.64±0.02	4.74	0.71
V	4.76	0.71	4.70	0.82	4.88	0.66	4.78	0.73

Treatments: I-control (without sprays); II- sprayed with *Si6* + *CV6*; III-sprayed with *Si30* + *CV30*; IV-sprayed with *Si200* + *CV200*; means of cultivar

Table 3. Amount of ascorbic acid, dry matter, soluble solids in tomato fruit, Babtai, 2012-2013

Sprays	Tomato cultivars			
	Balčiai	Viltis	Slapukai BS	mean
Ascorbic acid, mg 100g ⁻¹				
Control	17.29±0.45	16.67±1.24	17.50±0.46	17.15
<i>Si6</i> + <i>CV6</i>	19.51±0.63	16.93±0.68	17.95±0.95	18.13
<i>Si30</i> + <i>CV30</i>	19.71±0.31	17.90±0.61	18.52±0.96	18.71
<i>Si200</i> + <i>CV200</i>	18.95±0.73	17.64±1.05	18.10±1.05	18.23
Mean	18.87	17.29	18.02	18.06
Soluble solids, %				
Control	4.28±0.12	4.23±0.25	4.11±0.18	4.21
<i>Si6</i> + <i>CV6</i>	4.02±0.15	4.50±0.22	4.21±0.27	4.24
<i>Si30</i> + <i>CV30</i>	4.11±0.16	4.54±0.33	4.16±0.20	4.27
<i>Si200</i> + <i>CV200</i>	4.24±0.13	4.56±0.35	4.10±0.31	4.30
Mean	4.16	4.46	4.14	4.26

Conclusions

Results of investigation prove a positive effect of used preparations on total yield increasing in all cultivars. Total yield varied from 9.5 up to 11.8 kg m⁻². Different concentration of homeopathic extracts solutions *Silicea* and *Carbo vegetabilis* have positive impact for the tomatoes growing parameters. Tomato sprayed with *Si30* + *CV30* solution provided maximum economic efficiency (4.72-11.71%) among all tested tomato cultivars. Homeopathic extracts of different concentration had reliable impact on the amount of lycopene and β -carotene, ascorbic acid in tomato fruits. Plants sprayed by *Si6*+*CV6* solution showed positive effect on the amount of total sugar and reduced titratable acidity in tomato fruits. Homeopathic extracts had no reliable influence on the amount of soluble solids in all investigated variants.

References

- Adalid AM, Roselló S, Nuez F. (2010). Evaluation and selection of tomato accessions (*Solanum* section *Lycopersicon*) for content of lycopene, β -carotene and ascorbic acid. *J Food Compos Anal* 23(6):613-618.
- AOAC. Official Methods of Analysis. (1990). Helrich, K. (Ed.). Arlington, Virginia. 1298 p.
- Beckles D.M. (2011). Factors affecting the postharvest soluble solids and sugar content of tomato (*Solanum lycopersicum* L.) fruit. *Postharvest Biology and Technology*, 63(1): 129–140.
- Bettiol W., Ghini R., Galvao J. A. H., Siloto R. C. (2004). Organic and conventional tomato cropping systems. *Sci. agric.* 61(3): 253–259.
- Dabkevičius Z., Brazauskienė I. (2007). Plant pathology, Klaipėda. IDP Solution, 493 p (in Lithuanian).
- Dorais M., Papadopoulos M. A., Gosselin A. (2001). Greenhouse tomato fruit quality. *Horticultural reviews*, 26: 239–319.
- Hallmann E., Rembalkowska E. (2007). Comparison of the nutritive quality of tomato fruits from organic and conventional production in Poland. Proceedings of the 3rd International Congress of the European Integrated Project 'Quality Low Input Food' (QLIF). University of Hohenheim, Germany. 131-134.
- Heinonen M. J., Ollilainen V., Linkola E. K., Varo R., Koivisto P. E. (1989). Carotenoids in Finnish Foods: vegetables, fruits and berries. *Journal of Agricultural and Food Chemistry*, 37: 655-659.
- Johnson H. E., Salter G. J., Smith A. R., Hall M. A. (1998). Tomato growth and fruit quality in soilless culture. *Acta Horticulture*, 491: 337-342.
- Karklelienė R., Dambrauskienė E., Juškevičienė D., Radzevičius A., Rubinskienė M., Viškelis P. (2014). Productivity and nutritional value of dill and parsley *Horticultural Sciences* (Prague), 41(3): 131-137.
- Kaviraj D. V. (2006). Homeopathy for Farm and Garden. Mark Moodie Publications, Oaklands Park, Newnham-on-Severn, Gloucester, UK.
- Klocke P., Baumgartner S. (2009). Use of homeopathic preparations in experimental studies with healthy plants. *Homeopathy*, 98: 228–243.
- Malundo T. M. M., Shewfelt R. L., Scott J. W. 1995. Flavor quality of fresh tomato (*Lycopersicon esculentum* Mill.) as affected by sugar and acid levels. *Postharvest Biology and Technology*, 6 (1-2):103-110.
- Radzevičius A., Karklelienė R., Bobinas Č., Viškelis P. (2009). Nutrition quality of different tomato cultivars. *Žemdirbystė-Agriculture*, 96 (3): 67-75.
- Radzevičius A., Viškelis J., Karklelienė R., Juškevičienė D., Viškelis P. (2016). Determination of tomato quality attributes using near infrared spectroscopy and reference analysis. *Žemdirbystė-Agriculture*, 103 (1): 91–98.
- Sakalauskienė S., Karklelienė R., Radzevičius A., Bobinas C., Brazaitytė A., Sakalauskaitė J., Viškelis P., Samuolienė G., Duchovskis P., Pinikienė J. (2012). Effect of *Ocimum basilicum* L. biological preparation on tomato fruit quality grown in greenhouse. *Acta horticulturae* (ISHS), 952: 821-825.
- Scott K. J. (2001). Detection and measurement of carotenoids by UV/VIS spectrophotometry. *Current Protocols in Food Analytical Chemistry*. Inc., F.2.2.1-F.2.2.10.
- Stern D. J., Buttery R. G., Teranishi R., Ling L., Scott K. J., Cantwell M. (1994). Effect of storage and ripening on fresh tomato quality. *Food Chemistry*. 49(3):225-231.
- Survilienė E., L. Duchovskienė. (2008). Topicality of researches of harmful organisms in vegetable crops. *Sodininkystė ir daržininkystė*, 27 (3): 313–325 (in Lithuanian).

- Tarakanovas P., Raudonius S. (2003). Agronomic research, statistical analysis using computer programs ANOVA, STAT, SPLIT-PLOT from program package SELEKCIJA and IRRISTAT, 56 p. (in Lithuanian).
- Temple S. R., Hsiao T. C., Poudel D. D. (2000). Soil physical properties and tomato yield and quality in alternative cropping systems. *Agronomy Journal*, 92:924-932.
- Tomlekova N., Antanassova B., Baraljeva D., Ribarova F., Marinova D. (2007). Study on the variability of lycopene and β -carotene content in tomato (*Lycopersicon esculentum* Mill.). *Acta Horticulturae*, 729: 101-104.

EFFECT OF ORGANIC PRIMING ON SEEDLING EMERGENCE OF WATERMELON UNDER LOW TEMPERATURE STRESS

Kazım MAVİ¹, Mehmet ATAĞ²

¹Mustafa Kemal University, Faculty of Agriculture, Department of Horticulture 31034 Hatay / TURKEY

²Mustafa Kemal University, Faculty of Agriculture, Department of Field Crops 31034 Hatay / TURKEY

Abstract

Seed priming is a pre-sowing treatment in which seeds are exposed to an external water potential that is low enough to restrict germination by various agents (i.e. polyethylene glycol, potassium nitrate, vermiculite) but permits pre-germinative physiological and biochemical activities. Seeds of watermelon (*Citrullus lanatus* (Thunb.) Matsum. & Nakai.) cv. Crimson sweet were primed with leonardite (30 g moistened with 25 ml distilled water, 25 °C, 24h); waste tea (12 g waste tea moistened with 40 ml distilled water, 25 °C, 24h), potassium nitrate (KNO₃, 3%), polyethylene glycol, (PEG-6000, -1.25 MPa), and patula herbal tea (2 and 10 g dried petal / L) along with hydropriming and unsoaked control to study the effect of seed priming. The seed priming significantly increased the rate of as well as percentage of seed germination. Further, survival of primed seedlings was better than those of control seeds subjected to low temperature (15 °C) and greenhouse optimal condition (25 °C). Although priming agents weren't positive effect in germination stage, they showed higher performance in greenhouse condition. Especially, emergence percentage of watermelon seeding subjected to waste tea, leonardite, and patula were higher than control and others agents in greenhouse condition. In addition, the low temperature emergence performance of leonardite primed seeds was better than control. Organic seed priming with leonardite, waste tea and patula was a cost-effective and eco-friendly approach to develop low temperature emergence in watermelon cv. Crimson sweet.

Keywords: *Abiotic stress, germination, priming agents, seed treatment*

Introduction

Watermelon is a summer vegetable species which is established by transplanting seedlings in early spring in open fields, or in late summer into protected cultivation. It is one of the most important vegetable crops in the Turkey and classified as sensitive to low temperature stress. Low temperature can lead to asynchronous seedling emergence after the sowing of many warm season vegetables like a watermelon. However, various treatments have been shown to improve seedling performance at low temperatures. These include chemical treatments (Nelson and Sharples, 1980), osmoconditioning (Sachs, 1977; Demir and Van De Venter, 1999; Park et al. 2016), hidropriming (Sachs, 1977; Demir and Van De Venter, 1999), salt priming (Demir and Oztokat, 2003), plant growth regulators (Nelson, et al 1985; Korkmaz, et al., 2004), but they did not use any organic priming agents.

Today the environmental issues and concerns are growing rapidly as humans advance their technology and pursue industrial development across the globe. Organic farming has been put forward as a positive response to these issues and concern by encouraging the organic material use at all stages of farming. Organically produced seeds and seedlings of crops should be used in organic farming, i.e. seeds should not be treated with synthetic materials like pesticides, pelleting and priming agents. The use of organic materials for increasing seed germination rate and uniform seedling emergence has gained importance in the recent years. Different organic materials, such as, seaweed, humic acid and fulvic acid, *Moringa oleifera*

leaf extract, herbal tea of marigold flower and grapefruit juice were investigated as possible priming agents (Mavi, 2014).

Seed priming is promoted as being simple and effective due to shortening of the time from sowing to emergence in optimal and suboptimal conditions such as low temperature stress. There are many agents that can be used for priming watermelon seed but most of these are not cost effective and eco-friendly. Therefore, this study was conducted to investigate different priming agents for low temperature stress and optimal condition of watermelon cv. Crimson Sweet seeds in regard to better emergence and lower mean emergence time.

Materials and methods

Watermelon (*Citrullus lanatus* (Thunb.) Matsum. & Nakai.) cv. Crimson sweet) seed lot was obtained from commercial seed company in Turkey. Lot had 81% of initial standard laboratory germination percentages (ISTA, 2009). All organic priming agents were performed by placing 150 seeds in 15 cm Petri dishes. The seeds were allowed to imbibe water for 24 h at 25 °C in the dark. The seeds were primed with leonardite (LEO, 30 g moistened with 25 ml distilled water, 25 °C, 24h); waste tea (TEA, 12 g waste tea moistened with 40 ml distilled water, 25 °C, 24h), potassium nitrate (KNO₃, 3%), polyethylene glycol, (PEG-6000, -1.25 MPa), and patula herbal tea (PAT, 2 and 10 g dried petal/L, Mavi and Matthews, 2013) along with hydropriming (HYDRO) and untreated control to study the effect of seed priming.

After the treatments, standard germination test was conducted by keeping 3 × 50 seeds in rolled germination paper (20 × 20 cm) for 14 days at 25 °C. Mean germination time (MGT) (Ellis and Robert, 1980) was calculated by daily counting.

To determine the effect of priming treatments on emergence under low temperature stress (15 °C) and optimal condition (25 °C), seeds were sown at depths of 1-2 cm in peat moss (Klasman, Germany). Three replicates of 50 seeds per treatment were sown in the peat moss in aluminum containers (30 × 19 × 5 cm). While seedlings at low temperature condition were grown in the growing cabinet at 15 °C for 35 days, optimal condition seedlings were grown in greenhouse at 25 °C for 35 days. The appearance of the hypocotyl hook on the compost surface was used as an emergence criterion and emerged seedlings were recorded by daily. To find out the effect of the treatments on uniformity, mean emergence time (MET) (Ellis and Robert, 1980) were calculated.

One-way analysis of variance (ANOVA) was conducted on all data and means were separated with Duncan's multiple range tests at 5% level. Percentage values were arcsine transformed prior to analysis, and SPSS was used for all statistical procedures.

Results and discussion

Germination and mean germination time(MGT)

Germination percentages of watermelon were used for comparison of treated and untreated seeds. TEA primed seeds reached to 89%, while untreated seeds had 81% germination percentage. KNO₃ primed seeds showed 77% germination percentages. But all primed agents were not statistically significant (Fig. 1A). Similar results have been reported different cultivar of watermelon in 25°C germination test conducted by Demir and Van De Venter (1999). Depending on the watermelon cultivar, germination rate under low temperature (15°C) was improved by up to 15~66% in primed seeds, as compared to untreated seeds (Park, et al. 2016).

The difference between treated and untreated seed for mean germination time (MGT, days) was statistically significant. The treatments PEG, and control took maximum time of 4.01-3.88 days for germination. These treatments were statistically similar. The lowest MGT (3.00 days) was obtained by the TEA primed watermelon seeds. The MGT of HYDO primed seeds

was 3.15 days and KNO₃ primed seeds was 3.23 days. All of these treatments (TEA, HYDRO and KNO₃) were in same statistically group (Fig. 1B).

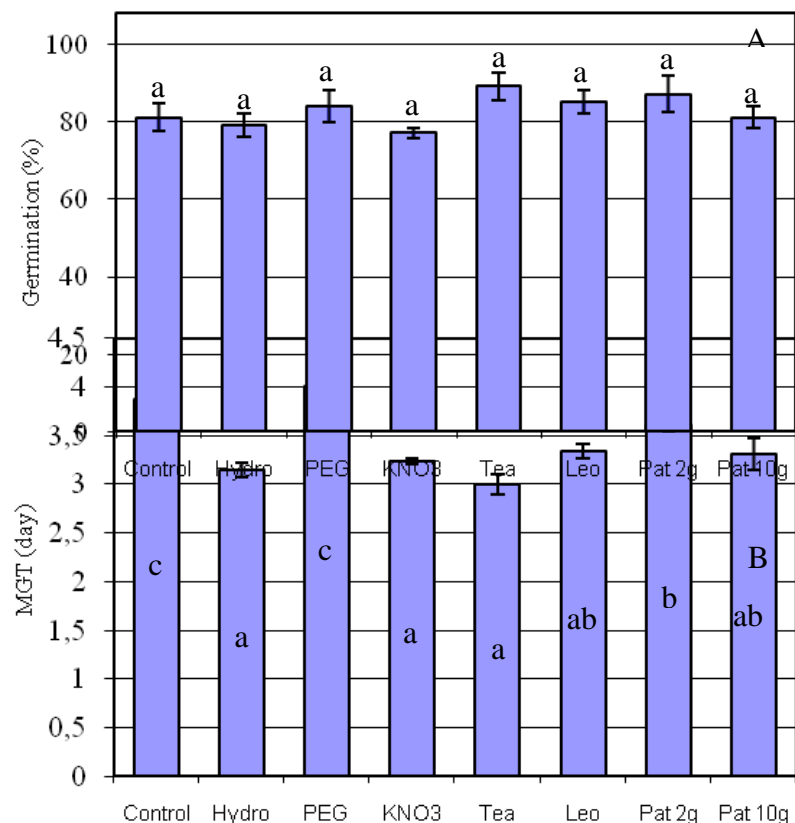

Fig. 1. Effects of priming treatments on total germination (A) and mean germination time (B) of watermelon seeds lot

Emergence and mean emergence time(MET)

The primed seeds emerged earlier and maintained a higher level of emergence throughout the emergence period in optimum conditions (Fig. 2A). Final emergence percentages of untreated seeds were significantly lower than each organic primed seeds in emergence tests. TEA primed seeds showed 73% emergence percentages. The maximum and significant ($P < 0.05$) advancement from priming was obtained in primed seeds in which, unprimed seeds had 50% emergence but corresponding values were 73% (TEA), 72% (PAT, 10g) and 70% (PAT, 2g), in organic primed seeds grown in optimal condition, respectively (Fig 2A). Supporting this finding, Mavi and Matthews (2013) found that PAT treatment increased emergence percentage of aubergine (*Solanum melongena*) seeds. TEA is also showed good performance for matrix priming.

MET decreased when the seed primed with TEA and PAT in optimal condition and was at minimum value of 23.2 daya in control and 21.4 days in TEA and PAT organic primed seeds in optimal condition, respectively (Fig 2B).

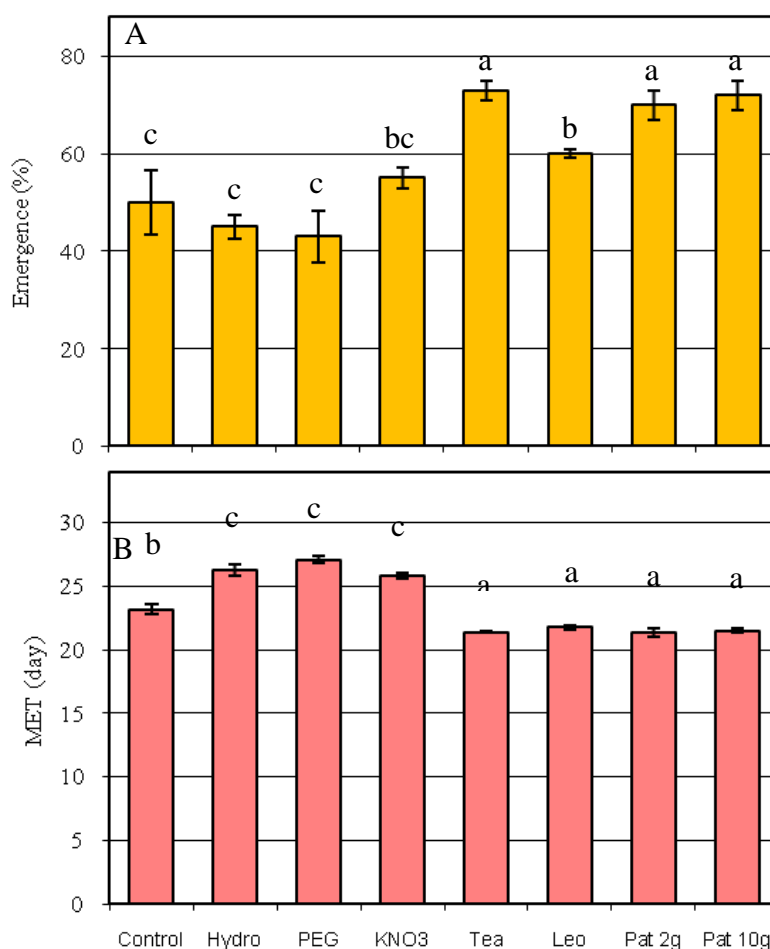

Fig. 2. Changes in emergence percentages (A) and mean emergence time (B) of watermelon seeds following various priming treatments

Low temperature emergence and mean emergence time

Analyses of variance showed that priming treatments were significant ($P < 0.05$) for low temperature stress conditions (Fig. 3). The primed seeds emerged earlier and maintained a higher level of emergence throughout the emergence period in low temperature stress condition except for PAT (10 g) (Fig. 3A). Final emergence percentages of untreated seeds were significantly lower than TEA, LEA and PAT (10 g) organic primed seeds in emergence tests. LEA primed seeds showed 73% emergence percentages. The maximum and significant ($P < 0.05$) advancement from priming was obtained in primed seeds in which, unprimed seeds had 35% emergence but corresponding values were 73% (LEA), 58% (KNO₃) and 57% (PEG), in primed seeds grown in low temperature stress condition, respectively (Fig 3A).

Priming not only improved seedling emergence but also enhanced the seedling vigour as indicated by lower mean emergence time and higher seedling uniformity. The beneficial effect of priming on glasshouse watermelon emergence confirms previous findings on the germination of watermelon seeds at low temperatures in laboratory conditions (Sachs, 1977; Nerson et al., 1985; Demir and Van de Venter, 1999; Demir and Oztokat, 2003). PAT priming promoted earlier emergence percentages of aubergine seedlings are in agreement with previous findings (Mavi and Matthews, 2013).

MET was decreased when the seed primed with TEA and KNO₃ in low temperature stress condition and was at minimum value of 20.1 day in untreated seeds and 16.9 day in TEA and 16.7 day in KNO₃ primed seeds, respectively (Fig 3B).

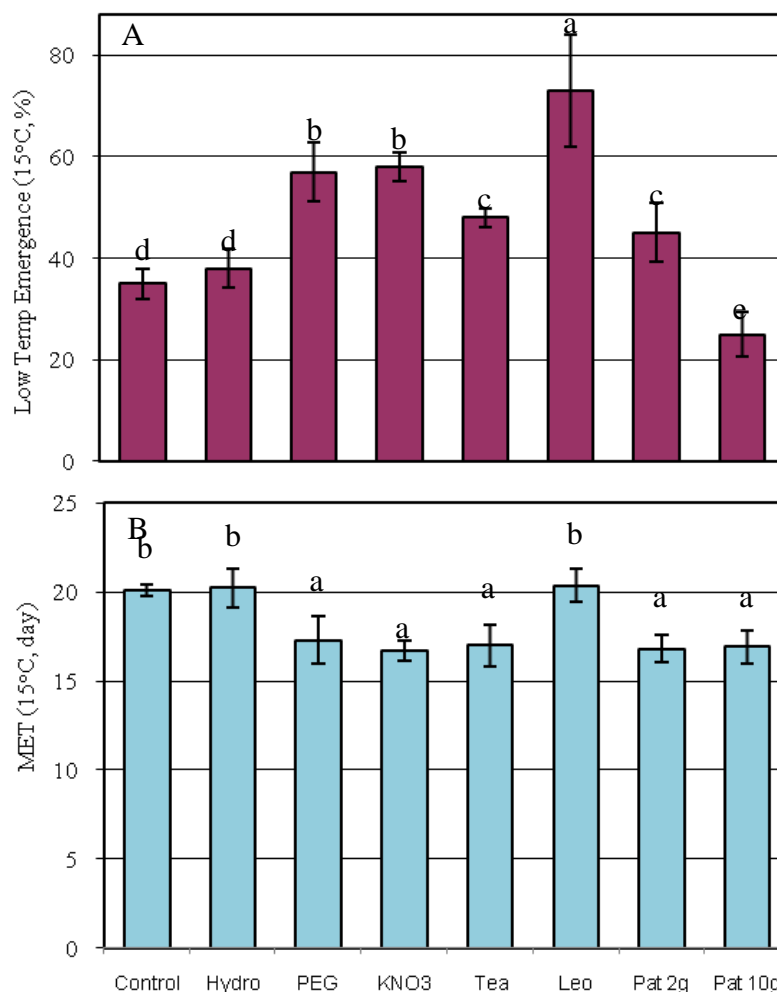

Fig. 3. Changes in low temperature emergence percentages (A) and mean emergence time (B) of watermelon seeds following various priming treatments

Conclusion

Organic priming (PAT, LEO and TEA) can be used as a tool in watermelon seed (1) to improve germination in laboratory condition, (2) to increase low temperature stress emergence of seeds in seedling tray and (3) to increase emergence and mean emergence time of seeds in optimal greenhouse condition.

Acknowledgements

This research was supported by BAP of Mustafa Kemal University (1106 M 0101).

References

- Demir, I. and Van de Venter, H.A. 1999. The effect of priming treatments on the performance of watermelon (*Citrullus lanatus* (Thunb.) Matsum. & Nakai) seeds under temperature and osmotic stress. *Seed Sci. Technol.* 27: 871–876.
- Demir, I. and Oztokat, C. 2003. Effect of salt priming on germination and seedling growth at low temperatures in watermelon seeds during development. *Seed Sci. Technol.* 31: 765–770.
- Ellis, R.H., Roberts, E.H., 1980. Towards rational basis for testing seed quality. In: Hebblethwaite, P.D. (Ed.), *Seed Production*. Butterworths, London, pp. 605–635.
- ISTA, 2009. *International rules for seed testing*. International Seed Testing Association, Bassersdorf, Switzerland.

- Korkmaz, A., Tiryaki, I., Nas, M. N., Ozbay, N. 2004. Inclusion of plant growth regulators into priming solution improves low-temperature germination and emergence of watermelon seeds, *Canadian J. Plant Science.*, 84(4), 1161-1165.
- Mavi, K. and Matthews, S. 2013. An alternative method of organic priming technique in naturally aged Aubergine seeds. 30th ISTA Seed Congress Abstract Book, Antalya.
- Mavi K, 2014. Use of extract from dry marigold (*Tagetes* spp.) flowers to prime eggplant (*Solanum melongena* L.) seeds. *Acta Sci. Pol. Hortorum Cultus* 13(4): 3-12.
- Nelson, J. M. and Sharples, G. C. 1980. Effect of growth regulators on germination of cucumber and other Cucurbit seeds at suboptimal temperatures. *HortScience* 15: 253–254.
- Nerson, H., Paris, H. S., Karchi, Z. and Sachs, M. 1985. Seed treatments for improved germination of tetraploid watermelon. *HortScience* 20: 897–899.
- Park, E., Lee, G., Park, Y., Choe, Y. U., Kang, J. 2016. Effect of osmotic priming treatment on seed viability and seedling growth in watermelon. *Journal of Environmental Science International*, 25(4): 557-566.
- Sachs, M. 1977. Priming of watermelon seeds for low temperature germination. *J. Am. Soc. Hortic. Sci.* 102: 175–178.

EFFECT OF ORGANIC GROWING SYSTEM ON MICROBIAL POPULATION IN RHIZOSPHERE OF MEDICINAL AND AROMATIC PLANT SPECIES

Nastasija MRKOVAČKI^{1*}, Dragana BJELIĆ¹, Ivica ĐALOVIĆ¹, Dušan ADAMOVIĆ¹,
Jelena MARINKOVIĆ¹, Marija ŠKRINJAR²

¹Institute of Field and Vegetable Crops, Maksima Gorkog 30, 21 000 Novi Sad, Serbia

²Faculty of Technology, University of Novi Sad, Bul. Cara Lazara 1, 21 000 Novi Sad, Serbia

*Corresponding author: nastasija.mrkovacki@nsseme.com

Abstract

The aim of this study was to compare abundance of microorganisms in the rhizosphere of four different medicinal and aromatic plant species (basil, mint, dill and marigold) grown under both conventional and organic management. The trials were set up on chernozem soil at experimental field of Bački Petrovac, Institute of Field and Vegetable Crops, Novi Sad (northern Serbia). Rhizosphere soil samples were collected in two sampling terms during 2015 (June 2 and July 28, 2015) and analysed by the indirect dilution method followed by plating of soil suspension on selective nutritive media. The obtained results showed significant differences in microbial abundance between plant species, growing systems and sampling terms. The highest number of azotobacters and cellulolytic microorganisms were obtained in rhizosphere of marigold, while total microbial number and fungi were the most abundant in rhizosphere of basil. The most common population of ammonifiers, free N-fixing microorganisms and actinomycetes were recorded in rhizosphere of dill. Significantly higher number of microorganisms was found in organic growing system compared to conventional, while the number of most tested microbial groups was higher at the first sampling period.

Keywords: *basil, dill, marigold, mint, organic production*

Introduction

Microorganisms are one of the indicators of the overall soil biogeny since they are actively involved in the processes of mineralization of organic compounds to inorganic and mobilization of difficult soluble inorganic compounds in the soil. In addition to nutrient cycling, soil microorganisms are involved in other important ecosystem functions, such as the formation and preservation of soil structure (Bastida et al., 2008). Number and composition of microorganisms in the rhizosphere can be affected by several factors including soil management practices, which strongly influence the quality and fertility of agricultural soils and consequently, the size, composition and function of the soil microbial community (Wu et al., 2011). Conventional growing systems lead to the disturbance of these relationships, which is manifested by reduced number and enzymatic activity of microorganisms, especially because modern agricultural production involves the use of large amounts of pesticides and fertilizers (Zhang et al., 2012). Low-input systems such as organic farming, substantially reduce the use of synthetic fertilizers, pesticides, energy and mechanic stress, and mitigate these negative impacts in order to improve sustainable production (Gomiero et al., 2011).

Beside management practices and soil type, the diversity and composition of microbial community in the rhizosphere also depend on plant species. A wide range of organic compounds secreted by plant roots increase microbial density and activity in the rhizosphere compared to bulk soil. Medicinal plants harbour a distinctive microbiome due to their unique and structurally divergent bioactive secondary metabolites that are most likely responsible for

the high specificity of the associated microorganisms (Ramesh et al. 2012). With the increased population pressure, costs and side effects and the development of resistance to allopathic drugs for infectious diseases, the uses of medicinal plants for a wide variety of human ailments are increasing. Using modern cultivation technologies to meet the demand for medicinal plants may degrade the quality of medicinal plant products, lead to resource degradation and negatively affect several soil ecological functions (Solaiman and Anawar, 2015). Development of innovative technologies and better understanding of short- and long-term responses of microbiological soil properties to different management practice in the cultivation of medicinal plants is required.

Therefore, the objective of this study was to compare the effects of conventional and organic system production on microbial number in the rhizosphere of different medicinal and aromatic plant species.

Material and Methods

The trial was set up on chernozem soil at experimental field of Bački Petrovac, Institute of Field and Vegetable Crops, Novi Sad (northern Serbia). Rhizosphere soil samples were collected from both conventional and organic grown four medicinal and aromatic plant species: mint (*Mentha x piperita* L.), marigold (*Calendula officinalis* L.), basil (*Ocimum basilicum* L.), and dill (*Anethum graveolens* L.). Samples for microbiological analyses were collected in two sampling terms (June 2 and July 28, 2015). Samples were analysed by the serial-dilution method followed by plating on different selective media (Bloem et al., 2006). Total number of microorganisms was determined on an agarized soil extract (dilution 10^7). Nitrogen-free medium was used for the determination of free N-fixing bacteria (dilution 10^6) and *Azotobacter* sp. (dilution 10^2). Ammonifiers (AMN) were determined on a mesopeptone agar (dilution 10^6). Cellulolytic microorganisms was determined on Waksman-Carey medium (dilution 10^5). The number of fungi was determined on Czapek-Dox medium, and actinomycetes on a synthetic medium (dilution 10^4). The microbiological analyses were done in three replications and the average number of microorganisms was calculated at 1.0 g absolutely dry soil (Jarak and Đurić, 2006). The variables were analysed in accordance with three-way model of analysis of variance (ANOVA) using Statistica software (StatSoft Inc. 2012), followed by mean separation according to Fisher's LSD test.

Results and Discussion

Determining the presence of certain systematic and physiological groups of microorganisms, provides insight into general microbiological activity, potential soil fertility and general causes of the certain condition of soil (Marinković et al., 2007). In this study, the number of microorganisms depended on the plant species, growing system, and sampling term. Number of tested microbial groups significantly differed between four plant species, with exception in number of actinomycetes and cellulolytic microorganisms. Significant differences in microbial abundance were also obtained between growing systems and sampling terms, except in number of fungi for both factors, and total microbial number for sampling terms (Tables 1-7).

Table 1. Number of *Azotobacter* sp. in rhizosphere of medicinal and aromatic plant species in conventional and organic growing systems (CFU/ml g⁻¹ absolutely dry soil)

Plant/Growing System	I sampling period		II sampling period		Plant Average
	Organic	Conventional	Organic	Conventional	
Mint	59 cdef	48 defg	82 bcd	24 gh	53 c
Marigold	53 defg	40 efgh	138 a	73 bcde	76 a
Basil	77 bcd	12 h	104 b	33 fgh	56 bc
Dill	54 defg	30 fgh	102 b	91 bc	69 ab

The different letter above the number indicates a significant difference at P < 0.05

Observed by plant species, the highest number of *Azotobacter* sp. was recorded in rhizosphere of marigold, significantly higher than number of this microbial group in the rhizosphere of mint and basil. Also, a higher number of azotobacters was obtained in an organic growing system compared to conventional at both sampling periods, while significant differences were recorded in rhizosphere of basil at first sampling period, as well as in mint, marigold and basil rhizosphere at second sampling (Table 1).

Table 2. Total number of microorganisms in rhizosphere of medicinal and aromatic plant species in conventional and organic growing systems (CFU/ml g⁻¹ absolutely dry soil)

Plant/Growing System	I sampling period		II sampling period		Plant Average
	Organic	Conventional	Organic	Conventional	
Mint	80 bcde	31 e	110 abc	51 de	68 b
Marigold	66 cde	64 cde	91 abcd	42 de	66 b
Basil	138 a	127 ab	55 cde	65 cde	96 a
Dill	50 de	49 de	54 cde	73 bcde	57 b

The different letter above the number indicates a significant difference at P < 0.05

On average, significantly higher total number of microorganisms was recorded in the rhizosphere of basil compared to other plant species. Total microbial number was higher in organic growing system, except in rhizosphere of basil and dill at second sampling period. Significant differences between growing systems were established only in mint rhizosphere at second sampling (Table 2).

Table 3. Number of ammonifiers in rhizosphere of medicinal and aromatic plant species in conventional and organic growing systems (CFU/ml g⁻¹ absolutely dry soil)

Plant/Growing System	I sampling period		II sampling period		Plant Average
	Organic	Conventional	Organic	Conventional	
Mint	77 def	73 def	97 bcde	60 def	76 b
Marigold	99 bcd	45 f	96 bcde	128 ab	92 ab
Basil	134 ab	84 cdef	69 def	81 cdef	92 ab
Dill	95 bcde	53 ef	152 a	124 abc	106 a

The different letter above the number indicates a significant difference at P < 0.05

The highest number of ammonifiers was recorded in rhizosphere of dill, while the smallest number was obtained in the rhizosphere of mint. Significant differences in the number of this group of microorganisms were obtained only between these two plant species. Organic growing system had a positive effect on the number of ammonifiers, while a higher number in

conventional growing system was recorded only in the rhizosphere of marigold and basil at the second sampling period (Table 3).

Table 4. Number of N-fixing microorganisms in rhizosphere of medicinal and aromatic plant species in conventional and organic growing systems (CFU/ml g⁻¹ absolutely dry soil)

Plant/Growing System	I sampling period		II sampling period		Plant Average
	Organic	Conventional	Organic	Conventional	
Mint	224 a	108 bc	96 c	63 c	123 a
Marigold	161 ab	166 ab	90 c	76 c	123 a
Basil	98 c	62 c	71 c	65 c	74 b
Dill	177 a	203 a	88 c	86 c	138 a

The different letter above the number indicates a significant difference at P < 0.05

On average, the highest number of N-fixing microorganisms was recorded in rhizosphere of dill, while significantly smaller number compared to other plant species was obtained in the rhizosphere of basil. A larger number of nitrogen-fixing microorganisms was recorded in an organic growing system, except in the rhizosphere of marigold and dill at the first period of sampling (Table 4).

Table 5. Number of fungi in rhizosphere of medicinal and aromatic plant species in conventional and organic growing systems (CFU/ml g⁻¹ absolutely dry soil)

Plant/Growing System	I sampling period		II sampling period		Plant Average
	Organic	Conventional	Organic	Conventional	
Mint	9.6 abcd	8 abcd	8 abcd	3 d	7 b
Marigold	7 abcd	5 bcd	6 abcd	4 cd	6 b
Basil	11 ab	9 abcd	10 abc	12 a	11 a
Dill	7 abcd	4 cd	6 abcd	6 abcd	6 b

The different letter above the number indicates a significant difference at P < 0.05

The number of fungi was significantly higher in the rhizosphere of basil in comparison to other plant species. Larger number of fungi was observed in the organic growing system, except in the rhizosphere of basil at the second sampling period (Table 5).

Table 6. Number of *Actinomycetes* in rhizosphere of medicinal and aromatic plant species in conventional and organic growing systems (CFU/ml g⁻¹ absolutely dry soil)

Plant/Growing System	I sampling period		II sampling period		Plant average
	Organic	Conventional	Organic	Conventional	
Mint	28 a	6 bcd	0 d	6 bcd	10 a
Marigold	20 ab	6 bcd	0 d	2 cd	7 a
Basil	16 abc	3 cd	3 cd	11 bcd	8 a
Dill	30 a	7 bcd	0 d	12 bcd	12 a

The different letter above the number indicates a significant difference at P < 0.05

The highest number of actinomycetes was recorded in the rhizosphere of dill, but significant differences between plant species were not established. At the first sampling period, a higher number of actinomycetes was recorded in organic growing system. On contrary, at the second sampling period, a larger number of actinomycetes was recorded in conventional system (Table 6).

Table 7. Number of cellulolytic microorganisms in rhizosphere of medicinal and aromatic plant species in conventional and organic growing systems (CFU/ml g⁻¹ absolutely dry soil)

Plant/Growing System	I sampling period		II sampling period		Plant Average
	Organic	Conventional	Organic	Conventional	
Mint	24 bc	10 cd	14 cd	5 d	14 a
Marigold	42 a	13 cd	14 cd	10 cd	20 a
Basil	30 ab	9 cd	12 cd	12 cd	16 a
Dill	19 bcd	17 bcd	10 cd	10 cd	14 a

The different letter above the number indicates a significant difference at $P < 0.05$

On average, the most common number of cellulolytic microorganisms was recorded in the rhizosphere of marigold, but significant differences in relation to other plant species were not observed. A larger number of cellulolytic microorganisms was obtained in an organic system in both sampling periods, except in the rhizosphere of basil and dill at second period of sampling (Table 7).

These results are in agreement with those of Bjelić et al. (2015) who revealed significant differences in microbial abundance between plant species, growing systems and sampling periods. Similar results were obtained by Ahmed et al. (2014) who determined that microbial community composition differed between eleven medicinal plant species. Research conducted by Mrkovački et al. (2012) also indicated a significantly higher number of microorganisms under organic production system compared to conventional. Research of Adamović et al. (2015) showed that organic growing system affected the abundance of microorganisms in rhizosphere of species investigated, especially in the second term of sampling. According to Hartmann et al. (2015), fertilization scheme, the application and quality of organic fertilizers in particular, is the major determinant of microbial diversity. However, the presence of organic and inorganic materials in soil is connected to the increase in nutrient content and further impact on soil properties, including the soil microbiological activity, as Zhong et al. (2010) concluded.

Conclusion

Microbial abundance significantly differed between four plant species. On average, the highest number of azotobacters and cellulolytic microorganisms were obtained in rhizosphere of marigold. Total microbial number and fungi were the most abundant in rhizosphere of basil. The most common population of ammonifiers, free N-fixing microorganisms and actinomycetes were recorded in rhizosphere of dill. Significantly higher number of microorganisms was found in organic growing system compared to conventional, which confirm the positive effect of this agricultural practice on microbial activity in soil compared to conventional management. The number of most tested microbial groups was higher at the first sampling period.

References

- Adamović D., Đalović I., Mrkovački N. (2015): Microbial abundance in rhizosphere of medicinal and aromatic plant species in conventional and organic growing systems. *Field and Vegetable Crops Research* 52: 1–6.
- Ahmed EA., Hassan EA., El Tobgy KMK., Ramadan EM. (2014): Evaluation of rhizobacteria of some medicinal plants for plant growth promotion and biological control. *Annals of Agricultural Sciences* 59: 273–280.
- Bastida F., Zsolnay A., Hernandez T., Garcia C. (2008): Past, present and future of soil quality indices: a biological perspective. *Geoderma* 147: 159–171.

- Bjelić D., Mrkovački N., Marinković J., Tintor B., Đalović I. (2015): Seasonal changes of microbial population in maize and soybean rhizosphere under conventional and organic growing systems. Proceedings of VI International Agricultural Symposium „Agrosym 2015”, 15-18 October, Jahorina, Bosnia and Herzegovina, p. 1156–1161.
- Bloem J., Hopkins WD., Benedetti A. (2006): Microbiological methods for assessing soil quality. CABI Publishing, Wallingford.
- Gomiero T., Pimentel D., Paoletti MG. (2011): Environmental impact of different agricultural management practices: conventional vs. organic agriculture. *Critical Reviews in Plant Sciences* 30: 95–124.
- Hartmann M., Frey B., Mayer J. Mäder P., Widmer F. (2015): Distinct soil microbial diversity under long-term organic and conventional farming. *The ISME Journal* 9: 1177–1194.
- Jarak M., Đurić S. (2006): Laboratory Manual of Microbiology. Faculty of Agriculture, University of Novi Sad.
- Marinković J., Milošević N., Tintor B., Vasin J. (2007): The occurrence of several microbial groups in different soil types. *Field and Vegetable Crops Research* 43: 319–327.
- Mrkovački N., Đalović I., Marinković J., Červenski J., Najvirt B. (2012): Microbial abundance in the rhizosphere of maize and soybean: conventional and organic system production. Proceedings of III International Scientific Symposium „Agrosym 2012“, Jahorina, Bosnia and Herzegovina, p. 241–244.
- Ramesh G., Hari B.N.V., Dhevendaran K. (2012). Microbial association with selected medicinal plants in rhizosphere and their biodiversity. *Advances in Natural and Applied Sciences* 6: 947–958.
- Solaiman ZM., Anawar HMD. (2015): Rhizosphere microbes interactions in medicinal plants. In: Plant growth promoting rhizobacteria (PGPR) and medicinal plants, Egamberdieva D., Shrivastava S., Varma S. (Eds.), Springer International Publishing, pp. 19–41.
- Wu M., Qin H., Chen Z., Wu J., Wei W. 2011. Effect of long-term fertilization on bacterial composition in rice paddy soil. *Biology and Fertility of Soils* 47: 397–405.
- Zhang QC., Shamsi IH., Xu DT, Wang GH, Lin XY, Jilani G., Hussain N., Chaudhry AN. 2012. Chemical fertilizer and organic manure inputs in soil exhibit a vice versa pattern of microbial community structure. *Applied Soil Ecology* 57: 1–8.
- Zhong W., Gu T., Wang W., Zhang B., Lin X., Huang Q., Shen W. 2010. The effects of mineral fertilizer and organic manure on soil microbial community and diversity. *Plant and Soil* 326: 511–522.

EVALUATION OF ANTI-FUNGAL EFFECTS OF PROPOLIS EXTRACTS

Yusuf YANAR, Sabriye BELGÜZAR*, Dürdane YANAR

Gaziosmanpasa University, Agricultural Faculty, Plant Protection Department-Tokat, Turkey

*Corresponding author: sabriye.yazici@gop.edu.tr

Abstract

This study was carried out to determine the antifungal activity of ethanol extract of propolis on *Macrophomina phaseolina*, *Cylindrocarpon destructans*, *Rhizoctonia solani* and *Fusarium oxysporum*. Propolis was collected from Tokat, Sivas and Corum provinces of Turkey. Ethanol extracts of propolis were mixed with Potato Dextrose Agar (PDA) media to obtain the final concentrations of 0.5, 1 and 3% (v/v). Discs (5-mm diameter) of the mycelial plugs from the actively growing edge of the fungal colonies were transferred on the PDA plates. The media without extract were used as the negative controls. Three replicates were used for each treatment. PDA plates were then incubated in the dark at 25 °C. Mycelial diameter of the fungus was measured after 7 days incubation periods. Based on the results of the study, increase in extract concentration resulted in increase of the extract efficacy. Tokat, Sivas and Corum propolis ethanol extract at 3% concentration inhibited the growths of all pathogens at the rates of 100%. Tokat, Sivas and Corum propolis ethanol extract at 1% concentration inhibited the growths of the pathogens between 58 and 100%. While Tokat and Corum propolis extract at 0.5% concentration inhibited the growths of all pathogens at high proportion, Sivas propolis extract was low on *F. oxysporum* ve *C. destructans*. In conclusion, propolis ethanol extract has antifungal activity on pathogens.

Key Words: *Propolis*, *Macrophomina*, *Cylindrocarpon*, *Rhizoctonia*, *antifungal*.

Introduction

Strawberry (*Fragaria ananassa*) is an economically important berry crop worldwide. However, commercial strawberry production is severely affected from soil-borne fungal pathogens and management is mainly reliant on chemical fumigation. Commercial strawberry production was severely conceded by crown and root diseases caused by *F. oxysporum*, *Rhizoctonia* spp., *Cylindrocarpon destructans*, and *Macrophomina phaseolina*. Among these, *F. oxysporum* was most frequently isolated from crowns at a frequency of 41%; *Rhizoctonia* spp. were most frequently isolated from roots at a frequency of 12%. *F. oxysporum*, *Rhizoctonia* spp. and *M. phaseolina* were found to be the most virulent pathogens on strawberry, and their virulence and consequent disease severity was influenced by the prevailing seasonal temperature. The development of effective strategies for disease management is limited due to the success of methyl bromide as a soil sterilant, currently restricted. In addition, the management includes cultivar selection, use of certified planting stock, replacement of plants annually, biological control, rotation crops, soil fumigation prior to planting, soil solarization and use of systemic fungicides during the crop cycle (Yigal et al., 1981; Yuen et al., 1991; Elmer and LaMondia, 1999; Benlioğlu et al., 2005). Alternative methods to control fungal diseases have been studied by using compounds derived from plant sources in an attempt to reduce the use of syntheti fungicides. Extracts of *Allium sativum*, *Coriandrum sativum*, *Curcuma longo* and *Cuminum cyminum* possessed a strong antifungal activity (Lalitha et al., 2011). Forty plants of different families were tested against *Fusarium oxysporum* f.sp. *cicero*, with *Chenopodium ambrosioides* having the highest inhibition (Minz et al. 2012). More recently, the antifungal activity of more than 500 plant species has been assessed (Rongai et al. 2012). Of all plants tested, only 3% showed a high antifungal activity.

Many authors have also studied the importance of secondary metabolites in fungal inhibition. Beside plant secondary metabolites other natural product like propolis contains similar types of antimicrobial compounds. Propolis is a resinous hive product collected from plant buds by bees. Propolis is a resin and its color changes from green to dark brown according to plant source. Investigations have indicated that propolis contains wax, flavonoids, amino acids, essential oils, pollen, minerals and organic matters (Crane 1990, Scheller et al., 1990). Propolis is thought to be used to seal the beehive (Lotti et al., 2010) to exclude draught and protect it against external invaders. However, its main function is to prevent the decomposition of organic matter (*i.e.*, organisms that have been killed by the bees after invasion) within the hive by inhibiting microbial growth. Therefore, the presence of propolis may provide an environment that is unsuitable for the growth of fungi and other microorganisms, thus maintaining an aseptic hive (Falcão et al., 2010). Over 300 compounds have been detected in propolis, and 160 of these have been identified of which 50% are phenolic compounds, mainly flavonoids (flavones, isoflavones, and flavones), aromatic acids and esters (caffeic acid, cinnamic and others), aromatic aldehydes (vanillin and isovanillin), coumarins and phenolic triglycerides. In addition, other groups of compounds and minerals are of fundamental importance for the biological activity of propolis, including provitamin A, certain B vitamins, lactones, polysaccharides, amino acids and other substances not yet identified (Quiroga et al., 2006; Kalogeropoulos et al., 2009; Falcão et al., 2010). Numerous studies have demonstrated the pharmacological activities of propolis, including antibacterial, antifungal, antiviral, antioxidant, and antitumor properties (Tolosa and Cañizares, 2002; Castagna et al., 2004; Garedeew et al., 2004; Quintero-Mora et al., 2008; Herrera et al., 2009; Saavedra et al., 2011). In different countries, the local propolis have been evaluated by Özcan et al. (2004), Quiroga et al. (2006), Giovanelli (2008), Meneses et al. (2009), and Özdemir et al. (2010) who obtained interesting results against phytopathogenic fungi. This study has been established for evaluation of antifungal activity of ethanol extract of propolis on *Macrophomina phaseolina*, *Cylindrocarpon destructans*, *Rhizoctonia solani* and *Fusarium oxysporum*.

Materials and Methods

Fungal Isolates

Macrophomina phaseolina, *Cylindrocarpon destructans*, *Rhizoctonia solani* and *Fusarium oxysporum* were obtained from the Department of Plant Protection, Agricultural Faculty, Gaziosmanpaşa University, Tokat (Turkey). The fungal isolates were maintained at 4°C on potato dextrose agar slants and kept in refrigerator prior to subculture.

Extracting Propolis

Ten propolis samples belonged to *Apis mellifera* colonies were collected from Tokat, Sivas and Corum provinces of Turkey. Ethanolic extract of propolis was prepared by adding 100 g of propolis sample to 200 ml absolute ethanol in 500 ml flask and shaken on orbital shaker (at 120 rpm) for one day. At the end of one day, extract was passed through muslin cloth to remove solid phase. Ethanol was evaporated at 32 °C using rotary evaporator. The solid phase was dissolved in 10% acetone to get 50% stock solution.

Antifungal activity of propolis

The antifungal potential of propolis was evaluated using the agar dilution method according to Quintero-Mora et al. (2008). The potato dextrose-agar medium (PDA) was sterilized at a temperature of 121 °C for 15 min, and were prepared with the propolis selected extract, obtaining concentrations of 0.5, 1.0, 3% (v/v), according to the volume of medium used, and a

control medium without propolis. The mixture was homogenized and poured into sterile Petri dishes (60 mm in diameter). The control treatment contained 10% acetone. Fungal plugs (5 mm in diameter) obtained from the actively growing edge of the fungal colonies were placed at the center of Petri dishes. The cultures were incubated at 25 ± 2 °C, and the radial growth of the mycelia were measured daily. For each fungus when the mycelial growth reached the edge of the plates in the control treatments experiment was completed. Inhibition percentage was calculated by using the following equation: (Deans and Svoboda 1990).

$$I = (C - T / C) \times 100$$

I: Inhibition (%),

C: Colony diameter of mycelium from control petri plate (mm),

T: Colony diameter of mycelium from test petri plate (mm),

Statistical analysis

The results were analyzed using an Analysis of Variance (One-Way ANOVA), and the comparisons between the means were performed using the multiple comparison test of Tukey, with a significance level of 5% ($P \leq 0.05$). The statistical program demo SPSS 11 was used.

Results and Discussion

The susceptibilities of four plant pathogenic fungi (*Macrophomina phaseolina*, *Cylindrocarpon destructans*, *Rhizoctonia solani* and *Fusarium oxysporum*) to the ethanolic extracts of propolis were evaluated in solid culture. There were significant differences ($P < 0.05$) between concentrations of propolis extract used in this study (Table 1, 2, and 3). In an agar diffusion assay, *M. phaseolina*, *C. destructans*, *R. solani* and *F. oxysporum* isolates were sensitive to propolis obtained from Çorum province at all concentration (0.5, 1.0, and 3.0% v/v) tested. As the concentration of the propolis extract increased, the diameter of the zone of inhibition also increased (Table 1). Inhibition rates of Çorum propolis were 90% and over on mycelial growth of the test fungi at 1 and 3% concentrations. Propolis extract from Tokat province exhibited the similar results with the Çorum propolis at 1 and 3% concentrations (Table 2). But *F. oxysporum* was less sensitive to Tokat propolis extract than the other fungus isolates. The propolis obtained from Çorum, Tokat and Sivas provinces gave between 96% and 100% inhibitions (Table 1, 2, and 3). The control (50% dimethyl-sulfoxide, v/v) did not form an inhibitory zone against any of the fungi tested. But inhibition rates of Sivas propolis were lower than the other two propolis at 0.5 and 1% concentration against the test fungi (Table 3). Results of the present study are in agreement with the results of previous studies on the antifungal effect of propolis against plant pathogenic fungi and molds. It was stated that the application of 1%, 5%, and 10% concentrations of ethanol-extracted propolis inhibited in vitro growth of *Penicillium digitatum* (Soylu et al., 2004, Soylu et al. 2008) and limited the growth of *Botrytis cinerea* on strawberry (La Torre et al. 1990). Yanar et al. (2005) reported that four of propolis methanol extracts concentrations (10, 7, 5, and 3 µg/ml) completely inhibited the mycelial growth of the three *Phytophthora* species. An other study Özcan (1999) showed that treatment with 4% water-extracted propolis resulted in more than 50% inhibition of some plant pathogens in vitro. The application of 2% and 5% concentrations of propolis methanol extract inhibited the growth of *Alternaria alternata* and *Fusarium oxysporium* f. sp. *melonis*. However, *F. oxysporium* was found to be more sensitive than *A. alternata* (Özcan, et al. 2004). In an other study, The ethanolic extract of Chilean propolis inhibited the growth of *Alternaria alternata*, *Fusarium* sp., *Ulocladium* sp., *Botrytis cinerea*, *Penicillium expansum* and *Trichoderma reesei* at four different concentrations (0.5, 1.0, 2.5 and 5.0 %) (Curifuta et al. 2012). Propolis has been found to possess antimicrobial activity and this has been attributed to specific chemicals in the propolis (Shehu et al. 2015, Temiz et al., 2013, Curifuta et al. 2012, Katircioglu and Mercan, 2006). Inhibition activity of propolis was

studied by many authors, these studies were conducted to an inhibition activity of propolis depending on factors, these factors were the area geographic and concentration of the collected propolis in these studies. Also propolis composition varies from region to region and therefore, the difference in the composition of the extract may lead to the inhibition of a difference in percentage from propolis extracted from one area to another (Shehu et al. 2015, Chee, 2002). Inhibition percentage is also different from one study to other according to the concentration of extracts, In addition, the method that is used to extract propolis may lead to variation in the results.

Conclusion

In conclusion, present results indicate that the ethanolic extract of Turkish propolis has the capacity to inhibit some of the economically important plant pathogenic fungi *in vitro*. The results obtained in this study are promising and support the importance of further *in vivo* investigations into the antifungal capacity of propolis from the Corum, Sivas and Tokat provinces of Turkey.

Table 1. Antifungal activity of ethanolic extracts of propolis sample obtained from Corum province of Turkey

Propolis Doses (%)	Mycelial Growth Inhibition (%)			
	<i>Cylindrocarpon destructans</i>	<i>Fusarium oxysporum</i>	<i>Rhizoctonia solani</i>	<i>Macrophomina phaseolina</i>
Control	0.0 a*	0.0 a	0.0 a	0.0 a
0.5	86.2 b	84.7 b	95.2 b	93.3 b
1.0	93.9 c	90.8 c	98.6 bc	95.2 c
3.0	100.0 d	96.7 d	100.0 cd	96.0 c

*Values within a column followed by the same letter are not significantly different ($p \leq 0.05$)

Table 2. Antifungal activity of ethanolic extracts of propolis sample obtained from Tokat province of Turkey

Propolis Doses (%)	Mycelial Growth Inhibition (%)			
	<i>Cylindrocarpon destructans</i>	<i>Fusarium oxysporum</i>	<i>Rhizoctonia solani</i>	<i>Macrophomina phaseolina</i>
Control	0.0 a*	0.0 a	0.0 a	0.0 a
0.5	57.0 b	66.3 b	100.0 b	82.4 b
1.0	100.0 c	70.7 b	100.0 b	100.0 c
3.0	100.0 c	100.0 c	100.0 b	100.0 c

*Values within a column followed by the same letter are not significantly different ($p \leq 0.05$)

Table 3. Antifungal activity of ethanolic extracts of propolis sample obtained from Sivas province of Turkey

Propolis Doses (%)	Mycelial Growth Inhibition (%)			
	<i>Cylindrocarpon destructans</i>	<i>Fusarium oxysporum</i>	<i>Rhizoctonia solani</i>	<i>Macrophomina phaseolina</i>
Control	0.0 a*	0.0 a	0.0 a	0.0 a
0.5	27.5 b	18.3 b	66.1 b	46.2 b
1.0	68.8 c	58.3 c	84.5 c	81.6 c
3.0	100.0 d	100.0 d	100.0 d	100.0 d

*Values within a column followed by the same letter are not significantly different ($p \leq 0.05$)

References

- Benlioğlu S, Boz Ö, Yildiz A, Kaşkavalci G, Benlioğlu K 2005. Alternative soil solarization treatments for the control of soil-borne diseases and weeds of strawberry in the Western Anatolia of Turkey. *J. Phytopathol.* 153:423-430.
- Castagna, A., A. Pinto, N. Mazzini, M. Matiuzzi, M. Sá, and L. Ribeiro. 2004. Alcoholic propolis extract: antimicrobial activity. *Ciencia Rural* 34: 159-163.
- Chee, H. Y. 2002. *In vitro* Evaluation of the Antifungal Activity of Propolis Extract on *Cryptococcus neoformans* and *Candida albicans*. *Mycobiology* 30(2): 93-95.
- Crane, E. 1990. Bees and Beekeeping Science Practice and World Resource Heinemann Professional Publishing Ltd. Oxford.
- Curifuta, M., Vida, J., Sánchez-Venegas, J., Contreras, A., Salazar, L. A., and Alvear, M. 2012. The *in vitro* antifungal evaluation of a commercial extract of Chilean propolis against six fungi of agricultural importance. *Cien. Inv. Agr.* 39(2):347-359.
- Deans, S.G. and Svoboda, K.P. 1990. The microbial properties of marjoram (*Origanum majorana* L.) volatile oil. *Flavour Fragr. J.*, 5, 187-190.
- Elmer W. H., LaMondia J.A. 1999. Influence of ammonium sulfate and rotation crops on strawberry black root rot. *Plant Dis.* 83:119-123.
- Falcão, S.I., M. Vilas-Boas, L.M. Estevinho, C. Barros, M.R. Domingues, and S.M. Cardoso. 2010. Phenolic characterization of Northeast Portuguese propolis: usual and unusual compounds. *Analytical Bioanalysis Chemistry* 396: 887-897.
- Garedew, A., E. Schmolza, I. Lamprecht. 2004. Microbiological and calorimetric investigations on the antimicrobial actions of different propolis extracts: an *in vitro* approach. *Thermochimica Acta* 422: 115-124.
- Giovanelli, L. 2008. Evaluation of an ethanolic extract of propolis as a potential pre- and postharvest fungicide for 'Fuerte' avocado (*Persea americana* Mill.) Fruits and Orchards. Thesis of Master of Science to the University of the Witwatersrand. Johannesburg, South Africa. 127 pp.
- Herrera, C., Alvear, M., Barrientos, L., Montenegro, G., Salazar, L.A. 2009. Actividad fungicida de seis extractos de propóleos comerciales chilenos sobre *Candida* spp. *Cien Inv Agr.* 2009;37:75-84.
- Kalogeropoulos, N., S.J. Konteles, E. Troullidou, I. Mourtzinou, and V.T. Karathanos. 2009. Chemical composition, antioxidant activity and antimicrobial properties of propolis extracts from Greece and Cyprus. *Food Chemistry* 116: 452-461
- Katircioglu, H., and Mercan, N. 2006. Antimicrobial activity and chemical compositions of Turkish propolis from different regions *African Journal of Biotechnology* 5 (11), pp. 1151-1153.
- La Torre A, Imbroglini G, Guccione M. 1990. Action of propolis based preparations against *Botrytis cinerea* Pers. of strawberry. *First Observation Agric*, 6: 169-177.
- Lalitha V., Kiran B., Raveesha K.A., Antifungal and antibacterial potentiality of six essential oils extracted from plant source, *Int. J. Eng. Sci. Techn.* 3, 3029-3038.
- Lotti, C., Campo Fernandez, M., Piccinelli, A. L., Cuesta-Rubio, O., Márquez Hernández, I., & Rastrelli, L. 2010. Chemical constituents of red Mexican propolis. *Journal of Agricultural and Food Chemistry*, 58(4), 2209-2213.
- Meneses, E., D.L. Durango, and C.M. García. 2009. Antifungal activity against postharvest fungi by extracts from colombian propolis. *Química Nova* 32: 2011-2017.
- Minz S., Samuel C.O., & Tripathi S.C. 2012. The effect of Plant Extract on the Growth of Wilt Causing Fungi *Fusarium oxysporum*, *J. Pharm. Bio. Sci.*, 4, 13-16.
- Özcan M, Ünver A, Ceylan DA, Yetiflir R. 2004. Inhibitory effect of pollen and propolis extracts. *Nahrung*, 48 (3): 188- 194.
- Özcan M. 1999. Antifungal properties of propolis. *Grasas Aceites*, 50: 395-398.
- Özdemir AE, Çandır EE, Kaplanköran M, Soylu EM, fiahinler N, Gül, A. 2010. The effects of ethanoldissolved propolis on the storage of grapefruit cv. Star Ruby. *Turk J Agric For*, 34: 155-162.

- Quintero-Mora, M., A. Londono-Orozco, F. Hernández- Hernández, P. Manzano-Gayosso, R. López-Martínez, C.I. Soto-Zarate, L. Carrillo-Miranda, G. Penieres-Carrillo, C.G. García-Tovar, and T.A. Cruz-Sánchez. 2008. Efecto de extractos de propóleos mexicanos de *Apis mellifera* sobre el crecimiento *in vitro* de *Candida albicans*. *Revista Iberoamericana de Micología* 25: 22-26.
- Quiroga, E.N., D.A. Sampietro, J.R. Sobero N, M.A. Sgariglia, and M.A. Vattuone. 2006. Propolis from the northwest of Argentina as a source of antifungal principles. *Journal of Applied Microbiology* 101: 103-110.
- Rongai D., Milano F., Sciò E. 2012. Inhibitory Effect of Plant Extracts on Conidial Germination of the Phytopathogenic Fungus *Fusarium oxysporum*, *Am. J. Plant Science*, 3, 1693-1698.
- Saavedra, N., L. Barrientos, C. Herrera, M. Alvear, G. Montenegro, and L. Salazar. 2011. Effect of Chilean propolis on cariogenic bacteria *Lactobacillus fermentum*. *Ciencia e Investigación Agraria* 38:117-125.
- Scheller, S. 1990. Plant origins of propolis: A report of work at Oxford Bee World, 30.
- Shehu, A., Rohin, M. K., Aziz, A., and Ismail, S. 2015. Antifungal, characteristic properties and composition of bee glue (propolis) *J. Chem. Pharm. Res.*7(3):1992-1996
- Soylu E.M., Özdemir A.E., Ertürk E, fiahinler N, Soylu S. 2008. Chemical composition and antifungal activity of propolis against *Penicillium digitatum*. *Asian J Chem*, 20: 4823-4830.
- Soylu E.M., Özdemir A.E., Ertürk E, fiahinler N. 2004. Antifungal activity of propolis against *Penicillium digitatum*, causal agent of green mold of citrus fruits. *Proceedings of the First European Conference of Apidology 'EurBee'*, Udine, Italy; pp. 160.
- Temiz, A., Mumcu, A. S., Tüylü, A. Ö., Sorkun, K., and Salih, B.2013. Antifungal Activity of Propolis Samples Collected From Different Geographical Regions Of Turkey Against Two Food-Related Molds, *Aspergillus Versicolor* And *Penicillium Aurantiogriseum* *GIDA* 38 (3): 135-142.
- Tolosa, L., and E. Cañizares. 2002. Obtención, caracterización y evaluación de la actividad antimicrobiana de extractos de propóleos de Campeche. *Ars Pharmaceutica* 43: 187-204.
- Yanar, Y., Yanar, D., and Arslan S. 2005. Antifungal Activity of Turkish Propolis Against *Phytophthora* Species. *Plant Pathology Journal*, 4: 58-60.
- Yigal, E., Ilan, C., Yigal, H. 1981. Biological control of *Rhizoctonia solani* in strawberry fields by *Trichoderma harzianum*. *Plant Soil* 60:245-254.
- Yuen, G.Y., Schroth, M.N., Weinhold, A.R., Hancock, J.G. 1991. Effects of soil fumigation with methyl bromide and chloropicrin on root health and yield of strawberry. *Plant Dis.* 75:416-420.

INFLUENCE OF SPECIAL HERBAL PREPARATION ON GROWTH AND DEVELOPMENT OF CUCUMBER, PEPPER AND TOMATO

Srdjan LJUBOJEVIĆ^{1*}, Viktor I. ELISEEV²

¹The Independent University of Banja Luka, Faculty for Ecology & Institute for Scientific Research, Bosnia and Herzegovina

²Orenburg State Agrarian University, Agricultural Scientific Research Institute, Russia

*Corresponding author: ljuboje@blic.net

Abstract

The trial tests of special herbal preparation (SHP) in the capacity of PGR were executed on cucumber, pepper and tomato at a large glasshouse in Orenburg Region of Russian Federation. Special preparation was based on wild growing herbs: comfrey (*Symphitum officinale*), dandelion (*Taraxacum officinale*), horsetail (*Equisetum arvense*), lemon balm (*Melissa officinalis*), nettle (*Urtica dioica*), valerian (*Valeriana officinalis*) and yarrow (*Achillea millefolium*). In order to extract the active matter without application of chemical means, an unique production process has been developed. The foundation of this process is based on a special combination of water extraction and biofermentation with continual oxygen enrichment. The experiment was executed as per following treatments: 1. Control, 2. Basic fertilization + SHP, 3. Basic fertilization, 4. Basic fertilization + additional fertilization + SHP, 5. Basic fertilization + additional fertilization. Treatments were repeated twice with random allocation on 100 m² sample plots for cucumber and tomato and 50 m² for pepper. The examinations have shown that SHP had a positive impact on growth and development of vegetable crops planted in the glasshouse.

Key words: *special herbal preparation, PGR, cucumber, pepper, tomato*

Introduction

Plant tissue is capable to synthesize a wide range of natural products that can be removed with neutral organic solvents or water to yield extractives, a mixture of naturally occurring organic compounds. From ancient times to the present days extractives, together with exudates, have provide a number of human needs such as: food, medicines, cosmetics, dyes etc. Extracts of wild plants and their derivatives also have their place in agriculture where are used as: mild fertilizers, plant growth regulators (PGR), plant protection means etc. (Ljubojević, 2015). Analogous or somewhat different behavior can be found among: herbal nutrients (Chang et al., 2014), biostimulants (Bulgari et al., 2015; Calvo et al., 2014; Stirling et al. 2016), plant-growth promoters (Stirling et al, 2016), plant strengthening products (Kuhne et Jahn, 2010), biological controlling agents (Nega, 2014), biopesticides (Zarins et al., 2009), botanical insecticides and repellents (Pavela, 2013), soil improvers/conditioners and uptake improvers (Calvo et al., 2014; Khan et al., 2009). Besides extractives as a mixture of organic compounds, from plant material can be isolated particular compounds such as phytohormones (auxins, cytokinins, gibberellins, ethylene, abscisic acid) and similar ingredients (betaines, sterols etc.). These endogenous PGR today are replaced by synthetic substitutes. Moreover, plant extracts are used in animal nutrition as appetite and digestion stimulants, stimulants of physiological functions and for prevention and treatment of certain pathological conditions (Frankič et al. 2009).

Main herbal raw material for the production of PGR and related phytopreparations are seaweeds. According to Zemke-White et Ohno (1999), at least 221 species of seaweeds are utilized globally, with 145 species for human food production and 101species for animal feed,

herbal nutrients and PGR. Apart from seaweed extracts, on some regional markets can be found: active dry yeast extracts (Hanafy et al., 2012), Siberian fir (*Abies sibirica*) needle extract and essential oil, as well as oleoresin (Komykova et al., 2012), natural growth regulators obtained from the seeds of corn cockle (*Agrostema githago*) weed, (Jelačić et al., 2007), plant growth promoting rhizobacteria (Ahemad et Kibret, 2014). Furthermore, extracts of wild growing herbs can also be used as a raw material. The grounds for such approach are numerous and they are elaborated in author's previous work (Ljubojević, 2015). This paper presents results of the experiment with SHP produced in industrial plant on the basis of selected wild growing herbs. Efficiency of SHP in the capacity of PGR were tested on cucumbers, peppers and tomatoes in the greenhouse conditions. The article also describes the procedure of SHP production and gives relevant manufacturing parameters. In this way it is possible to repeat and examine the results of the experiment.

Material and methods

Special herbal preparation and its production

SHP is designed to act as a plant growth regulator and as an uptake improver, behaving as a kind of catalyst and an accelerator of complex relations in the plant-soil system. SHP cannot provide a sufficient amount of nutrients for crops. It is only auxiliary means which helps existing stocks of nutrients to be better and faster utilized by crops.

SHP production was realized through the following working operations: 1. Disinfection and sterilization, 2. Water treatment, 3. Water extraction and aerobic fermentation, 4. Separation, 5. Filtration, 6. Pasteurization, 7. Finalization. All production vessels (containers, tanks etc.) and pipes ought to be disinfected and sterilized before a new batch start, using upgraded "Formalintec" aerosol device. Water treatment implies softening and heating. In order to increase the affinity of water towards extraction, tap water was softened with softener and then heated to 40 °C temperature. A total of 131 kg of dried herbs was flooded with 1,160 l of thus prepared water according to the following recipe: comfrey root (*Symphitum officinale*) - 22 %, dandelion leaf (*Taraxacum officinale*) - 10 %, horsetail herb (*Equisetum arvense*) - 8.5 %, lemon balm leaf (*Melissa officinalis*) - 8.5 %, nettle leaf (*Urtica dioica*) - 28 %, valerian root (*Valeriana officinalis*) - 15 %, yarrow herb (*Achillea millefolium*) - 10 %. This assortment is mainly based on personal research supported by works of Molisch (1937), Omahen (1985), Steiner (1993), Stickland (1989) and some other authors. Raw materials were purchased from two companies: "Krka-Zelišča", Slovenia and "D.co Ulrcih", Italy. Goods were cut and delivered in bags.

It is known that water is not an impeccable solvent. Some of the substances dissolve completely, another ones partially, while the rest do not dissolve at all. Among the substances which dissolve in pure water only partially, there are a lot of those very useful for plants. For this reason we use microorganisms to break down such raw material and to incorporate its ingredients in SHP. The foundation of this process is a special combination of water extraction and biofermentation with continual oxygen enrichment. Simultaneous extraction and fermentation take place in specially designed tanks. "Slow air" comes with a blower (wind machine) in large quantities, while "high-speed air" comes with a compressor in smaller amounts. During the entire extraction and fermentation processes waterfall flow takes place, using an eccentric screw pump, and eddy currents, using mixer with propellers. Cascade and vortex, unless have direct repercussions on the quality of the final product, also contribute to its "biodynamic dimension" as it is understood by R. Steiner (1993). It takes around 48 hours after the sinking of raw material, before the permanent sampling of the so-called "soup" (mixture of herbs and water) begins with conductometer. As long as the value of conductivity increases, processes of extraction and fermentation should not be considered complete. But as soon as there is not change in three consecutive readings, the process is

interrupted and separation begins. Hence, the conductivity is used as an indirect measure of the total amount of dissolved material in the “soup”.

Separating liquid from the solid phase performs on “FAN press screw separator” designed for fibrous suspension separation in agriculture and respective industries. Drained solid phase is directed to the production of vermicompost, while the liquid one passes through the 300 micron filter (sieve mesh 50). Batch intended for microfertigation is additionally filtered through the 130 micron filter (sieve mesh 120). The filtered out material is pasteurized in the tank for pasteurization. The overall process lasts for 90 minutes and takes place at 70 °C temperature.

After liquid is being cooled, finalization begins. A component with a fragrant and protective features being added in the form of infusion. This infusion was prepared according to the following recipe: mixture of herbs – 1.5 kg, boiling water – 36 l. The mixture of herbs is made of: lavender flowers (*Lavandula x intermedia*) – 50 %, leaf of wormwood (*Artemisia absinthium*) - 25 % and Dalmatian pyrethrum flower (*Tanacetum cinerariifolium*) - 25 %. Aforementioned set of plants was selected on the same basis as the previous one. Later studies by other authors have confirmed the exactitude of such a choice, including Al-Naser et Al-Abrass, 2014; EFSA, 2014; Grdiša et al., 2009. Since SHP was intended for foliar application, one more ingredient has been added. It was surface-active component, to act as a biosurfactant and a bioemulsifier. The ingredient was made as an infusion of baby’s breath rhizome (*Gypsophila paniculata*) in a ratio: 1 g of drug (*Radix Gypsophilae levanticae*) to 100 ml of boiling water. Apart from this source, such a component can be also extracted from soapwort (*Saponaria officinalis*) (Jang et al., 2013) or even obtained from soil microbes (Sachdev et Cameotra, 2013).

SHP is to be dissolved in water in proportion which is adjusted to the need of each crop. Performing spraying on leaves is the most efficient way of application. On the other hand, whenever foliar application is not possible, SHP can be applied through soil by watering around the plant, or through microfertigation. Also, SHP can be used for hydroponics culture.

Field trial

SHP was produced at the Agyos Athanasios Industrial Estate, Limassol, Cyprus, according to the author’s prescription. Sample taken from the regular production was brought to the glasshouse combine „Friendship” in Orenburg, Russia. The trial was performed under the auspices of The Russian Academy of Agricultural Science, Scientific – production department “South Ural”, together with Agricultural farm „Friendship”. Field trial lasted from March to July 1996. The results of the experiment were considered as a kind of trade secret and have not been published before.

Agrochemical characteristics of soil were determined as per standard procedure of The Russian Academy of Agricultural Science. Soil was sampled from the layer 0-30 cm from each experimental section (there were three sections for three crops). The following characteristics were determined from each sample: content of the humus, salinity, total P and K, HCO₃, Ca, Mg, Na, Cl. Experiment was executed as per following treatments: 1. Control, 2. Basic fertilization + SHP, 3. Basic fertilization, 4. Basic fertilization + additional fertilization + SHP, 5. Basic fertilization + additional fertilization. Field trial included following crops: cucumber, sort “Russian Emerald”, pepper, sort “Mercury” and tomato, sort “Rusich”. Treatments were repeated twice with random allocation on 100 m² sample plots for cucumber and tomato and 50 m² for pepper. Fertilization inputs are given in table 1.

Table 1: Fertilization inputs

Kind of fertilization	Treatments	Components	Units	Crops		
				Cucumber	Tomato	Pepper
Basic fertilization	2	Manure	t/ha	300	300	300
	3	Sawdust		150	150	150
	4	N - P - K	kg/ha	480 - 800 - 480	230 - 800 - 230	480 - 800 - 480
	5	MgSO ₄		250	250	250
Additional fertilization	4	N - P	kg/ha	37 - 55	-	-
	5	N - P - K		-	37 - 55 - 37	27 - 92 - 28
		SiSO ₄		8	8	-
		H ₃ BO ₃		2	2	2
		KMnO ₄		2	1.5	1.5
	Frequency	days	once	10 - 12	10 - 12	

Nitrogen in NPK mineral fertilizer was applied in the form of urea, phosphorus as a granular double superphosphate and potassium as potassium sulphate. Application of SHP was executed according to the following scheme (table 2).

Table 2: SHP inputs

Application	Cucumber		Tomato		Pepper	
	Timing	l/ha	Timing	l/ha	Timing	l/ha
I	Stage of 6 leaves	20	Stage of the first flower cluster	47	Stage of 6-8 leaves	70
II	Stage of blossoming	20	Stage of the second flower cluster	47	Stage of fruit formation	70
III	-	-	Stage of the third flower cluster	47	-	-

Yield was monitored every day throughout the complete process of fruit development. Changes in moisture, nitrate and protein concentration in fruits were observed three times per season – during initial, main and final harvest. Morphological characteristics such as plant height, distance between trusses, stalk diameter and number of fruits were also permanently monitored on tomato and pepper.

Results and discussion

Soil under the glasshouses was chernozem. The determined humus content was almost two times higher than the average for this type of soil in Russia, but at the same time chlorine content was very high as well. Another unfavorable feature of the observed soil was compaction. To avoid hardening of soil there used to enter sawdust. Such measure leads to improvement of air-water soil regime, but also lowers the pH of soil because wood is by nature an acidic substance. Agrochemical characteristics of soil sections with sample plots are given in table 3.

Table 3: Agrochemical characteristics of soil sections with sample plots

Crop	Humus	Salinity	Total P	Total K	HCO ₃	Ca	Mg	Na	Cl
	%				meq/100 g				
Cucumber	11.6	0.24	0.13	2.59	0.76	1.6	1.0	0.93	5.5
Tomato	12.5	0.33	0.12	2.74	0.78	3.4	1.5	1.33	7.5
Pepper	12.5	0.31	0.16	3.14	0.85	2.0	1.0	1.28	6.8

Cucumber

The highest seasonal yield of cucumber (15.9 kg/m²) was achieved with application of basic and additional fertilization plus SHP (table 4). In comparison to the control treatment, increment was 20.4 %. If we focus on treatments No. 2 and No. 3, we will notice that yield increment directly attributed to the SHP was 0.6 kg/m², or 4.2 % of the treatment without SHP. Also, due to the application of SHP with basic and additional fertilization, yield was raised by 1.2 kg/m², or 8.2 % of the treatment without SHP. Hence, two times sprinkling with 20 l/ha of SHP increases the yield of cucumber by 0.6 - 1.2 kg/m².

Table 4: Seasonal yield of cucumber

No.	Treatments	Yield kg/m ²	Yield increase	
			kg/m ²	%
1	Control	13.2	-	-
2	Basic fertilization + SHP	14.9	1.7	12.9
3	Basic fertilization	14.3	1.1	8.3
4	Basic fertilization + additional fertilization + SHP	15.9	2.7	20.4
5	Basic fertilization + additional fertilization	14.7	1.5	11.4

Period of cucumber fruit formation lasted five months (table 5). Most intense fruiting happened in May and June. At that time, treatments with SHP gave 76 % and 77 % of the total seasonal yield. In the interim, fruiting occurs a little bit earlier in comparison to the conventional way of growing.

Table 5: Variation of cucumber yield during the season

Treat- ments No.	Month										Total kg/ha
	March		April		May		June		July		
	kg/ha	%	kg/ha	%	kg/ha	%	kg/ha	%	kg/ha	%	
1	0.26	2	1.0	7	3.66	28	5.89	45	2.39	18	13.2
2	0.30	2	1.21	8	4.37	29	6.95	47	2.08	14	14.9
3	0.29	2	1.10	8	3.96	28	6.38	44	2.57	18	14.3
4	0.32	2	1.58	10	4.87	31	7.31	46	1.83	11	15.9
5	0.29	2	1.18	8	4.12	28	6.79	46	2.35	16	14.7

Changes in the quality of cucumber during the season have the following features: the content of moisture in all treatments and stage of harvest are not essentially different; in treatments with SHP the level of nitrate is reduced.

Table 6: Changes in cucumber quality during the season

Treatments No.	Initial harvest			Main harvest			Final harvest		
	Moisture %	Nitrate mg/100 g	Protein %	Moisture %	Nitrate mg/100 g	Protein %	Moisture %	Nitrate mg/100 g	Protein %
1	97.24	763	0.75	97.77	334	0.49	97.93	284	0.38
2	97.04	588	0.71	98.12	226	0.49	98.47	231	0.45
3	97.21	602	0.60	97.86	275	0.44	98.16	175	0.32
4	97.16	654	0.65	97.90	265	0.50	98.11	183	0.43
5	98.14	771	0.70	98.13	401	0.38	97.85	271	0.35

Tomato

The highest seasonal yield of tomato (7.9 kg/m²) was achieved with application of basic and additional fertilization plus SHP (table 7). In comparison to the control treatment, increment was 14.5 %. If we focus on treatments No. 2 and No. 3, we will notice that rise in yield directly attributed to SHP was 0.2 kg/m², or 2.7 % of the treatment without SHP. Also, due to the application of SHP with basic and additional fertilization, yield was raised by 0.1 kg/m², or 1.3 % of the treatment without SHP. Hence, two times sprinkling with 20 l/ha of SHP increases the yield of cucumber by 0.1 - 0.2 kg/m².

Table 7: Seasonal yield of tomato

No.	Treatments	Yield kg/m ²	Yield increase	
			kg/m ²	%
1	Control	6.9	-	-
2	Basic fertilization + SHP	7.5	0.6	8.7
3	Basic fertilization	7.3	0.4	5.8
4	Basic fertilization + additional fertilization + SHP	7.9	1	14.5
5	Basic fertilization + additional fertilization	7.8	0.9	13.0

Period of tomato fruit formation lasted four months (table 8). The highest yield was recorded in May-June, but treatments with SHP provided almost 50 % of the seasonal yield already in May.

Table 8: Variation of tomato yield during the season

Treatments No.	Month										Total kg/ha
	March		April		May		June		July		
	kg/ha	%	kg/ha	%	kg/ha	%	kg/ha	%	kg/ha	%	
1	-	-	0.54	8	2.50	36	3.52	51	0.33	5	6.9
2	-	-	0.64	9	3.02	40	3.67	49	0.17	2	7.5
3	-	-	0.57	8	2.64	36	3.72	51	0.38	5	7.3
4	-	-	0.74	9	3.17	40	3.68	47	0.31	4	7.9
5	-	-	0.61	8	2.82	36	3.98	51	0.40	5	7.8

Changes in tomato quality during the season have similar features as of cucumber: the content of moisture in all treatments and stage of harvest are not essentially distinctive; in treatments with SHP the level of nitrate is reduced and that of protein increased during initial and main harvest.

Table 9: Changes in tomato quality during the season

Treatments No.	Initial harvest			Main harvest			Final harvest		
	Moisture %	Nitrate mg/100 g	Protein %	Moisture %	Nitrate mg/100 g	Protein %	Moisture %	Nitrate mg/100 g	Protein %
1	96.31	332	0.71	96.73	210	0.60	95.34	152	0.45
2	96.06	280	0.80	96.18	176	0.71	96.73	144	0.40
3	96.16	310	0.73	97.03	188	0.65	96.60	144	0.44
4	96.51	292	0.78	96.21	241	0.70	97.02	163	0.42
5	97.24	351	0.76	96.03	312	0.38	96.73	212	0.46

The influence of SHP on tomato appearance was manifested through the increased number of fruits per truss. However, this phenomenon does not contribute to the significant increment of the overall yield. On the contrary, treatment with SHP gave trusses with extra but smaller fruits, which is not favorable and at the same time it decreases the harvest quality. In order to avoid such occurrence it will be necessary to undertake further investigations towards a better-tuned composition and dosage of SHP. When comparing treatments with basic fertilization (No. 2 and No. 3), application of SHP leads to a greater plant height, greater distance between trusses, but also thinner stalk. When it comes to treatments with additional fertilization (No. 4 and No. 5), all of this features are slightly smaller in treatments with SHP.

Pepper

The highest seasonal yield of pepper (4.6 kg/m^2) was achieved with application of basic and additional fertilization plus SHP (table 10). In comparison to the control treatment, increment was 27.8 %. If we focus on treatments No. 2 and No. 3, we will notice that yield increment directly attributed to SHP was 0.3 kg/m^2 , or 7.5 % of the treatment without SHP. Also, due to the application of SHP with basic and additional fertilization, yield was raised by 0.4 kg/m^2 , or 9.5 % of the treatment without SHP. Hence, two times sprinkling with 20 l/ha of SHP increases the yield of cucumber by 0.3 - 0.4 kg/m^2 .

Table 10: Seasonal yield of pepper

No.	Treatments	Yield kg/m^2	Yield increase	
			kg/m^2	%
1	Control	3.6	-	-
2	Basic fertilization + SHP	4.3	0.7	19.4
3	Basic fertilization	4.0	0.4	11.1
4	Basic fertilization + additional fertilization + SHP	4.6	1.0	27.8
5	Basic fertilization + additional fertilization	4.2	0.6	16.7

Pepper fruit formation period lasted five months (table 11). Most intense fruiting occurred in April and May. In that period treatments with SHP gave 90 % of the total seasonal yield. At the same time, period of fruit formation was shifted to an earlier period in comparison to the standard way of growing.

Table 11: Variation of pepper yield during the season

Treat- ments No.	Month										Total kg/ha
	March		April		May		June		July		
	kg/ha	%	kg/ha	%	kg/ha	%	kg/ha	%	kg/ha	%	
1	0.08	2	1.2	33	1.68	47	0.24	7	0.40	11	3.6
2	0.13	3	1.63	38	2.11	49	0.23	5	0.21	5	4.3
3	0.09	2	1.33	33	1.87	47	0.27	7	0.44	11	4.0
4	0.14	3	1.81	39	2.22	48	0.22	5	0.22	5	4.6
5	0.09	2	1.4	33	1.96	47	0.28	7	0.46	11	4.2

Similar to other crops, content of moisture in all treatments and at stage of harvest was not essentially different (table 12). In treatments with SHP, the level of protein was increased during the entire harvest season. However, with nitrates it was a different case. In principle, their content decreases with time, but the intragroup variability was rather strong to draw unambiguous conclusions.

Table 12: Changes in pepper quality during the season

Treat- ments No.	Initial harvest			Main harvest			Final harvest		
	Moisture %	Nitrate mg/100 g	Protein %	Moisture %	Nitrate mg/100 g	Protein %	Moisture %	Nitrate mg/100 g	Protein %
1	94.63	212	0.77	95.34	208	0.71	93.66	176	0.68
2	94.89	183	0.83	95.45	153	0.84	93.30	151	0.73
3	94.70	167	0.81	95.50	156	0.71	93.45	159	0.70
4	94.67	108	0.88	95.26	202	0.82	93.16	180	0.76
5	94.34	232	0.85	95.22	192	0.74	94.17	188	0.74

Treatments with SHP gave higher plants and greater distance between trusses, in both variants – with additional fertilization (treatment No. 4) or without (treatment No. 2). In variant without additional fertilization, treatment with SHP (No. 2) had more branches and fruits compared to its counterpart (No. 3). Finally, with increased fertilization (treatments No. 4 and No. 5) the observed differences got lost.

Conclusions

The obtained results clearly indicate that observed SHP has the capacity of a PGR. In variant when observed crops were provided with basic fertilization, a higher seasonal yield had always been achieved whenever SHP was added. The same applies with variant when observed crops were provided with basic and additional fertilization.

The results also suggest that SHP has the capacity of an uptake improver. For each of the observed crops, other than tomatoes, yield increment directly attributed to SHP was higher in variant when observed crops were provided with basic and additional fertilization, i.e. when larger amounts of nutrition were available.

Nevertheless when we consider the quality of the yield, specifically of tomato, the results are not so unambiguous. Treatments with SHP gave trusses with more but smaller fruits, which is not favorable and at the same time decreases the value of harvest. In order to avoid such occurrence it will be necessary to undertake further investigations towards better-tuned composition and dosage of SHP. Partial explanation for such manifestation probably lies in the fact that observed growing conditions were not optimal for tomatoes. This arises from a rather limited yield. In comparison, average yield of tomato achieved under greenhouses in Cyprus during the same growing season was 15 kg/m² and there increment influenced by the same SHP exceeded 15 %, or 2.2 kg/m² (personal data base).

References

- Ahemad M., Kibret M. (2014): Mechanisms and applications of plant growth promoting rhizobacteria: Current perspective. *Journal of King Saud University – Science*, 26. 1-20
- Al-Naser Z., Al-Abrass N. (2014): Chemical composition and fungitoxic activities of *Lavandula officinalis* L. oil and comparison with synthetic fungicide on the growth some fungi in vitro. *International Journal of ChemTech Research*, Vol.6, No.11. 4918-4926
- Bulgari R. et al. (2015): Biostimulants and crop responses: a review. *Biological Agriculture & Horticulture*, Vol. 31, No. 1. 1-17
- Calvo P., Nelson L., Kloeppe W.J. (2014): Agricultural uses of plant biostimulants. *Plant and Soil*, Vol. 383, No. 1. 3-41
- Chang C.S.K. et al. (2014): Natural farming: Oriental herbal nutrient. *Sustainable Agriculture* 11. *College of Tropical Agriculture and Human Resources*. 1-4
- European Food Safety Authority (2014): Outcome of the consultation with Member States and EFSA on the basic substance application for *Artemisia absinthium* for use in plant protection as fungicide in wheat and as nematicide and isecticide in vegetables. EFSA supporting publication 2014:EN-665. 1-37
- Frankič T. et al. (2009): Use of herbs and species and their extracts in animal nutrition. *Acta Agriculturae Slovenica*, 94/2. 95-102
- Grdiša M. et al. (2009): Morphological and biochemical diversity of Dalmatian pyrethrum (*Tanacetum cinerariifolium* (Trevir.) Sch. Bip.) *Agriculturae Conspectus Scientificus*, Zagreb, Vol. 74, No. 2. 73-80
- Jang A. R. et al. (2013): Development of a natural surfactant from extracts of *Saponaria officinalis* L. *Korean Society for Biotechnology and Bioengineering Journal*, 28(3). 202-207
- Jelačić S. et al. (2007): The effect of natural biostimulators and slow-desintegrated fertilizers on the quality of rosemary seedlings (*Rosmarinus officinalis* L.). *Journal of Agricultural Sciences*, Vol. 52, No 2. 85-94
- Khan W. et al. (2009): Seaweed extracts as biostimulants of plant growth and development. *Journal of Plant Growth Regulation*, 28. 386-399
- Komykova T.S. et al. (2012): Effect of Silk preparation in the conditions of complex action of temperature and water stress on tomato plants. *Agricultural Biology*, No.1. 86-92

- Kuhne S., Jahn M. (2010): German regulations on low-risk products for plant protection.
European Symposium of the Technical Institute for Organic Agriculture (ITAB): Plant protection products for organic agriculture. Use, regulations and European perspectives.
10-11 March, Lille, France. 18-19
- Ljubojević S. (2015): Impact of various herbal extracts on yield of lettuce (*Lactuca sativa*). VI
International Scientific Agricultural Symposium „Agrosym 2015“, Jahorina, 15.-18.10.2015
Book of Proceedings. 1118-1126
- Molisch H. (1937): The impact of one plant to another – Allelopathy (Original title: Das Einfluß einer Pflanze auf die andere – Allelopathie). Gustav Fischer, Jena. 1-106
- Nega A. (2014): Review on concepts in biological control of plant pathogens. Journal of Biology, Agriculture and Healthcare, Vol.4, No. 27. 33-54
- Omahen M. (1985): My bio garden (Original title: Moj bio vrt). Delo. Ljubljana. 1-111
- Pavela R. (2013): New possibilities of using the antifeedant and repellent effects of plant extracts in the protection of plants and human health. In: Plant extracts: role in agriculture, health effects and medical application. Nova Science Publishers. 219-240
- Sachdev P.D., Cameotra S.S. (2013): Biosurfactants in agriculture. Applied Microbiology and Biotechnology, Vol. 97 (3). 1005-1016
- Steiner R. (1993): Agriculture. Bio-Dynamic farming and Gardening Association Inc. 1-310
- Stickland S. (1989): The organic garden. Hamlyn. 1-128
- Stirling G. R. et al. (2016): Soil health, soil biology, soilborne diseases and sustainable agriculture: a guide. CSIRO Publishing. 1-280
- Zarins I., Daugavietis M., Halimona J. (2009): Biological activity of plant extracts and their application as ecologically harmless biopesticide. Scientific Works of the Lithuanian Institute of Horticulture and Lithuanian University of Agriculture, 28(3). 269-280
- Zemke -White L. W., Ohno M. (1999): World seaweed utilization: End-of-Century Summary. Journal of Applied Phycology, 11. 369-376

COMPARATIVE EVALUATION OF SUPPRESSIVE EFFECTS OF ESSENTIAL OILS ON FUNGAL PATHOGENS

Raoudha KHANFIR BEN JENANA*, Chourouk ZAHAF, Hazem BEN BRAHIM, Cherif HANACHI

Higher Institute of Agricultural Sciences of ChottMariem, Tunisia

*Corresponding author: bjnk@ yahoo.fr

Abstract

Four organic aromatic species: *Artemisia absinthum* (Aa), *Pelargonium graveolens* (Pg), *Cymbopogon citratus* (Cc) and *Santolina chamaecyparissus* (Sc), cultivated in the experimental field of the Technical Center of Organic Agriculture, were harvested. The essential oils of these four species were extracted by hydro-distillation and analyzed by GC/MS and GC-FID/IK methods. The suppressive effects of the essential oils were tested on four fungal pathogens *Fusarium solani* (Fs), *Fusarium oxysporum* (Fo), *Aspergillus niger* (An) and *Penicillium digitatum* (Pd). The confrontations essential oils /fungi were performed by the disk method. The results show that *Artemisia absinthum* gave the highest rate of essential oil (0.21%) while *Pelargonium graveolens* gave the lowest rate (0.07%). However, the suppressive effects of essential oils are not proportional to the performance; in fact we recorded after 7 days of confrontation in Petri dishes, a total inhibition (100%) of the four fungi by the essential oils of *Pelargonium graveolens* and *Cymbopogon citratus* species. *Santolina chamaecyparissus* had a total suppressive effect (100%) on *Fusarium solani* and on *Fusarium oxysporum*, a partial inhibition on *Aspergillus niger* (21%) and none on *Penicillium digitatum*. Essential oil of *Artemisia absinthum* had a partial suppressive effect on the four fungal strains tested (inhibition rates registered were 21% on *Penicillium digitatum*, 24% on *Fusarium oxysporum* and *Fusarium solani*, and 33% on *Aspergillus niger*). Therefore, we may conclude that essential oils can constitute an effective organic antifungal agent that could substitute chemical fungicides.

Keywords: *antifungal effects, essential oils, aromatic species.*

Introduction

Between 60 and 70% of pharmaceutical products are primarily from natural products, including medicinal and aromatic plants. Teixeira da Silva (2004) and Svoboda and Hampson (1999) have shown that aromatic and medicinal plants possess several biological activities with antimicrobial effects, insecticides and herbicides. Several research have focused on the anti fungal effect of the essential oils of plants (Cakir et al., 2004, Vidyasagar, 2013, Amri et al., 2013). Other effects of essential oils (EO) have been described such as the reduction of competition from other species (allelopathy) by chemical inhibition of seed germination and protection against the infectious microflora with the fungicidal and bactericidal properties ... etc. (Porter, 2001). Meyer (1989) defines the essential oils as oily substances, volatile and fragrant, aromatic and present in localized plants, in flowers, leaves, fruits, seeds, bark, roots. Moreover, Bruneton (1993) added that essential oils are generally quite complex composition of products containing volatile principles contained in plant and more or less modified during the preparation. According to a study by Deans (2002), the essential oil of geranium inhibits filamentous fungi such as *Aspergillus* and *Fusarium*. The citronella oil also has an antifungal effect by inhibiting several fungi such as *Fusarium*, *Aspergillus*, *Alternaria* and *Penicillium* (Onawunmi et al., 1984). The antifungal activity of essential oils of *Biota orientalis* was studied by Cakir et al., (2004) on different strains of phytopathogenic fungi including *Fusarium oxysporum* strains on different crops. Juteau et al., (2003) found that the oil

composition of the species *Artemisiaabsinthium* is variable depending on the geographical origin and is mainly antibacterial and antifungal. Citronella gasoline also has an antifungal effect on *Fusarium*, *Aspergillus*, *Alternaria* and *Penicillium* (Onawunmi et al., 1984). In this study, we determined the chemical composition and studied the antifungal activities of EO isolated by hydrodistillation from the fresh leaves of four aromatic species *Artemisia absinthium*, *Pelargonium graveolens*, *Cymbopogoncitratu*s and *Santolinachamaecyparissus*.

Material and methods

Plant material

The collected plants *Artemisia absinthium*, *Pelargonium graveolens*, *Cymbopogoncitratu*s and *Santolinachamaecyparissus* were planted in the field in 2008 in an experimental plot of the Technical Centre for Organic Agriculture of ChottMariem (Sousse, Tunisia). Planting distances was 25m × 80m. These aromatic plants were grown in rows, irrigated by a drip irrigation system. They were conducted in biological mode and fertilized by compost is well decomposed organic manure and treated with certified organic produce.

Extraction and analysis of essential oils

EO from the fresh leaves of the four species were found by hydrodistillation using a Clevenger type apparatus (Benyelles et al., 2014, Suwei and Dongke, 2014 and Okoh et al., 2010). Essential oils were stored in Eppendorf tubes at 4°C until use. The yield was expressed in percentage (%) and calculated according to the plant fresh weight using the following formula:

$$R = (PH / PV) * 100$$

PH: weight of the EO

A: essential oil yield

PV: Plant weight

Essential oil analysis

The identification of essential oil components was performed by GC and GC/MS. GC diagnostic were carried out on an HP5890-series II gas chromatograph (Agilent Technology, California, USA) with Flame Ionization Detectors (FID) characterized by: a fused silica capillary column, non polar HP-5 and polar HP Innowax (30 m × 0.25 mm ID, film thickness 0.25 µm). The temperature of the oven was 50 °C for 1 min, then it is programmed to achieve heating rate up to 5–240 °C/min and held isothermal for 4 min. Injector temperature: 250°C, detector temperature: 280 °C; nitrogen used as a carrier gas (1.2 ml/min); and injected 0.1 ml diluted in hexane 1%. The percentage of the constituents was calculated by electronic integration of FID peak areas without the use of response factor correction. Hewlett-Packard 5972 MSD system served for GC/MS analyses: HP-5 MS capillary column (30 m × 0.25 mm ID, film thickness of 0.25 mm) was directly coupled to the mass spectrometry. The comparison of the component mass spectra with those in the Wiley 275 GC/MS library and of their retention indices with literature data (Adams, 2001) served to their identification. Retention indices (RI) were calculated by the retention times of a series of n-alkanes.

Fungal material

Four strains of fungi were used for the antifungal tests *Fusarium solani*, *Fusarium oxysporum*, *Aspergillus Niger* and *Penicilliumdigitatum*. The micro-organisms were collected from Plant Pathology Laboratory of the Regional Centre for Research in Organic Agriculture and Horticulture of ChottMariem.

Isolation of fungal strains and study of the antifungal activity of EO

Fungal colonies were regenerated in PDA media and autoclaved. The conidial suspensions prepared from the regenerated colonies were distributed in Petri dishes. Antifungal studies have been evaluated by the method of disc-diffusion described by (Mayachiev and

Devahastin, 2008) and (Hussain et al., 2010). Under aseptic conditions, 8 µl of EO were applied to sterilized Whatman filter paper discs N° 3 (6 mm diameter). Plates were incubated at 25°C for 7days. Diameters of inhibition were measured in millimeter.

Statistical analysis

Statistical analysis of the different parameters was carried out by comparison of means by Duncan testusing the SPSS 20.0 software. The means were separated on the basis of least significant difference at 5% probability level.

Results and discussion

Essential oil yield

Fresh leaves essential oils yields vary from 0.07% to 0.4% (v/w) (Table 1).

Table 1: Essential oil yield of leaves of the species studied.

Species	<i>Artemisia absinthium</i>	<i>Pelargonium graveolens</i>	<i>Cymbopogon citratus</i>	<i>Santolina chamaecyparissus</i>
Essential oil yield (%)	0.21	0.07	0.4	0.4

Composition of essential oils

Essential oils of the 4 studied species (Aa), (Pg), (Cc) and (Sc)contain respectively 40, 49, 54 and 61 components identified, representing respectively 100%, 98.13%, 99.59% and 99.22% of the total fresh leaves oils. The essential components are illustrated in Table 2.

Table 2: Main components of essential oils extracted and analyzed

	<i>Cymbopogon citratus</i> (Cc)	<i>Santolina chamaecyparissus</i> (Sc)	<i>Artemisia absinthium</i> (Aa)	<i>Pelargonium graveolens</i> (Pg)
Myrcene	12,54	-	-	-
Neral	28,62	-	-	-
Géraniale	38,05	-	-	-
Géraniol	5,44	-	-	24,20
Artemisiaketone	-	53,60	-	-
Camphor	-	12,83	28,17	-
α-bisabolol	-	4,58	-	-
β-Thujone	-	-	29,23	-
Chamazulene	-	-	7,33	-
Linalool	-	-	-	7,43
Citronellol	-	-	-	25,50

Antifungal effect of essential oils

Antifungal activities of the fresh leaves essential oils registered after 7 days are reported in Figures 1 to 4.

Antifungal effect on *Penicilliumdigitatum*

All EO have a variable effect on *Penicilliumdigitatum*(Figure 1). The essential oils of (Cc)and (Pg)completely inhibited the mycelial growth of *Penicillium* (100%). This growth was inhibited by 21% essential oil of (Aa)while the essential oil of (Sc)had no inhibitory effect.

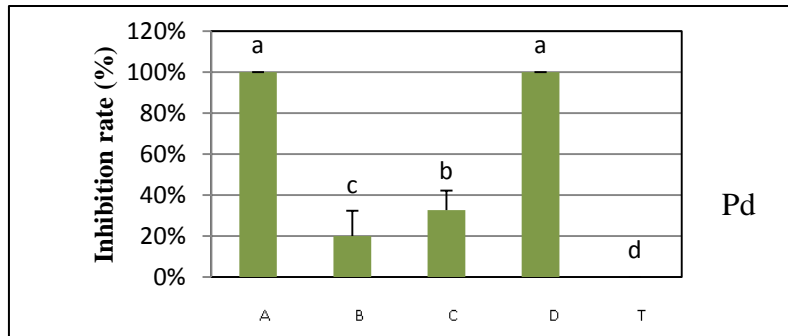

Figure 1. Percentage of inhibition of *Penicillium digitatum* (Pd) by the essential oils of *Cymbopogon citratus* (A) *Santolinachamaecyparissus* (B), *Artemisia absinthium* (C), *Pelargonium graveolens* (D) and control (C) 7 days after confrontation . Values with different letters are significantly different at $p < 0.05$ (Dancun)

Antifungal effect on *Fusarium solani*

Measurements of mycelial growth of *Fusarium solani* showed that the essential oils of Cc, PgSc and have a 100% inhibition whereas inhibition of the essential oil of Aa does not exceed 24 % (Figure 2).

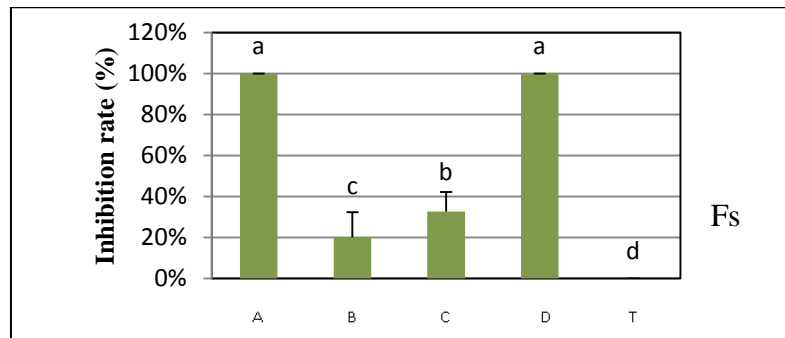

Figure 2: Percentage of inhibition of *Fusarium solani* (Fs) by essential oils of *Cymbopogon citratus* (A) *Santolinachamaecyparissus* (B), *Artemisia absinthium* (C), *Pelargonium graveolens* (D) and control (T) 7 days after confrontation. Values with different letters are significantly different at $p < 0.05$ (Dancun)

Antifungal effect on *Fusarium oxysporum*

All essential oils have shown an inhibitory effect on *Fusarium oxysporum* (Figure 3). The measurements of mycelial growth of *Fusarium oxysporum* showed that the essential oil of Cc, Pg and Sc have a 100% inhibition, while the Aa essential oil gave an inhibition rate of 24%.

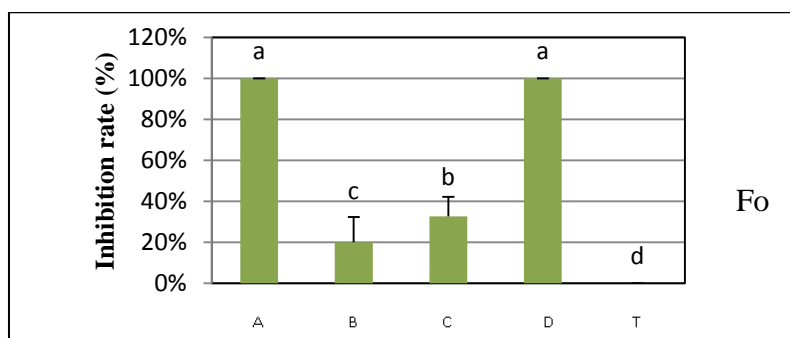

Figure 3. Percentage of inhibition of *Fusarium oxysporum* (Fo) by essential oils of *Cymbopogon citratus* (A) *Santolinachamaecyparissus* (B), *Artemisia absinthium* (C), *Pelargonium graveolens* (D) and control (T) 7 days after confrontation. Values with different letters are significantly different at $p < 0.05$ (Duncan)

Figure 4 shows that both essential oils of Cc (A) and Pg (D) completely inhibited the mycelial growth of *Aspergillus niger*. Whereas EO of Sc (B) and Aa (C) partially inhibited the fungal growth (21% and 33% respectively).

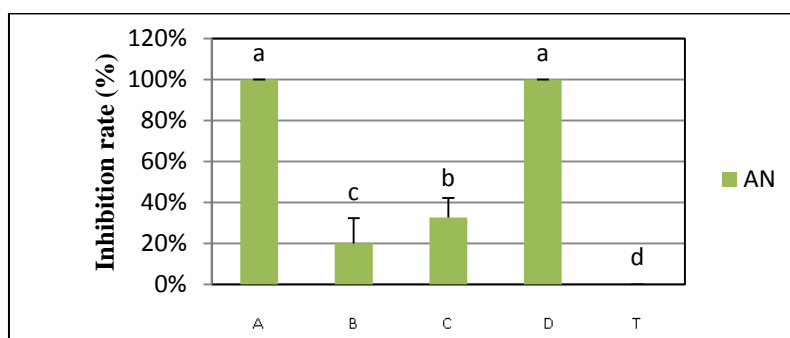

Figure 4. Percentage inhibition of *Aspergillus Niger* (An) by the essential oils of *Cymbopogon citratus* (A) *Santolinachamaecyparissus* (B), *Artemisia absinthium* (C), *Pelargonium graveolens* (D) and control (T) 7 days confrontation. Values with different letters are significantly different at $p < 0.05$ (Duncan)

All the essential oils tested showed antifungal activities. Our results confirm that several volatile oils are recognized to acquire antifungal and antibacterial properties (Bel Hadj Salah-Fatnassi et al., 2016). Many scientific investigations have been conducted to evaluate the biological activities; of about 60% of the essential oils possess antifungal and 35% of them exhibited antibacterial properties (Chaurasia and Vyas, 1977). A few series of studies have demonstrated the potential antimicrobial effect of essential oils from various *Santolina* species, (Rossi et al., 2007). Our results concerning the antagonist effect of EO on *Penicillium* confirm those of Onawunmi et al. (1984) and Vidyasagar (2013) who described an essential oil inhibiting effect on *Penicillium*. Inhibiting action of Pg established by this study confirms the work of Deans (2002) which shows that the essential oil of Pg inhibits filamentous fungi such as *Fusarium solani*. Our results confirm also those found by Vidyasagar, (2013) which shows the inhibitory effect of essential oils on *Fusarium*. Otherwise, our results showed 100% efficiency for Cc and Pg against all tested fungal species. The reaction of Sc was variable.

Fusarium solani and *Fusarium oxysporum* were most sensitive while *Penicillium digitatum* was very resistant.

Conclusion

This research aimed to evaluate the antagonistic effects of the essential oils of four aromatic species *Cymbopogon citratus* (A) *Santolinachamaecyparissus* (B), *Artemisia absinthium* (C), *Pelargonium graveolens* through against four fungal strains *Fusarium solani*, *Fusarium oxysporum*, *Aspergillus Niger* and *Penicillium digitatum* to contribute to biological control on fungal diseases. However molecular tests would be required to accurately determine the mechanisms of action and the molecules responsible for the removal of fungi. Field trials would also be interesting to demonstrate the practical use of essential oils studied.

Acknowledgements

The authors are grateful to the Technical Center of Organic Agriculture (CTAB) for the plant material, the medical school (University of Monastir) for the oil analysis and the Regional Center of Research in Horticulture and Organic agriculture (CRRHAB).

References

- Adams, R.P. (2001): Identification of Essential Oil Components by Gas Chromatography/Quadrupole Mass Spectrometry Allured Publishing Corporation, Carol Stream, Illinois, USA (2001)
- Amri, L. Hamrouni, M. Hanana, S. Gargouri, B. Jamoussi. (2013) : Propriétés antifongiques des huiles essentielles de *Biota orientalis* [antifungal properties of essential oils of *Biota orientalis*]; springer Paris L. p5.
- Bel Hadj Salah-Fatnassi K., Cheraif I., Khan S., Ben Jannet H., Hammami M., Aouni M., Harzallah-Skhiri F. (2016): Chemical composition, antibacterial and antifungal activities of flowerhead and root essential oils of *Santolinachamaecyparissus* L., growing wild in Tunisia. Saudi Journal of Biological Sciences Available online 26 March 2016
- Benyelles, B., Allali, H., Dib, M.A., Djabou, N., Tabti, B., Costa, J. (2014): Essential oil from *Rhaponticum macaule* L. roots: comparative study using HS-SPME/GC/GC-MS and hydrodistillation techniques. J. Saudi Chem. Soc., 18(6) (2014), pp. 972–976.
- Bruneton, J. (1993) : Phytochimie et pharmacognosie des plantes médicinales, éditions techniques et documentations Lavoisier. 915 p.
- Cakir, A., Kordali, S., Zengin, H., (2004): Composition and antifungal activity of essential oils isolated from *Hypericum hyssopifolium* and *Hypericum heterophyllum*. Flavour Frag J 19 (1) (2014), pp 62–8.
- Chaurasia, S.C., Vyas K.K. (1977): In vitro effect of some volatile oil against *Phytophthora parasitica* var. *piperina*. J. Res. Indian Med. Yoga Homeopathy (1977), pp. 24–26
- Deans, S. G., (2002): Antimicrobial property of pelargonium extracts contrasted with that of geranium. Geranium and Pelargonium. Geranium and Pelargonium: the genera Geranium and Pelargonium. M Lis-Balchin - 2002 - Taylor & Francis. 313p.
- Hussain A.I., Anwar F., Chatha S.A.S., Jabbar A., Mahboob S. and Nigam P.S. (2010), *Rosmarinus officinalis* essential oil: antiproliferative, antioxidant and antibacterial activities. *Brazilian Journal of Microbiology* 41: pp.1070-1078.
- Juteau F, Jerkovic I, Masotti V, Milos M, Mastelic J, Bessièrè J M, Viano J. (2003): Composition and Antimicrobial Activity of the Essential Oil of *Artemisia absinthium* from Croatia and France. *Planta Med.*; 69(2) pp. 158-161
- Mayachiew P., Devahastin S. (2008): Antimicrobial and antioxidant activities of Indian gooseberry and galangal extracts. *Food Science and Technology* 41; pp. 1153-1159.

- Meyer B. (1989) : les matières premières mondiales en compétition avec la production française et européenne. *Rivista italiana Eppos*, numéro spécial, pp. 273-281.
- Okoh, O.O. Sadimenko, A.P., Afolayan A.J. (2010) : Comparative evaluation of the antibacterial activities of the essential oil of *Rosmarinus officinalis* L. obtained by hydrodistillation and solvent free microwave extraction methods. *Food Chem.*, 120(1) (2010), pp. 308–312.
- Onawunmi GO, Yisak WA, Ogunlana EO. (1984): Antibacterial constituents in the essential oil of *Cymbopogon citratus* (DC.) Stapf. *J Ethnopharmacol.* 1984 Dec;12(3): pp 279-86.
- Rossi, P.G., Panighi, J., Luciani A., Serra D., de Rocca, J., Maury, M., Gonny, A., Muselli, J.M., Bolla, L. Berti (2007) : Antibacterial action of essential oils from Corsica. *J. Essent. Oil Res.*, (19), pp. 176–182.
- Suwei, Z. Dongke, Z., (2014): Supercritical CO₂ extraction of *Eucalyptus* leaves oil and comparison with Soxhlet extraction and hydro-distillation methods. *Sep. Purif. Technol.*, (133), pp. 443–451.
- Svoboda, K.P., Hampson, J.B., (1999): Bioactivity of essential oils of selected temperate aromatic plants: antibacterial, antioxidant, antiinflammatory and other related pharmacological activities. *Plant Biology Department, Oral Microbiology and Immunology*, 9(4):pp 202-208.
- Teixeira da Silva J.A. (2004): Mining the essential oils of the anthemideae. *African Journal of Biotechnology* 3(12) pp. 706-720.
- Vidyasagar G.M. (2013) : Antifungal Investigations On Plant Essential Oils. A Review. *Int J Pharm. Sci*, 5(2) pp. 19-28.

SUSTAINABLE WHEAT VARIETIES FOR ORGANIC PRODUCTION FOCUSING HARD CONTINENTAL CLIMATE

Zoran JERKOVIĆ*, Željana PRIJIĆ, Radivoje JEVTIĆ

Institute of Field and Vegetable Crops, 21000 Novi Sad, Serbia

*Corresponding author: zoran.jerkovic@nsseme.com

Abstract

Different of sustainable meaning economical and safe the organic production was limited by no use of pesticides. By residua content most critical were underground mostly formed vegetables also applicable after wheat. However, wheat had been important in crop rotation as weed most reductive. Generally for organic production, use of local naturally adapted genotypes by durable resistance to wide spectrum of pathogens was suggested. Level of such wheat varieties resistance to obligate parasites was correlated to growth parameters also. Different by last parameters in controlled and field conditions grain yield as respond to prevalent diseases were estimated in field trials 2011-2016th as well as technological quality parameters partially. Adequate by growth type main in production were of higher grain yield potential at least for 5% of above ones. Even accounted was application of fungicides before variety replacement because of unpredictable yield losses up to 30% by *Puccinia triticina* resistance overcome appeared more economical respecting continual of five years period. Novel race of stripe rust relative former more aggressive caused suggestion that complete resistant ones surround adequate variety type 1:5 in mercantile production. Expected benefit was also across accelerated nearby spreading of most effective insignificant yield influential rusts antagonist and practically increased technological quality by amylase presence. Seed productions of however minor varieties require protection of high seed categories while for mercantile ones untreated could be adequate single for stable organic production. Beside parasite overdevelopment temporary risk, some of could be also valuated trough stable gliadin share decrease and higher protein content.

Key words: *wheat varieties, organic production*

Introduction

Of organic farming area was 1,8 milion hectares involving wheat while basic was no apply of pesticides requiring not treated seed also (Konvalina et al., 2011). The inclusion of wheat in hard continental climate become logical trough results of pesticides residua in underground mostly formed vegetables trough soil while suitable to be sown post harvested without risk to be diseased, toxified or over amounted by heavy metals. Critical throw water deficit appeared to be ten days period after sowing. Maximal rainfall in focused climate was mostly at the end of June as drought-heath stress around middle or earlier by temperature increase more often these century (Jevtić et al., 2010). Also there was no other solution for weed control (Kruepl et al., 2006) and avoiding of same technology for soil preparation, however. The local adapted genotypes or such based varieties had to be propagated by organic farmers (Haring et al., 1999) meaning without processed seed. Wheat was mostly recognizable by long stem respecting addaptation to poor soils and permanent drought stresses (Koepke, 2009). Otherwise, at poor soils the grain yield of intermediate toll varieties with lower protein content appeared higher without significant influence of planting date (Darby et al., 2013). Also, focused was stored protein content of common and organic production (Krejčirova et al. 2006; Capoushova et al., 2007).

The leaf rust cause, most often disease in focused climate characterized by heat-drought stresses during grain filling, effect investigated Jerković and Jevtić (2012) while further were limited borders of possible mistake accounting facultative ones. Simultaneous, defined were antagonisms between facultative parasites and leaf rust causer. Stable, 3,2 - 3,8% percent of grain yield was lost by 10% increased pathogens severity (Jerković et al. 2103). The location of new rust races appearance could not be predicted annually and such, it become clear that wheat organic production without risks of epyphitotia require apply of varieties with high level of durable nonspecific resistance. The growth parameters as were SAGR and LGR were highly correlated while same values could be achieved by different genes or their combinations. The major such effective gene produced amylase confirmed by its influence on loaf volume also trough results of Denčić et al. (2011) while protein content was however more influential. From side of interactions with facultative parasites, recently questionable appeared *Septoria tritici* transfer other words to find minimal decreased stem lengths of varieties with durable resistance to obligate parasites enough to sustainable reduce its appearance on upper leaves (Tomerlin, 1985).

Generally, aimed was to investigate of some regionally novel viable varieties expected to be adequate for organic production potential and real grain yield and compare them with those of widespread ones. Nearby sowing and such accelerated anthagonists spreading was predicted to be solution for sustainable production in future. However, the economical difference of these from organic production had to be stated.

Material and Methods

Maximally ten of wheat varieties were simultaneous tested in the field trials 2011-2016th. The trial design was special by parallel same distanced 2m sown 3600 kernels at 6m² about November while stable performed at experimental fields of Institute of field and vegetable crops, Novi Sad. Stable was added about 50 kg of N at stage of first visible node while 70 kg before sowing was however present. The foliar protection by tebukonazole based fungicide was performed 2011-2013th at beginning of June while grain potential calculated directly, 2014th bentazone was applied in June, 2015th at 8th May while 2016th bentazone was at 22nd May and thiametoxam additional 8th June while controls and these results averaged for real grain yield calculation by maximal severity of each parasite however. Differences between varieties by grain yields were estimated by date of leaf green area disappearing (LAD), stem length, growth parameters as SAGR (the length from the spike to second nodus below divided with stem one) after 3rd June as well as last two levae distances. LGR or of seedlings first leaf plus stem divided with second leaf length was estimated at seedlings in glashouse during Mart. Additionally during last decade of May and near the end of the vegetation were recognized severities of stable prevalent parasites *Septoria tritici*, *Pyrenophora tritici repentis* (Ptr) and *Puccinia triticina* and contemporary appeared at last two years *Puccinia striiformis*. All of maximal severities were presented in percent of diseased middle or two last leaves. Generally the potential grain yield was accounted by increasing of realized fo r 3% by each 10% of assumed diseases severity on last two leaves as described above. The grain yield potential data was presented directly 2011-2013th by treated plots. Last three years when applied was bentazone compared were simultaneous present varieties same by parasites intensity on flag leaf and LAD.

Results and Discussion

The varieties were classified in three groups according o SAGR values, character not correlated with stem length. In the first group with values ranged 0,58-0,69 in the whole focused period were Evropa 90, Sonata, Simonida and NS 40S while added Ilina. Behind the character were genes with minor nonspecific influence on rust population as Lr Tc and Lr 34 or from Lr 13 same cluster (Prijić et al., 2016). These combination was almost equal by the value when single were present Lr 13 or Lr 14a while Lr Tc replaced Lr 2a as appeared to be

in NS 40S according to reaction to new race stripe rust during last two years and no necrosis due to novel defined gene Lr Tc. In the group with obligate Lr 22b and some of above genes by SAGR 0,66-0,76 always of higher SAGR for et least 0,05 were Rapsodija and Helena as Radojka, Brazda and Azra added during last years (Tab. 1). By the forecasting model it was defined that each 0,01 increase of SAGR from 0,5 decrease these parasites severity for about 2% confirmed by results of in focused period susceptible varieties by specific Lr genes as were Sonata and Evropa 90 while Simonida was such last three years. Longer stem of Azra prolonged LAD while SAGR was exclusive higher than was of Rapsodija. Of Brazda LAD was intermediate by increased sink capacity. The spreading of main rusts antagonist as was *Pyrenophora tritici repentis* from lower leaves was stopped at their middle ones while increased was the intensity at other variety type consequent by larger pustules with prolonged latency period at the beginning of May 2011-2013th. At Sonata infection by facultative parasites was from Rapsodija while of Evropa 90 from Helena stable near sown. Recognized was difference 5-10% in Ptr severity stable higher than was on other varieties in that period, while further intensity was stable lower due to drought before May (Tab. 2). The lesions on varieties with lower SAGR were larger, while such differences also previous recognized Lamary et al. (1989) without related parameters. Former the chance for nearby infection was increased by introduced varieties of other type. By above stated also could be explained the differences of results in trials and wide production.

Tab.1. Real and potential grain yields (t/ha), stem lengths (cm), SAGR and LAD range 2011-2016th

Variety/ grain yield	2011		2012		2013		2014		2015		2016		SAGR	LAD	Stem length
	Real	Pot.	R	P	R	P	R	P	R	P	R	P			
Helena	8,8	9,8	6.1		8.5		6.2		8.7	9.5	9.4		0,66- 0,73	19.6.	70-97
Raps.	8.5	9,4	6,2		8,3		5.1		7.8	9.0	9.2		0.68- 0.75	18.6.	58-88
Azra											9.5		0.70	21.6.	98
Brazda											9.0		0.68	20.6.	85
Radoj.									7.5	8.3	9.2		0.70- 0.71	20.6.	94
Ev. 90	8,6		6,7		9,5		6,0		8.8	10.1	9.3		0.60- 0.69	19.6.	73- 100
Simon	8,9		7,1		9,0		5,0		8.3	9.5	8.7		0.64- 0.70	18.6.	65-92
Sonata	9,6		7,1		10,0		7,8		8.9		9.0		0.60- 0.66	20.6.	65-92
Ilina							8,0		9.2		9.7		0.58- 0.59	21.6.	95-98
40S	8,9	10,2	7,7		10,8		8,8		9.5		9.7		0.58- 0.67	20.6.	68-98
			8,7		12,0		9,7		10.5		10.6				

Tab.2. Maximal severities of prevalent disease causers 2011-2016th

Variety	<i>Puccinia triticina</i>	<i>Puccinia striiformis</i>	<i>Pyrenophora tritici rep.</i>		<i>Septoria tritici</i>		
			Middle	Last	Middle	Last	
			Leaves		leaves		
					2011-2016 th (2016 th)		
Helena	30	10	20	10	30	(20)	30
Rapsodija	20	10	25	15	40	(20)	50
Azra	20	T	10	5	20	(10)	
Brazda	20	T	10	5	30	(20)	
Radojka	20	10	20	10	30	(15)	
Evropa 90	40	40	15	10	20	(10)	10
Simonida	30	30	20	10	30	(20)	30
Sonata	50	30	15	5	30	(15)	10
Ilina	40	20	10	5	20	(10)	10
NS 40S	40	20	15	5	25	(10)	10

The Ptr toxins were formed maximal in the period when leaf rust parasite was in latency period and such the effects on chloroses (Strelkov et al., 1998; Manning et al., 2012) avoided as their transfer in seed original formed. It was possible also to compare those different by SAGR but of parasites equal severities as were 40S and Ilina with those with similar LAD. Such focused, difference between NS 40S and Helena was than 9% in average lowest 2011th of 5%. Previous, recognized was also lowest grain protein content of Sonata while 11,9-13,6 of NS 40S near by however maximal achieved grain yield potential. Beside commented, on Sonata leaf rust cause (*Puccinia triticina*) severity was about 30% when treated were controls while stable reached was maximal severity of 50%. About 30% was decreased by antagonists and 20% by SAGR while Ptr was not stable effective from upper leaves. The 2014th was special by early fructification of yellow rust cause (*Puccinia striiformis*) wide visible in Mart. Even than the main losses were by such accelerated *Septoria tritici* fructification on all of genotypes. Trough nearby LAD and stem length Simonida was compared with Rapsodija focusing grain yield while average difference in potential appeared again 5% respecting this time similar protein content. Former maximal severity of both rusts was up to 50% at controls less than on by bentazone treated because of its effect to *Septoria tritici* 2015 and 2016th while 2014th was applied to late proving above stated anthagonism to both rusts (Jerković at al., 2015). Only 2014th Ptr appearance was in traces at middle leaves. However, temperatures below -12°C with snow, continual periods of six days with at least -5°C, intensive draught causing wind, before or after described period inhibited stripe rust cause early appearance as parasite with lowest optimal temperature. Continual cool and wet periods during the May in

last two years allowed late infections of upper leaves simultaneous with *Septoria tritici* transfer while most suitable for both mentioned appeared Simonida partial by no effective specific resistance genes to rust cause. However, the decrease from maximal 10% on varieties with high SAGRs was not possible without at least one adequate gene for specific resistance. When opposite two of could be such effective only when sucrose (Lr 13) was activated by pH fell. Specific Lr genes were predicted to decrease the gliadin share degrading disulphide linkages in gluten formed in leaves as recognized at seedlings Jerkovic et al. (2013a). Unfortunately the major hydrolytic stable genes adequate for the climate wheat grain filling begin were not effective to the parasitic population of both rusts (Jerkovic et al. 2014; Jerković et al., 2015). However, the rusts or assumed parasites on varieties with SAGR ranged from 0,66 2014th to 0,75 2012th never could reach severity over 40% at upper leaves. Trough LGR in Mart at about 20^oC in glasshouse values were ranged from 0,8 (Azra) to 1,45 (Ilina). Faster growth of second leaves on account of first one had to be useful especially in spring as weeds competitive character as was also stem increased length. Lodging consequential were saprophytes, another motif directed to for safe food production use varieties with as possible short stem with sustainable other consequences. At varieties by stem length about 1 m of systemic parasites reproduction was rare (Jerkovic, pers. comm.). *Septoria tritici* on upper leaves such was decreased compared to Rapsodija. Its severity was 50% 2014th while on Simonida similar by stem length was 30% proving no transfer of inoculum between varieties and difference in pycnide appearance. Higher SAGR was related to shorter flag leaf than one bellow in conditions optimal for the *Septoria tritici* infection in May. Unstability of the character was recognized on Rapsodia while 2016th on Azra caused *Septoria tritici* decrease for 10% comparing to similar high Helena indicating difference in flag leaf growth after infection. Explainable was by Lr 34 addition to Lr 22b and Lr 13 constellation. 2016th of Azra upper two leaves leaf distance was near equal to Helena but also of NS 40S and Ilina while Rapsodija one was approximate such shorter as stem length. Of last mentioned varieties with lower SAGR stable late resistance to *Septoria tritici* was by replacement of Lr 22a or Lr Tc by Lr 2a on 2D chromosome with Lr 13 resulting less sugar but more water then by Lr 22b during drought conditions. However, could not be achieved in wheat suitable for organic production by respecting other proposed characters.

Conclusion

Focusing parasite and host interactions genotypes with stem length maximally around 1m and SAGR higher for at least 0,5 of potentially highest yielding varieties in the trial could be stable introduced to organic production without risk of not predictable temporary losses up to 30% due to obligate parasites. Whenever, *Septoria tritici* with Lr 22b was decreased for 20% by temporary increased stem for 12cm and sustainable reduced to grain losses stable bellow 10%. Seed could be wide facilitated trough nearby sowing of varieties adequate for organic production around higher yielding ones in ratio 1:5. Mentioned could result proposed grain quality for the first class of 13% while major component had to have at least 12,5%. Expected was average yield increase by rusts antagonist spreading of about 2%. By avoided one treatment of seed its price for organic production could be decreased insignificant because its selecting was obvious for highest yielding varieties, however. Before system involvement it was more real to extra value proposed organic wheat by obligate enzymatic products as amylase presence and protein content while lower gliadin one was also stable opportunity. However, sustainability of varieties predicted for organic production have to be found previous trough above mentioned former crops extra valuation. At poor fertilized soils or less annual rainfall of organic proposed varieties, profit was predicted to be equal. Otherwise by applied proposed varieties of highest SAGR, organic productioner minimal minus of 3% have to be if leaf rust resistance was overcome during five years when accounted were one foliar

protection costs (10% of 5t/ha) at widespread varieties, while the real average had to be about doubled.

References

- Capouchova, I., Petr, J., Famera, O. (2007). The effect of organic and conventional growing systems on quality and storage protein composition of winter wheat. *Plant Soil Environment*, 53: 499-505.
- Darby, H., Cummings, E., Connor, B., Harwood, H., Monahan, S. (2013). 2013 organic wheat wheat planting date trial (<http://www.uvm.edu/exstension/cropsoil>)
- Denčić, S., Mladenov, N., Kobiljski, B. (2011). Effects of genotype and environment on breadmaking quality in wheat. *International Journal of Plant Production*, 5/1: 71-82.
- Djurić, V., Mladenov, N., Denčić, S., Malešević, M., Hristov, N., Kondić- Špika, A., Aćin, V. (2011). Klasifikacija NS sorti prema kvalitativnim kriterijumima javnih skladišta. *Zbornik referata s savetovanja agronoma*, 45: 33-40.
- Haring, M.; Hoogendoorn, J., van Mansvelt, J.D., Ruivenkamp, G.T.P. (1999). Sustainable organic plant breeding. Louis Bolk Institut, Driebergen, 60.
- Jerković Z., Jevtić, R. (2012). A solution for economical and safe wheat protection from parasites. *Proceedings of Safe food ECO conference*, 97-102.
- Jerković, Z., Jevtić, R., Lalošević, M., Prijić, Z. (2013). Integrated protection from prevalent wheat pathogens in semiarid regions. *Journal of agricultural sciences*, 58: 1-18.
- Jerković, Z., Prijić, Ž., Đurić, V., Jevtić, R., Lalošević, M. (2013a). Functions of Lr genes beside reduction of *Puccinia triticina*. *Field and Vegetable Crop Research*, 50/1: 6-12.
- Jerković, Z., Jevtić R., Prijić, Z., Orbović, B., Lalošević, M. (2014). Wheat variety specific at once protection of parasites and pests by pesticides. *Fifth International Scientific Agricultural Symposium „Agrosym 2014“*, Jahorina, October 23 - 26, *Proceedings*, 312-317.
- Jerković Z., Prijić Z., Jevtić R. (2015). Effect of bentazone on wheat genotypes different by Lr genes growth and parasites in hard continental climate. *Agrosym 2015, Proceedings*, 571-576.
- Jevtić, R., Telečki, M., Lalić, B., Mihailović, T.D., Malešević, M. (2010). Climate Change Impact on Small Grains Diseases Appearance in Vojvodina Region. In: Mihailovic, T., D. and Lalić, B. (Eds.), *Advances in Environmental Modeling and Measurements*. Nova Science Publishers Inc, New York, 209-222.
- Kopke, U. (2005). Crop ideotypes for organic cereal cropping systems. In: *Organic plant breeding strategies and the use of molecular markers*, E.T. Lammerts van Bueren, I. Goldringer & H. Ostergård (Eds), ECO PB, Driebergen, 13-16.
- Krejčířova, L., Capouchova, I., Petr, J.; Bicanova, E., Kvapil, R. (2006). Protein composition and quality of winter wheat from organic and conventional farming. *Žemdirbystė*, 93: 285-296.
- Kruepl, C.; Hoad, S.; Davies, K.; Bertholdsson, N., Paolini, R. (2006). Weed competitiveness. In: *Handbook cereal variety testing for organic and low input agriculture*, D, Donner & A. Osman (Eds), Louis Bolk Institute, Driebergen, 1-8.
- Lamari, L., Bernier, C.C. (1989). Evaluation of wheat lines and cultivars to tan spot (*Pyrenophora tritici-repentis*) based on type lesions. *Canadian Journal of Plant Pathology*, 11: 49-56.
- Manning, V.A., Chu, A.L., Steeves, J.E., Wolpert, T.J., Cuifetti, L.M. (2012). A host-selective toxin of *Pyrenophora tritici-repentis*, Ptr ToxA, induces photosystem changes and reactive oxygen species accumulation in sensitive wheat. *Mol. Plant Microbe Interact*, 22/6: 665-676.

- Prijić, Ž., Jerković, Z., Jevtić, R. (2016). Wheat necrosis basic gene influence on *Puccinia triticina*. Czech Journal of genetics and plant breeding, received, Jun, 2016.
- Strelkov, S., Lamari, I., Balance, G.M. (1998). Induced chlorophyll degradation by a chlorosis toxin from *Pyrenophora tritici repentis*. Can. J. Plant Path., 20: 428-435.
- Tomerlin, J.R. (1985). Preliminary studies on the effect of interrupted wet periods on infection of wheat by *Septoria nodorum*. In A.L. Scharen, ed. *Septoria of Cereals*. Proc. Workshop, Bozeman, MT, USA, 2-4 Aug. 1983, p. 68-69. USDA-ARS Pub. No. 12. pp. 116.

EFFECT OF ORGANIC AND CONVENTIONAL PRODUCTION ON SELECTED CHARACTERISTICS OF DRY BEAN (*Phaseolus vulgaris* L.)

Bojana PETROVIC^{1*}, Simonida DJURIC², Mirjana VASIC³, Vesna TUNGUZ⁴, Robert POKLUDA¹

¹Mendel University in Brno, Czech Republic

²University of Novi Sad, Faculty of Agriculture, Serbia

³Institute of Field and Vegetable Crops, Novi Sad, Serbia

⁴Faculty of Agriculture, University of East Sarajevo Bosnia and Herzegovina

*Corresponding author: petrovic_bojana@hotmail.com

Abstract

Bean is known as profitable crop and good preceding crop. Being a short season legume and possible second crop or intercrop, it is suitable in intensive agricultural systems under irrigation but also in sustainable ecological agricultural systems. The aim of this study was to compare the effect of bacterial inoculations on morphological and yield parameters of bean (*Phaseolus vulgaris*). Organic production was conducted on the field in the village Pivnice, while conventional production was conducted in the village Curug (Serbia) during 2014 on the chernosem type soil. Cultivars of beans Belko, Dvadesetica, Maksa, Slavonac, Sremac, Zlatko were used. Before sowing, the bean seeds were inoculated by biofertilizers NS-Nitragin. NS-Nitragin contains a mixture of selected strains of symbiotic bacteria *Rhizobium leguminosarum* bv. *phaseoli*. Laboratory analyses were performed in the Institute of Field and Vegetable Crops, Novi Sad. Determined parameters were: height of plant, height of first pod (distance from the ground to the first pod height), plant weight, number of pods per plant, number of seeds per plant, seed weight. The results showed that there were differences on morphological and yield parameters of bean (*Phaseolus vulgaris*). In organic system cultivar Slavonac had biggest mass of the plant (48.20), number of pods per plant (20.53), highest numbers of seed per plant (68.83), and the largest seed mass (27.29), while the cultivar Sremac in conventional system had the biggest mass of the plant (44.20), number of pods per plant (20.46), and the largest seed mass (21.87).

Keywords: *Dry bean, Morphology, Inoculation, Rhizobium.*

Introduction

Beans (*Phaseolus vulgaris*) are the main crops grown in Serbia to over 20,000 ha with the average annual yield of around 1.3 t/ha. In structure of total vegetable consumption in Serbia, beans take 4.3%. World level of beans consumption is 2.4 kilograms. In Europe consumption is very low and it is 0.7 kilograms, which is for 4.5 kilograms lower than in Serbia. Bean consumption is increasing in Serbia (Webster *et al.*, 1997). Beans, grown for seeds, have great economic importance, in addition to protein contains a large number of amino acids necessary for human consumption. Thus, the bean seeds composition are: tyrosine (0.5%), tryptophan (0.17 to 0.70%), lysine (0.68 to 2.18%) arginine (1.47 to 2.66%), cystine and histidine methionine (Govedarica and Jarak 1995). Considering different amino acid composition (Tepic *et al.*, 2007), they excellently complement with cereals. With cereals, they make the most important source of starch and energy. They are important as fiber sources, also important in diet (Costa *et al.*, 2006). Studies show that eating dry beans is helpful in prevention of heart and blood vessel deceases, diabetes and cancer (rich in fibers, poor in fats). It is recommended in diet of diabetics (assimilates slowly, has a low glycemic and insulin response), individuals with problems with high blood pressure, high cholesterol level,

obesity (Anderson *et al.*, 1999). Substitution of animal with proteins of plant origin protects diabetics from nephropathy (Anderson *et al.*, 1999). Besides the seeds beans are used for food and as young pods (Spasojevic, *et al.*, 1984).

Today it is widespread crop and can be grown in different environmental conditions.

Because bean is grown on different soils, it is necessary to produce such a mixture of microorganisms that the commercial preparation can be used as inoculants on different soil types or inoculants which contain strains of these microorganisms for soils of extreme acidity values.

There are symbiotic relations between plants and root nodule bacteria in soil under leguminosae. Specific root nodule bacteria for bean is *Rhizobium leguminosarum* *bv. phaseoli*, and nitrogen quantity that these bacteria can fix is between 20 and 115 kg N ha (Rennie and Kemp, 1983; Rushel *et al.*, 1982). Results showed that bacterial inoculation had positive impact on number of pods per plant and number of seed per pods on beans and content of nitrogen in the soil (Milic *et al.*, 2003). The species *Phaseolus vulgaris* grows in symbiosis with *Rhizobium leguminosarum* *bv. phaseoli* whose most effective strains have been incorporated into commercial microbial fertilizers (Milic and Mrkovacki, 2000). The application of rhizobium fertilizers increases the number of bacteria in the rhizosphere, soil microbial activity and the amount of fixed nitrogen (Alexander, 1977; Milic *et al.*, 1999).

An integral part of the system of sustainable agriculture is organic farming. The most efficient production of organic products is on integral organic farms that have crop and livestock production in one unit (Djurovka 2003). For organic fertilizers is used compost, peat, manure, wood ash, as well as other matters arising as a by-product in the food technology and industry. The conventional way of producing food over time based on the fulfillment of the growing demands with a large amount of food is a factor that has significantly influenced the deterioration of the situation with the conventional production, this method is certainly the moment that the trend of society with a magnification of capital contributed to the quality of conventional foods from year to year is reducing with greater use of pesticides, herbicides, chemicals and genetic modification in order to increase profits. The use of increasing doses of mineral nitrogen fertilizers leads to rapid mineralization of humus and other nitrogen compounds, an increase of gaseous nitrogen losses and losses of nitrates from the soil (Knowles 1982).

The aim of this study was to compare the effect of bacterial inoculations on morphological and yield parameters of bean (*Phaseolus vulgaris*) in organic and conventional production. Determined parameters were: height of plant, first pod height (distance from the ground to the first pod height), plant weight, number of pods per plant, number of seeds per plant, seed weight.

Materials and Methods

Studies were conducted at two sites. Production of beans in organic system in the experimental field in the village of Pivnice and production of beans in conventional system in the experimental field in the village of Curug on Chernosem soil type. Determining of morphological characteristics was performed in the laboratory of the Institute of Field and Vegetable Crops in Novi Sad. The experiment was set in 2014 according to the block system in four repetitions. Number of plants taken from each repetition was 3, so 12 plants in total were used for determination. Cultivars that have been used were: Belko, Dvadesetica, Maksa, Slavonac, Sremac, Zlatko. All cultivars were sown in six rows, a total of 42 rows were sown. All six cultivars of beans originate from the Institute of Field and Vegetable Crops in Novi Sad. Sowing was carried out at the optimum time in early May and applied all the necessary agro-technical measures. Spacing between rows was 60 cm, while spacing between plants was 6 cm. The seed beans were inoculated by the microbiological preparation NS-Nitragin

(produced by the Institute of Field and Vegetable Crops). NS-Nitrugin containing a mixture of selected strains of symbiotic bacteria *Rhizobium leguminosarum* bv. *phaseoli*.

Samples of plants were taken after harvest for morphological analysis. Determined morphological and yield parameters were: height of plant, first pod height plant weight, number of pods per plant, number of seeds per plant, seed weight.

All data obtained were processed statistically by StatSoft 'STATISTICA 12.0' program. The results were statistically analyzed according to the model of two-factor analysis of variance and consequently used Fisher's LSD test, the homogeneity of variance (Excel 2010, DSAASTAT 2014).

Results and Discussion

Within morphological and yield parameters of plant beans in this research was determined the influence of the organic and conventional production on plant height, first pod height (distance from the ground to the first pod height) and plants weight (Tab.1), number of pods per plant, number of seeds per plant and seed weight per plant (Tab. 2). Previous studies of the application of inoculation in the production of beans showed that inoculation of bean seed to individual strains of *rhizobium* or their mixture, beans provide nitrogen almost completely, while nodulation, number of pods, the content of nitrogen in seed and seeds weight depends on the cultivar of bean and properties of *rhizobium* (Marinkovic, 2006).

Table 1: Determination of height of plant, first pod height (distance from ground to first pod height) and plant weight.

	Cultivars	Height of plant (cm)	First pod height (cm)	Plant weight (g)
Conventional	Belko	54.40 a	18.86 c	34.39 b
	Dvandestecia	37.53 d	20.00 c	23.08 d c
	Maksa	43.90 b	19.83 c	34.64 b
	Slavonac	36.30 d	19.06 c	30.10 c b
	Sremac	38.33 d	16.30 d	44.20 a
	Zlatko	43.86 b	19.06 c	28.11 cb
	\bar{X}	42.38	18.86	34.42
Organic	Belko	45.20 b	14.76 d	25.25 d c
	Dvadesetica	37.20 d	15.56 b a	18.35 d
	Maksa	32.67 c	12.80 d b a	23.71 d c
	Slavonac	39,00 d	14.96 d a	48.20 a
	Sremac	31.30 c	16.43 d	17.01 d
	Zlatko	30.23 c	13.60 b	22.82 d c
	\bar{X}	35.93	14.69	25.89

Table 2: Determination of number of pods per plant, number of seeds per plant, seed weight.

	Cultivars	Number of pods per plant	Number of seeds per plant	Seed weight (g)
Conventional	Belko	20.30 a	71.96 c	18.07 c b
	Dvadesetica	11.13 e d c	34.40 d	13.53 d c
	Maksa	14.70 c b	50.16 b a	20.83 c
	Slavonac	12.70 e d c b	40.36 d b	15.06 d c
	Sremac	20.46 a	61.26 c a	21.87 b
	Zlatko	12.80 d c b	36.13 d	15.04 d c
	\bar{X}	15.35	49.05	17.4
Organic	Belko	15.73 e	66.76 c	14.63 d c
	Dvadesetica	10.16 e d	28.03 d	12.21 d
	Maksa	12.26 e d c b	37.26 d b	15.15 d c
	Slavonac	20.53 a	68.83 c	27.29 a
	Sremac	8.93 e	28.13 d	10.35 d
	Zlatko	9.76 e d	26.76 d	11.58 d
	\bar{X}	12.9	37.81	15.2

Determination of plant height

In the conventional production plant cultivar Belko had the longest stem (54.40cm), followed by the cultivars: Maksa and Zlatko, while the lowest and no significant difference in bean had cultivars Dvadesetica, Slavonac and Sremac. Same as in conventional production cultivar Belko had the longest stem in organic production (45.20cm), followed by cultivars Slavonac and Dvadesetica, while lowering plant cultivars were Sremac (31.30cm) and Zlatko (30.23cm).

Determination of first pod height (distance from ground to first pod height)

In cultivation of beans in conventional production the lowest length of the first pod (distance from ground to first pod height) had a cultivar Sremac (16.30) while the other cultivars had a uniform length of the first pod, and significantly higher than the cultivar Sremac. In the organic production Sremac had the highest length of the first pod (16.43) while the other cultivars not a statistically significant different.

Determination of plant weight

The largest mass in the conventional production had cultivar Sremac (44.20) and it is statistically the biggest compared to other cultivars. Cultivar that had a minimum mass is Dvadesetica while the other studied cultivars Belko, Maksa, Zlatko, Slavonac, Sremac have a uniform mass of plants, and there is no statistically significant difference. In organic production, cultivar Slavonac had statistically maximum mass plant (48.20) while other cultivars had a significantly lower weight and not statistically significantly different.

Determination of pods per plant

The highest number of pods per plant was recorded in the production of conventional

cultivars Belko and Sremac with amounts to over 20 pods per plant. In the organic production Sremac had the smallest number of pods per plant, while the highest number of pods per plant had cultivar Slavonac (20.53).

Determination of seeds per plant number

The number of pods per plant and number of seeds per pod as a result give the number of seeds per plant, so many authors are looking at this feature as a component of yield (Stoilov, 1994, Vasic *et al.*, 1997).

The number of seeds per plant in conventional production was the largest established in cultivars Belko, (71.96) and Sremac (61.26). In organic production the largest number of seeds per plant had cultivars Slavonac (68.83) and Belko (66.76). In the experiment, the average number of seeds per plant under the conventional production was estimated at 49.05, while in the organic production the average number (37.81).

Determination of seeds weight

In the conventional production the largest seed weight was observed in the cultivars Sremac and Maksa, while Belko and cultivars Zlatko, Dvadesetica, Slavonac have statistically significantly lower seed weight per plant.

In organic production the largest mass of seeds per plant had a cultivar Slavonac, over 27 seeds per plant and it is statistically the largest weight. The lowest seed weight per plant has a cultivar Sremac 10.35 also in organic production.

Conclusions

In organic and conventional production cultivar Belko has the longest stem.

In case of determining the height of the first pod (distance from ground to first pod height) in the organic production Sremac had the highest length of the first pod, while in conventional the lowest.

In determining the mass of the plant biggest mass has Sremac in the conventional production and Slavonac in organic production.

In the experiment, the average number of pods per plant in the conventional production is at 15.33, while in the organic production 12.9. The number of pods per plant in conventional production is highest at the cultivar Sremac, while in organic production the cultivar Slavonac and is over 20 pods per plant.

The highest numbers of seed per plant had cultivars Belko and Sremac in conventional production while the cultivar Slavonac in organic production.

Within conventional production the largest seed mass was observed in the cultivar Sremac, while cultivar Slavonac in organic production.

When comes to the recommendations of growing beans in organic and conventional production in selecting assortments recommended cultivation of cultivar Slavonac in organic production, while cultivar Sremac in conventional production. For other varieties there are no statistically significant differences in the investigated parameters of the plant so that they can cultivate in all systems of production.

References

- Alexander, M. 1977: Introduction to Soil Microbiology. John Wiley and Sons Inc., New York - London.
- Anderson J., Smith B., Washnock C. (1999).The American Journal of Clinical Nutrition 70, 464-474
- Costa G., Quiroz-Monici K., Reis S., de Oliviera A.(2006).Food Chemistry 94: 327-330,.

- Djurovka, M. (2003). Center for organic production, Edukons, Sremska Kamenica, Novi Sad
- Govedarica, M., Jarak, Lazic B., Sekulic P (1995). Microbiology Univerzitet Novi Sad
- Helen E. Roy, Fernando E. Vega, Dave Chandler, Mark S. Goettel, Judith K. Pell, Eric Wajnberg: (2010). The Ecology of Fungal Entomopathogens
- Jarak M., Zdravkovic M., Djuric S., Damjanovic M., (2005.); Response of beans to inoculation and fertilizers 8th international symposium on internaciplinary region (Hungari-Romania- Serbia and Montenegro. Proceedions section- ekology and envirometal protetion ep 22 (CD) Szeged, Hungaria 19-21 april.
- Knowles, R. (1982). Denitrification. *Microboil.rev.* 46 (1): 43-70
- Malesevic, M., Lazic S., Djurovka M., Lazarevic R. (2008). Organic farming, Institute for field and vegetables, Novi Sad.
- Marinkovic J. (2006); Effect of inoculation *Rhizobium leguminosarum* bv. *phaseoli* in the production of bean (*Phaseolus vulgaris*).
- Milic V., M. Marinkovic, Jarak M., (1999) Effect of inoculation of different bean genotypes on the efficiency of symbiotic association. *Proceedings of the volumes 32*, 299-304.
- Milic V., Mrkovacki N., Vasic M., Davidov A., Milosev D. 1999: Symbiotic effectiveness of bean genotypes. *Soil and Plant*, Vol 48, No 1, p. 43-48
- Milic, V., Vasic, M., Marinkovic, J (2003) Effect of inoculation and fertilizer application on nitrogen fixation in bean. *Scientific papers, Institute for field and vegetables, Novi Sad.*
- Rennie R.J., G.A. Kemp: (1983): N₂-fixatiomn field beans quantified by ¹⁵N isotope dilution II. Effect of cultivars of beans. *Agron. J.* 75, 645-649
- Ruschel A.P., Vose P.B., Matsui E., Victoria R.L. and Saito S. M. T. (1982): Field evaluation of N₂ fixation and N utilization by *Phaseolus* bean varieties determined by ¹⁵N isotope dilution. *Plant and Soil* 65, 397-407.
- Spasojevic, B.Stancev, S., Starcevic, Lj. Marinkovic, B. (1984). *Special farming*, Agriculture University, Novi Sad.
- Stoilova, (1994). Vasic *et al.*, (1997). Asociations of some characters with seed yield in *Phaseoulus* collections. *Eucarpia*, symposium on breeding of oil and protein crops Albena, Bulgaria.
- Tepic A., Vujicic B., Vasic M., Lucic A. (2007). *Proc.of the 2nd International Congress on Food and Nutrition*, Istanbul, Turkey, 24-26 October, pp.180
- Webster, J. Peter, Chang, Hai-Ru (1997). Atmospheric wave propagation in heterogeneous flow: basic flow controls on tropical-extratropical interaction and equatorial wave modification. *Dynamics of Atmospheres and Oceans* 27, pp. 91-134

COMPOST EFFECT ON THE YIELD AND COMPOSITION OF ESSENTIAL OILS OF *OCIMUM BASILICUM* "FIN VERT"

Raoudha KHANFIR BEN JENANA*, Ferdaws SMARI, Cherif HANACHI

Higher Institute of Agricultural Sciences of Chott Mariem, Tunisia

*Corresponding author: bjnkh@yahoo.fr

Abstract

Three crops of (*Ocimum basilicum* var Grand Vert) were conducted in the experimental field of the Technical Centre for Organic Agriculture of Chott Mariem (Tunisia). Plants fertilized with sheep manure served as a control and other plants were fertilized with two composts C₁ and C₂ with the respective compositions (30% cattle manure, 30% sheep manure, 30% poultry manure 5% straw and 5% olive mill) and (70% cattle manure, 25% poultry manure and 5% straw) and irrigated with the respective juices of both composts prepared with 1 volume of compost and 5 volumes of water. The extraction of essential oils from leaves was carried out by GC-MS. The results showed that the yields of essential oils have been improved by the tested composts (0.36% with compost C₁, 0.38% with compost C₂ against 0.28% in the control). The composition of essential oils has been modified by the composts. Indeed, rates of the major components of essential oils in the plants fertilized with compost increased: compost C₂ gave the highest levels of the following components Methyl cinnamate, Linalool, 1,8-Cineole 8- and β -elemene. However, 15-Octadecenoic Acid present in the essential oils of the control plants was not detected in plants treated with composts.

Keywords: *Essential oils, Ocimum basilicum, Chemical composition*

Introduction

At least 60 species and numerous varieties are included in the genus of *Ocimum*, of the family Lamiaceae (Labiatae), include (Sirvastava., 1982). Some *Ocimum* spp. are traditionally used in many Asian and African countries in medicine. (Yusuf et al., 1994). *Ocimum basilicum* L. is an aromatic herb used to add a distinctive aroma and flavor to food (Lee et al., 2005). Essential oils extracted from fresh leaves can be used in food, pharmaceuticals cosmetics and agriculture (Javanmardi et al., 2002; Koba et al., 2009). On the other hand, fertilization with composts and organic juice reduces the risk of toxicity and pollution caused by the use of chemical fertilizers (Zheljzakov et al., 2003). Otherwise, Khalid et al. (2005) established that treated plants with different combinations of organic fertilizers showed a significant increase in growth, yield characters, essential oil percentage and main components of essential oil extracted from dill plants In this context, this work aims to study the effect of compost on the basil essential oil percentage and chemical composition performance.

Material and methods

Plant material

Three rows (25cm × 80cm) of *Ocimum basilicum* var "Grand Vert" plants were cultivated under a greenhouse in the experimental field of the Technical Centre for Organic Agriculture of Chott Mariem (Tunisia). The trial lasted four months and the plants were irrigated by a drip irrigation system and fertilized at the beginning of the assay.

Composts and composts juices

One row of plants was fertilized with well decomposed organic sheep manure and used as control. Two rows were fertilized with two composts respectively: C₁ (30% cattle manure,

30% sheep manure, 30% poultry manure 5% straw and 5% olive mill) and C₂ (70% cattle manure, 25% poultry manure and 5% straw) and irrigated with the respective juices of both composts. The composts juices were prepared as follows: Each compost was suspended in tap water (1:5 vol/vol) in a loosely covered 10-liter plastic container. The suspension was incubated for 6 days at 15 to 20°C and daily stirred 5 to 10 minutes (Weltzein, 1992).

Extraction of essential oils

Essential oils (EO) were extracted from 500g of fresh leaves of *Ocimum basilicum* var Grand Vert by hydrodistillation using a Clevenger type apparatus (Benyelles et al., 2014 and Dongke, 2014; Okoh et al., 2010).

Essential oil yields

The yield of essential oil (Y) is defined as the ratio between the mass of the oil obtained after extraction (W') and the mass of the plant material used (W). It is given by the following formula:

$$Y = \frac{W'}{W} \times 100$$

Y: essential oil yield (%); W': essential oil weight (g); W: fresh leaves weight (g).

Essential oil analysis

The identification of essential oil component was performed by GC and GC/MS. GC diagnostic were carried out on an HP5890-series II gas chromatograph (Agilent Technology, California, USA) with Flame Ionization Detectors (FID) characterized by: a fused silica capillary column, non polar HP-5 and polar HP Innowax (30 m × 0.25 mm ID, film thickness 0.25 µm). The temperature of the oven was 50 °C for 1 min, then it is programmed to achieve heating rate up to 5–240 °C/min and held isothermal for 4 min. Injector temperature: 250°C, detector temperature: 280 °C; nitrogen used as a carrier gas (1.2 ml/min); and injected 0.1 ml diluted in hexane 1%. The percentage of the constituents was calculated by electronic integration of FID peak areas without the use of response factor correction. Hewlett-Packard 5972 MSD system served for GC/MS analyses: HP-5 MS capillary column (30 m × 0.25 mm ID, film thickness of 0.25 mm) was directly coupled to the mass spectrometry. The comparison of the component mass spectra with those in the Wiley 275 GC/MS library and of their retention indices with literature data (Adams, 2001) served to their identification. Retention indices (RI) were calculated by the retention times of a series of n-alkanes.

Results and discussion

Essential oil yield

The yields of essential oils are higher in plants treated with both composts compared to yields recorded in control C. In fact, results show that the highest yield (0.38%) is recorded with the C₂ treatment, 0.36% are obtained in essential oil fertilized with compost C₁, while the essential oil yield recorded for the control plants is 0.28% (Table 1). Both composts have therefore increased the essential oil extracted rate. This confirms the results of Khalid et al. (2006) who mention in a study on the effect of compost and compost tea on *Ocimum basilicum* that the highest values of herbal essential oil percentage were resulted from the treatments of static compost and its tea.

Table 1: Effect of the composts on the essential oil (%) extracted from *Ocimum basilicum* L. plants

Treatments	Yield (%)
C	0,28
C ₁	0,36
C ₂	0,38

C: Control (decomposed organic sheep manure); C₁ (30% cattle manure, 30% sheep manure, 30% poultry manure 5% straw and 5% olive mill) and C₂ (70% cattle manure, 25% poultry manure and 5% straw).

Essential oil composition

The effect of compost on the components number of essential oils is shown in Table 2. The results show that the total number of components is higher in essential oils of plants treated with the compost compared to control plants. Indeed, in the control we recorded 33 components in the essential oil extracted while the plants treated with C₁ compost gave essential oil containing 36 components and those treated with C₂ gave essential oil with 38 components. Similar results were found by Kalil et al. (2006), who showed that compost increases the vegetative growth parameters and essential oil contents.

Table 2: Effect of composts on the total compounds number of the essential oil extracted from *Ocimum basilicum* L. plants

Treatments	Number of components
C	33
C ₁	36
C ₂	38

C: Control (decomposed organic sheep manure); C₁ (30% cattle manure, 30% sheep manure, 30% poultry manure 5% straw and 5% olive mill) and C₂ (70% cattle manure, 25% poultry manure and 5% straw)

Data in Table 3 show the effect of composts on the compositions of essential oil in fresh leaves of basil. Our Results show that the major component is Methyl cinnamate while in a study conducted by Khalil et al., (2006), Linalool appears as the major constituent of essential oils extracted from basil leaves. On the other hand, composts affect differently the chemical composition of essential oils analyzed in the leaves of basil. Indeed, the major components 1,8-Cineole, Linalool and Methyl cinnamate increased by the effect of composts compared to control. 15- Octadecenoic Acid and Bornyl Acetate are present only in the control plants (with respective percentages of 3.37% and 1.30%). Composts used affect differently the rate of β -elemene and Epi-bicyclosesquiphellandrene which decreased under the influence of compost C₁ and increased with C₂. These results confirm partially those mentioned by Khalil et al., (2006) who indicate that herbal essential oil percentage of Linalool and 1,8 cineol increased by compost treatment and with results of Zheljazkov et al., (2003) who found that addition of compost to the growth medium increased Linalool and did not change other constituents such as 1,8-cineole, and Bornyl Acetate.

Table 3: Effect of the composts on the composition (%) of the essential oil extracted from *Ocimum basilicum* L. plants

Components	C	C ₁	C ₂
15- Octadecenoic Acid	3,37	-	-
1,8-Cineole	11.02	11,65	11,91
Linalool	17,46	17,56	18,21
β-Elemene	4,22	3,42	8,14
Methyl cinnamate	33,79	40,29	43,81
Cis-3-hexene-1-ol	0.14	0.14	0.13
Bornyl Acetate	1.30	-	-
Epi-bicyclosesquiphellandrene	3.23	3.03	5,21

C: Control (decomposed organic sheep manure); C₁ (30% cattle manure, 30% sheep manure, 30% poultry manure 5% straw and 5% olive mill) and C₂ (70% cattle manure, 25% poultry manure and 5% straw)

Conclusion

At the end of this study, we determined that the essential oil contents and components were affected by the compost fertilization. The highest essential oil content was determined at plants fertilized with compost C₂ and the lowest content was found in the control. The essential oil composition was also modified by the effect of compost fertilization, three main components (1,8-Cineole, Linalool and Methyl Cinnamate) increased. On the other hand, 15-Octadecenoic Acid and Bornyl Acetate were only detected in essential oil of control. Fertilization with compost might be a mean to modify the composition according to further use of the essential oil.

Acknowledgements

The authors are grateful to the Technical Center of Organic Agriculture (CTAB) for the plant material, the medical school (University of Monastir) for the oil analysis and the Regional Center of Research in Horticulture and Organic agriculture (CRRHAB).

References

- Adams, R.P. (2001): Identification of Essential Oil Components by Gas Chromatography/Quadrupole Mass Spectrometry Allured Publishing Corporation, Carol Stream, Illinois, USA (2001)
- Benyelles, B., Allali, H., Dib, M.A., Djabou, N., Tabti, B., & Costa, J. (2014): Essential oil from *Rhaponticum acaule* L. roots: comparative study using HS-SPME/GC/GC-MS and hydrodistillation techniques. J. Saudi Chem. Soc., 18(6) (2014), pp. 972–976.
- Javanmardi, J., Khalighi, A., Kashi, A., Bais, H. P. & Vivanco, J. M. (2002): Chemical characterization of basil (*Ocimum basilicum* L.) found in local accessions and used in traditional medicines in Iran. Journal of agricultural and food chemistry, 50(21), 5878-5883.
- Khalid, K. A., Hendawy, S. F., & El-Gezawy, E. (2006): *Ocimum basilicum* L. production under organic farming. Research Journal of Agriculture and Biological Sciences, 2(1), 25-32.

- Koba, K., Poutouli, P. W., Raynaud, C., Chaumont, J. P., & Sanda, K. (2008): Chemical composition and antimicrobial properties of different basil essential oils chemotypes from Togo. *Bangladesh Journal of Pharmacology*, 4(1), 1-8.
- Lee, S. J., Umamo, K., Shibamoto, T., & Lee, K. G. (2005): Identification of volatile components in basil (*Ocimum basilicum* L.) and thyme leaves (*Thymus vulgaris* L.) and their antioxidant properties. *Food Chemistry*, 91(1), 131-137.
- Okoh, O. O. Sadimenko, A. P. & Afolayan A. J. (2010): Comparative evaluation of the antibacterial activities of the essential oil of *Rosmarinus officinalis* L. obtained by hydrodistillation and solvent free microwave extraction methods. *Food Chem.*, 120(1) (2010), pp. 308–312.
- Sirvastava A.K., (1982): *Farm Bull.*(16) CIMAP. Lucknow, India.
- Suwei, Z., Dongke, Z., (2014): Supercritical CO₂ extraction of *Eucalyptus* leaves oil and comparison with Soxhlet extraction and hydro-distillation methods. *Sep. Purif. Technol.*, (133), pp. 443–451.
- Weltzien H. C. (1992): Biocontrol of foliar fungal disease with compost extracts. **In** Andrews J. H., Hirano SS. (eds.). **Microbial Ecology of leaves**. New York: Springer-Verlag, p. 430–450.
- Yusuf M., J.U. Chowdhury, M.A. Wahab and J.Begum, (1994): *Medicinal Plants of Bangladesh*. BCSIR, Dhaka, Bangladesh.
- Zheljazkov, V. D., Warman, P. R. (2003): Application of high Cu compost to Swiss chard and basil. *Science of the total environment*, 302(1), 13-26.

MYCOFLORA ANALYSIS AND INTERACTION STUDY OF PATHOGENS-ANTAGONISTS FUNGI ON WATERMELON DEVELOPMENT IN TUNISIA

Ibtissem BEN SALEM, Abdelhak RHOUMA, Hiba ALLAGUI, Naima BOUGHALLEB-M'HAMDI*

Department of Biological Sciences and Plant Protection, High Institute of Agronomy of Chott Mariem, 4042 Sousse, University of Sousse, Tunisia

*Corresponding author: n.boughalleb@laposte.net

Abstract

Soil mycoflora analysis from watermelon rhizosphere showed remarkable diversity. The screening revealed the presence of antagonist and pathogenic fungi belonging to 16 species. The highest isolation frequency was for *Aspergillus terreus* (13.82%), then *A. niger* (12.59%), *A. pseudoalegans* (10.81%) and *A. flavus* (9.88%). According to this work, both mesophilic and thermophilic pathogens are *Cladosporium cladosporioides* (6.92%) and *Colletotrichum gleosporioides* (2.59%). For thermophilic fungi, *Gliocladium viridian* (21.44%), *Scytalidium thermophilum* (18.42%) and *Arthrinum* Kunze (17.13%) are the most frequent. *In vivo*, *Trichoderma* species have demonstrated their effectiveness on the degree of symptoms caused by soil-borne pathogens. Indeed, in the case of plants inoculated with *R.solani*, *M. phaseolina*, *F. oxysporum*, *F. solani* treated preventively with both antagonists *T.viride* and *T. harzianum*, the disease severity index did not exceed 0.83. Treatment by *A. niger* (0.17) seemed the most effective against *M. phaseolina* and *F. solani*. Preventive treatment was the most effective for plants inoculated with *F. oxysporum*, treated by *Penicillium italicum* (0.33), and plants inoculated by *M. cannonballus*, treated with *T. harzianum* and *A. niger*.

Keywords: Antagonists, biological control, mycoflora, preventive and simultaneous treatment

Introduction

The soil is considered one of the most suitable environments for microbial growth (Kumar et al., 2013). The role of the diverse soil organisms could be beneficial or pathogens and soil fungi fulfil both roles and are ubiquitous (Hao-quin et al., 2008; Abo et al., 2011). A number of fungi species are known for their role in the agro-ecosystem either because they are associated with crop diseases or because they are used in the biological control of pest or involved in organic matter decomposition (Abo et al., 2011). Fungi are among the most diverse group of organisms on earth (Hammond, 1995). Fungi could be divided according to their tolerance to temperature. Accumulation of organic matter where in warm, humid and aerobic environment provides the basic physiological condition, in these habitats thermophiles may occur either as resting propagules or as active mycelium depending on the availability of nutrients and favourable environment (Khushaldas, 2009). The most available temperature for the development of the majority of fungi is between 20 and 37°C, which are called mesophilic (Maheshwari, 2011). Soil-borne fungi affecting cucurbits caused serious disease known as collapse and vine decline has identified in melon and watermelon, whereas many studies were established on sudden wilt of melon and several soil-borne pathogens such as *Fusarium oxysporum*, *F. solani* f.sp. *cucurbitae*, *Macrophomina phaseolina* (Tassi) Goid, *Rhizoctonia solani* and *Monosporascus cannonballus* have been isolated (Boughalleb et ElMahjoub, 2006). *M. cannonballus* Pollack & Uecker was first reported in commercial watermelon field of Gabes (Martyn et al., 1994; Ben Salem, 2009). Resistance to biocontrol microorganisms of fungal pathogens has not been reported and is considered an environmental-friendly approach (Freeman et al., 2002; Eziashi et al., 2007). The mycoparasite ability of *Trichoderma*,

Gliocladium and *Aspergillus* species against some important aerial and soil-borne plant pathogens lead to the development of biocontrol strategies (Dubey *et al.*, 2007; Hajieghrari *et al.*, 2008). In the present investigation a detailed survey of mycoflora of watermelon cropping area was under taken. The screening of the mycoflora was done to quantify, identify and to determine the diversity of fungal species. Based on the above mentioned literatures, this study is an attempt to evaluate the interaction between antagonists and pathogens fungi isolated from the soil.

Material and methods

Mycofloral analysis

Soil samples were collected from experimental plot cultivated previously by watermelon in High Institute of Agronomy Chott Meriem (Sousse, Tunisia). Rhizosphere soil samples were collected from six randomly selected plots in July 2015. Each sample was a mixture of three subsamples per plot collected along transects spaced 2 m apart. The mycofloral analysis of soil samples was conducted. The fungal population of the soil samples was determined by serial dilution agar plate method as described by Waksman (1922). For this, 1g of soil sample was suspended in 10 ml of double distilled water to make microbial suspensions (10^{-1} to 10^{-7}). One ml of microbial suspension of each concentration were added to sterile petri dishes (triplicate of each dilution) containing PDA media (15 ml). One percent streptomycin solution was added to the medium before pouring into petri plates for preventing bacterial growth. The Petri dishes were then incubated at 28°C in dark. The plates were observed daily for three days. Population densities are expressed in terms of Colony Forming Unit (CFU) per gram of soil with dilution factors. The percent contribution of each isolate was calculated as followed: Isolation percent = (Total No. of CFU of an individual Species / Total No. of CFU of all species) x 100. After 2-7 days, fungal colonies appeared on the PDA media. The fungal isolates were transferred to other plates for purification and identification.

Potential antimicrobial activity *in vivo*

This work presents in understanding the mechanisms involved in the interaction of some antagonists with phytopathogenic fungi and plants.

The isolates identified as antagonists were tested *in vivo* for their antagonistic activity against *Fusarium solani*, *F. oxysporum*, *Rhizoctonia solani*, *Macrophomina phaseolina* and *Monosporascus cannonballus*. *In vivo* experiments, was divided into two parts. The first is a preventive treatment of fungal antagonists and the second consisted of simultaneous treatment of watermelon seedlings (*cv.* Crimson Sweet) by pathogens and antagonists isolates. The seedlings were then planted with fifteen plants (5 per replicate) per each treatment. The inoculum was obtained according to each fungal pathogen. *Fusarium* sp. were grown on PDA at 25°C for 4 days until sporulation, then an erlenmeyer flasks containing 50 ml of potato dextrose broth (PDB, 20 g/l) were inoculated with four pieces of each *Fusarium* sp. isolate. Spore production was induced in an orbital shaker and the spores were recovered from culture by filtration and adjusted to 10^6 spores/ml. In the case of *R. solani*, *M. phaseolina* and *M. cannonballus*, the isolate were grown on PDA, 20 plates mixed with 2500g of autoclaved potting mix and placed in 20 cm pots. A haemocytometer was used to determine the concentration of the spores (10^7 spores/ml). The application of fungal antagonist was carried out by root dipping watermelon seedlings 15 days old into flask containing a conidial suspension of the different antagonist for 30 min, 24h before inoculation and 24h after inoculation by watering each plant a fungal antagonist suspension (10 ml). The pots are then placed in greenhouse for 60 days. Controls were performed by inoculated the plant with only pathogen in case of positive control (10 ml) and a distilled water (negative control). The experimental protocol was a randomized complete block. For each fungal species one cucurbit

plant randomly distributed with 5 plants per replicate (3 replicates) in each treatment. During the experiment, the plants were carefully removed from the pots at two times (30 and 45 days after inoculation). Disease incidence (%) for the five pathogen was assessed with a scale varying from 0 to 4 (0 = no collapse; 1 = initial wilting – reversible turgor loss (overview of the whole plot); 2 = collapse of up to 50% of plants; 3 = collapse of up to 75% of plants; 4 = total collapse of all plants) (Cohen *et al.*, 2000). The root systems were gently washed in tap water. Each root system was rated for the severity of the pathogen as described in Table 1.

Table 1. Disease severity of watermelon plants inoculated with *F. oxysporum*, *F. solani*, *M. phaseolina*, *R. solani* and *M. cannonballus*.

Fungi	Rating scale	Reference
<i>F. oxysporum</i>	0 = no symptoms; 1 = light vascular discoloration in the stem with or without stunting; 2 = vascular discoloration in the stem, stunting, wilting with or without yellowing of cotyledons; and 3 = dead seedlings.	Vakalounakis and Frangkiadakis (1999)
<i>F. solani</i>	0: healthy; 1: slight yellowing of leaves with slight rot pivot and lateral roots and crown rot; 2: significant yellowing in leaves with or without wilting, stunting of plants, severe rot at the pivot and lateral roots, significant rot and browning of vessels in the stem; 3: death of the plant.	Boughallebet <i>et al.</i> (2005)
<i>M. phaseolina</i>	0: symptomless, 1: 1 to 3% of shoot tissues infected, 2: 10% of shoot tissues infected, 3: 25% of shoot tissues infected, 4: 50% of shoot tissues infected and 5: more than 75% of shoot tissues infected.	Ravf and Ahmad (1998)
<i>R. solani</i>	0= healthy, 1= 1-20% diseased, 2= 21- 40% diseased, 3= 41-60% diseased, 4= 61-80% diseased and 5= 81-100% diseased.	Mathew and Gupta (1996)
<i>M. cannonballus</i>	0 = no symptoms; 1 = few lesions (covering <10% of root), secondary root rot slight; 2 = rot of secondary roots or lesions covering approximately 25% of the root; 3 = lesions covering at least 50% of the root and dead secondary roots; and 4 = general root rot, most of the root affected.	Aegerter <i>et al.</i> (2000)

The Disease severity index and disease incidence were analyzed with the GENMOD procedure using the multinomial distribution and the cumulative logit as link function, and means of the values were separated by χ^2 test at $P < 0.05$ using SAS program (SAS Institute, Cary, NC). The other variables were compared by analysis of variance (ANOVA) and means of the values were separated with Duncan test at $P < 0.05$ using SPSS 20.0 for Windows (SPSS Inc., Chicago, IL, USA).

Results and discussion

Mycoflora analysis

A total of 15 different fungal genera and 33 species were isolated from the soil samples. All fungi were identified on the basis of their cultural and morphological characteristics. The results of this study revealed the presence of mesophilic and thermophilic fungi. Among the mesophilic isolates the genera *Aspergillus* (42%), *Penicillium* (13.21%) were dominant. The most common species are *Aspergillus terreus*, *A. niger*, *A. pseudoelegans*, *A. flavus*, *Cladosporium cladosporioides* and *Penicillium italicum*. For the thermophilic isolates, *Gliocladium catenulatum*, *Scytalidium thermophilum* and *Arthrinum Kunze* were found to be the most identified isolates (Table 2).

Table 2. Isolation percentage of fungal species identified from soil.

Fungus	The percent contribution(%)	
	Mesophilic fungi (35°C)*	Thermophilic fungi 45°C
<i>Aspergillus terreus</i>	13.82	0.19
<i>A. fumigatus</i>	2.81	9.65
<i>A. nidulans</i>	2.17	7.17
<i>A. pseudoelegans</i>	10.81	0
<i>A. flavus</i>	9.88	5.69
<i>A. niger</i>	12.59	0
<i>A. brevipes</i>	0	0.2
<i>A. glaucus</i>	0	3.09
<i>A. parasiticus</i>	0	3.26
<i>Penicillium italicum</i>	4.9	0
<i>P. digitatum</i>	3.35	0
<i>P. janthinellum</i>	2.15	0
<i>P. purpurascens</i>	2.81	0
<i>Chaetomium globosum</i>	0.72	0
<i>Trichoderma harzianum</i>	2.09	0
<i>T. viride</i>	0.7	0
<i>Humicola grisea</i>	0.12	0
<i>H. insolans</i>	0.17	0
<i>Gliocladium penicillioides</i>	0.1	0
<i>G. virens</i>	0	0.59
<i>G. catenulatum</i>	0	21.44
<i>G. virides</i>	0	4.27
<i>Paecilomyces victoriana</i>	0	6.32
<i>Colletotrichum gleosporioides</i>	2.59	0
<i>Cladosporium cladosporioides</i>	6.92	0
<i>C. herbarum</i>	0.86	0
<i>Scytalidium thermophilum</i>	0	18.42
<i>Arthrinum Kunze</i>	0	17.13
<i>Fusarium oxysporum</i>	1.69	0
<i>F. solani</i>	0.65	0
<i>Rhizoctonia solani</i>	0.73	0
<i>Macrophoma phaseolina</i>	0.95	0
<i>Alternaria alternata</i>	0.14	0
<i>Monosporascus cannonballus</i>	0.00025	0
<i>Others</i>	16.27975	2.58
Total	100	100

*% Contribution= (Total No. of CFU of an individual Species / Total No. of CFU of all species) x 100, (means of nine values per fungal species).

The environmental factors such as the soil pH, moisture, temperature, organic carbon and nitrogen play an important role in the mycoflora distribution (Kumar *et al.*, 2015). These are the main factors affecting the fungal population that was very high in the soil samples

analyzed. The mycofloral analysis was in agreement with other studies such as Ratnasri *et al.* (2014) and Megha Bhutt *et al.* (2015). Serial dilution method adopted in this study displays highest number of fungal species isolates belongs to different fungal groups (Hussain *et al.*, 2014). This finding indicated that a reservoir of thermophilic and thermotolerant fungi always coexists (Kumar *et al.*, 2015). In relation to genus detected, the prevalence of *Aspergillus* and *Penicillium* in the soil samples is consistent with the reports of Soderlund (2009) and Onyimba *et al.* (2014).

Potential antimicrobial activity *in vivo*

The effectiveness of inoculation of watermelon plants with antagonists applied preventively and simultaneously in reduction of each pathogen infection was indicated according to the parameters measured. Antagonistic activities were also detected *in vivo* using the disease severity index data and specified a significant difference between watermelon plants inoculated with all pathogens and all antagonists, and between sampling date ($p < 0.05$).

Rhizoctonia solani

The preventive treatment of watermelon plants by *T. harzianum*, after 30 and 45 DAI, and by *P. italicum* after 45 DAI, revealed no typical symptoms of *R. solani* (Disease incidence 0%) ($p < 0.05$). When plants are treated simultaneously, all antagonists showed the same potential antifungal activity at 30 and 45 DAI ($p > 0.05$). Obtained results indicated that *T. viride* applied preventively or simultaneously reduces root infecting fungi ($p < 0.05$), presenting the lowest values at 30 (0 and 0.67) and 45 DAI (1 and 1.33) (control= 2 and 3.5) (Table 5).

Macrophomina phaseolina

M. phaseolina which causes charcoal rot disease in plants is reported to be suppressed preventively by *T. harzianum*, *P. italicum* and *P. digitatum* according to the disease incidence (%) recorded at 30 DAI ($p < 0.05$). The efficiency of these antagonists was more pronounced at 45 DAI (33.33% (control=100%)). However, only *P. italicum* treated simultaneously generated an inhibitory effect against *M. phaseolina* at 30 DAI ($p < 0.05$). Biocontrol efficacy of all antagonists was more noticed at 45 DAI with disease severity index varied between 0.83 (*A. niger*) and 1.83 (*P. digitatum*) (control=3.67) (Table 5).

Fusarium oxysporum niveum

No wilt symptoms were noticed in watermelon plant inoculated with *F. o. niveum* and treated preventively with *P. purpurascens* and *P. italicum* and simultaneously with *T. harzianum* according to disease incidence (%) at 30 DAI ($p < 0.05$). Among the six antagonists evaluated for potential biological control ability against *F.o. niveum*, only three *T. viride*, *T. harzianum* and *P. janthinelum* significantly ($p < 0.05$) reduced disease severity index of Fusarium wilt, the first one applied preventively and the other simultaneously at 30 DAI (Table 5).

Fusarium solani cucurbitae

In this study, *A. niger* and *T. harzianum*, applied preventively, effectively controlled *F. s. cucurbitae*, based on the results of disease incidence noted at 30 and 45 DAI, respectively ($p < 0.05$). The protective effect of *T. harzianum* and *Humicola insolans* was higher than *A. niger* following the two sampling date according to the simultaneous treatment. Disease severity index was also significantly low ($p < 0.05$) in combination: antagonists/ *F. s. cucurbitae* inoculated plants and treated preventively and simultaneously. Obtained values were between 0.17 (*T. viride*) and 0.67 (*Humicola insolans*) and from 0.33 (*Humicola insolans*) and 1.67 (*T. harzianum*) at 30 and 45 DAI according to these antagonists applied preventively, respectively (control=2.33). Further protection was observed in combined use of *T. viride* and *T. harzianum* applied simultaneously (0.83; control= 3.83) ($p < 0.05$) (Table 5).

Monosporascus cannonballus

Reduction in disease incidence caused by *M. cannonballus* was detected in the treatments with *T. viride*, *A. niger* (0%) and *T. harzianum* (16.67%) applied preventively ($p < 0.05$), and the efficacy of the two *Trichoderma* species was more prominent at 45 DAI (33.33%). These biocontrol agents *T. harzianum* and *T. viride* caused also reduction in incidence when they are applied simultaneously with 0 and 33.33 at 30 DAI ($p < 0.05$) and 33.33% at 45 DAI, respectively. In the presence of only the pathogen, disease severity index was significantly high compared with the negative control, addition of any of the biocontrol agents resulted in less root infection. Preventive treatment with *T. harzianum*, *T. viride* (0) and *P. purpurascens* (0.17; control=2) decrease the disease severity in root caused by *M. cannonballus* at 30 DAI ($p < 0.05$). However, root infection was less at 45 DAI in the treatments with *A. glaucus* and *Paecilomyces victoriae* ($p < 0.05$). Compared with the other biocontrol agents applied simultaneously in the presence of *M. cannonballus*, *T. harzianum* and *T. viride* ($p < 0.05$) exerted a significant antagonistic effect showing the lowest values (Table 5).

Table 4. *In vivo* effect of different fungal antagonists against *Rhizoctonia solani*, *Macrophomina phaseolina*, *Fusarium oxysporum* f.sp. *niveum*, *Fusarium solani* f.sp. *cucurbitae* and *Monosporascus cannonballus*.

Treatments	<i>Rhizoctonia solani</i>							
	Disease incidence (%) ^a				Disease severity index ^a			
	Preventive treatment		Simultaneous treatment		Preventive treatment		Simultaneous treatment	
	30 DAI ^b	45 DAI ^b	30 DAI	45 DAI	30 DAI	45 DAI	30 DAI	45 DAI
<i>T. viride</i>	66.67±0.05ab ^c	33.33±0.08ab	16.67±0.10b	66.67±0.04ab	0c	1±0.02c	0.67±0.02ab	1.33±0.02ab
<i>T. harzianum</i>	0b	0b	16.67±0.04b	66.67±0.04ab	0.67±0.02bc	0.67±0.02bc	1.5±0.05a	1.33±0.02ab
<i>P. italicum</i>	83.33±0.04a	0b	16.67±0.04b	66.67±0.04ab	1.33±0.05ab	1.5±0.05b	2±0.06a	1.83±0.04ab
<i>A. terreus</i>	50±0.10ab	33.33±0.06ab	16.67±0.04b	33.33±0.06ab	1±0.02abc	1.17±0.02b	2±0.06a	1.67±0.02ab
<i>A. nidulans</i>	50±0.10ab	66.67±0.10ab	33.33±0.06b	66.67±0.04ab	1±0.02abc	1±0.02b	1.67±0.05a	1.67±0.02ab
Negative control	0b	0b	0b	0b	0c	0c	0b	0c
Positive control	50±0.04ab	100a	50±0.04a	100a	2±0.06a	3.5±0.10a	2±0.06a	3.5±0.10a
<i>P values</i> ^d	0.169	0.038	0.591	0.333	0.015	<0.05	0.032	<0.05
<i>Macrophomina phaseolina</i>								
<i>T. viride</i>	16.67±0.01b ^c	66.67±0.01ab	100a	66.67±0.04ab	0.33±0.02b	0.67±0.02cd	0b	1.5±0.02b
<i>T. harzianum</i>	0b	33.33±0.04ab	16.67±0.04b	100a	0.33±0.02b	0.5±0.02cd	0.83±0.05b	1.83±0.02b
<i>P. italicum</i>	0b	33.33±0.04ab	0b	66.67±0.04ab	0.83±0.05b	1.33±0.05bc	0.83±0.05b	1.83±0.04b
<i>P. digitatum</i>	0b	33.33±0.04ab	66.67±0.02a	66.67±0.04ab	0.5±0.02b	1.83±0.02b	0.67±0.02b	1.5±0.02b
<i>A. niger</i>	0b	100a	16.67±0.04b	66.67±0.04ab	0.17±0.02b	0.83±0.02cd	1.17±0.06b	2.17±0.02b
Negative control	0b	0b	0b	0b	0b	0d	0c	0c
Positive control	100a	100a	100a	100a	2.33±0.06a	3.67±0.10a	3.67±0.10a	3.5±0.10a
<i>P values</i> ^d	<0.05	0.099	<0.05	0.182	<0.05	<0.05	<0.05	<0.05
<i>Fusarium oxysporum</i> f.sp. <i>niveum</i>								
<i>T. viride</i>	16.67±0.02b ^c	66.67±0.08ab	33.33±0.05ab	33.33±0.05b	0.17±0.02cd	1±0.02b	0.83±0.02cd	1.5±0.02ab
<i>T. harzianum</i>	16.67±0.04b	66.67±0.08ab	0b	33.33±0.05b	1.17±0.02b	0.83±0.02b	0.67±0.05cd	1.33±0.02ab
<i>P. purpurascens</i>	0b	50abc	33.33±0.05ab	66.67±0.04b	0.83±0.05bc	0.83±0.02b	1.17±0.06c	1.5±0.04ab
<i>P. italicum</i>	0b	33.33±0.06bc	100a	33.33±0.06b	0.33±0.02cd	1.5±0.02b	1.5±0.06bc	0.83±0.02ab
<i>P. janthinellum</i>	33.33±0.06b	66.67±0.10ab	33.33±0.05ab	33.33±0.05b	0.5±0.02bcd	1.5±0.02b	0.67±0.05cd	0.67±0.02ab
<i>P. digitatum</i>	33.33±0.06b	33.33±0.06bc	100a	66.67±0.04b	0.5±0.02bcd	1.5±0.02b	2.33±0.05ab	1.33±0.05ab
Negative control	0b	0c	0b	0c	0d	0c	0d	0b
Positive control	100a	100a	100a	100a	2.67±0.06a	2.67±0.10a	2.67±0.10a	2.67±0.10a
<i>P values</i> ^d	0.09	0.123	0.006	0.398	<0.05	<0.05	0.01	0.057
<i>Fusarium solani</i> f.sp. <i>cucurbitae</i>								
<i>T. viride</i>	16.67±0.10b ^c	50abc	66.67±0.05ab	66.67±0.04ab	0.17±0.02b	0.58±0.02b	0.83±0.02c	2a
<i>T. harzianum</i>	16.67±0.04b	33.33±0.06bc	33.33±0.06bc	66.67±0.04ab	0.33±0.02b	1.67±0.02a	0.83±0.05c	1.67±0.02b
<i>Humicolainsolans</i>	16.67±0.04b	50abc	100a	33.33±0.06ab	0.67±0.05b	0.33±0.05b	1c	1.83±0.04b
<i>A. niger</i>	0b	83.33±0.04ab	100a	100a	0.17±0.02b	0.67±0.02b	1.83±0.06b	1.67±0.02b
Negative control	0b	0c	0c	0b	0b	0b	0d	0d
Positive control	100a	100a	100a	100a	2.33±0.10a	2.33±0.10a	3.83±0.06a	3.83±0.06a
<i>P values</i> ^d	<0.05	<0.05	0.012	0.071	<0.05	<0.05	<0.05	<0.05
<i>Monosporascus cannonballus</i>								
<i>T. viride</i>	16.67±0.02bc ^c	33.33±0.06ab	33.33±0.05ab	33.33±0.05ab	0.5±0.02bcd	0.67±0.02cde	0.33±0.02cd	1.33±0.02bc
<i>T. harzianum</i>	0c	33.33±0.06ab	0b	33.33±0.05ab	0d	0.83±0.02bcde	0.17±0.05d	1.17±0.05c
<i>P. purpurascens</i>	66.67±0.08abc	83.33±0.06b	100a	100a	0.17±0.05cd	0.33±0.02ef	2b	1.83±0.06bc
<i>P. digitatum</i>	66.67±0.08abc	50ab	100a	66.67±0.08ab	0.67±0.02bcd	0.5±0.02cde	1.83±0.06b	2bc
<i>A. pseudoalegans</i>	66.67±0.08abc	83.33±0.06b	66.67±0.08ab	100a	0.83±0.02bc	1.17±0.02bc	1.83±0.06b	2bc
<i>A. flavus</i>	50abc	100a	66.67±0.08ab	100a	1b	0.5±0.02cde	1.67±0.05b	2.17±0.05b
<i>A. niger</i>	16.67±0.02bc	50ab	33.33±0.05ab	66.67±0.08ab	0d	0.33±0.02ef	1.17±0.05ab	1.33±0.05bc
<i>A. glaucus</i>	100a	100a	100a	100a	0.67±0.02bcd	0f	2.17±0.05b	1.67±0.05bc
<i>G. catenulatum</i>	66.67±0.08abc	83.33±0.06b	66.67±0.08ab	100a	0.5±0.02bcd	1bcd	1.5±0.05b	2.17±0.05b
<i>G. penicillioides</i>	66.67±0.08abc	66.67±0.08ab	66.67±0.08ab	66.67±0.04ab	0.67±0.02bcd	0.67±0.02cde	1.5±0.05b	1.83±0.06bc
<i>Paecilomyces victorioriae</i>	83.33±0.06ab	66.67±0.08ab	100a	66.67±0.04ab	0.5±0.02bcd	0.17±0.02f	1.83±0.06b	1.5±0.05bc
<i>G. virens</i>	66.67±0.08abc	66.67±0.08ab	66.67±0.08ab	66.67±0.04ab	0.5±0.02bcd	1.5±0.02ab	1.5±0.05b	1.5±0.05bc
Negative control	0c	0b	0b	0b	0d	0f	0d	0d
Positive control	100a	100a	100a	100a	2a	2a	3.83±0.10a	3.83±0.10a
<i>P values</i> ^d	0.048	0.171	0.006	0.398	<0.05	<0.05	<0.05	<0.05

^a Disease incidence (%) and Disease severity index were assessed with a scale for each fungus.

^b Sampling date : 30 and 45 days after inoculation.

^c ± Standard error, according to Duncan's Multiple Range Test, values followed by different superscripts are significantly different at p≤0.05.

^d Probabilities associated with individual F tests.

In vivo essay, dipping root in different spore suspensions of antagonists prior to inoculation of the culture substrate proved their efficiency to reduce the incidence of the soil-borne pathogens in Tunisia. Indeed, Sreedevi *et al.* (2011) have demonstrated that among the five

isolates of *Trichoderma* sp., *T. harzianum* and *T. viride* had maximum antifungal activity against *M. phaseolina*. Monteiro *et al.* (2010) reported that *T. harzianum* were capable of overgrowing and degrading *Rhizoctonia solani* and *M. phaseolina* mycelia. The effectiveness of biological control against *Monosporascus cannonballus* by *Trichoderma* sp. (Khalifa *et al.*, 2008) and indicates that the potential antimicrobial activity is more effective when combined as part of an integrated strategy against this pathogen. Many antagonistic strains have been proved to be effective biocontrol agents in controlled laboratory or greenhouse conditions. *Penicillium* spp., *Aspergillus* spp. and *Trichoderma* spp. (Sabuquillo *et al.*, 2006; Suarez-Estrella *et al.*, 2007; Rojo *et al.*, 2007) are a few among the long lists.

Conclusion

The study revealed that all samples were rich in fungal diversity and among all the fungal species identified *Aspergillus* sp. and *Penicillium* sp. were dominated. This may be due to the toxins produced by *Aspergillus* sp. and antibiotic produced by *Penicillium* sp. prevent the growth of other fungal species. The current study of the interaction antagonists-pathogens provides evidence that suppression of *Fusarium* sp., *M. phaseolina*, *R. solani* and *M. cannonballus* causing the principal soil-borne disease of watermelon and melon in Tunisia can be controlled by using these selected bioagents.

References

- Abo, K., Attadialo, H., Koffi, C. N., & Ganiyu, K. (2011). Fungi flora inventory in soils under different agrosystems along a gradient of cultivated fields in Oumé region, West Central Côte d'Ivoire. *Journal of Animal & Plant Sciences*, Vol., (3), pages (1339-1345).
- Aegerter, B.J., Gordon, T.R., & Davis, R.M. (2000). Occurrence and pathogenicity of fungi associated with melon root rot and vine decline in California. *Plant Disease*, Vol., (81), pages (224-230).
- Ben Salem, I. (2009). Biologie et Epidémiologie de *Monosporascus cannonballus*, responsable du dépérissement de la pastèque dans la région de Kairouan (Biology and Epidemiology of *Monosporascus cannonballus*, responsible of MRRVD of watermelon in Kairouan, Tunisia). Diplôme d'Etude Approfondies en Protection des Plantes et d'Environnement à ISACM, Université de Sousse, 116 pp.
- Boughalleb N., Armengol J., El Mahjoub M. (2005). Detection of races 1 and 2 of *Fusarium solani* f. sp. *cucurbitae* and their distribution in watermelon fields in Tunisia. *J. Phytopathol.*, Vol., (153), pages (162-168).
- Boughalleb N., Ben Janet H., El Mehri Z. and El Mahjoub M. (2006). Contrôle biologique par *Trichoderma harzianum* in vitro des isolats tunisiens de *Rhizoctonia solani* (Kuhn) et modes d'actions potentiels (Biocontrol ability in vitro of *Trichoderma harzianum* against Tunisian *Rhizoctonia solani* (Kuhn) and their potential mode of action). *Revue de l'I.N.A.T.* 21 (1) :25-40.
- Boughalleb, N., & El Mahjoub, M. (2006). *Fusarium solani* f.sp. *cucurbitae* and *F. oxysporum* f.sp. *niveum* Inoculum densities in Tunisian soils and their effect on watermelon seedlings. *Phytoparasitica*. Vol., (2), pages (149-158).
- Cohen, R., Pivonia, S., Burger, J., Edelstein, M., Gamliel, A., & Katan, J. (2000). Toward integrated management of *Monosporascus* wilt of melons in Israel. *Plant Disease*, Vol., (84), pages (496-505).
- Dubey, S.C., Suresh, M., & Singh, B. (2007). Evaluation of *Trichoderma* species against *Fusarium oxysporum* f.sp. *ciceris* for integrated management of chickpea wilt. *Biological Control*, Vol., (40), pages (118-127).

- Eziashi, E.I., Omamor, I.B., & Odigie, E.E. (2007). Antagonism of *Trichoderma viridae* and effects of extracted water soluble compounds from *Trichoderma* species and benlate solution on *Ceratocystis paradoxa*. *Afr. J. Biotechnol.*, Vol., (4), pages (388-392).
- Freeman, S., Zveibil, A., Vintal, H., & Maymon, M. (2002). Isolation of nonpathogenic mutants of *Fusarium oxysporum* f. sp. *melonis* for biological control of *Fusarium* wilt in cucurbits. *Phytopathology*, Vol. (92), pages (164-168).
- Hajieghrari, B., Torabi-Giglou, M., Mohammadi, M.R., & Davari, M. (2008). Biological potential of some Iranian *Trichoderma* isolates in the control of soil borne plant pathogenic fungi. *African Journal of Biotechnology*, Vol., (8), pages (967-972).
- Hammond, P.M. (1995). Magnitude and distribution of biodiversity, In: *Global biodiversity assessment*. Edition: Heywood V.H. 107-91 pp. Cambridge University Press. Cambridge, UK, London.
- Hao-quin, P., Jin-Feng, Y., Yue-ming, W., Tian-Yu, Zh., & Hong- Feng, W. (2008). *J. Zhejiang Univ. Sci. B.*, Vol., (10), pages (829-834).
- Hussain, T., Ishtiaq, M., Azam, Sh., Jawad, W., & ulHaq, I. (2014). Comparative analysis of air, soil and water mycoflora of Samahni Area, District Bhimber Azad Kashmir, Pakistan. *African Journal of Microbiology Research*, Vol., (23), pages (2295-2306).
- Khalifa, E.Z., Awad, M.A., Mostafa, M.M., & El-Saidy, A.M. (2008). *Monosporascus cannonballus*; the causal organism of cucumber sudden wilt disease and its control. *Journal of Plant Pathology*, Vol., (90), pages (S2.411).
- Kumar, A., Gond, S.K., Mishra, A., Sharma, V.K., Verma, S.K., & Kharwar, R.N. (2013). Role of different variables on site-specific isolation and distribution patterns of soil mycoflora from Varanasi. *Vegetos.*, Vol., (1), pages (88-95).
- Kumar, P.K.R., Hemanth, G, Niharika, P.S., & Kolli, S.K. (2015). Isolation and identification of soil mycoflora in agricultural fields at Tekkali Mandal in Srikakulam District. *Int. J. Adv. Pharma., Bio. Chem.*, Vol., (2), pages (2277-4688).
- Maheshwari, R., (2011). *Fungi: Experimental methods in biology (Mycology Vol. 28)*, 358 pp. Second Edition. Boca Raton: Taylor & Francis Group, New York.
- Martyn, R.D., Lovic, B.R., Maddox, D.A., Germash, A., & Miller, M.E. (1994). First report of *Monosporascus* root rot/vine decline of watermelon in Tunisia. *Plant Disease*, Vol., (78), pages (1220).
- Mathew, K.A., & Gupta, S.K. (1996). Studies on web blight of French bean caused by *Rhizoctonia solani* and its management. *Indian J. Mycol. Plant Pathol.*, Vol., (26), pages (171-177).
- Megha Bhutt, Patel, S., Prajapti, P., & Jasral, Y.T. (2015). Isolation and Identification of Soil Microflora of National parks of Gujarat, India. *Int. J. Curr. Microbiol. App. Sci.*, Vol., (3), pages (421- 429).
- Monteiro, V.N., Silva, R.N., Steindorff, A.S., Costa, F.T., & Noronha, E.F. (2010). New insights in *Trichoderma harzianum* antagonism of fungal plant pathogens by secreted protein analysis. *Curr. Microbiol.*, Vol., (61), pages (298-305).
- Onyimba, I.S., Ogbonna, C.I.C., Chukwu, C.O.O., & Odu, C.C.E. (2014). Occurrence of potentially hazardous fungi in exposed brewery spent sorghum grains. *European Scientific.*, Vol., (9), pages (449- 457).
- Ratnasri, P.V., Lakshmi, B.K.M., Ambika, Devi K., & Hemalatha, K.P.J. (2014). Isolation, characterization of *Aspergillus fumigatus* and optimization of cultural conditions for amylase production. *International journal of Research in Engineering and Technology*, Vol., (2), pages (457-463).
- Ravf, B.A., & Ahmad, I. (1998). Studies on correlation of seed infection to field incidence of *Alternaria alternata* and *Macrophomina phaseolina* in Sunflower. 113 pp. 13th Iranian Plant Protection Congress-Karaj. Iran.

- Rojo, F.G., Reynoso, M.M., Ferez, M., Chulze, S.N., & Torres, A.M. (2007). Biological control by *Trichoderma* species of *Fusarium solani* causing peanut crown root rot under field conditions. *Crop Protect.*, Vol., (26), pages (549–555).
- Sabuquillo, P., De Cal, A., & Melgarejo, P. (2006). Biocontrol of tomato wilt by *Penicillium oxalicum* formulations in different crop conditions. *Biol. Control*, Vol., (37), pages (256–265).
- Soderlund, C. (2009). Computational techniques for elucidating plant-pathogen interactions from large-scale experiments on fungi and Oomycetes. *Brief Bioinforma*, Vol., (6), pages (654-663).
- Sreedevi, B., Charitha, D.M., & Saigopal, D.V.R. (2011). Isolation and screening of effective *Trichoderma* spp. against the root rot pathogen *Macrophomina phaseolina*. *Journal of Agricultural Technology*, Vol., (3), pages (623-635).
- Suarez-Estrella, F., Vargas-García, M.C., López, M.J., Capel, C., & Moreno, J. (2007). Antagonistic activity of bacteria and fungi from horticultural compost against *Fusarium oxysporum* f. sp. *melonis*. *Crop Protection*, Vol., (26), pages (46-53).
- Vakalounakis, D.J., & Fragkiadakis, G.A. (1999). Genetic Diversity of *Fusarium oxysporum* isolates from cucumber: Differentiation by Pathogenicity, Vegetative Compatibility, and RAPD Fingerprinting. *Phytopathology*. Vol., (2), pages (161-168).
- Waksman, S.A. (1922). A method of counting the number of fungi in the soil. *J. Bact.*, Vol., (7), pages (339-341).

SCREENING OF SEED-BORNE FUNGI OF VEGETABLES CROPS AND THEIR EFFECT ON ORGANIC GROWING PLANTS IN TUNISIA

Naima BOUGHALLEB-M'HAMDI*, Ibtissem BEN SALEM, Yosra ABDELKHALEK, Néji TARCHOUN, Mahmoud M'HAMDI

UR 13AGR03, Department of Biological Sciences and Plant Protection, High Institute of Agronomy of Chott Mariem, 4042 Sousse, University of Sousse, Tunisia

*Corresponding author: n.boughalleb@laposte.net

Abstract

Seed health testing to detect seed borne pathogens is an important step in the management of crop diseases. Seed borne pathogens were isolated from vegetable crops (melon, cucumber, tomato and pepper) and their impact on organic farming was evaluated. A direct confrontation of each pathogen and antagonist collected from the same plant was performed. For melon, *Macrophomina phaseolina*, *Rhizoctonia solani*, *Cladosporium* sp., and *Trichothecium roseum* were confronted against *Aspergillus niger*, *Aspergillus terreus*, *Penicillium digitatum*, *Trichoderma harzianum*, *Trichoderma atroviride* and *Aspergillus flavus*. The highest inhibition rate was recorded by *T. harzianum* and *T. atroviride* with 60%. For tomato, only *T. harzianum* has reduced the mycelial growth of *Fusarium oxysporum* f. sp. *lycopersici* (51.80%). Concerning pepper, mycelial growth inhibition rate of *Phytophthora parasitica* was performed by *A.niger* (44.23%) and *T. harzianum* (43%). For cucumber, *Alternaria alternata* was confronted with *T. harzianum*, *P. digitatum*, and *P. italicum* and showed an inhibition rate of 77.65%, 79.37% and 6.6%, respectively. *In vivo* essay, a disease severity index caused by various pathogens alone and combined with antagonists compared with control plants was accomplished. The pepper plants inoculated by *Ph. parasitica* and treated curatively by *T. harzianum* have recorded a low value (0.26). Treatment by *A. terreus* (0.56) seemed the most effective against *M. phaseolina*. Preventive treatment was the most effective for melon plants inoculated with *R. solani*, treated by *Penicillium digitatum* (0.78), similarly against *T. roseum* (1.33), and for tomato plants inoculated by *F.o. lycopersici* and treated with *T. harzianum* (1.5).

Keywords: *biological control, in vitro, in situ, seedborne fungi.*

Introduction

Plant pathogens present a serious threat to seedling establishment and the potential for plant disease epidemics. Hence, pathogen exclusion by detection and elimination of infested seedlots remains a requisite tactic for seedling production and disease management. Unfortunately, the numbers of contaminated seed within a lot may be low and infested seed may be asymptomatic making their detection difficult. To address these issues seed detection assays have been developed, but many of them have shortcomings that reduce their effectiveness (Walcott, 2003). Seed borne diseases are very important from the following points of view; (i) introduction of new pathogens (ii) quantitative and qualitative crop losses and (iii) permanent contamination of soil (Anselme, 1981; Ora *et al.*, 2011). Fungi are the principal organisms associated with seed in storage (Ora *et al.*, 2011). The fungus is both internally and externally seedborne (Ramachandran *et al.*, 2007). In some cases infected seeds display characteristic symptoms, including discoloration and shriveling (Murakishi, 2002). Additionally, seeds infested by fungi, bacteria and viruses may display no macroscopic symptoms, making visual or physical inspection of seeds useless as a detection assay. Seed-borne fungi decrease protein, carbohydrate, cholesterol contents, iodine values and increase acid quantity (Ahmad *et al.*, 1994; Morrison, 1999). A direct method of testing seeds is by

allowing pathogens to grow from them onto appropriate artificial media. Many selective and semi selective media have been developed for seedborne fungi and bacteria (Toussaint *et al.*, 2001). Seedling grow-out is one of the most applicable and widely used seed detection assays (Lee *et al.*, 1990; Yang *et al.*, 1997) but for successful implementation, infected seedlings must display obvious and characteristic symptoms. Testing seeds for plant pathogens can be a difficult task. Unlike infected vegetative plant tissues, infested seeds can be asymptomatic, making visual detection impossible. Additionally, pathogen populations on seeds may be low, and infested seeds may be non-uniformly distributed within a lot. Many detection assays exist for different seed borne pathogens. Seed treatments with biological, physical and chemical agents and techniques applied to seed to provide protection and improve the establishment of healthy crops (Neergaard, 1977). Biological control is a nature friendly approach that uses specific microorganisms. Commercial preparations of plant disease biocontrol agents are based on the practical application of rhizosphere competent species of bacteria or fungi (Amand and Reddy, 2009). The mycoparasite ability of *Trichoderma* species against some important aerial and soil borne plant pathogens (Elad, 2000; Freeman *et al.*, 2004, Dubey *et al.*, 2007) lead to the development of biocontrol strategies (Hajieghrari *et al.*, 2008). Numerous researches have been focused on searching and selecting antagonist microorganisms on diverse soil pathogens. The aim of this present study is to determine i) isolation and identification of seed borne fungi and ii) the association of pathogens and antagonists.

Material and methods

Screening of seed-borne fungi of vegetables crops

Organic seeds samples were provided by the technical center of organic agriculture (CTAB, Tunisia), which four vegetable crops are collected: melon (cvs. Maazoun, local, Oasis chnini, 2012, Mahdia), cucumber (cv. local), tomato (cv. Rio Grande), and pepper (cvs. Bar-abid, Chaabani) (CTAB, 2013/2014). The collected seed samples were analyzed for the presence of major seed borne fungal. Two hundred seeds were tested for each variety maintaining four replications. Twenty-five seeds were placed on three layers of moist blotting paper (ISTA, 1996) in each glass Petri dish. The Petri dishes were incubated at $25\pm 1^{\circ}\text{C}$ under 12/12 hrs light and darkness cycle for 7 days. Each seed was observed under stereomicroscope in order to record the presence of fungal colony. In doubtful cases with temporary slides were prepared from the fungal colony and observed under compound microscope. For proper identification of fungi another method was performed, the agar plate method. Surface disinfected seeds (0.1% mercuric chloride) were plated on the PDA medium and plated seeds were usually incubated for 5-7 days at $22-25^{\circ}\text{C}$ under 12h altering cycles of light and darkness. At the end of the incubation period, fungi growing out from the seeds on the agar medium were examined and identified. Identification was done based on colony characters and morphology of sporulation structures. The results were presented as percent isolation for individual pathogen.

Potential antimicrobial activity

This work presents in understanding the mechanisms involved in the interaction of some antagonists with seedborne fungi and plants. The antagonists isolates identified were tested for their antimicrobial activity *in vitro* and *in vivo*.

Potential antifungal activity *in vitro*

Mycelial disc (4mm diameter) was obtained from the peripheral of five day old mycelial antagonist isolate was placed in front of the pathogen from the opposite edge of the plate. For the control, a mycelial plug of pathogen was placed in the center of the plate. Three replicates were prepared per treatment (pathogen/ antagonist). The plates were incubated at

28°C and the mycelial lengths of colonies of each pathogen were measured. The inhibition percent was determined by the formula of Hmouni *et al.* (1996): $I (\%) = (1 - C_n/C_0) \times 100$, which C_n is the radial growth of the pathogen in the presence of the antagonist and C_0 is the radial growth of the pathogen without antagonist.

Potential antifungal activity *in vivo*

This experiment was carried out in greenhouse, sowing the pre-germinated seeds was made in indented trays containing peat sterilized. Germinated seedlings are displaced in a pot at a rate of 3 to 5 plants in each pot. The substrate used in the experiment is a mixture of peat and vermiculite (1:1). The inoculum was obtained according to each fungal pathogen. *Fusarium* sp. and *Trichothecium roseum* were grown on PDA at 25°C for 4 days until sporulation, and an erlenmeyer flasks containing 50 ml of potato dextrose broth (PDB, 20 g/l) were inoculated with four pieces of each isolate. Spore production was induced in an orbital shaker and the spores were recovered from culture by filtration and adjusted to 10^6 spores/ml. In the case of *R. solani*, *M. phaseolina*, the isolate were grown on PDA, 20 plates mixed with 2500g of autoclaved potting mix and placed in 20 cm pots. *Phytophthora parasitica* was prepared by placing mycelial disc in distilled water contained in erlenmeyer flasks for 5 days and then they are retained in freezer for one hour for sporulation. Spores of the antagonist were recovered by rinsing the Petri plates with sterile distilled water and the suspension filtering. A haemocytometer was used to determine the concentration of the spores (10^6 spores/ml). The application of fungal antagonist was performed 24 h before and after inoculation by watering each plant by fungal antagonist suspension (10 ml). The pots are then placed in a greenhouse for 45 days. Controls were performed by inoculated the plant with only pathogen in case of positive control (10 ml) and a distilled water (negative control). The experimental protocol was a randomized complete block. For each fungal species one plant randomly distributed with 5 plants per replicate (3 replicates) in each treatment. The root systems were gently washed in tap water. Each root system was rated for the severity of the pathogen as described in Table 1.

Table 13 : Disease severity of seed borne pathogens identified.

Fungi	Rating scale	Reference
<i>F. oxysporum</i>	0 = no symptoms; 1 = light vascular discoloration in the stem with or without stunting; 2 = vascular discoloration in the stem, stunting, wilting with or without yellowing of cotyledons; and 3 = dead seedlings.	Vakalounakis and Frangkiadakis (1999)
<i>Ph. parasitica</i>	0 = healthy plant, no necrosis on the roots, 0.5 = necrosis limited to the rootlets extremity, 1 = necrosis stopped at the lower half of the primary roots 2 = necrosis up to the collar, 3 = necrosis reaching the collar and adventitious roots, 4 = hypocotyl rot, 5 = death of the plant due to widespread necrosis.	Palloix <i>et al.</i> , 1988
<i>M. phaseolina</i> , <i>R. solani</i> and <i>T. roseum</i>	0: symptomless, 1: 1 to 3% of shoot tissues infected, 2: 10% of shoot tissues infected, 3: 25% of shoot tissues infected, 4: 50% of shoot tissues infected and 5: more than 75% of shoot tissues infected.	Ravf and Ahmad (1998)

The Disease severity index was analyzed with the GENMOD procedure using the multinomial distribution and the cumulative logit as link function, and means of the values were separated by χ^2 test at $P < 0.05$ using SAS program (SAS Institute, Cary, NC). The other variables were compared by analysis of variance (ANOVA) and means of the values were separated with Duncan test at $P < 0.05$ using SPSS 20.0 for Windows (SPSS Inc., Chicago, IL, USA).

Results and discussion

Screening of seed-borne fungi of vegetables crops

A total of 12 seed born fungal species were identified. The highest isolation percent was recorded by *M. phaseolina* with 40%, isolated from melon and the morphology of this fungus was in agreement with Snesana *et al.* (2014). Other pathogen was predominant in melon like *R. solani* (13%) showing characteristics consistent with Parmeter (1970). *Trichoderma harzianum* was also detected from melon and cucumber seeds with 21 and 5% respectively. The description is identical to Ahsanur *et al.* (2009). *Aspergillus terreus* was isolated only from melon seed with 13% and the identification was in agreement with Deak *et al.* (2009) and Samson *et al.* (2011).

Table 14 : *Isolation percentage of fungal species identified from vegetables crop.*

Vegeteable crop	Fungi		Isolation percent (%) [*]	
	Pathogenic	Antagonists		
Concombre	<i>Alternaria alternata</i>	<i>Trichoderma harzianum</i>	10%	5%
Melon	<i>Macrophomina phaseolina</i>	<i>Aspergillus niger</i>	40%	33%
		<i>Rhizoctonia solani</i>	13%	15%
		<i>Cladosporium sp</i>		7%
		<i>Trichothecium roseum</i>	8%	21%
		<i>Trichoderma atroviride</i>		10%
		<i>Aspergillus flavus</i>		10%

* Isolation percent (%) ;

Potential antifungal activity *in vitro*

Statistical analysis ($p < 0.05$) reveals that all bioagents more or less significantly, inhibited the mycelial growth of all pathogen. Differential biocontrol ability among the six antagonists against pathogens collected from melon, cucumber, pepper and tomato are presented in Table 3. Growth inhibition in the pathogen differed significantly ($p < 0.05$). *T. roseum* isolated from melon displayed a good resistance against all antagonists with potential antimicrobial activity values between 13.97 and 45.56%. *Trichoderma harzianum*, *T. atroviride* *P. digitatum* proved to be the most potent bioagents. *F. o. lycopersici* ($p < 0.05$) and *Ph. parasitica* ($p > 0.05$) exhibited a moderate resistance in dual culture with *A. terreus*, *T. harzianum* and *A. niger*. *T. harzianum* and *P. digitatum* reduced the radial growth of *Alternaria alternata* successfully with 77.65 and 79.37%, respectively (Table 3).

This work presented the first seed borne screening from local and varieties vegetable crop seeds. The detected antagonists proved their efficiency to reduce the incidence of the major vegetable crop seed borne pathogens in Tunisia. Most of effective *Trichoderma* strains produced cell wall lytic enzymes and volatile and nonvolatile toxic metabolites that impede colonization by antagonized microorganisms. Among these metabolites, the production of harzianic acid, alamethicins, tricholin, peptaibols, antibiotics, 6- penthyl- α -pyrone, massoilactone, viridin, gliovirin, glisoprenins, heptelidic acid and others have been described to protect plant from disease (Chet *et al.*, 1997; Vey *et al.*, 2001). Indeed, Etabarrian (2006) and Sreedevi *et al.* (2011) have demonstrated that among the five isolates of *Trichoderma* sp., *T. harzianum* and *T. viride* had maximum antifungal activity against *M. phaseolina*. Monteiro *et al.* (2010) reported that *T. harzianum* were capable of overgrowing and degrading *Rhizoctonia solani* and *M. phaseolina* mycelia. Many antagonists strains have been proved to be effective as biocontrol agents in laboratory or greenhouse conditions; *Penicillium* spp. (Sabuquillo *et al.*, 2006), *Aspergillus* spp. (Suarez-Estrella *et al.*, 2007), and *Trichoderma* spp. (Rojo *et al.*, 2007) are a few among the long lists. The antagonists revealed different reactions for the reduction of the mycelial growth of *F.o. melonis*. *P. digitatum*, *A. flavus*, *A. fumigatus*, *A. terreus* and *A. niger* are classified as the most effective against this pathogen, *P. italicum* is moderately effective (Suarez-Estrella *et al.*, 2007). Hibar *et al.* (2005) showed that tomato plants in a mixture of perlite inoculated with *F.o. radialis-lycopersici* and *T. harzianum* reduced root rot infection. In addition, plants revealed a better vegetative and root growth. Most biocontrol success has been achieved in greenhouse cultivation (Xu *et al.*, 2011), where ecological parameters are less variable. Biocontrol using antagonists represents a potentially attractive disease management approach to reduce the Phytophthora blight, caused by either *Phytophthora capsici* or *P. parasitica* (*P. nicotianae*) (Marini *et al.*, 2014).

Conclusion

The result of the present study reveals that seed borne pathogens are present on most vegetable crop analyzed. Although in certain instances they occurred in trace levels but under suitable environmental condition they may create the disease in epidemic level. Pathogen free seed is the vital input in agriculture. The imported hybrid varieties are treated with seed treating chemicals for maintaining quarantine regulations. But from the present study it was revealed that seed borne pathogens were associated with untreated organic seeds, and it was also noticed that a particular pathogen was observed in a particular variety. So the seed health status was assessed by studying the potential antimicrobial antagonists against the major seedborne pathogens

References

- Ahmad, K.G.M., EL-Said, S.I.A., Fawzy, R.N., Badr, A.E., & Abd-Allah, M.A. (1994). Pathological study on sunflower plant, chemical and biological control and seed oil content. *Annals Agric. Sci. Moshtoh.*, vol., (3), pages (1529-1543).
- Anand S. and J. Reddy 2009. Biocontrol potential of *Trichoderma* sp. against plant pathogens. *International Journal of Agriculture Sciences*, Vol., (1), pp-30-39.
- Anselme, C. (1981). The importance in cultivation of pathogenic organisms transmitted by seeds. *Seed sci. Technol.*, Vol., (9), pages (689-695).
- Chet I, Inbar J, Hadar I. 1997. Fungal antagonists and mycoparasites. In *The Mycota IV: Environmental and microbial relationships*. ed. D.T. Wicklow, B. Söderström. 165-184. Springer-Verlag, Berlin.
- Deak, E., Wilson, S.D., White, E., Carr, J.H., Balajee, S.A. (2009). *Aspergillus terreus* accessory conidia are unique in surface architecture, cell wall composition and germination kinetics. *PLOS One*, Vol., (4), pages 7673.

- Dubey, S.C., Suresh, M., & Singh, B. (2007). Evaluation of *Trichoderma* species against *Fusarium oxysporum* fsp. *ciceris* for integrated management of chickpea wilt. *Biological Control*, Vol., (40), pages (118-127).
- Elad, Y. (2000). Biological control of foliar pathogens by means of *Trichoderma harzianum* and potential modes of action. *Crop Prot.*, Vol., (19), pages (709-714).
- Etabarian HR. 2006. Evaluation of *Trichoderma* isolates for biological control of charcoal stem rot in melon caused by *Macrophomina phaseolina*. *Journal of Agricultural Science and Technology* 8, 243-250.
- Freeman, S., Zveibil, A., Vintal, H., & Maymon, M. (2002). Isolation of nonpathogenic mutants of *Fusarium oxysporum* f. sp. *melonis* for biological control of *Fusarium* wilt in cucurbits. *Phytopathology*, Vol. (92), pages (164-168).
- Hajieghrari, B., Torabi-Giglou, M., Mohammadi, M.R., & Davari, M. (2008). Biological potential of some Iranian *Trichoderma* isolates in the control of soil borne plant pathogenic fungi. *African Journal of Biotechnology*, Vol., (8), pages (967-972).
- Hibar, K., Daami-Remadi, M., Khiareddine, H., & El Mahjoub, M. (2007). Effet inhibiteur in vitro et in vivo du *Trichoderma harzianum* sur *Fusarium oxysporum* f. sp. *radicis-lycopersici*. *Biotechnol. Agron. Soc. Environ.*, Vol., (9), pages (163-171).
- Hmouni, A., Hajlaoui, M.R., & Mlaiki, A. (1996). Résistance de *Botrytis cinerea* aux benzimidazoles et aux dicarboximides dans les cultures abritées de tomate en Tunisie. *OEPP/EPPO Bull.*, Vol., (26), pages (697-705).
- ISTA, (1996). International Rules for Seed Testing. *Seed Sci. Technol.*, Vol., (24), pages (39-42).
- Lee, K.W., Lee, B.C., Park, H.C., & Lee, Y.S. (1990). Occurrence of green mottle mosaic virus disease of watermelon in Korea. *Kor. J. Plant Pathol.* Vol. (6), pages (250-255).
- Marini, F., Dianez, F., Santos, M., Carretero, F., Gea, F. J., Castaneda, C., Navvaro, M. J. & Yau, J.A. (2014). Control of *Phytophthora capsici* and *Phytophthora parasitica* on pepper (*Capsicum annuum* L.) with compost teas from different sources, and their effects on plant growth promotion. *Phytopathologia Mediterranea*, Vol., (53), pages (216-228).
- Monteiro, V.N., Silva, R.N., Steindorff, A.S., Costa, F.T., & Noronha, E.F. (2010). New insights in *Trichoderma harzianum* antagonism of fungal plant pathogens by secreted protein analysis. *Curr. Microbiol.*, Vol., (61), pages (298-305).
- Morrison, R.H. (1999). Sampling in seed health testing. *Phytopathology*, Vol., (89), pages (1084-1087).
- Murakishi, H.H. (2002). Purple seed stain of soybean. *Phytopathology*, Vol., (41), pages (305-318).
- Neergard, P. (1977). *Seed pathology*. New York: John Wiley, 839 pp.
- Ora, N., Faruq, A.N., Islam, M.T., Akhtar, N. & Rahman, M.M. (2011). Detection and Identification of Seed Borne Pathogens from Some Cultivated Hybrid Rice Varieties in Bangladesh. *Middle-East Journal of Scientific Research* Vol., (4), pages (482-488).
- Palloix, A., Daubèze, A.M., & Pochard, E. (1988). *Phytophthora* root rot of pepper influence of host genotype and pathogen strain on inoculum density disease severity relationships. *J Phytopathol.*, Vol., (123), pages (25-33).
- Parmeter J.R. (1970). *Rhizoctonia solani*, biology and pathology. American Phytopathological society, Symposium on *Rhizoctonia solani*, October 1965. University of California Press, Berkeley, Los Angeles and London, 255 pp.
- Ramachandran N, Madhavi RK, Rathnamma K. 2007. Current status of chili Anthracnose in India. In: First international symposium on chili Anthracnose. National Institute of Agricultural Science and Technology, Rural Development Administration, Korea and Hoam Faculty House, Seoul National University, Korea, September 17- 19, 2007.

- Ravf, B.A., & Ahmad, I. (1998). Studies on correlation of seed infection to field incidence of *Alternaria alternata* and *Macrophomina phaseolina* in Sunflower. 13th Iranian Plant Protection Congress-Karaj. Iran, 113 pp.
- Rojo, F.G., Reynoso, M.M., Ferez, M., Chulze, S.N., & Torres, A.M. (2007). Biological control by *Trichoderma* species of *Fusarium solani* causing peanut crown root rot under field conditions. *Crop Protect.*, Vol., (26), pages (549–555).
- Sabuquillo, P., De Cal, A., & Melgarejo, P. (2006). Biocontrol of tomato wilt by *Penicillium oxalicum* formulations in different crop conditions. *Biol. Control*, Vol., (37), pages (256–265).
- Samson, R.A., Peterson, S.W., Frisvad, J.C., Varga J. (2011). New species in *Aspergillus* section *Terrei*. *Studies in Mycology*, Vol. (69), pages (39–55).
- Sreedevi, B., Charitha, D.M., & Saigopal, D.V.R. (2011). Isolation and screening of effective *Trichoderma* spp. against the root rot pathogen *Macrophomina phaseolina*. *Journal of Agricultural Technology*, Vol., (3), pages (623-635).
- Suárez-Estrella, F., Vargas-García, M.C., López, M.J., Capel, C., Moreno, J. (2007). Antagonistic activity of bacteria and fungi from horticultural compost against *Fusarium oxysporum* f. sp. *melonis*. *Crop Protection*, Vol. (26), pages (46-53).
- Toussaint, V., Morris, C.E., & Carisse, O. (2001). A new semi-selective medium for *Xanthomonas campestris* pv. *vitians*, the causal agent of bacterial leaf spot of lettuce. *Plant Dis.*, Vol. (85), pages (131–136).
- Vakalounakis, D.J., & Fragkiadakis, G.A. (1999). Genetic Diversity of *Fusarium oxysporum* isolates from cucumber: Differentiation by Pathogenicity, Vegetative Compatibility, and RAPD Fingerprinting. *Phytopathology*. Vol., (2), pages (161-168).
- Vey A, Hoagland RE, Butt TM. 2001. Toxic metabolites of fungal bio control agents. In: Butt T.M., Jackson C., Magan N. (eds): *Fungi as bio control agents: Progress, problems and potential*. CAB International, Bristol. 311-346.
- Walcott, R.R., (2003). Detection of Seedborne Pathogens. *Hortechology*, Vol., (1), pages (40-47).
- Xu, X.M., Jeffries, P., Pautasso, M., & Jeger, M. J. (2011). Combined use of biocontrol agents to manage plant diseases in theory and practice. *Phytopathology*, Vol. (101), pages (1024-1031).
- Yang, Y., Kim, K., & Anderson, E.J. (1997). Seed transmission of cucumber mosaic virus in spinach. *Phytopathology*, Vol. (87), pages (924–931).

4. ENVIRONMENT PROTECTION AND NATURAL RESOURCES MANAGEMENT

CHLORINE IN RENEWABLE FUELS - MOBILITY AND EFFECTIVENESS OF BINDING IN THE BOILER FURNACE

Danuta KRÓL¹, Sławomir POSKROBKO²

¹Silesian University of Technology, Konarskiego 18, 44–101 Gliwice, Poland

²Technical University of Białystok, Wiejska 45A, 15–351 Białystok, Poland

*Corresponding author: drposkrobko@wp.pl

Abstract

The aim of this study is to identify the transformation of chlorine during the combustion process of biomass fuels and waste, and the possibility of its binding in the boiler. The forms of chlorine in the biomass (animals waste) and waste are quite different. Biomass is mainly a chlorine carrier in inorganic combinations. In waste, apart from mineral bindings, chlorine is bound in organic compounds. It affects the behavior of this element in the boiler: the way, the speed and the form in which it is released from the combustible material. This in turn is reflected in its removal (binding) from the gas space of the combustion chamber. This paper presents the results of chlorine migration and binding by lime sorbent in industrial, two-stage combustion installation (I⁰ - gasification, II⁰- afterburning), during the combustion of fuel formed from municipal and industrial waste. Fuel choice was dictated by the fact that rational management of waste is about their maximum recovery and recycling (in this case the energy recycling). As a binding material hydrated lime was used. Purposefulness of studying the physicochemical and functional properties of solid fuels formed from waste is justified by the fact that only fuels that meet specific technical and operational requirements, including emission, can be used directly in energy sector.

Keywords: *waste, chlorine, calorific value, combustion.*

Introduction

Biomass is mainly a chlorine carrier in inorganic combinations (Johansen et al., 2013), Wei et al., 2005). In waste chlorine, in addition to mineral calls (mainly NaCl), is mostly present in organic compounds, e.g. PVC, PVDC (Nasrullah et al., 2015, Ma et al., 2010). The nature of the chlorine binding determines the behavior of this element in the boiler furnace, i.e. the method, speed and the form in which it is released from the combustible material. Combustion of fuel containing the composition of organically or inorganically bound chlorine, causes serious operational disturbance (Gruber et al., 2015), Shao et al., 2012): (i) the reduction of the softening temperature of ashes due to the presence of alkali and heavy metal chlorides, (ii) high temperature chlorine corrosive degradation of structural steel boiler furnace elements. It is also the cause of the excessive emission of HCl and PCDD/F - harmful and toxic to the environment (Ruokojarvi et al., 200, Abad et al.2002).

The issue presented in this paper is an excerpt from our own experience and operational research in the field of combustion of chlorine-rich industrial waste fuels and waste biomass (in this case animal) (Poskrobko et al., 2012, Poskrobko, 2013). Combustion processes was carried out in a two-stage technology i.e. the I⁰ - solid fuel gasification and II⁰- burning combustible gas (syngas) obtained in I⁰. In both cases, the purpose of the study was to observe the HCl capture process in the furnace of the boiler. In the case of fuel from waste incineration, Ca(OH)₂ limestone sorbent was used to bind HCl. During combustion of animal waste, HCl was created at a high temperature (about 1100-1200°C), II⁰ combustion. Reducing the share of HCl in the flue gases took place in an environment of reactive calcium oxide.

Calcium oxide was a product of thermal decomposition of bone material (hydroxyapatite). Fuels from waste were gasified continuously on the grid in 1^o installation. In contrast, animal waste were gasified (in continuous operation mode) in adapted for this purpose rotating chamber. The paper presents the possibility of emission reduction (capture) of HCl in thermal conversion processes: (i) fuel from waste, (ii) animal biomass. But not always presented methods can improve boiler operating conditions in terms of their corrosive effect. Such difficulties occur when the animal biomass rich in NaCl is combusted. The test results indicated which dechlorination technologies can be used for recycling wastes significantly different from each other.

Materials and Methods

Fuel properties of the waste fuel

Studies included fuel Pas-r – formed from industrial wastes. This fuel is produced by grinding to an appropriate granulation such waste as: paper, cardboard, foils, textiles, plastic wrap, tape, cables, cleaning rags or tires. Tables 1-3 show the fuel and physicochemical properties - PN-93-Z-15008/02; PN-EN-ISO 9029:2005; PN-ISO 1171:2002 and chlorine gram fraction was denoted in compliance to Polish Standard PN-ISO 587/2000, HHV - PN-ISO 1928:2002 and PN-Z-15008-04:1993.

Table 1. Fuel properties Pas-r

Fuel	Moisture [%]	Flammable fraction [% dry m.]	Inflammable fraction [% dry m.]	HHV [kJ/kg dry .m.]	LHV [kJ/kg dry m.]
Pas-r	5.74	82.80	17.20	20974	19315

Table 2. Elemental composition of flammable substance in fuels and PVC [%]

Fuel	C	H	N	S	Cl	O
Pas-r	63.90	7.60	3.55	1.26	0.52	23.17
PVC	48.91	6.11	0.25	0.05	17.21	27.47

For the purpose of the study, the fuel Pas-r was grained up successively with admixture of recycled polyvinyl chloride PVC. Therefore a number of fuels different in gram share of chlorine was received (Table 3) (Poskrobko et al. 2012).

Table 3. Elemental composition of the fuel flammable substance Pas-r supplemented with PVC recyclete granules [%].

Fuel	Addition of PVC [%]	C	H	N	S	Cl	O
Pas-r 1	0	63.90	7.60	3.55	1.26	0.52	23.17
Pas-r 2	0.5	63.83	7.59	3.53	1.25	0.61	23.19
Pas-r 3	1	63.75	7.59	3.52	1.25	0.69	23.20
Pas-r 4	2	63.60	7.57	3.48	1.24	0.86	23.25

Only the type of chlorine, which was in addition of recycled PVC was clearly defined. Obtained model fuel were mixed with different amounts of limestone sorbent Ca(OH)₂, in order to reduce the mobility of chlorine in the gasifier chamber. Limestone sorbent was in the form of a fine powder. Then the gasification of the fuel Pas-r 1÷4 was carried out. In these processes, concentrations of basic gas products or hydrogen chloride were measured. HCl emission measurement results were converted into relative emission (Φ) - extensively discussed in papers (Poskrobko et al. 2012).

Fuel properties of animal waste

Chlorine in animal waste is associated with alkali metal chlorides KCl, NaCl. Hydrogen chloride is formed in the high temperature environment of the combustion chamber (H°) in an indirect way. Substrates belonging to the waste gases are $\text{NaCl}_{(g)}$, $\text{KCl}_{(g)}$, SO_2 , H_2O and O_2 . The study included slaughterhouse waste (tripe, fat, bones, feathers, sludge, slush, bristles, blood), and meat and bone meal.. Each time the waste came from another supplier (Tables 4) . The heat of combustion is determined using the LHV calorimetry technique. If the tested material is animal waste, it creates great difficulties in applying the calorimeter bomb to tests. It is very difficult to obtain a representative and homogeneous sample. As the results in Table 5 show, the LHV for particular types of waste are very diverse. In addition, the caloric content of the same type of waste with each supply varies greatly. This creates big difficulties, not only analytical but also technological.

Table 4. Results of the first series of research on calorific value

Type of sample	Moisture [%]	Sulfur S [%]	LHV [kJ/kg]
MBM	5.5	0.3972	23244
Sediment	61.9	0.0071	10277
Bones	46.1	0.0071	8456
Tripes	66.0	0.0064	22980
Bristles	66.1	0.7202	10393
Feather	64.4	0.6943	22645
Tripes 2	738	0.0080	6889
Fat	2.9	1.3860	39063
Bones 2	56.5	0.1019	7726
Slush*	48.6	0.1096	28308
Bristles 2	75.1	0.6421	9734
Feather 2	65.5	0.5142	8575
Sediment 2	66.2	0.0046	17066
Blood	20.2	0.3768	21076
MBM 2	6.0	0.4860	19092

*Sample described as slush contained 2 layers: at the bottom-slush, on the top-fat. The bottom layer was taken for studies.

In practice, there is no possibility of charge calibration. With so much different values for calorific values, it creates enormous difficulties in maintaining stable parameters of the combustion process and emissions of SO_2 , HCl, CO i NO_x .

This shows that in given conditions of the combustion process, one has to deal with the thermal decomposition of hydroxy and carbon-apatites. They are basic constituents of the bone material. At temperatures $>700^{\circ}\text{C}$ they decompose with emitting (among other things) a porous CaO. The reactive CaO is associated with HCl according to the equation:



However, the efficiency of HCl capture in high temperatures ($1100 - 1200^{\circ}\text{C}$) is low, which is extensively discussed in papers (Poskrobko, 2013).

Combustion of fuel Pas-r from industrial waste

Fuels formed from industrial waste were burned in a two-stage combustion technology in plants with a capacity of 1MW (Fig. 1), (Poskrobko et al., 2012). The temperature in the gasification chamber was $T_1 = 650^{\circ}\text{C}$, in secondary combustion chamber $T_2 = 1000^{\circ}\text{C}$.

Ultimately, the system is designed for thermal disposal of medical waste. Capture of HCl in the furnace was carried out using a limestone sorbent - hydrated lime $\text{Ca}(\text{OH})_2$. This was added to the fuel in different proportions. The scope of mobility limitations of chlorine coming out from the fuel in the furnace (chamber) of the gasifier cooperating with a secondary combustion chamber (Fig. 1) was compared and defined (Poskrobko et al., 2012).

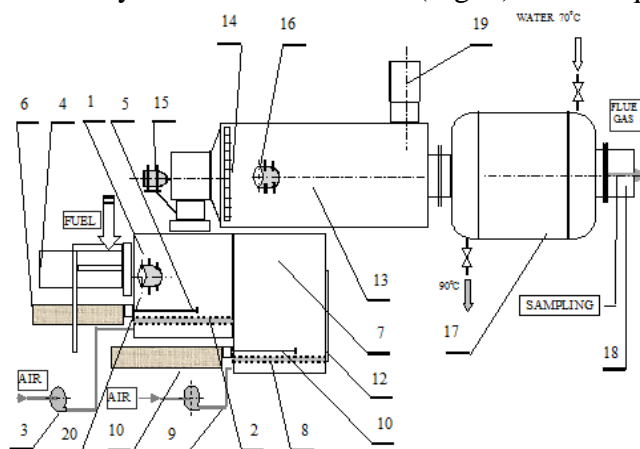

Fig. 1. Diagram of two-stage combustion plant with a capacity of 1 MW: (1) gasification chamber, (2) grid with air nozzles (3) installation of blowing air into the gasification chamber (4), loading system, (5) fuel and ash scraper, (6) drive and mechanism of scraper, (7) combustion chamber (8), grate of incineration chamber with air nozzles (9) installation of air blower (10) scraper for removing ash (11) drive and mechanism of ash scraper (12) bleed gates, (13) secondary combustion chamber (14) blinds of combustion air blower, (15) primary burner, (16) burner support, (17) regenerative heat exchanger (18) exhaust

Animal waste combustion

It is contemplated, as in the case of industrial waste fuel, a two-step process of thermal destruction of animal waste. In the first stage I^o gasification was carried out at a temperature of 650-700^oC. In the second stage II^o, in the secondary combustion chamber, at a temperature of 1100^oC-1200^oC, gaseous and solid products of gasification were burned. The study was conducted in a full technical scale. Oxygen test method (Poskrobko 2013) consisted of dispensing variable secondary air through nozzles placed at the outlet of the synthesis gas from the gasifier chamber to the combustion chamber. Loading capacity of waste was 1000kg/h. Fat and meat-and-bone meal constituted fixed caloric input ensuring autothermal combustion. Therefore, for combustion of the mentioned mass flow of waste was consumed 200kg/h of fat and 100kg/h of flour were used. At the same time, in the combustion chamber, thermal decomposition of bone material was taking place. Diagram of the thermal part of the installation is shown in Fig. 2. The hot exhaust gases were cooled in the waste heat exchanger (steam generator) at temperature 200-180^oC, and then emitted into the atmosphere through the system of multicyclones, exhaust fan, a bag filter and a chimney. The installation worked continuously. Secondary air blown into the secondary combustion chamber, in each case of the test, was carried out for 1.5 hours, continuously adjusting the performance of the fan 7 (Fig. 2). Measurements of exhaust components emission was made in a continuous manner, by means of exhaust gas analyzer system produced by Environment SA (MIR-IS and Grab HIT 52M models).

Results and discussion

Fuel from waste

During the studies, the scale limit of the mobility of chlorine liberating from the fuel in the gasifier chamber was set. Breakdown of the combustible substance during heating of fuel Pas-R leads to release of chlorine in the form HCl, which is easily released from the PVC, already in the temperature above 180^oC. The liberated HCl, on the grill gasifier was bound by

calcium sorbent. The higher the temperature, the more the binding of HCl did not keep the rate of its release from PVC. The resulting calcium chloride CaCl_2 underwent partial decomposition at elevated temperatures, releasing HCl again, but the higher the temperature, the faster the process. The obtained experimental data and specific functional dependencies enable: (i) selection of the percentage addition of $\text{Ca}(\text{OH})_2$ for fuels with different proportions of chlorine gram share (according to the desired concentration of HCl in the flue gas); (ii) determination of the maximum addition of PVC, which can be loaded to fuel formed from waste; (iii) concluding on the binding efficiency of chlorine in the fuel combustion using calcium sorbents.

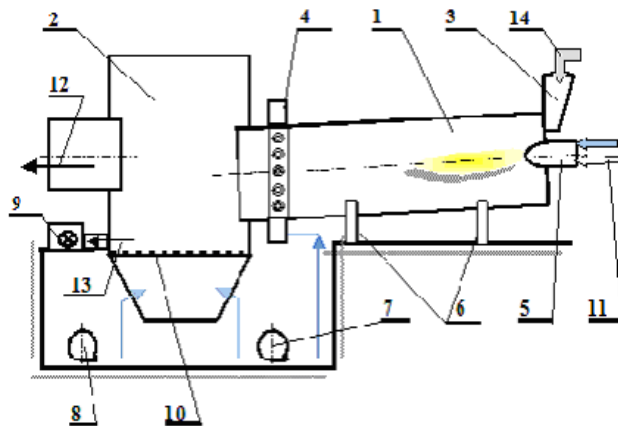

Fig. 2. Diagram of installation for thermal treatment of animal and post-mortem waste, [17] where: (1) rotating gasifier chamber, (2) fluidized bed afterburning synthesis gas, (3) hopper (4) secondary air blower manifold, (5) fat burner, (6) rotating rollers, (7) secondary combustion air blower, (8) tertiary combustion air blower, (9) skimming mechanism (10) grate of secondary combustion chamber, (11) power-ring the burner with fat and primary air, (12) the direction of the flue gases flow to the waste heat

Determining the percentage of PVC additive for fuels, we can decide of the scale limit of HCl emissions, depending on the percentage addition of $\text{Ca}(\text{OH})_2$ to the fuel (Fig. 3). This emission decreases linearly, with the rate of decline being the greater, the greater the addition of PVC to fuel.

Linear relationships: 1, 2, 3, 4 correspond to the consumption of sorbent in cases where the percentage of fuel additive PVC Pas-r was respectively 0%, 0.5%, 1%, 2%. Experimentally determined characteristics allow selection of $\text{Ca}(\text{OH})_2$ amount for fuels containing different amounts of PVC. These characteristics make it possible to model the fuel so formed, as not to exceed the specified emission of HCl. Thus, it is possible to make an optimal choice for the treatment of exhaust gases installation. Furthermore, Fig. 3 shows, that fuels with higher content of PVC, thus chlorine in the combustible material, are characterized by greater susceptibility to the calcium sorbent activity, than those with less fuel recycle.

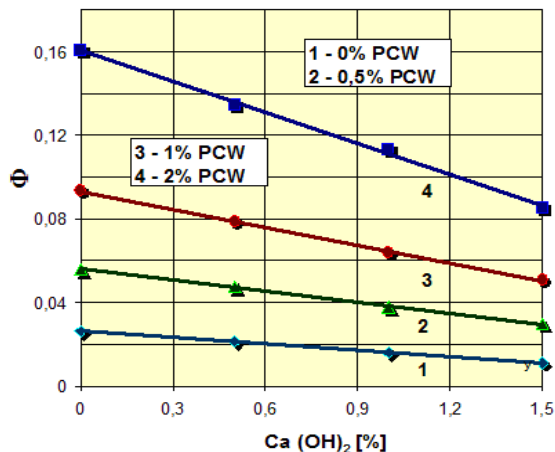

Fig. 3. The dependence of relative concentration of HCl in the wet exhaust gas from the sorbent addition $\text{Ca}(\text{OH})_2$ to fuel Pas-r 1.

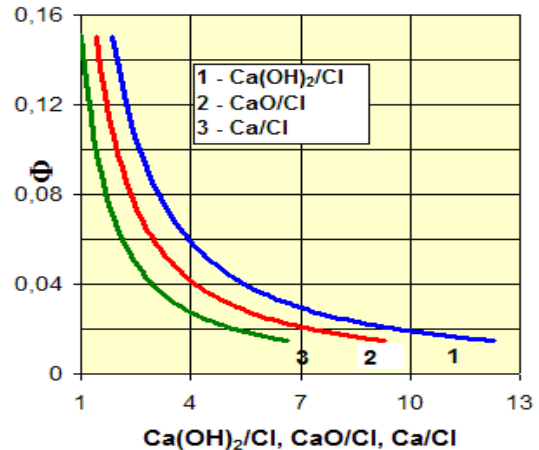

Fig. 4. The relative concentration of HCl wet exhaust gas in comparison to gram relations of calcium forms to chlorine in the

In Fig. 4 HCl concentration referred to gram relationship: $\text{Ca}(\text{OH})_2/\text{Cl}$, CaO/Cl i Ca/Cl , in which calcium contained in the fuel and sorbent $\text{Ca}(\text{OH})_2$ was recalculated to form: an oxide and elemental. The results are therefore hypothetical. This relationship allows to evaluate the potential use of the sorbent, e.g. in the form of CaO , wherein to this use the same range of HCl concentrations is attributed, which corresponds to the application of the sorbent. It follows that the CaO sorbent can more effectively bind the HCl in the exhaust gas than $\text{Ca}(\text{OH})_2$.

Animal waste

The increase in the concentration of HCl in the flue gases is due to the presence of potassium and sodium sulfatizing reaction, affecting simultaneously reduction in SO_2 concentration. It is indicated by the results presented in (Poskrobko 2013). The formation of HCl may also be promoted by of secondary processes of HCl formations from Cl_2 .

Fig.5 illustrates HCl concentration changes as a function of the percentage share of oxygen in the exhaust gas. It can be seen that most of the measuring points is in the range of high HCl concentrations of $40\text{-}80 \text{ mg}/\text{Nm}^3$. The data presented in Fig.5 initially indicate that with the increase of the oxygen content, we may have to deal with the Deacon reaction in the process: $4\text{HCl} + \text{O}_2 \rightarrow 2\text{Cl}_2 + 2\text{H}_2\text{O}$. The condition for the occurrence of this reaction is the presence of fly ash, which in this case form deposits on the tubes of the waste heat exchanger, where the temperature may fall to 400°C . Two-stage combustion technologies are characterized by relatively high emissions of fly ash when compared to other technologies e.g grate technologies, which promotes intensification of the deposition on the tubes of the heat exchanger. After cleaning the tubes in the waste heat boiler (after removal of deposits from the walls of the tubes), in conditions of excess air - oxygen saturation ($> 12\% \text{ O}_2$ in gases), there was no decrease in the concentration of HCl in the flue gas (Fig.6). This may indicate that in the absence of sediment, which catalyze the oxidation of HCl, Deacon reaction does not occur. This is a process which negatively affects the stability of heating surfaces (superheating, Cl_2 diffusion) and the heat exchange efficiency decreases.

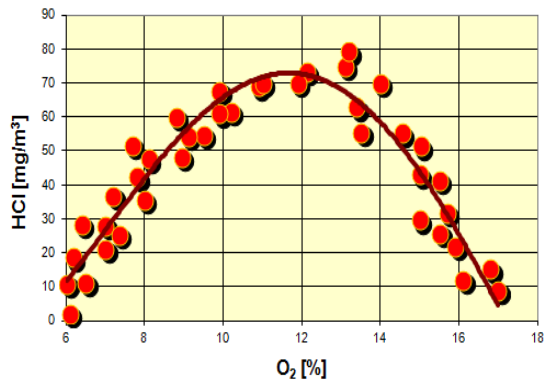

Fig. 5. HCl = f(% O₂)

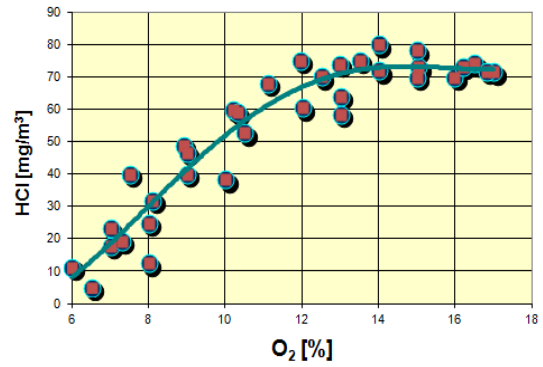

Fig. 6. HCl = f(% O₂) – after removal of sediments

Fig. 7 shows the effect of SO₂ concentration on the formation of HCl for the O₂ content in the exhaust gases from 6 to 16% (according to the oxygen test carried out in the experiment). As has the conducted test cycle shown, reduction of the SO₂ in the flue gas causes an increase of HCl to a maximum value of about 80-90 mg/Nm³, corresponding to the O₂ content in the flue gas of approx. 11 to 13%. In a further step to increase the flow of air (up to a content of O₂= 12-16%) we note a downward trend of HCl, due to the initiation of Deacon reaction on the surface of the waste heat boiler exchanger. The observed phenomenon suggests that in the secondary combustion chamber, at a high temperature occurs the process of HCl formation by sulfatizing (NaCl)_g and (KCl)_g. These process conditions may create reactions of molecular chlorine Cl₂ formation, and secondary processes of hydrogen chloride. It should be noted that the high concentration of SO₂ in the gaseous combustion products (approx. 1600 mg/Nm³, related to low O₂ share in the exhaust gas) is due to a relatively high sulfur content of animal waste for disposal. Phenomena that occur at high temperature in the secondary combustion chamber (with the participation of reactive CaO) do not affect the HCl emission reduction, on the contrary, the concentration of HCl increases. This process is accompanied by a decrease in the concentration of SO₂. Dependence disclosed during the animal biomass incineration (rich in alkali metal chlorides) HCl = f(SO₂) shown in Fig. 7, requires a testing research in laboratory scale. It seems that such research can significantly bring closer qualitatively and quantitatively the processes forming gaseous environment during the combustion of biomass rich in alkali chlorides.

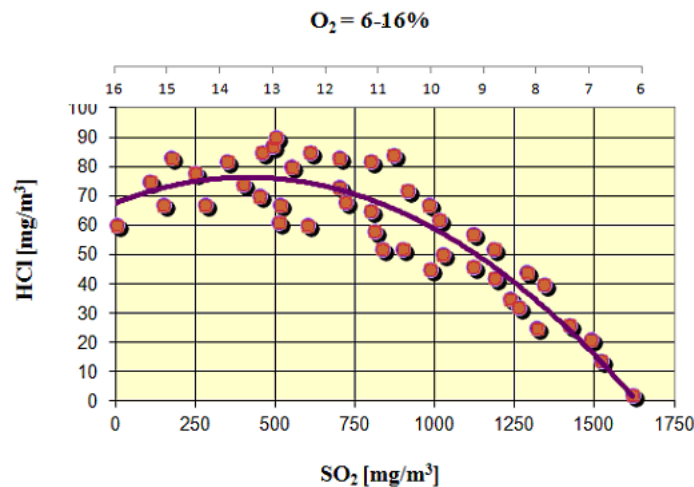

Fig. 7. HCl = f(SO₂) for O₂ = 16-6%

Conclusions

In an experiment conducted in a full technical scale, the capture of HCl intensively proceeded in case of combustion of fuel from waste (Pas-r) rich in chlorine. The process of HCl capture with lime sorbent $\text{Ca}(\text{OH})_2$ was ran in the furnace, mainly in its first stage (I^0), i.e. on the grill of the gasifier. On the gasifier grate the fuel was fed, with different Cl and limestone sorbent $\text{Ca}(\text{OH})_2$ share. Dechlorination process proceeded more intensively for fuel with a high percentage of the element Cl i.e. fuel with a large addition of recycled PVC. For example, the fuel Pas-r 4, where the proportion of Cl = 0.86, dechlorination of gaseous products was intense - the process was of about double the efficiency. Fuels with lower rate of Cl (0.69%, 0.61%, 0.52%)- dechlorination process was less intense with the same amount of lime sorbent added. During the two-stage combustion of animal waste, the presence of reactive waste lime sorbent CaO, does not produce significant results in the dechlorination process. In general, HCl formed in the oxidizing zone ($T = 1100\text{-}1200^\circ\text{C}$) due to sulfatizing of pairs $\text{NaCl}(\text{g})$ and $\text{KCl}(\text{g})$, does not react with highly reactive CaO, which in turn arises from the decomposition of bone material. It should be noted that the proportion of CaO in the secondary combustion chamber is high and the ash content is approx. 35 - 45%. At the same time CaO is actively involved in the flue gas desulfurization. Looking for a way to dechlorinate waste gases, the share of air in the combustion process was increased. Firstly noted was the growth of HCl formed by sulfatizing alkali chlorides, and then in the share O_2 in the flue gases, from 12 - 16.5% followed a rapid decline of HCl. That is, this process could take place under conditions typical for the Deacon reaction, on volatile dusts polluting the heating surfaces of the heat exchanger. This phenomenon was confirmed after cleaning the heat exchanger of mineral deposits. The share of HCl in the flue gas, regardless of the O_2 share, was determined at a constant maximum level.

The analysis of the results shows that much better ecological effects, as regards to the emission of HCl, are obtained in the case of two-stage combustion of fuel from waste, i.e. gasification of fuel and afterburning of synthesis gas in a secondary combustion chamber. In case of fuels formed from waste with a high proportion Cl, the method of HCl capturing from gaseous products of combustion described in the paper (dechlorination), can be successfully implemented. In case of animal waste (because of the nature of the chlorine binding – mineral), the dechlorination process in a two stage furnace practically does not occur. However, it may occur at sufficiently low temperatures (about 400°C) outside the furnace, on mineral sediments deposited in the waste heat exchanger tubes.

Acknowledgement

They financed from the funds of the Ministry of Science – project No. SWBiŠ/2015.

References

- Johansen J.,M., Aho M, Paakkinen K., Taipale R., Egsgaard H., Jakobsen J.,G., Frandsen F.,J., Glarborg P.(2013): Release of K, Cl, and S during combustion and co-combustion with wood of high-chlorine biomass in bench and pilot scale fuel beds, Proceedings of the Combustion Institute, 34, pp., 2363–2372
- Wei X., Schnell U, Hein K.R.G. (2005): Behaviour of gaseous chlorine and alkali metals during biomass thermal utilisation, Fuel, 84, pp., 841–848
- Nasrullah M., Vainikka P., Hannula J., Hurme M.: Elemental balance o SRF production process: Solid recovered fuel produced from commercial and industrial waste, Fuel, 145, 2015, 1-11
- Ma W., Hoffmann G., Schirmer M., Chen G., Rotter V.,S. (2010): Chlorine characterization and thermal behavior in MSW and RDF, Journal of Hazardous Materials, 178, pp., 489–498

- Gruber T., Schulz K., Scharler R., Obernberger I. (2015): Investigation of the corrosion behaviour of 13CrMo4–5 for biomass fired boilers with coupled online corrosion and deposit probe measurements, *Fuel*, 144, pp., 15–24
- Shao Y., Xu Ch., Zhu J., Preto F., Wa J., Tourigny G., Badour Ch., Li H. (2012): Ash and chlorine deposition during co-combustion of lignite and a chlorine-rich Canadian peat in a fluidized bed – Effects of blending ratio, moisture content and sulfur addition, *Fuel*, 95, pp.,25-34
- Ruokojarvi P., Tuppurainen K, Mueller Ch., Kilpinen P., Ruuskanen J. (2001): PCDD/F reduction in incinerator ue gas by adding urea to RDF feedstock, *Chemosphere*, 43, pp., 199 – 205
- Abad E., Adrados M. A., Caixach A.J., Rivera J. (2002): Dioxin Abatement Strategies and mass balance at a Municipal Waste Management Plant, *Environ. Sci. Technol*, 36, pp., 92-99
- Poskrobko S., Król D., Łach J. (2012): Hydrogen Chloride Bonding with Calcium Hydroxide in Combustion and Two-Stage Combustion of Fuels from Waste, *Energy & Fuels*, 26, pp., 842–853
- Poskrobko S. (2013): Identification and stabilization of combusting animal waste with active participation of bone material — Emission of SO₂ and HCl, *Fuel Processing Technology*, 113, pp., 20–27

EROSION PROCESSES IN THE DRAINAGE BASIN OF THE PREDEJANE RIVER (SOUTHEASTERN SERBIA) IN THE PERIOD 1953-2012

Sonja BRAUNOVIĆ*, Mihailo RATKNIĆ, Tatjana RATKNIĆ, Ljubinko RAKONJAC,
Aleksandar LUČIĆ

Institute of Forestry, Kneza Višeslava3, Belgrade, Serbia

*Corresponding author: sonjabraunovic@yahoo.com

Abstract

The first organised torrent control works in Serbia started in Grdelica Gorge in the late 19th century because the area was the locus of the most intensive erosion processes. They required the implementation of various methods and structures for torrent control and soil protection against erosion. The works were carried out in drainage basins (biological and biotechnical works) and in torrent channels (technical works). The effects of the performed works on the state of erosion in the drainage basin of the Predejane River were studied through a comparative analysis of the situation in 1953 and in 2012, with the aim of upgrading the methods of water erosion and torrential flood control. The intensity of erosion processes in 1953 was determined on the basis of available erosion maps, whereas in 2012 it was determined by using satellite images and field research. The values of Z erosion coefficient for all reference periods were calculated after Prof Gavrilović's methodology and then used to conduct a comparative analysis of the obtained data.

Key words: *erosion process intensity, drainage basin, torrent control works, Serbia*

Introduction

A large part of the territory of Serbia is threatened by water erosion of different intensity. It must be stressed that 36% of the territory is affected by extensive, intensive and medium erosion processes. There are more than 12 000 registered torrential streams which cause enormous damage and often endanger human lives. The damage includes removal of soil and sediment accumulation in reservoirs and regulated riverbeds (water management aspect), the loss of soil nutrients and sediment accumulation on arable land (agricultural aspect), damage to roads, industrial facilities, settlements, etc (economy in general) and chemical - mechanical pollution of watercourses and reservoirs (ecological aspect).

In order to improve the methods of controlling water erosion and torrential floods, it is necessary to examine the effects of the works carried out so far and their impact both on the state of erosion in the basin and on the protection against torrential floods.

Materials and Methods

The Predejane River (*Predejanska reka in Serbian*) drainage basin is located in southeastern Serbia, in Grdelica Gorge (*Grdelička klisura in Serbian*). It belongs to the municipality of Leskovac (cadastral municipalities of Predejane and Crveni Breg). The Predejane River is a right tributary of the South Morava River (*Južna Morava in Serbian*), into which it flows near the village of Predejane. It has a relatively long course (8.5 km), with a fan-like basin and very narrow and steep gorge-like river valleys. The drainage area is 19.68 km², with an east-west direction. The field research was conducted in the period from 2011 to 2012 and together with satellite images and thematic (topographic, geological, soil, land use, erosion, etc.) digital maps it formed the basis for assessing the effects of natural factors, land use changes and anthropogenic factors on the state of erosion in the basin. Land use pattern was studied and defined in 2011 (Braunović and Ratknić, 2010). The structure of the area was

determined by using homogeneous plots, within which productive and unproductive areas were identified and digitized. The following productive areas were distinguished: forests, degraded forests, meadows and pastures, degraded meadows and pastures, alpine meadows and pastures, plough land, vineyards, orchards, house yards and gardens. Unproductive areas included: gullies, rocky grounds, gravel, road network, waterways and construction zone of settlements. This classification was then used to define land use and create a thematic map. We studied the state of erosion in 1953 (before the start of erosion control works) and in 2012 (the current state). The intensity and distribution of erosion processes in 2012 were determined on the basis of a 1:50 000 digital map of erosion. The coefficient of erosion (Z) was determined using land survey data, data on bedrock, soil, climate, and distribution of vegetation for each homogeneous plot (Gavrilović, 1972).

Results and Discussion

Orographic and hydrographic characteristics of the basin are presented in Figure 1. Starting from the mouth of the Predejane River, which is at a height of 295 m, the watershed reaches and exceeds 800 m on both sides, and then gradually increases to the highest point of 1284 m, which is also the farthest point from the mouth. The average decrease in the longitudinal profile is 10.36%. The decrease is the biggest in the section upstream of its confluence with the Samarski Creek (*Samarski potok in Serbian*) (14%). The section is 5.3 km long with a height difference of 739 m. The average decrease downstream of the confluence with the Samarski Creek is 6.04% (a 4.4 km long section) and the height difference is 266 m. The longitudinal profile of the upper and partially of the middle part of the course is very steep, which points to the tremendous energy of the topography and results in erosion and accumulation of sediment in the lower course.

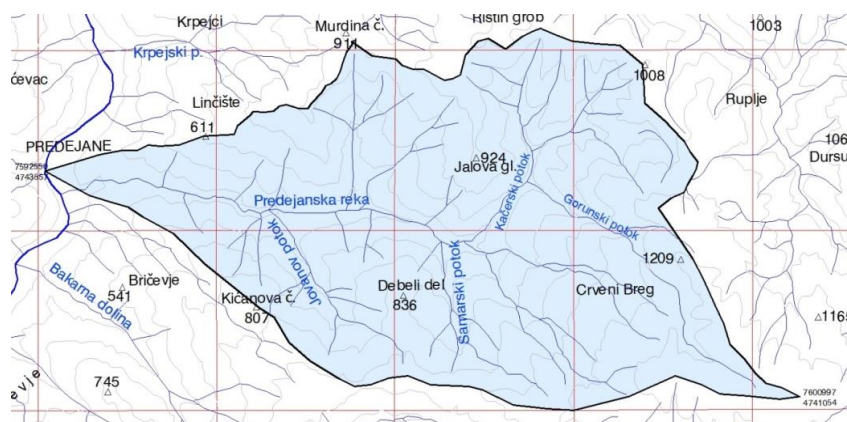

Figure 1. Topographic map of the Predejane River basin (Source: Original)

Table 1. Areas per altitudinal zones in the basin

Area	Altitudinal zones					Total
	below 300 m	300-500 m	500-700 m	700-1000 m	above 1000 m	
km ²	0.3	1.93	4.37	9.38	3.7	19.68
%	1.52	9.81	22.21	47.66	18.80	100.00

Source: Original

The largest part of the basin, or 47.66%, is located in the altitudinal zone from 700 to 1000 meters, while 18.80% of the area is above 1000 meters above sea level. (Table 1).

The bedrock is composed mainly of muscovite schists. Together with large falls and inadequate use of land, it favors the occurrence of erosion processes of different types and intensity. The distribution of bedrock in the basin is shown in Figure 2. Albite-chlorite-

muscovite schists and (dotted) gneisses are found on 86.94% of the total area, while dacites and andesites make 13.6% of the area in the upper part of the basin.

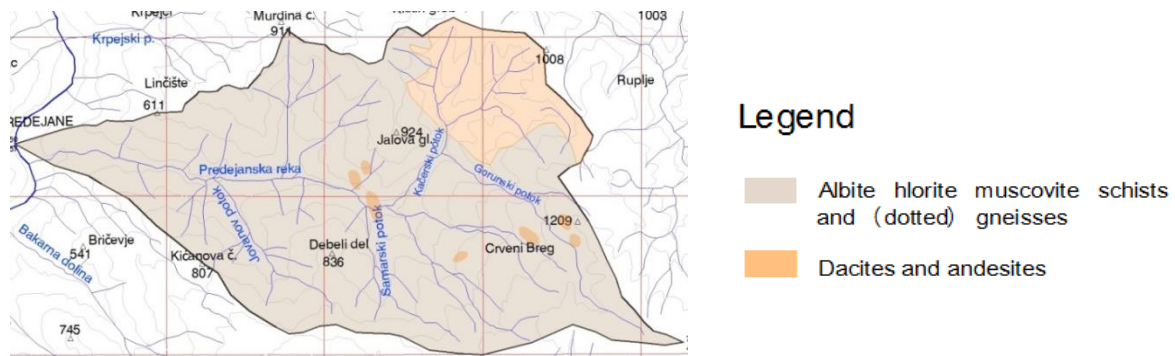

Figure 2. Geological map of the Predejane River basin (Source: Original)

Regarding soil characteristics, it was found that distric cambisol accounts for 19.32 km², or 98.1%, while regosol makes only 2.9% of the total area of the basin (Figure 3). Both types of soil are subject to erosion processes.

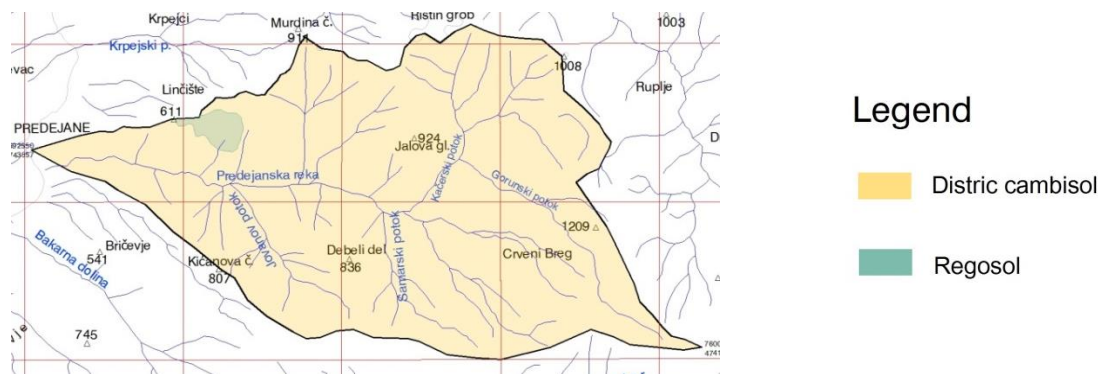

Figure 3. Soil map of the Predejane River basin (Source: Original)

The Predejane River basin is located on the territory of 3 cadastral municipalities. They are characterized by a constant population decline, especially in the CM Crveni breg, located at an altitude of 1083 m (Tables 2 and 3). According to the population projections, Crveni breg will be a depopulated village in 2021 (Penev, 2007). Socio-demographic characteristics of the drainage basin had a significant impact on the development and intensity of erosion processes (Braunović and Ratknić, 2010a).

Table 2. Population statistics by census years

Cadastral municipality	AL masl	Census year							
		1948	1953	1961	1971	1981	1991	2002	2011
Predejane (village)	592	631	528	540	616	508	456	491	401
Predejane	592	469	625	853	857	1217	1434	1222	1086
Crveni breg	1083	400	392	416	287	169	69	30	13
Total		1500	1545	1809	1760	1894	1959	1743	1500

Source: Original

The basin covers 94 homogeneous plots within which the following productive and unproductive areas were distinguished: arable fields, meadows, pastures, settlements, road network, alluvium (gravel). Land use changes were caused by population migration and agricultural land abandonment. There are now arable fields only in the lower part of the basin, but their surface area has been significantly reduced (Table 4; Figure 4). The abandoned arable fields in the upper parts of the basin have had their vegetation cover recovered, so today there are meadows and pastures and in some parts forests (Braunović, 2011).

Table 3. Population density in the drainage basin of the Predejane River

CM	Area (km ²)	Population density							
		1948	1953	1961	1971	1981	1991	2002	2011
Crveni breg	10.46	38.24	37.48	39.77	27.44	16.16	6.60	2.87	1.24
Predejane	9.28	68.00	56.90	58.19	66.38	54.74	49.14	52.91	43.21
Predejane town	0.52	901.92	1201.92	1640.38	1648.08	2340.38	2757.69	2350.00	2088.46

Source: Original

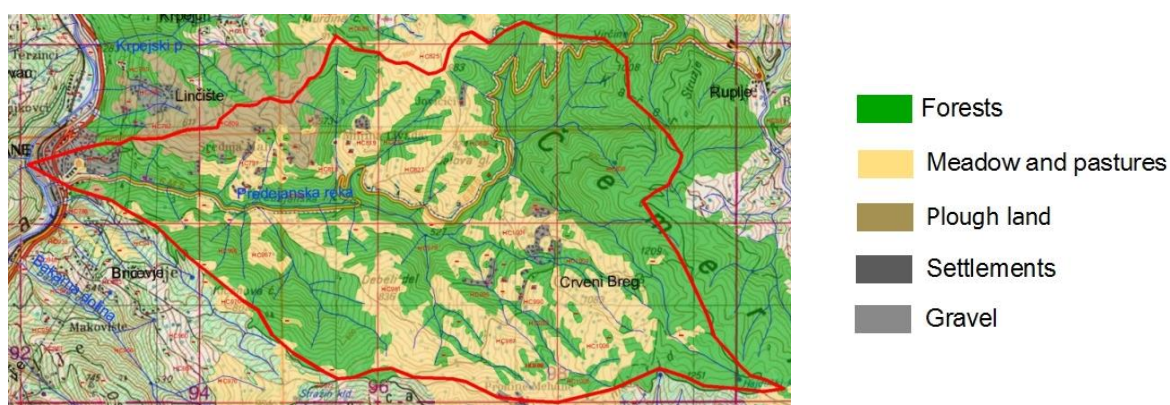

Figure 4. Map of land use in 2012 (Source: Original)

Table 4. Land use in the drainage basin of the Predejane River in 1953 and 2012

LU	1953		2012	
	Area km ²	%	Area km ²	%
Forests	9.15	46.49	10.95	55.64
Plough land	3.78	19.21	0.95	4.83
Meadows and pastures	5.64	28.66	6.50	33.03
Non-productive area	1.11	5.64	1.28	6.50
Total	19.68	100.00	19.68	100.00

Source: Original

Regarding the distribution of erosion processes in 1953, there were processes of excessive (48.77%), intensive (13.38%) and medium (37.84%) erosion in the basin. On the other hand, the erosion processes were intensive (1.63%), medium (6.95%), weak (48.67%) and very weak (33.50%) in 2012 (Braunović, 2013). Based on Z_{mean} in 1953, the basin was generally

affected by intensive erosion processes ($Z_{\text{mean}} -0.93$), but after performing minor erosion control works the basin had the processes of weak erosion ($Z_{\text{mean}} - 0.23$). However, despite the low values of Z_{mean} in 2012, it was observed that the basin still had the erosion processes caused by poor maintenance of technical structures in the riverbed and inappropriate management of the forest plantations which were established in order to mitigate the erosion processes.

The basin was rehabilitated by performing technical and biological works (Table 8). 9 dams were built of stone in cement mortar, and reforestation was done with Austrian pine (bench terraces and pits). The required technical works in the basin have not been completely conducted. Therefore, the Predejane River, regardless of the general state of erosion in the basin, still poses a potential danger. This has been aggravated by the small scale of the reforestation conducted in the basin (only about 5% of the basin area). Furthermore, the applied forest management does not take into account that these are special-purpose forests. This has caused the occurrence of small erosion loci in the area that was considered to be rehabilitated.

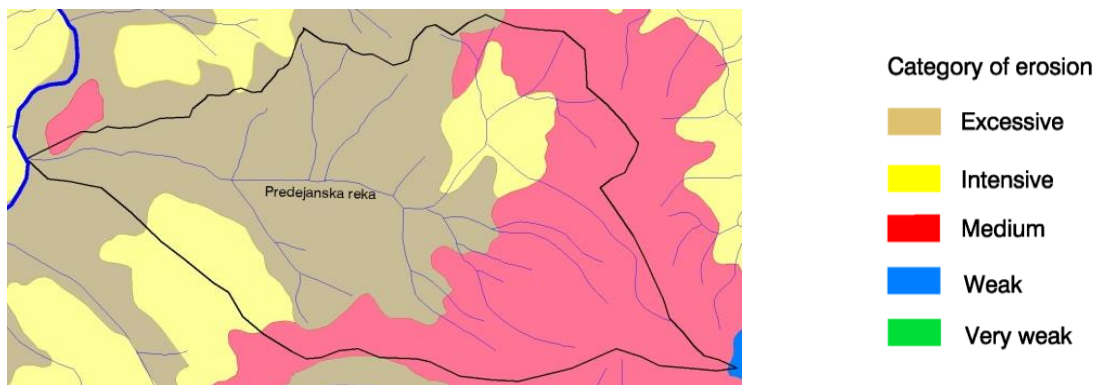

Figure 5. Map of erosion in 1953 (Source: Original)

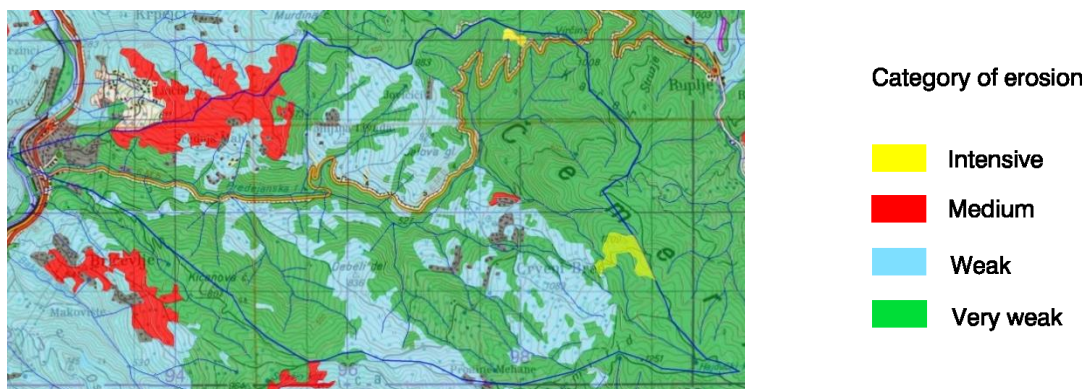

Figure 6. Map of erosion in 2012 (Source: Original)

Table 7. Areas by the intensity of erosion in 1953 and 2012

Erosion category											
I	II	III	IV	V	Z_{mean}	I	II	III	IV	V	Z_{sr}
1956					2012						
9.55	2.62	7.41	0.00	0.00	0.93	0	0.32	1.36	9.53	6.56	0.26

Source: Original

Table 8. Erosion control works conducted in the basin



Number of objects	Excavation (m ³)	Wall m ³)	Reforestation (ha)	Grassing (ha)
9	1940	1390	92,0	63,0

Source: Jelić, B. (1978)

Conclusions

In order to improve the methods of controlling water erosion and torrential floods, this study deals with the effects of conducted erosion control works and their impact on the state of erosion, through a comparative analysis of the situation in the Predejane River drainage basin in 1953 and in 2012.

The natural characteristics of the area are favorable for the development of erosion processes (climate, topography, soil, bedrock, developed hydrographic network).

The intensity of erosion registered in 2012 was primarily the result of the active fight against erosion and the changes in social and demographic factors that caused changes in land use. Positive changes affected the uppermost parts of the basin (the slopes of Kačer, Čemernik and Crveni Breg), areas further away from settlements, where the erosion control works were actually performed.

The land use changes registered in the observation period, along with other factors, contributed to the decrease in the intensity of erosion processes in the Predejane River basin. The Predejane River, regardless of the general state of erosion in the basin registered in 2012, still poses a potential threat. Technical works in the basin have not been completely carried out, the structures are not maintained and the scope of reforestation in the basin is small (only about 5% of the basin). The applied forest management contributes to the recurrence of erosion processes in the areas that have been rehabilitated. This requires continued monitoring of the changes in the erosion processes in the basin, because of the potential risk of torrential floods affecting the lower part of the basin (Predejane village and Predejane town) and the road infrastructure.

Acknowledgement

This paper was realized as a part of the project "The development of technological procedures in forestry with a view to an optimum forest cover realisation" (31070) and project "Studying climate change and its influence on the environment: impacts, adaptation and mitigation"(43007), financed by the Ministry of Education and Science of the Republic of Serbia within the framework of integrated and interdisciplinary research for the period 2011-2016.

References

Braunović S., Ratknić M., (2010): *The Changes of Land Use in Grdelica Gorge and Vranje Valley*. International Scientific Conference 'Forest Ecosystems and Climate Changes'. Institute of Forestry, Belgrade. Proceedings pp 83-88

- Braunović S., Ratknić M., (2010/a): *The Migration Trends and Soil Protection from the Erosion in Grdelica Gorge and Vranje Valley*. International Scientific Conference `Forest Ecosystems and Climate Changes`. Institute of Forestry, Belgrade. Proceedings pp 289-295
- Braunović, S., Ratknić, M. (2011): *Regeneration of natural ecosystems in habitats degraded by erosion processes (south-eastern Serbia)*, International Conference `Nature Protection in XXI Century`. Proceedings, book No 2, Institute for Nature Protection of Montenegro, pp 389-401
- Braunović S. (2013): *Effects of control works on the state of erosion in Grdelica Gorge and Vranje Valley*“, defended PhD thesis, Faculty of Forestry, Belgrade
- Gavrilović, S. (1972): *Engineering of torrential streams and erosion*.
- Jelić, B. (1978): *Erosion control works carried out in the Morava River Basin in the period 1947-1977*, `Erosion` No.9, Belgrade, pp. 25-42
- Penev, G. (2007): *Population projections in Serbia, 2002–2052*, `Review of the Republic of Serbia`, LI, 3, pp 9–26

GIS BASED LAND USE MODELLING USING SOIL DATA: A CASE STUDY IN THE SURUC PLAIN, SOUTHEASTERN TURKEY

Yüksel ŞAHİN, Mehmet Ali ÇULLU

Ministry of Food, Agriculture and Livestock, General Directory of Plant Production, Turkey
University of Harran, Faculty of Agriculture, Department of Soil Science and Plant Nutrition, Turkey

Abstract

The aim of this study was to develop land use model for Suruc Plain using detailed soil, climate, topographical and spatial land values data. For modeling, detailed soil maps data, topography, geology, climate and socio-economic factors were loaded into a geographic information system (GIS). Soil parameters representing the land characteristics were converted into raster formats and attribute tables. A Digital Elevation Model (DEM) was generated using topographical maps and they were converted into raster format. Aspect (slope direction), slope, and elevation layers were extracted from the DEM. Climate data, consisting of minimum, maximum, and mean temperatures and precipitation, obtained from 16 weather stations were loaded into the GIS media and converted to a map by using geostatistical analyses methods. All these databases in the GIS media were used to model land suitability classes. The model was designed using the Model Builder tools using more files regarding suitable land use type. The analysis suggested that the model allows using various data in the GIS media and it is easily/quickly utilizable and works efficiently for decision making in land use evaluations at agricultural plains.

Keywords: Soil Information Management, Geostatistics, Land Use Evaluation Modeling

Introduction

Land/soil uses are changed according to soil, climate and socio-economical characteristics. In the recent years, increased population and intensive agriculture practices for tackling food security are main purposes of land use changes. When the lands are used inefficiently, they lose their fertility. Land use systems designed and change according to their potential for high agricultural yield and agricultural sustainability.

Evaluations of the suitability of lands to any sort of activities including agriculture is crucial in terms of maintaining sustainability of land sources, utilizing them more efficiently and also reach to optimum production capacity of soils to achieve reasonable yield. Suitability assessment also guarantees that lands can be used for future generations. Agricultural developments not taking into account land capacities will likely fail to stay sustainable and in lands which are utilized inefficiently, productivity will decrease and ecosystems will degrade (Hamdan et al., 2006).

Because of the close relationship between lands and the way they are used, the result of wrong and unplanned land management is irretrievable damage to the lands and eventually, they become useless in terms of agriculture activities. Therefore, another key goal of the assessment of land use is to explain the adverse affects of mismanagements of lands and also give the farmers and decision makers a chance to compare the best management of them (FAO, 1976).

Some soils are good for growing crops and others are inherently unsuitable. Some lies in between. Many lands have limitations because of the conditions in which they have existed. Knowing their potential and limitations can protect soil from degradation by applying optimal management practices. Our goal is to reach their optimum potential for soils (Magdoff and van Es, 2000). Sustainability of agricultural lands have been evaluated on the basis of soil

properties, terrain data, climatic data and Development of Climate Change Scenarios Models (Ahmed et al., 1998; Hamdan et. al., 2006) and DEM (Baja et al., 2002). In this research, soil polygons, attribute and ancillary data, topographic structure, climate characteristics of plant for optimum growth and spatial land values were integrated to GIS media for modeling lands of Suruc Plain.

Material and Methods

The Study Area

The study area, Suruc plain, is located in southwestern part of Sanliurfa city, Turkey ($37^{\circ} 05'$ N Lat, $38^{\circ} 45'$ Long) covering a total area of 73500 ha (Fig.1). The Suruc plain is a part of the Southeastern Anatolia Project (SAP) as one of the planned regions for open to irrigation.

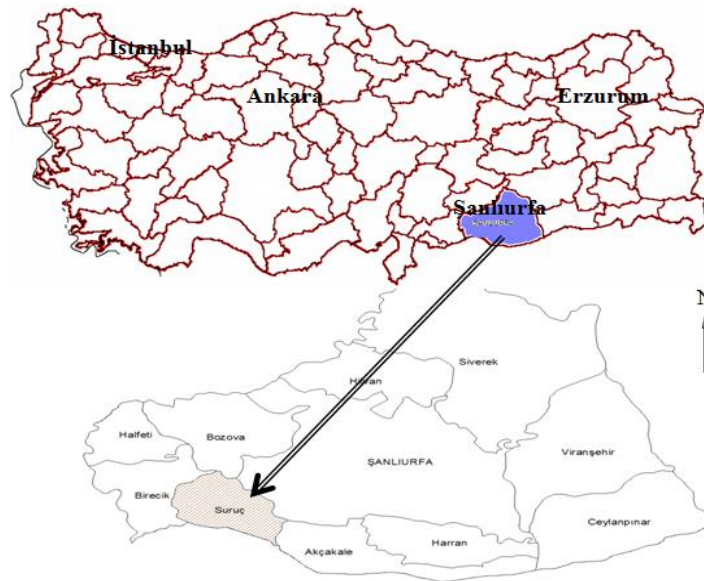

Figure 20. Study Area

Required Data

In the study, soil data were gathered from detailed soil maps prepared by Dinc et al. (1988) (at scale of 1:25000) for General Directorate of Rural Services and storie index maps (at scale 1:5000) with auxiliary soil profile data. A digital elevation model (DEM) was created using topographical maps (at scale of 1:25000) produced by General Command of Mapping. In order to determine the non-agricultural areas (such as roads, residential, industry and other infrastructure sites) geological maps produced by General Directorate of Mineral Research and Exploration (Turkish acronym, MTA) (at scale of 1: 500.000) were used. Long term monthly temperature and precipitation data were obtained from climate stations located nearby the study areas by Turkish State Meteorological Services. Actual land use types were derived from remote sensing data (Landsat TM 7) obtained in 2004. ERDAS Imagine 8.1 software was used for image processing and interpretation. The analysis, storage, inquiry and mapping of geographical data, integration vector with raster data were performed using ArcView 3.2 and ArcMAP 9.2; digitization of geographical data using NetCad 4.0 and calculations and reports using SPSS and MS office. Visual Basic was used for programming language.

Parameters used in the database

The digital soil database of the plain was formed by using basic soil parameters and their corresponding table information. All the soil chemical, physical and mineralogical characteristics were integrated with their polygons. This soil attribute table was compiled not only for root depth, but also for each soil horizons. This detailed soil database can give a wide query possibility for different land suitability classes. Suitability of the soils in the study area was evaluated for cotton, lentil wheat and pistachio production. Topographical suitability classes were determined according to the crop requirements for topographical parameters such as aspect (slope direction), elevation and slope. Geology maps at the scale of 1:500.000 was digitized and converted into raster format according to fault zones. Suitability classes for land use types were identified by evaluating the impact of geological structures on land use types. After the analysis of the fault zone and the formation suitability classes, the most suitable areas for land use types were identified.

Long term temperature and precipitation data obtained from 16 meteorology stations were used in the model. Climate data as well as the spatial information including geographical locations and altitude of the climate stations were entered into the GIS environment. The long term monthly, minimum and maximum, the mean temperatures and precipitation data were spatially interpolated using kriging and co-kriging analyses to generate the regional precipitation and temperature surface layers. These layers were used to develop suitability classes for the minimum and maximum temperature and the average precipitation according to the specific requirements of land use types. Profitability and social impact for cotton, lentil, and wheat and pistachio production was evaluated as an effecting parameter.

GIS Analysis and Model Development

A GIS based model was performed in order to carry out the land suitability analysis for specific crops (Sahin, 2007). The model compares existing land uses derived from satellite images with the land suitability classes derived from the GIS analysis. In the actual landuse, farmers make their choices according to custom, local consuetude and marketing situation. This model will compare the actual landuse with ideal suitability usage of land by model running.

The model is comprised of seven stages performed within the GIS environment (Fig 2, 3). The suitability assessment of the model is based on the requirements of land use types for soil, topography, climate and geology. The model works in the ArcMap environment and model parameters and variables can be identifiable in this environment.

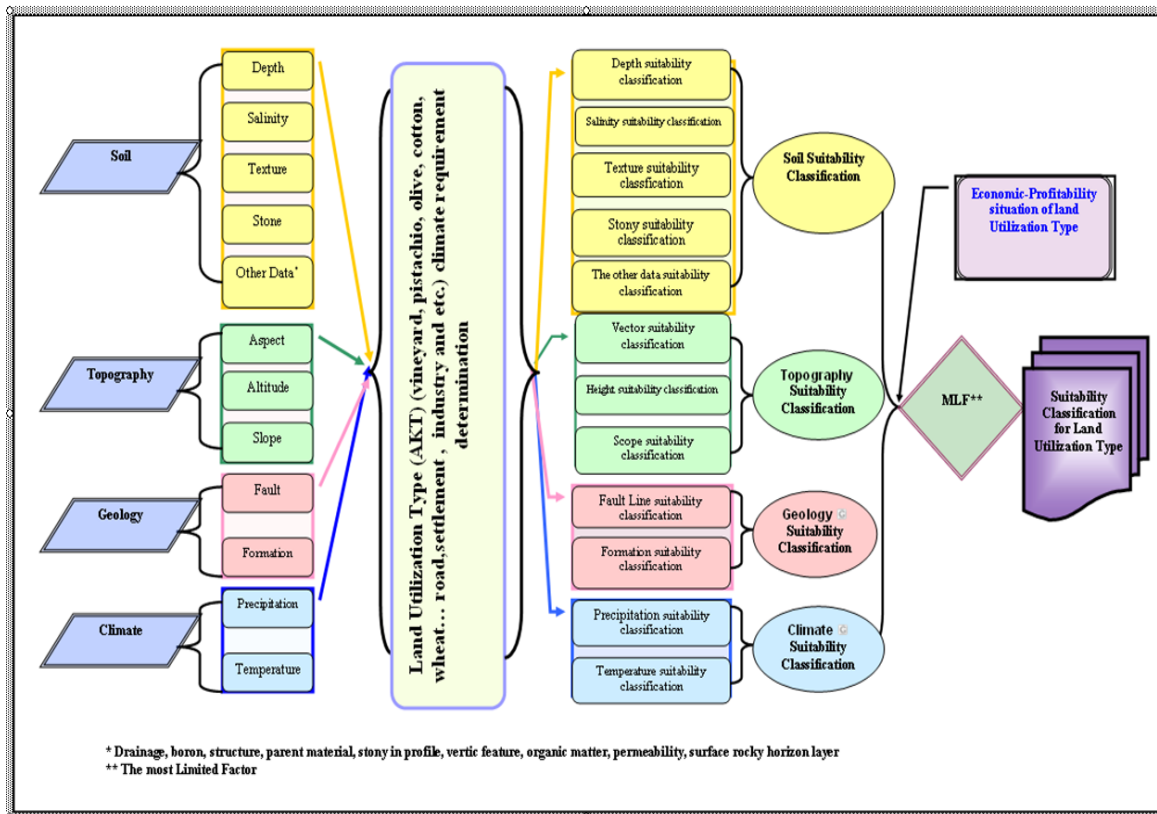

Figure 21. Model Flow Chart Diagram

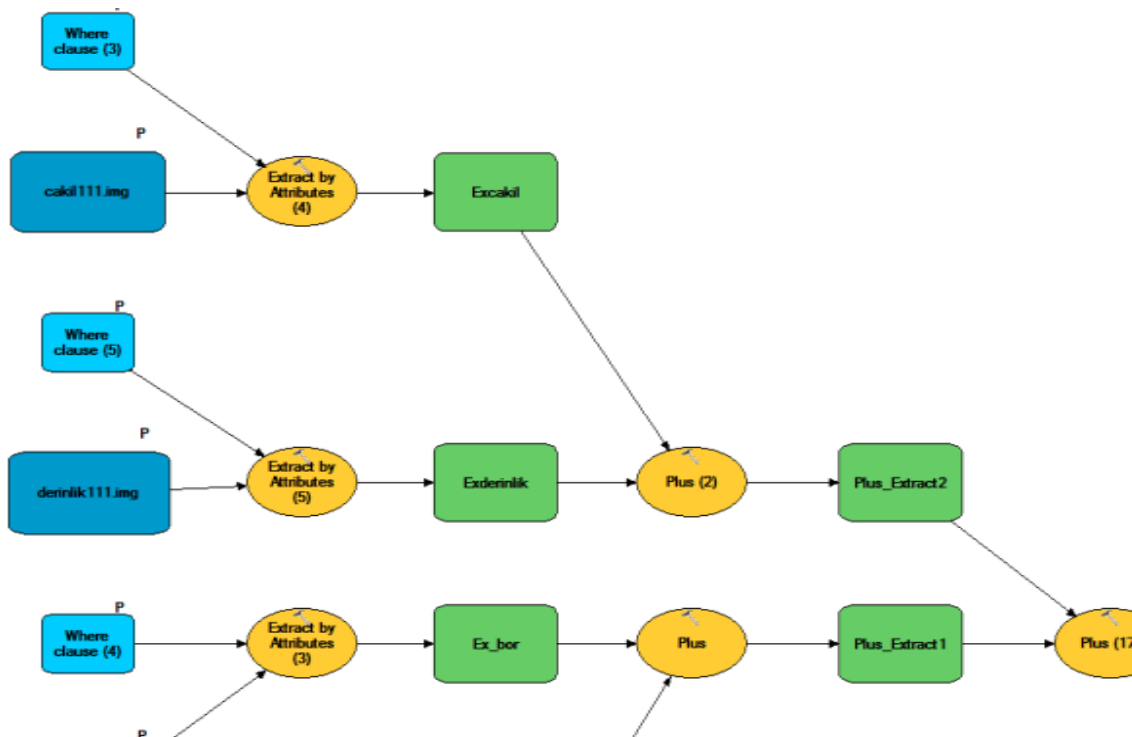

Figure 22. On Model Builder Flow Diagram Identification of Different Lands Use Type (LUT)

Soil and climate characteristics are main databases in determining of each Land Use Type (LUT). In the study, 5 different groups including horticulture (apple, pear, peach), vegetables

(tomato, potato, and cucumber), dry agriculture (apricot, pistachio), field crops (wheat, barley and lentil) and settlement were evaluated in the model.

In the study area, cotton, lentil, wheat and pistachio were the major crops recently grown at the studied areas and these landuse types mapped by using satellite images (Fig 4).

In the research, the most suitable areas for cotton, lentil, wheat and pistachio potentially and economically grown were determined by model (Sahin, 2007) then the model output were combined with actual land use (Fig 5a,5b,5c,5d). For determination of suitable areas by using the model, the environmental parameters required by Lands Use Type (LUT) soil, topography, climate, geology and social and economical factors were integrated in the GIS environment. All these parameters loaded into model with each ideal grown parameter for each crop groups. The lands of Suruc Plain classified according to FAO (1976) evaluation procedures (Table 1).

Table 17. Determined Land Use Type (LUT) Classes According to Value of Physical Survey Unite Index (PSUI)

PSUI	Symbol	Suitability Class
100–90	S1	More Suitable
89–70	S2	Suitable
69–50	S3	Moderate Suitable
49–30	S4	Less Suitable
29–10	N1	None Suitable (Temporarily)
9–0	N2	None Suitable (Permanently)

Results and Discussion

As input, a total of five representative soil, topography, geology, climate and spatial land values data were used for modeling the land use of the Suruc Plain. These kind of data can be displayed spatially and include attributes in tabular format, making them suitable for Geographical Information System. When soils are planned in terms of their ability, they can be protected from degradation. Soils are used according to their characteristics which play an important role on the plant growth. In the plant growth, soils characteristics are not only sufficient, other affecting factors such as climate slope and spatial values play important roles. Therefore, modeling data about lands gives an advantage to reach data easily in GIS environment. In this study a land use model was conducted for the Suruc Plain, Southeastern Turkey.

The model was carried out at two stages;

- a) Mapping of actual land use from the satellite images (Fig 4).
- b) Potential Suitable Map was derived by analyzing the soil, climate, topography, geology and spatial land values of the study area in the GIS media (Fig 5a, 5b, 5c).

After the running the model, six suitability classes were mapped and combined with actual land use.

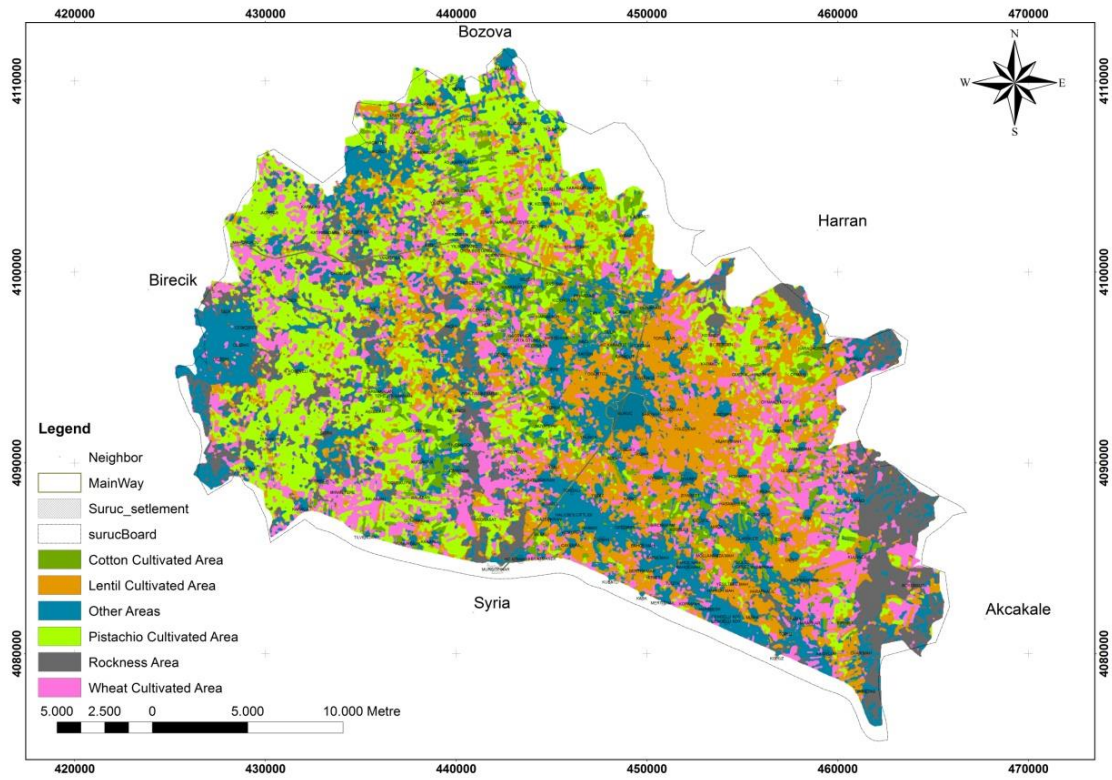

Figure 23. Actual Land use Map Derived from the Satellite Images

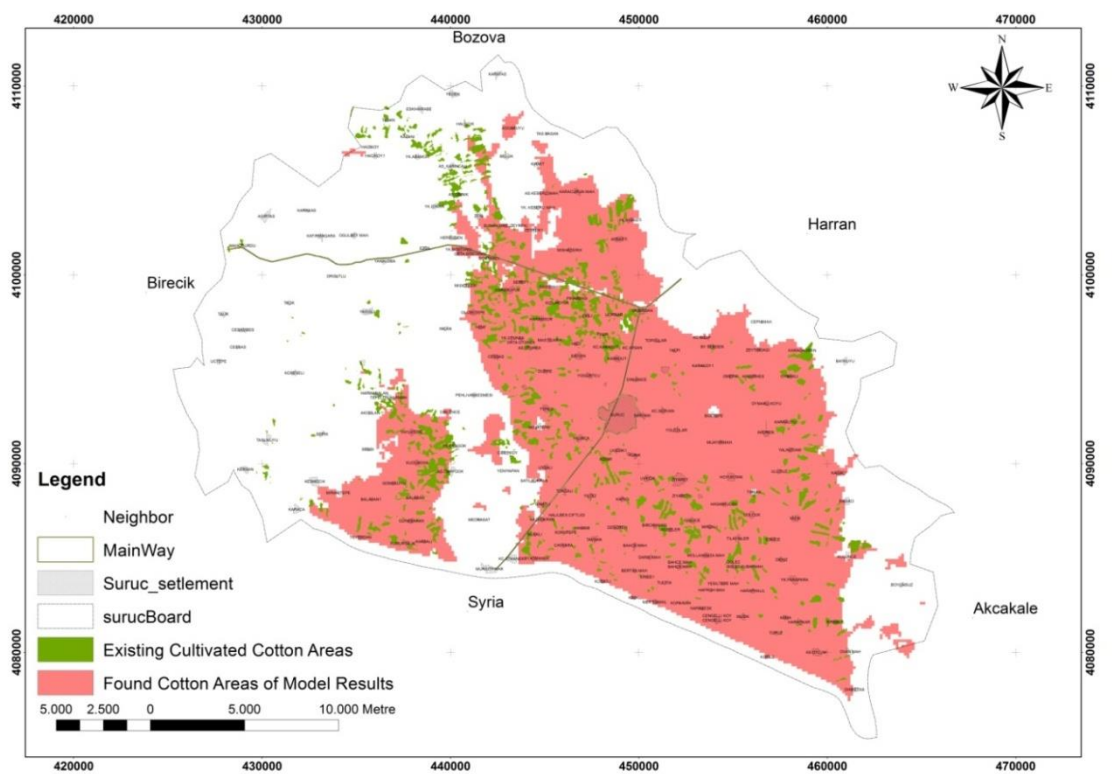

Figure 24a. Integration of Potentially Suitable and Actual Planted Lands for Cotton

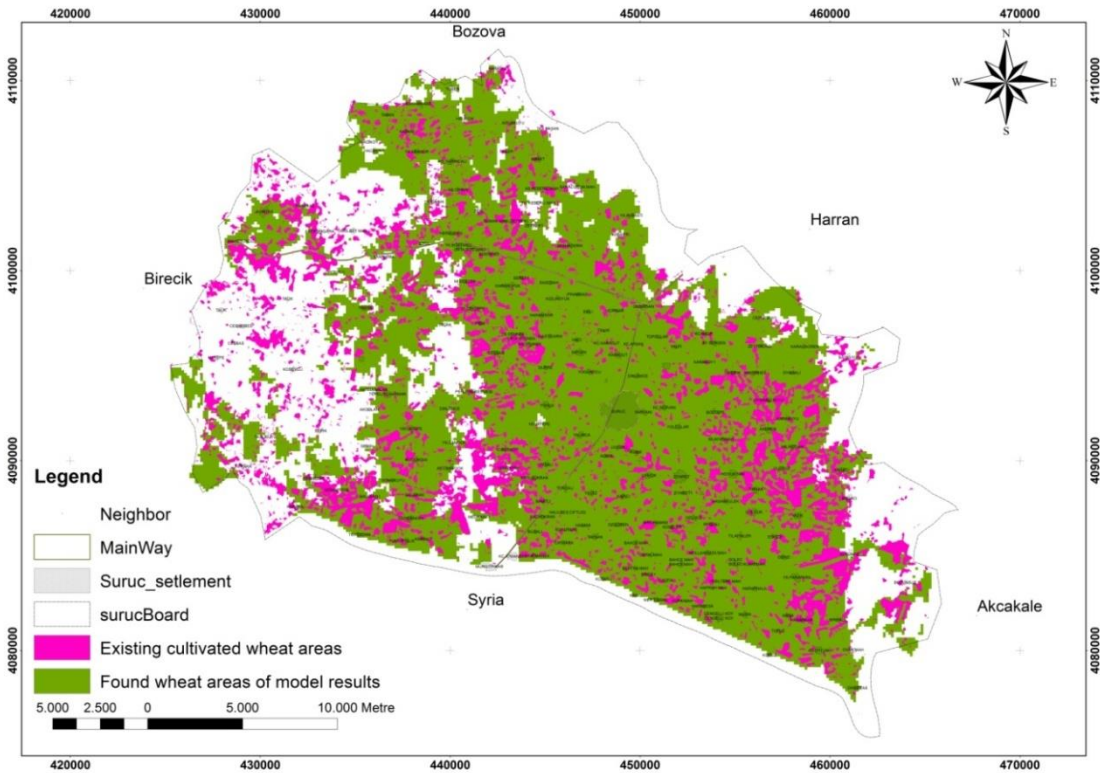

Fig 5b. Integration of Potentially Suitable and Actual Planted Lands for Wheat

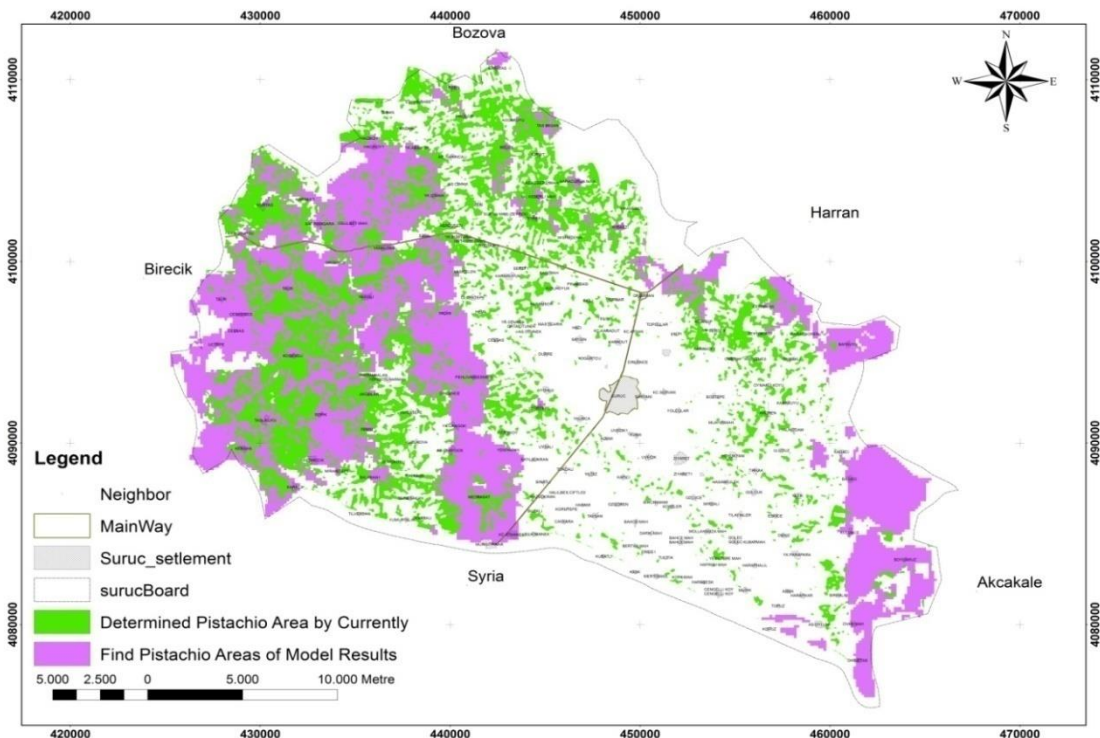

Fig 5c. Integration of Potentially Suitable and Actual Planted Lands for Pistachio

In the study area, when the actual land use map combined with potential map, the differences clearly can be seen. The data suggested that farmers cannot use their land according to soil capabilities. The latter may cause significant yield losses and land degradation. If we evaluate pistachio crop in the model we can see considerable differences between actual and potential use. The most suitable areas for pistachio was determined according to the model and

integrated to the actual pistachio planted lands. According to the model evaluation, only 28 % of pistachio planted lands are planted in ideal soil/land conditions. The cotton, lentil, wheat and barley planted lands were mapped for 2004 using satellite images. According to this result, totally planted areas of these crops were 17254 ha, whereas, potentially suitable areas obtained by the model were 30785 ha. This model gives accurate data for choose land use type according to soil, topography and climate. Farmers or industrial sectors can give a right direction using this data.

This study showed the efficiency of GIS in the analysis of multilayer spatial data simultaneously and delineation of the suitability classes of the lands provided the data from sources such as soil, topography, climate, geology and remote sensing using GIS techniques and interpretation of satellite images. Using this approach lands can be better managed and determination of land suitability can be improved which in turn help sustainable agriculture.

Conclusion

A GIS based multi criteria land evaluation was performed in Suruc Plain. The model output has a good potential to be used as a support tool for decision makers, land manager and politician for agricultural investment.

Land use planning is based on a combination of factors including zoning, population density, soil suitability, locations of floodplains and the types of existing land uses.

We conclude that there is a big difference between actual and potential land uses according to the model output.

GIS capability gives a wide possibility to use and integrate soil, climate, and topography map and attributes tables. These wide integrated data evaluated in GIS media contributed to give a right direction to land manager for ideal land planning.

References

- Ahmed, A. U. and M. Alam,1998, 'Development of climate change scenarios with general circulation models', in S. Huq, Z. Karim, M. Asaduzzaman, and F. Mahtab (Eds.), *Vulnerability and Adaptation to Climate Change for Bangladesh*, Kluwer Academic Publishers, Dordrecht, pp. 13-20.
- Baja, S., Chapman, D. M., Dragovich, D. 2002. Using GIS-based continuous methods for assessing agricultural land-use potential in sloping areas. *Environment and Planning B – Planning&Design*. 29:3-20.
- Dinç, U., Şenol, S., Sayın, M., Kapur, S., Yılmaz, K., Sarı, M., Yeğingil, İ., Yeşilsoy, M.Ş., Çolak, A.K., Özbek, H., Kara, E.E. 1991. *The Physical,Chemical and Biological Properties and Classification. Mapping of Soils of the Harran Plain*. TÜBİTAK-TOAG, No:534, Soils of the Harran Plain, p: 1-10, 1991, Ankara
- FAO, 1976. *A Framework for land evaluation*. FAO Soils Bulletin 32, Rome, Italy.
- Hamdan, M., J., Bhermana, A., Ruhana, B. 2006. Towards sustainable agricultural development of Kotawaringing Barat Regency, Kalimantan, Indonesia. *Journal of Sustainable Agriculture*. 29:75-93.
- Magdoff, F. R., and H. M. van Es., 2000. *Building Soils for Better Crops*. Handbook Series Book 4. Sustainable Agric. Network, Beltsville, MD.
- Sahin, Y., 2007. *Geographical Information System (GIS) based of soil information management in land se modeling: A case study in application at Suruç-Sanlıurfa Plain*. PhD. Thesis. Harran University. Graduate School. 250p.

DEVELOPMENT OF IRRIGATION AUTOMATION SYSTEM (IAS) USING BY PROGRAMMABLE LOGIC CONTROLLER (PLC) AND ITS APPLICATION ON IRRIGATION SCHEDULING CREATED USING CLASS A PAN

Cafer GENÇOĞLAN*, Serpil GENÇOĞLAN

Biosystem Engineering, Faculty of Agriculture, University of Kahramanmaraş Sütçü İmam, Kahramanmaraş, Turkey

*Corresponding author: gencoglan@ksu.edu.tr

Abstract

Aims of this study are to develop irrigation automation system (IAS) using PLC and to measure water level automatically in Class A Pan by IAS for daily evaporation and to refill certain level with pressure transducer, to calculate amount of water to be given irrigation treatments from daily evaporation, to control drip irrigation control unit and to irrigate pear plots when total daily evaporation reached about 35 mm. The two years of the study, scheduled three years, was conducted (*Pirus communis* L.) in the Department of Biosystem Engineering, Faculty of Agriculture and University of Kahramanmaraş Sütçü İmam. In the first year, IAS was installed and its program code was written in CODESYS language and loaded into PLC and tested in the workshop. In the second year, the system was also tested irrigating 11 years old dwarf pear during irrigation season. Water depth in Class A Pan was measured using one pressure transducer at 10:00 am. IAS started to irrigate Dwarf pear orchard at 10:10 am during irrigation season when total evaporation from Class A Pan reached about 35 mm. Irrigation management treatment was created as 120%, 100%, 80%, 60% and 40% application of 35 mm evaporation from Class A Pan. Using randomly block design, there were totally 5 irrigation treatments, namely, I₁₂₀, I₁₀₀, I₈₀, I₆₀, and I₄₀ and which were replicated 3 times. Irrigation started in June and terminated in October. Irrigation automation system successfully completed the test conducted in both workshop in 2014 and also pear orchard during irrigation season in 2015 in accordance with program code. As a result of study, it could be stated that IAS could decrease labor and labor cost of irrigation and increase irrigation water use efficiency. If the IAS is used by famers, crop production cost would lessen and farmer income would increase.

Keyword: *PLC, automation, irrigation, pear.*

Introduction

Turkey's total land area is 78 million ha. Almost one third of this, 28 million ha, can be classified as cultivable land. Recent studies indicate that an area of about 8.5 million ha is economically irrigable under the available technology. Presently irrigated area is about 4.9 million ha (DSI). Turkey is located in the semi-arid climates and therefore, crop production cannot be done without irrigation. Irrigation, especially surface irrigation, needs much more labor. Labor cost has increased day by day and also there is no agricultural worker. On the other hand, Moutonnet (2002) reports that water is a finite resource for which there is increasing competition among agricultural, industrial and domestic sectors. The allocated water to agricultural irrigation should be used effectively without causing environmental pollution. In addition (Cote et al., 2003) states that the increased use of trickle irrigation is seen as one way of helping to improve the sustainability of irrigation systems around the world. However, irrigation scheduling should be determined in the trickle irrigation. Preparing irrigation scheduling is time consuming, needed labor, sometime expensive and

also hard to follow it. Irrigation automation system could decrease all irrigation scheduling processes, labor and labor cost.

For this reason, aims of this study are to develop irrigation automation system using (IAS) by PLC and to measure water level in Class A Pan for daily evaporation and to refill certain level with pressure transducer, to calculate amount of water to be given irrigation treatments from daily evaporation, to control drip irrigation control unit and to irrigate pear plots when total daily evaporation reached about 35 mm.

Material Methods

The study was conducted at the Faculty of Agriculture, University of Sütçü İmam (37° 32' 08" N and 36° 54' 59" E and altitude 700 m above sea level) in Turkey. An experiment was set up for three years - in 2014 in the experimental field of the Department of Biosystems and second (2015) and third (2016) year in the orchard of dwarf pear with 11 and 12 years old trees (*Pirus communis L.*). However, results were only from 16.06.2015 to 09.10.2015. Pear trees with Comice variety had been planted on 4.5X0.6 m spacing. The experimental area was under Mediterranean climate conditions with cool, rainy winters and hot, dry summers. Long-term average rainfall in the area is 712 mm.

The soil is classified as an Entisol with a clay-loam texture. Some physical and chemical properties of the experimental soil are given in table 1.

Table 1. Some soil physical properties of experimental area

Soil depth (cm)	Texture	Field Capacity (g g ⁻¹)	Wilting point (g g ⁻¹)	Bulk density (g cm ⁻³)	pH	EC (dS m ⁻¹)	CaCO ₃ (%)	Organic Matter (%)
0-30	CL	35.04	22.39	1.38	7.61	0.022	9.29	0.88
30-60	CL	35.99	24.17	1.36	7.76	0.018	7.96	1.76
60-90	C	41.19	20.43	1.50	7.80	0.019	9.29	2.67

(FC=388.52 mm and WP=210.054 mm)

Irrigation water is obtained from a deep well in the experimental area, and its quality is classified as C₂S1, with pH 7.0, and an average electrical conductivity is 0.41 dSm⁻¹.

An electrical panel of IAS for this study seen in figure 1 was installed according to PLC system variables given in Table 2. There were 16 digital input, 23 digital outputs, 18 analog input and 1 analog output for the IAS. In order to control 58 end elements in this study, one PLC's CPU and 7 modules were used. A program was written using CODESYS-ST language (ABB, 2015) considering 58 end element and below items:

- 1- It was irrigation time when total evaporation was equal or greater than 35 mm.
- 2- Water tank refilled up to 174 cm when level of water in tank was below 150 cm.
- 3- Class A Pan refilled up to 200 mm when level of water in Class A Pan was below 150 mm.
- 4- One pulse generated by digital water meter was equal to 1 liter when volume of water was measured by digital water meter.
- 5- Volume of water to be applied to treatment parcels was calculated by Equation 1

$$V=W*L*E0*Kcp \quad (1)$$

Where:

V- volume of water (L), W- parcel width (m), L- parcel length, E0- evaporation (mm), Kcp: crop-pan coefficient.

6- Soil moisture above the field capacity assumed as deep percolation.

7- In the evapotranspiration calculation of dwarf pear, water budget method was used.

8. Data of Class A Pan, soil moisture, irrigation water, evapotranspiration and precipitation were saved into SD card.

Table 2. PLC system variables (inputs and outputs) and control magnitudes

System Variables	Inputs		Outputs		Control Magnitudes
	Digital (DI)	Analogu e (AI)	Digital (DO)	Analogu e (AO)	
Digital water meters (15) and rain gage (1)	16				24 VDC
Solenoid valves at parcels (15, $\varnothing 1/2''$)			15		24 VDC
Solenoid valves at control unit($2\varnothing 2''$ ve $1\varnothing 1/2''$)			4		24 VDC
Proportional valve ($1\varnothing 2''$)				1	0-10 V 24 VAC
Position indication for rotary actuator		1			
Pressure transducer (50 mBar) for water tank and (250 mBar) for Class A Pan		2			4-20 mA
Class A Pan water input solenoid valve ($1\varnothing 1/2''$) Class A Pan excessive water motopump			2		24 VDC
Soil moisture sensors		15			4-20 mA
Inverter			1		220 VAC
Reserved			1		
Total	16	18	23	1	

Depth of water in Class A Pan was measured by IAS using a pressure transducer at 10:00 am during the pear irrigation season (fig. 2). In order to obtain same water depth value between directly measured water depth by micrometer and calculated by IAS according to pressure transducer output, adjustment was made using by pressure transducer line in Picture 2. The minimum level of water in Class A Pan was 150 mm and maximum level was 200 (Güngör et al., 2004). Class A pan was filled automatically up to 200 mm level when water level is equal or drop below 150 mm at 10:00 clock am.



Fig. 1. IAS electrical panel

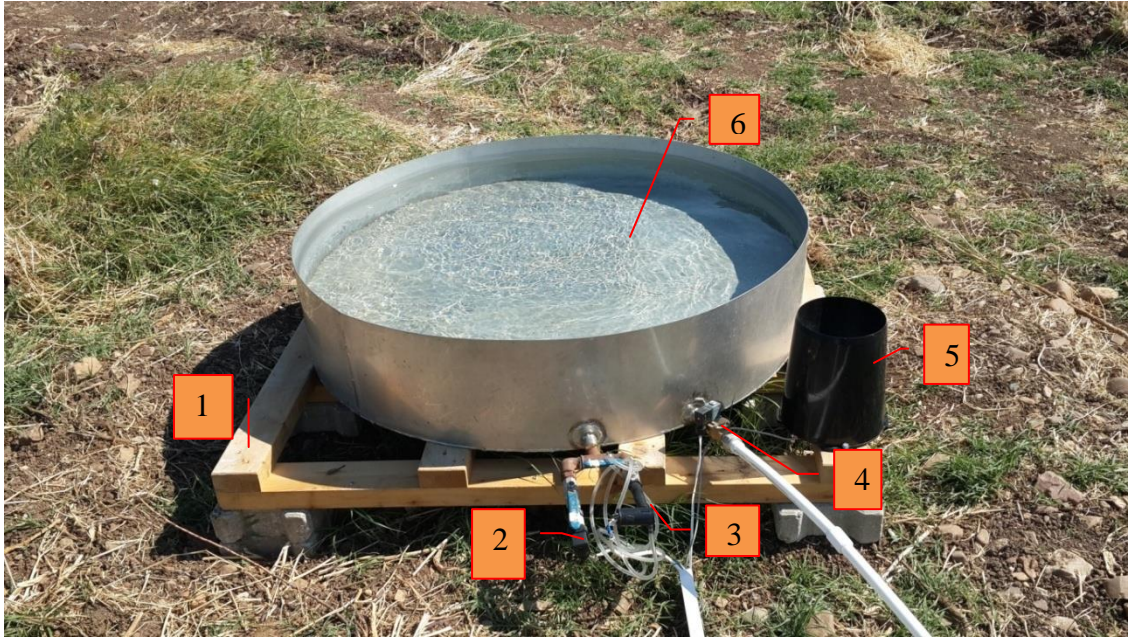

1: Slatted Platform, 2: Pressure transducer, 3: Motopump, 4: Solenoid valve, 5: Rain gage, 6: Class A pan
 Fig. 2. Class A Pan and water depth measurement system.

Dwarf pear orchard was irrigated when total evaporation from Class A Pan was equal or greater than 35 mm. Irrigation management treatment was created as 120%, 100%, 80%, 60% and 40% application of 35 mm evaporation water from Class A Pan. Using randomly block design, there were totally 5 irrigation treatments, namely, I_{120} , I_{100} , I_{80} , I_{60} , and I_{40} and which are replicated 3 times. Length of each parcel with 16 dwarf pear tree was 10 m. Width of parcels assumed to be equal to canopy diameter of the dwarf pear. So, it was taken as 1.42 m. Amount of irrigation water was calculated using Equation 1. It could be re-written as $V=1.42*10*K_{cp}*E_0$. K_{cp} coefficients were taken as 1.2, 1.0, 0.8, 0.6 and 0.4 for I_{120} , I_{100} , I_{80} , I_{60} , and I_{40} irrigation management treatments, respectively. Amount of water irrigation was applied irrigation treatments through digital water meter (fig. 3). One pulse generated by digital water meter was equal to 1 liter. At the beginning of irrigation time, IAS opened the solenoid valves to irrigate irrigation parcels and in the meantime the pulses generated by digital water meter were counted by the IAS. When the counted value was equal to volume of water to be applied to parcels, stopping the solenoid valves, irrigation ended. Irrigation started in June and terminated in October.



Fig. 3. Digital water meter

Irrigation water source is a deep well, near the pear orchard. A plastic tank of 7 ton was placed close to irrigation treatments and connected to deep well with a $\varnothing 40$ PE pipe. Water level in the water tank was controlled by pressure transducer. When water level was below 150 cm, water tank was refilled to 174 cm water level. Water in the tank was applied to irrigation plots through 2 kW motopump, controlled by driver, via hydrocyclone, media filter, disc filter, solenoid valves, digital water meters and finally laterals. But also, there was fertilizer tank in the drip control unit.

Results and Discussion

Only the second year's results were given in this paper, and irrigation of Comice dwarf pear started 16.06.2015 and with the start of leaves to turn yellow, ended 09.10.2015. IAS measured totally evaporation of 1104 mm from Class A Pan during the irrigation period. In the first irrigation, amount of 52 mm irrigation water was applied to effective rooting depth of 60 cm to refill available water to field capacity. When total evaporation from Class A Pan was equal or above 35 mm, IAS calculated amount of irrigation to be applied to I_{120} , I_{100} , I_{80} , I_{60} and I_{40} irrigation management. IAS started irrigations at 10:10 am. In 2015 irrigation season, IAS irrigated 27 times Comice dwarf pear. Irrigation interval changed between 3-12 days depending on climatic conditions and crop development stage. In the second half of June, and July and August irrigation interval was 3-4 days, in September 3-6 days and in October increased to 12 days. In each irrigation, amount of water applied to I_{120} , I_{100} , I_{80} , I_{60} and I_{40} irrigation management treatment varied between 62-40, 52-33, 42-26, 31-20 and 21-13 mm, respectively and the mentioned irrigation treatments were applied totally 1314, 1104, 894, 683 and 473 mm water, respectively.

In temperate climates Comice pear varieties generally harvested towards to end of September. Taking into consideration this knowledge, the fruits of pear were harvested manually on date of 04.10.2015 (Fig. 4).



Fig. 4. A view from the harvested dwarf pear orchard.

IAS irrigated irrigation management treatments of dwarf pear in accordance with the written program code without any problems during the irrigation season. Applied by IAS different amount of irrigation water according to irrigation management, the dwarf pear fruit yields given in table 3 were harvested from I_{120} , I_{100} , I_{80} , I_{60} and I_{40} irrigation management treatment, respectively. As seen in Table 3, mean fruit yields per dwarf pear tree for the irrigation treatments were 4.1, 3.4, 3.4, 3.0 and 2.6 kg/per tree, respectively. The highest fruit yield harvested from I_{120} and the lowest fruit yields from I_{40} . Yields of the other treatments changed between the yields of two treatments. Fruit yields of sunrise and Bartlett cultivars changed from 0 to 30 kg per tree and from 0.1 to 19.3 kg per tree by 2000-2008 years, respectively

(Bell and Zwet, 2011). Yield of Comice dwarf pear took place among the yields of sunrise and Bartlett cultivars, changing by years.

Table 3. Fruit yields harvested from irrigation treatments (kg/per tree)

Irrigation treatments	Replication			Fruit yield (kg/per tree)
	1	2	3	
I120	4,9	3,9	3,6	4,1
I100	2,8	5,2	2,1	3,4
I80	4,7	3,9	1,8	3,4
I60	3,3	3,1	2,6	3,0
I40	2,7	2,6	2,6	2,6

Conclusion

The test of IAS performed in the workplace during 8 month and at dwarf pear orchard was completed successfully according to the written program code during irrigation season in 2015. As a result of study, it could be stated that IAS could decrease labor and labor cost and increase irrigation water use efficiency. If the IAS is used by famers, production cost would lessen and farmer income would increase.

Acknowledgement:

The project with the number of 213O097 was supported by the Scientific and Technological Research Council of Turkey (TUBİTAK).

References

- ABB (2015). Getting start with AC500-eCo Starter-Kit.<https://library.e.abb.com/public/e759bb56d84c9e57c1257c22002e8e6b/2CBA125031M0201.pdf>
- Bell, R.L., Zwet (2011). Sunrise Pear. HortScience, 46/1, pp.118-120.
- Cote, CM., Bristow, KL. Charlesworth, PB. Cook, FJ., Thorburn PJ. (2003). Analysis of soil wetting and solute transport in subsurface trickle irrigation. Irrig Sci, vol. 22, pp.143–156.
- DSI (2016). <http://www.dsi.gov.tr/toprak-ve-su-kaynaklari>.
- Güngör, Y., Erözel, Z., Yıldırım, O. (2004). Irrigation. Publish Number:1540, Lecture Book Number:493. Faculty of Agriculture, University of Ankara, Ankara/ Turkey.
- Moutonnet, P. (2002). Yield response factors of field crops to deficit irrigation In deficit irrigation practices. Food And Agriculture Organization Of The United Nations Rome.

CFD MODELLING OF AIR VELOCITY IN A TRACTOR CABIN FOR WINTER CONDITIONS

Serap AKDEMİR^{1*}, Serhat ÖZTÜRK², Poyraz ÜLGER²

¹Air-Conditioning and Refrigeration Programme, Technical Sciences Vocational School, Namik Kemal University, Tekirdağ, Turkey

²Faculty of Agriculture, Biosystem Engineering, Namik Kemal University, Tekirdag, Turkey

*Corresponding author: sakdemir@nku.edu.tr

Abstract

In this study, distribution of air velocity in a tractor cabin was analysed with Computational Fluid Dynamic method. Spatial distributions of air velocity on different planes were determined in the tractor cabin. Materials were tractor with air-conditioned cabin, Testo 435 air velocity sensor. Air velocity were modelled and measured in a tractor cabin for winter conditions. ANSYS Fluent software was used to estimate distribution models of ambient factors. Estimated and measured data were compared each other. Measurements were realised when driver was inside and outside temperature 8°C for winter condition. One sensor was used for air velocity measurements in this research. Number of the elements in mesh was 1074644. Types of meshes were prismatic and hexagonal. Air has a certain temperature in the model. There was heat flux from surface of engine and human body. In addition, convection and radiation heat transfer was accepted in the CFD models. Mean measured and estimated air velocity for winter conditions were calculated as 4.1 m/s and 4.15 m/s, respectively. Mean difference between measurements and CFD model estimations was 0.05 m/s. Accuracy of the model estimation was 11.18%.

Keywords: *Tractor, cabin, modelling, Computational Fluid Dynamics, air velocity*

Introduction

The conditions inside a tractor cab have significant impact on the performance of the operator, and in that way on the total efficiency of the operator-tractor-environment system as well. The main principle for both the improvement of the microclimatic conditions and the reduction of air-conditioning energy consumption in any type of cabin is the cooling the operator's body by the effective use of airflow from the air-conditioning system. Cabs usually have an air distribution system with air vents (outlets of ventilation system) placed on the ceiling. The vents mostly have a circular cross-section and the operator can change the velocity and direction of the air jet, and optionally, temperature. Vapour compression systems are (Ruzic, 2014). Thermal environment in tractor cabs differs from typical working places in buildings and usually is highly non-uniform and asymmetric, also characterized by following features: cab interior volume is small, changing of microclimate parameters could be rapid (when cab changes the orientation to the sun, etc), glazing area is large in comparison to the cab surface area, operator is not able to change position within the cab, changes of body posture are limited etc. From these reasons, obtaining both the uniform and comfortable conditions in the cab is not a simple task. Homogenous environment is preferable from the aspects of thermal comfort, and this is achievable in a later stage of staying in the cab, if steady state conditions are reached (Ruzic and Poznic, 2011).

In this research; distribution of air velocity in a tractor cab with air-conditioning was modelled by Computational Fluid Dynamics (CFD) methods and validated by sensor measurements. CFD analysis results of air velocity were shown on plains in the tractor cab. Differences between CFD Model and measured data of air velocity were investigated. ANSYS Finite elements model of tractor cab carrier system known its load-elasticity curve

were created and boundary conditions were defined by Kalkan (2007). Solutions of fluid mechanics for biological cleaning processes of different ventilators were compared by using Computational Fluid Dynamics (CFD) Akbulut (2010). Air conditioning system is the only active method for control of microclimate conditions in a cab. The system has a direct effect on heat exchange between an operator and a cab interior. This paper deals with an analyze of heat losses from individual body parts as well as whole body, for different air nozzles positions and different settings. The research was done with virtual operator model in tractor cab, using the computational fluid dynamic (CFD). The results showed that in this case the airflow direction has more significance on the operator heat loss than the air nozzles positions (*Ružićand Časnji*, 2011). CFD models were developed and tested by sensor measurements for determination of temperature and relative humidity distribution in an experimental cold store Akdemir *et al.* (2012).

Materials and Methods

Hattat A 110 Maxi model tractor with air-conditioned cab was used in this research (Hattat, 2015). Technical specifications of tractor were given table 1. Air velocity was measured by using Testo 435 sensor. Measurement rage was 0.2 - 40 m/s (Testo, 2015). Measurements were realized in cab when outside temperature was 8°C. Air velocity was measured from 14 points as shown in Figure 1. In addition, air-condition was worked at highest as 4th level and 1500 rpm of tractor engine for determining maximum capacity of it.

Table 1. Technical specifications of tractor

Model	A110 4WD
Emision type	Euro3
Max. power KW/HP/rpm (ISO 14396)	74,9/102/2200
Max. Motor torque Nm/Rpm	416/1400
Type of the air filter	Dry type, Screen warning
Aspiraiton	Turbocharge with Intercooler
Total unloaded wieght - (kg)	3740
Cab	Air-conditioning, wide cab, with second seat

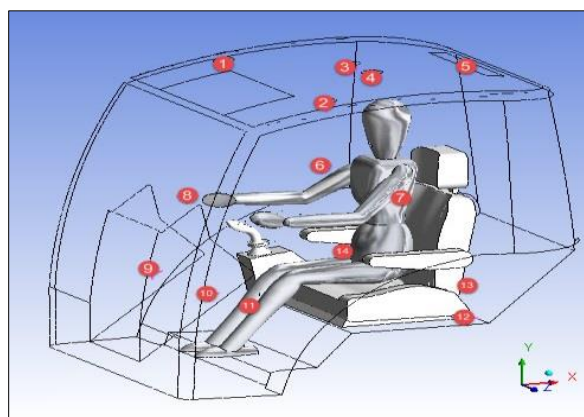

Figure 1. Measurement points in the cab

Flow analysis of air ventilated by air-condition in tractor cab was modelled by Computational Fluid Dynamics (CFD). Solid model of tractor cab was created by using Pro-Engineer software (Figure 2). File extension was STP was introduced with Design Modeller module after tractor solid model were created and flow volume of solid models and name of boundary conditions were entered by opening the mesh module. Required corrections were made on solid model created using Design Modeller. Then mesh module used to establish flow volume

of the model (Figure 3). Mesh structure was also created by Mesh Module (Figure 4). Number of the prismatic and hexagonal elements in the mesh structure was 1074644.



Figure 2. Solid model

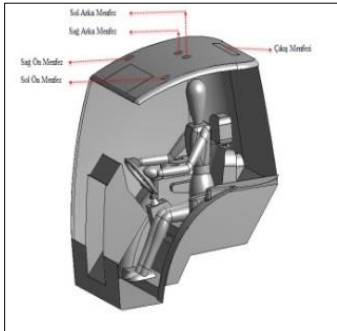

Figure 3. Flow volume of model

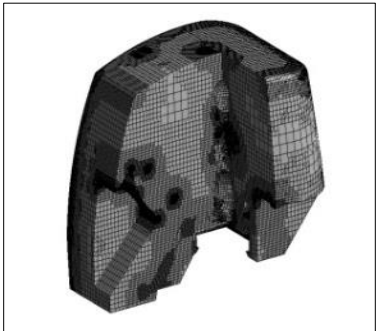

Figure 4. Mesh structure

Air at certain temperature and humidity enters through vents. There were heat fluxes from motor and human surface. Heat exchange by convection and radiation from other surfaces was concerned. Names of the boundary conditions for tractor were given in Figure 5 and Table 2.

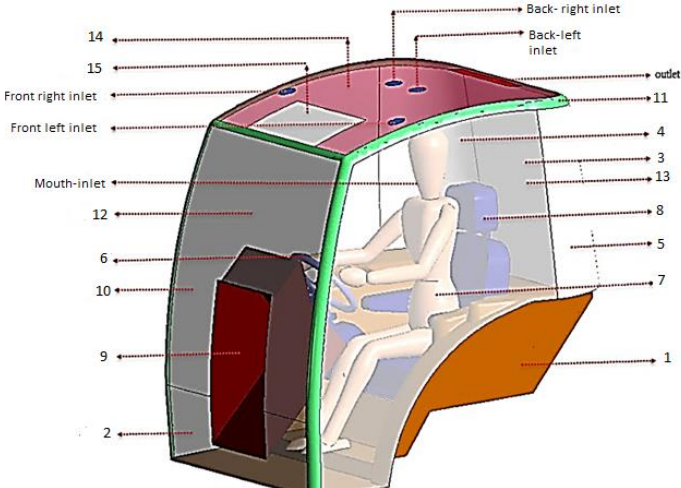

Figure 5. Names of the boundary conditions

Table 2. Boundary conditions of tractor cab

Boundary Conditions	Material	Thick (m)	Thermal Conductivity (W/m ² .K)	Heat Dissipation Capability	Heat Flux (W/m ²)
Basement (1)	Polyurethane	0.005	10	0.9	***
Lower glass (2)	Glass	0.005	10	0.88	***
Back glass (3)	Glass	0.005	10	0.88	***
Back right (4)	Glass	0.005	10	0.88	***
Back left (5)	Glass	0.005	10	0.88	***
Steering Wheel (6)	***	***	10	***	***
Driver (7)	***	***	***	***	65
Seat (8)	***	***	10	***	***
Engine (9)	Pvc	***	***	***	110
Front glass (10)	Glass	0.005	10	0.88	***
Frame (11)	Steel	0.005	10	0.97	***
Right glass (12)	Glass	0.005	10	0.88	***
Left glass (13)	Glass	0.005	10	0.88	***
Ceiling (14)	Polyester	0.05	10	0.95	***
Ceiling glass (15)	Glass	0.005	10	0.88	***

Material specifications of the tractor cab were given in Table 3.

Table 3. Technical specifications of tractor cab materials

Malzeme	Heat capacity (j/kg.K)	Heat conductivity coefficient (W/m.K)
Vents	1006.43	0.0242
Polyurethane	1500	0.024
PVC	900	0.19
Polyester	1400	0.17
Steel	502.48	16.27
Glass	840	0.8

As a method of this research; CFD models were developed by using ANSYS Fluent software to estimate distribution of the air velocity for winter conditions in the tractor cab. Different points were determined in the tractor cab to measure air velocity by sensor. Value of the air velocity at same points was also determined using ANSYS Fluent software. Differences as value and as a percentage between model and measured data were calculated to compare model and measurements.

Results and Discussions

Hattat A 110 MAXI brand tractor's CFD analysis was carried out and then distribution of the air velocity of air coming from vents were determined. Air velocity of behind the driver's seat section was 0.2 m/s from Figure 6. Air velocity of the outlet orifice cross section was determined as 4.5 m/s (Figure 7).

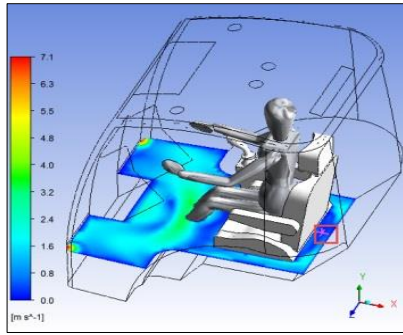

Figure 6. Behind seat

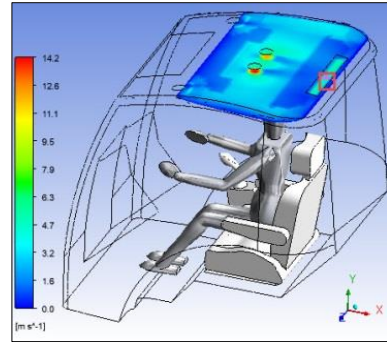

Figure 7. Outlet orifice

Speed values for the right and left rear vent respectively 12 m/s and 14.2 m/s were observed from Figure 8, and Figure 9. Right and left front of the vents points respectively 6.5 m/s and 5.5 m/s were determined. Air velocity value of the point on the knee was 2.7 m/s (Figure10), and for portion located on the right front console speed value was observed as 1.2 m/s (Figure11).

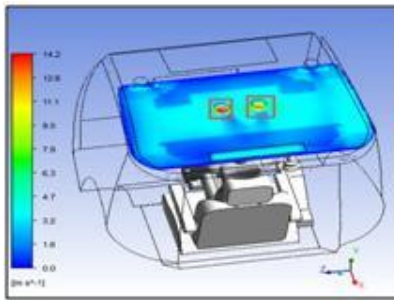

Figure 8. Rear vents

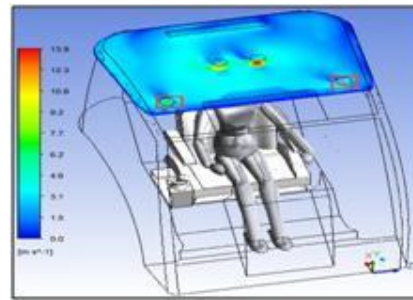

Figure 9. Front vents

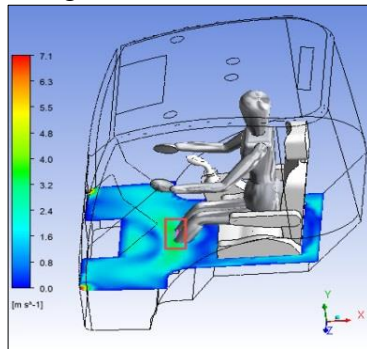

Figure 10. The below knee

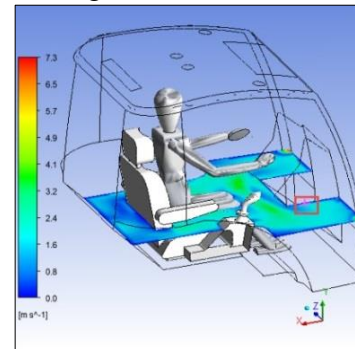

Figure 11. The front of right console

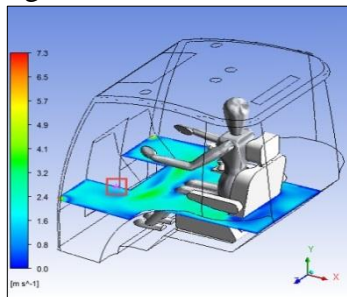

Figure 12. The left front of the console

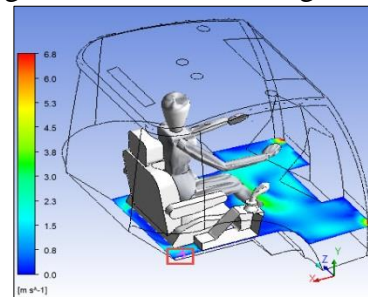

Figure 13. Under the right side of the seat

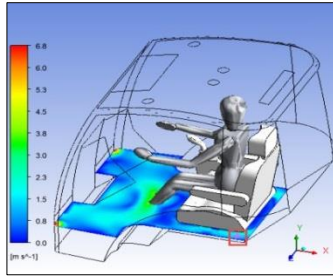

Figure 14. Under the left side of the seat

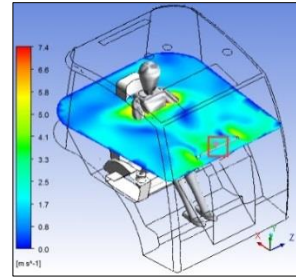

Figure 15. Middle of front console

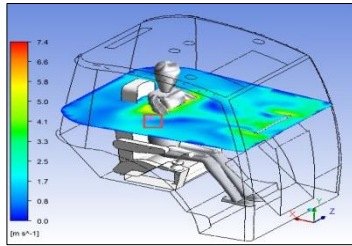

Figure 16. Right side of the cab

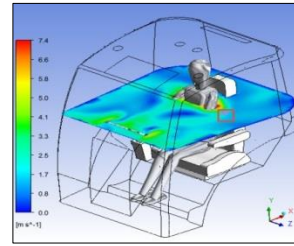

Figure 17. Left side of the cab

The comparison of the values CFD model (v_{CFD}), measurements (v_m) and differences (Δv) for winter conditions in the Tractor cabin are given in Table 4.

Table 4. The comparison of the values CFD model and measurements for air velocity

Sensor No and location	v_m (m/s)	v_{CFD} (m/s)	Δv (m/s)	% Δv
1 (right front vent)	5.85	6.50	0.65	11.1
2 (left front vent)	5.71	5.50	0.21	3.7
3 (right rear vent)	12.36	12.00	0.36	2.9
4 (left rear vent)	14.68	14.20	0.48	3.3
5 (outlet vent)	4.50	4.50	0.00	0.0
6 (left side of the driver)	2.00	2.30	0.30	15.0
7(right side of the driver)	1.20	1.40	0.20	16.7
8(Middle of front console)	3.60	3.30	0.30	8.3
9(right of front console)	0.90	1.20	0.30	33.3
10 (left of front console)	1.50	1.70	0.20	13.3
11 (the below knee)	2.50	2.70	0.20	8.0
12 (left the rear of seat)	1.40	1.20	0.20	14.3
13 (behind the rear of seat)	0.10	0.20	0.10	10.0
14 (right the rear of seat)	1.20	1.4	0.20	16.7
Mean	4.10	4.15	0.05	11.18

The maximum air velocity was determined as 14.68 m/s for left rear vent and the minimum air velocity was measured as 0.1 m/s at behind the rear of seat in the tractor cab. It can be seen from Table 4 that there were only small differences as 0.05 m/s between CFD model estimations (mean 4.1 m/s) and data logger measurements (mean 4.15 m/s) and relative error as percentage was calculated as 11.18%.

Conclusions

Variations in air velocity depend heat from the engine, differences between heat transfer coefficient of materials, angle of solar radiation and heat caused by tractor driver. According to the results of this research; differences between CFD model and measurements were within acceptable limits as error of 11.18 %. Created CFD model was successful to estimate air velocity in the tractor cab in 11.18. Even more sensitive studies than that the tractor cab 15-20% model error were evaluated (Moureh and Flick (2004) and Chourasi A and Goswami (2007). When the subject is discussed in terms of air velocity; air velocity value around driver except of the inlet and outlet air sections were above air velocity value 1.5 m/s, reported by Anonymous (1981).

References

- Akbulut C. (2010). A low speed mechanical surface aerator with vertical shaft by computational fluid dynamics (CFD) analysis (in Turkish:Analysis of Düşük Hızlı Düşey Milli Mekanik Yüzey Havalandırıcının Hesaplamalı Akışkanlar Dinamiği (HAD) Analizi). (MSc Thesis), Gebze High Technology Institute, Kocaeli, Turkey
- Akdemir S., Öztürk S., Edis F.O., Ülger P. (2012). Modelling of ambient factors by computational fluid dynamic (in Turkish: (CFD) in cold storage Soğuk Hava Depolarında Ortam Koşullarının Hesaplamalı Akışkanlar Dinamiği (CFD) ile Modellenmesi, 27. Tarımsal Mekanizasyon Kongresi Samsun, 8(2), 241-248.
- Anonymous. (1981). Microclimate cabs of self propelled agricultural machines and its effect on workers. World Health Organization. The Kiew Research Onstitute on Labour Hygiene and Occupational Disease, 1981. Kiev p. 16
- Chourasia M.K., Goswami T.K. (2007). Steady state CFD modelling of airflow, heat transfer and moisture loss in a commercial potato cold store, International Journal of Refrigeration, 30(4): 672–689
- Hattat. (2016). Tractor technical specification, <http://www.hattatraktor.com/tarla>(access date 19/06/2016)
- Kalkan E. (2007). Investigation of Tractor Safety Cabinet Static Loading Tests by Finite Element Method, MSc Thesis, Sakarya University, Graduate School of Natural and Applied Sciences.
- Moureh J., Flick D. (2004). Airflow pattern and temperature distribution in a typical refrigerated truck configuration loaded with pallets, International Journal of Refrigeration, 27: 464 – 474.
- Ruzic, D., Poznic A. (2011). Efficiency assessment of different cab air distribution system layouts, 15th Symposium on Thermal Science and Engineering of Serbia, Sokobanja, Serbia, October 18–21, 2011, proceeding:819-828 web page:
- Ruzic D. (2014). Comparison of a different air vents arrangements in a tractor cab using CFD techniques, The Eighth International Symposium KOD 2014 Machine and Industrial Design in Mechanical Engineering, 12 - 15 June 2014, Balatonfüred, Hungary Proceedings: 97-105
- Testo. (2015). Air velocity measurement devices, <https://www.testo.com.tr/urunler/hava-hizi-ve-debisi/index.jsp> (access date 19.06.2016)

SOILS OF EASTERN HERZEGOVINA AND WRB CLASSIFICATION SYSTEM

Vesna TUNGUZ^{1*}, Ljiljana NESIC², Jovica VASIN³

¹*University of East Sarajevo, Faculty of Agriculture, Bosnia and Herzegovina*

²*University of Novi Sad, Faculty of Agriculture, Serbia*

³*Institute of Field and Vegetable Crops, Novi Sad, Serbia*

*Corresponding author: *Vesna Tunguz, vesna.tunguz@gmail.com*

Abstract

The World Reference Base for Soil Resources (WRB) is the internationally-accepted soil classification system. In our age of increasing globalisation, however, international communication has become an urgent requirement. The WRB is intended to serve as a common denominator of national soil classification systems to facilitate such international communication. The aim of this study is to determine the characteristics of soil investigations of certain types of soil, using the example of eastern Herzegovina, harmonization of the national classification system of soil, with WRB classification, in order to adapt the existing system and become comparable with the WRB classification system and allow communication at the international level. Field research was carried out in 2010 to 2015. A total of 44 profiles of soil were open on the surface, which covers about 30,000 hectares. The external and internal morphology is described for all pedological profiles (Munsell Soil Color Charts, 1954), soil samples in a disturbed state were taken for all genetic horizons. Laboratory testing of physical and chemical properties of the soil were carried out according to generally accepted methods in laboratory Faculty of Agriculture in East Sarajevo, Bosnia and Herzegovina. WRB classification will provide a high degree of comparability, but also the international applicability of the results. The paper, based on detailed field and laboratory tests, show the cartographic unit area of eastern Herzegovina to the classification system of the World reference base for soil (WRB) and according to the criteria of classification of land that is now applied in the BiH (Resulović, 2008) and Serbia (Soil classification of Yugoslavia, Škorić et al., 1985). WRB classification will provide a high degree of comparability, but also the international applicability of the results.

Keywords: *Soils of Eastern Herzegovina, WRB classification, Soil classification of Yugoslavia*

Introduction

The World Reference Base for Soil Resources (WRB) is the internationally-accepted soil classification system, endorsed by the International Union of Soil Science (IUSS), and hence by the International Council of Scientific Unions (ICSU). It is intended for correlation of soil individuals as defined by the pedon concept and for defining map units of medium- and small-scale maps. It is ideally suited to discussing world soils, their major properties and genesis. The WRB is a two-level classification: 30 reference groups which have major differences in terms of pedogenesis, geography, and use potential. These are further specified by a set of qualifiers: strong expression, intergrades, and weak expression. As many qualifiers as apply to a soil may be used (Rossiter, 2007).

Anyone working in a natural science discipline will be aware of the necessity and importance of classification and systematic structuring. This naturally includes pedology. In fact, every country possesses its own pedological classification system tailored to its specific natural features. In our age of increasing globalisation, however, international communication has become an urgent requirement. The WRB is intended to serve as a common denominator of national soil classification systems to facilitate such international communication; some basis ideas of the WRB will, therefore, be outlined below by way of introduction: Globalization and

global environment issues necessitate harmonisation and correlation of technical languages, such as the one used by science. A common language is vital to the functioning of any science; The WRB is designed as an easy mean of communication amongst scientists; The Reference Base is not meant to substitute for national soil classification systems but rather to serve as a common denominator for communication at an international level. This implies that lower-level categories, possibly a third category of the WRB, could accommodate local diversity at country level. Concurrently, the lower levels emphasize soil features that are important for land use and management. (Deckers et al.,1998 in Nestroy, 2007)

The aim of this study is to determine the characteristics of soil investigations of certain types of soil, using the example of eastern Herzegovina, harmonization of the national classification system of soil, with WRB classification, in order to adapt the existing system and become comparable with the WRB classification system and allow communication at the international level.

Materials and methods

Field research was carried out in 2010 to 2015. A total of 44 profiles of soil were open on the surface, which covers about 30,000 hectares (Tunguz et al., 2015).

The external and internal morphology is described for all pedological profiles (Munsell Soil Color Charts, 1954), soil samples in a disturbed state were taken for all genetic horizons. Soil samples in undisturbed condition were taken from individual genetic horizons, in three repetitions, by cylinders of Kopecký and average soil samples were taken too.

Laboratory testing of physical and chemical properties of the soil were carried out according to generally accepted methods in laboratory Faculty of Agriculture in East Sarajevo.

Results and discussion

Setting aside systematic soil units of the studied area was done according to the principles of valid soil classification of soils in Yugoslavia (Škorić et al., 1985). The investigated soils in this area shown in Table 1.

From the order of automorphic soils, the following types of soil were singled out:

Table 1. Pedosystematic units of the studied area

Order	Class	Type	Subtype	Profile structure	WRB
Automorphic soils	Humus-accumulative soils	Limestone-dolomite black soil	Organo-mineral black soil	A-R, A-C	Molic Leptosol
		Rendzina or humus-calcareous soils	On soft limestones	A-R, A-C	Rendzic Leptosols
			On dolomite	A-R	Rendzic Leptosols
			On calcareous gravel	A-C	Rendzic Leptosols
	Cambic soils	Brown soil on limestone and dolomite	Typical	A-(B)-C	Cambic Umbrisols; Calcic Cambisols

25 profiles represented limestone-dolomite soils (Calcomelanosol). According to the classification of the soil of Yugoslavia (Škorić et al., 1985), they belong to the order of automorphic soil, to the humus-accumulative class, subtype organo-mineral black soil, variety: lytic, with A-C profile structure, with mollis horizon. Resulović et al. (2008) denote horizons of limestone-dolomite black soils as $A_{h-m}C$, and there is no transitional AC horizon.

According to WRB classification, limestone-dolomite black soil is Mollic Leptosol (FAO, 2006; 2014).



Figure 1. The external morphology of limestone-dolomite soils at the site Slivlja

Profile 5

Location: Slivlja

Elevation: 1120 m

Relief: flat

Vegetation: Pasture

On the pedological map of BiH R 1: 50000 soil described as:

Rendzinas on compact limestones, brown soil on limestones and cherts and delluvial soils of sinkholes $cRZ + c, RZ$
B+DV (40% + 40% + 20%)



Figure 2. The internal morphology of limestone-dolomite black soil

Order: Automorphic

Class: humus-accumulative

Type: limestone-dolomite black soil
(Calcomelanosol)

Subtype: Organomineral black soil

Variety: lytic

Profile: A-R

Form: With mollis horizon

A_{mo} (0-20 cm) - mollis, accumulative-humus horizon of brown color (7.5YR 4/2) when dry and when wet dark brown (7.5 YR 3/2). Texture is silty loam, powdery structure, non-carbonate, strongly imbued with veins of grassy vegetation.

Rendzine or humus-carbonate soils are in 9 profiles. According to the classification of soils of Yugoslavia (Škorić et al., 1985), they belong to the order of automorphic soils, the class of

humus-accumulative; subtype on the soft limestone, calcareous variety, low skeletal (profiles 19, 30, 55, 59, 70); subtype on dolomitic erosion, variety carbonate (profile 12); subtype on calcareous gravel (27, 61, 72), with the AR, A-C profile structure. According to Resulović et al. (2008), rendzinas are denoted as A_h -IC. The transitional horizon which is referred to as A_h IC is one of the characteristics by which rendzina differs from the black soil on limestone. According to WRB classification rendzina is Rendzic Leptosols (FAO, 2006; 2014).



Figure 3. The external morphology of rendzina, on the site Medanići

Profile 19

Location: Medanić

Altitude: 955 m

Relief: gently sloping

Vegetation: meadow

On the pedological map of BiH R 1:50000 soil described as: Rendzinas, brown very shallow and shallow soils on compact limestones and delluvial soil of sinkholes

C5RZ C51,2B+DV+(50%+30%+20%)



Figure 4. The internal morphology of rendzina

Order: Automorphic soils

Class: humus-accumulative soil

Type: Rendzina

Subtype: On calcareous gravel

Variety: Carbonate

Profile: A_{mo}-A_{mo}C-C

Form: Deep

A_{mo} (0-12 cm) mollis, accumulative-humus horizon of light gray color (10YR 6/2) when dry and when wet dark gray (10YR 5/2). Texture is silty clay loam, powdery structure, calcareous.

A_{mo}C (12-25 cm), gray (10YR 5/1) when dry and when wet dark gray (10YR 4/1). Texture is silty clay loam, powdery structure, calcareous.

C (25-50 cm) of light gray color (10 YR 6/2) when dry and when wet dark gray (10YR 5/2). Texture is silty clay loam, prismatic structure.

Brown soils on limestone and dolomite (10 profiles), according to the classification of the soils of Yugoslavia (Škorić et al., 1985), they belong to the order of automorphic soils, class cambic soils, subtype of non-carbonate (profiles 1, 2, 10, 11, 15, 18, 22, 60), carbonate (profiles 3, 29), with the A- (B) -C profile structure. According to Resulović et al. (2008) these soils are denoted as A_h-Brz-Cn. According to WRB classification, the brown soil on limestone and dolomite is Cambic Umbrisols; Calcic Cambisols (FAO, 2006; 2014).



Figure 5. External morphology of brown soils on limestone and dolomite (Calcocambisol), site Vrtine

Profile 3

Location: Vrtine

Altitude: 960 m

Relief: Upland

Vegetation: meadow

On the pedological map of BiH R 1:50000 soil described as: Brown soils on cherts and limestone r_{z,c}B



Figure 6. The internal morphology of brown soil on limestone and dolomite

Order: Automorphic

Class: Cambic soils

Type: Brown soil on limestone and dolomite (calcocambisol)

Subtype: Typical

Variety: Medium deep

Profile: Amo- Amo II- (B)

Form: loamy

A_{mo}I (0-5 cm) - mollis, accumulative-humus horizon of light brown color (10 YR 5/4) when dry and when wet brown color (10 YR 4/4). Texture is loam, crumb structure, non-carbonate, imbued with veins of grassy vegetation.

A_{mo}II (5-15 cm) - light brown (10 YR 5/4) when dry and when wet brown color (10 YR 4/4). Texture is loam, crumb structure, calcareous, imbued with veins of grassy vegetation.

(B) (15-42 cm) - light brown (10 YR 5/6) when dry and when wet dark brown color (10 YR 4/4). Texture is clay loam, large grained structure, calcareous.

Conclusion

Work on pedological study and mapping of Bosnia and Herzegovina are in the seventies and eighties of the last century. Map-making unit of land are defined in accordance with current soil classifications of time in which the soil maps made. We used the different terms and have been applied different criteria for defining the mapping unit of land.

The paper, based on detailed field and laboratory tests, show the cartographic unit area of eastern Herzegovina to the classification system of the World reference base for soil (WRB) and according to the criteria of classification of land that is now applied in the BiH (Resulović, 2008) and Serbia (Soil classification of Yugoslavia, Škorić et al., 1985).

WRB classification will provide a high degree of comparability, but also the international applicability of the results.

References

- Deckers J.A. et al.,1998. in NESTROY, O. (2007): The World Reference Base for Soil Resources (WRB) as an Instrument for the National and International Communication, *Agriculturae Conspectus Scientificus*, Vol. 72, No. 1 (9-12)
- FAO (1998): World Reference Base for Soil Resources, World, Soil Resources Report No. 84. Rome.
- FAO (2006): Guidelines for soil description. 4th edition. Rome.
- FAO (2014): World Reference Base for Soil Resources, World, Soil Resources Report No. 106. Rome.
- Munsell Soil Color Charts (1954): Maryland, USA.
- Resulovic, H., Custovic, H., Cengic, I. (2008): Soil classification, Sarajevo.

- Rossiter, D. G. (2007): Classification of Urban and Industrial Soils in the World Reference Base for Soil Resources, *Journal of Soils and Sediments*, Volume 7, Issue 2, pp 96-100.
- Skorić A., Filipovski DJ., Ciric M. (1985): Soil classification Jugoslavije, special edition, the book LXXVIII, Department of Natural Sciences and Mathematics, Book 13, Academy of Sciences and Arts of Bosnia and Herzegovina, Sarajevo (1-72)
- Tunguz, V., Nestic, Lj., Petronic, S., Mojevic, M., Berjan, S., Jugovic, M. (2015): Application of the World Reference Base for Soil Resources (WRB) guide at selected sites of Eastern Herzegovina, *Book of Abstracts, Agrosym 2015, Jahorina, Bosnia and Herzegovina*.

THE EVALUATION OF AIR POLLUTION IN SOUTH-EASTERN REGION OF ALBANIA

Lirim BEKTESHI^{1*}, Pranvera LAZO², Trajçe STAFILLOV³

¹University of Elbasan, Faculty of Natural Sciences, Department Of Chemistry, Elbasan, ALBANIA

²University of Tirana, Faculty of Natural Sciences, Department Of Chemistry, Tirana, ALBANIA

³ Institute of Chemistry, Faculty of Science, Sts. Cyril and Methodius University, Skopje, MACEDONIA

*Corresponding author: lirimbekteshi@ymail.com

Abstract

Atmospheric pollution causes serious damage for human health and to all natural ecosystems. Nowadays, the biggest provocative of atmospheric pollution is anthropogenic human activities and transport sector, main pollutants being heavy metals (HM). Study and evaluation of air pollution level from heavy metals in south – eastern Albania region was performed with mosses (specie *Hypnum cupressiforme*) as bio-monitor. Active biomonitoring technique for determination of atmospheric deposition level of heavy metals was applied in Albania since 2010. Based on the fact that the mosses are plant with un-development root system, consequently they take the nutrients mainly from rain and atmospheric deposition, the amount of heavy metals in those, reflect direct the air quality. The mosses were collected in 7 different stations in south- eastern region of Albania. Sampling was performed in accordance with the LRTAP Convention – ICP Vegetation protocol and sampling strategy of the European Program on Bio-monitoring of Heavy Metal Atmospheric Deposition. The ICP/AES analysis of 11 elements (Al, Cr, Cu, Fe, Li, Mg, Mn, Ni, Pb, V and Zn) was performed by the Institute of Chemistry, Faculty of Science, Sts. Cyril and Methodius University, Skopje, Macedonia. Statistical analysis and correlation analysis, was applied to distinguish elements mainly of anthropogenic origin from those predominantly originating from natural sources and to point out the most polluted areas. The study of the contamination factor for the analyzed elements show that the region south - eastern Albania is slightly contaminated by heavy metals.

Keywords: *moss, ICP/AES, heavy metal, contaminated factor.*

Introduction

The study of atmospheric deposition of trace elements through bio-monitoring technique and analytical treatment with special methods, is performed for the first time in Albania in 2010. The aim of this study is to assess the level of air contamination by heavy metals in south-eastern region of Albania, as an important touristic region..

Monitoring of air pollution using bioindicators is emerging as a potentially effective and more economical alternative performing by direct ambient air measurements. This is especially relevant for monitoring large areas (Rühling and Tyler, 1968). The usefulness of mosses in determining trace- and heavy-metal concentrations in different geographical areas has been discussed and demonstrated in several studies (Gjengedal and Steinnes, 1990; Markert *et al.*, 2003). In practice, controlling anthropogenic air pollutants is a very complex problem where sources and emissions have to be managed and monitored, and economic aspects have to be integrated.

Suspended particulates are introduced into the atmosphere from a variety of natural and anthropogenic sources, although the latter are predominant in the urban and industrial areas. Some of the well known anthropogenic processes contributing to the airborne particulate pollution include transportation, mine and industrial activities, biomass burning and

agricultural activities. In the case of anthropogenic pollution, the particulate matter can contain metal trace element like Cr, Cu, Zn, Ni, Pb, and so forth (Berandovky *et al.* 2012).

The group of mosses *Hypnum cupressiforme* (family of bryophytes) are plants that have no real roots, thus they have a close relationship with the atmosphere, and get their food from wet and dry atmospheric depositions. (Rühling and Steinnes, 1998; Puckett, 1998).

The qualities, that make the mosses usable as bio-monitors, primarily depend on their ability to absorb and fixed metals in their tissues. The stability of metal organic complexes and chelates and the great cation exchange capacity of the tissues are primarily conditions for the sorption of heavy metals by mosses (Tyler, 1970).

Heavy metals are stable in the atmosphere and soil. Being such, they contaminate the soil and air. From contaminated soil through crops, they passed to humans and animals, so enter the food chain. Through the process of bioaccumulation and their contents biomagnifikimit grow from one to the next link in the chain, so those in low concentrations are dangerous for health. Combustion processes are the source of contamination by heavy metals, as these are ingredients (although in small amounts) of fuels such as coal, diesel or gasoline (Lammel *et al.* 2006). Uncontrolled combustion processes of waste disposal in their fields or burning in incinerators are source of pollution from heavy metals. (Nriagu 1989). The aim of this study is to assess the air pollution in south-eastern region of Albania by heavy metals, and determine the sources of this pollution.

Material and Methods

Study area

The study area was situated in south-eastern Albania. The study area has comprised of diverse geographical representation, composed of mountains and plateau at altitudes above 700m from sea level being characterized from a continental climate.



Moss species and sampling

Moss sampling was performed according to the guidelines of the UNECE-ICP Vegetation monitoring manual for air pollution monitoring of the atmospheric deposition of heavy metal deposition using bryophytes, as well as the procedure used in the previous European moss surveys Monitoring Manual 2010. Samples were collected at least 300 m from main roads and populated areas and at least 100 m from local roads, and 200 m from villages or single houses.

Figure 1. Monitoring station in the area study

Sample preparation and digestion

In the laboratory, the samples were cleaned but not subjected to any further washing and dried to a constant weight for 48 hours at room temperature. Green and green-brown parts of the moss that correspond to three years of moss growth were sorted and prepared for analysis. For digestion, moss samples (0.5000 g) were placed in Teflon digestion vessels, and 7 ml of trace

pure HNO₃ (Merck, Germany) and 2 ml H₂O₂ p.a. (Alkaloid, Macedonia) were added, and the vessels were capped closed, tightened and placed in the rotor of a Mars microwave digestion apparatus (CEM, USA). Plant samples were digested at 180° C. After cooling, the digested samples were quantitatively transferred into 25 ml calibrated flask.

Instrumentation

The analyses were performed at the Institute of Chemistry, Faculty of Natural Sciences and Mathematics in Skopje. All analyzed elements (Al, Cr, Cu, Fe, Li, Mg, Mn, Ni, Pb, V and Zn) were determined by the application of ICPAES (Varian, 715-ES) applying an ultrasonic nebulizer CETAC (ICP/U-5000AT+).

Results and discussion

Based on obtained data, aiming to evaluate contamination level and element distribution, the analytical results were statistically treated by using descriptive statistics.

High differences exist between max and min concentrations values of Al, Fe, Ni, V and Mn in the moss samples. Coefficients of variation (CV) for Cu, Mg, Fe and Mn are moderate (20-45%) and for Zn, Pb and Ni are higher than 70% . The elements Zn, Pb and Ni present the highest statistical parameters (CV, kurtosis and skewness) see Table 1.

Table 1. Descriptive statistics of the data analysis (in mg/kg DW)

Element	Al	Cr	Fe	Li	Mg	Mn	Ni	Pb	V	Cu	Zn
Mean	1401	12.63	1798	1.43	2146	70	39	2.82	3.21	9.31	30
Median	1046	10.50	1861	1.19	2246	60	23	1.38	2.38	8.76	18
Kurtosis	-0.10	2.96	-0.81	-0.16	-1.48	-1.0	5.00	8.09	-0.9	2.42	7.66
Skewness	0.83	1.74	0.62	0.18	0.28	0.69	2.13	2.81	0.65	1.50	2.71
EuroMed	200	0.55	209	-	1730	256	1.14	1.17	0.92	3.6	26.5
CV%	57	58	36	62	30	43	89	82	73	20	70

Generally, the highest values of these elements (Al, Fe, Cr, Ni) were measured near the industrial centers positioned mainly in central part of the country. The influence of the wind is stronger in the southeast direction, which is reflected in the increase of aluminum content in mosses of south – eastern region of Albania.

The high concentration values of the elements Al, Li, Fe, Ni, Mn and Pb typically are associated with soil particles (in the study are have operated different Fe and Ni mines). The present median values are generally comparable with those from Macedonia and other neighboring countries. (Qarri *et al* 2013). The metals concentrations are substantially higher than the corresponding values from most European countries (except Zn) carried over the years 2010-2011. (Harmens *et al* 2013)

Table 2. The results of correlation between elements in the studied moss.

Eleme	Al	Cr	Fe	Li	Mg	Mn	Ni	V	Pb	Cu
Cr	0.14 0.71									
Fe	0.77 0.65	0.02 0.06								
Li	0.99 0.00	0.26 0.51	0.80 0.01							
Mg	- 0.69 0.09	0.32 0.39	-0.08 0.83	0.52 0.15						
Mn	0.91 0.01	0.19 0.63	0.81 0.01	0.84 0.01	-0.50 0.17					
Ni	0.63 0.07	-0.64 0.43	0.30 0.78	-0.11 0.09	-0.60 0.07	-0.42 0.26				
V	0.62 0.07	0.03 0.94	0.31 0.42	0.70 0.03	-0.40 0.30	0.28 0.47	-0.72 0.03			
Pb	0.93 0.00	0.39 0.30	0.87 0.00	0.96 0.00	-0.37 0.33	0.84 0.01	-0.44 0.24	0.55 0.13		
Cu	0.29 0.45	-0.67 0.05	-0.26 0.51	0.19 0.62	-0.83 0.01	0.25 0.52	-0.39 0.30	0.15 0.71	0.06 0.88	
Zn	0.28 0.47	0.20 0.60	0.20 0.61	0.29 0.46	-0.27 0.49	0.18 0.65	-0.48 0.20	0.40 0.28	0.12 0.76	-0.20 0.61

To distinguish some relations on the origin of the elements in moss samples, correlation analysis between elements concentrations was carried out. The results are shown in Table 2. Significant correlations were found for the pairs of elements Al-Li, Al-Mn and Al-Fe.

Multivariate analysis

In order to identify the main source categories of moss samples regarding the site contamination and element distribution as well as to detect the similar patterns of element concentrations, cluster analysis (CA), and factor analysis (FA), were applied.

The results of cluster analysis clearly explain the geogenic associations of these elements, which may be caused by wet and dry depositions of soil dust in moss samples as described down here for each cluster.

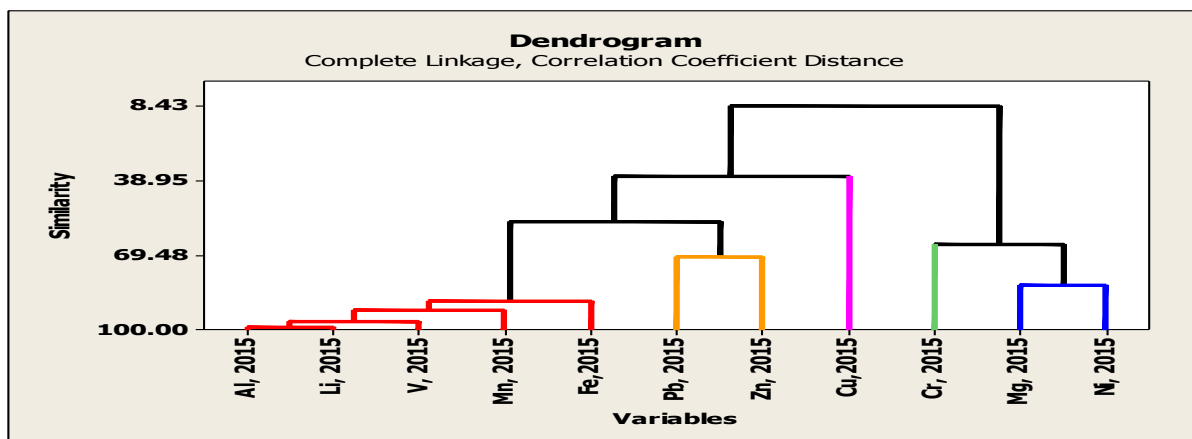

Figure 2. Dendrogram Cluster analysis (CA)

Cluster 1 is associated with the elements Al, Li, Mn, V and Fe typically chromite mineralisations in Shibeniku and Pogradeci areas. Cluster 2 is associated with Pb and Zn that were related with nickel-silicate and iron-nickel mineralisations in this region of Albania. Cluster 3 is associated with Cu as typical element of sulphure ores in the region. Cluster 4 is associated with Cr. Elevated level of Cr concentrations in moss samples were observed in the vicinity of chromium mines in the region. Cluster 5 is associated with Mg and Ni originating from magnezite cliffs of area and chrome mines.

This classification supports the results obtained through factor analysis by distinguishing two main factors on element distribution: geogenic origin and industrial pollution.

The results of Factor Analysis are summarized in Table 3 and Figure 3. Through the results of Factor Analysis three main factors that represent 88.5 % of total variance were identified through the Factor Analysis (Table 3, Figure 3).

Factor 1 is the strongest factor representing 51.6 % of the total variance. It is associated with the elements Al, Li, Mn, V, Pb, Cr and Fe (see Table 3 the values of each element). This associations may be attributed to their geogenic origin related with soil particles. The association of Cr and Fe is also related with air pollution from industrial emissions.

Factor 2 is the second strongest factor with 24.5% of the total variance. It is mainly influenced by the high loadings of Cu, as typical element of sulphure ore as chalcopyrite. The main deposits of this mineral are situated in Pogradeci area. This factor probably related to soil dust emissions

Factor 3 represent only 12.4 % of the total variance. This factor influenced from high loadings of Zn and Pb and is negatively loaded by the elements Cu, and Ni. The negative loading values may indicate a reverse tendency on the concentration of these elements when the total metal concentrations increase.

Principal Component Analysis: Al, 2015, Cr, 2015, Fe,2015, Li, 2015, Mg, 2015, Eigenanalysis of the Correlation Matrix

Table 3 Principal component analysis data

Eigenvalu	5.67	2.68	1.37	0.67	0.38	0.16	0.05	0.01	0.00	0.00	-0.0
Proportion	0.52	0.24	0.12	0.06	0.04	0.01	0.01	0.00	0.00	0.00	-0.0
Cumulativ	0.52	0.76	0.88	0.95	0.98	0.99	1.00	1.00	1.00	1.00	1.0

Variable	Al	Cr	Fe	Li	Mg	Mn	Ni	Pb	V	Cu	Zn
PC1	0.42	0.08	0.32	0.41	-0.26	0.37	-0.28	0.29	0.39	0.11	0.15
PC2	0.01	-0.53	-0.37	-0.05	-0.40	-0.06	-0.30	0.09	-0.16	0.53	-0.03
PC3	-0.09	0.08	-0.16	-0.04	0.06	-0.29	-0.35	0.40	-0.17	-0.32	0.68

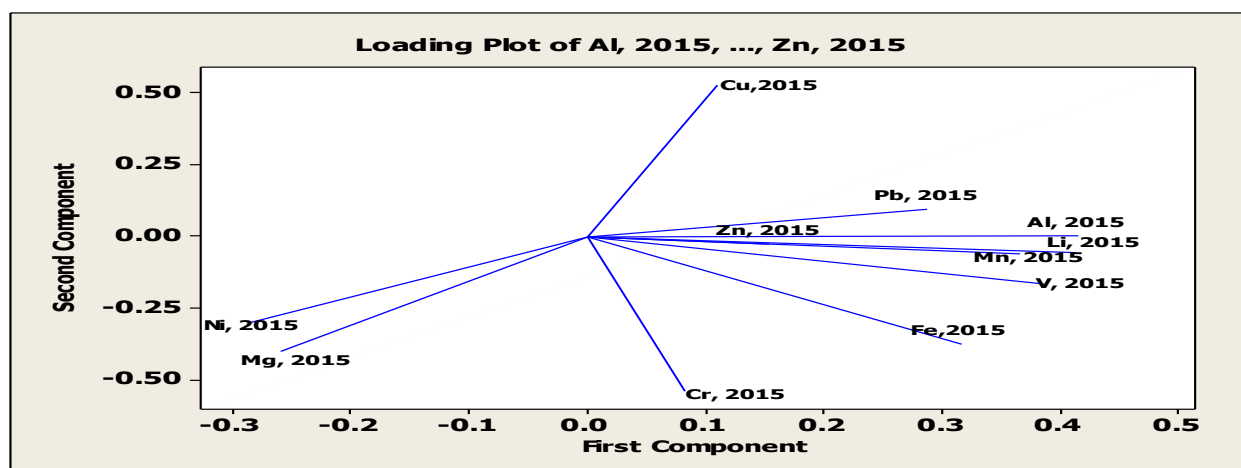

Figure 3. Loading plot of elements.

Conclusion

From the obtained results, we can say that the south-eastern region Albania (Korça - Pogradeci-Erseka-Gramshi region) is generally a region less contaminated are from heavy metals.

By comparing the concentrations of metals in moss with the European Union carried over the years 2010-2011, we see that they are lower than the European average.

Higher values than the European average represent Fe, Ni, Cr and Ca (approximately 3 to 5 times higher), fact that related to mineral characteristics of the area and industrial activities operating in this region as nickel iron mines, nickel - silicate, chromium or quarry industry (Zemblaku area).

References

- Barandovski L, Frontasyeva MV, Stafilov T, Sajin R, Pavlov SS, Enimiteva V (2012) Trends of atmospheric deposition of trace elements in Macedonia studied by the moss biomonitoring technique. *J Environ Sci Health Part A Taylor & Francis* 47:2000–2015
- Gjengedal and Steines (1990). Uptake of metal ions in moss from artificial precipitation. *Environ. Monit. Assess.* 14: 77-87.
- Harmens, H., Norris, D., Mills, G. and the participants of the moss survey, 2013. Heavy metals and nitrogen in mosses: spatial patterns in 2010/2011 and long-term temporal trends in Europe. <http://icpvegetation.ceh.ac.uk>; Accessed on 25 July 2013
- Lammel G., Ghim Y. S., Broekaert J., Gao H. 2006: Heavy Metals In Air of an Eastern China Coastal Urban Area and the Yellow Sea. *Fresenius Environmental Bulletin*, Volume 15, No 12a, 1539-1548.

- Markert B. A., Breure A. M. & Zechmeister H. G. 2003: Definitions, strategies and principles for bioindication/biomonitoring of the environment. In: Markert B. A., Breure A. M. & Zechmeister H. G. (eds) *Bioindicators and biomonitors*. Elsevier, Oxford, p 3-39.
- Rühling Å., Tyler G. 1968: An ecological approach to the lead problem. *Botaniska Notiser*. 122: 248-342.
- Markert B., Wappelhorst O., Weckert V., Herpin U., Siewers U., Friese K., Breulmann G. 1999: The use of bioindicators for monitoring the heavy-metal status of the environment. *Journal of Radioanalytical and Nuclear Chemistry*. 240: (2) 425-429.
- Nriagu J. O. 1989: A global assessment of natural sources of atmospheric trace metals. *Nature* 338:47-49.
- Puckett KJ. 1998: Bryophytes and lichens as monitors of metal deposition. In: Nash TH III & Wirth V(eds) *Lichens, bryophytes and air quality*. J. Cramer, Berlin, Stuttgart. *Bibliotheca Lichenologica*. 30: 321-267.
- Qarri F, Lazo P, Stafilov T, Frontasyeva M, Harmens H, Bekteshi L, Baceva K, Goryainova Z (2013) Multi-elements atmospheric deposition study in Albania. *Environ Sci Pollut Res* doi 10.1007/s-11356-013-2091-1.
- Rühling Å., Steinnes E. 1998: Atmospheric heavy metal deposition in Europe 1995-1996. *Nordic Council of Ministers, NORD* 15: 66.
- Tyler, G.: 1970, 'Moss Analysis – A Method for Surveying Heavy Metal Deposition, in: Englund, H. M. and Berry, W. T. (eds.), *Proc. Sec. Int. Clean Air Congress*, Academic Press, New York.

LONG TERM VARIATION OF RAINFALL IN SOUTHEASTERN ANATOLIAN PROJECT (GAP) AREA

Kadri YUREKLI

Agriculture Faculty, Department of Biosystem Engineering, Tokat-Turkey,
Corresponding author: kadriyurekli@yahoo.com

Abstract

In this study, variation in annual and seasonal rainfalls in Southeastern Anatolian Project (GAP) area was analyzed by using the non-parametric and parametric approaches. According to Mann-Kendall (MK) test, there were significance monotonic trend in the five of the considered rainfall stations, whereas unit root test was incompatible with the MK.

Key Words: *GAP, Mann-Kendal, unit root test*

Introduction

The increased concentrations of greenhouse gases caused by human activities would alter the magnitude and seasonal variations in temperature and precipitation patterns in many parts of the globe (IPCC (2007)). According to IPCC (2013), in the last half of the 20th century, there has been an upward trend in the number of heavy precipitation events in many parts of the world. Giorgi (2006) emphasized that Mediterranean basin was among the most sensitive regions in term of the future precipitation extreme conditions. Unal et al. (2012) reported that a dominating trend in decreasing annual precipitation existed throughout Anatolia, including west, and southwest sections while an increased trend in annual precipitation was observed only in northeast Black Sea region of Turkey.

Due to the foregoing described facts, the analysis of long term variation of seasonal and annual rainfall in Southeastern Anatolian Project (GAP) region, planned in the boundaries of the upper Euphrates and Tigris river basin is very crucial owing to the inherent climate characteristic in the GAP area. The GAP project is the largest investment in terms of regional development throughout the history of Turkish Republic and the fourth largest irrigation project in the world. The development of the GAP region was originally deliberated on its water and land resources. Therefore, a probable drought event would cause the failure of the GAP because of the water resources development program as relating to the GAP consists of 13 groups of irrigation and energy projects, seven of which are on the Euphrates River and, the largest and comprehensive project including Atatürk Dam and Urfa Tunnels is on the lower Euphrates. (Altınbilek 2004; Kibaroglu and Unver 2000). The main objectives of this study were: to make up new data set to be analyzed by summing up monthly precipitation of the stations in the study area, and to apply Mann-Kendal (MK), Sen Slope estimators tests and unit root test to new data set in order to detect the direction and magnitude of a trend.

Material and Methods

The Euphrates–Tigris basin is largely fed from snow precipitation over the uplands of north and eastern Turkey, Iraq and Iran. Precipitation in the basin largely falls during the winter months from October to April. A large proportion of precipitation in this period occurs as snow on the uplands and it remains in solid form until temperatures increase up to the spring or early summer. Thereupon, snow-melt is decisive on the flow characteristics of both the Euphrates and Tigris. A substantial amount of precipitation which converts to runoff or groundwater in the basin takes places over Turkey (Beaumont 1998). In the GAP region, including 9 provinces, monthly rainfall amounts from 9 rain gauges (site) operated by Turkish

State Meteorological Service were used in the analysis. The geographical locations, characteristic information and data availability of the 9 stations in the GAP are presented in the Figure 1 and Table 1. The data quality control of monthly rainfall series was performed in the context of the missing data and homogeneity. Each station performed the homogeneity condition according to Mann-Whitney U.

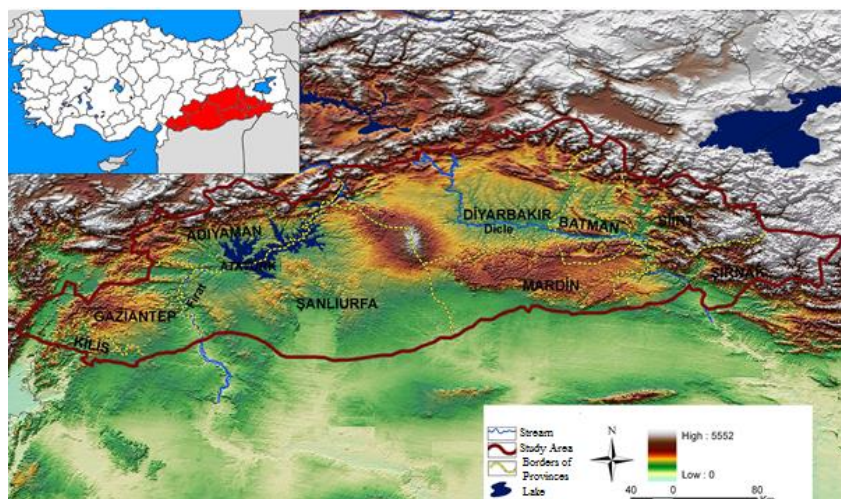

Figure 1. Rainfall stations in GAP region

In the analysis, the monthly data sets of the 9 sites were arranged at seven different categorical data sets, namely period one (from January to March), period two (from April to June), period three (from July to September), period four (from October to December), period five (from January to June), period six (from January to September) and period seven (from January to December). Monthly precipitation time series were summed up to obtain the data set to be analyzed for each station at time scales of interest.

Table 1. Characteristics of the sites in the GAP area

Gauging Stations	Longitude (E)	Latitude (N)	Elevation (m)	Mean Annual Precipitation (mm)	Data Period
Gaziantep	37°22'	37°05'	840	554	1940-2013
Kilis	37°05'	36°44'	680	498	1960-2013
Adiyaman	38°17'	37°46'	669	713	1963-2013
Sanliurfa	38°46'	37°08'	547	453	1929-2013
Mardin	40°44'	37°18'	1150	678	1940-2013
Diyarbakir	40°14'	37°55'	677	487	1929-2008
Batman	41°07'	37°52'	550	492	1952-2013
Sirnak	42°47'	37°53'	1350	673	1970-2013
Siirt	41°57'	37°56'	895	718	1938-2013

Analysis of change in the data

Variation in meteorological variables has been tested using both parametric and non-parametric approaches (e.g., Abdul Aziz and Burn 2006; Espadafor et al. 2011; Hamed 2008; Liang et al. 2010; Tabari and Talae 2011). The non-parametric approaches have some advantages over the parametric. The most attractive one is the assumption that values have any distribution form for non-parametric approaches, the requirement is the normally distributed variables (Huth 1999; Zhang et al. 2008). The Mann-Kendall (MK) method is the most popularized non-parametric method to define variation in hydrologic variables. The null hypothesis (H_0) of the MK test assumes that time series values are independent, and identically distributed while alternative hypothesis (H_1) is that there is a monotonic trend in the data set. Mathematical formulation of this test is given as following:

$$S = \sum_{i=1}^{n-1} \sum_{j=i+1}^n \text{sgn}(x_j - x_i) \quad \text{sgn}(x_j - x_i) = \begin{cases} +1 & \text{if } (x_j - x_i) > 0 \\ 0 & \text{if } (x_j - x_i) = 0 \\ -1 & \text{if } (x_j - x_i) < 0 \end{cases} \quad (1)$$

According to Eq.(1), a positive or negative S value indicates upward and downward monotonic trend in the data, respectively. It is assumed that the statistic S is approximately normally distributed with the mean zero and, in case where the sample size $n > 10$, its variance and the MK test statistics (Z_{MK}) are calculated by the equation 2 and 3.

$$\sigma_s^2 = 18^{-1} \left[n(n-1)(2n+5) - \sum_{i=1}^m t_i(t_i-1)(2t_i+5) \right] \quad (2)$$

$$Z_{MK} = \left\{ \begin{array}{l} \frac{S-1}{\sqrt{\sigma_s^2}} \quad \text{if } S > 0, \\ 0 \quad \text{if } S = 0, \\ \frac{S+1}{\sqrt{\sigma_s^2}} \quad \text{if } S < 0 \end{array} \right\} \quad (3)$$

The Z_{MK} test statistic here follows a standard normal distribution. This value calculated from the Eq.(3) is compared to the value of $Z_{1-\alpha/2}$ from standard normal distribution table at 5% significance level. The null hypothesis associated with no trend is accepted if the Z_{MK} test statistic is smaller than the critical value of the standard normal distribution at the significance level of α . The Z_{MK} test statistic having a positive or negative value signifies an increasing or decreasing trend.

Theil-Sen's estimator (Q_{med}) (Sen 1968; Theil 1950) has been substantially considered in specifying the magnitude and direction of the trend in hydrologic variables. The brief descriptions of the statistical method are in Yurekli (2015). In order to directly apply the MK test to the raw data, there should be no serial correlation among the observations; otherwise the presence of serial correlation in the raw data would lead to misinterpretation over trend (Hamed and Rao 1998). According to Yue and Wang (2002), the existence of serial correlation in any data set would result in a significant positive trend. To avoid the undesirable situation, Yue and Pilon (2003) suggested a new modified technique called as a trend-free pre-whitening (TFPW), and was used in the study. The percent change related to the seasonal and annual rainfall data set with monotonic trend was found by the following equation given in Petrow and Merz (2009).

$$\Delta x_R = (x_{end} - x_{start}) \times (\bar{x})^{-1} \quad (4)$$

In equation, X_{end} , x_{start} are the values associated with the trend line at the end and at the start of observation period. \bar{x} is the mean of observations. In this study, parametric unit root test was also applied to data sequences.

Results and discussions

In the first attempt, The $Q(r)$ statistic suggested by Ljung and Box (1978) was applied to all of the series to detect the presence of serial correlation among the observations. For this purpose, the statistic for every data was calculated for lag one and was compared to critical value of the χ^2_{Table} at 5% significant level. This statistic value was shown in bold characteristic when this value was greater than critical value of the reference table (Table 2). The TFPW method was applied to the data found statistically significance in terms of serial dependence.

Table 2. $Q(r)$ statistics at lag one of each station in the GAP area (Yurekli, 2015)

Gauging Stations	$Q(r)$ value							χ^2 -table (P)>0.05
	P-I	P-II	P-III	P-IV	P-V	P-VI	P-VII	
Gaziantep	0.71	0.11	2.34	0.27	0.70	0.57	0.85	0.13-0.70
Kilis	1.66	0.01	0.48	0.18	1.61	1.91	0.44	0.17-0.92
Adiyaman	0.38	0.01	2.26	0.14	0.48	0.48	0.02	0.13-0.96
Sanliurfa	2.79	1.52	1.75	0.10	4.67	6.12	0.34	0.01-0.75
Mardin	2.69	3.16	7.10	0.00	0.00	0.00	2.38	0.01-1.00
Diyarbakir	1.04	6.11	0.13	2.05	4.82	4.98	1.97	0.01-0.72
Batman	0.15	0.97	0.10	0.33	0.00	0.00	0.77	0.32-0.99
Sirnak	1.57	0.88	1.21	1.24	0.01	0.04	1.32	0.21-0.92
Siirt	4.48	1.99	2.81	0.03	0.40	0.39	5.88	0.02-0.87

Mann-Kendal test using one-sided hypothesis at 5% significance level was applied to the seasonal and annual rainfall data sets. The results of this test are presented in Table 3. As can be seen in the table, monotonic trend was detected for the rainfall series of five provinces in the GAP region. The seasonal and annual rainfall series belonging to Kilis, Mardin and Siirt provinces showed downward trend while the rainfall series in PIII and PIV periods for Gaziantep and Sirnak provinces have significance upward trend.

Table 3. The results of Mann-Kendal test for each station in the study area (Yurekli, 2015)

Gauging Stations	Z_{MK} test statistic						
	P-I	P-II	P-III	P-IV	P-V	P-VI	P-VII
Gaziantep	-1.12	0.60	1.13	1.77 ⁺⁺	-0.27	-0.04	0.79
Kilis	-1.98 ^{**}	-1.00	1.64	-0.12	-2.39 ^{**}	-2.05 ^{**}	-1.77 ^{**}
Adiyaman	-0.41	-0.64	0.51	0.06	-0.68	-0.63	-0.33
Sanliurfa	-1.43	-0.33	***	0.16	-1.30	-1.20	-0.72
Mardin	-2.10 ^{**}	-0.76	***	-0.71	-2.03 ^{**}	-1.99 ^{**}	-2.11 ^{**}
Diyarbakir	-0.47	-0.41	-0.67	0.30	-0.37	-0.39	-0.47
Batman	-1.44	-0.92	-0.47	-0.50	-1.30	-1.47	-1.47
Sirnak	1.33	-0.85	2.96 ⁺⁺	1.92 ⁺⁺	1.19	1.36	1.56
Siirt	-2.38 ^{**}	-0.79	0.89	-0.63	-1.42	-1.30	-1.66 ^{**}

The “++,**” shows increasing and decreasing monotonic trend in the data of interest

The MK test for the PIII period of Sanliurfa ve Mardin sites could not be carried out due to many years with no precipitation. Theil-Sen’s estimator results of five stations having monotonic trend are in the Table 4. In the same table, the highest and lowest values of the

TSE at 99 % confidence level were also given. The TSE values were located between the highest and lowest values.

Surprisingly, the results of parametric unit root test were quite different from that of Mann-Kendall test. The unit root test found to be monotonic trend in the period III of Sanliurfa site and the period V of Sirnak site while there was no trend for the other data sets. For the sites with monotonic trend in the Table 3, percent change varied between 19 and 57%. The highest percent change was in the period III for Sirnak site while the lowest percent change was in the period VII for Kilis site.

Table 4. The TSE results in quantifying the slope of the trend line (Yurekli, 2015)

Gauging Stations	Q_{med}						
	P-I	P-II	P-III	P-IV	P-V	P-VI	P-VII
Gaziantep				0.71			
Kilis	-1.19				-1.82	-1.55	-1.79
Mardin	-1.31				-1.56	-1.54	-2.36
Sirnak			0.13	2.51			
Siirt	-1.01						-1.65
Q_{min}	-2.94	-0.26	-0.13	-5.74	-4.19	-3.88	-5.34
Q_{max}	0.45	1.41	1.69	6.11	0.48	0.58	0.97

Conclusion

In conclusion summarize the main findings of trend analysis in the context of GAP. The most comprehensive attempt to the date have been achieved by Turkish Republic with Southeastern Anatolian Project (GAP), which is the largest investment for regional development in the history of Turkey and the fourth largest irrigation project in the world. In this sense, having information on rainfall variation in the region with dominant arid and semi-arid climate characteristic are crucial in terms of a sustainable water resources management. Especially, the decrease in precipitation would affect the failure of the GAP because the water resources development program in the GAP is composed of 13 groups of irrigation and energy project.

References

- Abdul Aziz, OI, Burn, DH (2006). Trends and variability in the hydrological regime of the Mackenzie River Basin. *Journal of Hydrology*, 319, 282–294.
- Altınbilek, D (2004). Development and management of the Euphrates–Tigris basin. *Water Resources Development*, 20, 15-33.
- Beaumont, P (1998). Restructuring of Water Usage in the Tigris-Euphrates Basin: the Impact of Modern Water Management Policies. Ed. Albert J, Bernhardsson M and Kenna R. *Transformations of Middle Eastern Natural Environments: Legacies and Lessons*. Yale School of Forestry and Environmental Studies, Bulletin Series No. 103, New Haven, Connecticut, USA, pp. 168–186.
- Espadafor, M, Lorite, IJ, Gavilán, P, Berengena, J (2011). An analysis of the tendency of reference evapotranspiration estimates and other climate variables during the last 45 years in Southern Spain. *Agriculture Water Management*, 98, 1045–1061.
- Giorgi, F (2006). Climate change Hot-Spots. *Geophysical Research Letters*, 33, L08707.
- Hamed, KH (2008). Trend detection in hydrologic data: The Mann-Kendall trend test under the scaling hypothesis. *Journal of Hydrology*, 349, 350–363.
- Hamed, KH, Rao, AR (1998). A modified Mann-Kendall trend test for autocorrelated data. *Journal of Hydrology*, 204, 182-196.

- Huth, R (1999). Testing for trends in data unevenly distributed in time. *Theoretical and Applied Climatology*, 64: 151–162.
- IPCC. (2007). *Climate Change 2007: Synthesis Report, Contribution of Working Groups I, II and III to the Fourth Assessment Report of the Intergovernmental Panel on Climate Change*, Cambridge University Press, Cambridge.
- IPCC. (2013). *Climate Change 2013: The Physical Science Basis, Contribution of Working Group I to the Fifth Assessment Report of the Intergovernmental Panel on Climate Change*, Cambridge University Press, Cambridge.
- Kibaroglu, A, Unver, IHO (2000). An institutional framework for facilitating cooperation in the Euphrates-Tigris River Basin. *International Negotitation: A Journal of Theory and Practice*, 5, 311-330.
- Liang, LQ, Li, LJ, Liu, Q (2010). Temporal variation of reference evapotranspiration during 1961–2005 in the Taoer River Basin of Northeast China. *Agricultural and Forest Meteorology*, 150, 298–306.
- Ljung, GM, Box, GEP (1978). On a measure of lack of fit in time series models. *Biometrika*, 65, 297–303.
- Petrow, T, Merz, B (2009). Trends in flood magnitude, frequency and seasonality in Germany in the period 1951–2002. *Journal of Hydrology*, 371, 129–141.
- Sen, PK (1968). Estimates of the regression coefficient based on Kendall's tau. *Journal of the American Statistical Association*, 63, 1379–1389.
- Tabari, H, Talaei, PH (2011). Temporal variability of precipitation over Iran: 1966–2005. *Journal of Hydrology*, 396, 313–320.
- Theil, H, (1950). A Rank Invariant Method of Linear and Polynomial Regression Analysis, part 3. *Netherlands Akademie van Wetenschappen, Proceedings*, 53, pp. 1397–1412.
- Unal, YS, Deniz, A, Toros, H, Incecik, S (2012). Temporal and spatial patterns of precipitation variability for annual, wet, and dry seasons in Turkey. *International Journal of Climatology*, 32, 392-405.
- Yue, S, Wang, CY (2002). Applicability of prewhitening to eliminate the influence of serial correlation on the Mann–Kendall test. *Water Resources Research*, 38, 1068, doi:10.1029/2001WR000861.
- Yue, S, Pilon, P (2003). Canadian streamflow trend detection: impact of serial and cross-correlation. *Hydrological Sciences Journal*, 48, 51–63.
- Yurekli, K. (2015). Impact of climate variability on precipitation in the Upper Euphrates–Tigris Rivers Basin of Southeast Turkey. *Atmospheric Research*, 154: 25-38.
- Zhang, Q, Xu, CY, Zhang, Z, Chen, YD (2008). Changes of temperature extremes for 1960–2004 in Far-West China. *Stochastic Environmental Research and Risk Assessment*, 23, 721-735

USE OF PASSIVE SAMPLING TECHNIQUES FOR MONITORING OF PESTICIDES IN SURFACE WATER

Dragana ŠUNJKA*, Sanja LAZIĆ, Slavica VUKOVIĆ

University of Novi Sad, Faculty of Agriculture, Serbia

*Corresponding author: draganas@polj.uns.ac.rs

Abstract

The Water Framework Directive (2000/60/EC) (WFD) adopted in 2000, with its daughter directives, provides a common framework for water management and protection in Europe. The goal of the WFD was to achieve good qualitative and quantitative status of all aquatic systems by 2015. However, this has been prolonged to 2021. Among other things, this refers, also, to the control of pesticide residues presence in surface waters. Directive 2013/39/EU defines the list of 45 priority substances for surface waters, which must stay below the specified levels that are safe for water bodies and human health, including 15 pesticides. According to NORMAN list, number of pesticides labeled as emerging substances is significantly higher. In order to achieve this, it is necessary to carry out continuous monitoring program. Representative monitoring of organic micropollutants such as pesticides in aquatic systems is a challenging issue. Most studies that report the occurrence of these contaminants in water were conducted using traditional sampling methods, with a spot or composite samples. Recently, passive sampling, a new innovative method for sampling of a wide range of pesticides and other POPs, is applied. These new techniques (SPMD, POCIS, LDPE, silicon rubber, etc.) have many advantages compared to spot sampling. Some of them are enabling the preconcentration of contaminants, increasing the capability for detecting trace concentrations that otherwise requires large volumes of water and enabling the determination of time-weighted average (TWA) concentration over extended sampling periods. However, the use of passive samplers needs sampling rate (R_s) of the targeted compounds, which is usually determined via laboratory calibration experiment. In this study, a review on use of passive sampling technology for monitoring of pesticides in surface water is given, with the special emphasis on laboratory calibration experiments with the aim of R_s determination.

Keywords: *Passive sampling, Monitoring, Pesticide residues.*

Introduction

The presence of organic contaminants in the environment has recently become a great concern, with paying attention to pesticides that represent emerging contaminants. The main pathway through which pesticides enter the aquatic environment is agricultural activity. Runoff over fields, spray drift and infiltration caused by precipitations are the major causes of the presence of these agrochemicals in surface and ground waters, and as a consequence, residues of some harmful pesticides can be detected in water samples. Pesticide pollution can be not only problematic for human health, but it also endangers aquatic organisms.

EU Water Framework Directive (WFD) 2000/60/EC established protection of aquatic environment and establishing a strategy against the chemical pollution of water bodies. For surface waters, this protection is partly achieved by identification of Priority Substances that include 12 pesticides, and the establishment of Environmental Quality Standards for priority substances at European level in the daughter Directive 2008/105/EC, amended in 2013 by 2013/39/EU. According to the latest one, priority substances comprise 10 additional

pesticides. The WFD includes the obligation for Member States to identify pollutants of national concern as river basin specific pollutants and to set environmental quality standards for them at national level. According to their analysis of pressures and impacts, Member States need to set up monitoring programs for surface waters covering a wide range of contaminants in order to characterize the risks, and the need for action. In addition, new Watch List, introduced by Commission Decision (EU) 2015/495 requires the monitoring of substances that might pose a risk at EU level for which monitoring data are not yet sufficient to confirm the risk.

In addition to EU WFD, the NORMAN (Network of reference laboratories, research centers and related organizations for monitoring of emerging environmental substances) database of emerging substances lists over 700 non-regulated environmental contaminants with potentially harmful effects. The NORMAN prioritization scheme ranks compounds based on their occurrence, toxicity and use. In the NORMAN scheme none of the substances is discarded from the prioritization because of lack of monitoring or toxicity data (Vrana *et al.*, 2016).

In order to achieve this, it is necessary to implement a continuous monitoring program which should provide a comprehensive and interrelated overview of water status (WFD Guidance WG 2.7), which requires the application of appropriate sampling and determination techniques.

Until now, the procedure for sampling and quantification of residual pesticide quantities in water environment based upon application of traditional sampling techniques which imply periodic taking of individual samples. However, this type of sampling provides only temporary overview of pollutant presence in water; it gives inappropriate information on variability of their concentrations, making difficult registration of timely oscillation of water contamination level, as well as extreme, accidental emission incidences; it demands large amounts of water for determination of compounds present in low concentrations and use of highly sensitive equipment during instrumental analysis. In order to overcome the named deficiencies, it is possible to increase the frequency of individual sampling or use automatic *on-line* monitoring systems. Both of these solutions are extremely costly and impractical; imply long lasting labor process, choice of the appropriate locality, and etc.

In recent times, as the alternative, a technique of passive sampling of pollutants in water, including pesticides (ISO 5667-23:2011) was introduced.

Passive sampling

Passive sampling represents a contemporary technique for timely integrated measurements of the levels of pollutants present in different environmental mediums, suitable for different types of monitoring. Since seventies of the last century, this sampling method has been used for environmental monitoring, by development and use of the first samplers for assessment of air quality and exposure of the working area to potentially hazardous pollutants in the air. This method of sampling of the seventies used for environmental monitoring, development and implementation of the first samplers for assessing air quality and exposure to the working area of potentially hazardous pollutants in the air (Vojinović-Miloradov *et al.*, 2014). As opposed to this, passive samples adapted to monitoring of water, soil and sediment quality are in the phase of development and introduction.

Beside simple construction and handling, this contemporary technique is characterized by low price and the possibility of multiple uses. The base of the technique is accumulation of analytes in corresponding sorption material in device for passive sampling. Generally, passive sampling techniques are based on the diffusion of chemicals from a medium to a receiving phase, basically due to a difference in the chemical potential gradients. The uptake of the analytes depends on several factors such as the properties of the receiving phase, the

physicochemical properties of the compounds, and environmental parameters such as temperature, water properties (pH, salinity, etc.), water turbulence and flow, biofouling, etc. (Vrana *et al.*, 2005). Depending on the kind of the compound, for pollutant sampling in surface waters different devices such as PDMS (*polydimethylsiloxane*), SPMD (*semipermeable membrane device*), LDPE (low density polyethylene), DGT (Diffusive Gradient in Thin-films), MESCO (membrane enclosed sorptive coating), POCIS (*polar organic chemical integrative sampler*), Chemcatcher are available (Figure 1). Among them, POCIS, SPMD and Chemcatcher® samplers have been successfully applied for the determination of TWA concentrations of pesticides (Schafer *et al.*, 2008; Alvarez *et al.*, 2005, 2007; Arditoglou and Voutsas, 2008) in various aquatic environments (wastewater effluents, streams, lakes, rivers, and coastal waters).

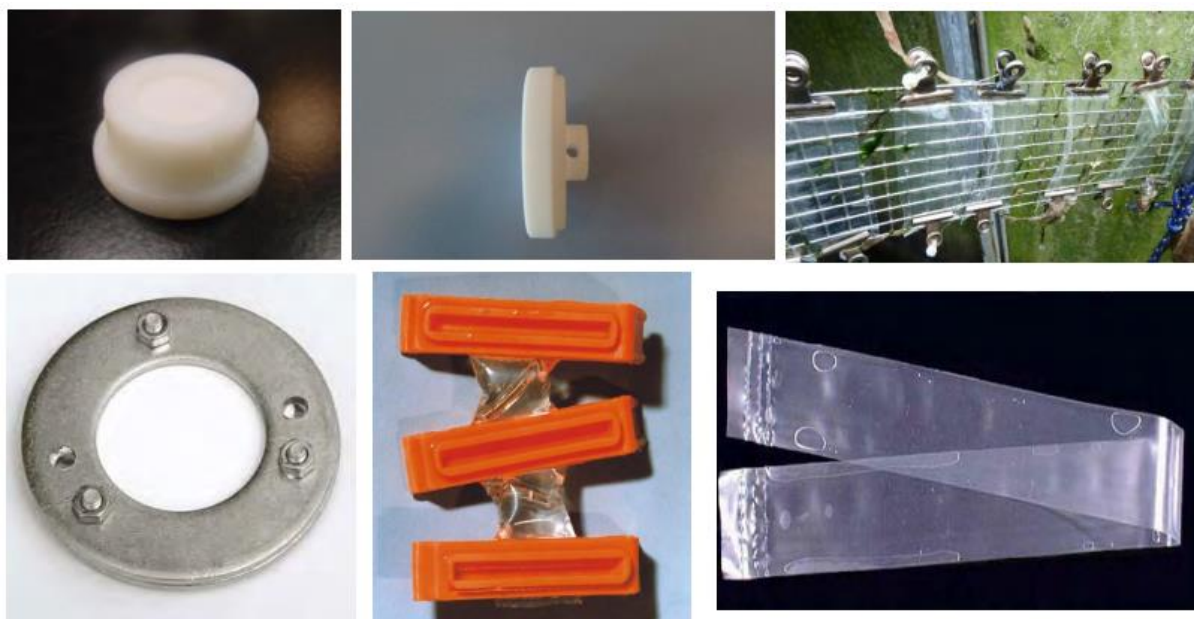

Figure 1. Passive samplers (Mills, 2015)

The technique involves placing of the device in water environment for a longer time period which varies from several days to several weeks, depending on the kind of the compound. In such a manner the average concentrations of pollutants dissolved in water during defined time period (*time-weighted average concentrations, TWA*) are obtained as results, which enables monitoring the trend of spatial and seasonal variations.

Sampling rate, R_s

For application of the technique for determination of pesticides in real conditions of aqueous environment, it is necessary to determine the value of the sampling rate (R_s), specific for each compound. R_s can be stated as the number of liters of water per day that are sampled 'through' the sampler during the exposure time. However, for the most of the pesticides there is a lack of data on the sampling efficiency and sampling rates. The available data on R_s have been obtained by laboratory or *in-situ* calibration of devices for passive sampling and refer to smaller number of pesticides, mainly those from WFD list of priority pollutants.

Different calibration methods have been described over the last years, which makes comparison between sampling rates hard (Harman *et al.*, 2012) and leads to that an overall model is lacking for correlating different compounds and sampling rates (Harman *et al.*, 2011). Until now, laboratory calibration experiments were mainly conducted in static systems (Hernando *et al.*, 2005; Mazzella *et al.*, 2007, 2010; Lissalde *et al.*, 2011) or in static system

under stirring conditions (Alvarez *et al.*, 2004, 2007; Thomatou *et al.*, 2011). These tests imply exposure of a sampler to a beaker with spiked water, but they also have important drawbacks for the achieved R_s values; do not include the influence of the parameters of the exposure media.

Constant flow conditions, that include impact of the listed parameters in a laboratory calibration experiment, have been applied only in several studies (Harman *et al.*, 2009; Mazzella *et al.*, 2007).

Calibration procedure implies exposure of passive sampling devices to water spiked by corresponding concentration of the studied compound. During a certain period of time, lasting the most frequently 2-4 weeks, samples are removed from water at regular time intervals. After that, compounds accumulated in medium of the sampler are separated by extraction and then quantified by specified analytical procedure, by corresponding chromatograph method.

The accumulation of a compound in a passive sampler is assumed to follow first-order kinetics, which consists of three phases: linear, curvilinear and equilibrium partitioning (Alvarez *et al.*, 2004) (Figure 2). In the linear phase the adsorbent can be assumed to be an infinite sink (Alvarez *et al.*, 2004). This assumption makes an estimation of the TWA concentration possible for a specific period of time (Alvarez *et al.*, 2004). Moreover, for this purpose a linear regression model with zero intercept was often used (Mazzella *et al.*, 2007; Arditoglou and Voutsas, 2008).

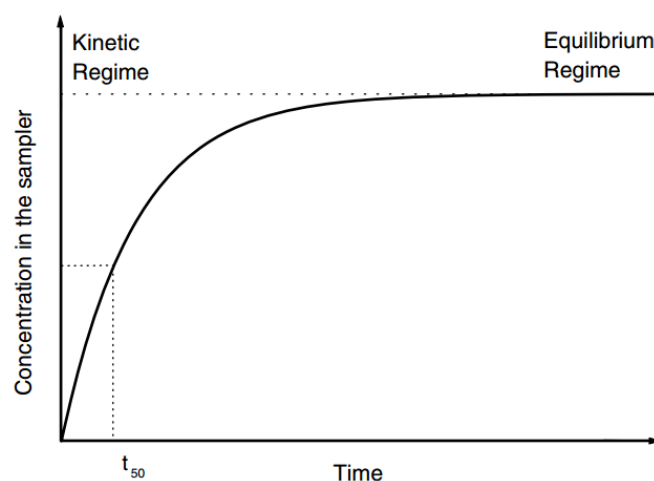

Figure 2. First-order kinetics for accumulation of a compound in a passive sampler over time. The three phases (linear, curvilinear and equilibrium) and the half-life time ($t_{1/2}$) are shown (Vrana *et al.*, 2005)

Determination of pesticides content

Application of the passive sampling technique leads to the increase in sensitivity of analytical methods, having in mind that pre-concentration of analytes runs inside the sorption medium. Unlike many traditional methods, the described type of sampling enables increase in sensitivity and improvement of stability of analytes in the sample, without additional treatments (adjustment of pH values, etc.) In some cases, use of passive samplers enables reduction, or even total elimination of use of high quantities of extraction solvents.

In accordance with the restrictive European Union (EU) regulations, that limit the maximum amount allowed for a single pesticide in drinking water to 0.1 $\mu\text{g/l}$ and the sum of the pesticides to 0.5 $\mu\text{g/l}$ including toxic transformation products (Council Directive 98/83/EC), very sensitive analytical methods for monitoring drinking and surface water samples are required.

In line with these, the application of sensitive instrumental analysis techniques is required. For water soluble and thermally labile pesticides, HPLC is the preferred approach, extensively used with ultraviolet (UV) or diode array detection (DAD). Nowadays, HPLC coupled with mass spectrometry (MS) or tandem mass spectrometry (MS/MS) methods, which have the advantages of high sensitivity and high degree of selectivity, have been proven to be a powerful tool for pesticide residues determination in environmental samples (de Lafontaine *et al.*, 2014). Thermally stable pesticides are successfully analyzed by gas chromatography, using electron capture detector (ECD), or coupled with mass spectrometry (MS, MS/MS).

Performance reference compounds, PRCs

Calibrated R_s is necessary to correct the variability of the exposure conditions. Recently, the use of performance reference compounds (PRCs) has been successfully applied for the assessment of the R_s and correction of laboratory-derived sampling rates (Mazzella *et al.*, 2010). PRCs are non-interfering compounds not found in environmental waters to be sampled (such as deuterated compounds) (Alvarez *et al.*, 2007). It is a compound that is added to the sampling device during the device production and is lost into surrounding water during the experiment.

Measured values of PRC loss rates are used to account for any rate affecting differences between field and calibration study exposure conditions. This approach to *in situ* calibration is based on the principle that the rate of residue loss is proportional to the rate of residue uptake. How much sampling rates are affected by environmental conditions is hard to determine without the use of PRCs (Harman *et al.*, 2011). The purpose of this is to obtain a correction factor (elimination constant rate, k_e) in order to compensate environmental conditions in the field and, therefore, to provide a better estimation of the TWA water concentrations.

Instead of conclusion

Passive sampling represents one of the most acceptable techniques for timely integrated measurements of pesticides concentration levels and other pollutants present in different environmental media, especially in water. One of the major advantages of passive sampling is higher sensitivity and the possibility of measuring TWA concentrations. Finally, the development of efficient method-validation schemes for passive sampling techniques is essential to gain broader acceptance for the technology in regulatory programs (Vrana *et al.*, 2005) and application of passive sampling methods for monitoring organic chemicals within the framework of the WFD.

Acknowledgements

We acknowledge the financial support of the Ministry of Education and Science of the Republic of Serbia, grant III43005.

References

- Alvarez D.A., Huckins J.N., Petty J.D., Jones-Lepp T., Stuer-Lauridsen F., Getting D.T., Goddard J.P., Gravell A. (2007). Tool for monitoring hydrophilic contaminants in water: polar organic chemical integrative sampler (POCIS). In: Greenwood R., Mills G.A., Vrana B. (Editors), *Comprehensive Analytical Chemistry. Passive Sampling Techniques in Environmental Monitoring*. Elsevier.
- Alvarez D.A., Petty J.D., Huckins J.N., Jones-Lepp T.L., Getting D.T., Goddard J.P., Manahan S.E. (2004). Development of a passive, in situ, integrative sampler for hydrophilic organic contaminants in aquatic environments. *Environ. Toxicol. Chem.*, vol. 23, 1640–1648.

- Alvarez D.A., Stackelberg P.E., Petty J.D., Huckins J.N., Furlong E.T., Zaugg S.D., Meyer M.T. (2005). Comparison of a novel passive sampler to standard water-column sampling for organic contaminants associated with wastewater effluents entering a New Jersey stream. *Chemosphere*, Vol. 61, 610–622.
- Arditsoglou A., Voutsas D. (2008). Passive sampling of selected endocrine disrupting compounds using polar organic chemical integrative samplers. *Environ. Pollut.*, Vol. 156, 316–324.
- Harman C., Allan Y.I., Vermeirssen E. (2012). Calibration and use of the polar organic chemical integrative sampler - a critical review. *Environmental Toxicology and Chemistry*, Vol. 31, 2724–2738.
- Commission Decision (EU) 2015/495 of March 2015. Official Journal of the European Communities L78/40, 24th March 2015.
- De Lafontaine Y., Beauvais C., Cessna A.J., Gagnon P., Hudon C., Poissant L., *Science of the Total Environment*, 1, 2014, 479.
- Directive 2000/60/EC of the European Parliament and of the Council of 23 October 2000 Establishing of Framework for Community Action in the field of Water Policy, Official Journal of the European Communities L327/1, 22nd December 2000.
- Directive 2008/105/EC of the European Parliament and of the Council of 16 December 2008. Official Journal of the European Communities L3487/84, 24th December 2008.
- Directive 2013/39/EU on environmental quality standards in the field of water policy, Official Journal of the European Union L 226 (2013) 1.
- European Council Directive 98/83/EC of 3 Nov 1998 on the quality of water intended for human consumption, Official Journal L 330, 05/12/1998, Community legislation in force – document 398L0083 (1998) 0032–0054.
- Harman C., Boyum O., Thomas K.V., Grung M. (2009). Small but different effect of fouling on the uptake rates of semipermeable membrane devices and polar organic chemical integrative samplers. *Environ. Toxicol. Chem.*, Vol. 28, 2324–2332.
- Harman C., Reid M., Thomas K.V. (2011). In situ calibration of a passive sampling device for selected illicit drugs and their metabolites in wastewater, and subsequent year-long assessment of community drug usage. *Environ. Sci. Technol.*, Vol. 45, 5676–5682.
- Hernando M.D., Martínez-Bueno M.J., Fernández-Alba A.R. (2005). Seawater quality control of microcontaminants in fish farm cage systems: Application of passive sampling devices. *Boletín Instituto Español De Oceanografía*, Vol. 21, 37-46.
- <http://www.norman-network.net/>
- Lissalde S., Mazzella N., Fauvelle V., Delmas F., Mazellier P., Legube B. (2011). Liquid chromatography coupled with tandem mass spectrometry method for thirty-three pesticides in natural water and comparison of performance between classical solid phase extraction and passive sampling approaches. *J. Chromatogr. A*, Vol. 1218, 1492–1502.
- Mazzella N., Dubernet J.F., Delmas F. (2007). Determination of kinetic and equilibrium regimes in the operation of polar organic chemical integrative samplers, Application to the passive sampling of the polar herbicides in aquatic environments. *J. Chromatogr. A*, Vol. 1154, 42–51.
- Mazzella N., Lissalde S., Moreira S., Delmas F., Mazellier P., Huckins J.N. (2010). Evaluation of the use of performance reference compounds in an oasis-HLB adsorbent based passive sampler for improving water concentration estimates of polar herbicides in freshwater. *Environ. Sci. Technol.*, Vol. 44, 1713–1719.
- Mills G. (2015). Active and Passive Sampling for Pollutants of Emerging Concern, presentation at Emerging contaminants in waters and soils, practical considerations: Sampling, analysis and consequences Sheffield, 4th March, 2015. http://www.rsc.org/images/Graham-Mills_tcm18-245688.pdf

- Schafer R.B., Paschke A., Liess M. (2008). Aquatic passive sampling of a short-term thiacloprid pulse with the Chemcatcher: Impact of biofouling and use of a diffusion-limiting membrane on the sampling rate. *J. Chromatogr. A*, Vol. 1203, 1-6.
- Thomatou A.A., Zacharias I., Hela D., Konstantinou I. (2011). Passive sampling of selected pesticides in aquatic environment using polar organic chemical integrative samplers. *Environ. Sci. Pollut. R.*, Vol. 18, 1222–1233.
- Vojinović Miloradov M., Turk Sekulić M., Radonić J., Milić N., Grujić Letić N., Mihajlović I., Milanović M. (2014). Industrial emerging chemicals in the environment. *Hem. Ind.*, Vol. 68 (1), 51–62.
- Vrana B., Mills G.A., Allan I.J., Dominiak E., Svensson K., Knutsson J., Morrison G., Greenwood R. (2005). Passive sampling techniques for monitoring pollutants in water. *Trac Trend. Anal. Chem.*, Vol. 24, 845–868.
- Vrana B., Smedes F., Prokeš R., Loos R., Mazzella N., Mieke C., Budzinski H., Vermeirssen E., Ocelka T., Gravell A., Kaserzon S. (2016). NORMAN interlaboratory study (ILS) on passive sampling of emerging pollutants; EUR 27655 EN; doi:10.2788/6757

EFFECT OF CLIMATE CHANGE ON AGRO HYDROLOGICAL BALANCE FOR SOME REGIONS IN BOSNIA AND HERZEGOVINA

Sabrija ČADRO*, Jasminka ŽUROVEC, Ajla MRKULIĆ, Dženita ŠEHIĆ,
Amela ŠERO, Gvozden MIĆIĆ

Faculty of Agriculture and Food Sciences (PPF), University of Sarajevo (UNSA), Bosnia and Herzegovina

*Corresponding author: s.cadro@hotmail.com

Abstract

The main characteristic of agro-hydrological balance (AHB) in Bosnia and Herzegovina (B&H) is the occurrence of surplus water during the cold months and water deficit during the warmer months. In the southern regions, surpluses and deficits of water are significantly more pronounced than in the central and northern regions of B&H. Among other things, within the research of agro-hydrological balance made for the period up to 1991, it was found that B&H agriculture covers most of the water needs throughout precipitation inputs (around 83%). Based on the comparative analysis for the period of 1981-2010, with respect to the reference period of 1961-1990, average yearly air temperature in B&H increased from 0.4 to 0.8°C, whereas temperature increases during vegetation period were up to 1.0 °C. Significant variability in precipitation has not been recorded within the same period. The main objective of this paper is to determine the significance of changes in AHB in some regions B&H as a result of climate change, with a special focus on the trend of water surpluses and deficits and their impact on agricultural production. Data from weather stations: Banja Luka, Tuzla, Zenica and Mostar, for the period 1991 - 2015 were used for analysis of AHB components by Thornthwaite-Mather method (TM). Potential evapotranspiration (PET) calculated with Thornthwaite method was used as input for water balance calculation. A significant increase in air temperature (1981 – 2015) resulted in change of PET value, and therefore the value of other AHB components, primarily water surplus and deficit.

Keywords: *Bosnia and Herzegovina, climate change, agro-hydrological balance, water deficit*

Introduction

The knowledge about the water cycle at a specific smaller area for a certain period of time has a very practical significance because in this way we come to the water balance (agro-hydrological balance), the term that was introduced to hydrology from commercial balance (Vlahinić et al. 1972).

Information gained through the AHB are significant especially for understanding the possibilities of organizing agricultural production in a given area. If the inflow of water from precipitation (P) in the soil is less than potential evapotranspiration (PET) plant available water content in the soil will decrease and through balance procedure soil water deficiency will indicate the need for irrigation. If the inflow of water is bigger it will result in occurrence of excess water in the soil, which will indicate the potential runoff and drainage needs (Žurovec, 2012).

In the area of B&H, researchers are analyzing the AHB of the soil for almost six decades. The mostly used methods of Potential evapotranspiration (PET) calculation are first of all empirical method by Thornthwaite (1948), the method by Penman (1948) and Turk (1961). Compared to other methods, Thornthwaite method requires least input data (average temperature and geographical position) and according to some authors on regional level provides the best results (Čustović et al., 2012). The obtained PET values are then used in

Thornthwaite-Mather (TM) (1957) model of the AHB for obtaining data about the soil water deficit, runoff (Blue Water) and actual evapotranspiration (Green water).

During the war period (1991-1995), most of the meteorological stations (MS) in the area of B&H have stopped working, but most of them were again put in operation in 2000s. Because of discontinuity in the monitoring of the climate data, it was not possible to determine the current situation and changes in the values of AHB parameters and most of the researchers used previously obtained values (time series until 1991). Today, 25 years after the war, it is possible to create a reliable and actual water balances for the MS that had continuous climate data collection or where discontinuity did not last long.

B&H has experienced serious incidences of extreme weather events in the past two decades, causing severe economic losses. Based on available data and currently available climate projections, exposure to threats from climate change will continue to increase (Žurovec et al., 2015). Observed climate changes are reflected through an increase in average temperatures in B&H. For the last hundred years, the average temperature has increased by 0.8 °C (which is in line with global trends), with a tendency to accelerate, the decade of 2000–2010 is warmest in the last 120 years (INCBiH, 2009). The first decade of the twentieth century in B&H can be characterized as distinct periods of extremes in terms of excessive humidity, severe droughts and heat waves (Žurovec et al., 2011; 2015).

This significant increase in air temperature for the result has a change of Thornthwaite PET value based mainly on mean air temperature data and connected with PET, change in the value of other AHB components, primarily water surplus and deficit.

The main objective of this paper is to determine the significance of changes in AHB in some regions B&H as a result of climate change, with a special focus on the trend of water surpluses and deficits and their impact on agricultural production.

Materials and methods

Determination of changes in AHB for selected regions of B&H was achieved by: (i) analysis of secondary data related to AHB for B&H; (ii) climate data collection for the time series 1991-2015 and calculation of all AHB components for selected MS; and (iii) a comparative analysis of the values of AHB components between the two analyzed periods (period 1961-1991 and 1991-2015). Collected secondary data were cross-checked for avoiding inconsistency and contradictions.

Data from several weather stations (Banja Luka, Tuzla, Zenica and Mostar), for the period 1991 – 2015, were used for analysis of agro-hydrological balance components by Thornthwaite-Mather method (TM). Potential evapotranspiration (PET) calculated with Thornthwaite method was used as input for water balance calculation. Required input parameters used: monthly precipitation (P), monthly potential evapotranspiration (PET) and readily available soil water holding capacity of 100 mm (RAW).

Selected MS with their locations may represent the northern (Banja Luka, Tuzla), Central (Zenica) and south (Mostar) region of B&H. In addition, these are the MS that were in operation during the war and have a continuous series of data for a period of 25 years.

To make the two data sets (the period until 1991 and the period from 1991 to 2015) comparable, the calculation of AHB for the period 1991-2015 is made by the same method (TM) and with the same RAW values (100 mm) used by researchers in previous years.

Results and discussion

In the *Long-term B&H Land Reclamation Program* by the *Republican Committee on Agriculture, Forestry and Water Management Sarajevo*, for the period 1986 - 2000 (RKPŠV, 1986) determination of irrigation water need is based on agro-hydrological analysis of long-term time series (20-60 years long) for a larger number of MS in B&H. It was found that the average annual soil water deficiency or irrigation water requirement in the northern parts of

the country is around 100 mm, with up to 200 mm in one part of Semberija. Soil water deficiency in the central parts of the country is 50 mm, while in the south deficiency increased up to 300.

In the study of Vlahnić and Hakl (1989), the analysis of AHB included two distinct climatic ambients; one with mediterranean (Mostar), and the other with continental (Tuzla) climates. AHB are made for the time series of 30 years (1951-1980). The average PET for the Mostar area is 807 mm, average water deficiency 182 mm while AET was 625 mm. In the area of Tuzla PET amounted 660 mm, water deficiency 53 mm, and AET 607 mm.

The study *Hydro-melioration Problems of Agricultural Land of B&H* done by the FZAP (1994) treated 27 MS for time series of 20 years (1959-1978). In table 1 extracted values for weather stations: Banja Luka, Tuzla and Mostar are shown:

Table 1. Agro-hydrological balance for the selected stations (FZAP, 1994)

Part of B&H	Station	Precipitation	PET	Runoff – Blue Water (V)	Soil water deficiency	AET
Northern	Banja Luka	1050	695	411	56	639
	Tuzla	913	658	864	46	612
Southern	Mostar	1465	846	301	245	601

In the period after 2000, the results of another AHB for the entire B&H appeared in the literature. Results of this AHB (table 2) are used in many publications (Vlahinić, 2000a, 2000b, 2000c, 2004; Vlahinić et al. 2001a, 2001b; Alagić, 2003; Čustović, 2005; INCBH, 2009; Čustović et al., 2012; Hodžić et al., 2013).

Table 2. Main agro-hydrological balance for B&H

Average annual hydrological component in mm	B&H average	Southern parts	Central parts	Northern parts
Precipitation (P)	1200	2000	1000	800
Potential Evapotranspiration (PET)	725	900	650	700
Runoff – Blue Water (V)	600	1400	400	200
Soil water deficiency (M)	125	300	50	100
Actual Evapotranspiration - Green water (AET)	600	600	600	600

This AHB (table 2) is in the literature often referred as the main agro-hydrological balance of B&H, but to the best of our knowledge, it is nowhere precisely defined for which time series was made, which MS were used, nor the southern, central and northern regions of B&H were spatially determined. According to it, precipitation represents the greatest water resource in B&H. Average annual precipitation is about 1200 mm, which in terms of volume amounts to 61.6 billion m³. However, precipitation is the most variable hydrological parameter in terms of space and time. Average annual precipitation in the southern parts of B&H amounts to about 2000 mm, in central parts about 1000 mm and in northern parts about 800 mm (Vlahinić et al., 2001a; INCBH, 2009). Annual precipitation in all three parts of B&H is higher than annual potential evapotranspiration, but because of uneven precipitation distribution the potential evapotranspiration is not covered by precipitation.

A significant contribution to the analysis of AHB is achieved through the study done PPF (2004), titled "*Water Balance of Land in Bosnia And Herzegovina in Order to Prevent Erosion, Droughts and Floods.*" In this study balance is based on data obtained at 68 meteorological stations with different lengths of time series in seven large river catchments (Una, Vrbas, Bosna, Drina, Neretva and Trebišnjica, Cetina and Krka, immediate catchment of the Sava). The water balances (table 3) for the B&H state level (total area of 5.1 million ha) show the following average state:

Table 3. Agro-hydrological balance for B&H (Čustović, et al., 2004, 2012; Vlahinić, 2007)

Average annual hydrological component	mm	billion m ³
Precipitation (P)	1120	57.3
Potential Evapotranspiration (PET)	660	33.7
Runoff – Blue Water (V)	547	28.0
Soil water deficiency (M)	87	4.4
Actual Evapotranspiration - Green water (AET)	573	29.3

If we compare the results of the previously mentioned AHB, although the balancing was done for the relatively similar time series, differences in the values of the components can be observed. Thus, by comparing the results of the last AHB (table 3) with the previously mentioned (table 2) the lower values of all hydrological components were determined. The biggest change is the average amount of precipitation which is lower by 80 mm, and the value of PET which is lower by 65.

To determine the effect of climate change on AHB for some regions in Bosnia and Herzegovina for the time period 1961-1991 data for four analyzed MS from study by PPF (2004) were used, and compared with calculated data for 1991-2015 time series. Fig. 1-5 are showing the change in the values of average annual AHB components between the two analyzed time series.

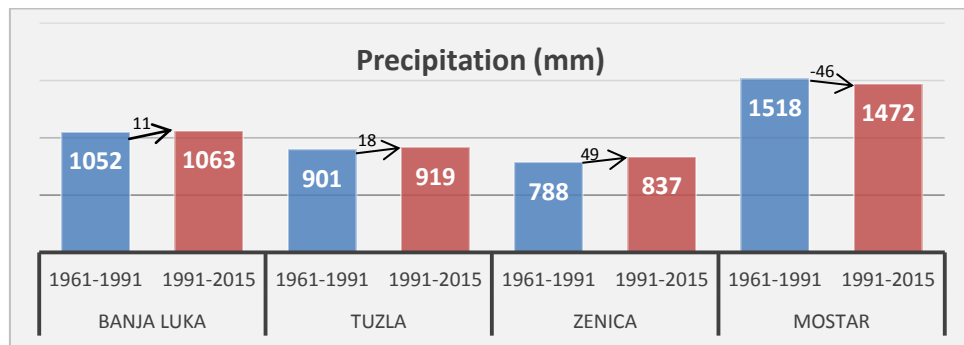

Fig. 1. Average annual precipitation (mm), difference between analyzed time series

On MS Banja Luka, Tuzla and Zenica, there was an increase of precipitation amount (Fig. 1). The largest increase of 49 mm is in the central part of B&H (Zenica). Southern parts, represented with MS Mostar had noticeable decrease in the amount of rainfall of 46 mm.

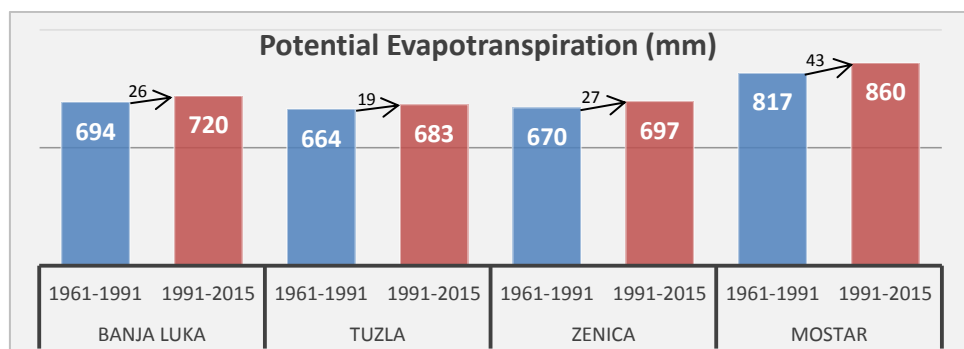

Fig. 2. Average annual PET (mm), difference between analyzed time series

As expected, PET values for second time series (1991-2015) for all analyzed MS are higher from 19 to 43 mm (Fig. 2). The largest increase was determined in the Mostar area (South part).

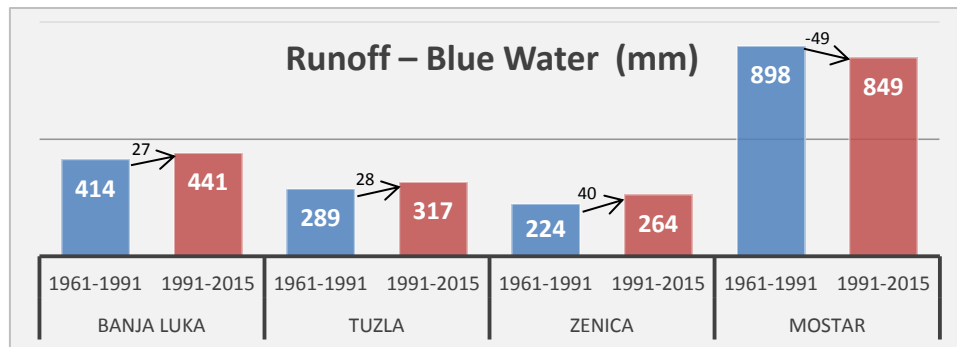

Fig. 3. Average annual runoff (mm), difference between analyzed time series

Like Precipitation, and the amount of runoff increased on all analyzed MS except Mostar (Fig. 3). A significant increase of 40 mm was determined in the central part or MS Zenica, as well as the northern part - MS Tuzla (28 mm) and Banja Luka (27 mm).

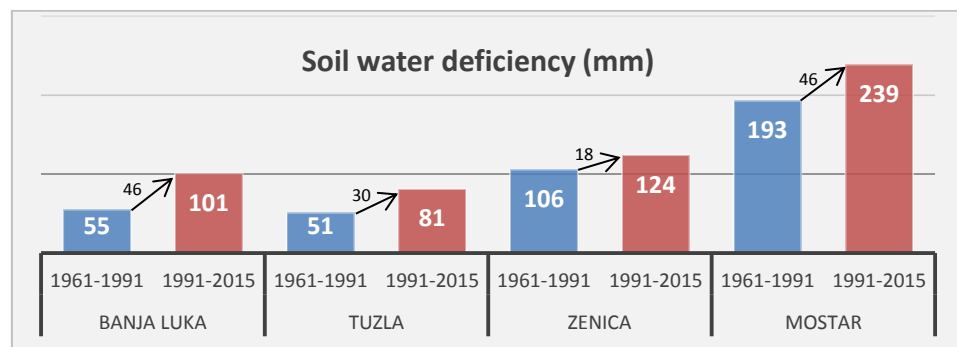

Fig. 4. Average annual soil water deficiency (mm), difference between analyzed time series

As a result of the increase in air temperature, soil water deficiency is increased at all analyzed MS. This highest increase of 46 mm is at the area of MS Banja Luka and Mostar (Fig. 4). Thus, annual irrigation water requirements for southern and central part of B&H, in relation to the period until 1991, increased for 430 m³/ha.

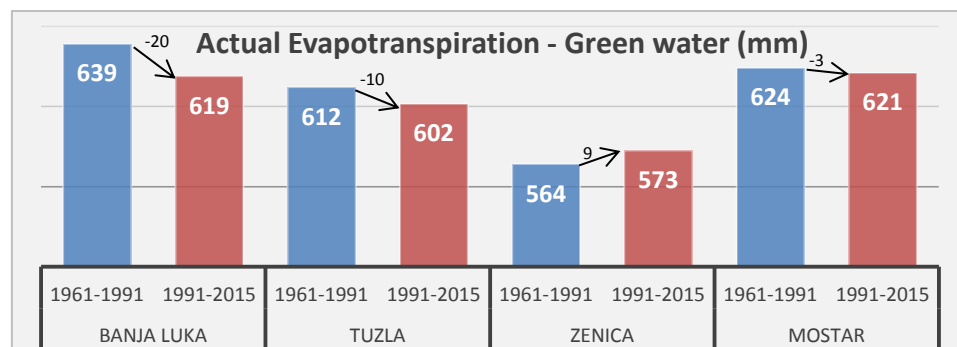

Fig. 5. Average annual AET (mm), difference between analysed time series

Values of AET are slightly changed. By increasing the value of PET (Fig. 2) at all analyzed MS, there was a reduction of the annual value of AET. This is not the case for MS Zenica where a significant increase in the amount of rainfall of 49 mm results in AET increase of 9 mm.

Conclusion

Based on the analysis of the secondary data related to agro-hydrological balance, as well as a comparison of the water balance time series 1961-1991 and 1991-2015, it can be concluded

that there is a significant need to develop new agro-hydrological balance for specific parts and the entire area of Bosnia and Herzegovina.

As result of climate change and increased climate variability, significant changes in agro-hydrological balance in some regions of B&H occurred. At the all analyzed meteorological stations (Banja Luka, Tuzla, Zenica and Mostar) there has been an increase in the annual value of PET and soil water deficit. These changes have important impact on the agricultural production, particularly in irrigation water requirements, which in relation to the period prior to 1991, increased up to 430 m³/ha.

References

- Alagić, E. (2003). Navodnjavanje-Preventivna Zaštita od Suše u Bosni i Hercegovini / Irrigation-preventive Droughts protection in Bosnia and Herzegovina. Presentation at the Conference, Vodoprivreda 0350-0519, 35, p. 203-206.
- Čustović, H. (2005). An Overview of General Land and Soil Water Conditions in Bosnia And Herzegovina. European Soil Bureau – Research report no. 9.
- Čustović, H., Vlahinić, M., (2004). Vodni bilans zemljišta Bosne i Hercegovine u cilju prevencije erozije, suše i poplava / Water Balance of Land in Bosnia And Herzegovina in Order to Prevent Erosion, Droughts and Floods. Study, Faculty of Agriculture and Food Science Sarajevo (PPF).
- Čustović, H., Vlahinić, M., Žurovec, O. (2012). Soil Water Balance Analyses On the Level of Bosnia & Herzegovina – Possibilities and Control of Green and Blue Water Regime. 11th Alps-Adria Scientific Workshop. Smolenice, Slovakia.
- INCBH (2009). Initial National Communication of Bosnia and Herzegovina under the United Nations Framework Convention on Climate Change. Ministry of Environmental and Spatial Planning.
- FZAP - Institute of Agropedology (1994). Hidromelioraciona Problematika Poljoprivrednih Zemljišta, Pravci Njegovog Uređenja u Cilju Proizvodnje Hrane / Hydro-melioration Problems of Agricultural Land of B&H. Book I i II. Sarajevo.
- Penman, H.L. (1948). Natural evapotranspiration from open water, bare soil and grass. Proc. Roy. Soc. London, Series A, 193, p. 120-146.
- RKPŠV (1986). Uređenje Zemljišta s Posebnim Prilozima o Uređenju zemljišta na Društvenim gazdinstvima, u Periodu od 1986. do 2000. / Land Reclamation with a Special Annexes for the Landscaping at State Farms, for a Period 1986 – 2000.
- Hodžić, S., Marković, M., Čustović, H. (2013). Drought Conditions and Management. Strategies in Bosnia and Herzegovina - Concise Country Report. UNW-DPC Proceedings No. 11. 1st
- Thornthwaite, C.W. (1948). An Approach toward a Rational Classification of Climate. The Geographical Review, vol.38, p. 55-94.
- Thornthwaite, C.W., Mather, J. R. (1957). Instructions and Tables for Computing Potential Evapotranspiration and the Water balance, laboratory of Climatology, Publications in Climatology.
- Vlahinić, M., Muftić H. (1972). Poljoprivredne Melioracije i Uređenje Zemljišta / Agricultural Amelioration and Land Reclamation, Sarajevo.
- Vlahinić, M., Hakl Z. (1989). Frekvencija i Trend Pojave Suše u Nekim Područjima Bosne i Hercegovine / Frequency and Trend of drought occurrence in some areas of Bosnia and Herzegovina. Poljoprivredni pregled 4, 5 i 6.
- Vlahinić, M. (2000a). Zemljište i vodni menadžment / Land and Water Management. Seminar for agricultural inspectors in Federation of Bosnia and Herzegovina. Cazin, 10. i 11. March 2000.

- Vlahinić, M. (2000b). Agrohydrological Parameters as one of Indicators of (non)sustainability of agriculture, ANUBiH, Sarajevo, p.45-60.
- Vlahinić, M. (2000c). Hidroakumulacije, poljoprivreda i zemljišno-vodni menadžment u Bosni i Hercegovini / Hydro-accumulation, agriculture and land-water management in Bosnia and Herzegovina. *Voda i Mi*, No. 27, p. 26-37.
- Vlahinić, M., Hakl Z. (2001a) Odvodnjavanje Poljoprivrednih Zemljišta. Prvo izdanje / Drainage of agricultural land. First Edition. University of Sarajevo, Agriculture Faculty, Sarajevo.
- Vlahinić, M., Čustović, H., Alagić, E. (2001b). Situation of Drought in Bosnia and Herzegovina.
- Vlahinić, M. (2004). Poljoprivredno-melioracijska i Agrohidrološka Monografija Popova polja / Agriculture land reclamation and hydrological monograph of Popovo Polje. Department of Natural Sciences and Mathematics Book 6. Book LXXXVIII. ANUBiH
- Vlahinić, M. (2007). Uloga Zelene Vode U Proizvodnji Hrane i Održivosti Ekosistema / The role of green water in food production and ecosystems sustainability. "Voda i Mi" Journal of Public Enterprise "Vodno područje slivova rijeke Save" Sarajevo.
- Žurovec, J. (2012). Melioracije i Uređenje Poljoprivrednog Zemljišta / Melioration and agriculture land reclamation. University of Sarajevo.
- Žurovec, J., Čadro, S. (2011). Crops Yield Reduction in Conditions without Irrigation in Northeastern Bosnia, 46th Croatian and 6th International Symposium on Agriculture, Opatija.
- Žurovec, J., Čadro, S. (2015) Temporal Drought and Soil Moisture Variability in the Arable Land Of Spreča Valley. 26th International Scientific expert Conference in Agriculture and Food Industry, Sarajevo, p. 398 – 403.
- Žurovec, O., Vedeld, P.O., Sitaula, B.K. (2015). Agricultural Sector of Bosnia and Herzegovina and Climate Change—Challenges and Opportunities. *Agriculture*, 5, p. 245-266.

EFFECT OF COMPOST APPLICATION ON CHEMICAL COMPOSITION AND QUALITY OF ORIENTAL TOBACCO KRUMOVGRAD 90

Violina ANGELOVA^{1*}, Venelina POPOVA², Radka IVANOVA³, Givko TODODROV³,
Krasimir IVANOV¹

¹Department of Chemistry, Agricultural University, Plovdiv, Bulgaria

²University of Food Technology, Plovdiv, Bulgaria

³Department of Plant science, Agricultural University, Plovdiv, Bulgaria

*Corresponding author: vileriz@abv.bg

Abstract

A comparative research on the impact of compost on the chemical composition and quality of Oriental tobacco Krumovgrad 90 has been carried out. The experiment was performed on an agricultural field contaminated by the lead zinc smelter near the town of Kardzali, Bulgaria (Ostovitsa village). The field experiment was a randomized complete block design containing two treatments and four replications (8 plots). The treatments consisted of a control (no organic amendments) and compost amendments (40 t/daa). Heavy metals were measured in roots, stems and leaves of Oriental tobacco Krumovgrad 90. The compost treatments had significant effects on the uptake and allocation of plant nutrients and heavy metals. It can be concluded, that heavy metals were accumulated mainly in the tobacco leaves. Soil contamination with heavy metals did not affect the quality of tobacco leaves. Application of the compost leads to increased content of potassium, calcium and magnesium in the leaves of tobacco and therefore may favorably affect burning properties of tobacco. Incorporation of compost in the soil affect plant height and number of leaves formed, leads to an increase in the size of the leaves and to a lowering of the quality of the tobacco. Application of compost to soil resulting in increased mineral substances (pure ash) and quantity of proteins, and reduces the amount of reducing sugars in tobacco leaves in relation to the control. The application of compost to the soil affects more negatively as regards quality and typicality of oriental tobacco variety of Krumovgrad 90.

Keywords: *Compost, Oriental Tobacco, Quality, Chemical composition*

Introduction

Tobacco is a major agricultural crop for many countries, including Bulgaria. Appropriate climatic conditions in the country determine the cultivation of high-quality oriental tobaccos that are distinguished by their specific smoking and technological properties. Among the Bulgarian oriental tobaccos, Krumovgrad origin is most common in the production and best realizing in the international markets. The quality of the tobacco is largely determined by its chemical composition. The study of the chemical composition of the tobacco is primarily associated with its technological qualities, mainly with the combustibility but tobacco consumption makes them significant also in terms of their biological effects on human health. This issue is particularly important given the ability of the tobacco to accumulate heavy metals, and the ability of part of them to be emitted in the main and side tobacco smoke stream (Stoilova and Markova, 2004). Chemical properties of tobacco depend on many factors, among which the following should be noted: variety, habitat (soil and climate), as well as the impact of agro-technical practices on the physical, chemical and biological properties of the soil. Soil conditions and nutrient content are crucial for the growth and development of plants. Yield and quality of tobacco is strongly influenced by fertilization and especially by the introduction of nitrogen and potassium fertilizers (Bozhinova and Bozhinov,

2006). The use of organic fertilizers can affect the physicochemical properties of the soil and can improve the conditions for crop development. Also, the organic fertilizer can neutralize or reduce the acidity of the soil and can increase the content of certain trace elements such as zinc and copper. Organic fertilizers can increase the weight of tobacco leaves and yield. The efficiency of organic fertilization is manifested in rapid growth, earlier senescence of leaves, and improvement of the combustibility of the leaves (Wang *et al.*, 2009). The increasing application of organic fertilizers leads to improvement of the soil's ability to deliver nutrients, in this way providing enough quantities of N, P, and K for the development of tobacco (Cao *et al.*, 2004).

The purpose of this study was to conduct a comparative study that would allow us to determine the influence of compost on chemical composition and quality of Oriental tobacco variety Krumovgrad 90.

Material and Methods

The study included oriental tobacco (variety Krumovgrad 90) grown near Lead-Zinc Complex /LZC/ - Kardzhali. Field trials were set in 2 variants under the block method in four repetitions (8 plots): 1- introduction of 40 t/daa of compost to the soil and 2 - control variant. Characteristics of soil and compost are shown in Table 1. Soil samples taken from the area of LZC – Kardzhali (Ostrovitsa village) are slightly polluted with Pb and Cd and are characterized by acidic reaction (pH 6.3) and average content of organic matter (2.2%). Soil characteristics are a prerequisite for low to medium mobility of metals, which is confirmed by the results of the amounts of Pb, Cd, Zn and Cu (weak mobility for Pb, Zn and Cu, and an average for Cd) extracted with DTPA.

Technically senesced leaves of various stem positions were taken for analysis. As the leaves of oriental tobacco ripen sequentially, harvesting is done in stages (harvests) by following the sequence of senescence of leaves. Harvesting of leaves is carried out for 4 harvests (primings). The collected technically senesced leaves were strung on a single needle and dried in natural conditions, observing the technology of solar drying of oriental tobacco.

In the dried leaves, the content of substances was determined, directly related to the quality and the smoking properties of tobacco - total nitrogen, protein, reducing substances, mineral substances, nicotine. Analyzes were carried out according to conventional methods (ISO 15154, BDS 9142), as they are expressed in percentage by dry matter. The content of heavy metals, micro and macronutrients in tobacco leaves was determined by the method of dry mineralization. The total content of metals in the soil was determined in accordance with ISO 11466. The mobile forms were extracted by a solution of DTPA (1 M NH_4HCO_3 and 0.005 M DTPA, pH 7.8) (Soltanpour and Schwab, 1977). The quantitative measurements were carried out with inductively coupled plasma emission spectrometry (ICP) (Jobin Yvon Emission - JY 38 S, France).

Table 1. Characterization of the soil and compost used in the experiment

Parameter	Soil		Compost
pH	6.3		6.9
EC, dS/m	0.3		0.2
Organic matter, %	3.9		72.1
N, %	0.22		1.49
P, mg/kg	1223.5 *	32.5**	12653.9 *
K, mg/kg	6300	570.1	6081.7
Ca,mg/kg	12937.5	323	32158.7
Mg,mg/kg	8310	559	2086.5
Fe, mg/kg	33400	41.3	3177.3
Mn,mg/kg	864.5	70.3	360.5
Cu, mg/kg	34.4	6.3	14.2
Pb, mg/kg	130.4	30.9	12.0
Cd, mg/kg	3.3	0.55	0.19
Zn, mg/kg	267.7	46.0	170.8

*Total content; **DTPA –extractable; Maximum permissible concentrations (pH 6.0-7.4): Pb-60 mg/kg, Cd-2.0 mg/kg, Zn-320 mg/kg

Results and Discussion

The height of the plant is directly connected with the formed leaves, and hence this indicator can be used as an indicator of the possible number of leaves (Ali *et al.*, 1984). Incorporation of compost in the soil has a positive effect on plant height and number of leaves formed (data not shown).

Besides the number of leaves suitable for picking, yield and quality of the leaves is determined by their size. Length and width of leaves in technical senescence vary depending on the harvesting zone. Fig. 1 presents data on the size of leaves from four stem positions - 7th, 14th, 19th and 28th leaf. In all stem positions the leaves of the smaller sizes are obtained in the control. A relationship is established between the amount of leaves (length and width) and the stem position. Plants are distinguished by smaller leaves of a lower zone and bigger from middle and upper zone (Fig. 1). Typical of the oriental tobaccos is that the smaller the size of the leaves, the more typically expressed is the type (Gyuzelev, 1983). The incorporation of compost results in increasing the length of the leaves and exceeding the limit value for the quality (20 cm).

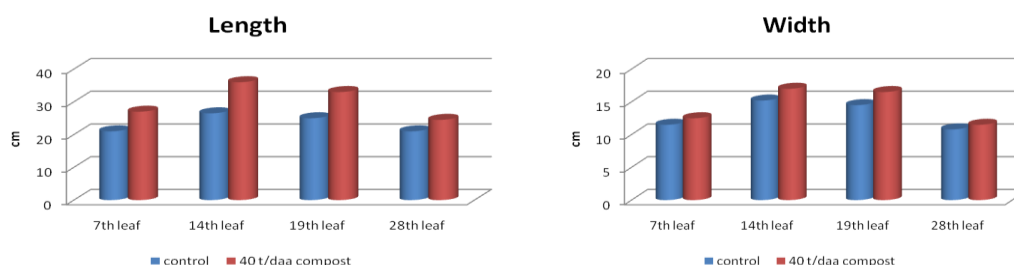

Fig.1. Length and width 7th, 14th, 19th and 28th leaf (cm), representative of a lower, middle and upper harvesting layer

The results of the influence of organic amendments on the accumulation of heavy metals, micro and macronutrients in the leaves of Oriental tobacco are presented in Fig. 2.

The lead content in tobacco leaves varies from 135.6 to 272.5 mg/kg in the control, and from 149.9 to 310.4 mg/kg in variants with incorporation of compost. Visible symptoms, caused by

high levels of Pb, which occur in tobacco - dark green leaves, leafroll of old leaves, dark brown and short roots, were not observed in our experiments. According Tso (1991), the content of Pb in tobacco leaves varies widely - from 0 to 200 mg/kg, and depends largely on the soil characteristics, the type and variety of tobacco, as well as the place of cultivation (Lugon-Moulin *et al.*, 2004). The significantly higher results, received by us, are probably due to soil and aerosol pollution. The incorporation of compost leads to an increase of the lead content in tobacco leaves from the lower and middle zone (Fig.2).

The cadmium content in tobacco leaves varies from 6.4 to 9.0 mg/kg in the control, and from 5.2 to 9.8 mg/kg in variants with incorporation of compost. Visible symptoms caused by the increased content of Cd in plants, such as growth arrest, damage to the root system, chlorosis on leaves, reddish to dark brown colour on their edges, were not observed. According Golia *et al.* (2007) the content of Cd in tobacco ranges from 0.5 to 3.5 mg/kg, while Tso (1991) reports values reaching up to 11.6 mg/kg.

The content of lead and cadmium is lowest in the leaves from the first harvest. Our results are inconsistent with those of Wagner (1994), according to whom the highest values of Cd are found in the leaves from the lower zone of tobacco and significantly lower in the leaves of top zone, assuming gradual accumulation over time. Incorporation of compost leads to a reduction of cadmium in tobacco leaves from the middle and upper zone.

The zinc content in tobacco leaves varies from 151.1 to 218.2 mg/kg in the control, and from 134.6 to 220.5 mg/kg in variants with incorporation of compost. Symptoms of zinc toxicity which manifest themselves as chlorosis and necrosis at the edges of the leaves, inter-veinal chlorosis in young leaves, plant growth arrest as a whole, damage to the roots, were not observed as well. According to Jones *et al.* (1991) and Campbell (2000) the optimum amount of Zn in the tobacco is in the range from 20 to 60 (80) mg/kg, and excess were observed in values above 80 to 100 mg/kg.

According to Campbell (2000) the optimum values of copper for tobacco are 5-10 mg/kg. The values identified by us for Cu in leaves are in the range 14.1 - 21.1 mg/kg. The content of zinc and copper is higher in the leaves from the first harvest, in comparison with the leaves of the second and third harvest. Possible reason for this is the poor mobility of these elements in tobacco plant (Tso, 1991). The incorporation of compost increases the content of zinc in tobacco leaves from the lower zone and reduction of the copper content (Fig. 2).

The iron content in tobacco leaves varies from 215.2 to 584.4 mg/kg in the control, and from 221.6 to 329.1 mg/kg in variants with incorporation of compost. In scientific literature the optimal iron content in tobacco leaves is 50 to 300 mg/kg (Campbell, 2000), whereas 40-50 mg/kg is considered low concentration depending on the stage of plant development (Jones *et al.*, 1991). The iron content established by us in the technically senesced leaves is above the indicated critical value for tobacco. The incorporation of compost leads to decrease of the iron content in the tobacco leaves from the middle and upper zone.

The manganese content in tobacco leaves varies from 24.5 to 64.1 mg/kg in the control, and from 26.6 to 54.7 mg/kg in variants with incorporation of compost. Although the content of mobile manganese in the soil is not high, tobacco leaves contain manganese above the lower limit of 20 ppm indicated by Campbell (2000). The incorporation of compost results in increased manganese content in leaves of the tobacco from the lower zone (Fig. 2).

Phosphorus content in tobacco leaves, depending on the stage of development, ranges from 0.1 to 1% (Jones *et al.*, 1991). Observed concentrations in technically senesced leaves of oriental tobacco are around the lower limit, despite the good preservation of the soil by mobile phosphorus (Table 1). Most rich in phosphorus are technically senesced leaves from the upper harvesting zone. This zone is enriched directly from the soil and by the re-utilization of phosphorus from the lower leaves that become poorer. The influence of compost on the phosphorus content in leaves is relatively weak. A trend for reduction of phosphorus in

leaves is observed in the leaves of the upper and lower harvesting zone while increase in the concentration is observed in the leaves of the 4th harvest.

The content of K in the leaves of tobacco plants varies depending on the stem position (Fig.2). These values are similar to those reported by Volodarskiy (1971), according to whom the content of K in the leaves 2.5-4.2% has a positive influence on tobacco combustibility. The content of potassium in leaves is the highest in the lower harvesting zone. In the middle and lower zone the content is reduced more than 2 times, probably due to reuse of potassium by inflorescences. Despite the good soil preservation with assimilable potassium, the concentration of potassium in leaf tissues decreases. This may be due to the high content of calcium and therefore of antagonism between potassium and calcium, where the intensity of the absorption of potassium is greatly reduced (Enikov and Benevski, 1984). Similar are the results obtained following the incorporation of compost in soil. There is a notable trend of reduction of K at the above-situated leaves.

The calcium content in tobacco leaves varies from 1.9 to 4.3% in the control (Fig.2). These values are similar to those reported by Yancheva (2002). The concentration of Ca in tobacco leaves depends on the stem position. Most Ca is accumulated in senesced leaves from the bottom harvesting zone and senesced leaves from the middle and upper harvesting zone have a significantly low content due to the lack of re-utilization of elements and its focus in older tissues (Fig. 2). The incorporation of compost in soil results in an increase of the calcium content in tobacco leaves (up to 5.0% in the leaves of the lower zone and 3.5% in the leaves of the upper zone).

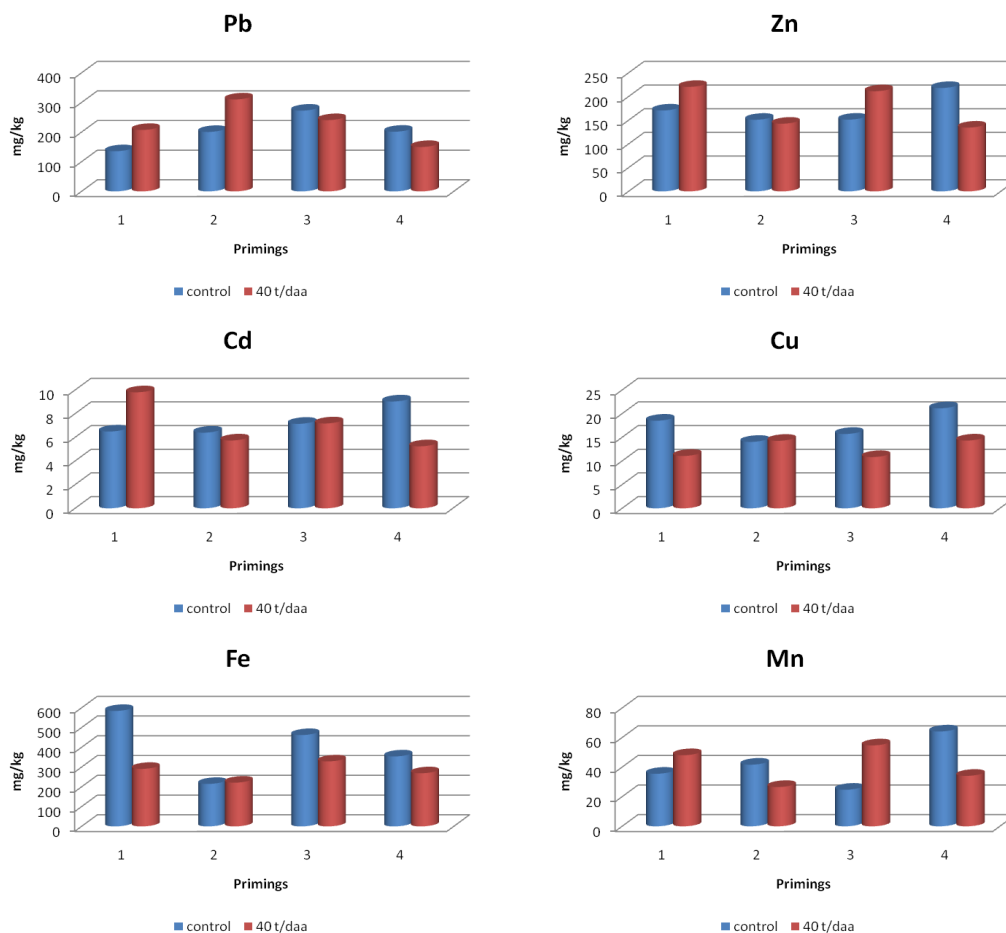

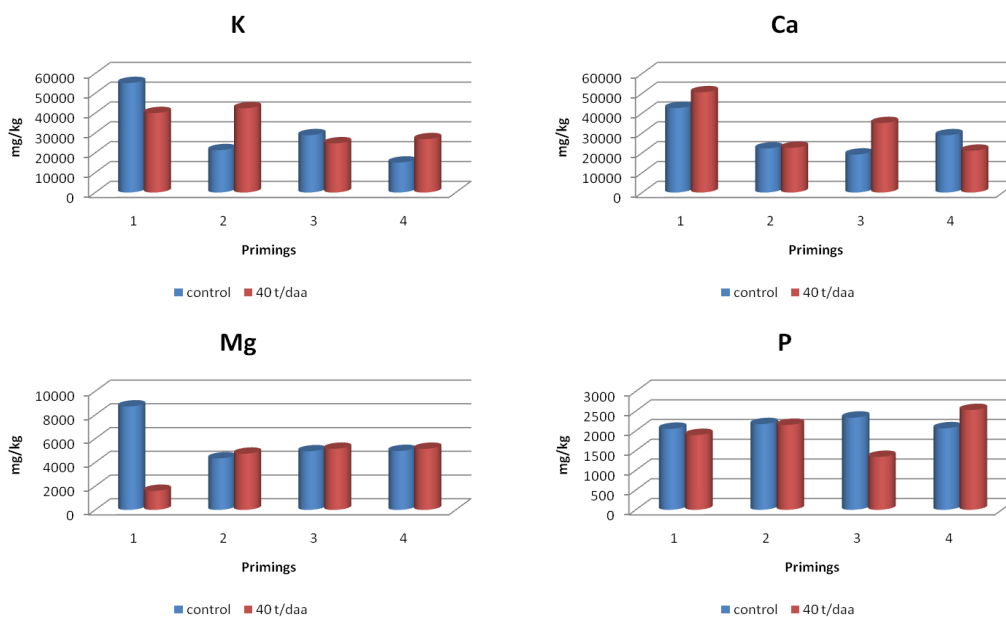

Fig. 2. Effect of compost on uptake of heavy metals, micro and macronutrients in Oriental tobacco leaves variety Krumovgrad 90

The minimum magnesium content in tobacco leaves, where symptoms of insufficiency do not appear, is about 0.25% (Tso, 1991). According to Yancheva (2002) the content of magnesium in technically senescent leaves of oriental tobacco is changed in a narrow range - from 0.33 to 0.69% and depends mainly on the location of the leaves to the stem. According to McCants and Woltz (1967) plants in Mg deficiency have a lower content of the element in the lower leaves in comparison to the upper ones, while in normal supply, the highest concentration of Mg is in the lower leaves. The magnesium content established by us in technically senescent leaves is above the critical value for tobacco. The highest concentration of magnesium is in the leaves of the lower harvesting zone. Apparently, the good preservation of the soil with Mg provides enough direct intake of magnesium in the above organs, which reduces the need for reuse, of which this element is subject to Bozhinova and Bozhinov (2006). The organic additives lead to an increase in the magnesium content in tobacco leaves from the middle and upper zone (Fig. 2).

The K/Ca ratio is important for the quality of tobacco raw material and is mainly associated with its structure, the tobacco leaf and combustibility. When calcium prevails over potassium, raw material is obtained with poor elastic properties and volume. Our results show that K content in tobacco leaves from control plants prevails over the content of Ca. The exception only occurs in the leaves of the 4th harvest. The incorporation of compost in the soil leads to increased contents of potassium and calcium, the K/Ca ratio is changed, in the leaves of the 1st and 3rd harvest it is reduced, while in the leaves of the 2nd and 4th harvest it is increased.

Table 3 presents the results of the impact of compost on chemical parameters (content of ash, sugars and total nitrogen).

Ash. The content of mineral substances (ash) has a well-expressed correlation with the fleshiness of tobacco leaves, and from there with their quality. Ash content in dried leaves of oriental tobacco ranges from 12% to 15% (Gyuzelev, 1983). The increase in the ash content compared to the control sample is evident in the incorporation of compost in the soil. A relationship is established between the content of potassium and magnesium in tobacco leaves and ash content. The increase in the amount of macro elements leads to the increase of ash content.

Table 3. Chemical composition (%) of dried tobacco leaves, variety Krumovgrad 90

Primings (Harvests)	Mineral substances, %	Soluble carbohydrates, %	Proteins, %	Total nitrogen, %	Nicotine, %	Schmuck's number
Control						
I	26.62	6.58	14.30	2.90	0.88	2.27
II	18.66	13.94	15.07	2.41	0.84	5.78
III	15.48	18.67	12.33	1.97	0.60	9.48
IV	17.87	15.46	13.90	2.22	0.66	6.96
40 t/daa compost						
I	28.17	6.79	14.14	2.26	0.62	3.00
II	18.24	13.52	16.07	2.57	0.88	5.26
III	19.51	7.98	15.90	2.55	0.94	3.13
IV	18.92	11.17	15.25	2.44	0.88	4.58

Protein substances. The influence of protein substances on consumer qualities of tobacco is generally negative, since pyrolysis of proteins produces nitrogenous substances in tobacco smoke with unpleasant odor and irritating taste. The content of proteins in tobacco leaves varies from 4 to 16% while in the oriental tobaccos it reaches up to 8.5%. The increase in protein in leaves from the four harvests compared to the control sample is strongly expressed in the incorporation of compost. A correlation is established between magnesium content in tobacco leaves and the content of proteins. The increase in the amount of magnesium leads to the increase in the content of protein substances.

Soluble carbohydrates. Oriental tobaccos contain significant amounts of reducing sugars and small amounts of protein. According to Gyuzelev (1983) the average content of soluble sugars in oriental tobaccos ranges from 10 to 18%. At very high content of soluble carbohydrates - over 16 % for oriental tobaccos and low content of nitrogen compounds, a lopsided taste with insufficient completeness is obtained, and the burning sensation is enhanced. The incorporation of compost in soil leads to lower content of soluble carbohydrates in tobacco leaves.

For the objective determination of the quality of light tobaccos, especially important is the balance between the main components of the chemical composition expressed in various ratios. With the help of the Schmuck's number (ratio of soluble carbohydrates and proteins) the main quality categories of oriental tobaccos can be objectively characterized (Schmuck and Nauk, 1953). Quality tobacco has value over 1.0, average quality - between 0.5 and 1.0, and low-quality - below 0.5. Schmuck's number ranges from 2.2 to 9.48 in the control sample, and from 3.0 to 5.26 in the variant with compost.

The indicators of the chemical composition characterize the material from the four harvests as quality and of average quality, which correlates very well with the results of the expert evaluation of the tobacco samples (data are not shown). The results obtained show that soil pollution with heavy metals do not affect the performance of the chemical composition, determining the quality of tobacco. The normal course of amendment of the chemical indicators is expressed by harvests, characteristic of the oriental tobacco. The resulting values are typical for tobacco of Krumovgrad origin (variety Krumovgrad 90) grown in field conditions, with the exception of the content of nicotine, which is significantly less than the typical for this variety and origin.

The chemical composition in tobacco with compost shows higher content of mineral substances, total nitrogen and nicotine and lower - of reducing substances, i.e. quality deterioration (particularly in the third and fourth harvest). This is also confirmed by the

following indices: (1) reducing substances/pure ash that characterizes fleshiness - in samples without compost it is 0.25-1.21; in those with compost – 0.24-0.74; (2) reducing substances/nicotine - without compost 7.5-31.1, with compost 8.5-12.7. The incorporation of compost in the soil affects negatively as regards to the quality and typicality of the oriental tobacco of variety Krumovgrad 90.

With regard to the smoking properties, in first and second harvests there is almost no difference between samples with compost and those without (but these are harvests with mediocre quality of oriental tobacco), but in third and fourth harvests the samples with compost fall far short of those without compost.

Conclusions

Incorporation of compost affect plant height and number of leaves formed, leads to an increase in the size of leaves and a decrease in the quality of tobacco.

The introduction of compost resulting in increased uptake of macro elements potassium, calcium and magnesium, and leads to improvement of the life status of the tobacco plant, and has a beneficial effect on burning properties of tobacco.

Compost affects the indicators defining the quality of tobacco (ash content, protein and reducing sugars). Application of compost to soil resulting in increased mineral substances (pure ash) and quantity of proteins, and reduces the amount of reducing sugars in tobacco leaves in relation to the control.

The application of compost to the soil affects more negatively as regards quality and typicality of oriental tobacco variety of Krumovgrad 90.

References

- Ali K., Siraj M., Rashid A., Shah M.A. (1984). Testing of some tobacco varieties for different morphological characters and chemical composition. Pak. Tob., 8(1), pp.17-20.
- BDS 9142 (1988). Tobacco - Determination of the content of proteins – method of Moore.
- Bozhiova P., Bozhinov V. (2006). Exploring the influence of some soil parameters on growth and yield of Oriental tobacco Ustina origin. Scientific works Agricultural University Plovdiv, 51, pp.41-46.
- Campbell C. (2000). Tobacco, Flue-cured”, in *Reference sufficiency ranges for plant analysis in the southern region of the United States*, C. R. Campbell, Ed. Southern Cooperative Series Bulletin 394, 2000, pp. 39-45.www.ncagr.gov/agronomi/saaesd/scsb394.pdf
- Cao P.Y., Lu S.J., Zhang W.S. (2004). Advances in soil organic matter contents and vermicomposts application in tobacco growing areas. Acta Tabacaria Sinica, 10(6),pp.40-42.
- Enikov, K., Benevski, M. (1984). Guide on fertilization, Zemizdat, Sofia, pp.294.
- Gyuselev L. (1983). Science of tobacco commodity. Hristo G. Danov, Plovdiv, pp.184.
- Golia E.E., Dimirkou A., Mitsios I.K. (2007). Accumulation of metals on tobacco leaves (primings) grown in an agricultural area in relation to soil. Bull Environ Contam Toxicol., 79 (2), pp. 158-162.
- ISO 15154. (2003). Tobacco. Determination of the content of reducing carbohydrates. Continuous-flow analysis method.
- ISO 11466. (1995). Soil quality – Extraction of trace elements soluble in aqua regia.
- Jones J., Wolf B., Mills H.A. (1991). Plant Analysis Handbook, Micro-Macro Publishing Inc.
- Lugon-Moulin N., Zhang M., Gadani F., Rossi L., Koller D., Krauss M.,Wagner G.J. (2004). Critical review of the science and options for reducing cadmium in tobacco (*Nicotiana tabacum* L.) and other plants. Adv. Agron., 83, pp.111-180.
- McCants C.B.,Woltz W.G. (1967). Growth and Mineral Nutrition of Tobacco. Advances in Agronomy, 19, pp. 211-265.

- Schmuk A., Nauk I.A. (1953). The taste, quality and chemical composition of tobacco. In Gavrilov, N.I. (ed.), "The Chemistry and Technology of Tobacco", Pishchepromizdat, Moscow, pp. 5-22.
- Soltanpour P.N., Schwab A.P. (1977). A new soil test of macro- and micro- nutrients in alkaline soils. *Commun. Soil Sci. Plant Analysis*, 8, pp.195-207.
- Stoilova A., Markova K. (2004). Exploring the contents of major macro and micro elements in tobacco smoke. *Scientific Works University of Food Technology*, 51 (3), pp. 137-142.
- Tso T.C. (1991). *Production, physiology and biochemistry of tobacco plant*, Beltsville, MD, Ideals,
- Volodarskiy N. I. (1971). Mineral nutrition of tobacco. In Rubin, B.A. (ed.), "Physiology of agricultural plants", Moskow University, Moskow, pp. 196-243.
- Wagner G.J. 1994. Accumulation of cadmium in crop plants and its consequences to human health. *Adv. Agronomy*, 51, pp.173-212.
- Wang X.Z., Liu G.S., Hu H.C., Wang Z.H., Liu Q.H., Liu X.F., Hao W.H., Li Y.T. (2009). Determination of management zones for a tobacco field based on soil fertility. *Computers and Electronics in Agriculture*, 65, pp.168-175.
- Yancheva D. (2002) Mineral composition of the oriental tobacco leaves depending on the nitrogen vermicompost rate. The Second Balkan Scientific Conference "Quality and efficiency of the tobacco production, treatment and processing", Plovdiv, 162-166.

VISUAL IMPACT OF WIND TURBINES IN LITHUANIAN LANDSCAPE

Jonas ABROMAS¹, Dovilė KALKĖ²

¹Klaipėda University, Klaipėda, Lithuania, Corresponding author: j.abromas@gmail.com

²Klaipėda University, Vilnius Gediminas technical University, Lithuania, dovilekalke@gmail.com

Abstract

In the 21st century, wind energy has started to be seen as a national asset. It is estimated that by 2020, wind turbines should produce 12% of all the consumed electric energy. Wind energy benefits include very eco-friendly source; efficiency of the generated electric power is up to 25-30 % (solar panel efficiency is up to 20 %); independent and safe source of energy which is getting increasingly affordable (Kytra, 2006). Due to their visual – spatial parameters, these sites are becoming dominant verticals, thus, changing the local landscape and its visual quality, which in turn determines the quality of the living environment. In order to preserve the identity of the regional landscape, it is important to estimate the potential impact of both existing and planned wind turbines on the landscape. Visual impact of wind turbines depends on a number of features: the size, colour and shape of the turbine, observation distance, landscape diversity, time of day, and many other factors.

Considering visual-spatial parameters of wind turbines in Lithuania, landscape features with their potential, and the impact of anthropogenic environment, the basic methodological principles for the assessment of visual impact of wind turbines have been developed. The main phases are distinguished: determining the zones of visual impact; creating GIS (geographic information system) database; visibility modeling; assessment of nature, significance and contrast of the impact.

Keywords: Wind turbines, *visual impact, zones of visual influence, environmental impact assessment.*

Introduction

Wind turbines are becoming an integral part of the landscape in Western Lithuania. The hub height of the wind turbines currently under construction reaches 80-120 m, while the blade-tip height is 120-150 m. Under good visibility conditions, wind turbines can be visible from up to 25-30 km distance. Their construction in the area is initiated by the average annual wind speed, reaching 6-7 m/s. Although this region has important protected areas, resorts (Palanga, Neringa), intensive tourist routes, as many as six wind farms operate in Kretinga district alone (which borders the municipality of Palanga). Also, quite often problems arise when wind turbines are built in the area of natural framework, in the approaches to the national and regional parks, near the important site of cultural heritage and their visual protection zones, and villages. Due to these aspects, the valuable landscape has changed in some areas, since the future impact of the wind turbines under construction had not been adequately estimated.

Due to their visual - spatial parameters, these sites are becoming dominant verticals thus changing the local landscape and its visual quality, which in turn determines the quality of the living environment. In order to preserve the identity of the regional landscape, it is important to estimate the potential impact of both existing and planned wind turbines on the landscape (Kamicaityte-Virbašienė J., Abromas J. 2012).

Materials and methods

Subject matter of the research is the visual impact of wind turbines on the cultural landscape of Lithuania.

The developed methodology for the assessment was tested during the research on wind turbines and wind farms in the districts of Kretinga, Šilutė, Tauragė, Pagėgiai, and Šilalė. Photofixation and assessment (determining the nature and significance of the impact of wind turbines, and degree of contrast) was carried out during the research in situ.

Results and discussion

The world is experiencing rapid development of wind turbine construction. Up until 2008, the European continent was in the lead according to the installed capacity of wind power. At a later period (and now), new wind power has been mostly installed in Asia. At the end of 2015, the total capacity of wind turbines installed worldwide reached 432,883 MW (Global..., 2015). The total amount of wind energy installed in Lithuania is not relatively high (amounted to 438 MW at the beginning of 2016) (LITGRID 2016). The big wind turbines and their farms are concentrated in the western Lithuania. The majority of wind turbines were built in Kretinga, Šilutė and Tauragė district areas. Although this region has important protected areas, resorts (Palanga, Neringa), intensive tourist routes, as many as six wind farms operate in Kretinga district alone (which borders the municipality of Palanga).

Visual impact of wind turbines depends on a number of features: the size, colour and shape of the turbine, observation distance, landscape diversity, time of day, and many other factors (*table 1*). Visibility itself usually includes even several types of landscapes. Therefore, in order to properly assess the visual impact, the size of the landscape area to be visually impacted should be determined, i.e. it is important to determine the extent of the visual impact zone of a wind turbine. As a result, determining the visual impact zone of a wind turbine as a visual dominant of the landscape, and estimating the nature of the impact becomes especially relevant (University of Newcastle, 2002).

Table 1. Factors that influence wind turbines visibility

Factors	Comment
Wind turbine general parameters	Current wind turbine tower manufacturing technologies make it possible to build towers high and reliable. In Lithuania wind turbines Enercon E 82 (2 MW) prevail over the others. These wind turbines are of two types: with metallic tower and those with reinforced concrete tower. The characteristics of wind turbine with metallic tower: height of the tower is 86 m; diameter of the wheel is 82 m; total height is 126 m. The characteristics of wind turbine with reinforced concrete tower: height of the tower is 121 m; diameter of the wheel is 82 m; total height is 150 m. The wind turbine visibility when observing them from certain viewing points depends very much on the height of a tower and the length of a blade.
The number of wind turbines	Wind farm produces a great amount of energy. Due to its general height it can become a dominant, just like a standalone wind turbine. One of the main reasons why a wind farm gets very conspicuous in landscape is the vastness of area it occupies. For example, in six wind farms in Kretinga district 61 wind turbine is located. Together with 8 standalone wind turbines operating over there, too. Different layout of wind turbines at the wind park itself may also make an impact on the landscape quite differently.
Colour and materiality	Colour and materiality of wind turbine are two of the main factors of wind turbine visual impact size and significance. In Lithuania, the wind turbines with metallic as well as reinforced-concrete-and-metallic towers prevail. The colour of wind turbines being operated in Lithuania usually is white or a combination of green and white (green at the bottom of the tower with gradual transition to white at the top of it). The wind turbines of such a colour in rural landscape make visual contrast to green agricultural surroundings.
Second infrastr.	Electric substations, access roads, power transmission lines and other infrastructure enhance the wind turbine's visual impact on landscape, too (Homewood, 2011; Cialdea, 2010).

Factors	Comment
Observing distance	Observing distance is one of the most important aspects in evaluating wind turbine visual impact. With increase of the distance both the vertical and horizontal viewing angle of a wind turbine proportionally decreases. When observing a wind turbine from a greater distance, the sight is also affected by an atmospheric effect caused by small dust particles and humidity of the air. Because of this effect wind turbines attain a greyish hue, and grey colour decreases visual contrast between the background and the wind turbine
Observer's dynamism	Wind turbine visibility differs depending on whether the wind turbine is being observed in a static or dynamic state. When wind turbine is being observed from a static position, its view doesn't change in time. But when we study motor vehicle traffic and are in a dynamic state of observing, the visual relationship between wind turbines and landscape is in constant change. The field of view may be partly restricted by the lack of physical possibilities to observe wind turbines from the vehicle (e.g. due to window size).
Wind turbine location and weather conditions	In cases when we look at a wind turbine from the place lower than the wind turbine is the most part of it is seen in the background of the sky. A visual contrast forms between the white colour of wind turbine and clouds, together with their colour. The clouds of dark grey colour contrast with wind turbine more sharply than white clouds do. The level of contrast also depends on the sun's position and the location of a wind turbine. When the sun is in front of the observer, the wind turbine's visible part is in the shade. If background is dark, the contrast between it and the wind turbine is not so sharp. When the sun is behind the observer, the entire wind turbine gets lightened. If background is lighter, then the contrast is not so sharp in comparison with when the background is dark. Under cloudy weather conditions wind turbines are usually less visible. In some cases wind turbine blades can be totally invisible in the background of clouds (Enviromental Resources Management. 2009).
Purpose of land use	Wind turbines (especially wind farms) are usually installed in terrains with small population where the land is of agricultural use. Agrarian territories, if they are not hilly, can be overviewed widely (because open visual spaces prevail), so wind turbines can be seen from afar. The forests that are present on these territories camouflage wind turbines so their visual impact is reduced. In such cases the towers of wind turbines or their bottom parts are usually prevented from being seen. Only the wheel and cabin are visible. Villages and towns, due to vertical elements present in them, also reduce the visibility of wind turbines.
Territory relief	In hilly territories there are places from which wind turbines are easier, or, in contrary, harder to see. With relief being uniform, the wind turbines visibility gradually decreases with a distance.
Time of the day	The time of the day is of special importance for the wind turbines visibility. During bright period of the day, wind turbine's visibility is at its highest, and, when it's getting dark, it decreases. At night, only wind turbine signal lights are visible.

Visual impact zones. Observation decks and their number become the main object of the visual impact assessment in the analysis of wind turbine impact zones. It is important to select properly the observation (assessment) points, and to evaluate the local landscape, the deployment of important natural as well as anthropogenic activity elements. The degree of visual influence is determined by taking into account the observation distance and wind turbine's visibility. It is important to note that the adjacent visual impact zones (away from a wind turbine (>10 km)) are slightly different from one another in the degree of influence. At a distance of 0 – 3 km wind turbines usually dominate in landscape, at a distance of 4 – 7 km – they become accents, at a distance of 7 – 10 km – subdominants and at a distance of >10 km – background elements (*table 2*). Subdominants (about 7-10 km). Wind turbines are less clearly visible, the size is visually diminished, but the movement is noticeable. With the increasing distance, wind turbines become general elements of the landscape. Remote elements of the landscape (background elements) (>10 km). The turbines are no longer clear, of a small shape and look insignificant. The movement of the blades is generally unnoticeable. The overall size of the turbines is very small (authors of the article, and Jallouli, Moreau 2009).

Table 2. Theoretical visual impact zones of wind turbines

Distance to the wind farm (km)	Visual impact degree	Exposure zones of anthropogenic elements
0-1	Wind turbines dominate because of their large scale, movement of blades, close proximity and the number of them.	Scale domination zone (up to 500 m)
1-3	Wind turbines generally dominate in a landscape. The impact is more significant due to the proximity, visual parameter of wind turbines, which dominate in landscape.	Sight domination zone (up to 3.5 km)
3-5	Wind turbines are clearly seen, and their impact is average. Also, with the distance their domination decreases. The blade movement is seen. Though wind turbines are seen, they are not totally dominating when being observed from the observation point (with enough level of visibility). They become landscape accents .	Psychological effect zone (up to 6.0 km)
5-7	Wind turbines are seen but do not stand out clearly from the overall picture. The blade movement is seen when visibility is good and average. They become landscape accents .	Psychological effect zone (up to 6.0 km)
7-10	Wind turbines are less clear, and, visually, their size is decreased, but movement can be noticed (level of subdominants).	Object is visible but it becomes impersonal in the background of landscape.
10-13	The visual impact is weak, and the movement can be noticed on a bright day – wind turbines get among all the common elements (background elements).	
13-16	Wind turbines become indistinct, with slight impact on the remote landscape. The movement of blades can be seen, but with greater distance they become background elements .	
16-20	Wind turbines and movement of blades can be seen on a bright day but their visual impact is insignificant .	
>20	No impact or it is insignificant. Visibility is influenced by weather conditions, wind turbine visual parameters (rotor diameter, hub height), the local terrain, single trees and forest arrays.	

Map of wind turbine visibility. GIS modelling of the visibility of future wind turbines in the landscape is carried out during construction of wind turbines (especially if the territory is near the populated areas, important cultural heritage sites or observation decks). This is particularly true for expressive Lithuanian territories. With the help of GIS system, the map distinguishes the zones by visibility schemes, which include: *the whole wind turbine; blades only; the rotor (fig. 1)*.

The GDB50 vector map of the territory and Spatial Relief Model of the Republic of Lithuania SRM_LT were used for modelling the visibility of wind turbines. Wind turbine coordinates as well as parameters of the hub height and blade-tip height are entered into the GIS system. The wind farm in Šilutė District was chosen for modelling. This is the only wind farm in Lithuania built on the hilly terrain (Žemaičiai Upland), whereas the influence of the local relief on the visibility of wind turbines is especially relevant.

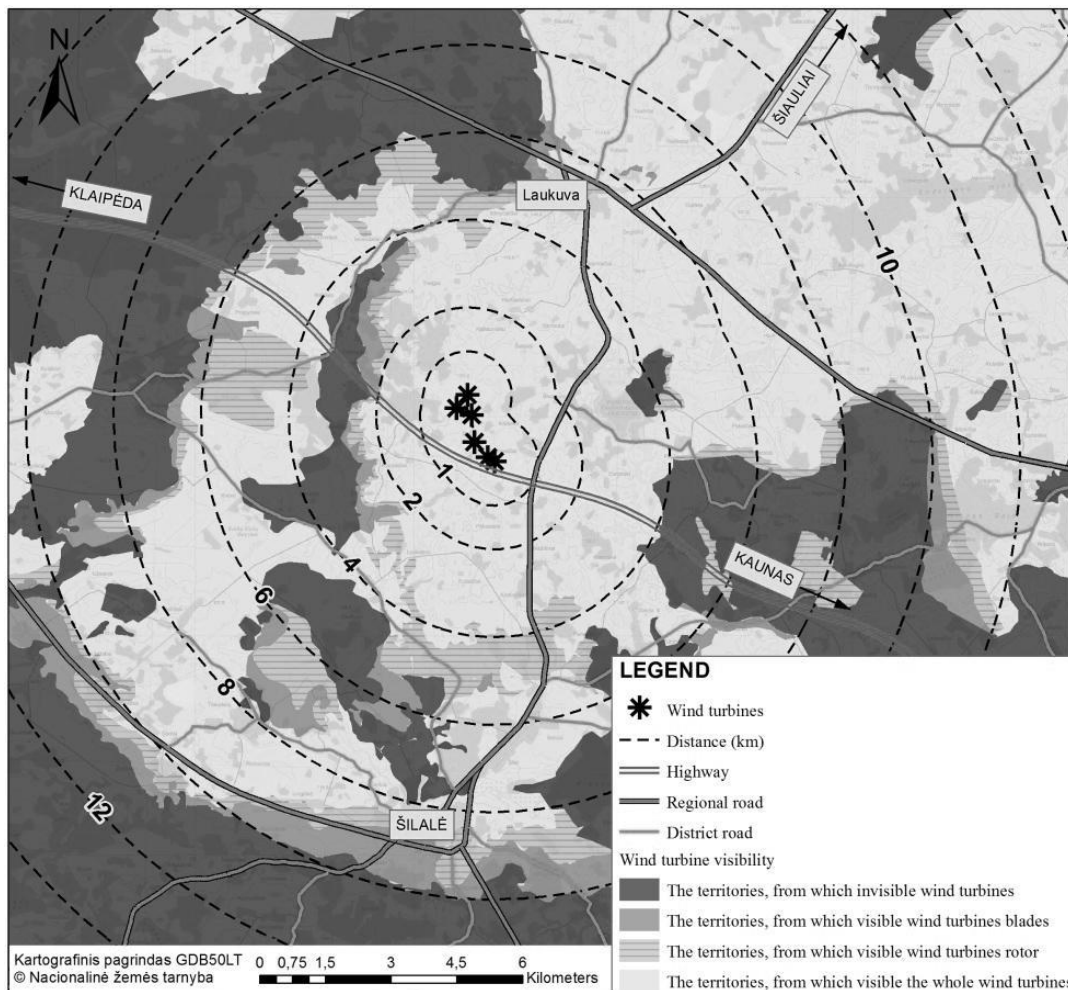

Fig 1. Visibility zones of separate wind turbine parts according to the example of the wind farm in Šilalė district (cartographic base LTDBK50LT © Nacionalinė žemės tarnyba)

Calculating the size of viewing angles. Taking into account the parameters of the vertical field of human vision, *it is important to determine the size of wind turbine's viewing angle* when observing from the particular observation deck chosen (fig. 2-4).

When the vertical viewing angle of wind turbine is up to 0.5° – the visual impact is not significant. The referred viewing angle is determined by an observation distance. With shorter observation distance and the vertical viewing angle of 0.5° - 2.5° – visually, wind turbines become potentially visible. When observing wind turbines from even smaller distance, and with the viewing angle of 2.5° - 5° – wind turbines become visually dominant.

It is particularly important to assess the size of the viewing angle when observing wind turbines from important observation deck in terms of cultural heritage and tourism. In determining the size of the viewing angle, Siemens SWT-2.3-101 wind turbines in Šilalė district were analyzed. The visible angle was calculated under three different situations: when the wind turbine is fully visible; when the wind turbine's rotor and tower's upper part is visible; when only the blades are visible. Parameters of the referred wind turbines: tower height – 99,5 m; rotor diameter – 101 m; blade-tip height – 150 m; and blade length – 50,5 m. In all cases, the wind turbine was observed from a 1000 m distance.

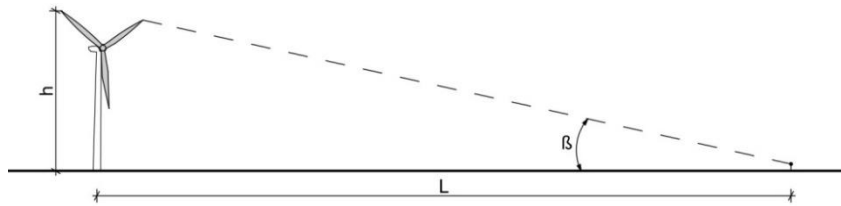

Fig 2. Observation angle of openly visible wind turbine, and its calculation (author of the scheme: J. Abromas, 2016)

- h – Height of wind turbine (150 m)
- L – Distance between the observer and wind turbine (1000 m)
- β – Observation angle of wind turbine

Calculation of the angle β of an openly visible wind turbine

$$\beta = \arctan \frac{h}{L} = \arctan \frac{150}{1000} = 8,53^\circ$$

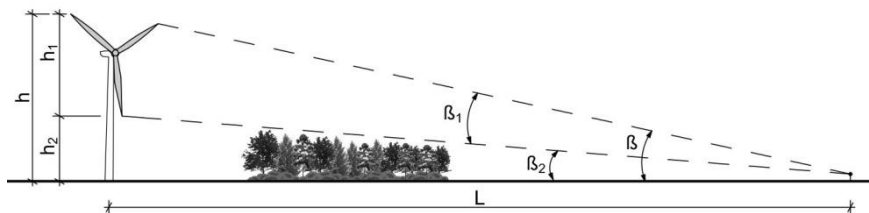

Fig 3. Observation angle of wind turbine and its calculation, when wind motor and tower's upper part is visible (author of the scheme: J. Abromas, 2016)

- h – Height of wind turbine (150 m)
- h_1 – Rotor diameter (101 m)
- h_2 – Tower height up to the blade's lowest point
- $h_2 = h - h_1 = 150 - 101 = 49$ m
- L – Distance between the observer and wind turbine (1000 m)
- β / β_1 / β_2 – Observation angles of wind turbine

$\beta = 8,53^\circ$ (see calculation in Fig. 2)

Calculation of the angle β_1 when the rotor and the tower's upper part is visible

$$\beta_2 = \arctan \frac{h_2}{L} = \arctan \frac{49}{1000} = 2,81^\circ$$

$$\beta_1 = \beta - \beta_2 = 8,53^\circ - 2,81^\circ = 5,72^\circ$$

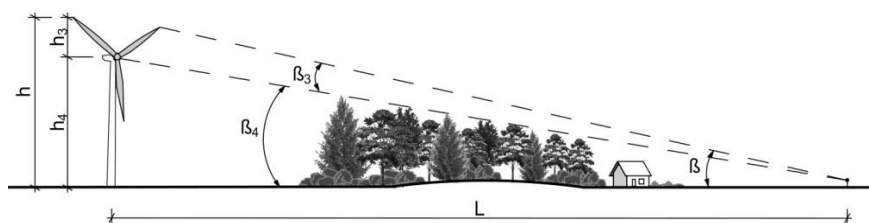

Fig 4. Observation angle of wind turbine and its calculation, when only wind turbine blades are visible (author of the scheme: J. Abromas, 2016)

- h – Height of wind turbine (150 m)

h_3 – Blade length (50,5 m)
 h_4 – Tower's height (90,5 m)
 L – Distance between the observer and wind turbine (1000 m)
 $\beta/ \beta_3/ \beta_4$ – Observation angles of wind turbine
 $\beta=8,53^0$ (see calculation in Fig. 2)

Calculation of the angle β_3 when only the blades are visible

$$\beta_4 = \arctan \frac{h_4}{L} = \arctan \frac{99,5}{1000} = 5,68^\circ$$

$$\beta_3 = \beta - \beta_4 = 8,53^0 - 5,68^0 = 2,85^0$$

Determining the contrast, and significance of the impact on the landscape. After discussing the assessment methodologies of different countries, and their relevance to Lithuania, *principles for determining the contrast of the surrounding area (low, medium, high)* have been distinguished. Significance of the principles lies in their determination based on the *factors relevant to the assessment* of the impact of wind turbines on the landscape, namely the distance, time of observation, relative size, scale of observation, season, lighting conditions, spatial relationships, atmospheric conditions, and movement.

Determination of the visual significance of the impact of wind turbines on the landscape is based on the following criteria: visual insignificance, slightly significant impact (slight impact), the average impact, and substantial impact (table 3).

Table 3. Visual significance of the impact of wind turbines on the landscape

Landscape Visual Sensitivity	Magnitude of Landscape Visual Change			
	Negligible	Low	Medium	High
High	Visual insignificance	The average impact/ Slight impact	Substantial impact/ The average impact	Substantial impact
Medium	Visual insignificance	Slight impact	The average impact	Substantial impact/ The average impact
Low	Visual insignificance	Slight impact	Slight impact	The average impact/ Slight impact

Discussion

Following the research and systemised data, visual impact zones have been revised (*table 2*). Distance zones under assessment have been compacted at the 0-7 km distance from a wind farm. Also, the zones have been divided by the nature of dominance, general dominance, highlights, subdominants, and background elements.

When being at the distance of 0-7 km from the wind farm, it can be noticed that 1-2 km interval is of great importance to the visual impact evaluation. When the distance is greater, the interval of 1-2 km loses its previous importance.

During the assessment procedure, it was found that visual significance is characteristic not only to huge woodlands and spatial structures of the villages, but also to minor objects at small distances from the observer (roadside bushes, single buildings, trees, etc.) which also change the visual influence of wind turbines. The turbines seen on the road perspective axis are of special importance not only because they are observed for a bigger length of time, but because they often become a vertical landmark. In constructing wind turbines it is essential to

take into consideration that the visual domination of the existing important vertical objects is to be preserved.

Atmospheric conditions such as cloudiness also have a big influence on the visual impact of the wind farm. The color of the wind turbines is light grey. When clouds are of the same or similar color the set of blades in some cases can be invisible or on the contrary can be visible more clearly if the clouds are darker.

Evaluating visual impact of wind turbines in Šilalė region visibility of the turbines was conditioned by the additional factor – terrain undulations. Due to this aspect (as well as forested areas) going by highway in the direction of Vilnius the wind turbines become visible only at 6 km distance.

The more anthropogenic objects are in the visual space the more visual impact of the wind farm is decreased. In some cases wind farm can become a background element.

Even though the blade-tip height of the major wind turbines (up to 120-150 m) are observed at the distance of 30 km at good visibility, the visual effect on the landscape is produced only by background elements located at the distance of 15-20 km. When viewed from the roads and from a dynamic position, a more significant effect is produced by the wind turbines located nearer the roads. The turbines located farther from the observer (at a distance of 10-20 km) make visual influence only when seen on the road perspective axis.

Conclusion

1. The visual nature of landscape and its visual-aesthetic quality is changing due to wind farms and single wind turbines built mostly in the Western Lithuania. There are six wind farms in Kretinga district alone (which borders the municipality of Palanga). The hub height of current wind turbines reaches 80-120 m, while the blade-tip height is 120-160 m. These objects are becoming dominant verticals. The documents of territorial planning already provide for the construction of wind turbines in Šilutė and Pagėgiai district areas with the blade-tip height of 200 m. Under ideal weather conditions, the wind turbines can be seen from up to 25-30 km distance. It is important to evaluate the impact of both existing and planned wind turbines on the landscape.

2. The research *in situ* and the summarized data allowed to distinguish factors mostly determining visual impact of wind turbines: visual-spatial parameters of wind turbines, the local terrain, forest arrays and smaller natural and anthropogenic elements between an observer and wind turbines, village deployment, weather conditions and arrangement of wind turbines in the farm/ group.

3. Considering visual-spatial parameters of wind turbines in Lithuania, landscape features with its potential, and the impact of anthropogenic environment, the basic methodological principles for the assessment of visual impact of wind turbines have been developed. The main phases are distinguished: determining the zones of visual impact; creating GIS database; visibility modelling; assessment of nature, significance and contrast of the impact.

References

- Arakawa C., Ariga S., Lida M. 2002. Proposal of Vernacular design for wind turbine. *Jornal of Wind Engineering and Industrial Aerodynamics* 90, pp. 1731–1741.
- Bureau of Land Management 2012. *Visual Resource Contrast Rating: Information Document*. Washington.
- Cialdea, D.; Maccarone, A.; Sollazzo, A. Wind energy and landscape in Molise – Legislation, Incentives and Problems, *International Conference on Renewable Energies and Power Quality (ICREPQ'10)*, March 23-25, 2010, Granada (Spain).

- Domingo-Santos J. M., Fernández de Villarán R. F., Rapp-Arrarás Í., Corral-Pazos de Provens E. 2011. The visual exposure in forest and rural landscapes: An algorithm and a GIS tool, *Landscape and Urban Planning* 101, pp. 52–58.
- Environmental Resources Management. 2009. Ararat Wind Farm Victoria. Landscape and visual assessment report. Australia.
- Global Wind Energy Council. Global Wind Report. Annual Market Update 2015. Available at http://www.gwec.net/wpcontent/uploads/vip/GWEC-Global-Wind-2015-Report_April-2016_22_04.pdf
- Homewood, A. 2011. Eden Wind Farm. Landscape and visual impact assessment. Australia.
- Jallouli J., Moreau G. 2009. An immersive path-based study of wind turbine landscape: A French case in Plouguin. Denmark. *Renewable Energy* 34, pp. 597–607.
- Kamicaityte-Virbašienė J., Abromas J. 2012. Problems of Determining Size and Character of Wind Turbines' Visual Impact Zones on Lithuanian Landscape. *Environmental Research, Engineering and Management* 4 (62), pp. 21-29.
- Kytra, S. *Atsinaujinantys energijos šaltiniai*. Kaunas: Technologija, 2002. 301 p.
- LITGRID 2016. Report on the electric power generated from renewable resources. Available at <http://www.litgrid.eu/index.php/energetikos-sistema/elektros-energetikos-sistemas-informacija/irengtoji-galia/502>
- Möller B. 2006. Changing wind-power landscapes: regional assessment of visual impact on land use and population in Northern Jutland, Denmark, *Applied Energy* 83, pp. 477-494.
- The Landscape Institute. Institute of Environmental Management and Assessment. 2005. *Guidelines for Landscape and Visual Impact Assessment*. Second Edition. London: Spon Press, 166 p.
- Tsoutsos T., Tsouchlaraki A., Tsiropoulos M., Serpetsidakis M. 2009. Visual impact evaluation of a wind park in a Greek island. Denmark. *Applied Energy* 86, pp. 546–553.
- University of Newcastle 2002. *Visual Assessment of Windfarms: Best Practice*. Scottish Natural Heritage Commissioned Report F01AA303A.

CHEMICAL-LIMNOLOGICAL ASSESSMENT OF WATER QUALITY OF VIROI LAKE (ALBANIA)

Marsela ALIKAJ^{1*}, Irena DUKA², Romina KOTO², Ferdi BRAHUSHI²

¹Department of Biology, Faculty of Natural Sciences, University “Eqrem Çabej”, Gjirokastra, Albania

²Department of Agro Environment & Ecology, Faculty of Agriculture & Environment, Agricultural University of Tirana, Tirana, Albania

*Corresponding author: alikajmarsela@yahoo.com

Abstract

Viroi Lake is one of the most important lakes in Gjirokastra district, south of Albania. This lake has a surface of 17 ha, which is supplied by the limestone source ‘Mother of Viroi’, a natural monument. This study aims to assess quality of fresh water of this ecosystem, the eutrophication process and the determination of trophic status referring to the Carlson’s equations. The water samples for their physico-chemical assessment were collected in 5 sampling sites of Viroi Lake during 2011 - 2014. Immediately after collection water samples were transported to the laboratory in ice boxes in a constant temperature of 4°C, according to the standard procedures. The methods that were used during the analysing were ISO standard methods. The water of Viroi Lake, according to Water Framework Directive (WFD) 2000/60/EC, for the maximal values of nutrients has been classified as follow: for nitrites N-NO_2^- from class II to IV and for the concentration of nitrates, ammoniums and orthophosphates in water, class I and II. The values of calculated trophic index (TSI) for Viroi Lake according to the total phosphor, total nitrogen, chlorophyll- α and Secchi disc depth, resulted in the average values showing the *Mesotrophic* status of this water ecosystem.

Keywords: *water, eutrophication, nutrient, trophic state index, mesotrophic*

Introduction

Water is a vital matter for all aspects of human and ecosystem survival and health. Thus, its quality is also important (Hamid Zare Abyaneh, 2014). Surface waters are a great asset to the economy of a country. They are important for many traditional uses like irrigation, fishing, tourism and industry. Next to the rivers and lakes are many inhabited and industrial areas in addition to agricultural and animal farming ones. Thus, almost all the rivers, lakes and coastal areas, serve as sites for urban waste discharge and industrial liquid and in some cases solid ones (Miho et al., 2005).

Aquatic habitats are very sensitive due to the degradation from extensive uses of the people. The influence of humans in the water ecosystems leads to the increase and circulation of chemical substances and its organic pollutants (Alikaj et al., 2014; Alikaj, 2015). In addition human activities influence in the influx of nitrogen and phosphor in water ecosystems. The increase of anthropogenic nitrogen and phosphor in the rivers, lakes and seawaters is the main reason of eutrophication. In general the increase of concentration of nutritional elements in the water ecosystems, is accompanied with the growth of phytoplankton and it spoils the balance between algae production and consumption.

Since coastal eutrophication has become more common over recent years, words like oligotrophic, mesotrophic and eutrophic have also become more frequent in scientific literatures; oligotrophic means low productive and eutrophic means high productive aquatic environment. Several indicators and indices are available for assessing trophic status and quality of aquatic ecosystems and their evolution under different anthropogenic pressures and inherent threats (Jayachandran & Nandan, 2011).

In this context the use of trophic state index according to Carlson (1977), for the estimation of trophic status of water ecosystems is the most widely used. Therefore the aim of this study was to evaluate the occurrence of nutrients in the waters of Viroi lake and the trophic status using abovementioned index. Using Carlson equations, were calculated the concentration of chlorophyll- α and Secchi disc depth, taking into account the concentration of total phosphor. Evaluation of trophic status in Viroi lake is not only a good option in environmental assessment but it is essential in its planning and menagment.

Materials and methods

The study area

Viroi lake (40°6'1"N 20°7'24"E) is located in the north-west of Gjirokastra district and 3 km distance from the town itself. It has a karstic water source called "Mother of Viroi", with a flow of 17 m³/second, and its yearly average temperature is 13-14°C (Rogo et al., 2008). Viroi Lake has a water area of 17 ha and its surrounding area of 11.13hectares, which is mainly wooded with pine.

Sampling method

In the water ecosystem of Viroi lake are performed 8 expeditions during June 2011-April 2014 and water samples were collected in all seasons, taking in the consideration:

- the existence of the source
- anthropogenic and natural factors in the lake
- the estuary of water lake



Figure 1. Sampling points in Viroi lake (Google earth)

Samples were collected in 5 sampling sites, taken in 1.5-L plastic containers and transported in a cool box at a temperature of 4°C. The water analyses were performed within 24 h at the scientific laboratory of the Department of Agro-Environment and Ecology, Agricultural University of Tirana. The chemical parameters such as N-NH₄⁺, N-NO₂⁻, N-NO₃⁻, P-PO₄³⁻, TP, and TN were analyzed by using ISO standard methods. *In situ*, pH, DO, conductivity and temperature were measured by using a portable apparatus Multi 340.

Through Carlson and (Kratzer and Brezonik, 1981) equations were calculated trophic index (TSI) for total phosphor and total nitrogen.

$TSI(TP) = 4.15 + 14.42 \ln(TP)$ (total phosphor, in $\mu\text{g/L}$); $TSI(TN) = 54.45 + 14.43 \ln(TN)$ (total nitrogen in mg/L). Taking into consideration the concentration of total phosphor were

calculated the values of chlorophyll- α and Secchi disc depth and then TSI(CHL- α) and TSI(SD).

$\ln \text{Chl} = 1.449 \ln \text{TP} - 2.442$ (for Chl- α) and $\text{SD} = 48(1/\text{TP})$ (for Secchi disc depth)

$\text{TSI (CHL)} = 30.6 + 9.81 \ln (\text{CHL})$ (chlorophyll - α , in $\mu\text{g/L}$)

$\text{TSI (SD)} = 60 - 14.41 \ln (\text{SD})$ (Secchi disc depth in m)

Results and discussions

The results for physico-chemical parameters that were measured in situ are presented in Table 1. The results showed that pH values ranged in the interval 7-9, in the average values from 7.72 in V1 to 8.16 in V4. Since the pH is an important parameter in the dissolution of many chemical substances, it is also important for aquatic ecosystems. Therefore waters of Viroi lake are classified as high quality based on pH values, but pH values between 6.9-8 do not favour the transformation of NH_4^+ ions into NH_3 which are toxic for fish (Abazi & Balliu, 2012), thus the waters of Viroi lake satisfy this condition. The average values of electrical conductivity ranged from 324 $\mu\text{S/cm}$ to 412 $\mu\text{S/cm}$. This parameter that relates directly to the content of ions dissolved in water, it is not a problem for aquatic ecosystems. However, its measurement helps on identifying a number of problems in aquatic systems and finding the source of these problems. Dissolved oxygen values ranged from 6.46mg/l to 7.46mg/l and according to the WFD, the waters of Viroi lake corresponds to class III (moderate) and II (good).

Table 1. Average values of in situ physico-chemical parameters in Viroi lake

Parameters	V	V2	V3	V4	V5
pH	7,72 \pm 0.22	7,99 \pm 0.57	8,09 \pm 0.26	8,16 \pm 0.56	7,88 \pm 0.25
Temp °C	13,18 \pm 2.92	17,11 \pm 3.95	16,1 \pm 3.31	17,7 \pm 4.83	14,65 \pm 3.3
DO mg/l	6,46 \pm 0.32	6,79 \pm 0.72	7,24 \pm 1.32	7,08 \pm 1.83	7,46 \pm 1.45
EC $\mu\text{S/cm}$	395 \pm 75.41	412 \pm 61.8	324 \pm 143.5	368 \pm 44.96	393 \pm 74.84

The average, maximum and minimum values of nutrients are shown in Table 2.

Table 2. Average values of nutrients in the waters of Viroi lake

Stations	N-NH ₄ ⁺ mg/l	N-NO ₂ ⁻ mg/l	N-NO ₃ ⁻ mg/l	TN mg/l	P-PO ₄ ³⁻ mg/l	TP mg/l
V1	0,031 ± 0.046	0,021 ± 0.013	0,487 ± 0.35	0,568 ± 0.34	0,036 ± 0.48	0,037 ± 0.49
V2	0,050 ± 0.037	0,012 ± 0.0091	0,205 ± 0.31	0,265 ± 0.32	0,025 ± 0.012	0,025 ± 0.012
V3	0,07 ± 0.071	0,031 ± 0.048	0,375 ± 0.38	0,402 ± 0.4	0,026 ± 0.029	0,026 ± 0.029
V4	0,089 ± 0.1	0,013 ± 0.008	0,314 ± 0.4	0,418 ± 0.43	0,021 ± 0.013	0,029 ± 0.034
V5	0,022 ± 0.023	0,015 ± 0.008	0,382 ± 0.36	0,45 ± 0.35	0,017 ± 0.01	0,031 ± 0.04
max	0,27	0,14	1,22	1,27	0,15	0,15
min	0,001	0,003	0,01	0,018	0	0

The values of ammonium in lake waters vary from 0.022mg/l at V5 station to 0.08mg/l in V4 station and according to WFD, the Viroi water lake are classified in the I class (<0.2mg/N/l) of the environmental quality for the ammonium content. On the other hand the average pH values in Viroi lake between 7.72-8.16, do not allow the transformation of the anion of NH₄⁺ in to toxic form of NH₃. The average values of nitrites range from 0.012mg/l in V2 station to 0.031mg/l in V3 station. In maximal values, N-NO₂⁻ in the waters of Viroi lake range from 0.03mg/N/l to 0.14mg/N/l, classifying thus the waters according to WFD from class II(0.03mg/l) in to class IV(<0.3mg/l) of the environmental quality (figure 2). Even though nitrites pass to nitrate during nitrification, in the lake such values are due to on average low temperatures. It is believed that for temperatures lower then 17°C, mainly 12-14°C, the proportion of nitrites oxidation to nitrate gets lower, thus leading to nitrification process control (Randall and Buth, 1984).



Figura 2. Maximal values of N-NO₂⁻ in the waters of Viroi lake according WFD

The high level of nitrates is the source for the eutrophication process, flourishing of algae and diminishing of oxygen in water ecosystems. In Viroi lake the average values of nitrates have varied from 0.205mg/l in V2 station to 0.487mg/l in V1 station. The highest value of nitrates is obtained at the water source in a value of 1.22mg/l. According to WFD in maximal values, the waters of Viroi lake are classified as the I class (<1mg/N/l) and II class (<3mg/l), within these values the process of eutrophication can be controlled (figure 3).

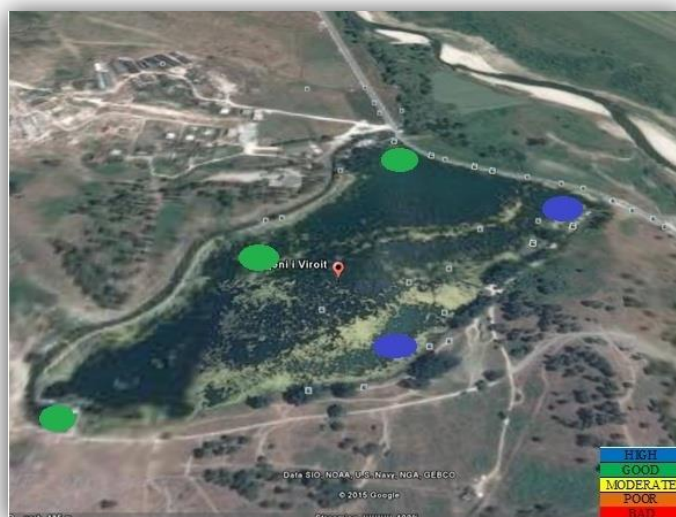

Figure 3. Maximal values of N-NO₃ in the waters of Viroi lake according WFD

Total nitrogen has resulted with values from 0.265mg/l in V2 station to 0.568mg/l in V1 station and the obtained maximal value is 1.27mg/l. Based on average values of total nitrogen and according to WFD, the waters of Viroi lake are of a very good quality (<1.5mg/l). Phosphor is an element that in phosphate forms or total phosphor affects mainly the growth of algae in the lake. Its concentration in waters varies not only between seasons but even from one year to the other, therefore the collection of samples through all the monitoring period it is very important. Thus, the waters of the lake had average values of phosphate content from 0.017mg/l in V5 station to 0.036mg/l in V1 station. Meanwhile, the total phosphor values varies from 0.025mg/l in V2 station to 0.037mg/l in V1 station. The content of total phosphor is considered as a key parameter in many monitoring programs for the assessment of trophic status of rivers and lakes. Regarding to the content of phosphor, the water of the Viroi lake can be considered as of excellent quality.

Assessment of trophic status in Viroi lake with Carlson trophic index (TSI)

In Table 3, for obtained samples in each station are presented the calculated values of TSI trophic index according to total nitrogen, total phosphor as well as to the chlorophyll a and Secchi disc. The last mentioned parameters are calculated through application of Carlson equation taking into consideration the concentration of total phosphor in every analysed sample. Referring to classification according to Carlson and Simpson 1996, the waters of the lake present a trophic index from 40.99 in V3 station to 45.19 in V2 station, which shows the Mesotrophic status $40 < TSI < 70$ (Table 4). From Table 3 showing a consequence of TSI according to the parameters respectively as: $TSI(SD) \geq TSI(TP) > TSI(CHLa) > TSI(TN)$. In average values the trophic index according to Secchi disc and total phosphor are almost equal, $TSI(SD) = TSI(TP) > TSI(CHL)$, which respectively show conditions, non-algae particles or colour domination towards the diminishing of light.

Table 3. Trophic indexes and trophic status for Viroi lake

Stations	Chl, $\mu\text{g/l}$	Secchi disc(m)	TSI (TP)	TSI(TN)	TSI(CHLa)	TSI(SD)	Carlson TSI	Trophic status
V1	0,85	2,48 \pm 1.8	45,56 \pm 21.34	44,11 \pm 8.9	38,93 \pm 10.89	47,24 \pm 8.89	43,91	MESOTROPHIC
V2	0,64	2,38 \pm 1.34	49,09 \pm 7.80	26,27 \pm 18.11	36,94 \pm 4.33	49,54 \pm 7.66	45,19	MESOTROPHIC
V3	0,1	3,75 \pm 2.68	45,22 \pm 13.74	32,84 \pm 18.69	31,62 \pm 10.81	46,14 \pm 13.3	40,99	MESOTROPHIC
V4	0,52	2,87 \pm 1.9	48,68 \pm 13	32,78 \pm 20.31	35,78 \pm 6.36	48,97 \pm 12.7	44,47	MESOTROPHIC
V5	0,42	3,17 \pm 1.82	47,01 \pm 13.55	37,05 \pm 16.9	34,8 \pm 6.26	47,65 \pm 13.16	43,15	MESOTROPHIC

Table 4. Trophic status according to Carlson and Simpson

TSI	Trophic status
<30	Oligotrophic
30-40	
40-50	Mesotrophic
50-60	Eutrophic
60-70	
70-80	Hipereutrophic
>80	

Conclusions

Based on obtained values the water quality of Viroi lake, resulted under the average level of the quality according to the contents of nutrients. The trophic status of the lake resulted in mesotrophic state according to Carlson's trophic index. The values of nutrients nitrogen and phosphor compared to WFD, showed that the phenomenon of eutrophication can be kept under control. The high TSI values according to Secchi disc can be explained by the fact that erosion lead to adding the small particles floating in the lake. The actual situation of the lake requires continuous assessment and better management in order to prevent further deterioration of this ecosystem and its biodiversity.

References

- Abazi U. and Balliu A., (2012). Evaluation of irrigation water quality across major water resources in Albania during a five-year monitoring process. *Journal of Food, Agriculture & Environment*. Vol.10 (2): 919-924.
- Alikaj M., (2015). Environmental assessment of Viroi lake and Drino river in Gjirokastra district and the perspectives of their development. PhD thesis. Tirana
- Alikaj M., Brahushi F., Piro C., PutoK. (2014). Assessment of trophic state in the water ecosystem of Gjirokastra district-Albania. *Fresenius Environmental Bulletin* Vol. 23, No.12b, 2014, pages 3308-3313. (IF=0.641).
- Carlson RE., (1977). A trophic state index for lakes. *Limnology and Oceanography* 22, 361-369.
- Hamid Zare Abyaneh,(2014). Evaluation of multivariate linear regression and artificial neural networks in prediction of water quality parameters. *Journal of Environmental Health Science & Engineering*. <http://www.ijehse.com/content/12/1/40>
- Jayachandran P. R. & Bijoy Nandan S., (2011).Assessment of trophic change and its probable impact on tropical estuarine environment (the Kodungallur-Azhikode estuary, India), Mitigation and Adaptation Strategies for Global Change. ISSN 1381-2386.DOI 10.1007/s11027-011-9347-1. Springer Science+Business Media B.V. 2011
- Miho A., Çullaj A., Hasko A., Lazo P., Kupe L., Bachofen R., Brandl H., Schanz F., Baraj B., (2005).Environmental State of Some Rivers of Albanian Adriatic Lowland, Tirana
- Randall, C. W. and Buth, David (1984). "Nitrite build up in activated sludge resulting from temperature effects." *J. Water Pollut. Control Fed.*, 56(9),1039
- Rogo N., Qiriazhi P., Ruspi, G., (2008). Natural monuments in Gjirokastra districtGjirokastra. Water quality. Physical, chemical and biochemical methods. Determination of nitrite. Molecular absorption spectrometric method. S SH EN 26777:1993.
- Water quality. Determination of phosphorus, Ammonium molybdate spectrometric method. ISO 6878:2004.
- Water quality, Determination of ammonium. Manual spectrometric method. ISO 7150:1984.
- Water quality, Determination of nitrates. Dimetil 2,6fenol spectrometric method. SSH ISO 7890/1:200.
- WFD 2000/60/EC: The Water Framework Directive – integrated river basin management for Europe. Directive 2000/60/EC of the European Parliament of the Council establishing a framework for the Community action in the field of water policy,adopted/on/23/October/2000(http://ec.europa.eu/environment/water/waterframework/index_en.html)

ASTERACEAE IN THE FLORA OF THE JAHORINA MOUNTAIN (BOSNIA AND HERZEGOVINA)

Sladjana PETRONIC*, Natasa BRATIC

Faculty of Agriculture, University of East Sarajevo, East Sarajevo, Bosnia and Herzegovina

*Corresponding author: sladjanapetronic2504@gmail.com

Abstract

The aim of this paper is to present floristic diversity of the family Asteraceae in the flora of the Jahorina Mountain in Bosnia and Herzegovina (BiH). The Jahorina Mountain is located in the central part of BiH and entity of Republic of Srpska, southeast of Sarajevo city. It belongs to continental Dinarides with the direction of the main ridge from northwest to southeast. Jahorina massif is long about 30 km, with the highest peak Ogorjelica (1916 meters above sea level). Research was carried out in the period 2010-2011. Taxonomic analysis of the Asteraceae family was found in 203 taxa (135 species, 49 subspecies, 13 varieties and 6 forms). The analysis of the areal spectrum shows the dominance of the endemic areal group with 24 species and Euroasian group with 20 species. The biological spectrum of the Asteraceae family indicates the dominance of plants belonging to the hemikryptophytes life forms.

Key words: *Asteraceae, flora, Jahorina Mountain*

Introduction

The Jahorina Mountain is located in the central part of BiH and entity of Republic of Srpska, southeast of Sarajevo city. The Jahorina Mountain range is determined with coordinates 43° 39' to 43° 47' north latitude and 18° 31' to 18° 43' east longitude. It belongs to continental Dinarides with the direction of the main ridge from northwest to southeast. Jahorina massif is long about 30 km, with the highest peak Ogorjelica (1916 meters above sea level). In geological terms Jahorina is composed of a variety of rocks of Paleozoic, Mesozoic and Permian Triassic age. The base consists of Carbon and Permian sandstones and shales, and above them there are Mesozoic Triassic limestones. From the land, on carbonate surface, the following have been developed: lithosols, organogenic and organomineral calcomelanosol, calcocambisol, luvisols, and on a silicate substrate: brown podzols, podzols, swampy gley peat and ranker. The lowest altitude position is in the climate which is temperate continental, in a central part of Jahorina is subalpine climate, and in the highest mountain areas is alpine continental climate.

The oldest data relating to the research of flora of Jahorina date back from the works by Fiala (1893, 1895), Back-Mannagetta (1886-1898, 1903-1923), Maly (1938, 1939), Bjelčić (1964-1965). Herbarium collection that was created as a result of these studies is well-preserved and located in Sarajevo at the National Museum of Bosnia and Herzegovina. Numerous floristic data were described in the ecological papers (Maly 1931-1932; Kusan, 1952; Bjelčić, 1965; Pavlović, 1976; Lakusić, 1981; Petronić, 2000). The aim of this paper is to present floristic diversity of family Asteraceae in the flora of the Jahorina Mountain.

Material and methods

Research was carried out in the period of 2010-2011. Along with field research, the literature, relating to the nature of the study area, was studied. Herbarium collection created as a result of

these studies is well-preserved and located in the Republic Institute of the Protection of Cultural and Natural Heritage of RS.

Identification of species was based on floristic literature (Beck, 1903; Beck, 1927; Josifovic ed.1970-1977; Javorika and Csapody, 1979). The nomenclature is in line with Flora Europaea (Tutin, et al. 1964-1980). Floral elements are given by Oberdorfer (2001) and Gajić (1980). Life forms are given by Oberdorfer (2001).

Results and Discussion

Table 1 shows the tax of the family Asteraceae in the flora of Jahorina mountain with its life forms and floral elements. Data of life forms are given before the name of tax, a phytogeographical affiliation behind. For life forms and floral elements used are given appropriate abbreviations.

Table 1. List of genus, species and infraspecific tax with associated life forms and floral elements

Life forms	List of genus, species and infraspecific tax	Floral elements
H	<i>Eupatorium cannabinum</i> L.	eurassubozean-smed
H	<i>Solidago virga-aurea</i> L.	euras (subozean)
	<i>S. v. subsp. minuta</i> (L.) Arcangeli	
H	<i>S. canadensis</i> L.	adv (N. Am)
H	<i>Bellis perennis</i> L.	subatl-smed
	<i>B. perennis</i> L. var. <i>meridionalis</i> Favrat	
H	<i>Erigeron annuus</i> (L.) Pers.	adv (N. Am)
H	<i>E. acer</i> L.	
H	<i>E. atticus</i> Vill.	alpine-carpathian-balkan
H	<i>E. alpinus</i> L.	alp
T, H	<i>Conyza canadensis</i> L.	adv (N. Am)
H	<i>Omalotheca sylvatica</i> (Gunn.) Schultz Bip.	no-euras (subozean), circ
	<i>O. s. var. alpestre</i> Brügg.	
H	<i>O. norvegica</i> (Gunn.) Sch. Bip & F. W. Schultz	alp-arkt (subozean)
T, H	<i>Filaginella uliginosa</i> (L.) Opiz	eurassubozean-smed
Ch	<i>Anthenaria dioica</i> (L.) Gärtner	no-euras
	<i>A. dioica</i> (L.) Gärtner. var. <i>corymbosa</i> Hartman	
H	<i>Inula britannica</i> L.	euraskont-smed
G, H	<i>I. salicina</i> L.	euraskont (-smed)
H	<i>Bupthalmum salicifolium</i> L.	pralp (-osmed)
G, H	<i>Telekia speciosa</i> (Schreber) Baumg	opralp (bale)
T	<i>Bidens tripartitus</i> L.	euras-smed
T	<i>Galinsoga parviflora</i> Cav.	adv (N. Am)
T	<i>Anthemis cotula</i> L.	med-smed-eurassubozean
T	<i>A. arvensis</i> L.	eurassubozean-med
H	<i>Achillea lingulata</i> Waldst. & Kit.	submoesian-subcarpathian

H	<i>A. clavennae</i> L.	oalp
	<i>A. c.</i> L. var. <i>argentea</i> Vis.	
H	<i>A. distans</i> Waldst. & Kit.	alp
H	<i>A. stricta</i> (Koch) Schleicher	alp
	<i>A. s.</i> Schleich f. <i>lanuginosa</i>	
H (Ch)	<i>A. millefolium</i> L.	no-eurassubozean
H	<i>A. collina</i> J. Becker	europkont
H	<i>A. nobilis</i> L	euraskont-smed
T	<i>Matricaria trichophylla</i> (Boiss.) Boiss.	subbalkan
	<i>M. t.</i> (Boiss.) Maly f. <i>chloranthum</i> (Waisb.) Maly	
T	<i>M. perforata</i> Mérat	kosm (gemäßkont)
T	<i>Chamomilla recutita</i> (L.) Raus	kosm eurassubozean (-smed)
T	<i>C. suvaeolens</i> (Pursh) Rydb.	adv (Asia)
H	<i>Tanacetum parthenium</i> (L.) Schuttz	osmed
H	<i>T. macrophyllum</i> (Kield) Schuttz	opralp
H	<i>Leucanthemum vulgare</i> Lam	osmed
	<i>L. vulgare</i> Lam. subsp. <i>triviale</i>	
	<i>L. praecox</i> (Horvatić) Horvatić	
H (Ch)	<i>Artemisia vulgaris</i> L.	eurassubozean
G (H)	<i>Tussilago farfara</i> L.	no-uras-smed
G	<i>Petasites albus</i> P. Gäertner	pralp (-smed-subatl)
G (H)	<i>P. hybridus</i> (L.) P. Gäertner	gemäßkont-osmed (-pralp)
G	<i>P. kablikianus</i> Tausch.	Balkan
H	<i>Homogyne alpina</i> (L.) Cass	pralp-alp
H	<i>Adenostyles alliariae</i> (Gouan) A. Kerner	pralp-alp
H	<i>Doronicum austriacum</i> Jacq	pralp
H	<i>D. columnae</i> Ten.	subbalkan-apennine
	<i>D. c.</i> f. <i>orientale</i> Hay.	
H	<i>Senecio fluviatilis</i> Wallr.	euras-kont
	<i>S. nemorensis</i> L. subsp. <i>fuchsii</i> (C. C. Gmelin) Čelik	gemäßkont (-osmed)
H	<i>S. papposus</i> (Reichenba) Less.	Illyrian
	<i>S. p.</i> subsp. <i>papposus</i> (Griseb.) Boiss	
H	<i>S. subalpinus</i> Koch.	alps-carpathian
H	<i>S. rupestris</i> Waldst. & Kit.	subbalkan-subapennine
	<i>S. r.</i> f. <i>adustus</i> (Beck) Murb.	
T (H)	<i>S. vulgaris</i> L.	(kosm) smed-uras
H	<i>Carlina vulgaris</i> L	subatl-smed
	<i>C. v.</i> subsp. <i>longifolia</i> Nyman	
H	<i>C. acaulis</i> L.	pralp (-smed)

	<i>C. a. var. alpina</i> Jacq.	
H	<i>Arctium tomentosum</i> Miller	euras-kont
H	<i>A. lappa</i> L.	-smed
H	<i>A. minus</i> Bernh.	subatl-smed (-med)
H	<i>Jurinea mollis</i> (L.) Reichenb.	subbalkan
H (T)	<i>Cardus nutans</i> L.	smed-euras
H	<i>C. micropteris</i> (Borb.) Teyber	balkan-apennine
H	<i>C. acanthoides</i> L.	gemäßkont (-smed)
H	<i>C. personata</i> (L.) Jacq.	carpatho-balkan-apennine
H	<i>C. candicans</i> Waldst. & Kit.	balkan
	<i>C. c. var. albanica</i> Bald.	
H	<i>C. carduelis</i> (L.) Gren	illyrian-apennine
	<i>C. carduelis</i> (L.) Gren. subsp. <i>alpestris</i> Rossi.	
H	<i>Cirsium eriophorum</i> (L.) Scop.	(o) smed-pralp
	<i>C. eriophorum</i> (L.) Scop. subsp. <i>velenovskiyi</i> Vandas	
H	<i>C. vulgare</i> (Savi) Ten.	eurassubozean-smed
H	<i>C. rivulare</i> (Jacq.) All.	opralp- gemäßkont
H	<i>C. erisithales</i> (Jacq.) Scop.	pralp-smed
H	<i>C. waldsteinii</i> Rouy	alps-carpathian
H	<i>C. oleraceum</i> (L.) Scop.	euras (kont)
T, H	<i>C. candelabrum</i> L.	balkan
H	<i>C. acaule</i> Scop.	subatl-smed
	<i>C. a. var. incanum</i> (Fisch.) Ledeb	
H	<i>C. palustre</i> (L.) Scop.	no-euras (subozean)
G	<i>C. arvense</i> (L.) Scop.	no-eurassmed
H	<i>Onopordon acanthium</i> L.	smed-euras
H	<i>Centaurea kotschyana</i> Heuffel ex Koch	balkan
	<i>C. k. subsp. diversifolia</i> (Murb.) Hay.	
H	<i>C. scabiosa</i> Beck	eurassubozean-smed
H	<i>C. jacea</i> L.	eurassubozean-smed
	<i>C. jacea</i> L. var. <i>semipectinata</i> Greml.	
H	<i>C. transalpina</i> Schleicher	alp
H	<i>C. nigrescens</i> Willd.	eurassubozean-smed
H	<i>C. phrygia</i> L.	
H	<i>C. stenolepis</i> A. Kerner subsp. <i>bosniaca</i> (Murb) Dostál	
H	<i>C. triumfetti</i> All.	smed-pralp
	<i>C. triumfetti</i> All. subsp. <i>adscedens</i> (Bartl.) Hay.	
T	<i>Carthamus lanatus</i> L	med-smed-eurassubozean
H	<i>Cichorium intybus</i> L.	(kosm) eurassubozean-smed
H	<i>Aposeris foetida</i> (L.) Less.	(o) pralp

H	<i>Hypochaeris maculata</i> L.	euras (kont) (-smed)
	<i>H. m. subsp. pelivanovic</i> (Velen) Hayek	
	<i>H. m. var. citrina</i> Maly	
H	<i>H. radicata</i> L.	subatl (-smed)
H	<i>Leontodoa autumnalis</i> L.	no-subatl
H	<i>L. hispidus</i> L.	eurassubozean-smed
H	<i>L. crispus</i> L.	
H	<i>Picris hieracioides</i> L.	euras- (kont)-smed
H	<i>Scorsonera purpurea</i> L.	kont
	<i>S. p. subsp. rosea</i> (Waldst. & Kit.) Nyman	
H	<i>S. hispanica</i> L.	gemäßkont (-smed)
H	<i>Tragopogon pratensis</i> L.	smed- gemäßkont (pralp)
T	<i>Sonchus asper</i> (L.) Hill.	(kosm) eurassubotean (-smed)
T	<i>S. oleraceus</i> L.	(kosm) euras-smed-med
H	<i>S. arvensis</i> L.	(kosm) euras (kont)
T (Ch)	<i>Lactuca serriola</i> L.	smed- (gemäß) kont
H	<i>L. perennis</i> L.	smed
H	<i>Cicerbita alpina</i> (L.) Wallr.	pralp-no (subozean)
H	<i>C. pancicii</i> (Vis.) Beauverd	west moesian-south illyrian
H	<i>Prenanthes purpurea</i> L.	pralp –smed
H	<i>Micelis muralis</i> (L.) Dumort.	subatl-smed
H	<i>Taraxacum officinale</i> Weber	(kosm) no-euras (subozean)
H	<i>T. laevigatum</i> D.C.	
H	<i>T. apeninum</i> (Ten.) Ten.	
H	<i>T. palustre</i> (Lyons) Symons	subatl-smed
H	<i>Chondrilla juncea</i> L.	med-smed-kont
T (H)	<i>Lapsana communis</i> L.	eurassubozean-smed
H	<i>Crepis viscidula</i> Fröhl.	moesian-carpathian
H	<i>C. paludosa</i> (L.) Moench	
H	<i>C. aurea</i> (L.) Cass.	alps-carpathian
	<i>C. a. f. dentata</i> Maly	
H	<i>C. bocconi</i> F. D.	alp
H	<i>C. conyzifolia</i> (Gouan) A. Kerner	alp-pralp
H	<i>C. biennis</i> L.	gemäßkont (-opralp)
H, T	<i>C. capillaris</i> (L.) Wallr.	subatl-smed
H	<i>C. froellichiana</i> subsp. <i>dinarica</i> (Beck) Guteman	dinaric
H	<i>Hieracium hoppeanum</i> Schultes	oalp
	<i>H. h. subsp. leucocephalum</i> Vukot	
	<i>H.h. Schult. subsp. multisetum</i> N.P.	
	<i>H.h. subsp. osmanicum</i> N.P	

	<i>H. brachiatum</i> Bert. subsp. <i>brachiatiforme</i> M.P	
	<i>H. b.</i> subsp. <i>crociflorum</i> N.P. v. <i>angustias</i> M.Z.	
	<i>H. b.</i> f. <i>glandulosissimum</i> M.	
H	<i>H. pilossela</i> L.	no-eurassubozean
	<i>H. p.</i> L subsp. <i>acuminatissimum</i> (N.P.) Z. f. <i>alpinus</i> (N.P.) Z	
	<i>H. p.</i> subsp. <i>subvirescens</i> N.P	
	<i>H. p.</i> var. <i>coniosphera</i> Z.	
	<i>H. p.</i> var. <i>subcaulescens</i> (N.P.) H.	
H	<i>H. pavichii</i> Heuffel	submediumbalkan
	<i>H. p.</i> subsp. <i>pseudoholeion</i> Zahn	
	<i>H. p.</i> subsp. <i>astolonum</i> Vukot.	
	<i>H. p.</i> Heuff. f. <i>ziljevanum</i> Z.	
H	<i>H. praealtum</i> Vill.	gemäßkont-osmed
	<i>H. p.</i> subsp. <i>bauhinni</i> (Bess.) Petunnikov	
	<i>H. p.</i> subsp. <i>adenocymum</i> (N.P) M. i Z.	
H	<i>H. cymosum</i> L.	no- gemäßkont
	<i>H. c.</i> subsp. <i>heldreichianum</i> M	
	<i>H. c.</i> subsp. <i>meizocephaloides</i> H.Z	
	<i>H. c.</i> subsp. <i>mizocephalum</i> N. P	
	<i>H. c.</i> subsp. <i>sabinum</i> Leb. et Mur.	
	<i>H. c.</i> subsp. <i>viridans</i> N.P.	
	<i>H.c.</i> subsp. <i>xanthophyllum</i> Vukot	
H	<i>H. caespitosum</i> Dumort.	no-euras-kont
H	<i>H. aurantiacum</i> L.	no-pralp
	<i>H. guthnickianum</i> Hg. var. <i>pseudoaurantiacum</i> M	
	<i>H. g.</i> subsp. <i>erythrodes</i> (N.P) Z.	
	<i>H. g.</i> subsp. <i>xanthophylogenes</i> Z.	
H	<i>H. murorum</i> L.	no-subatl-smed
	<i>H. murorum</i> L. subsp. <i>pleiophyllogenes</i> Z. f. <i>normale</i> Z	
H	<i>H. praecurrens</i> Vuko	
	<i>H. p.</i> subsp. <i>eupraecurrens</i> Z. f. <i>genuinum</i> Maly	
	<i>H. p.</i> subsp. <i>pseudoleiphylloides</i> M.Z.	
	<i>H. p.</i> subsp. <i>trachysetum</i> Borb.	
	<i>H. bifidum</i> Kit.	alp-pralp-nosubozean
	<i>H. b.</i> subsp. <i>bifidum</i> (Kit.) Z.	
	<i>H. b.</i> subsp. <i>caesiiflorum</i> Almq.	
	<i>H. b.</i> subsp. <i>caesitosum</i> Z.	
	<i>H. b.</i> subsp. <i>caesiotropum</i> M.Z.	
	<i>H. b.</i> subsp. <i>incisifolius</i> f. <i>glandulosum</i> Z	

	<i>H. trebevicianum</i> K. Maly	
	<i>H. t.</i> subsp. <i>deanum</i> Z.	
	<i>H. t.</i> subsp. <i>epiprasium</i> Z.	
	<i>H. t.</i> subsp. <i>subpleiophyllum</i> Z.	
	<i>H. vulgatum</i> Fries	
	<i>H. v.</i> subsp. <i>subrivale</i> Z.	
	<i>H. rotundum</i> Kit.	
	<i>H. r.</i> var. <i>largidens</i> M. Z.	
H	<i>H. villosum</i> Jacq.	alps-carpathian
H	<i>H. pilosum</i> Schl.	alps-carpathian
	<i>H. p.</i> subsp. <i>villosifolium</i> N. P. var. <i>genuinum</i> Z.	
	<i>H. dentatum</i> subsp. <i>runcinatum</i> N.P. var. <i>zlatištense</i> M.Z.	
	<i>H. waldsteini</i> Tausch	
H	<i>H. bupleuroides</i> C. C. Gmel.	pralp (-smed)
	<i>H.b.</i> subsp. <i>schenkii</i> var. <i>glabriflorum</i> N.P	
	<i>H. macrodontoides</i> (Zahn) Zahn	
	<i>H. prenanthoides</i> Vill.	
	<i>H. p.</i> subsp. <i>bupleurifolium</i> (Tsch.) Z.	
	<i>H. austroslavicum</i> K. Maly & Zahn	

Taxonomic analysis of the Asteraceae family found 203 tax, of which 51 genus, 135 species, 49 subspecies, 13 varieties and 6 forms (tab. 2).

Table 2. Taxonomic review of the family Asteraceae

The family Asteraceae	
Genus	51
Species	135
Subspecies	49
Variety	13
Form	6
Total:	203

Extensive studies of the flora of Jahorina mountain explored by Bjelic (1965: 109-157) noted 1044 tax. Recent studies of the flora of the Jahorina mountain, shows 1159 tax (Petronic, Pavlovic, 2012: 13). In the flora of BiH in the family Asteraceae, there are 260 tax stated (Redzic et al., 2008: 18-19). In the area of Jahorina, Bjelic (1965: 142-147) recorded 163, and Petronic, Pavlovic (2012: 24-27) 203 tax. These results show a remarkable floristic diversity of the family Asteraceae in Jahorina.

The areal spectrum of the family Asteraceae (Graph 1) consists of 12 areal groups. There were a dominance of endemic species with 23 (19%) and euroasian 20 (16%) areal groups. Besides these groups, significantly present are species of prealpine 14 (12%), boreal 12 (10%) and the alpine 10 (8%) areal groups. Less represented in the construction of areal spectrum are species of the submediterranean, subatlantic, cosmopolitan, moderately continental, adventive, mediterranean, european and continental areal groups.

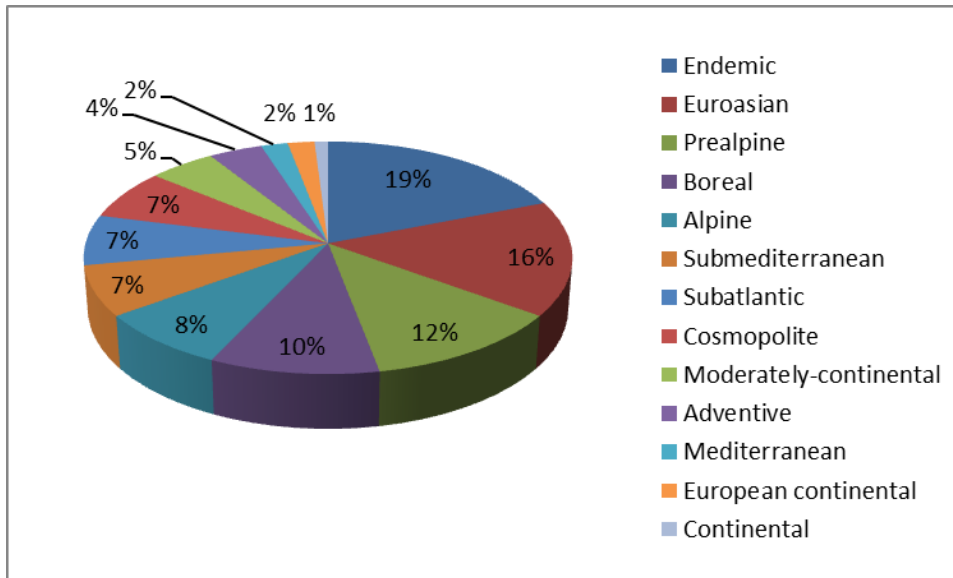

Graph 1. Areal spectrum of the family Asteraceae

Endemic areal group includes species with relative distribution restrictions. These are mainly subendemics or hemiendemics spread to larger geographic units: dinaric (*Crepis froellchiana* subsp. *dinarica*), balkan (*Centaurea kotschyana*, *Petasites kablikianus*, *Cirsium candelabrum*, *Cardus candicans*), alpine-carpathian-balkan (*Erigeron atticus*) submoesian-subcarpathian (*Achillea lingulata*), subbalkan (*Matricaria trichophylla*, *Jurinea mollis*), subbalkan-apennine (*Doronicum columnae*), illyrian (*Senecio papposus*), alps-carpathian (*Hieracium villosum*, *Hieracium pilosum*, *Cirsium waldsteinii*, *Cirsium waldsteinii*, *Crepis aurea*), balkan-apennine (*Cardus micropteris*), carpatho-balkan-apennine (*Cardus personata*), illyrian-apennine (*Cardus carduelis*), west moesian-south illyrian (*Cicerbita pancicii*), moesian-carpathian (*Crepis viscidula*), submediumbalkan (*Hieracium pavichii*). Among the endemic species mezoendemic is dominant, while few species of stenoendemic can be found in infraspecific forms of subspecies, varieties and forms.

Chart 2 shows the results of analysis of life forms. Among the species of the family Asteraceae percentage dominance have hemicryptophyte with 103 species (81%). In the construction of the biological spectrum the following participate: therophytes with 17 species or 13%, geophytes with 7 species or 5% chamaephytic with 1 species or 1%.

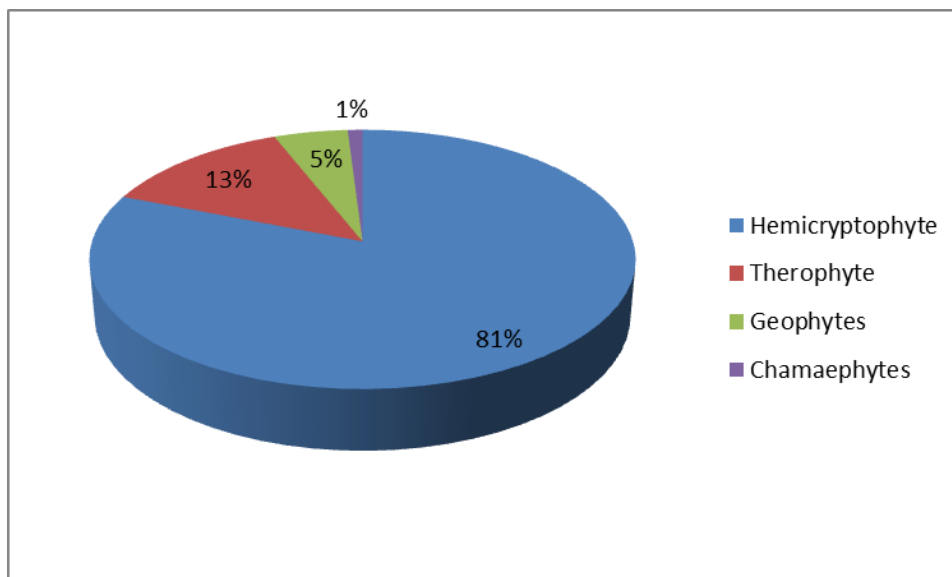

Graph 2. Biological spectrum of the family Asteraceae

A significant number of species of the family Asteraceae is on the preliminary Red List of threatened plants of Bosnia and Herzegovina (Šilić, 1996: 323-367). Category of vulnerability is determined by the current IUCN criteria. Rare and endangered species from the preliminary Red List of Bosnia and Herzegovina are: *Erigeron atticus* (K), *Telekia speciosa* (V), *Achillea lingulata* (V), *Achillea clavennae* (V), *Leucanthemum praecox* (V), *Petasites kablikianus* (R), *Centaurea kotschyana* (V), *Hypocrepis illyrica* (R), *Cicerbita pancicii* (V), *Crepis bosniaca* (R), *Crepis dinarica* (R), *Hieracium trebevicianum* u *Hieracium waldsteini* (R).

According to the Regulation on the Red List of endangered species of flora and fauna of RS („Official gazette of Republic of Srpska“ no: 124/12) the following species are protected: *Achillea lingulata*, *Achillea clavennae*, *Centaurea kotschyana*, *Centaurea ruperists*, *Cirsium rivulare*, *Cicerbita pancicii*, *Crepis froellchiana* subsp. *dinaricum*, *Erigeron atticus*, *Hieracium trebevicianum*, *Hieracium waldsteinii*, *Hypochaeris maculata* subsp. *pelivanovic*, *Leucanthemum praecox*, *Omalotheca norvegica*, *Senecio papposus* subsp. *papposus*, *Taraxacum palustre*, *Telekia speciosa*. For these species, categories of threat are not specified.

Conclusions

Data of the flora of the Jahorina mountain, which refer to the Asteraceae, have been obtained on the basis of research and literature data. After analyzing the obtained data the following conclusions were drawn:

The high degree of diversity of the family Asteraceae from the Jahorina mountain is reflected in the presence of 135 species, 49 subspecies, 13 varieties and 6 forms.

In the areal spectrum the dominant percentage has been shown by the plants that belong to the endemic areal group. Among the endemic species mezoendemic are dominant, while few species of stenoendemic can be found in infraspecific forms of subspecies, varieties and forms.

In the biological spectrum of the family Asteraceae, the most frequent are hemicryptophytes while therophytes, geophytes and chamaephytic are less represented. A significant number of species of the family Asteraceae are on the Preliminary Red List of threatened plants of BiH as well as on the Red List of endangered species of flora and fauna of RS.

References

- Beck, G. (1903): Flora Bosne, Hercegovine i Novopazarskog Sandžaka. I dio, /Flora of Bosnia, Herzegovina and the Sanjak of Novi Pazar/, first part, Zemaljska štamparija, Sarajevo.
- Beck, G. (1927): Flora Bosnae, Hercegovinae i Novopazarskog Sandžaka. II dio, /Flora of Bosnia, Herzegovina and the Sanjak of Novi Pazar/, second part, Državna štamparija u Sarajevu, Beograd-Sarajevo.
- Bjelčić, Ž. (1966): Flora planine Jahorine, /Flora of Jahorina Mountain/, Glasnik Zemaljskog muzeja, Prirodne nauke, sv. III-IV, Sarajevo.
- Bjelčić, Ž. (1966): Vegetacija predplaninskog pojasa planine Jahorine, /Vegetation pre-mountain strip of Jahorina/ Poseban otisak iz Glasnika Zemaljskog muzeja Prirodne nauke, sv. V, Sarajevo.
- Јосифовић, М. (уредник), (1970-1977): Флора Србије. /Flora of Serbia/ 1-9, САНУ, Београд.
- Javorka, S., Csapody, V. (1975): Iconographie der Florae des Südöstlichen Mitteleuropa. Akademiai Kiado, Budapest.
- Oberdorfer, E. (2001): Pflanzensoziologische Exursionsflora für Deutschland und angrenzende Gebiete. Eugen Ulmer Verlag, Stuttgart.
- Петронић, С., Павловић, Д. (2012): Флора и вегетација Јахорине. /Flora and vegetation of Jahorina Mountain/ Републички завод за заштиту културно-историјског и природног наслеђа, Бања Лука
- Redžić, S., Barudanović, S., Radević, M. /ed/ (2008): Bosna i Hercegovina – zemlja raznolikosti. /Bosnia and Herzegovina - Land of diversity/ Sarajevo
- Gajić, M. (1980): Pregled flore Srbije sa biljnogeografskim oznakama. /Review flora of Serbia with biogeographic plant labels/ Glasnik Šumarskog fakulteta, 54, 111-154, Beograd.
- Šilić, Č. (1996): Spisak biljnih vrsta (Pteridophyta i Spermatophyta) za Crvenu knjigu Bosne i Hercegovine. /The list of plants (Pteridophyta and Spermatophyta) for the Red Book of Bosnia and Herzegovina/.Glasnik Zemaljskog muzeja (PN), N. S. sv. 31: 323-367.
- Tutin T. G. (ed.), (1964-1980): Flora Europaea 1-5, Cambridge University Press, London.
- Уредба о Црвеној листи заштићених врста флоре и фауне Републике Српске /Regulation on the Red List of endangered species of flora and fauna of the Republic of Srpska/ (Службени гласник Републике Српске" број: 124/12)

**COMPARISON WITH EMPIRICAL METHODS OF ACTUAL WATER
CONSUMPTION VALUES DETERMINED FOR SUGAR BEET (*BETA VULGARIS L.*)
IN THE KIRŞEHİR PROVINCE CONDITIONS, TURKEY**

Sultan KIYMAZ^{1*}, Çağlar SAĞMAKLI¹, Ahmet ERTEK²

¹Ahi Evran University, Agriculture Faculty, Department of Biosystems Engineering, Kırşehir, Turkey

²Süleyman Demirel University, Agriculture Faculty, Department of Irrigation and Drainage, Isparta, Turkey

*Corresponding author: skiyamaz@ahievran.edu.tr

Abstract

The efficient and economical use of water in agricultural areas is an extremely important element. Evapotranspiration, which has a very important place in plant-atmosphere cycle, is an indispensable element for agricultural area and planning, construction and operation of the irrigation projects. The study was carried out during the period 2012-2013 in the district Çukurçayır of Kırşehir Province of Turkey. In the study, the evaporation values measured from the Class A Pan were used to determine the irrigation water requirements of the sugar beet grown in Kırşehir conditions. For this purpose, it was used the three different plant-pan coefficients aimed of the water shortage. The actual evapotranspirations of treatments were determined with the gravimetric method. The values of evapotranspiration obtained in the present study were compared with estimation methods of some evapotranspiration (FAO-56 Penman Monteith, FAO-24 and USDA-SCS Blaney Criddle, Radiation (R-FAO), Hargreaves-Samani (HS) by utilizing the region's climate data. In the comparison; correlation coefficients of the relationships between actual ET and estimated ET, the ratio of calculated ET using different methods to the measured actual ET as percentage, and root mean square error (RMS) were considered to determine the most appropriate of estimation methods. Results indicated that the Blaney Criddle (USDA-SCS Modifikasyonu) and FAO A Pan methods are appropriate alternatives for estimation of ETo under climatic conditions of Kırşehir, Turkey. Results showed that empirical methods used for estimation of plant water consumption were compatible with direct measurement methods.

Keywords: *Evapotranspiration, empirical method, sugar beet, Kırşehir province*

Introduction

Water is an indispensable source of all life. Demand for water increasing dramatically in all major use sectors, namely, agriculture, production of energy, industrial uses and human consumption. Worldwide, agriculture accounts for 70% of all water consumption, compared to 20% for industry and 10% for domestic usage (Food and Agriculture Organization, 2016). For this reason, the efficient and economical use of water in agricultural areas is an extremely important element. Appropriate irrigation scheduling based on timely measurements or estimations of soil moisture content and crop water requirements, is one of the most essential applications for irrigation management (Hoffman *et al.*, 1990). Evapotranspiration, which has a very important place in plant-atmosphere cycle, is an indispensable element in planning farm irrigation systems and for improving irrigation practices. Evapotranspiration (ET) is the sum of evaporation and plant transpiration. Evapotranspiration can be measured directly or determined by estimation methods from meteorological parameters. Methods obtained by direct measurement are the most reliable method in the estimation of crop evapotranspiration. However, due to time-

consuming and costly of the devices and equipment, human laborious, global-warming problem and climate changes recently, evapotranspiration values determined for previous years will not be viable in the future (Ertek, 2011). For this reason, prediction methods for crop water requirements are used owing to the difficulty of obtaining accurate field measurements (Doorenbos and Pruitt, 1977; Jensen *et al.*, 1990). Many factors such as climate, water supply, soil and topography affect the amount of water consumed by agricultural crops. Climate among these factors is one of the most important factors that determine crop water needs for optimum growth and yield. The crop water requirement is defined as the amount of water required to compensate the evapotranspiration loss from the cropped field (Allen *et al.*, 1998). Many researchers describe it as the total water needed for evapotranspiration. Therefore, the water requirement can be decided by determining the actual evapotranspiration. The crop water requirement can be related to the amount of water used by a reference crop. The reference crop typically is grass or alfalfa that is well irrigated and covers 100 % of the ground. The reference evapotranspiration (ET_o) includes the water evaporated from the soil surface and the water transpired by the plants. The methodologies of ET_o estimation redefined by the Food and Agricultural Organization of United Nations (FAO) were successfully applied at different time scales in various climatic regions of the world (Allen *et al.*, 1998). There are many studies on the comparison and calibration of evapotranspiration estimation equations under local climate conditions (Thorntwaite, 1948; Penman, 1948; Blaney and Criddle, 1950; Jensen and Haise, 1963; Hargreaves and Samani, 1985; Allen *et al.*, 1989; Jensen *et al.*, 1990; Smith *et al.*, 1996; Walter *et al.*, 2000; Landaras, 2008). In the present study; evapotranspiration values measured by Class A-Pan are compared with estimated evapotranspiration values (Penman Monteith (FAO-56), Penman (FAO-24 modification) and USDA-SCS Blaney Criddle, Radiation (R-FAO modification), Hargreaves-Samani (H-S) Class A Pan Evaporation (FAO- A Pan) under the climate conditions of Kırşehir Province situated in middle of the Anatolia region of Turkey.

Materials and methods

Agro-Climatic conditions: The experiment carried out during the period 2012-2013 under the field conditions in the Çukurçayır district of Kırşehir Province, situated in middle of the Anatolia region of Turkey. Çukurçayır is located at a 36°42' and 39°16' N latitude, 31°14' and 34°26' E longitude and at an elevation of 1017 meters above sea level. The climate is semi-arid climate characteristics, with cool and rainy winters, and hot and dry summers. The long-term (1970-2012) annual mean temperature, relative humidity, total annual precipitation, wind speed, and sunshine duration per day in the area were 11.4°C, 55%, 384.4 mm, 2.7 m s⁻¹, and 7.2 h, respectively. During the vegetative periods (from April to the end of October) of the years 2012 and 2013, an average temperature of 19.1 and 18.0°C, total precipitation of 121.1 and 121.6 mm, and an average relative humidity of 50.7 and 48.5% were recorded, respectively (Kiymaz and Ertek, 2015). The soil of texture is clay loam at 0-30 cm soil depth, silty-clay loam at 30-60 cm and 60-90 cm soil depth. Field capacity and wilting point ranged between 26.0 and 29.6 percent, 13.7 and 15.0 percent, and bulk density was 1.30 g cm⁻³ at 0-90 cm soil layer. The soil was alkaline. The average pH, limy and organic matter values of 7.52-7.61, 53.89% to 61.07% CaCO₃, 1.10%-1.99% , respectively (Kiymaz and Ertek, 2015).

Plant variety: In the study, the Isella sugar beet (*Beta vulgaris* L.) variety common-growing by producers in this region was used as the plant material.

Irrigation and Evapotranspiration: Irrigation water was supplied from a well using a pump. The water was classified as C₃S₁ with a low sodium risk and a high electrical conductance (USSL, 1954). The 16 mm diameter lateral pipes carrying 4 l h⁻¹ water had inline drippers with 20 cm

spacing. Soil water contents were measured by the gravimetric method from the soil samples taken from soil depths at 30–60 and 90cm increments in each plot at sowing, pre-irrigation, and at the final harvesting date. Experimental plots were irrigated by precipitation at the beginning of uniform plant establishment. After the emergence of sugar beet seedlings, the plants were irrigated by drip irrigation for a soil profile of 0–90cm to field capacity. Subsequent irrigations were applied according to the prescribed irrigation rates at 7 day intervals. Cumulative evaporation between the irrigations was measured in a class A pan located near the plots. In calculating irrigation water volume, class A pan evaporation, whose fundamentals were described by Doorenbos and Pruitt (1977) and Ertek *et al.* (2012), was used, as Eq. (1):

$$I_r = E_{\text{pan}} \times K_{\text{cp}} \times A \quad (1)$$

Where: I_r - the volume of irrigation water applied (liter); E_{pan} - the cumulative evaporation at class A pan in the irrigation intervals (mm); K_{cp} - the plant-pan coefficient; A - the plot area (m^2). Thus, treatments constituted from three different irrigation levels

($I_1 = E_{\text{pan}} \times K_{\text{cp}_1} \times A$, $I_2 = E_{\text{pan}} \times K_{\text{cp}_2} \times A$ and $I_3 = E_{\text{pan}} \times K_{\text{cp}_3} \times A$).

Soil water measurements were taken throughout the crop growth season. The water in the soil profile, up to the 90cm depth in 30cm increments, was measured gravimetrically (oven dry basis) at sowing, pre-irrigation, and at final harvest. Evapotranspiration was calculated for each treatment by the water balance method (Eq. (2)) (James, 1988):

$$E_t = I_r \times P \times C_r - D_p - R_f - D_s \quad (2)$$

Where: E_t - the evapotranspiration (mm); I_r - the irrigation water (mm); P - the precipitation (mm); C_r - the capillary rise (mm); D_p - the water loss by deep percolation (mm); R_f - the surface runoff (mm); D_s - the change in profile soil water content (mm).

Precipitation was measured daily at a nearby weather station. C_r was considered to be zero because there was no high underground water problem in the area. If the available water in the root zone (90 cm) and total volume of applied irrigation water were above the field capacity, it was assumed that any water leakage would be the deep percolation value (Kanter *et al.*, 1993; Ertek *et al.*, 2006a). On the other hand, due to the fact that irrigation water volume was calculated and applied according to pan evaporation, there was no surface runoff (Ertek *et al.*, 2006b).

The empirical equations: Considering the evapotranspiration forecasting methods are FAO24 Blaney-Criddle method (B-C), Blaney-Criddle method (USDA-SCS modification), FAO56 Penman-Monteith (P-M FAO), FAO modification of the radiation method (FAO-R), Hargreaves-Samani (H-S), FAO modification of Class A Pan Evaporation (FAO- A Pan). Evapotranspiration estimation methods were calculated with equations mentioned Doorenbos ve Pruitt 1977, 1992; Cuenca, 1989; Allen *et al.*, 1989; Jensen *et al.*, 1990; Burman, 1994; Kanter *et al.*, 2000 method. All climate data were taken Kırşehir Center Meteorology Station, placed about 3 km from the experimental area.

In the comparison, the highest correlation coefficients (r) of the relationships between actual ET and estimated ET, ratio of calculated ET using different methods to the measured actual ET as percentage, the smallest root mean square error (RMSE) and seasonal mean crop coefficients (k_c) which is closest to 1 value were considered the criteria for assessing the most appropriate method. In the study, the crop coefficients (K_c) were obtained by comparing with the values of references evapotranspiration (E_{T0}) obtained empirical methods and the actual evapotranspiration value calculated in the field (Figure3).

Results and Discussions

For the experiment conducted in 2012 and 2013 measured evapotranspiration values with reference evapotranspiration values obtained by empirical methods are given in Table 1. As seen from Table 1, in the first year, evapotranspiration values 7 daily-measured were between 2.18 and 14.66 mm day⁻¹, in the second year, it shows between 0.81 and 14.61 mm day⁻¹. The highest evapotranspiration (ET) values were observed as 14.66 mm day⁻¹ the last period of July, in 2012; the highest water consumption as 14.61 mm day⁻¹ in 2013 was observed during the end of June. The water consumption was realized as 84 mm and 88.5 mm respectively. Reference evapotranspiration (ET_o) values calculated by evapotranspiration estimation equations evapotranspiration values were 45.4-138.7 mm in 2012, while in 2013 it ranged from 46.2-133.0 mm. There is a linear relationship between values of seasonal evapotranspiration and irrigation water applied to treatments (Figure 1). As seen in Figure 1, evapotranspiration values were increased in parallel to applied irrigation water. The highest ET value was determined in the I₃N₄ treatments as 873.7 mm and 844.6 mm, respectively in 2012-2013 (Kiymaz and Ertek, 2015)

The monthly cumulative potential evapotranspiration values estimated using empirical equations with actual evapotranspiration shown in Figure 2. As seen in Figure 2, FAO-A Pan and Blaney Criddle (USDA-SCS modification) methods give the closest values to the actual evapotranspiration. The average results for two-year relating to the parameters taken into account to determine the appropriate evapotranspiration estimation method given in Table 2. The highest compensation rate (ET %) of actual ET by applied irrigation water with 83.2% and 82.9%, the smallest RMSE with 3.56 and 6.89, highest correlation coefficient (r) of the relationship between measured and predicted water consumption with 0.96 and 0.93, and the closest seasonal average crop coefficient (K_c) to 1 with 1.03 and 0.97. With Blaney Criddle (USDA-SCS modification) and FAO A Pan methods gives the best results in estimated the closets evapotranspiration to reality. The crop coefficients (K_c) by suggested this method obtained and seasonal mean values for two-year are shown in Figure 3. When examined the K_c obtained, it usually has been seen as having reached the lowest at the beginning of the season of plant growth, high mid season, the lowest value again at the end season. K_c values empirically determined in the III period for a peak period, the highest values of 1.06 with FAO A Pan and 1.10 with Blaney Criddle (USDA-SCS modification) method has reached.

Factors affecting the value of the crop coefficient (K_c) are mainly the crop characteristics, crop planting or sowing data, rate of crop development, length of growing season and climatic conditions (Doorenbos and Pruitt, 1977).

The relationships between the ET values determined according to treatments and Class A pan values measured from the *Class A Evaporation Pan* in the same period were detected. Equations and regression coefficients (R²) indicating the relationship between Evapotranspiration and Pan evaporation values according to the two-year mean values are given in Table 3. As seen from the table, significant linear relationships determined in all treatments at 1% significance level between evapotranspiration and A evaporation pan.

Table 1. The reference evapotranspiration values measured and calculated by different methods (mm day⁻¹)

Experiment Year	Irrigation Dates	Actual ET (mm day ⁻¹)	The reference evapotranspiration (ET _o , mm day ⁻¹)					
			FAO24 Blaney Criddle	Blaney Criddle (USDA- SCS)	FAO56 Penman Monteith	FAO Radtion	Hargraves- Samani	FAO - A Pan
2012	27.06.2012	2.18	10.18	5.66	5.41	6.23	7.81	2.00
	05.07.2012	9.13	10.92	7.47	5.94	7.77	8.70	3.30
	12.07.2012	7.07	12.57	8.94	7.84	8.79	10.34	3.86
	19.07.2012	10.69	13.69	10.47	9.69	9.04	11.73	3.69
	26.07.2012	14.66	11.96	10.51	9.05	8.02	11.84	4.46
	02.08.2012	2.35	10.04	7.05	5.76	6.89	8.22	4.50
	09.08.2012	7.33	10.94	7.29	6.45	7.33	8.77	3.70
	16.08.2012	4.46	10.81	6.19	6.72	7.56	7.92	3.80
	23.08.2012	4.62	10.69	6.97	7.74	7.42	9.15	3.60
	30.08.2012	5.69	9.92	5.69	5.73	6.26	7.36	4.20
	06.09.2012	8.07	9.64	3.62	6.73	6.34	6.34	2.74
	13.09.2012	3.27	9.02	4.15	5.54	5.97	7.27	2.91
	20.09.2012	4.48	8.28	3.65	5.07	4.92	6.57	2.62
	Total	84.0	138.7	87.7	87.7	92.5	112.0	45.4
2013	27.06.2013	14.61	11.77	7.89	7.04	7.78	10.26	4.60
	04.07.2013	3.24	12.82	8.78	8.65	8.96	10.39	3.60
	11.07.2013	11.47	12.10	8.57	7.86	8.01	9.88	5.20
	18.07.2013	6.29	11.13	6.96	6.50	7.32	8.33	3.26
	25.07.2013	11.61	10.99	7.24	6.92	7.81	8.97	3.60
	01.08.2013	1.65	10.53	6.73	6.57	7.59	8.24	7.00
	06.08.2013	2.86	11.41	7.05	7.64	8.01	8.69	2.47
	15.08.2013	12.09	11.01	6.94	7.06	7.35	8.23	4.20
	22.08.2013	8.15	10.32	7.39	7.11	7.32	9.20	3.43
	29.08.2013	4.84	8.87	6.19	5.36	5.93	7.49	3.20
	05.09.2013	6.64	7.99	2.95	4.24	5.02	5.63	2.20
	12.09.2013	4.22	7.72	3.38	3.80	5.04	6.07	2.60
	19.09.2013	0.81	6.32	2.24	2.53	4.80	4.36	0.82
	Total	88.5	133.0	82.3	81.3	90.9	105.7	46.2

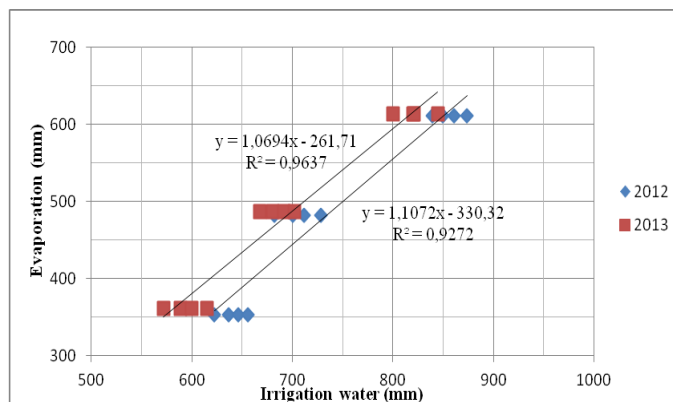

Figure 1. The relationship between irrigation water and evapotranspiration in 2012-2013

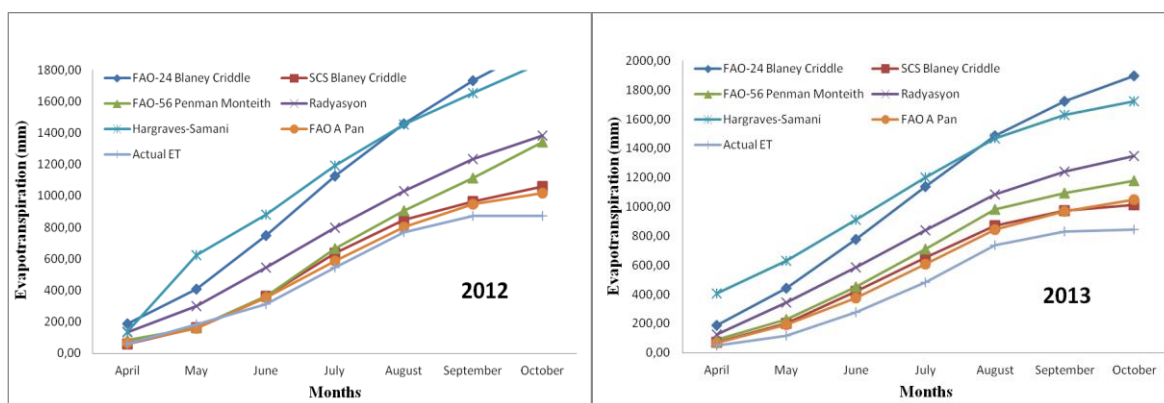

Figure 2. The cumulative reference (potential) evapotranspiration values calculated by equations

Table 2. The criteria considering in determining the appropriate evapotranspiration estimation methods based on a two-year mean values

Evapotranspiration estimation methods	RMSE	Relationship between measured ET and estimated ETo		Seasonal mean kc	The plant water consumption compensation rates of irrigation water applied (% ET)
		Regression equations	Correlation coefficient (r)		
FAO24 Blaney Criddle	10.75	ET=1.0648 170.908	ETo - 0.92	0.48	44.5
Blaney Criddle (USDA-SCS modification)	7.09	ET=1.0405 31.379	ETo - 0.93	1.03	82.9
FAO56 Penman Monteith	6.89	ET=0.9715 51.974	ETo - 0.84	0.82	68.3
FAO Radyasyon	7.21	ET=1.4677 163.248	ETo - 0.92	0.68	63.0
Hargreaves-Samani	8.78	ET=0.5573 19.438	ETo - 0.46	0.59	48.1
FAO A Pan	3.56	ET=1.1851 52.085	ETo - 0.96	0.47	83.2

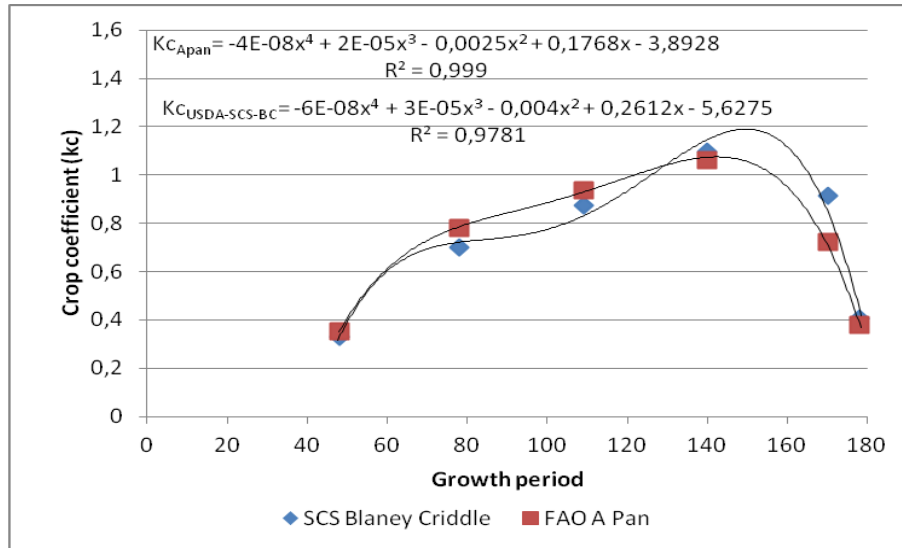

Figure 3. The coefficient curve of sugar beet for USDA-SCS-BC and FAO A Pan methods

Table 3. The relationship between evapotranspiration and Pan evaporation values according to the two-year mean values

Treatments	Equation	R ²
I ₁ N ₁	ET = 0.3457939 A Pan+40.839612	0.97**
I ₁ N ₂	ET = 0.3457939 A Pan+40.839612	0.97**
I ₁ N ₃	ET = 0.3457939 A Pan+40.839612	0.97**
I ₁ N ₄	ET = 0.3457939 A Pan+40.839612	0.97**
I ₂ N ₁	ET = 0.5190761 A Pan+9.8332239	0.97**
I ₂ N ₂	ET = 0.5190761 A Pan+9.8332239	0.97**
I ₂ N ₃	ET = 0.5190761 A Pan+9.8332239	0.97**
I ₂ N ₄	ET = 0.5190761 A Pan+9.8332239	0.97**
I ₃ N ₁	ET = 0.6685082 A Pan -15.32029	0.97**
I ₃ N ₂	ET = 0.6685082 A Pan-15.32029	0.97**
I ₃ N ₃	ET = 0.6685082 A Pan -15.32029	0.97**
I ₃ N ₄	ET = 0.6685082 A Pan-15.32029	0.97**

** significant at level of 1%.

Conclusions

At the end of the study, USDA SCS- Blaney-Criddle and FAO Pan equations gave the closest values to the water consumption obtained by gravimetric moisture method. Results indicated that the Blaney Criddle (USDA-SCS Modifikasyonu) and FAO A Pan methods and the crop coefficients (K_C) are appropriate alternatives for estimation of ETo under climatic conditions of Kırşehir, Turkey. Results showed that empirical methods used for estimation of plant water consumption were compatible with direct measurement methods.

Acknowledgement

This study was financially supported by the Scientific Research Fund of Ahi Evran University, Kırşehir, Turkey (Project no: ZRT.E2.16.010). We thank to the Ankara Kırşehir Region Meteorological staff for climate data.

References

- Allen R.G., Jensen M.E., Wright J.L., and Burman R.D. (1989). Operational estimates of reference evapotranspiration. *Agron. J.*, Vol. 81, No. 4, pp. 650-662.
- Allen R. G., Pereira L.S., Raes, D. And Smith M. (1998). Crop evapotranspiration- Guidelines for computing crop water requirements. Rome: FAO. 300 pp. [Online] Available from: <http://www.fao.org/docrep/X0490E/x0490e00.htm>. [3 March 2007].
- Burman R., Pochop L.O. (1994). Evaporation, evapotranspiration and climatic data. *Development in Atmospheric Science*, Elsevier, The Netherlands, 22:278.
- Blaney H.F., Criddle W.D., (1950). Determining water requirements in irrigated areas from climatological and irrigation data. US Soil Conservation Service, TP96.
- Cuenca R.H. (1989). Irrigation system design. An engineering approach Prentice Hall, Englewood Cliffs, New Jersey.
- Doorenbos, J., Pruitt, W.O., 1977. Crop Water Requirements. FAO Irrigation and Drainage Paper 24. FAO-UN, Rome, Italy, 144 pp.
- Doorenbos, J., Pruitt W. O., 1992. Crop water requirements. Irrigation and Drainage Paper 24, FAO, Roma
- Ertek A. (2011). Importance of pan evaporation for irrigation scheduling and proper use of crop-pan coefficient (K_{cp}), crop coefficient (K_c) and pan coefficient (K_p). *African Journal of Agricultural Research*, Vol. 6, No. 32, pp. 6706-6718.
- Ertek A., Sensoy S., Gedik I. and Kucukyumuk, C. (2006a). Irrigation scheduling based on pan evaporation values for cucumber (*Cucumis sativus* L.) grown under field conditions. *Agric. Water Manage*, Vol. 81, No. 1–2, pp. 159–172.
- Ertek A. Sensoy S. Kucukyumuk C. and Gedik I. (2006b). Determination of plant-pan coefficients for field-grown eggplant (*Solanum melongena* L.) using class A pan evaporation values. *Agric. Water Manage*, Vol. 85, pp. 58–66.
- Ertek A., Erdal I., Yılmaz H.I. and Senyigit U. (2012). The appropriate water and nitrogen application levels for the optimum of processing tomato yield and efficient water usage. *J. Agric. Sci. Technol*, Vol. 14, No. 4, pp. 889–902.
- Food and Agriculture Organization, 2016. Information System on Water and Agriculture. <http://www.worldometers.info/water/>
- Hargreaves G.H. Samani, Z.A.(1985). Reference crop evapotranspiration from temperature. *Appl. Eng. Agric*, Vol. 1, No. 2, pp. 96–99.
- Hoffman G. J., Howell T.A. and Solomon K.H. (1990). Management of farm irrigation system. American Society of Agriculture Engineers. St. Joseph, Mi. (USA). ISBN 0-929355-11, ISSN 3. p 1094.
- Jensen M.E., Haise H.R. (1963). Estimating evapotranspiration from solar radiation. *J. Irrig. Drain*, Vol. 89, No. 4, pp. 15–41.
- James, L.G., 1988. Principles of Farm Irrigation System Design. Wiley, New York, pp. 543.
- Jensen, M.E., Burman, R.D., Allen, R.G., 1990. Evapotranspiration and irrigation water requirements. ASCE Manuals and Reports on Engineering Practices no. 70. American Society of Civil Engineers, NY.

- Kiyamaz S., Ertek A. (2015). Yield and quality of sugar beet (*Beta vulgaris* L.) at different water and nitrogen levels under the climatic conditions of Kırsehir, Turkey. *Agricultural Water Management*, Vol. 158, pp. 156–165.
- Kanber, R., Yazar A., Onder S. and Koksal H.(1993). Irrigation response of pistachio (*Pistacia vera* L.). *Irrig. Sci.*, Vol. 14, pp. 1–14.
- Kanber, R., Ünlü, M., Köksal, H., 2000. Evapotranspiration (ETc) and plant coefficients (Kc). Directorate of Tarsus Rural Services Research Institute. Plant - Atmosphere Relations Seminar. 4-8 September 2000.
- Landeras G., Ortiz-Barredo A., Lopez J.J. (2008). Comparison of artificial neural network models and empirical and semi-empirical equations for daily reference evapotranspiration estimation in the Basque Country (Northern Spain). *Agricultural Water Management*, Vol. 95, pp. 553 – 565.
- Orta A.H. (1997). Evapotranspiration of Pepper for Ankara Conditions. *Tr. J. of Agriculture and Forestry*, Vol. 21, pp. 513-517.
- Penman H.L., (1948). Natural evaporation from open water, bare soil and grass. *Proc. Royal Soc. Lond. A: Math. Phys. Sci.*, Vol. 193, No. 1032, pp. 120–145.
- Smith M., Allen R. And Pereira L., (1996). Revised FAO methodology for crop water requirements. In: *Proceedings of the International Conference on Evapotranspiration and Irrigation Scheduling*, San Antonio, TX, USA, pp. 133–140.
- Thornthwaite C.W. (1948). An approach toward a rational classification of climate. *Geogr. Rev.*, Vol. 38, No. 1, pp. 55–94.
- USSL (1954). *Diagnosis and Improvement of Salina and Alkali Soils*. Agriculture Handbook No: 60, USA., pp. 160.
- Walter I.A. Allen R.G., Elliott R., Jensen M.E., Itenfisu D., Mecham B., Howell T.A., Snyder R., Brown P., Echings S., Spofford T., Hattendorf M., Cuenca R.H., Wright J.L. and Martin D. (2000). ASCE's standardized reference evapotranspiration equation. *Watershed Management and Operations Management 2000*. In: *ASCE Conference Proceedings*, vol. 105. p. 126.

DYNAMICS OF WASTEWATER QUALITY BEFORE AND AFTER TREATMENT THROUGH PILOT PLANT

Irena DUKA^{1*}, Seit SHALLARI¹, Romina KOTO¹, Marsela ALIKAJ², Ardian MAÇI¹, Julian SHEHU¹

¹Department of Agro Environment and Ecology, Agricultural University of Tirana, Albania

²Department of Biology, Faculty of Natural Sciences, University “Eqrem Çabej”, Gjirokastër, Albania

*Corresponding author: irenaduka@hotmail.com

Abstract

Discharge of untreated wastewater into the environment and/or especially in the superficial freshwater like rivers, lakes and the coast is the main cause of pollution. Untreated wastewater consists of liquid wastes discharged by domestic residences, commercial centres, industries, and/or the agriculture sector and can include a wide range of potential pollutants. For this purpose, considerable work was done to assess the quality of contaminated residence's wastewater near the Agricultural University of Tirana, before and after treatment, using a pilot plant. Physical and chemical parameters of wastewater were examined, and the necessary recommendations were suggested in order to improve water quality. Quality assessment of untreated and treated wastewater, analysing physical and chemical parameters, was performed for a period of three years, from 2012 to 2014. Physical and chemical pre-treatment parameters (pH 8.10, TSS 213.4 mg/l, N-NH₄ 38 mg/l, 1.03 mg/l for N-NO₃, N-NO₂ 0.21 mg/l, N-Total 44.4 mg/l, P-Total 4.26 mg/l, COD-Total 270 mg/l and BOD 176.28 mg/l) and after treatment parameters (pH 7.9, N-NH₄ < 0.05 mg/l, N-NO₃ 0.1 mg/l, N-NO₂ < 0.02 mg/l, P-Total < 0.05 mg/l and COD 40 mg/l) were analysed. Results confirmed that the quality of the treated water through the use of the pilot plant, referred to the content of COD, BOD₅, TSS, N and P, is within the standard norms set by the Albanian and EU standards, for the third level treated water.

Keywords: *wastewater, pilot plant, physical and chemical parameters, permissible level*

Introduction

Wastewater is the liquid end-product of municipal, agricultural and industrial activity. So, due to its value, wastewater is treated and then discharged to a receiving stream. As such the chemical composition of wastewater naturally reflects the origin from which it comes. Consequently, the water we use for drinking, washing, bathing etc. ultimately ends up back in the stream, river, lake, or groundwater where it will be withdrawn, treated, and used again (Duka et al, 2013).

Today, however, human pressure on natural environments is greater and more negative changes in the environment caused by human activities, such as urban discharges, industrial, agricultural and livestock, the use of pesticides and other chemicals on agricultural lands. One of the main sources of surface water pollution in our country are urban discharges, which contain organic matter, soluble compounds of phosphorus and nitrogen that favour the process of eutrophication, pathogenic bacteria and viruses, heavy metals and subjects that spoil the appearance of water and give them a bad smell (Duka et al, 2012). For this reason, special attention is dedicated in assessing the quality of surface waters and determining the primary pollutants discharged into them, in order to protect the environment and enable the creation of a database for integrated management and sustainable use of water resources.

Materials and methods

Physical and chemical parameters play an important role in the dynamics of water. Evaluation of physical and chemical parameters was performed for a three-year period (2012-2014). The samples for which these characteristics have been determined were taken at two different points, in the entrance and the exit of wastewater. In the main sewers, the first sampling point is selected during the period from 6 March 2012 until 22 July 2014. Wastewater samples were collected in 1.5 L bottles, which were previously washed with distilled water and then, at the time of sampling, were rinsed three times with water that was taken as a representative sample for analysis. Temperature and dissolved oxygen were measured 'in-situ', by a thermometer and a portable dissolved oxygen meter; all of these devices have been calibrated before.

Results and discussions

Untreated wastewater

Below we present the data obtained for the four study periods, using the respective tables and figures. Table 1 presents the average values of the physical and chemical analysed parameters of untreated wastewater. These values vary: pH 8.10, TSS 213.4 mg/l, N-NH₄ 38 mg/l, 1.03 mg/l for N-NO₃, N-NO₂ 0.21 mg/l, N-Total 44.4 mg/l, P-Total 4.26 mg/l, COD-Total 270 mg/l and BOD 176.28 mg/l.

Table 1: Summary of results of physical and chemical parameters in untreated wastewater for the years 2012-2014

Parameters	Unit	Min	Max	Average	Stdev	CV %
pH	-	7.69	8.63	8.10	0.23	2.83
EC	µS/cm	1152	2220	1695.43	383	22.6
Sal.	mg/l	0.3	1	0.67	0.23	34.32
O₂	mg/l	0.16	1.14	0.47	0.32	68.1
TSS	mg/l	21	688	213.42	180.03	84.35
TDS	mg/l	806	2000	1425.79	930.47	65.26
N-NH₄	mg/l	10.48	70.61	38.37	19.52	50.87
N-NO₃	mg/l	0.7	1.4	1.03	0.15	14.56
N-NO₂	mg/l	0.08	0.67	0.21	0.18	85.71
N-Tot.	mg/l	16	74	44.41	19.93	44.87
P-Tot.	mg/l	1.7	6.55	4.26	1.52	35.68
COD	mg/l	115	896	269.42	193.88	71.96
BOD₅	mg/l	75	450	176.28	99.50	56.44

Domestic wastewaters at the area around University were found not to be significant fluctuations in terms of pollution, during different seasons of 2012, as well as during other years of study.

Data analysis

The collected data was organized in Excel tables. The arithmetic mean (average), standard deviation (SD), coefficient of variation (CV) was defined using Excel formulas. The coefficient

of variation represents the ratio of standard deviation to the arithmetic average, and was used as a statistical tool to compare the degree of change from one series of data to another, even when the averages differed from each other dramatically. If CV is lower than 2%, parameters measured are considered as more homogeneous; when CV values are between 2% and 30% ($2\% < CV < 30\%$), measured parameters are considered homogeneous; and when CV is greater than 30%, the measured parameters are considered as heterogeneous. According to this table, we noticed that the various parameters measured fall under the classification of heterogeneous ($CV > 30\%$), with the exception of pH, EC and $N-NO_3$, where measurements make these parameters homogeneous ($CV < 30\%$) (Wolfgong et al, 2012).

The changing value of COD and BOD₅ during 2012-2014

The main difference between COD and BOD₅ is the fact that through BOD₅ determined organic matter may oxidize in the biological pathway, while through COD determined substances may oxidize in the chemical pathway (Wayne Bayles, 1997). As expected, the COD values are higher than the values of BOD₅, but it seems quite clear that there is a similar trend between them. Referring to the chart below, fluctuations in the values of COD in untreated waters range from the minimum value of 92 mg/l DO to the maximum value of 896 mg/l DO and for the BOD₅ parameter, the values range from 30 mg/l DO in its minimal value to the maximum value of 450 mg/l DO (Fig. 1). These changes in the values of COD and BOD₅ are directly related to the status of sewage pollution. Also, the high values of COD and BOD₅ measured in March 2012 show the presence of biodegradable organic material. During the months of May and June of 2013, the COD values at the entrance of the plant range from a minimum value of 120 mg/l DO to the maximum value of 317 mg/l DO.

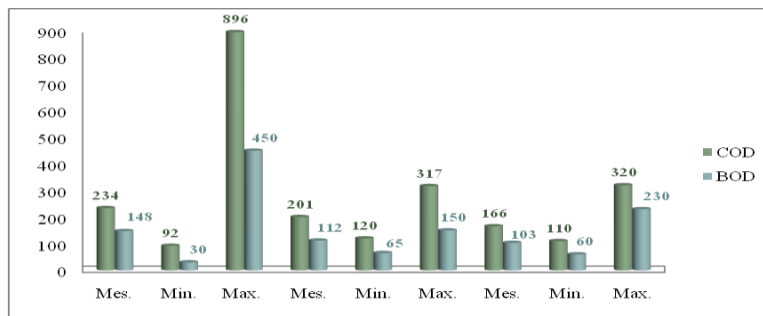

Figure 1. The changing values of COD and BOD₅ during the 2012-2014 periods

The changing value of TSS during 2012-2014

Referring to our study, the TSS values range from the minimum value of 4 mg/l, reaching an average of 85.42 mg/l, with a maximum value of 688 mg/l in 2012. While continuing in 2013, these values range from a minimum value of 4 mg/l, to the maximum value of 57 mg/l, with an average of 26.15 mg/l. (Fig. 2). In 2014, the values range from 14 mg/l which is the minimum value, to the maximum value of 255 mg/l, with an average value of 75.13 mg/l. High values of total suspended solids (TSS), often come due to heavy load of minerals and organic materials generated by the population. For this reason, the wastewater can be classified as strong and as such must be treated before being discharged into the receiving water environments (as cited Wolfgang et al 2012).

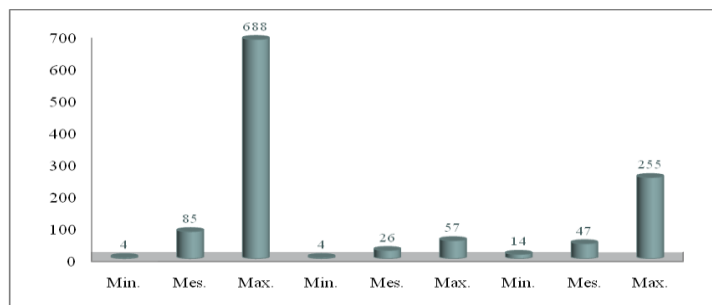

Figure 2. The changing values of TSS during the 2012-2014 periods

Measurements of the level of N-Total and its components (N-NO₃, N-NO₂, N-NH₄) in wastewater

In the figures below are presented the summary results of each nutrient content in water samples analysed for each year of study. Results represent the average of three years. In untreated wastewater, total nitrogen levels range from 16 mg/l to 74 mg/l. So, referring to our study, the concentration of total nitrogen in all samples analysed ranges from a minimum value of 16 mg/l, to a maximum value of 74 mg/l, with an average value of 39.56 mg/l during 2012 and then continues with a minimum value of 16 mg/l, an average value of 39.62 mg/l and a maximum value of 70 mg/l in 2013. In 2014, values range from 21.2 mg/l as the minimum value to 39.7 mg/l as the maximum one, and have an average value of 28.75 mg/l. Ammonia is a component of wastewater, resulting from the degradation of proteins. Raw wastewater typically has ammonia concentrations in the range levels of 20 to 30 mg/l, as ammonium N (Johal et al, 2014). Figure 3 shows that concentrations of ammonia (N-NH₄) differ, on average, between 24.94 mg/l in 2014 and 35.07 mg/l in 2013. The minimum values range from 10.2 mg/l in 2013 to 15.21 mg/l in 2014. Also, Figure 4 shows that concentrations of nitrate nitrogen (N-NO₃) vary, with the minimum value of 0.5 mg/l recorded in 2013 and the maximum value of 1.4 mg/l recorded in 2012. Nitrites nitrogen (N-NO₂) is a strong poison for fish, reducing their ability to transfer oxygen into the bloodstream (Murphy, S., 2007). In polluted waters, it varies between 0.04 mg/l to 0.67 mg/l with an average of 12.21 mg/l, analysed in 2012, and in 2013 its values range from 0.05 mg/l as the minimum value to 12.21 mg/l as the maximum value, with an average of 0.12 mg/l. Similarly, its measured values during 2014 are exactly 0.04 mg/l as the minimum value, 0.2 mg/l as the maximum value and 0.12 mg/l as the average one.

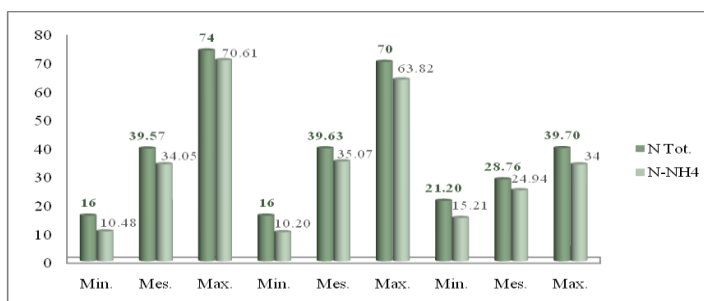

Figure 3. The change of N-Total and N-NH₄ values during the 2012-2014 periods

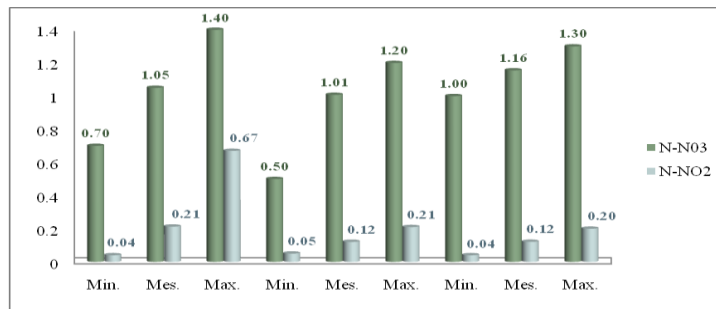

Figure 4. The change of N-NO₃ and N-NO₂ values during the 2012-2014 periods

Total Phosphorus (TP)

Phosphorus is a nutrient for living species. He serves as a pollutant if is found in high concentrations in specific environmental conditions. The measurements show that the concentration of phosphorus in the untreated wastewater in the study, range in more or less the same levels. For this reason, since they are household waters, phosphorus is derived from the same source, from human waste, food and detergents. Then, referring to the years in which the study was conducted, phosphorus ranges from 1.7 mg/l which is the minimum value to the maximum value of 6.55 mg/l and the average value of 3.89 mg/l, as analysed in 2012, while in 2013 it ranged from 1.6 mg/l to 5.64 mg/l, with an average value of 3.47 mg/l. For 2014, were registered slightly lower values than the previous two years, ranging between 1.14 mg/l to 3.85 mg/l with an average value of 2.3 mg/l (fig.5).

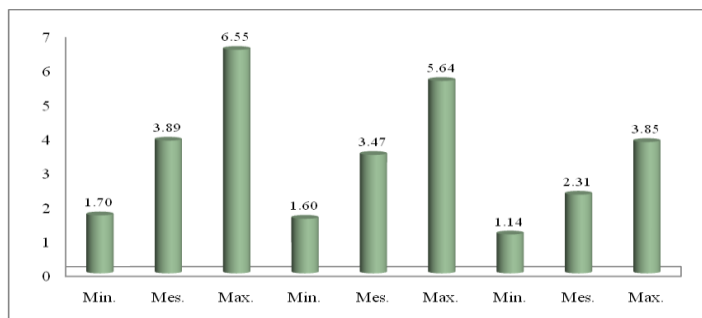

Figure 5. Change the value of P-Total during the 2012-2014 periods

Treated water after using the pilot plant

The study was conducted using wastewaters from 1.000 residents, with a total flow rate of 2 m³/d. The aim was to assess the quality of treated water in terms of compliance with national and international standards.

COD and BOD in treated water

The main focus of wastewater treatment plants is to reduce the COD and BOD in the effluent discharged to natural waters. Wastewater treatment plants are designed to function as bacteria farms, where bacteria are fed oxygen and organic waste. If effluent with high BOD levels is

discharged into a stream or river, it will accelerate bacterial growth in the river and consume the oxygen levels in the river (Brown and Caldwell, 2001).

At the exit of the plant, COD values ranged from the minimum value of 16 mg/l DO to the maximum value of 47 mg/l DO, while BOD₅ values ranged from the minimum value of 4 mg/l DO to the maximum value of 9 mg/l DO. Based on the values obtained, we can suggest the idea of a high percentage reduction in the COD, respectively 95%, the same as defined in the literature (Fig.6).

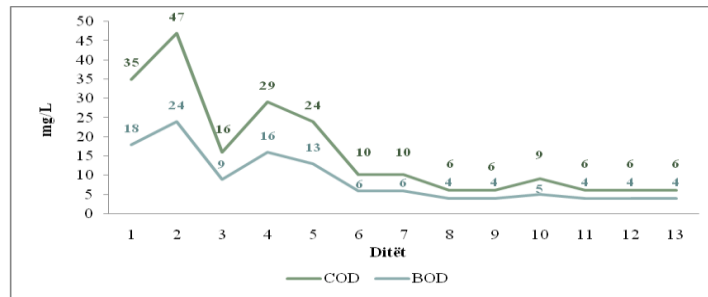

Figure 6. COD and BOD₅ change in discharges of treated water

The degree of reduction of total nitrogen and its components

N-Total and its components are measured as concentrations of N-NH₄, N-NO₃, N-NO₂ in treated waters, during the three years of stable operation, taking in consideration the processes of partial nitrification and denitrification, that require special aerobic and anoxic conditions. What is striking is the fact that the concentration of total nitrogen decreased from 71 mg/ l to 0.4 mg/l. After the wastewater treatment, N-NH₄ was reduced to 0.01 mg/l. As can be seen, the nitrogen components in the treated water were and mainly formed of gaseous nitrogen, showing a stable behaviour of nitrification.

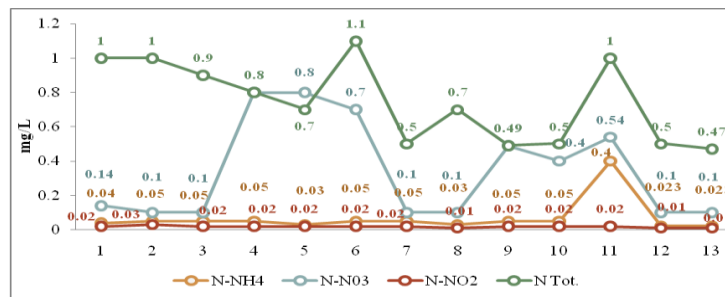

Figure 7. The rate reduction of N-Total and its components from using SBR pilot

The values of total phosphorus in treated water

Phosphorus values after the water treatment using SBR pilot, reduced to 99.6%. So phosphorus values were reduced from 6.55 mg/l which is the maximum value, to the value of 0.01 mg/l.

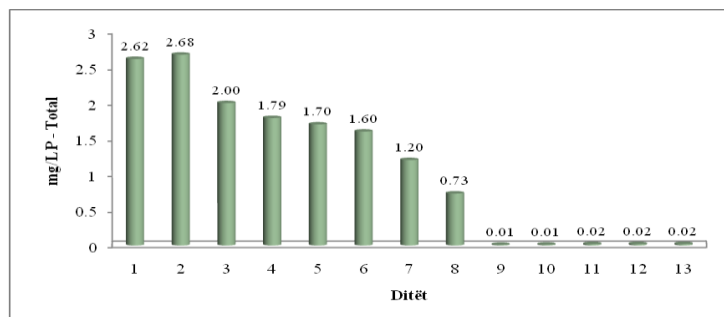

Figure 8. P-Total change in discharges of treated wastewater

By (Strom, 2006) the removal of phosphorus from wastewater, biological assimilation was achieved through the inclusion of phosphorus as an essential element in biomass, mainly through increased photosynthetic organisms (plants, algae, and some bacteria, such as cyanobacteria). This is achieved through treatment ponds containing algae or plankton, root vegetables, or even floating plants (e.g. aquatic plants, hyacinth, duckweed, etc.). Also, as Peter F. Strom pointed out, concentrations of phosphorus in values less than 0.1 mg/l can be achieved for long periods (more than a month), values of 0.03 mg/l for a week, and values even under 0.02 mg/l for several days following.

Conclusion

The study showed that the values obtained from the analysis of household untreated wastewater are higher than the limits recommended by the Albanian Standard and European Directive on the discharge of treated wastewater into the aquatic environment. Based on physical and chemical wastewater characteristics and their sources, classified and adapted from Metcalf and Eddy Inc. (2001), values of those parameters in untreated wastewater are classified as low. The reducing of pollution, assessed by the indicators of BOD₅ and COD is respectively 94.7 %, for the nutrients P Total and N Total is 99.8% and 98.6% respectively, whereas for N-NH₄ and N-NO₃ is 99.8% and 92.8 % respectively. These results show that the quality of treated water through the use of the pilot plant, referred to the content of COD, BOD₅, TSS, N and P, is within the standard rates set by the Albanian and EU for treating water at the third level.

References

- Duka et al. (2012). Assessment of the quality of sewage waters entering the treatment plant. *International Conference of Ecosystems (ICE)*, (pp. 780-785). Tirana, Albania.
- Duka et al. (2013). Characterization of wastewaters in semi urban settlements in agriculture university of Tirana, Albania. *The 1st International Conference on Research and Education – Challenges Toward the Future (ICRAE2013)* (pp. 1-10). Shkodër, Albania: University of Shkodra “Luigj Gurakuqi”.
- Brown and Caldwell. (2001, May). A guidebook for local governments for developing regional watershed protection plans.
- Johan et al. (2014). Efficiency Assessment and Mathematical Correlations Development between Bod and Other Parameters in Jalandhar Sewage Treatment. *International Journal of Innovative Research in Science, Engineering and Technology*, 3 (6), 13088-13096.
- Murphy, S. (2007). General Information on Nitrogen. Retrieved from <http://bcn.boulder.co.us/>.
- Strom, P. F. (2006). Technologies to Remove Phosphorus from Wastewater.

Wayne Bayles. (1997). Standard Methods for the Examination of Water and Wastewater, 15th Edition.

Wolfgong et al. (2012). Physicochemical evaluation of wastewater from the main sewer in Abidjan city. Journal of Ecology and the Natural Environment, 4 (1).

DETERMINATION OF BIOGAS PRODUCTION POTENTIAL AND ENERGY VALUE FROM ANIMAL MANURE IN TURKEY (AFYONKARAHİSAR PROVINCIAL EXAMPLE)

Cengiz KARACA

Mustafa Kemal University, Faculty of Agriculture, Department of Biosystems Engineering, Hatay, Turkey
Corresponding author: ckaraca@mku.edu.tr

Abstract

The aim of this study was to determine biogas amount and the energy value, being produced from animal manure in Afyonkarahisar (or Afyon) province, Turkey. For this purpose, biogas potential is calculated considering the number of cattle and laying hens. Afyonkarahisar has a total of about 350 thousand cattle, 5 thousand buffalo, and 18.5 million laying hens. The annual total of 4 million tons of manure is obtained from these animals in the province. There are 3.5 million tons of cattle manure, 51.5 thousand buffalo manure, and 540 thousand tons of laying hens manure. Annually 84.8 million m³ of biogas can be produced from the usable amount of this manure. The heating value of biogas produced from this manure is about 1.9 PJ. The electricity production from this biogas is about 214 GWh_{el}. These values can provide 16.6% of Afyonkarahisar's annual electrical energy consumption (1,284 GWh_{el}). The distribution of these calculated amounts by districts was mapped. When districts are arranged according to amount of biogas production, the top ten Afyonkarahisar districts are Central district (27.7%), Bolvadin (10.2%), Başmakçı (9.6%), Sinanpaşa (7.4%), Sandıklı (7.2%), Çay (6.8%), Şuhut (6%), İhsaniye (4.6%), Emirdağ (4.1%) and Dinar (3.7%).

Keywords: *Biogas potential, Animal manure, Turkey, Afyonkarahisar*

Introduction

Energy plays an important role in the world's future. Energy is central to economic development, and there is a clear correlation between energy consumption and living standards. Energy sources are split into three categories: fossil fuels, renewable sources and nuclear sources (Karaca, 2015). Renewable energy systems, such as biogas, based on national and regional biomass resources, can increase the security of the national energy supply and reduce dependency on imported fuels. Biogas from anaerobic digestion does not only improve the energy balance of a country, but also makes important contributions to the conservation of the natural resources and environmental protection (Al Seadi *et al.*, 2008).

Anaerobic digestion is a simple technology that allows for decentralized energy production from various biomass, such as animal manure, energy crops, and food industry wastes. In addition to the direct effect of producing energy, anaerobic digestion has several other environmental benefits, including reduced greenhouse gas emissions. (Møller *et al.*, 2008).

Turkey's primary energy demand is met by natural gas (35%), coal (28.5%), oil (27%), hydro-power (7%), and other renewable resources (2.5%). Turkey's total electricity power demand has been increasing rapidly. It reached 264 TWh in 2015. The structure of other energy sources used for electricity generation in 2015 was composed of coal (28.4%), hydro-power (25.8%), wind-power (4.4%) geothermal (1.3%), fuel oil, diesel and naphtha (1.6%), and biogas (0.6%) (MENR, 2015).

The objective of this study was to determine the production potential of biogas from animal manure (only cattle and laying hens) and mapping in Afyonkarahisar with separate districts. For these purposes, biogas potential and its energy potential of animal manure were evaluated by ArcGIS which is a geographical information system (GIS) program. The differences in data among the districts for seeing more clearly were created maps in GIS. A database was created within the GIS for Afyonkarahisar and its districts. The number of animals, calculated biogas potential, and its heating value in the province for the year 2015 were inputs to this database.

Materials and methods

Afyonkarahisar (previous name Afyon) province in Turkey has located between 37°45'-39°17' N latitudes and 29°40'-31°43' E longitudes and covering 14,570 km² areas. Afyonkarahisar is located as a gateway to the Aegean Sea and inner regions of Anatolia, located at the crossroads of 3 different regions of Turkey (Figure 1). The province is divided into 18 districts. These districts include Central (Afyonkarahisar), Başmakçı, Bayat, Bolvadin, Çay, Çobanlar, Dazkırı, Dinar, Emirdağ, Evciler, Hocalar, İhsaniye, İscehisar, Kızılören, Sandıklı, Sinanpaşa, Sultandağı, and Şuhut.

Within the scope of this study, Turkish Statistical Institute's 2015 animal statistic data has been used as material (TUIK, 2015). The data used in the calculation of the biogas production potential were considered only cattle, buffalo and laying hen population. Because the attainability of animal manures, as determined by staying time in the barn, provides the highest value in a cattle farm (65%) and laying hens farm (99%) (Başçetinçelik *et al.*, 2005). Another animal data is not used in calculating of biogas amount for this ratio be lower.



Figure 1. The districts of Afyonkarahisar and their locations

Animal manure and biogas production calculation methods

The following methods were used to calculate the amount of animal manure and biogas production (Başçetinçelik *et al.*, 2006; Ozsoy and Alibas, 2015; Ayhan, 2015).

$$AFM = \frac{NA \times MPPA}{1000}$$

Where, AFM is the amount of fresh manure as a daily value (t/d); NA is the number of animals; MPPA is the daily manure production per animal (kg/d. animal). The MPPA is 27.24 for cattle and 0.08 for laying hens.

$$ASM = AFM \times SMR$$

Where, ASM is the amount of daily solid manure (t/d); SMR is solid manure ratio (%).

$$TUSM = ASM \times AOM \times 365$$

Where, TUSM is annual total usable solid manure (t/a); AOM is the attainability of manure (%).

$$AB = TUSM \times BCR_{SM}$$

Where, AB is the amount of biogas (m³/a); BCR_{SM} is biogas conversion ratio of solid manure (200 m³/t).

$$THV = AB \times HV$$

Where, THV is the total heating value (MJ/a); HV is the heating value of unit biogas (22.7 MJ/m³).

Electricity generation from biogas with a gas engine was calculated by the following equation.

$$EP = \frac{THV}{3.6} \times EPE_{Net}$$

Where, EP is electricity production (MWh_{el}/a); EPE_{Net} is the net electricity production efficiency of biogas engine (40%) (Clarke Energy, 2016).

For each district, the calculated values, the total amount, the total biogas production, and the total energy potential of animal manures, were mapped using ArcMAP Software.

Results and discussion

Total animal manure potential of Afyonkarahisar in 2015 as a solid matter depending on the number of cattle and laying hens is presented in Table 1.

Table 1. Number of animals, and total amount of animal manure as fresh and solid matter

Animal	NA	AFM (t/d)	SMR (%)	ASM (t/d)	AOM (%)	TUSM (t/a)
Cattle	348,608	3,466,070	12.7	440,191	65	286,124
Buffalo	5,183	51,532	12.7	6,545	65	4,254
Laying hens	18,468,607	539,283	25	134,821	99	133,473
TOTAL		4,056,886		581,556		423,851

According to Table 1, the total amount of usable solid manure, obtained from cattle and laying hens, is 424 thousand tons in 2015. Its distributions by the sources are cattle (68.5%) and laying hens (31.5%).

The amount of biogas which can be obtained from the total animal manure as a solid matter along with the electricity generation from this biogas is presented in Table 2.

Table 2. The biogas potential and the energy potential of biogas in Afyonkarahisar

Animal	TUSM (t/a)	AB (m ³ /a)	THV (GJ/a)	EP (MWh _{el} /a)
Cattle	286,124	57,224,814	1,299,003	144,334
Buffalo	4,254	850,802	19,313	2,146
Laying hens	133,473	26,694,525	605,966	67,330
TOTAL	423,851	84,770,140	1,924,282	213,809

Table 2 presented that the total biogas potential of Afyonkarahisar was calculated to be 84.77 million m³/a. Besides, its heating value was calculated to be 1,924 TJ/a. It was determined that almost 214 GWh_{el}/a. energy can be obtained by the conversion of all the biogas potential from animal manure into electrical energy by means of a gas engine. These values can provide 16.6% of Afyonkarahisar's annual electric energy consumption (1,284 GWh_{el}).

A study carried out by Kizilaslan and Onurlubas (2010) in Tokat Province, Turkey indicated that the total biogas derived from animal manure was 37.9 million m³/a.

Ozsoy and Alibas (2015) reported the amount of biogas production from animal manure was about 52 million m³/a, equivalent to about 400 GWh/a. of energy.

The potential of biogas from animal manure was determined in Yozgat province, Turkey. The total biogas potential was determined as 45 million m³/a in the province. (Eryilmaz, *et al.*, 2015).

As a result, the biogas potential of Afyonkarahisar province only from cattle, buffalo and laying hens is greater than the three provinces (Bursa, Tokat, Yozgat).

Table 3. Amount of fresh manure, biogas potential and energy values in the districts of Afyonkarahisar

Districts	Fresh Manure (t/a)	Biogas Potential (m ³ /a)	Heating Value (GJ/a)	Electric Energy (MWh _{el})	Share in total (%)
Center	866,286	23,507,131	533,612	59,290	27.7
Başmakçı	250,742	8,106,964	184,028	20,448	9.6
Bayat	30,744	508,966	11,554	1,284	0.6
Bolvadin	388,472	8,604,885	195,331	21,703	10.2
Çay	345,821	5,726,173	129,984	14,443	6.8
Çobanlar	113,923	1,881,561	42,711	4,746	2.2
Dazkırı	96,027	1,712,412	38,872	4,319	2.0
Dinar	189,396	3,129,883	71,048	7,894	3.7
Emirdağ	179,155	3,480,977	79,018	8,780	4.1
Evciler	92,615	1,530,061	34,732	3,859	1.8
Hocalar	68,002	1,124,193	25,519	2,835	1.3
İhsaniye	227,304	3,890,112	88,306	9,812	4.6
İscehisar	142,660	2,357,091	53,506	5,945	2.8
Kızılören	13,036	215,907	4,901	545	0.3
Sandıklı	302,413	6,142,116	139,426	15,492	7.2
Sinanpaşa	355,284	6,302,464	143,066	15,896	7.4
Şuhut	307,759	5,107,548	115,941	12,882	6.0
Sultandağı	87,245	1,441,697	32,727	3,636	1.7
TOTAL	4,056,886	84,770,140	1,924,282	213,809	

Considering 17 districts of Afyonkarahisar for the year 2015, animal fresh manure, biogas potential obtainable from solid manure, the heating value of this biogas potential, and the electrical energy produced from this biogas, were presented in Table 3.

Central of the province has the highest potential with 23.5 Mm³/a value and 27.7% of the share in total. This is followed by Bolvadin, Başmakçı, Sinanpaşa and Sandıklı districts with 8.6 Mm³/a. and 10.2%, 8.1 Mm³/a. and 9.6%, 6.3 Mm³/a. and 7.4%, 6.1 Mm³/a. and 7.2%, respectively.

While the amount of cattle manure in all districts generates the majority of the total manure, these rates vary only in the Centre and Başmakçı district. The share of cattle manure inside of the total manure is 67.8% and the share of laying hen manure is 32.2% in the Central district. In the district of Başmakçı, the share of cattle manure and laying hens manure within total manure are 52% and 48%, respectively. Because Afyonkarahisar is the center of the egg production in Turkey, the vast majority of egg production is carried out in these two districts. Therefore, laying hens manure generates a major problem because of its large amount yearly.

The amount of biogas and their energy values were calculated separately for each district and were mapped using ArcMAP Software. The distribution map of biogas potential and its energy values for 18 districts of Afyonkarahisar are given in Figures 2 and 3.

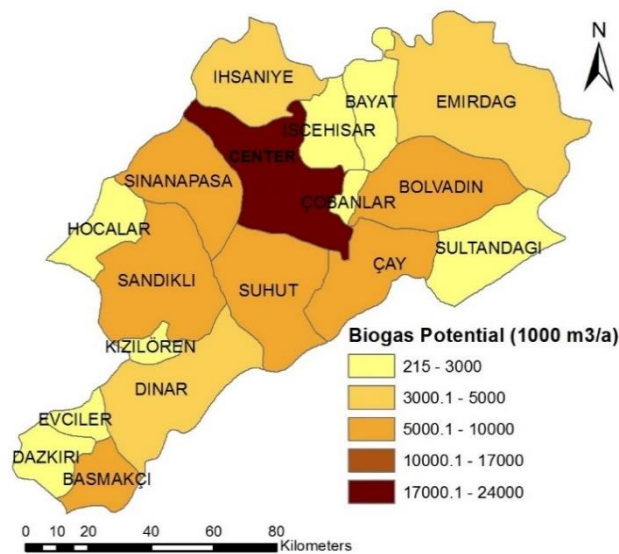

Figure 2. The distribution map of biogas potential in Afyonkarahisar

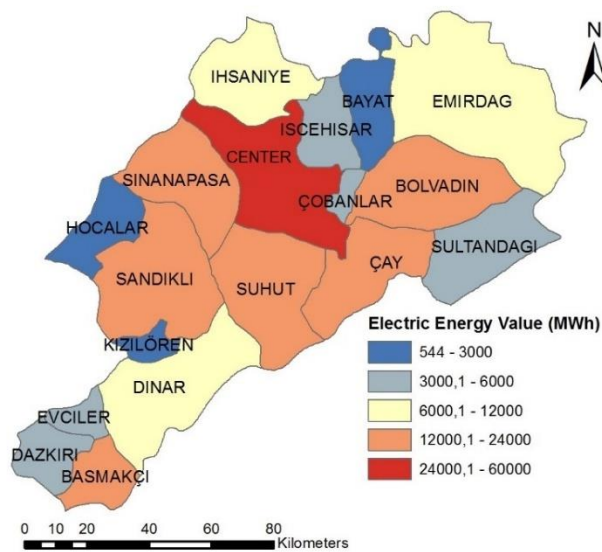

Figure 3. The distribution map of electricity generation from biogas in Afyonkarahisar

These maps show that the biogas potential is concentrated in the Center of the province and decreased from center to outward in the region. Başmakçı district is excepting. This means that the biogas production plants can be established in the central and districts nearing. This situation is an advantage in terms of raw material supply for biogas production plants.

Conclusion

In this study, it was detected that the biogas potential of Afyonkarahisar from cattle, buffalo and laying hens manures was 84.77 million m³/a depending on the number of the animals in the years 2015. A 27.7% of this potential was enabled by the Centre of the province while 10.2%, 9.6%, 7.4%, and 7.2% of it were supplied by Bolvadin, Başmakçı, Sinanpaşa, and Sandıklı, respectively.

If all the biogas potential from animal manure are converted into electricity by means of a gas engine, it can be obtained almost 214 GWh_{el}/a. electrical energy. These values can provide 16.6% of Afyonkarahisar's annual electric energy consumption (1,284 GWh_{el}).

Although Afyonkarahisar province has a large biogas potential, this potential has not been able to be adequately assessed. At present in the province, there are two biogas plants installed capacity with 4.254 MW_{el} and 2.4 MW_{el}. While the electricity generation potential of biogas in Afyonkarahisar is 24.43 MW_{el}, today only 27% of this potential is evaluated.

In this study, the created maps were provided to visualize more clearly the differences of data from the districts. The mapping can provide the rise of public awareness, and policy-makers' reference about these matters.

Turkey has a great potential of renewable energy sources. Unfortunately, it is an energy-importing country. The country needs to use more of its renewable energy sources in order to be independent with regards to energy. Therefore, biogas can be a very attractive choice because it is sustainable, environmentally friendly and a native energy source for Turkey.

References

- Al Seadi, T., Rutz, D., Prassl, H., Köttner, M., Finsterwalder, T., Volk, S., Janssen, R. (2008). Biogas Handbook, University of Southern Denmark Esbjerg, Denmark.
- Ayhan, A. (2015). Biogas production potential from animal manure of Bursa province. Journal of Agricultural Faculty of Uludağ University, 29(2), 47-53
- Başçetinçelik, A., Karaca, C., Öztürk, H.H., Kaçira, M., Ekinci, K. (2005). Agricultural biomass potential in Turkey. Proceedings of the 9th International Congress on Mechanization and Energy in Agriculture & 27th International Conference of CIGR Section IV: The Efficient Use of Electricity and Renewable Energy Sources in Agriculture: 195-199, İzmir-Turkey, 195-199
- Başçetinçelik, A., Öztürk, H.H., Karaca, C., Kaçira, M., Ekinci, K., Kaya, D., Baban, A., Komitti N., Barnes, I., Nieminen, M. (2006). Final Report of Exploitation of Agricultural Residues in Turkey. AGRO-WASTE - Exploitation of Agricultural Residues in Turkey. EU Life Program Project, Project No: LIFE03 TCY/TR/000061.
- Clarke Energy (2016). CHP efficiency for biogas, (Retrieved June 20, 2016, from <https://www.clarke-energy.com/2013/chp-cogen-efficiency-biogas/>).
- Eryilmaz, T., Yesilyurt, M.K., Gokdogan, O., Yumak, B. (2015). Determination of biogas potential from animal waste in Turkey: A case study for Yozgat province. European Journal of Science and Technology, 2 (4), 106-111.
- Karaca, C. (2015). Mapping of energy potential through annual crop residues in Turkey. International Journal of Agricultural and Biological Engineering, 8(2), 104-109.

- Kizilaslan, H., Onurlubas, H.E., (2010). Potential of production of biogas from animal origin waste in Turkey (Tokat provincial example). *Journal of Animal and Veterinary Advances* 9(6), 1083-1087.
- MENR (Ministry of Energy and Natural Resources). (2015). Turkey's energy profile and strategy, www.enerji.gov.tr.
- Møller, H.B., Nielsen, A.M., Murto, M., Christensson, K., Rintala, J., Svensson, M., Seppälä, M., Paavola, T., Angelidaki, I., Kaparaju, PL. (2008). Manure and energy crops for biogas production: Status and barriers, Nordic Council of Ministers, Copenhagen, Denmark.
- Ozsoy, G., Alibas, I., (2015). GIS mapping of biogas potential from animal wastes in Bursa, Turkey. *Int J Agric & Biol Eng*, 8(1): 74–83.
- TUIK (Turkish Statistical Institute) (2015). Livestock statistics: All districts of Afyonkarahisar province.

BATCH PROCESS TESTING FOR ANAEROBIC CO-DIGESTION AS AN ALTERNATIVE FOR RENEWABLE BIOGAS

Ilijan MALOLLARI^{1*}, Xhaklina CANI¹, Jorgaq KAÇANI², Lorina LIÇI², Redi BUZO³, Mirela QYRA¹

¹University of Tirana, Faculty of Natyral Science, Tirana, Albania

²Polytechnic University of Tirana, Albania

³National Food Authority, Albania

*Corresponding author: ilirjan.malollari@fshn.edu.al

Abstract

A bioreactor was filled with different substrates at once and left to degrade anaerobically without any interference until the end of the cycle phase. Experiments were performed in usual 1.5-l digester flasks in the batch process and measurement of biogas was done by standard water displacement method. The biogas production was recorded up to 50 days. Different agricultural and animal wastes have been tested. In most of the cases pretreatment in the form of soaking in water, acid or alkali was found to increase the biogas content on digestion mixed with chicken manures or any other animal waste the yield was higher. Our study has been firstly focused in preparing biomass for the anaerobic digestion for methane profit, using calculated mixtures of different agro-forestry residues such as spent organic substrates, wheat straw, corn straw, corncob and a mixture of leaves and thin sticks etc., premixing them with animal wastes like manures and other organic wastes. Experimental series have been performed with wide ratios C:N in range 23-40. So, we have followed a systematic procedure for the anaerobic biologic digestion process design simulated in a fixed capacity chosen. At the end as a result we have recommended an engineering flow sheet for the specified biochemical process.

Keywords : *Renewable energy, Biogas, Biomass, spent substrate, anaerobic digestion.*

Introduction

This article focus on the overall analysis of the organic raw materials, which will be used for the development of experiments. The intention was to analyze the physical - chemical properties of the samples, which will be used as raw material for the pre-treatment process for biogas production (Amon *et al.*, 2007; Bernard *et al.*, 2000). There are a lot of recommended and explained methods for pretreatment of the biomass.

We were focused more on the acidic and alkaline pretreatment and on the development of experiments, analysis of raw materials, taking samples before and after appropriate pretreatment (Batstone *et al.*, 2002; Colussi *et al.*, 2009). It has been determined characteristics such as: humidity, dry matter, ash, the carbon to nitrogen, ratio, pH value, electrical conductivity and biological oxygen demand (BOD). Raw materials to be analyzed were: alfalfa, wheat straw, corn straw, corncob and a mixture of leaves and thin and dry wooden sticks. The aim of pretreatment process was to overcome this recalcitrance, to separate the cellulose from the matrix polymers, and to make it more accessible for enzymatic hydrolysis. During this process it was expected a certain change of the composition ratio within lignin: hemicelluloses: cellulose, which influence on the particle size, degree of polymerization, pore volume, solubility rate etc. Although there are

different types of pretreatment such as mechanical, thermique, acidic, alkaline, (said chemical), as well as biological method.

From other studies has been shown that the anaerobic digestion (AD) was an alternative method recently studied for breaking down biodegradable material in an oxygen- free environment to produce a solid digestate along with biogas. Anaerobic digestion converts organic matter into carbon dioxide (~40%) and methane (~60%) via four defined stages: hydrolysis, fermentation, acetogenesis and finally methanogenesis. The anaerobic degradation process is suitable for waste treatment; based on the biological oxidation of organic matter by the action of specific microorganisms (in the absence of atmospheric oxygen) as a result of this process, organic matter is converted into stable end products and still, at the same time it generates biogas (mainly methane and carbon dioxide) [5-7] with a considerable energy potential while producing an energy rich biogas (55-70% methane, CH₄) that can be valorised energetically.

Most literature sources report substantial differences in the yields and kinetics of methane on anaerobic digestion depending of type of substrate.

Materials and methods

Materials preparing for anaerobic digestion

Raw materials for the anaerobic disintegration have been taken from one chicken farm located in Tirana. As biomass were used alfalfa, corn straw, wheat straw, wood chips and dried leaves, humus, chicken manure and livestock (cattle). At the beginning, physical pretreatment was performed. After collecting the crude raw materials, drying was done at room temperature and then in thermostat at 105 ° C ± 2 ° C for 4 hours. Once the plant residues was dried up, they were cut off into very small pieces, 2 mm sizes in order to have a greater contact surface between biomass, water and other substances for biogas production.

Raw materials (organic wastes) analysis

Organic wastes were physically characterized with the moisture content, dry matter, organic matter, ash, free carbon, total nitrogen (method Kjeldalh) and pH value.

Biomass Pretreatment for degrading of ligno - cellulosic material

For the biomass pretreatment the following method was used (Yadvika *et al.*, 2004). At first 10g catalyst CuSO₄: K₂SO₄ (1:10) was mixed with the sample, about 20 ml sulfuric acid was then added to the solution. After that, digestion temperature was increased up to 40 °C and 200 ml distilled water, antifoaming agent and 70 ml NaOH 40% were added. The solution was cooled to the environment temperature. In order to determine the nitrogen content the following formula

was used:
$$\%N = \frac{14 \cdot T}{W(100 - M)}$$

Where; **T**= standard acid used for titration, **W**= sample weight,

M= moisture sample.

Results and discussion

The results of the experiment are presented in various graphs and tables, which are presented below. Set of samples shown in table 1 have been pretreated according to standard procedure in different condition varying from acid and alkaline added and finally were let to rest in 500 ml bottles for 40 days. The experimental set-up which has been build for the process is showed in the figure 1.

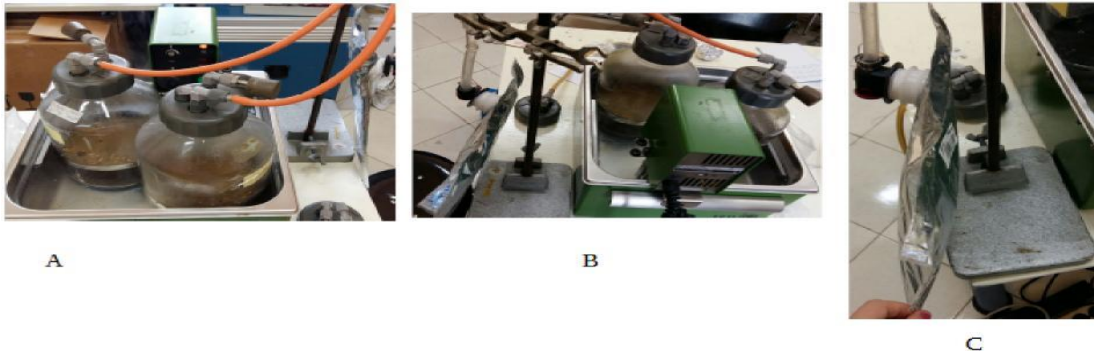

Figure 1. Experimental set up of the biomass pre-treatment . In A) is presented on the first day, B) is after a week pre-treatment, which has just started production of biogas and C) for the final amount of biogas collected after 40 days of experiment.

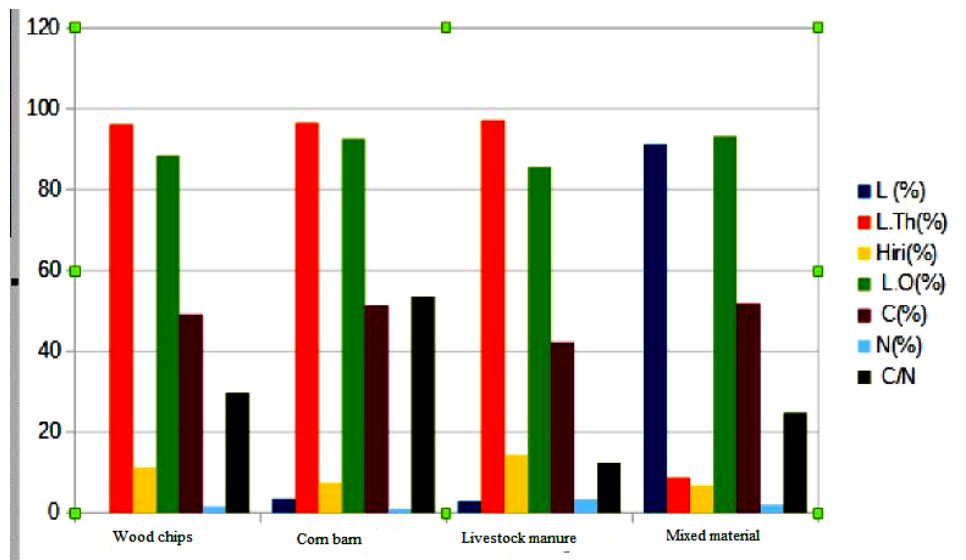

Figure 2. The graphical presentation of the analyzes on raw materials.

Then tests were performed for aerobic digestion during 14 days at 70°C. Then sample bottles were kept at 40 °C for other 26 days.

Table 1. Analysis of the first day for the material used in 3-liter bottle

	R (%)	D.S (%)	Ash (%)	O.M (%)	C (%)	N (%)	C/N
Woodchips	3.75	96.25	11.28	88.5	49.17	1.65	29.8
Corn bran	3.45	96.55	7.48	92.52	51.40	0.96	53.54
Livestock manure	2.97	97.21	14.4	85.6	42.2	3.42	12.34
Mixed material	91.23	8.77	6.78	93.22	51.79	2.09	24.78

Table 2. Consistently determination of pH throughout the experiment time

Day	0	10	20	30	40
pH	10.78	9.45	8.26	8.06	7.96

Characterization of waste

Chicken manure that was used for the experiment, was taken from one chicken farm located in the region of Tirana. Samples were left to dry several days before use. Chicken manure was very rich in nitrogen which was needed for the biogas production.



Figura 3. Experiments conducted with bottles balloon, A) the first day of the experiment, B) as anaerobic conditions were set for 24 hours, and C) observation of biogas production.

Table 3. Result of analysis of chicken manure

	R (%)	D.S (%)	Ash (%)	O.M (%)	C (%)	N (%)	C/N
Manure	69.93	30.07	10.09	89.01	48.75	2.9	16.81

During 40 days of experiment manure is constantly mixed in the bottle, in order to increase the contact surface between the biomass and alkaline treatment. It was observed that due to the composition process was first lightly alkaline, but after the dissolution of the material and the production of biogas the ph becomes at value pH 6.5 - 7.5. In this way we can take the desired result. Increased the % of nitrogen proves the fact that the dissolved ligno cellulosic material has created the conditions for the production of biogas (Deublein *et al.*, 2008). The amount of biogas is expected to be generated based on data from the literature. According to the references obtained from various studies conducted in many countries, it said that from 1 kg chicken waste must be generated approximately 50 L biogas (Cioablă *et al.*, 2009). The data obtained give us a solid content of 30% ± 1. These value was decisive for modeling analysis used. Theoretically has been described this value to be 31% ± 1, so close to our analysis results.

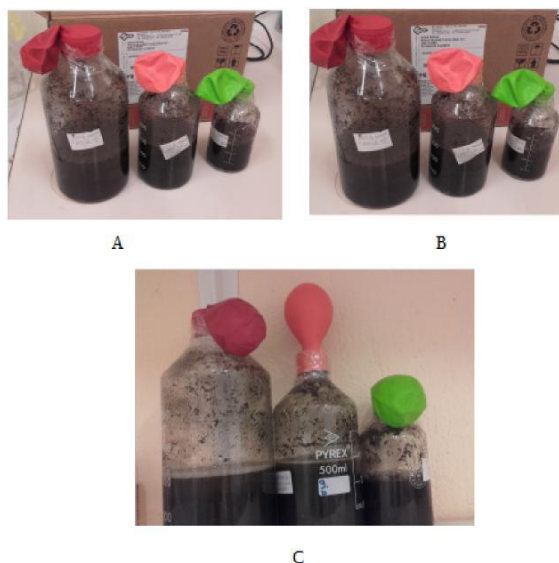
Table 4. Solid content measurements

Measure before drying (g)	Measure after drying (g)	Solid content (%)
50.136	15.071	30.06
51.243	15.865	30.96
49.854	15.023	30.14

It can be clearly seen that the organic matter was consumed in a great portion from the beginning, which was caused by the degradation of it from the hydrolysis during pretreatment. Further one can see that during basic pretreatment we got a smaller decrease of organic matter, than from acidic pretreatment. Also ash content was decreased during pretreatment, due to the decrease of O.M. On the other hand the Nitrogen content was increased during pretreatment, due to the fact of mineralization of Nitrogen into the form of ammonia, nitrates, nitrites etc.

Conclusion

It should be emphasized that a great importance in the pre-treatment process has not only the choice of ligno cellulose material to be treated, but the storage, drying and its fragmentation. To have a pre-treatment as well, and a performance in the production of biogas must not only make a combination of pretreatment methods but also the raw material that will be pre-treated. In this way become possible attacks on faster ligno cellulosic wall, biodegradable material growth and enable increasing the amount of biogas.

The anaerobic digestion converts organic residue (agricultural and food residue, animal waste) in energy (in the form of biogas or electricity).

Production of biogas from anaerobic decomposition of bacteria depends on the ability to operate with biomass. The survival of bacteria depends on the temperature, pH, and physical anaerobic digestion conditions.

The main purpose of the pre-treatment for biogas production was to increase the interaction of the hemiceluloze and lignoceluloze compound, as well as the decomposition of complex structure. To improve the process of pre-treatment of biogas, can be suggested a combination of pre-treatment methods, with at least the use of two types of pretreatment. From our experience we justify the fact that in some studies have been found very effective combination of thermal pre-treatment with the chemical in order to increase the biogas amount profited. The combination of pre-treatment methods need to be used in order to improve the anaerobic process performance for the production of biogas must be based also on the economic analysis.

Chicken manure were selected for an application model that describes the experimental data and model in order to describe the real case. Chicken manure were chosen because they have a high potential for production of biogas and is a very good opportunity to achieve anaerobic digestion. The amount of biogas produced from chicken manure was distinguished after 5 days of the experiment. It should be noted that another important parameter influencing the performance of the regular experiment was repeatedly mixing the manure in the bottle. Mixing took place throughout the day with an interval of about 5 minutes every 2 hours.

References

- Amon, T. et al. (2007). Biogas production from maize and dairy cattle manure – Influence of biomass composition of the methane yield, *Agriculture Ecosystems and Environment*, 118 (2007), pp. 173 – 182, ISSN 0167 – 8809.
- Bernard, S. and Gray, N. E: Aerobic digestion of pharmaceutical and domestic wastewater sludge at ambient temperature. *Water Res.*, 34, 725-734 (2000).
- Batstone D.J., Keller J., Angelidaki I., Kalyuzhnyi S.V., Pavlostathis S.G., Rozzi A., Sanders W.T.M., Siegrist H., Vavilin V.A., 2002b, *Anaerobic Digestion Model No.1*, Scientific and Technical Report (STR) No 13, International Water Association, London, UK.
- Colussi I., Cortesi A., Gallo V., Stefani N., Vitanza R., 2009, *Anaerobic Treatment of Winery Wastes in Suspended and Attached Growth Biomass Reactors*, Atti della Conferenza “5th International Specialized Conference on Sustainable Viticulture: Winery Waste and Ecologic Impacts Management”, Trento e Verona (I), 30 March – 3 April, 325-331.
- Cioablă, A. E. (2009). *Theoretical and experimental contributions concerning biogas production from biomass residues*, PhD Thesis, Politehnica Publishing House, Timisoara.
- Deublein, D & Steinhauser, A. (2008). *Biogas from waste and renewable resources, an introduction*, ISBN 978 – 3 – 527 – 31841 – 4 .

THE COMPARISON OF SOWING METHODS ON *DICHONDRA REPENS* IN IGDİR CONDITIONS (TURKEY)

İbrahim HOSAFLIOĞLU¹, Hakkı AKDENİZ^{2*}, M. Kazım KARA³

¹Iğdir University, Department of Landscape Architecture, Agricultural Faculty, Iğdir, Turkey

²Iğdir University, Department of Field Crops, Agricultural Faculty, Iğdir, Turkey

³Iğdir University, Biometry and Genetic of Animal Husbandry, Agricultural Faculty, Iğdir, Turkey

*Corresponding author: hakki_akdeniz@hotmail.com

Abstract

Dichondra repens is the most widely used vegetation as ground cover plant that has a creeping habit in the landscape. Increasing seeding rates may help decrease weed pressure in *Dichondra repens* with proper sowing methods. The objectives of this paper are to analyse two different sowing methods (1.the agricultural nonwoven fabric (agril) method and 2. the conventional sowing method) at different seeding rates (10, 20, 30, 40, 50,100, 150, 200, 250 and 300 ha⁻¹) on covering rate of *Dichondra repens* on ecological conditions of Iğdir plain. The obtained data were analysed by repeated measures design with two factors, sowing method and time. The results showed that there was a significant difference between in both sowing methods and times in terms of covering ratio (p<0.05). Weeds were difficult to control in *Dichondra* on the conventional sowing method compared with the agril nonwoven method in the experimental area. The covering on the surface of the plots with biodegradable nonwoven material (the agricultural nonwoven fabric method) before seeding had a positive impact on covering ratio of *Dichondra repens* compared with the conventional sowing method. While the plant covering ratio reached up to 85 % in the agricultural nonwoven fabric method, but the covering ratio was 1% in the conventional sowing method at T6, respectively. However, strong linear relationships are obtained between the plant covering ratio and seeding rates in both the agricultural nonwoven fabric method, R² (0.96, 0.89, 0.88, 0.85 and 0.70) and the conventional sowing method, R² (0.95, 0.97, 0.98, 0.98 and 0.93) at (T1, T2, T3, T4 and T5), respectively. Consequently, the agriculture nonwoven fabric sowing method to be used in parks, gardens and landscapes will provide a very significant savings, reducing the use of seed and for weed control and will be particularly prominent in terms of health maintenance.

Keywords: *Dichondra repens*, Sowing methods, Seed rates and Plant covering rate

Introduction

Dichondra repens is a warm season ground cover that grows close to the ground. It has broad, almost circular leaves and when mown low establishes a thigh dense carpet look. Originally weed; it is now used in many ground cover situations where normal grasses may not do as well. It has a bright green colour and a cushion feel underfoot (http://www.univagro-iasi.ro/vvintu/images/5/5c/Dichondra_repens.pdf). *Dichondra repens* is originally described from a Nex Zealand collection, but subsequently the name became used in a broad sense to cover a complex fo related plant in tropical to warm-temperature areas fo both hemispheres (Margot B. Forde, 1978).

Zhu at al. (2009) conducted a pot experiment to study the biomass allocation and morphological characteristics of *Dichondra repens* under different levels of shading (100%, 66 %, 20%, and 9%

transparency that with the increasing of shading, the biomass per plant decreased after an initial increase. *Dichondra repens* had definite adaptability to varied light environment.

Dichondra repens is low growing, creeping perennial the spreads by underground runner. The leaves are kidney shaped and dark green in colour. Ideally spring planting is most rewarding, but *Dichondra* may be planted at any time of the year. In addition to this, *Dichondra* is not recommended for sunny position, but in shady or part shade position it will provide a good low maintenance lawn substitute (http://www.zanthorrea.com/info/Dichondra_Lawn.pdf). Turkey is recognized as an important gene source, because of the rich genetic diversity found in Turkey's flora. Turkey has a great variety of native plant species. However, the number of cultivated plant species doesn't reflect this richness (Bülent and Şirin, 2005). In addition to this, since the seeding technology in Turkey was not developed, we are forced to import a very large body of seeds and therefore economic losses were increasing. The related reports are still needed in literature since many research has not been carried concerning with *Dichondra*. *Dichondra repens* is a type of ground covering and it is expected to covering the soil surface after planting, as soon as possible. The aim of this research is to choose the best sowing method by using the least amount of seeds of *Dichondra*.

Material and Method

The research was carried out to compare two methods (1: the agricultural nonwoven fabric (agril) method and 2: the conventional sowing method) at different seeding rates (10, 20, 30, 40, 50, 100, 150, 200, 250 and 300 kg ha⁻¹) on covering rate of *Dichondra repens* on ecological conditions of Iğdır plain at the Agricultural Faculty, Iğdır University in Turkey in 2013. The average annual temperature 12.08 °C, the hottest month is July (26 °C), the coldest month in January (-3.5 °C), the highest temperature in July (33.6 °C), the lowest temperature in January (-8.0 °C) the total annual rainfall 260.3 mm, the average number of rainy days 85 days 24 days number of days covered with snow, the average number of days of frost is 97.5 days (Anonymous 2014). Sowing was conducted by hand in May, 2014.

The experimental site had previously been used for producing barley. Parcel size was 2 x 1=2 meter square. We applied the agricultural nonwoven fabric and the conventional at different seeding rates (10, 20, 30, 40, 50, 100, 150, 200, 250 and 300 kg ha⁻¹) on covering rate of *Dichondra repens* on ecological conditions of Iğdır plain. The coated *Dichondra* seed was shown on 22nd of May, 2014. On the surface of all the plots were broadcasted for 1 cm turf as cover soil. Half of 120 kg ha⁻¹ N (ammonia sulphate with 46% N) and all of the phosphorus (triple super phosphate) 80 kg ha⁻¹ P₂O₅ were applied before sowing and the half of the nitrogen were applied for T3:30 10 July 2014. The experimental design was analysed by repeated measures design with two factors, sowing method and time. To ensure homogeneity the data obtained in the conventional sowing method was transformed as $\sqrt{(x - 1)}$.

Bonferroni multiple comparison test for times and Duncan multiple comparisons was applied for seed rates. It was measured the covering rate of the soil of *Dichondra repens* in each plot by using quadrates at different times (T1:10 June 2014, T2: 20 June 2014, T3:30 10 July 2014, T4: 10 July 2014, T5: 20 July 2014, and T6: 30 July 2014).

Results and Discussion

The coating rates of *Dichondra repens* at different sowing methods (1.the agricultural nonwoven fabric method, 2. the conventional sowing method) in different seed rates are seen in Table 1. Both sowing methods increased plant covering rate and that is to say when the seed rate increased the covering rate of plant increased. In the nonwoven sowing method, at different seeding rates (10, 20, 30, 40, 50, 100, 150, 200, 250 and 300 kg ha⁻¹) at T1, the covering of the plant were 1.0%, 1.9%, 3.7% 3.1%, 6.9%, 20.0%, 38.0%, 37.8%, 40.0% and 42.9 %, respectively. The plant's soil coverage rates at the same time (T1) in the conventional method were found 0.7%, 0.9, 2.2, 2.4, 6.3, 10.7, 23.1, 27.1, 38.5, and 37.7 respectively and statistically was different from each other. The plant's soil coverage in the conventional sowing method by using 10 kg ha⁻¹ seed rate at T1, T2, T3, T4, T5 and T6 were 1.0%, 1.4, 1.9, 7.0, 21.0, and 84.8 % respectively. At the same time, the plant's coverage rate as in traditional methods according to the order of 0.7%, 0.4, 1.0, 0.5, 1.0 and 1.0% was found. *Dichondra repens* covering rate was 84.8% at T6 in the agricultural nonwoven sowing method by using 10 kg ha⁻¹ seed and plant growth rate was 1% in the conventional methods in the same amount of seed. Plant covering rate was about 85% at T6 by using 10 kg seed per hectare and plant covering rate was 100 % in the other seed rates in the all plots. Whereas the plant covering rates were measured the lower and covering rate reached 98 % at T6 measurement time, by using 300 kg seed ha⁻¹ in the conventional sowing system. Covering rates were higher in the agril nonwoven method than the conventional sowing at T6.

Uncovered soil is more prone to weed problems but, a ground cover with a fast rate of spread is usually desirable to minimize weed invasion. Plant covering rate was 100 % at T6, with using 20 kg ha⁻¹ without weeds in the plots of the agricultural nonwoven fabric method and whereas the rate of weeds in the plots of conventional sowing method was higher. However, covering rate was about 2 percent in applying 20 kg seed ha⁻¹ at the end of the experiment, T6. Hence, the rates of weeds were approximately 98 % in the plots of conventional sowing methods.

Plant covering rate reached 100 % by using 100 kg seed rate ha⁻¹ at T4 time in the agricultural nonwoven fabric method. Therefore, if the long-term, full covering of the land is the purposes of the landscape, sufficient seed is suitable for as 20 kg ha⁻¹. Therefore, when the plant covering ground in a short time is very crucial in landscape establishment, it is necessary to use 10 kg of seeds.

The covering rate of 85% was obtained from the plots received 10 kg seed rate ha⁻¹ at T6 and on the other hand, the covering rate was able to reached to 88 percent by seeding 100 kg seed rate ha⁻¹ at T3. Consequently, in a short time, to reach maximum coating rate is necessary to be used about 10 times more seed.

The covering rate could reach to 100 % using 100 kg dichondra seed per ha at T4 time in the agricultural nonwoven fabric method whereas covering rate was be able to reached to 44.8%. As the average of seeds, plant covering rates at T1 T2, T3, T4, T5 and T6 in the *Dichondra repens* were 37.6%, 46.9, 50.7, 61.1, 79.0 and 78.5 respectively. Eydurán et al. (2013) stated that the time effect was identified that continuous variables in the data of repeated measures. However, T4, T5 and T6 also had the highest covering rate and but there was no significant differences between times (T4, 5, 6).

The coverage rate increased in all the times in the agricultural nonwoven fabric method, by using the amount of 150 kg of seed ha⁻¹. While this increasing was found in the conventional sowing methods in the norm of 300 kg of seed ha⁻¹. Weeds was not found in the plots which were applied at least amount of seed rates in the agricultural nonwoven fabric method.

As expected, the lowest covering rate speed was recorded for T1 time, up to 1 month after planting time. The conventional methods of cultivation, as average seeds norms at T1, T2,

T3, T4, T5 and T6, the plant soil covering rate were 14.9%, 25.5, 37.0, 38.4, 39.9, 42.9 and was significant differences between times. Repeated measurement design are recommended with research that focuses on performance trends over time. The sphericity assumption is met if all the differences between pairs of treatment condition scores are equally variable, and if variances of differences for all treatment conditions are homogenous. Eyduran at al. (2016) mentioned that in repeated measurement data of laying hens, cumulative age weight per hen as a dependent variable was recorded per week, and treatment, time and treatment x time interaction effects were added as independent variables. Harrington at al. (2005) reported *Dichondra* (*Dichondra micrantha*) gave a good ground cover for the first few years but slowly regressed to hard-to-control weed species.

Table 1. The covering rates of *Dichondra repens* in the different sowing method and seed rates

Seed rate (kg ha ⁻¹)	1. The agricultural nonwoven fabric method						2. The conventional sowing method					
	T1	T2	T3	T4	T5	T6	T1	T2	T3	T4	T5	T6
10	1.0 d	1.4 e	1.9 f	7.0 f	21.0 d	84.8 b	0.7 f	0.4 h	1.0 g	0.5 e	1.0 f	1.0 gb
20	1.9 d	2.9 e	5.0 e	13.9 e	58.5 c	100.0 a	0.9 f	0.7 h	1.6 g	1.1 e	1.7 f	1.7 g
30	3.7 d	4.6 de	8.5 d	20.7 d	60.9 c	100.0 a	2.2 f	2.1 gh	1.7 f	2.7 e	3.3 f	2.7 g
40	3.1 d	7.8 cd	12.7 c	39.6 c	82.3 b	100.0 a	2.4 f	5.3 gh	9.5 f	14.2 d	14.7e	17.0 f
50	6.9 d	9.3 c	12.4 c	39.6 c	87.3 b	100.0 a	6.3 e	7.0 cf	9.4 f	15.0 d	45.9 c	50.3 d
100	20.0 c	76.6 b	88.0 b	100.0 a	100.0 a	100.0 a	10.7 d	16.9 e	40.3	44.8 c	41.6 cd	44.1 e
150	38.0 ab	90.1 a	94.8 a	100.0 a	100.0 a	100.0 a	23.1 c	26.7 d	56.4 d	41.1 c	34.5 4	53.7 d
200	37.8 ab	91.3 a	94.8 a	100.0 a	100.0 a	100.0 a	27.1 b	38.1 c	66.2 c	70.6 b	73.6 b	84.0 b
250	40.0 ab	92.9 a	95.6 a	100.0 a	100.0 a	100.0 a	38.5 a	76.0 b	87.5 b	96.1 a	88.0 a	76.1 c
300	42.9 a	97.1 a	95.8 a	100.0 a	100.0 a	100.0 a	37.7 a	81.3 a	94.9 a	97.7 a	95.0 a	98.13 a
Means	37.6 E	46.9 D	50.7 C	62.1 AB	79.0 A	98.5 A	14.9 D	25.5 C	37.0 B	38.4 A	39.9 A	42.9 A

However, the strong linear relationships were recorded between the plant covering rates and seeding rates in both the agricultural nonwoven fabric method and the conventional sowing method all the times except for T6 time. Figure 1, 2, 3, 4, 5 show that R² (0.96, 0.89, 0.88, 0.85 and 0.70) in the agricultural nonwoven fabric method, however, Figure 1a, 2a, 3a, 4a, 5a show that R² (0.95, 0.97, 0.98, 0.98 and 0.93) in the conventional sowing system at (T1, T2, T3, T4 and T5), respectively.

Figure 1. The agril nonwoven method, T1

Plant covering rate (%) = $-1,618 + 1,4456 * \text{Seed rate kg/m}^2$
 Correlation: $r = ,96307$

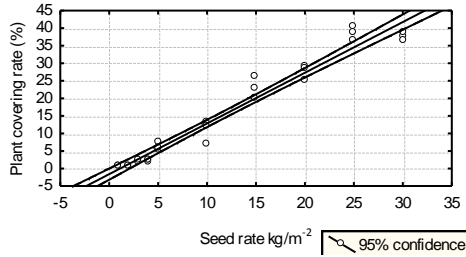

Figure 1a. The conventional method, T1

Plant covering rate (%) = $,23617 + 1,6082 * \text{Seed rate kg/m}^2$
 Correlation: $r = ,94813$

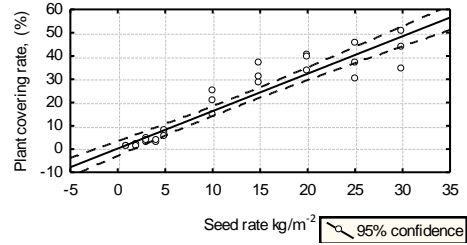

Figure 2. The agril nonwoven method, T2

Plant covering rate (%) = $3,0995 + 3,8177 * \text{Seed rate, kg/da}$
 Correlation: $r = ,89886$

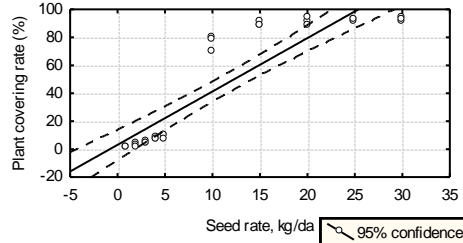

Figure 2a. The conventional method, T2

Plant covering rate (%) = $-7,466 + 2,8666 * \text{Seed rate kg/m}^2$
 Correlation: $r = ,97316$

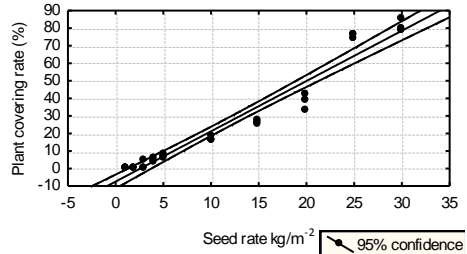

Figure 3. The agril nonwoven method, T3

Plant covering rate (%) = $7,0220 + 3,8204 * \text{Seed rate, kg/da}$
 Correlation: $r = ,87991$

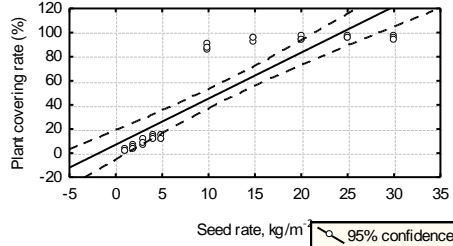

Figure 3a. The conventional method, T3

Plant covering rate (%) = $-3,705 + 3,5091 * \text{Seed rate kg/m}^2$
 Correlation: $r = ,98632$

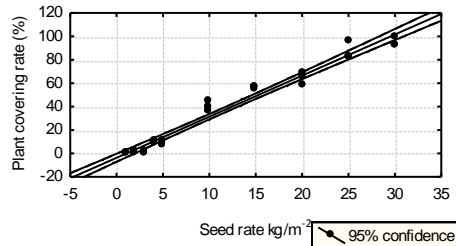

Figure 4. The agril nonwoven method, T4

Plant covering rate (%) = $24,380 + 3,3287 * \text{Seed rate, kg/da}$
 Correlation: $r = ,84937$

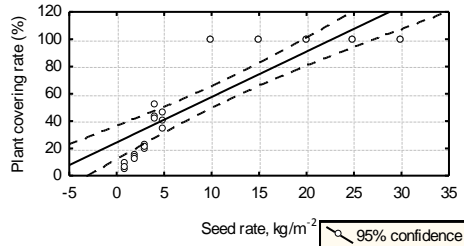
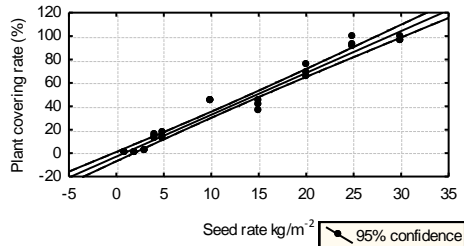
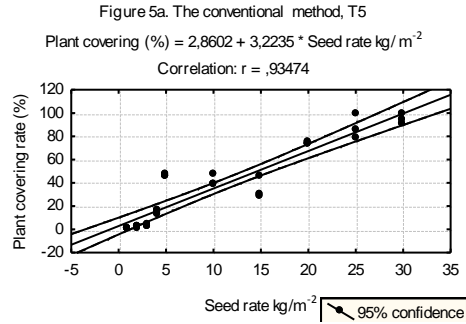
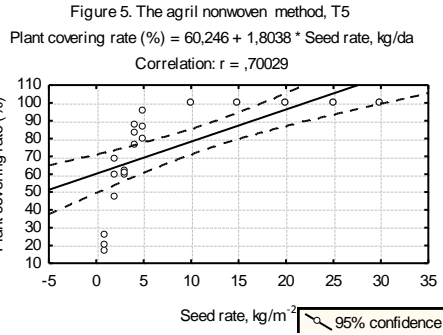

Figure 4a. The conventional method, T4

Plant covering rate (%) = $-2,925 + 3,5740 * \text{Seed rate kg/m}^2$
 Correlation: $r = ,98244$





Consequently, the agricultural nonwoven fabric method to be used in parks, gardens and landscapes will provide a very significant savings, both reducing the use of seed and for weed control and will be particularly prominent in terms of health maintenance.

Conclusion

As results of this trial, the agricultural nonwoven fabric method compared to the conventional sowing method had most crucial advantages as following:

1. The coverage rate of dichondra was the highest in all times by using $150 \text{ kg seed ha}^{-1}$ in the agricultural nonwoven fabric method.
2. In the conventional sowing method, the rate of covering of plant was the lowest than the other method.
3. The increasing of covering rate was found in the conventional sowing methods in the norm of $300 \text{ kg of seed ha}^{-1}$.
4. Weeds was not found in the plots which were applied at least amount of seed rates in the agricultural nonwoven fabric method although of the weeds were in the soil.
5. It is recommended that the norm of $150 \text{ kg seed ha}^{-1}$ in the agricultural nonwoven fabric method and the norm of $300 \text{ kg of seed ha}^{-1}$ in the conventional sowing methods.
6. The nonwoven fabric material prevented the growth and the germination of weeds by covering the ground with a carpet of the soil.

References

- Anonymous (2014). Iğdır Regional Directorate of Meteorology Data.
- Bülent, D. and Şirin, U. 2005. Potential Use of Some Native Herbaceous Plants Found of Samson Mountain as Ornamental. *ADÜ Ziraat Fakültesi Dergisi*, 2(2):5-12.
- Eyduran, E., Tatlıyer., A., Waheed., A., Tariq, M.M., 2013. Dermination of the Most Appropriate Covariance Structure for Data with Missing Observations in Repeated Measures Design. *KSU J. Nat. Sci.*, 16(3), 32-37.
- Eyduran, E., Ser, G., Cinli, H., Tirink, C., Yakar, Y., Duru, M., Javed, Y., Tariq, M.M., 2016. Analysis of Random Intercept and Slope Model (RISM) for Data of Repeated Measures from Hy-Line White Laying Hens. *Pakistan J. Zool.*, vol. 48(4), pp. 0-0, (QPJZ-386-15).
- Harrington, K.C., Hartley, M.J., Rahman, A. and James, T.K. 2005. Long Term Ground Cover Options For Apple Orchards. *New Zealand Plant Protection* 58:164-168.
- http://www.univagro-iasi.ro/vvintu/images/5/5c/Dichondra_repens.pdf).
- http://www.zanthorrea.com/info/Dichondra_Lawn.pdf.

- Margot, B. Forde. 1978. The cultivated dichondra. *New Zealand Journal of Botany*. 1978. Vol. 16: 283-385.
- Zhu Xiao-Zhou Shou-Zheng He-quan, Yang Ji-hui, Liu Shou., 2009. Effects of shading on biomass allocation and morphological characteristics of *Dichondra repens*. *Chinese Journal of Ecolog*, 2009-07. (http://en.cnki.com.cn/Article_en/CJFDTOTAL-TXZ200907035.htm).

RUDERAL ASSOCIATION *SAMBUCETUM EBULI* FELFÖDY 1942. OF THE MUNICIPALITY OF PALE (BOSNIA AND HERZEGOVINA)

Sladjana PETRONIĆ, Nataša BRATIĆ

Faculty of Agriculture, University of East Sarajevo, East Sarajevo, Bosnia and Herzegovina

*Corresponding author:sladjanapetronic2504@gmail.com

Abstract

The aim of this paper is to present the floristic composition, syntaxonomic affiliation, ecological and phytogeographical characteristics of the association. The studies were performed using the method of transect (Braun-Blanquet, 1965). Identification of species was based on floristic literature (Beck, 1903 и 1927; Josifovic ed. 1970-1977; Javorka et Csapody, 1979). Floral elements and life forms of plants have been given by Oberdorfer (2001). The floristic composition of this plant association is built out of 91 species. The dominant species *Sambucus ebulus* L. shows the highest level of presence (V) and ground cover (2150). The analysis of the areal spectrum shows the dominance of the Euroasian species (38%). The association has hemicyptophytic character, 43 species (47%).

Key words: *ruderal association, areal spectrum, biological spectrum, Pale*

Introduction

The municipality of Pale (entity of Republic of Srpska, Bosnia and Herzegovina) is situated in a valley between mountain ranges, Jahorina from the south, Gosina from the east, Romanija from the northeast, Ozren from the north and northwest and Trebevic from the west. The municipality of Pale is located at an altitude of about 820m. The main flow of water makes river Miljacka. Climatogenic vegetation of Pale make beech and fir forests *Abieti-Fagetum illyricum* Fuk. Et Stef. 1958, *Fagetum montanum illyricum* s.l., fir-spruce forests *Abieto-Piceetum* s.l., and smaller areas belonging to the vegetation of oak forests *Quercetum petraea montanum* s.l. Meadow vegetation of the area belongs to the class *Arrhenatheretea* Br.-Bl. 1974 and order *Arrhenatheretalia* Pawl. 1928.

Materials and methods

Floristic research field and taking phytocoenological recordings were conducted during 2011 and 2012, a period of optimal association development. The studies were performed using the method of transect (Braun-Blanquet, 1965). Identification of species was based on floristic literature (Beck, 1903 и 1927; Josifovic ed. 1970-1977; Javorka et Csapody, 1979). Floral elements and life forms of plants are given by Oberdorfer (2001).

Results and Discussion

Association *Sambucetum ebuli* Felfödy 1942, develops in villages and the suburbs of town, along the roads, gardens and fields, beside rivers, railways, waste dumps, the edges of the surrounding forests. Habitats are nitrified, and trampling and mowing is reduced to a minimum. Data on the floristic composition and other structural characteristics coenological, of that community, are based on the 10 phytocoenological records which are integrated into the phytocoenological table 1.

Syntaxonomic position of the association *Sambucetum ebuli*:

Class: Artemisietea vulgaris Lohm., Prsg. et Tx. 1950.

Order: Artemisietalia vulgaris Lohm., Prsg. et Tx. 1950.

Alliance: Arction lappae Tx. (1937) Oberd. 1950.

Ass.: *Sambucetum ebuli* Felfödy 1942.

Table 1. The floristic composition and structural characteristics of association

Level of presence	Ground cover	Association	<i>Sambucetum ebulii</i> FELFÖDY 1942									
		Number of localities	1	2	3	4	5	6	7	8	9	10
		Surface of the recordings (m ²)	30	100	50	50	30	40	50	100	50	100
		General coverage (%)	95	100	100	100	100	100	100	100	100	100
		The increase of association (cm)	120	130	130	130	70	120	130	120	80	40
		Exposure	/	/	/	W	N	NE	/	N	/	N
		Slope (°)	/	/	/	70	/	/	/	30	20	20
		Number of species in phytocoenological record	21	24	16	5	16	24	21	17	16	30
V	550	<i>Sambucus ebulus</i> L.	4.4	3.3.	5.5.	5.4.	3.2.	4.4.	4.4.	3.3.	3.3.	3.3.
V	206	<i>Convolvulus arvensis</i> L.	+1	+1	+1	+1	1.2	1.1	1.1	+1	1.1	+1
V	59	<i>Artemisia vulgaris</i> L.	+1	+1	+1	+1	+1	+1	1.1	+1	+1	+1
IV	301	<i>Urtica dioica</i> L.	1.2	1.1	+1	.	1.2	1.1	.	.	1.1	1.1
III	276	<i>Tusilago farfara</i> L.	.	2.2	.	+1	.	.	1.2	1.2	.	.
III	202	<i>Cirsium arvense</i> (L.) Scop.	+1	.	.	.	1.3	1.3	1.2	.	1.1	+1
III	153	<i>Agropyron repens</i> (L.) Beauv.	.	1.2	+1	.	+1	1.3	1.2	.	+1	.
III	201	<i>Fragaria vesca</i> L.	+1	1.1	1.1	1.1		1.1
III	201	<i>Capsella bursa – pastoris</i> (L.) Med.	+1	.	.	.	1.2	1.2	.		1.1	1.1
III	201	<i>Dactylis glomerata</i> L.	+2	.	.	.	1.3	1.3	.	1.2	1.2	.
III	200	<i>Achillea millefolium</i> L.	1.1	.	.	.	1.2	1.2	.	.	1.1	.
III	200	<i>Galium aparine</i> L.	1.3	1.1	1.1	.	1.1	.
III	103	<i>Pteridium aquilinum</i> (L.) Kuhn	.	+1	+1	.	+1	.	.	.	1.1	1.1
III	102	<i>Polygonum aviculare</i> L.	+1	.	+1	.	1.1	1.2
III	53	<i>Plantago major</i> L.	+1		+1		+1			1.1		
III	53	<i>Ajuga reptans</i> L.		+1	+1				+1			1.1
III	53	<i>Rubus caesius</i> L.		1.2					+1	+1		+1
III	4	<i>Geum urbanum</i> L.	+1	+1	+1					+1		
II	350	<i>Salvia glutinosa</i> L.		2.2		2.2						
II	176	<i>Pastinaca sativa</i> L.						2.2				+1

II	150	<i>Lamium maculatum</i> L.	1.1		1.1				1.2			
II	150	<i>Galium molugo</i> L.	1.1			1.1		1.2				
II	150	<i>Lamiastrum galeobdolon</i> (L.) E. & K.		1.2	1.1							1.1
II	150	<i>Ranunculus acer</i> L.					1.2			1.2	1.1	
II	150	<i>Taraxacum officinale</i> Web.					1.1				1.1	1.1
II	101	<i>Potentilla reptans</i> L.	1.1						1.1			+1
II	100	<i>Ranunculus repens</i> L.	1.1									1.1
II	100	<i>Chenopodium album</i> L.					1.2				1.1	
II	52	<i>Euphorbia amygdaloides</i> L.		+1	+1							1.1
II	51	<i>Agrostis stolonifera</i> L.	+2							1.2		
II	51	<i>Asarum europaeum</i> L.		+1					1.1			
II	51	<i>Cerastium arvense</i> L.					1.2			+1		
II	51	<i>Centaurea jacea</i> L.						1.2			+2	
II	2	<i>Genista tinctoria</i> L.		+1	+1							
II	2	<i>Equisetum arvense</i> L.		+1	+1							
II	2	<i>Lathyrus pratensis</i> L.		+1	+1							
II	2	<i>Clinopodium vulgare</i> L.		+1	+1							
II	2	<i>Cirsium lanceolatum</i> (L.) Scop.		+1		+1						
II	2	<i>Geranium robertianum</i> L.		+1								+1
II	2	<i>Sambucus nigra</i> L.			r					r		

Species with the degree of presence I are: *Arrhenatherum elatius* (L.) M.K., *Chenopodium bonus-henricus* L., *Origanum vulgare* L., *Atriplex patula* L., *Sonchus asper* (L.) Hill, *Arctium lappa* L., *Calystegia sepium* (L.) R. Br., *Cirsium candelabrum* Gris, *Cichorium intybus* L., *Mentha longifolia* (L.) Huds., *Torrilis aevensis* (Huds.) Lk., *Sonchus oleraceus* (L.) Gou., *Rumex obtusifolius* L., *Senecio erraticus* Bertol, *Viola tricolor* L., *Geum rivale* L., *Linaria vulgaris* Mill., *Sanquisorba minor* Scop., *Bellis perennis* L., *Rubus hirtus* W. et Kit., *Petasites albus* (L.) Gaert., *Lathyrus venetus* (Mill.) Wohlf., *Plantago lanceolata* L., *Ononis spinosa* L., *Cherophyllum aureum* L., *Trifolium pratense* L., *Solidago virga-aurea* L., *Valeriana montana* L., *Daucus carota* L., *Festuca pratensis* Huds., *Melanpyrum arvense* L., *Agrimonia eupatoria* L., *Medicago lupulina* L., *Anthriscus sylvestris* (L.) Hoffm., *Veronica chamaedrys* L., *Scrophularia nodosa* L., *Cruciata laevipes* Opiz., *Lisimachia nummularia* L., *Leucanthemum vulgare* Lam., *Rumex acetosa* L., *Barbarea vulgaris* R. Br., *Ligustrum vulgare* L., *Rosa canina* L., *Ranunculus ficaria* L., *Stellaria holostea* L., *Glechoma hederacea* L., *Chelidonium majus* L. и *Poa bulbosa* subsp. *vivipara* L.

The floristic composition of the association consists of 91 plant species and 50 is represented in only one shot. A dominant species *Sambucus ebulus* gives a distinctive look to the association, building a completely closed circuits, almost pure facies. The characteristic combination of species are: *Sambucus ebulus*, *Convolvulus arvensis*, *Artemisia vulgaris*. Those species are found in all phytocoenological records.

The areal spectrum of the association *Sambucetum ebuli* (Graph 1) consists of 10 areal groups. By analyzing the areal spectrum established dominance of species broader geographical distribution, eurasian 35 species (or 38%), boreal 16 species (or 18%) and 15 cosmopolite species (or 17%). Species of subatlantic, submediterranean, subalpine, moderately-continental, balkan

and mediterranean area groups are less represented. Dominant species *Sambucus ebulus* belongs to a submediterranean floral element, whit the center of the areal in the area of submediterranean deciduous forests which extends to the deciduous-coniferous forests of western Europe. Areal of association *Sambucetum ebuli* generally encompasses the area of Central Europe and the Balkan peninsula. The association was first described in Hungary (Felfödy, 1942: 87-138).

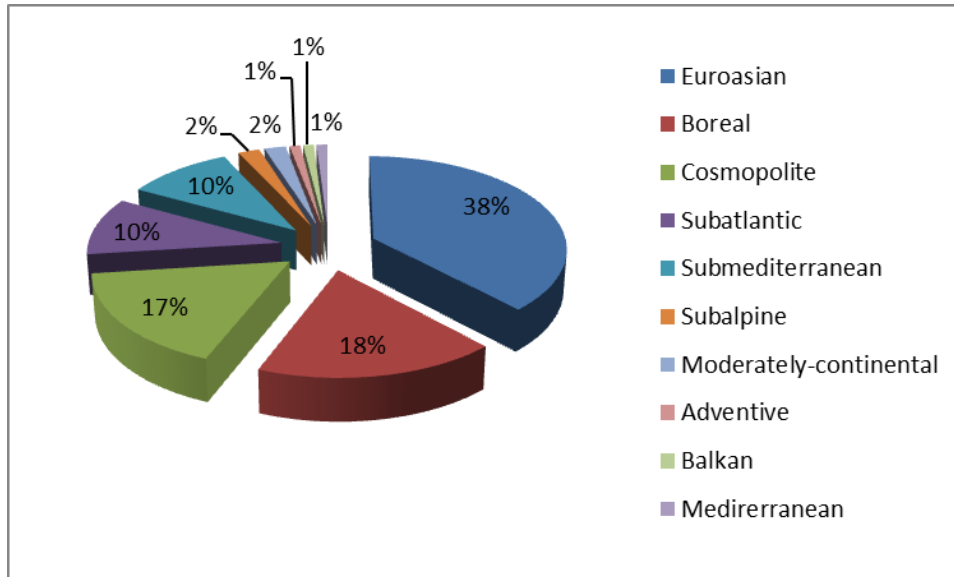

Graph 1. Areal spectrum of association

Chart 2 presents the results of the analysis of life forms of plants that build association *Sambucetum ebuli*. There are a dominance of hemicryptophyte with 43 species (or 47%) of which *Artemisia vulgaris* and *Urtica dioica* have a higher cover value. Species *Sambucus ebulus* belongs geophytes, thanks to the most important quantitative and qualitative participation largely determines the ecological character of the association. Therophytes are present with 20 species (or 22%), geophytes with 17 species (or 19%), while chamaephytes and phanerophytes mostly represent the elements of the surrounding vegetation and the recent degradation of forest ecosystems.

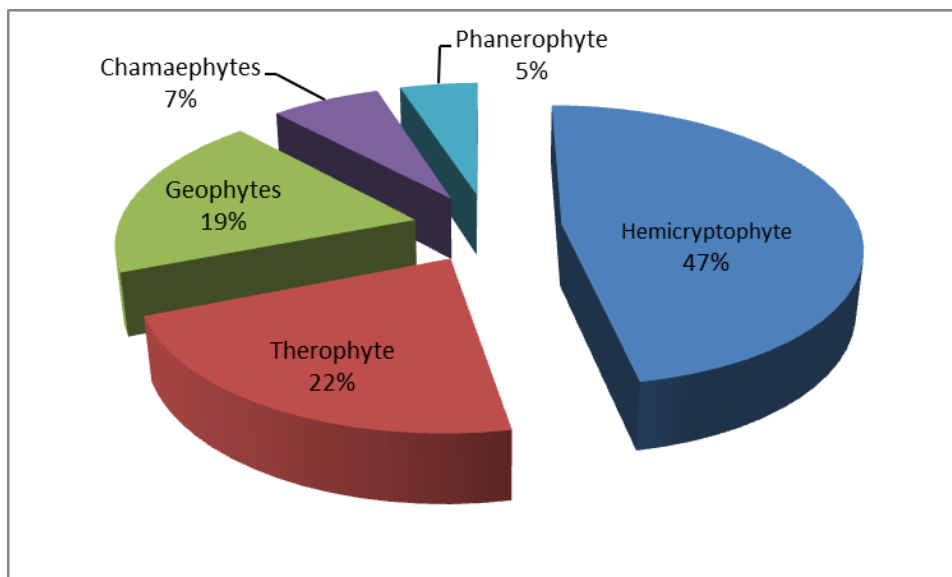

Graph 2. Biological spectrum of association

Lakušić this association stated in Prodrum plant communities of Bosnia and Herzegovina (1978: 54), and in a manuscript describes the association in several locations in Bosnia and Herzegovina.

A large number of researchers has described the association *Sambucetum ebuli*, for Hungary Felföldy (1942: 87-138), Croatia (Marković, 1964: 257-272), Macedonia (Matvejeva, 1982: 1-70), Czechoslovakia (Hejny et al., 1979 : 1-100), Serbia (Jovanović 1994: 129-134), Bosnia and Herzegovina (Topalić-Trivunović, 2006: 100-110) and others. In Macedonia, the association differentiated into three subassociations (typicum, parietariosum and urticetum piluliferae (Matvejeva 1982: 1-70), and for Czechoslovakia (Hejny et al., 1979: 1-100) states subassociations: typicum, brometosum tectorum and brometosum inermis. Association *Sambucetum ebuli* of the municipality of Pale, exhibits considerable floristic similarity (43.08%) (Petronić, 2006) with the same name association of Banja Luka (Topalić-Trivunović, 2006: 100-110), less similarity with the association of Belgrade (28.88%) (Jovanović 1994: 129 -134). The analysis of the biological spectrum ass. *Sambucetum ebuli* of Pale and Banja Luka (Topalić-Trivunović, 2006: 100-110) show to the dominance of perennial herbaceous plants hemicryptophytes.

Conclusions

Association *Sambucetum ebuli* Felföldy 1942, develops in villages and the suburbs of town, along the roads, gardens and fields, beside rivers, railways, waste dumps, the edges of the surrounding forests. Habitats are nitrified, and trampling and mowing is reduced to a minimum. The floristic composition of the association consists of 91 plant species and 50 is represented in only one shot. A dominant species *Sambucus ebulus* gives a distinctive look to the association, building a completely closed circuits, almost pure facies. The association has hemicryptophytic character, 43 species (47%).

Areal spectrum of the association *Sambucetum ebuli* consists of 10 areal groups. By analyzing the areal spectrum established dominance of species broader geographical distribution, Eurasian 35 species (or 38%), Boreal 16 species (or 18%) and 15 cosmopolite species (or 17%).

References

- Beck, G. (1903): Flora Bosne, Hercegovine i Novopazarskog Sandžaka. /Flora of Bosnia, Herzegovina and the Sanjak of Novi Pazar /first part, I dio, Zemaljska štamparija, Sarajevo.
- Beck, G. (1927): Flora Bosnae, Hercegovinae i Novopazarskog Sandžaka /Flora of Bosnia, Herzegovina and the Sanjak of Novi Pazar /second part, II dio, Državna štamparija u Sarajevu, Beograd-Sarajevo.
- Braun-Blanquet, J. (1965): Plant sociology - The study of plant communities. Hefner Publisching Company, New York.
- Hejny, S. Kopecký, K., Jeheík, V., Krippelova, T. (1979): Přehled ruderalních rostlinných společenstven Československa. Rozpravy . Čehoslovenské. Akademie věd., Řada mat. a přír. věd -89/2): 1-100 Praha.
- Jovanović, S. (1994): Ekološka studija ruderalne flore i vegetacije Beograda. / Ecological studies of ruderal flora and vegetation of Belgrade / Biološki fakultet Univerziteta u beogradu, Beograd.
- Kojić, M., Popović, R., Karadžić, B. (1997): Vaskularne biljke Srbije kao indikatori staništa. / Vascular plants of Serbia as indicators of habitat/ Institut za istraživanja u poljoprivredi „Srbija“ Institut za biološko istraživanje „Siniša Stanković“, Beograd.
- Lakušić, R., Pavlović, D., Abadžić, S., Grgić, P., (1978): Prodromus biljnih zajednica Bosne i Hercegovine. /Prodromus of plant communities of Bosnia and Herzegovina/.Godišnjak Biološkog instituta Univerziteta u Sarajevu, Posebno izdanje, **30**: 1-87, Sarajevo.
- Marković, Lj. (1984): Ruderalna vegetacija Gorskog Kotora. /Ruderal vegetation of Gorski Kotar/ Acta Botanica Croatica, 43, 257-272.
- Матвејева, J. (1982): Рудералната вегетација на СР Македонија. /Ruderal vegetation of SR Macedonia/ Македонска академија на науките и уметности. Одделение за биолошки и медицински науки. 1-70. Скопје.
- Oberdorfer, E. (2001): Pflanzensoziologische Exursionsflora für Deutschland und angrenzende Gebiete. Eugen Ulmer Verlag, Stuttgart.
- Petronić, S. (2006): Ruderalna flora i vegetacija područja Pala. /Ruderal flora and vegetation of Pale/ Doktorska disertacija, PMF Univerziteta u Banja Luci.
- Topalić-Trivunović, Lj. (2006): Ruderalna flora i vegetacija područja Banja Luke. /Ruderal flora and vegetaton of Banja Luka/ Doktorska disertacija, PMF Univerziteta u Banja Luci.

AN IMPROVED SIMULATION METHOD OF CRUDE OIL FRACTIONAL SEPARATION TO ACHIEVE A HIGHER QUALITY IN NATURAL SOURCE MANAGEMENT

Xhaklina CANI^{1*}, Ilirjan MALOLLARI¹, Ismet BEQIRAJ¹, Lorina LIÇI²

¹Chemical Process Engineering Group, Faculty of Natural Sciences,
University of Tirana, Albania

²Politechnic University, Tirana, Albania

*Corresponding author: xhaklina.cani@yahoo.com

Abstract

Crude oil refinery units are basic components in process plants of petroleum refinery. Changes in these units have a great impact on product yield and quality, so it is recommended to operate these units at optimal conditions, especially the distillation unit. The process of crude oil distillation impacts the refinery economy greatly. Design of crude oil distillation systems, which consists of distillation columns and heat recovery systems, are of great importance in the overall processes. The main objective of this paper is the evaluation of simulation results, in order to improve and archive optimized process units of crude oil distillation which will lead to a higher quality in natural source management. This way, we can reach better fractioning stages, reduced power and an overall integrated process. We have made the characterization of some natural oilfield in Albania through distillation and evaluation of their physical characteristics. During the sampling process we also observed their environmental impact and determined the constituent components of crude oil. The aim of the study includes drawing true boiling curves based on our experimental measurements of crude oil sources in Albania and also interpretation of differences between simulation results and experimental results, in order to get an optimal characterization of crude oil.

Keywords: *Crude Oil, Simulation, Distillation unit, Albania.*

Introduction

Crude oil distillation units are an important part in petroleum refinery as this operation is carried out in large equipments that normally consume considerable amount of energy. Changes in this units have a great impact on product yield and its quality and, therefore, it is recommended to operate these units at optimal conditions from technical and economical points of view; that means operating conditions such as temperatures, pressures and flows of the unit that maximize their economic performance, subject to their real physical restrictions and their design capabilities (Yela *et al.*, 2009). Crude distillation is the process that has been used for very long time and it constitutes the most important part of any refinery. The distillation of crude oil provides refined products such as gasoline, diesel, etc. With the advent of large, highly integrated refineries, it is critical to understand the operation of major units and predict desirable and undesirable changes in unit performance as function of key operating conditions (Chang *et al.*, 2012). Crude distillation has a long history and refiners have developed hundreds of empirical correlations for feed conditions and process variables. It is very difficult to develop general correlations applying a variety of operating scenarios that modern refineries face (Lopez *et al.*, 2009). Crude oils are the most important feedstocks for refining processes. To properly simulate the refining

processes we must have good understanding of the compositional information and thermophysical properties of crude oils and petroleum fractions (Chang *et al.*, 2012). A typical crude assay includes two types of information for an oil sample: (1) bulk properties; and (2) fractional properties. Bulk properties include specific gravity, sulfur content, nitrogen content, asphaltene content, flash point, viscosity, carbon residue, boiling point curve, etc. Bulk properties provide a quick understanding of the type of the oil sample such as sweet and sour, light and heavy, etc. However, refineries require fractional properties of the oil sample that reflects the property and composition for specific boiling-point range to properly refine it into different end products such as gasoline, diesel, and raw materials for chemical process. Fractional properties usually contains paraffines, naphthenes and aromatics content, nitrogen, sulfur content for each boiling – point range, octane number for gasoline, cetane index, etc. The aim of the study is the drawing of true boiling curves for samples taken during the study from crude oil natural sources in Albania and to compare the differences between the simulation results and experimental data for an optimal characterization of crude oil, also to determine the constituent components for Marinza and Cakran-Drenova oilfield. To run the simulation we used Design II software (Design II, 2016).

Materials and methods

Evaluation of crude oil parameters like API gravity, viscosity, determination of heavier components like saturates, asphaltenes, resins and aromatics are important in order to effectively estimate the reservoir performance, the volume in the reservoir and its recoverability. Characterization of crude oil is made from; 10 individual wells in Marinza, decantation plant in Marinza and decantation plant in Cakran-Drenova. In this study crude oil assay contains the following:

1. TBP (True Boiling Point) indicating start and the end temperature in °C or in °K
2. Yield of cut (wt% and vol% of Crude).
3. Determination of Aromatics wt%, Olefins wt%, Saturates wt%.

Aromatics, Olefins and Saturates are determined by ASTM D 1319 and expressed in wt%.

The true boiling point (TBP) distillation of crude oil results from using the ASTM D- 86 test procedure.

The key results from a distillation test are achieved from the boiling point curve, that is, the boiling point of the oil fraction versus the fraction of oil vaporized. The initial boiling point (IBP) is defined as the temperature at which the first drop of liquid leaves the condenser tube of the distillation apparatus. The final boiling point or the end point (EP) is the highest temperature recorded in the test (Chang, 2012). The ASTM D 2892 method details procedures for the production of a liquefied gas, distillate fractions, and residuum of standardized quality on which analytical data can be obtained, and the determination of yields of the above fractions by both mass and volume. From the experimental data information, a graph of temperature versus mass % distilled can be produced. The experimental procedure is presented in figure 1. During the process is followed the volume % and is noted the temperature. To record the temperatures we connect the measuring instrument to a computer and so digitally are record the temperatures. As soon as sufficient

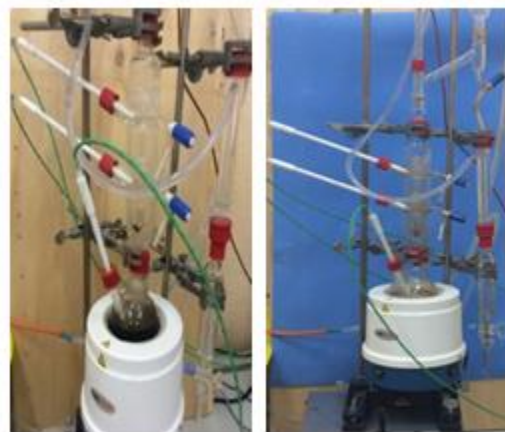

Figure 1. Fractional distillation laboratory scheme

distillate has condensed in the receiver flask- both trays should be saturated (Phywe, 2016). The purpose of this separation technique is to better track the distribution of crude oil compounds and to carry out the distillation of at least two petroleum fraction by taking into account the procedure of ASTM D 2892. As results, we can calculate the mass concentration and the cumulated weight of each crude oil fraction.

Results and Discussion

Crude oil wells sample (Table 1) is composed mainly by heavy compounds (66.5 wt%). They have a low amount of water and sediment. IBP-266 fraction is composed by 76 wt% of saturates. 266- 343 °C is composed mainly by 57 wt% aromatics.

Table 1. Summary of major cuts for crude oil wells sample, in Marinza area.

Summary of major cuts for crude oil wells sample								
		Total sample	IBP-266°C	266-343°C	343-399°C	399-454°C	454-527°C	527 ⁺ °C
TBP Temp at Start, °C			20	266	343	399	454	527
TBP Temp at End, °C			266	343	399	454	527	
Yield of cut(wt% of crude)	ASTMD 2892		10.9	16.8	5.8	66.5		
Yield of cut(vol% of crude)	ASTM D 2892		13.4	18.5	6.1	62.1		
Sediment, volume fraction	ASTM D 4007	0.005						
Water, volume fraction	ASTM D 4007	0.015						
Total, S&W, volume fraction	ASTM D 4007	0.02						
Aromatics, wt	ASTM D 1319	25.4	19.3	57.1				
Olefins,wt	ASTM D 1319	2.9	4.6	10.9				
Saturates,wt	ASTM D 1319	71.7	76.0	32.0				

Table 2. Fractional (wt %) for decantation crude oil sample, in Marinza area.

Fraction	C5-70	70-165°C	165-190°C	190-230°C	230-325°C	325-370°C	370 ⁺	550 ⁺
wt%	0.09	3.48	1.16	3.22	7.45	6.94	77.51	49.93
vol%	0.14	4.77	1.5	4.03	8.42	7.45	73.4	45.65

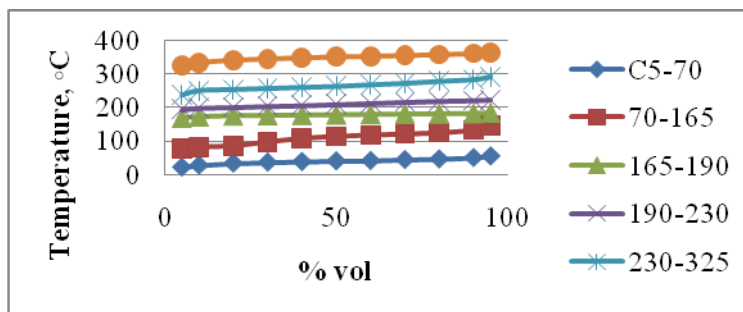

Figure 2. True Boiling Point for different fraction (°C) of crude oil in Marinza area.

Sample under study consists primarily of heavy compounds, with a high content (77.51 wt%) of fractions with boiling temperature 370⁺ (Table 2). Decantation crude oil have a maximum content

of 33.38 % paraffins, 45.93 % iso-paraffins, 25.4% naphtenes and 22.3 % aromatics (Table 3). Light fractions have a high content of the iso-paraffins and low aromatic contents.

Table 3. The characteristics of crude oil fractions.

Fraction (°C)	C5-70°C	70-165°C	165-190°C	190-230°C	230-325°C	325-370°C	370+ °C	550+ °C
wt%	0.09	3.48	1.16	3.22	7.45	6.94	77.51	49.93
vol%	0.14	4.77	1.5	4.03	8.42	7.45	73.4	45.65
Dens.15°C (kg/m ³)	677.3	760.9	806.6	832.9	884.4	931.3	1055.5	1093.2
Total sulphur(%)	0.21	0.49	1.04	1.48	2.49	3.41	6.71	7.77
Paraffins	33.38	16.31	8.62					
Iso-paraffins	45.93	35.94	43.68					
Naphtenes	19.73	31.1	25.4					
Aromatics	0.96	16.65	22.3					
flash point(°C)	<20	<20	50	66	108	164		
Naphtalenes(% vol)				1.21	8.24	19.45		
Asphaltenes (wt%)							17.56	27.35

Simulation allows the designer or plant engineer to reasonably optimize the operation or the design of the plant using experimental data for the pilot plant or the current plant (Mendez *et al.*, 2006). In this case it is shown a simple simulation based on Design II, in which are used specifications for real case of refinery crude oil unit in Albania, composed by two distillation columns (preflash and atmospheric unit). The experimental data from distillation are used as input in Design II program (software) to simulate the preflash column, to determine the constituent components and true boiling point of crude oil. The distillation schemes used in Design II is shown in figure 3. To make a complete simulation it is required more specifications per unit. In this case are used specifications for the top and bottom temperatures of the column, the flow inlet pressures and temperature, temperatures at the outlet of heat exchangers, the amount of the raw material and the quantity of steam.

Based on the specifications, we defined characteristics by design II (flow speeds, temperatures, pressures) for each stream, also characteristics of equipment and crude oil constituent components. In the study are used two samples from two oilfields; Cakran-Drenova and Marinza. Design II program is used to simulate a process which is composed of a preflash column, a condenser and two heat exchangers. We set specifications for temperature, pressure and distillation curve defined by

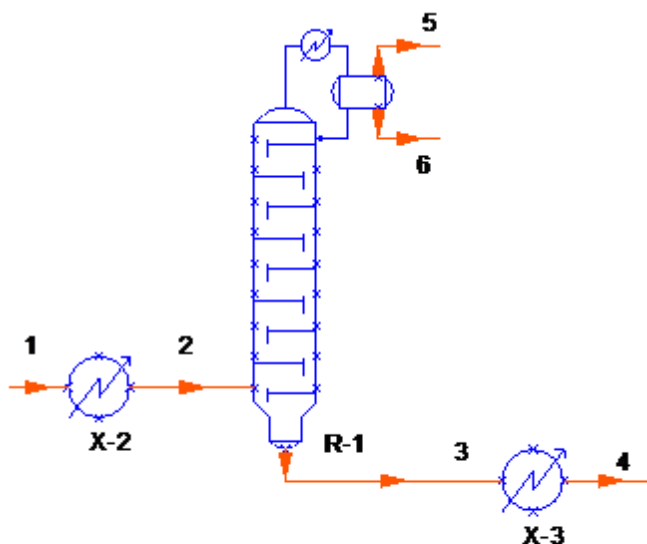

Figure 3. The simulation scheme in Design II, for preflash unit in crude oil distillation process

Engler distillation (ASTM D86) and the amount in the entry of raw material (crude oil) also the specifications for temperature and heat transfer coefficient for the heat exchanger. It used a column with seven trays. After the simulation is finished, the results appear in an excel spreadsheet, where are defined all the characteristics of currents and equipment used in the process. In this study, the part that interests us from the simulation are; crude oil constituent components used and the distillation curves, in order to make the comparisons between the distillation curve determined by laboratory data and distillation curve from Design II simulation. From the simulation is concluded that:

Cakran-Drenova oilfield: 5 and 6 stream mainly consisting of light compounds (from CH₄ to n-pentane). While 3 and 4 stream consist of compounds that have a high content in heavy compounds (compounds that are boiling at temperatures 325 °K and 616 °K).

Marinza oilfield: The particularity of the oil fields is the 0 kmol/s compounds content that boiling at 388 °K-421 °K temperature and a higher compounds content that boiling at 513 °K. Also these mainly consist of compounds with boiling temperature from 571 °K to 631 °K.

The laboratory distillation results are roughly the same as simulated by the distillation curve, for bottom product of preflash unit, (figure 4). To determine the distillation curves for crude oil by-product, the distillation process must be carried out together with the atmospheric distillation column.

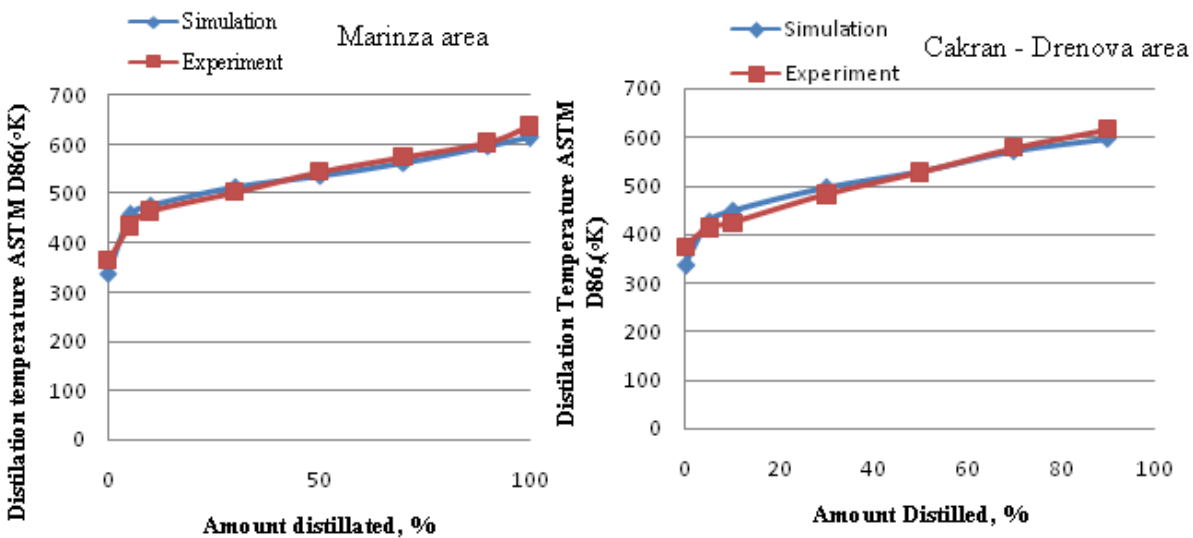

Figure 4. Simulation and experiment ASTM D86 of bottom product in preflash column

Conclusions

Crude oil Marinza oilfield is classified as heavy crude oil with a large percent of the heavy compounds. Crude oil wells sample is composed mainly by heavy compounds (66.5 wt%). They have a low amount of water and sediment. IBP-266 fraction is composed by 76 wt% of saturates. 539- 616 °K is composed mainly by 57 wt% aromatics. Decantation crude oil have a maximum content of 33.38 % paraffins, 45.93 % Iso-paraffins, 25.4% naphtenes and 22.3 % aromatics. Cakran-Drenova oilfield consist of heavy compounds (compounds that are boiling at temperatures 598 °K and 616 °K).

To make a complete simulation it is required to have a higher number of specification per unit. In this case study we used specific temperatures for the top and bottom of the column, the flow inlet

pressures and temperature, temperatures at the outlet of heat exchangers, the amount of raw material and the quantity of steam, also the laboratory true boiling point. Based on the specifications we defined characteristics by Design II (flow speeds, temperatures, pressures) in each stream, characteristics of equipment and also the components of crude oil used during experimental measurements. The simulation software is the optimal tool to evaluate crude oil refinery efficiency. With Design II we can determine the constituent component and the true boiling point for by-products of crude oil.

References

- Chang A.F., Pashikanti K., and Liu Y.A. (2012). Refinery Engineering: Integrated Process Modeling and Optimization, First Edition, Wiley-VCH Verlag & Co. KGaA, Germany.
- Chang A.F., Pashikanti K., and Liu Y.A. (2012). Refinery Engineering: Integrated Process Modeling and Optimization, First Edition, Wiley-VCH Verlag & Co. KGaA, Germany.
- Chang A.F., Pashikanti K., and Liu Y.A. (2012). Refinery Engineering: Integrated Process Modeling and Optimization, First Edition, Wiley-VCH Verlag & Co. KGaA, Germany.
<https://www.phywe.com/en/>. Accessed on 2016.
- <https://www.winsim.com/design.html>. Accessed on 28/04/2016. (Winsim's Design II for windows process simulation solution).
- Lopez D., Mahecha A., Hoyos L., Acevedo L., and Villamizar J. (2009). Optimization model of a system of crude oil distillation units with heat integration and metamodeling, CT&F-Ciencia, Tecnologia y Futuro-Vol.3 Num .5 Dic.2009, Colombia, pages (159 – 173)
- Mendez C., Grossmann E., Harjunkoski I., Kabore P. A simulation optimization approach for off-line blending and scheduling of oil – refinery operations. Computers and Chemical Engineering 30 (2006), Germany, pages (614 – 634).
- Yela S. (2009). Framenwork for operability assessment of ptoDUCTION facilities: An application to a primary unit of a crude oil refinery, B.Tech., Kakatiya University, Louisiana.

MORPHOLOGICAL DIVERSITY OF WILD MYRTLE (*MYRTUS COMMUNIS* L.) POPULATIONS IN ALBANIA

Dhimitër PEÇI^{1*}, Alfred MULLAJ¹, Xhensila METKO², Gledjan CAKA², Aida DERVISHI²

¹National Center of Flora and Fauna, Faculty of Natural Sciences, Tirana University, Albania

²Department of Biotechnology, Faculty of Natural Sciences, Tirana University, Albania

*Corresponding author: dhimiter.peci@fshn.edu.al

Abstract

Myrtus communis L. is a common shrub of the Mediterranean basin, well known for its medicinal properties, content of essential oils and ornamental value. In Albania, myrtle grows wild, mainly in the western part of the country, where it forms a vegetation belt. Morphological and genetic diversity of wild *Myrtus communis* L. populations in Albania have not been evaluated yet. This research explored and morphologically evaluated 16 wild myrtle populations collected from four localities in Albania in order to provide the first characterization and obtain important data for the management and conservation of myrtle genetic resources and also for future domestication and breeding programs. The data showed high variability among myrtle populations for some of the examined traits, such as plant height, branch height, leaf height and width. The Unweighted Pair Group Method with Arithmetic mean (UPGMA) clustering revealed morphological diversity, the mean similarity value among populations was low (0.18); the populations grouping was not clearly related to their geographical distribution. The Principal Coordinate Analysis (PCoA) performed on Nei's unbiased genetic distance matrix showed no grouping of populations based on their geographical origin, supporting the results obtained in UPGMA cluster analysis. The results obtained in this study highlighted a high level of variation of wild myrtle populations in Albania, which represents a valuable resource to be conserved.

Keywords: *Myrtis communis* L., morphological traits, diversity, Albania.

Introduction

Myrtle, (*Myrtus communis* L.), is a common shrub of *Myrtaceae* family widespread in the Mediterranean basin. This plant has been used since ancient time for its ornamental and aromatic value (Agrimonti *et al.*, 2007). Nowadays it is widely used for its medicinal properties as antibacterial and anti-inflammatory (Barboni *et al.*, 2010).

The knowledge on the level of diversity among populations is important to provide the basic data for elaboration of future conservation strategies. The exploration of genetic diversity of Mediterranean myrtle was carried out using morphological characters (Bruna *et al.*, 2005), molecular markers *Random Amplification of Polymorphic DNA* (RAPD) (Messaoud *et al.*, 2007), Inter Simple Sequence Repeats (ISSR) (Messaoud *et al.*, 2007; Melito *et al.*, 2013), *Amplified Fragment Length Polymorphism* (AFLP) (Bruna *et al.*, 2005; Messaoud *et al.*, 2011). The correlation among morphological, chemical and genetic characters in wild myrtle populations is also reported by Melito *et al.* (2016).

In Albania myrtle grows wild in different geographical areas and different types of soil and plant associations. It is found in calcareous soils associated with kermes oak (*Quercus coccifera*), ash (*Fraxinus ornus*), field maple (*Acer campestre*), narrow-leaved mock privet (*Phillyrea angustifolia*), holm oak (*Quercus ilex*), stone pine (*Pinus pinea*) and flax-leaved daphne (*Daphne*

gnidium). In silty soil *M. communis* L. grows associated with cluster pine (*Pinus maritime*), stone pine (*Pinus pinea*), European wild pear (*Pirus pyraister*), mastic (*Pistacia lentiscus*), autumn heather (*Erica manipuliflora*), holm oak (*Quercus ilex*), wild blackberry (*Rubus ulmifolius*), narrow-leaved mock privet (*Phillyrea angustifolia*), while in regions with *flyschy* sandstone soil, myrtle is associated with Mediterranean *maquis* element like heather (*Erica arborea*), ash (*Fraxinus angustifolia*), mastic (*Pistacia lentiscus*), bladder-senna (*Colutea arborescens*), wild blackberry (*Rubus ulmifolius*). In regions with sandy soil *M. communis* is associated with stone pine (*Pinus pinea*), Aleppo pine (*Pinus halepensis*), ash (*Fraxinus angustifolia*), autumn heather (*Erica manipulifolia*), mastic (*Pistacia lentiscus*), wild blackberry (*Rubus ulmifolius*), Mediterranean smilax (*Smilax aspera*), ivy (*Hedera helix*), field elm (*Ulmus minor*), evergreen rose (*Rosa sempervirens*), sweet-scented virgin's bower (*Clematis flammula*), silk vine (*Perploca graeca*).

To our knowledge there are no data on the level of genetic diversity of myrtle populations in Albania. In this paper, we investigate the morphological variation of 16 wild myrtle populations collected from four localities in Albania in order to provide the first characterization and obtain important data for the management and conservation of myrtle genetic resources and also for future domestication and breeding programs.

Materials and Methods

Sixteen wild populations of *M. communis* L. in four regions; Spille, Divjake, Pishporo, and Dukat (Table 1); were sampled to assess their morphological diversity. Plants were sampled at distances of 20 to 30 m to avoid multiple sampling of the same genotype. The myrtle populations grow at altitudes from 1.8 m (Pishporo 1) to 365.7m (Dukat) above the sea level. Their distribution regions are composed of different soil types as *flyschy* sandstone, sandy, silty and calcareous at Spille, Divjake, Pishporo, and Dukat, respectively. The location sites of sampling are presented in table 1.

Morphologic characteristics as plant length, leaf length and width, leaf length / leaf width ratio, petiole length, peduncle length, fruit length and width, fruit length / fruit width ratio, branch length and qualitative traits as the type of branches, leaf arrangement and fruit color were measured and examined in each of accessions collected.

A dendrogram based on the similarity matrix, generated using Dice similarity coefficient from obtained data, was constructed using the UPGMA cluster analysis and the Principal Coordinate Analysis (PCoA) was performed on Nei's unbiased genetic distance matrix in NTSYS-pc v. 2.1 software (Rohlf, 2000).

Table 1. The geographical sites of 16 wild *Myrtus communis* L. populations analyzed.

No	Population code	Latitude	Longitude	Altitude (m)
1	Spille 1	41° 06' 23"	19° 28' 16.1"	20
2	Spille 2	41° 06' 25"	19° 28' 16.5"	23
3	Spille 3	41° 06' 28.5"	19° 28' 16.7"	32
4	Spille 4	41° 06' 22.7"	19° 28' 20.1"	26.5
5	Spille 5	41° 06' 25.9"	19° 28' 21.6"	39.9
6	Spille 6	41° 06' 27.6"	19° 28' 20.8"	41.1
7	Spille 7	41° 06' 47.2"	19° 27' 9.64"	28.6
8	Spille 8	41° 06' 49"	19° 27' 9.9"	29.5
9	Spille 9	41° 06' 52.7"	19° 28' 2.3"	28.9
10	Divjake 1	40° 59' 37.5"	19° 29' 12.2"	5.1
11	Divjake 2	40° 58' 52.1"	19° 28' 8.58"	5.7
12	Divjake 3	40° 58' 40.4"	19° 29' 40.4"	10.3
13	Divjake 4	40° 59' 39.6"	19° 29' 54.1"	6
14	Pishporo 1	40° 39' 8.67"	19° 22' 4.78"	1.8
15	Pishporo 2	40° 39' 8.7"	19° 22' 4.6"	2.4
16	Dukat	40° 15' 13.3"	19° 33' 8.78"	365.7

Results and Discussion

The assessment of diversity among 16 wild myrtle populations from four important localities carried out by morphological characters showed a remarkable variation among populations for traits such as; plant height, branch height, leaf length and width. The mean plant height varied from 0.5 m at Spille 7 and Spille 8 to 4 m at Divjake 1 and Divjake 2, populations. The mean of values of leaf length ranged from 2.5 cm (Pishporo 1) to 4.2 cm (Spille 8), while the leaf width mean values ranged from 0.8 cm to 2.5 cm in Spille 3 and Divjake 2 populations, respectively (Table 2).

The studied populations were less variable for traits as petiole length and peduncle length, while there were no observed variations among populations regarding qualitative traits; all populations had the opposite leaf arrangement which is one of the common form of branch morphology found also in Italian myrtle (Bruna *et al.*, 2006). No variation was observed in fruit color, all populations had black berry, which is far more common than the white colored one in wild populations (Şerce *et al.*, 2008).

Table 2. Morphological characters as observed in 16 Albanian myrtle populations

Population	Plant Length (m)	Leaf Length (mm)	Leaf width (mm)	L/ W leaf ratio	Petiole length (mm)	Penducle length (mm)	Fruit length (mm)	Fruit width (mm)	L/W fruit ratio	Branch Length (cm)
Spille/1	1.6±0.79	35±1.5	15±1.5	2.3±0.3	0.2±0.1	15±3	7±1.5	5±2.2	1.4±0.7	48±3.5
Spille/2	1.7±0.61	38±1.5	16±2.2	2.4±0.2	0.3±0.15	2±3	8±1.5	6±1.5	1.3±0.7	30±5.8
Spille/3	2±0.79	27±2.5	8±1.5	3.3±0.3	0.4±0.21	14±7	9±1.5	7±1.5	1.3±0.7	36±3.3
Spille/4	1.5±0.7	30±2.2	15±1.5	2±0.07	0.2±0.1	16±4	7±1.5	6±1.5	1.1±0.7	59±3.1
Spille/5	1.8±0.7	34±2.1	13±2.9	2.6±0.6	0.4±0.15	16±4	8±1.5	6±1.5	1.3±0.7	26±2.1
Spille/6	1±0.36	33±1.5	16±1.5	2.06±1.3	0.2±0.1	1±3	6±2.2	4±2.2	1.5±0.2	34±2.2
Spille/7	0.5±0.59	32±1.5	14±1.5	2.2±0.16	0.3±0.1	9±4	7±1.5	6±1.5	1.1±0.7	33±2.2
Spille/8	0.5±0.36	42±1.2	20±1.2	2.1±0.08	0.4±0.1	25±6	8±1.5	7±1.5	1.1±0.7	24±2.5
Spille/9	1±0.32	34±1.8	16±1.8	2.1±0.12	0.2±0.1	5±1	7±1.5	7±1.5	1±0.7	40±3.5
Divjakë/1	4±0.61	50±1.5	22±1.5	2.2±0.12	0.3±0.07	2±3	9±1.5	7±1.5	1.3±0.7	32±1.5
Divjakë/2	3±0.27	50±1.5	25±1.5	2±0.08	0.4±0.15	4±5	8±1.5	7±1.5	1.1±0.7	60±4.2
Divjakë/3	1.5±0.18	26±1.5	10±1.5	2.6±0.28	0.2±0.1	43±3	9±1.5	8±1.5	1.1±0.7	58±2.1
Divjakë/4	4±0.4	42±2.5	20±2.7	2.1±1.18	0.3±0.1	35±3	8±1.5	6±1.5	1.3±0.7	30±5.8
Pishporo/1	2.7±0.3	25±1.6	13±2.4	1.9±0.28	0.3±0.07	17±4	6±2.2	5±2.2	1.2±0.7	35±1.5
Pishporo/2	3±0.38	34±3.6	14±2.7	2.4±0.37	0.2±0.1	3±6	7±1.5	6±1.5	1.1±0.7	30±5.8
Dukat	3±0.41	28±1.5	11±1.9	2.5±0.4	0.3±0.2	16±4	8±1.5	7±1.5	1.1±0.7	21±1.5

A similarity matrix was generated using Dice coefficient, the mean similarity value was 0.18, with a minimum of 0.14 and a maximum value of 0.28, indicated the high level of diversity among 16 myrtle populations.

The dendrogram, obtained by cluster analysis based on similarity matrix and the UPGMA algorithm (Figure 1), highlights the formation of three distinct clusters. The first clade comprised four populations from Spille and one from Divjaka and one from Pishporo. The second clade comprised seven populations belonging to the four locations. The third clade comprised three populations from Spille and one from Divjaka. It was not observed a clear grouping of populations according to their geographical origins or to the ecological factor (type of soil). This may be due to the high level of variability among these populations or related to geographical continuity of Mediterranean *maquis* vegetation along the coast allowing gene flow along populations of different areas as suggested by Bruna *et al.* (2005)

The PCoA performed on Nei's unbiased genetic distance matrix showed no grouping of populations based on their geographical origin (Figure 2), supporting the results obtained in UPGMA cluster analysis. The total variation was 60.3%, the first three PCO explain 23.3, 20.1 and 16.8 % of the total variation respectively.

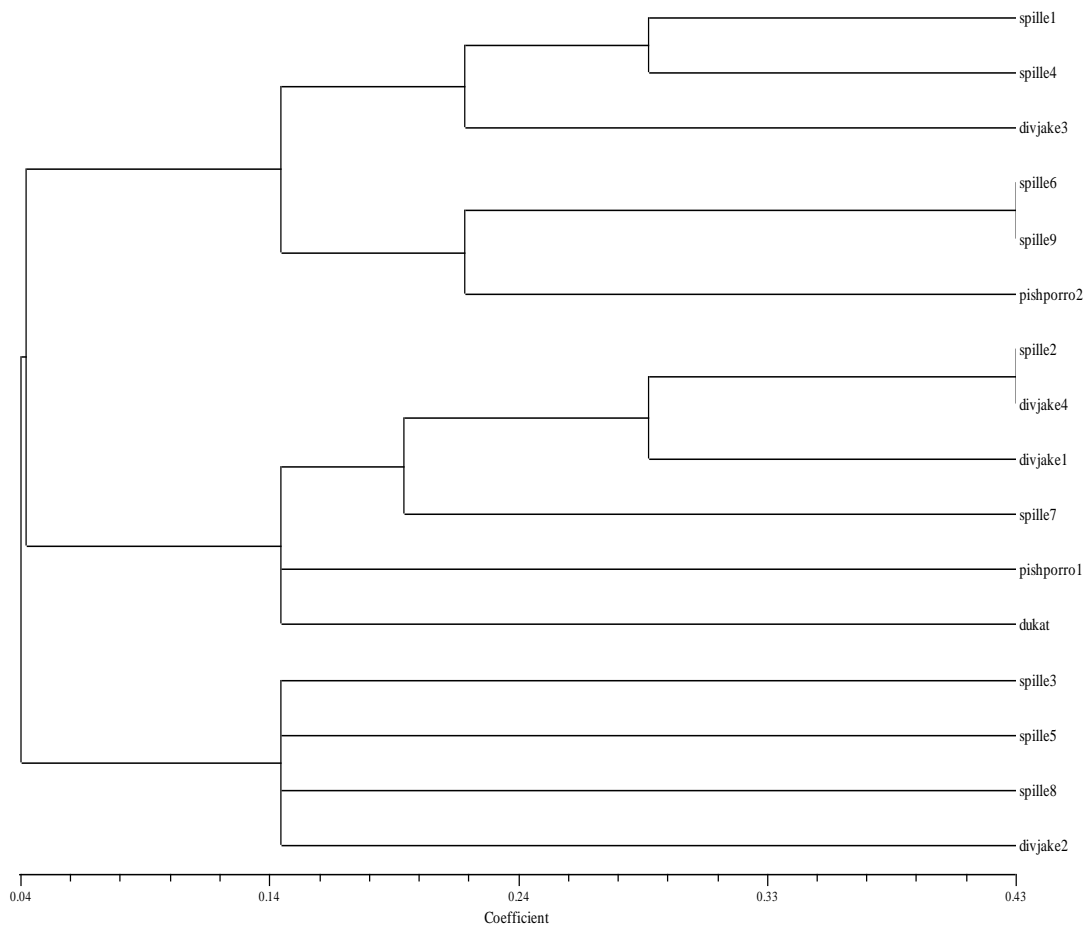

Figure 1. UPGMA dendrogram based on Dice coefficient of similarity for 16 wild *Myrtus communis* L. populations.

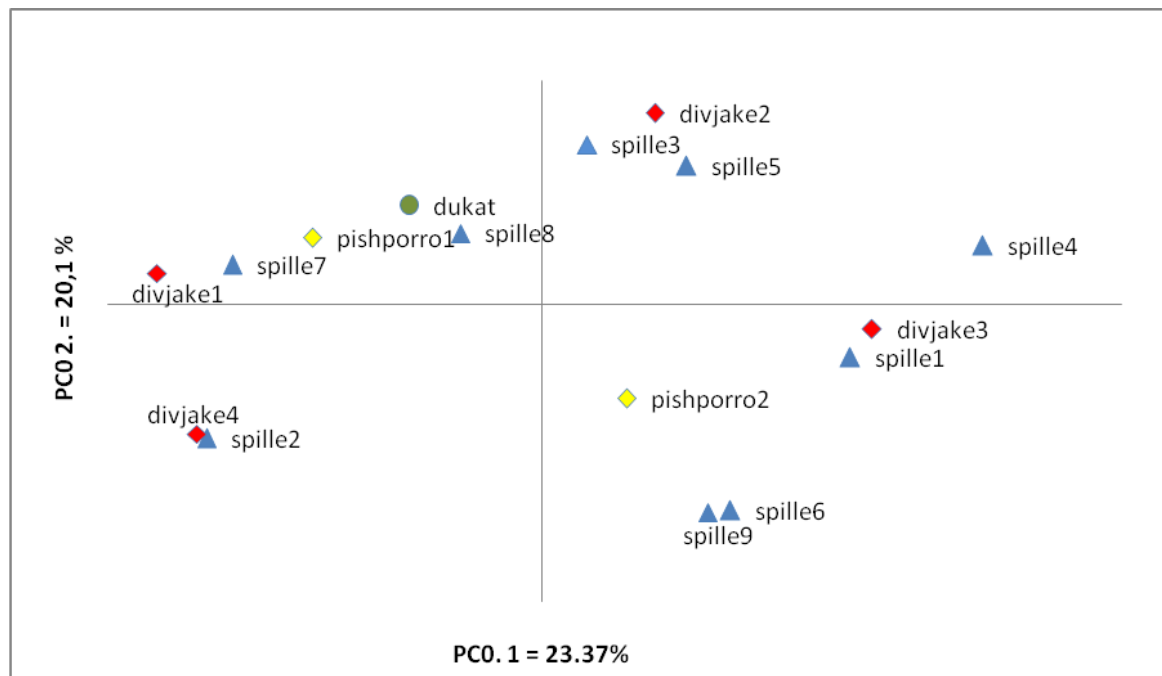

Figure 2: Principal Coordinate Analysis (PcoA) plot of 16 myrtle populations based on two principal coordinates (PCO 1 = 23.37%; PCO2 = 20.1%).

Conclusion

This study explored and morphologically evaluated 16 wild myrtle populations collected from four localities in Albania in order to provide the first characterization and obtain important data for the management and conservation of myrtle genetic resources and also for future domestication and breeding programs. The populations showed high variability for some of the examined traits, such as plant height, branch height, leaf length and width that can be used to select the superior genotypes. The UPGMA clustering and PCoA analysis showed no grouping of populations clearly related to their geographical origin or ecological factor (type of soil). The results obtained in this study highlighted a high level of variation of wild myrtle populations in Albania, which represent a valuable resource to be conserved.

References

- Agrimonti C., Bianchi R., Bianchi A., Ballero M., Poli F., Marmioli N. (2007). Understanding biological conservation strategies: a molecular-genetic approach to the keys of myrtle (*Myrtus communis* L) into Italian regions: Sardinia and Calabria. *Conserv Genet*, 8: 385-396.
- Barboni T., Venturini N., Paolini J., Desjobert JM., Chiaramonti N., Costa J. (2010). Characterisation of volatiles and polyphenols for quality assessment of alcoholic beverages prepared from Corsian *Myrtus communis* berries. *Food Chemistry*, 196 (4): 1304-1312.
- Bruna S., Mercuri A., Cervelli C., Braglia L., De Benedetti L., Sciva T. (2005). Genetic characterization of *Myrtus communis* L. wild genotypes using AFLP markers. Proc. Vth IS on New Flor. Crops. Eds: A.F.C. Tombolato and G.M. Dias-Tagliacozzo. *Acta Hort* 683, ISHS: 430-436.

- Melito S., Chessa I., Erre P., Podani J., Mulas M. (2013). The genetic diversity of Sardinian myrtle (*Myrtus communis* L) populations. *Electronic Journal of Biotechnology*, 16(4). DOI: 10.2225/vol16-issue6-fulltext-13
- Melito S., La Bella S., Martinelli F., Cammalleri I., Tuttolomondo T., Leto C., Fadda A., Molinu MG., Mulas M. (2016). Morphological, chemical, and genetic diversity of wild myrtle (*Myrtus communis* L.) populations in Sicily. *Turk J. Agric For*, 40: 249-261.
- Messaoud C., Afifa M., Boulilaa A., Rejebb M.N., Boussaida M. (2007). Genetic variation of Tunisian *Myrtus communis* L. (Myrtaceae) populations assessed by isozymes and RAPDs. *Ann. For. Sci.* 64: 845-853.
- Messaoud C., Bèjaoui A., Boussaid M. (2011). Fruit color, chemical and genetic diversity and structure of *Myrtus communis* L. var. *italic* Mill. morph populations. *Biochem Syst Ecol*, 39: 570-580.
- Messaoud C., Khoudia M., Boussaid M. (2006). Genetic diversity and structure of wild Tunisian *Myrtus communis* L. (Myrtaceae) populations. *Genet. Resour Crop Ev*, 53: 407-417.
- Rohlf F.J. (2000). NTSYS pc: Numerical taxonomy and multivariate analysis system. Version 2.1. Exeter Software.
- Şerçe S., Şimsek Ö., Gunduz K., Aka-Kacar Y., Ercisli S. (2008). Relationships among myrtle accessions from Turkey as revealed by fruit characteristics and RAPD. *Romanian Biotechnology Letters*, 13 (6): 4054-4065.

ASSESSMENT OF LARGE SCALE IRRIGATION SCHEMES USING IRRIGATION INTENSITY INDICATOR IN TURKEY

Hasan DEĞİRMENÇİ^{1*}, Çağatay TANRIVERDİ¹

¹Department of Biosystem Engineering, Faculty of Agriculture, University of Kahramanmaraş Sütçü İmam, Kahramanmaraş, Turkey

*Corresponding author: degirmenci@ksu.edu.tr

Abstract

Irrigation management is one of the key factors for the sustainability of irrigated agriculture. There has been a good number of performance indicators developed for the assessment of irrigation schemes. The most important one among them is the irrigation intensity indicator. In this paper, obtained the data that regarding irrigated area and command area that is transferred irrigation schemes for 2015. This data was used to calculate irrigation intensity. In this study, three climatic zones (Continental, Mediterranean and Black Sea) fourteen irrigation schemes, more than 20.000 ha of command area for each scheme, were assessed. The average irrigation intensity of the irrigation schemes in Turkey is around 62%. Of the 14 irrigation schemes assessed in this study, 5 of them are found to be below the national average in terms of their irrigation intensities. The most important factors that determine the non-irrigated lands in the irrigation schemes include fallowing, socio-economical reasons and sufficient rainfall. The average values of these irrigation intensities for the transferred irrigation schemes were always higher than that of the government-operated schemes. This study suggest that the transfer of the SHW-operated schemes to the water use associations must be initiated and encouraged, in addition to the set up of legal procedures for participatory irrigation management, in order to cope with the possible operation and maintenance (O&M) problems of irrigation schemes. In order to mitigate the factors reducing the irrigation intensity, the agricultural publications intended for farmers and the policies in favor of irrigated farming practices should be materialized.

Keywords: *Irrigation scheme, Irrigation intensity, Cluster analysis, Water users associations*

Introduction

The last 50 years have seen significant developments in farming and water resources. A good number of irrigation schemes have been built and allocated to the use of the farmer. Today, water and irrigation still retains its importance, as the water becomes more and more a strategic commodity due to the failure of the water supply to meet the ever increasing world population demand. In the future, the single most important factor determining the use and quality of water will be the population. For this reason, the sustainable and efficient use of our land and water resources (and the operation and management of irrigation) in particular is a vitally important issue. The total surface area of Turkey is 78 million hectares (783.577 km²), 28 million hectares of which are cultivable agricultural lands. In 2014, a total of 6.09 million hectares of land has been put into operation in Turkey. Of the irrigation areas put into operation, approximately 81% of them are irrigated by surface water resources, while the remaining 19% of them by underground water resources. In Turkey, the management of irrigation schemes have been assigned to the water user organizations since 1994. According to this irrigation management

assignment scheme, the irrigation areas that were previously run by the state have been assigned to the irrigation associations (89.1%), cooperatives (5.1%), municipalities (3%), legal village entities (1.6%) and the unions of village delivery service (0.9%) (DSI, 2015). Following the completion of assignment procedures, monitoring and assessment activities and the performance of the assignees have gained significance. Various researchers have developed performance indicators for such monitoring and assessment activities (Molden *et al.*, 1998; Malano *et al.*, 2004; Bos *et al.*, 2005). The indicator that best represents the agricultural activity in assessing the performance of the irrigation schemes is the irrigation intensity. It is the intensity of the irrigation area to the total irrigation area, which is represented in percentages. Knowing the reasons behind the poor irrigation intensity and developing solutions accordingly is very important for the irrigation economy. Irrigation intensity is one of the most commonly used performance indicators in assessing the irrigation schemes in Turkey and in the world. In this respect, numerous studies have been conducted on different irrigation schemes by various researchers in Turkey and in the world (Beyribey *et al.*, 1997; Vermillon *et al.*, 2000; Çakmak, 2001; Değirmenci, 2001; Mishra *et al.*, 2009; Mateos *et al.*, 2010; Garcia-Balanos *et al.*, 2011; Tanrıverdi *et al.*, 2011; Akkuzu and Mengü, 2012). This study has attempted to assess 14 irrigation schemes in Turkey that comprise an irrigation area of more than 20.000 hectares by using the irrigation intensity indicator. The cluster analysis and statistical charts have been used in the assessment. The aim of this study is to identify irrigation management performance of irrigation schemes with irrigation intensity indicator and to benchmark of the irrigation schemes.

Materials and Methods

The climate of Turkey is semi-arid with some extremities in temperature. Average annual precipitation is 643 mm, ranging from 250 mm in the Central Anatolia, to over 2500 mm in the coastal area of north-eastern Black Sea. Approximately, 70% of the total precipitation falls during the period between October and April, and there is a little rainfall during summer months. The average annual temperature varies between 15°C and 20°C on the coastal zones, falls to 4°C and 18°C in the inland areas. The majority of Turkish agricultural soils have alkaline characteristics, generally with low organic matter contents, with high and medium level lime contents. The majority of soils in Turkey are of loam texturing, and high potassium level. Two of the irrigation schemes that have been assessed are located in the Central Anatolian region (Çumra and İvriz) and under the influence of continental climate. The winters are cold and the summers are hot. Two irrigation schemes are located in the eastern Anatolian region (Erzincan and Iğdır) where the summers are short and chilly whereas the winters are cold and longer. Another irrigation scheme is located in the Southeastern region (Şanlıurfa-Harran) where the summer is very hot and the winter is mild. 6 of the irrigation schemes are located in the Mediterranean and Aegean regions that are under the influence of Mediterranean climate. In those places, the summers are hot and dry whereas the winters are mild and rainy. Another irrigation scheme is located in the Black Sea region where is rainy in all seasons. The summers are chilly and the winters are mild on the coasts, but colder and snowy in the higher areas. Data on the reasons of non-irrigated areas were determined with the face to face interviews of the farmers of irrigation association managers and with the field observations. These data were obtained from the assessment reports of the irrigation schemes (DSI, 2016). The locations of the irrigation schemes being assessed are provided in the Figure 1, whereas the characteristics of each irrigation scheme are listed in the Table 1 below.

The following equation has been used in calculating the irrigation intensity of the irrigation schemes for the year 2015:

$$\text{Irrigation Intensity (\%)} = \frac{\text{Irrigated Area (ha)}}{\text{Command Area (ha)}} \times 100$$



Fig. 1. Location of the selected fourteen irrigation schemes in Turkey.

Table 1. Characteristics of Fourteen irrigation schemes

Code	Irrigation Scheme	Surface (ha)	Water Diversion (Percentages by area)		Main Crops(Percentages by area)		
			Gravity	Pumped			
1	Menemen	22865	91	9	Cotton (56%)	Corn (18%)	Vegetables(8%)
2	Ahmetli	50232	100	-	Corn (53%)	Grape (35%)	Fruit trees (4%)
3	Çumra	59560	88	12	Cereals (53%)	Corn (35%)	Sugarbeet (12%)
4	İvriz	36108	81	19	Cereals (46%)	Corn (31%)	Sunflower(10%)
5	Seyhan	142274	99	1	Corn (42%)	Citruses (15%)	Nursery tree (11%)
6	Mersin	21762	65	35	Citruses (38%)	Vegetables (20%)	Corn (18%)
7	Ceyhan	101726	89	11	Corn (79%)	Peanut(10%)	Cotton (56%)
8	Tokat	20275	82	18	Corn (24%)	Vegetables (20%)	Fruit trees (15%)
9	Bafra	21550	100	-	Paddy(74%)	Vegetables ((12%)	Corn (9%)
10	Erzincan	29112	63	37	Cereals (50%)	Sugar beet (16%)	Bean (15%)
11	Şanlıurfa Harran	134366	100	-	Cotton (78%)	Cereals (22)	-
12	Söke	26000	100	-	Cotton (100%)	-	-
13	Baklan P	44072	100	-	Sunflower (54%)	Corn (15%)	Fruit trees(10%)
14	Iğdır	61900	94	6	Forage(50%)	Corn (31%)	Grassland(13%)

The irrigation intensity data calculated for each irrigation project has been subjected to the cluster analysis and studied in terms of their similarities to each other. The cluster analysis is a multivariable statistical method that aims to divide a set of observations into a limited number of groups or clusters. Division is done in such a way as to ensure that the similar observations are

gathered in one group while the observations of a different nature are put together in a different group (Neil, 2002). Observations (units) or variables may constitute the subject of the grouping or clustering. In clustering the units, the aim is to classify a set of observations into groups or clusters, in which neither the number of groups nor group membership is known to the researcher. In clustering the variables, however, similarities can be detected by conducting a factor analysis and thereby establishing the interrelated variable groups, and therefore the common factor structures (Özdamar, 2004). Moreover, the irrigation intensities calculated for each irrigation scheme are shown on a graphic (Fig. 3).

Results and Discussion

The cluster analysis dendrogram of the irrigation schemes being assessed are presented in the Figure 2 below. As is shown in the dendrogram, the irrigation schemes are gathered in 3 groups. The highest irrigation intensities seem to have been achieved in the irrigation schemes of Çumra, Ceyhan, Seyhan, Söke, Şanlıurfa and Baklan. Such irrigation schemes are located in the regions that are under the influence of the Mediterranean climate. The crops that are planted the most in such lands are corn and cotton. The use of mechanization in planting such crops is very common. The preferential crops in the area are those that do not require labor. The second group includes the irrigation schemes of Menemen, Bafra, Mersin and İvriz. The third group includes the irrigation schemes of Iğdır, Tokat, Erzincan and Ahmetli. The irrigation intensities in the third group are fairly poor.

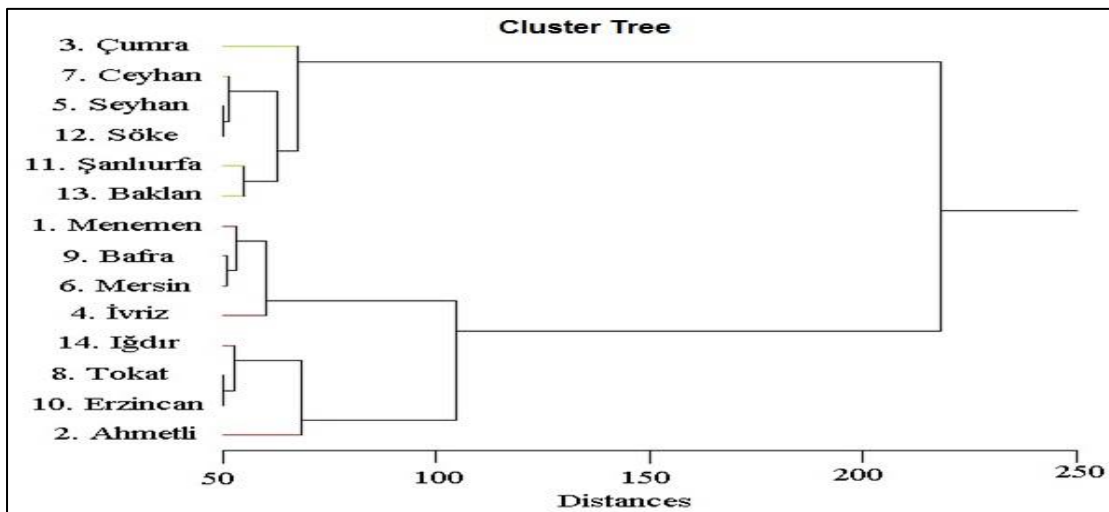

Fig. 2. Dendrogram of hierarchical cluster analysis of fourteen irrigation schemes in Turkey (x-axis reports the level of dissimilarity).

The irrigation intensities of the 14 irrigation schemes that have been assessed are provided in the Figure 3. When reviewing the Figure 3 below, it is seen that 5 irrigation schemes (İvriz, Iğdır, Tokat, Erzincan and Ahmetli) are below the average national irrigation intensity (62%). The factors that most contribute to the reduction of the irrigation intensity are as follows: insufficient water resources, social and economic reasons, following, insufficient rainfall, insufficient repair and maintenance facilities, salinity and insufficient irrigation facilities. The reasons for non-irrigation areas within the irrigation schemes being assessed are provided in the Table 2. The mains reasons for non-irrigation areas in Ahmetli irrigation scheme, which has the lowest irrigation intensity, are respectively listed as follows: sufficient rainfall, insufficient repair and maintenance facilities and insufficient irrigation structures. The following reasons have been

identified for non-irrigation within the following irrigation schemes with the corresponding percentages: Falloving (68%) in İvriz irrigation scheme, sufficient rainfall (91%) in Baklan irrigation scheme, insufficient irrigation structures (57%) in Bafra irrigation scheme, social and economic reasons (54%) in Şanlıurfa Harran irrigation scheme.

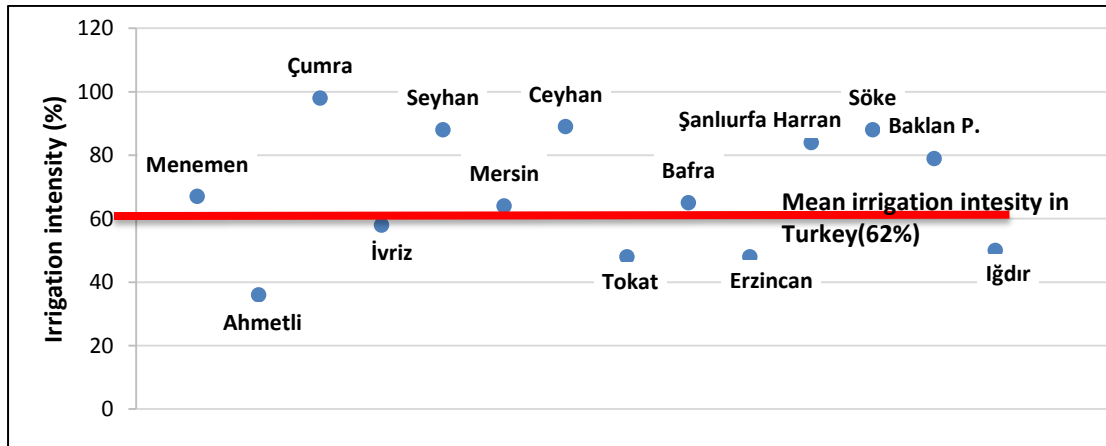

Fig. 3. Irrigation schemes and irrigation intensities.

Table 2. Irrigation schemes and main reasons of non-irrigation areas

Irrigation Scheme	Main reason of non-irrigation area(Percentages by non-irrigation area)		
Menemen	Falloving (55%)	Rainfed cropping(28%)	Economic and social problems(16%)
Ahmetli	Rainfed cropping(36%)	Inadequate maintenance(29%)	Insufficient irrigation structure(20%)
İvriz	Falloving (68%)	Inadequacy of water resources(18%)	Inadequate maintenance(5%)
Seyhan	Rainfed cropping(57%)	Industrial institution (24%)	Economic and social problems(16%)
Mersin	Industrial institution (50%)	Rainfed cropping(33%)	Economic and social problems(12%)
Ceyhan	Economic and social problems(50%)	Falloving (29%)	Industrial institution (11%)
Tokat	Rainfed cropping(47%)	Economic and social problems(20%)	Industrial institution (11%)
Bafra	Insufficient irrigation structure(57%)	Rainfed cropping(19%)	Rainfed Grassland(18%)
Erzincan	Falloving (64%)	Economic and social problems(14%)	Rainfed Grassland(10%)
Şanlıurfa Harran	Economic and social problems(54%)	Inadequacy of water resources(29%)	Drainage problems(9%)
Söke	Rainfed cropping(67%)	Economic and social problems(30%)	Industrial institution (3%)
Baklan P.	Rainfed cropping(91%)	Economic and social problems(9%)	-
İğdır	Economic and social problems(44%)	Salinity problem(32%)	Rainfed Grassland(11%)

Conclusion

According to the cluster analysis conducted on the 14 irrigation schemes, each having an irrigation area of more than 20.000 hectares, the irrigation intensity of the irrigation schemes in the first group appears to be very high. However, the irrigation intensity of the irrigation schemes in the third group is found to be below the national average. The national irrigation intensity is planned to be increased to 68% as per the development plan for 2014-2018. In order to realize that goal, the reasons behind the aforementioned non-irrigation areas should be addressed first. For minimizing the fallow lands, agricultural publications and training programs for farmers should be promoted. Most irrigation schemes in Turkey perform gravity irrigation. This reduces the irrigation performance directly. Future irrigation investments should be planned according to the pressure irrigation method, and the old irrigation schemes should be modernized soon. One of the reasons for poor irrigation density is the social and economic status of the Turkish farmer. Farmers are unable to cultivate their lands due to social and economic reasons. The marketing infrastructure for the produce should be improved to eliminate social and economic problems, and the product prices and marketing conditions should be brought up to the international standards. Moreover, the policies should be developed in favor of irrigated farming.

References

- Akkuzu E., Mengü G. P. (2012). Evaluation of Irrigation System Performance of Water User Associations in Lower Gediz Basin Using Comparative Performance Indicators. *Ege Üniversitesi Ziraat Fakültesi Dergisi*. 49.2 (2012): 149-158.
- Beyribey, M., Çakmak, B., Sönmez, F. K., Oğuz, M. (1997). Comparison of Irrigation Requirements Based on Blaney-Criddle and Penman-Monteith Method in Irrigation Schemes. *Tarım Bilimleri Dergisi*, 1997, 3 (1) 1-5.
- Bos, M. G., Burton, M. A. S., Molden, D. J. (2005). *Irrigation and Drainage Performance Assessment: Practical Guidelines*. CABI, 2005.
- Çakmak, B. (2001). Evaluation of Irrigation System Performance in Irrigation Associations, Konya. *Tarım Bilimleri Dergisi*, 2001, 7 (3), 111-117. Ankara.
- Değirmenci, H. (2001). Assesment of Turnover Irrigation Schemes with Comparitive Indicator. *Uludağ Üniversitesi Ziraat Fakültesi Dergisi*, 15, 31-41.
- DSİ. (2015). General Directorate of State Hydraulic Works 2015 Annual Report. <http://www.dsi.gov.tr/docs/stratejik-plan/dsi-2015-faaliyet-raporu.pdf?sfvrsn=2#page=71>. (Last access date: 01.06.2016).
- DSİ. (2016). Assesment Report of Irrigation Schemes in Turkey. DSI, 2016, Ankara.
- García-Bolaños, M., Borgia, C., Poblador, N., Dia, M., Seyid, O. M. V., Mateos, L. (2011). Performance Assessment of Small Irrigation Schemes Along the Mauritanian Banks of the Senegal River. *Agricultural Water Management*, 98(7), 1141-1152.
- Karagöz, A. (2009). Country Pasture/Forage Resource Profiles, Turkey.
- Malano, H., Burton, M., Makin, I. (2004). Benchmarking Performance in the Irrigation and Drainage Sector: a Tool for Change. *Irrigation and Drainage*, 53(2), 119-133.
- Mateos, L., Lozano, D., Baghil, A. B. O., Diallo, O. A., Gómez-Macpherson, H., Comas, J., Connor, D. (2010). Irrigation Performance Before and After Rehabilitation of a Representative, Small Irrigation Scheme Besides the Senegal River, Mauritania, *Agricultural Water Management*, 97(6), 901-909.
- Mishra, A., Nanda, P., Ghosh, S., Kumar, A. (2009). Impact Assessment of Rehabilitation and Irrigation Management Transfer in the Minor Irrigation Systems of Orissa, India. *Research Bulletin 45, Directorate of Water Management, Bhubaneswar – 751023*, 2009.

- Molden, D. J., Sakthivadivel, R., Perry, C. J., De Fraiture, C. (1998). Indicators for Comparing Performance of Irrigated Agricultural Systems. IWMI, Vol. 20.
- Neil, T. H. (2002). Applied Multivariate Analysis. Secaucus, NJ, USA:Springer-Verlag New York.
- Tanriverdi C., Değirmenci, H., Sesveren, S. (2011). Assessment of Irrigation Schemes in Turkey Based on Management Types. African Journal of Biotechnology, 10(11), 1997-2001.
- Özdamar, K. (2004). Statistical Data Analysis with Package Programs. Eskişehir: Kaan Kitabevi.
- Vermillion, D. L., Samad, M., Pusposutardjo, S., Arif, S. S., Rochdyanto, S. (2000). An Assessment of the Small-scale Irrigation Management Turnover Program in Indonesia. IWMI, Vol. 38.

SPRINKLER IRRIGATION MANAGEMENT FOR PASTURE IN LOAM SOIL

Vladimir ZHALIAZKO¹, Viktor LUKASHEVICH², Otilija MISECKAITE^{3*}

¹Faculty of Land Reclamation and Construction, Belarusian State Agricultural Academy, Belarus

²Department of Land Reclamation and Water Management, Belarusian State Agricultural Academy, Belarus

³Institute of Water Recourses Engineering, Water and Land Management Faculty, Aleksandras Stulginskis University, Lithuania

*Corresponding author: otilija.miseckaite@asu.lt

Abstract

The sprinkler irrigation systems are often regarded as a hydraulics problem. The average rate of water application is usually fixed at some level below the basic infiltration rate of the soil to avoid surface water runoff. However, water starts to accumulate on the soil surface when the water application rate exceeds the infiltration rate for a sufficiently long period of time. Surface runoff occurs when sufficient water accumulates on the soil surface to overflow shallow depressions and flow over or past surface. A good pasture management is the production of economically optimum forage yield and quality without compromising the environment. This field experiments (Gorki district, Belarus) aims to determine irrigation time for traveling irrigation device Bauer Rainstar T-61, and the required water supply rate without puddles and runoffs formation to loamy soil. Results show that irrigation rate without soil erosion was: in loose soil - 12.8–15.8 mm; then plant are 5–10 cm high - 28.8 mm or more at the vegetation beginning and 19.2–23.4 mm at the vegetation end; then plant are 10–20 cm high - at the vegetation beginning and at the end - the same - 30.0 mm and more. The watering time until beginning to runoff formation consisted from 64 min to 150 min. The average artificial rain droplet diameter for traveling irrigation device Bauer Rainstar T-61 was established from 0.7 to 1.2 mm. Maximum diameter of 1.2 mm and 0.7 mm drops were formed when the 30 mm and 16 mm diameter spray were used respectively. The resulting value correspond to the allowed limits of quality agronomic characteristics of irrigation, without causing damage to irrigated crops using any removable irrigation spray.

Keywords: *erosion, Bauer Rainstar T-6, traveling irrigator.*

Introduction

Agriculture is an important component in the economies of Eastern Europe. It has the potential to become globally important. The sector employs about 17% of the working population of Eastern Europe. Agriculture contributes between 9 and 15% to national GDP (Nikolayeva *et al.*, 2012). Irrigated land area has expanded rapidly over the last years. In 1961, irrigation occupied 141 million hectares globally, increasing to 287 million hectares in 2015, and forecasted to 318 million hectares by 2050. Irrigation water withdrawal was 2620 km³ in 2005, and will increase 2906 km³ in 2050 (Bruinsma, 2009). Irrigation is the most important water use sector accounting for about 70% of the global freshwater withdrawals and 90% of consumptive water uses (Siebert *et al.*, 2010). Climate change is expected to intensify problems of water scarcity and irrigation requirements in the Mediterranean region (Rodriguez *et al.*, 2007). Water use efficiency is an important performance indicator of sustainable production, widely used overseas (Martin *et al.*, 2006). Irrigated agriculture causes various direct or indirect problems, including leaching of nutrient and pesticides, soil salinization, overexploitation of aquifers (leading to ground

subsidence and sea-water intrusion), modification of natural flow regimes and damages to water dependent ecosystems (Doll and Siebert, 2002; Stigter *et al.*, 2006). The use of irrigation is critical to quality crop production and continuous-move irrigation systems are suited to the requirements of sandy soils, however their mobility could be affected by traffic ability problems depending upon soil moisture (Chico-Santamarta *et al.*, 2009). Sprinkler systems are used on 50% of the irrigated crop land and have a water use efficiency of 75% (Locascio, 2005). During a sprinkler irrigation event some water is lost due to wind drift and evaporation. After the irrigation event, plant-intercepted water is lost due to evaporation. The water lost causes microclimatic changes which could result in positive or negative plant physiological changes. Sprinkler irrigation during daytime strongly modified the microclimate where plants grow during the irrigation time and for a short period after the irrigation event finished (Cavero *et al.*, 2009). As pressure on water resources increases, pasture species that express traits for improved water-use efficiency while maintaining desirable agronomic and production characteristics are needed (White and Snow, 2012). The dairy industry is under increasing pressure to use water more efficiently in response to water market reforms and restrictions on future irrigation water availability, creating interest in the potential of alternative irrigation methods. Surface runoff was significantly reduced under sprinkler and subsurface drip irrigation. The high water use by gravity fed irrigation methods is attributed to a combination of higher evaporation and groundwater accessions (Wood and Finger, 2006). Potential water savings by new irrigation technology and improved irrigation management may be off set by increases in irrigated areas and appropriate measures are necessary to limit water use to sustainable levels (Wriedt *et al.*, 2009). The mobile irrigator was developed for effective utilization of the available water in dry land agriculture instead of following the supplementary irrigation. For the efficient performance of the irrigator, the height of the crop should be less than or up to 1.5 m. (Ravi, *et al.*, 2015). The quality irrigation means, at first, water distribution for all areas without forming the surface runoff, causing not only a great loss of water, but also the destruction of soil structure, reducing its air permeability and the formation of soil crust. These conditions depend on the structure of the artificial rain produced by a particular sprinkler installation, soil, climate, the relief and the agro technical characteristics of the irrigated area. The purpose of this study was to investigate the irrigation time and rate for traveling irrigation device for pasture in loam soil by analysing time from irrigation beginning until starts formation surface runoff at different moisture contents and the distribution droplet size of rain, depending on the sprinkler nozzle diameter.

Materials and methods

Field experiments were conducted at the experimental field Gorki district, Belarus in 2012–2015. Soils are soddy-podzolic loamy. The soil characteristic in a layer 0–100 cm: density - 1.62 g cm⁻³, the density of solids - 2.65 g cm⁻³, the lowest moisture content - 22.3% by weight of dry soil, the max slope 0.005. The vegetation cover is represented by herbage height from 5 to 20 cm. Traveling gun sprinkler Bauer Rainstar T-61 was used for irrigation. Irrigation was carried out to three levels of pre-irrigation moisture (60–70% of the field moisture susceptibility (MS), 70–80% MS and 80–90% MS) for the following conditions: 1 variant: friable soil after pre-treatment; 2 variant: the soil is dense; 3 variant: herbage height of 5–10 cm, at the beginning of the growing season; 4 variant: herbage height of 5–10 cm, at the end of the growing season; 5 variant: height of 10–20 cm, at the beginning of the growing season; 6 variant: herbage height of 10–20 cm, at the end of the growing season. Before the start of the experiment on the soil surface were established credentials mortise frame. Accounting rules irrigation was performed using rain gauges. The moments of the time then in the surface were form pools of 2-3 cm diameter was the

beginning of the surface runoff. Irrigation rate is 30 mm, pressure 4-5 bar, watering duration 150 min. The rotation speed around the machine axis of the machine gun equals 0.7 circle/min. Droplet size of rain determined using filter paper in multiple 3 replications. Soil moisture was determined at 10 cm and 20 cm depth. The angle of the sprinkler preparations from the horizon was in the standard position (24°). The diameter of the nozzle sprinkler device was 16-30 mm. All irrigation was carried out in calm weather. Interdependence of the individual factors was analysed, using binomial correlation method: the determined correlation and reliability of the data was checked by autocorrelation analysis. Correlation methods (r) have been used for data analysis. Irrigation intensity by sprinkling time can be described by the equation:

$$i_i = \frac{A}{t^B} + i_r, \quad (1)$$

where A and B - empirical parameters, depending on the soil and relief and other factors affecting the intensity of allowable irrigation; t - time watering until starts formation surface runoff, min; i_r - penetration rate at sprinkling time, mm min^{-1} .

Results and discussion

The results for irrigation system tests for the three considered soil moisture for all 6 variants are presented in fig.1 (soil moisture 60-70 % MS), fig.2 (soil moisture 70-80 % MS) and fig.3 (soil moisture 80-90 % MS). The resulting equation has a high correlation (0.99, table 1).

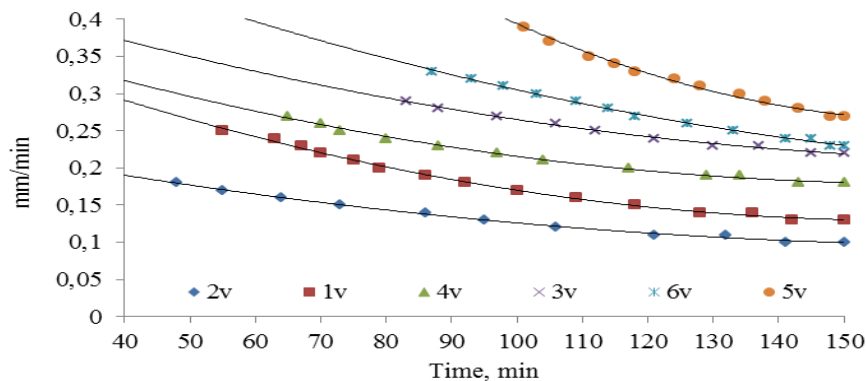

Fig. 1. The infiltration rate (moisture 60-70 % MS) during irrigation

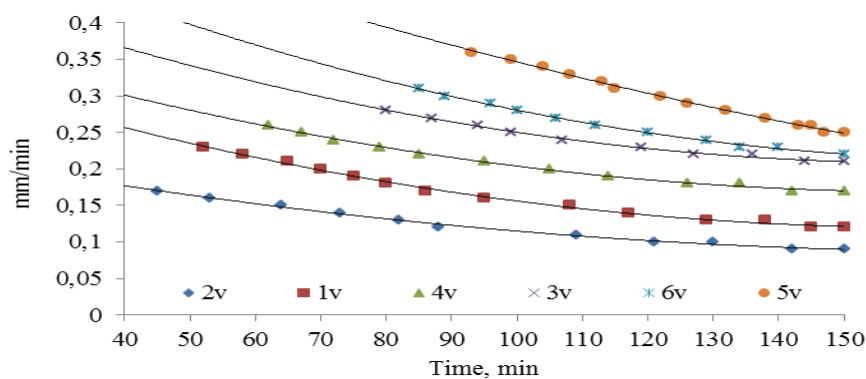

Fig. 2. The infiltration rate (moisture 70-80 % MS) during irrigation

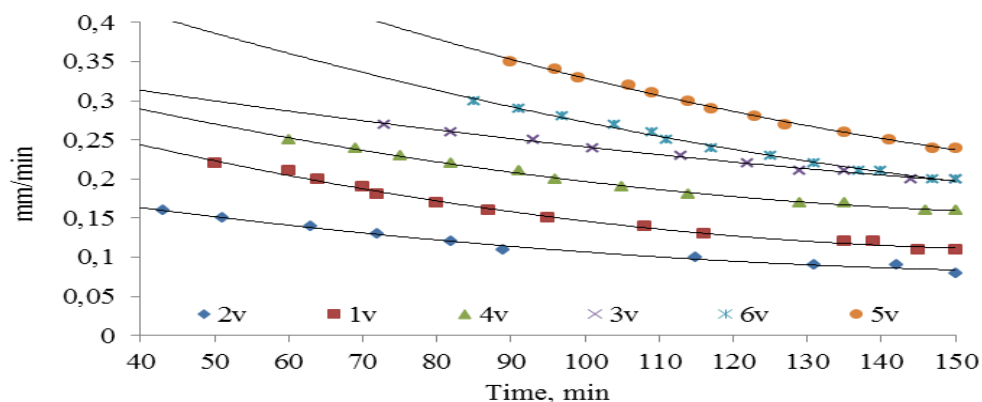

Fig. 3. The infiltration rate of the soil (moisture 80-90 % MS) during irrigation

Table 1. Irrigation intensity by sprinkling time

Variant	i_i , mm min^{-1}	Time until starts formation surface runoff, min	The parameters of the equation		i_r , mm min^{-1}	r
			A	B		
I	0.25–0.11	50–150	3,17–4,36	0,64–0,70	0,13–0,11	0,99
II	0.18–0.08	43–150	1,27–1,48	0,53–0,54	0,1–0,08	0,99
III	0.29–0.20	75–150	1,92–2,42	0,45–0,48	0,22–0,2	0,99
IV	0.27–0.16	60–150	1,98–2,14	0,49–0,52	0,18–0,16	0,99
V	0.42–0.24	90–150	12,26–29,63	0,79–0,94	0,23–0,2	0,99
VI	0.33–0.20	85–150	4,84–9,22	0,62–0,77	0,27–0,24	0,99

The values of the permissible intensity with intermittent sprinkling for sprinkler irrigation, to avoid excess runoff and erosion risk, the following: 1 variant - 0.25– 0.11 mm min^{-1} ; 2 variant - 0.18– 0.08 mm min^{-1} ; 3 variant - 0.29–0.20 mm min^{-1} ; 4 variant - 0.27–0.16 mm min^{-1} ; 5 variant - 0.42–0.24 mm min^{-1} ; 6 variant - 0.33– 0.20 mm min^{-1} . The intensity of the obtained values was determined erosion-permissible values of irrigation norms and irrigation while providing watering without forming puddles and surface runoff (table 2).

Table 2. Irrigation rates and the time for sprinkling irrigation.

Variant	Soil moisture, % MS	Irritation time until the formation surface runoff, min	Irrigation norm until the formation surface runoff, mm
I	60–70	79	15.8
	70–80	70	14.0
	80–90	64	12.8
II	60–70	Irrigation is not recommended	
	70–80		
	80–90		
III	60–70	Surface runoff was not observed	
	70–80		
	80–90	144	28.8
IV	60–70	117	23.4
	70–80	105	21.0
	80–90	96	19.2
V	60–70	Surface runoff was not observed	
	70–80		
	80–90		
VI	60–70	Surface runoff was not observed	
	70–80		
	80–90	150	30.0

Table 2 shows that the values of the permissible norms of irrigation and irrigation time differ markedly according to the variant of experience. So permissible irrigation rate will be: to loose soil 12.8–15.8 mm; dense soil – watering is not recommended; herbage height of 5–10 cm at the beginning of the growing season of 28.8 mm and above; herbage height of 5–10 cm at the end of the growing season of 19.2– 23.4 mm; herbage height of 10–20 cm at the beginning and end of the growing season of 30.0 mm and above. Time to form irrigation surface runoff was from 64 minutes to 150 minutes.

Also as a result of the experiments, it was found that due irrigation sprinkler apparatus Bauer machine breaks drops a diameter from 0.1 mm to 2.3 mm. But the droplet size distribution is irregular. Experiments have shown that with increasing distance from the sprinkler device amount of raindrops grew, and maximum values recorded in the 0.7–0.8 distance range from sprinkler nozzle (fig. 4). The smallest droplet diameter was 0.1 mm at a distance from 2.5 to 5 m from the apparatus.

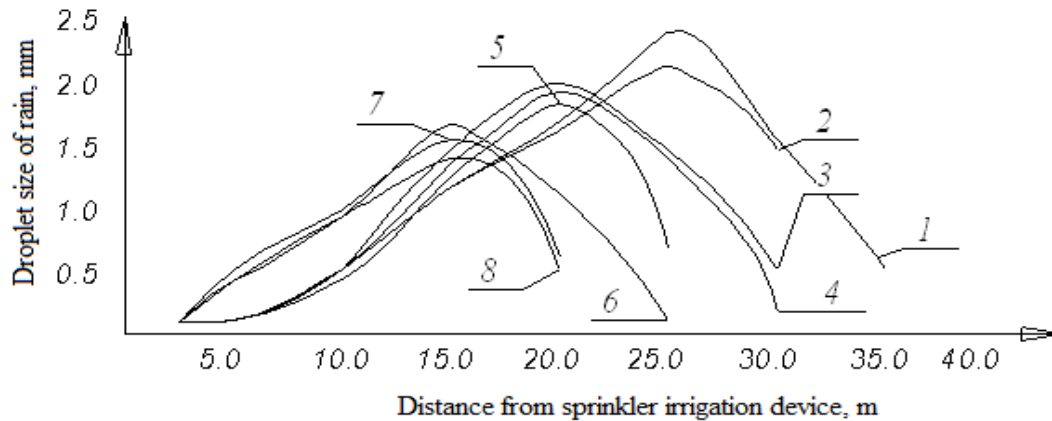

Fig. 4. – Drop size distributions, depending on the sprinkler nozzle diameter
 Sprinkler nozzle diameter:
 1 – 30 mm, 2 – 28 mm, 3 – 26 mm, 4 – 24 mm, 5 – 22 mm, 6 – 20 mm, 7 – 18 mm, 8 – 16 mm

The highest value of average droplet diameter of 1.2 mm obtained when watering sprinkler nozzle is 30 mm, and the smallest - 0.7 mm at 16 mm. All values obtained are acceptable agronomic characteristics of quality irrigation, which prevents damage to irrigated crops in any replacements sprinkler nozzles. But according (DeBoer, 2002), nozzle diameter had a minimal effect on drop size, but nozzle pressure had a significant inverse influence.

Conclusions

Results show that irrigation rate without soil erosion and time to ensure traveling gun sprinkler Bauer Rainstar T-61 without forming puddles and surface runoff to the sod-podzolic loamy soil depend on the state of the soil surface and the height of the vegetation cover and are: in loose soil - 12.8–15.8 mm; then plant are 5–10 cm high - 28.8 mm or more at the vegetation beginning and 19.2–23.4 mm at the vegetation end; then plant are 10–20 cm high - at the vegetation beginning and at the end - the same - 30.0 mm and more. The watering time until beginning to runoff formation consisted from 64 min to 150 min. The values of the average diameter of the artificial rain produced by the traveling gun Bauer Rainstar T-61 vary from 0.7 to 1.2 mm. Maximum diameter (1.2 mm) drops formed then was used the 30 mm diameter sprinkler nozzle and 0.7 mm – the 16 mm sprinkler nozzle. All values obtained are acceptable agronomic characteristics of quality irrigation in any sprinkler nozzles.

References

- Bruinsma, J. (2009). The resource outlook to 2050. In Expert meeting on how to feed the world in. Vol. 2050, pp. 1-33.
- Cavero, J., Medina E. T., Puig M., Martínez-Cob A. (2009). Sprinkler irrigation changes maize canopy microclimate and crop water status, transpiration, and temperature. *Agronomy Journal*, Vol. 101 (4), pp. 854–864.
- Chico-Santamarta L., Richards T.E., Godwin R.J. (2009). A laboratory study into the mobility of travelling irrigators in air dry, field capacity and saturated sandy soils. *American Society of Agricultural and Biological Engineers*, p. 1.
- DeBoer, D.W., 2002. Drop and energy characteristics of a rotating spray-plate sprinkler. *Journal of irrigation and drainage engineering*, 128(3), pp.137-146.

- Doll P., Siebert S. (2002). Global modeling of irrigation water requirements. *Water Resources Research*, Vol. 38 (4), pp. 8.1–8.10 <http://dx.doi.org/10.1029/2001WRR000355>. Accessed on 16/06/2016.
- Locascio S.J. (2005). Management of irrigation for vegetables: Past, present, and future. *HortTechnology*, Vol. 15 (3), pp. 482–485.
- Martin R.J., Thomas S.M., Stevens D.R., Zyskowski R.F., Moot D.J., Fraser T. J. (2006). Improving water use efficiency on irrigated dairy farms in Canterbury. In *Proceedings of the conference-New Zealand grassland association*, vol. 68, pp. 155–160.
- Nikolayeva L., Denisov, N., Novikov V. (2012). *Climate change in Eastern Europe: Belarus, Moldova, Ukraine*. 60p.
- Ravi P., Kaveri G., Rajesh K., Amreena N., Parthasarathi G. (2015). Development and Performance Evaluation of Mobile Irrigator for Dry Land Agriculture. *Agricultural Engineering*, Vol. 3 (3), pp. 53 – 62.
- Rodriguez D., Weatherhead E.K., Knox J.W., Camacho E. (2007). Climate change impacts on irrigation water requirements in the Guadalquivir river basin in Spain. *Regional Environmental Change*, 7, pp. 149–159.
- Siebert S., Burke J., Faures J. M., Frenken K., Hoogeveen J., Doll P., Portmann F. T. (2010). Groundwater use for irrigation – a global inventory, *Hydrology and Earth System Sciences*, 14, 1863-1880, doi:10.5194/hess-14-1863-2010 Accessed 25/06/2016.
- Stigter T.Y., Carvalho Dill A.M.M., Ribeiro L., Reis E. (2006). Impact of the shift from groundwater to surface water irrigation on aquifer dynamics and hydrochemistry in a semi-arid region in the south of Portugal *Agricultural Water Management*, 85, pp. 121–132.
- White T. A., Snow V. O. (2012). A modelling analysis to identify plant traits for enhanced water–use efficiency of pasture. *Crop and Pasture Science*, Vol. 63, pp. 63–76. <http://dx.doi.org/10.1071/CP11250> Accessed on 18/06/2016.
- Wood M. L., Finger L. (2006). Influence of irrigation method on water use and production of perennial pastures in northern Victoria. *Animal Production Science*, Vol. 46 (12), pp. 1605–1614.
- Wriedt G., Van der Velde M., Aloe A., Bouraoui F. (2009). Estimating irrigation water requirements in Europe. *Journal of Hydrology*, Vol. 373 (3), pp. 527–544.

CONSERVATION OF BIODIVERSITY AND GEOGRAPHICAL INDICATIONS IN MOUNTAIN AREA OF ALBANIA

Roland BARDHI¹, Alban IBRALIU²

¹ MADA (Mountain Areas Development Agency), Tirana, Albania.

²Department of Plant Sciences and Technologies Faculty of Agriculture and Environment Agricultural University of Tirana, Tirana, Albania

*Corresponding author: lbardhi@mail.com

Abstract

There are two decades or so, that the biodiversity issue was enriched by a new dimension called “Agrobiodiversity”. Geographical indications have been developed for primary and processed products of biodiversity. Geographical indication can be a tool to enhance the value of agrobiodiversity products and promote sustainable rural development. Geographical indications establish a connection between products (or services) and their territorial identity, and the quality, characteristics, and reputation of origin-based products are essentially associated with their geographical origins. The natural and cultural heritage of the Albanian Alps is one of the most rich and varied in Europe. The populations in these areas are, extremely poor and exploiting these natural resources, whether through farming or gathering, is one of the main means of earning an income. Official quality signs, especially Geographical Indications and organic farming, make it possible to improve product prices and value added for producers while encouraging the preservation of biodiversity by introducing this subject in product specifications. The aim of this paper is to present a research-action project aiming at crossing environmental injunction of biodiversity *in situ* conservation and traditional knowledge with economic objectives of rural period October 2015-March 2016P objectives were to identify, promote and protect agrobiodiversity in the poorest part of the country, creating quality signs of the local products (including medicinal and aromatic plants). BiodivBalkan project wants through the preservation of agrobiodiversity to: (i) improve the quality, adopt the standard and quality controls along the value chain; (ii) increase competitiveness of marginal producers in the market to bring higher income to farmers.

Keywords: *Agrobiodiversity, geographical indications, BiodivBalkan Project*

Introduction

This paper is intended to present the situation changed only in the last years when Albania began to embrace GIs as a useful rural development. Northern Albania has rich natural resources with a very high biodiversity and provides a significant contribution to the Albanian natural heritage. Nowadays the system is threatened by the unsustainable use and the degradation of the economic situation.

A geographical indication (GI) is a form of protection highlighted in the Trade Related Aspects of Intellectual Property Rights (TRIPS) Agreement of the World Trade Organization (WTO) Geographical Indication (GI) is a form of intellectual property identifying a product as originating from a region/locality/territory where its quality and reputation is associated with its geographical origin (UNIDO, 2010). GI have been thought to have the potential to protect the traditional indigenous know-how that is associated with agro-food production and to legally regulate land-use strategies and harvesting practices, by means of various specifications. As a

result, GI provides a relevant tool to protect and promote or enhance biodiversity (Larson Guerra, 2004). A geographical indication (GI) identifies a good as originating in a country, a region or a locality where a given quality, reputation, or other characteristics of such a good are essentially attributable to its geographical origin (Garcia et al., 2007). It is important therefore not only to consider the biological characteristics of a geographical area, but also the local knowledge and practices involved (Bérard and Marchenay, 2006) in order to achieve biodiversity benefits.

Today, geographical indications (GI) have an international reputation (Sylvander, 2005). GI are economic tools designed to create a specific market by differentiating products on the basis of their specific link to a given territory. Their founding principle is the legal protection of the geographical name attached to the product.

The European Union has registered some of its agricultural products as GIs and this has added billions of moneys to their economy. The products registered include MAPs whose qualities are determined by the geographical setting and resources, production system, handling, processing and storing methods; thus a human and natural link.

Albania has acknowledged the importance of GI and a law to facilitate GI registration has been in place from 2008.

Wild Bilberry is a potential MAP product for GI registering in two potential regions (Tropoja and Kukes) in Northern part of Albania. This product is unique in taste which is attributed to specific environment and weather conditions (Ibraliu and Beqaj, 2012). Apart from increasing monetary value and employment creation, this product has promoted area and biodiversity conservation through a number of programs.

Legal and institutional framework is very important in protecting of GI product. Giovannucci et al., (2009) emphasise that even with originality of potential GI product, the benefits will not accrue to the actors without the support of the legal and institutional framework. Other factors that support GI registration of products include; collective action, prices and market for the product, specificity and reputation of product, support from other actors along the value chain, production methods and link of the product characteristics to history or tradition of the geographical area (Bramley and Biénabe, 2013).

Perceptions on wild bilberry reputation and quality by the producers and consumers on the bilberry identified as potential for GI registration in northern Albania, have been attributed to the geographical area where the bilberry is produced and the initiatives by the stakeholders in the area. These initiatives include capacity building through trainings on bilberry forest management, bilberry value addition, ecosystem conservation and supply with equipment for product storing and drying, and processing.

The objective of the paper is to identify, promote and protect agrobiodiversity in the poorest part of the country, creating quality signs of the local products (including medicinal and aromatic plants). BiodivBalkan project wants through the preservation of agrobiodiversity to: (i) improve the quality, adopt the standard and quality controls along the value chain; (ii) increase competitiveness of marginal producers in the market to bring higher income to farmers.

The aim of this paper is to present and discuss BiodivBalkan project results which is conducted in Albania during period October 2015-March 2016.

Materials and Methods

This study was conducted in northern part of Albania, on the production of the different agriculture products. Wild Bilberry in two potential regions (Tropoja and Kukes) is considered as a good model for conservation of biodiversity through development of geographical indication.

These areas have already seen the establishment of a GI (Northern bilberry) and its own name is already used by the bilberry associations, established for each area.

In Albanian territory (Kukes and Tropoja regions) bilberry plant grows at high altitudes ranging from 1.000 m – 1.400 m and in steep terrain. Bilberry (*Vaccinium L*) is a shrub that ranges from 0 - 50 cm in height. From observations made in the field, it is found that the bilberry is a bush that grows as the sub forest element of the oak and subalpine and alpine meadows. Under the shadows of oak trees bilberries are developing little or none, while in subalpine and alpine meadows are develop pretty good giving a considerable amount of production.

in 2012300 , including farmers, pickers, collectors, processors and traders (Ibraliu and Beqaj, 2012). Few reports were used as information sources for the value chain analysis such as: the report of the project “The potentials of bilberry in the areas of Tropoja and Kukes regions in the context of quality signs and development of the respective value chain” (Ibraliu and Beqaj, 2012).

In order to receive qualitative and quantitative data, a field survey was conducted in two districts (Kukes and Tropoja) for a period of 4 weeks, where the team group has conducted face to face interviews in the defined areas with the farmers, pickers, collectors, processors and traders of bilberry product. The idea was to assess the changes that have occurred in qualitative and quantitative terms of bilberry product in two areas of the project.

Regarding to quantitative data, the questionnaire was organized in receiving of information of: (i) changes in the surface area collected from farmers; (ii) changes in the number of farmers involved in the collection of the product; (iii) the increase of the total quantity of product collected; (iv) increasing the quantity of the stored product, and (v) increasing product sold.

Regarding to the quality information and data, during the October 2015, we have collected samples in 10 different localities in Northern of Albania, in order to assess the anthocyanins content.

Results and Discussions

Bilberry producers and other actors in this sector can benefit from GI product registration. This would increase prices premiums and income for producers, forming an incentive to conserve the habitat for sustainable production. More support from political and institutional environment, regional and local organizations, coordination of actors in bilberry sector, creation of awareness on GI is however needed to facilitate registration of bilberry and conservation of the biodiversity around the products origin.

Management guidelines have been devised to protect, maintain or enhance wild bilberry resources. Different techniques and priorities for bilberry management have been implemented on the basis of site capability, survey results, and the rarity of suitable sites and the current age structure of bilberry producing stands within the management unit. Tabulations of currently utilized bilberry patches by location and age indicate an uneven distribution of bilberry picking opportunities, requiring prioritization of berry species for management in each territory or active intervention to rectify unbalanced age class structures. It is suggested that damages to bilberry areas in managed stands can be minimized through careful winter logging with understory protection, the use of partial cutting, light broadcast fire, and the use of selective brushing.

Information on bilberry auto-ecology, historic use patterns, and habitat suitability provides the basis for developing management rules for bilberry production.

A bilberry management plan which identifies specific areas to treat, when and how to treat them, however, cannot be provided until yield targets have been determined and yield curves have been

produced for various habitats. The bilberry quantity production to be targeted will also vary with the balance of resource emphasis options determined for a given landscape unit or territory.

Based on the data and information received and proceeded by the questionnaires, it is concluded that: (i) the total collection area used by farmers is increased with 7%; (ii) the number of farmers involved in the collection of the product is 5% higher in 2015 than 2014; (iii) the total quantity of product collected is increase with 6%; (iv) the quantity of the stored product is increase with 10%, which mean that farmers are more interested in fresh product, and (v) the product sold immediately after the collection is reduced with 12%; (vi) incomes increased 10%.

During the October 2015, we have collected samples in 10 different localities in Northern of Albania.

Total anthocyanins content. Total anthocyanin content was investigated according to the procedure described in Ph. Eur. 6.0 (European Pharmacopoea 6.0., 2008). Briefly, 50g of fresh berries were crushed extemporaneously. To 5g of crushed, accurately weighed drug, 95 ml of methanol were added and mechanically stirred for 30 min then filtered into a 100 ml volumetric flask. Filter was rinsed and diluted to 100 ml with methanol. A 50-fold dilution of this solution in a 0.1 per cent v/v solution of hydrochloric acid in methanol was prepared. The absorbance of the solution was measured at 528 nm, using a 0.1 per cent v/v solution of hydrochloric acid in methanol as the compensation liquid.

Delimitation of territory.

Tropoja area

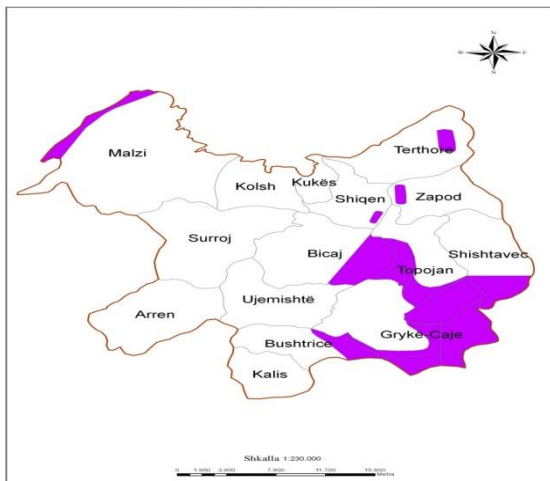

Kukes area

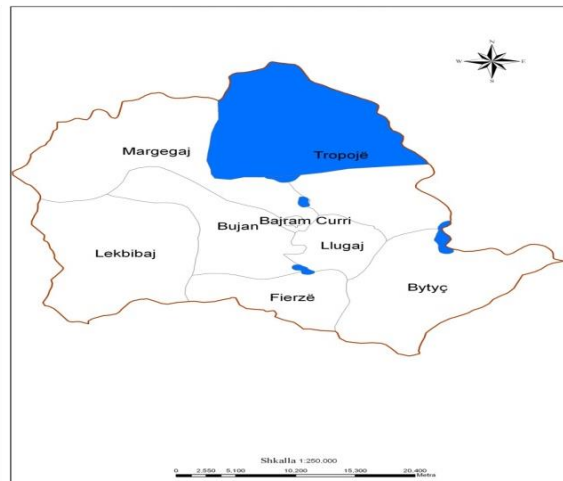

Quality results of the bilberry in two regions.

Kukes and Tropoja regions

Sample	Total anthocyanins	Total phenolics
• <i>Tropoje-shkelzen-kernaje</i>	• 0.49 ± 0.02	• 905.4 ± 29.6
• <i>Cerem Tropoje</i>	• 0.51 ± 0.02	• 1027.1 ± 23.8
• <i>Teblim puke</i>	• 0.46 ± 0.01	• 719.8 ± 51.2
• <i>Kolosjan -</i>	• 0.51 ± 0.01	• 708.3 ± 32.8
• <i>Gryke Caji</i>	• 0.41 ± 0.01	• 662.0 ± 43.1
• <i>Komuna fierze</i>	• 0.45 ± 0.02	• 735.3 ± 12.7
• <i>Dardhe</i>	• 0.16 ± 0.02	• 542.3 ± 52.4
• <i>Komune kelmend</i>	• 0.45 ± 0.02	• 620.4 ± 33.8
• <i>Kabash-blerim</i>	• 0.15 ± 0.00	• 433.9 ± 17.6
• <i>Gryke Caji</i>	• 0.47 ± 0.01	• 711.5 ± 56.8

Higher amounts of total phenolics were detected in our samples harvested from localities in Tropoja and Kukes region, especially the samples exposed to the sun in comparison with berries grown in shadow. It has been reported earlier that light intensity. The highest amounts of total anthocyanins were noticed in the same samples which were also the samples containing the highest amounts of total phenolics. Concerning the quality of tested samples from different sites of the project we believe to the very good potential of the bilberry in North of Albania and through economic development and commercial use of available natural resources populations living in those regions could achieve a better standard of living for farmers in these rural areas.

Conclusions

The rural development of Northern part of Albania can be improved through the creation of value added, and (GI) is a possible means towards that end where product has particularities and a preferential position in markets.

A distinctive sign-GI is created to protect bilberry as a unique product as well as to protect the territories from imitation and fraud with respect to their origin.

The local capacity of producer organizations and municipal governments in the areas where blueberries GIs have potential is also a significant factor when looking at the feasibility of GI implementation.

While there are expectations that GIs will provide protection against copy, imitation, and fraud, their effectiveness is limited by the nature of the products and conditions in local territories and the weakness of regulations and institutional capacity for enforcement. Regarding to bilberry GI since the law and its regulations as well as many other regulations are not in force, there is the risk about the sustainability of bilberries protection against imitation, fraud or false production.

Thus, there is a need for various instruments to protect local products of biodiversity - primary and processed - to allow the benefits to be retained by local communities and committed producers and processors.

A comprehensive sustainable development approach-agro-biodiversity valorization and conservation – requires a reflexive and practical iterative method all along the collective action process. This process brings shareholders and stakeholders together with a common understanding of these challenges, and finds the best fit between private interests, management of

the common good (labels), and public good (agro-biodiversity conservation). It has to be complementary to the product identification process, environmental assessment, production system analyses and support to appropriate practices. A set of various labels can be combined in order to fit with the different challenges of natural resources conservation, product development and market opportunities. Obviously, as shown by previous GI success story, there is no simple recipe: all cannot be done at the same time and collective dynamics may start from a very small coalition (Boutonnet J.P., Devautour H., Danflous J.P. 2009).

Recommendations

Bilberry collector, producers and traders in Northern part of Albania can benefit from GI potential bilberry, if the GI legal and institutional framework is active and other measures as per GI cycle are developed and considered. This would increase prices premiums and income for producers, forming an incentive to protect and conserve bilberry and the habitat for sustainable production. More support from political and institutional environment, regional and local organizations; coordination of actors in the bilberry sector; creation of awareness on GI is however, needed to facilitate GI registration of bilberry and conservation of the biodiversity around the products' origin.

Capacity within responsible national institutions must be improved to allow for effective enforcement of GI legislation and to promote their establishment in cases with proven potential. Access to information on the benefits, opportunities, necessary commitments, and investment and managerial needs for GIs to lead into successful business must be improved to ensure interested members of society can effectively engage in the process. Technical assistance to local producer organizations with potential to achieve GIs for local primary or processed products must also be improved when compelling opportunities have been identified.

References

- Bérard L., Marchenay P. (2006). Local products and geographical indications: taking account of local knowledge and biodiversity. *International Social Science Journal*, vol. 187, *Cultural Diversity and Biodiversity*, p. 109-116.
- Bramley, C. and E. Biénabe. (2013). *Guidelines for Selecting Successful GI Products*. p. 123-136.
- Boutonnet J.P., Devautour H., Danflous J.P. (2009). Conditions for the emergence of local products in the French Mediterranean. In: H. Ilbert, Tekelioglu Y., Tozani S. (eds). *terroir products, geographical indications and the local sustainable development of the Mediterranean countries*. Montpellier: CIHEAM - Mediterranean Seminars. p. 185-198. (*Mediterranean Options* n°89).
- Giovannucci D., Josling, T., Kerr, W., O'Connor, B and Yeung, M.T. (2009). *Guide to geographical indications, Linking products and their origins*. International Trade Centre, Geneva.
- Garcia C., Marie-Vivien D. , Kushalappa Chepudira G , Chengappa P. G. , and Nanaya K. M. (2007). *Geographical Indications and Biodiversity in the Western Ghats, India*. *Mountain Research and Development*, 27(3):206-210. 2007.
- Ibraliu A., Beqaj B., (2012). *Bilberry value chain assessment for Tropoja, Puka and Kukes districts, Albania*,
- Larson Guerra, J. (2004). *Geographical indications and biodiversity: bridges joining distant territories*. *Bridges* 8(2), 17–18.

Sylvander, B. (2005). "The products: the challenges of the twenty-first century ", In: INAO end Taste of origin". Paris: Hachette/INAO, 60–77.

UNIDO, (2010). Origin consortia: A key to the inclusive and sustainable valorisation of typical regional products.

SHORT- AND LONG-TERM EXPERIMENTS. HOW CAN WE INTERPRET THE RESULTS?

Marianna MAKÁDI^{1*}, Ibolya DEMETER¹, Tibor ARANYOS¹, Viktória OROSZ¹, Bernadett FEHÉR¹, József MÉSZÁROS², Attila TOMÓCSIK¹

¹Research Institute of Nyíregyháza, University of Debrecen, Nyíregyháza, Hungary

²Nyírségvíz Closed Shareholder Group, Nyíregyháza, Hungary

*Corresponding author: makadim@gmail.com

Abstract

Sewage sludge could be a valuable waste all over the world. Its agricultural utilization has high importance because of: i) the decreasing organic matter content of soils, ii) the environmentally sound recycling of a waste, iii) complex nutrient supply of cultivated plants. The quality of sewage sludge can be improved by composting, which process stabilizes the organic matter content of the sludge, disinfects the sludge, and the applied additives can improve the macro- and microelements content and other properties/components of the compost. However, the sewage sludge compost (SSC) application could have negative effects, especially the accumulation of toxic elements in the soil-plant system. The evaluation of the effects of SSCs bases on experiments with different duration. Therefore, we look for answers for the following questions: Do we want to utilize the SSC once or regularly? Can we deduce the effects of regular SSC utilization from the results of a two-year- experiment? Is it important to maintain long-term experiments? Our answers based on the results from a 13-year long-term experiment where 0, 9, 18 and 27 t/ha⁻¹ doses of SSC have applied in every third year in a small-plot experiment since 2003. The SSC contains dewatered sewage sludge (40%), straw (20%), rhyolite (25%) and bentonite (5%), designed for acidic sandy soils. Soil was sampled every autumn. The regular SSC application resulted in continuous changes of soil properties.

Keywords: *sewage sludge compost, sandy soil, soil enzymes, soil chemical properties.*

Introduction

Although the circular economy policy of EU is forced the zero waste or at least the minimum waste technologies, today the environmentally sound waste utilization has high importance. Waste utilization could be captured with soil improvement or plant nutrition by utilization especially organic wastes and by-products (Lakhdar et al., 2009; Weber 2014). Although sewage sludge composts (SSCs) have favourable properties and effects like high organic matter and plant nutrient content (Alvanger et al., 2015), increasing the biological activity of the soil (Peña et al., 2015), increasing the crop yield (Warman and Termeer, 2005), but SSCs could have also some negative effects, like toxic elements content (Smith, 2009), organic pollutants (Clarke and Smith, 2011), human pathogens (Alvanger et al., 2015) presenting in compost.

Chemical and microbiological processes of soils take place during different timescales (Targulian and Krasilnikov, 2007). Any treatments could have short- and long-term effects. When we study the effects of a treatment after some month or one year we could not measure long-term effects. However, the repeated use of wastes and different products made from them is the economical

way of their use in practise causing the presence of cumulative effects of these wastes which can be studied only in long-term experiments.

Are there any differences in the effects of one-off or regular treatments? Can we predict long-term effects based on one or two years experiments?

On the bases of our 13-year long-term sewage sludge compost experiment we try to find the answers for the questions of regular or one-off application of SSC and we try to compare the results of short-term and long-term utilization period regarding the effect of applied SSC on different soil parameters.

Materials and methods

A sewage sludge compost experiment was started in 2003 in the field of Research Institute of Nyíregyháza, Hungary, where our common product with Nyírségvíz Ltd., called NYÍRKOMPOSZT has applied in every third year at the rates of 0, 9, 18 and 27 t/ha⁻¹ doses. Small-plots are in size of 19 m X 12 m. The SSC was designed for acidic sandy soils therefore it contains dewatered sewage sludge (40% m/m), straw (20% m/m), rhyolite (25% m/m) and bentonite (5% m/m). The chemical parameters of SSC are not constant. The pH of our SSC was about 7, it contained about 25% (m/m, in dry matter (DM)) organic matter, 1.2% (m/m, DM) total-N, 1% (m/m, DM) total P₂O₅ and 0.2% (m/m, DM) total K₂O. The chemical properties of SSC applied in 2006, 2009, 2012 and 2015 met the requirements of Hungarian laws regulated the agricultural utilization of SSCs. Triticale (*x Triticosecale* Wittmack), maize (*Zea mays* L.) and green pea (*Pisum sativum* L.) were the test plants in the crop rotation, sown them in every year.

The soil of the experiment is acidic sand, Dystric Lamellic Arenosol in World Reference Base of soils. Soil was sampled in every autumn after harvesting all test plants and before sowing triticale. Samples were collected from the 0-30 cm soil layer. Main soil chemical parameters were the followings at the start of the experiment: pH_(KCl) 5.3, Humus content 0.9%, NO₃-N 9.6 mg kg⁻¹, AL-K₂O 183.3 mg kg⁻¹, AL-P₂O₅ 240.1 mg kg⁻¹.

Soil chemical parameters were measured according to the Hungarian Standards. Briefly, the pH was measured in a 1:2.5 soil: KCl (1 N) solution; the humus content was measured after the digestion with potassium dichromate and cc. sulphuric acid; NO₂-NO₃-N was measured in KCl extract; K₂O and P₂O₅ were measured in ammonium-lactate extract. Now we present and discuss the results of the years 2007, 2008 and 2014 which represent the 2nd and the 4th application period of the SSC.

Invertase activity was measured according to Mikanová et al. (2001) on the base of glucose formation. Catalase activity was estimated by measuring the release of O₂ from H₂O₂ amended soil samples according to the Hungarian Standard MSZ-08-1721/4-86. Chemical and microbiological results represent the average measured values of the soils of three test plants.

Statistical analysis was done by MS Excel and SPSS 22.0 programs. The data obtained were statistically analysed yearly by analysis of variance. For pairwise comparison of the means Tukey's test were used after ANOVA. With the whole database (26 soil parameters) of the year 2014, Principal Component Analysis was done. The significance level was p<0.05.

Results and discussion

Soil parameters are affected not only by treatments (Debosz et al., 2002) and used agricultural methods (Rusu et al., 2009), but by natural processes like weather conditions (temperature, precipitation), too (Wang and Wu, 2013). These circumstances can modify our activities. Agricultural utilizations of wastes usually are planned for long periods as a regular activity. In

Table 1 we present some soil chemical parameters of SSC treated plots. These are the main soil parameters contributing to nutrient supply of cultivated plants.

Data obtained in 2007 represent short-term (4 years) changes after 1st and 2nd SSC application. The results from 2008 represent a middle-term, while from 2014 the long-term changes caused by regular SSC treatment of agricultural land. The applied doses of SSC are moderate, planned for long-term, environmentally sound utilization.

Table 1. Chemical properties of soils

Year	Compost dose (t*ha ⁻¹)	pH _{KCl}	Humus (%)	NO ₂ -NO ₃ -N (mg*kg ⁻¹)	AL-P ₂ O ₅ (mg*kg ⁻¹)	AL-K ₂ O (mg*kg ⁻¹)
2007	0	6.18 a	0.95 a	10.46 a	224.65 a	190.68 a
	9	6.25 a	1.02 a	10.10 a	276.59 a	201.61 a
	18	6.25 a	0.99 a	8.45 a	234.16 a	199.53 a
	27	6.13 a	1.01 a	9.78 a	235.25 a	210.75 a
2008	0	4.67 a	0.79 a	7.21 a	134.59 a	187.94 a
	9	5.56 b	0.82 a	7.63 a	155.78 a	177.47 a
	18	6.01 b	0.85 a	10.40 a	240.61 b	174.52 a
	27	6.12 b	0.98 a	10.60 a	331.39 c	188.85 a
2014	0	4.60 a	0.58 a	4.11 a	154.00 a	125.16 a
	9	5.79 b	0.64 ab	4.71 a	205.93 b	160.37 b
	18	6.29 c	0.74 bc	5.61 a	259.80 c	187.73 bc
	27	6.50 c	0.85 c	5.42 a	297.20 c	211.13 c

a-c indexes mean different groups of means according to the Tukey's test at the significance level of $p < 0.05$.

In 2007 we have not found significant treatment effects on pH and macroelements content of soil samples. However, some trends could be seen in case of pH and phosphorus (P) content: the measured values are higher in SSC treated soils. Based on these results we could state that SSC application does not result in changes of the main soil chemical parameters and we could conclude that the soil can buffer the effects of our treatments. However, Warman and Termeer (2005) found an increase of plant available nitrogen (N) and P content of soil after two years of compost treatment. While the applied compost doses and the macronutrients content of compost was similar to our compost, the different effects could be caused by the different soil types and climatic conditions of experimental sites. But the question arises: if they have found changes in soil properties after 2 years of application, what will be the intensity of changes after 10 years?

In the middle of the 2nd SSC application period (2008) the directions of pH changes stabilized: non-treated soil had decreasing pH while high doses of applied SSC resulted in continuous increase of pH KCl. pH is the main soil parameter determining the soil processes (Nikol et al., 2008; Kemmitt et al., 2006).

The humus (organic matter) content and the concentration of macroelements varied among the years. Generally, the concentrations of the available N and P were increased with increasing SSC doses in every year but we had not found an increasing tendency similar to changes of pH KCl.

However, after examination of data obtained in 2008 and 2014, significant differences were found among treated plots which indicated changes taking place in treated plots after regular application of SSC in the experiment.

Similar effects were found in case of measured soil enzymes (Table 2). In 2007 the measured enzymes activities were similar in all treated soil samples. In the following years we found strong differences between the two measured enzymes. Invertase had significant annual fluctuations with not significant treatment effects in each year. However, the applied SSC resulted in organic matter (OM) input into the soil and the invertase takes place in the destruction of OM, this extra OM could not increase its activity. On the other hand, significant treatment effect was measured in the catalase activity after the 2nd SSC application.

Table 2. Soil enzymes activities in SSC treated soil samples.

Year	Compost dose (t*ha ⁻¹)	Invertase (mg glucose * 1 g ⁻¹ dry soil*4 h ⁻¹)	Catalase (mg O ₂ * 1 g ⁻¹ dry soil*1 h ⁻¹)
2007	0	0.870 a	1.35 a
	9	1.008 a	1.40 a
	18	0.915 a	1.39 a
	27	1.134 a	1.48 a
2008	0	4.451 a	1.32 a
	9	4.699 a	1.56 ab
	18	5.194 a	1.67 ab
	27	5.755 a	2.23 b
2014	0	0.296 a	1.31 a
	9	0.374 a	1.53 ab
	18	0.379 a	1.92 bc
	27	0.319 a	2.26 c

a-c indexes mean different groups of means according to the Tukey's test at the significance level of P<0.05.

On the base of the presented results we can conclude that the regular SSC treatment caused some changes in soil chemical and microbiological conditions until 2014. This statement is based on 7 general soil parameters. However, analysing more soil parameters (meso- and microelements, the total of 26 parameters) revealed that after 11 years of regular SSC application the soil properties have changed comparing to the non-treated soil (Fig.1). This result indicated that the measured slight changes appeared year by year could cause a shift of the whole soil properties. These processes could be slow as in our case, depending on the applied treatments therefore long-term experiments have high importance to study the effects of regular activity of humans.

Figure 1. Results of Principal Component Analysis of total database from year 2014.

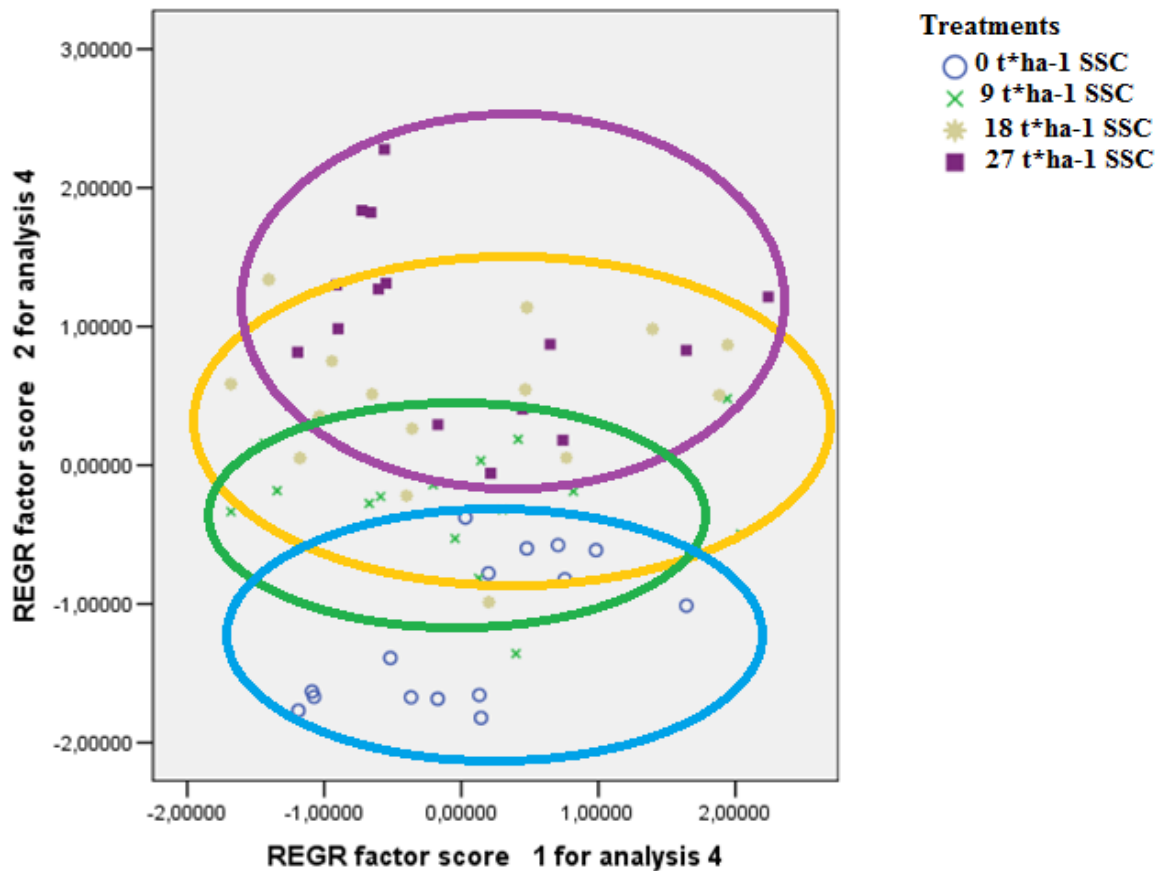

Conclusion

The activity of humans always affects the nature. If these interventions into our environment are not too strong, their effects occur only after long time. Therefore, it is a hard problem to predict the changes of soil properties after regular and long-term waste utilization. Many research groups work on testing the effects of waste utilization, but the experimental conditions are different which reduces the accuracy of comparing results, especially on the base of the duration of treatments. As our results proved, the results of short-term applications could be different from long-term, regular applications. After 11 years the treatment of soil with our SSC resulted in positive changes with small increase of nutrient content of soil without accumulation of toxic elements. But the changes in soils are continuous processes determined by climate, applied agrotechnical methods, etc. Therefore, we can conclude the expected changes of soil properties after a long-term activity like waste utilization in agriculture but for assessing the real processes, long-term experiments are needed.

Acknowledgement

We gratefully acknowledge the support of Nyírségvíz Closed Shareholder Group to maintain the long-term experiment.

References

- Alvarenga P., Mourinha C., Farto M., Santos T., Palma P., Sengo J., Morais M.C., Cunha-Queda C. (2015). Sewage sludge, compost and other representative organic wastes as agricultural soil amendments: Benefits versus limiting factors. *Waste Management*, Vol. 40, pp. 44-52.
- Clarke B.O., Smith S.R. (2011). Review of 'emerging' organic contaminants in biosolids and assessment of international research properties for the agricultural use of biosolids. *Environment International*, Vol. 37, pp. 226-224.
- Debosz K., Petersen S.O., Kure L.K., Ambus P. (2002). Evaluating effects of sewage sludge and household compost on soil physical, chemical and microbiological properties. *Applied Soil Ecology*, Vol. 19, pp. 237-248.
- Kemmitt S.J., Wright D., Goulding K.W.T., Jones D.L. (2006). pH regulation of carbon and nitrogen dynamics in two agricultural soils. *Soil Biology and Biochemistry*, Vol. 38 (5), pp. 898-911.
- Lakhdar A., Rabhi M., Ghnaya T., Montemurro F., Jedidi N., Abdelly C. (2009). Effectiveness of compost use in salt-affected soil. *Journal of Hazardous Materials*, Vol. 171, pp.29-37.
- Mikanová O., Kubát J., Mikhailovskaya N., Vörös I., and Biró B. (2001). Influence of heavy metal pollution on some soil-biological parameters in the alluvium of the Litavka river. *Rostlinna Vyroba*, Vol. 47, pp. 117-122.
- Nicol G.W., Leininger S., Schleper C., Prosser J.I. (2008). The influence of soil pH on the diversity, abundance and transcriptional activity of ammonia oxidizing archaea and bacteria. *Environmental Microbiology*, Vol. 10 (11), pp. 2966-2978.
- Peña A., Mingorance M.D., Rossini-Oliva S. (2015). Soil quality improvement by the establishment of a vegetative cover of a mine soil added with composted municipal sewage sludge. *Journal of Geochemical Exploration*, Vol. 157, pp. 178-183.
- Rusu T., Gus P., Bogdan I., Moraru p.I., Pop A.I., Clapa D., Marin D.I., Oroian I., Pop L.I. (2009). Implications of minimum tillage systems on sustainability of agricultural production and soil conservation. *Journal of Food, Agriculture & Environment*, Vol. 7 (2), pp. 335-338.
- Smith S.R. (2009). A critical review of bioavailability and impacts of heavy metal in municipal solid waste compost compared to sewage sludge. *Environ. Int.*, Vol. 35, pp. 142-156.
- Targulian V.O., Krasilnikov P.V. (2007). Soil system and pedogenic processes: Self-organization, time scales, and environmental significance. *Catena*, Vol. 71 (3), pp. 373-381.
- Wang J., Wu Q. (2013). Impact of experimental warming on soil temperature and moisture of the shallow active layer of wet meadows on the Qinghai-Tibet Plateau. *Cold Regions Science and Technology*, Vol. 90-91, pp.1-8.
- Warman P.R., Termeer, W.C. (2005). Evaluation of sewage sludge, septic waste and sludge compost application to corn and forage: yields, and N, P and K content of crops and soils. *Bioresource Technology*, Vol. 96, pp. 955-961.
- Weber J., Kocowicz A., Bekier J., Jamroz E., Tyszka R., Debicka M., Parylak D. and Kordas L. (2014). The effect of a sandy soil amendment with municipal solid waste(MSW) compost on nitrogen uptake efficiency by plants, *European Journal of Agronomy*, 54, 54- 60.

CHANGES OF THE SOIL PHYSICAL PROPERTIES IN AREA IMPACT OF ZAGREB-SPLIT HIGHWAY IN CROATIA

Danijela JUNGIC^{1*}, Vida VLADIMIR², Stjepan HUSNJAK¹

¹Department of Soil Science, Faculty of Agronomy, Zagreb, Croatia

²Department for landscape planning, Istraturist, Umag, Croatia

*Corresponding author: dvrhovec@agr.hr

Abstract

The biggest change occurring in the area of the highway Zagreb – Split is the degradation of the natural soil, especially its physical properties. The main objectives of this study were: (1) determine the physical properties of the soil in the area impact the highway (damaged soil) and outside these area (natural soil), and (2) determine the level, type and current processes of soil degradation. The research was conducted in 2006 on the section of the highway Zagreb - Split, from Gospić to Sveti Rok. Each of the 20 representative sites is divided into two sub sites: damaged soil and origin/natural soil to determine the condition and quality of the soil before and after the highway construction. The surface layer (0-10 cm) of damaged soils generally was less porous, smaller soil capacity for water and air, higher bulk density of soil, strong compacted, with more clay and unstable to a little stable macroaggregates. Excavation of topsoil, filling, and subsequently spreading new layers of soil in the lower horizons of the damaged soil contributed to the deterioration of its water and air conditions, poor infiltration, and difficulty in growing the plants. The results of the soil analysis as well as the state determinate in the field, indicating that the degree of soil degradation in the area of highway was extremely high. It is necessary to make repairs a unfavorable soil properties by agro ameliorative measures considering the plant requirements. Also, it is important to plan the full protection of the soil.

Keywords: *physical properties of soil, soil quality, highway, soil degradation.*

Introduction

Construction of highways as part of the global transport system is a fundamental condition for developing countries (Crnjak et al., 2008). The dynamic development of road transport leads to many unwanted consequences for man and the environment. The biggest problem in the impact zone of highways is the degradation of the natural soil in terms of pronounced changes in its physical, chemical and biological properties. For example, deterioration of soil structure, loss of organic matter and mineral nutrients in the soil, and loss of soil fertility (Zhao et al, 2007). Particle size distribution of the soil along highways is different than originally –natural soil- soil fertility and nutrient amounts are smaller, as same as the water capacity of soil, leading to a nearly irreversible damage to the soil (Shuqing et al., 2007). Only about 44% of the original soil can achieve quality improvement, and only after 10 years if stored 30% of the natural vegetation. Also along highways increases and bulk density of the soil, and the soil horizons are mixed and not consistent (Auerbach et al., 1997).The construction of the Zagreb – Split highway achieved better interregional connections within Croatian territory, but at the same time it actualized the problems of soil protection nearby the highway.Many relevant information related to the protection of the soil in the zone of the highway are scarce or have not been implemented in practice.

Therefore, the main objectives of this study were: (1) determine the physical properties of the soil in the impact zone of the highway (damaged soil) and outside this zone (natural soil), and (2) determine the level, type and current processes of soil damage.

Materials and methods

The survey was conducted in 2006 in the area of the field called Ličko polje on the part of the highway Zagreb - Split, from node Gospić to Sveti Rok tunnel with a length of 39,927 m. Mostly part of the field is at 570-608 m a. s. l. with a flat to slightly wavy configuration of the terrain and dominated heaths and grasslands. Although the route of the highway does not go into space Ličko polje, southern part of the route is nearing the Velebit mountain, and on the section of highway on the field no significant changes caused by the highway construction. As a part of field research, this route divided on 20 representative sites, and each site is divided into 2 subsites: damaged soil (within the 60 m width corridor of the highway) and natural soil (outside this zone), to determine the damage to the soil due to the operation carried out in the area. Ten sites were located along the highway in the direction of Split, and ten in the direction of Zagreb. On each subsites (total 40), was opened soil profile various depth, depending of soil type-and soil samples were taken for physical analysis only from topsoil (0-10 cm). Laboratory analysis of the basic physical properties of soils were determined based on ISO standards, or the manual for Soil Research (Škorić, 1982).

Results and discussion

During the study, at selected locations within the zone of the highway had been identified different causes and types of soil damage, Table 1.

Table 1. Causes and types of soil damage on route of the highway Gospić –Sveti Rok

Causes of soil damage	Types and processes of soil damage
Soil removing- the notchs construction	Excavation of entire soil profile- parent material on the soil surface (1,2, 4, 8,13,19 i 20)*
Soil removing – the slope embankment construction	Excavation the soil part and covering it with building and heterogenous soil materials without natural soil layers by filling, spreading and i planning (3,5, 6,7, 12, 14, 15, 16, 17,18)* Unfavorable ecological soil depth (7, 14, 18)*
Very strong slope, soil without vegetation	Active soil erosion processes (1,2,4, 8, 13, 18, 19, 20)* The occurrence of minor landslides (8 i 13)* Very collapsing of rock detritus (1 9, 10, 11)*
Small slopes	Soil erosion by rain (5, 12, 16)*
Soil degradation	Degradation of physical properties by compaction- heavy machinery and deposit of building materials (all locations) Degradation of chemical properties by alkalization – different building materials and waste were incorporated into soil (3, 5, 13, 15)* Degradation of biological properties (all locations)

* These numbers is refer to the number of locations-site on the researched route

Rockiness and skeletal structure of soil at locations 9, 10 and 11 cause excessive drainage, as well as poor water retention by soil, and the emergence of strong erosion processes. Ecological soil depth, in the impact zone of the highway, was often limited due to the application of different types of substrates, the foundation (cot, buffer zones), building materials and waste, and

impermeable film and various installations. The slope of the hillside along the highway was often greater than 45° which lead to of different types and intensity of erosion processes but also disabled the retention of vegetation.

At some locations, the cuts in the highway zone, it was found the parent material on the soil surface as a result of the excavation and construction of cuts. The result is the loss of the entire soil profile. In the other sections, where the embankments were constructed, after opening the soil profile was observed the presence of the reclamation of crushed stone and heterogeneous soil materials, and the location 7 was set also impermeable film for the purposes of the closed drainage system. In these soils has not been natural horizons, but only heterogeneous artificial soil layers, which is confirmed by Jim (1997). The results of our study confirmed the Craul (1992), which is in several soil profiles in urban areas found there pedogenetic discontinuity caused by construction projects. The above constructions have influenced the change water and air relationship in the soil, poor infiltration, and thus difficult penetration of plant roots. Otherwise, in natural soils outside the zone of influence highway were identified the correct stratigraphy in soil profile.

This is a karst area (limestone and dolomite, limestone and dolomite breccia) that are typical proluvial and aeolian sediments from which they developed distric cambisol and luvisol. Due to filling and making watertight layers (cot, tampons) in the construction of the highway, coming to break the influence of the parent material on mineral detritus which entering the soil profile. The effects of the highway to change some important physical properties of the surface layer (0-10 cm) of natural and damaged soils are shown in graphs 1-5. The total porosity (P) on both soils varied from little porous to very porous soils. The porosity of the damaged soil, mainly the lower (43,8- 60,5% vol.) compared to the natural soil (43.0 -65.0% vol.), Graph 1.

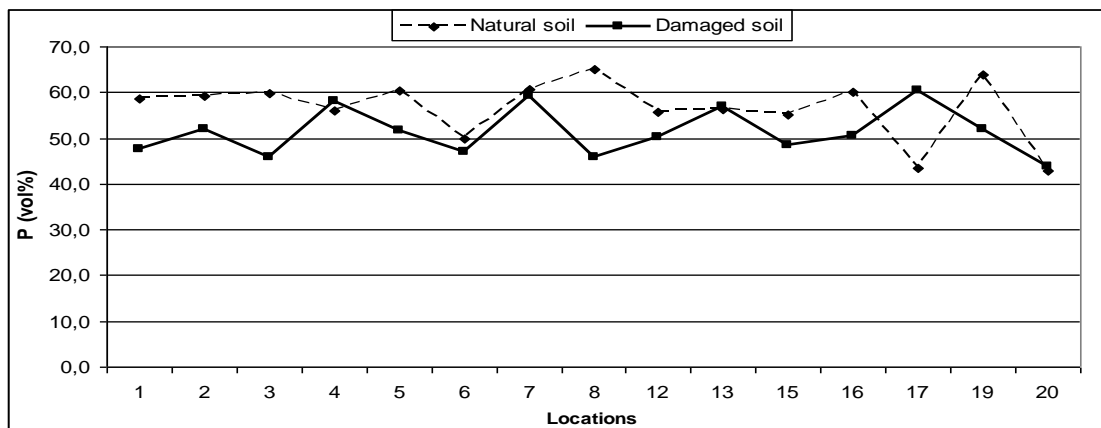

Graph 1. Total porosity (P) in surface layer (0-10 cm) of natural and damaged soil

Soil capacity for water (Cw) in natural soils was mostly larger than damaged soil had medium values. In natural soils, Cw were ranged from 39,0 to 51,8% vol. (medium to large Cw), and a na from 33,3 to 51,3% vol.in damaged soils (low to large Cw), Graph 2.

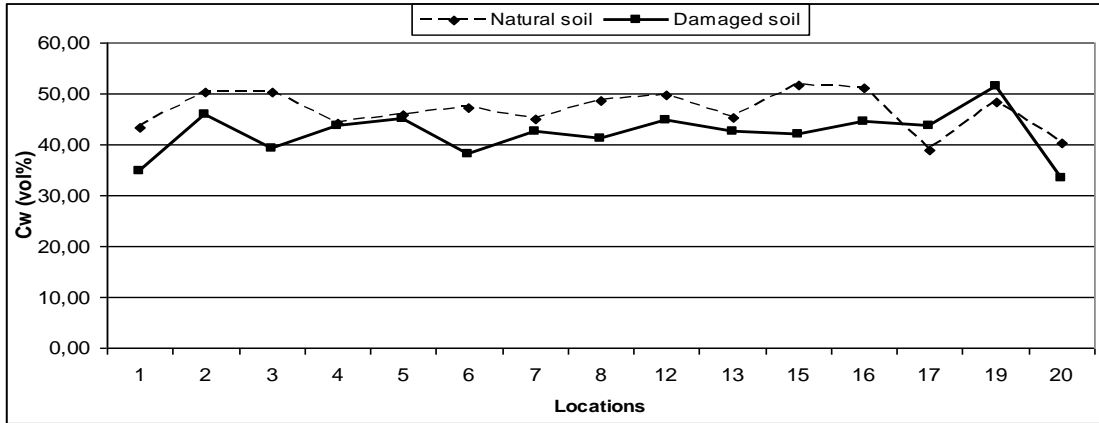

Graph 2. Soil capacity for water (Cw) in surface layer (0-10 cm) of natural and damaged soil

Soil capacity for air were in wide range from 2,6 to 16,3 % vol on natural soils and from 0,7 to 17,0 % vol on damaged soils. It was soils with very low to very large soil capacity for air, Graph 3. For 8 of the 15 locations of the damaged soils, soil capacity for air were less than 10%, and this value was considered as critical limit below which there was stopped of gas diffusion and reduced the hydrodynamic air permeability. In these conditions the roots of the grass stops growing, and other processes in the soil were slow down (mineralization of organic matter, changes of CO₂ and O₂ during respiration of plants and microorganisms in the soil), which stand out and Ćosic et al. (2005).

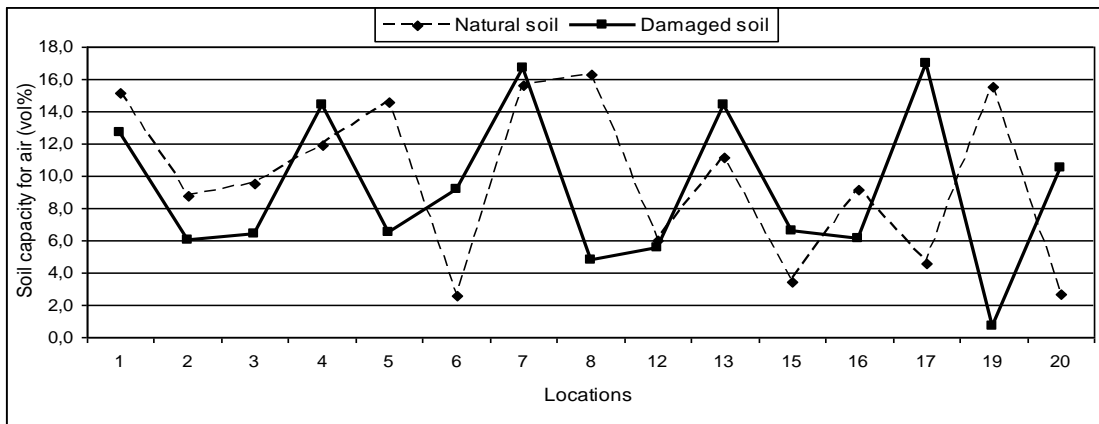

Graph 3. Soil capacity for air in surface layer (0-10 cm) of natural and damaged soil

Soil compaction varied between the natural and the damaged soil. In the damaged soil, at all locations it was higher than the natural soil. In natural soil compaction is small to medium, from 1.05 to 1.66 g / cm³, while the damaged soil medium to very strong (1.42 to 1.95 g / cm³), Graph 4. Increased soil compaction was result of the use of heavy machinery, and various rock and / or soil material adverse hydraulic properties, which are mixed and used for reclamation and planning the slope of the embankment along the highway. Such a compacted layer of the thin material piled loose and shallow surface layer is the limiting factor in the spread of the root system of plants, but it is developed in the surface layer of the soil as evidenced Zisa et al. (1980).

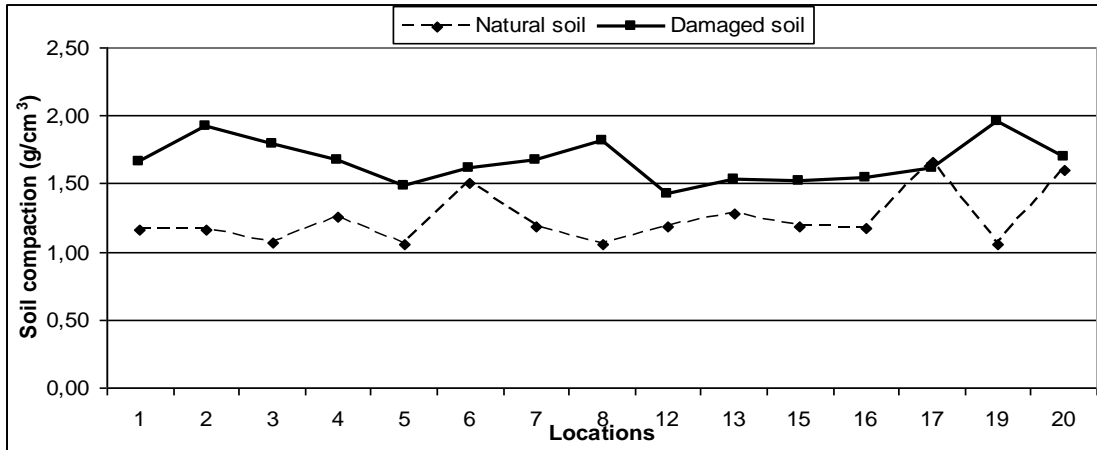

Graph 4. Compaction in surface layer (0-10 cm) of natural and damaged soil

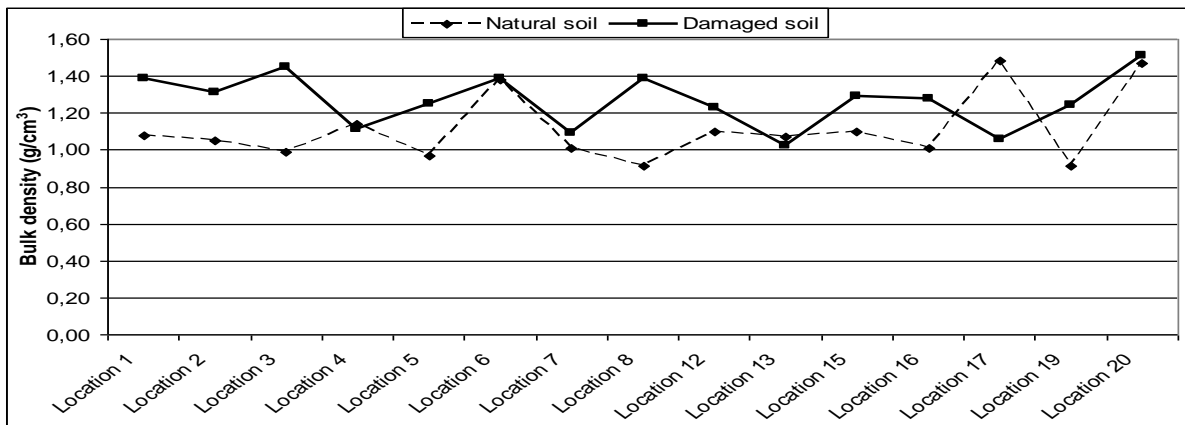

Graf 5. Bulk density (ρ_v) in surface layer (0-10 cm) of natural and damaged soil

Bulk density (ρ_v) in damaged soil was higher (1,02 - 1,51 g/cm^3) than natural soil (0,91 - 1,48 g/cm^3), Graph 5. Because of the increased bulk density of damaged soil, a slowdown water infiltration occurs, as well as increasing runoff of water across the soil surface and increasing the risk of soil erosion. As a result, there was the destruction of the sown grass species, especially on the locations 2, 8 and 19, which is in accordance with studies Duffy and McClurkin (1974). Soil texture only at locations 5, 6 and 12 was the same on both soils, but in damaged soils (locations 2, 4, 7, 8, 13, 17, 19) was increased the clay content relative to the natural soil, Table 2.

Table 2. Analysis of soil degradation by changing soil texture

Intensity of change the soil texture*		Number of locations
Natural soil	Damaged soil	
SL	C	4
I	C	3
SL	SCL	2
SL	CL	1
SL	L	1
L	SaCL	1
No changes		3

* **Legend:** SL-silty loam; L-loam; SaCL-sandy clay loam; SCL- silty clay loam; CL-clay loam; C- clay

At the damaged soil was less stability of macroaggregates (completely unstable to a little stable), while the stability of microaggregates was higher (quite stable to very stable) in relation to the natural soil, Table 3. These results confirmed by Craul (1992), which found that interventions such as excavation, relocation and spreading influence the unstable structure of the topsoil.

Table 3. Analisis of soil degradation by changing soil structure

Intensity of change the soil macroaggregates		No loc.	Intensity of change the soil microaggregates		No loc.
Natural soil	Damaged soil		Natural soil	Damaged soil	
complete. stable	completely unstable	8	little stable	very stable	4
complete.stable	unstable	3	very little stable	little stable	3
complete. stable	little stable	3	quite stable	very stable	3
quite stable	completely unstable	1	very little stable	quite stable	2
little stable	completely unstable	1	little stable	stable	1
unstable	completely unstable	1	unstable	little stable	1
No changes		-	No changes		2

During the construction of this highway, a major problem was a lack of specified measures for soil protection. Eg. It was not specified the manner in which the excavated material must deposit, and were not taken into account the pedological parameters such as porosity, structure, humus and soil capacity for water during the preparatory work on highway construction. In addition, the locations with visible soil and vegetation damages gave the impression of unattractive landscape and reduced visual quality of the landscape.

Conclusion

Soil degradation in the zone of Zagreb-Split highway were result of the relocation, excavation and filling with different building and soil materials. Consequences were: loss of part or the whole soil profile, soil stratigraphy changes, adverse physical soil properties and lack of ecological soil depth. In most locations, damaged soils had a lower porosity, capacity of soil for water and air, and a larger bulk density and soil compaction in relation to the natural soil. At 7 locations was increased clay content in the soil. In accordance with the condition of the soil in the field and the results of analysis of soil physical properties must be detailed corrected and improved conditions in the soil and to align them with the requirements of the plants. During the construction of new highways special attention should be paid to the soil protection.

References

- Auerbach N.A., Walker M.D., Walker D.A. (1997). Effects of roadside disturbance on substrate and vegetation properties in Arctic tundra. *Ecological Society of America. Ecological Applications* 7 (1) : 218-235.
- Craul P.J.(1992). *Urban soil in landscape design*. John Wiley and sons inc. New York.
- Crnjak M., Puž G., Marić A., Čleković V. (2008). *Croatian motorways*. Croatian motorways ltd. Zagreb
- Ćosić T., Čoga L., Potočić N., Herak Ćustić M., Poljak M., Petek M., Horvat T. (2005). Causes of lawn and ornamental plants degradation at the Patriotic War Memorial Cemetery in Vukovar. *Agronomski glasnik*, 2 (4) : 267-283
- Duffy P.D., D.C. McClurkin (1974). Difficult eroded planting sites in north Mississippi evaluated by discriminant analysis. *Soil Science Society of America Proceedings* 38:676-678.

- Jim C.Y. (1997). Urban soil characteristics and limitations for landscape planting in Hong Kong. *Landscape and Urban Planning*, 40 (1998): 235-249.
- ShuQing Z., BaoShan C., LiNa G., Jie L. (2007): Effects of highway construction on soil quality in the Longitudinal Range- Gorge Region in Yunnan Province. *Chinese Science Bulletin*. Vol. 52: 192-202.
- Škorić A. (1982). *Manual for Soil Research*. Faculty of agricultural sciences, Zagreb
- Zhao H., Cui BS., Bai JH, Ren HL. (2007). Effects of expressway on the soil-plant systems in the Longitudinal Range – Gorge Region. *Chinese Science Bulletin*. Vol. 52 (2): 203-212
- Zisa, R.P., Halverson H.G., Stout B.B. 1980. Establishment and early growth of conifers on compact soils in urban areas. USDA Forest Service Research Paper NE-451, 8 p. Northeastern Forest Experiment Station, Broomall, Pa.

THE EVALUATION RESULTS OF CLIMATE CHANGES FOR SLCAL BENEFICIARIES' PROJECT

Mohammed HUSSEIN^{1*}, Mohamed ELRAEE²

¹Department of Agronomy, Earth & Human Centre for Research and Study (EHCRS)

²Director of, Earth & Human Centre for Research and Study (EHCRS)

*Corresponding author:mahkh101@yahoo.com

Abstract

Farmers in the Gaza Strip are affected by the climate changes of temperature, humidity, wind, rain and frost which have caused economic losses of more than 80% of their agricultural production. The researchers conducted 11 workshops in five areas in the southern part of the Gaza strip (Abasan, Khuzaa, Al-Qarara, Al-Shoka and Al-Fokhary) in the period between 1-17 December, 2015. It aimed to educate farmers about climate changes and its effects on agriculture sector. A structured interviewed questionnaire was used to collect data on climate change effects on the targeted farmers in SLCAL project. The total number of farmers who participated in the interviews in all areas was 206 participants. The researchers used the questionnaire as a tool for monitoring and identifying these changes in the Gaza Strip and how the farmers are dealing with these changes. The main indicators which were used to measure the climate change effects are: A) Temperature: Through the analysing the farmer's answers in different areas, where they mentioned that the crops affected by high temperature in all areas with a relative weight of 43.7%. B) Rain: The intensity of the rainfall negative impact was the greatest on agricultural crops in all areas and reached 45.3%. C) Humidity: Considering the effect of moisture on agricultural crops, results showed that the high humidity has the greatest impact rate which reached 59.3%. D) Wind: According to the farmers' opinions, it has been shown that all areas affected by wind in terms of intensity, speed and direction, relative weight were as follows 50% - 33.7% - 16.3%.

Keywords: *Evaluation, agricultural crops, climate changes, beneficiaries.*

Introduction

Climate change is considered one of the most important issues that have become the focus of the world attention due to the effects of these changes and their growing impact on the lives of people in all respects. The agricultural sector is considered one of the most important sectors affected by these changes because of its direct relation to the components and elements of climate change, which include temperature, humidity, wind and rain. Perhaps, concern of the impact of these changes on the agricultural sector and studying these impacts objectively is prioritized over the other sectors due to the importance of the agricultural sector in providing food security for citizens. Therefore, the study of the impact of these changes on the production volume of the agricultural sector, from one hand, and to study ways to reduce or adapt to those changes in order to reduce the size of the effects of those changes on farmers, the other hand, are some of the core issues that are of concern and debate in the Palestinian economic circles. This is due to the effect on Palestine in general by these changes and the Gaza Strip in particular. The project of "strengthening livelihoods through community adaptation and learning" (SLCAL) is one of the first pioneering piloting applied research projects in the Gaza Strip. This project is funded by

Federal Ministry for Economic cooperation and Development (BMZ)- Germany in partnership with Care international and implementing by Applied Research - Institute Jerusalem (ARIJ) and Earth and human centre for researches and studies – Gaza Strip (EHCRS). It studies the effects of climate change on the agricultural sector and conducts experiments and applied research to study the impact of these changes on the agricultural productivity of the sector, both on the field crops level or vegetables. Furthermore, this project introduces modern agricultural techniques and modern innovations as one of the experiences and important trends that can be generalized to a regional and international scale to limit the negative impacts of climate change on the agricultural sector, or at least adapt to them. Perhaps, one of the most modern technologies that have been used to reduce these changes is to follow the new patterns in irrigation such as the regular drip irrigation systems, and the use of improved varieties of field crops seeds adapted to climate change. In addition, other technologies can be used such as Hydrogel or mulch to reduce the volume of water losses and other technologies that will be displayed within this research paper. Studies of the Earth Research Centre and human experience of the first quality tests are also considered in this area in the Gaza Strip since this project meets the vision and mission of the centre. This vision focuses on finding new mechanisms and techniques to reduce life problems by using scientific research. Therefore, the results of this project have relied fully on the results of a real research process that used the experimental method to obtain the results that will be displayed. This study is an important reference for dealing with climate changes at the agricultural level. It highlights the most important instruments and methods that the farmer can use to face climate changes such as temperature, winds, humidity and fluctuations in rainfall. The study also constitutes an important tool to evaluate the effect of climate change on the changes of quality of agriculture in the past ten years and therefore to determine the adaptation policies with climate changes and the choice of suitable types of plants amidst these changes. In general, the study is an important tool for directing agricultural policies towards the best practices required to face climate changes according to the study results. The study is an important tool for researchers and specialists in both the agricultural and environmental sectors. This study conforms with the report of adaptation strategy with climate changes in the Palestinian territories (United Nations Development Programme/ Programme of Assistance to the Palestinian, 2009). The main dangers resulting from climate changes in achieving food and water security in the Gaza Strip have been determined. They are: changes in the areas of agricultural crops due to lack of optimal agricultural conditions, a decrease in the production of crops and livestock, increasing danger of water scarcity and drought and increasing irrigation requirements.

Materials and methods

First: Methodology of Data Collection:

Authors relied on the structured interview questionnaire tool in order to assess climate impacts on the target group of the SLCAL project. The methods to deal with these changes were 11 implemented workshops carried out in the intervention areas in various provinces in the southern Gaza Strip (Abassan, Khaza'a, Qarara, Shoka, Fukhary). The workshops explained to farmers the concept and the different forms of climate change and explained and clarified the questionnaire used for purposes of monitoring these changes in the Gaza Strip. It also aimed to identify how the farmers dealt with it during the past period. The researchers depended on the methodology of structured interviews in this questionnaire and the total number of targeted farmers in all implementation regions was 206. They participated in various workshops where their attitudes

about the impact of climate change on them and how to confront these changes in its various forms were monitored. The sample of farmers was chosen according to the various different geographical areas in the southern Gaza Strip.

Second: Systematic Data Analysis:

The researcher has adopted the comparative descriptive approach in the analysis of the data that was extracted. The results of the various questionnaires and workshops were analysed and summarized. The methodology conducted was the descriptive analysis approach and the results were presented using various tools, including charts and graphs, and others.

Results and discussion

First: The Impact of Climate Change on the Agricultural Sector:

The Effect of Temperature on the Agricultural Sector: According to the farmers' orientation and opinions about the effects of temperature in different areas, the table below describes the effect of the degree of temperature on agricultural crops.

Table1: Effect of temperature degree on agricultural crops

#	Climate effects	Degree	Mean	Molecular Weight	Standard deviation
1	Temperature*	Rise	1.69	43.7%	0.79
		Low	2.51	16.3%	0.56
		Frost	1.74	42%	0.79

Source: Analysis of farmers' point of view.

*We have relied on 1-3 scale where 1 is the class of high importance, while Class 3 low importance

Effect of Rain Cases:

According to the farmers' orientations and opinions about the effects of rain in different areas, the table below describes the raining effects on agricultural crops.

Table 2: Raining effects on agricultural crops.

#	Climate effects	Ways	Mean	Molecular Weight	Standard deviation
2	Raining	Quantity	1.96	34.7%	0.7
		Description	2.37	21%	0.69
		Degree	1.64	45.3%	0.87

Source: Analysis of farmers' point of view.

The Effect of Moisture on the Cases of the Agricultural Sector:

According to the farmers' orientations and opinions about the effects of humidity in different areas, the table below describes the humidity effects on agricultural crops.

Table 3: Humidity effects on agricultural crops.

#	Climate effect	Humidity	Mean	Molecular Weight	Standard deviation
3	Humidity	High	1.22	59.3%	0.43
		Low	1.78	40.7%	0.44

Source: Analysis of farmers' point of view.

The Effect of Wind on the Agricultural Sector:

According to the farmers' orientations and opinions about the effects of wind in different areas, the table below describes the wind effects on agricultural crops.

Table 4: wind effects on agricultural crops.

#	Climate effect	Type of effects	Mean	Molecular Weight	Standard deviation
4	Wind	Speed	1.99	33.7%	0.68
		Direction	2.41	16.3%	0.69
		Strong	1.5	50%	0.78

Source: Analyses of Farmers point of view.

Secondly: The Farmers' ways of dealing with climate change:

A. Temperature:

Table 5: The ways that the farmers deal with climate changes, especially temperature

#	Temperature	Ways	Farmers %	
1	High temperature	Sprinkler Irrigation		53.4%
		Ventilation		17%
		Others	Erection the Greenhouses	29.6%
			Planting high trees around crops	
Put visor sun above crops				
2	Low temperature	Heating		39.3%
		Decrease irrigation		17.5%
		Others	Put Nylon to protect the trees	43.2%
			Fertilizing	
3	Forts	Heating		58.3%
		Irrigation by wells		13.6%
		Others like Fertilizing		28.1%

Source: Analyses of Farmers point of view.

B. Rain: The table below describes the ways that the farmers use to deal with climate changes, especially in raining and also the percentage of farmers that used each way.

Table 6: the ways that the farmers use to deal with climate changes, especially in raining

#	Raining	Ways	Farmers %	
1	Quantity	Collecting pools from raining	18%	
		Water channels	82%	
2	Description	Water channels	80%	
		Collecting pools from raining	15%	
		Others	Irrigation	5%
			Open branch channels	
No action				
3	Degree	Sand barriers	65%	
		Drainage channels	20%	
		Others	Channels	15%
			Small valleys	
			Soil tillage	
No action				

Source: Analyses of Farmers point of view.

C. Humidity: The table below describes the ways that the farmers used to deal with changes especially, with humidity and also the percentage of farmers that used each way

Table 7: The farmers used to deal with climate changes especially, with humidity

Humidity	Ways	Farmers %
High humidity	Ventilation the greenhouses	70%
	Decrease Irrigation and use pesticides	15%
	Others	Use fire for heating
Low humidity	Increase irrigation	65%
	Ventilation and heating the crops	14%
	Others	Use pesticides No action

Source: Analyses of Farmers point of view.

How to Deal with the Wind Changes: The table below refers to the ways and mechanisms used by farmers to deal with climate change, particularly with regard to strongly wind.

Table 8: The ways how the farmers deal strongly wind

#	Winds	Ways	Farmers %
1	Speed	Put barrier	43%
		Planting high trees	47%
		Others	10%
2	Direction	Change the direction of farm	30%
		Planting high trees	51%
		Others like planting crops with strong stalks	19%
3	Degree	Planting high trees	80%
		Put nylon around crops	12%
		Others	8%
		Put fence around farm Spray hormones to Install the flowers	

Source: Analyses of Farmers point of view

Conclusion

The Gaza Strip has been affected by varied temperatures over the past years. The effect of high temperature has had the utmost importance for farmers where this situation led to the burning and wilting of crops, in addition to the droughts of different varieties of crops which led to damage in many seasons. Also, it has been affected by different rain rates over time. Cases of severe rain have had the greatest impact on farmers as one of the most important forms of climatic change. This situation has led in many cases to the erosion of the soil and the destruction of agricultural crops in the Gaza Strip. High humidity levels have had the biggest impact on farmers in the various areas where they have led to plant pathology and burn and damage to the crops. Cases of high winds are important phenomena associated with climate change in the Gaza Strip. The effect was on the largest agricultural crops in different areas where the impact led to cracking and dislocation of crops and trees and damage to the crops. One of the main methods used by farmers to cope with cases of high temperatures are irrigation water workshops (53%), while 17% used ventilation to cope with this situation method and 30% used other methods to cope with those changes. The establishment of fences and barriers are some of the most important methods used by farmers to cope with cases of severe rain. 65% of them use this method. 20% of them set up drainage channels for water to cope with this situation, while 15% of them use other methods. Most farmers resort to ventilate greenhouses in case of high humidity rates. 70% of farmers use this method. 15% of them resort to reducing the rates of irrigation and spraying fertilizers in this case. 15% use other methods. In cases of high winds, 80% of farmers turn to the cultivation of high trees and the establishment of screens to protect agricultural crops, while 12% of them resort to nylon to develop and mesh crops to protect them. 8% resort to the use of other methods to deal with this situation.

References

- Abu-Jamous, S. (2009) Potential Impact of Climate Change on Agricultural Water Demand: A Case Study of Jericho District, Palestine. MSc thesis, Birzeit University.
- El-Kadi, A. (2005) Global warming: a study of the Gaza temperature variations in the period 1976-1995", Islamic University Magazine 13(2): 1-19.

Mason, M., Mimi, Z. and Mark Zeitoun, M. (2009) Climate Change Adaptation Strategy and Program of Action for the Palestinian National Authority: Climate Change Adaptation strategy for the Occupied Palestinian Territory. The program was initiated by environmental Quality Authority (EQA) and financed by UNDP/PAPP.

Palestinian Water Authority (2007) Rainfall Data in Gaza Strip, Ramallah: PWA.

Yacoubi, Ahmad (2008) Gaza Strip: Sustainable Yield of the Coastal Aquifer. Unpublished report, Ministry of Agriculture, 2008. Rainfall Seasonal Report 2007/2008, Palestine.

BEHAVIOUR OF SEVERAL APPLE (*MALUS DOMESTICA* BORKH.) CULTIVARS GROWN UNDER AGRO-ECOLOGICAL CONDITIONS OF GJAKOVA, KOSOVO

Gjokë DUHANAJ¹, Lush SUSAJ^{2*}

¹University "Fan S. Noli", Faculty of Agriculture, Department of Horticulture, Korçë, Albania

^{2*} Agricultural University of Tirana, Faculty of Agriculture and Environment, Department of Horticulture and Landscape Architecture, Kodër Kamëz, 1029, Tirana, Albania

*Corresponding author: lsusaj63@hotmail.com

Abstract

Study “Behaviour of several apple (*Malus domestica* Borkh.) cultivars grown under agro-ecological conditions of Gjakova, Kosovo”, was carried out during the period 2014-2015, in Skivjan, Gjakova, in an apple orchard planted in 2006, using grafted seedlings over M9. Apple trees were planted in distances 3.8 m x 1.8 m (1460 trees/ha). Six apple cultivars (variants) (Montear Gala, Royal Gala, Red Falstaff, Saturn, Jonagored, and Golden Delicious), 4 replications, with 5 apple trees for each variant on each replication, were used. There was found that there were significant differences between cultivars for flowering period and duration. Montear Gala bloomed the first (April 26), followed by Royal Gala (April 27), Red Falstaff (April 29), Saturn (May 10), and Jonagored (May 12). Flowering duration varied from 13 days, for the earliest cultivar (Montear Gala) to 9 days, for the latest cultivar (Jonagored). At harvest time, there were measured, evaluated, accounted and compared several quality indicators, such as moisture content (%), total soluble solids content (°Brix), dry matter content (%), total acidity (mg/100 g), and vitamin C (mg/kg). DMC varied from 14.2% (Saturn and Montear Gala) to 16% (Golden Delicious), TSSC varied from 11.46°Brix (Royal Gala) to 12.8°Brix (Saturn), TA varied from 0.25 (Saturn) to 0.395 mg/100 g, and vitamin C varied from 195 mg/kg (Red Falstaff) to 230 mg/kg (Montear Gala). Observed differences between cultivars were significant and statistically confirmed by ANOVA, while, there was found a strong relationship between chemico-technological features of the apple fruits ($r > 0.9$).

Keywords: *apple cultivar, blooming period, chemico-technological features, duration, orchard.*

Introduction

Apple is one of the most important fruit in the world which, due to its high nutritional value, ranks thirds in consumption, after citrus and banana (UIE, 2013). The total world apple production for 2012 was 76 378 700 tonnes (FAO, 2014), where China is in the first place by 37 001 601 tonnes, followed by USA with 4 110 050 tonnes, Turkey by 2 889 000 tonnes, Poland by 2 877 340 tonnes, India by 2 203 400 tonnes, Italy by 1 991 310 tonnes, and so on (FAO, 2015; Ferraj & Thomaj, 2014). Apple tree belongs to Family Rosaceae, Genus *Malus*, Species *Malus domestica* Borkh., with several types which can be easily grafted (Pollan, 2001). There are more than 7500 known cultivars of apples, resulting in a range of desired characteristics. Apple tree is very well adapted in different climate conditions, that's why it is widespread in different eco-geographical regions. The original wild ancestor of *Malus domestica* was *Malus sieversii*, found growing wild in the mountains of Central Asia in southern Kazakhstan, Kyrgyzstan, Tajikistan, and Xinjiang, China (Pierre-éric *et al.*, 2006; Janick *et al.*, 1996). The most decisive role in the creation of new cultivars and rootstocks belongs to wild apple, *Malus sylvestris*, *Malus sieversii* (Kaukazan apple), *Malus pumila*, and *Malus floribunda* (Mehinagic *et al.*, 2004).

Blooming and yield features of apple cultivars depends upon to cultivar and the climate conditions of the region. There exists a strong interaction and relationship between blooming features and yield of apple (Shala, 1995). There is a need for the raise of knowledge of differences and behavior of different cultivars, and relationship between blooming and yield features, as well, for the raise of investments effectivity (Stainer *et al.*, 1996). Such features like starting and ending time of flowering, as well as the duration of flowering, are very important for a good regionalization of apple cultivars and to determine the right variety structure (De Long *et al.*, 1999). Fruit features, such as dry matter content, total soluble solution content, total acidity, mean fruit weight, color and fruit firmness, shape and flavor, etc, are very important for the final product destination (De Jager & Roelofs, 1996). Knowing the expression level of productivity features under certain climate and land conditions helps the improvement of variety structure and the better regionalization of varieties for fresh consumption and for agro-industry (Lind *et al.*, 2003). Starting and ending time of flowering, as well as chemico-technological features, are different for different cultivars, even for the same cultivar in different climate and land conditions (Ingle *et al.*, 2000). Market and consumers require fresh apples with a good commercial appearance, uniform size and color, specific taste and flavor (Aaby *et al.*, 2002). Total soluble solids content, organic acids content, aromatic and phenolic compounds are very important for consumer and alimentary industry. Fresh apple fruits contain mineral salts, vitamins and phytochemicals, such as carotenoids, flavonoids and phenolic acids. Consumer is interested especially for chemical compounds of apples as very important antioxidants for human organism (Ackermann *et al.*, 1992). Nowadays, the farmers are working for constructing of new, highly sustainable and intensive orchards, which express high biological and productivity characters, using densed planting, with lower crop loads and bound forms, etc (Awad & De Jager, 2002). Observed results of different cultivars for productivity features were subject to ANOVA Test ($p \leq 0.05$), while for the analysis of relationship between features with reciprocal effect, the correlation analysis was used (Lekaj *et al.*, 2014).

Materials and methods

Experimental design. The study of determination of blooming period and fruit chemico-technological features of several apple cultivars grown under agro-ecological conditions of Gjakova, Kosovo, was carried out during the period 2014-2015, in Skivjan, Gjakova, in an apple orchard 400 m elevation, planted in 2006, using grafted seedlings over M9. Apple trees were planted in distances 3.8 m x 1.8 m (1460 trees/ha). A randomized complete design with four replications and six variants (apple cultivars) (Montear Gala, Royal Gala, Red Falstaff, Saturn, Jonagored, and Golden Delicious), with a plot size of 5 apple trees for each variant on each replication, were used. Apple trees were selected with an uniform vigor and size. Study was focused on determination of starting, duration and ending time of flowering, and determination of the chemico-technological features of apples.

Determination of starting, duration and ending time of flowering was evaluated on a representative samples of 5 branches for each apple tree of each cultivar on each replication. Branches were taken randomly in different parts of the crop load. For each branch and apple tree of each cultivar on each replication, there were counted all the buds and flowers. Starting stage was evaluated when 15% of the total buds have bloomed and ending stage when >70% of the total buds have bloomed.

Determination of fruit chemico-technological features. Apple fruits were harvested at the commercial maturity stage (Ullah *et al.*, 2004). Prior to the measurement of quality attributes, fruits were allowed to attain the room temperature. Fruit chemico-technological analyses were

carried out at the Lab of the Agriculture Institute of Peja, Kosovo. There were measured the below mentioned features: fruit moisture content (FMC - %), dry matter content (DMC - %, total soluble solution content (TSSC - °Brix), total acidity (TA – mg/100 g fresh apple fruit), and vitamin C (ascorbic acid) content (AAC) (mg/kg).

The future investment on apple orchard construction and determination of the variety structure in Gjakova region must take into consideration the chemico-technological features of apples and the production destination.

Statistical analyses. The obtained data were subject to ANOVA-test ($p \leq 0.05$), LSD ($p \leq 0.05$) and correlation analysis (Lekaj *et al.*, 2014).

Results and discussion

Climate conditions of the lower part of Gjakova. The lower part of Gjakova is being characterized by relatively high mean annual temperature (11°C), mean temperature of the hottest months (July and August) is 21.6 and 21.7°C, while for the coldest month (January), mean temperature -0.5°C, with a mean amplitude of 22.2°C. In Gjakova, there is more than 60.5% of the year with full solar radiation, while the annual relative air humidity is about 79.3%. At the driest month (September), the relative air humidity is 68.9% and at the wettest month (November), the relative air humidity is 88.6%. During the period March-September, there is an uniform and normal distribution of precipitation. All the above mentioned climate conditions make the Gjakova's region a very suitable area for apple cultivation.

Starting, ending, and duration period of flowering (days). There were observed significant differences between cultivars for the stage of flowering. Flowering period depends on the cultivar's characteristics, air temperature and relative air humidity. The earliest apple cultivar for flowering was Montear Gala, which blooms on April 24, followed by Royal Gala (April 26), Red Falstaff (April 27), while the latest cultivar was Jonagored, which blooms on May 10 (Table 1). There were observed significant differences between cultivars for the duration of flowering period (days). There was observed that between starting of flowering, daily mean temperature and flowering duration exists a strong positive relationship, i.e., Montear Gala, which bloomed the first, when daily mean temperature was lower, showed the longest flowering period (14 days), while Jonagored, which bloomed the last when daily mean temperature was higher, showed the shortest flowering duration (10 days) (Table 1).

Table 1. Starting, ending and duration of flowering period of apple cultivars under Gjakova climate conditions (mean values, different letters indicate significant differences at $p \leq 0.05$)

Cultivar	Flowering		
	Starting (15%)	Ending (>70%)	Duration period (days)
Montear Gala	April 26	May 09	14 c
Royal Gala	April 27	May 09	13 b
Red Falstaff	April 29	May 11	13 b
Golden Delicious (clone B)	April 30	May 10	11 ab
Saturn	May 10	May 22	12 ab
Jonagored	May 12	May 22	10 a

Taking into consideration the starting and duration of flowering, for Gjakova climate conditions, the most interesting cultivars were Jonagored, Golden Delicious (clone B), and Saturn, because of

late and short duration of flowering, avoiding the peak bloom during late spring precipitation, cloudiness and cold temperatures in late April and early May.

Apple fruit quality (chemico-technological) indicators. Ripening time and harvest, as well as fruit quality indicators, depend on the cultivar. Observed results showed that there exist significant differences between cultivars for dry matter content (DMC - %) [as well as, moisture content (MC - %)], total soluble solids content (TSSC - °Brix), total acidity (TA - mg/100 g fresh apple fruit), and ascorbic acid (vit C) content (AAC - mg/kg). The highest DMC (%) was observed for Golden Delicious (clone B) (16.7%), followed by Royal Gala (16.5%), while the lowest DMC was observed for Montear Gala and Saturn (14.6%). The highest TSSC (°Brix) was observed for Saturn (12.7°Brix), followed by Red Falstaff (12.4°Brix), while the lowest TSSC was observed for Royal Gala (11.33°Brix). The lowest TAC (mg/100g) was observed for Saturn (0.250 mg/100g), followed by Red Falstaff (0.275 mg/100g), while the highest TAC was observed for Royal Gala (0.395 mg/100g). The highest vitamin C (AAC - mg/kg) was observed for Montear Gala (230 mg/kg), followed by Saturn (201.7 mg/kg) and Golden Delicious (clone B) (210 mg/kg), while the lowest AAC was observed for Red Falstaff (195 mg/kg) (Table 2).

Table 2. Fruit chemico-technological indicators [dry matter content (DMC - %), total soluble solids content (TSSC - °Brix), total acidity (TA - mg/100 g fresh apple fruit), and ascorbic acid (vit C) content (AAC - mg/kg)] of cultivars under study (mean values, different letters indicate significant differences at $p \leq 0.05$)

Cultivar	DMC (%)	MC (%)	TSSC (°Brix)	TA (mg/100g)	AAC (mg/kg)
Montear Gala	14.6 ^c	85.4	11.80 ^a	0.280 ^d	230.0 ^a
Royal Gala	16.5 ^a	83.5	11.33 ^a	0.395 ^a	203.3 ^c
Red Falstaff	15.6 ^b	84.4	12.40 ^a	0.275 ^a	195.0 ^d
Golden Delicious (clone B)	16.7 ^a	83.3	12.33 ^a	0.314 ^d	210.0 ^b
Saturn	14.6 ^c	85.4	12.70 ^a	0.250 ^e	210.7 ^b
Jonagored	16.1 ^{ab}	83.9	12.10 ^a	0.355 ^b	206.3 ^c

Correlation analysis for fruit quality indicators showed that there existed a strong relationship between MC (%) and DMC (%) ($r = 0.9743$), a medium strong relationship between DMC (%), TSSC (°Brix), and TAC (mg/100 g fresh fruit) ($r = 0.7512$ and $r = 0.774$, respectively), and so on, while between some other indicators existed a weak relationship ($r < 0.7$) (Table 3).

Table 3. correlation analysis for the relationship between fruit quality indicators

Quality indicators	MC (%)	DMC (%)	TSSC (%)	TAC (mg/100 g)	AAC (mg/kg)
MC (%)	1				
DMC (%)	0.9743	1			
TSSC (%)	0.9764	0.7512	1		
TAC (mg/100 g)	0.58347	0.7743	0.77861	1	
AAC (mg/kg)	0.5140	0.5472	0.1834	0.2764	1

Differences between cultivars for fruit quality indicators were significant and statistically confirmed by ANOVA-test [$F_{\log} = 23.4782 > F_{\text{crit}} = 2.8012$ dhe $194.8 > 3.26782$, and $P\text{-value}$ ($0.00031 < \alpha = 0.005$)] (Lekaj *et al.*, 2014) (Table 4).

Table 4. Results of ANOVA-test for the relationship between apple fruit chemico-technological indicators

<i>Source of Variation</i>	<i>F_{log}</i>	<i>P-value</i>	<i>F_{crit}</i>
Variants (cultivars)	23.4782	0.00031	2.8012
Indicators	194.8	2.7E-12	3.26782

Apple fruit chemico-technological indicators determine the product destination. Apples with higher DMC must be used by the alimentary industry for compotes and marmalades, while them with lower DMC and higher moisture content and higher vitamin C content can be used for apple juice, and so on. Taking into consideration all the above fruit quality indicators, Golden Delicious (clone B), Jonagored and Royal Gala, can be used for fresh consumption, Saturn, Montear Gala and Red Falstaff for apple juice, and so on.

Conclusions

Apple cultivars, grown under Gjakova, Kosovo, agro-ecological conditions, showed significant differences for time and duration of flowering, and apple fruit quality indicators. Montear Gala started the flowering the first (April 24), followed by Royal Gala (April 26), Red Falstaff (April 27), while the latest flowering cultivars were Saturn (May 07) and Jonagored (May10). There existed a strong relationship between flowering duration and daily mean air temperature. Montear Gala, which started the flowering the first, showed the longest flowering duration (14 days), while, Jonagored, which started the flowering the last, showed the shortest flowering duration (10 days). Taking into consideration the late spring precipitations and low daily mean temperatures, Golden Delicious (clone B), Saturn and Jonagored showed to be very interesting cultivars. At the same time, those cultivars showed high apple fruit quality, as well. Fruit quality indicators must be taken into consideration for the final product destination, fresh consumption or alimentary industry (apple juice, compotes and marmalades).

References

- Aaby, K., Haffner, K, Skrede, G. (2002). Aroma quality of Gravenstein apples influenced by regular and controlled atmosphere storage. *Lebensm.-Wiss. + Technol.* 35: 254-259.
- Ackermann, J., Fischer, M., Amado, R. (1992). Changes in sugars, acids, and amino acids during ripening and storage of apples (cv. Glockenapfel). *J. Agric. Food Chem.* 40: 1131-1134.
- Awad, M. A. & De Jager, A. (2002). Influences of air and controlled atmosphere storage on the concentration of potentially healthful phenolics in apples and other fruits. *Postharvest Biol. Technol.* 27: 53-58.
- De Jager, A. & Roelofs, F. (1996). Prediction of the optimum harvest date of Jonagold. In: A. De Jager, D. Johnson, E. Hohn (ed.). *Determination and prediction of optimum harvest date of apples and pears.* COST 94. European Commission. Luxembourg: 21-31.
- De Long, J. M., Prange R. K., Harrison, P. A., Shofield, R. A., De Ell, J. R. (1999). Using the Streif index as a final harvest Window for controlled-atmosphere storage of apples. *Hortisciens* 34(7): 1251-1257.
- FAO (2014). List of countries by apple production. https://en.wikipedia.org/wiki/List_of_countries_by_apple_production
- FAO (2015). "FAO production data". <http://faostat3.fao.org/download/Q/QC/E>. FAO. Retrieved 2 July 2015.

- Ferraj, B. & Thomaj, T. (2014). Pomology I. Teaching text, Agricultural University of Tirana: 30-31.
- Ingle, M., D'Souza, M. C., Townsend, E. C. (2000). Fruit characteristics of York apples during development and after storage. *Hort. Science*, Vol. 35(1): 95-98.
- Janick, J., Cummins, J. N., Brown, S. K., Hemmat, M. (1996). "Chapter 1: Apples". In Jules Janick and James N. Moore. *Fruit Breeding, Volume I: Tree and Tropical Fruits* (PDF). John Wiley & Sons, Inc. p. 9. ISBN 0-471-31014-X.
- Lekaj, P., Gjini, B., Ozuni, E., Mulliri, J., Mustafa, S., Ahmeti, A. (2014). Microsoft Excel Computer Applications. Agricultural University of Tirana: 212-218.
- Lind, K., Lafer, G., Schloffer, K., Inerhoffer, G., Meister, H. (2003). "Organic Fruit Growing": 63-64.
- Mehinagic, E., Royer, G., Symoneaux, R., Bertrand, D., Jourjon, F. (2004). Prediction of the sensory quality of apples by physical measurements. *Postharvest Biology and Technology*, Vol. 34: 257-269.
- Pierre-éric, L., Maguylo, K., Trottier, C. (2006). "Architecture and size relations: an essay on the apple (*Malus x domestica*, Rosaceae) tree". *American Journal of Botany* (Botanical Society of America, Inc.) **93** (93): pp. 357–368. doi:10.3732/ajb.93.3.357.
- Shala, A. (1995). Ennobling of trees and grape-vine (Fisnikërimi i Pemëve dhe Hardhisë së Rrushit). Teaching text, University of Prishtina: 187-189.
- Stainer, R., Giuliani, G., Youseff, J., Toffolutti, B. (1996). Qualitative characteristics and consumer assessment of new apple cultivars. *Rivista di Frutticoltura e di Ortofloricoltura* 58: 11, 43-46.
- UIE (University of Illinois Extension). (2013). "Apples and more. Apples facts. Available online at <http://urbanext.illinois.edu/apples/intro.cfm>
- Ullah, J., Khan, N., Ahmad, T., Zafarullah, M., Durrani, Y. (2004). Effect of Optimum Harvesting Dates (OHD) on the Quality of Red Delicious Apple. *Asian Journal of Plant Sciences*, 3: 65-68.

QUALITY ANALYSIS OF THE *MISCANTHUS X GIGANTEUS* BIOMASS CULTIVATED IN AGROECOLOGICAL CONDITIONS OF THE REPUBLIC OF SERBIA

Jelena MAKSIMOVIĆ^{1*}, Željko DŽELETOVIĆ², Zoran DINIĆ¹, Aleksandra STANOJKOVIĆ-
SEBIĆ¹, Radmila PIVIĆ¹

¹Institute of soil science, Teodora Drajzera 7, Belgrade, Serbia

²Institute for the Application of Nuclear Energy, Banatska 31b, Zemun, Serbia*Corresponding author:
jelena.maks@yahoo.com

Abstract

The paper presents the results of the quality of *Miscanthus* biomass grown in two locations in the Republic of Serbia, on two soil types with different production capabilities (Luvic Chernozem and Calcic Gleysol). Chemical parameters of *Miscanthus* biomass were obtained by analyzing leaf and stem of *Miscanthus* at the end of the third year of cultivation on experiment variants with the following structure of the rhizomes planting: 2 and 3 per m². By examining the content of total forms of potassium, phosphorus, calcium and magnesium, it was found that the values of those parameters are within the range of values that are confirmed and exercised in a variety of research in Europe. By analyzing the values of the results of chemical analysis of biomass, difference is noticeable in the most of the examined parameters obtained in leaf and stem from different localities. The most significant is the increased content of calcium in leaf of *Miscanthus* grown on Calcic Gleysol. The values of examined parameters obtained are below the critical values for solid fuels. Preliminary research results show that *Miscanthus* grown in the Republic of Serbia, both on soils suitable for intensive crop production, such as chernozem, could be also grown on soil with slightly unfavorable production capacity as Calcic Gleysol. Research is needed to expand both trials set up on marginal soils, or in areas where it is necessary to conduct remediation and supplemented by additional physical-chemical analyzes of biomass, in order to give a complete assessment of the possibilities for exploitation of the *Miscanthus* biomass as a biofuel.

Keywords: *Miscanthus*, quality biomass, Luvic Chernozem, Calcic Gleysol

Introduction

The global problem of energy insecurity and effects of climate change are inevitable occurred by emissions of gases causing the effect of "greenhouse" imposes the need to increase the share of environmentally friendly energy sources. Solar energy, wind, water and biomass energy crops are CO₂ - neutral energy sources (Lewandowski and Kicherer, 1997). Crop farming plants that with annual production of biomass can provide sufficient quantities of raw materials for biofuels also belong to the group of energy crops (Glamočlija et al., 2012).

Miscanthus (*Miscanthus x giganteus* Greef et Deu.) is considered to be the most promising crop for the production of bioenergy in Europe (Lesur et al., 2014).

It is harvested each year and has a very high yield potential, which is a prerequisite for the efficient production of bioenergy (Dželetović et al., 2013). *Miscanthus* biomass combustion is discharging into the atmosphere the same amount of carbon dioxide that plants incorporate into

the organic substance during the growing season, which significantly reduces the "greenhouse effect" (Christian et al., 2008).

Brosse et al. (2012), and Lewandowski and Kicherer (1997) quotes that the biomass of *Miscanthus* can be used for combustion in the form of bales, pellets or briquettes, or after the transformation of lignocellulose as liquid and gas biofuels. In addition, biomass can be used to produce biodegradable products, as ecological building material and for soil reclamation (Dželetović and Glamočlija, 2011).

Biochar obtained by pyrolysis process of *Miscanthus* can be used to repair the physical and chemical properties and increase the soil fertility (Melligan et al., 2012). Due to its high productivity, its tolerance to abiotic and biotic stresses, and its biomass with multiple uses, the perennial grass *Miscanthus* is considered as a suitable candidate plant to couple management of metal-contaminated lands and biomass production (Nsanganwimana et al., 2016). This plant species is an important candidate for phytoremediation of heavy metals in the soil (Hartley et al., 2009) while Jones et al. (2006) proposed it for the remediation of soil leachate. Wanat et al. (2013) emphasize that *Miscanthus × giganteus* can grow on contaminated soils and thereby perform short term role of phyto-stabilization without additional investment in soil reclamation.

The final product and the purpose of growing *Miscanthus* is its combustion or conversion to some other form of fuel. Since the commercial yield is reached only after the third year of cultivation, the content of total forms of potassium, phosphorus, calcium and magnesium during this period is an important indicator of the quality of biomass. High yields and chemical composition of its biomass recommend *Miscanthus* for combustion (Milovanovic et al., 2011).

Compared with wheat straw or other ligno-cellulosic species, the mineral content of *Miscanthus* is lower, while is higher than the mineral composition of biomass in dense plantations of willow tree, or in short rotation planting of poplar tree (Lewandowski et al., 2000).

The characteristics of biomass can significantly vary between years and locations of planting (Lewandowski and Kicherer, 1997). These authors point out that the contents of water and mineral salts are significantly lower in biomass of *Miscanthus* grown in warmer climates.

Harvesting time, preferably, should be after the end of the winter. This is very important due to a fact that by completion of the vegetation period, mineral salts from the aboveground part of the plant move to the rhizomes. This gives the plant strong independence for the following growing season.

Through maturing of the plant, Cl, K, and other elements move from the above ground parts of the plant to the rhizomes, causing the changes in the composition of the leaves (Lewandowski and Kicherer, 1997). During the autumn and winter, fallen leaves remain on the soil surface, increasing the quality of biomass combustion, primarily due to lower content of nitrogen.

Mineralization of the leaves remains enriches the surface layer of soil, and some authors point out that *Miscanthus* and thus supplying additional nutrients and does not depend excessively on the supplemental feeding. The nitrogen content in the plant material is mainly responsible for the emission of NO_x gases during the combustion process; therefore, the primary aim should be the production of biomass with low concentrations of said element (Lewandowski and Kicherer, 1997).

Despite biomass losses during winter, *Miscanthus* is usually harvested at the end of the winter to improve combustion quality, to reduce the energy demand for drying (Lewandowski and Heinz, 2003) and to enable nutrient recycling between the aboveground and belowground biomass (Cadoux et.al, 2012, Lesur-Dumoulin et al., 2016).

The high efficiency of nitrogen results in biomass with a low concentration of N, which is highly desirable for direct combustion with the aim of minimal environmental pollution (Miguez et al., 2008).

In Serbia, there are relatively a favorable agroecological conditions for growing this plant (Dželetović et al., 2014-a). Except for experimental purposes, surface area for commercial growing of *Miscanthus* for bioenergy, is constantly increasing.

The aim of this study was to examine the quality of *Miscanthus* biomass grown on two different locations in wider area of Belgrade, as the basis of its suitability for further use.

Material and

Field experiments were set in the period from 2011 to 2014 at two locations: experimental field INEP, Zemun on soil Luvic Chernozem, and experimental field in Grabovac near the thermal power plant Nikola Tesla Obrenovac on soil Calcic Gleysol. The basic characteristics of the soils are shown in Table 1. According to WRB classification (2014), Luvic Chernozem has clay loam texture, while Calcic Gleysol belongs to the clayey soils. Chemical properties of soils indicate that Luvic Chernozem is acidic in soil reaction, medium provided with easily available potassium, low provided with easily available phosphorus, medium provided with organic matter and total nitrogen and with a high content of tradable calcium and magnesium. Calcic Gleysol is neutral in soil reaction, medium provided with available potassium, medium supplied with available phosphorus and total nitrogen, low in organic matter and with high content of tradable calcium and magnesium (Šestić et al., 1969).

Table 1. Locations of experimental fields planted with *Miscanthus*, texture class and chemical properties of soils

Location	INEP - Zemun	Grabovac - Obrenovac
Coordinates	44°51' N, 20°22' E	44°37' N, 20°6' E
Texture class	Clay loam	Clay
Soil type	Luvic Chernozem	Calcic Gleysol
Chemical properties	Average values	
pH (H ₂ O)	6.36	7.84
pH (1M KCl)	5.44	6.76
Total N (%)	0.13	0.16
Available P ₂ O ₅ (mg 100g ⁻¹)	9.26	10.82
Available K ₂ O (mg 100g ⁻¹)	15.4	20.23
Available Ca (mg 100g ⁻¹)	384.18	750.01
Available Mg (mg 100g ⁻¹)	43.38	111.44
SOM Organic matter (%)	2.22	1.23

The production technology is the standard applied agricultural technology (Dželetović et al., 2006), with the structure of planting the rhizomes: 2 and 3 per m². Manual harvesting of *Miscanthus* was carried out at the end of the winter, during the period when the trees had the lowest moisture content. For the chemical analysis of biomass it is used the yield from the third year of cultivation, because in this period the plant reaches a maximum yield rate (Dželetović et al., 2009). The analyses of aboveground parts of plants were done separately, tree and the leaves were analyzed individually. Chemical analyses of the plant material is determined by the value of biomass for its use as energent. Overall patterns of potassium, phosphorus, calcium and

magnesium were determined by destruction of 1g of plant material after dry ashing at 500°C, added nitric and hydrochloric acid, to complete the destruction of organic matter. From the resulting filtrate it was determined the phosphorus content (spectrophotometrical) and potassium (flame emissionphotometric). Ca and Mg were determined by atomic adsorption analyzer SensA Dual (GBC Scientific Equipment Pty Ltd, Victoria Australia) (Helrich, 1990). The contents of total forms of carbon, nitrogen and sulfur in *Miscanthus* plant material were determined by elemental analysis on CNS analyzer Vario EL III (Nelson and Sommers, 1996).

The climatic parameters, meaning the data on monthly rainfall and average monthly air temperature for the area of study, were obtained from the Republic Hydrometeorological Service of the Republic of Serbia. Both sites had an unfavorable water regime in 2011 and 2012 because the total rainfalls were less than the long-term average and below 600 mm which is considered the minimum quantity for the growth and development of *Miscanthus* (Tuck et al., 2006). Slightly more favorable in terms of rainfall was 2013, while 2014 had an annual sum of rainfall of 1095 mm, which is significantly higher than the average for this area. The annual air temperature during the study was higher than the multi-year in average 0.6°C to 1.5°C. Average air temperature during the growing season compared to a multi-year period, was also higher in all four years of research from 0.1°C in 2014 to 2.5°C in 2012.

Results and discussion

By analysing the *Miscanthus* biomass it was determined low nitrogen content in the stems of *Miscanthus* grown on Calcic Gleysol (0.15%), which was below the limit of available published results of other authors, while slightly higher range was determined in the stems sampled on Luvic Chernozem (0.15 to 1.23%) (Table 2). Differences in concentrations that depend on location were also recorded by Dželetović et al. (2014). Jorgensen (1997) points out that the average nitrogen content in the dry biomass of plants over a three year growing period was 0.59%. Similar results were obtained by Lewandowski et al. (2000), in the harvest in early spring nitrogen content were ranged from 0.2% to 0.6%. The contents of K and Ca in the *Miscanthus* plants grown on Calcic Gleysol were within the limits of results obtained by other authors (Beuch, 1998; Lewandowski et al., 2000).

High concentration of K and Ca in plants from Luvic Chernozem was confirmed in previous research of Dželetović et al. (2014). Depending on the location, these authors recorded the varying levels of potassium from 4.35% to 4.43% in the peak part of the stems. The content of phosphorus in the tree *Miscanthus* grown on Luvic Chernozem ranged from 0.06 to 0.21%, which is similar to the values obtained by Lewandowski et al. (2000). High levels of phosphorus in plants from Calcic Gleysol (0.34%) were confirmed by the results of Dželetović et al. (2014) in *Miscanthus* biomass grown in the area of Vranje, where it was obtained 0.37% of this element in the tree. The specific content of Mg was also in the range of values established by named researchers. The analyzed plant material contained low concentrations of sulfur (1-2 g kg⁻¹), and the results are within the permissible limit which can furtherly be reduced by proper combustion technology (Lewandowski and Kicherer, 1997). Carbon content (40.91 to 47.91%) in the analyzed plant material is considerably lower than the value of 47.8 to 49.7% by results published by Lewandowski et al. (2000). Content of S does not affect the release of harmful gases with the effect of "greenhouse gases" because the carbon during the growing season was formed by photosynthesis and as such represents a biochemically neutral element. The mineral content in *Miscanthus* biomass from both tested sites was below the critical values for solid fuels (Lewandowski and Kicherer, 1997).

By observing the chemical composition of the leaf and stem of *Miscanthus*, there is a difference which is certainly expressed for each element between the localities of *Miscanthus* cultivation. Besides the differences that occur between sites, for certain elements it has been identified the differences on the site (Table 2). Similar results were also obtained by Lewandowski et al. (2003). This is the most evident for the increased content of Ca in leaf of *Miscanthus* grown on Calcic Gleysol.

Table 2. Chemical composition of *Miscanthus* biomass

Location/ soil type	Planting density (m ⁻²)	Plant part	Chemical composition (%)						
			N	P	K	Ca	Mg	C	S
Zemun/ Luvic	2 rhizomes	leaf	1.55	0.18	0.17	0.48	0.06	42.73	0.18
		stem	0.15	0.06	0.17	0.16	0.05	45.38	0.14
Chernozem	3 rhizomes	leaf	2.14	0.10	0.28	0.09	0.06	42.60	0.14
		stem	1.23	0.21	2.77	0.25	0.11	40.91	0.17
Grabovac/ Calcic Gleysol	2 rhizomes	leaf	0.95	0.36	0.14	0.68	0.12	45.96	0.15
		stem	0.15	0.34	0.12	0.16	0.09	47.37	0.11
	3 rhizomes	leaf	0.95	0.31	0.11	0.71	0.10	46.16	0.12
		stem	0.15	0.34	0.30	0.14	0.08	47.91	0.10

Conclusion

Chemical analysis of *Miscanthus* biomass indicates that there is an impact of the site on the quality of *Miscanthus* biomass. The analysis of the tested parameters of biomass and comparing with critical values proposed for solid fuels, it can be noted that *Miscanthus* grown at both sites where the research was conducted, is suitable for use as biofuel. In further research, for a more detailed consideration of the use of *Miscanthus* as a biofuel, it is necessary to expand research on more sites and soil types in order to obtain the valid data on the suitability for cultivation and quality of the resulting biomass. This applies particularly to the research to be carried out on marginal soils and soils that need remediation because the cultivation of *Miscanthus* is recommended primarily on soils that are not suitable for intensive crop production. Also, it is necessary to determine the calorific value as a key parameter for assessing the energy value and implement a detailed chemical analysis of the ash resulting from combustion of *Miscanthus*.

Acknowledgment

The study was financially supported by the Ministry of Education, Science and Technological Development of Republic of Serbia, Projects TR-37006 and TR-31018.

References

- Beuch, S. (1998): Influence of cultivation and biomass structure of *Miscanthus* × *giganteus* (Greef et Deu.) on the balance of nutrients and soil organic matter. Shaker, Aachen, Germany.
- Brosse, N., Dufour, A., Meng, X., Sun, Q., Ragauskas, A. (2012): *Miscanthus*: a fast-growing crop for biofuels and chemical production. *Biofuels, Bioproducts and Biorefining*, 6(5):580-598.
- Christian, D.G., Riche, A.B., Yates, N.E. (2008): Growth, yield and mineral content of *Miscanthus* × *giganteus* grown as a biofuel for 14 successive harvests. *Industrial crops and products*, 28: 320–327.

- Cadoux, S., Riche, A.B., Yates, N.E., Machet, J-M. (2012) Nutrient requirements of *Miscanthus x giganteus*: conclusions from a review of published studies. *Biomass and Bioenergy*, (38), 14–22.
- Dželetović, Ž., Dražić, G., Blagojević, S., Mihailović, N. (2006): Specific agrotechnical conditions of *Miscanthus* cultivation. *Agricultural Engineering*, 31 (4): 107-115.
- Dželetović, Z., Mihailović, N., Glamočlija, Đ., Dražić, G. (2009): Postponed harvest of *Miscanthus x Giganteus* – influence on the quality and quantity of accumulated biomass, 170 PTEP -Journal of Process Engineering and Energy in Agriculture, 13 (2): 170-173.
- Dželetović, Ž., Glamočlija, Đ. (2011): The economic importance of growing *Miscanthus*. *Agricultural engineering*, 36 (2): 61-68.
- Dželetović, Ž., Mihailović, N., Živanović, I. (2013): Prospects of using bioenergy crop *Miscanthus x giganteus* in Serbia. In: *Materials and processes for energy: communicating current research and technological developments* (Ed. A. Méndez-Vilas), Formatex Research Center, Badajoz, Spain: 360-370.
- Dželetović, Ž., Andrejić, G., Živanović, I., Pivić, R., Simić, A., Maksimović, J. (2014): The protection, development and sustainable use of agricultural land in the territory of the Republic of Serbia cultivating bioenergy grass *Miscanthus x giganteus*. University of Belgrade, Institute for Application of Nuclear Energy, Zemun, (in Serbian).
- Dželetović, Ž., Maksimović, J., Živanović, I. (2014-a): Yield of *Miscanthus x giganteus* during crop establishment at two locations in Serbia. *Journal on Processing and Energy in Agriculture*, 18 (2): 62-64.
- Glamočlija, Đ., Janković, S., Pivić, R. (2012): *Alternative Grains: economic importance, growing conditions, species and cultural practices*. Institute of Soil Science, Belgrade, Mladost biro DD. Zemun, (in Serbian).
- Hartley, W., Dickinson, N.M., Riby, P., Lepp, N.W. (2009): Arsenic mobility in brownfield soils amended with green waste compost or biochar and planted with *Miscanthus*. *Environmental Pollution*, 157 (10): 2654-2662.
- Helrich, K. (1990): *Official methods of analysis of the association of official analytical chemists*. 15th edition. Association of Official Analytical Chemists, USA, 41.
- Jones, D.L., Williamson, K.L., Owen, A.G. (2006): Phytoremediation of landfill leachate. *Waste Management*, 26 (8): 825-837.
- Jorgensen, U. (1997): Genotypic variation in dry matter accumulation and content of N, K, and Cl in *Miscanthus* in Denmark. *Biomass and Bioenergy*, 12 (3): 155-169.
- Lesur, C., Bazot, M., Bio-Beri, F., Mary, B., Jeuffroyand, M., Loyce, C. (2014): Assessing nitrate leaching during the three-first years of *Miscanthus x giganteus* from on-farm measurements and modeling. *GCB Bioenergy*, 6: 439-449.
- Lesur-Dumoulin, C., Lorin, M., Mathieu Bazot, M., Jeuffroy, M.H., Loyce, C. (2016): Analysis of young *Miscanthus x giganteus* yield variability: a survey of farmers' fields in east central France, *GCB Bioenergy* 8, 122–135.
- Lewandowski, I., Kicherer, A. (1997): Combustion quality of biomass: practical relevance and experiments to modify the biomass quality of *Miscanthus x giganteus*. *European Journal of Agronomy*, 6: 163–177.
- Lewandowski, I., Clifton-Brown, J.C., Scurlock J.M.O., Huisman W. (2000): *Miscanthus*: European experience with a novel energy crop. *Biomass and Bioenergy*, 19: 209–227.
- Lewandowski, I., Clifton-Brown, J.C., Andersson, Basch, G., Christian, D.G., Jorgensen, U. (2003): Environment and harvest time affects the combustion qualities of *Miscanthus* genotypes. *Agronomy Journal*, 95:1274–1280.

- Melligan, F., Dussan, K., Auccaise, R., Novotny, E.H., Leahy, J.J., Hayes, M.H.B., Kwapinski, W. (2012): Characterisation of the products from pyrolysis of residues after acid hydrolysis of *Miscanthus*. *Bioresource Technology*, 108: 258-263.
- Miguez, F.E., Villamil, M.B., Long, S.P., Bollero, G.A. (2008): Meta-analysis of the effects of management factors on *Miscanthus × giganteus* growth and biomass production. *Agricultural and Forest Meteorology*, 148 (8-9): 1280–1292.
- Milovanović, J., Babović, N., Đorđević, A., Spasić, S., Marisova, E., Končekova, L., Kotrla M., Tothova M. (2011): External and internal factors influencing the growth and biomass production of short rotation woods genus *Salix* and perennial grass *Miscanthus*. Editors: Zuzana Jureková, Gordana Dražić. Faculty of Applied Ecology FUTURA, Singidunum University Belgrade.
- Nelson, D., Sommers L. (1996): Total carbon, organic carbon, and organic matter. In *Methods of Soil Analysis*, 961-1010. SSSA Special Books, Part 3, Madison, WI.
- Nsanganwimana, F., Christophe Waterlot, C., Louvel, B., Bertrand Pourrut, B., Francis, D. (2016): Metal, nutrient and biomass accumulation during the growing cycle of *Miscanthus* established on metal-contaminated soils, *J. Plant Nutr. Soil Sci.*, 179, 257–269.
- Šestić, S., Glintić, M., Manojlović, S. (1969): Interpretation of the results of soil analysis. In: *Handbook for Systematic Control of Soil Fertility and Fertilizers Use*, Center for the Improvement of Agricultural Production in Serbia-Professional Board for Control of Soil Fertility and the Use of Mineral Fertilizers, Belgrade, Serbia, (in Serbian).
- Tuck, G., Glendining, M.J., Smith, P., House J.I., Wattenbach, M. (2006): The potential distribution of bioenergy crops in Europe under present and future climate. *Biomass and Bioenergy*, 20(3): 183-197.
- Wanat, N., Austruy, A., Joussein, E., Soubrand, M., Hitmi, A., Gauthier-Moussard, C., Lenain, J., Vernay, P., Munch, J.C., Pichon, M. (2013): Potentials of *Miscanthus × giganteus* grown on highly contaminated Technosols. *Journal of Geochemical Exploration*, 126-127: 78-84.
- WRB (2014) World Reference Base for Soil Resources - International soil classification system for naming soils and creating legends for soil maps: Food and Agriculture Organization of the United Nations, Rome, <http://www.fao.org/3/a-i3794e.pdf>, accessed May 2016.

FUEL CELLS: A PRACTICAL ANSWER TO THE WORLD'S PRESSING NEED FOR CLEAN AND EFFICIENT POWER

Pramod KUMAR OMRE

Department of Post Harvest Process and Food Engineering, G.B. Pant Univ. of Agric. and Tech., Pantnagar
India

*Corresponding author: pkomre@rediffmail.com

Abstract

A fuel cell turns hydrogen the fuel, into electricity using air and other catalysts. The fuel cell harnesses chemical energy trapped in hydrogen gas and converts it into kinetic energy we know as electricity, without fossil fuels, combustion, or polluting emissions. As a remarkably efficient, incredibly clean source of renewable energy fuel cells can take the place of both batteries and engines to power vehicles, laptops and residential power grid. Such a clean power source, guarantees less dependence on the dwindling supplies of fossil fuels, creates less greenhouse gases that contribute to global climate change, and does not explode or malfunction as frequently as engine driven electricity. These sources are pollution free and hence provide clean energy apart from being inexhaustible. Fuel cells offer utilities the opportunity to provide customers with an added value energy service that is not subject to the same competitive or regulatory pressures as exist for conventional electric supply and will be able to do so at overall lower cost. India is the only country in the world to have an exclusive ministry for renewable energy development. Power generation in India has grown in size to around 1 lakh MW. The demand for power is growing rapidly. Under such condition, environment-friendly and pollution-free, non-conventional and renewable energy sources known as 'clean and green energy' have emerged as an important alternative to conventional energy source. The potential available under solar photovoltaic energy is 20MW per sq. km, but the process is rather slow. A lot of work has been done and is being done in the field of wind energy, solar energy, solar thermal energy and biomass, but still its contribution to the nationwide power requirement is less. Now is the time when we need to explore other sources of non-conventional energy. One such source is fuel cell.

Keywords: *fuel cell, non-conventional sources of energy, hydrogen power.*

Introduction

The industrial revolution of the 19th century ushered in new technologies. The spurt in inventions in that century was unprecedented in many ways. Some of these inventions involved use of resources like coal and oil. The thought of exhaustible nature of these resources and the environmental damage from the use of these resources never occurred either to the inventors or the subsequent generation. It has become imperative to look at energy technology with a new perspective. There are abundant renewable sources of energy such as wind, sun, water, sea and biomass apart from even daily wastes. These sources are pollution free and hence provide clean energy apart from being inexhaustible.

India is the only country in the world to have an exclusive ministry for renewable energy development. Power generation in India has grown in size to around 1 lakh MW.

The demand for power is growing rapidly. Under such condition, environment-friendly and pollution-free, non-conventional and renewable energy sources known as 'clean and green energy' have emerged as an important alternative to conventional energy source.

Potential and exploitation of renewable energy sources:

India ranks fifth in the world in wind power with installed capacity of 1612 MW out of an estimated potential of 45000MW. In biomass power the country has an installed capacity of 381MW out of total potential of 1000 MW. The potential available under solar photovoltaic energy is 20MW per sq. km, but the process is rather slow. Under the tenth five year plan government has set the national goal of meeting 10% of grid capacity from renewable sources by 2010 has. Though a lot of work has been done and is being done in the field of wind energy, solar energy, solar thermal energy and biomass, but still its contribution to the nation wide power requirement is less. Now is the time when we need to explore other sources of non-conventional energy. One such source is fuel cell.

What is a fuel cell?

If you want to be technical about it, a fuel cell is an **electrochemical energy conversion** device. A fuel cell converts the chemicals hydrogen and oxygen into water, and in the process it produces electricity. The other electrochemical device that we are all familiar with is the battery. A battery has all of its chemicals stored inside, and it converts those chemicals into electricity too. This means that a battery eventually "goes dead" and you either throw it away or recharge it. With a fuel cell, chemicals constantly flow into the cell so it never goes dead -- as long as there is a flow of chemicals into the cell, the

Technology involved

With no internal moving parts, fuel cells operate similar to batteries. Fuel cells electrochemically combine a fuel (typically hydrogen) and an oxidant without burning, thereby dispensing with the inefficiencies and pollution of traditional energy conversion systems. Fuel cells forego the traditional fuel-to-electricity production route common in modern power production, which consists of heat extraction from fuel, conversion of heat to mechanical energy and, finally, transformation of mechanical energy into electrical energy. Fuel cells function on the principal of electrolytic charge exchange between a positively charged anode plate and a negatively charged cathode plate. When hydrogen is used as the basic fuel, "reverse hydrolysis" occurs, yielding only water and heat as byproducts while converting chemical energy into electricity, as shown in Figure 1. Pollutant emissions are practically zero.

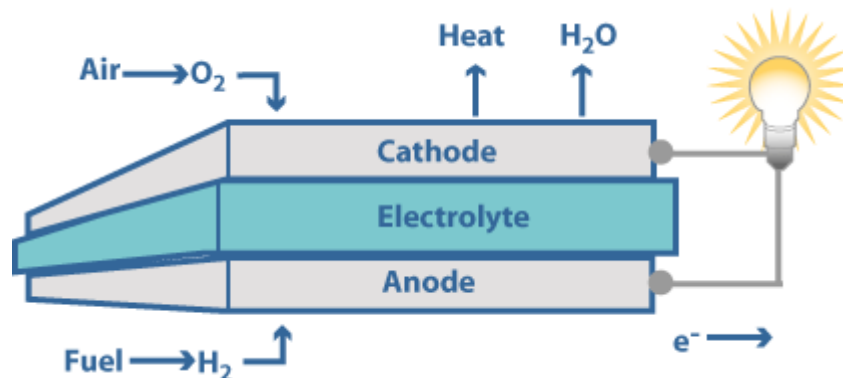

Fuel cell functions

Types of fuel cells:

Fuel cell types are generally characterized by electrolyte material. While there are dozens of types of fuel cells, there are six principle kinds. The following sections describe each of these fuel cell types:

1. Proton exchange Membrane: The proton exchange membrane fuel cell (PEMFC) uses one of the simplest reactions of any fuel cell. A PEMFC contains a layer of solid polymer that allows protons to be transmitted from one face to other. PEMFCs require hydrogen and oxygen as inputs, though the oxidant may also be ambient air (humidified). PEMFCs operate at a fairly low temperature (about 176 degrees Fahrenheit).

2. Alkaline: Alkaline Fuel Cells (AFCs) were the first type of fuel cell to be widely used for manned space applications. AFCs contain a potassium hydroxide (KOH) solution as the electrolyte. AFCs operate at temperatures between 100°C and 250°C. The fuel supplied to an AFC must be pure hydrogen.

3. Molten Carbonate: The electrolyte in an MCFC is an alkali carbonate or a combination of alkali carbonates that is retained in a ceramic matrix of lithium aluminum oxide. An MCFC operates at 600 to 700°C. MCFCs offer greater fuel flexibility and higher fuel-to-electricity efficiencies approaching 60 percent.

4. Phosphoric Acid: Phosphoric Acid Fuel Cell (PAFC) technology is the most mature of the types in use today. PAFCs use a concentrated 100% phosphoric acid (H₃PO₄) electrolyte retained on a silicon carbide matrix and operate at temperatures between 150 and 220°C.

5. Solid Oxide: Solid oxide fuel cells (SOFCs) are currently being demonstrated in sizes from 1kW up to 250 kW plants, with plans to reach the multi MW range. SOFCs utilize a non-porous metal oxide. SOFCs operate between 650 and 1000°C, where ionic conduction is accomplished by oxygen ions. SOFCs offer the stability and reliability of all-solid-state ceramic construction.

6. Direct Methanol: The direct-methanol fuel cell (DMFC) is similar to the PEM cell in that it uses a polymer membrane as an electrolyte. However, a catalyst on the DMFC anode draws hydrogen from liquid methanol, eliminating the need for a fuel reformer.

Fuel cell technology benefits:

- Environment benefits because of no combustion
- Flexibility in the types of fuels that can be used with fuel cell technology
- Relieves the reliance on existing natural resources used for energy consumption
- Higher quality of power and energy efficient
- Safe, quiet, and reliable
- Fuel cells can run continuously for long periods of time before servicing is required
- Fuel cells provides another method of generating energy

Applications of the fuel cell technology in the industry:

- Boilers
- Domestic Hot Water (DHW)
- Space Heating Loops
- Absorption Cooling Thermal Loads
- Automobiles
- New bicycle powered by fuel cell
- Home Power Generation

Conclusion:

Fuel cells, with their roots in the space program, have the potential to truly revolutionize power generation. Fuel cells a technology first pioneered by NASA for manned space flight, has been claimed could help countries suffering natural disasters to clean up after the event. According to the Flint Journal, Kettering University in the US sees fuel cell technology as having important applications in cleanup operations where disasters have left people without power. The claims have never been more pertinent in the US, with two hugely devastating hurricanes ravaging the south coast and causing serious damage to the city of New Orleans in particular.

Over the next several years, R&D will enable the widespread utilization of fuel cells for distributed power generation. However, there are other (non-technical) issues and barriers that must be addressed to enable this widespread use of fuel cells (as well as other distributed generation technologies).

References:

- Anonymous. 2005. Renewable energy. *Far and Near in Water and Energy*. 15(1): 15
- Anonymous. 1999. New and renewable sources of energy. *IREDA News*. 10(2)
- Cao, J. and Djilali, N. 2005. Numerical modeling of PEM fuel cells under partially hydrated membrane conditions. *Journal of Energy Resources Technology*. 127(1): 26-36
- Gonzalez, E.R.; Ticianelli, E.A.; Tanaka, A.A. and Avaca, L.A. 1989. A project for electrochemical production of hydrogen in Brazil. *Energy Sources*. 11(1): 53-58.
- Kikuchi, R. 2004. Analysis of availability and accessibility of hydrogen production: an approach to sustainable energy system using methane hydrate resources. *Environment development and Sustainability*. 6(4): 453-471.
- Sunalava, P.B. 1981. Recycling of municipal, agricultural and industrial wastes to generate renewable sources of energy. *J-Sci-Ind-Res*. 40(9): 547-560
- <http://www.fuelcell.org>
- <http://www.nrdc.org>

EFFECTS OF FRUIT THINNING METHOD ON FRUIT QUALITY INDICATORS OF “ROYAL GALA” APPLE CULTIVAR, UNDER GJAKOVA’S CLIMATE CONDITIONS

Gjokë DUHANAJ¹, Lush SUSAJ^{2*}, Elisabeta SUSAJ³, Nikollaq ROSHANJI⁴

¹ University "Fan S. Noli", Faculty of Agriculture, Department of Horticulture, Korçë, Albania

^{2*} Agricultural University of Tirana, Faculty of Agriculture and Environment, Department of Horticulture, Kodër Kamëz, 1029, Tirana, Albania,

³ University POLIS, Research and Development Institute, Tirana, Albania

⁴ University “Fan S. Noli”, Faculty of Agriculture, Department of Crop Production, Korçë, Albania

Corresponding author: lsusaj63@hotmail.com

Abstract

The study on effects of fruit thinning method on quality indicators of “Royal Gala” apples, trained on slender spindle and improved pyramidal shapes, was carried out during 2015, in Skivjan, Gjakova, in the South-Western part of Kosovo. Two different fruit thinning methods (hand thinning and chemical thinning using a combination of Carbaryl 1000 ppm + NAA 40 ppm, with 1200 L ha⁻¹ spraying solution) and two replications, with 10 apple trees for each variant on each replication for each system shape, were used. Fruit thinning was carried out 15 days after bloom, when fruit diameter was 10-12 mm. At the harvest time, there were measured, evaluated, accounted and compared several quality indicators, such as fruit firmness (kg/cm²), fruit colour (H^o), pH of juice, total soluble solids content (Brix), dry matter content (%), total acidity and malic acid content (% per 100 ml), and were counted the mean values for each thinning method. Observed results showed that thinning method (hand and chemical) significantly affected the fruit quality indicators of “Royal Gala” apple cultivar, of training systems, slender spindle and improved pyramidal shapes. Hand thinning showed more coloured fruits, higher SSC, higher DMC, and lower TA/MA, compared to chemical thinning (CB + NAA). The observed results were statistically confirmed by Anova ($p \leq 0.05$).

Keywords: *Carbaryl, chemical thinning, fruit quality indicators, “Royal Gala”, hand thinning, Naphthalene Acetic Acid (NAA).*

Introduction

The most important orchard management practices that influence crop load and fruit quality of apples are the effects of rootstock, and flowers and fruitlets thinning. Rootstock has effects on tree size and crop density, which normally increase with increasing rootstock vigour. Dwarfing rootstocks such as M9 are known for their high yield efficiency and more regular flowering than more vigorous rootstocks (Wertheim, 2000). Fruit thinning is a very well-known agronomic practice which is being used from centuries to control the crop load and productivity of apple, pear, plum, grapevine, olive (Dennis, 2000) and several citrus cultivars (McArtney *et al.*, 2007) which have the tendency of biennial production. Fruit thinning is defined as the removal of certain flowers or clusters of flowers or individual fruitlets after fruit set and natural dropping have occurred. Most apple cultivars have an over-abundant flower density and percentage fruit set. Crop regulation through blossom or fruit thinning can moderate alternate bearing, resulting in more consistent production and improved fruit size, as well as, increasing fruit quality (Davis *et al.*, 2004). Palmer *et al.* (1997) established different crop loads, from completely de-flowered to heavily fruiting, on 4-year-old ‘Braeburn’/M.26 trees. A low crop load decreased fruit yield, but

improved fruit weight and fruit quality. Fruit thinning of apple and to the other fruit trees can be achieved mechanically, by hand (which is a very high labour cost practice, used mainly to new orchards and in limited areas), or by applying plant growth regulators at first bloom or at the fruitlet stage. The most common treatment is a combination of chemical thinning followed by hand-thinning, for a final adjustment to the correct crop load. According to Meland (2009), chemical thinning application of apple trees is justified because of three reasons: chemical thinners reduce biennial production, reduce the cost of manual thinning, and their use affect the improvement of apple fruit quality. However, sometimes, except positive effects such as the increase of fruit mass (Pavicic and Paulic, 1989) and reduction of periodical productivity, chemical fruit thinning can cause negative effects such as reduced yield (Duhanaj *et al.*, 2015), fruit deformation at cv “Royal Gala” (Rogers and Williams, 1977), poor fruit coloration at cv Mutsu (Byers and Carbaugh, 1991), low calcium concentration in fruit, etc. Results from the recently published literature point to advantages of combining certain growth regulators and insecticides for apple fruit thinning (Jemrić *et al.*, 2003). Combination of carbaryl and 1-naphthaleneacetic acid has given good results in some years and climate conditions, but caused excessive thinning in some other years and climate conditions (Marini, 2004). The most used chemical apple fruit thinners are Ethephon (ETH), Carbaryl (CB), Naphthalene Acetic Acid (NAA), 6-Benzyladenine (6-BA), and fish oil (Reyes *et al.*, 2008), which are being used for chemical treatment of fruitlets (10-15 mm), 2-3 weeks after bloom, and are being applied as liquid solution in given concentrations (Ferree and Schmid, 2001; Marini, 2002). Through winter pruning and green operations, such as branch top cutting, flower and fruit thinning, etc., fruit growers aim to ensure 30-40 healthy leaves for each fruit and try to avoid the high yield the first growing years of apple trees, which causes premature aging of apple trees (Davis *et al.*, 2004). “Royal Gala” and “Red Delicious” are two of the most widespread apple cultivars in Albania and Kosovo, which, according to Marini (2002) are difficult to thin by hand, that’s why is being used chemical fruitlets thinning using the combination of Carbaryl and NAA. Marini (2004), Jemrić *et al.* (2003), etc., have reported that chemical fruit thinning had affected the year-by-year yield of “Royal Gala”, reducing the genetic tendency for biennial yield. The aim of our study was to determine the effect of hand and chemical thinning (Carbaryl 1000 ppm + NAA 40 ppm) on fruit quality indicators of “Royal Gala” apple cultivar, trained on slender spindle and improved pyramidal systems

Materials and methods

Orchard placement. Study was carried out in 2013 in Skivjan, Commune of Gjakova, Kosovo, a much known area for orchard development, in general, and, especially, apple orchards. “Royal Gala” apple orchard was planted in November 2006, with saplings grafted on M-9 rootstock, planted 3.8 m between rows and 1.8 m within a row (1462 apple trees ha⁻¹). Rows orientation was North-South. Orchard was constructed in a hill 400 elevation. Eight years apple trees were healthy and with the same vegetative growth and development. “Royal Gala” apple cultivar is one of the most widely planted cultivar in Gjakova’s region, as well as in Albanian and Kosovo’s orchards. Apple trees were trained on slender spindle, with hanged shoots, and improved pyramidal shapes, for better use of the solar energy. Space between rows was grassed with tapecant plants and all cultural other cultural practices were applied regularly, as in common apple orchards.

Apple fruit thinning methods: The main objective of the study was to determine the effect of hand and chemical thinning (Carbaryl 1000 ppm + NAA 40 ppm) on fruit quality indicators of “Royal Gala” apple cultivar, trained on slender spindle and improved pyramidal shapes. Apple

fruit thinning was applied 15 days after bloom, when the fruit equatorial diameter was 10-12 mm. There were tested two thinning methods (two variants):

- V1 - hand thinning (mechanical thinning), leaving 1 fruit per cluster
- V2 - Chemical thinning, using Carbaryl 1000 ppm + NAA 40 ppm, with a spraying volume of 1200 L per ha.

There were used two variants and two replications, with a variant size of 10 apple trees per replication. There were used 40 apple trees for each trained shape under study. Fruits were harvested on September 15, 2013. Harvest date has been determined according to the standard method. There were randomly selected 5 apple trees for fruit analysis. Apple trees were marked with plastic labels since at the beginning of the study. Fruits of each tree were kept and analysed separately for every fruit quality indicator and there were calculated the mean values for each thinning method and each trained shape.

Measurements and chemical analysis: Sample for chemical fruit analysis included 30 randomly selected fruits for each thinning method in each replication, and each apple training system. Fruits were taken from different parts of the crop load of 5 randomly and previously selected and marked apple trees. Fruits of each tree were transported separately and were sent immediately for chemical analysis at the Lab of Agricultural Institute of Peja, Kosovo. There were determined, accounted and compared several fruit quality indicators. Fruit colour (Hue angle - H°) was measured according to CIE Lab Colour System using a colorimeter, which was calibrated with black and white plates supplied with the instrument. Fruit firmness (kg/cm^2) was measured using an Effegi penetrometer with 11 mm probe and was presented as a mean value of four measurements made on opposite sides of the fruit. Apple fruits squeezing was carried out using the instrument Delimano Fusion Juicer. Then, the fruit juice was used for determination of pH, total soluble solids content (TSSC) ($^{\circ}\text{Brix}$), dry matter content (DMC - %), titratable acids (TA) and malic acid content (MA). pH of juice was measured using a digital pH meter, total soluble solids content ($^{\circ}\text{Brix}$) was measured using a digital refractometer (PAL BX/RI), while, dry matter content (%) was determined using the MICROWAVE-OVEN QUICK METHOD, placing juice samples at 105°C for 2 hours, as it was described by OECD (2014). Titratable acidity (TA) (%) and malic acid content (MAC - % per 100 ml of juice) was accounted by standard titration method with 0.1 N NaOH, pH 8.1, using phenolphthalein as an indicator, as it was described by OECD (2014).

Data analysis. The obtained data were subject of descriptive and statistical analysis (ANOVA: Two-Factors Without Replication) ($\alpha = 0.05$) (Lekaj *et al.*, 2014).

Results and discussion

Effects of thinning methods on fruit quality indicators of “Royal Gala” apple cultivar were observed for two training systems, slender spindle and improved pyramidal shape. Observed results showed that thinning method (hand or chemical) has significantly affected several quality indicators of “Royal Gala” apple cultivar on both training systems. Fruit firmness (kg/cm^2) and fruit colour (H° - Hue angle). Obtained results showed that thinning method (hand or chemical) has significantly affected fruit firmness of “Royal Gala” apples on both training systems. Apple fruits from hand thinned trees showed higher firmness and higher colour intensity compared to chemically thinned trees (using CB 1000 ppm + NAA 40 ppm). *Fruit firmness* (kg/cm^2) (mean value) of hand thinned trees was $6.87 \text{ kg}/\text{cm}^2$ and $6.79 \text{ kg}/\text{cm}^2$, respectively, for slender spindle and improved pyramidal systems, while for chemically thinned trees fruit firmness was $6.42 \text{ kg}/\text{cm}^2$ and $6.38 \text{ kg}/\text{cm}^2$, respectively, for slender spindle and improved pyramidal systems. Fruit colour from hand thinned trees showed a higher intensity on both training systems. Data were

similar to McCartney *et al.* (2007) that have reported the increase of fruit firmness of “Cameo” apples as a direct result of reduction of fruit number and yield. Differences between thinning methods for fruit firmness and fruit colour were significant and statistically confirmed at $p \leq 0.05$, but were not confirmed between training systems (Table 1).

Table 1. Effect of thinning method on fruit firmness (kg/cm²) and fruit colour (H₀ - Hue angle) of “Royal Gala” apples, trained on slender spindle (SS) and improved pyramidal (IP) systems (mean values, * significant at $p \leq 0.05$).

Fruit thinning method	Fruit firmness (kg/cm ²)		Fruit colour (H ⁰)	
	SS	IP	SS	IP
Hand thinning	6.87	6.79	102.7	102.5
Chemical thinning	6.42	6.38	101.9	101.7
F-test	*	*	*	*

Note: Chemical thinning = (CB 100 ppm + NAA 40 ppm)

Total soluble solids content (TSSC - °Brix) and pH of juice. Total soluble solids content (TSSC) was determined using a digital refractometer (PAL BX/RI), and pH of juice was measured using a digital pH meter. Obtained results showed that thinning method has significantly affected the total soluble solids content and pH of juice of “Royal Gala” apples trained on slender spindle and improved pyramidal systems. Apple fruits from hand thinned trees showed higher TSSC (%) and lower pH of juice compared to chemically thinned trees (using CB 1000 ppm + NAA 40 ppm). Total soluble solids content (%) (mean value) of hand thinned trees was 14.25% and 14.32%, respectively, for slender spindle and improved pyramidal systems, while for chemically thinned trees TSSC was 12.98% and 13.05%, respectively, for slender spindle and improved pyramidal systems. Data were similar to Jemrić *et al.* (2003) and El Salhy (1996) who have reported higher soluble solids content on hand thinned “Golden Delicious” and “Dorset Golden”. pH of apple juice showed to be lower on chemically thinned apples. Differences between thinning methods for TSSC and pH of juice were significant and statistically confirmed at $p \leq 0.05$, but were not confirmed between training systems (Table 2).

Table 2. Effect of thinning method on total soluble solids content (TSSC - %) and pH of juice of “Royal Gala” apples, trained on slender spindle (SS) and improved pyramidal (IP) systems (mean values, * significant at $p \leq 0.05$).

Fruit thinning method	Total soluble solids content (TSSC) (%)		pH	
	SS	IP	SS	IP
Hand thinning	14.25	14.32	102.7	102.5
Chemical thinning	12.98	13.05	101.9	101.7
F-test	*	*	*	*

Obtained results showed that thinning method has significantly affected the dry matter content (DMC - %), titratable acidity (TA - %) and malic acid content (MAC - % per 100 ml juice) of “Royal Gala” apples trained on slender spindle and improved pyramidal systems. Apple fruits from hand thinned trees showed higher DMC (%) and lower TA (%) and MAC (%). *Dry matter content* (DMC - %) (mean value) of hand thinned trees was 15.83% and 15.72%, respectively, for

slender spindle and improved pyramidal systems, while for chemically thinned trees DMC was 14.72% and 14.67%, respectively, for slender spindle and improved pyramidal systems.

Titrateable acididy (TA - %) (mean value) of hand thinned trees was 7.11% and 7.16%, respectively, for slender spindle and improved pyramidal systems, while for chemically thinned trees TA (%) was 7.45% and 7.49%, respectively, for slender spindle and improved pyramidal systems.

Malic acid content (MAC - % per 100 ml juice) of hand thinned trees was 0.52% and 0.54%, respectively, for slender spindle and improved pyramidal systems, while for chemically thinned trees MAC was 0.45% and 0.47% per 100 ml juice, respectively, for slender spindle and improved pyramidal systems (Table 3).

Table 3. Effect of thinning method on dry matter content (DMC - %), titrateable acididy (TA - %) and malic acid content (MAC - % per 100 ml juice) of “Royal Gala” apples, trained on slender spindle (SS) and improved pyramidal (IP) systems (mean values, * significant at $p \leq 0.05$).

Fruit thinning method	Dry matter content (DMC) (%)		TA/MAC (% per 100 ml juice)	
	SS	IP	SS	IP
Hand thinning	15.83	15.72	7.11/0.45	7.16/0.47
Chemical thinning	14.72	14.67	7.45/0.52	7.49/0.54
F-test	*	*	*	*

Results of ANOVA showed that the relationship between thinning method and fruit quality indicators was significant. Effects of thinning method on fruit quality indicators of “Royal Gala” apples was statistically confirmed by statistical indicators values ($F = 14.2654 > F\text{-crit} = 3.2783$ and $P\text{-value} = 2.08E-05 = 2.16/10^5 < \alpha = 0.05$). There were not statistically confirmed differences between training systems for the same thinning method (Table 4).

Table 4. ANOVA: Two-Factor without Replication for testifying the effect of thinning method on fruit quality indicators of “Royal Gala” apples, trained on slender spindle and improved pyramidal systems ($p \leq 0.05$)

Source of variation	F	P-value	F-crit
Rows (training systems)	1.49448	0.223028	2.4876
Columns (thinning methods)	14.2654	2.16E-05	3.2783

Achieved results of the study showed that thinning method affects the fruit quality indicators of “Royal Gala” apples, regardless of the training system of the orchard, at least in the ecological conditions of Skivjan, Gjakova, Kosovo. Evethough, there was observed higher fruit quality for hand thinned apples, because of the high cost, it cannot be applied in large areas and it is recommended for small growers and small areas under cultivation.

Conclusions

Obtained results showed that fruit thinning method significantly affects the fruit quality indicators of “Royal Gala” apple cultivar under climatic conditions of Skivjan, Gjakova, Kosovo. Hand thinned trees showed higher fruit quality than chemically thinned trees, using Carbaryl 1000 ppm + NAA 40 ppm. Hand thinned trees showed higher firmness, higher color intensity, higher total soluble solids content, higher dry matter content, lower titrateable acids and higher

malic acid content compared to chemically thinned trees. Taking into consideration the cost of hand thinning, it can be recommended that for small growers and small areas under cultivation, is better to apply hand thinning in order to get better quality apples, while for large areas, where the product is being used for the alimentary industry, must be applied chemical thinning. Fruit quality indicators were not affected by the training system, slender spindle and improved pyramidal system. Differences between fruit thinning methods for fruit quality indicators were statistically confirmed by ANOVA-test ($F > F\text{-crit}$ and $P\text{-value} < \alpha = 0.05$).

References

- Byers, R.E., Carbaugh, D.H. (1991). Effect of chemical thinning sprays on apple fruit set. Hort Technol. 2, 41-48.
- Davis, K., Stover, E., Wirth, F. (2004). Economics of Fruit Thinning: A Review Focusing on Apple and Citrus. HortTechnology, April-June 2004, 14 (2), 282-289.
- Dennis, Jr. F. G. (2000). The history of fruit thinning. Plant Growth Regulation 31 (1), 1-16.
- Duhanaj, Gj., Susaj, L., Roshanji, N., Susaj, E. (2015). Effects of Fruit Thinning Method on Crop Load and Yield on “Royal Gala” Apple Cultivar, Under Gjakova’s Climate Conditions. Online International Interdisciplinary Research Journal, Vol.V, Jan 2015 Special Issue, 12-19.
- El Salhy, A.M. (1996). Effect of hand and chemical thinning on fruit retention and quality of Dorsett Golden trees. Assiut J Agric Sci 27, 19-132.
- Ferree, D.C., Schmid, J.C. (2001). Chemical thinning ‘Gala’ apple in the Midwest. J. Amer. Pomol. Soc. 55, 109- 113. Greene, D.W. (2002) Chemicals, timing, and environmental factors involved in thinner efficacy on apple. Hort Science 37, 477-481.
- Jemrić, T., Pavičić, N., Blašković, D., Krapac, M., Pavičić, D. (2003). The effect of hand and chemical fruit thinning on 'Royal Gala cl. B' apple fruit quality. Current Studies of Biotechnology (02/2003) 3, 193-198.
- Lekaj, P., Gjini, B., Ozuni, E., Mulliri, J., Mustafa, S., Ahmeti, A. (2014). Microsoft Excel Computer Applications. Agricultural University of Tirana: 212-218.
- Marini, R.P. (2004) Combinations of ethephon and Accel for thinning ‘Delicious’ apple trees. J. Amer. Soc. Hort. Sci. 129, 175-181.
- Marini, R.P. (2002). Thinning ‘Royal Gala’ and spur ‘Delicious’ with combinations of Carbamates and NAA. Hort.Science 37, 534-538.
- McArtney, S., Dick Unrath, D., Obermiller, J.D., Green, A. (2007). Naphthaleneacetic Acid, Ethephon, and Gibberellin A4 + A7 Have Variable Effects on Flesh Firmness and Return Bloom of Apple. HortTechnology January-March 2007 Vol. 17 (1), 32-38.
- Meland, M. (2009). Effects of different crop loads and thinning times on yield, fruit quality, and return bloom in *Malus domestica* Borkh. ‘Elstar’. Journal of Hort. Science & Biotechnology (2009) ISAFRUIT Special Issue, 117– 121.
- Meland, M. (1997). Thinning apples and pears in a Nordic climate. III. The effect of NAA, ethephon and lime sulfur on fruit set, yield and return bloom of three apple cultivars. Acta Horticulturae, 463, 517–525.
- OECD (Organisation for Economic Cooperation and Development (OECD). (2014). Guidance on objective tests to determine quality of fruits and vegetables and dry and dried produce. 36 p, 3-18. <http://www.oecd.org/agriculture/code/19515719.pdf>.
- Palmer, J. W., Giuliani, R., Adams, H. M. (1997). Effects on crop load on fruit and leaf phosynthesis of ‘Braeburn’/M26 apple trees. Tree Physiology, 17, 741–746.

- Pavicic, N., Paulic, N. (1989). Effect of chemical thinning on the Goldspur (Auvil spur) cultivar on the amount of yield, diameter, rustiness and the degree of ripeness of the fruit (in Croatian). *Agron. Glas.* 55, 3-11.
- Reyes, D.I.B., Chacón, A.R., Campos, Á.R. M., Prieto, V.M.G. (2008). Apple fruit chemical thinning in Chihuahua, México. *Rev. Fitotec. Mex.* Vol. 31 (3), 243-250.
- Rogers, B.L., Williams, G.R. (1977). Chemical thinning of spur-type Delicious apple fruit. *Virginia Fruit* 65, 23-28.
- Wertheim, S.J. (2000). Developments in the chemical thinning of apple and pear. *Plant Growth Reg.* 31 (1), 85-100.

PREDICTION OF AVAILABLE SOIL ZINC USING CHEMICAL EXTRACTANTS

Jelena MILIVOJEVIĆ^{1*}, Vera ĐEKIĆ¹, Miodrag JELIĆ², Zoran SIMIĆ³, Vesna PERIŠIĆ¹

¹Small Grains Research Centre, Save Kovacevica 31, Kragujevac, Serbia

²University of Priština, Faculty of Agriculture, Kopaonička bb, Lešak 38219, Kosovo and Metohija, Serbia

³University of Kragujevac, Faculty of Science, Department of Chemistry, 34000 Kragujevac, Serbia

*Corresponding author: milivojevic54@gmail.com; ivanmaja@kg.ac.rs

Abstract

Zinc (Zn) is an essential micronutrient for crop growth. Deficiency of zinc has been frequently detected in soils in Serbia. Soil parent material, pedo-chemical transformations and anthropogenic interventions play important roles in the distribution of zinc (Zn) into its various forms in the soil and ultimately, its bio-availability for plant uptake. This study included 10 cultivated agricultural soils field of Serbian (field) and their uncultivated pairs (meadow). A batch extraction scheme was used to estimate water-soluble and exchangeable adsorbed (I), specifically adsorbed and carbonate bound (II), Mn oxide- and Fe-oxide bound (III), organic bound (IV), and silicate structural bound (residual forms) (V) zinc (Zn) in each soil. The distribution of Zn in the soils on the basis of average concentrations was in the order 60.15 mg kg⁻¹ residual Zn (71.93 %) > 16.07 mg kg⁻¹ oxide bound Zn (19.89%) > 5.31 mg kg⁻¹ organic bound Zn (6.69%) > 0.68 mg kg⁻¹ specifically adsorbed and carbonate bound Zn (0.89%) > 0.2 mg kg⁻¹ exchangeable adsorbed Zn (0.26%). The correlation analysis showed that exchangeable adsorbed and specifically adsorbed Zn amounts increase by decreasing soil pH, CEC, clay and clay + silt as well as by increasing silt and sand. The residual Zn fraction varied directly with soil pH, clay, CEC, clay + silt. The fact is that the soils in Serbia are dominated by stable fractions of zinc, while its content in easy available forms is low. The zinc present in water-soluble, exchangeable and adsorbed fractions is readily bio-available, while zinc associated with primary and secondary soil minerals is relatively unavailable for plants.

Keywords: *agricultural soils, correlations, soil fractionation, Serbia, zinc content*

Introduction

Zinc (Zn) is an important essential element which is required only in limited amounts by plants, animals and humans for various physiological and reproductive functions. It influences the quality and yield of crops (Alloway, 2003; Chidanandappa et al., 2008) and in humans it is a necessary cofactor in more than 300 enzymes and numerous transcription factors (FAO/WHO/IAEA, 1996; Haug et al., 2010). The deficiency of Zn in human diet has been recognized to commonly cause impaired growth (stunting) in children and consequently poor human development (Hambridge et al., 1986). Typically soil total Zn ranges between 10-300 mg kg⁻¹ with a mean value of 55 mg kg⁻¹ (Kiekens, 1995), however knowledge of total Zn provides only limited information about its transformations and bio-availability. For a better understanding, total soil Zn can be broadly described in five mechanistic fractions which can be quantified using sequential or batch fractionation schemes (Fedotov and Spivakov, 2008; Saffari et al., 2009). Generally these are: (1) water soluble Zn in the soil solution, (2) easily exchangeable Zn in electrostatic reaction with soil particles, (3) organic Zn complexed, chelated or adsorbed to organic ligands, (4) inorganic Zn associated with secondary minerals such as

carbonates or insoluble metal oxides and (5) residual Zn held in primary minerals (Alloway, 2003; Saffari et al., 2009). These fractions provide broad information on the biological, geological and chemical processes which have occurred in a soil and are useful for predicting the availability of Zn for plant uptake. The extent to which each fraction is present and the transformations in equilibrium between fractions is influenced by soil properties such as pH, clay, and cation exchange capacity, clay + silt, K₂O as well as presence of metal oxides and soil organic matter. It has been widely reported that the residual Zn and oxide bound Zn are the more stable fractions while the exchangeable Zn and water soluble Zn fractions are rather more soluble (Saffari et al., 2009).

Low levels of bio-available Zn found in soils has been attributed to one or a combination of low native Zn, very slow solubilization of Zn from soil minerals, strong adsorption of Zn on soil surfaces, or co-leaching of Zn with dissolved organic matter (Zimdahl and Skogerboe, 1977; Rieuwerts et al., 2006). Soil Zn has been well studied in Serbia and there is insufficient information that could be used in predicting Zn bio-availability. More than 65% of farmable soils in Serbia have <1 mg kg⁻¹ DTPA extractable Zn (0.5-0.8 mg kg⁻¹). The objective of this study was to characterize the distribution of Zn in its various fractions in selected Serbian soils and to determine if cropping affects their distribution.

Materials and methods

Samples were taken from vertisol soil in the Ap horizon at ten different locations in Serbia: 1) Milutovac, 2) Priština, 3) Trnava, 4) Rekovac, 5) Vranje (Neradovac), 6) Zaječar, 7) Bela Crkva, 8) Blace, 9) Salaš and 10) Kragujevac. Sub-samples were taken from field and meadow ecosystems, from a depth of 0 to 20 cm, after which they were air-dried and crushed in a porcelain mortar up to particles of 2 mm in size.

Determination of Soil Characteristics

The basic physical and chemical properties of soil were determined using standard methods (Soil. Sci. Yug., 1966). Soil pH was determined in a suspension with water and 1M KCl mixture, with the ratio of soil/solution 1:2.5 after a 0.5 - hour equilibration period; the organic content was determined using the humus method by Kotzmann-y, the available P₂O₅ and K₂O content was determined using the Al method by Egner-Riehm, CEC was determined using the method with 1 M NH₄OAc, pH 7, and particle size distribution was determined by a pipette method. The total content Zn was determined by atomic adsorption spectrophotometry (AAS, Model Carl Zeiss Jena, AAS 1N), after digested soil in acid mixture (HF, HNO₃ and HClO₄) in Pt pots.

Sequential Fractional Procedures

Zinc (Zn) in different soil fractions was extracted using the procedure proposed by Tessier et al. (1979). The methods followed for the fractionation procedures are outlined below:

1. Water soluble and exchangeable Zn was determined extraction 10 g of soil with 100 ml 0.1 M CaCl₂ (pH 7.0) for 20 min.
2. Specifically adsorbed Zn and Zn bound to carbonates were determined by extraction 10 g of soil with 100 ml of 1.0 M NaOAc (pH 5.0) for 5h.
3. Reductant releasable Zn occluded in oxides of Fe and Mn was determined by extraction 2.5 soil g of soil with 50 ml of 0.04 M hydroxylamine hydrochloride in 25% of HOAc, pH 3. for 6h.
4. Zinc bound to the organic matter where determined by extraction with 7.5 ml of 0.02 M HNO₃ in 30 % and 12.5 ml of H₂O₂ pH 2.0.

5. Metals structurally bound in silicates (residual fraction) were determined by calculation as the difference between the total content determined with HNO₃-HF-HClO₄ and the sum of the first four fractions.

The distribution of Zn in the chemical fractions 1–4 was determined by flame AAS (atomic absorption spectrometry).

The results obtained for the different contents of zinc (total, accessible and different chemical fractions) in the Vertisols were statistically evaluated by the Student's t-test and the Pearson correlation coefficients.

Results and discussion

The analyses have shown that the samples taken from 10 localities in Serbia were considerably differing regarding their physical and chemical properties (Table 1).

The reaction of soil was found to range in a fairly wide interval of pH values from acid to weakly alkaline reaction (from 4.60 to 7.04 in N KCl). The content of humus was considerably varying, ranging from 2.00 to 5.95% (weakly humus to humus soils), being unaffected by land use. In addition, the content of available phosphorous also ranged in a wide interval. Thus, on the smonitzas under meadow soil, the content of available P ranged from 0.8 to 17.8 mg/100g, whereas on those under field, its content ranged from 0.6 to 28 mg/100g. According to the content of the available P, the smonitzas in question are low to medium supplied with this element. In contrast to the available phosphorous, the soils were found to be rich in potassium (19.0-53.5 MG/100g). In addition, these soils indicated a high cation exchange capacity and, by mechanical composition, could be defined as medium to heavy clay soils. The above-mentioned average values of the investigated properties proved to be very much the same for the field and for the meadow smonitzas.

Table 1. Examined physical-chemical characteristics of Vertisols in Serbia (means, standard deviation and range)

Soil characteristic	Field			Meadow		
	Mean	Range	Standard deviation	Mean	Range	Standard deviation
pH (H ₂ O)	7.1	5.8–8.1	0.9	6.9	5.6-8.1	0.9
pH (KCl)	6.0	4.6-6.9	0.9	5.8	4.7-7.0	0.9
Humus content, %	3.3	2.5-4.0	0.5	3.5	2.0-5.6	1.1
P ₂ O ₅ mg/100 g	7.7	0.6-28.0	8.5	4.2	0.8-17.8	5.0
K ₂ O mg/100 g	34.4	19.0-59.6	11.8	31.1	20.4-53.5	10.4
CECmeq/100 g	25.1	15.5-31.5	5.6	23.8	16.9-34.7	6.6
Sand, %	29.6	21.4-36.0	4.8	32.2	22.3-50.5	9.0
Silt, %	24.6	18.8-31.2	3.6	22.8	11.9-29.4	5.6
Clay, %	45.8	33.5-54.4	7.2	44.9	28.9-64.3	11.1
Silt + Clay, %	70.4	64.0-78.6	4.8	67.7	49.5-77.7	9.0

Total Zn in the soils ranged between 55-119 mg kg⁻¹ and 60-117 mg kg⁻¹ in field and meadow respectively with an average concentration of 82 mg/kg. It is higher than its average value of "world soils" (60 mg kg⁻¹, Davies and Jones, 1988). Tagwira et al. (1993) in Zimbabwe and Chahal (2005) in India demonstrated that finer textured soils contain higher concentrations of Zn in all the fractions when compared to coarser textured soils. Contents of zinc in different

fractions of examined soils, presented in mg kg⁻¹ and in % in respect to the total content, are given in Table 2.

The presented results of the fractional distribution of soil Zn showed that residual Zn (71.93 %) > oxide bound Zn (19.89%) > organic bound Zn (6.69%) > specifically adsorbed and carbonate bound Zn (0.89%) > exchangeable adsorbed Zn (0.26%). The more stable Ox-Zn and Res-Zn fractions accounted for more than 70% of soil Zn. This is similar to observations reported by, Chidanandappa et al. (2008) and Saffari et al. (2009), Chirva et al. (2012) who found residual Zn to be predominant in soils.

Table 2. Content of Zn in different fractions for the Serbian Smonitza (Means, Standard Deviation and Interval), in mg/kg

Mode of soil utilisation	I	II	III	IV	V	Total Zn
Field	0.17±0.16 0.1-0.6	0.55±0.45 0.1-1.4	13.95±2.96 8.8-18.4	5.33±1.38 3.5-8.0	62.68±16.2 35.2-93.2	82.7±15.3 60.0-117.0
Meadow	0.23±0.22 0.1-0.8	0.81±0.50 0.3-1.7	18.15±3.99 12.2-24.0	5.28±1.58 3.1-8.2	57.65±18.3 34.5-89.7	82.1±19.0 55.0-119.0
t-test field:meadow	0.6794 ^{NS}	0.81 ^{NS}	2.5528 ^{NS}	0.0750 ^{NS}	0.6503 ^{NS}	NS

NS-No statistically significant

The fraction of Mn and Zn oxides (III) ranks second in the content of Zn after the residual fraction. Although the total Zn content in the soils from field and those from the meadow are similar, the occurrence of Zn in this fraction is higher in the smonitza from the meadow (22.2%) than in the ones from the field (17.5%). A different distribution of Zn between different chemical fractions of the smonitizes from the field and those from the meadow occurs due to the heterogeneity of the general properties of the smonitza soils.

The presence of Zn in the organic mater fraction is low being about 5.3 % in the smonitizes from the field and meadow.

The fraction of the specifically adsorbed as well as of carbonate bound Zn represents, a reserve of the potentially available Zn. In both group soils, the content of Zn in this fraction is low (0.1-3.1%). A somewhat higher relative occurrence in the samples from the meadow compared to those from the field is probably a result of a considerably higher content of carbonates in the samples.

The content of Zn in the exchangeable fraction (I) is very low with individual relative values of about 0.1 %. Zn in this fraction is weakly bound, soluble and directly available to plants (LeClaire, 1984).

Zinc Fraction According to Soil Characteristics

Relations between the Zn fraction and soil characteristics were determined using the Pearson correlation coefficient (Table 3).

Table 3. Correlation coefficient between the zinc content in different fractions and some soil characteristics for fields and meadows

Fraction Properties	I	II	III	IV	V
pH (H ₂ O)	- 0.74**	- 0.60**	NS	NS	0.57**
pH (KCl)	- 0.70**	- 0.59**	NS	NS	0.58**
Humus, %	NS	NS	NS	NS	NS
P ₂ O ₅ mg/100 g	NS	NS	NS	NS	NS
K ₂ O mg/100 g	NS	- 0.50*	NS	NS	0.53*
CECmeq/100 g	- 0.65**	- 0.58**	NS	NS	0.72**
Sand, %	0.49*	0.50*	NS	NS	-0.67**
Silt, %	0.48*	NS	NS	NS	-0.46*
Clay, %	- 0.62**	- 0.47*	NS	NS	0.75**
Silt + Clay, %	- 0.49*	- 0.51*	NS	NS	0.67**

NS- No statistically significant differences; *Significant at the 0.05 probability level; ** Significant at the 0.01 probability level

Relations between the Zn fraction and soil characteristics were determined using the Pearson correlation coefficient (Table 3). The analysis showed that the content of Zn in water-soluble + exchangeable Zn (I) and specifically adsorbed Zn (II) generally show significant and negative correlations with selected soil properties such as pH value of soil, the content of clay (CEC), silt+clay and K₂O. The clay content and pH influence the CEC to a large extent, the increase of CEC strengthens the bond between Zn and the solid phase of soil, which reduces the mobility and solubility of Zn in this fraction. Conversely, soil with larger soil fractions (sand and silt) had an increased Zn content in fraction.

The Zn associated with the residual fraction was negatively correlations with sand and silt content and positively with the soil pH values, readily available K₂O, clay, CEC and the silt + clay fractions. The negative correlation between the residual Zn and sand and a positive correlation with the clay content and silt + clay indicates that most of zinc his fraction is bound to clay particles. The clay fractions usually contain high amounts of metals (Zn) due to high adsorption,

Conclusion

The fractional distribution of Zn in Serbian soils was in the order residual Zn (71.93 %) > oxide bound Zn (19.89%) > organic bound Zn (6.69%) > specifically adsorbed and carbonate bound Zn (0.89%)>exchangeable adsorbed Zn (0.26%). Res-Zn>CO₃-Zn>Org-Zn>Ex-Zn and they can be clustered into stable (Ox-Zn and Res-Zn), intermediate (CO₃-Zn and Org-Zn) and available (Ex-Zn) forms. Extractable Zn concentrations of these soils are generally low because the stable fraction is the dominant form in soils. Given low levels of bio-available Zn in many Serbian soils, the implication is that in the transformation of soil Zn, the stable form is only very slowly released into the available fraction and the intermediate forms offer a strong buffering to replenishing the soluble form albeit at a slow equilibrium. Soil Zn concentrations were influenced by the colloidal properties of the soils such that soils with high pH and those with finer texture were more likely to have higher Zn concentration in the various fractions. Land cultivation will probably result into lower soil Zn concentration.

References

- Alloway, B.J., 2003. Zinc in Soils and Crop Nutrition. International Zinc Association, Brussels, Pages: 114.
- Chidanandappa, H.M., H. Khan, T. Chikkaramappa and B.L. Shivaprakash, 2008. Forms and distribution of zinc in soils under mulberry (*Morus indica* L.) of multivoltine seed area in Karnataka. *J. Agric. Sci.*, 42: 26-32.
- Chirwa M., and Olusegun A. Yerokun, 2012. The Distribution of Zinc Fractions in Surface Samples of Selected Agricultural Soils of Zambia. *International Journal of Soil Science*, 7: 51-60.
- Davies, B. E, and Jones L.H. (1988). Micronutrients and toxic elements. In A. Wild ed Russell's soil conditions and Planth growth, 11th ed., Longman, Harlow, UK.780-814.
- Meki Chirwa and Olusegun A. Yerokun, 2012. The Distribution of Zinc Fractions in Surface Samples of Selected Agricultural Soils of Zambia. *International Journal of Soil Science*, 7: 51-60.
- Milivojevic, J., M. Jakovljevic and M. Jelic, 2005. Content of different forms of microelements in Smonitza soils in Serbia. *Acta Biol. Yugoslavica*, 54: 73-84.
- Rieuwerts, J.S., M.R. Ashmore, M.E. Farago and I. Thornton, 2006. The influence of soil characteristics on the extractability of Cd, Pb and Zn in upland and moorland soils. *Sci. Total Environ.*, 366: 864-875.
- Tessier, A., Campbell, P.G.C., Bisson, M., 1979. Sequential Extraction Procedure for the Speciation of Particulate Trace Metals. *Anal.Chem.*, 51,844-851
- FAO/WHO/IAEA, 1996. Trace Elements in Human Nutrition and Health. WHO, Geneva.
- Fedotov, P.S. and Y.B. Spivakov, 2008. Fractionation of elements in soils, sludges and sediments: Batch and dynamic methods. *Russ. Chem. Rev.*, 77: 649-660.
- Hambridge, K.M., C.E. Casey and N.F. Krebs, 1986. Zinc. In: Trace Elements in Human and Animal Nutrition, Mertz, W. (Ed.). 5th Edn., Academic Press, Inc., New York, USA., pp: 1-137.
- Haug, H., O.A. Christophersen, J. Kinabo, W. Kaunda and L.O. Eik, 2010. Use of dried kapenta (*Limnothrissa miodon* and *Stolothrissa tanganicae*) and other products based on whole fish for complementing maize-based diets. *Afr. J. Food Nutr. Dev.*, 10: 2478-2478.
- Kiekens, L., 1995. Zinc. In: Heavy Metals in Soils, Alloway, B.J. (Ed.). Chapman and Hall, London, pp: 284-303.
- LeClaire, J.P., Chang, A.C., Levesque, C.S., Sposito, G. (1984): Trace Metal Chemistry in Arid-Zone Field Soils Amended with Sewage Sludge: IV. Correlations Between Zinc Uptake and Extracted Soil Zinc Fractions. *Soil Sci. Am. J.*, 48,509-513.
- Saffari, M., J. Yasrebi, N. Karimian and X.Q. Shan, 2009. Evaluation of three sequential extraction methods for fractionation of zinc in calcareous and acidic soils. *Res. Biol. Sci.*, 4: 848-857.
- Sing, J.P., Karwasra, S.P.S. and Mahendra Singh (1988): Distribution and forms of copper, iron, manganese, and zinc in calcareous soils of India. *Soil. Sci.*, 146, 359-365.
- Zimdahl, R.L. and R.K. Skogerboe, 1977. Behavior of lead in soil. *Environ. Sci. Technol.*, 11: 1202-1207.
- Yugoslav Society of Soil Science (1966): Manual for Soil Chemical Analysis. Manual for Soil testing, Books I, Belgrade.

CHANGES IN SOIL PHYSICAL PROPERTIES WITH HAZELNUT HUSK AND TOBACCO WASTE APPLICATIONS

Coskun GÜLSER

Ondokuz Mayıs University, Faculty of Agriculture, Department of Soil Science and Plant Nutrition, Samsun, 55139
Turkey

Corresponding author: cgulser@omu.edu.tr

Abstract

Recycling organic wastes has been attention to sustain soil quality in agricultural fields recently. In this study, the effects of hazelnut husk and tobacco waste on soil physical properties such as, bulk density, aggregate stability and saturated hydraulic conductivity were investigated. After incorporating 5% rate of hazelnut husk and tobacco waste into a clay loam soil, soil samples were incubated 18 weeks under greenhouse conditions. Both organic waste treatments significantly increased organic matter content, aggregate stability and saturated hydraulic conductivity of soil while they decreased soil bulk densities compared with the control. Soil organic matter content had significant positive correlations with aggregate stability (0.667*) and saturated hydraulic conductivity (0.700*) and a significant negative correlation with bulk density (-0.844**). It was found that hazelnut husk and tobacco waste can be recycled into farmlands and used as a soil conditioner to improve soil physical properties and to prevent soil degradation.

Key words: *Hazelnut husk, tobacco, bulk density, aggregate stability, permeability.*

Introduction

The loss of soil organic matter due to intensive agricultural practices causes soil degradation and decline of soil structure (Dexter, 2004; Usowicz and Lipiec, 2009). Organic waste application into soils has a greatest effect on organic matter content and nutrient values, and also improves structure, water and air balance, and microbiological activities of soils (Chenu et al, 2000; Candemir and Gülser, 2010). Soil aggregates are the main units of soil structure, and addition of organic residues to soils improves soil structure by increasing aggregate stability (Gülser, 2006; Gülser and Candemir, 2015). Organic residues contribute to the development of soil structure as a binding agent in the formation of aggregates. The soil organic carbon has a greater effect on aggregation especially in coarse textured soils (Bronick and Lal, 2005). Organic matter and compost application into soils improve soil physical and chemical quality. Addition of organic wastes to soils reduces bulk density, increases total pore space, permeability, microbial activity, mineralization, available nutrient elements and electrical conductivity of soils (Gülser et al., 2015). Hydraulic conductivity is an important soil physical property for determining soil hydrological processes and may change as water permeates and flows in a soil due to various chemical, physical and biological processes (Hillel, 1982).

Hazelnut and tobacco plants are important agricultural products in the Black Sea Region of Turkey. Large quantity of hazelnut husk and tobacco waste as agricultural waste materials are available in the region. Therefore, these waste materials might be reused as an organic matter source in sustainable agricultural management systems. The objective of this study was to investigate possible uses of hazelnut husk (HH) and tobacco wastes (TW) as soil conditioners to improve soil physical properties.

Materials and methods

A greenhouse study was carried out in a randomized plot design with three different treatments (control, HH and TW) and three replications for 18 weeks in 2011. After sieving the air dried clay loam soil sample from 4 mm sieve, pots were filled with 1 kg of soil sample. According to oven dry weight basis, 5% rate of hazelnut husk (HH) and tobacco waste (TW) were incorporated into pots homogenously. Soil samples were irrigated with distilled water to maintain moisture level of soils around field capacity during the experiment.

Soil particle size distribution was determined according to hydrometer method (Day, 1965), soil reaction (pH) and electrical conductivity ($EC_{25^{\circ}C}$) values in 1:1 soil:water suspension (Kacar, 1994), soil organic matter (OM) by 'Walkley-Black' method and exchangeable cations by ammonia acetate extraction method (Kacar, 1994). According to some soil properties given in Table 1, the soil is a non-saline, moderately alkaline, clay loam, low in organic matter (Soil Survey Staff., 1993). Bulk density (BD) of the each soil core was determined according to Blake (1965). Aggregate stability using a wet sieving method according to Kemper and Rosenau (1986), saturated hydraulic conductivity by constant head method (US Salinity Lab. Sta., 1954) were determined.

Variance analyses of the data were run using SPSS program and pairs of mean values compared using Duncan test.

Table 1. Some physical and chemical properties of the soil

Sand, %	41.44	OM, %	0.19
Silt, %	24.57	Exc. K, cmol kg^{-1}	0.51
Clay, %	33.99	Exc. Ca, cmol kg^{-1}	29.70
pH (1:1)	8.40	Exc. Mg, cmol kg^{-1}	7.90
$EC_{25^{\circ}C}$, dS m^{-1}	0.40		

Results and discussion

Hazelnut husk and tobacco waste significantly increased soil organic matter content according to the control ($P < 0.01$) (Figure 1). The highest OM content (3.12%) was determined in HH treatment. Electrical conductivity values were significantly increased by tobacco waste application ($P < 0.01$) (Figure 1). Soil EC values in HH and TW treatments increased 33% and 695% over the control. Smith and Doran (1996) reported that electrical conductivity can serve as a measure of soluble nutrients for both cations and anions. EC is also useful in monitoring the mineralization of organic matter in soil (De Neve et al., 2000). Candemir and Gülser (2010) found that application of agricultural wastes increased EC values in soil. They also reported that the highest increment in soil EC value was obtained with tobacco waste application compared with the other treatments.

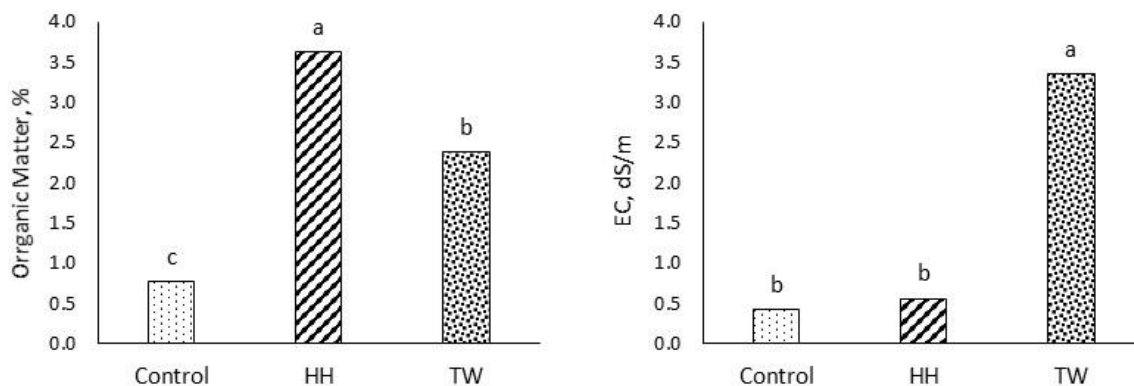

Figure 1. Changes in soil organic matter contents and EC values with hazelnut husk (HH) and tobacco waste (TW) applications.

Increasing organic matter content in soil by the application of agricultural wastes significantly decreased the soil bulk density ($P < 0.05$) (Figure 2). The lowest bulk density (1.02 g/cm^3) was determined with HH treatment. According to the control treatment, percentage decreases in bulk density by the applications of HH and TW were 15% and 13%, respectively. There was a significant negative correlation (-0.844^{**}) between OM and BD values (Table 2).

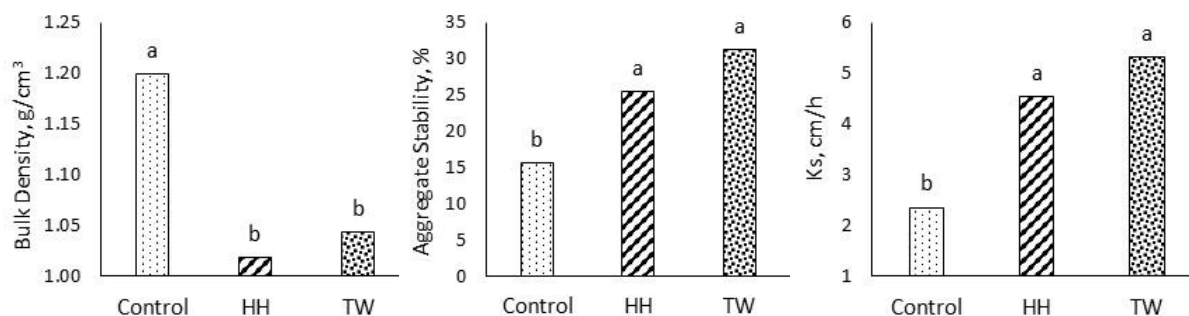

Figure 2. Changes in bulk densities, aggregate stability and saturated hydraulic conductivity (K_s) values with hazelnut husk (HH) and tobacco waste (TW) applications.

Agricultural waste treatments significantly increased aggregate stability of soil compared with the control ($P < 0.01$) (Figure 2). Aggregate stability (AS) in HH and TW increased by 63% and 99% respectively, relative to the control. Improved aggregate stability by addition organic residue to soils is a result of released plant phenolic acid interactions during the decomposition of residues structural components and increasing microbial activity due to carbohydrates metabolisms (Martens, 2000). AS values had a significant positive correlation (0.667^*) with soil OM (Table 2). Gülser (2006) reported that increasement in organic C content significantly decreases bulk density and increase total porosity and the proportion of larger aggregates, and that there was a significant positive correlation between OM and AS. In this study, reduce in bulk density caused increase in total porosity and saturated hydraulic conductivity. Applications of HH and TW significantly increased K_s values in soil ($P < 0.05$) (Figure 2). Percentage increases in K_s by the HH and TW treatments relative with the control were 92% and 125%, respectively. Soil K_s

values gave significant positive correlations with OM (0.700*) and AS (0.885**), and a significant negative correlation with BD (-0.727*) (Table 2). Candemir and Gülser (2007) reported that during the decomposition period of organic waste in soil reduced soil bulk density and increased soil permeability due to increases in total porosity and aggregate stability. In this study, it was similarly found that increasing OM in soil due to agricultural waste applications helps to increase soil Ks with increasing AS and reducing BD.

Table 2. Correlations among the soil properties after agricultural waste treatments.

	EC	BD	AS	Ks
Organic Matter	0.116	-0.844**	0.667*	0.700*
EC		-0.360	0.762*	0.624
Bulk Density (BD)			-0.852**	-0.727*
Aggregate Stability (AS)				0.885**

** Correlation is significant at the 0.01 level, * Correlation is significant at the 0.05 level

Conclusion

Incorporating agricultural wastes into soil increased EC by mineralization of organic matter and improved soil aggregate stability. Total porosity of soil increased with reducing BD significantly by the HH and TW applications. Soil OM content and AS values had significant positive correlations each other and with Ks. Significant increases in OM after HH and TW applications caused increases in AS and Ks. Recycling of agricultural wastes is a useful technology with respect to environmental protection and also can have an economic benefit for farmers in sustainable agricultural practices.

References

- Blake, G.R. 1965. Bulk Density. In: Methods of Soil Analysis, Part 1. Physical and Mineralogical Properties, C.A. Black (Ed.). ASA-SSSA, No: 9. Madison, Wisconsin, USA. pp. 374-390.
- Bronick, C.J., Lal, R., 2005. Soil structure and management: a review. *Geoderma* 124(1-2):3-22.
- Candemir, F., Gülser, C., 2007. Changes in some chemical and physical properties of a sandy clay loam soil during the decomposition of hazelnut husk. *Asian J. Chem.* 19(3):2452-2460.
- Candemir, F., Gülser, C., 2010. Effects of different agricultural wastes on some soil quality indexes at clay and loamy sand fields. *Communication in Soil Science and Plant Analysis* 42 (1): 13-28.
- Chenu, C., Le Bissonnais, Y., Arrouays, D. 2000. Organic matter influence on clay wettability and soil aggregate stability. *Soil Science Society of America Journal* 64: 1479-1486.
- Day, P.R., 1965. Particle fractionation and particle size analysis. In: Methods of Soil Analysis, Part 1. Physical and Mineralogical Properties, C.A. Black (Ed.). ASA-SSSA, No: 9. Madison, Wisconsin, USA. pp. 545-567.
- De Neve, S., Van de Steeve, J., Hartmann, R., Hofman, G., 2000. Using time domain reflectometry for monitoring mineralization of nitrogen from soil organic matter. *European Journal of Soil Science* 51(2): 295-304.
- Dexter, A.R. 2004. Soil physical quality: Part I. Theory, effects of soil texture, density, and organic matter, and effects on root growth. *Geoderma* 120(3-4): 201-214.

- Gülser C., Candemir F., 2015. Effects of agricultural wastes on the hydraulic properties of a loamy sand cropland in Turkey. *Soil Science & Plant Nutrition* 61 (3): 384-391.
- Gülser, C., 2006. Effect of forage cropping treatments on soil structure and relationships with fractal dimensions. *Geoderma* 131(1-2): 33-44.
- Gülser, C., Candemir, F., Kanel, Y., Demirkaya, S., 2015. Effect of manure on organic carbon content and fractal dimensions of aggregates. *Eurasian Journal of Soil Science* 4(1):1-5.
- Hillel, D. 1982. *Introduction to soil physics*. Academic Press, Inc. San Diego, California.
- Kacar, B., 1994. *Chemical Analysis of Plant and Soil III. Soil Analysis*. Ankara University, Faculty of Agriculture No:3, Ankara, Turkey.
- Kemper, W.D., Rosenau, R.C., 1986. Aggregate stability and size distribution. In: *Methods of Soil Analysis, Part 1. Physical and Mineralogical Properties*, A. Klute (Ed.). ASA-SSSA, No: 9. Madison, Wisconsin, USA. pp. 425-442.
- Martens, D.A., 2000. Plant residue biochemistry regulates soil carbon cycling and carbon sequestration. *Soil Biology & Biochemistry* 32, 361–369.
- Smith, J., J.W. Doran, 1996. Measurement and use of pH and electrical conductivity for soil quality analysis. In: *Methods for Assessing Soil Quality*. Doran, J.W., Jones, A.J. (Eds), Soil Science Society of America Specific Publication No. 49. SSSA, Madison, WI, USA. pp. 169-185.
- Soil Survey Staff, 1993. *Soil Survey Manual*. USDA Handbook. No:18. Washington D.C.
- US Salinity Lab. Sta., 1954. *Diagnosis and improvement of saline and alkali soils*. Agricultural Handbook, No. 64, USDA. Washington DC, USA.
- Usovics, B., Lipiec, J., 2009. Spatial distribution of soil penetration resistance as affected by soil compaction: The fractal approach. *Ecological Complexity* 6(3): 263-271.

THE POSSIBILITY OF USING HOUSEHOLD FOOD WASTE IN REDUCING NICOTINE CONTENT IN TOBACCO WASTE

Vesna RADOJIČIĆ^{1*}, Nemanja MANDIĆ¹, Maja MALNAR¹, Boris PISINOV²

¹University of Belgrade, Faculty of Agriculture, Belgrade-Zemun, Serbia

²Department of Food Safety, Institute of Veterinary Medicine of Serbia, Belgrade, Serbia

*Corresponding author:

Abstract

Tobacco waste is generated during its growth and processing, and represents a significant part of the agro-industrial and municipal waste. Although tobacco waste has a high content of organic matter, its use is limited due to its nicotine content, which is above the limit of 500 mg/kg. Domestic food waste has also become a significant global issue. The aim of this study was to examine the possibilities of the nicotine reduction through the composting process, by mixing tobacco with the household waste. Through this process we can: solve the problem of generating different types of waste, reduce pollution and get a stable product. In this experiment, we used Virginia tobacco leaves, which are classified as tobacco waste (TW) after processing, as well as the household food waste. Three experimental samples of the same composition percentage (50% TW + 50% household food waste) were formed. The two of them were placed in the chamber, while the third one was held at room temperature. The experiment was carried out in the laboratory of the Faculty of Agriculture, during a period of 44 days. The nicotine content in the samples was determined by High Performance Liquid Chromatography (HPLC) method. Already by mixing tobacco with the household waste, the content of nicotine was reduced by one-third. At the end of the experiment, the nicotine content of the samples that were held in the chamber has fallen below 10 mg/kg. Nicotine content in the batch that has been kept at room temperature was 76.5 mg/kg.

Keywords: *household food waste, tobacco waste, composting, nicotine*

Introduction

Household waste is becoming an increasingly important global issue. One survey has found that consumers throw away 31% of the purchased food. Huge amounts of household waste end up in landfills, which has a negative impact on the environment (Nahman et al., 2012).

According to FAO data, 1.3 billion tons of edible food produced for human consumption, deteriorates every year. This is one-third of produced food, which is sufficient to feed one-eighth of the world's population (Chalak et al., 2016; Gustavsson et al., 2011). The composition of household waste varies considerably depending on the place of origin and to a large extent depends on the eating habits (Chang and Hsu, 2008).

Household waste is the most comprehensive organic component of municipal solid waste by weight, which makes 14-40% of solid waste. Therefore, household waste should be diverted from landfills. After an appropriate technological treatment (especially composting), it could be converted into an economically and environmentally friendly product (Wang et al., 2016). Composting is an acceptable solution, due to the fact that it can reduce the volume and mass of the waste, which can afterwards become a stable end-product (Kopčić et al., 2013). Therefore, composting is recommended in organic waste management (NSCEP, 2000).

The composting process involves a biological breakdown of organic waste under aerobic or anaerobic conditions. The resulting compost is a stable, complex mixture enriched in nutrients, which can improve physical properties of the soil. During the composting process, it is of great importance to regulate and to control parameters, in order to provide optimal working conditions for microorganisms which degrade the organic matter (Lim et al., 2016).

Tobacco waste, which is generated in all processes, from its production to the production of tobacco cigarettes, accounts for a significant percentage of the agro-industrial and municipal waste in Serbia (Radojičić et al., 2009). The largest amount of the waste is collected in the very beginning - while purchasing dry tobacco leaves from the manufacturer. The reason is the poor quality of the sheets, which - according to the current criteria for classification of tobacco (Classification criteria for tobacco leaves JUS.E.P1.110: 2004) - cannot be redeemed or used for the manufacture of tobacco products. Producers have the greatest responsibility for collection, transport, processing and safe disposal of tobacco products (Curtis et al., 2016).

In management of the tobacco waste the use of biological or thermal processes is recommended. Biological waste treatment is more time-consuming, compared with the thermal processes. However, the big advantage of biological methods is their simple technology and lower costs. Also of great importance is the fact that artificially induced natural processes does not pose a risk by creating new chemicals that are dangerous, as it is the case with their burning (Piotrowska-Cyplik et al., 2009).

Despite the fact that tobacco waste has a high content of organic matter, its use is limited because of the nicotine content, which is above the limits set by the EU (Civilini et al., 1997). According to European Union Regulations (Novotny and Zhao, 1999) nicotine content over 500 mg/kg categorizes this waste as hazardous. For this reason, tobacco waste cannot be disposed of together with urban waste (Pichtel, 2005), but must be destroyed under special conditions, which has an economically negative impact on tobacco producers and processors.

The aim of this study was to examine the possibilities of reduction of nicotine content through the process of composting, by mixing tobacco waste with household waste. Composting process cannot only solve the problem of generating different types of waste, but it can also reduce pollution and enables to get a stable product that can be used as an organic fertilizer.

Materials and methods

Virginia tobacco leaves, which are declared as waste after redrying process, were used for the purposes of the experiment. As components in experimental batches, mixed household waste was used: onions, potatoes and carrots. Experiment was carried out during the period of two months, February and March 2016 (total 44 days) at the Faculty of Agriculture, University of Belgrade. Experiment is carried out in several stages:

Preparation of experimental batches - Low humidity is one of the main characteristics of tobacco waste; in the first phase of the experiment were performed wetting, grinding and mixing tobacco waste and household waste. Different compost batches were formed (Table 1).

Table 1. Compost batches ingredients (%)

Composting batch	TW	Household waste
R	50	50
1	50	50
2	50	50

TW - tobacco waste

Monitoring parameters of the composting process - The compost batches 1 and 2 were placed in a chamber with controlled conditions (temperature and humidity), while the compost batch R was the reference sample which was held in the laboratory at room temperature.

During the experiment, temperature and moisture measurements were performed daily in samples 1 and 2, which had been placed in the chamber (WET Sensor, type WET-2, Delta-T Devices Ltd) as well as temperature and relative humidity in the chamber (mini weather stations Kestrel 4000, Nielsen-Kellerman).

Analysis of nicotine content in samples of experimental batches (Radojičić et al., 2015) - Nicotine content in a clean TW and in batches during the composting process was determined by High Performance Liquid Chromatography method (HPLC, Waters Breeze, USA).

Results and discussion

Table 2 shows the results of nicotine content in experimental batches.

Table 2. The nicotine content in experimental batches after mixing (mg/kg)

Composting batch	09.02.2016.	18.02.2016.	02.03.2016.	14.03.2016.	24.03.2016.
R	5687.0	1089.8	311.0	117.7	76.5
1	5687.0	474.4	178.8	45.7	<10
2	5687.0	660.4	258.3	27.5	<10

Nicotine content in a clean tobacco waste (100% TW) at the beginning of the experiment was 17363 mg/kg. Already by mixing tobacco waste with household waste, the nicotine content decreased by as much as 2/3 to the initial value. All experimental compost batches showed excellent dynamics of decomposition of nicotine.

After 44 days, the nicotine content in compost batches 1 and 2 dropped below 10 mg/kg, which is far below the prescribed value according to the EU directives

Although the process of tobacco waste biodegradation was successfully completed in all experimental batches, degradation of nicotine in batch 1 was the fastest. Already after 9 days the nicotine content dropped below 500 mg/kg, which is below the limit prescribed by the EU directive. When it comes to the batch 2, the speed of nicotine degradation has been somewhat slower and after 22 days the nicotine content was 258.3 mg/kg, which is also below the permissible limit. In the sample without treatment, the nicotine content fell below 500 mg/kg also after 22 days. At the end of the experiment nicotine content in batches 1 and 2 dropped below 10 ppm, while the untreated sample contained 76.5 ppm of nicotine.

During the experiment, the parameters of the process were also measured (temperature and humidity). They also affect the rate of degradation of nicotine. The chamber temperature was

kept constant. The chamber was active every day during 8 hours, while the temperature was maintained at a value of 52°C. In the afternoon, the thermostat was excluded until the next morning (a total of 16 hours). The temperature inside the chamber did not fall below 21°C. Relative humidity in the chamber was maintained at 60% during the experiment.

Figure 1 shows the mean values of temperature at intervals during the experiment. Temperatures in the experimental batches were nearly identical which has led to a faster degradation of the nicotine, compared with the batch with no treatment. We can conclude that at room temperature an acceptable rate of degradation of nicotine is also achievable.

Figure 1. Temperature means values during the composting process

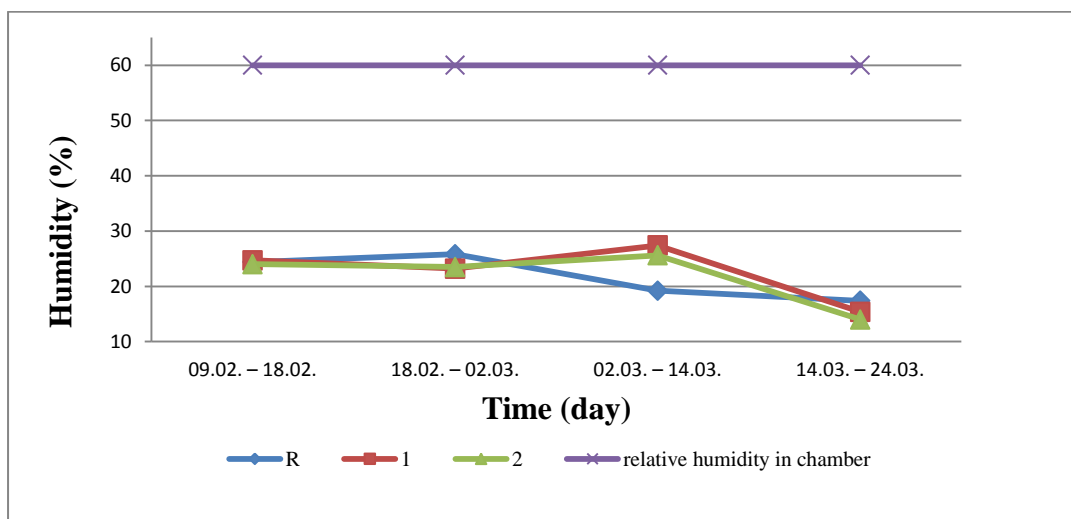

Figure 2. Humidity mean values during the composting process

Based on the mean value of moisture in the experimental batches, in given time periods, shown in Figure 2, we can say that the experimental batch 1 had a slightly higher moisture content, which resulted in a faster degradation of the nicotine than in the batch 2. At the last stage of the experiment, when it was determined that the nicotine content decreased to 27.5 mg/kg in batch 2, and 45.57 mg/kg in the batch 1, we stopped with the addition of the water. As a result, after 14.03. there was a sudden drop in humidity in both of the batches, which is evident in Figure 2. In the same period there has been a slight drop in temperature in the batches, from 37°C to 34°C (Figure 1). Regardless of the changes in the values of temperature and moisture in the samples, the degradation of nicotine did continue; the content has dropped below 10 mg/kg in both batches.

During the experiment, the values of the process parameters (humidity and air temperature) were measured in one same place in the chamber. Although batches 1 and 2 had the same composition, the difference in intensity of nicotine reduction can only be explained by non-identical values of temperature and humidity in every part of the chamber.

The results of this experiment confirm that the organic material, in this case the household waste, can be used for composting of tobacco waste, primarily in order to reduce the nicotine content.

Also, the results showed that the process of composting of tobacco waste can be done in a controlled as well as in uncontrolled environmental conditions but the pace of nicotine reduction varies. Comparing with the results of previous studies (Radojičić et al., 2015), in which the

composting of tobacco waste was performed in partially controlled conditions, the process will be shortened by 50 days.

Besides reducing the nicotine content in the samples, there was a reduction in the mass of the samples (Table 3).

Table 3. Mass loss in samples (kg)

Composting batch /mass	09.02.	18.02.	02.03.	14.03.	24.03.
1	1	0.807	0.702	0.603	0.336
2	1	0.754	0.558	0.410	0.256

Experimental batch 1 has lost 66.4% of its weight and the batch 2 has lost more (74.4%). We have to mention that at the moment of measuring the mass at the end of the experiment, batch No.1 had slightly higher moisture content, as it can be seen in Figure 2.

Conclusion

Based on the results of the experiment it can be concluded that the scientific goal of the research was achieved. Eligible dynamics of degradation of nicotine in tobacco was achieved by mixing the waste with household waste. Already by mixing, the nicotine content decreased to one third compared with the initial amount. At the end of the experiment nicotine content in all samples fell below 10 mg/kg, which is far below the 500 mg/kg (the value determined by the European Union Regulations).

The results of the experiment also confirmed that the composting of tobacco waste can be done in controlled as well as in uncontrolled conditions, but the pace of nicotine reduction changes. By controlling the process conditions (regulation of temperature and moisture in compost batches, in a controlled atmosphere) we can increase the efficiency of nicotine degradation.

References

- Chalak A., Abou-Daher C., Chaaban J., Abiad G. M. (2016). The global economic and regulatory determinants of household food waste generation: A cross-country analysis. *Waste Management*, Vol.48, 418–422.
- Chang I. J., Hsu T. E. (2008). Effects of compositions on food waste composting. *Bioresource Technology*, Vol. 99, 8068–8074.
- Civilini M., Domenis C., Sebastianutto N., de Bertoldi M. (1997). Nicotine decontamination of tobacco agro-industrial waste and its degradation by micro-organisms. *Waste Manage Res.* 15, 349-58.
- Curtis C., Novotny E. T., Lee K., Freiberg M., McLaughlin I. (2016). Tobacco industry responsibility for butts: a Model Tobacco Waste Act. *Tob Control*, Published Online First, doi:10.1136/tobaccocontrol-2015-052737.
- Gustavsson J., Cederberg C., Sonesson U., van Otterdijk R., Meybeck A. (2011). Global food losses and food waste - extent, causes and prevention. Food and Agriculture Organization of the United Nations (FAO), International Congress – Save Food, Düsseldorf, Germany.
- Kopčić N., Vukovic Domanovac M., Kučić D., Briški F. (2013). Evaluation of laboratory scale in-vessel co-composting of tobacco and apple waste. *Waste Management* 34, 323-328.
- Lim L. S., Lee H. L., Wu Y. T. (2016). Sustainability of using composting and vermicomposting technologies for organic solid waste biotransformation: recent overview, greenhouse gases emissions and economic analysis. *Journal of Cleaner Production*, Vol.111, Part A, 262-278.

- Nahman A., de Lange W., Oelofse S., Godfrey L. (2012). The costs of household food waste in South Africa. *Waste Management*, Vol.32, 2147–2153.
- Novotny T.E., Zhao F. (1999). Consumption and production waste: another externality of tobacco use. *Tob Control* 8, 75-80.
- Novotny T.E., Zhao F. (1999). Consumption and production waste: another externality of tobacco use. *Tob Control* 8, 75-80.
- NSCEP (National Service Center for Environmental Publications) (2000). *Biosolids technology fact sheet: use of composting for biosolids management*. US Environmental Protection Agency (EPA), Publication place/city.
- Piotrowska-Cyplik A., Olejnik A., Cyplik P., Dach J., Czarnecki Z. (2009). The kinetics of nicotine degradation, enzyme activities and genotoxic potential in the characterization of tobacco waste composting. *Bioresource Technology*, Vol.100, 5037–5044.
- Pichtel J. (2005). *Waste Management Practices: Municipal, Hazardous and Industrial*. CRC Press, Taylor & Francis Group, London.
- Radojčić V., Mandić N., Ećim-Đurić O., Raičević V., Lalević B. (2015). Reducing the nicotine content through tobacco waste composting with other organic materials. *Sixth International Scientific Agricultural Symposium “Agrosym 2015”, Book of Proceedings*, 1462-1467.
- Radojčić, V., Milošević, M., Tomašević, B. (2009). Tobacco waste management in Serbia. *Ecological truth* 09, Proceedings, 218 -221.
- Wang X., Selvam A., Wong W.C.J. (2016). Influence of lime on struvite formation and nitrogen conservation during food waste composting. *Bioresource Technology*, DOI: 10.1016/j.biortech.2016.02.117.

SEX RATIO IN LOCAL POPULATION OF SPECIES *Chondrostoma phoxinus* Heckel, 1843 (Teleostei: Ostaryophysi, Cyprinidae) FROM Buško LAKE

Denisa ŽUJO ZEKIĆ^{1*}, Mirzeta KAŠIĆ-LELO², Suvad LELO², Aida ABAZA¹

¹Biology Department, Teachers' Faculty, University „Džemal Bijedić“; USRC Sjeverni logor bb, Mostar, Bosnia and Herzegovina

²Association for Registering and Protection of Animals, Omladinska 2, 71380 Ilijaš, Bosnia and Herzegovina

²Department of Biology, Faculty of Science and Mathematics, University in Sarajevo, Zmaja od Bosne 33-35, 71000 Sarajevo, Bosnia and Herzegovina

*Corresponding author: denisa@unmo.ba

Abstract

Within species with separated male and female sex, the sex ratio is one of the significant features of the population. The specified aspect of the sexual differentiation is represented in the development of needs for fertilization and realization of total population size and minimal presentation of genetic drift and inbreeding effect. The species *Chondrostoma phoxinus* Heckel, 1843 (known as The Minnow Nase) is described based on samples from Sinj (Croatia), and later it has been found on the territory of Bosnia and Herzegovina, more precisely in Buško Lake. Material, individuals *Chondrostoma phoxinus* Heckel, 1843, has been periodically collected from April 2003 to September in 2004 and during 2008 to 2009 with standard ichthyology methods. The noticed differences are analyzed with chi-square test. In the summed sample from 2003 to 2004 (marked as the first subsample) there were 71 units of the Minnow Nase: 51 males and 20 females (0,7183:0,2817). Summed sample from 2008 and 2009 (marked as the second subsample) included 252 units of Minnow Nase, 87 males and 118 females (0,4244:0,5756), while for 47 units we could not determine the sex. From the specified data it is possible to determine imbalance in the subsamples (first subsample: 2,55:1,00 with chi-square 13,56 and probability of random finding of the noticed differences $P < 0,001$; second subsample: 0,74: 1,00 with chi-square 2,50 and probability of random finding of the noticed differences $0,2 < p < 0,01$) between males and females in samples. However, total sample of 276 individuals have been represented with perfect ratio of 138 males and 138 females and ideal *sex ratio* 1:1.

Keywords: *Chondrostoma phoxinus*, Minnow Nase, Buško Lake, sex ratio.

Introduction

The species of the genus *Chondrostoma* Agassiz, 1835 have a very interesting life area and now take an important place in Biosystematics and Fish morphology. So far there have been described around 18 species, all in the territory of Europe (except for The United Kingdom, Scandinavia, Finland and the basin of the Arctic Ocean), also in the basin of the Black and the Caspian Sea and the waters of the Tigris and Euphrates.

Heckel was the first to describe this endemic species (in 1843) near Sinj in Dalmatia (Croatia) and a little later it was found in the territory of Bosnia and Herzegovina (Buško lake and Livanjsko field). More detailed descriptions of the types *Chondrostoma phoxinus* were given by other authors also, referring to the data by Heckel and Kner (1858), with comparative results of some other scientific methods (cytological, biochemical, physiological, genetic, comparative-anatomical, embryological, paleontological and the like.)

A number of authors including Ćurčić (1916), Karaman (1923; 1928), Kišpatić (1893, 1925) Taler (1954), Vuković (1966), Aganović (1969), Vuković and Ivanović (1971), cite a basic description of this type, representing meristic and morphometric parameters in the formula: D: III 8; A: 8-9 III; Q: I 6-8; Q: I 11-16; LL 80-99 .

Veledar and Kosorić (1972, 1974) analyzed Minnow nase length and weight growth from the water of Livanjsko field. Feeding of this type has partially been analyzed by Jerković et al. (1973), while Kačanski and Jerković (1978) write about the feeding of some fish species from the Buško Lake in general, including the type of *Chondrostoma phoxinus*. Bozja (1973) analyzed the morphology and histological structure of the intestinal tract of *Chondrostoma phoxinus* type and later Mikavica and Bošnjak (1989) give the morphological characteristics of the digestive tract. In addition to meristic and morphometric characters, Seratlić - Savić (1976) give information about the shape and size of the otolith, material and shape of bones, the number of vertebrae, and some information on the brain morphology of the *Chondrostoma phoxinus*. Elvira (1987) partially speaks/writes about biosystematic position of *Ch. Phoxinus* within the taxonomy elaboration of the whole genus *Chondrostoma* Agassiz, 1835 (Pisces, Cyprinidae). Kerovec et al. (1998) published a paper on the findings *Chondrostoma phoxinus* kinds in Croatia. Žujo (2005) presents the results of biosystematic position and the population status of the *Chondrostoma phoxinus* species in Buško Lake. Kottelat and Freyhof (2007) provide details on the morphology, ecology, distribution, habitat and biology of species referring in particular to the protection status. Mrakovčić et al. (2006) in the Red Book of freshwater fish of Croatia emphasize the status of endangered endemic species *Chondrostoma phoxinus*. Čaleta et al. (2009) published a paper on endangered fish species in the world, with emphasis on the aforementioned type. Taking all previous relevant research as a starting point in the paper, Žujo Zekić (2009-2010) published his own research of biological diversity of fish populations in Buško Lake with the object of interest on endemics: *Chondrostoma phoxinus*, *Telestes (Leuciscus) Turskyi* and *Aulopyge huegeli*. This research aims at creating the fullest possible introduction of this endemic species, with a directly given confirmation of the current status of the population (gender and age distribution) and the status of the threat through an accurate distribution of the waters of Bosnia and Herzegovina.

Material and methods

Buško Lake is an artificial accumulation since 1974, which belongs to the hydrographic system of Cetina and makes the final southern part of Livanjsko field (Livno karst field). Located at 700 m above sea level with a length of 12.5 km, the width of 11.5 km and an area of around 50 square km, Buško Lake creates a natural hydrographic, uliginous system, the largest of its kind in the fields of Bosnia and Herzegovina. The total area of this aquatic complex at the maximum water level is 56.7 square km.

A representative sample of *Chondrostoma phoxinus* types Heckel, 1843, has been collected periodically from April 2003 to September 2004, and during repeated fishings in 2007, 2008 and 2009. Established differences were analyzed by chi-square test. During the first site visits there have been taken specimens from four sites: Prisoje, Cave (Pećina), Marinovac and Široka Draga, where ichthyo-samples have been composed of 71 individuals of *Chondrostoma phoxinus*. The ichthyologic research continued during spring-summer season in 2008, fall-winter season in 2008 and the same seasons in 2009. Repeated field work at the accumulation Buško Lake resulted in fishing out of ten catching sites: Ričine Riverbed, Vrbovi Panji, Marinovac, river Mukišnica, Kazaginac dam, Široka Draga, Matkovača, Kanal (Channel), Bilo Field and Golinjevo. There have been used two types of fishing nets for this research: “popunica” net (diameter mesh 10 mm,

16 mm, 28 mm, 32 mm and 50 mm) and "barracudas" net (70 mm, 80 mm, 90 mm, 110 mm and 120 mm), which have been used in attempt to avoid selectivity of ichthyomaterial.

The individuals were pre-fixed in 4% formaldehyde and transferred to the laboratory for further processing. Biosystematic determination was made according to Vuković and Ivanović (1971), and Vuković (1977), and Kottelat and Freyhof (2007). More detailed analysis of ichthyomaterial implied determining sexes, which has been performed by dissection and examination of the gonads, where the sex ratio has been elaborated.

Results and discussion

In addition to the clear evidence that genetic material of female and male contains genes for the formation of both sexes and having in mind the sexual differentiation of the individual certainly depends, along with genetic interactions, on some environmental conditions, numerous authors (before us) have identified that the sex ratio in populations of some species is not equal. This ratio can be examined through the different age classes, though, since the first (initial) investigated sample included 71 specimens of Minnow Nase, which belongs to the age class 3+, this part of the research was facilitated. Also, in most of the works that have dealt with this issue it can be evident the phenomenon that in the age class 3+ the ratio of males and females is always in favor of the. In the analyzed sample of 71 individuals of *Chondrostoma phoxinus* from Buško Lake there has been found an unequal ratio, i. e. a simple counting revealed 20 female and 51 male, which is almost 2.5 times more males. To define this ratio we have used the *difference test* between the ratio of the studied sample. On the basis of this test, the proportion difference, it has been found that this ratio looks like this (71.8 % males and 28.2% females). The analysis of the *difference test* between males and females show a statistically significant difference ($Z = 5.196$, $p < 0.05$).

Being guided by the fact that introducing numerical ratio and the distribution of the sexes in fish populations represents an important guideline in the analysis of the population growth dynamics, the research has been continued and expanded during the 2008 - 2009 year through several field works. It was important to confirm the theoretic sex ratio in natural conditions, which should be 50:50.

Possessing a data on the quantitative and qualitative structure of different fish populations in Buško Lake, as well as the fact of dangerous domination of allochthonous/non-native fish species over indigenous, particular attention, with regards to the analysis of gender and age structure, has been directed towards endemic fish species. A detailed individual analysis of sex ratio included a total number of 252 individuals Minnow Nase, whose length exceeded 10 cm. By examining the gonads in these individuals it has been stated the disproportion in the ratio between the total number of males and females in a given population.

The Table 1. gives a transparent sex ratio, expressed in absolute and relative values set in a direct relation to the age class of samples of *Chondrostoma phoxinus*.

In this review it is evident that sex gender representation is not homogenized, as it is dominated by the females. From a total number of 252 individuals caught in ten locations in Buško Lake, during four seasons and the two-year research period, there were found and determined 118 female and 87 male individuals. Of the total number of Minnow Nase individuals, 47 individuals have not been sexually specified, which is a relatively small number compared to the total number of this fish population.

Based on ichthyo-sample analysis of Minnow Nase population, it has been ascertained the relative value expressed as a percentage of the ratio between males and females in a given population with 34.5 % of males, compared to a slightly higher share of females, 46.8 %, without

considering individuals with unspecified sex, whose percentage share in the total number of the analyzed sample is 18.7 %.

Table 1. Distribution of samples of *Chondrostoma phoxinus* (Heckel, 1843) based on sexual characteristics, age group and their sex ratio

GENDER		AGE CLASS								TOTAL
		Indeterminate	1+	2+	3+	4+	5+	6+	7+	
Indeterminate	Number of samples	46	0	1	0	0	0	0	0	47
	% within sex	97,9%	0,0%	2,1%	0,0%	0,0%	0,0%	0,0%	0,0%	100,0%
	% within age class	100,0%	0,0%	5,9%	0,0%	0,0%	0,0%	0,0%	0,0%	18,7%
Male ♂♂	Number of samples	0	4	12	32	19	13	6	1	87
	% within sex	0,0%	4,6%	13,8%	36,8%	21,8%	14,9%	6,9%	1,1%	100,0%
	% within age class	0,0%	80,0%	70,6%	72,7%	24,1%	30,2%	35,3%	100,0%	34,5%
Female ♀♀	Number of samples	0	1	4	12	60	30	11	0	118
	% within sex	0,0%	0,8%	3,4%	10,2%	50,8%	25,4%	9,3%	0,0%	100,0%
	% within age class	0,0%	20,0%	23,5%	27,3%	75,9%	69,8%	64,7%	0,0%	46,8%
TOTAL	Number of samples	46	5	17	44	79	43	17	1	252
	% within sex	18,3%	2,0%	6,7%	17,5%	31,3%	17,1%	6,7%	0,4%	100,0%
	% within age class	100,0%	100,0%	100,0%	100,0%	100,0%	100,0%	100,0%	100,0%	100,0%
	% of total number of samples	18,3%	2,0%	6,7%	17,5%	31,3%	17,1%	6,7%	0,4%	100,0%

Also, examining the following chart displays the sex ratio expressed through age classes of individuals present in the catch material, with percentile values within certain age class, as well as within sex category. It follows that the majority of male individuals caught in the age 3+, which represents 36.8% of the total number of identified specimens of the male sex (87). On the other hand, the least number of male individuals has been recorded in the age class 7+ - only one of them or 1.1%. Considering the representation of Minnow Nase female individuals in certain age classes, surprisingly, there is an extreme number of females aged 4+. Within the total number of female individuals, 60 registered individuals have a high share of 50.8%. Percentage ratio of female individuals in the age class 4+, to the total number of 79 caught individuals in that age class, is quite high at 75.9%. And, finally, the number of female individuals in the age class 4+, compared with the total number of caught Minnow Nase individuals (252), expressed in percentage, is 23.8%. This figure, which refers to the dominance of females in the total population, especially in reproductively expressive period, which has resulted in a trend of growth and dynamics of survival of the population. Following further results of the sex ratio analysis in the remaining age groups, it is registered the prominent number of female individuals. The age group 5+ (30 females) in the total number of caught registered females makes a share of 25.4%, and in the age category 6+, (11 females), it represents 9.3%. Similar considerations can be expressed for individual males in the age classes 2+, 3+, 4+, 5+, 6+ also. In the age class 1+ there are 4 male individuals, in the class 2+ there are 12 individuals and 32 males are equally present in the age class 3+, resulting a slightly higher number of males over females in these age classes. On the other hand, slightly less (19) individuals of the male sex in the age class 4+, 13 in the age class 5+ and 6 Minnow Nase males in the age class 6+, which is a significant number and representation of female in the mature reproductive age and again

demonstrates the positive trend of growth of this species population. The higher number of female Minnow Nase individuals can be closely related with the spawning period (late spring), when there is a numerically richest fishing throughout the research period. A review of all Minnow Nase individuals (252) caught in the research period, it has been noticed that only 5 of them are trapped in the age class 1+, 4 males and one female. In the age class 2+ there have been caught 17 individuals - 12 males and 4 females. In the age class 3+, number of caught fish specimens is very high at 44, of which 32 males and 12 females. The sex structure in numeric ratio is rapidly changing in higher age classes, thus in the age class 4+, from a total of 79 individuals, 60 of them are females and only 19 individuals are male, etc. A detailed statistical analysis, using χ^2 , may show a statistically significant difference between the observed Minnow Nase individuals of a particular gender and with determined age. For this analysis there have been taken only the Minnow Nase specimens with specified both gender and age group, which refers to the 205 individuals of this species. Also, they are logically grouped according to a reproductive period at the level of younger individuals, reproductively mature and older individuals with a pronounced period of stagnation. The statistical analysis in this case indicates the limit of significance in the Minnow Nase sample at the level of 0.004, or 99.6% (Table 2).

Table 2. Distribution of male and female types *Chondrostoma phoxinus* (Heckel, 1843) according to age class and their sex ratio

SEX		AGE CLASS			TOTAL
		Low level of reproductive maturity (1+, 2+)	Sexually mature samples (3+, 4+, 5+)	The downtrend of reproductive performance (6+, 7+)	
Male ♂♂	Number of samples	16	64	7	87
	% within sex	18,4%	73,6%	8,0%	100,0%
	% within age class	76,2%	38,6%	38,9%	42,4%
Female ♀♀	Number of samples	5	102	11	118
	% within sex	4,2%	86,4%	9,3%	100,0%
	% within age class	23,8%	61,4%	61,1%	57,6%
TOTAL	Number of samples	21	166	18	205
	% within sex	10,2%	81,0%	8,8%	100,0%
	% within age class	100,0%	100,0%	100,0%	100,0%

χ^2 -Test			
	Value	df	Asymp. Sig. (2-sided)
Pearson Chi-Square	10,911 ^a	2	0,004

In an attempt to discuss on a given topic about the sex ratio and sex structure of the local population of a species *Chondrostoma phoxinus* from Buško Lake there has not been found a sufficient number of valid data and results to which it would be possible to compare the results displayed in the paper. Therefore, the final observations and discussions are mainly based on some universal data on the state of the Minnow Nase population from watercourses in the Livno field. Valid examples for studying sex ratio of mixed fish population in the Buško Lake are given

by Mučibabić et al. (1973), who analyze the population of Tursky Dace, Dalmatian barbel gudgeon, Dalmatian rudd, Minnow Nase, Brown trout and Rainbow trout. According to this reference, within the population Minnow Nase of Buško Lake water there is a greater representation of females compared to males. The ratio of female to male individuals was 53.68%: 46.32%, which is close to the current actual data given in this paper during the research period 2007/2008/2009 year.

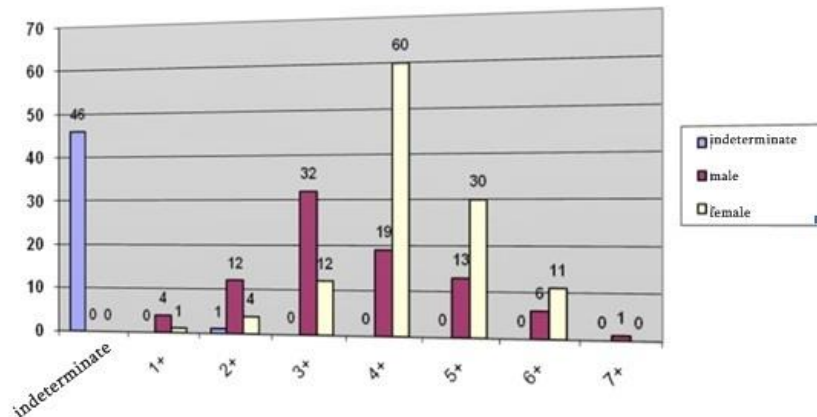

Figure 1. The review of age class and sex structure ratio of *Chondrostoma phoxinus* Heckel, 1843

Similar results are given by Aganović et al. (1974), who notice the increased representation of female individuals, on the basis of extensive research, sex ratio in the population Minnow Nase from Livno watercourses. Cvijović and Kosorić (1985), analyzing the population Minnow Nase conclude that the population is characterized by a greater number of females. Specifically, based on the 150 analyzed specimens of its kind, the relative ratio of the sexes is 46.67%: 53.33% in favor of females, which in just 6.66% deviates from the theoretical ratio.

The results of a similar analysis were recorded in previously referenced papers, including the paper by Mikavica and Kosorić (1987), who analyzed the age structure Minnow Nase from Buško Lake and noted 7 age classes from 3+ to 9+, with the largest number of individuals belonging to the age class 5+ (50 individuals, 33.33%). In the total number of analyzed individuals (150), they recorded 70 males and 80 females and agreed that the older age classes outnumber females. Because of absence of younger age classes, the authors in the coming period foresee stagnation of Minnow Nase population in reproduction, which currently cannot be confirmed by examining the actualized data.

Conclusion

In the discussion and presentation of results regarding the ratio of age groups and sex of certain fish species from the Buško Lake, there is no recent data referring to the 21st century. Therefore, particular attention has been directed to the presentation of the current results of the mentioned area related to the status of endemic ichthyofauna and the requisite to preserve the irrecoverable natural resources. The research tasks which include monitoring populations of species *Chondrostoma phoxinus* as an endemic Adriatic catchment area are an immense scientific contribution in ichthyological communities in Bosnia and Herzegovina and the whole Europe. As the reproductive potential of most sexually reproductive population is limited by the number of females included, to the overall size of the population concerned the actual rate of population growth expectedly must have a tendency to equalization of numerous sex relations. Therefore, in

the ordinary meeting of the sexes (any male with any female) the maximum probability of meetings between members of the opposite sex (and the formation of all existing individuals in couples) is in case the sex ratio in the local population is half half.

The total analyzed sample of 276 individuals was presented with a perfect ratio of 138 males and 138 females, or ideal sex ratio 1:1.

References

- Aganović, M. (1969). Sastav ribljih populacija rijeke Jaruge. *Ichthyologia*, Serija E, Vol. 2, No. 1. 3-10. [The structure of fish population of the river Jaruga. *Ichthyologia*, Series E, Vol. 2, No. 1. 3-10].
- Aganović, M., Vuković, T., Kosorić, Đ., Kapetanović, N., Guzina, N., Savić-Seratić, D., Vuković, N., Veledar, I. (1974.). *Gospodarska osnova ribarstva na akumulaciji Buško Blato i kompenziranom bazenu Lipa*. Biološki institut Univerziteta u Sarajevu, Sarajevo. [Commercial basis of fishing at Buško Blato accumulation and compensated pool Lipa. Institute of Biology, University of Sarajevo, Sarajevo].
- Crivelli AJ (2005) *Chondrostoma phoxinus*. In: IUCN 2006. 2006 IUCN Red List of Threatened Species. <http://www.iucnredlist.org>. Downloaded on 10 March 2006.
- Ćurčić, V. (1916). Narodno ribarstvo u Bosni i Hercegovini III. Zapadno-bosanski krš. Glasnik Zemaljskog muzeja u Bosni i Hercegovini, XXVIII. Zemaljska štamparija, Sarajevo. [National fishing in Bosnia and Herzegovina III. West-Bosnian karst. Journal of the National Museum of Bosnia and Herzegovina, XXVI. Provincial Press, Sarajevo]
- Čaleta, M., Mrakovčić, M., Buj, I., Mustafić, P., Zanella, D., Marčić, Z. (2009). Threatened fishes of the world: *Chondrostoma phoxinus* Heckel, 1843 (Cyprinidae). *Environ Biol Fish* 84: 229–230
- Elvira, B.(1987). Taxonomic revision of the genus *Chondrostoma* Agassiz, 1835 (Pisces, *Cyprinidae*). *Cybium* v. 11 (núm. 2): 111-140.
- Heckel, J. J. (1843). *Ichthyologie [von Syrien]*. A: J. von Russegger. Reisen in Europa, Asien und Africa, mit besonderer Rücksicht auf die naturwissenschaftlichen Verhältnisse der betreffenden Länder unternommen in den Jahren 1835 bis 1841, etc. Stuttgart. *Ichthyol. von Syrien* v. 1 (pt 2): 990-1099.
- Heckel, J., Kner, R. (1858). *Die Susswasserfische der Österreichischen Monarchie mit Rücksicht auf die angrenzenden Länder*. Engelmann, Leipzig, 388 pp
- Jerković, L., Aganović, M., Remeta, D. (1973). Prilog poznavanju ishrane *Chondrostoma phoxinus* H e c k e l. *Evropski kongres ihtiologa, Zbornik referata* (62), Sarajevo. [A contribution to nutrition conversance of *Chondrostoma phoxinus* Heckel. European Congress ichthyologists, Proceedings (62), Sarajevo].
- Kačanski, D., Jerković, L., Hafner, D., Aganović, M. (1978). O ishrani nekih vrsta riba iz Buškog blata. *Ichthyologia*, Serija E, Vol. 10, No. 1, 67-75. [Concerning nutrition of some fish species at Buško Blato. *Ichthyologia*, Series E, Vol. 10, No. 1, 67-75].
- Karaman, S. (1923). O porijeklu slatkovodnih riba našega krša. (Über die Herkunft der Süßwasserfische unseres Karstes), Str. 163-176, Glasnik Zemaljskog muzeja u Bosni i Hercegovini XXXV. Zemaljska štamparija, Sarajevo. [Concerning the origin of the freshwater fish of our karst. p.p 163-176, Journal of the National Museum of Bosnia and Herzegovina XXXV. Provincial Press, Sarajevo].
- Karaman, S. (1928). Beiträge zur Ichthyologie von Jugoslavien I. *Bull. Soc. Sci. Skoplje* v. 6: 147-176.

- Kerovec, M., Mrakovčić, M., Schneider, D., Tomaskovic, N. (1998). Occurrence of *Chondrostoma phoxinus* in Croatia. FOLIA ZOOLOGICA, Vol. 47 Issue: 1 pp.39-43.
- Kottelat M, Freyhof J (2007). Handbook of European freshwater fishes. Kottelat, Cornol, Switzerland and Freyhof, Berlin, Germany, 646 pp
- Kišpatić, M. (1893). Ribe. Matica Hrvatska, Zagreb [The fish. "Nut" Croatia, Zagreb].
- Kišpatić, M. (1925). Ribe.- Ribolovni glasnik, 1/8, 2-3; 1/9, 2-3; 1/10, 2-3; 1/11, 2-3; 1/12, str. 2, Osijek. [The fish. Fishing Gazette, 1/8, 2-3; 1/9, 2-3; 1/10, 2-3; 1/11, 2-3; 1/12, p. 2, Osijek].
- Mikavica, D., Kosorić, Đ. (1987). Uzrasna i polna struktura, dužinsko i težinsko rastenje podbile (*Chondrostoma phoxinus* Heckel, 1843) iz Buškog jezera. Godišnjak biološkog instituta, Vol. 39. 71-80. [Age and sex structure, lengthwise and weight growth of minnow nase (*Chondrostoma phoxinus* Heckel, 1843) from Buško Lake. Annual Biological Institute, Vol. 39. 71-80].
- Mikavica, D., Bošnjak, Ž. (1989). Morfološke karakteristike digestivnog trakta nekih vrsta riba iz roda *Chondrostoma*. Ichthyologia Serija E, Vol. 21, No. 1, 7-16. [Morphological characteristics of a digestive tract of some fish species of *Chondrostoma*. Ichthyologia Series E, Vol. 21, No. 1, 7-16].
- Mrakovčić, M., Brigić, A., Buj, I., Čaleta, M., Mustafić, P., Zanella, D. (2006). Red book of freshwater fish of Croatia. Ministry of Culture, State Institute for Nature Protection, Republic of Croatia, 253 pp (in Croatian with English summary)
- Mučibabić, S. (1973): Limnološka ispitivanja akumulacionih jezera Buško Blato. Biološki institut Univerziteta Sarajevo, Socijalistička Republika Bosna i Hercegovina, Sarajevo. [Limnological research of an accumulation lake Buško Blato. Institute of Biology of the University of Sarajevo, Socialist Republic of Bosnia and Herzegovina, Sarajevo].
- Seratić-Savić, D. (1976). Morfološko taksonomska studija vrsta roda *Chondrostoma* iz voda Bosne i Hercegovine. Magistarski rad. Prirodoslovno-matematički fakultet Sveučilišta u Zagrebu, Zagreb. [A morphological and taxonomic study of species of *Chondrostoma* from the water of Bosnia and Herzegovina. Master's thesis. Faculty of Science, University of Zagreb, Zagreb].
- Taler, Z. (1954). Rasprostranjenje i popis slatkovodnih riba Jugoslavije. Glas. Prirodnog muzeja Srpske zemlje, Serija B, knjiga 5-6, (str. 440) Beograd. [Distribution and a list of freshwater fish of Yugoslavia. Gazette Natural Museum of Serbian land, Series B, books 5-6 (p. 440), Belgrade].
- Veledar, I., Kosorić, Đ. (1972). Dužinsko i težinsko rastenje podbile (*Chondrostoma phoxinus* Heckel, 1843) iz voda Livanjskog polja. Ichthyologia, Vol. 4, No. 1, 89 – 95. [Lengthwise and weight growth of minnow nase (*Chondrostoma phoxinus* Heckel, 1843) from the water of Livanjsko field. Ichthyologia, Vol. 4, No. 1, 89 – 95].
- Veledar, I., Kosorić, Đ. (1974): Metodi određivanja starosti podbile *Chondrostoma phoxinus* Heckel, 1843 iz voda Livanjskog polja. Ichthyologia, Vol.6, No 1, 93-109. [Methods of age assessment of minnow nase - *Chondrostoma phoxinus* Heckel, 1843 from the water of Livanjsko field. Ichthyologia, Vol.6, No 1, 93-109].
- Vuković, T. (1966). Fauna riba Bosne i Hercegovine. Biološki institut Univerziteta u Sarajevu, Sarajevo. [Fauna of the fish of Bosnia and Herzegovina. Institute of Biology, University of Sarajevo, Sarajevo].
- Vuković, T., Ivanović, B. (1971). Slatkovodne ribe Jugoslavije. Zemaljski muzej BiH, Posebna izdanja, str. 268., Sarajevo. [Freshwater fish of Yugoslavia. The National Museum of Bosnia and Herzegovina, special edition, p. 268, Sarajevo].

- Vuković, T. (1977). Ribe Bosne i Hercegovine. ključ za određivanje. IGKRO Svjetlost, OOUR
Zavod za udžbenike, Sarajevo. [The fish of Bosnia and Herzegovina, a key for assessment.
IGKRO Light, BOAL Textbook Institute, Sarajevo].
- Žujo, D. (2005). Biosistematska istraživanja vrste *Chondrostoma phoxinus* Heckel, 1843. iz
Buškog jezera. Magistarski rad. Prirodno-matematički fakultet, Univerzitet u Sarajevu.
Sarajevo. [Biosystematic research of *Chondrostoma phoxinus* Heckel, 1843 from Busko Lake.
Master's thesis, Faculty of Science, University of Sarajevo. Sarajevo].
- Žujo Zekić, D. (2009). Biodiverzitet ihtiopopulacija Buškog jezera. (doktorska disertacija).
Odsjek za biologiju, Nastavnički fakultet, Univerziteta „Džemal Bijedić“ u Mostaru, Mostar.
[Biodiversity of Busko Lake ichthyo-populations. (doctoral thesis). Department of Biology,
Teacher Training Faculty, University "Dzermal Bijedic" in Mostar, Mostar].

EFFECT OF DIFFERENT ORGANIC WASTES ON MICROBIAL PROPERTIES OF MAIZE (*Zea Mays Indendata*) RHIZOSPHERE AND ROOT FREE SOIL

Rıdvan KIZILKAYA^{1,2*}, Coskun GULSER¹

¹Ondokuz Mayıs University, Faculty of Agriculture, Department of Soil Science and Plant Nutrition, Samsun, Turkey

²Agrobigen R&D Ltd.Co., Samsun Technopark, Ondokuz Mayıs University, Samsun, Turkey

*Corresponding author: ridvank@omu.edu.tr

Abstract

This study was carried out in order to determine the effects of various organic wastes (tobacco production waste, wheat straw, tea waste and hazelnut husk) under greenhouse conditions on microbial biomass C (Cmic) and basal respiration (BSR) in clay loam soil and rhizosphere (*Zea mays indandata*) soil of maize plant. The organic wastes were thoroughly mixed with the soil at a rate equivalent to 50 g kg⁻¹ on air-dried weight basis. Experimental design was randomized plot with the replications in greenhouse. The moisture content in soil was maintained around 60 % of maximum water holding capacity by weighing the pots every day. Changes in the Cmic and BSR were determined in the soil and rhizosphere (*Zea mays indendata*) samples and root free soil taken in 15, 30, 45, 60, 75 and 90 days after the experiment was conducted. At the end of experiment, all organic waste added soil increased Cmic and BSR in comparison with the control ($P<0,01$) at all experimental periods. Moreover, Cmic and BSR in rhizosphere soil were higher than in root free soil at all organic waste application ($P<0,01$). Increased amount of organic wastes had different effects on Cmic and BSR trend ($P<0,01$). The most increases are in the Cmic and BSR in the soil treated with wastes of tea and waste of tobacco production with supplying of low initial C/N ratio compared to the other organic wastes

Key words: *Organic waste, Soil, Rhizosphere, Microbial biomass, Basal soil respiration.*

Introduction

The loss of soil organic matter under intensive land use is one of the many factors that degraded agricultural soil of Anatolia. Traditional agricultural practices also leads to decrease fertility and, therefore, to declining productivity. Soil organic matter is extremely heterogenous ranging from only slightly decomposed plant and microbial residues to highly humified organic substances. The most common practice to preserve and/or restore soil fertility is to add organic matter, which, preferentially, should be sufficiently stabilized to produce beneficial effects (Gallardo-Lara and Nogales, 1987; Mathur et al., 1993). Therefore, different types of organic wastes have increasingly been applied to soils in recent years. Organic wastes applications haven't only increased the soil organic matter, but have also enhanced the soil's carbon (C) and N contents, and have improved biological activity in soil (Vigil et al., 1991).

Plants influence C turnover and organic matter content in soils, both because they provide C inputs for microbiological characteristics in the soil through litter and exudation in the rhizosphere, and because they stimulate the turnover of existing soil C by rhizosphere microorganisms and their activities (Chen et al., 2006). The functional capacity of the soil microbial community, as reflected in the activities of enzymes involved in nutrient mineralization processes, varies among soils dominated by plant roots (Waldrop et al., 2000; Kourtev et al.,

2003). Nevertheless, there have been relatively few studies that have examined root exudation, microbial rhizosphere community composition of plants (Kourtev et al., 2003). Microbial activity plays an important role in regulating soil fertility. Indeed, the microbiological processes taking place in soil are at the centre of many ecological functions (Nannipieri et al. 1990), since microbiological activity is related to soil structure, soil fertility, and the transformation of soil organic matter. Several microbiological parameters have been used to define the status and sustainable development of soil productivity in agricultural ecosystems. There are many methods currently available for studying the microorganisms and their activities at the microhabitat level (Nannipieri et al. 1990). The dependence of the microbiological properties of agricultural soils on site and soil factors has been studied (Vekemans et al. 1989). Some soil microbiological characteristics such as respiratory activity and microbial biomass are used as bio-indicators for soil quality and health in environmental soil monitoring.

The experiment in the present study was conducted in the greenhouse, simulating field conditions of organic matter management with different organic wastes (hazelnut husk, wheat straw, tea waste and tobacco production waste) in soil. The organic wastes used in the research were selected due to their variance in very large interval (C/N; 20 - 171). All organic wastes were sifted from 0.5 mm sieve after grinding in order to eliminate any effect that could be occurred due to magnitude of the particles. Our objectives were to determine the effects of the organic wastes on microbiological properties such as microbial biomass C (C_{mic}) and basal respiration (BSR) in rhizosphere and root-free soil.

Material and methods

Material

Surface soil (0-20 cm) was taken from Bafra, Samsun (Turkey). The soil used in this experiment is a Typic Udipsamment and contained 20.60 % clay, 18.36 % silt, and 61.04 % sand. Soil texture can accordingly be classified as sandy clay loam (SCL). The pH in water was 8.1, the oxidizable organic matter content was 1.68 %, and the soil C:N ratio was 13.9. The site is located in the Black Sea Region, Northern Turkey (Latitude, 41⁰21'N; longitude, 36⁰15'W). The climate is semi humid, (R_f = 47.21) with temperatures ranging from 6.6 °C in February to 23 °C in August. The annual mean temperature is 14.2 °C and annual mean precipitation is 670 mm.

Hazelnut is one of the major agricultural products in Turkey with a yield of 650,000 tons per year; it is especially produced in the Black Sea Region. Hazelnut husk (HH) was collected from hazelnut trees in the Eastern Black Sea Region, Turkey. Tea and tobacco plants are commonly grown in the Eastern and Middle Black Sea Region of Turkey. Therefore, there is much tea (TEW) and tobacco (TOW) production waste in this region. These organic wastes were taken from the industry of tea and tobacco production in this region. Wheat straw (WS) was collected during the grain harvest season in Samsun, Turkey. All organic wastes were dried and sieved into less than 0.50 mm. The properties of the organic wastes was expressed on a moist-free basis and analyzed by standard procedures, given in Ryan et al. (2001).

Experimental procedure

The soil samples were air-dried in a laboratory and sieved through 0-2 mm screens. The samples (500 g air-dried soil) were placed in 600 ml cylindrical plastic container. The organic wastes (WS, HH, TOW and TEW) were thoroughly mixed with the soil at a rate equivalent to 5% on an air-dried weight basis. Then, five individuals of maize (*Zea mays indendata*) seeds were placed in the soils. The moisture contents in the soils were adjusted to 60% water holding capacity (WHC) and the containers were incubated in greenhouse for 90 days. The moisture content was

maintained throughout the experiment. The maize-planting containers were regarded as rhizosphere and the other containers as root free soil (nonrhizosphere). Changes in the microbiological properties were determined in the root free soil and rhizosphere samples taken in 15, 30, 45, 60, 75 and 90 days after the experiment was conducted. During the sampling of soil the crops were gently pulled out, and the soil remaining on the maize roots was regarded as rhizosphere. At the same time, the root free soil was taken from the nonplanting containers at the same depth. Soil without organic waste addition was used as a control. A randomized complete plot design with three replicates per treatment and soil was used. This greenhouse experiment was total 180 pots. The experiment was performed with the following 10 treatment:

- (1) control for soil (without organic waste addition and plant see)
- (2) + 50 g kg⁻¹ hazelnut husk (without plant seed)
- (3) + 50 g kg⁻¹ wheat straw (without plant seed)
- (4) + 50 g kg⁻¹ tobacco production waste (without plant seed)
- (5) + 50 g kg⁻¹ tea production waste (without plant seed)
- (6) control for rhizosphere (without organic waste addition and with plant seed)
- (7) + 50 g kg⁻¹ hazelnut husk(with plant seed)
- (8) + 50 g kg⁻¹ wheat straw (with plant seed)
- (9) + 50 g kg⁻¹ tobacco production waste (with plant seed)
- (10) + 50 g kg⁻¹ tea production waste (with plant seed)

Methods

Microbiological characteristics in soils and rhizosphere

All determinations of microbiological properties were performed for the each soil sample in triplicate, and all values reported are averages of the three determinations expressed on an oven-dried sample basis at 105 °C for 48 h.

Microbial biomass carbon (C_{mic}) was determined by the substrate-induced respiration method of by Anderson and Domsch (1978). A moist sample equivalent to 10 g oven-dry soil or cats was amended with a powder mixture containing 40 mg glucose. The CO₂ production rate was measured hourly using the method described by Anderson (1982). The pattern of respiratory response was recorded for 4 h. C_{mic} was calculated from the maximum initial respiratory response in terms of mg C g⁻¹ soil as 40.04 mg CO₂ g⁻¹ + 3,75. Data are expressed as mg C g⁻¹ dry sample. Basal soil respiration (BSR) at field capacity (CO₂ production at 22 °C without addition of glucose) was measured, as reported by Anderson (1982); by alkali (Ba(OH)₂.8H₂O + BaCl₂) absorption of the CO₂ produced during the 24h incubation period, followed by titration of the residual OH⁻ with standardized hydrochloric acid, after adding three drops of phenolphthalein as an indicator. Data are expressed as µg CO₂-C g⁻¹ dry sample.

Results and discussion

Composition of organic wastes

Among the OW used in this study, TEW had the highest organic matter (92.72%) while that of TOW was the lowest (66.21%). Regarding N content, TEW again had the highest N content (2.46%) and the lowest N content belong to WS (0.31%). C:N ratio of the OW ranged from 20 to 171 and the highest level C:N ratio observed in WS while that of lowest is TOW. The order of OW associated with C:N ratio was WS > HH > TEW > TOW. In addition these OW contained major important nutrients such as P₂O₅, K₂O, which are agronomically important (Table 1).

Table 1. Composition of organic wastes in measured variables

Organic waste	Organic matter, %	C/N	N (%)	P ₂ O ₅ (%)	K ₂ O (%)
TEW	92,72	22	2.46	0.48	5.83
TOW	66,21	20	1.97	0.45	4.71
HH	85,34	52	0.96	0.28	5.17
WS	91,17	171	0.31	0.25	4.77

Microbiological characteristics in rhizosphere and root free soil

The effects of different organic waste treatments on microbial biomass C (Cmic) and basal respiration (BSR) in rhizosphere and root free soils are presented in Table 2 and 3. Considerable variations in Cmic and BSR were found for the different organic wastes and with/without plant roots at different sampling times. Statistically significant variations were found in Cmic and BSR at various organic waste application and sampling times. Microbiological characteristics were also affected by incubation period, organic waste and plant root. The analysis of variance of the results obtained in our experiment on the periodic sampling times with organic waste showed that all factors (organic waste types, plant roots and incubation periods) significantly influenced all microbiological characteristics. After organic waste addition a rapid and significant increase in Cmic and BSR was observed in waste amended soils followed by a progressive increase in Cmic and BSR in rhizosphere amended with the organic waste. At the end of the experiment, Cmic and BSR measured in waste-treated soils were statistically different from those measured in the control soils.

Table 2. Microbial biomass C (Cmic) in rhizosphere and root free soils ($\mu\text{g CO}_2\text{-C g}^{-1}$ dry soil). Standard error in parenthesis.

Incubation Days	Organic wastes									
	Control		TEW		TOW		HH		WS	
	Rhizosphere soil									
15 days	2,7	(0,43)	8,4	(0,40)	7,5	(0,98)	6,2	(0,24)	5,6	(0,15)
30 days	3,6	(0,11)	12,2	(0,80)	10,3	(0,16)	8,2	(0,14)	6,2	(0,13)
45 days	4,5	(0,09)	15,5	(0,52)	14,7	(0,36)	8,2	(0,30)	8,9	(0,84)
60 days	5,5	(0,35)	18,3	(0,24)	16,2	(0,82)	13,7	(0,61)	9,9	(0,56)
75 days	7,1	(0,14)	20,8	(0,25)	18,4	(1,27)	15,4	(0,34)	12,8	(0,43)
90 days	9,6	(0,70)	20,9	(0,76)	18,3	(0,53)	17,2	(0,37)	15,2	(0,31)
	Root free soil									
15 days	2,6	(0,37)	8,5	(0,18)	7,8	(0,85)	5,8	(0,22)	4,4	(0,41)
30 days	2,5	(0,16)	11,5	(0,16)	9,6	(0,19)	7,4	(0,39)	5,5	(0,38)
45 days	2,8	(0,16)	12,7	(0,57)	10,5	(0,74)	9,4	(0,74)	7,8	(0,56)
60 days	2,9	(0,61)	13,6	(0,49)	11,4	(0,29)	10,1	(0,08)	8,9	(0,68)
75 days	3,0	(0,48)	13,7	(0,49)	12,7	(0,29)	12,5	(0,37)	9,1	(0,11)
90 days	3,1	(0,22)	15,1	(0,42)	13,2	(0,80)	13,1	(0,27)	11,0	(0,75)

Table 3. Basal soil respiration (BSR) in rhizosphere and root free soils ($\mu\text{g CO}_2 \text{ g}^{-1}$ dry soil). Standard error in parenthesis.

Incubation Days	Organic wastes									
	Control		TEW		TOW		HH		WS	
	Rhizosphere soil									
15 days	27.5	(4.40)	85.7	(4.12)	29.1	(3.83)	63.9	(2.43)	57.2	(1.53)
30 days	40.1	(1.22)	137.8	(8.97)	116.1	(1.84)	92.2	(1.57)	69.6	(1.49)
45 days	44.4	(0.91)	153.0	(5.10)	144.9	(3.89)	92.2	(2.94)	57.8	(4.31)
60 days	38.3	(2.95)	182.0	(2.95)	161.8	(8.19)	136.5	(6.10)	98.5	(5.56)
75 days	49.9	(5.81)	212.0	(2.50)	134.7	(8.84)	156.5	(3.48)	130.7	(4.39)
90 days	101.7	(7.44)	212.7	(8.10)	194.8	(5.62)	182.5	(3.91)	161.3	(3.25)
	Root free soil									
15 days	17.3	(1.66)	86.8	(1.88)	52.9	(3.89)	42.5	(3.24)	45.6	(4.21)
30 days	28.6	(1.80)	129.8	(1.79)	108.6	(2.14)	83.1	(4.40)	41.6	(3.13)
45 days	18.8	(4.29)	124.9	(5.65)	74.1	(5.74)	92.9	(5.74)	51.7	(3.89)
60 days	28.4	(6.13)	135.4	(4.92)	113.2	(2.90)	100.9	(0.75)	62.4	(4.83)
75 days	30.3	(4.93)	139.6	(4.92)	129.7	(2.90)	127.6	(3.75)	93.1	(1.10)
90 days	33.4	(2.33)	160.6	(4.50)	140.0	(8.51)	139.6	(2.91)	116.5	(8.01)

Different organic waste application significantly affected the levels of Cmic and BSR in the rhizosphere, when compared with the control treatment and root free soils. Table 2 and 3 shows that the Cmic and BSR in rhizosphere were higher than in control treatment and in root free soils at all sampling times and organic waste treatments. This situation might be related the supply of organic material from plant roots and plant exudates. The supply of organic material from plant roots is crucial to soil microbial communities whose growth is carbon limited. The type and amount of nutrients released will affect both the microbial biomass and their activity. This primary carbon supply to the soil system arrives through plant litter and more directly from roots. These include the release of plant exudates, many of which appear to be simply lost by leakage from the root. Plant exudates contain carbohydrates, amino acids, organic acids, lipids, hormones, vitamins and enzymes. These organic substances are stimulated for soil microbiological activity. It is well known that root-derived organic C from root exudates stimulates the growth of microorganisms and increases microbial activity in the rhizosphere (Toal et al., 2000; Kourtev et al., 2003). Results from this study also showed the greater Cmic and BSR in all organic waste added soils under plant roots compared with root-free soil. Greater microbiological characteristics in all organic waste added soils under rhizosphere after 90 days contributed to greater under root free soil. It is likely that increased levels of organic C and N due to root exudation could have led to greater microbial activity. The amount of root-derived C flow through the rhizosphere has a significant impact on transformations of soil organic C, N, P and S (Helal and Sauerbeck, 1989). It has been established that soluble organic C and N in mineral soils is mainly derived from root derived from root exudates and root residues (Huang and Schoenau, 1998).

Table 2 and 3 shows that both rhizosphere and root free soils Cmic and BSR in all organic waste treatments were higher than in control treatment at all sampling times. This situation may be related carbon source of organic wastes and increased the organic matter level, which consequently elevated the microbiological characteristics of soil. For this reason, increased soil organic matter content is correlated positively with microbiological activity in soil, generally. The organic waste treatments had consistent or significant effect on Cmic and BSR. This indicated accumulation of organic matter and improvement in nutrient status of soil, as microbial biomass and their activity is a labile reservoir of plant nutrients (Jenkinson and Ladd, 1981). The

Cmic and BSR in rhizosphere and root free soil for all organic waste treatments were similar in all sampling times. Addition of organic material increases the microbial activity in soil (Pascual et al. 1997). Garcia-Gilet et al. (2000) reported increases microbial biomass and their activity in soil organic waste application application to soil. Such increases in rhizosphere and root free soil BSR and Cmic were probably caused by the higher level of soluble organic-C in organic wastes. Availability of biogenic material for biomass stimulation (Jenkinson and Ladd, 1981) induced the increase in soil microbial activity of enriched soils. The increase may also correspond to the growth of the zymogenous population associated with organic matter enrichment and incorporation of exogenous microorganisms (Perucci, 1992). The highest Cmic and BSR were generally found in rhizosphere and root free soil at TOW and TEW treatments. There have been numerous studies (Pascual et al. 1997; Madejón et al., 2001) on the effects of organic wastes on microbial activity in soil. These studies generally indicated larger effects in organic matter or organic waste treated soils than in control or non-treated soils. However, in most studies it was possible to establish relationships between and microbiological characteristics and the magnitude of the effects of organic waste type's especially chemical composition, nutrient content and C/N ratio.

Conclusion

According to data, this study showed a clear relationship between organic wastes and microbiological activity (Cmic and BSR). We assume that the replacement of organic waste has stimulating effects on Cmic and BSR in rhizosphere and root free soil, due to the quantity and quality of the organic waste incorporated into soil, and the microbial growth caused by the addition of organic compounds to the soil. Organic materials are possibly the most important C source for microorganisms. It consists mainly of root exudates and organic waste degradation products. Differing organic waste inputs in the system were reflected by the C and N contents which, however, varied much more between the systems than did microbiological characteristics. In general, initial low C/N ratios of organic wastes application (TEW and TOW) caused the most beneficial effects on Cmic and BSR in rhizosphere and root free soil among the investigated types of organic waste on clay loam soils. The use of these organic wastes can contribute to an enhancement of the level of organic matter and the fertility of the agricultural soils. Furthermore, organic waste had a stronger impact on Cmic and BSR in rhizosphere compared to root free soil. Hence, it can be concluded that the Cmic and BSR was clearly governed by the organic waste incorporated into soil under the conditions of the investigated greenhouse experiment. At the same time this practice seems to be a potentially effective way of recycling wastes and solving the problem of their disposal.

References

- Anderson, J.P.E. 1982. Soil respiration. In: Page, A.L. (Ed.) *Methods of soil analysis, Part 2, Chemical and microbiological properties*, Wisconsin: ASA-SSSA. pp. 831-871.
- Anderson, J.P.E., Domsch, K.H., 1978. A physiological method for the quantitative measurement of microbial biomass in soils. *Soil Biol. Biochem.* 10: 215 – 221.
- Chen, C.R., Condrón, L.M., Xu, Z.H., Davis, M.R., Sherlock, R.R. 2006. Root, rhizosphere and root-free respiration in soils under grassland and forest plants. *Eur. J. Soil Sci.* 57: 58–66.
- Gallardo-Lara, F., Nogales, R., 1987. Effect of the application of town refuse compost on the soil plant system: a review. *Biol. Wastes* 19: 35–62.

- Garcia-Gil, J.C., Plaza, C., Soler-Rovira, P., Polo, A., 2000: Long-term effects of municipal solid waste compost application on soil enzyme activities and microbial biomass. *Soil Biol. Biochem.* 32, 1907-1913.
- Helal, H.M., Sauerbeck, D., 1989. Carbon turnover in the rhizosphere. *Zeitschrift für Pflanzenernährung und Bodenkunde* 152, 211–216.
- Huang, W., Schoenau, J., 1997. Seasonal and spatial variations in soil nitrogen and phosphorus supply rates in a boreal aspen forest. *Can. J. Soil Sci.* 77: 597 – 612.
- Jenkinson, D.S., Ladd, J.N., 1981. Microbial biomass in soil: measurement and turnover. In: Paul, E.A., Ladd, J.N. (Eds), *Soil Biochemistry*, Vol. 5, Marcell Dekker pp. 415 – 471.
- Kourtev, P.S., Ehrenfeld, J.G., Haggblom, M. 2003. Experimental analysis of the effect of exotic and native plant species on the structure and function of soil microbial communities. *Soil Biol. Biochem.* 35, 895–905.
- Madejón, E., Burgos, P., López, R., Cabrera, F., 2001. Soil enzymatic response to addition of heavy metals with organic residues. *Biol. Fertil. Soils* 34: 144-150.
- Mathur, S.P., Owen, G., Diné, H., Schnitzer, M., 1993. Determination of compost biomaturity I. Literature review. *Biological Agriculture and Horticulture* 10, 65–85.
- Nannipieri, P., Grego S., Ceccanti, B., 1990. Ecological significance of the biological activity in soil, In: Bollag, J.W., Stotzky, G. (Eds.) *Soil biochemistry Volume 6*, Marcel Dekker, pp. 293 – 355. New York, USA.
- Pascual, J.A., Garcia, C., Hernandez, T., Ayuso, M., 1997: Changes in microbial activity of an arid soil amended with urban organic wastes. *Biol. Fertil. Soils* 24: 429-434.
- Perucci, P., 1992. Enzyme activity and microbial biomass in a field soil amended with municipal refuse. *Biol. Fertil. Soils* 14: 54-60.
- Ryan, J., Estefan, G., Rashid, A., 2001. *Soil and plant analysis laboratory manual*. International Center for Agricultural Research in the Dry Areas (ICARDA). Syria.
- Toal, M.E., Yeomans, C., Killham, K., Meharg, A.A., 2000. A review of rhizosphere carbon flow modelling. *Plant Soil* 222: 263–281.
- Vekemans, X., Godden, B., Penninckx, M.J., 1989. Factor analysis of the relationships between several physico-chemical and microbiological characteristics of some Belgian agricultural soils. *Soil Biol. Biochem.* 21: 53-57.
- Vigil, M.F., Kissel, D.E., Smith, S.J., 1991. Field crop recovery and modelling of nitrogen mineralized from labeled sorghum residues. *Soil Sci. Soc. Amer. J.* 55: 1031-1037.
- Waldrop, M.P., Balsler, T.C., Firestone, M.K., 2000. Linking microbial community composition to function in a tropical soil. *Soil Biol. Biochem.* 32: 1837–1846.

TREATED SEWAGE SLUDGE APPLICATIONS: HEAVY METAL CONTENTS OF CORN AND SECOND CROP WHEAT SEEDS GROWN IN SANDY CLAY SOIL

Sezai DELİBACAK*, Ali Rıza ONGUN

Ege University, Faculty of Agriculture, Department of Soil Science and Plant Nutrition, Bornova İzmir Turkey

*Corresponding author: sezai.delibacak@ege.edu.tr; sezai.delibacak@gmail.com

Abstract

In this study, effect of treated sewage sludge (TSS) rates and mineral fertilizer applications on heavy metal content of corn and second crop wheat seeds grown in a sandy clay soil was investigated. The experiment was conducted in the experimental fields of Ege Agricultural Research Institute during 2011-2012 in Menemen-İzmir Turkey. The field study was conducted in 20 plots in a randomized-block design with four replications and five different applications including control, mineral fertilizer, treated sewage sludge 12.5 t ha⁻¹; 25.0 t ha⁻¹; 37.5 t ha⁻¹ as dry matter. Corn (*Zea mays* L. var. ZP 737) was the first crop, wheat (*Triticum durum* L. var. Ege 88) was second crop. Increasing TSS applications to soil resulted in significantly increased concentrations of Pb in corn seeds. But it was under threshold values. The heavy metal contents of corn seeds were within the normal limits for Cr, Cu, Ni, Pb and Zn while Cd was not present in corn seeds. Increasing TSS and mineral fertilizer applications to soil resulted in significantly increased concentrations of Cu in second crop wheat seeds according to control. But also it was under threshold values. The heavy metal contents of second crop wheat seeds were within the normal limits for Cd, Cr, Ni and Zn while Pb was not present in wheat seeds. It is recommended that 37.5 t ha⁻¹ TSS of İzmir city can be used once in a 2-year period for improving properties of sandy clay soil for corn and wheat growth without having any heavy metal problems.

Key words: *Corn, Heavy metals, Treated sewage sludge, Sandy clay soil, Wheat*

Introduction

The use of sewage sludge in agriculture is one of the most important alternatives. Applying sewage sludge determines the modification of soil physical, chemical and biological characteristics and getting higher yields, as compared to the unfertilized control. The sewage sludge, rich in organic matter and mineral elements for plants, can be a substitute for the fertilization but also a source of heavy metals pollution for soil, when high rates are applied or when it is used for many years on the same field (Singh and Agrawal, 2008; Delibacak et al., 2009).

The uptake of trace elements by plants is a function of the soil characteristics, climate, of the concentration of the element and plant species. Many soil and plant factors affect the bioavailability of trace elements and heavy metals to plants. The soil factors that affect trace element uptake are soil pH, organic matter, element interactions, soil water, soil temperature and soil aeration (Epstein, 1971; Epstein et al., 1978).

Absorption, accumulation and tolerating ability of crops vary at different levels of sewage sludge amendment. Davis and Carlton-Smith (1980) reported wide variations in heavy metal accumulation in crops grown on sludgeamended soil. Cd accumulation was highest in different species. With respect to species, the trend of accumulation was tobacco > lettuce > spinach > celery > cabbage for Cd; kale > rye grass > celery for Pb; sugar beet > some varieties of barley

for Cu; sugarbeet > ryegrass > mangold > turnip for Ni; and sugarbeet > mangold > turnip for Zn. Alloway et al. (1990) found a trend of Cd uptake as lettuce > cabbage > radish > carrots. Cadmium generally tends to accumulate in leaves, and therefore is more risky especially for leafy vegetables grown on contaminated soils than in seed or root crops (Alloway et al., 1990). Mondy et al. (1984) also recorded a significant increase in concentrations of B, Cd, Cu, Ni, and Zn in potato tubers grown on sludgeamended soils, but no significant trend was observed for Co, Cr, Fe, Mn and Pb concentrations.

The purpose of this work has been to evaluate the effect of municipal TSS doses on the heavy metal concentration of corn and second crop wheat seeds grown in sandy clay soil.

Materials and methods

Experimental site: The experiment was conducted at the research field of Aegean Agricultural Research Institute in Menemen plain, Izmir, Turkey (38°56'87.96"-38°56'91.02"N; 27°03'57.52"-27°03'58.61"E). The experimental site is in the Western Anatolia region of Turkey, where the Mediterranean climate prevails with a long-term mean annual temperature of 16.8 °C. Long-term mean annual precipitation is 542 mm, representing about 75% of rainfalls during the winter and spring, and the mean relative humidity is 57%. Long-term mean annual potential evapotranspiration is 1,570 mm (IARTC, 2012). The investigated soil is characterized by sandy clay texture with slightly alkaline reaction and classified as a Typic Xerofluvent (Soil Survey Staff, 2006). Some selected properties and total heavy metal concentrations in the experimental soil and TSS used in the experiment are given in Table 1 and 2.

Table 0. Some selected properties and total heavy metal concentrations of experimental soil

Sand	(%)	44.84	pH	(Saturation paste)	7.53
Silt	(%)	16.44	Pb	mg/kg	15.93
Clay	(%)	38.72	Cu	mg/kg	16.30
Texture		Sandy clay	Zn	mg/kg	51.16
Salt	(%)	0.167	Cd	mg/kg	0.62
CaCO ₃	(%)	0.51	Cr	mg/kg	13.43
Org. matter	(%)	0.94	Ni	mg/kg	23.75

Table 2. Some selected properties and total heavy metal concentrations of treated sewage sludge used in the experiment

EC	dS/m	16.35	Fe ¹	%	1.14
CaCO ₃	(%)	10.24	Cu ¹	mg/kg	268.8
Org. matter	(%)	70.32	Zn ¹	mg/kg	1335
Org. C	(%)	40.79	Mn ¹	mg/kg	298.6
N ¹	(%)	5.33	B ¹	mg/kg	35.2
P ¹	(%)	1.33	Co ¹	mg/kg	14.2
K ¹	(%)	0.68	Cd ¹	mg/kg	4.1
Ca ¹	(%)	3.74	Cr ¹	mg/kg	250.6
Mg ¹	(%)	0.68	Ni ¹	mg/kg	115.4
Na ¹	(%)	0.59	Pb ¹	mg/kg	199.4

¹Total

Field experiment: The field study was conducted in 20 plots in a randomized-block design with four replications, during 2011-2012. The plot dimensions were 3 m width and 3 m length. The TSS used in the experiment was obtained from the wastewater treatment plant of Metropolitan

Region, Izmir city. It may produce around 600 t (moist basis) sewage sludge per day. Calcium oxide was added to raise the efficiency of the dewatering process of sewage sludge. In addition, the SS produced presented a pH varying between 10 and 13, what increased the pathogen control and decreased the heavy metal availability by added calcium oxide. TSS was added only once during experiment to the soil under investigation at the rates of 12.5 t ha⁻¹; 25.0 t ha⁻¹; 37.5 t.ha⁻¹ as dry matter on July 14, 2011. Also 150 kg N, 150 kg P₂O₅, 150 kg K₂O ha⁻¹ (1000 kg ha⁻¹ 15.15.15. composed fertilizer) were applied to the only mineral fertilizer plots at the same time and mixed with soil to 15 cm depth. Corn seeds were sown with seeding machine on rows 18 cm and in rows 70 cm apart. Drop irrigation was provided when required. Harvest of corn was done by hands on November 17, 2011. Wheat seeds were sown with seeding machine on November 22, 2011 to 5 cm of soil depth as second crop. Also 80 kg N and 80 kg P₂O₅ ha⁻¹ (400 kg ha⁻¹ 20.20.0. composed fertilizer) were applied to the only mineral fertilizer plots at the same time and mixed with soil to 15 cm depth before wheat seeding. Wheat was harvested with machine on July 10, 2012. Second year, without applying any TSS (for determination of its second year effect), corn seeds were sown with seeding machine on July 18, 2012. Also 150 kg N, 150 kg P₂O₅, 150 kg K₂O ha⁻¹ were applied to the only mineral fertilizer plots at the same time and mixed with soil to 15 cm depth before corn seeding. Harvest of second year's corn was done by hands on November 1, 2012.

Plant and soil analyses: The Corn and wheat seeds were collected from each plots after harvest, dried in an oven at 65-70°C until the last two weighing were equal. Dry weights of corn and wheat seeds were determined, and seeds were ground in a mill for heavy metal analysis. Results were evaluated on a dry matter (65°C) basis. Particle size distribution of experimental soil was determined by the Bouyoucos hydrometer method (Bouyoucos, 1962), Total salt, OM concentration, CaCO₃, pH, total N, P, K, Ca, Mg, Na, Fe, Cu, Mn, Zn, Cd, Cr, Ni and Pb concentrations of soil samples and TSS were all determined according to Page et al., (1982). Heavy metal (Zn, Cu, Cd, Cr, Ni and Pb) concentrations of corn and wheat seeds were also determined according to Page et al., (1982). The concentrations of these elements in the extracts were determined by AAS (AOAC, 1990).

Statistical analysis: Data were analyzed using the Statistical Package for the Social Sciences (SPSS) version 17 (SPSS 17.0, 2008). Variance analysis was performed to determine the effects of TSS rates on heavy metal concentrations of corn and wheat seeds grown in sandy clay soil. Tukey test was used to find if differences in the treatments were significant at P≤0.01 or P≤0.05.

Results and discussion

Effect of treated sewage sludge applications on heavy metal (Cu, Cd, Cr, Ni, Pb and Zn) concentrations (mg/kg) of corn seed grown in sandy clay soil were given in Table 3.

Table 3. Effect of treated sewage sludge (TSS) applications on heavy metal (Cu, Cd, Cr, Ni, Pb and Zn) concentrations (mg/kg) of corn seed grown in sandy clay soil

Cu (mg/kg) Tukey: $P \leq 0,01$

Applications	Average of 1st and 2nd year	1st year		2nd year		
Control	2,344 a ¹	1,313 a	B ²	3,375 a	A	**
Fertilizer	2,297 a	1,181 a	B	3,413 a	A	**
12.5 t ha ⁻¹ TSS	2,144 a	1,000 a	B	3,288 a	A	**
25.0 t ha ⁻¹ TSS	2,053 a	1,119 a	B	2,988 a	A	**
37.5 t ha ⁻¹ TSS	2,197 a	1,294 a	B	3,100 a	A	**

Significant differences between treatments at ** $P \leq 0,01$ or * $P \leq 0,05$ level indicated by different letters. ¹Small letter in column for applications, ²capital letter in row for years. N=4 for all measurements.

Cr (mg/kg) Tukey: $P \leq 0,05$

Applications	Average of 1st and 2nd. year	1st year		2nd year		
Control	0,387 ab ¹	0,406 a	A ²	0,368 a	A	
Fertilizer	0,394 ab	0,425 a	A	0,363 a	A	
12.5 t ha ⁻¹ TSS	0,653 a	0,688 a	A	0,619 a	A	
25.0 t ha ⁻¹ TSS	0,356 b	0,375 a	A	0,336 a	A	
37.5 t ha ⁻¹ TSS	0,380 ab	0,400 a	A	0,360 a	A	

*

Ni (mg/kg) Tukey: $P \leq 0,01$; $P \leq 0,05$

Applications	Average of 1st and 2nd year	1st year		2nd year		
Control	4,884 a ¹	1,206 a	B ²	8,563 a	A	**
Fertilizer	4,869 a	1,163 a	B	8,575 a	A	**
12.5 t ha ⁻¹ TSS	4,738 a	1,325 a	B	8,150 a	A	**
25.0 t ha ⁻¹ TSS	4,556 a	1,225 a	B	7,888 a	A	**
37.5 t ha ⁻¹ TSS	4,656 a	1,100 a	B	8,213 a	A	**

Pb (mg/kg) Tukey: $P \leq 0,01$; $P \leq 0,05$

Applications	Average of 1st and 2nd year	1st year		2nd year		
Control	1,131 a ¹	1,238 a	A ²	1,025 a	A	1,131 a ¹
Fertilizer	1,281 a	1,375 a	A	1,188 a	A	1,281 a
12.5 t ha ⁻¹ TSS	1,275 a	1,375 a	A	1,175 a	A	1,275 a
25.0 t ha ⁻¹ TSS	1,339 a	1,488 a	A	1,190 a	A	1,339 a
37.5 t ha ⁻¹ TSS	1,456 a	1,625 a	A	1,288 a	A	1,456 a

Zn (mg/kg) Tukey: $P \leq 0,01$

Applications	Average of 1st and 2nd year	1st year		2nd year		
Control	36,925 a ¹	25,713 a	B ²	48,138 a	A	**
Fertilizer	37,541 a	25,531 a	B	49,550 a	A	**
12.5 t ha ⁻¹ TSS	36,787 a	25,163 a	B	48,413 a	A	**
25.0 t ha ⁻¹ TSS	38,316 a	29,369 a	B	47,263 a	A	**
37.5 t ha ⁻¹ TSS	39,659 a	31,069 a	B	48,250 a	A	**

Significant differences between treatments at ** $P \leq 0,01$ or * $P \leq 0,05$ level indicated by different letters. ¹Small letter in column for applications, ²capital letter in row for years. N=4 for all measurements.

According to the results, the average Cu, Ni, Pb and Zn concentrations of the corn seeds samples taken in 2 years from the experiment did not show statistically significant changes with increasing doses of treated sewage sludge applications when compared with mineral fertilizer and control. In other words, the average Cu, Ni, Pb and Zn concentrations of the corn seeds samples taken in 2 years from the experiment were not increased by the application of treated sewage sludge doses. On the other hand, average Cr concentrations of the corn seeds samples taken in the experiment showed statistically significant changes with applications when compared with control. The highest average Cr concentration ($0,653 \text{ mg kg}^{-1} \text{ Cr}$) was determined with 12.5 t ha^{-1} TSS application. Despite these increases, Cr concentrations of corn were found under the threshold values in all wheat seed samples. Normal value of Cr in vegetables and fruits changes between $0,1-1,0 \text{ mg kg}^{-1}$ for human health (Türkdoğan et al., 2002). Also all heavy metal concentrations of corn were found under the threshold values in all corn seed samples for human health (Türkdoğan et al., 2002). Meanwhile, Cd did not be determined in the corn seeds. Cadmium is regarded as the most hazardous metal element based on its concentration in sewage sludges, its soil chemistry, and the ability of plants to accumulate Cd (Logan and Chaney, 1983). Increase in the dietary uptake of Cd is a potential risk to human health associated with the land application of sewage sludge (US Environmental Protection Agency, 1985).

Effect of TSS applications on heavy metal (Cu, Cd, Cr, Ni, Pb and Zn) concentrations of second crop wheat seed grown in sandy clay soil are given in Table 4. According to the results, Cd, Cr, Ni and Zn concentrations of the wheat seeds samples taken in the experiment did not show statistically significant changes with increasing doses of treated sewage sludge applications when compared with mineral fertilizer and control. In other words, Cd, Cr, Ni and Zn concentrations of the wheat seeds samples taken in from the experiment were not increased by the application of treated sewage sludge doses. On the other hand, Cu concentrations of the wheat seeds samples taken in the experiment showed statistically significant changes with increasing doses of treated sewage sludge and mineral fertilizer applications when compared with control. The highest Cu concentration ($11,175 \text{ mg kg}^{-1} \text{ Cu}$) was determined with 37.5 t ha^{-1} TSS application. Despite these increases, Cu concentrations

of wheat were found under the threshold values in all wheat seed samples. Limit value of Cu in vegetables and fruits changes between $2-20 \text{ mg kg}^{-1}$ for human health (Türkdoğan et al., 2002). Meanwhile, Pb did not be determined in the wheat seeds samples taken in from the experiment.

Table 4. Effect of treated sewage sludge (TSS) applications on heavy metal (Cu, Cd, Cr, Ni, Pb and Zn) concentrations (mg/kg) of second crop wheat seed grown in sandy clay soil

Tukey: $P \leq 0,05$

Applications	Control	Fertilizer	12.5 t ha ⁻¹ TSS	25.0 t ha ⁻¹ TSS	37.5 t ha ⁻¹ TSS
Cu (mg/kg) (Tukey: *)	9,950 c ¹	11,050 ab	10,263 bc	10,788 ab	11,175 a
sd	0,319	0,842	0,617	0,660	0,466
Cd (mg/kg) (Tukey: ns)	0,950 a ¹	1,013 a	0,875 a	0,813 a	0,938 a
sd	0,108	0,138	0,065	0,085	0,149
Cr (mg/kg) (Tukey: ns)	1,063 a ¹	0,963 a	1,000 a	0,913 a	1,088 a
sd	0,075	0,131	0,122	0,111	0,149
Ni (mg/kg) (Tukey: ns)	6,000 a ¹	5,838 a	5,113 a	5,775 a	5,988 a
sd	0,879	1,036	1,768	0,380	0,647
Zn (mg/kg) (Tukey: ns)	58,488 a ¹	61,425 a	61,525 a	64,788 a	64,588 a
sd	1,696	5,079	3,827	5,699	5,207
Pb (mg/kg)	none	none	none	none	none

¹Significant differences between treatments at $*P \leq 0,05$ level indicated by different letters.

ns: statistically not significant, sd: standart deviation, N=4 for all measurements.

Conclusions

The fertility benefits from sewage sludge amendment can be achieved against the potential hazards of heavy metal contamination by screening the plants sensitivity at different sludge amendment ratios. Plants differ in their heavy metal uptake, accumulation and tolerance levels. The problem related to sewage sludge application arises when it contains high concentrations of potentially toxic heavy metals. The release of heavy metals associated with sewage sludge is strongly influenced by soil pH, cation exchange capacity, organic matter, and mobility and speciation of specific metals. Excessive application of sewage sludge to soil has been found to increase the bioavailability of heavy metals, but the low doses of sewage sludge did not cause a significant increase in heavy metal concentrations. Sewage sludge amendment increases the production of a variety of plants including vegetables, cereals, grasses and trees. Elevated levels of some heavy metals like Zn in corn and wheat grain grown on treated sewage sludge applied soil may be helpful in elevating of deficiency of these micronutrients in humans and animals. In our study, we found that all heavy metal levels of corn and wheat seeds were under threshold values. Therefore, we concluded that TSS could be used to improve for soil properties and plant nutrients in soils of Turkey when the heavy metal concentrations there are taken into consideration. However, further studies must be carried out in the next years to confirm the positive long-term effects of TSS in order to maintain and improve soil properties and fertility.

Acknowledgements

We thank the Scientific and Technical Research Council of Turkey (TUBITAK) for financial support (Project no: 108G167).

References

- Alloway, B.J. Jackson, A.P. Morgan, H. 1990. The accumulation of cadmium by vegetables grown on soils contaminated from a variety of sources. *Sci. Total Environ.* 91, 223–236.
- AOAC 1990. Official methods of analysis In: Helrich K (ed) Association of official analytical chemists, Washington, DC
- Bouyoucos, G. J. 1962. Hydrometer method improved for making particle size analysis of soil. *Agronomy Journal*, 54(5), 464–465.
- Davis, R. D. and Carlton-Smith. C. 1980. Crops as indicators of the significance of contamination of soil by heavy metals. Technical Report 140. Water Research Centre, Stevenage. UK
- Delibacak, S. Okur, B. Ongun, A. R. 2009. Influence of treated sewage sludge applications on temporal variations of plant nutrients and heavy metals in a Typic Xerofluent soil. *Nutr. Cycl. Agroecosyst.*, 83: 249-257.
- Epstein, E. 1971. Effect of soil temperature on mineral element composition and morphology of the potato plant, *Agronomy J.* 63: 664–666.
- Epstein, E. Keane, D.B. Meisinger, J.J. Legg, J.O. 1978. Mineralization of nitrogen from sewage sludge and sludge compost. *Journal Environmental Quality* 7:217–21.
- IARTC 2012. Weather Station Climate Datas of International Agricultural Research and Training Center. Menemen, İzmir.
- Logan, T.J. Chaney, R.L. 1983. Utilization of municipal wastewater and sludge on land-metals. In: Page, A.L. et al. (Eds.), *Proceedings of the Workshop on utilization of municipal wastewater and sludge on land.* University of California, Riverside, CA, pp. 235–326.
- Mondy, N.I. Naylor, L.M. Philips, J.C. 1984. Total glycoalkaloid and mineral content of potatoes grown in soils amended with sewage sludge. *J. Agric. Food Chem.* 32, 1256–1260.

- Page, A.L. Miller, R.H. and Keeney, D.R. (Eds.), (1982) In:Methods of soil analysis. Part 2. Chemical and microbiological properties, 2nd ed. Agron. Monogr. 9. ASA-SSA, Madison, USA.
- Singh, R.P., Agrawal, M., 2008. Potential benefits and risks of land application of sewage sludge. Waste Manage. 28, 347–358.
- Soil Survey Staff 2006. Keys to soil taxonomy. 10th ed. Washington DC, USA: US Government Printing Office.
- SPSS 17.0, 2008. SPSS 17.0 for Windows. Chicago, IL, SPSS Inc.
- Türkdoğan, M. K. Kilicel, F. Kara, K, Tuncer, I. Uygan, I. 2002. Heavy Metal in Soil, Vegetables and Fruits in the Endemic upper Gastrointestinal Cancer Region of Turkey, Environmental Toxicology and Pharmacology, 13, 175-179.
- US Environmental Protection Agency. 1985. Summary of environmental profiles and hazards indices for constituents of municipal sludges. USEPA, Washington

VARIABILITY ANALYSIS ON WATER QUALITY OF STREAMFLOW FROM YESILIRMAK BASIN IN TURKEY

Kadri YUREKLI

University of Gaziosmanpasa, Agriculture Faculty, Department of Biosystem Engineering, Tokat-Turkey,
Corresponding author: kadriyurekli@yahoo.com

Abstract

In this paper, variability in monthly water quality records at Durucasu monitoring station on the Yeşilirmak River in Turkey was analyzed by considering the Mann-Kendal (MK) and Theil-Sen Slope estimator (TSE) statistical approaches to detect the direction and magnitude of an available monotonic trend in any given data. For this purpose, the data sets of nine analysis parameters, based on monthly measurement at the monitoring station, were considered in the study. The pH, chlorides, sulfates and SAR data sequences for some months had statistically significance upward trend when there was a decreasing trend in streamflow data of the nine months. The largest percent change in streamflow data was found as 153% in November, whereas July in the pH, June in chlorides and January in sulfates and SAR had the maximum percent change.

Key words: *Yesilirmak, water quality, Mann-Kendal, Theil-Sen Slope estimator*

Introduction

Freshwater rivers represent an essential and integral component of the natural source of the world in terms of quantity and quality. But, among the most important issues facing civilization in the 21st century is the growing scarcity of fresh and clean water. Maintaining and improving the quality and quantity of freshwater has long-term economic, health, and ecological implications. In a broad term, water quality refers to the physical, biological and chemical statues of the water body. The quality of life is often judged on the availability of pristine waters. Therefore, water quality is important not only because of its linkage to the availability of water for various uses and its impact on public health, but also because water quality has an intrinsic value. Also, the presence, abundance, diversity and distribution of aquatic species in surface waters are depended upon a myriad of physical and chemical factors, such as temperature, electrical conductivity, suspended solids, nutrients, chemicals, and in-stream and riparian habitats (Kurunc et al, 2005). Non-parametric approaches by researchers on the subject in many countries are widely used in the analysis of changes in hydro-climatic variables. The study was aimed to detect variation in streamflow and eight water quality parameters from Durucasu monitoring station on Yesilirmak River by using Mann-Kendall test, commonly known.

Material and Methods

The Yeşilirmak Basin is one of the major basins in Turkey. The water of the Yeşilirmak is mostly used for irrigation in agriculture in addition to drinking, bathing, propagation of fisheries and wildlife, etc. Due to population explosion and rapid industrialization the river has been indiscriminately polluted and misused (Kurunc et al, 2005).

The river flows approximately 519 km and reaches to the Black Sea. It drains an area of 38,730 km² which is about 5% of Turkey's surface area. The basin of the river is bounded 39° 30' and 41° 21' N latitudes, 34° 40' and 39° 48' E longitudes. The land rises from an altitude of the sea

level to 2800 m. In terms of land use, there are about 39% forest regime, 39% cropland and 19% pasture land in the basin (Anonymous, 1970; Munsuz and Ünver, 1983). The major tributaries to the Yeşilirmak River are Kelkit, Çekerek, Çorum Çat and Tersakan Streams.

In Durucasu monitoring station, water flow is measured and water samples are taken for once every month by the General Directorate of State Hydraulic Works (DSI). The geographic coordinate of this water quality monitoring station is 40° 44' 40" N latitudes and 36° 06' 43" E longitudes. The drainage area of the monitoring station is about 21,650 km². Figure 1 shows the location map of the monitoring station.

In addition to streamflow (Q) in m³/s, among the water quality constituents measured by DSI at Durucasu monitoring station are water specific conductivity (EC) in dS/m, temperature (T) in °C, sodium (Na⁺), potassium (K⁺), calcium+magnesium (Ca²⁺+Mg²⁺), chlorides (Cl⁻) and sulfates (SO₄²⁻) in mg/l and pH. In addition to these water quality constituents, calculated sodium adsorption rate (SAR) is also used in this study. The records for these constituents available for the analysis as presented in this paper are on a monthly basis for the period 1984–2002.

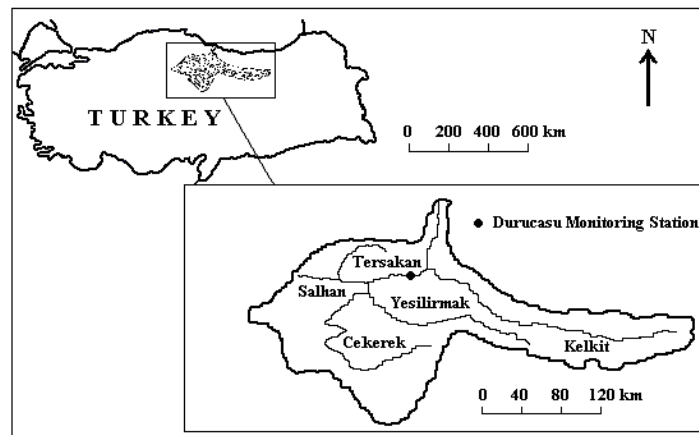

Figure 1. Location of Durucasu monitoring station in the Yeşilirmak River Basin

Testing change in the data: Variation in water quality variables in the study has been analyzed by non-parametric approach (Mann-Kendall, MK), which is commonly used in many areas. The method was given in Yurekli(2015) as detailed. In this study, only test statistic (Z_{MK}) of the MK was presented as follows:

$$Z_{MK} = \left\{ \begin{array}{l} \frac{S-1}{\sqrt{\sigma_s^2}} \text{ if } S > 0, \\ 0 \text{ if } S = 0, \\ \frac{S+1}{\sqrt{\sigma_s^2}} \text{ if } S < 0 \end{array} \right\} \quad (1)$$

In the equation, S is total value based on positive and negative differences among observations. It is assumed that the statistic S is approximately normally distributed with the mean zero. In case where the sample size $n > 10$, the σ_s^2 is its variance.

The Z_{MK} test statistic is evaluated to according to the standard normal distribution. This value is compared to the value of $Z_{1-\alpha/2}$ from standard normal distribution table at 5% significance level.

The null hypothesis associated with no trend is accepted if the Z_{MK} test statistic is smaller than the critical value of the standard normal distribution at the significance level of α . The Z_{MK} test statistic having a positive or negative value signifies an increasing or decreasing trend.

In this study, Theil-Sen's estimator (TSE) (Sen 1968; Theil 1950) was taken into account when specifying the magnitude and direction of variation in water quality data. The brief descriptions of the statistical method are as follows:

(I) The slope estimates (Q_k) of N pairs of data series are first computed by sorting data in ascending order:

$$Q_k = \frac{x_j - x_i}{j - i} \text{ for } k = 1, \dots, N \quad (2)$$

(II) If N is odd or even, the median concerning with the Q_k is obtained from:

$$Q_{\text{med}} = \begin{cases} Q_{[(N+1)/2]} & \text{if } N \text{ is odd} \\ 2^{-1} \{ Q_{[(N)/2]} + Q_{[(N+2)/2]} \} & \text{if } N \text{ is even} \end{cases} \quad (3)$$

In equations, x_i, x_j is the i^{th} and j^{th} observations, N is the number of observations, Q_{med} is Theil-Sen's estimator.

The percent change of the upward and downward trend in water quality data is found by the following equation given in Yue and Hashino (2003).

$$\% \text{ PC} = \frac{Q_{\text{med}} \times t}{\bar{x}} \quad (4)$$

Where t is data analysis period (years), the \bar{x} is mean of the data.

Results and discussions

Variation in streamflow, the water quality constituents and sodium adsorption rate (SAR) was tested by Mann-Kendall (MK) in the study. The MK results related to the mentioned data were given in the Table 1. As can be seen the table, according to the critical value of ± 1.645 from standard normal distribution table at 5% significance level, the streamflow data sequences of the remaining months had significance downward trend except streamflow data of April, May and June. As for pH, there were upward trend in eight months while the four months (February, Marc, December and November) had statistically insignificance trend. Additionally, an increasing trend was detected in chlorides data sets of January and June. Besides, sulfates and SAR data sequences for January had also upward trend. But, the data sequences concerning with water specific conductivity, temperature, sodium, potassium, calcium+magnesium had statistically significance monotonic trend in none of all months. Theil-Sen's estimator results of streamflow and water quality constituents with monotonic trend at Durucasu monitoring station are in the Table 2.

According to the Equation 4, the percent change of the downward trend in streamflow data varied between 68% (July) and 153% (November), whereas the percent change for the upward variation of the pH was between 3.8% (April) and 13.1% (July). The percent change for chlorides data sets of January and June months were 39.4% and 44.5%, respectively. As for sulfates and SAR data sequences for January, The percent change was calculated as 50.3% and 27.3%, respectively.

Table 1. Mann-Kendal test results for Durucasu Monitoring Station

Months	Q	T	pH	EC	Na	K	Ca+Mg	Cl	SO ₄	SAR
1	-3.08	-0.46	2.39	0.42	1.58	1.58	0.28	2.21	2.77	2.24
2	-2.80	0.25	0.84	1.12	0.91	0.98	1.37	1.12	1.61	0.77
3	-1.82	0.28	0.35	0.46	0.35	-0.54	1.44	0.11	0.53	0.35
4	-1.26	-0.57	1.77	0.56	0.39	-1.27	0.14	0.14	-0.32	0.42
5	-0.37	0.42	2.59	0.04	0.87	0.46	-0.12	0.04	0.95	1.24
6	-1.21	-1.05	2.47	0.23	1.18	0.12	-0.11	2.39	1.21	1.44
7	-2.38	1.07	5.00	-0.14	1.40	0.35	-0.14	0.67	1.61	1.61
8	-1.94	-0.04	2.06	0.87	1.20	0.21	1.07	0.54	1.44	1.11
9	-2.51	1.25	2.53	1.03	1.15	-0.54	0.50	1.03	1.32	1.11
10	-3.43	1.34	1.70	-0.29	0.00	-0.50	-0.08	0.37	0.12	0.95
11	-3.43	0.78	1.24	-0.82	0.00	-0.79	-0.78	0.25	-0.62	0.37
12	-3.29	-0.46	0.70	0.70	0.99	1.20	0.33	1.45	0.78	1.44

Table 2. The TSE results for Durucasu monitoring station

Constituents	1	2	3	4	5	6	7	8	9	10	11	12
Q	-4.1	-3.9	-4.3				-1.0	-1.2	-1.5	-2.0	-1.8	-4.0
PH	0.04			0.02	0.02	0.03	0.06	0.03	0.02	0.02	0.04	
Cl	0.47					0.47						
SO ₄	2.46											
SAR	0.01											

Conclusion

As mentioned above, at Durucasu monitoring station on Yesilirmak river, monthly data sets of streamflow and water quality constituents in some months showed a monotonic trend in the sense of upward or downward. The reason of this variation may be explained by some socio-economic evolution in the Yesilirmak river basin. The cause of pollution is the increase in industrialized and urbanized areas, animal husbandry without any wastewater treatment and the development of roads and airports. Besides, extreme use of mineral fertilizers, soil degradation and rotation cropping system were very impact on water quality in the basin and have led to variation in concentration of some water quality.

References

- Anonymous, (1970). Soils of Yeşilirmak Basin. General Directorship of Soil-water publications, Publication Number: 241, Ankara-Turkey, 141 pp. (in Turkish).
- Kurunc, A, Yurekli, K, Cevik, O (2005). Performance of Two Stochastic Approaches for Simulating River Water Quality and Streamflow. *Environmental Modeling & Software*, 20(9), 1995-2000.
- Munsuz, N, Ünver, I (1983). Waters of Turkey. University of Ankara, Agricultural Faculty Publications, Publication Number: 882, Ankara-Turkey, 392 pp. (in Turkish).
- Sen, PK (1968). Estimates of the regression coefficient based on Kendall's tau. *Journal of the American Statistical Association*, 63, 1379–1389.
- Theil, H, (1950). A Rank Invariant Method of Linear and Polynomial Regression Analysis, part 3. *Netherlands Akademie van Wetenschappen, Proceedings*, 53, pp. 1397–1412.

- Yue, S, Hashino, M (2003). Long term trends of annual and monthly precipitation in Japan. *Journal of the American Water Resources Association*, 39, 587–596.
- Yurekli, K. (2015). Impact of climate variability on precipitation in the Upper Euphrates–Tigris Rivers Basin of Southeast Turkey. *Atmospheric Research*, 154: 25-38.

COMPARATIVE STUDY OF COLD PRESS AND ACCELERATED SOLVENT OIL EXTRACTION FROM *CAMELINA SATIVA* AND *BRASSICA CARINATA*

Umesh Chandra LOHANI^{1*}, ²Vijay SUNDARAM, ³Kasiviswanathan MUTHUKUMARAPPAN

¹G B Pant University of Agril & Tech, Pantnagar, India

^{2,3}South Dakota State University, USA

*Corresponding author: ulohani@gmail.com

Abstract

The aim of the current research was to compare the cold press (CP) and accelerated solvent extraction (ASE) methods for oil yield and qualities of non-edible *Camelina sativa* and *Brassica carinata* oilseeds. A full factorial design with three levels of extraction temperature (80, 100 and 120°C), and extraction time (40, 65 and 90 min) for ASE and three levels of screw frequency (15, 20 and 25 Hz), and nozzle diameter (5.6, 6.4 and 7.2 mm) for CP were used to extract the oil. Maximum oil yield for both the oilseeds was obtained at 100°C, 90 min for ASE and at 20 Hz, 5.6 mm for CP extraction. ASE produced 6-10% more oil recovery than that of CP for both the oilseeds. The heating values of oil extracted from both oilseeds using ASE and CP were found in the range of 39.4-40.5 MJ/kg and 39.7-40.8 MJ/kg, respectively. Solvent extracted camelina oil exhibited 23% less viscosity than that of cold pressed oil. Density of both the oils ranged from 906.5-930.1 kg/m³, and 905.3-935.3 kg/m³ for ASE and CP, respectively. Camelina oil was rich in linolenic acid, whereas oleic acid was dominant free fatty acid in carinata oil regardless the extraction methods. ASE extracted oil was found more suitable for the upgradation to the biofuel.

Keywords: *accelerated solvent extraction, cold press, camelina, carinata, viscosity*

Introduction

Petroleum based jet fuels have amplified the conundrums associated with energy security, environmental pollution, and energy costs. The United States Federal aviation administration has set a goal to produce one billion gallon of biojet fuel by the year 2018 . Across the world, research works were initiated to develop the biojet fuels from non-food oil crops. Oilseeds are an important economical factor in world trade of agricultural products. The oil content of seed is a key interest to the oil industry because the monetary assessment in the trade of oilseeds is based on this value as now a days, oil from oilseeds is being upgraded to biodiesel or jet fuel to overcome the future crisis of fossil fuels. *Camelina sativa* (camelina) and *Brassica carinata* (carinata) poses a potential business opportunity to develop an aviation biojet fuels .

Prior to upgrade the oil into fuels, extraction of oils from oilseeds is a challenging task and has become the cynosure to all research scientists in last few years. Cold press is being used to keep away the hazardous of solvent extraction, but it is limited to the extraction of edible oils for human food. As far as non-edible oil extraction is concerned, especially for biofuel upgradation, solvent extraction method can be taken into consideration. Conventional solvent extraction can be replaced by accelerated solvent extraction. Accelerated solvent extraction employs organic solvents at elevated temperatures and pressures for oil extraction that reduces extraction time and solvent consumption (Dunford and Zhang, 2003). Cold press extraction involves mechanical pressing of seeds without the application of heat or chemicals, requiring less energy thus extracting oil with better nutritional properties (Thanonkaew et al., 2012). Camelina and carinata

oilseeds have been reported for cold press extraction (Czaplicki et al., 2011; Dobre and Jurcoane, 2011; Dorado et al., 2004; Fröhlich and Rice, 2005; Patil et al., 2009; Ratanapariyanuch et al., 2013; Zhao et al., 2014) extensively, however literatures on accelerated solvent extraction of camelina are limited (Lohani et al., 2015) and none in case of carinata. Therefore, this study involves comparative study of cold press and accelerated solvent extraction techniques for both the oilseeds.

The main objective of the study was to compare oil qualities from *Camelina sativa* and *Brassica carinata* seeds using two different oil extraction methods, viz. cold press oil extraction and accelerated solvent extraction. Specific objectives were to study the effects of screw speed, die nozzle size for cold press oil extraction, and extraction temperature, extraction time for ASE on different oil properties such as viscosity, density, free fatty acids, and heating value.

Materials and Methods

Camelina sativa and *Brassica carinata* oilseeds were procured from Seed house, South Dakota State University. All seeds were ground in a hammer mill (Thomas Wiley laboratory mill, Swedesboro, NJ) to pass a 2 mm screen. Moisture content of all seeds were found in the range of 7.5-9.0% that was suitable (<10%) for solvent extraction. All seeds were packed in airtight poly bags and stored at 4°C for further oil extraction. n-hexane as an extraction solvent was procured from Fisher Scientific and stored in the safety cabinet at room temperature.

1.1 Moisture content

Moisture content (MC) of ground oilseeds was determined by air oven standard methods recommended by AOAC (AOAC, 1980). Initially 5 g of sample in triplicate was dried in hot air oven at 130-133°C for 2 h. After drying, dried sample was again weighed. Following formula is used for calculating the MC.

$$\text{MC (wb, \%)} = \frac{W_i - W_f}{W_i} \times 100$$

W_i = initial weight of sample (5 g),

W_f = weight of sample after drying, g

1.2 Solvent extraction

Accelerated Solvent Extractor (ASE 350, Dionex) was used to extract the oil from camelina, and carinata oilseeds using n-hexane. Oils were extracted at three different temperatures, i.e. 80, 100 and 120°C for 40, 65 and 90 min of extraction time. The solvent to seed ratio was kept constant as 4:1 from preliminary trails. The system pressure was controlled at 1500 psi throughout the experiments. Different treatment conditions employed for oil extraction from ASE are given in Table 1.

1.3 Cold press extraction

Oil extraction was carried out using cold press oil extractor (M70 oil press, Oil press. Co) consisting of VFD motor (2 HP, 1.5 kW) for operating the screw press. A heating collar was wrapped around the barrel to regulate the temperature for oil extraction. This temperature was kept constant at $90 \pm 2.0^\circ\text{C}$. Oils were extracted at 3 different screw frequency, i.e. 15, 20 and 25 Hz using 3 different die nozzles of diameter 5.6, 6.4, and 7.2 mm. About 2 kg of oilseeds were used to extract the oil under different conditions. Extracted oils were stored at 4°C for further analysis. Different treatment conditions employed for oil extraction from CP are given in Table 1.

1.4 Soxhlet extraction

Two g of ground oilseeds were extracted in a Soxhlet apparatus with 30 mL of boiling n-hexane for 8 h. The mixture of oil and hexane was collected, concentrated under vacuum, and dried for 5 min at 105°C. Extraction yield was determined using the official recommendation (ISO, 2009).

1.5 Oil characteristics

1.5.1 Density

Density measurements were carried out using a pycnometer at a temperature of 25°C ($\pm 0.1^\circ\text{C}$). The pycnometer of capacity 25 mL was calibrated with water.

1.5.2 Viscosity

Viscosity measurement was carried out using a viscoanalyzer rheometer (ATS Rheosystems, NJ) equipped with RheoExplorer 39E commercial computer software (Version 5.0, Rheological instruments AB, 1999-2003). The experiments were conducted using a concentric cylinder geometry consisting of a rotational inner cylinder (bob) with an outer radius of 25 mm and 44.5 mm immersed height. Bob rotates in an outer stationary cup having 26 mm inner radius and thus giving 1 mm gap for fluid to be sheared. Measurements were taken for 15 ml sample at 25°C ($\pm 0.1^\circ\text{C}$) controlled temperature. The viscometer operated at forty fixed shear rates from 0 to 200 s^{-1} .

1.5.3 Heating value

Oxygen bomb calorimeter (IKA C2000, Wilmington, NC) was used to determine the heating value of the oil samples. A known quantity of oil was placed in the cup inside the bomb filled with oxygen for combustion. Instrument gave the direct heating value calculated from temperature increased in the water surrounding the jacket after combustion of known amount of sample.

1.5.4 Elemental analysis

Carbon (C), hydrogen (H), nitrogen (N), and oxygen (O) content analysis of oil samples were determined using a CE-440 Elemental Analyzer (Exeter Analytical, Inc., MA, USA) according to ASTM D4057 standard. Acetanilide was used for calibration. For CHN content analysis, the combustion and reduction temperatures were kept as 980°C and 650°C, respectively. The oxygen and helium pressure were maintained at 1.51×10^5 Pa (22 psi) and 1.17×10^5 Pa (17 psi), respectively. For O content analysis, the combustion and reduction temperature were 960°C and 770°C, respectively. Only helium was used as the carrier gas at 1.17×10^5 Pa (17 psi). Samples were sealed in a tin capsule and placed in a nickel sleeve. C, H, N, and O (wt%) values were directly recorded from the software attached to the analyzer.

1.5.5 FFA analysis

20 mg oil was mixed with 2 ml hexane and 2 ml BF_3 methanol in a 20 ml conical flask. Mixture was then heated in a water bath at 60°C for 1 h followed by cooling down to room temp. Mixture was topped up by 2 ml distilled water then was shaken for 10 min in shaker to get two different layers. Sometimes, mixture was required to centrifuge at 2500 rpm for 10 min to get layers. The upper layer was decanted in vials and a little amount of sodium sulphate was added in to vial to absorb the water from mixture. After 10 min, the mixture was filtered through 2 μm syringe filter to remove the salt impurities. After diluting the mixture with hexane in 1:1 ratio, derivatized sample was run in GC-MS (Agilent GC- 7890A and MSD-5975C) to identify the free fatty acids present in oil sample. The operating conditions were injection port temperature, 250°C; interface temperature, 250°C; column oven temperature, 75°C for 2 min, ramped at $15^\circ\text{C min}^{-1}$ to 250°C

with a 2 min hold; helium carrier gas (flow rate of 1 mL min⁻¹ at 75°C). The injector was operated in the splitless mode for 1 min after injection of the sample and capillary column (30 m × 0.25 mm × 0.25 mm DB-5MS) was used.

1.5.6 Unsaponifiable matter

Unsaponifiable matter of the oils was determined according to AOCS Recommended Practice Ca 6a-40 (AOCS, 2003) and was expressed as a percentage (w/w) of oil.

1.6 Statistical analysis

Full factorial design was used for experimental plan and results were compared by analysis of variance (ANOVA) using SPSS (16.0) statistical software. All data were reported as mean ± standard deviation of replicates. Tukey's tests were used to compare the significant differences of the mean values with the family error rate held at 0.05.

2. Results and Discussion

2.1 Effect of extraction time and temperature on oil yield and oil qualities

Main effect of extraction temperature and time on the oil yield are shown in Fig. 1. It is obvious that with increase in the extraction temperature during solvent extraction, oil yields of camelina and carinata oilseeds increased significantly ($p < 0.05$). However, for carinata, transition of temperature from 100°C to 120°C did not make any significant ($p > 0.05$) change in the oil yield (Fig. 1a). Similar results were found when the extraction time was varied from 40 min to 90 min (Fig. 1b). More extraction time allows more fat to diffuse into the extraction solvent. As the temperature increased, the viscosity of the solvent is reduced, thereby increasing its penetration to the sample matrix and solubilize the analyte (fat). The addition of thermal energy also assists in breaking analyte matrix bonds and encourages analyte diffusion from the matrix surface (Giergielewicz-Możajska et al., 2001).

The oil yield of camelina and carinata oilseeds exhibited a range of 29.85%-36.22%, and 31.50%-34.40%, respectively (Table 2). These values were in accordance with the findings reported by Budin et al. (Budin et al., 1995); Patil et al. (Patil et al., 2009) for camelina and Cardone et al. (Cardone et al., 2003); Stamigna et al. (Stamigna et al., 2012) for carinata. Treatment condition 6 (100°C-90 min) gave the maximum oil yield of camelina and carinata during accelerated solvent extraction. At low (80°C) extraction temperature, the oil yields of camelina did not show any significant ($p > 0.05$) difference when extraction time increased from 40 min to 90 min, whereas carinata oil yield increased significantly ($p < 0.05$) from 40 min to 65 min followed by no significant ($p > 0.05$) change with further increase in extraction time. At high temperature of 100°C and 120°C, oil yields of both oilseeds showed the significant ($p < 0.05$) increase with increase in extraction time from 40 min to 90 min. Similar trend was observed by Lohani et al. (Lohani et al., 2015) for solvent extraction of camelina. At higher temperature, less viscous solvent solubilized more analyte as an effect of increase in extraction time. At 65 min of extraction time, increase in temperature from 80°C to 120°C had no significant ($p > 0.05$) effect on oil yield of both oilseeds, whereas, at lowest (40 min) and highest (90 min) extraction time, camelina and carinata oil yields significantly ($p < 0.05$) increased with increase in the temperature from 80°C to 120°C, though there was no significant ($p > 0.05$) change in the oil yield of both oilseeds when the temperature was elevated from 100°C to 120°C (Table 2).

Camelina had higher oil content than carinata oilseeds. Maximum oil yield was found from both oilseeds at a temperature range of 100°C to 120°C and 90 min extraction time. Oil yields of both oilseeds extracted from ASE were also compared with those using Soxhlet extraction. Maximum

ASE oil yield of camelina and carinata were 3.9%, and 2.3% less than Soxhlet extracted oil yield, respectively (Table 2).

2.1.1 Heating value

Heating value for the oils extracted from camelina and carinata oilseeds ranged from 39.4-39.8 MJ/kg, and 40.0-40.5 MJ/kg, respectively. Lohani et al. (Lohani et al., 2015); and Dobre and Jucoane (Dobre and Jurcoane, 2011) reported the similar values, however, Bernardo et al. (Bernardo et al., 2003); Patil et al. (Patil et al., 2009); and Leung et al. (Leung et al., 2010) reported the higher heating values for camelina oil. Carinata oil did not show any significant ($p>0.05$) change in the heating values with increase in the extraction time and temperature (Table 2). Camelina oil exhibited the significant ($p<0.05$) increase in the heating values with increase in the extraction temperature from 80°C and 120°C for 40 min extraction time. The effect of temperature was insignificant ($p>0.05$) when the oil was extracted for 65 min and 90 min. On the other hand, the effect of extraction time on the heating values of camelina oil was not significant ($p>0.05$) for all the experimental extraction temperatures (Table 2). Lohani et al. (Lohani et al., 2015) found no significant change in the heating values of solvent extracted camelina oil with the variation of extraction temperature and time.

The average heating values for carinata oil was nearly 1.5% higher than that of camelina oil. Oils with higher heating values were obtained at 90 min extraction time and extraction temperature ranged from 80°C to 120°C.

2.1.2 Viscosity

Camelina and carinata oil exhibited the viscosity varied from 42.35-47.65 cp, and 66.75-70.75 cp, respectively (Table 3). Bernardo et al. (Bernardo et al., 2003); and Lohani et al. (Lohani et al., 2015) reported the similar results for camelina. At low temperature (80°C), viscosity of camelina oil increased significantly ($p<0.05$) when the extraction time increased from 40 min to 90 min, whereas, this effect was inverse at 120°C extraction temperature. Viscosity of camelina oil did not show any significant ($p<0.05$) change with extraction time at 100°C. For 65 min and 90 min of extraction time, the viscosity increased and decreased ($p<0.05$), respectively when extraction temperature raised from 80°C to 100°C. However, there was no significant ($p>0.05$) change in camelina oil viscosity after 100°C for both the extraction time. At low extraction time (40 min), viscosity of camelina oil exhibited insignificant ($p>0.05$) change when the extraction temperature increased from 80°C to 120°C. For carinata oil, the extraction time did not show any significant ($p>0.05$) effect on viscosity at all experimental extraction temperatures. For 65 min extraction time, the viscosity of carinata oil decreased significantly ($p<0.05$) with an increase in temperature from 100°C to 120°C, whereas, for the other two extraction times, no significant ($p>0.05$) change was observed in the viscosity when the extraction temperature varied from 80°C to 120°C (Table 3).

Camelina oil was found less viscous (35% on average) compared to carinata oil. Minimum oil viscosities for both the oilseeds were observed at a range of extraction temperature from 100°C-120°C for 40 and 90 min extraction time.

2.1.3 Density

Camelina and carinata oil densities varied from 906-918 kg/m³, and 922-928 kg/m³, respectively (Table 3). Bernardo et al. (Bernardo et al., 2003); Patil et al. (Patil et al., 2009); Leung et al. (Leung et al., 2010); Dobre and Jucoane (Dobre and Jurcoane, 2011); Lohani et al. (Lohani et al., 2015), and Bouaid et al. (Bouaid et al., 2005) reported less values for camelina and carinata oil density, respectively. At 80°C and 100°C extraction temperatures, the density of camelina oil

significantly ($p < 0.05$) decreased and increased, respectively with increase in the extraction time from 40 min to 90 min. No significant ($p > 0.05$) change was observed in the density when the extraction time was 40 min and 90 min at 120°C, though the density dropped significantly ($p < 0.05$) for 65 min extraction time. Camelina oil did not exhibit any significant ($p > 0.05$) difference in the density at 80°C and 120°C for 40 min and 90 min extraction time. However, there was significant drop and increase in the density at 40 min and 90 min, respectively when the temperature was raised from 80°C to 100°C (Table 3). No significant ($p > 0.05$) effect of extraction temperature was observed on camelina oil density at 65 min extraction time. For carinata oil, the density was not significantly ($p > 0.05$) affected with increase in the extraction time from 40 min to 90 min at 100°C and 120°C temperature. There was a significant ($p < 0.05$) increase in the density at low temperature (80°C) when the extraction time was increased from 40 min to 65 min. However, the density of the oil after 90 min extraction time was not significantly ($p > 0.05$) differ than that of 40 min extraction time. Carinata oil did not show any significant ($p > 0.05$) change in density when the extraction temperature was varied from 80°C to 120°C for all the experimental extraction time (Table 3).

On an average carinata oil was 1.4% denser than the camelina oil. Maximum density of camelina oil was observed at extraction temperature ranged from 100°C-120°C for 90 min extraction time, whereas, for carinata oil, the maximum density was observed at 65 min extraction time in the temperature range of 80°C-120°C.

2.2 Effect of nozzle diameter and screw frequency on oil yield and oil qualities

Main effect of nozzle diameter and screw frequency on the oil yield are shown in Fig. 2. Apparently, an increase in nozzle diameter from 5.6 mm to 7.2 mm significantly ($p < 0.05$) dropped the oil yield of camelina and carinata oilseeds (Fig. 2a). The oil yield of carinata did not exhibit any significant ($p > 0.05$) change when the screw frequency was varied from 15 Hz to 25 Hz, whereas, camelina oil yield was significantly ($p < 0.05$) higher at 20 Hz screw frequency (Fig. 2b). Smaller diameter nozzle created a back pressure on the oilseeds inside the cold press resulting in more oil extraction. Higher the screw frequency, the oilseed retained for shorter time inside the cold press which cause decrease in the oil yield.

Camelina and carinata oil yield ranged from 22.4%-34.1%, and 27.0%-32.4%, respectively (Table 2). For 6.4 mm and 7.2 mm nozzle diameters, the oil yield of camelina was observed significantly ($p < 0.05$) higher at 20 Hz screw frequency and no significant ($p > 0.05$) difference in density was observed at 15 Hz and 25 Hz. Zhao et al. (Zhao et al., 2014) also found the maximum oil yield of camelina at 20 Hz screw frequency. Camelina oilseed did not show any significant ($p > 0.05$) change in the oil yield with increase in screw frequency at 5.6 mm nozzle diameter. With increase in nozzle diameter from 5.6 mm to 6.4 mm, camelina oil yield decreased significantly ($p < 0.05$) followed by no significant ($p > 0.05$) change further in the oil yield when the nozzle diameter varied from 6.4 mm to 7.2 mm at all experimental screw frequencies. For carinata oilseed, only for 5.6 mm diameter nozzle, the oil yield was found to be significantly ($p < 0.05$) higher at 20 Hz screw frequency. For rest of the two nozzle diameters, carinata oil yield did not show any significant ($p > 0.05$) change with increase in the screw frequency from 15 Hz to 25 Hz. When the nozzle diameter increased from 5.6 mm to 7.2 mm, there was significant ($p < 0.05$) drop in the carinata oil yield at all experimental screw frequency level.

Maximum oil yield was found from both oilseeds at 20 Hz screw frequency and 5.6 mm nozzle diameter. Oil yields of both oilseeds extracted with CP were also compared with Soxhlet extraction. Maximum CP oil yield of camelina and carinata were 9.5%, and 8.0% less than the Soxhlet extracted oil yield, respectively (Table 2).

2.2.1 Heating value

Heating value of the oils extracted from the camelina and carinata oilseeds varied from 39.7-39.9 MJ/kg, and 40.4-40.8 MJ/kg, respectively (Table 2). For 5.6 mm and 7.2 mm nozzle diameter, the camelina oil did not exhibit any significant ($p>0.05$) change in the heating value when the screw frequency was varied from 15 Hz to 25 Hz. Heating value significantly ($p<0.05$) increased with increase in the screw frequency from 20 Hz to 25 Hz for 6.4 mm nozzle diameter. Oil extracted from the camelina oilseed showed significant ($p<0.05$) increase in the heating value with increase in the nozzle diameter from 6.4 mm to 7.2 mm at 15 Hz and 20 Hz screw frequencies, whereas, at 25 Hz screw frequency, increase in the heating value was significant ($p<0.05$) when the nozzle diameter varied from 5.6 mm to 6.4 mm followed by no significant ($p>0.05$) change in the heating value with further increase in the nozzle diameter (Table 2). For the carinata oil, there was no significant ($p>0.05$) effect of screw frequency on heating value oil was extracted using 7.2 mm nozzle diameter. However, for 5.6 mm and 6.4 mm nozzle diameter, the heating value significantly ($p<0.05$) increased and decreased, respectively with increase in the screw frequency from 15 Hz to 25 Hz. When the carinata oil was extracted at 15 Hz and 20 Hz screw frequencies, heating value of the oil did not exhibit any significant ($p>0.05$) change with the variation in the nozzle diameter from 5.6 mm to 7.2 mm. However, there was significant ($p<0.05$) decrease in the heating value at 25 Hz screw frequency when nozzle diameter varied from 5.6 mm to 6.4 mm (Table 2).

The average heating values for the carinata oil was nearly 2% higher than the camelina oil. Camelina oil extracted using large nozzle diameter had high heating values regardless of screw frequencies. However, carinata oil with higher heating values were obtained using 6.4 mm nozzle diameter and at low screw frequency.

2.2.2 Viscosity

Camelina and carinata oils viscosity ranged from 55.7-57.1 cP, and 69.4-72.1 cP, respectively (Table 3). For camelina oil, nozzle diameter and screw frequency did not exhibit any significant ($p>0.05$) effect on the viscosity. Viscosity of carinata oil increased significantly ($p<0.05$) with increase in the screw frequency from 15 Hz to 25 Hz at 5.6 mm nozzle diameter. No significant ($p>0.05$) effect of screw frequency on the viscosity was observed for rest of the two nozzle diameters. Varying the nozzle diameter from 5.6 mm to 7.2 mm did not significantly ($p>0.05$) affect the viscosity of carinata oil at 15 Hz. However, at 20 Hz and 25 Hz screw frequency, heating value significantly ($p<0.05$) decreased with increase in the nozzle diameter from 6.4 mm to 7.2 mm (Table 3).

For both the oils, minimum viscosities were found for large nozzle diameter regardless the screw frequency. On average, camelina oil was 20% less viscous than the carinata oil.

2.2.3 Density

Density of the camelina and carinata oils ranged from 905-917 kg/m³, and 923-935 kg/m³, respectively. Camelina oil did not show any significant ($p>0.05$) change in the density with increase in the screw frequency at 6.4 mm and 7.2 mm nozzle diameter. With increase in the screw frequency from 20 Hz to 25 Hz, the oil density increased significantly ($p<0.05$) at 5.6 mm nozzle diameter. There was no significant ($p>0.05$) effect of nozzle diameter on the density, when camelina oil was extracted at 20 Hz and 25 Hz screw frequency. At lowest experimental screw frequency, density was significantly ($p<0.05$) higher at 6.4 mm than that of other two nozzle diameters. Carinata oil did not exhibit any significant ($p>0.05$) change in the density with increase in the screw frequency at 6.4 mm and 7.2 mm nozzle diameter. For 5.6 mm diameter, there was significant ($p<0.05$) increase in the oil density when screw frequency was varied from

20 Hz to 25 Hz. Oil density increased significantly ($p < 0.05$) with increase in the nozzle diameter from 5.6 mm to 7.2 mm at 15 Hz and 20 Hz screw frequency, whereas for 25 Hz, no significant ($p > 0.05$) change in the density was observed with increase in the nozzle diameter. Carinata oil was denser (22% on average) than the camelina oil. Minimum densities of both the oils were observed at less nozzle diameter and screw frequency range of 15 Hz and 20 Hz.

2.3 Comparison of ASE and CP extracted oils

The optimum conditions for ASE and CP was found as 100°C temperature, 90 min extraction time, and 5.6 mm nozzle diameter, 20 Hz screw frequency, respectively. Oil qualities of both the oilseeds for ASE and CP extraction were compared in these conditions. Camelina and carinata oils extracted at ASE condition were almost 6% more than the cold pressed oils. Heating values of ASE extracted camelina and carinata oils were similar to that of oils extracted from CP (Table 2). Solvent extracted camelina oil exhibited 23% less viscosity than the cold pressed oil, whereas for carinata oilseed, there was no significant difference in the viscosity of ASE and CP extracted oils. As far as density was concerned, solvent extracted camelina oil was found 13% denser than that of cold pressed oil. However, ASE and CP extracted carinata oil had similar densities at respective optimum extraction conditions (Table 3).

2.3.1 Elemental content

Solvent extracted camelina and carinata oils contained higher carbon and less oxygen than that of cold pressed oils which indicated higher calorific values of ASE extracted oils (Table 4). Nitrogen content of all the oils were lower than 1% which indicates low level of phospholipids. The hydrocarbon (H/C) ratio of camelina oils ranged from 1.73 to 1.77, whereas H/C ratio varied from 1.76-1.81 for carinata oils which were lower than petroleum product H/C ratio (2.0). Zhao et al. (2014) also found the similar elemental values for cold pressed camelina oil.

2.3.2 Free fatty acid (FFA) profile

Free fatty acid profiles for Camelina and carinata oil extracted by ASE and CP at their optimum conditions are given in Fig. 3. Five free fatty acids, i.e. palmitic, linoleic, linolenic, oleic, and stearic acid were identified in all the four oil samples. From the observation of peak heights and areas of chromatogram, it was found that camelina oil was rich in linolenic acid as a polyunsaturated fatty acid, whereas oleic acid (monounsaturated fatty acid) was dominant in carinata oils regardless of the extraction methods (Table 5). Similar reports were found by Jucoane (Dobre and Jurcoane, 2011); Rosie et al. (Ciubota-Rosie et al., 2013); Waraich et al. (Waraich et al., 2013); Lohani et al. (Lohani et al., 2015); Zaleckas et al. (Zaleckas et al., 2012) for camelina and by Dorado et al. (Dorado et al., 2004) for carinata. The fatty acid profiles of solvent-extracted and cold pressed oil samples followed a similar trend.

2.3.3 Unsaponifiable matter

The unsaponifiable matter for camelina and carinata oil extracted from ASE and CP at their optimum conditions are shown in Table 4. It was obvious that the oils extracted by ASE had less unsaponifiable matter than that of extracted from CP for both camelina and carinata oils. Also camelina oil showed less unsaponifiable matter than carinata oil. The values of unsaponifiable matter were found in range reported by Czaplicki et al. (Czaplicki et al., 2011) for camelina oil.

3. Conclusions

Results from this study conclude that the yield and quality (heating value, density, viscosity, elemental analysis, free fatty acid profile, and unsaponifiable matter) of oils removed from Camelina *sativa* and Brassica *carinata* using ASE are better than that of the oil removed by CP.

Extraction time and temperature of 90 min, and 100°C, respectively can be recommended for oil extraction from selected oilseeds using ASE. The optimum condition for CP was found as 5.6 mm nozzle diameter and 20 Hz screw frequency. Though both the oils had potentiality to upgrade in to biofuel, camelina oil exhibited better oil qualities required for further biofuel upgradation. Accelerated solvent extraction can be a best alternative for oil extraction method at commercial scale due to less time and higher oil recovery with better oil qualities.

Acknowledgement

The authors gratefully acknowledge the funding provided by Agricultural Experiment Station, College of Agriculture and Biological Sciences, South Dakota State University. We would also like to thank funding agencies - NC Sun Grant, DoT, DoE, SD Oilseeds Initiative, Griffith Foundation for this research.

References

- Ag-West Bio (accessed Aug. 2015), Economic evaluation of drop-in hydrotreated renewable jet fuel production from camelina and carinata, <http://www.agwest.sk.ca/ckfinder/userfiles/files/>.
- Federal aviation administration (accessed Aug. 2015), Sustainable Alternative Jet Fuels, https://www.faa.gov/about/office_org/headquarters_offices/apl/research/alternative_fuels.
- AOAC, 1980. Official methods of analysis, Air oven method, 13 ed. Association of Official Analytical Chemist, Washington, DC.
- AOCS, 2003. In: Firestone, D. (Ed.), Official Methods and Recommended Practices of the American Oil Chemists' Society. AOCS Press, Champaign, USA.
- Bernardo, A., Howard-Hildige, R., O'Connell, A., Nichol, R., Ryan, J., Rice, B., Roche, E., Leahy, J.J., 2003. Camelina oil as a fuel for diesel transport engines. *Industrial Crops and Products* 17, 191-197.
- Bouaid, A., Diaz, Y., Martinez, M., Aracil, J., 2005. Pilot plant studies of biodiesel production using Brassica carinata as raw material. *Catalysis Today* 106, 193-196.
- Budin, J.T., Breene, W.M., Putnam, D.H., 1995. Some compositional properties of camelina (*camelina sativa* L. Crantz) seeds and oils. *Journal of the American Oil Chemists' Society* 72, 309-315.
- Cardone, M., Mazzoncini, M., Menini, S., Rocco, V., Senatore, A., Seggiani, M., Vitolo, S., 2003. Brassica carinata as an alternative oil crop for the production of biodiesel in Italy: agronomic evaluation, fuel production by transesterification and characterization. *Biomass and Bioenergy* 25, 623-636.
- Ciubota-Rosie, C., Ruiz, J.R., Ramos, M.J., Pérez, Á., 2013. Biodiesel from Camelina sativa: A comprehensive characterisation. *Fuel* 105, 572-577.
- Czaplicki, S., Ogrodowska, D., Derewiaka, D., Tańska, M., Zadernowski, R., 2011. Bioactive compounds in unsaponifiable fraction of oils from unconventional sources. *European Journal of Lipid Science and Technology* 113, 1456-1464.
- Dobre, P., Jurcoane, S., 2011. Camelina crop-opportunities for a sustainable agriculture. *Scientific Papers-Series A, Agronomy* 54, 420-424.
- Dorado, M.P., Ballesteros, E., López, F.J., Mittelbach, M., 2004. Optimization of Alkali-Catalyzed Transesterification of Brassica Carinata Oil for Biodiesel Production. *Energy & Fuels* 18, 77-83.
- Dunford, N.T., Zhang, M., 2003. Pressurized solvent extraction of wheat germ oil. *Food Research International* 36, 905-909.

- Fröhlich, A., Rice, B., 2005. Evaluation of *Camelina sativa* oil as a feedstock for biodiesel production. *Industrial Crops and Products* 21, 25-31.
- Giergielewicz-Możajska, H., Dąbrowski, Ł., Namieśnik, J., 2001. Accelerated Solvent Extraction (ASE) in the Analysis of Environmental Solid Samples — Some Aspects of Theory and Practice. *Critical Reviews in Analytical Chemistry* 31, 149-165.
- ISO, 2009. Oilseeds - Determination of oil content (Reference method), EN ISO 659:2009.
- Leung, D.Y.C., Wu, X., Leung, M.K.H., 2010. A review on biodiesel production using catalyzed transesterification. *Applied Energy* 87, 1083-1095.
- Lohani, U.C., Fallahi, P., Muthukumarappan, K., 2015. Comparison of Ethyl Acetate with Hexane for Oil Extraction from Various Oilseeds. *Journal of the American Oil Chemists' Society* 92, 743-754.
- Patil, P.D., Gude, V.G., Deng, S., 2009. Biodiesel Production from *Jatropha Curcas*, Waste Cooking, and *Camelina Sativa* Oils. *Industrial & Engineering Chemistry Research* 48, 10850-10856.
- Ratanapariyanuch, K., Clancy, J., Emami, S., Cutler, J., Reaney, M.J.T., 2013. Physical, chemical, and lubricant properties of Brassicaceae oil. *European Journal of Lipid Science and Technology* 115, 1005-1012.
- Stamigna, C., Chiaretti, D., Chiaretti, E., Prosini, P.P., 2012. Oil and furfural recovery from *Brassica carinata*. *Biomass and Bioenergy* 39, 478-483.
- Thanonkaew, A., Wongyai, S., McClements, D.J., Decker, E.A., 2012. Effect of stabilization of rice bran by domestic heating on mechanical extraction yield, quality, and antioxidant properties of cold-pressed rice bran oil (*Oryza sativa* L.). *LWT - Food Science and Technology* 48, 231-236.
- Waraich, E.A., Ahmed, Z., Ahmad, R., Ashraf, M.Y., Naeem, M.S., Rengel, Z., 2013. '*Camelina sativa*', a climate proof crop, has high nutritive value and multiple-uses: A review. *Australian Journal of Crop Science* 7, 1551.
- Zaleckas, E., Makarevičienė, V., Sendžikienė, E., 2012. Possibilities of using *Camelina sativa* oil for producing biodiesel fuel. *Transport* 27, 60-66.
- Zhao, X., Wei, L., Julson, J., Huang, Y., 2014. Investigated Cold Press Oil Extraction from Non-Edible Oilseeds for Future Bio-Jet Fuels Production. *Journal of Sustainable Bioenergy Systems* 04, 199-214.

Figure Captions

Figure 1. Main effect of ASE variables, (a) temperature and (b) time, on camelina and carinata oil yield. Values with the different letters at different points in the same line are significantly ($p < 0.05$) different

Figure 2. Main effect of CP variables, (a) nozzle diameter and (b) screw frequency, on camelina and carinata oil yield. Values with the different letters at different points in the same line are significantly ($p < 0.05$) different

Figure 3. GC-MS chromatogram of camelina oil (a) ASE extracted (b) CP extracted, and carinata oil (c) ASE extracted (d) CP extracted at optimum conditions

THE POSSIBILITY OF OBTAINING ORGANIC FERTILIZER FROM TOBACCO WASTE

Nemanja MANDIĆ¹, Maja MALNAR¹, Vesna RADOJIČIĆ^{1*}, Boris PISINOV²

¹University of Belgrade, Faculty of Agriculture, Belgrade-Zemun, Serbia

²Department of Food Safety, Institute of Veterinary Medicine of Serbia, Belgrade, Serbia

*Corresponding author: mntabacco@agrif.bg.ac.rs

Abstract

The aim of this study was to examine the possibilities of composting of tobacco waste (TW) with the addition of various organic waste materials, to obtain fertilizer with a high content of organic matter and low levels of toxic elements. Virginia tobacco leaves, which are classified as waste in the tobacco processing, were used in this experiment. Two experimental samples are formed according to the following scheme: I 50% TW + 50% cabbage; II 50% TW + 20% soil + 20% dry forest leaves + 10% cabbage. The comparison was made with the reference sample (only TW).

The experiment was set up in the indoor area at the Faculty of Agriculture, during the winter period, without automatic control of temperature and humidity. Nicotine content in the samples was determined by the HPLC method. Mineral matter content was determined by the atomic-absorption spectrophotometer AAS Perkin Elmer AAnalyst 300th. The results showed it is possible to obtain organic fertilizer from tobacco waste, through the process of composting. At the end of the composting process, the nicotine content had fallen below 10 mg/kg. The content of the basic macronutrients in experimental samples was suitable from the point of agricultural production. The levels of all heavy metals, except cadmium, were all below the allowable limit. Application of obtained products could come into consideration only if they are mixed with fertilizer, which has a low content of cadmium, so that its content in the mixture does not exceed the allowed 0.7 mg/kg.

Key words:

Introduction

The rapid increase in world population causes an increase in living standards, which inevitably leads to greater consumption of goods and services, and hence creates large quantities of waste per capita (Lim et al., 2016). The global increase of waste causes multiple problems - from the creation of large landfills which occupy the cities arable land to environmental contamination with heavy metals and chemicals (Bijaya et al., 2008; Garg et al., 2008). In the last ten years, the growth of the environmental awareness has led to an attempt to reduce a waste amount, get a useful product and at the same time to protect the environment (Jovičić, 2006).

The largest part of the waste, is certainly solid, municipal waste. Considering the percentage of the agricultural population (about 10%), the Republic of Serbia, in addition to municipal waste, faced with large amounts of agricultural waste. The largest part of the agricultural waste is corn (Jovanović et al., 2009), but a significant percentage of the total waste also makes tobacco waste generated after cultivation, processing, and tobacco, as well as after consumption of tobacco products (Radojičić et al., 2009).

The main characteristics of the tobacco waste are low moisture content, and high-value of organic carbon, nitrogen, and nicotine (Channiwala and Parikh, 2002; Civilini et al., 1997; Kopčić, 2016).

Directly dumping of the tobacco waste can pollute the environment, primarily due to the nicotine which is soluble in water and, as such, represents a threat to groundwater. EU Tobacco Directive classifies tobacco waste as hazardous if the nicotine content is greater than 500 ppm, while the Ministry of Agriculture and Environmental Protection and the Environmental Protection Agency of the Republic of Serbia, classifies it as non-toxic, but hazardous waste (Civilini et al., 1997; Pichtel, 2005; Waste Catalogue, 2010). Therefore, tobacco waste cannot simply be disposed of in a landfill along with other waste, but it has to be destroyed with specific procedures entrusted to the companies for tobacco processing.

Before disposal, tobacco waste can be biologically or thermally treated. Biological treatment (composting) involves partially or fully controlled process in which an organic matter gets biologically degraded. Finally, stable biodegradable waste compost is produced. So, composting is an acceptable solution because it reduces a cumbersome tobacco waste, transforming it into a stable organic fertilizer (Kopčić, 2016). Composting of tobacco waste accelerates the degradation of nicotine and produces nontoxic organic waste (Briski et al., 2003; Okur et al., 2008).

If we take into account that in 2005, total global production of tobacco waste amounted to more than 25.1 million tons (Kopčić, 2016), it is evident why the recycling is crucially important, both for environmental protection and in the economy (Novotny and Zhao, 1999; Okur et al., 2008)

The aim of this study was to examine whether tobacco waste (TW) can be composted by adding different organic waste, and would this process produce fertilizer with high organic and low toxic content. This work becomes especially important if we take into consideration that so far tobacco waste has been untapped, and its destruction requires a high economic investment.

Materials and methods

Study material were leaves of the large leaves tobacco (Virginia type tobacco), classified as waste during treatment. Soil and dry leaves collected in the park Faculty of Agriculture, University of Belgrade (Serbia) were added to the experimental batches, as well as commercially available waste cabbage leaves. The experiment was performed from the December 2014 until March 2015 at the Faculty of Agriculture, University of Belgrade. It was carried out in several steps: 1. preparation of experimental batches, 2. monitoring parameters of the composting process, 3. analysis of nicotine content, trace elements and heavy metals in samples of experimental batches. 1. Since all of the samples initially had a low water content, the first phase of the experiment was humidification, then grinding and finally mixing tobacco waste with biodegradable waste. Three diverse compost batches were made: the reference contained only tobacco waste and in the other two had a mixture of tobacco waste and other organic waste (the outline is given in Table 1).

Table 1. Compost batches ingredients (%)

Compost batches	Tobacco waste	Soil	Cabbage leaves	Dry leaves
1	50	-	50	-
2	50	20	10	20
R	100	-	-	-

2. The experiment was performed in a room without automatic parameters control. Thus, the parameters were manually adjusted if necessary (heating, ventilation). During the experiment, temperature and humidity of the samples and the experimental room were controlled daily

(thermometer K-TYPE 5115; microprocessor - moisture meter, model No. RS7825PS, CE ISO-2178, mini meteorological station Kestrel 4000, Nielsen - Kellerman).

3. In the experiment nicotine content in the compost batches were determined by HPLC method. Mineral matter is determined with atomic-absorption spectrophotometer AAS Perkin Elmer Analyst 300th.

Results and discussion

The results depicted in Table 2 indicate a change in the nicotine content during the experiment. The initial nicotine content in tobacco waste was 17363 mg/kg (sample R). Already at the beginning of the experiment when tobacco waste mixed with other forms of waste, there has been the reduction in nicotine content of approximately 50%, in sample 1, and 43% of sample 2.

Table 2. Nicotine content in experimental batches (mg/kg)

Sample	10.12.2014.	26.12.2014.	15.01.2015.	31.01.2015.	15.02.2015.	03.03.2015.	18.03.2015.	03.04.2015.
R	17363.0	13064.5	11234.2	9515.3	8796.3	6902.0	5680.0	5132.0
1	8830.1	5164.6	4862.2	3864.5	938.8	118.2	< 10	< 10
2	9790.6	8767.6	6102.8	782.8	323.3	108.6	< 10	< 10

All samples achieved complete degradation of nicotine during the composting process, but the dynamics of degradation varied in different samples. Sample 2 showed better results in the degradation of nicotine than Sample 1 which needed additional 20-odd days to drop nicotine content below the authorization limit of 500 mg/kg (EU guideline).

The dynamics of nicotine decomposition mostly depended on the temperature and humidity in experimental samples. Temperature and humidity were measured daily. For the better transparency, the results in Figure 1 and Figure 2 give the average values of the process parameters.

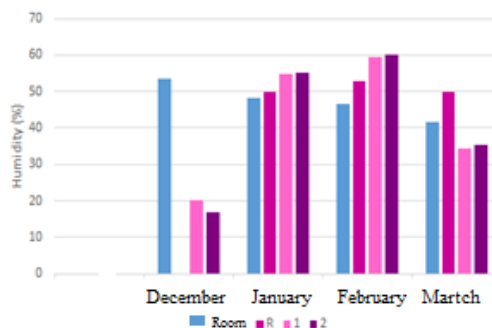
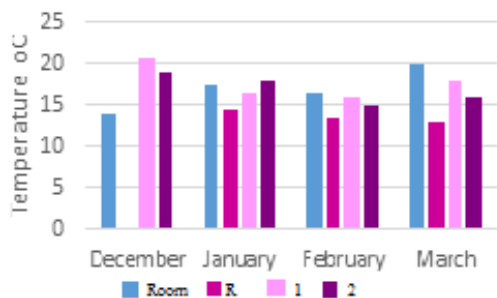

Figure 1. Temperature change during batching Figure 2. Humidity changes during batching

On the basis of the process parameters depicted in Figures 1 and 2, it can be concluded that the nicotine degradation has increased with rising temperature and humidity. Sample 1 showed a rapid drop in temperature in the first month, which resulted in a somewhat lower degradation of nicotine. In the next month, the temperature stabilized, so the speed of nicotine degradation increased. Sample 2 showed a constant temperature during the experiment which was responsible for the faster nicotine degradation compared to sample 1. Both samples had almost an identical

increase of the humidity. It was noteworthy that the experiment was carried out in the winter in a room without automatic control parameters, which slowed down the process.

Mineral matter content was determined in all samples at the end of the experiment. The results are presented in Table 3.

Table 3. Mineral matter in the compost batches

Sample/ Parameter	R			1			2		
	N	Result	SD	N	Result	SD	N	Result	SD
Nitrogen content, %	3	1.84	0.15	3	1.85	0.26	3	1.01	0.21
Calcium content, %	3	3.37	0.20	3	4.59	0.28	3	4.43	0.20
Potassium content,%	3	1.80	-	3	2.80	-	3	1.90	-
Phosphor content,%	3	0.19	0.04	3	0.25	0.02	3	0.19	0.05
Ash content, %	3	41.16	0.3	3	46.93	0.52	3	57.93	0.61
Cadmium content, mg/kg	3	3.575	0.023	3	4.241	0.145	3	2.905	0,073
Lead content, mg/kg	3	7.800	0.266	3	3.143	0.627	3	27.988	1.842
Arsenic content, mg/kg	3	7.760	0.388	3	5.306	0.265	3	8.617	1.034
Mercury content, mg/kg	3	<0.020	-	3	<0.020	-	3	< 0.020	-
Copper content, mg/kg	3	33.813	0.027	3	25.329	0.099	3	16.578	0.126
Zinc content, mg/kg	3	49.650	0.328	3	75.215	1.053	3	43.630	0.236
Iron content, mg/kg	3	873.980	0.961	3	808.337	0.808	3	905.861	4.167
Manganese content, mg/kg	3	301.302	0.964	3	222.746	0.869	3	337.626	0.169
Magnesium content, %	3	0.197	0.001	3	0.191	0.001	3	0.200	0.001

On the average, compost contains 0.35% N; 0.20% P; 0.25% K, 3.7% Ca and 75% organic matter (Radivojević et al., 1998). The results obtained in this experiment fit in with the expected value.

The content of nitrogen, phosphorus, mercury, and magnesium was the same in all samples. Compared with the sample 1, sample 2 had a slightly higher ash, lead, arsenic, iron, and manganese content. Nitrogen, phosphorus, potassium, calcium and copper values were concordant with the values given by Tedesco et al. (2011). Zinc, copper, magnesium and manganese content in the samples were several times lower than in those produced by Tedesco et al. (2011).

To promote high safety standards, ECOFI in May 2014 proposed a unified approach to organic fertilizers safety criteria. According to this recommendation, secure borders for heavy metals in soil are: 2 mg/kg of mercury, 120 mg/kg of lead, 200 mg/kg of copper and 600 mg/kg for zinc. The experimentally obtained values are several times less than prescribed (ECOFI).

However, according to Official Gazette of the Republic of Yugoslavia (2002), allowed quantities of heavy metals in Serbia are: Cd - 0.7 ppm; Pb - 70 ppm; As - 10 ppm; Hg - 0.7 ppm; Cu - 70 ppm; Zn - 210 ppm. When we discuss the heavy metal contents (Cd, Pb, As, Hg, Cu, Zn) the results in Table 3 point that only cadmium (Cd) was above the permitted limits of these Regulations both in the compost batches and in the reference sample.

Sample 1 (a mixture with 50% of cabbage) had the highest cadmium content, even 6 times above the permitted level. Previous research has found that cabbage, compared with other types of vegetables, absorbs the largest amount of cadmium from the soil (Petrović-Gegić et al., 2007).

The maximum amount of cadmium entered the experimental batches straightly from tobacco waste, which can be documented from the cadmium content in the reference sample (5 times

above the permitted amounts). Since we did not have information about the tobacco waste origin, as well as cabbage origin (location, soil type and pH in which it was grown, use of fertilizers, pesticides, and insecticides, irrigation water quality) we could not conclude what was the reason for such high cadmium content.

Conclusion

This research was primarily carried out to solve the problem of tobacco waste in Serbia, which destruction requires large expenses, mainly due to the nicotine content.

The results showed that it is possible to produce organic fertilizer from tobacco waste through the composting. Nicotine, the toxic waste, drops almost 50%, just by mixing tobacco waste with other forms of available organic waste. At the end of the composting, the nicotine content has dropped below 10 mg/kg, which is much lower than 500 mg/kg, a content required by EU regulations.

In the terms of the agricultural production, the content of the basic macronutrients in the experimental samples is appropriate. The content of all heavy metals except cadmium is below the allowable limit.

If we consider that the experiment took place under conditions similar to the natural (in the winter months, with occasional adjustment of the room temperature and humidity), it is clear that composting can be done in those natural conditions, thus increasing the economic value of tobacco waste. If the composting process took place in the season with higher air temperature, this natural process would be much faster.

References

- Bijaya K. Adhikaria, Suzelle Barringtona, José Martinezb, Susan Kinga (2008). Characterization of food waste and bulking agents for composting. *Waste Management*, Volume 28, Issue 5, 795–804.
- Briski F., Horgas N., Vukovic M., Gomzi Z. (2003). Aerobic composting of tobacco industry solid waste - simulation of the process. *Clean Techn Environ Policy* 5, 295–301.
- Channiwala A.S., Parikh P.P. (2002): A unified correlation for estimating HHV of solid, liquid and gaseous fuels. *Fuel* 81, 1051-1063.
- Civilini, M., Domenis, C., Sebastianutto, N., et al. (1997). Nicotine decontamination of tobacco agro-industrial waste and its degradation by micro-organisms. *Waste Manage Res.* 15, 349-58.
- ECOFI Responses and Proposals for Quality and Safety Criteria for Organic Fertilizers, Organic Soil Improvers and Organo-Mineral Fertilizers, V8, 27 May 2014.
- Garg K. V., Gupka R., Yadav A. (2008). *Current Developments in Solid-state Fermentation*. Springer New York, pp 468-511, DOI 10.1007/978-0-387-75213-6-20.
- Jovanović, B., Parović, M. (2009). *Condition and development of biomass in Serbia*. Jefferson Institute, Belgrade.
- Jovičić N. (2006). *Solid Waste Management*. The script, Faculty of Mechanical Engineering. [in Serbian]
- Kopčić N. (2016). Evaluation of laboratory-scale in-vessel co-composting of tobacco and apple waste. *Waste Management*, Volume 34, Issue 2, 323–328.
- Lim I. S., Lee H. L., Wu Y. T. (2016). Sustainability of using composting and vermicomposting technologies for organic solid waste biotransformation: recent overview, greenhouse gases emissions and economic analysis. *Journal of Cleaner Production*, Volume 111, Part A, Pages 262–278. Special Volume: Process Integration for Cleaner Production.
- Novotny, T.E., Zhao, F. (1999). Consumption and production waste: another externality of tobacco use. *Tobacco Control*, 8, 75-80.

- Official Gazette of the Republic of Yugoslavia (2002). Rules on the methods of organic crop production and gathering of forest fruits and medicinal herbs as products of organic agriculture, No. 51. [in Serbian]
- Okur, N., Kayıkçıoğlu, H., Okur, B., Delibacak, S. (2008). Organic amendment based on tobacco waste compost and farmyard manure: influence on soil biological properties and butter-head lettuce yield. *Turk. J. Agric. For.* 32, TÜbitak.
- Petrović - Gegić A., Vojinović- Miloradović B. M., Sabo Cehmajster J. K., Ileš I. F. (2007). Absorption of essential and toxic elements in various fruit and vegetable sorts in the flooded area of the Tisa River. *Chem.Ind.* 61 (5a), 321 - 325. [in Serbian]
- Pichtel J. (2005). *Waste Management Practices: Municipal, Hazardous and Industrial.* CRC Press, Taylor & Francis Group, London.
- Radivojević D. Hristov, S. Joseph I. (1998). Technological and hygiene aspects of the removal and use of liquid manure. *Contemporary Agriculture*, Vol. 48 (2), 229-233. [in Serbian]
- Radojičić, V., Milošević, M., Tomašević, B. (2009). Tobacco waste management in Serbia. *Ecological truth* 09, Proceedings, 218 -221.
- Tedesco J.M., Lauschaner H.M., Gianello C., Bortolon L., Kray H.C. (2011). Land disposal potential of tobacco processing residues. *Ciência Rural*, Santa Maria 41 (2), 236-241.
- Waste Catalogue (2010). Ministry of Environment and Spatial Planning and the Agency for Environmental Protection of the Republic of Serbia. [in Serbian]

THE INFLUENCE OF LAND USE ON WATER-PHYSICAL PROPERTIES OF SOILS IN VOJVODINA (SERBIA)

Ljiljana NEŠIĆ¹, Katarina MILUNOVIĆ¹, Milivoj BELIĆ¹, Vladimir ĆIRIĆ¹, Jovica VASIN²,
Lazar PAVLOVIĆ^{1*}

¹University of Novi Sad, Faculty of Agriculture, Novi Sad, Serbia

²Institute for field and vegetable crops Novi Sad, Serbia

*Corresponding author: lazar.pavlovic@polj.uns.ac.rs

Abstract

Due to the different land use, the man significantly influences and changes soil properties, water-air, thermal, biological and nutritious regime. In order to evaluate the influence of different land use (arable fields, meadows and forests) on water physical properties, the research was conducted in selected representative soil samples which were taken on the territory of Vojvodina autonomous province and it covered six soil types. For research purposes, the undisturbed soil samples were taken from different localities (61 localities) from surface horizon (0-30 cm) by Kopetzky cylinders in 3 repetitions. The rate of water permeability through soil sample is determined by method of constant pressure of water column. The majority of soil samples have a value of K-Darcy coefficient of 10^{-3} cm / s, which means that they belong to the class of soil that has good water permeability. Ecologically, the most favourable values of density and porosity have soils under meadows (1.25 g cm^{-3} and 47.24%), followed by soils under forests (1.35 g cm^{-3} and 45.05%) and the arable lands have at least a decent level (1.45 g cm^{-3} and 41.09%). From the results of statistical analysis it can be seen that land use has a much greater effect on the tested properties than soil type. On the basis of this research it can be concluded that land use significantly affects the water-physical properties. Arable agricultural land subjected to high anthropogenic influence is more likely exposed to deterioration of these properties.

Keywords: *soil, water permeability, land use, water-physical properties*

Introduction

Soils with different chemical, physical and biological characteristics are formed under the influence of different pedogenetic factors and processes on parent material. The function of soil in human history is significant, because the first civilisation appeared on the most fertile grounds (Kastori, 1995). By converting soil in to a medium for agricultural production, the man became crucial factor in pedogenesis and pedoevolution. The development of agricultural engineering and sciences, allows him to change composition and properties of soil according to requirements of plants. Sometimes, human activities can cause deterioration of soil properties and promotion of damaging processes in soil (Đorđević and Radmanović, 2016). On the other hand, natural “virgin” soils are not exposed to anthropogenic influence, and their properties entirely depends on the pedogenetic factors and processes that occur “in situ”.

In order to protect soil from negative anthropogenic influence and degradation, it is necessary to define significant prevention measures, identify the hazard and find appropriate solutions for their transcendence. Therefore, systematic control of soil fertility and content of harmful and hazardous substances i.e. monitoring of soil quality was suggested (Ličina et al., 2011; Nešić et al., 2015).

The Ministry of Education, Science and Technological Development of Republic of Serbia initiated and supported the project “Status, trends and possibilities to increase the fertility of agricultural land in Vojvodina Province” TR31072, 2011-2015. The aim of this project is to determine the quality of agricultural land in Vojvodina and to evaluate the possibility for production of high quality health-certified food. Part of the research from named project, which refers to results of soil water-physical properties, will be presented in this paper. Soil condition is usually assessed in terms of suitability for crop production and soil’s impact on the environment (Birkas, 2008). Water-physical properties which describe soil condition are bulk density, total porosity and water permeability.

Bulk density or density of dry land is defined as the mass of solid phase of soil drained on 105 °C per unit volume of soil, with pores. This soil property depends on structure, moisture, mechanical composition, aggregate composition and packing density of aggregates and particles. It is typically expressed in kg/m^3 or g/cm^3 . Unlike specific weight, the values of bulk density are changeable and vary in a wide range (Dugalić and Gajić 2012).

Soil pores, filled out with water or air, are located between primary soil particles and structure aggregates. Total porosity is defined as volume of all pores per unit of soil volume. This soil property is expressed in volume percentages (vol. %). Size, shape and ratio between pores are different and depend on mechanical and aggregate composition (packing density, shape and size of soil particles and aggregates), content of organic matter and activity of root system of plants and soil fauna (Vučić, 1987). Total soil porosity varies in wide range because of the same factors that have influence on bulk density.

Water permeability presents one of the primary hydrological characteristic of soil. When all soil pores are saturated and filled with water, water starts to filter through soil horizons. Water permeability is highly dependent on other soil properties (porosity, mechanical composition, structure, compaction, soil moisture etc.), as well as on properties of water which appear on soil surface through precipitation or irrigation. Water permeability is defined by K- Darcy’s coefficient which represents the rate of water filtration, and it is expressed in cm/sec, m/h, and m/day. Stable values of water filtration are developed after 4-5 hours and they are used in different calculations (Vučić, 1987).

Materials and methods

Soil sampling was conducted on territory of Autonomous Province of Vojvodina from June to July 2015. Samples were collected from 61 localities which represent the most frequent soil types of this area. The network of squares sized 4 x 4 km was set over a soil map of Vojvodina R 1:50 000 (Nejgebauer et al., 1971), so that each soil sample represents an area of 1 600 hectare. GPS coordinates of all localities are marked on the digitized soil map of Vojvodina R 1:50 000 (Benka and Salvai, 2005). Undisturbed soil samples were taken with Kopetzky cylinders and undisturbed soil samples were taken in cardboard boxes from surface horizons of each locality. Laboratory analyses were conducted at the Laboratory of Pedology, Faculty of Agriculture in Novi Sad.

The following properties of selected soil samples were analysed:

- Bulk density (S_m) of soil was determined by method with cylinders in 3 repetitions (three cylinders) and classified according to Katzinski (1965).

- Total porosity (UP) was calculated by formula from bulk density and specific weight of soil and classified according to Miljković (1996).

-The rate of water filtration (K-Darcy coefficient) through the soil sample (Kopetzky cylinders in 3 repetitions) was determined by the method of constant water pressure of water column and soil classification was done according to the Yugoslavian Society for Soil Science (1971).

Statistical analyses of the data on bulk density, total porosity, land use and soil type were processed in software program STATISTICA 7, StatSoft, Inc. The significance of effect of land use and soil types on bulk density and total porosity was determinate using ANOVA. „LSD Fisher“ test was used to separate values at the $p < 0.05$ level of significance. Arithmetic means, maximum and minimum were calculated for the water permeability results.

Results and discussion

Undisturbed and disturbed soil samples collected for laboratory analyses represent 6 different types of soil on the territory of Autonomous Province of Vojvodina. The most widespread type of soil is chernozem which occupies 41%, followed by fluvisol occupying 19 %, humoglay 15 %, eutric cambisol and arenosol 10 %, and finally vertisol 5 %.

The tested localities have three types of land use and mainly consist arable land 62 %, followed by forests 21%, and meadows 17%.

Table 1. Average values of bulk density and total porosity according to land use

Land use	Bulk density (g/cm ³)	Total porosity (vol. %)
<i>Meadow</i>	1,25	47,24
<i>Forest</i>	1,35	45,05
<i>Arable land</i>	1,45	41,09

By analysing the bulk density in collected soil samples, the results showed that the highest average value had arable land 1,45 g/cm³, followed by forest 1,35 g/cm³, and the lowest value had meadow 1,25 g/cm³ (Table 1.). According to average values of bulk density, soils under meadows and forests can be classified as slightly compacted, while arable lands belong to class of more compacted soils. Bošnjak et al. (1997) point out that in natural conditions, soil compaction can be caused due to deficiency of organic matter and pressure of upper layers of soil. Ćirić et al. (2008) as main reasons for soil compaction consider untimely and excessive tillage during high moisture content in soil, constant tillage on the same depth, pulverisation of structural aggregates and numerous walkthroughs of agricultural mechanization.

Analysis of variance (ANOVA) of data on bulk density and soil type showed that there is no significant effect of soil type on bulk density. On the other hand, the effect of land use differs between soils under meadows and forests and arable lands (Graph 1.). Arable lands have greater effect than soils under meadows and forests, because of different agricultural and amelioration measures applied by man.

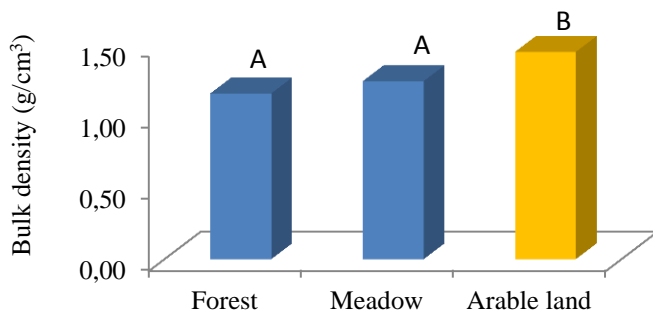

Graph 1. Effect of land use on bulk density (Different letters show significantly different means of bulk density between land uses calculated by Fisher's LSD test ($p < 0.05$))

Average values of total porosity in examined samples varied from 47,24 to 41,09 vol.% (Table 5.). Arable lands have the lowest average value of total porosity which is 41,09 vol.% and therefore belong to class of soils with low porosity. According to Vučić (1992), low total porosity decreases aeration and water permeability of soil. Regarding average values of total porosity, soils under meadows (47,24 vol.%) and forests (45,05 vol.%) can be classified as porous soils. Thanks to activity of root system of forest and meadow plant communities and pedofauna, soils with good porosity and looseness occur in natural condition. (Živković and Đorđević, 2003). The data on soil type, land use and total porosity were also analysed by ANOVA. "LSD Fisher" test separated significant values of total porosity in relation to land use and soil type (Graph 2.). The results of this test show no significant effect of chernozem, vertisol, eutric cambisol and arenosol on total porosity.

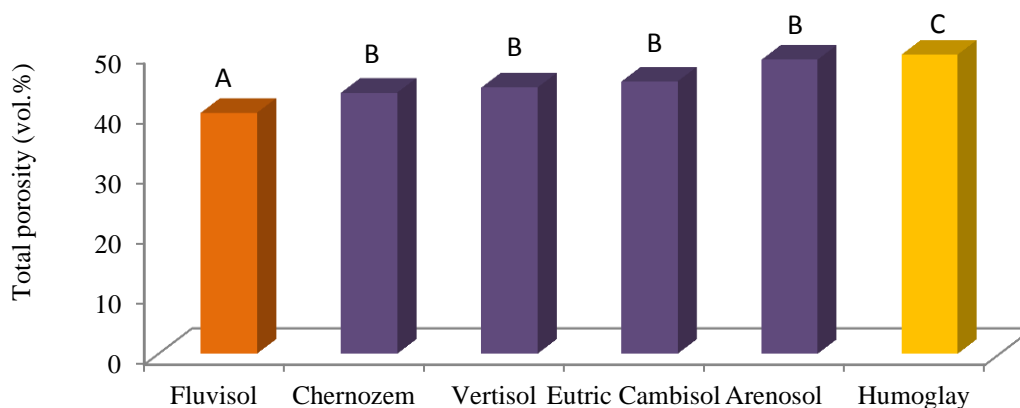

Graph 2. Effect of soil type on total porosity (Different letters show significantly different means of total porosity between soil types calculated by Fisher's LSD test ($p < 0.05$))

However, fluvisol and humoglay are an exception, because these types of soil have an effect on the total porosity. The same statistical test is also used for the data on land use and total porosity and the results indicate that every way of land use have high effect on total porosity (Graph 3.).

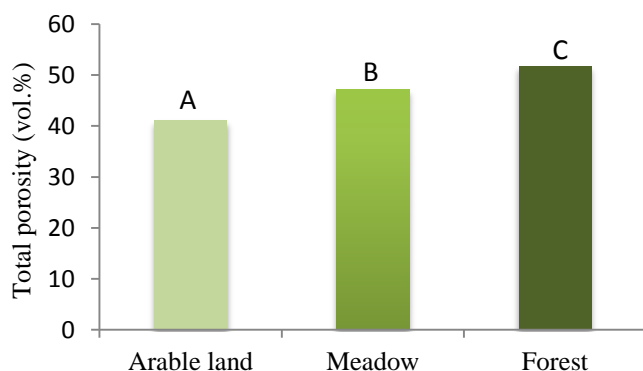

Graph 3. Effect of land use on total porosity (Different letters show significantly different means of total porosity between land uses calculated by Fisher's LSD test ($p < 0.05$))

The rate of water permeability for analysed soil samples varied in the interval of the order of 10^{-5} (minimum) to 10^{-1} cm/sec (maximum) (Table 2.). Average values of K-Darcy's coefficient in tested soil samples are of the order of 10^{-3} cm/sec, which means that chernozem, vertisol, eutric cambisol, fluvisol, and humoglay belong to the class of soils with high water permeability (Belić et al., 2014). However, arenosol presents the only exception because it has average value of K-Darcy's coefficient in the interval of the order 10^{-1} cm/s and it is classified as soil with very high water permeability.

Table 2. Average values, maximums and minimums of K-Darcy's coefficient according to land use

Land use	K- Darcy's coefficient (cm/s)		
	Average value	Minimum	Maximum
Meadow	1.27×10^{-2}	8.75×10^{-5}	1.00×10^{-1}
Arable land	2.98×10^{-3}	1.10×10^{-5}	8.92×10^{-3}
Forest	2.59×10^{-2}	1.25×10^{-4}	1.00×10^{-1}
All samples	9.45×10^{-3}	1.10×10^{-5}	1.00×10^{-1}

When it comes to land use, it has been concluded that arable agricultural soils have lower water permeability compared to soils of forests and meadows. Hadžić et al. (1999) indicate that in certain circumstance, conventional tillage activates processes that can lead to degradation of soil characteristics, and thus to a deterioration of water, air, thermal, biological and food regime. During the production process in intensive agriculture, water-physical properties of ploughing horizon (0-30 cm) are deteriorating due to the mineralization of organic matter and soil compaction (Nešić, 1991).

Conclusion

Based on research results of analysed disturbed and undisturbed soil samples, collected from 61 localities on territory of Autonomous Province of Vojvodina, from 6 different types of soil, the following conclusions stands out:

Average values of bulk density in examined samples range in the interval of $1,25 \text{ g/cm}^3$ to $1,45 \text{ g/cm}^3$, which means that analysed soils belong to classes of slightly and more compacted soils.

Analysis of variance (ANOVA) of data on bulk density, land use and soil type, obtain results which show that there is no significant effect of soil type on bulk density, however bulk density is significantly affected by land use, especially by arable lands.

According to average values of total porosity in examined samples which varied from 47,24 to 41,09 vol.%, it can be concluded that the analysed soils belong to class of porous soils.

The data on soil type, land use and total porosity were also analysed by ANOVA. "LSD Fisher" test separated significant values of total porosity and the results of this test show no significant effect of chernozem, vertisol, eutric cambisol and arenosol on total porosity. However, fluvisol and humogley are an exception, because the results of test show that these types of soil have an effect on total porosity. When it comes to data on land use and total porosity, the obtained results indicate that land use have high effect on total porosity.

Average value of K-Darcy's coefficient in tested soil samples is in the interval of the order of 10^{-3} cm/sec, which means that chernozem, vertisol, eutric cambisol, fluvisol, and humogley belong to the class of soils with high water permeability (Belić et al., 2014). The only exception presents arenosol, which has average value of K-Darcy's coefficient in the interval of the order 10^{-1} cm/s, and therefore this soil can be classified as soil with very high water permeability.

Overall research results indicated that land use has great influence on water-physical properties of soil. Arable agricultural soils have high values of bulk density, low porosity and water permeability because of incorrect tillage and numerous walkthroughs of agricultural mechanization. During the production process in intensive agriculture, water-physical properties of ploughing horizon are deteriorating as a result of great anthropogenic influence and negative changes of these properties are usually observed in arable soil.

Acknowledgments

Part of this study was conducted as part of the Project No. TR 31072: "Status, trends and possibilities to increase the fertility of agricultural land in the Vojvodina Province", which is supported by the Ministry of Education, Science and Technological Development of Republic of Serbia

References

- Belić M., Nešić Lj., Ćirić V. (2014): Praktikum iz pedologije (Practicum for pedology), Poljoprivredni fakultet, Novi Sad
- Benka P., Salvai A. (2005): Digitalizacija pedološke karte Vojvodine za potrebe GIS-a, Melioracije u održivoj poljoprivredi (Digitalisation of soil map of Vojvodina for GIS, Soil ameliorations in sustainable agriculture), Novi Sad: Poljoprivredni fakultet, Departman za uređenje voda, Novi Sad, p. 53-59, ISBN 86-7520-057-9, UDK: 626.8:631.95
- Birkas M. (2008): Environmentalny-sound adaptable tillage, Akademia Kaido, Budapest, Hungary
- Ćirić V., Nešić Lj., Belić M., Savin L., Simikić M. (2012): Stanje sabijenosti černozema u proizvodnji kukuruza (The state of compaction of chernozem in maize production), časopis Savremena poljoprivredna tehnika, vol.38, No 1, 1-70, UDK:621.979:633.31, p. 21-30
- Dugalić G., Gajić B. (2012): Pedologija (Pedology), Univerzitet u Kragujevcu, Agronomskifakultet u Čačku
- Hadžić V., Marinković B., Nešić Lj., Belić M. (1999): Problemi sabijanja zemljišta (The problems of soil compaction), poglavlje u monografiji, Sabijanje zemljišta, Institut za poljoprivrednu tehniku i Naučni institut za ratarstvo i povrtarstvo, Novi Sad, p. 1-18

- Jugoslovensko društvo za proučavanje zemljišta (1971): Priručnik za ispitivanje zemljišta, Knjiga V, Metode istraživanja fizičkih svojstava zemljišta (Handbook for soil examination, Book V, The methods for analyses of physical soil properties), Beograd, p. 60-82.
- Ličina V., Nešić Lj., Belić M., Hadžić V., Sekulić P., Vasin J., Ninkov J. (2011): The Soils of Serbia and their degradation, Ratar. Povrt. / Field Veg. Crop Res. 48 (2011), p. 285-290
- Miljković N. (1996): Osnovi pedologije (Basic principles of Pedology), Prirodno-matematički fakultet- Institut za geografiju, Novi Sad
- Nešić Lj. (1991): Promene fizičkih i hemijskih svojstava zemljišta i hranljivog supstrata u stakleniku, Magistarska teza (The changes of physical and chemical soil properties and nutritious substratum in glasshouse, Magister's thesis), Poljoprivredni fakultet, Novi Sad
- Nešić Lj., Vasin J., Belić M., Ćirić V., Gligorijević J., Milunović K., Sekulić P.(2015): Koloidna frakcija i kapacitet adsorpcije katjona u nekim zemljištima Vojvodine (The colloid fraction and cation exchange capacity in soils of Vojvodina), Ratarstvo i povrtarstvo 2015, vol. 52, br. 1, doi:10.5937/ratpov52-7720 , p. 18-23
- Nejgebauer V., Živković B., Tanasijević Đ., Miljković N. (1971): Pedološka karta Vojvodine R 1 : 50 000 (Soil map of Vojvodina R 1 : 50 000), Institut za poljoprivredna istraživanja, Novi Sad.
- Škorić A., Filipovski G., Ćirić M. (1985): Klasifikacija zemljišta Jugoslavije (Soil classification of Yugoslavia), Akademija nauka i umetnosti Bosne i Hercegovine, knjiga 13, Sarajevo, p. 38-46.
- Vučić N. (1992): Higijena zemljišta (Soil hygiene), Vojvođanska akademija nauka i umetnosti, Novi Sad
- Vučić N. (1987): Vodni, vazdušni i toplotni režim zemljišta, (Water, air and thermal regime of soil) Vojvođanska akademija nauka i umetnosti, Novi Sad
- Živković M., Đorđević A. (2003): Pedologija (Pedology), Poljoprivredni fakultet univerziteta u Beogradu, Beograd

THE POSSIBILITY OF USING BURLEY TOBACCO STALKS AS A BIOFUEL

Maja MALNAR^{1*}, Vesna RADOJIČIĆ¹, Gordana KULIĆ¹, Nemanja MANDIĆ¹, Savo SKOČIĆ²

¹University of Belgrade, Faculty of Agriculture, Nemanjina 6, 11080 Belgrade-Zemun, Serbia

²Jugoispekt, Laboratory testing of solid mineral fuels and mineral resources, Belgrade, Serbia

*Corresponding author: mmaja@outlook.com

Abstract

The reduction of world's fossil fuel reserves, as well as concern environmental pollution, encourages the use of renewable energy sources. In the Republic of Serbia, biomass from agriculture represents a significant energy potential. The aim of this paper was to examine the possibility of using tobacco stalks as biofuels, considering that each year, after the harvest of leaves, about 70 000 tons of stalks from all tobacco types remains in the fields. The material used in this study were Burley tobacco stalks, sawdust from beech wood and wheat straw, which were chosen due to the fact that they are already in use as biofuel. In the first part of the experiment the ash content in all samples was determined, which is used to predict the higher heating value (HHV). The HHV as a function of ash content (ash, wt %) was calculated using the equation by Sheng and Azevedo. The experimental determination of the calorific value of all samples in a calorimetric bomb was conducted in the second part of the study. Based on predicted (18208.18 kJ/kg) and experimentally determined HHV of tobacco stalks (17504.44 kJ/kg), as well as comparisons with other forms of biomass, it was concluded that Burley tobacco stalks can be used as biofuel. Experimental values of tobacco stalks are only 9% lower in relation to HHV of beech sawdust. Tobacco stalks and wheat straw have the approximate values of HHV.

Keywords: *burley, tobacco stalks, ash, higher heating value (HHV), biofuel*

Introduction

Energy, as life's base, affects the living standard and technological progress of each country. However, excessive use of conventional forms of energy, primarily fossil fuel has led to many problems; this practice has polluted the planet and minimized fuel reserves. Owing to the decrease of fossil fuel reserves, substantial use of renewable sources of energy has a large, primarily the economic and ecological impact (Demirel, 2012). Renewable energy sources (biomass, geothermal and solar energy, hydropower and wind power) participate with approximately 14% of total world energy consumption; biomass makes up 62% of that amount (Nakomcic-Smaragdakis et al., 2016).

In the Republic of Serbia, agriculture engages about 10% of the population, while its share in GDP makes almost 11%. At the same time, the increase in agricultural production increases waste products and pollutes the environment. Serbia produces about 12.5 million tons of biomass annually; of these more than 1.7 million tons are the byproduct of agriculture. This biomass usually ends up burned or plowed in the field, which increases the ecosystem pollution and causes significant loss of resources (Jovanović et al., 2009). It is important to note that the CEI recommends that by 2020 use of biomass from wood must be reduced and substituted with the biomass from agriculture (CEI, 2013).

According to data from the National Statistical Office of the Republic of Serbia, the main agricultural product in Serbia, wheat, was cultivated on 589922 ha in 2015. On average wheat yielded 4.1 t/ha, which made more than 2.4 million tons. In 2015, tobacco were cultivated on 5012 ha; with an average yield of 1.8t/ha, so total production of tobacco in Serbia amounted to 8700 tons (Statistical Yearbook of the Republic of Serbia, 2015).

Tobacco leaves are indispensable in cigarette production, but the tobacco stalks are considered to be a biodegradable waste. The Waste Catalogue (2010) issued by the Ministry of Environment and Spatial Planning and the Environmental Protection Agency of the Republic of Serbia classify them as non-toxic waste. It should be noticed that tobacco stalks yield about 22 000 stalks/ha, and solely in 2015 the total number was greater than 115 million stalks, they represent a significant possible resource. So far, these stalks had no monetary value. However, in recent years, researchers have intensively studied the chemical composition of tobacco stalks and concluded that they are suitable for the production of numerous commodities like paper, cardboard, textiles, cotton, flax, other plant fibers, pesticides, and organic fertilizers (Chaturvedi et al, 2008; Kapadiya et al., 2010; Martin et al.,2008; Shakhes et al., 2011). Depending on the chemical composition of tobacco stalks, they could be utilized in briquettes or heating pellets production. These preliminary results are very noteworthy since useful energy is obtained and waste products decreased simultaneously (Kulić et al. 2011; Malnar et al., 2014; Radojičić et al., 2014; Radojičić et al., 2014).

The higher heating value indicates whether a substance can be used as a fuel. It is established experimentally or mathematically. Experimental assessment of HHV requires particular equipment, but mathematical caloric value computation needs only the biomass chemical composition data, which are easily achieved with the available laboratory equipment. Many researchers have studied the biofuel higher heating value based on the fundamental chemical structure (Demirbas, 1997; Sheng and Azevedo, 2005; Yin, 2011). Comparing with other formulas the formula which links the ash content and HHV ($HHV = 19.914 - 0.2324 \cdot \text{Ash}$), proposed by Sheng and Azevedo (2005), provides the highest reliability. It is typically used in practice to predict the biomass HHV; therefore, we applied it in this study.

This study investigate the possibility of using tobacco stalks as biofuels , and how they compare to other sources of biomass. We underline that, unlike other biomass sources, Burley tobacco stalks are dried along with leaves, so they do not prescribe an additional investment of energy for drying raw materials. Predicting tobacco stems HHV made the basis for the cost-effectiveness study of biofuels in Serbia, largely as a heat source for Virginia type tobacco drying.

Materials and methods

In this study, we used briquettes made of Burley tobacco stalks, beech wood sawdust, and wheat straw. Compressing reduced the volume of biomass about 10 times; the produced briquettes were easily transported, stored and incinerated. Since beach wood chips are the most commonly used base for briquettes, we chose them for this study. Wheat straw is selected because wheat is one of the major agricultural products in the Republic of Serbia and it is already used as biofuel. All raw materials are from the same agricultural area in Serbia (Sabac region). The tobacco stalks were taken from the tobacco production company after the drying and after removing the tobacco leaves. This experiment was significant because the briquettes are made without using any binding materials. Briquettes are made on the machine Comafer Dinamic, Italy.

For the experimental determination of ash content and calorific value of the samples, briquettes were milled (Mill Fritsch, Germany) and homogenized. The samples were sifted in a vibrating sieve and the particles 0.5-1mm in diameter were isolated and subsequently analyzed. Moisture

content was given in a standardized method (EN 14774-2, Solid biofuels. Determination of moisture content. Oven dry method. Total moisture. Simplified method) in the oven, Binder FD 240, Germany. Ash content is determined by ignition at 550°C in a furnace, Nabertherm Controller C6, Germany (EN 14775 Solid biofuels. Determination of ash content).

Based on the moisture content, the results were given relative to the sample's dry matter. Ash content was utilized to predict the higher heating value (HHV) of the test material. The calculation was used with the Sheng and Azevedo (2005) equation:

$$\text{HHV} = 19.914 - 0.2324 \cdot \text{Ash} \quad (1)$$

To determine the experimental values of thermal power, briquettes were burned in an oxygen bomb calorimeter - Calorimeter, IKA C5000, Germany (EN 14918, Solid biofuels. Determination of calorific value). Experimental values were then compared with the values predicted by ash content.

All analyses were repeated five times. However, to simplify we showed only the mean values.

Results and discussion

Table 1 represents the results of this study.

Table 1. Content of moisture, ash and HHV of samples

Sample	Tobacco stalks	Beech wood sawdust	Wheat straw
Moisture content (%)	9.96	7.72	8.24
Ash content (%)	7.34	0.60	8.06
Prediction of HHV (kJ/kg)	18208.18	19774.56	18040.86
Qg (kJ/kg)	15761.00	17612.00	16063.00
HHVexp (kJ/kg)	17504.44	19085.39	17505.45

The moisture content in the tested samples ranged from 7.72% to 9.96%. The higher moisture content of the samples would represent the problem since it would be necessary to consume energy for drying them. Also, the higher moisture content would cause a lower calorific value of samples, and would affect the quality of combustion.

The content of mineral substances in most plants is about 3%. Combustion of mineral substances creates an ash, which accumulates in the oven. Compared to fossil fuels, biomass produces a very small amount of ash during combustion. Also, the ash content is negatively correlated with the high heating value of the fuel; it is considered that an increase of 1% of ash reduces the calorific value by 200 KJ / kg (Monti, 2008). The data in Table 1 show that sawdust has the lowest and wheat straw has the highest ash content. The tobacco stalks briquettes have 7.34% ash content; this data match the data from other literature (Radojičić, 2011). The results is true for wheat straw briquettes which have 8.06% of ash (Brkić et al., 2007).

Based on the ash content we predicted the HHV values of the samples. According to the literature, the calorific value of biomass from agricultural production is between 13000 and 18000 kJ/kg (Brkić et al, 2007). The calorific value of wheat straw, reduced to the dry weight, is about 15800 kJ/kg; sawdust has a caloric value of 18600 kJ/kg, and tobacco stalks about 18000 kJ/kg (www.agroinfotel.net). Predicted HHV values of the samples based on ash content were slightly higher than in the literature. The wheat straw HHV was 14.3% and sawdust HHV 6.3% higher than the values reported in the literature (Malnar et al., 2014), while the tobacco stalks HHV was almost the same. Differences in HHV were the result of the different chemical

composition of samples, which depend on the production area agro-ecological characteristics from which they are taken.

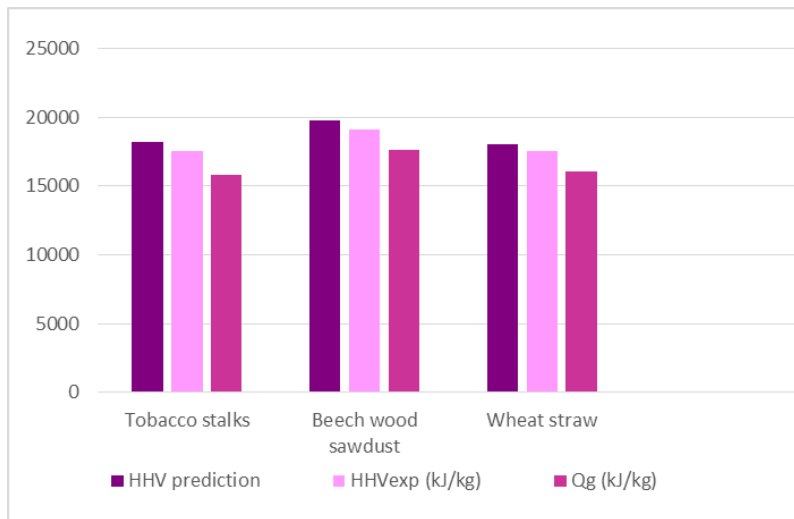

Figure 1. High heating value of the samples

Experimentally, in the calorific bomb, the results of the samples thermal power (Q_g) were obtained (Q_g) in deliverable state (with certain moisture content). Experimental data show that biomass has about 10% lower Q_g value than the chip (Table 1, Figure 1). The comparison of only the biomass from agricultural production, tobacco stems have about 2% lower calorific value than the wheat straw. This result was expected because tobacco stalks had a slightly higher moisture content. Since the heating value of tobacco stalks does not deviate significantly from the heating value of the wheat straw, already used as a biofuel, it can be concluded that the tobacco stems can be used for the same purposes.

To simplify the comparison, the calorific value of samples (Q_g) were calculated relative to the dry matter of the sample (HHV exp in Table 1). HHV values obtained experimentally are, on average lower about 3.86% for tobacco stems, 3.49% for sawdust, and 2.97% for wheat straw compared to the predicted HHV values. From the low deviation of the theoretical from the experimental HHV values, it can be concluded that the formula which connects the HHV with the ash content has high reliability, which confirms results from the literature (Sheng and Azevedo, 2005). The paramount importance has the fact that the experimental tobacco stalks HHV value is only 9% lower than the sawdust HHV. Between tobacco stalk HHV and wheat straw HHV has no significant difference.

The results of this study, HHV values determined experimentally and predicted from the ash content, confirm that it is possible to use tobacco stalks as biofuel. This will increase their economic value while reducing environmental pollution caused by their inadequate disposal or destruction in fields with fire. As a benefit, it opens the possibility of reduced investments in fuels (gas, oil fuel, electricity) for drying other types of tobacco, especially tobacco Virginia type.

Conclusion

The aim of this study was to determine the possibility to utilize Burley tobacco stalks as a biofuel, through determining HHV, and comparing it with other forms of biomass already used in Serbia.

Research has shown that Burley tobacco stalks have a low moisture content, which means that no additional energy is necessary for their drying and that certainly increases their energy efficiency. It was experimentally proved that the Burley tobacco stalks have a high HHV (17504.44 kJ / kg), which does not deviate from the wheat straw HHV, and is only 9% lower than the sawdust HHV. The high calorific value of tobacco stalks, in combination with other parameters, shows that they constitute a suitable raw material for the production of energy briquettes. Briquetting is a way to create a significant energy product from monetary insignificant tobacco stalks and solve uncontrolled waste disposal at the same time.

The fact that the tobacco stalks could be used for the production of briquettes founded the way for new research of their profitability as a drying agent for other types of tobacco, primarily the Virginia tobacco.

References

- Brkić, M., Janić, T., Tešić, M., Timofej, F., Martinov, M.: Potential and opportunities for briquetting and pelleting of biomass in the province of Vojvodina, University of Novi Sad, Faculty of Agriculture, Novi Sad, 2007. [in Serbian]
- CEI - Central European Initiative. A country-based consultation for the growth of local economies by producing advanced bio-fuels and by rural innovation, Stakeholders' Meeting – The Republic Serbia, Belgrade 28th May, 2013
- Chaturvedi, S., Upreti, D.K., Tandon, D.K., Sharma, A., Dixit, A. (2008). Bio-waste from tobacco industry as tailored organic fertilizer for improving yields and nutritional values of tomato crop. *Journal of Environmental Biology* 29, 759-763.
- Demirbas A. Calculation of higher heating values of biomass fuels. *Fuel* 1997; 76(5): 431–434.
- Demirel Y. Energy. Production, Conversion, Storage, Conservation and Coupling, University of Nebraska, Lincoln, USA 2012; Chapter 2, pp 27-28.
- Jovanović, B., Parović, M., State and development of biomass in Serbia, Jefferson Institute, Belgrade, 2009
- Kapadiya, S., Shilpkar, P., Shah, M.: Biogas Potential of Tobacco (*Nicotiana Tabacum*) Stem Waste. (2010). *Journal Advances Developmental Research* 1(1), 53-58.
- Kulić, G., Radojičić, V. (2011). Analysis of cellulose content in stalks and leaves of large leaf tobacco. *Journal of Agricultural Sciences*, 56 (3), 207-215.
- Malnar, M., Radojičić, V., Ećim-Djurić, O. (2014). Energy and environmental aspects of tobacco stalks combustion, 45th International Congress & Exhibition on Heating, Refrigeration and Air Conditioning, Belgrade, Proceedings, CD version, ISBN 978-86-81505-75-5, 5 pages.
- Martín, S., Fernández, T., García, A., Carrillo, E., Thomsen, A.B. (2008). Wet oxidation pretreatment of tobacco stalks and orange waste for bioethanol production. Preliminary results. *Cellulose Chem. Technol.* 42 (7-8), 429-434.
- Monti A., Di Virgilio N., Venturi G. (2008). Mineral composition and ash content of six major energy crops, *Biomass and Bioenergy* 32, 216-223
- Nakomcic-Smaragdakis B., Cepic Z., Dragutinovic N. (2016). Analysis of solid biomass energy potential in Autonomous Province of Vojvodina, *Renewable and Sustainable Energy Reviews*, Volume 57, Pages 186–191
- Radojičić, V. (2011). Quality control of tobacco. Practicum of tobacco processing technology. University of Belgrade, Faculty of Agriculture, Belgrade. [in Serbian]
- Radojičić, V., Ećim-Djurić, O., Srbinoska, M., Djulančić, N., Kulić, G. (2014). Possibilities of virginia tobacco stalks utilization, *Tütün/ Tobacco*, 64 (7-12), 71-76.

- Radojičić, V., Ećim-Đurić, O., Djulančić, N., Srbinska, M., Kulić, G. (2014). The Possibility of Using Burley Tobacco Stalks as Biomass, XXII International Scientific and Professional Meeting "Ecological Truth", Bor, Serbia, Proceedings, 284-290.
- Shakhes, J., Marandi, M.A.B., Zeinaly, F., Saraian, A., Saghafi, T. (2011). Tobacco residues as promising lignocellulosic materials for pulp and paper industry. *BioResources* 9 (4), 4481-4493.
- Sheng, C., Azevedo, J.L.T. (2005). Estimating higher heating values of biomass fuels from basic analysis data. *Biomass and Bioenergy*, 28 (5), 499-507.
- Statistical Yearbook of the Republic of Serbia, Statistical Office of the Republic of Serbia 2015. [in Serbian]
- Yin CY. Prediction of higher heating values of biomass from proximate and ultimate analyses. *Fuel* 2011; 90 (3):1128–1132.
- Waste Catalogue (in Serbian), Ministry of Environment and Spatial Planning and the Agency for Environmental Protection of the Republic of Serbia, 2010

EFFECT OF WATER HOLDING POLYMERS AND WATER RESTRICTION ON GROWTH OF TOMATO CULTIVATED IN DIFFERENT SOILLESS CULTURES

Hakan BAŞAK^{1*}, Emre ŞAHİN¹, Sultan KIYMAZ²

¹Department of Horticulture, Faculty of Agriculture, Ahi Evran University, Kırşehir, Turkey

²Departments of Biosystems Engineering, Faculty of Agriculture, Ahi Evran University, Kırşehir, Turkey

* Corresponding autor: hbasak@ahievran.edu.tr

Abstract

This study was conducted to determine the effects of water holding polymers and water restriction on growth parameters of tomato (*Lycopersicon esculentum* Mill.) cultivated by different soilless culture techniques. The experiment was designed as a randomized plot in factorial designs (2x3x3) with three replication. Two soilless cultures (perlite and cocopeat), three levels of water holding polymers (0, 2, 4 g gel per pot) and three levels of irrigations based on the percentage of drainage (I1: the amount of water given until 30% of the water becomes drainage, I2: 75% of I1, I3: 50% of I1 applications were examined as the pot experiment in the greenhouse. Plant height, stem diameter, number of leaves, early yield, fresh and dry weight of stem and root were measured at the end of day of trial. The results revealed that; (1) there were no phytotoxic effects of water holding polymers on the growth and development of the tomatoes, (2) water holding polymers improved the general growth status of tomatoes, and (3) the best tomato growth was obtained by treatment of 4 g water holding polymers + I2 water application in cocopeat soilless culture. In conclusion, water holding polymer application provided minimum water saving of 25%.

Key Words: *Water holding polymers, water restriction, soilless culture, tomato*

Introduction

Water is the most significant life source for all living creatures. Seventy percent of the water consumed is used for agricultural purposes, which is followed by industry and domestic use with 19% and 11%, respectively (FAO, 2013). In Turkey, 72% of the water consumption is used in the agricultural sector. The lower the country's development level, the higher its agricultural water consumption rate, which may reach 82% (WWAP, 2003). According to a report by the United Nations, agricultural production is estimated to increase by 67% in developing countries between 2000 and 2030. It is further projected that the available water potential cannot cover this increase, and that it can only be covered if the agricultural water demand is maintained at 14% by increasing yield in agriculture. Hence the agricultural sector will need to produce more agricultural product with less (WWAP, 2006). Today, water resources are decreasing due to environmental effects and improper practices of humankind, and the current water resources are becoming inadequate to cover the needs. Hence it is significant to develop strategies to reduce the amount of water used in agriculture. Gels, also known as water retaining polymers, ensure water that enters the soil as a result of natural precipitations and irrigation to be retained in the roots zone of plants for an extended period of time. Water retaining polymers increase water retaining capacity of the soil and reduce erosion risk as they boost water permeability of soil (Zhang and Miller, 1996; Lentz and Sojka, 1994; Hickman and Whitney, 1998; Johnson, 1984). As is the case with vegetable species, in the production of other

products that cannot be grown without water, the soil's capacity to retain water and nutrients can be increased with water retaining polymers in order to avoid the negative effects of inadequate water and drought (Sevimay *et al.*, 1994). Furthermore, use of gel in agriculture reduces irrigation and fertilization costs, as it ensures water and fertilizers to be used more efficiently. Even if the most significant advantage of soilless agriculture is its ability to avoid soil borne problems, the method brings several other advantages, as well. The soilless agriculture technique ensures plants to be nourished in a more controlled manner, reduces the workforce, and makes agriculture practical for industrial agriculture. It further optimizes fertilizer and water use, increases yield, avoids weeds, and makes it possible to perform agricultural practices on lands that are not appropriate for growing plants (Resh, 1991; Gül, 2008). Solid medium (substrate) culture is preferred to hydroponic culture due to lower installation cost, and it acts like a buffer, thanks to the substrate and provides a medium where the plant can hold on to. The most frequently used substrates in solid medium culture are rock wool, cocopeat, and perlite. As they do not cause any waste material problems and due to their price advantage, cocopeat and perlite have been the most preferred cultures in recent years. Furthermore, Turkey has a significant advantage, as it has half of the perlite reserve in the world. This study was conducted to determine the effect of different irrigation doses and water retaining gel applications on the plant development of tomatoes grown in two different substrates, both frequently used in soilless agriculture.

Material and Methods

This study was conducted in August-October 2015 in the greenhouse used for research purposes belonging to Ahi Evran University, Faculty of Agriculture, Department of Horticulture. Plant material used in the test was indeterminate tomato (*Solanum lycopersicum* cv. Nazal F₁), while two different substrates were used as the growth medium (cocopeat and perlite), and Stockosorb® 400K was used as the water holding polymer. The study covered two different substrates (perlite and cocopeat), three different irrigation levels (I₁: the amount of water given until 30% of the water becomes drainage, I₂: 75% of I₁, I₃: 50% of I₁), and three different water holding polymer levels (0, 2, and 4 g/pot). The study was conducted in three replication, while a factorial test pattern was used in randomized parcels.

The main principle of substrate culture is to avoid salt accumulation in the root zone by allowing a certain amount of nutrition solution to be drained. The amount of drainage is recommended to be 30% during summer and 20% during winter (Gül, 2008; Cantliffe *et al.* 2008; Montesano *et al.* 2010; Jensen, 1997). In this study, the amount of irrigation under I₁ was adjusted daily to ensure that the drained solution was 30% of the total amount of nutrition solution applied.

On August 7, 2015, each plant was planted in a 6 lt plastic pot. The study was conducted with a total of 54 pots in the greenhouse with two substrates, three irrigation dosages, and three gel dosages (2x3x3=18) with three replication. Taking the test subjects into consideration, predefined amounts of water retaining polymers were turned into gels using water and the gels were mixed with substrates and applied to the pots, ensuring they covered the root zones. In order to determine the amount of water to be fed to the pots, control pots with no gel were given water until reaching the 30% drainage rate. This amount was accepted as I₁ irrigation dosage, and 75% (I₂) and 50% (I₃) of this amount were applied to the pots daily within the scope of limited irrigation. The water and nutrition needs of the plants were met using a complete nutrition solution, the content of which is given in Table 1. The amount of the solution to be applied to pots was determined in accordance with the irrigation limits (Hoagland and Arnon, 1950).

Table 1. Concentration of nutrient solution (mg l⁻¹)

Element	N	P	K	Mg	Ca	S	Fe	Mn	B	Cu	Zn	Mo
Concentration (mg/l)	210	31	234	48	200	64	2.5	0.5	0.5	0.02	0.05	0.01

As the plant material used in the study, Nazal F₁, has a indeterminate type growth habit, it was attached to the sling, and the axil shoots were regularly pruned during the test period. Other cultural procedures were conducted in accordance with the principles of Sevçican (2002).

As the greenhouse where the test was conducted had no heating system, the study was finalized on October 9, 2015, during the early harvest season. After finalization of the test, early yield, plant height, diameter of stem, number of leaves, and wet and dry weights of the stem and root were measured in each parcel.

The data were statistically analysed by using Windows Version of SPSS (release 16.00). The significant means were grouped according to Duncan Multiple Range Test (Düzgüneş *et al.*, 1987; Akgül and Çevik, 2005).

Results and Discussion

Plant Height: The greatest plant height average (136.5 cm for perlite and 140.25 cm for cocopeat) was observed in plants in the I₂ irrigation group with 4g of gel. While the lowest height average (95.75 cm for perlite and 122.5 cm for cocopeat) was observed in plants falling under I₃ irrigation with no gel (Table 2). Even if water restriction caused height loss in plants with no gel application, increasing the amount of gel used for plants falling under I₁ irrigation led to no statistically significant change. The heights of plants falling under I₂ (75%) irrigation dosage, which were grown in perlite substrate with an application of 2 g and 4 g of gel, and the heights of the plants grown in the cocopeat substrate with an application of 4 g of gel were determined to be statistically greater compared to the plants falling under I₁ irrigation with gel application. This is deemed to be caused by the fact that gel application increases water and nutrition adherence in the root zone even when the amount of water given is reduced by 25%. All factors and interactions between such factors were determined to have a significant effect on the plant height for both perlite and cocopeat media (P<0.05) (Table 2). Maboko (2006) reported that tomato plant height increased as a result of an increase in the gel-polymer application rate. In their studies on other plants such as coarse bean and triticale, Ekmekçi and Geren (2013) and Geren *et al.* (2011) reported that the coarse bean grew to the greatest height when 6 kg da⁻¹ gel applied with TK-70 irrigation dosage, while triticale required the application of 18 kg da⁻¹ gel with TK-75 irrigation dosage. In the plants subjected to 50% water limitation, plant height loss was observed when the gel dosage was increased. This incident, which was also determined in the studies of Ekmekçi and Geren (2013) and Geren *et al.* (2011), is thought to be caused by the fact that when the amount of gel is increased under limited irrigation conditions, the gel tends to absorb good water with a greater power compared to the roots.

Stem Diameter: Just like the plant height, the greatest figures in terms of diameter of stems (12.06 mm for perlite and 13.09 mm for cocopeat) were observed in plants falling under I₂ irrigation dosage with an application of 4 g of gel. Based on the comparison between the values obtained from the irrigation dosages of I₂ and I₁, the difference was found to less than, especially for perlite. The negative effect of I₃ water limitation on stem diameter was not observed in I₂ dosage due to gel application. The results of the statistical analysis indicated that each individual factor and the interaction between gel dosage and irrigation dosage had an effect on stem diameter; however, other interactions between the factors had no significant effect (Table 2). Maboko (2006) stated that the greatest gel dosage (40 g) had a significant effect on stem diameter compared to the control application, while no other dosage had a significant effect.

Table 2. Effect of water holding polymers and water restriction on growth of tomato cultivated and interactions between parameters

Factors			Parameters							
Substrat	Gel Dose (g pot ⁻¹)	Irrigation Dose (%)	Height (cm)	Stem Diameter (mm)	Early Yield (g)	Leaf Number	Stem Fresh Weight(g)	Stem Dry Weight(g)	Root Fresh Weight(g)	Root Dry Weight(g)
Perlite	0	I ₁	121.00 ^{gh}	10.59 ^{fghi}	521.14 ^{bcdef}	16.00 ^{abc}	603.33 ^{efgh}	107.45 ^b	125.90 ^{def}	11.06 ^{cdef}
	0	I ₂ (75% of I ₁)	115.25 ^h	10.16 ^{hij}	510.26 ^{cdef}	16.00 ^{abc}	536.67 ^{hij}	89.39 ^{cde}	115.41 ^{efg}	8.92 ^g
	0	I ₃ (50% of I ₁)	95.75 ⁱ	9.34 ^j	415.20 ^h	14.00 ^{ef}	424.00 ^k	78.20 ^{ef}	81.64 ^h	6.73 ^h
	2	I ₁	123.00 ^{fg}	11.62 ^{cdef}	577.21 ^{abc}	16.33 ^{ab}	620.00 ^{defg}	112.63 ^{ab}	137.68 ^d	11.38 ^{cde}
	2	I ₂ (75% of I ₁)	132.00 ^{bcde}	11.84 ^{bcde}	604.37 ^a	15.67 ^{abcd}	585.00 ^{fghi}	105.70 ^b	131.34 ^{de}	11.44 ^{cd}
	2	I ₃ (50% of I ₁)	126.50 ^{defg}	10.47 ^{ghi}	428.38 ^{gh}	15.33 ^{abcde}	519.33 ^{ij}	88.59 ^{cde}	109.12 ^g	9.77 ^{defg}
	4	I ₁	125.25 ^{efg}	11.15 ^{cdefgh}	585.13 ^{ab}	15.67 ^{abcd}	633.33 ^{def}	111.88 ^{ab}	132.10 ^{de}	11.18 ^{cdef}
	4	I ₂ (75% of I ₁)	136.5 ^{ab}	12.06 ^{bc}	607.68 ^a	16.00 ^{abc}	656.67 ^{def}	116.98 ^{ab}	141.53 ^d	12.27 ^c
Cocopeat	0	I ₁	132.5 ^{bcd}	11.53 ^{cdefg}	554.18 ^{abcde}	16.33 ^{ab}	696.67 ^{bcd}	105.80 ^b	145.14 ^{cd}	14.83 ^b
	0	I ₂ (75% of I ₁)	126.00 ^{defg}	10.72 ^{efghi}	472.23 ^{fgh}	15.00 ^{bcdef}	665.00 ^{cde}	90.09 ^{cd}	130.69 ^{de}	12.29 ^c
	0	I ₃ (50% of I ₁)	122.5 ^{fg}	9.69 ^{ij}	338.82 ⁱ	13.67 ^f	553.33 ^{ghij}	71.9 ^f	113.62 ^{efg}	9.33 ^{efg}
	2	I ₁	133.00 ^{bcd}	12.76 ^{ab}	572.23 ^{abcd}	16.67 ^a	745.00 ^{ab}	109.09 ^{ab}	174.20 ^{ab}	16.29 ^{ab}
	2	I ₂ (75% of I ₁)	136.00 ^{ab}	11.81 ^{bcde}	601.44 ^a	16.00 ^{abc}	733.33 ^{abc}	109.98 ^{ab}	159.87 ^{bc}	14.59 ^b
	2	I ₃ (50% of I ₁)	133.75 ^{abc}	11.05 ^{cdefgh}	490.00 ^{efg}	14.67 ^{cdef}	620.00 ^{defg}	94.02 ^c	139.13 ^d	11.95 ^c
	4	I ₁	132.25^{bcde}	11.91^{bcd}	562.08^{abcde}	16.67 ^a	781.67^a	111.23^{ab}	180.97^a	17.34^a
	4	I ₂ (75% of I ₁)	140.25 ^a	13.09 ^a	619.39 ^a	16.67 ^a	800.00 ^a	120.61 ^a	189.36 ^a	18.05 ^a
4	I ₃ (50% of I ₁)	128.50 ^{cdef}	10.79 ^{defghi}	465.11 ^{fgh}	14.33 ^{def}	581.67 ^{fghi}	92.13 ^{cd}	135.37 ^d	11.12 ^{cdef}	
Pooled SEM			0,731	0,115	7,522	0,106	5,743	0,868	1,381	0,150
Significance			P Values							
Intereaction of substrat			0.000	0.000	0.427	0.863	0.000	0.427	0.000	0.000
Intereaction of gel dose			0.000	0.000	0.000	0.056	0.000	0.000	0.000	0.000
Intereaction of irrigation dose			0.000	0.000	0.000	0.000	0.000	0.000	0.000	0.000
Intereaction of substrat x gel dose			0.000	0.750	0.206	0.337	0.925	0.265	0.021	0.147
Intereaction of substrat x irrigation dose			0.038	0.504	0.762	0.172	0.513	0.403	0.757	0.002
Intereaction of irrigation dose x gel dose			0.000	0.010	0.059	0.342	0.035	0.000	0.033	0.003
Intereaction of substrat x irrigation dose x gel dose			0.022	0.626	0.062	0.650	0.743	0.529	0.245	0.305

^{a-k}: The differences between the averages shown in different letters p <0.05 is significant.

Number of Leaves: Gel doses were observed to have no significant effect on the number of the leaves for both of the substrates, while irrigation doses were observed to have significant effect. It is a known fact that the stricter the water restriction is, the greater the leaf loss (Karipçin, 2009; Liu *et al.*, 2007). Ekmekçi and Geren (2013) reported that the leaf rate increased when the water dosage was increased from TK-30 to TK-70, while the increase in gel dosage had no effect on leaf rate, except for TK-30 dosage. In this study, the lowest number of leaves was observed in plants subject to 50% water limitation. Only irrigation factor was found to be statistically significant in terms of number of leaves, while the other factors and interactions between them were determined to have no significant effect at all (Table 2).

Early Yield: Based on the yield values, which were determined by weighing all fruits on the plants after completion of the test, the highest early yield was found to be 607.68 g and 619.39 g for perlite and cocopeat substrates, respectively, which were both observed in plants falling under the scope of I₂ irrigation with 4 g of gel application. While the lowest yield was found to be 415.20 g and 338.82 g for perlite and cocopeat substrates, respectively, which were both observed in plants falling under the scope of I₃ irrigation limit with no gel application (Table 2). As it was already argued in our study, several researches reported water restriction to decrease yield (Biber and Kara, 2006; Güneş *et al.*, 2008; Kıymaz and Ertek, 2015). However, our study indicated a significant decrease in yield for plants falling under the scope of I₃ irrigation (50% water restriction) with gel application, while no yield decrease was reported for plants grown with I₂ irrigation limit with gel application. In his study on soy plants, Sivapalan (2001) reported that the increase in gel dosages boosted grain yield and water-use efficiency, and that the greatest values were obtained from 0.07% polymer applications. El-Hadi and Camelia (2004) reported water retaining polymers to increase yield in tomatoes. In this study, irrigation and gel dosages were determined to have significant effects on fruit weights, while the substrate factor and the interaction between the factors were observed to bear no significant effect. For both substrates, fruit weights of the plants grown with 50% water restriction were determined to be significantly lower for all gel dosages compared to the values observed in other water dosages. However, the difference between fruit weights falling under the scope of I₂ irrigation, which was 25% shorter in water compared to I₁, was determined to have no statistically significant difference when 2 g and 4 g of gel was applied.

Stem Fresh Weight: In this study, the greatest value in stem fresh weight was 800 g, which was observed in plants grown in the cocopeat substrate within the scope of I₂ irrigation with 4 g gel application. On the other hand, the lowest stem fresh weight, 424 g, was observed in plants grown in perlite with 50% water restriction (I₃ irrigation) with no gel application. Each individual factor (substrate, gel, and irrigation dosage) and the interaction between gel dosage and irrigation dosage were determined to affect stem fresh weight. No significant effect was determined to be caused by other interactions between the factors (Table 2). In their study, Sayyari and Ghanbari (2012) argued that increasing dosages of superabsorbent polymer (SAP) significantly increased stem fresh weight in pepper plant. However, prolonging irrigation intervals led to significant decreases in stem fresh weights.

Stem Dry Weight: The greatest stem dry weight, 120.61 g, was found in plants grown in the coco peat substrate, with I₂ irrigation and 4 g of gel application. On the other hand, the lowest stem dry weight, 71.9 g, was observed in plants grown in the coco peat substrate, with 50% water limitation (I₃) and no gel application. Stem dry weight was observed to be significantly affected by gel dosage, irrigation dosage, and the interaction between irrigation and gel dosages. The substrate type and interaction between other factors were determined to have no significant effect

(Table 2). Hiroshi *et al.* (1999) reported silica gel application to increase plant height and dry weight in rice plants, compared to control plants.

Root Fresh Weight: The greatest root fresh weight, 189.36 g, was determined in plants grown in the cocopeat substrate with I₂ irrigation and 4 g gel application. The lowest weight, 81.64 g, was observed in plants grown in perlite medium with I₃ irrigation and no gel application. Regardless of the irrigation and gel dosages, the plants grown in the cocopeat medium produced better root development compared to those grown in the perlite medium. The gel application boosted root development in both of the substrates. Each individual factor and the interactions among those factors were found to have a statistically significant effect on root fresh weight, except for the interactions between substrate x irrigation dosage and substrate x gel dosage x irrigation dosage (Table 2). Maboko (2006) reported the root fresh weight to be 39.15 g in tomato plants grown in 20 lt pots with 8 g and 16 g of Stockosorb® 400K application with no gel. The weight grew to 67.30 g and 104.68 g when 8 g and 16 g of gel was applied, respectively. As seen in both studies, increasing the amount of gel increased root fresh weight, as well. Hence, increasing root development also supports the plants in terms of water and nutrition absorption, and effects vegetative development positively. Similarly, Hiroshi *et al.* (1999) reported gel application to stimulate a greater number of new root developments in rice plants.

Root Dry Weight: The greatest root dry weight, 18.05 g, was measured in plants grown in the cocopeat substrate with I₂ irrigation and 4 g of gel application. The lowest weight, 6.73 g, was observed in plants grown in the perlite medium with I₃ irrigation and no gel application. Each individual factor and the interactions between those factors had statistically significant effect on root dry weight, except for the interactions between substrate x gel dosage and substrate x gel dosage x irrigation dosage (Table 2). Maboko (2006) reported that gel application in tomato plants significantly increased root dry weight compared to control plants; however, an increase in gel dosages were reported not to effect root dry weight significantly. Sayyari and Ghanbari (2012) reported similar results as well.

Conclusions

The results of the study indicate that the effects of water holding polymers applied in varying dosages on growth and development parameters analyzed for tomato plants subjected to water restriction varied. Results showed that: (1) there was not any phytotoxic effects of water holding polymers on the growth and development of tomatoes, (2) water holding polymers improved the general growth status of tomatoes, and (3) the best tomato growth was obtained with treatment of 4 g water holding polymers + I₂ water application in coco peat soilless culture. In conclusion, water holding polymer application provided a minimum water savings of 25%. The use of soilless of water holding polymers should be extended under greenhouse conditions due to its advantages such as prevention of environmental pollution, fertilizer and water savings.

Acknowledgement

This work was supported by Ahi Evran University Scientific Research Project Coordination Unit. with ZRT.E2.16.012 project number.

References

- Akgül A., Çevik O. (2005). Statistical analysis techniques management applications in SPSS, Emek Offset, Ankara.
- Biber Ç., Kara, T. (2006). Evapotranspiration and restricted irrigation applications of corn. Journal of Agriculture Faculty of Ondokuz Mayıs University, 21(1): 140-146.

- Cantliffe D.J., Castellanos J.Z., Paranjpe A.V. (2008). Yield and quality of greenhouse grown strawberries as affected by nitrogen level in coco coir and pine bark media. *Proc.Fla.State Hort Soc.* 120:157-161.
- Düzgüneş O., Kesici T., Kavuncu O., Gürbüz F. (1987). Research and experimental methods. Ankara University, Publication of Agricultural Faculty, pp.381.
- Ekmekçi T., Geren H. (2013). Effect of deficed irrigation and gel applications on the herbage yield and some yield characteristics of horse bean (*Vicia faba* var. *minor* L.). *Journal of Agriculture Faculty of Ege University*, 50 (2): 161-169.
- El-Hadi O.A., Camelia Y.E. (2004). The conditioning effect of composts (natural) or/ and acrylamide hydrogels (synthesized) on a sandy calcareous soil. Growth response, nutrients uptake and water and fertilizers use efficiency by tomato plants. *Journal of Applied Science Research*, 2 (12): 1293-1297.
- FAO (2013). <http://www.fao.org/nr/water/aquastat/main/index.stm> Accessed on 10/01/2015.
- Geren H., Simic A., Ekmekçi T. (2011). Effect of different irrigation rates and silica gel application on some agronomical characteristics of triticale (*Triticale* sp.). The 9th Field Crops Congress of Turkey, 12-15 September, Bursa. Vol. 1, pp. 235-238.
- Gül A. (2008). Soilless culture. Hasad Publishing, pp.144, Istanbul.
- Güneş M., Aktaş M. (2008). Effects of potassium application on the growth and yield of young corn plants grown under drought conditions. *Journal of Agriculture Faculty of Harran University*, 12 (2): 33- 36.
- Hickman J.S., Whitrey A.D. (1998). Soil conditioners north central regional extension publication 295. Kansas State University.
- Hiroshi F., Tsuyoshi H., Katsushi Y., Ho A. (1999). Effect of silica application to a nursery bed of rice on rooting ability and early growth of rice plants, *Japanese Journal of Soil Science and Plant Nutrition*, 70 (6): 785-790.
- Hoagland D.R., Arnon D.J. (1950). The Water-Culture Method for Growing Plants without Soil. California Agricultural Experiment Station. 347 (2): 32.
- Jensen M.H. (1997). *Hydroponics*. HortScience, 32 (6): 1018-1021.
- Johnson M.S. (1984). The effects of gel-forming polyacrylamides on moisture storage in sandy soils. *J. Sci. Food Agriculture*, Vol. 35, pp. 1196-1200.
- Karıpçın M.Z. (2009). Determination of Drought Tolerance on Wild and Domestic Watermelon Genotypes. Department of Horticulture Institute of Natural and Applied Sciences University of Çukurova, PhD Thesis, Pages:259, Adana.
- Kıymaz S., Ertek A. (2015). Yield and quality of sugar beet (*Beta vulgaris* L.) at different water and nitrogen levels under the climatic conditions of Kirsehir, Turkey. *Agricultural Water Manegement (AGWAT)*, Vol. 158, pp. 156–165.
- Lentz R.D., Sojka R.E. (1994). Field results using polyacrylamide to manage furrow erosion and infiltration. *Soil Science*, Vol. 158, pp. 274-282.
- Liu F., Savic S., Jensen C.R., Shahnazari A., Jacobsen S.E. Stikic, R., Andersen M.N. (2007). Water relations and yield of lysimeter-grown strawberries under limited irrigation, *Scientia Horticulturae*, Vol. 111, pp. 128–132.
- Maboko M.M. (2006). Growth, yield and quailty of tomatoes (*Lycopersicon esculentum* Mill.) and lettuce (*Lactuca sativa* L.) as affected by gel-polymer soil amendment and irrigation management. Master's Dissertation. Natural and Agric. Sci. University of Pretoria. pp. 105.
- Montesano F., Parente A., Santamaria P. (2010). Closed cycle subirrigation with low concentration nutrient solution can be used for soilless tomato production in saline conditions. *Scientia Horticulturae*, Vol. 124, pp. 338–344.

- Resh H.M. (1991). *Hydroponic Food Production*. 464 pp. California.
- Sayyari M., Ghanbari F. (2012). Effects of super absorbent polymer a200 on the growth, yield and some physiological responses in sweet pepper (*capsicum annum l.*) under various irrigation regimes. *International Journal of Agricultural and Food Research*. Vol. 1, No. 1, pp. 1-11.
- Sevgican A. (2002). *Greenhouse Vegetable Growing (Soilless Culture)*, Vol. 2. Publication of Agricultural Faculty of Ege University, Pages:168, İzmir.
- Sevimay C.S., Kendir H., Sancak C. (1994). Determining Appropriate Method for a Quickly Production with Colan in *Trifolium*. *Journal of Field Crops Research Institute*, Vol. 3, No.3-4, pp. 159-171.
- Sivapalan S. (2001). Effect Of A Polymer On Growth And Yield Of Soybeans (*Glycine Max*) Grown In A Coarse Textured Soil. In *Proceedings Irrigation 2001 Regional Conference*, pages pp. 93-99, Toowoomba, Queensland, Australia.
- WWAP (World Water Assessment Programme) (2003). *Water for people, water for life*. United Nations World Water Development Report 3: Paris/London, UNESCO Publishing/ Earthscan.
- WWAP (World Water Assessment Programme) (2006). *A Shared Responsibility*. World Water Development Report 2: Water: Paris/New York, UNESCO/Berghahn Books.
- Zhang X.C., Miller W.P. (1996). Polyacrylamide effect on infiltration and erosion in furrows. *Soil Sci. Soc. Am. J.* 60:866-872.

THE STABILITY OF STRUCTURAL MICROAGGREGATES AND THE RISK OF THE SOIL CRUSTING IN THE AREA OF THE FLOODED AGRICULTURAL SOILS OF THE REPUBLIC OF SERBIA

Radmila PIVIĆ¹, Zoran DINIĆ^{1*}, Jelena MAKSIMOVIĆ¹, Aleksandar STANOJKOVIĆ²,
Dragana JOŠIĆ¹, Aleksandra STANOJKOVIĆ-SEBIĆ¹

¹Institute of soil science, Teodora Drajzera 7, Belgrade, Serbia

²Institute for Animal Husbandry, Autoput 16, Belgrade - Zemun, Serbia

*Corresponding author: drradmila@pivic.com

Abstract

In 2014, in the area of the flooded agricultural soils of the Republic of Serbia, it was conducted the study on the effect of extreme climatic conditions, especially rainfall, on the structural micro aggregates stability and the risk of crust formation. The agricultural soil samples were taken in a disturbed state from the surface soil layer (0-30 cm) from fifty locations affected by the floods. The degree of the micro aggregates stability was expressed according to Vageler and determined by the ratio between the total content of clay particles in soil samples prepared with sodium pyrophosphate, and the content of such particles in soil suspension prepared with water. The risk of the soil crust formation was determined according to a Van der Watt & Claassen pattern on the basis of the ratio between the content of organic matter, and total content of the clay and silt particles in soil samples. The obtained results showed that the analyzed soil samples had stable to very stable degree of the structural micro aggregates stability and that extreme climatic conditions have not significantly influenced the tested parameter. In the analysed samples the risk of the soil crusting was in limit values in 58% of the samples, than, in high risk values - in 40%, while in one soil sample (2%, respectively) the risk of soil crusting was low.

Keywords: *agricultural soil, floods, structural aggregates stability, soil crusting.*

Introduction

Republic of Serbia in the second half of May 2014 afflicted catastrophic floods, which have left behind a devastated agricultural land. After the withdrawal of the flood, during August and September it was conducted a site visits on sites which was mostly affected by flood wave and collected soil samples in disturbed conditions. On collected soil samples it was conducted testing in order to examine to what extent this natural disaster changed the structural stability of micro aggregates of agricultural soils.

Establishment of crop production after the floods depends on the impact that the floods had on agricultural land. Rehabilitation of soil could last for a long period and require significant involvement of funds.

Land structure is an important factor of fertility of agricultural soil which is gradually formed by the complex physical and chemical processes. The influence of different cropping systems leads to changes in soil structure (Ćiric et al., 2013).

The stability of structural aggregates, according to the Bronicki and Lal, 2005, is considered a key to soil fertility.

Creating structures (Tisdall and Oades 1982, Oades and Waters, 1991) is a very complex process which depends on the interaction between soil types, cement agents, soil management and environmental conditions. Soil structure is very dynamic dimension, especially in the upper

horizon which changes under the influence of climatic factors, crops and processing (Vučić, 1964). Favorable soil structure is necessary to preserve and unfavorable to improve (Belić et al., 2004). According to the Amezket, 1999, the stability of structural aggregates is very hard to explain and quantify because it is a characteristic of soil that affects the sustainability of soil and plant production.

From the agronomical aspect, the most significant are structural aggregates from 1 to 10 mm (Edwards, 1991; Amezket, 1999). The most significant properties for the evaluation of soil structure are the content of macro-aggregates, their mechanical strength and water stability, as well as porosity (Sorochkin, 1991). Soil structure is a dynamic value that depends on the soil properties, climate and tillage conditions (Angers, 1998). The factors affecting soil structure and aggregate composition are tillage, irrigation and climate (Guerif et al., 2001). Soil aggregate stability declines rapidly as the consequence of cropping, and the diameter of dry aggregates increases (Kandelero and Murer, 1993; Shepherd et al., 2001).

The data obtained by determining the stability of micro aggregates contribute in defining clearer and more complete overview of the soil structure. In soils with less stable micro aggregates it is reduced the share of stable macro aggregates (Belić et al., 2004). Based on the stability of the micro aggregates it can be predicted the risk of erosion (Igwe and Obalum, 2013). Micro aggregates are mainly formed by coagulation of colloids or colloids and opposite-charged ions, and also can be formed by fragmentation of macro aggregates.

Material and

Area of study included a total of 23 municipalities in Serbia affected by floods in May 2014, as follows: Obrenovac, Šabac, Loznica, Ub, Vladimirci, Valjevo, Surčin, Ljig, Barajevo, Bogatić, Lajkovac, Lazarevac, Koceljeva, Krupanj, Smederevska Palanka, Jagodina, Trstenik, Paraćin, Kraljevo, Čačak, Kruševac, Velika Plana and Kosjerić.

Figure 1. presents the locations of sampling of soil samples in disturbed condition for the purpose of assessing the structural stability of micro aggregates.

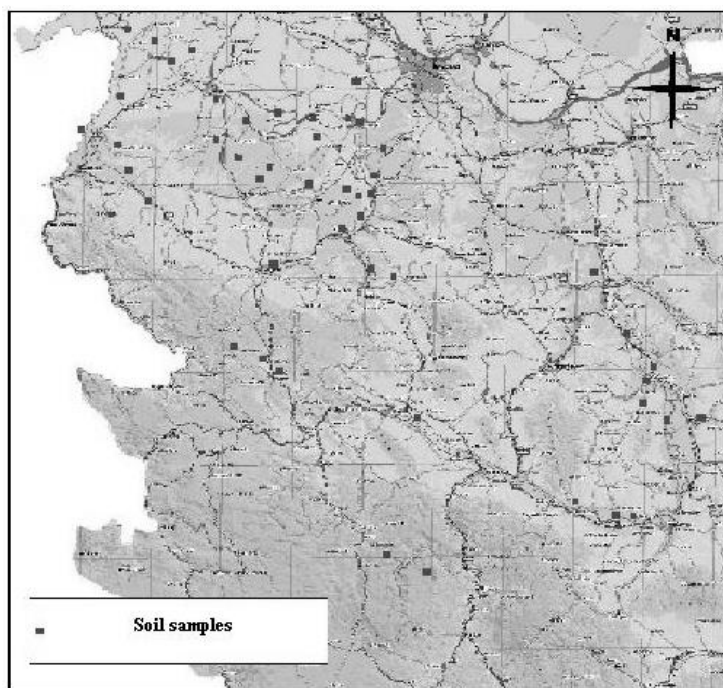

Figure 1.-Locations of soil sampling

Soil samples were obtained from the 0-30 cm depth in period from August-September 2014. Preparation of collected soil samples implied processes of drying, grinding and screening following the laboratory analysis. The samples were air-dried at room temperature. A portion of the sample was sieved through 0.25 mm sieve. The content of organic matter (SOM) was determined by Kotzman, JDPZ (1966).

Determination of physical characteristics of the soil included analysis of the stability of structural aggregates in 50 samples of soil material. The principle of determination was based on an analysis of the relationship between the total content of particles smaller than 0.002 mm (clay) in the soil sample prepared with sodium pyrophosphate ($\text{Na}_4\text{P}_2\text{O}_7 \times 10 \text{H}_2\text{O}$) and the content of these particles in the suspension of soil prepared with water (H_2O).

The stability of the micro aggregate is calculated according to the Vageler's index of their stability (Ss) according to the formula:

$$Ss = (FP - FNP) / FP \times 100,$$

where:

FP (%) - particles smaller than 0.002 mm in the soil material prepared with ($\text{Na}_4\text{P}_2\text{O}_7 \times 10 \text{H}_2\text{O}$);

FNP (%) - particles smaller than 0.002 mm in the soil material prepared with H_2O .

Risk of the soil crusting R(%) is determined according to formula Van der Watt & Claassen-a (1990):

$$R = \text{SOM} \times 100 / (\text{clay} + \text{silt})$$

where:

SOM content of organic matter in the soil (%);

Clay + Silt - content of certain mechanical fraction (%).

The climate characteristics of the studied area were obtained by analyzing available data collected from the Internet site of Republic Hydro meteorological Service of Serbia (RHMS), www.hidmet.gov.rs (accessed May 2016.)

Results and discussion

Weather in spring 2014 in Republic of Serbia was warm and extremely rainy. In the most areas of the country, seasonal maximum of rainfalls were registered, and on five main weather stations it was registered absolute daily maximum of rainfalls.

Average air temperature in spring period was in the range from 10.7°C in Dimitrovgrad to 13.9°C in Belgrade, while in mountain area from 3.1°C on Kopaonik to 7.8°C on Zlatibor.

The total rainfall during the spring in most parts of Serbia were much higher than average.

Table 1. Show the values of total precipitation in the spring of 2014 and the historical data of spring maximums registered at the main meteorological stations.

Table 1. Values of the sum of the quantities of rainfall (RR mm) during the spring and the previous spring maximums at the main meteorological stations (MMS) (source: RHMZS)

MMS	RR max (mm)	Date of registration	Current maximum	Date of registration
Loznica	110.0	15.05.2014.	82.0	24.05.1937.
Sremska Mitrovica	69.1	15.05.2014.	53.5	26.25.1934.
Valjevo	108.2	15.05.2014.	59.0	12.05.1939.
Beograd	107.9	15.05.2014.	75.6	22.04.1892.
Smederevska Palanka	95.3	15.05.2014.	59.6	23.05.2013.

The highest amount of precipitation was registered in the period from 14 to 16 May 2014, when, for example, in Loznica were registered 213.2 mm of precipitation.

The biggest three-day total precipitation was recorded in western and central part of Serbia (over 100 mm), which is more than the average values for the month of May.

According to the percentile method, rainfalls in most parts of Serbia were in the categories of extremely rainy and very rainy.

Table 2. shows the sum of the maximum rainfall during the month of May 2014, registered at the main meteorological stations.

Table 2.- Main meteorological stations (MMS) on which historical maximum of total monthly amount of rainfall (mm) during May was overcome since the starting of measurement (source: RHMZS)

MMS	Σ precipitation 01- 31.05.2014.	Average for May	The current maximum Σ of precipitation during May	Year of registering
Loznica	314.6	82.7	218.6	1938
S.Mitrovica	189.0	58.2	184.9	1939
Valjevo	317.6	88.1	213.2	1957
Beograd	278.5	70.7	191.7	1900
S.Palanka	238.2	69.9	164.7	1929

of structural aggregates. The principle of determination was based on an analysis of the relationship between the total content of particles smaller than 0.002 mm (clay) in the soil sample prepared with sodium pyrophosphate ($\text{Na}_4\text{P}_2\text{O}_7 \times 10 \text{H}_2\text{O}$) and the content of these particles in the suspension of soil prepared with water (H_2O).

The stability level of the micro aggregate is estimated by using the classification by Vageler (JDPZ, 1997), shown on Table 3.

Table 3.- Classification of stability level of the structure micro aggregate in soil

Index of stability of micro aggregates (Ss)	Level of stability by Vagler
<10	totally unstable
10-20	unstable
20-30	low stable
30-50	slightly stable
50-70	rather stable
70-90	stable
>90	very stable

The risk of soil crust formation is high if the value of R is less than 5%, on the borderline if R is 7% and low if R is greater than 9% (quote Ćirić et al., 2012).

Results of performed analysis of fifty soil samples in disturbed condition are shown in Table 4.

Table 4.- Locations of sampling and examined parameters

Minicipality	No. of samples	Index of stability of micro aggregates (Ss)	Level of stability by Vagler	SOM (%)	Risk of the soil crusting (R)
Obrenovac	4	71.2-88.1	stable	2.31-6.13	4-9
Barajevo	1	77.6	stable	2.43	4
Surčin	1	81.6	stable	3.41	5
Lazarevac	3	82.0-90.9	stable-very stable	2.12-4.39	4-6
Koceljeva	2	86.4-90.6	stable-very stable	2.45-2.99	4-5
Vladimirci	3	85.3-88.1	stable	2.40-4.98	4-8
Bogatić	3	78.9-79.4	stable	2.43-4.10	4-7
Šabac	3	76.7-78.4	stable	3.76-4.92	4-7
Ub	3	79.7-84.4	stable	2.14-3.49	3-5
Lajkovac	2	83.9-89.3	stable	3.14-4.65	5-7
Valjevo	1	83.4	stable	4.24	6
Ljig	2	90.5-93.5	very stable	1.86-3.37	4-5
Velika Plana	2	88.9-97.1	stable-very stable	1.82-2.02	3-4
Kraljevo	2	90.3-97.9	very stable	2.7-3.32	4-5
Kruševac	1	95.9	very stable	1.52	3
Trstenik	2	93.5-98.1	very stable	2.29-3.98	6-8
Čačak	1	92.0	very stable	4.46	7
Krupanj	2	74.7-98.1	stable-very stable	1.50-3.39	2-7
Loznica	3	91.0-99.3	very stable	2.03-5.25	5-10
Kosjerić	3	87.8-98.4	stable-very stable	2.05-3.18	5-7
Jagodina	4	82.4-99.3	stable-very stable	2.29-3.87	4-6
Paraćin	2	98.7-99.0	very stable	2.76-4.30	6-8

The results of the analysis showed that the soil samples have stable to very stable level of stability micro aggregates. On the territory of the municipalities that are heavily exposed to floods, it is noted frequent occurrence of stable degree of stability of micro aggregates, which may lead to the conclusion that this natural disaster had an impact on the eventual deterioration of the structural stability of microaggregates of soils.

Soil organic matter is a key attribute of soil quality that affects the aggregation and aggregate stability (Franzluebbers, 2002). In the analyzed samples organic matter content is in the range from low to high content, which is correlation with a certain value of the risk of crust formation. In the analysed samples the risk of the soil crusting was in limit values in 58% of the samples, than, in high risk values - in 40%, while in one soil sample (2%, respectively) the risk of soil crusting was low.

Conclusion

The aim of this research is to assess the productive capacity and the degree of potential risk of different types of soil affected by floods in May 2014, for plant production.

Soil management after floods requires a clear plan that, among other things, include the removal of sediments and waste from soil, repairing a physical damage of soil, repairing chemical properties of soil, stimulating microbiological activity of the soil, reducing the formation of other consequences (preventing of formation of surface crust).

Water saturation of soils as result of flood, probably led to deterioration of structure, the creation of lumpy aggregates, as well as reducing water resistance of structural aggregates but did not significantly affected the structural stability of micro aggregates.

Acknowledgment

Project No. TP 37006 is funded by the Ministry of Education, Science and Technological Development, Republic of Serbia.

References

- Amezketta, E. (1999): Soil aggregate stability: A review. *J. Sustain. Agric.* 14, 83–151.
- Angers, D. A. (1998): Water-stable aggregation of Québec silty clay soils: some factors controlling its dynamic. *Soil Till. Res.* 47, 91–96
- Belić, M., Pejić, B., Hadžić, V., Bošnjak, Đ., Nešić, Lj., Maksimović, L., Šeremešić, S. (2004): Uticaj navodnjavanja na strukturno stanje černoze. "Zbornik radova", Naučnog Instituta za ratarstvo i povrtarstvo, Novi Sad, vol. 40:129-141, (in Serbian).
- Bronick, C.J., Lal, R.(2005): Soil structure and management: a review. *Geoderma*,124:3-22.
- Ćirić, V., Manojlović, M., Belić, M., Nešić, Lj., Šeremešić, S. (2012): Stabilnost agregata i procena rizika od stvaranja pokorice na solonjecu pri različitim načinima korišćenja. *Ratarstvo i povrtarstvo*, 49(3), 243-249, (in Serbian).
- Ćirić, V., Belić, M., Nešić, Lj., Savin, L., Simikić, M., Gligorić, R., Šeremešić, S. (2013): Stabilnost strukture černoze pri različitim načinima proizvodnje. *Savremena poljoprivredna tehnika*, 39(3): 177-186, (in Serbian).
- Daraghmech, O.A, Jensen, J.R., Petersen, C.T. (2009): Soil structure stability under conventional and reduced tillage in a sandy loam, *Geoderma* 150:64-71.
- Đurović, N., Pavlović, R., Pivić, R. (2010): Effect of irrigation on pseudogley structural composition in the protected cultivation, *Zemljište i biljka*, Beograd, 59(1):29-38.
- Edwards, W. M. (1991): Soil Structure: Processes and Management. In: *Soil Management for Sustainability*. Soil and Water Conservation Society, Ankeny, Iowa 7-14.

- Franzluebbers, A. J. (2002). Water infiltration and soil structure related to organic matter and its stratification with depth. *Soil and Tillage Research*, 66(2), 197-205.
- Gérif, J., Richard, G., Dürr, C., Machet, J. M., Recous, S., Roger-Estrade, J. (2001): A review of tillage effects on crop residue management, seedbed conditions, and seedling establishment. *Soil Till. Res.*61:13-32.
- Green, V.S., Stott, D.E., Cruz, J.C., Curi, N. (2007): Tillage impacts on soil biological activity and aggregation in a Brazilian Cerrado Oxisol. *Soil Tillage Res.* 92,114-121.
- Igwe, C. A., Obalum, S. E. (2013): Microaggregate Stability of Tropical Soils and its Roles on Soil Erosion Hazard Prediction. Chapter in Book: *Advances in Agrophysical Research*, by Dobrzański, S. Grundas and A. Stepniewski, InTech.
- JDPZ (1966): Grupa autora, Priručnik za ispitivanje zemljišta, Knjiga I, Hemijske metode ispitivanja zemljišta, Beograd, (in Serbian).
- JDPZ (1997): Grupa autora, Metode istraživanja i određivanja fizičkih svojstava zemljišta, Novi Sad, (in Serbian).
- Kandeler, E., Murer, E. (1993): Aggregate stability and soil microbial processes in a soil with different cultivation. *423 Geoderma*, 56:503–513.
- Oades J.M, Waters A.G. (1991): Aggregate hierarchy in soils. *Australian journal of Soil Research*, 29: 815-828.
- Sorochkin, V. M. (1991): On the question how to choose indices for agronomical evaluation of the soil structure. *Soil Sci.* 7:50–58 (in Russian).
- Shepherd, T. G., Sagar, S., Newman, R. H., Ross, C. W., Dando, J. L. (2001): Tillage-induced changes to soil structure and organic carbon fractions in New Zealand soils. *Aust. J. Soil Res.* 39:465–489.
- Tisdall J.M, Oades J.M. (1982): Organic matter and water-stable aggregates in soils. *Journal of Soil Science*, 33: 141-163.
- Van der Watt H. V. H., Claasens A. S. (1990). Effect of surface treatment on soil crusting and infiltration. *Soil Technol.* 3, 241-251.
- Vučić N. (1964): Vodne osobine černoze i livadske crnice i njihov značaj za navodnjavanje na irigacionom području Bačke, *Savremena Poljoprivreda -posebno izdanje*, broj 1., Novi Sad, (in Serbian).
- Vučić N.V., Marić V. (1992): Higijena zemljišta. *Vojvođanska akademija nauka i umetnosti*, (in Serbian).

POTENTIAL USES OF SPENT MUSHROOM SUBSTRATE IN AGRICULTURE

Funda ATILA

Ahi Evran University, Faculty of Agriculture, Department of Horticulture, Kırşehir, Turkey

*Corresponding author: funda.atila@ahievran.edu.tr

Abstract

The world mushroom industry has expanded rapidly in the last decade. Total mushroom production was 9.926.966 ton in 2013 in the world. The commercial production of edible and medicinal mushrooms is carried out on substrates formulated with animal manure and lignocellulose materials from different sources (such as wheat straw, sawdust, cotton seed hulls and etc), either alone or mixed with each other. The substrate left after the mushrooms have been harvested is known as spent mushroom substrate (SMS). SMS is a nutrient rich in organic by-product of the mushroom industry. Five (5) kg of SMS will be generated from the production of 1 kg of mushrooms. At least 50 million tons of spent mushroom substrate is produced annually in the world. On the other hand, SMS contain high level of organic material and salts. These contents of SMS may result in environmental pollution if dumped as waste. Therefore it has to be properly disposed of to avoid environmental problems, such as water and soil contamination. In parallel with this, the question of what can be done with it raises. This paper reviews the potential uses of spent mushroom compost as a substrate in horticulture or as an energy feedstock for ruminants.

Keywords: *Edible mushroom, spent mushroom substrate, compost, feedstock, ruminant*

Introduction

Mushrooms are one of the world's greatest natural food resource. They provide high quantities of fiber, essential amino acids, vitamins and minerals. Thus, cultivated mushrooms may play a greater role in developing countries to decrease malnutrition. Mushrooms have been known for their nutritional and culinary values as well as used medicines by humans for ages. Moreover, most of mushrooms use as a complementary medicine and dietary supplements for anticancer, antiviral, antibacterial, immunostimulating, hypoglycemic, hypolipidemic and hepatoprotective agents due to their some medicinal properties.

The world mushroom industry has expanded steadily in the last decade in the world. Total mushroom production was reached in 2013 to 9.926.966 ton (FAO, 2013). About 71% is produced in China, followed by the Italy (8%), the USA (4.1%), Netherlands (3.3%), Poland (2.2%). *Agaricus bisporus*, *Lentinula edodes* and *Pleurotus ostreatus* are popular mushrooms with high commercial values and are thus cultivated worldwide. Seventy percent of world production is derived from only these kinds of mushroom.

Mushrooms do not have chlorophyll and cannot produce carbohydrates by photosynthesis. Instead, during their vegetative growth stage, mushroom mycelia secrete enzymes that break down compounds such as cellulose and lignin present in the substrate. So, they are cultivated on a specially designed and selective medium that supplies the nutritional requirements of the mushroom crop. There are many recipes for this medium, which must provide an adequate supply of all nutrients for mushroom growth. The mushroom industry generates two main types of mushroom substrate, one for *Agaricus bisporus* and other for special mushrooms. The most

commonly cultured mushroom is *Agaricus bisporus* (also called the white button mushroom). *Agaricus bisporus* is grown on compost consisting of cereal straw, manure (poultry and/or horse manure), nitrogen containing compounds and calcium sulphate. On the other hand, the commercial production of special mushrooms as *Pleurotus spp*, *Ganoderma lucidum*, *Lentinula edodes* and etc. is carried out on substrates formulated with lignocellulose materials from different sources (such as wheat, rye or rice straw, sawdust, cotton seed hulls and etc), either alone or mixed with each other (Sanchez and Royse, 2009).

At the end of mushroom harvests, the growing material is considered spent. This paper reviews the potential uses of spent mushroom compost as a substrate in horticulture or as an energy feedstock for ruminants.

2. Spent Mushroom Substrate

Mushroom cultivation technology is friendly to the environment and mushrooms are very nutritious and functional foods. In spite of these advantages, the production of mushrooms generates large volumes of solid waste products (called spent mushroom substrate). Many countries have no data on SMS discharge, but it is believed that about 5 kg of waste substrates are generated from the production of 1 kg of mushrooms (Medina *et al.*, 2012). Correspondingly, the SMS production in the world was approximately 50 millions tons in 2013 (Table 1).

Table 1 . Mushroom production and estimated spent compost production around the world (2013)

Country	Mushroom production (t)*	Estimated Spent Mushroom Compost (t)
China	7.076.842	35.384.210
Italy	792.000	3.960.000
USA	406.198	2.030.990
Netherland	323.000	1.615.000
Poland	220.000	1.100.000
Spain	149.700	748.500
France	104.621	523.105
Iran	87.675	438.375
Canada	81.788	408.940
United Kingdom	79.500	397.500
Ireland	63.600	318.000
Others	542.042	2.710.210
Total	9.926.966	49.196.455

* FAO (2013)

** Mushroom production multiplied by 5

SMS needs heat treatment before being removed from the growing chamber. Without proper treatment, contaminated SMS can cause re-contamination. But it takes extra cost and presents an economic problem for mushroom industry. On the other hand, disposal of SMS is one of the major environmental problems in the mushroom producing countries. Improper disposal of SMS may result in environmental problems such as mildew reproduction (Liu *et al.*, 2008) and water contamination (Liu, 2009) and air and soil pollution (Rajput *et al.*, 2009) if it is dumped as waste. Public awareness and the pressure of environmental laws is forcing the mushroom industry to take responsibility for the disposal or recycling of its own spent raw materials. The

waste disposal problems can be reduced by waste minimization, reuse and recycling of its components and converting the organic components of the waste into a valuable product and reused without adversely affecting the environment (Fathi *et al.*, 2014). Moreover, recycling of SMS by different ways may increase sustainability and also help farm economy.

2.1. Characteristics of Spent Mushroom Substrate

As mentioned above, preparation of mushroom substrate is usually done in two different processes depending on species of mushroom and a lot of types of material are generally used for these substrates. So the exact composition of SMS shows a significant variability due to the varying mixes and types of ingredients utilized in the manufacturing of the selective mushroom substrate, composting process and cropping cycle.

SMS exhibits many favourable characteristics, some of which are typical of other organic waste by-products, which include a relatively low bulk density and a high organic matter and moisture content (Maher *et al.*, 1993). The integration of organic materials into soils has proven to improve cation exchange capacity, increase soil aggregation, water-holding capacity, water infiltration, and aeration porosity while it decreases soil crusting, surface run-off (Chenu *et al.*, 2000). It remains, however, a good source of general nutrients (0.7% N, 0.3% P, 0.3% K plus a full range of trace elements) (Bradley, 2004). SMS does not contain any pests or weed seeds, because of the high temperatures associated with the composting and pasteurization processes. Before removing the spent substrate from the mushroom house, the grower "pasteurizes" it with steam. This final pasteurization kills weed seeds, insects and other organisms (Berley, 2016).

SMS displays a high level of high pH and soluble salts. The high pH levels originate from the gypsum added during composting and lime added in the casing layer. So it should not be used on acid-loving plants, nor should it be applied too frequently, as it will overly raise the soil's pH levels (Bradley, 2004).

2.2. Fresh and Weathered Substrate

SMS is a good growing medium for vegetables like cucumber, tomato, broccoli, cauliflower, peppers and spinach. But plant response is varied with SMS application. Fresh SMS contains a lot of salts and unstable organic materials. Availability of some elements such as P, Mn and B (Lucas and Davis, 1961), high Ca content (Dallon, 1988) and high ammonium level may cause to weak plant growth due to either salinity effects or causing high ammonium concentration in the root zone (Baran *et al.*, 1995). For this reason, sometimes, fresh substrate is placed in fields for at least one winter season before reutilization to reduce the electrical conductivity (EC), resultant from high salt content. Conductivity gradually goes down due to leaching during the weathering process, depending on rainfall. Leaching peaks during the fifth and sixth months of weathering and most of the salts originally present in the SMS are released during the first year of weathering. Obtained material at the end of this process is called "weathered substrate". Most studies have been done with lower salt-containing weathered SMSs. Overall, weathered SMS is preferable over fresh SMS for use in crop production.

Table 2. Average analysis of fresh and aged spent mushroom compost (SMS) (adapted from Beyer, 2016).

Contents Units	Units	Avg. Fresh	Weathered 16 mos
Sodium	% Dry Wt	0.21-0.33.	0.06
Potassium	% Dry Wt	1.93-2.58	0.43
Magnesium	% Dry Wt	0.45-0.82	0.88
Calcium	% Dry Wt	3.63-5.15	6.27
Iron	% Dry Wt	0.18-0.34	0.58
Phosphorus	% Dry Wt	0.45-0.69	0.84
Amonia-N	% Dry Wt	0.06-0.24	0.00
Organic nitrogen	% Dry Wt	1.25-2.15	2.72
Total N	% Dry Wt	1.42-2.05	2.72
Solids	% Dry Wt	33.07-40.26	53.47
pH	Standart Unites	5.8-7.7	7.1
N-P-K ratio	ppm Dry Wt.	1.8-.0.6-2.2	2.7-0.8-0.47
% x10.000=ppm			

Polat et al, (2009) reported that as an organic material source and amendment of greenhouse soil application of at least 6 months kept SMS was very effective and beneficiary for cucumber production, quality and recycling the spent mushroom compost.

Çaycı et al. (1998) SMC could be more suitable removing of salts by leaching and decreasing ammonium level by weathering before the use of fresh SMS as growing medium. Weathered SMS is also a good growing medium for the highest yield and quality of tomato seedlings (Lohr and Coffey, 1987).

This aged material has slightly different characteristics because the microbial activity in the field will change the composition and texture (Table 2). Raising environmental concerns and limited natural resources force us to answer the question of “What can use this valuable material from mushroom production have?”.

3. Use of SMS

3.1. Use of SMS in Horticulture

SMS are, in general, wastes with a stabilised organic matter, due to the composting or fermentation process carried out in the preparation of the substrates for *A. bisporus* or *P. ostreatus*, respectively (Paredes et al., 2009). SMS does not contain a lot of nitrogen, phosphorus and potassium in comparison to mineral fertilizers. So it is not a good fertilizer. But it improves soil physical structure by increasing organic matter, soil aggregation, water-holding capacity, water infiltration, buffering capacity and aeration porosity. Uzun (2004) suggested that SMC improved the biological, physical and chemical characteristics of the soil.

Most of researchers suggested the use of spent mushroom substrates in field crops (Wuest, 1991), fruits (Uzun, 2004), vegetables (Segarra et al., 2007), greenhouse crops (White, 1976; Dallon, 1987) and foliage plants (Raymond et al., 1998) to their disposal in an environment-friendly way and reduces the need for peat simultaneously.

Spent compost from the cultivation of *Agaricus* spp. represents a possible alternative substrate for the production of lettuce since the material exhibits some characteristics that are appropriate for the growth of seedlings (Ribas et al, 2009; Zhang et al., 2012; Marques et al., 2014).

Zhang et al (2012) suggested that spent *Flammulina velutipes* mushroom substrate mixed with perlite or vermiculite had suitable physical and chemical properties for the growth of tomato or cucumber seedlings. Chong et al (1994) and Benito et al (2005) suggested that the mixes made of pruning waste compost and spent mushroom compost for ornamental plants in pots. On the other hand, Kwack et al (2012) reported that white button mushroom SMS is the more suitable substrate than tested SMS based sawdust for transplant production when appropriately mixed with substrates. SMSs used sawdust as the main ingredient must be manipulated carefully in order to improve their physical and chemical properties for use as growing media. Ribas et al (2009) found that *Lentinula edodes*- SMS provided negative results when a fertilization objective was selected.

Medina et al (2009) reported that the media containing *Agaricus bisporus* spent- SMS and mixed *Pleurotus ostreatus*-SMS: *Agaricus bisporus*-SMS (1:1) had adequate physical properties, notable contents of plant nutrient and high pH and electrical conductivity values.

Agaricus bisporus spent substrate can be also used as growing substrate for other mushroom species such as *Auricularia auricula* (Sharma and Jandaik 1994), *Lentinula edodes* (Kilpatrick et al. 2000), *Pleurotus* spp. (Sharma and Jandaik 1994); *Volvariella volvacea* (Poppe 2000).

3.2. Uses of SMS in Bioremediation

SMSs are effectively in bioremediation strategies. The bioremediation activity is dependent upon the ability of the fungal species, colonizers of the substrate, to produce oxidative lignolytic enzymes such as laccase, manganese and lignin peroxidase. These enzymes are responsible for lignin degradation (Buswell et al., 1996) Additionally, incorporation of SMSs into soil is responsible for microbial changes on diversity due to nutritional supplementation.

SMS can be utilised successfully in the stabilisation of disturbed and commercial sites such as abandoned coalmines, pipeline construction sites, industrial and mining sites. SMS acts as a slow releasing fertiliser and provides small amounts of CaCO₂ which leads to the elevation of the soil pH. SMS microorganisms can degrade many hydrocarbons and insecticide components carbaryl and 1-Naphthol, both of which are toxic to soil and water biota. SMS can also remove biocide PCP (pentachlorophenol) from water, a pesticide and wood preservative, through the presence of a PCP degrading bacterium in SMS.

Ribas et al., (2009) reported that *A. subrufescens*- SMS and *L. edodes*-SMSs presented potential to be used in soil bioremediation.

3.3. Use of SMS as a feedstock

SMS contains more minerals, more protein less cellulose and lignin (Albores et al, 2006) Among many recycling methods, SMSs use as an animal feed seems to be reasonable and promising because the ingredients used as mushroom substrates are used as animal feeds as well. Anyway the use of SMS as a cattle feed, after its use to produce *Pleurotus* spp. was suggested by a lot of researcher (Adamovic et al., 1998; Lee et al., 2008). They reported that by-products of mushrooms could be used as ruminant feed without any harmful effects on eating behavior and blood metabolites in cattle.

Although several species of higher fungi possess ligninolytic activity, *Pleurotus* spp. is the most studied fungi since they improved the digestibility (Kundu et al., 2005) and nutritional quality of straws (Kakkar et al., 1990).

Pleurotus spp. is cultivated by two different methods, a straw-based compost culture and a sawdust-based plastic bottle culture system. Spent straw compost could be directly fed to the ruminant animal or reprocessed by fermenting the compost supplemented with corn meal,

soybean meal and wheat bran using *Aspergillus sp.* and yeast to improve the nutritional value, especially the crude protein level (Adamovic et al., 1998). Straw breakdown is achieved by the influence of *P. osteratus* digestive enzymes, particularly on cell wall components, cellulose and lignin, and these straws can be more easily digested by ruminants. However the sawdust-based SMS was hard to recycle due to the low nutritional value. However, as the digestibility of sawdust-based SMS is low, the sawdust-based SMS should be further processed and improved nutritionally before feeding. Furthermore, SMS is hard to store due to it is wet and putrefactive (Kwak et al., 2008) so SMS should be used quickly because it starts to putrefy within 3–4 days of storage.

4. Conclusions

SMS is by no means a waste product. SMS has the potential to solve several agricultural and non-agricultural issues. It may be considered an inexpensive and an environmental-friendly strategy in agriculture particularly in the bioenergy area, tillage enterprise and in bioremediation of contaminated land remains a largely uncharted area.

The most important limiting factor in the use of SMS as a fertilizer amendment appeared to be its high soluble salts content. Recomposting / weathering is required for added advantages. After weathering, SMS from *Agaricus bisporus* production can be used in wide use in horticulture a component of potting soil mixes, as a casing material in the cultivation of subsequent *Agaricus bisporus*, in the bio-remediation of contaminated soils, in agriculture or landscape trades to enrich soil.

On the other hand, spent substrate from other mushroom species provided negative results when it used a fertiliser. SMS makes a contribution of nitrogen but this is not readily available to the crop until a year after application. Therefore a supplementary N fertiliser must be used. Special mushroom- SMS has found more suitable as food for animals and as ingredients in the cultivation of other mushroom species than as fertiliser. Straw based-SMS is suggested as foodstock for ruminants because of low nutritional value and digestibility of the sawdust-based. But further studies with different application strategies are needed for conclusive results.

Recycling of SMS and converting the organic components of the waste into a valuable product and reused without adversely affecting by different ways may increase sustainability in developing countries and may partially solve the ever increasing problems of feed crisis to livestock and also help farm economy.

Acknowledgement

This work was supported by the Ahi Evran University Scientific Research Projects Coordination Unit. (Project Number: ZRT .E2.16.029)

References

- Adamovic, M., Grubic, G. Milenkovic, I., Jovanovic, R., Protic, R., Sretenovic L. and Stoicevic., L., 1998. The biodegradation of wheat straw by *Pleurotus ostreatus* mushrooms and its use in cattle feeding. *Anim. Feed Sci. Technol.* 71:357-362.
- Alborés, S., Pianzola, M.J., Soubes, M. and Cerdeiras, M.P., 2006. Biodegradation of agroindustrial wastes by *Pleurotus* spp for its use as ruminant feed. *Electronic Journal of Biotechnology* ISSN: 0717-3458. Vol.9 No.3, Special Issue.
- Baran, A., Çaycı, G. and İnal, A., 1995. Some physical and chemical properties of different agricultural wastes. Pamukkale University Engineering College, *J. Engineering Sciences.* 2-3:169-172.

- Benito, M., Masaguer, A., De Antonio, R. and Moliner, A., 2005. Use of pruning waste compost as a component in soilless growing media. *Bioresour Technol.* 96: 597-603.
- Beyer, D.M., 2016. Spent mushroom substrate. <http://extension.psu.edu/plants/vegetable-fruit/mushrooms/mushroom-substrate/spent-mushroom-substrate> (June 21, 2016).
- Bradley, S., 2004. *Vegetable Gardening: Growing and Harvesting Vegetables*. Murdoch Books. ISBN 1-74045-519-3.
- Buswell, J.A., Cai, Y.J., Chang, S.T., Peberdy, J.F., Fu, S.Y. and Yu, H.S., 1996. Lignocellulytic enzyme profiles of edible mushroom fungi. *World J. Microbiol. Biotechnol.* 12, 537-542.
- Chenu, C., Le Bissonnais, Y. and Arrouays, D., 2000. Organic matter influence on clay wettability on soil aggregate stability. *Soil Science Society of America Journal* 64(4): 1479-1486.
- Chiu, S.W., Ching, M.L., Fong, K.L. and Moore, D., 1998. Spent oyster mushroom substrate performs better than many mushroom mycelia in removing the biocide pentachlorophenol. *Mycological Research* 102(12):1553-1562.
- Chong, C., Cline, R.A. and Rinker, D.L., 1994. Bark- and peat-amended spent mushroom compost for containerised culture of shrubs. *Hort Sci* 29(7): 781-784.
- Çaycı, G., Baran, A., Bender, D., 1998. The Effects of Peat and Sand Amended Spent Mushroom Compost on Growing of Tomato. *Tarım Bilimleri Dergisi* 1998, 4 (2), 27-29.
- Dallon, J., 1987. Effects of spent mushroom compost on the production of greenhouse-grown crops. *Combined Proceedings of the International Plant Propagators Society*. 37: 323-329.
- Dallon J., 1988. Effects of spent mushroom compost on the production of greenhouse-grown crops. *Combined Proceed. Int. Plant Propagators Soc.* 37: 323-329.
- Food and Agriculture Organization of the United Nations (FAO). Retrieved June 20, 2016, from <http://faostat3.fao.org/faostat-gateway/go/to/download/Q/QC/S>.
- Fathi H, Zangane A, Fathi H and Moradi H., 2014. Municipal solid waste characterization and its assessment for potential compost production: A case study in Zanjan city, Iran. *American journal of Agriculture and Forestry*, 2(2): 39-44.
- Guo, M. and Chorover, J., 2006. Leachate migration from spent mushroom substrate through intact and repacked subsurface soil columns. *Waste Management* 26:133-140.
- Kakkar, V.K., Garach, H.S., Dhanda, S. and Makkar, G.S., 1990. Mushroom harvested spent straw as feed for buffaloes. *Indian Journal of Animal Nutrition* 7:267-272.
- Kilpatrick, M., Murray, D.J. and Ward, F., 2000. Influence of substrate formulation and autoclave treatment on *Lentinula edodes* production. *Mushroom Science* 15:803-810.
- Kundu S.S., Mojumdar A.B., Singh K.K. and Das M.M., 2005. Improvement of poor quality roughages. In: SS Kundu, SK Mahanta, S Singh, PS Pathak (Eds.) *Roughage Processing Technology*, Satish serial publishing house, Delhi, India. pp. 193-209.
- Kwack, Y. Song, JH, Shinohara, Y, Maruo, T and Chun, C., 2012. Comparison of Six Spent Mushroom Composts As Growing Media for Transplant Production of Lettuce. *Compost Science and Utilization* Vol. 20, No. 2, 92-96.
- Lee, S.M., Hwang, J.H., Yoon, Y.B., Kwak, W.S, Kim, Y.I. ,Moo S.H. and Jeon, T., 2008. Effects of spent mushroom substrates addition on eating behavior of growing Hanwoo. *J. Kor. Grassl. Forage Sci.* 28:107-117.
- Liu, H., 2009. Utilization of spent mushroom substrate in China. <http://www.cefa.org.cn/html/2009/10/14/181.html>.
- Liu, W., Yao, T., Sun, L., Fan, L., 2008. The feasibility of spent mushroom substrate as a kind of microbial fertilizer carrier. *Journal of Agro-Environment Science* 231, 94-102.

- Lucas, R.E. and Davis, J.F., 1961. Relationships between pH values of organic soils and availabilities of 12 plant nutrients. *Soil Sci.*, 92:177-182.
- Maher, M.J., Lenehan, J.J. and Staunton, W.P., 1993. Spent Mushroom Compost – Options for Use. Teagasc, Dublin, Ireland. pp. 1–44.
- Marques, E.L.S, Martos, E.T., Souza, R.J., Silva, R., Zied, D. C and Souza Dias, E., 2014. Spent Mushroom Compost as a Substrate for the Production of Lettuce Seedlings, *Journal of Agricultural Science*; Vol. 6, No. 7.
- Medina, E., Paredes, C., Pérez-Murcia, M. D., Bustamante, M. A. and Moral, R., 2009. Spent mushroom substrates as component of growing media for germination and growth of horticultural plants. *Bioresource Technology*, (100), 4227-4232. <http://dx.doi.org/10.1016/j.biortech.2009.03.055>,
- Medina, E., Paredes, C., Bustamante, M.A., Moral, R., Moreno-Caselles, J., 2012. Relationships between soil physic-chemical, chemical and biological properties in a soil amended with spent mushroom substrate. *Geoderma*, 173-174: 152-161.
- Obodai, M., Cleland-Okine, J., Vowotor, K.A., 2003, Comparative study on the growth and yield of *Pleurotus ostreatus* mushroom on different lignocellulosic by-products. *Journal of Industrial Microbiology and Biotechnology* 30: 146-149.
- Paredes, C., Medina, E., Moral, R., Pérez-Murcia, M.D., Moreno-Caselles, J., Bustamante, M.A. and Cecilia, J.A., 2009. Characterization of the different organic matter fractions of spent mushroom substrate. *Commun. Soil Sci. Plan.* 40, 150– 161.
- Poppe, J. 2000. Use of agricultural waste materials in the cultivation of mushrooms. *Mushroom Science* 15(1):3-22.
- Polat, E., Uzun, H.I., Topçuoğlu, B., Önal, K., Onus, NA. and Karaca, M., 2009. Effects of spent mushroom compost on quality and productivity of cucumber (*Cucumis sativus* L.) grown in greenhouses. *African Journal of Biotechnology* Vol. 8 (2), pp. 176-180.
- Rajaratnam, S. and Bano, Z., 1989. *Pleurotus* mushrooms. Biotransformations of natural lignocellulosic waste. *Crit. Rev. Food Sci. Nutr.* 28:31–123.
- Rajput, R., Prasad, G. and Chopra, A.K., 2009. Scenario of solid waste management in present Indian context. *Caspian J. Env. Sci.* 7: 45–53.
- Raymond, D.A., Chong, C. and Varoney, R.P., 1998. Response of four container grown woody ornamentals to immature composted media derived from waxed corrugated cardboard. *Compost Science and Utilization* 6(2):67-74.
- Ribas, L.C.C., Mendonça, M.M., Camelini, C.M. and Soares, C.H.L., 2009. Use of spent mushroom substrates from *Agaricus subrufescens* (syn. *A. blazei*, *A. brasiliensis*) and *Lentinula edodes* productions in the enrichment of a soil-based potting media for lettuce (*Lactuca sativa*) cultivation: Growth promotion and soil bioremediation. *Bioresource Technology*, 100(20), 4750-4757. <http://dx.doi.org/10.1016/j.biortech.2008.10.059>.
- Sanchez, J. E. and Royse, D. J. 2009. *Scytalidium thermophilum*- colonized grain, corncobs and chopped wheat straw substrates for the production of *Agaricus bisporus*. *Bioresource Technol.* 100: 1670–1674.
- Segarra, G., Casanova, E., Borrero, C., Aviles, M. and Trillas, I., 2007. The suppressive effects of composts used as growth media against *Botrytis cinerea* in cucumber plants. *Eur. J. Plant Pathol.* 117, 393–402.
- Sharma, V.P. and Jandaik, C.L., 1994. Recycling of spent compost for growing *Auricularia polytricha* and *Pleurotus* species. *Mushroom Information* 10/11:15-20.
- Uzun, İ., 2004. Use of spent mushroom compost in sustainable fruit production. *Journal of Fruit and Ornamental Plant Research*, Vol. 12, 2004 Special ed.

- White, J.W., 1976. Mushroom casing soil and sphagnum moss peat: growing media for Easter lilies. *Pennsylvania Flower Grower's Bulletin* Progress Report 1:3-5.
- Wuest, P.J. and Fahy, H.K., 1991. Spent mushroom compost. Traits and Uses. *Mushroom News* 39(12): 9–15.
- Zhang, R. H., Duan, Z. Q. and Li, Z.G., 2012. Use of Spent Mushroom Substrate as Growing Media for Tomato and Cucumber Seedlings. *Pedosphere*, 22(3), 333-342. [http://dx.doi.org/10.1016/S1002-0160\(12\)60020-4](http://dx.doi.org/10.1016/S1002-0160(12)60020-4).

THE EFFECT OF LONG-TERM USE OF PHOSPHATE FERTILIZERS ON THE CONTENT OF EXCHANGEABLE BASES IN VERTISOL

Nebojša GUDŽIĆ^{1*}, Miroljub AKSIĆ¹, Slaviša GUDŽIĆ¹, Gordana ŠEKULARAC², Aleksandar VUKOVIĆ¹

¹University of Priština, Faculty of Agriculture, Kosovska Mitrovica - Lešak, Serbia

²University of Kragujevac, Faculty of Agronomy, Čačak, Serbia

*Corresponding author: nesagudzic@gmail.com

Abstract

A long-term use of mineral fertilizers affects many soil properties, including the content of exchangeable cations. The study has been conducted to determine the effect of a thirty-year use of phosphate fertilizers on major agrochemical properties of Vertisol in leaching (pH, Y1, organic matter content, total N, total P, total K, available P, and available K) and the concentration of exchangeable base cations: K^+ , Na^+ , Ca^{2+} and Mg^{2+} . During the experiment, two doses of phosphorus were continuously applied, a lower one, with which phosphorus has been applied every year in the amount of 80 kg P ha^{-1} and higher than 160 kg P ha^{-1} . Both doses of phosphorus were combined with a constant amount of nitrogen (120 kg N ha^{-1}) and potassium (80 kg K ha^{-1}). The research has been carried out on a stationary model farm in Kragujevac in central Serbia. The thirty-year use of mineral fertilizers has caused an additional acidification of Vertisol. However, continuous use of phosphate fertilizers has provided a smaller effect on the acidification of the surface layer of Vertisol than nitrogen and potassium fertilizers. At the same time phosphate fertilizers has significantly contributed to the increase in total and available phosphorus, the increase in the concentration of exchangeable K^+ , and the reduction in the concentration of exchangeable Na^+ , Ca^{2+} and Mg^{2+} .

Keywords: *long-term fertilization, Vertisol, phosphate fertilizer, content of exchangeable bases*

Introduction

A reasonable use of mineral fertilizers in a longer period of time can maintain or improve the soil quality, and its production capacity (Belay et al., 2002). One of the best ways to evaluate the effect of fertilization with mineral fertilizers on fertility and other soil properties is the use of long-term experiments (Michell et al., 1991) that provide information on the sustainability of agricultural systems. One of solutions for possible harmful effects of a long-term and unilateral use of fertilizers is the implementation of fertilization management, which takes care of the input and output of nutrients and crop rotation, thus preventing a negative effect of applied fertilizers on some chemical soil properties (Hirzel et al., 2011).

A long-term continuous use of phosphoric fertilizers (MAP, superphosphate, triple superphosphate) can significantly affect numerous soil properties. Their effect can be observed from several aspects, of which two are most prominent. The first is a small utilization of phosphorus by plants, which, in conditions of constant implementation, leads to an inevitable accumulation of this element in the soil, especially its available forms (Berti and Cunningham, 1997; Pizzeghello et al., 2011). The second refers to the fact that phosphoric fertilizers are produced from raw materials containing microelements (Ricchards et al., 2011), as well as some potentially hazardous trace elements, and they remain as impurities in the fertilizer after

fabrication, and in the system of long-term use, cadmium (Mulla et al., 1980; Brennan and Bolland, 2004; Grant and Sheppard, 2008), arsenic and lead (Jiao et al., 2012) have the potential to be accumulated in the soil and transmitted through the food chain. For this reason, the goal of the research was to, after thirty years of continuous application of mineral fertilizers on a model farm in central Serbia, in the system of wheat and corn rotation, evaluate the changes that these fertilizers caused to the soil of Vertisol type.

Materials and methods

The research has been carried out on a stationary model farm of Small Grains Research Center in Kragujevac (44°00'51" and 20°54'42"). Since 1984, the examination of the effect of long-term application of phosphorous mineral fertilizers on the properties of Vertisol soil has been performed.

During the experiment, two doses of phosphorus were continuously applied, a lower one, with which phosphorus was entered every year in the amount of 80 kg P ha⁻¹ (P1 variant) and higher with 160 kg P ha⁻¹ (P2 variant). Both doses of phosphorus were combined with a constant amount of nitrogen (120 kg N ha⁻¹) in NP1 and NP2 variants and a constant amount of nitrogen (120 kg N ha⁻¹) and potassium (80 kg K ha⁻¹) in NP1K and NP2K variants. Nitrogen and potassium were applied independently in a special variant (NK variant). Fertilization treatments were compared with the control variant, i.e. with the variant where fertilizers were not applied (O). The total amounts of phosphorus and an appropriate part of nitrogen were entered by the application of MAP fertilizers (NH₄H₂PO₄). The remainder of the provided amount of nitrogen was supplemented by applying Urea fertilizers (CO(NH₂)₂). An appropriate amount of potassium chloride (KCl) was used for potassium intake. The experiment was performed as a random complete block design (RCBD) in four replications. The average (composite) soil samples were collected in the layer from 0 – 20 cm, and they were formed of five sub-samples for each treatment. By mixing the sub-samples, so-called average or composite sample was singled out, which was chemically analyzed after a proper preparation. Soil samples were taken in the fall of 2013 (after the corn harvest).

The soil pH was determined by the pH meter with a glass electrode in a 1:2.5 suspension with water and 1 M KCl. The hydrolytic acidity, i.e. H, was determined by Kappen's method by treating a soil sample with (CH₃COO)₂Ca, and then a neutralization of excess acid with 0.1 M NaOH was carried out. Accessible phosphorus and potassium were determined by Al method, where ammonium lactate (pH = 3.7) was used as an extractant. After the extraction, potassium was determined by flame emission spectrometry, and phosphorus by spectrophotometry after developing color with NH₄MoO₄ and SnCl₂. Total phosphorus was determined spectrophotometrically at the wavelength of 400-490 nm after a digestion with HClO₄ and a treatment with ammonium paramolybdate-vanadate reagent (Olsen and Sommers, 1982), and total potassium was determined photometrically after the destruction of the sample with a mixture of HF and H₂SO₄. The content of exchangeable bases (Ca²⁺, Mg²⁺, K⁺ i Na⁺) has been determined with the atomic absorber after an extraction with 1 mole L⁻¹ CH₃COONH₄ at pH 7.

Statistical analyses were performed on SPSS software, variant 16. The effects of the treatment on all variants were tested by ANOVA. Statistical differences between the treatments were determined using the t-test (95 and 99%) by Pearson for Fisher's LSD. The significance of correlations between them was analyzed through Pearson correlation matrices (SPSS, 2007).

Results and discussion

The soil on which the research has been carried out was characterized by leaching processes. The main characteristics of Vertisol before the beginning of the experiment are shown in Table 1. Its basic characteristics in the surface layer before the beginning of the experiment were an expressed sour reaction, a low content of available phosphorus, a mean content of organic matter and available potassium.

Table 1. Agrochemical characteristics of Vertisol before the beginning of the experiment

pH		H	OM	tot N	Total		available		Exchangeable			
H ₂ O	KCl	c mol kg ⁻¹	----- %	-----	P	K	P	K	K ⁺	Na ⁺	Ca ²⁺	Mg ²⁺
					----- mg kg ⁻¹ -----				----- c mol kg ⁻¹ -----			
5.90	4.60	8.64	2.69	0.170	977.4	15000	26.0	180	0.47	0.22	17.60	6.00

The long-term continuous application of mineral fertilizers has contributed to an additional acidification of Vertisol (Table 2), and the reason should be sought in the fact that it is the fertilizer application zone, thereby the zone of their direct effect. On that occasion, it was established that, in the layer from 0 – 20 cm, the differences between active, substitution, and hydrolytic acidity between the control and fertilization variants were highly significant ($p > 0.01$).

Table 2. Agrochemical properties of Vertisol after 30 years of fertilizing with phosphorus

Variants	pH		H	OM	total N	total P	total K	avail P	avail K
	H ₂ O	KCl	c mol kg ⁻¹	----- %	-----	----- mg kg ⁻¹ -----			
O	5.58	4.18	9.17	2.70	0.157	924	13200	18.9	188.0
NK	5.30	4.02	11.57	2.15	0.125	967	16500	20.2	258.3
NP1	5.36	4.10	11.04	2.38	0.138	1202	14100	104.4	168.9
NP2	5.40	4.12	10.64	2.40	0.140	1381	14000	115.5	154.8
NP1K	5.42	4.10	10.68	2.36	0.137	1283	15000	125.5	288.3
NP2K	5.52	4.13	10.52	2.48	0.144	1605	16000	168.2	255.5
Lsd 0.05	0.066	0.069	0.113	0.135	0.008	86.6	530.3	4.37	4.08
Lsd 0.01	0.091	0.094	0.155	0.184	0.011	118.6	726.5	5.99	5.58

The contribution to acidification of used fertilizers has not been the same. The highest acidification has been caused by nitrogen and potassium fertilizers, i.e. NK variant. This implies that a long-term use of only nitrogen and potassium fertilizers significantly increases the acidity of soil, rather than when the same fertilizers are used with phosphoric ones. This trend has been expected because soil acidification by long-term application of nitrogen fertilizers is well-known and confirmed by numerous experiments (Khonje et al., 1989; Bolan et al., 1991; Barak et al., 1997; Zhao et al., 2010). However, long-term, continuous use of fertilizers that, in addition to N, contain phosphorus, such as MAP, frequently result in an increased acidification (Magdoff et al., 1997; Belay et al., 2002; Saleque et al., 2004).

In all variants of fertilization, the content of organic matter and total nitrogen in the surface layer has significantly been reduced compared to the control variant ($p < 0.01$). Although the importance of long-term fertilization with nitrogen to maintain or increase the organic matter content (Bundy et al., 2011), total (Tong et al., 2009) or nitrate nitrogen (Zhang, 2012) is often emphasized, in this research, the nitrogen from fertilizers has not had a positive effect on their contents.

After 30 years, in all the variants where P fertilizers were applied, the contents of total and available phosphorus have been increased. In relation to the control and NK variants, the

differences were highly significant ($p < 0.01$) and in proportion with the rates of applied fertilizers, and the long-term application of fertilizers has strongly contributed to the accumulation of available forms in the area of intake (Marocco et al., 1999; Otto and Kilian, 2001; Cakmak et al., 2010; Selles et al., 2011). It has also been noted that, in this layer, the same rates of phosphorus from NPK variants had a significantly greater contribution to the accumulation of this element in relation to the NP variants.

The concentrations of exchangeable K^+ , Na^+ , Ca^{2+} and Mg^{2+} have been changed in all the variants of fertilization in comparison to the control variant (Table 3). Fertilization has had an effect on an increase in the concentration of only exchangeable K^+ , especially in NK variant ($p < 0.01$), while, at the same time, the content of the other exchangeable cations (Na^+ , Ca^{2+} and Mg^{2+}) has been reduced. On that occasion, the lowest concentrations of Na^+ and Mg^{2+} has been found in the variant where phosphorus (NK) has not been used, and the lowest concentration of Ca^{2+} was found in the variants with a full regimen of nutrition, especially in NP1K variant.

Table 3. The contents of exchangeable base cations in Vertisol after 30 years of fertilization

Variants	K^+	Na^+	Ca^{2+}	Mg^{2+}
	c mol kg ⁻¹			
O	0.42 ± 0.10	0.24 ± 0.04	16.70 ± 0.25	7.20 ± 0.25
NK	0.50 ± 0.09	0.16 ± 0.05	15.90 ± 0.45	5.50 ± 0.60
NP1	0.40 ± 0.10	0.20 ± 0.07	15.60 ± 0.20	6.50 ± 0.75
NP2	0.40 ± 0.08	0.20 ± 0.04	15.60 ± 0.20	6.30 ± 0.75
NP1K	0.47 ± 0.05	0.20 ± 0.06	12.80 ± 0.55	6.50 ± 0.30
NP2K	0.45 ± 0.04	0.20 ± 0.05	13.50 ± 0.20	6.60 ± 0.35
Lsd 0.05	0.054	0.036	0.229	0.355
Lsd 0.01	0.073	0.049	0.314	0.486

Immobilization of phosphates from fertilizers can be considered as an important contributor to a decrease in Ca^{2+} concentration. A reduction in the concentration of some cations in the surface layer, in particular Ca and Mg, has primarily been caused by their replacement with H^+ ions and flushing lower in the soil profile (Belay et al., 2002). In addition to flushing, a cause for lower concentrations of the mentioned cations in the adsorptive complex of the surface layer is also their adoption by plants.

Table 4. Pearson correlation coefficients

	pH KCl	H	OM	P tot	P avail	K avail	K^+	Na^+	Ca^{2+}
pH KCl	1								
H	-.702	1							
OM	.654	-.858	1						
P tot	.158	.152	.035	1					
P avail	.129	.274	.013	.948	1				
K avail	-.334	.466	-.319	.114	.146	1			
K^+	-.223	-.712	-.423	-.397	-.427	-.249	1		
Na^+	.607	-.218	.499	.043	.004	-.302	-.366	1	
Ca^{2+}	.080	-.832	.175	-.684	-.774	-.670	.499	.115	1
Mg^{2+}	.671	-.389	.792	.057	.136	-.273	-.491	.728	.027

A consequence of flushing cations from the surface area is their accumulation in the deeper layers. The process of flushing and accumulation in the depths has especially been expressed in Ca^{2+} . Its concentrations have shown a high negative dependence in relation to H (-.832) and a medium negative dependence in relation to total P (-.684), available P (-.774) and available K (-.670), which is shown in Table 4. To a lesser extent, Mg^{2+} and K^+ flushing has been found, while in Na^+ , it has been found only in the control and NK variants. On that occasion, a mean dependence of Mg^{2+} concentration was found in relation to pH in KCl (-.671), and organic matter (.792), and in K^+ , a medium negative dependence in relation to Y1 (-.712), while the Na^+ concentration was dependent on the pH (.607) and partly on the organic matter content (.499).

Conclusion

The thirty-year use of mineral fertilizers has caused an additional acidification of Vertisol, and then a reduction in the content of organic matter and total nitrogen. Phosphoric fertilizers, regardless of the amount entered, have had a smaller effect on acidification. The concentrations of total and available phosphorus and potassium have been increased in all cases where fertilizers containing these two elements were used, and they have been proportional to the doses applied. Exchangeable base cations have reacted differently to the introduction of fertilizers, K^+ concentrations in the surface layer have increased in all variants where this element was applied, in particular in NK combination, while, in relation to the control variant, the concentrations of Na^+ , Ca^{2+} and Mg^{2+} have been reduced. At the same time, exchangeable cations in the surface layer have been flushed. The biggest flushing has been found in Mg^{2+} and Ca^{2+} , which suggests caution because, over time, apart from an increase in acidity, a serious deficit in base cations in the surface layer can occur.

References

- Barak, P., Jobe, B.O., Krueger, R.A., Peterson, L.A., Laird, D.A. (1997). Effects of long-term soil acidification due to nitrogen fertilizer inputs in Wisconsin. *Plant and Soil*, 197(1), 61-69.
- Belay.,A., Claassens, A., Wehner, F. (2002).Effect of direct nitrogen and potassium and residual phosphorus fertilizers on soil chemical properties, microbial components and maize yield under long-term crop rotation. *Biology and Fertility of Soils*, 35(6), 420-427.
- Berti, W.R., Cunningham, S.D. (1997). In-place inactivation of Pb in contaminated soils. *Environ. Sci. Technol.*, 31, 2673-2678.
- Bolan, N.S., Hedley, M.J., White, R.E. (1991). Processes of soil acidification during nitrogen cycling with emphasis on legume based pastures. *Plant and Soil*, 134(1), 53-63.
- Brennan, R.F., Bolland, M.D.A. (2004). Wheat and canola response to concentration of phosphorus and cadmium in a sandy soil. *Australlian Journal of Experimental Agriculture*, 44(10), 1025-1029.
- Bundy, L.G., Andraski, T.W., Ruark, M.D., Peterson, A.E. (2011). Long-Term Continuous Corn and Nitrogen Fertilizer Effects on Productivity and Soil Properties. *Agronomy Journal*, 103(5), 1346-1351.
- Cakmak, D., Saljnikov, E., Mrvic, V., Jakovljevic, M., Marjanovic, Z., Sikiric, B., Maksimovic, S. (2010). Soil Properties and Trace Elements Contents Following 40 Years of Phosphate Fertilization. *J. Environ. Qual.*, 39(2), 541-547.
- Grant, C.A., Sheppard, S.C. (2008). Fertilizer impacts on cadmium availability i agricultural soils and crops. *Human and Ecological Risk Assessemant*, 14(2), 210-228.
- Hirzel, J., Undurraga, P., Gonzales, J. (2011). Chemical properties of volcanic soil affected by seven – year rotations. *Chilean Journal of Agricultural Research*, 71(2), 304-312.

- Jiao, W., Chen, W., Chang, A.W., Page, A.L. (2012). Environmental risks of trace elements associated with long-term phosphate fertilizers application. A review. *Environmental Pollution* 168, 44-53.
- Khonje, D.J., Varsa, E.C., Klubek, B. (1989). The acidulation effects of nitrogenous fertilizers on selected chemical and microbiological properties of soil. *Soil Science and Plant Analysis*, 20(13-14), 1377-1395.
- Magdoff, F., Lanyon, L., Liebhardt, B. (1997). Nutrient cycling, transformation and flows: implications for a more sustainable agriculture. *Advces in Agronomy*, 60, 1-73.
- Maroko, J.B., Buresh, R.J., Smithson, P.C. (1999). Soil phosphorus fractions in unfertilized fallow-maize system on two tropical soils. *Soil Sci. Soc. Am. J.*, 63, 320-326.
- Mitchell, C.C., Westerman, R.L., Brown, J.R., Peck, T.R. (1991). Overview of long-term agronomic research. *Agronomy Journal*, 83(1), 24-29.
- Mulla, D.J., Page, A.L., Ganje, T.J. (1980). Cadmium accumulation and bioavailability in soil from long-term phosphorus fertilization. *J. Environ. Qual.*, 9, 408-412.
- Olsen, S.R., Sommers, L.E. (1982). Phosphorus. pp. 403-430. In: A.L. Page, R.H. Miller, and D.R. Keeney (eds.), *Methods of Soil Analysis*. 2nd ed. Agronomy Series No.9, Part 2. Soil Science Society of America, Inc., Madison, WI.
- Otto, W.M., Kilian, W.H. (2001). Respons of soil phosphorus content, growth and yield of wheat to long-term phosphorus fertilization in a conventional cropping system. *Nutrient Cycling in Agroecosystems*, 61(3), 283- 292.
- Pizzeghello, D., Berti, A., Nardi, S., Morari, F. (2011). Phosphorus forms and P-sorption properties in three alkaline soils after long-term mineral and manure applications in north-eastern Italy. *Agriculture, Ecosystems & Environment*, 141(1-2), 58-66.
- Richards, J.R., Zhang, H., Schroder, J.L., Hattey, J.A., Raun, W.R., Payton, M.E. (2011). Micronutrient availability as affected by the long-term application of phosphorus fertilizer and organic amendments. *Soil Science Society of America Journal*, 75(3), 927-939.
- Saleque, M.A., Naher, U.A., Islam, A., Pathan, A.B.M.B.U., Hossain, A.T.M.S., Meisner, C.A. (2004). Inorganic and organic phosphorus fertilizer effects on the phosphorus fractionation in wetland rice soils. *Soil Sci. Soc. Am. J.*, 68, 1635-1644.
- Selles, F., Campbell, C.A., Zentner, R.P., Curtin, D., James, D.C., Basnyat, P. (2011). Phosphorus use efficiency and long-term trends in soil available phosphorus in wheat production systems with and without nitrogen fertilizer. *Can. J. Soil Sci.*, 91(1), 39-52.
- SPSS.(2007). SYSTAT version 16: Statistics. SPSS, Chicago, IL.
- Tong, C., Xiao, H., Tang, G., Wang, H., Huang, T., Xia, H., Keith, S.J., Li, Y., Liu, S., Wu, J. (2009). Long-term fertilizer effects on organic carbon and total nitrogen and coupling relationships of C and N in paddy soils in subtropical China. *Soil and Tillage Research*, 106(1), 8-14.
- Zhang, J.B., Zhu, T.B., Cai, Z.C., Qin, S.W., Müller, C. (2012). Effects of long-term repeated mineral and organic fertilizer applications on soil nitrogen transformations. *European Journal of Soil Science*, 63(1), 75-85.
- Zhao, B.Q., Li, X.Y., Li, X.P., Shi, X.J., Huang, S.M., Wang, B.R., Zhu, P., Yang, X.Y., Liu, H., Chen, Y., Poulton, P.R., Powlson, D.S., Todd, A.N.D., Payne, R.W. (2010). Long-term Fertilizer Experiment Network in China: crop yields and soil nutrient trends. *Agron. J.*, 102(1), 216-230.

IMPROVING MANAGEMENT OF AGRICULTURAL WATER RESOURCES: TECHNICAL OPTIONS AND STRATEGIC OPPORTUNITIES

Atef HAMDY*, Adel ALY

International Centre for Advanced Mediterranean Agronomic Studies of Bari (CIHEAM-Bari), Valenzano (Bari),
Italy

*Corresponding author: hamdy@iamb.it

Abstract

In arid and semi arid regions water is the main constraint to agriculture sustainability and food security. Available information characterizing the water status in those regions evidently indicate that water scarcity will escalate with increasingly fall down in the available water resources particularly those allocated to the agriculture sector. In the context of overgrowing water resources scarcity to tackle the challenges of more efficient and sustainable agriculture water use, it is needed to have a sustainable water resources management strategy that is identifying and streamlining policies, governance and practice that can sustainably improve agriculture productivity and food security. In addition, on the national level, sustainable scarce water resources management should include a group of actions to put in place instruments for optimal water allocation between sectors and to ensure that water allocated for agriculture is used efficiently and productivity. The priority areas of actions should be evidence-based-to know what are the components of effective intensive structures that drive farmer behavior, reduce water consumption and support food production improvements. In this paper emphasis will be given to discuss the strategic opportunities to implemented for improving the scarce water resources management in the agriculture sector, as well as the technical options and innovative modalities to tackle the challenges of producing more with less water.

Keywords: *water scarcity. Water productivity, food security, water use efficiency, opportunities, challenges.*

Introduction

On the globe, many arid and semi-arid countries are facing twin challenges of water stress and food security – challenges that are already pressing and projected to grow (Rostrom et al 2009 and Folely et al 2011). Because crop production is the largest global consumer of freshwater, and because water is a key resource in food production, neither of these challenges can be addressed in isolation. Postel (2003); and Roohafken, and Stewart (2008). Improving crop water productivity and producing more food for each drop of water will be a crucial strategy to address both challenges (Molden, 2007, Abu-Zeid and Hamdy 2010).

In arid and semi arid countries it is well recognized that water scarcity will escalate and that available water resources must be managed more efficiently and sustainably than ever before. This involves actions in national level to put in place instruments for optional water allocation between sectors while providing the institutional and incentive frameworks for efficient and sustainable water resources management at agricultural sector to ensure that water allocated to agriculture is used efficiently and productively.

In arid regions including those of the Mediterranean, water is the binding constraint in agriculture. In addition as water resources are already over allocated and demand is rising from other sectors, improving productivity from existing water must be the principle path to agriculture growth. The pathways to sustaining agriculture growth whilst using less water can mainly be realized through further improvement in agriculture water management – more income for less drop.

In most arid and semi arid countries the key element for achieving both water and food security is fundamentally the function of how water is used and managed in the agricultural sector as agriculture is by far the largest water user, but, at present, it is fairly common to find that more than half of the amount of water withdrawn from the resource does not even reach the fields being irrigated. (FAO, 1993, 2003). Such water losses in enormous quantities is strongly pushing towards finding the appropriate approaches to improve the agricultural water management which it is undoubtedly considered a major conservation option in the future. (Hamdy et al 2002).

Here it should be clearly understood the water allocated to the agriculture sector to be managed more efficiently and sustainably there are significant challenges still remain in the areas of technological management and policy innovation and adaptation, human resources development, information transfer and social environmental considerations.

These issues can not be listed in any order of priority since their importance and relevance may well differ from one country to another, and also over time. Indeed, for most developing countries meeting water scarcity challenges through water saving, efficient use of irrigation water and increasing crop water productivity is still in need to a far greater effort and significant changes in: how is agriculture water is managed? What needs to be changed? What are the technical options and strategic opportunities required for improving agricultural water management?

Agricultural water management: The surrounding questions

In arid and semi arid regions there are several questions surrounding the sustainable use and management of scarce water resources. Among those raised questions, which are seeking for sustainable answers the followings:

- What are the advanced tools to be used to quantify the benefits and the costs of alternative policy options to address food insecurity while sustaining water resources?
- What are the institutional solutions and modern technologies to be adopted to increase the efficiency and productivity of water use in the different sectorial water use and particularly in the agriculture one.
- Which are the incentive frameworks should be established that reposition farmers at the centre of sustainable management of land and water resources.
- How to mainstream gender issues the backbone of strategic visions planning, reuse and management of water resources and management of water resources.
- How to meet this ample increase in water demand at a time when pressure on resources are increasing and their mobilization is becoming increasingly expensive.

The bottleneck and the master key for a reasonable answer to the above questions as well as to the problems deriving from the presence of such water imbalance are focused and they mainly depend on the way water is used and managed in the agricultural sector (Abu-Zeid and Hamdy 2010). The reason for that is not because of water losses exceeding 50%, while most of such water losses could be avoided through water saving and appropriate agricultural water management techniques.

However, for agricultural water management there are several questions to be asked: How efficient really is agricultural water management? How can productivity be boosted? And, how can gender responsive good practice be shared and built on?

Agricultural water management improvement: The difficulties

In most developing countries and particularly those suffering severe water shortage there are numerous difficulties facing appropriate water management and particularly in the agricultural sector due to a wide variety of factors including: (Water Bank, 2007)

- The overall economic situation in some of the countries due to tight budget constraints.
- Making it difficult to government supporting the adoption of better water and land management practices to improve and increase crop water productivity.
- The strategies to increase agricultural production and reduce land degradation to improve agricultural productivity are not location specific, and that at a given context, there are only a few win-win.
- Poor water governance and the incapability of the public institutions and organizations in implementing the world developments reports dealing with agricultural water productivity.
- In most of those countries governments have developed the resource and allocated water between sectors and to users but have not developed the flexible and participatory institutional mechanisms and accountability structures needed and sectoral water conflicts.
- In many areas where increases in water productivity are needed, knowledge exists, but institutional capacity and human capital are inadequate support the knowledge transfer needed to accelerate the adoption of new technologies that leads to increased yields and water productivity. (Hamdy 2016). According to (Lal 2007) in such cases, the top down approach to technology transfer is not effective and should be changed into participatory approach combining traditional knowledge with scientific technology.
- Lack of successful programmes provide for good water governance arrangements, with well designed institutions having clear authorities, the necessary resources and stability. Indeed, for many countries in arid and semi arid regions, water sector institutions are not always adopted to new technologies, innovation and the development of the resource.

Improving Agricultural water management: Important measures to be taken

In arid and semi arid regions water scarcity challenges could be met through improving water management in the agricultural sector (Hamdy 2000). However, there are several important measures to be taken among them:

- Create a broad consensus on the water reform agenda among all involved stakeholders.
- Acknowledge farmer's role in promoting a shift in the way water resources are used and managed.
- Involve the private sector as the actual manager of the food value chain and the supplier of the latest available technologies.
- Establish partnerships that are action oriented and result based
- Develop tools to concretely measure results and collect evidence to support policy making and decision making processes.

Practical approaches to improve crop water productivity in irrigated agriculture

Resources management strategies, in general are, coherent statements in directing how particular resource should be developed, and what is the approach that would have to be taken to achieve one or more management objectives successfully. Regarding the water management improvement in the agricultural sector, there are a certain number of strategic principles to be followed (Abu-Zeid and Hamdy 2010):

- The strategic options have to be cross-cutting in nature, therefore capable of securing highly integrated solutions, with the aim of involving a variety of interested socio-economic sectors as well as stakeholders;
- The proposed strategic options have to be, on one hand comprehensive enough to encapsulate most of the problems in water sectors in arid and semi arid conditions, as well as have a wide geographic coverage, however, the packages of actions in each of the options, on the other hand, have to allow for the possibility of a adjustment to local situation and conditions;
- The strategic options have to be based on assessment of local situations in order to find what are good existing practices and what could work in the future water resources management.

Options and strategic opportunities for improving agricultural management:

On farm water use efficiency and agricultural several practical approaches could be implemented to improve irrigated agriculture and to increase agricultural crop productivity among them the followings:

- Supporting high input irrigated production using high yielding varieties, fertilizers, pesticides and other inputs.
- Utilization of efficient technology micro irrigation systems, along with plastic houses are effective tools for improving the technical efficiency of irrigation. The effective role of both technologies to reduce evaporation and leakages can cut water use by 50 percent per hectare and still increase yields significantly showing that less can actually produce more.
- The development of best practices that could help, arid countries to establish an incentive framework for promoting water use efficiency and water productivity in agriculture.
- Reallocation of irrigation water supply to low water consuming and high value crops: Crop rotation is an essential part of proper irrigation water demand management, cropping pattern should be modified through the use of less water consuming crops and high value crops. In this regard new strategies are needed for changing cropping patterns to suit future water allocation, such strategies should be based on the availability of water supply and applied through economic reforms and structural adjustments.
- Irrigation techniques to meet insufficient water supply
 - Supplementary irrigation: Supplemental irrigation when water supply is insufficient to meet full crop water demand or too expensive, alternative strategies can be used, so called supplemental irrigation. Supplemental irrigation shown large potential to improve water productivity especially in semiarid and dry sub-humid cropping systems with high rainfall variability (Baron, 2004), however, such irrigation technique is not a common practice to supplement rainfed agriculture.
 - Deficit irrigation: The potential benefits of deficit irrigation in improving crop water productivity arise from enhanced water productivity and lower production costs if one or more irrigation application can be eliminated. However, the successful implementation of this technique implies that farmers should know the deficit that can be allowed at each of the growing stages and the level of water stress that already exists in the root zone.

- Water harvesting: Water harvesting is the collective name a range of technologies that aim to concentrate water flows and storage, either as in-situ technologies (in principal using the soil as storage for infiltrated rainfall), or in natural or manmade storage structures such as dams, ponds and tanks. With successful water harvesting techniques, over 50% of lost water can be recovered at relatively little costs (Oweis and Hachum. 2006).
- Conjunctive use of water supplies: The conjunctive water use is one of the approaches to be highly recommended in arid and semi arid regions where countries are suffering acute water shortages. It implies the combined use of water resources of more than one type resources their exploitation through efficient management in techno-economic terms by taking advantage of the interaction between them and the impact of one on the other.
According to Hamdy (2003), through the use of such approach there is high potentiality of improving irrigated agriculture productivity. Indeed, this approach provides high potentiality to the reuse and recycling of each drop of wastewater from the different sectorial uses and thereby providing additional water supply to the irrigation sector and reducing the fresh water use in this field. However, such technique in spite of the advantages it could provide in improving agriculture production and its productivity and good fresh water saving, yet, in most countries suffering water scarcity, the conjunctive water use is rarely practiced.

Improving water management in the agricultural sector: Potential tools

Mobilizing new supplies

In arid and semiarid countries and particularly those of the Mediterranean although most resources are fully developed, there may some potential to develop further storage and optimize release on existing storage. (Hamdy 2003 and Abu-Zeid and Hamdy 2004). However the economic and environmental tests for new development will be hard to pass. Such option will need to be flexible and have low capital operating costs. In this regard(FAO 2007) showed that local hill dams, water harvesting and on farm water storage may prove to be the most economical solution.

The reuse and recycle of treated wastewater and brackish/saline water.

In arid and semiarid countries the reuse of treated wastewater is a fundamental option to fulfil water scarcity in the agriculture sectors. In those countries as cities grow and invest in treatment plants, the resource will increase and can provide a useful –if relatively modest- new source for agriculture. It is a renewable resource, increases day by day, provide energy and supply the needed fertilizers for the growing crops and above all is not affected by climate changes. (Hamdy and Eslamian, 2016).

However, for this source there are barriers of costs, location and incentives to overcome, and a regulatory framework and workable incentive structure are required

Drainage water, brackish saline water and ground water.

For those saline water resources there is a high potentiality to be sustainably used in irrigation. However, to be successfully used In the agriculture sector, it is needed to have in hand an appropriate integrated crop, water, soil management to avoid losses in crop production and maintain soil at a high productivity level without degradation. (Hamdy 1998).

Here it is to be stressed that the potential and the sustainable use on a large scale of the non-conventional water resources (Municipal treated wastewater and saline brackish water) vary by country and from one location to other and for great number of countries there is an urgent need

that each country should have a legal, regulatory and incentive frame work to ensure the sustainability of the use and reuse of such water resources. (Hamdy and Ragab 2005)

Rapid depletion of this vital water resource accompanied by deterioration of water quality and saline intrusion. Sustainability of groundwater quantity and quality with equitable access implies that the country should have: (Romani 2006) i) a rights and regulations approach; ii) an incentive structure to favour conservation and efficiency, iii) decentralization groundwater resource management to the local level supported by iv) monitoring, information, education and communications.

Improving agricultural water management in the Mediterranean: the need for regional cooperation

The development of a regional collaborative strategy focusing on policies, investments and practices that are necessary to sustainable intensification of agricultural production under water scarce conditions.

Such regional collaboration could contribute to improving water scarcity management in the agriculture sector. This collaboration might cover in particular: sharing of data, information and knowledge on agricultural water management, best practices in governance and institution building, benchmarking, research and development, capacity building; technical cooperation, and awareness raising. Furthermore, regional cooperation could be very helpful in providing:

- A regional collaborative review on the implications of the energy/water/food nexus,
- Regional programme on research and development, capacity building and technical cooperation.
- Assessment on yield and water productivity gaps through modern technologies,
- Synergy and joint work across the region in research, exchange of experiences and best practices, etc.

Concluding remarks and recommendations

- In countries suffering shortage in their available water resources efforts should be directed to improve agricultural water management. In the context of those countries should clearly identify: governance reform, economic, institutional and technical options and innovation to tackle the challenges of more efficient and sustainable agricultural water use.
- Within the agricultural sector, strategic opportunities exist for improving management of water resources including: improving water use efficiency and crop water productivity, irrigation modernization, rainfed agriculture enhancement, improved water shed and dry land management, sustainable use of non conventional water resources.
- Improving management of agricultural water resources the priority areas for action should focus on technology and institutions for increasing crop water productivity through: promoting research, innovation and strategies for risk reduction; institutional adaptation accompanying technological innovation; joint monitoring of climate change trends and development of adaptive strategies and introducing innovation sources for financing.
- At community level improvements in agriculture water management by increasing water productivity could be achieved through including conserved agricultural practices, deficit and supplementary irrigation production packages, grey water system for irrigation and establishing water saving knowledge and innovation platform and improving the institutional capacity building.
- Strengthening governance and institutions, integrated approach to water resources management, decentralization and participation, supply side management; demand side management and the

establishment of an incentive frame work are recommended priorities to be put in action to improve agricultural water management in arid and semi arid countries.

- Although there are no simple solutions to the water scarcity, there are smart choices, it is needed to inject innovative thinking into the way water resources are used and managed for the benefit of the food security. Equally, promoting cost effective water investments and management practices is a highly recommended option to be carefully considered.
- Irrigation managers, water specialists, and decision makers as well recognise that if we succeed in increasing water productivity in the irrigation sector through implementing intelligent water conservation and demand management installing efficient and institutional incentives to shift water among users, then new sources of water supply to irrigation can largely be avoided in many countries where water scarcity is rapidly growing.
- Climate change will have a negative impact on agriculture water availability and will increase farmers' vulnerability at regional and national level research should be strengthened on modelling and monitoring and the preparation of adaptation strategies.

References

- Abu-Zeid, m. and Hamdy, A. (2010). Water Crisis in the Arab World: Analysis and solutions.in. Encyclopedia on water resources development and management in arid and semiarid regions of the arab world (eds. Abu-Zeid, M and Hamdy, A.).Volume 1.pp5-91.
- Abu-Zeid, M. and Hamdy, A. (eds). (2010). Water Food and Agricultural challenges in the Arab world. In: Encyclopedia on water resources development and management in Arid and Semi-arid regions of the Arab world. Vol 3: 299.
- Abu-Zeid. M and Hamdy, A. (eds) (2004). Water crisis and food security in the Arab world: where we are and where do we go. Cairo, Egypt, 14 April 2004. Pp: 76.
- Barron, J. 2004. Dry spell mitigation to upgrade semi-arid rainfed agriculture: Water harvesting and soil nutrient management for smallholder maize cultivation in Machakos, Kenya. Doctoral thesis in Natural Resource Management. Department of Systems Ecology Stockholm University 106 91 Stockholm SWEDEN, pp 1 -38.
- FAO (1993). The state of food and agriculture 1993. FAO. Rome.
- FAO (2003). Unlocking the water potential of agriculture. Pp. 62.
- FAO, (2007). Coping with water scarcity. Chalanges of the twenty-first century. UN water, FAO 2007).
- Foley, JA. Et al (2011). Solutions for a cultivated planet. Nature, 478: 337-42.
- Hamdy A. (2016). Crop water productivity improvement as an appropriate response to water scarcity challenge. In proceeding 4th African regional conference on irrigation and drainage (ARCID). Egypt. Aswan. 26-28 April, 2016.
- Hamdy, A. (1998). Saline irrigation management for a sustainable use. In proc. Advances short course on sustainable use of non conventional water resources in the Mediterranean region. Aleppo, Syria, 18-30 April, 1998.
- Hamdy, A. (2000). Water resources management in the Mediterranean countries: Priority actions. Development and agri-food policies in the Mediterranean region. Annual report, 2000, 133-159.
- Hamdy, A. (ed) (2003). Regional action programme (RAP). Water resources management and water saving in irrigated agriculture. Option Mediterranean series B: studies and research n° 44: PP 255.

- Hamdy, A. and Ragab, R (2005). Reuse of treated wastewater in irrigation: challenges and prespectives. In: R. Ragab and S. Koo-Oshima (eds). International workshop of environmental consequences of irrigation with poor water quality. Center for ecology and hydrology. Kuala Lumpur. Malaysia. Pp. 3-28.
- Hamdy, A; Lacirignola, C. and Trisorio, Liuzzi, G. (2002) the integration of soil and water resources management towards sustainable agricultural development in the Mediterranean. Options Mediterraneans, serie A. Mediterranean seminar. No. 50. 11-27.
- Hamdy,A and Eslamian, S. (2016). Sustainable reuse and recycling of treated urban wastewater. In Urban Water Reuse Handbook. Ed: Saeid Eslamian. Vol. 80. Pp 1049-1064.
- Lal. R. (2007). Tragedy of the global commons. Soil water and air. CSA news. 52 (10): 10-11. American society of agronomy Madison, Wisec.
- Molden, D. (2007). Water for food, water for life: A Comprehensive Assessment of Water Management in Agriculture. London, UK: Earthscan/ James and James.
- Oweis, T., and Hachum, A., (2006). Water harvesting and supplemental irrigation for improved water productivity of dry farming systems in West Asia and North Africa. J. Agricultural Water Management , 80, 57–73.
- Postel, S. L. (2003). Security water for people, crops and ecosystems: new mindset and new priorities. Nat. Resour. Forum 27 (89 – 98).
- Rockstorm et al. (2009). Conservation farming strategies in East and southern Africa: Yields and rain water productivity from on farm action research. Soil Tillage Res. 103 (23-32).
- Romani, S. (2006). Groundwater Management-Emerging challenges-Governance- Ownership of groundwater and its pricing. Proceedings of the 12th national symposium on hydrology. New Delhi, November 14-15.
- Roohafken, P. and Stewart, B. A. (2008). Water and cereals in dry lands, food and agricultural organization, Rome, and Earthscan, London.
- World Bank (2007). Making the most of scarcity. Accountability for better water management in the Middle East and North Africa.

THE REDUCTION OF NICOTINE CONTENT IN THE COMPOSTING PROCESS OF TOBACCO WASTE MIXING WITH SHEEP AND CHICKEN DROPPINGS

Gordana KULIĆ*, Nemanja MANDIĆ, Vesna RADOJIČIĆ, Maja MALNAR

University of Belgrade, Faculty of Agriculture, Nemanjina 6, 11080 Belgrade-Zemun, Serbia

*Corresponding author: gkulic@agrif.bg.ac.rs

Abstract

Due to the rise of industrialization and urbanization, the amount of waste is gradually increasing as well, both in developed and developing countries. Tobacco waste generates in all processes it starts in the field and ends up with the production of cigarettes. The total global tobacco waste production in the year 2005 was more than 25.1 million tons. In our experiments we used Virginia tobacco waste (TW) after processing, as well as sheep and chicken drop pings. Two experimental samples were formed according to the following scheme: I 50% TW + 50% sheep drop pings, II 50% TW + 50% chicken drop pings. The comparison is made with the reference sample (100% TW). The experiment was conducted at the experimental farm of the Faculty of Agriculture, under natural conditions, in the open, during a three months period. The nicotine content in the samples was determined by a HPLC method. At the beginning of the experiment, the nicotine content in the tobacco waste was 17 363 mg/kg. By adding sheep and chicken droppings, nicotine content decreased by 66.5%. At the end of the research, nicotine content as dropped below 10mg/kg in both experimental samples. The results confirmed that the organic material, sheep and chicken manure, can be successfully used for composting of tobacco waste, primarily in order to reduce the nicotine content. Composting can be done in the open air and on the site where the waste is made, thereby it reduces energy costs, and what's the most important – the costs of the transport.

Keywords: *composting, tobacco waste, sheep droppings, chicken droppings, nicotine.*

Introduction

The organic solid waste poses a serious threat to the environment. Biological technologies for treating waste materials, between where composting is also classified are considered clean and sustainable methods for organic waste management. Compost production has gained popularity, due to the fact that it is a method by which we can reduce pressure on landfills, extend their use, and minimize environmental pollution. It is the raise in environmental awareness among the society in recent years that caused the increase in people's interest in composting process, so as to prevent or reduce environmental pollution and establish sustainable management of the waste (Radojičić et al., 2009). Composting process can degrade various types of organic waste (Lim et al., 2016).

Composting is a biological decomposition of organic matter, caused by microorganisms in aerobic conditions. Composting process leads to stabilization of biodegradable waste (wet and solid organic matter, food waste, garden waste, paper, cardboard, etc.), and to the formation of a stable product, compost (Jovičić, 2006). This process can be conducted in controlled, partly controlled and uncontrolled environmental conditions. Composting is an acceptable solution, as it reduces the volume (mass) of the organic waste, whereas the material becomes a stable product at the end of the process, which can be used as an organic fertilizer. A substrate with optimal

physical and chemical characteristics for composting can be formed by mixing two or more types of biodegradable waste (Kopčić et al., 2013).

Agriculture production and industry generates large amounts of solid waste that may be suitable substrates for composting. The total global tobacco (*Nicotiana tabacum* L.) waste production in the year 2005 was more than 25.1 million metric tons (Radojičić et al., 2015). Tobacco waste, which is generated in all processes, from tobacco production in the fields to cigarettes manufacturing, accounts for a significant percentage of the agro-industrial and municipal waste in Serbia (Radojičić et al., 2009). According to the principle of extended responsibility, producers of tobacco products can be held responsible for the collection, transport, processing and safe disposal of tobacco products (Curtis et al., 2016). The main characteristics of the tobacco waste are high value of the total organic carbon (TOC), as well as high contents of nicotine, which is a toxic compound (Civilini et al., 1997).

According to Waste Catalogue issued by the Ministry of Environment and Spatial Planning and the Agency for Environmental Protection of the Republic of Serbia (Waste Catalogue, 2010), tobacco is categorized as nontoxic waste. While this waste is not classified as dangerous, neither as inert, it cannot therefore be disposed of to landfill without treatment (Radojičić et al., 2009).

According to EU Directive nicotine content above 500 ppm declares this waste into the category of hazardous waste (Radojičić et al., 2009). Also, due to the high solubility of nicotine in water, there is a serious risk that, when the waste material is kept, nicotine can be flushed out of the waste and get to the groundwater, which is a particular threat to the environment and human health. For these reasons tobacco waste cannot be disposed of together with urban waste (Pichtel, 2005), but must be destroyed under special conditions, which is an economic burden for tobacco producers and processors.

Previous research has found that the tobacco waste can be used as fertilizer because of its high content of organic matter and low content of toxic elements. But it first needs treatment, because in its original form (primarily due to its content of nicotine) it still toxic (Radojičić et al., 2009, Radojičić et al., 2008). As such it affects human health and the environment.

To release the tobacco waste from toxic elements, primarily nicotine, the composting process is the optimal solution. Clean scrap tobacco has a detrimental effect on the microbial activity in the soil, but compost can stimulate them, primarily due to a significant content of trace elements.

Radojicic et al. examined the possibility of growing mushrooms on compost prepared from tobacco refuse. They found that it is possible to perform microbiological degradation of nicotine in tobacco waste and turn it into such a relatively neutral plant material like any other plant waste. As such, it can be successfully used for producing compost for mushroom growing (Radojičić et al., 2008).

An experiment which was conducted in South Africa examined the changes that have taken place during the composting of solid waste tobacco, along with other types of organic waste (Adediran et al., 2006). By mixing tobacco waste with other organic waste and their dilution, nicotine content was reduced from 12180 mg/kg to 4872 mg/kg, while the composting process further reduced nicotine content to less than 160 mg/kg. The results of the experiment showed that the obtained compost is very suitable for use in horticulture.

In the experiment of Turkish scientists in Izmir in 2006, they treated the land on which one sort of lettuce was cultivated with compost derived from tobacco waste and manure, in different scales, in order to examine the impact of this kind of organic fertilizers on the biological properties of the soil and the growth of lettuce (Okur et al., 2008). Following mixtures were made: TWC 25% + 75% FYM; 50% + 50% TWC FYM; TWC 75% + 25% FYM and TWC 100% and 100% FYM (TWC - tobacco waste compost, and compost derived from tobacco waste

FYM - farmyard manure). Composting is carried out in the open, or under the roof. It has been found that the microbial biomass increased by using all the proportions of compost, and the results indicate that compost waste tobacco is a good alternative to recharge and improve soil characteristics (Okur et al., 2008).

The reasoning for this research was the problem of unused tobacco waste in the Republic of Serbia, expensive process of destruction under strictly controlled, legally prescribed conditions as well as the uncontrolled disposal, with the aim of revitalizing the waste in accordance with the requirements of environmental protection. The goal of this study was to examine the possibilities of reduction of nicotine content through the process of composting, waste mixing tobacco with sheep and chicken droppings.

Materials and methods

Virginia tobacco leaves, which are declared as waste after redrying process, were used for the purposes of the experiment. Sheep and chicken droppings were used as components in experimental batches. Experiment was carried out during the period of three months: begin of March – end of May. The experiment was conducted at the experimental farm of the Faculty of Agriculture, University of Belgrade (Serbia).

Preparation of experimental batches - Tobacco waste was stirred with sheep and chicken droppings. For the purposes of the experiment the following compost batches were formed:

Table 1. Compost batches ingredients (%)

Composting batch	TW	Sheep droppings	Chicken droppings
1	50	50	/
2	50	/	50
R	100	/	/

TW – tobacco waste

R–control sample

Composting is carried out in the open, under the roof. Aeration is provided by manual tumbling, and humidity is kept constant. The batches were covered with leaves to maintain moisture. The process was completed in three months, when the temperature of compost achieved the same value as the outdoor temperature.

Analysis of nicotine content in samples experimental batches- Nicotine content in the batches (at the beginning and at the end of the experiment) was determined by High Performance Liquid Chromatography method (HPLC, Waters Breeze, USA).

The method applied in this analysis involves water extraction of the milled material followed by separation of the alkaloids on reverse-phase C18 column with a mobile phase of 40% methanol containing 0.2% phosphoric acid buffered to pH 7.25 with triethylamine. This procedure allows the quantitative analysis of four "major" alkaloids in tobacco and may it be partially automated as to handle a larger number of samples (Saunders and Blume, 1981).

Results and discussion

Table 2 shows the results of the nicotine content in experimental batches.

Table 2. The nicotine content in experimental batches (mg/kg)

Composting batch	Initial value	Final value
R	17363.0	5132.0
1	5790.0	<10
2	5812.0	<10

The initial content of nicotine in tobacco waste was 17363 mg/kg. Already by mixing tobacco waste with other organic waste, the nicotine content decreased by 66.6% in the first batch of compost, and 66.5% in the second. This percentage decrease is even higher when compared with the literature data (Adediran et al., 2006). The experiment which was conducted in South Africa examined the reduction of nicotine in tobacco during composting of solid waste. Mixing tobacco waste with other organic waste reduced the nicotine content from 12180 mg/kg to 4872 mg/kg, with a single dilution (Adediran et al., 2006), which accounted for 60% reduction.

At the end of the experiment, after three months, the nicotine content decreased below 10 mg/kg, in both experimental batches, which is far below the value specified by the European Directive (Radojičić et al., 2009). In a previous study conducted by authors from Serbia ((Radojičić et al., 2015). the process was carried out under partially controlled conditions, also lasted three months. Also, the results obtained in this study were far better than in previous studies, where the composting process decreased the nicotine content in the waste below 160 mg/kg (Adediran et al., 2006).

Our results confirm that the organic material, sheep and chicken droppings, can be successfully used for composting of tobacco waste, primarily in order to reduce the nicotine content.

In experimental batches of compost in addition to reducing nicotine there was a loss of weight (Table 3).

Table 3. Loss of mass during the composting process

Composting batch	Initial mass (kg)	Final mass (kg)	Loss (%)
1	10	3,30	67
2	10	3,50	65

Based on these data we can see that the weight loss of the samples was approximately equal among all samples, or that it was slightly higher in the compost batch number 1. In the first batch the weight loss was 67%, while in the second one it was 65%.

Conclusion

Given that tobacco waste accounts for a significant part of the total agro-industrial and municipal waste in Serbia it is necessary to examine the possibilities of its use. Tobacco waste, as a specific type of agro-industrial biodegradable waste, with the use of composting process can be converted in to a product that has practical agricultural value.

Based on these results, it can be concluded that, already by mixing tobacco waste with sheep and chicken droppings, nicotine content decreased by 66%. Nicotine content at the end of experiment

dropped below 10 mg/kg in both experimental compost batches, which is far below the 500 mg/kg - the value prescribed by the EU directive.

The results of the experiment showed that biodegradation of tobacco waste, by mixing it with chicken droppings and eggs and composting it, can be an effective method of removing nicotine. That way the obtained organic material can be used without posing a risk to the environment.

The importance of this experiment lies in the fact that the process of biodegradation can be carried out in natural conditions. Regardless of the longer duration of the process, it does not require a high economic investment. Also, this experiment has proven the fact that the composting process can take place on the site where the waste is disposed, which can lead to saving on the transport costs.

References

- Adediran, J. A., Mnkeni, P. N. S., Mafu, N. C., Muyima, N. Y. O. (2006). Changes in chemical properties and temperature during the composting of tobacco waste with other organic materials, and effects of resulting composts on lettuce (*Lactuca sativa* L.) and spinach (*Spinacea oleracea* L.), *Biological Agriculture & Horticulture*, AB Academic Publishers.
- Civilini, M., Domenis, C., Sebastianutto, N., et al. (1997). Nicotine decontamination of tobacco agro industrial waste and its degradation by micro-organisms. *Waste Manage Res.* 15, 349-58.
- Curtis C., Novotny E T., Lee K., Freiberg M., McLaughlin I. (2016). Tobacco industry responsibility for butts: a Model Tobacco Waste Act, *Tob Control* Published Online First, doi: 10.1136/tobacco control-2015-052737.
- Jovičić N. (2006). Solid Waste Management, The script, Faculty of Mechanical Engineering,
- Kopčić N., Vukovic Domanovac M., Kučić D., Briški F. (2013). Evaluation of laboratory scale in vessel composting of tobacco and Apple waste, *Waste Management* 34, 323-328.
- Lim L. S., Lee H. L., Wu Y. T. (2016). Sustainability of using composting and vermin composting technologies for organic solid waste biotransformation: recent overview, green house gases emissions and economic analysis, *Journal of Cleaner Production*, Vol. 111, Part A, 262-278.
- Okur, N., Kayikçioğlu, H., Okur, B., Delibacak, S. (2008). Organic amendment based on tobacco waste compost and farmyard manure: influence on soil biological properties and butter-head lettuce (*Lactuca sativa* L. var. *Capitata* L.) yield. *Turk. J. Agric. For.* 32, 91-99.
- Pichtel J. (2005). *Waste Management Practices: Municipal, Hazardous and Industrial*, CRC Press, Taylor & Francis Group, London
- Radojčić, V., Milošević, M., Tomašević, B. (2009). Tobacco waste management in Serbia. *Ecological truth* 09, Proceedings, 218 -221.
- Radojčić V., Mandić N., Ećim-Đurić O., Raičević V., Lalević B. (2015). Reducing the nicotine content through tobacco waste composting with other organic materials., *Sixth International Scientific Agricultural Symposium "Agrosym 2015"*, Book of Proceedings, 1462-1467.
- Radojčić, V., Nikolić, M., Ićitović, S. (2008). Some possibilities of tobacco waste utilization, *Ecological truth* 08, Proceedings, 481-484.
- Saunders, J. A., Blume, D. E. (1981). Quantitation of major tobacco alkaloids by high performance liquid chromatography. *Journal of Chromatography*, 205, 147-154.
- Waste Catalogue (2010). Ministry of Environment and Spatial Planning and the Agency for Environmental Protection of the Republic of Serbia. [in Serbian].

PHYSICAL AND CHEMICAL CHARACTERISTICS OF RAW WASTEWATER FROM MEAT PROCESSING PLANTS IN ALBANIA

Ilirjana BOCI*, Xhuljeta HAMITI, Sonila VITO

Department of Industrial Chemistry
Faculty of Natural Sciences, University of Tirana, Albania

*Corresponding author: ilirjanaboci@yahoo.com

Abstract

Food industry is a large consumer of water, both as an ingredient as well as for technological purposes. Though food industry doesn't pose any severe environmental threatening in soil or air pollution it produces a large quantity of wastewater which needs to be treated before their discharge in the surrounding environment. In particular, the meat processing industry is one of the major consumers of freshwater besides food and beverage processing facilities, which makes meat processing plants a significant producer of wastewater effluents. Such effluents characterized by high chemical oxygen demand, biological oxygen demand, nutrients, and organic and inorganic contents, if discharged without proper treatment, pollute severely receiving water bodies and disrupts complete ecosystem. Thus, appropriate treatment methods are required to meet the effluent discharge standards. This paper presents the data obtained from the physical chemical analysis performed in wastewater effluent produced from meat processing plants in Albania. Frequent wastewater samplings have been made according to peak plant production. The daily composite samplings have been made to the effluent flow before mixture with the municipal waste water. All samples were analyzed in duplicate for COD, BOD, suspended solid content, pH, chlorides, total nitrogen and phosphorus, oils and grease content. Analyses were done according to methods outlined in Metodi Analitici per le Acque (APAT). The data collected were compared to the existing Albanian Norms outlined in the respective Albanian Regulation for meat processing plants and some alternatives for effluent wastewater treatment are given as well.

Keywords: *meat processing plant, wastewater, effluent, characteristics, effect.*

Introduction

All food sectors including fruit and vegetables; meat, poultry, and seafood; beverage and bottling; and dairy operations consume huge amount of water for processing food. A considerable part of these waters are potential wastewaters to be treated for safe disposal to the environment. There are typical rates of water use for various food-processing sectors. An abundant and inexpensive source of water is a requirement for success in the food-processing industry.

The main constituents of food processing wastewater is often complex to predict because of highly biodegradable organic matter presence and often varietal seasonal nature of processing plants (Christian, 2010)

The meat industry covers slaughterhouses and cutting plants as well as meat products (fresh, cured, or cooked) manufacturing plants. However, these are generally separated into slaughterhouse/cutting plant and manufacturing plant. The meat processing industry uses 24% of the total freshwater consumed by the food and beverage industry and up to 29% of that consumed by the agricultural sector worldwide (Bustillo – Lekompte & Mehrvar, 2015).

From an environmental viewpoint, the production of wastewater differs markedly depending on the type of installation concerned. Thus, whereas slaughterhouses/cutting plants generate large volumes of wastewater with a high organic load, production at manufacturing plants is lower and tends to remain fairly constant over time.

For meat processing plant blood is the main constituent, having a chemical oxygen demand (COD) of 375 000 mg/l. Such wastewater contains as well large quantities of oils and fats, grease, and solid suspended in particular (Christian, 2010).

Killing animals and rendering processes create blood by-products and waste streams, which are extremely high, even in BOD. Waste streams vary per facility, but they can be generalized into the following: process wastewaters; carcasses and skeleton waste; rejected or unsatisfactory animals; fats, oils, and greases (FOG); animal feces; blood; and eviscerated organs.

As can be seen wastewater is generated during almost all the processes involved as well as when cleaning the installations. The final volume produced is high and it has been estimated that around 5 liters of water is required per kilogram body weight for the live animal. (Wastewater Treatment for Meat Processors, 2015) The MPWW (meat processing wastewater) generated generally carries with it slurries, meat remnants, blood, hair, pieces of entrails, and surface fat, which together mean that the water has a content of organic matter, material in suspension, oils and fats, nitrogen (ammonia and organic), phosphates, and detergents and disinfectants used during cleaning. In addition, the load in the wastewater varies markedly depending on the time of day and even from one hour to the next.

Typical parameters related to the organic matter and nutrient content of the effluent generated in a meat processing plant are COD (mgO_2/L), BOD₅ (mgO_2/L), solids in suspension (mg/L), total nitrogen (mg N/L), total phosphorous (mg P/L).

The aim of our study was the inspection of wastewater in the meat and poultry sector, specifically the main physical characteristics of untreated water from meat processing plants near the seaside region in Albania. The basic analysis consisted to estimate pH, TSS (Total Suspended Solids), BOD (Biological Oxygen Demand) COD, TN, TP and FOG (Fats, Oils and Greases) levels connected with the expected total volume of wastewater output each day.

The analysis results may be used as a good start, first to know specifications of meat processing wastewaters in terms of standards limit levels and second to properly set either to municipal wastewater treatment facilities, or if the meat processing plant facility need to develop its own treatment options.

Materials and methods

The target of this study were two of the main meat processing plants in Kavaja city situated near the Albanian seaside with wastewater pouring to a water stream followed next into the sea. These plants consume approx. 3 lt water/kg product, which is high taking into consider the large production rate of both plants. The research was done during March-June 2016 period in order to know and make an overall estimation of the characteristics of meat processing wastewater and to estimate the potential pollution to the receiving surface water. The wastewater samples were collected at the outlet plant wastewater line. It had not undergone any preliminary treatment before discharge.

The sampling was made four times during this period and was analyzed in duplicate for BOD₅, COD, total suspended solids, pH, chloride, P as P₂O₅, organic nitrogen and fat, grease & oil content (FOG). All the samples have been taken more or less at the peak time of plants operating hours in order to properly estimate the maximum environmental risk of wastewater produced. Sampling was made according to the detailed procedure described in literature (Metodi Analitici

per le Acque) and stored at proper temperature until next day when it was not possible testing the same sampling day. Analyses were done mainly according to Metodi Analitici per le Acque for BOD, COD and TSS and according to methods described fully in the text book (Cullhaj A. 2010.) for pH, Chloride content, E_{redox} , organic nitrogen, phosphate content as P_2O_5 .

Results and discussion

The experimental results of physicochemical characteristics of wastewater generated from the two meat processing plants, taken into consideration in this research, are presented in table 1. Degree of wastewater pollution is shown by the mean values of pollution indicators: COD, BOD, total suspended solids, pH, chlorides, total organic nitrogen and total phosphorus. No significant difference in values obtained which could affect on the conclusions drawn, was noticed during the four months period of study.

Table1 Physicochemical characteristics of meat processing plant wastewater.

	Pollution indicators	Unit of measure	Mean value
1	COD	mg/l	1200
2	BOD ₅	mg/l	980
3	TSS	mg/l	480
4	pH	pH unit	7.14
5	Chlorides	mg/l	144
6	Nitrogen organic	mg/l	280
7	FOG	mg/l	650
8	Phosphorous as P_2O_5	mg/l	20
9	Potential redox	mV	-20

From the data obtained, especially for BOD/COD ratio = 0.81 we can presume that the raw wastewater from meat processing plant are highly biodegradable.

Table 2 Permissible norms of the wastewater from foodstuff production plants (Meat production & processing plants)

Indicators	Albanian norms	EU norms
pH	69	
Total suspended solids	50 mg/l	35 mg/l
BOD ₅	50 mg/l	50 mg/l
COD	250 mg/l	125 mg/l
FOG	10 mg/l	
Total nitrogen	10 mg/l	10 mg/l
Total phosphorous	5 mg/l	

Comparing these data to the Albanian permissible norms outlined in the Decision nr.177 dated 31.03.2005 of the Council of Ministers and the respective EU norms shown in the Table 2 we can make the following comments and discussion.

Considering the table nr.1, the level of some indicators as BOD₅ and COD shows the high content of the biodegradable matter consequently we can say that the wastewaters of these two factories may be classified as considerably polluted. Direct discharge of raw MPWW effluents to a water body is impractical due to their high organic strength. An easy way for treatment would be the *Septic Systems* that in Albania have started with other plants. Anyway a typical septic system will probably not properly work for most meat processing plants because of the high levels of BOD, TSS in the wastewater. So the meat processing plants need to consider other options like connecting to municipal wastewater services, building a pond or lagoon system, building a constructed wetland, especially in case of small or low wastewater discharges. Anyway the most used option for wastewater in meat processing plants is the connection to municipal wastewater system only if they will be submitted to treatment in wastewater treatment plant. (Wastewater Treatment for Meat Processors 2015) Unfortunately this is not the case for most of the meat processing plants located far from these wastewater treatment plants in Albania, so most of the producers discharge the wastewater to raw municipal wastewater without further treatment being so a serious potential for water pollution. It results that meat processing plants in Albania should find alternative ways in order to comply with permissible norms according to Legislation. Considering the considerable content of N and P compounds specific for meat processing plants we can say that biological combined with chemical method should be applied to minimize the potential risk to the environment. It is interesting to note the higher value of N-compounds compared to permissible norms which is characteristic of meat processing and the lower value of P-compounds which mostly is derived from the detergents used in the plant for sanitary purposes and partly from the polyphosphate used as binder in meat processing technology.

Literature used for the recommended treatment methods for meat wastewater processing plants offer similar technologies used in municipal wastewater and they include conventional treatments such as preliminary, primary, secondary, and even tertiary treatment. The most recommended treatment system for MPWW should be based on the design of a complete system involving water pretreatment to remove large and small solids, along with oils and fats. Screens and fat traps are the minimum means of pretreatment in any system considering the high value of FOG content specific for meat processing industry. MPWW management methods after preliminary treatment are various, but they can be divided into five major subgroups: land application, physicochemical treatment, biological treatment, AOPs, and combined processes. (Bustillo – Lekompte & Mehrvar, 2015) Flotation, in some cases aided by chemical addition, may also be carried out to remove suspended solids and emulsified fats.

The choice of an appropriate biological treatment system will be influenced by a number of factors, including wastewater load and the need to minimize odors. Extended aeration is an effective form of treatment, but care must be taken to minimize odors. Disinfection of the final effluent may be required if high levels of bacteria are detected. Ponding is a simple solution but requires considerable space. Chemical methods, usually based on chlorine compounds, are an alternative. If the biological treatment is anaerobic, the biogas generated can be used to produce electrical energy, thereby reducing the overall consumption of the installation. (Bustillo – Lekompte & Mehrvar, 2015)

Conclusion

Wastewater generated from monitored meat processing plants contains high concentration of degradable organic matter. However the amounts of the pollution indicators varies within a wide range depending from production rate, degree of the water managements policies applied and seasonal fluctuation of the production.

Based on the results collected and fact that companies have not undertaken all the necessary precautions which will allow adequate treatment of the produced wastewater, we can conclude that the reduction in fresh water needs and minimization of the environmental impact of the site is of high importance and measures should be taken to minimize the overall environmental and economic cost of fresh water quantity used and wastewater treatment.

Some treatment options for the considered meat processing plants are available in literature. The simplest option could be the connection to municipal wastewater treatment plant.

Both plants under study are located near these services, so it will probably be worth it to pay the initial connection fees and monthly costs rather than build and manage their own wastewater treatment system. Septic system is another option though it doesn't properly work for such high value of wastewater BOD and COD. Other technologies are fully described in the literature which can be widely used in meat processing plants successively.

Acknowledgment

The authors express their gratitude to the managers and the staff of the meat processing plants in Albania who gave their unsaved assistance for sampling, as well as for willingness & interest to discuss for collaboration in the future for their wastewater treatment options.

References

Bustillo–Lekompte C.F.&MehrvarM.September(2015).Slaughterhouse wastewater characteristics treatment and management: A review on trends and advances. *Journal of Environmental Management* (161) (pg. 287-302)

Christian O. Characteristics of the untreated wastewater produced by food industry (2010)

Analele Universității din Oradea, Fascicula: Protecția Mediului, Vol. XV, (pg. 709-714)

Cullhaj A. Kimia e mjedisit- Universiteti i Tiranes, Fakulteti i Shkencave te Natyres (2010)

Metodi Analitici per le Acque (APAT). Metodi analitici per le acque. Metodi di Campionamento Manuali e Linee Guida 29 (2003)

Wastewater Treatment for Meat Processors www.nichemeatprocessing.org updated on September 9 (2015).

CHARACTERISTICS OF SOIL AROUND THE MAIN DUMP IN NOVI SAD (SERBIA) AND PROPOSAL FOR ITS RECULTIVATION

Ljiljana NEŠIĆ¹, Dunja KRSTIĆ¹, Lazar PAVLOVIĆ^{1*}, Milivoj BELIĆ¹, Jovica VASIN²,
Vladimir ĆIRIĆ¹

¹University of Novi Sad, Faculty of Agriculture, Novi Sad, Serbia

²Institute for Field and Vegetable Crops, Novi Sad, Serbia

*Corresponding author: lazar.pavlovic@polj.uns.ac.rs

Abstract

One of the biggest potential sources of environmental pollution are dumps. Soil around dumps can be considered as a buffer zone, which retains different types of pollution generated in the process of decomposition of waste. This paper presents the results of analyzes of soil characteristic, located around the main dump in Novi Sad, Serbia. Soil sampling was done at two depths of 0-30 and 30-60 cm, at two sites near the dump. Also, one sample was taken from the sludge in the canal, which drains atmospheric water from the dump. Based on results it can be said that tested soil, around the dump belong to the texture class loamy coarse sand, it is characterized by an alkaline reaction (pH in H₂O of 8.43 to 8.61), it is very carbonate (from 7.87% to 9.11% CaCO₃). Also it has very low content of humus, nitrogen, and medium content of and potassium. Content of microelements (Cu, Zn, Co, Mn) and heavy metals (Pb, Cd, Ni, Cr, As, Hg) in all tested samples is significantly lower than the maximum permissible concentrations (MPC) and is at the level of the value of heavy metals in the soils of the wider area of Novi Sad. Based on these results it can be concluded that the land near dump are not contaminated with heavy metals. Considering a highly favorable chemical properties of mud it should be considered the possibility of using the sludge in the future recultivation in terms of increasing soil fertility around dump.

Keywords: *Dumps, soil characteristics, recultivation*

Introduction

With a rapid urbanization and development of cities with massive migration of citizens from rural to urban areas has led to a large increase in population on a relatively small area. One of the consequences of this trend is increasing of production of municipal solid waste (MSW) that must be stored (Arunel. 2010). In many parts of the world, practice is that municipal solid waste need to be stored in landfill prepared for that. Landfills are often the most cost-efficient way to dispose of waste, especially in non developed countries (Jhamnani and Singh, 2009; Longe and Balogun, 2010; Arunet al.,2010) In Serbia generation of MSW per year is about 2, 65 mil. t., while municipality of Novi Sad (Vojvodina province, Serbia) produces about 133 kt per year. (Statistical Office of Republic of Serbia, 2012).

Landfills have the potential to cause a number of issues. One of problems can be pollution of the local environment, such as contamination of groundwater, soils and air and generally landscape (Zhou et al., 2011). Soil around the landfill can be considered as a buffer zone which retains different types of pollution generated in the processes off decomposition of waste. The role of soil around the landfill is multiple, because besides keeping pollution and filtering leachate from the landfill, it also provides a habitat for plants, mostly trees species that act as a windbreaks. The impact of the landfill on the environment can be reduced and isolated through the process of

making a protective green breaksconsisting of trees, shrubs and herbaceous plants. In order to preserve these plants growth, as well as provide the best possible isolation of the landfill, it is necessary to recultivate contaminated soil around the landfill. By definition, recultivation presents a set of actions that lead to the creation of sufficient phytoproductivity on soil that has been previously degraded (Miljkovic, 1996). The aim of this paper is to, based on field and laboratory research and existing literature about this area propose measures for recultivation if necessary.

Material and method

Novi Sad city is located in the southern part of the Pannonian Plain, on the border of the Bačka and Srem regions, on the banks of the Danube river, facing the northern slopes of Fruška Gora mountain. It is the second largest city in Serbia and the administrative seat of both, the province of Vojvodina and the South Bačka District. Since its founding, the population of the city has been constantly increasing and today city has 341,625 inhabitants (Statistical Office of Republic of Serbia). Area in which the trial was conducted is in geomorphologic point of view of the lowest part of alluvial terrace of the Danube. Natural soil type is fluvisol, which is hydromorphic soil and belong to class of under developed fluvial soils with soil profile (A) or G (A)-C. These soils are recent, river, sea and lake deposits with layers. Pedogenetic processes are poorly expressed due to youth of deposit or because of sedimentation prevails pedogenesis. Physical and chemical properties depend on the number of layers and their thickness, texture, origin and sequence. Some typical characteristics are rarely discussed and they are different from profile to profile (Živanov and Ivanisević, 1986, Nešić et al., 2014).

City landfill in Novi Sad is controlled and partially remediated dump. It is located north of the city in the peripheral part of Novi Sad, outside of the construction zone, and occupied area of 35.381 m². In order to determine the type and level of soil contamination there were collected five soil samples from tree sites. At first two localities sampling was performed at two depths of 0-30 cm and 30-60 cm, as this is the part of the bulk of the solum that plants developing roots. The third site was the bottom of the leachate canal, which is located around the landfill, and in that period canal was without water. Soil samples were air-dried and manually sieved through a 2 mm sieve for chemical and texture analysis. The collected samples were analyzed at the Laboratory of Soil and Irrigation and Laboratory for Agrochemistry at the Faculty of Agriculture, University of Novi Sad, with contemporary, recognized methods used for this type of research (JDPZ, 1997; Bošnjak et al., 2012; Belić et al., 2014; Ubavić and Bogdanović, 2001). Laboratory studies include the determination of texture according to International B-pipette method with preparation in sodium pyrophosphate; pH value in the suspension of soil with H₂O and KCl, and the measurement is carried out using a pH meter "inoLab"; content of humus, the method of Tjurin; calcium carbonate (CaCO₃) - using Scheibler's calcimeter total nitrogen content (elemental analysis of the total sample burning) automatic method - CHNS analyzer; ammonium lactate P₂O₅- spectrophotometric determination of available phosphorus; ammonium lactate K₂O - determination of available potassium by flame photometer; total content of macronutrients, micronutrients and heavy metal destruction with concentrated nitric acid, induced coupled plasma ICP – OES and total Hg content - Direct method for determination of mercury - the machine DMA-80 direct mercury analyzer (Direct Analysis).

Results and discussion

The results of soil texture are shown in Table 1. Based on results soil in this area is characterized by homogeneous and lighter texture composition. Soil in the area that is planned to be protective windbreaks is characterized by sandy texture, while the sludge from channels around the landfill is coarse sandy loam.

Table 1. Granulometric composition of tested soil

Locality	Depth	Coarse sand %	Fine sand %	Dust %	Clay %	Total sand %	Total clay %	Texture class	
		2-0.2 mm	0.2-0.02 mm	0.02-0.002 mm	<0.002 mm	2-0,02 mm	0,02 mm		
1	0-30 cm	60.40	27.92	6.40	5.28	88.32	11.68	Loamy sand	coarse
	30-60 cm	35,0	58,88	1,32	4,80	93,88	6,12	Loamy sand	fine
2	0-30 cm	83.80	14.04	1.24	0.92	97.84	2.16	Loamy sand	coarse
	30-60 cm	52.9	42.26	0.40	4.44	95,16	4,84	Loamy sand	coarse
Sludge	0-30 cm	70.30	14.70	8.40	6.60	85.00	15.00	Coarse sand loam	

Table 2: Chemical properties of tested soil

Locality	Depth	pH 1M KCl	pH y H ₂ O	CaCO ₃ %	Humus %	Total N %	Al-P ₂ O ₅ mg/100g	Al-K ₂ O mg/100g
1	0-30 cm	7,87	8,49	9,11	0,56	0,059	13,3	11,8
	30-60 cm	7,82	8,43	8,28	0,54	0,057	9,6	7,3
2	0-30 cm	8,17	8,55	8,28	0,27	0,028	2,2	2,6
	30-60 cm	8,25	8,61	7,87	0,11	0,011	2,4	2,6
Sludge	0-30 cm	7,63	8,16	19,87	11,82	0,758	29,4	61,5

Localities 1 and 2 are belong to the class of textured loamy coarse sand, they are characterized by an alkaline reaction (pH of the H₂O from 8.43 to 8.61), they are very carbonate (7, 87% to 9.11% CaCO₃) and poorly in humus (from 0.11% to 0.56%). Soil on these localities is poorly

provided in total nitrogen, medium provided with easy available phosphorus (from 2.2 mg / 100g 13.3 mg / 100g P₂O₅) and potassium (2.6 mg / 100g 11.8 mg / 100g K₂O). In terms of pH value and carbonate status there is no significant differences between the samples taken from the northern and southern parts of the tested area. Soil on both sites is very alkaline and carbonate. However for content of humus, total nitrogen and easy available phosphorus and potassium it can be seen slightly higher soil fertility in northern than in the south, although the content is still at the level of poorly to medium provided.

On the other hand a sample of mud from the canal near the landfill is characterized by mild alkaline reaction (pH in H₂O 8.16), it is very carbonate (19.87% CaCO₃), high content of humus (11.82%), it is very provided in total nitrogen (0.758% N), and excessively to extremely provided with easy available phosphorus (29.4 mg / 100 g of P₂O₅) and potassium (61.5 mg / 100 g of K₂O). According to very favorable chemical properties of sludge from the canal near the landfill, it should consider the possibility of application of it in the future for soil recultivation near the landfill in terms of increasing the fertility of very poor and sandy soils, on which is planned to be applied biological and technical recultivation.

Regulations on permitted amounts of hazardous and harmful substances in soil and water for irrigation (Sl.glasnik. 23/1994) defines the maximum permissible concentration (MPC) and test method for determination of contents of heavy metals in the soil. Results of this study are shown in table 3. At the same time, it is important to determine the content of microelements which high concentration can have negative effect on plant growth.

Table 3: Content of heavy metals and microelements in soil

Local ity	Dep th	As mg/ kg	Cd mg/ kg	Cr mg/ kg	Cu mg/ kg	Pb mg/ kg	Ni mg/ kg	Zn mg/ kg	Co mg/ kg	Mn mg/ kg	Fe mg/ kg	Hg mg/ kg
1	0-30 cm	15,8	< 0,15	13,2	61,6	13,5	12,1	71,5	4,0	171, 3	9940, 0	0,04 3
	30- 60 cm	8,4	< 0,15	15,0	29,1	9,7	11,5	63,0	3,9	178, 3	9362, 0	0,03 4
2	0-30 cm	3,6	<0,1 5	7,7	12,2	5,2	7,4	36,2	2,7	118, 8	6103, 0	0,02 0
	30- 60 cm	2,7	< 0,15	10,1	14,4	4,6	8,1	63,3	2,7	137, 1	6250, 0	0,01 5
Sludg e	0-30 cm	6,2	<0,1 5	29,5	41,4	14,2	19,4	91,3	5,5	225, 3	1408 0,0	0,08 4
	MP C*	25,0	3,0	100, 0	100, 0	100, 0	50,0	300, 0	50,0	/	/	2,00 0

The amount of available elements for plants depends on of chemical, physical and biological properties of the soil, respectively from pH value, humidity, temperature, microbial activity, and presence of clay fractions in soil, organic matter content and content of hydrated oxide of Fe, Al (Ubavić at al. 1995). The concentration of hydrogen ions (pH) has a huge influence on the

dynamics of trace elements and heavy metals in the soil. In the acidic environment there are more trace elements in the solution, which can lead to the occurrence of the toxicity, particularly in Mn and Cu. This toxicity is usually temporary, if it is a light sandy soil, but in heavy soils with more clay, toxicity of trace elements is manifested in a longer period of time. Content of trace elements (Cu, Zn, Co, Mn) and heavy metals (Pb, Cd, Ni, Cr, As, Hg) in tested soil is less than the maximum permissible concentrations (MPC). In comparing with natural soil in this area, fluvisol, (Sekulić et al. 2007, Nesic et al 2010), it can be said that the soils in around the landfill are not significantly different than natural soil, and that content of heavy metals is not different also. When comparing the value of the contents of heavy metals in the sludge, with values in the tested sites, it shows that the contents in sludge is two to three times higher than the other two localities, but is still far below the MPC. This fact can be explained by the high content of organic matter in the sludge, which has a high adsorption capacity, and has the ability to have higherfixes rate of cations from the solution rather than sandy soil around the landfill. Based on these results it can be said that the land near the landfill are not contaminated with heavy metals, however based on the determined characteristics, to the landfill area and its surroundings, the natural habitat conditions are permanently altered, and it is necessary to perform the recultivation in order to protect environment and give better quality of soil for plant growth.

Conclusion

Based on the results it can be concluded that recultivation of soil around landfill should applied, in order to improve soil characteristics and fertility. Soil on localities 1 and 2 belongs to the class of textured loamy coarse sand, they are characterized by an alkaline reaction, and they are very carbonate and poorly in humus. Also, soil on these localities is poorly provided in total nitrogen, medium provided with easy available phosphorus and potassium. However sludge from the canal near the landfill is characterized by mild alkaline reaction, it is very carbonate, high content of humus, it is very provided in total nitrogen, and excessively to extremely provide with easy available phosphorus and potassium. According to very favorable chemical properties of sludge it should consider the possibility of application of it for soil recultivation in terms of increasing the fertility of very poor and sandy soils. Windbreaksshould be consist trees and shrubs that have shown resistance to the stress caused by the changed environmental conditions. Species that are most appropriate for this area are: Poplars (*Populus* sp), Willow (*Salix* sp), Turkish hazel (*Corylus colurna* L.), Norway maple (*Acer platanoides* L.), Persian walnut (*Juglans nigra* L.), birch (*Betula pendula* Roth.), Hornbeam (*Carpinus betulus* L.), Black locust (*Robinia pseudoacacia* L.) and Siberian elm (*Ulmuspumila* L.).

Acknowledgments

Part of this study was conducted as part of the Project No. TR 31072: “Status, trends and possibilities to increase the fertility of agricultural land in the Vojvodina Province”, which is supported by the Ministry of Education, Science and Technological Development of Republic of Serbia

References

- Belic M., NesicLj., Ciric V., (2014): Pedology practicum, Faculty of Agriculture Novi Sad, Novi Sad, Serbia.
- Bošnjak, Đ., Pejić, B., Mačkić, K., (2012): Irrigation of agricultural plants-practicum, Faculty of Agriculture Novi Sad, Serbia

- JDPZ, (1997). Yugoslav Society of Soil Science: Methods of research and determination of physical soil characteristics, Novi Sad.
- Jhamnani B., Singh S.K., (2009), Groundwater contamination due to Bhalaswa landfill site in New Delhi, *Int J Environ Sci Eng*, 1 pp. 121–125
- Longe E.O., Balogun M.R., (2010), Groundwater quality assessment near a municipal landfill, Lagos, Nigeria, *Res J ApplSciEngTechnol*, 2 pp. 39–44
- Miljkovic N., (1996): Basics of pedology, University of Novi Sad, Faculty of Science, Geographi department, Novi Sad, Serbia.
- Nešić, Lj., Belić, M., Ćirić, V. Pavlović, L., Pejić, B. (2014): Water and physical properties of urbisol. V International Scientific Symposium of Agriculture, "Agrosym 2014", Jahorina, 23-26 October 2014, Bosna and Hercegovina, Book of proceedings, 783-788.
- Sekulic P., Pucarevic M., Nestic Lj., Belic M., Milosevic N., Vasin J., Zeremski Skoric T. (2007) Study " Testing of soil and groundwater in the municipality of Novi Sad "from the Program Planning of urban land for 2007. Institute for field and vegetable crops Novi Sad, Serbia
- Statistical Office of Republic of Serbia (2012), Statistics of waste and waste management in the Republic of Serbia, Statistical Office of Republic of Serbia, Belgrade, Serbia
- Ubavić M., Dozet D., Darinka Bogdanović (1993): Heavy metals and pesticides in soil - heavy metals and pesticides in soils of Vojvodina, p. 31-47 and 217-223, Kastori R. (editor), Institute of Field and Vegetable Crops, Novi Sad.
- Ubavić, M., Bogdanović, D., (1995): Agrochemistry, Faculty of Agriculture Novi Sad, Serbia
- Ubavić, M., Bogdanović, D., (2001): Agrochemistry practicum, Faculty of Agriculture Novi Sad, Serbia
- Zhou C., Liu J., Wang R., Yang W., Jin J. (2011), Exergetic assessment of municipal solid waste management system in south Beijing, *Ecol. Complex.*, 7), pp. 162–169
- Živanov, N. i Ivanisević, P. (1986). Soils for Poplar and Willow growing, In Monograph "Poplars and Willows in Yugoslavia": 105-121.

THE ANALYSIS OF BROWN BEAR (*URSUS ARCTOS* L.) POPULATION CONDITION IN BOSNIA AND HERZEGOVINA WITH REFERENCE TO THE REGION

Siniša CINCAR^{1*}, Damir MRĐENović², Aleksandar TEPAVAC³

¹Public Forest Enterprise “Forests of the Republic of Srpska”, Sokolac Forestry Office, Glasinačka 9, 71350 Sokolac, Bosnia and Herzegovina

²Ministry of Agriculture, Forestry and Water Management of the Republic of Srpska, Trg Republike 1, 78000 Banja Luka, Bosnia and Herzegovina

³Public Forest Enterprise “Vojvodina Forests“, Morović Forestry Office, 22245 Morović, Serbia

*Corresponding author: cincarsinisa@yahoo.com

Abstract

The brown bear (*Ursus arctos* L.) is autochthonous and biggest beast in Bosnia and Herzegovina (BiH), and one of the most attractive species of wild animals. Bears living in BiH are part of the Dinaric-Pindos population, which is the second largest population in Central and Southern Europe. The bears in BiH, together with those in Slovenia and Croatia, are genetically similar to the remaining bears from the Alps and as such are suitable for reintroduction of extinct populations in Western Europe. Bears were once numerous and widely distributed in highland areas of BiH, among other things, due to preserved forests and small openness of the areas. More recently (2004), the estimated number of bear population is 438 individuals on the area of about 12.000 km². This type of game to the current number is not threatened in BiH, but it needs improvement of the management planning of its populations and habitats. This paper analyzes the condition and numbers of listed population as well as the main threats and protection measures for bear and its habitats, both in BiH and in the region.

Keywords: *bear, habitat, population size, analysis of the condition, Bosnia and Herzegovina.*

Introduction

Brown bear (*Ursus arctos* L.) is one of eight bear species, that evolved from same ancestor predator *Miacid* 25 milion years ago (Huber et al., 2008b). Bear is a mammal class (*Mammalia*), category of beasts (*Carnivora*) and bear family (*Ursidae*). In large part of Europe, brown bear is permanently protected. Excessive hunt in majority of European countries lead to his extermination, that made him listed on Red List of Endangered Species. European Standard created action plan for saving brown bear that have international character and it is obligating by all countries of European Union (further in text EU) and all signatories of Berne Convention. In majority of countries there is action plan or strategy management of bears. On territory of Republic of Srpska (further in text RS), bear is sporadically spread in forest ecosystems. Because of small quantity and its big importance, in RS he is labeled as endangered (Article 11, Hunting Act, Official Gazette of the Republic of Srpska no. 4/02). Bear is largest autochthonous beast in BiH, and according to many people, it is most popular for hunting. Bears from BiH, Slovenia, Croatia, Serbia and Montenegro are genetically similar to other bears and because of that they are good for reintroduction of extinct species of Western Europe. This makes bear most valued in natural heritage of BiH (Sinanović et al., 2008). The main goal of this work is to uncover main factors of endangering and safety measures for bears in territory of BiH, and to give specified recommendations for maintained usage and preservation of it's kinds and habitats.

Material and method

Research and gathering of necessary data for this work is done in last period for which we have data about managing population of brown bear. For purposes of gathering and comparison of data with results of previous research (Adamič et al., 2006; Sinanović et al., 2008), next activities have been performed:

- gathering data about quantity, habitat and results of management in last period;
- analysis of national and international relevant regulations;
- comparative analysis of status and management of bears in BiH and nearby countries (Serbia, Slovenia, Croatia, Montenegro, Macedonia).

Primary material is made of various documents published by BiH official journal (Official Gazette of the Republic of Srpska and Official Gazette of the Bosnia and Herzegovina), numerous scientific and expert literature, also articles from this domain. For additional data supplement and evaluation about quantity and status of bear population in BiH, there was conducted conversations with people responsible for hunting in Ministry department of agriculture, waterworks and forestry in both entities. For purpose of better understanding of problems about main factors of endangering and protective measures for bears, analysis of action plans for managing population of bears in nearby countries have been performed. Data involving quantity, habitat and results of managing bears in BiH have been taken from previous research and published texts. Differences in managing bears in BiH and nearby countries, that manage Dinaric-Pindos population, have been displayed in works, with lawful regulation that is associated with international laws and conventions. With comparative analysis of action plans and ways of bear management, measures and given recommendations for protection and management of bears in BiH have been concluded.

Results and discussion

Areal and quantity of bears

Areal of bears is world largest with holarctic distribution in Europe, Asia and North America (Servheen, 1990). It is estimated that total world population of bears is larger than 200.000 individuals. Russia have largest quantity of bears, it's believed to have over 100.000 individuals (IUCN, 2012). In other countries estimated quantity is: 33.000 individuals in USA, 25.000 individuals in Canada, and 17.000 individuals in Europe (without Russia) (Katschinsky et al., 2013). In Europe bear is can be found in 22 countries. Based on existing data about distribution, like in many geographic, ecological, social and political factors, 10 populations have been specified: Scandinavian, Karelian, Baltic, Carpathian, Dinaric-Pindos, East-Balkan, Alps, Abruzzo (Central-Alpen), Cantabrian and Pyrenees.

Status and main factors of endangering bears in BiH

Bears in BiH are part of Dinaric-Pindos population. Total Dinaric-Pindos population of bear is 3.500 individuals and it is second in size in Europe, after Carpathians.

Analysation of regulations for bear management

International law regulations

During several international conventions, bear is placed in different categories of/and annexes of protection, according to that signatory countries of those international documents have duty to take necessary measures including measures to members of this kind. Besides, BiH is signatory of next international conventions:

- Bern convention for protection of European wild fauna and flora and natural habitats, organized in Bern (1979), and confirmed by Presidency of BiH in year 2008. (Official journal of BiH, no. 8/08).
- Convention for Biological Diversity (CBD), organized in Rio de Janeiro (1992), and confirmed by Presidency of BiH in year 2002. (Official journal of BiH, no. 13/02).
- Convention for international trading of endangered species of wild fauna and flora (CITES), organized in Washington (1973), and edited and expanded 1979. In Bonn. This convention is confirmed by Presidency of BiH in year 2008. (Official journal of BiH, no. 11/08).

Analysis of bear management

Bear management in BiH exists since year 1893. and it's pronounced as first Hunting law, after occupation by Austro-Hungarian empire (Kunovac et al., 2012). Bears used to be hunted in all possible ways and wasn't protected by law. Already after World War 1 quantity of bears was greatly decreased, and after World War 2. decreased to minimal, critical number of 50 individuals. After that, strict regulations have been made involving hunting and bear became protected and his quantity started to increase. In period 1945-1990., constant increase in quantity of bears was registered, and it reached 1.364 individuals. Areas suitable for bear survival occupied around 1.248.000 ha, and registered managing capacity of 1.494 individuals (1,2 individuals per 1.000 ha). Approximate culling per year was around 90-100 individuals. Population was vital, and culled individuals had good trophy value. Interest by international hunters for bear hunting was huge. Special hunting managements was formed (Koprivnica, Bugojno), and most valuable wild animal for hunting was bear. Bear is managed in two entities made by splitting of BiH (year 1995.): Republic of Srpska (RS); Federation of Bosnia and Herzegovina (FBiH).

Table 1: Status and management of bears in states that manage Dinaric-Pindos population

State	Lawful status	Associated institution	Action plan	Level of management
Albania	Strictly protected	General direction for forestry and plantations	No	National
BJP Macedonia	Strictly protected	Ministry of agriculture, forestry and waterworks and Ministry for living environment and areal planning	No	National and Regional
Bosnia and Herzegovina	Wild animals protected by hunt stoppage	Ministry of agriculture, forestry and waterworks in both entities.	No	National
Greece	Strictly protected	Ministry for agricultural development and food	Yes	National and regional
Slovenia	Strictly protected	Ministry for living environment and areal planning	Yes	National and regional
Serbia	Strictly protected	Ministry of agriculture, forestry and waterworks and Ministry for living environment and areal planning	Yes	National
Croatia	Wild animals protected by hunt stoppage	Ministry of agriculture, forestry and waterworks	Yes	National and regional
Montenegro	Wild animals protected by hunt stoppage	Ministry of agriculture, forestry and waterworks, and Ministry for living environment and areal planning	No	National

Table 2: Management, lawful status and hunting season on bears in BiH, per entities

Entity	Associated institution	Status	Hunting season
Republic of Srpska	Ministry of agriculture, forestry and waterworks, in both entities	Wild animals protected by hunting prevention	1. october - 15. may
Federation of BiH			1. october - 31. december 1. march - 15. may

Distribution of bears

Bear managed to survive on northwest, west, central and eastern mountain massives, relatively around 21,8% of total BiH land territory, or around 11.883,5 km² (Adamič et al., 2006). Habitats can be categorised as permanent and temporary (table 3).

Table 3: Bear habitat territory in BiH

	Habitat territory (km ²)	Quantity – current status year 2008.
Current- permanent	10.565,0	438
Temporary	1.318,5	-
Totals:	11.883,5	438

Permanent habitat covers 10.565 km². That is territory in which bear satisfies all needs for food, water, territory, peace, shelter, breeding and nesting, and there he is constantly present through four season periods.

Main factors of bear endangering

Even on global plan (IUCN, 2008), bear is categorized for least concern for extinction „LC“ (*Least Concern*), numerous factors are affecting his population and they are threatening to his existence. Main factors for endangering bears in countries that manage Dinaic-Pindos population are displayed in table 4.

Table 4: Factors of endangering bears in countries that manage Dinaric-Pindos population

Main factors of endangering	Albania	Bosnia and Herzegovina	BJP Macedonia	Montenegro	Greece	Croatia	Slovenia	Serbia
Hunting							x	
Illegal hunting	x	x	x	x	x			x
Infrastructure	x		x		x	x	x	x
Fragmentation and habitat isolation	x		x	x	x		x	x
Forest occupation	x		x	x				
Bad execution of legal regulations	x	x		x				
Low quantity		x						
Damage		x	x					x
Lack of support from state institutions		x						x
Lack of financial assets for research and hunting activities		x		x				x
Lack of experts framework		x						x
Traffic					x	x	x	
Artificial food sources (junk yards)						x		
Problematic bears						x	x	
Poisoned lure			x		x			
Forest fires	x				x			
Turistic and recreational activities			x				x	
Frightened local population		x					x	x
Bad and inadequate management				x				x
Capturing, show off and trading of living bears			x	x				x
Political and economical instability		x		x				x

Conclusions

Bear is autochthonous and largest beast in Bosnia and Herzegovina, and it is one of most attractive wild species. Estimated quantity of bear population in BiH is from 432-1.196 individuals, because of that it's considered non endangered species. Main measures of protection of bear in BiH are:

- establishment of monitoring;
- strict protection and limited usage;
- providing of financial support for research and activities in hunting;
- more strict inspection supervision and penalties;
- establishment of breeding areas for bear;
- creation of management plan;
- constant education and informing of hunters and people.

Based on results of this work and analysis of bear management plans in nearby countries (Croatia, Serbia, Slovenia, Macedonia and Albania) next conclusions can be made: most important factors that endanger bears in said countries are: illegal hunt; degradation, fragmentation and habitat isolation; low degree of acceptance and conflict with people caused by destroying of property.

References

- (2002) Zakon o lovstvu, Sl. glasnik RS br. 4/02 (Hunting Act, Official Gazette of the Republic of Srpska no. 4/02)
- (2009): Plan lovstva za lovnu 2009/2010. godinu (Hunting plan for hunting season 2009/2010.), Javno Preduzeće Šumarstva „Šume Republike Srpske“ a.d. Sokolac, Banja Luka, 15 str.
- Adamič, M., Rapaić, Ž., Popović, Z., Kunovac, S., Koprivica, M., Soldo, V., Marković, B., Maunaga, R., Mićević, M., Ilić, V., (2006): Ugrožene vrste divljači u Bosni i Hercegovini (Endangered species of wildlife in Bosnia and Herzegovina), Studija - Finalni izvještaj, Projekat razvoja i zaštite šuma, Banja Luka, 1-30)
- Huber, Đ., Kusak, J., Majić-Skrbinšek, A., Majnarić, D., Sindičić, M., (2008b): A multidimensional approach to managing the European brown bear in Croatia, *Ursus*, 19: 22–32
- Jurić, M. (2009): Prioritet – izrada plana gospodarenja smeđim medvjedom u BiH (The priority - development of a Brown Bear Management plan in BiH), *Glasilo Lovачkog saveza Herceg Bosne i Kinološkog saveza Herceg Bosne*, 66: 1-52 str.
- Kaczensky, P., Chapron, G., von Arx, M., Huber, Đ., Andrén, H., and Linnell, J. (2013): Status, management and distribution of large carnivores bear, lynx, wolf & wolverine - in Europe, *European Commission* (1): 72 str
- Kunovac S., Bašić M., Sadiković N., Omanović M., Grubešić M., Tomljanović K. (2012): Brown bear management in Central Bosnia, International symposium on hunting: „Modern aspects of sustainable management of game population“, Zemun-Belgrade, Serbia, 22.-24. June, 2012: 27-31
- Sinanović N., Zuko A., Huber Đ. (2008): Potreba za izradom plana gospodarenja smeđim medvjedom (*Ursus arctos*) u Bosni i Hercegovini (The need for the Action plan for Brown Bear (*Ursus arctos*) management in Bosnia and Herzegovina), *Veterinaria*, 57 (1-2): 118-131
- Swenson, J., Gerstl, N., Dahle, B., Zedrosser, A. (2000): Action plan for the conservation of the brown bear (*Ursus arctos*) in Europe, *Nature and environment*, 114: 1-72 str.
- Zedrosser, A., Dahle, B., Swenson, J.E., Gerstl, N. (2001): Status and management of the brown bear in Europe, *Ursus*, 13: 9-21

RESERVOIR TILLAGE TECHNIQUE

İlknur DURSUN, Ergin DURSUN*

Department of Agricultural Machinery and Technologies Engineering, Faculty of Agriculture,
Ankara University, Turkey

*Corresponding author: edursun@agri.ankara.edu.tr

Abstract

Many countries located in arid and semi-arid regions have water scarcity problems due to low rainfall and uneven distribution throughout the season. On the other hand, soil erosion is a serious environmental problem in some region of the world due to intensive rainfalls and the arid and semi-arid regions. Therefore, soil and water conservation is so important in these areas. Different type of soil tillage techniques such as reduced tillage, mulch tillage, ridge tillage, strip tillage, no-till, direct seed and reservoir tillage had been developed to conserve soil and water. Reservoir tillage has been defined as a system in which a large number of depressions or small reservoirs are formed to hold rain or sprinkler applied water. Reservoirs are formed on whole soil surface, between rows or in furrows using different types of equipment or equipment combinations. These equipment are commercially available and their prices are reasonable. Reservoir tillage is used to control both runoff and soil erosion. It can be used with many crops such as potato, corn, sugar beet, cotton, sunflower, sorghum, tomatoe and wheat. Studies have showed that reservoir tillage could increase soil water content, enhance infiltration, reduce soil erosion and increase crop yield. The purpose of this paper is to explain reservoir tillage technique and introduce equipment used for this technique.

Keywords: *Reservoir tillage technique, Runoff, Soil erosion, Soil and water conservation.*

Introduction

Approximately 40% of the world's agricultural land is seriously degraded (Anonymous, 2016a). Each year, 75 billion tons of soil is removed due to erosion largely from agricultural land, and about 20 million-ha of land is already lost (Pandey et al., 2009). Drought is an other important proplem except for erosion. Drylands cover about 41% of earth's land surface and about one third of world population is affected from drought (Safriel and Adeel, 2005). Approximately 6.6%, 10.6%, 15.2% and 8.7% of drylands are consisted of hyper-arid, arid, semiarid, and dry subhumid, repectively. In dry farming regions, total annual rain is low than 500 mm and distributed unevenly throughout the season.

Soil tillage is a method of soil preparation for seeding and planting. Moulboard plow, disc harrow, field cultivator and other mechanical implements are used to prepare the field for crop production in conventional tillage. However, most of the crop residue are incorporated or buried into the soil. That's why, conventional tillage leaves soils vulnerable to wind and water erosion and causes to the loss of soil moisture. Different type of soil tillage techniques such as reduced tillage, mulch tillage, ridge tillage, strip tillage, no-till, direct seed and reservoir tillage had been developed to conserve soil and water (Anonymous, 2013a; Dursun, 2015). The purpose of this paper is to explain reservoir tillage technique and introduce equipment used for this technique.

Reservoir Tillage and Its Advantages

Reservoir tillage is defined as a system in which a large number of depressions or small reservoirs are formed to hold and collect rain or sprinkler applied water and to prevent surface runoff from irrigation or rainfall (Longley, 1984; Hacweell *et al.* 1991; Anonymous, 2005a; Anonymous, 2013a; Salem *et al.* 2015). Figure 1 shows a reservoir tillage implement and reservoirs formed on soil surface. Reservoir tillage is applied in the regions where soil erosion is a problem, dry farming regions, and fields irrigated with low-pressure center pivots and lateral move irrigation systems. Distance between reservoirs or holes is 60-90 cm (Busch and Kincaid, 1995).

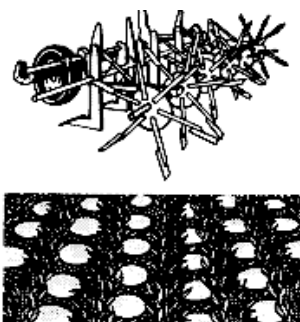

Figure 1. An equipment combination for reservoir tillage and reservoirs created on the soil surface after tillage (Kranz *et al.*, 1996).

Reservoir tillage has a lot of benefits. Small reservoirs or depressions created on the soil surface hold water and reduces surface runoff during irrigation or rainfall (Anonymous, 2016b). Particularly, reservoir tillage prevents soil erosion if there is not enough crop residue on the soil surface (Dursun, 2015). Reservoir tillage enables to in-situ water harvesting in dry farming regions and can increase level of surface storage. The surface area of the soil is increased due to small reservoirs or depressions created on the soil surface and thus infiltration of rain or applied irrigation water is increased. On the other hand, soil warms faster because of greater surface area (<http://tillso.co.uk>). Moreover, the loss of valuable soil, residual chemicals and nutrients could be reduced by small reservoir or depressions formed on soil surface in the fields irrigated with low-pressure center pivots and wheel-move irrigation systems (Anonymous, 2005a). Reservoirs could increase rainwater or applied irrigation water use efficiency and soil water content. As a result of this, crops could benefit from water more efficiently, crop yield could be increased and irrigation costs could be decreased.

Many research has been conducted on reservoir tillage. We noticed same variations in equipment and terminology interested with reservoir tillage when we examined these research. It is known under different names such as furrow diking, furrow damming, basin tillage, basin listing, microbasin tillage, and tied ridges (Hackwell *et al.*, 1991; Jones and Baumhardt, 2003). The shapes, dimensions and distributions of reservoirs, dikes, basins, dams and ridges created on the soil surface are different by mentioned tillage techniques. Furrow diking is not a new technology. It was used in the U.S.A., in the 1930s (Hasheminia, 1994; Jones and Baumhardt, 2003). But, reservoir tillage is a more new technique (Garvin *et al.*, 1986).

Small earthen dams shaped rectangle are formed periodically between furrow ridges in furrow diking (Figure 2). Furrow diking can be adapted to both dryland and irrigated crop production. It is often used on gently sloping land in arid and semiarid areas (Anonymous, 2013b). This practice was mostly used for cotton production in Africa in 1940. But, the practice of furrow

diking for wheat production was abandoned because of slow operating speed of diking equipment, poor weed control, difficulty with seedbed preparation and subsequent tillage, and mainly little benefit in yield in U.S.A., in the 1950s. However, furrow diking had been widely adopted due to improved mechanical equipment for constructing the dikes, herbicide tolerant crops and more effective herbicides to control weeds (Jones and Baumhardt, 2003). It was reported that favorable responses were obtained with some kind of crops such as cotton, sorghum, corn and sunflower in field tests (Hasheminia, 1994; Anonymous, 2013b).



Figure 2. The view of furrow dikes created on the field (left) and the most common type of furrow diker (right) (Warrick *et al.*, 2002; Warrick, 2008).

Tied ridges is also known as furrow blocking, furrow damming, furrow diking, and basin listing. In this practice, ridges and furrows are made firstly and then dams that tied with small mounds are formed in furrows (Figure 3) (Hudson, 1987). This practice has been developed to prevent rain or irrigation water runoff from crops on sloping land ([http://www. briggsirrigation.co.uk](http://www.briggsirrigation.co.uk)).



Figure 3. The practice of tied ridges (<http://www.briggsirrigation.co.uk>).

Basin tillage is also called reservoir tillage and more suitable to crop rows. In this practice, a series of micro-catchments between crop rows are created for retention of water under center pivots and lateral move irrigation systems (Figure 4). This practice is especially preferred when the applied water exceed intake rate of the soil. The basins length usually ranges from 60 to 180 cm (Busch and Kincaid, 1995). It has been reported that this practice has been used successfully for runoff control on field slopes of less than 5 percent. The failure potential of individual basins in furrows is increased as field slope increased (Kranz *et al.*, 1996).

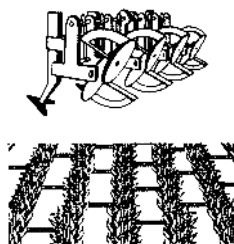

Figure 4. Basin tillage between crop rows (Kranz *et al.*, 1996).

The basins are constructed across the slope using a special implement called basin-lister in the method of basin listing. (Figure 5). This practice increases time to rain water for infiltration into the soil (Anonymous, 2005b).



Figure 5. The practice of basin listing for cotton field (<http://agritech.tnau.ac.in>)
In microbasin tillage, individual earth blocks or basins are created along furrows. The length of each block is about 65-75 cm (Figure 6). This practice has been used successfully on fields with slopes of 5-7 percent (Sui *et al.*, 2016).



Figure 6. The practice of microbasin tillage (Sui *et al.*, 2016).

Equipment for Reservoir Tillage

There are three different application of reservoir tillage. In the first application, reservoirs are builded on whole soil surface. In the second application, reservoirs are only builded between rows. In the third application, reservoirs are only builded in furrows. The first application of reservoir tillage is called “New Reservoir Tillage System” (Ventura *et al.*, 2003).

Different equipment or equipment combinations are used for reservoir tillage depend on cultivated crop variety, soil condition and application region. The rollers or soil conditioners used for reservoir tillage have different forms and they are known under different names. The shapes and dimensions of reservoirs changes depend on constructional features of soil conditioners. One type of soil conditioner has durable rubber cones that fixed to a rubber carcass and forms reservoirs shaped in half cone. The other type of soil conditioner known “Imprinting roller” creates reservoirs that are narrow and long. The other soil conditioner has triangle prisms on its roller surface. This type of soil conditioner creates reservoirs shaped with triangle prism. The equipment combinations such as rotovator + soil conditioner, horizontal cut subsoiler + modified row planter + roller formed with plastic wheels, chisel plow + spike-tooth harrow + seed drill + spiked roller, potato planter + soil conditioner, subsoiler or chisel plow + soil conditioner can be used used for tillage (Figure 7) (Ventura *et al.*, 2003; Salem *et al.*, 2015; <http://tillso.co.uk>). The weight per unit working width of soil conditioner is about 80 daN/m for vegetable and root crops and 180 daN/m for grain crops (<http://tillso.co.uk>).



Figure 7. Three different types of soil conditioner used for reservoir tillage and soil surfaces after tillage (Ventura *et al.*, 2003; Anonymous, 2012; Anonymous, 2016c).

The reservoir tillage that including reservoirs only between rows is especially preferred at row crops irrigated with low-pressure center pivots and lateral move irrigation systems. The reservoirs between rows are formed using a soil conditioner roller or an equipment combination such as subsoiler (inter-row ripper) + multi-spoke “spider” or chisel + multi-spoke “spider”. The reservoirs are formed by multi-spoke “spider” when using equipment combination (Figure 8) (Schneider *et al.*, 2000; Ventura *et al.*, 2003). Reservoirs can be created hoes or shovels placed at between coulters of spacing drill during sowing. The shapes and dimensions of reservoirs changes depend on constructional features of soil conditioners. It is reported that reservoirs or holes 15 to 25 cm in diameter, 15-20 cm deep, and spaced about 60 cm on center into the soil (Hansen ve Trimmer, 1997).



Figure 8. A hand type soil conditioner and a combination of inter-row ripper and multi-spoke “spider” (Geisel, 2012; Keith, 2016; <http://www.Terramanustech.com>; <http://www.dammerdiker.com>)

Reservoir tillage is widely used for potato grown in ridges and reservoirs are only formed in furrows. Different equipment combinations such as lister + chisel + multi-spoke “spider”, subsoiler or chisel + multi-spoke “spider” and subsoiler or chisel + soil conditioner can be used. In these combinations, reservoirs are formed by multi-spoke “spider” or soil conditioner (Figure 9). Reservoirs could be formed before planting, during planting or after planting.



Figure 9. The application of ridge till and formation of reservoirs by an equipment combination (<http://www.dammerdiker.com>)

Conclusion

Reservoir tillage is a soil and water conservation practice. In this practice, a large number of depressions or small reservoirs are formed to hold rain water or sprinkler applied water and to prevent surface runoff from irrigation or rainfall. Reservoirs are formed on whole soil surface, between rows or in furrows using different types of equipment or equipment combinations. The practice of reservoir tillage can be used with many crops such as potato, corn, sugar beet, cotton, sunflower, sorghum, tomatoe and wheat. Studies on reservoir tillage have showed that it could increase soil water content, enhance infiltration, reduce soil erosion and surface runoff and increase crop yield. Whereas, it has some disadvantages such as difficulty in weed control, need a new equipment and being a new technique for farmers. However, it is reported that reservoir tillage or similar practices is widely used by farmers. Because, nowadays, the price of equipment used for reservoir tillage is reasonable and more effective herbicides is used to control weeds.

References

- Anonymous, (2005a). Reservoir tillage. Irrigation Branch, Agricultura, Food and Rural Development, IB020-2005, Alberta, <http://www.demofarm.ca/pdf-2006/IB020-2005.pdf> Accessed on 03.06.2016.
- Anonymous, (2005b). Mechanical measures for soil & water conservation. <http://www.punenvi.nic.in/water/technologies4.htm> Accessed on 06.06.2016.
- Anonymous, (2012). Imprinting soils-creating instant edge for large scale revegetation of barren lands. The Permaculture Research Institute, <http://permaculturenews.org/2012/09/19/imprinting-soils-creating-instant-edge-for-large-scale-revegetation-of-barren-lands/> Accessed on 08.06.2016.
- Anonymous, (2013a). Terminology and definitions for soil tillage and soil-tool relationships. ASAE EP291.3 FEB2005 (R2013), American Society of Agricultural and Biological Engineers, ASABE Standards, 8 pp., USA.
- Anonymous, (2013b). Furrow dikes. Land management systems. <http://www.twdb.texas.gov/conservation/BMPs/Ag/doc/4.4.pdf> Accessed on 03.06.2016.
- Anonymous, (2016a). Soil erosion/land degradation. Food and Agriculture Organization of the United Nations, http://faostat3.fao.org/faostat-documents/ES_Soil_erosion_Land_degradation_e.pdf Accessed on 27.05.2016.
- Anonymous, (2016b). Presses & Consolidation. Products and Implements: Presses & Consolidation Roller Systems. Great Plains, <http://www.greatplainsint.com/en-gb/implements/all-international/presses-%26-consolidation-roller-systems> Accessed on 08.06.2016.

- Anonymous, (2016c). Simba Aqueell II. Great Plains, <http://www.greatplainsint.com/en-gb/products/736/simba-aqueel-ii> Accessed on 09.06.2016.
- Busch, J.R. and Kincaid, (1995). Reservoir tillage for controlling runoff and saving energy. Irrigation Energy Efficiency, USDA.
- Dursun, İ., (2015). Soil Tillage Equipment (In Turkish: Toprak İşleme Alet ve Makinaları). Ankara Üniversitesi Ziraat Fakültesi, Yayın No: 1618, Ders Kitabı: 570, Ankara Üniversitesi Basımevi, 584 pp., Ankara.
- Garvin, P.C., Busch, J.R. and Kincaid, D.C. (1986). Reservoir tillage for reducing runoff and increasing production under sprinkler irrigation. ASAE Paper No. 86-2093, ASAE, St. Joseph, MI49085, USA.
- Geisel, B. (2012). Effect of reservoir tillage on potato yield and grade. Manitoba Potato Research, <http://mbpotatoresearch.ca/resources/KMS-Reservoir-tillage-Evaluation-Final-report-2011-MHPEC-ver.pdf.pdf> Accessed on 06.06.2016.
- Hackwell, S.G., Rochester, E.W., Yoo K.H., Burt, E. C. and Monroe, G.E. (1991). Impact of reservoir tillage on water intake and soil erosion. Transactions of the ASAE, 34(2): 0436-0442, American Society of Agricultural Engineers.
- Hashemina, S.M. (1994). Controlling runoff under low pressure center pivot irrigation systems. Irrigation and Drainage Systems, 8: 25-34, Kluwer Academic Publishers, Netherlands.
- Hansen, H. and Trimmer, W. (1997). Irrigation runoff control strategies. Oregon State University Extension Service Publication. PNW 287.
- Hudson, N.W. (1987). Soil and water conservation in semi-arid areas. Water Conservation. Soil Resources, Management and Conservation Service FAO Land and Water Development Division Food and Agriculture Organization of the United Nations Rome.
- Jones, O.R. and Baumhardt, R.L. (2003). Furrow dikes. Encyclopedia of Water Science, doi: 10.1081/E-EWS 120010226, p. 317-320, New York.
- Keith, W. (2016). Terrastar soil conditioner. Soil conditioning device. US7478684, <http://rexresearch.com/terrastar/terrastar.htm> Accessed on 10.06.2016.
- Kranz, W., Shelton, D.P., Dickey, E.C. and Smith, J.A. (1996). Water runoff control practices for sprinkler irrigation systems. File G1043, <http://infohouse.p2ric.org/ref/20/19742.htm> Accessed on 15.06.2015.
- Longley, T.S. (1984). Reservoir tillage for center pivot irrigation. ASAE Paper No. PNR 84-209. ASAE, St. Joseph, MI 49085, USA.
- Pandey, A., Mathur, A., Mishra, S.K. and Mal, B.C. (2009). Soil erosion modeling of a Himalayan watershed using RS and GIS. Environmental Earth Sciences 59: 399-410.
- Safriel, U. and Adeel, Z. (2005). Dryland systems. Assessment Report Chapters, Chapter 22, Millennium Ecosystem Assessment Board, p. 623-662.
- Salem, H.M., Valero, C., Munoz, M.A. and Gil-Rodriguez, M. (2015). Effect of integrated reservoir tillage for in-situ rainwater harvesting and other tillage practices on soil physical properties. Soil & Tillage Research 151: 50-60.
- Schneider, A.D., Buchleiter, G. and Kinciad, D.C. (2000). LEPA Irrigation Developments. National Irrigation Symposium, ASAE, November 14-16, p. 89-96, Arizona.
- Sui, Y., Ou, Y., Yan, B., Xiaohong, X., Rousseau, A. N. and Zhang, Y. (2016). Assessment of micro-basin tillage as a soil and water conservation practice in the black soil region of Northeast China. PMID: 27031339 [PubMed - in process], <http://dx.doi.org/10.1371/journal.pone.0152313>.
- Ventura, E.V., Norton, L.D., Ward, K., López-Bautista, M. and Tapia-Naranjo, A. (2003). A New Reservoir Tillage System for Crop Production in Semiarid Areas. ASAE Meeting Presentation

Paper Number: 032315, USA, [http://elibrary.asabe.org/azdez.asp?AID = 14035&t=2](http://elibrary.asabe.org/azdez.asp?AID=14035&t=2)
Accessed on 26.05.2016.

Warrick, B.E., Sansone, C. and Johnson, J. (2002). Grain sorghum production in West Central Texas. Extension Entomologist and Extension Economist Educational Programs, Texas AgriLife Extension Service, <http://www.soilcropandmore.info/crops/sorghum/furrowd1.jpg>
Accessed on 06/06/2016.

Warrick, B.E. (2008). Agronomy News. Texas AgriLife Extension Service Texas A&M University System, <http://www.soilcropandmore.info/Newsletter/nl012008.htm> Accessed on 06/06/2016.

<http://www.briggsirrigation.co.uk/products/tied-ridger/> Accessed on 06.06.2016.

http://agritech.tnau.ac.in/agriculture/agri_majorareas_dryland_enggmeasures_basin_listing.html
Accessed on 06.06.2016.

<http://tillso.co.uk/aqueel.html> Accessed on 07.06.2016.

<http://www.Terramanustech.com/terrastar-technologies/> Accessed on 10.06.2016.

<http://dammerdiker.com/dammer-diker.html> Accessed on 15.06.2016.

APPLICATION OF INTERO MODEL FOR SOIL LOSS ESTIMATION CASE STUDY: S7-1 WATERSHED OF SHIRINDAREH RIVER BASIN, IRAN

Leila GHOLAMI^{1*}, Pedro Veloso Gomes BATISTA², Atefeh BEHZADFAR³, Abdulvahed KHALEDI DARVISHAN⁴, Morteza BEHZADFAR⁵

^{1*} Department of Watershed Management Engineering, College of Natural Resources, Sari University of Agricultural Resources and Natural Resources, Sari, iran

² Federal University of Lavras, Department of Soil Science, Lavras, Brazil

³ Azad University, Science and Research Branch, Tehran, iran

⁴ Dep. of Watershed Management Eng., College of Natural Resources, Tarbiat Modares University, iran

⁵ Planning and Budgeting Organization of North Khorasan Province, Bojnord, iran

*Corresponding author: l.gholami@sanru.ac.ir

Abstract

Soil erosion is a naturally occurring process that affects all landforms. In agriculture, soil erosion refers to the wearing away of a field's topsoil by the natural physical forces of water and wind. It may be a slow process that continues relatively unnoticed, or it may occur at an alarming rate causing serious loss of topsoil. As the measuring of soil erosion is costly and time consuming process, therefore soil erosion models have been used more and more to estimate soil erosion as well as sediment yield. For calculation of the sediment yield in the S7-1 Watershed of Shirindareh river, Iran we used the IntErO model based on the EPM method. Calculated peak discharge from the S7-1 Watershed was $75 \text{ m}^3\text{s}^{-1}$ for the incidence of 100 years and the net soil loss was $11034 \text{ m}^3\text{km}^{-2}$, specific $242 \text{ m}^3 \text{ km}^{-2}$ per year. The results of the present study and previous experiences of the other researchers revealed that the IntErO model can be used to estimate soil loss in the other regions similar to Shirindareh watershed.

Keywords: *Soil erosion, IntErO Model, sediment yield, Shirindareh watershed.*

Introduction

Healthy soil is the foundation of the food system. It produces healthy crops that in turn nourish people. Maintaining a healthy soil demands care and effort from farmers because farming is not benign. By definition, farming disturbs the natural soil processes including that of nutrient cycling – the release and uptake of nutrients (Benites & Benites, 2005). Soil loss is a serious problem in developing countries (Wolancho, 2010) that cause great ecological concerns (Gholami *et al.*, 2013) in various environments worldwide (Kisic *et al.*, 2016; Ballesteros-Cánovas *et al.*, 2015; Pimentel, 2006; Nikkami, 2012, Stoffel and Huggel, 2012, Ristic *et al.*, 2001). There are several types of water erosion, including splash, sheet, interrill, rill, gully and stream bank erosion (Khaledi Darvishan *et al.*, 2012; Gholami *et al.*, 2013 and 2014; Khaledi Darvishan *et al.*, 2014 and 2015, Sadeghi *et al.*, 2015a and b; Gholami *et al.*, 2016, Sadeghi *et al.*, 2016). The soil loss from land surfaces by erosion is widespread and reduces the productivity of all natural ecosystems, agricultural, forest, and pasture ecosystems (Pimentel *et al.*, 1995; Troeh *et al.*, 2004; Pimentel and Burgess, 2013). With the growing human population, soil erosion, water availability, climate change due to fossil fuel consumption, eutrophication of inland and coastal marine bodies of water, lack of vegetation protection to reduce the water competition and loss of biodiversity rank as the prime environmental problems of the world (Burguet *et al.*, 2016; Pimentel & Burgess, 2013).

Study of soil erosion and sediment yield in the watershed is one of the basic necessities to achieve integrated land management and soil and water conservation (Khaledi Darvishan *et al.*, 2016). The estimation of the erosion in a watershed is therefore essential to encompass a lot of environmental problems and to evaluate the amount of sediment moved, transported and deposited in and out of the basin. Direct measurements of erosion in a watershed are possible with multi-years measurement of solid transport in the closing-section (Behzadfar *et al.*, 2014a and Behzadfar *et al.*, 2014b). As the water and sediment sampling in given intervals and drawing hydrograph and sediment graph need a lot of time and costly laboratorial works (Sadeghi *et al.*, 2014; Khaledi Darvishan *et al.*, 2010; Sadeghi *et al.*, 2013), therefore soil erosion models have been used more and more to estimate soil erosion as well as sediment yield (Spalevic *et al.*, 2013a, 2013b, 2013c, 2013d, 2013e). The modelling of the erosion process has progressed rapidly, and a variety of models have been developed to predict both runoff and soil loss. We used the computer-graphic models (Spalevic, 2011; Spalevic, 1999a, 1999b) for prediction of soil erosion intensity from the watershed area – IntErO model.

In the present research, the IntErO model was verified and tested in the S7-1 Watershed of the Shirindareh River Basin, Iran. Soil erosion processes, soil erosion intensity and runoff of the Shinindareh River were calculated using the IntErO model.

Material and Methods

The study was conducted in the area of the S7-1 Watershed of the Shirindareh River Basin.

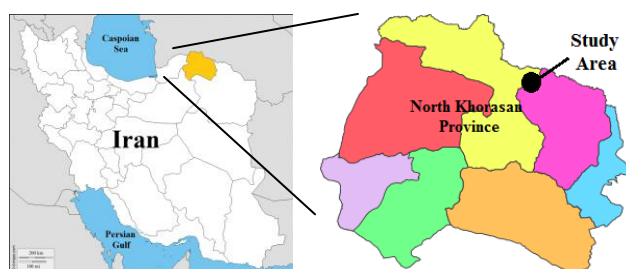

Figure 1. Study area of the S7-1 watershed, the Shirindareh River Basin, Iran

The study area is placed in north eastern parts of Iran are mountainous, in the area of the Shirindareh River Basin, one of the main tributary of the river Atrak. Atrak originates from Hezar-Masjed mountains in the region of Razavi Khorasan and lies between steep slopes and plains till to enter the territory of Turkmenistan on Chaat region and finally drains to Caspian Seaa in the Gulf of Hasan Ghuly (Behzadfar *et al.*, 2014a).

The S7-1 watershed is covering an area of 45 km². It is one of the medium to big sized watersheds of the natural entity of the Shirindareh region. During the field work, using a morphometric methods, various data on intensity and forms of soil erosion, land use, and the measures taken to reduce or mitigate erosion were recorded.

According to our calculations, the shortest distance between the fountainhead and the mouth, l_v , is 8.9 km; and the total length of the main watercourse with tributaries is 87 km. The relief has very pronounced dynamics; the average slope gradient in the river basin, l_{sr} , is calculated on 33% what indicates that in the river basin prevailing very steep slopes. The average river basin altitude H_{sr} , is calculated on 1823 m; the average elevation difference D , on 279 m.

The geological structures and soil characteristics of the area was analysed based on the research of the National Geological Survey Organization (NGS) led by Bolourchi (1987). He analysed the

physical and chemical properties of all geological formations of North Khorasan province, including those in the study area of the S7-1 watershed. Climatological data were received from the meteorological stations located in North Khorasan province of Iran.

The IntErO model (Spalevic, 2011) as a computer-graphic method, with the Erosion Potential Method – EPM (Gavrilovic, 1972) embedded in the algorithm of this model, was used for obtaining data on estimate of peak discharge and sediment yield from the studied watershed. The basic analytical equation for the calculation of erosion-induced soil losses is as follows:

$$G_{yr \times sp}^{-1} = T \times H_{yr} \times \pi \sqrt{Z^3} \times R_u$$

where: $G_{yr \times sp}^{-1}$ – specific annual total erosion-induced sediment yield reaching the confluence, $m^3 yr^{-1} km^{-2}$; T – temperature coefficient of the watershed; H_{yr} – amount of rainfall, mm; π – 3.14; Z – coefficient of erosion; R_u – coefficient of retention of soil in the watershed.

This methodology is currently in use in: Bosnia & Herzegovina, Brazil, Bulgaria, Croatia, Czech Republic, Italy, Macedonia, Montenegro, Morocco, Saudi Arabia, Serbia, South Africa and Slovenia (Al-Turki *et al.*, 2015; Gazdic *et al.*, 2015; Spalevic *et al.*, 2015a, 2015b, 2015c, 2015d, 2015e, 2015f, 2015g, 2015h, 2015i, 2015k; Vujacic & Spalevic, 2015; Kostadinov *et al.*, 2014; Spalevic *et al.*, 2014a, 2014b, 2014c, 2014d; Spalevic *et al.*, 1999c). The provided methodology have been successfully used in Iran in the regions of Chamgardalan, Kasilian, Kermanshah, Razavi Khorasan (Spalevic *et al.*, 2016; Draganic *et al.*, 2015a; Draganic *et al.*, 2015b; Barovic *et al.*, 2015; Behzadfar *et al.*, 2015; Barovic & Spalevic, 2015; Behzadfar *et al.*, 2014a; Yousefi *et al.*, 2014; Behzadfar *et al.*, 2014b; Zia Abadi & Ahmadi, 2011; Amiri, 2010; Sadeghi, 2005; Sadeghi, 1993) and other regions.

Results and Discussion

The climate. The climate of studied area is continental, with the absolute maximum temperature and the negative of 34.6°C and -24.4°C, respectively. The temperature coefficient and also the average annual air temperature, t_0 , is 10.2°C and T , is calculated on 1; the amount of torrential rain, hb , on 37 mm. The average annual precipitation, H_{yr} , is 328.4 mm (Source: Data from the North Khorasan Meteorological stations of Iran).

Vegetation and land use. The studied area is located in Middle- East of the Kope-Dagh geographical region. According to the available literature and the analysis using the Google maps and Google Earth, including the records from the field visits, the pastures and meadows are covering the area of 51% and non-arable land of 49%. The coefficient of the river basin planning is calculated on 0.75. The coefficient of the vegetation cover is calculated on 0.9.

Soil erosion and runoff characteristics. The dominant erosion form in this area is surface erosion and is the most pronounced on the steep slopes without vegetation cover. Problems with overgrazing and livestock traces are recorded also all over the studied area.

Processing the input data by the IntErO model we received the results in relation to the sediment yield of the S7-1 Watershed of the Shirindareh River Basin of Iran (Table 1).

Table 1. The IntErO report for the S7-1 watershed river basin

INPUTS			
River basin area	F	45.59	km ²
The length of the watershed	O	22.25	km
Natural length of the main watercourse	Lv	8.91	km
The shortest distance between the fountainhead and mouth	Lm	6.88	km
The total length of the main watercourse with tributaries of I and II class	ΣL	87.64	km
The lowest river basin elevation	Hmin	1544	m
The highest river basin elevation	Hmax	2448	m
A part of the river basin consisted of a very permeable products from rocks	fp	0.14	
A part of the river basin area consisted of medium permeable rocks	fpp	0.73	
A part of the river basin consisted of poor water permeability rocks	fo	0.13	
A part of the river basin under the forests	fs	0	
A part of the river basin under grass, meadows, pastures and orchards	ft	0.51	
A part of the river basin under plough-land and without vegetation	fg	0.49	
The volume of the torrent rain	hb	37	mm
Average annual air temperature	t0	9.1	°C
Average annual precipitation	Hyr	345.1	mm
Types of soil products and related types	Y	1.1	
River basin planning, coefficient of the river basin planning	Xa	0.75	
Numeral equivalents of visible and clearly exposed erosion process	φ	0.53	
RESULTS			
Density of the river network of the basin	G	1.92	
Average river basin altitude	Hsr	1823.93	m
Average elevation difference of the river basin	D	279.93	m
Average river basin decline	Isr	32.84	%
Coefficient of the region's permeability	S1	0.7	
Coefficient of the vegetation cover	S2	0.9	
Maximal outflow from the river basin	Qmax	75	m ³ /s
Production of erosion material in the river basin	Wyr	41805.46	m ³ /yr
Coefficient of the deposit retention	Ru	0.264	
Real soil losses	Gyr	11034.77	m ³ /yr
Real soil losses per km2	Gyr/km ²	242.04	m ³ /km ² yr

Conclusions

The study of calculation of the sediment yield in the S7-1 Watershed of Shirindareh River, Iran showed the following results:

- The structure of the river basin, (X_a , is 0.74706) mountain pastures are the most widespread plant form (50.98%). The proportion is as follows: plough-lands (49.02%). The coefficient of the vegetation cover is calculated on 0.9.
- Types of soil products and related types, (Y, is 1.1): The study area was included decomposed limestone and marls, cement rocks (55.45%), serpentines, red sand stone, flishe deposits (29.33%) and epieugleysol and Marshlands (15.22%).
- Calculated soil losses are $11034 \text{ m}^3 \text{ yr}^{-1}$ and the peak discharge is $75 \text{ m}^3 \text{ s}^{-1}$ (incidence 100yr).

With present study new information about the recent state of the sediment yield of the S7-1 watershed, of the Shirindareh river basin in the North Khorasan province of Iran was provided which is in formats that can simplify the management in the watersheds, demonstrating the possibility of soil loss estimation using the IntErO Model. Some measurements are needed for the

model verification, including additional analysis in relation to the land use changes in order to have more reliable conclusions.

The results of the present study confirmed the findings of Barovic *et al.*, 2015; Behzadfar *et al.*, 2015, 2014a, 2014b; Yousefi *et al.*, 2014; Zia Abadi & Ahmadi, 2011; as well as Amiri, 2010; Sadeghi 1993 in possibility of implementing the Erosion Potential Method in Iran, what leads to the conclusion that the IntErO model may be a useful tool for researchers in calculation of runoff and sediment yield for the river basins of the Caspian Sea with the similar physical-geographical characteristics like the Shirindareh river basins.

References

- Al-Turki, A.M., Ibrahim, H.M., Spalevic, V., (2015). Impact of land use changes on soil erosion intensity in Wadi Jazan watershed in southwestern Saudi Arabia. *Agrosym 2015, Jahorina, Bosnia and Herzegovina*; 10/2015
- Amiri, F., (2010). Estimate of Erosion and Sedimentation in Semi-arid Basin using Empirical Models of Erosion Potential within a Geographic Information System. *Air, Soil and Water Research*, 3: 37-44.
- Ballesteros-Cánovas JA, Czajka B, Janecka K, Lempa M, Kaczka R.J, Stoffel M. (2015). Flash floods in the Tatra Mountain streams: Frequency and triggers. *Science of the Total Environment* 511: 639–648.
- Barovic, G., Leandro Naves Silva, M., Veloso Gomes Batista, P., Vujacic, D., Soares Souza, W., Cesar Avanzi, J., Behzadfar M., Spalevic, V. (2015). Estimation of sediment yield using the IntErO model in the S1-5 Watershed of the Shirindareh River Basin, Iran. *Agriculture and Forestry* 61(3): 233-243
- Barovic, G. and Spalevic, V. (2015). Calculation of runoff and soil erosion intensity in the Rakljanska Rijeka Watershed, Polimlje, Montenegro. *The 6th International Symposium Agrosym 2015, Jahorina, 15-18 October 2015, Bosnia and Herzegovina.*
- Behzadfar, M., Curovic, M., Simunic, I., Tanaskovik, V., Spalevic, V. (2015). Calculation of soil erosion intensity in the S5-2 Watershed of the Shirindareh River Basin, Iran. *International Conference on Soil, Tirana, Albania*; 4-7 May, 2015.
- Behzadfar, M., Djurovic, N., Simunic, I., Filipovic, M. and Spalevic, V. (2014a). Calculation of soil erosion intensity in the S1-6 Watershed of the Shirindareh River Basin, Iran. *International Scientific conference: Challenges in modern agricultural production, December 11, 2014, Skopje, Macedonia.*
- Behzadfar, M. Tazioli, A., Vukelic-Shutoska, M., Simunic, I., and Spalevic, V. (2014b). Calculation of sediment yield in the S1-1 Watershed, Shirindareh Watershed, Iran. *Agriculture and Forestry*, 60 (4): 207-216.
- Benites, A. and Benites, J. (2005). The importance of soil organic matter. *FAO Soils Bulltin* 80, 95pp.
- Bolourchi, M., Mehr Parto, M., and Afsharharb, A., (1987). Geological quadrangle map of Iran no. J5 (Bojnurd sheet), scale 1:250,000, Geological Survey Of Iran.
- Burguet, M., Taguas, E.V., Cerda, A., Gomez, J.A. (2016). Soil water repellency assessment in olive groves in Southern and Eastern Spain. *Catena* 147 (2016): 187–195.
- Draganic, J., Drobnjak, B., Campar, J., Bulajic, B., Zajovic, V., Behzadfar, M., Spalevic, V. (2015a). Calculation of Sediment yield using the IntErO Model in the S1-3 Watershed of the ShirinDareh River Basin, Iran. *9th Congress of the Soil Science Society of Bosnia and Herzegovina. 23rd – 25th of November 2015, Mostar, Bosnia and Herzegovina.*

- Draganic, J., Silva, M. L. N., Avanzi, C. J., Kistic, I., Spalevic, V. (2015b). Soil Loss Estimation using the IntErO Model in the S1-2 Watershed of the ShirinDareh River Basin, Iran. 9th Congress of the Soil Science Society of Bosnia and Herzegovina. 23rd – 25th of November 2015, Mostar, Bosnia and Herzegovina.
- Gavrilovic, S., (1972). Inzenjering o bujicnim tokovima i eroziji. Izgradnja. Beograd.
- Gazdic, M., Pejovic, S., Vila, D., Vujacic, D., Barovic, G., Djurovic, N., Tanaskovikj, V., Spalevic, V. 2015. Soil erosion in the Orahovacka Rijeka Watershed, Montenegro. The 6th International Symposium Agrosym 2015, Jahorina, 15-18 October 2015, Bosnia and Herzegovina.
- Gholami L., Banasik K., Sadeghi S.H.R., Khaledi Darvishan A., & Hejduk L. (2014). “Effectiveness of straw mulch on infiltration, splash erosion, runoff and sediment in laboratory conditions”, *Journal of Water and Land Development*. 22, 51-60.
- Gholami, L., Sadeghi, S.H.R., & Homae, M. (2012). “Efficiency of rice straw mulch as a soil amendment to reduce splash erosion”, *Erosion and Sediment Yields in the Changing Environment (Proceedings of a symposium held at the Institute of Mountain Hazards and Environment, CAS-Chengdu, China, 11–15 October 2012) (IAHS Publ. 356, 2012)*, 173-177.
- Gholami, L., Sadeghi, S.H.R., & Homae, M. (2013). “Straw mulching effect on splash erosion, runoff and sediment yield from eroded plots. *Soil Science Society of America Journal*, 77, 268–278.
- Gholami, L., Sadeghi, S.H.R., & Homae, M. (2016). “Different effects of sheep manure conditioner on runoff and soil loss components in eroded soil”, *Catena*, 139, 99-104.
- Kistic, I., Bogunovic, I., Birkas, M., Jurisic, A., Spalevic, V. (2016). The Role of Tillage and Crops in the Existence of the Soil. *Archives of Agronomy and Soil Science*, p: 1-11; DOI: 10.1080/03650340.2016.1213815.
- Khaledi Darvishan, A., Banasik K., Sadeghi S.H.R., Gholami, L. and Hejduk L. (2015). Effects of rain intensity and initial soil moisture on hydrological responses in laboratory conditions. *International Agrophysics*, 29:165-173.
- Khaledi Darvishan, A., Sadeghi, S.H.R., Homae, M. and Arabkhedri, M. (2014). Measuring Sheet Erosion using Synthetic Color-Contrast Aggregates. *Hydrological Processes*, 28(15): 4463-4471.
- Khaledi Darvishan, A., Sadeghi, S.H.R., Homae, M. and Arabkhedri, M. (2012). Potential Use of Synthetic Color-Contrast Aggregates and a Digital Image Processing Technique in Soil Splash Measurements, *IAHS Publication, No. 356: 364-368*.
- Khaledi Darvishan, A., Sadeghi, S.H.R. and Gholami, L. (2010). Efficacy of Time-Area Method in Simulating Temporal Variation of Sediment Yield in Chehelgazi Watershed, Iran. *Annals of Warsaw University of Life Sciences*, 42(1): 51-60.
- Kostadinov S, Zlatic M, Dragicevic S, Novkovic I, Kosanin O, Borisavljevic A, Lakicevic M, Mladjan D. (2014). Anthropogenic influence on erosion intensity changes in the Rasina river watershed - Central Serbia. *Fresenius Environmental Bulletin*. 23(1a): 254-263.
- Nikkami, D. (2012). Investigating sampling accuracy to estimate sediment concentrations in erosion plot tanks. *Turk J Agric For* 36: 583–590.
- Pimentel, B. and Burgess, M. (2013). Soil Erosion Threatens Food Production. *Agriculture*, 3: 443-463.
- Pimentel, D. (2006). Food and environmental threat of soil erosion. *J Env Dev and Sustain* 8: 119–137.

- Pimentel, D., Harvey, C., Resosudarmo, P., Sinclair, K., Kurz, D., McNair, M., Crist, S., Sphpritz, L., Fitton, L., Saffouri, R. (1995). Environmental and economic costs of soil erosion and conservation benefits. *Science* 1995, 267, 1117–1123.
- Ristic, R., Kostadinov, S., Malosevic, D., Spalevic, V. (2001). Erosion aspect in the assessment of soils of hydrologic classes and determination of CN number of runoff curve. *Acta biologica Iugoslavica - serija A: Zemljište i biljka*. 2001, vol. 50, No 3, p.165-174.
- Sadeghi, S.H.R., Sharifi Moghadam, E., & Khaledi Darvishan, A. (2016). Effects of subsequent rainfall events on runoff and soil erosion components from small plots treated by vinasse. *Catena*, 138: 1-12.
- Sadeghi, S.H.R., Gholami, L., Homae, M., & Khaledi Darvishan, A. (2015a). “Reducing sediment concentration and soil loss using organic and inorganic amendments at plot scale”, *Solid Earth*, 7, 63-89.
- Sadeghi, S.H.R., Gholami, L., Sharifi Moghadam, E., & Khaledi Darvishan, A. (2015b). “Scale effect on runoff and soil loss control using rice straw mulch under laboratory conditions”, *Solid Earth*, 6, 1-8.
- Sadeghi, S.H.R., Gholami, L., Khaledi Darvishan, A. and Saeidi, P. (2014). A Review of the Application of the MUSLE Model World-Wide. *Hydrological Sciences Journal*, 59(1-2): 365-375.
- Sadeghi, S.H.R., Gholami, L. and Khaledi Darvishan, A. (2013). Suitability of MUSLT for Storm Sediment Yield Prediction in Chehelgazi Watershed, Iran. *Hydrological Sciences Journal*, 58(4): 892-897.
- Sadeghi, S. H. (2005). Semi-Detailed Technique for Soil Erosion Mapping Based on BLM and Satellite Image Applications. *J. Agric. Sci. Technol.* Vol. 7: 133-142.
- Sadeghi, H. (1993). Comparison of some erosion potential and sediment yield assessment models in Ozon-Dareh sub-catchment. *Proceedings of the National Conference on Land Use Planning, Tehran, Iran*, pp. 41-75.
- Spalevic, V., Barovic, G., Vujacic, D., Mijanovic, D., Curovic, M., Tanaskovic, V., and Behzadfar, M. (2016). Calculation of Sediment yield at the S 7-4 catchment of the Shirindareh Watershed of Iran using the River Basins model. *Geophysical Research Abstracts*. Vol. 18, EGU2016-6673, 2016. EGU General Assembly.
- Spalevic, V., Curovic, M., Barovic, G., Florijancic, T., Boskovic, I., Kistic, I. (2015a). Assessment of Sediment Yield in the Tronosa River Basin of Montenegro. *The 9th International Symposium on Plant-Soil Interactions at Low pH*. October 18-23, 2015, Dubrovnik, Croatia.
- Spalevic, V., Curovic, M., Barovic, G., Vujacic, D., Tunguz, V., Djurovic, N. (2015b). Soil erosion in the River Basin of Provala, Montenegro. *Agrosym 2015, Jahorina, Bosnia and Herzegovina*; 10/2015.
- Spalevic, V., Vujacic, D., Barovic, G., Simunic, I., Moteva, M. and Tanaskovic, V. (2015c). Soil erosion evaluation in the Rastocki Potok Watershed of Montenegro using the Erosion Potential Method. *2nd International Symposium for Agriculture and Food - ISAF 2015, Faculty of Agricultural Sciences and Food – Skopje*, 7-9 October, 2015, Ohrid, Macedonia.
- Spalevic, V., Frankl, A., Nyssen, J. Curovic, M. and Djurovic, N. (2015d). Calculation of soil erosion intensity in the Sutivanska Rijeka Watershed of Montenegro using the IntErO model. *2nd International Symposium for Agriculture and Food - ISAF 2015, Faculty of Agricultural Sciences and Food – Skopje*, 7-9 October, 2015, Ohrid, Macedonia.

- Spalevic, V., Curovic, M., Barovic, G., Vujacic, D., Djurovic, N. (2015e). Soil erosion in the River Basin of Kisjele Vode, Montenegro. International conference: Land Quality and Landscape Processes, Keszthely, Hungary; 06/2015
- Spalevic, V., Barovic, G., Vujacic, D., Bozovic, P., Kalac, I., Nyssen, J. (2015f). Assessment of soil erosion in the Susica River Basin, Berane Valley, Montenegro. International Conference on Soil, Tirana, Albania; 4-7 May, 2015.
- Spalevic, V., Barovic, G., Mitrovic, M., Hodzic, R., Mihajlovic, G., Frankl, A. (2015g). Assessment of sediment yield using the Erosion Potential Method (EPM) in the Karlicica Watershed of Montenegro. International Conference on Soil, Tirana, Albania; 4-7 May, 2015.
- Spalevic, V., Blinkov, I., Trendafilov, A., Mukaetov, D., Djekovic, V., Djurovic, N. (2015h). Soil erosion assessment using the EPM method: A case study of the Ramcina River Basin, Montenegro. International Conference on Soil, Tirana, Albania; 4-7 May, 2015.
- Spalevic, V., Curovic, M., Vujacic, D., Barovic, G., Frankl, A., and Nyssen, J. (2015i). Assessment of soil erosion at the Brzava small watershed of Montenegro using the IntErO model. Geophysical Research Abstracts. Vol. 17, EGU2015-15007, 2015. EGU General Assembly 2015
- Spalevic, V., Curovic, M., Tanaskovic, V., Djurovic, N., Lenaerts, T. and Nyssen, J. (2015k). Application of the IntErO model for the assessment of the soil erosion intensity and runoff of the river basin Dragovo Vrelo, Montenegro (invited speaker). Balkan Agriculture Congress, 8-10 September 2014. Edirne, Turkey.
- Spalevic, V., Curovic, M., Andjelkovic, A., Djekovic, V., Ilci, S. (2014a). Calculation of soil erosion intensity in the Nedakusi Watershed of the Polimlje Region, Montenegro. International Scientific conference: Challenges in modern agricultural production, December 11, 2014, Skopje, Macedonia.
- Spalevic, V., Tazioli, A., Djekovic, V., Andjelkovic, A., and Djurovic, N. (2014b). Assessment of soil erosion in the Lipnica Watershed, Polimlje, Montenegro. The 5th International Symposium "Agrosym 2014", Jahorina, 23-26 October 2014, Bosnia and Herzegovina, p 723-729.
- Spalevic, V., Hübl, J., Hasenauer, H. and Curovic, M. (2014c). Calculation of soil erosion intensity in the Bosnjak Watershed, Polimlje River Basin, Montenegro. The 5th International Symposium "Agrosym 2014", Jahorina, 23-26 October 2014, Bosnia and Herzegovina, p 730-738.
- Spalevic, V., Curovic, M., Billi, P., Fazzini, M., Frankl, A., and Nyssen, J. (2014d). Soil erosion in the Zim Potok Watershed, Polimlje River Basin, Montenegro. The 5th International Symposium "Agrosym 2014", Jahorina, 23-26 October 2014, Bosnia and Herzegovina, p 739-747.
- Spalevic, V., Djurovic, N., Mijovic, S., Vukelic-Sutoska, M., Curovic, M. (2013a). Soil Erosion Intensity and Runoff on the Djuricka River Basin (North of Montenegro). Malaysian Journal of Soil Science, Vol. 17: p.49-68.
- Spalevic, V., Curovic, M., Tanaskovic, V., Oljaca, M., Djurovic, N. (2013b). The impact of land use on soil erosion and run-off in the Krivaja river basin in Montenegro. The First International Symposium on Agricultural Engineering, 4th - 6th October 2013, Belgrade-Zemun, Serbia, VI: 1-14.
- Spalevic, V., Nyssen, J., Curovic, M., Lenaerts, T., Kerckhof, A., Annys, K., Van Den Branden, J., Frankl, A. (2013c). The impact of land use on soil erosion in the river basin Boljanska Rijeka in Montenegro. In proceeding of the 4th International Symposium "Agrosym 2013" (3-6 October, 2013, Jahorina, Bosnia). Key note speakers, p. 54-63.

- Spalevic, V., Curovic, M., Uzen, N., Simunic, I., Vukelic-Shutoska, M. (2013d). Calculation of soil erosion intensity and runoff in the river basin of Ljesnica, Northeast of Montenegro. In proceeding of the 24th International Scientific-Expert Conference on Agriculture and Food Industry, Sarajevo, Bosnia and Herzegovina.
- Spalevic, V., Curovic, M., Tanaskovik, V., Pivic, R., Djurovic, N. (2013e). Estimation of soil erosion intensity and runoff in the river basin of Bijeli Potok, Northeast of Montenegro. In proceeding of the 1st International Congress on Soil Science, XIII Congress of Serbian Soil Science Society "SOIL – WATER – PLANT", October, 2013. Belgrade, Serbia.
- Spalevic, V. (2011). Impact of land use on runoff and soil erosion in Polimlje. Doctoral thesis, Faculty of Agriculture of the University of Belgrade, Serbia, p 1-260.
- Spalevic, V. (1999a). Application of computer-graphic methods in the studies of draining out and intensities of ground erosion in the Berane valley. Master thesis. Faculty of Agriculture, University of Belgrade, Serbia. p 1-131.
- Spalevic, V., Dlabac, A., Jovovic, Z., Rakocevic, J., Radunovic, M., Spalevic, B., Fustic, B. (1999b). The Surface and distance Measuring Program. Acta Agriculture Serbica, Vol IV, 8, p.63-71.
- Spalevic, V., Dubak, D., Fustic, B., Jovovic, Z., Ristic, R. (1999c). The Estimate of the Maximum Outflow and Soil Erosion Intensity in the Kaludra River Basin. Acta Agriculture Serbica, Vol.IV, 8, p.79-89.
- Stoffel, M., Huggel, C. (2012). Effects of climate change on mass movements in mountain environments. Progress in Physical Geography 36, 421–439.
- Troeh, F.R., Hobbs, A.H.; Donahue, R.L. (2004). Soil and Water Conservation: For Productivity and Environmental Protection; Prentice Hall: Upper Saddle River, NJ, USA.
- Vujacic, D., Spalevic, V. (2016). Assessment of Runoff and Soil Erosion in the Radulicka Rijeka Watershed, Polimlje, Montenegro. The 6th International Symposium Agrosym 2015, Jahorina, 15-18 October 2015, Bosnia and Herzegovina. Agriculture and Forestry, 62 (2): 283-292.
- Yousefi, S., Kivarz, N., Ramezani, B., Rasoolzadeh, N., Naderi, N., Mirzaee, S. (2014). An Estimation of Sediment by Using Erosion Potential Method and Geographic Information Systems in Chamgardalan Watershed: A Case Study of Ilam Province, Iran. GRIB, Vol. 2 (2): XXXIV to XLI
- Wolanchu, L.W. (2012). Watershed Manegement: An option to station dam and reservoir function in Ethiopia. J. Environ. Sci. Tech. 5(5): 262-273.
- Zia Abadi, L., Ahmadi, H. (2011). Comparison of EPM and geomorphology methods for erosion and sediment yield assessment in Kasilian Watershed, Mazandaran Province, Iran. Desert, 16: 103-109.

REPRESENTATION OF THE CONTENT OF INORGANIC NITROGEN IN ELESKA RIVER

Tatjana BLAZHEVSKA*, Marija MENKINOSKA, Valentina PAVLOVA, Viktorija STAMATOVA, Nikola LEKOVSKI

Technology-technical Faculty, "Petre Prlichkov" Veles, University "St. Climent Ohridski", Bitola, Republic of Macedonia

*Corresponding author: msptatjana@yahoo.com

Abstract

The composition of surface water is quite different because of specific physicochemical and biological processes that take place in them. The rivers which man uses are variable in their composition and largely depend on the quality of water flowing into them. The purpose of this paper is to determine the content of inorganic nitrogen expressed through ammonia, nitrites and nitrates, and dissolved oxygen and thus determine the water quality in the Eleska River. The Eleska River is a tributary of the Crna River. Its source is on the eastern slopes of Mount Baba in the Aegean part of Macedonia. It flows into the Crna River between the villages Bukri and Brod. In the experimental part were taken water samples from Eleska River after its entry into R. Macedonia near the village of Egri. Samples were taken in the first week of July and September. To make experimental research the following procedures were used: Ammonia and nitrite in the water were assessed spectrophotometrically with device Spectroquant UV / VIS Pharo 300. Ammonia according to the method 14752 (Mitrovis, 1954), while the nitrites with method 14776. Determination of nitrates was performed with UV PASTEL - a tool for direct readout of values. The obtained values indicate that there is no greater fecal contamination (according to the content of ammonia), but according to its quality and purpose the water belongs to the third category. This water according to the purpose can be used for irrigation.

Keywords: *Eleshka River, ammonia, nitrates, nitrites, dissolved oxygen*

Introduction

Man with his activity, satisfying their interests increasingly degrades the environment and thus disturbs the balance in aquatic ecosystem (Kannel *et al.*, 2007). Consequently, the natural process of autoperification is disturbed too. Surface water is the most susceptible to these changes. Therefore there is a need to determine the water quality and their proper management (Yanga *et al.*, 2007). Two percent (2%) of the total territory of the Republic of Macedonia is under water. The biggest right tributary of river Vardar is Crna River. Eleshka River, which is the research subject, is right tributary of Crna River. The main goal of this research is to determine the quality and the current state of the water in Eleshka River, thereby to determine its purpose. The main goal will be realized by determining the following parameters: content of ammonia, nitrates, nitrites and dissolved oxygen.

Hydrographic features of Eleshka River

Eleshka river rises above the village. Owl, on the eastern slopes of Baba Mountain at an altitude of 1300 m, in the Aegean part of Macedonia and in the upper course is known under the name

River Blasko. Throughout its course passes through the city Florina- Greece. The river enters in the territory of the Republic Macedonia between the villages Kremenica Germijan, and flows into Black River between the villages Bukri and Brod (Novaci), under the name Eleshka River. The total length of the river is 41 km (Kostov *et al.*, 2010). The main goal of the research is to determine the quality, the current state of water in Eleshka River, thereby to determine its purpose.

Material and Methods

The water of Eleshka River is the material which is used for the purposes of the research. For this purpose, in the experimental part of the research, were carried out analysis of the samples taken from Eleshka River. Samples of the water were taken in the first week of July and September. Taken samples were transported in sterile glass bottles at a temperature of $\pm 4^\circ\text{C}$ in field refrigerators. The following analyses were used for the purposes of the experimental researches. The determination of ammonia and nitrite in the water, was done with spectrophotometric device Spectroquant UV / VIS Pharo 300, according to the method 14752 Determining of the: nitrates, dissolved oxygen, is performed with UV PASTEL (SECOMAM - France)– instrument for direct readout of values with UV analyzer software and the necessary calibrations.

Results and Discussion

Circulation of nitrogen in surface waters is a chain reaction composed of several different processes of transformation of the different types of nitrogen. The main role in these processes has microorganisms (Juhna *et al.*, 2007; Beversdorf *et al.*, 2013). The results of two months of testing are presented in graphs to get a visual impression of the current state of water in Eleshka River for May and June.

Nitrogen in the form of ammonia (NH_3)

Ammonia is an important form of nitrogen that can catalyze the process of eutrophication and to facilitate the rapid growth of algae. It can be said that ammonia is an "indicator of pollution that occurred recently" (Zhao *et al.*, 2005; Dalmacija *et al.*, 2011).

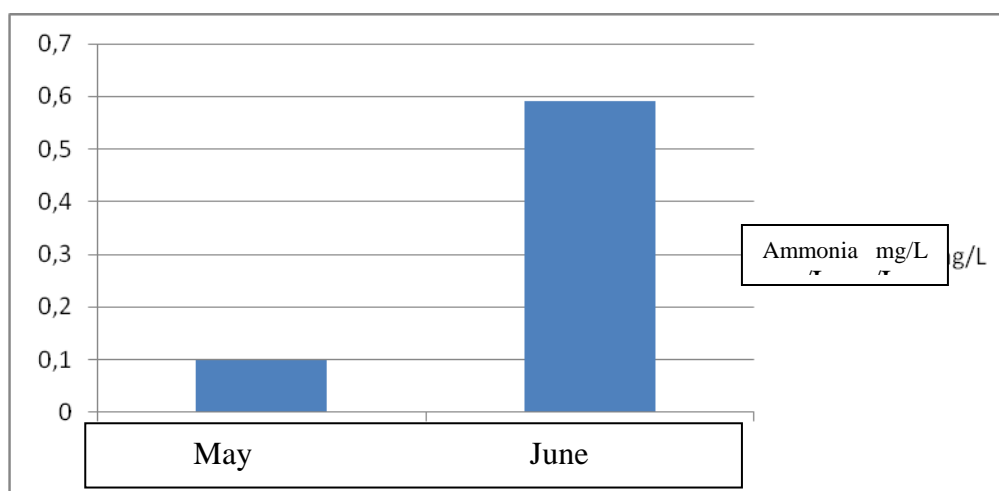

Figure 1. Concentration of ammonia in the water Eleshka River for May and June.

According to data presented in Figure 3, we see that the amount of ammonia nitrogen in the samples of water from the Eleshka River is higher in June as opposed to May. This situation is due to the increased concentration of organic matter, which comes to the river from the surrounding villages. It can be concluded that the water from Eleshka River in May and June, ranks third and fourth category of waters. It suggests that the water in May can be used for irrigation

Nitrite nitrogen

Determining the presence of nitrites in the water indicates a decrease in its quality. According to Glavan (2010), the origin of nitrites in the water may be from the biodegradable organic matter or as a result of the activity of anaerobic bacteria that lead to the reduction of nitrates. (Djuikom *et al.*, 2006).

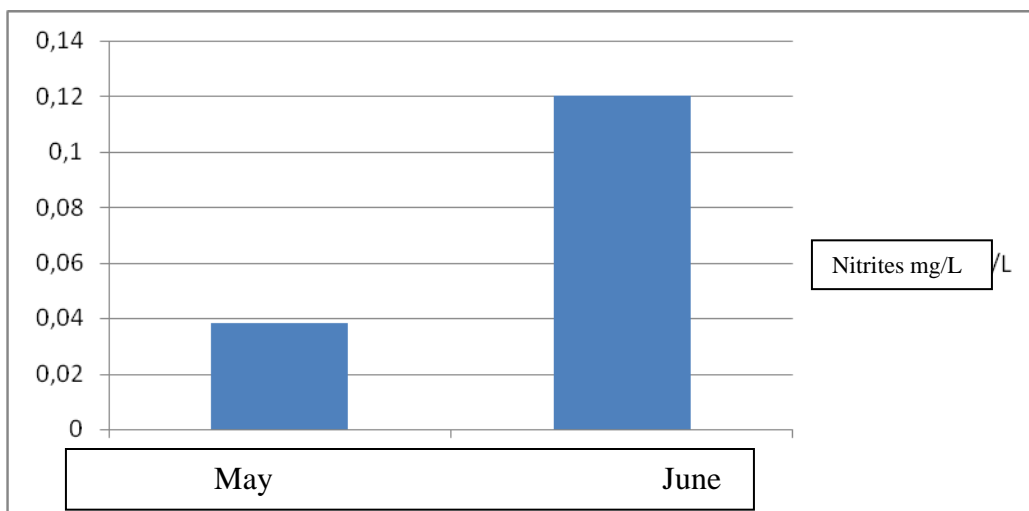

Figure 2. Concentrations of nitrite in the water of Eleshka River for May and June.

From Figure 2, we can conclude that the amount of nitrogen present which is present in the form of nitrite is higher in June as opposed to May. Ambient temperature which is typical for summer has a catalytic effect on the processes of nitrification and it is the reason why we have more intensive chemical reactions in which there is a greater amount of nitrates. Despite these monthly fluctuations we can conclude that organic nitrogen load which has Eleshka River in May and June does not exceed the maximum allowable concentrations and its water belongs to the third category.

Nitrate nitrogen ($\text{NO}_3\text{-NO}_3\text{-N}$)

The presence of nitrates in the water indicates a "final phase" of the degradation of organic matter. According to Dalmacija (2011), their presence in surface water originates from nitrogen fertilizers, as well as the uncontrolled discharge of waste water with organic matter and the high level of nitrates indicates that it is the final stage of degradation of organic matter (Wakida *et al.*, 2005; Zhao *et al.*, 2015).

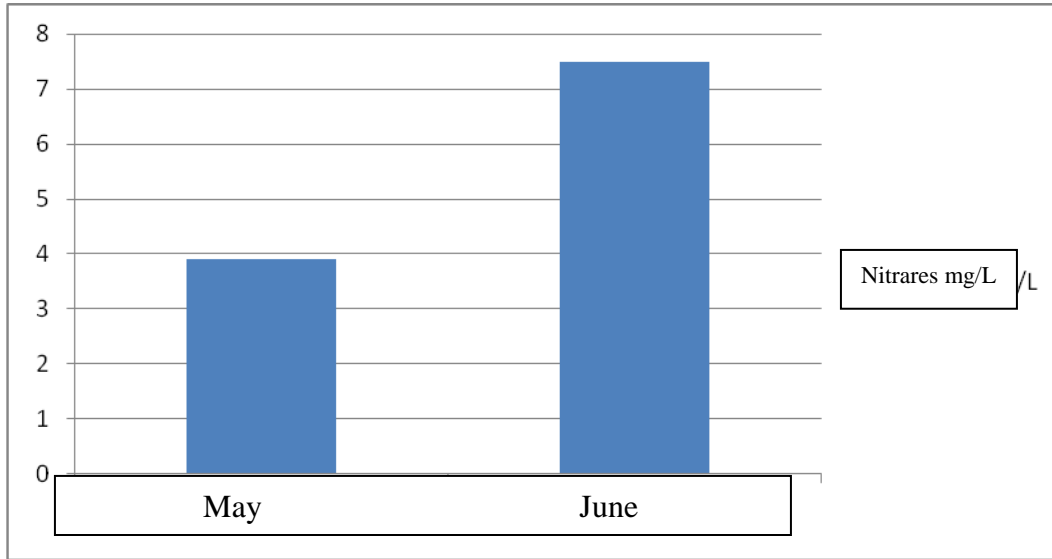

Figure 3. Concentration of nitrates in water from the Eleshka River for May and June.

From Figure 3 can be clearly seen that the amount of nitrate nitrogen, recorded in the sample of water from Eleshka River is higher in June as opposed to May. Water pollution with nitrogen compounds (of any kind) usually occurs from the decomposition of organic compounds under the influence of the relevant bacteria. We believe that the reason for the difference in the concentrations is due to the higher temperature in June as opposed to May. Also, the water level appears as a reason, namely, in summer the water level in the river is lower and it causes higher concentration of organic matter and thus higher concentration of the nitrates. Knowing the factors that influence the chemical reactions, we can conclude that the higher temperature accelerates chemical reactions (Venkatesharaju *et al.*, 2010). In terms of present organic matter for decomposition, the higher temperature accelerates the nitrification process. Although this is some increase in the content of nitrates - 7,5 mg/L in June, we can conclude that the amount of nitrates in the sample water does not exceed the limit.

Dissolved oxygen

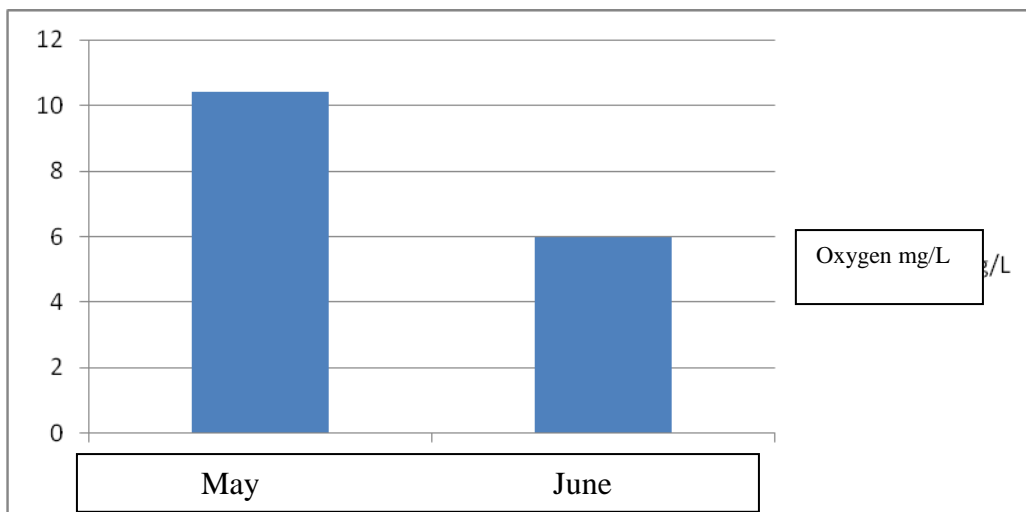

Figure 4. Concentration of dissolved oxygen in the water of the Eleshka River for May and June.

According to Figure 4, we can conclude higher content of dissolved oxygen in May compared to June. We can determine the intensity of decomposition of the organic compounds present in the water samples, are affecting inversely on the amount of dissolved oxygen in the water, ie the more increases the amount of nitrates, nitrites and ammonia, the more it reduces the amount of dissolved oxygen.

Conclusion

With sublimation of the data, we can deduce the following conclusions: The water from Eleshka River, although a mountain river which is considered with relatively clean water, however along its course dissolves part of the minerals from the surrounding villages receives certain organic load and of course pollution caused by fertilizers used in the surrounding fields. The obtained values indicate that there is no great fecal contamination (according to the content of ammonia) but that it is a water, which according to its quality and purpose belongs to the third category. This water according to the purpose can be used for irrigation.

The amount of nitrates, nitrites and ammonia is greater in June, compared to May, and it is due to the difference in temperature in these two months and reduced water levels typical for the summer period of the year. By reducing the water level of the river, the concentration of organic matter present in it is increasing. We believe that this pollution comes from Eleshka River, is affecting the water quality in the Crna River, but is not the only pollutant. We think that our data and monitoring which makes HMS Skopje, gives us a clear picture of the impact of Eleshka River on water quality in the Black River. The responsibility remains on us and our relationship to the planned use of the waters and their protection from pollution.

References

- Beverdors, L.J., Miller, T.R., and McMahan, K.D. (2013) The role of nitrogen fixation in cyanobacterial bloom toxicity in a temperate, eutrophic lake. *PLoS ONE* 8: e56103.
- Dalmacija, B., (2011): Granične vrednosti emisije za vode, Prirodno-Matematički fakultet, Novi Sad.
- Djuikom, E., Njine, T., Nola, M., Sikati, V., and Jugnia, L. (2006): Microbiological water quality of the Mfoundi River watershed at Yaoundé, Cameroon, as inferred from indicator bacteria of fecal contamination. *Environ Monit Assess* 122: 171–183
- Glavan M., and Pintar M., (2010): Impact of point and diffuse pollution sources nitrate and ammonium concentrations in the karst – influenced Temenica river. *Fresenius Environmental Bulletin*, vol. 19 No. 5a.
- Juhna, T., Birzniece, D., and Rubulis, J. (2007) Effect of phosphorus on survival of *Escherichia coli* in drinking water biofilms. *Appl Environ Microbiol* 73: 3755–3758.
- Kannel, P.R., Lee, S., Kanel, S.R., Khan, S.P., and Lee, Y. (2007): Spatial-temporal variation and comparative assessment of water qualities of urban river system: a case study of the river Bagmati (Nepal). *Environ Monit Assess* 129: 433–459.
- Kostov, V. Panov, N., Rusevski, R. (2010) : Fishing map for the basin of Crna River for the period of 2011-2016 Institute of Animal Science - Skopje Ministry of Agriculture, Forestry, and Water Management of the Republic of Macedonia Venkatesh Raju, K., Ravikumar, P., Somashekar, R.K., and Prakash, K.L. (2010) Physico-chemical and bacteriological investigation on the river Cauvery of Kollegal stretch in Karnataka. *J Sci Eng Technol* 6: 50–59.
- Zhao Yu X., Zimin Wei, Yue Zhao, Beidou Xi, Xueqin Wang, Taozhi Zhao, Xu Zhang and Yuquan Wei (2015): Environmental factors influencing the distribution of ammonifying and denitrifying bacteria and water qualities in 10 lakes and reservoirs of the Northeast,

China. *Microbial Biotechnology* published by John Wiley & Sons Ltd and Society for Applied Microbiology, *Microbial Biotechnology*, 8, 541–548

Wakida, F.T., and Lerner, D.N. (2005): Non-agricultural sources of groundwater nitrate: are view and case study. *Water Res* 39: 3–16.

Yang, H., Shen, Z., Zhang, J., and Wang, W. (2007): Water quality characteristics along the course of the Huangpu River (China). *J Environ Sci* 19: 1193–1198.

EFFECTS OF IRRIGATION AND FERTILIZATION ON THE NUMBER OF FORMED FLOWERS AND FRUITS SETS IN PRUNED PEPPER

Vjekoslav TANASKOVIK^{1*}, Ordan CUKALIEV¹, Velibor SPALEVIC², Milena MOTEVA³,
Mile MARKOSKI¹

¹ Faculty of Agricultural Sciences and Food, University Ss. Cyril and Methodius in Skopje, Macedonia

² Institute of Forestry, Podgorica, Montenegro

³ University of Architecture, Civil Engineering and Geodesy & Research Institute of Soil Science, Agrotechnologies and Plant Protection "N. Pushkarov", Sofia, Bulgaria

*Corresponding author: vjekoslavtanaskovic@yahoo.com; vtanaskovic@zf.ukim.edu.mk

Abstract

The main goal of this investigation was to compare effects of different irrigation and fertilization regimes on the number of formed flowers and fruits sets in pruned pepper ("V" system). For this purpose, the field experiment with pepper (*Capsicum annum L. var. Bela dolga*) grown in an experimental plastic house in the Skopje region was conducted during the period of May to September in 2005, 2006 and 2007. Four different irrigation and fertilization regimes were performed during the investigation. Three of the treatments were irrigated with drip irrigation and drip fertigation (DF1, DF2, DF3), while the last one was irrigated with furrow irrigation and conventional application of fertilizer (\emptyset_B). From the results obtained during the three years of investigation, we can conclude that drip fertigation frequency of every 2 days (DF1) has shown the largest number of formed flowers (69.67) and fruits sets (41.67) in comparison to DF2, DF3 and \emptyset_B . The results are statistically significant at 0.5 level of probability. Also, drip fertigation frequency of every 4 days (DF2) significantly affects the number increase of formed flowers and fruits sets in comparison to DF3 and \emptyset_B . A positive effect of drip fertigation on the number of formed flowers and fruits sets is presented by comparison of the results from the treatments DF3 (drip fertigation scheduled by tensiometers) and \emptyset_B . Namely, the DF3 treatment (with similar and sometimes a bit longer irrigation interval compared to \emptyset_B) has shown 8.32% and 19.2% higher number of formed flowers and fruits sets compared to \emptyset_B . The results are statistically significant at 0.5 level of probability.

Keywords: *drip fertigation, furrow irrigation, pruned pepper, fructification*

Introduction

The plants growth, biology of development and their changes that appear during the vegetation are genetic properties of each variety or population, but at the same time these properties are in direct relation with the complex external factors (Jankulovski, 1983). Bosland and Votava (2000) reported that pepper is one of the most sensitive vegetable to external factors, especially to light, temperature, soil moisture and air moisture. The pepper needs a lot of heat during whole growing period, which is connected with its native place of origin (Jankulovski, 1997; Gvozdenović *et al.*, 2004). If the temperature is below 15°C, there are possibilities for increase of the falling of flowers (Lazić *et al.*, 2001; Gvozdenović *et al.*, 2004). Also, the flowers and fruits can fall if the temperature rises above 35°C (Rylski, 1986). The best pepper yields can be obtained when the air temperature during the day time is between 18-32°C, especially in the stage of fruit formation (Bosland and Votava, 2000). Also, it is well known that pepper is the most sensitive to water shortage (drought) during the flowering and fruit formation (Candido *et al.*, 2009; Bosland and

Votava, 2000). Water deficit during the period between flowering and fruit development reduced the final fruit production (Jaimezet *al.*, 2000; Dalla Costa and Gianquinto, 2002; Sezenet *al.*, 2006). Also, many authors indicate that cultivation practices have influence on pepper plant growth and biology of development. Jankulovski (1983) indicates that pepper varieties have influence on the duration of the vegetation period. Burt *et al.*, (1998) and Tanaskovik *et al.*, (2015) noted similar effect as result of the irrigation and fertigation techniques. Antony and Singandhupe (2004) and Sezenet *al.*, (2006) indicate influence of drip irrigation on flower and fruit development, as well as on yield production. Jovicich *et al.*, (2004) and Rusevski (2005) reported influence of pruning systems on yield potential, flower and fruit development. Irrigation of agricultural crops always had great importance for climatic conditions of the Republic of Macedonia. Results from the terrain show that surface irrigation is still a commonly used irrigation technique in vegetable production in the country, and therefore farmers have low yield potential and low water and fertilizer use efficiency. Even if drip irrigation is used by farmers, still there are problems especially related to irrigation scheduling and application of fertilizer (conventional use of fertilizers). According to Tanaskovik *et al.*, (2015), the reasons for low pepper productivity (about 18 t/ha) in the country are traditional cultivation practices or just partial (separate) use of modern technologies, even though there is real possibility to combine them and improve production. Therefore, the main objective of this research was to assess the effects of different irrigation and fertilization regimes on the number of formed flowers and fruits sets in two stem pruned pepper grown in an unheated plastic house. Furthermore, one of the goals of this study is to provide opportunities to pepper producers in the country to improve their yields by using drip fertigation practice and pepper pruning technology in their fields.

Material and methods

The field experiments were conducted with pepper crop (*Capsicum annum L. var. Bela dolga*) in an experimental plastic house located near the Faculty of Agricultural Sciences and Food in Skopje (42° 00' N, 21° 27' E), during the period of May to September in 2005, 2006 and 2007. The soil type of the experimental field was Fluvisol (WRB 2015). The average results of chemical and physical characteristics of the soil layer 0-60 cm are presented in Table 1.

Table 1. Chemical and physical characteristics of the soil layer 0-60 cm

<i>Chemical characteristics</i>	
Reaction (pH in water)	8,04
Electrical conductivity (ECedS/m)	2,31
CaCO ₃ %	3,54
Organic matter %	0,77
Available N mg/100 g soil	2,80
Available P ₂ O ₅ mg/100 g soil	13,2
Available K ₂ O mg/100 g soil	22,5
<i>Particle size of the soil layer</i>	
Total sand in %	62,2
Silt in %	13,0
Clay in %	24,8
<i>Water physical properties</i>	
Wilting point (soil moisture retention at 15 bars) in volume %	14,37
Field capacity (soil moisture retention at 0,33 bars) in volume %	34,05
Bulk density in g/cm ³	1,52

The pepper planted in our conditions with yields up to 60 t/ha needs the following amount of nutrients: N 485 kg/ha, P₂O₅ 243 kg/ha and K₂O 585 kg/ha (Jankulovski, 1997; Lazić *et al.*, 2001). The application of the fertilizer for the treatments was done in two portions (before transplanting and during the growing season), which is a common practice in our country. For all treatments, the first portions of the fertilizers were applied before transplanting pepper, while the rest of the fertilizers were applied through the fertigation system for the drip fertigation treatments (Table 2) and conventional fertilization of soil for the control treatment (spread in two portions - at flowering and fruit formation). All investigated treatments received the same amount of fertilizers, but by different methods and frequency of application of water and fertilizers, which was the main idea of this study.

Table 2. Type and amount of fertilizers used during the vegetation period in drip fertigation treatments in kg/ha

Type of fertilizers	Amount of applied fertilizer	Period of application
15:15:15	318 kg/ha	before transplanting
0:52:34	375 kg/ha	drip fertigation during the vegetation
0:0:51+18S	802 kg/ha	drip fertigation during the vegetation
46:0:0	952 kg/ha	drip fertigation during the vegetation

*Remark: the same amounts and quantity of fertilizers were used for furrow irrigation treatment

A drip irrigation system with integrated compensating drippers and a discharge of 4 l/h was installed. The fertigation equipment for the drip fertigation treatments was Dosatron 16, with a plastic barrel as reservoir for concentrated fertilizer. The source of water was the water supply system for the city of Skopje. The irrigation of the experiment (treatment DF1, DF2 and Ø_B) was scheduled according to long-term average daily evapotranspiration of pepper in the Skopje region (Figure 1). The long-term average (LTA) crop evapotranspiration was calculated by FAO software CROPWAT using crop coefficient (K_c) and stage length adjusted for the local conditions.

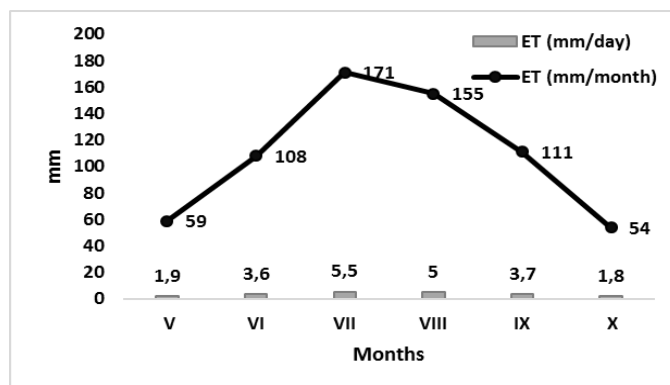

Figure 1. Long-term average daily and monthly evapotranspiration (mm) for pepper in the Skopje region calculated by FAO software CROPWAT

The irrigation scheme used in the field experiments was designed according to randomized block design for experimental purposes with four treatments in three replications. Generally, the experimental treatments were set up according to the daily evapotranspiration rate and irrigation and fertilization techniques. Therefore, the following experimental treatments were applied in this

field experiment: Drip fertigation according to daily evapotranspiration with application of water and fertilizer every 2 days (DF1); Drip fertigation according to daily evapotranspiration with application of water and fertilizer every 4 days (DF2); Drip fertigation scheduled with tensiometers (DF3) with recommendations undertaken by Tekinel and Kanber (2002); Furrow irrigation according to daily evapotranspiration with application of water every 7 days (\emptyset_B) and conventional fertilization. The daily evapotranspiration of DF 1 and DF2 in our study was decreased by 20% (coverage coefficient) similarly to Xie *et al.*, (1999).

The size of each plot (replication) was 6.6 m² (25 plants in 0.75 m of row spacing and 0.35 m plant spacing in the row). Each plot (replication) was designed with five rows of crop and five plants in each row. Five plants from the middle row from each plot and treatment were assumed for experimental purposes. The flowers formed on each plant were marked with colored tie and counted. The picking and counting of formed fruits (fruit sets) from the representative plants was carried out in the stage of technical-technological maturity. The ratio between the number of formed flowers and fruit sets presents the percentage of fructification.

The plant pruning started when pepper plants were at least a foot tall (mid of May). Lateral branch shoots were pruned to form a plant structure of “V” system (two main shoots).

The collected data were subjected to statistical analysis of variance and the means were compared by using the least significant difference (LSD) at the 5% level of probability ($P < 0.05$) test. Also, bivariate Pearson correlation (with SPSS 17) between the number of formed flowers, number of fruits sets and yield potential was done in this study.

Results and discussion

The meteorological conditions during the research

During our investigation, the average monthly temperatures in the experimental plastic house in all three years (Figure 2) were within the optimum values recommended by many authors (Rylski, 1986; Bosland and Votava, 2000). Gvozdenović (2004) reported that lower relative air humidity followed by high temperature can affect flower and fruit falling. Except in July 2007, the average relative humidity during our investigation was close to the recommended values for pepper production in controlled environment (Jankulovski 1997; Penella *et al.*, 2014).

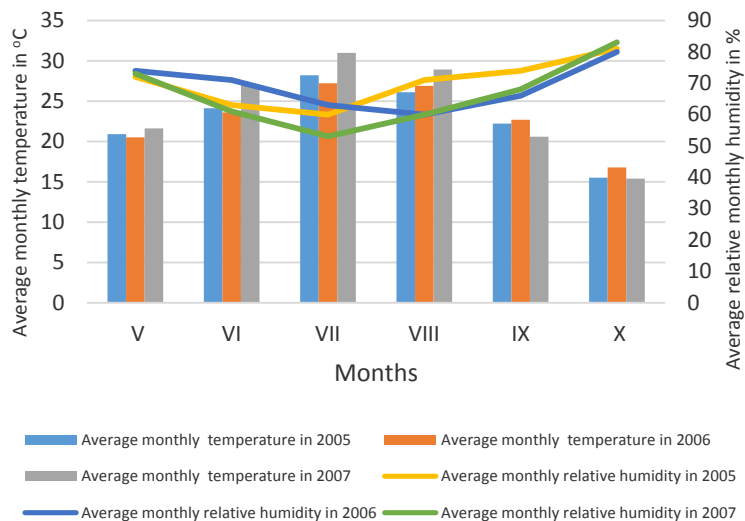

Figure 2. Monthly average air temperature and relative humidity in experimental plastic house in 2005-2007

Effects of irrigation and fertilization on the number of formed flowers, fruits sets, percentage of fructification and yield potential

As mentioned above, all investigated treatments in the present study received the same growing conditions during the vegetation, the only difference was in the irrigation and fertilization techniques and frequency of water and fertilizers application. This approach enabled us to estimate the effects of different irrigation and fertigation regimes on the number of formed flowers and fruits sets in pruned pepper. As it can be seen from the results in Table 3, the examined treatments have noted differences according to the number of formed flowers and the number of fruits sets per plant. The largest number of formed flowers (69.67) and fruits sets (41.67) was noted in the drip fertigation treatment with 2 day frequency (DF1) with a statistical significance of 0.5 level of probability in comparison to DF2, DF3 and \emptyset_B . Then comes the DF2 treatment with 65.90 formed flowers and 38.50 fruits sets and statistical significance of 0.5 level of probability when compared to DF3 and \emptyset_B . Similar effects of the drip irrigation interval on the number of bell pepper fruits are presented by Sezen *et al.*, (2006). A positive effect of drip fertigation on the number of formed flowers and fruits sets in our study is presented by comparison of the results from the treatments DF3 (drip fertigation scheduled by tensiometers) and \emptyset_B . Namely, the treatment DF3 (with similar and sometimes a bit longer irrigation interval compared with \emptyset_B) has shown 8.32% and 19.2% higher number of formed flowers and fruits sets compared to \emptyset_B . The results are statistically significant at 0.5 level of probability. Antony and Singandhupe (2004) indicated that drip irrigation pepper had bigger plant height and higher number of branches compared with surface irrigated crops. As the plant height and branches increased, new nodes for flower and fruit development appeared resulting in an increase in number of fruits and total yield. In this context, Burt *et al.*, (1998) reported that drip irrigated peppers do not experience the moisture stress that furrow irrigated peppers experience between irrigations. This seems to allow more uniform growth rates and development without periods of starting and stopping.

Table 3. Average number of formed flowers and fruit sets per plant, and percentage of fructification for the period 2005-2007

Treatments	Number of formed flowers	Number of fruits sets	Percentage of fructification	Comparison of percentage of fructification with treatment \emptyset_B
DF1	69,67 ^a	41,67 ^a	59,8	119,8
DF2	65,90 ^b	38,50 ^b	58,4	117,0
DF3	60,64 ^c	33,26 ^c	54,8	109,8
\emptyset_B	55,98 ^d	27,91 ^d	49,9	100

*Values in rows followed by the same letter are not significantly different at the 0.05 probability level

Regarding the percentage of fructification, the highest percentage was noted in the DF1 and DF2 treatments. This positive effect of these two treatments is due to the higher number of formed flowers and the greater opportunity for them to be fructified, which can be connected with the proper irrigation and fertigation regime enabled through the drip irrigation system. The DF3 treatment has achieved a somewhat lower percentage of fructification when compared to DF1 and DF2 or expressed through relative values 9, i.e. 6.5% lower fructification. The highest abortion of flowers, i.e. lowest fructification of 49.9%, was noted in the treatment with furrow irrigation with application of water every 7 days with conventional fertilization (\emptyset_B). Jankulovski (1983) noted an average fructification of 19.78% in Sweet Yellow variety up to 31.22% in

StajkovskiKavardjik. Our results for pepper fructification in furrow irrigated treatment with conventional fertilization are better than those of Jankulovski (1983), what can be result of the technology of controlled pepper growth (pruning of pepper). According to Rusevski (2005), pruned pepper has possibility for re-flowering, it means that pepper can form fruits and flowers again; even if harvest was previously done from the same nodes. However, the highest percentage of abortion of flowers in the \emptyset_B treatment in our investigation may be associated with continuous water stress which is result of inadequate water and soil nutrient procurement affected by the irrigation and fertilization regime. In this context, Candido *et al.*, (2009) emphasized that water deficit and reduced fertilizer availability, especially of nitrogen, are very harmful for bell pepper during the reproductive phase. Wiertz and Lenz (1987) suggested that water shortage can be more detrimental to pepper than nutrient deficiency. Therefore, water stress during flowering or fruit sets causes flower drop (Candido *et al.*, 2009), lower size, number and weight of fruits (Katerjiet *al.*, 1991), as well as yield losses (Jaime *et al.*, 2000; Sezen *et al.*, 2006). According to Rego *et al.*, (1988), suitable irrigation can increase the soil water content and also nutrient availability, which according to many authors results in better water and fertilizer use efficiency, as well as improving of yields (Burt *et al.*, 1998; Cukaliev *et al.*, 2008; Kafkafi and Tarchitzky 2011; Tanaskovikand Cukaliev 2014; Bar-Tal *et al.*, 2015; etc). Tanaskovik *et al.*, (2015) indicated that drip fertigation created better environment for initial flowering and technological maturity in pepper than furrow irrigation and conventional application of fertilizers. Also, in the present study we have found that irrigation and fertigation regime affects yield potential too (Table 4).

Table 4. Average pepper yields (t/ha) for the period 2005-2007

	DF1	DF2	DF3	\emptyset_B
Yield t/ha	71,11 ^a	68,40 ^a	62,61 ^b	54,74 ^c
Comparison with treatment \emptyset_B in %	129,9	125,0	114,4	100

*Values in rows followed by the same letter are not significantly different at the 0.05 probability level

From the data presented in Table 4, it can be concluded that the highest average pepper yield of 71.11 t/ha has been realized in the DF1 treatment, followed by the DF2 treatment with 68.40 t/ha or 2.71 t/ha less yield, while the DF3 treatment showed 8.5% i.e. 5.79 t/ha less yield when compared to DF1 and DF2. Similar effects of drip fertigation intervals as ours were reported by Bar Yosef (2003). According to Agele *et al.*, (2006), the trend to increase crop yields has led to frequent fertigation and therefore the time intervals between successive fertigation events have diminished to hours or even less. Otherwise, the lowest yield of 54.74 t/ha in our study was noted in the control treatment (\emptyset_B), which is result of applied irrigation and fertilization techniques. All three treatments with drip fertigation show statistically significant yield when compared to the control treatment (\emptyset_B). Our results are consistent with a number of other investigations (Oğuzer *et al.*, 1991; Halitligil *et al.*, 2002; Antony and Singandhupe 2004; Tanaskovic *et al.*, 2005; Sezen *et al.*, 2006; Tanaskovik *et al.*, 2011).

Table 5. Correlation coefficients determined by bivariate Pearson analysis

	Number of irrigation application rate	Number of formed flowers	Number of fruits sets	Yield
Number of irrigation application rate	1	0,768	0,682	0,625
Number of formed flowers	0,768	1	0,869	0,755
Number of fruits sets	0,682	0,869	1	0,878
Yield	0,625	0,755	0,878	1

Furthermore, to confirm our results mentioned above, we have done correlation analysis between the number of irrigation application rate, number of formed flowers, number of fruits sets and yield potential. According to the Petz classification (1985), a significant positive correlation was found between the number of irrigation application rate, number of formed flowers, number of fruits sets and yield potential (Table 5). The achieved results in our study once again showed positive effect of the drip irrigation regime on the productive characteristics of the pepper. In this context, Candido *et al.*, (2009) reported that plants subjected to periods of water shortage exhibited a significant reduction of the number of peppers and marketable yields in comparison with properly irrigated plants. Dalla Costa and Gianquinto (2002), noted that yield losses in stressed pepper are always related due to reduced number of fruits. As it can be seen from the results in the Table 5, there is a strong linkage between the productive characteristics of the pepper crop. Antony and Singandhupe (2004) in their investigations established positive correlation between plant height and number of branches with pepper yield.

Conclusions

Fortwo stem pruned pepper grown in an unheated plastic house and irrigated and fertigated with the same amount of water and fertilizers, the drip fertigation technique provides higher number of formed flowers and fruits sets, better percentage of fructification and higher yield compared to furrow irrigation and conventional application of fertilizers. Generally, from the results achieved in our study, we can conclude that drip fertigation at 2 and 4 day intervals is the best option to achieve higher percentage of fructification and higher yield, as well as better farmer's income and productivity.

References

- Agele S., Shabtai Cohen S., Assouline S. (2005). Hydraulic characteristics and water relations of net house-grown bell pepper as affected by irrigation regimes in a Mediterranean climate. *Environmental and Experimental Botany*, 57: 226-235
- Antony E., Singandhupe R. B. (2004). Impact of drip and surface irrigation on growth, yield and WUE of capsicum (*Capsicum annum L.*). *Agricultural Management*, 65: 121-132.
- Bar-Tal A., Fine P., Yermiyahu U., Ben-Gal A., Hass A. (2015). Practices that simultaneously optimize water and nutrient use efficiency, Israeli experiences in fertigation and irrigation with treated wastewater. In: *Managing water and fertilizer for sustainable agricultural intensification*, IFA, IWMI, IPNI, IPI, Paris, France: 209-241.
- Bar-Yosef B. (2003). Optimizing the use of drip fertigation: soil, water, nutrients and crop considerations. Training course notes: *Irrigation and Fertigation in Controlled Environment*, MASHAV, Israel
- Bosland P. W., Votava E. J. (2000). *Peppers. Vegetable and Spice Capsicums*. New Mexico State University, Las Cruces, USA, CABI Publishing.
- Burt C., O'Connor K., Ruehr T. (1998). *Fertigation*. California Polytechnic State University, San Luis Obispo, California.
- Candido V., Miccolis V., Rivelli A. R. (2009). Yield traits and water and nitrogen use efficiencies of bell pepper grown in plastic-greenhouse. *Italian Journal of Agronomy*, 3: 91-100.
- Cukaliev O., Tanaskovik V., Kanwar R. S., HengKheng Lee., Mukaetov D. (2008). Irrigation and fertigation effects on nitrogen use efficiency and tomato yield. *International Agricultural Engineering Journal*, 17: 19-26.

- Dalla Costa L., Gianquinto G. (2002). Water stress and waterable depth influence yield, water use efficiency, and nitrogen recovery in bell pepper: lysimeter studies. *Australian journal of Agricultural Research*, 53: 201-210.
- Gvozdenović Dj., Takac A. (2004). Pepper. Agricultural library, Draganic, Beograd.
- Halitligil M.B., Akin A.I., Kislal H., Ozturk A., Deviren A. (2002). Yield, nitrogen uptake and nitrogen use efficiency by tomato, pepper, cucumber, melon and eggplant as affected by nitrogen rates applied with drip-irrigation under greenhouse conditions. In: *Water balance and fertigation for crop improvement in West Asia*, IAEA: 99-110.
- Jaimez R. E., Vielma O., Rada F., Garcia-Nunez C. (2000). Effects of water deficit on the dynamics of flowering and fruit production in *Capsicum chinense Jacq* in a tropical semiarid region of Venezuela. *Journal of Agronomy and Crop Science*, 185: 113-119.
- Jankulovski D. (1983). Examination of biological, morphological and quality characteristics of important long pepper populations (*Capsicum annum L. syn. C. mexicanum Hazenb.*) in SR Macedonia. [Ph.D. Thesis.] Skopje, Faculty of Agriculture of Ss. Cyril and Methodius University in Skopje: 1-174.
- Jankulovski D. (1997). Pepper and Eggplant. Faculty of Agriculture of Ss. Cyril and Methodius University in Skopje.
- Jovicich E., Cantliffe D. J., Stoffella P. J. (2004). Fruit yield and quality of greenhouse-grown bell pepper as influenced by density, container and trellis system. *HortTechnology* 14 (4): 507-513
- Kafkafi U., Tarchitzky J. (2011). Fertigation: A tool for efficient fertilizer and water management. IFIA and IPI, Paris, France.
- Katerji N, Hamdy A, Raad A, Mastroilli M (1991). Conséquence d' une contrainte hydrique appliquée à différents stades phénologiques sur le rendement des plantes de poivron (Consequences of water stress applied at different growth stages in the production of pepper plants). *Agronomie* 11: 679-687
- Lazić B., Djurovka M., Marković V., Ilin Ž. (2001). *Vegetable Production*. 2nd Ed. Novi Sad, Tampograf.
- Oğuzer V., Yazar A., Yardimcioglu T. (1991). Effect of different cover materials and trickle irrigation intervals on the yield and quality of green peppers grown under high plastic tunnels. *Turkish Journal of Agriculture and Forestry*, 15 (2): 406-422.
- Penella C., Nebauer S. G., López-Galarza S., San Bautista A., Rodriguez-Burruezo A., Calatayud A. (2014). Evaluation of some pepper genotypes as rootstocks in water stress conditions. *Horticultural Science*, 41 (4): 192-200.
- Petz B. (1985). *Osnovne statističke metode za nematematičare (Basic statistical methods for non-mathematical users)*. Sveučilišna naklada Liber, Zagreb
- Rego T. J., Grundo N. J., Asher C. J., Edwards D. G. (1988). Comparison of the effect of continuous and relieved water stress on nitrogen nutrition of grain sorghum. *Australian Journal of Agricultural Research*, 39: 773-782.
- Rusevski R. (2005). Controlled stem growth, new technology of producing pepper in Macedonia. GTZ, Skopje.
- Rylski I., (1986). Pepper (*Capsicum*): In Shaul P. Monselise (ed.). *CRC Handbook of fruit set and development*. CRC Press, Inc, Boca Raton, Florida: 341-352.
- Sezen M., Attila Y., Salim E. (2006). Effect of drip irrigation regimes on yield and quality of field grown bell pepper. *Agricultural Water Management*, 81: 115-131
- Tanaskovik V., Cukaliev O., Moteva Milena., Jankulovska Mirjana., Markoski, M., Spalevic V., Rusevski R., Zvezda Bogevska., Margarita Davitkovska., (2015). The influence of irrigation

- and fertilization regime on some phenological stages and earliness of pruned pepper. The Journal Agriculture & Forestry, Vol. 61 Issue 2, pp.7-17, Podgorica
- Tanaskovic V., Cukaliev O. (2014). Drip Fertigation. University “St’s. Cyril and Methodius”, Faculty of Agricultural Sciences and Food, Skopje, Macedonia: 127
- Tanaskovic V., Cukaliev O., Romić D., Ondrasek G. (2011). The influence of drip fertigation on water use efficiency in tomato crop production. Agriculture Conspectus Scientificus, 76 (1): 57-63.
- Tanaskovic V., Cukaliev O., Iljovski I., Rusevski R., Kuzmanovska Biljana., (2005).Modern agro-technical practice and plant protection for increasing the pepper yields grown in controlled environment. In: Proceedings of the Ist Congress of plant protection, Environmental concern and food safety, Ohrid, R. Macedonia: 35-38.
- Tekinel O., Kanber R. (2002). Trickle irrigation experiments in Turkey. In: Özay M., Biçak. A. H. (ed.): Modern and Traditional Irrigation Technologies in the Eastern Mediterranean. Ottawa, Canada, International Development Research Centre: 27-72.
- Wiertz R., Lenz F. (1987). The growth and yield of pepper (*Capsicum annum L.*) depending on water and nutrient supply. Gartenbauwissenschaft 52: 39-45
- WRB (2015). World reference base for soil resources 2014. FAO, Rome: 1-192
- Xie J., Cardenas E. S., Sammis W. T., Wall M. M., Lindsey L. D., Murray L. W. (1999). Effects of irrigation method on chili pepper yield and *Phytophthora* root rot incidence. Agricultural Water Management, 42: 127-142.

AGRO-CHEMICAL CHARACTERISTICS OF SOIL IN RASPBERRY-GROWING REGION OF IVANJICA (SERBIA)

Mira MILINKOVIC*, Rade MILETIC, Milan LUKIC

Fruit Research Institute, Cacak, Serbia

*Corresponding author: miramilinkovic@yahoo.com

Abstract

Raspberry growing in certain parts of Serbia is rapidly developing owing to cost-effectiveness of production and specific physical-chemical characteristics of the soil, making it unsuitable for other types of fruit-growing. Analysis of soil samples from existing and prospective raspberry plantations reveals its heterogenic composition, depending on sampling site and actual method of land use. Prospective raspberry-growing land areas are characterised by strong substitution acidity ($\text{pH/KCl} < 4.5$) in 52.8% samples, with non-carbonic composition present in 88.9% of samples and an approximately equal share of medium and high content of humus and total nitrogen in the humus horizon, compared to a considerable reduction of these parameters in the sub-humus horizon. The content of accessible phosphorus is $< 6 \text{ mg/100 g}$ in 41.7% of humus horizon samples, compared to 55.6% in sub-humus horizon, whereas accessible K_2O content ranged from low to medium supply required for raspberry cultivation. Soil under raspberry plantations shows presence of acidic soil reaction in the humus horizon, with 97.2% of non-carbon samples and a significant number of samples having a high content of humus and total nitrogen, as well as a high content of accessible phosphorus in the humus horizon in 77.8% of samples, as opposed to only 16.7% in soils of prospective raspberry plantations. The high content of accessible potassium was pronounced, reaching 94.4%. The presented results show that unfavourable agro-physical and agro-chemical composition of soil is compensated by high volumes of mineral and organic fertilizers, with potentially multiple impacts on environmental sustainability and productivity of raspberry plantations.

Key words: *Agro-chemical analysis, Soil reaction, Phosphorus, Potassium, Raspberry.*

Introduction

Soil is complex and dynamic system which tends to change its biological, chemical and physical characteristics when subjected to agricultural production. A number of studies indicate that intensive agricultural production causes deterioration of the soil quality. On the other hand, it is well-known that proper soil management, good agricultural practices (implying regular control of soil fertility and implementation of basic measures of fertilisation and agro-technology) can sustain the soil's productive capacity at a minimum impact on the environment (Milivojevic et al., 2012). Preventive measures, detection of risk and devising effective solutions play a vital role in protecting soil from degradation. To this end, it is recommended to conduct systematic checks of the soil fertility and contents of hazardous substances, i.e. to conduct monitoring of the soil quality (Sekulic et al. 2005). The variability of climatic conditions and incomplete agro-technical measures due to insufficient implementation of fertilisers have a significant impact on the accessibility of nitrogen in the soil, thereby frequently reducing accessibility of the plant nutrient (Bogdanovic 2009). A limiting factor in intensive farming is the soil acidity and insufficient supply of plant nutrients. Large areas of land in our country are characterised by presence of acid

soils such as lessive and pseudo-gley soils. Stevanovic et al. (1995) state that in the total area of 4.700.000 ha of cultivation areas in the territory of Central Serbia and Kosovo, over 2.800.000 ha or more than 60% are lands of acidic reaction, around 30% of which are extremely acidic. With the exception of one part of regions of Mačva, Pomoravlje and Stig, acidic soils dominate the agricultural areas of Central Serbia, as well as the largest part of the hills-and-mountains region of the country. Considering that most of cultivated plants require mildly-acidic, neutral to mildly-alkalic soil reaction, there are few plants that can endure the conditions of these soil types. Voluminous research so far has supported the conclusion that the content of mobil aluminium in these soils has increased (Dugalic et al., 2008; Djalovic et al., 2012). Narro et al. (2001) and Sumner (2004), state that the weak fertility of acid soils occurs as a result of the reduced conductivity of certain biogenic elements and compounds (P, Mo, B), as well as due to the increased presence of certain toxic elements, primarily Al. There is also a large number of authors who point that the main reason for the reduced productivity of this type of soils is its increased content of mobile Aluminium, which is toxic for most of cultivated plant species (Jelic,1996; Jelic et al., 2004; Jelic and Djalovic, 2008). Due to the reasons stated above, there is the growing need to formulate fertilisation and cultivation systems for most of the cultivated plant types, taking into consideration both the soil and climatic conditions of diverse farming areas.

The aim of the paper was to determine the agro-chemical characteristics of the soil in the region of Ivanjica Municipality and its suitability for cultivation of different types of fruits.

Material and methods

Sampling of soil was performed in August 2015 in the rural area of the Ivanjica municipality, at agricultural land under raspberry plantations, as well as potential cultivation areas (plough-fields, stubble-fields, meadows, fodder fields), collecting an equal number of samples from a total of 72 sampling localities. The samples were taken from two depth levels (0-30 cm and 30-60 cm, respectively) and the sampling plots were assigned GPS coordinates. The number of samples per local village areas was determined in proportion with the area of cultivated land and the actual level of agricultural production of the area, primarily focusing on raspberry production according to the data from the 2012 Agricultural Census. The agro-technical characteristics of the soil were determined using the following methods: pH value in H₂O and 1 MKCl-u (potentiometrically); humus (using the Kotzman method); total nitrogen (Kjehdahl method); easily accessible phosphorus and potassium (AL method), P₂O₅ (colorimetric method), K₂O (flame-photometric).

Results and discussion

The active acidity of the soil, shown in Graph 1 at both sampling depths in cultivated areas which are not used for fruit cultivation (plough-fields, meadows, stubble-fields, fodder fields) was in the range between the strong acid reaction (50.0-58.3% of the samples) and medium acid reaction in 25-30.6% of the samples. A neutral reaction of the soil was present in only 13.9% of the samples. Areas under raspberry plantations were also mostly found to have a strong acid reaction of the soil (41.7-47.2%) of the samples, as well as a medium acid reaction in 36.1-38.9% of the samples. Samples taken in certain localities show extremely acid reaction (8.3%), and a similar trend was observed for neutral and weak alkalic reaction.

Substitution acidity of the soil, (Graph 2) in the humus (Ah) horizon (0-30 cm) of agricultural areas not used for fruit-growing was in 58% of the samples found to have a strong acidic reaction of the soil, which represents a limiting factor in a potential use of these types of soils for intensive production of most fruit types except berries. An acidic reaction was observed in 25.0-

27.8% of the samples, whereas the percentage of occurrence of a weak acid reaction was even lower (13.9-19.4%). In 36.1% of samples taken from the 0-30 cm layer of land areas under raspberry plantations, there was a strong acid reaction, whereas 44.4% of the samples showed an acid reaction. With the increase of the sampling depth in the sub-humus the acidity of the soil increases as well, so that 55.6% of the samples recorded a strong acid reaction of the soil. In addition to this, acid reaction was recorded in 25.0% of the samples, whereas the number of samples with a weak to neutral reaction in both horizons ranged between 2.8% and 16.6%. The over-excessive acidity is one of the factors reducing the overall quality of the soil and its fertility, thereby their productive capacity. The low productivity of the cultivated plants occurs due to the combination of the toxic effects (Al, Mn, Fe and H) and the insufficiencies of P, Ca, Mg, K and Zn (Milivojevic et al., 2012).

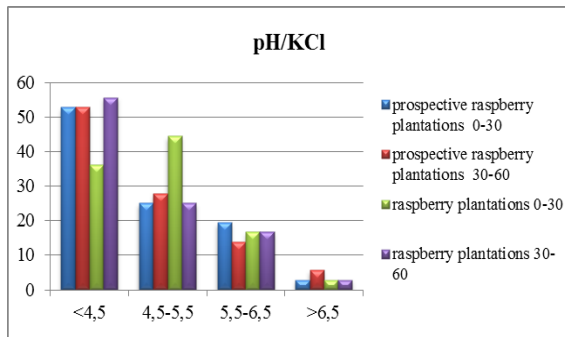

Graph 1. Active acidity of the soil (pH/H₂O)

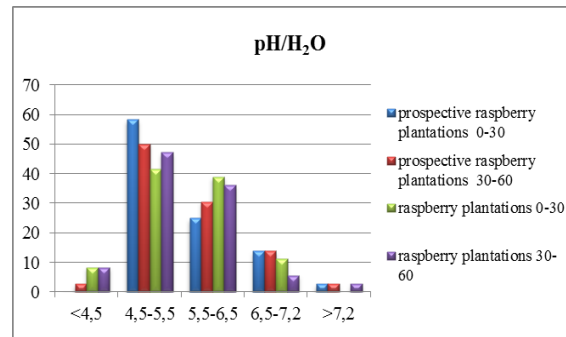

Graph 2. Substitution acidity of the soil (pH/KCl)

In farmland areas that are not currently used for fruit-growing, there was an 88.9% share of non-carbon, compared to 5.5% of mildly carbon soils (0-2% CaCO₃). The areas under fruit plantations, 97.2% of the samples in both sampling horizons were non-carbon soils. Presence of calcium carbonate was established in certain individual localities, as a consequence of non-decomposure of the material that was applied in the calcification process.

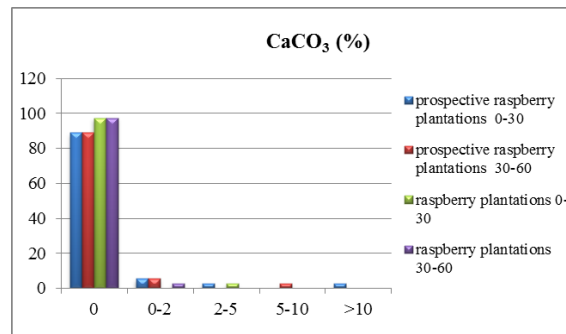

Graph 3. Content CaCO₃ (%)

The humus content in the soils present in the Ivanjica municipality region (Graph 3) mostly belong to the class of humus soils (3-5% hums), as established in 50.0% of the humus horizon samples and 61.1% samples taken from the sub-humus horizon. High-humus soils are present in 47.2% of the samples taken in the humus horizon and 16.6% of the sub-humus horizon samples. A lower level of humus (< 3%) was observed in 2.8% of the samples from the humus horizon (0-30 cm) and 22.2% of the samples from the sub-humus horizon. Similar results were found in the soils under fruit plantations.

Study results shown in Graph 4 show that the soils under consideration possess a medium (0,10-0,20%) to high (>0,20%) contents of total nitrogen, depending on the depth of the soil sampling profile. The farmland areas that are not used for cultivation, there was a high nitrogen content (>0,20%) established in 80.6% of the samples of the soil and 44.4% of the sub-humus horizon samples. The content of the total nitrogen decreases with the increase of the sampling depth. In the land areas under raspberry plantations, the content of total nitrogen in the soil was higher in the humus (Ah) horizon, since 91.7% of the samples showed high nitrogen contents.

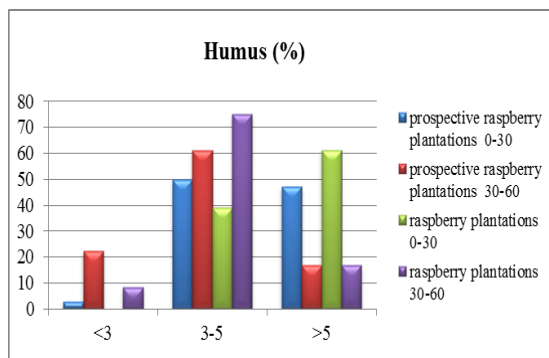

Graph 4. Content of humus (%)

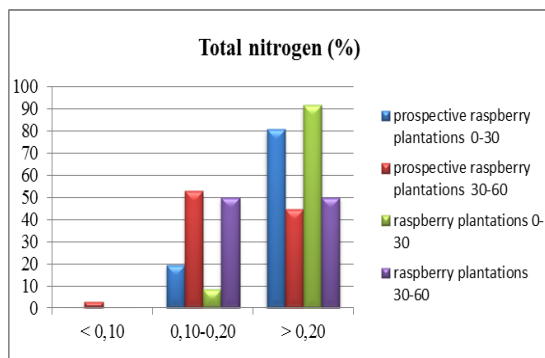

Graph 5. Content of total N (%)

Based on the border values determining the ranges of easily-accessible P_2O_5 levels in soils possessing $pH < 6$ in 1M KCl, the highest percentage of the samples from the potential raspberry-growing land areas showed a very low content of easily accessible phosphorus (< 6 mg $P_2O_5/100g$ of the soil). In the potential fruit-growing land, very low content of phosphorus (< 6 mg $P_2O_5/100$ g of the soil) was found in the humus (Ah) horizon (0-30 cm) of 41.7% of the soils samples, compared to 55.6% of the samples in the sub-humus horizon (30-60 cm). The low pH value contributed to the bonding. The low phosphorous content is mostly found in soils with acid reaction. It is well-known that accessibility of phosphorus in acid soils decreases due to its immobilisation by free Al^{3+} and Fe^{3+} ions (Debnath et al. 2000).

The soils under fruit plantations show significant differences in the content of accessible phosphorus, compared to other farmland areas where the sampling was performed. In 77.8% of the humus (Ah) horizon (0-30 cm) and 58,3% of the sub-humus horizon (30-60 cm), the content of the easily accessible phosphorus is high (>16 mg $P_2O_5/100g$ of the soil). The optimum content of easily accessible phosphorus (10-16 mg $P_2O_5/100g$ of the soil) was found in 8.3 % of the samples taken from both depths of the soil, whereas the other samples contained a low phosphorus content. Improper and uncontrolled use of fertilisers in excessive doses can lead to antagonism in certain elements, and can also lead to different changes in biological balance of agro-systems with an ultimate adverse impact on the quality of the yield (Wu et al. 1998, Kraus et al. 2000).

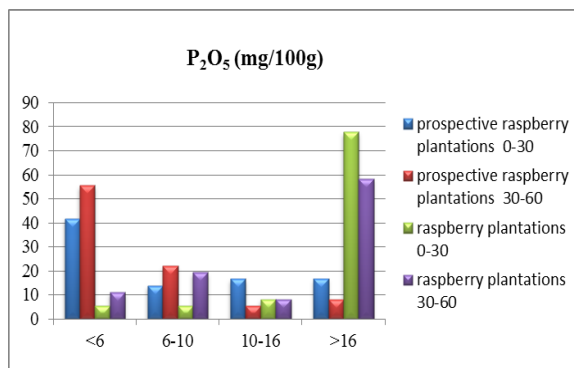

Graph 6. Content of easily accessible P₂O₅ (mg/100g of the soil)

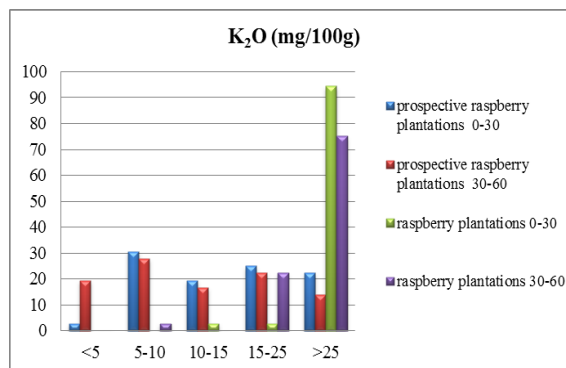

Graph 7. Content of easily accessible K₂O (mg/100g of the soil)

The soils of farmland areas that are not currently used for fruit production were found to have a low content of easily accessible potassium (K₂O 5-10 mg/100g of the soil) in 30.6% of the samples from the humus horizon (0-30 cm) and a medium content of this element (10-15 mg/100g of the soil) in 19.4% of the samples. The optimum content of potassium (K₂O 15-25 mg/100g of the soil) was found in 25.0% of the samples from the humus horizon, whereas a high potassium content (K₂O >25 mg/100g of the soil) was present in 22.2% of the samples. With the increased depth of sampling (30-60 cm), there was a reduced presence in the class of optimum and high content values of this element, which was complemented with a higher percentage of the low to very low content class. The optimum content of the easily accessible potassium was found in 22.2% of the samples, compared to 27.8% of the samples with a low content of easily accessible potassium; the percentage of the samples within other intervals of boundary values was between 13.9% and 19.4%.

Soils under fruit plantations occupy a large share (94,4%) in the category of the samples with a high content of easily accessible potassium (K₂O >25 mg/100g of the soil), which is an indication of intensive nutrition of plants with this element. A high content of the easily accessible potassium was found in 75.0% of the samples from sub-humus (30-60 cm) horizon, compared to 22.2% of the samples with an optimum content of this element.

Conclusion

Soils of the Ivanjica raspberry-growing region are mostly characterised by highly acidic to acidic soil reaction, carbon-free in 88.9-97.0% of samples, depending on the type of sampled areas. The humus content in most of the sampling areas was in the range between 3 and 5%, with no significant differences being observed in relation to the type of the cultivated land. At the same time, the total nitrogen content was high in over 80% of the samples, with raspberry plantations soil having a higher total nitrogen content compared to other types of cultivation land. The soil of the farm-land under raspberry has a high content of easily-accessible phosphorus to over-excessive nutrition, while at the same time the soils of non-cultivated areas are extremely poor in this element. The potassium level depends on the level of nutrition, with a lower content of potassium being present in the less-cultivated areas, compared to a high content of this element generally present in 94.4% of samples taken from intensive raspberry plantations. The results show that agro-chemical characteristics of the soil in most localities do not support cultivation of most fruit types, whereas the measures for cultivation of raspberry-growing land require pre-planned implementation of melioration measures, which are not standardly used in most plantations.

Acknowledgements

This study was funded by the Ministry of Agriculture and Environmental Protection of the Republic of Serbia, under the project entitled 'Agro-physical and Agro-chemical Characteristics of the Soils of West Serbia (Moravičko-Kolubarski Region) with a Recommendation for their Use in Growing Different Types of Fruits', partial funding was provided by the Ministry of Education and Science of the Republic of Serbia (Donation No. TP 31080).

References

- Bogdanovic D. (2009). Fertilizer consumption in our country since the beginning of chemization to date. XII Congress of the Society for the Study of Land Serbia, Book of Abstracts, page 146.
- Debnath A., Bhattacharjee T. K., Debnath N. C. (2000). Behaviour of inorganic phosphate fractions in limed acid soils, *Journal of the Indian Society of Soil Science*, 48, pages (829-831).
- Dozet D., Pucarevic M., Milosevic N., Jarak M., Djuric S., Ralev J., Skorić-Zeremski T. (2005). Serbian soil as a resource for sustainable development, plenary presentation at the XI Congress of the Society for the Study of land Serbia and Montenegro, Budva 13th to 16th September 2005, plenary papers and abstracts, pages (18-37).
- Dugalic, G., Jelic, M., Gajic, B., Djalovic, I. (2008). The content of mobile aluminum in forest, meadows and cultivated profiles pseudogley Čačak and Kraljevo basin, counseling "Eco-ist", Bor, Proceedings, pages (245-249).
- Djalovic I., Jockovic Dj., Dugalic G., Bekavac G., Purar B., Seremesic S., Jockovic M. (2012). Soil acidity and mobile aluminium status in pseudogley soils in the Čačak-Kraljevo basin, *Journal of Serbian Chemical Society*, Vol. 77 (6), pages (833- 834).
- Ilic M. (1996). The study of mineral nutrition of wheat grown on luvic smonitza, doctoral dissertation, Faculty of Agriculture Zemun.
- Jelic M., Dugalic G., Stojanovic J., Milivojevic J., Zivanovic S. (2004). Mobile aluminum in some Serbian acid soils and its toxic impact on plants of wheat and corn, *Soil and plant*, Vol. 53 (1), pages (21-28).
- Jelic M., Djalovic I. (2008). Adaptation mechanisms of plants wheat grown on soil acidity, XIII Conference on Biotechnology, introductory lecture, Faculty of Agriculture-Čačak.
- Krauss M., Wilcke W., Zech W. (2000). Reactivity and bioavailability of PAHs and PSBs in urban soils of Beyreuth, Proceedings First International Conference Soils of Urban, Industrial, Traffic and Mining Areas (W. Burghardt and C. Dornauf Eds), Essen 12-18 July, 3, pages (657-661).
- Milivojevic J., Djekic V., Jelic, M. (2012). Fertility of arable land arable production sites of Kragujevac privately owned. *Field and Vegetable Crops*, Vol. 49 (2), pages (195-201).
- Narro L. A., Perez C. J., Pandey S., Crossa J., Salazar F., Arias P.M. (2001). Implications of soil-acidity tolerant maize cultivars to increase production in developing countries, In: N. Ae et al. (ed.), *Plant nutrient acquisition: New perspectives*, NIAES series 4. Springer Verlag, Japan, pages 447-463.
- Sumner M. E. (2004). Food production on acid soils in the developing world: problems and solutions, Proceedings of the 6th International Symposium on Plant-Soil Interactions at Low pH (Editors: Matsumoto H. et al.), August 1-5, Sendai, Japan, pages (2-3).
- Sekulic P., Nesic Lj., Hadzic V., Belic M., Vasin J., Ubavic M., Bogdanovic D., Cuvardic M., Stevanovic D., Jakovljevic M., Martinovic Lj. (1995). Solving the problem of acid soils

precondition Serbia-increase food production and protect the land. Advising "repair of acid soils Serbia applying lime fertilizer" Njival Ca ", Proceedings, Paracin, pages (7-21).

Wu Q., Blume H P., Rexilius L., Abend S., Schleuss U. (1998). Sorption of organic chemicals in Urbic Anthrosols. *Advances in Geoecology* 31, pages (781-789).

PHYSICAL ATTRIBUTES IN SOIL QUALITY FOR SUSTAINABLE SOIL MANAGEMENT

Coskun GÜLSER^{1*}, Ridvan KIZILKAYA^{1,2}

¹Ondokuz Mayıs University, Faculty of Agriculture, Department of Soil Science and Plant Nutrition, Samsun, 55139 Turkey

²Agrobigen R&D Ltd.Co., Samsun Technopark, Ondokuz Mayıs University, Samsun, 55139 Turkey

*Corresponding author: cgulser@omu.edu.tr

Abstract

Soil is one of the most important natural resources and degraded due to intensive agricultural practices. Soil degradation decreases soil fertility with decreasing soil physical, chemical and biological quality parameters. Management of physical soil quality parameters shapes the dynamic parts of soil chemical and biological quality. Basic physical soil quality indicators can be summarized as soil texture, soil depth, infiltration, bulk density, water holding capacity, aggregate stability and penetration resistance. Recycling organic wastes in agricultural fields is important to improve soil physical parameters as a part of whole soil quality. Evaluating soil physical behaviours helps to decision for basic agricultural practice or crop pattern in sustainable land management systems.

Key words: *Soil quality, physical indicators, organic waste*

Introduction

The health of our environment depends on soil, air, and water quality. As a natural resource, soil can provide the physical support, nutrients, water, and gas exchange necessary for crop growth. The soil quality concept placed in the literature in the early 1990s (Doran and Safely, 1997; Wienhold et al., 2004). General definition of soil quality is ‘‘the capacity of a specific kind of soil to function, within natural or managed ecosystem boundaries, to sustain plant and animal productivity, maintain or enhance water and air quality, and support human health and habitation’’ (Karlen et al., 1997).

Soil quality has an intrinsic part covering a soil's inherent capacity for crop growth, and a dynamic part influenced by the manager. Natural or inherent soil quality, that is a function of geological materials and soil state factors or variables such as topography, parent material, mineralogy and particle size distribution, are mainly viewed as almost static and usually show little change over time. Dynamic part of soil quality generally changes in response to soil use and management (Larson and Pierce, 1994). The distinction between inherent and dynamic parts of soil quality can be characterized by the genetic (or static) pedological processes versus the kinetic (or dynamic) processes in soil (Richter 1987; Koolen 1987; Carter 1990).

The smallest set of soil properties is called as minimum data set for soil quality assessment. Indicators in minimum data set of soil quality are need to be developed for (i) integrate soil physical, chemical and/or biological properties and processes, (ii) apply under diverse field conditions, (iii) complement either existing databases or easily measurable data, and (iv) respond to land use, management practices, climate and human factors (Doran and Parkin, 1994). In this paper attributes of soil physical quality parameters and using organic wastes to improve soil physical quality in agricultural management system were reviewed.

Physical soil quality indicators

Physical indicators of soil quality are mostly related to water storage and movement, soil structure. Basic physical indicators of soil quality are soil texture, soil depth, infiltration, bulk density, water holding capacity, aggregate stability and penetration resistance (Table 1). Some physical indicators such as; texture and topsoil depth are fixed soil properties that cannot be altered, except over long time periods or sediment deposition by erosion. These soil properties influence soil use or productivity, they are inherent part of soil quality. For example, soil texture is an inherent soil property which strongly influences many soil quality indicators, like drainage and water holding capacity.

Table 1. Physical, chemical, and biological indicators for soil quality (Doran et al., 1996; Larson and Pierce, 1994; and Doran and Parkin, 1994)

Soil Physical Indicator	Rationale for assessment
Soil texture	Indicates how well water and chemicals are retained and transported. Provides an estimate of soil erosion and variability.
Soil depth and rooting	Indicates productivity potential.
Infiltration	Describes the potential for leaching, productivity, and erosion.
Soil bulk density	Describes soil structure, porosity, aeration and water holding capacity and permeability. It is used to correct soil analyses to volumetric basis.
Water holding capacity	Describes water retention, transport, and erosion. Available water is related with soil bulk density and organic matter.
Aggregate stability	Describe soil erodibility, capacity to store and transmit water, aeration
Penetration resistance	Describes soil strength for effective penetration by crop roots

Managing physical soil quality indicators

Many soil quality indicators interact with each other, and the value of one indicator may be influenced by one or more of the other selected parameters (Arshed and Martin, 2002). Changes in soil quality can be assessed by measuring appropriate soil quality indicators at different time intervals for a specific use in a selected agro-ecosystem. Using organic wastes is very important for improving soil physical quality in agricultural fields (Özdemir et al., 2015; Gülser et al. 2015). Candemir and Gülser (2011) studied the effects of different agricultural wastes on some soil quality indexes over two years in a clay field and a loamy sand field. They found that soil organic carbon contents were around 2% after 30 months in clay while they were generally less than 2% after 7 months in loamy sand. Candemir and Gülser (2010) found that addition of organic wastes generally decreased bulk density of the fine and coarse textured soils (Figure 1).

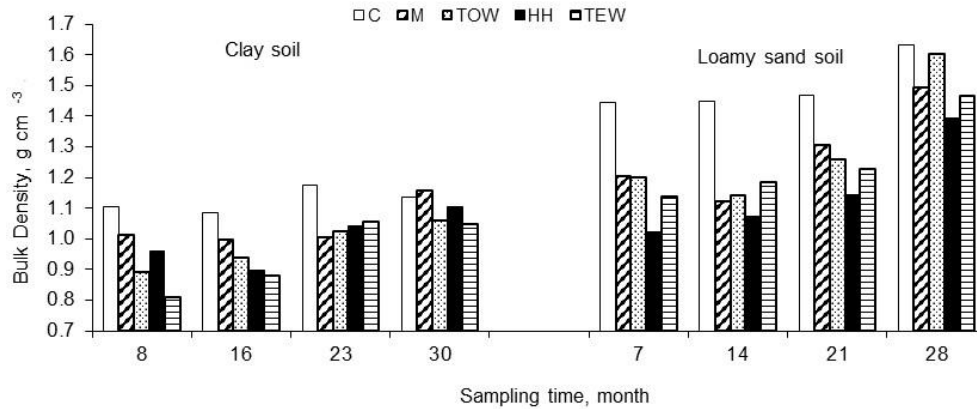

Figure 1. Effects of organic wastes on bulk density in clay and loamy sand soils (C:control; M:manure; TOW: Tobacco waste, HH: hazelnut husk, TEW:tea waste) (Candemir and Gülser 2010).

Bulk density is dependent on the densities of the soil particles (sand, silt, clay, and organic matter) and their packing arrangement. Bulk density is a dynamic property that varies with the structural condition of the soil. This condition can be altered by cultivation; trampling by animals; agricultural machinery; and climate (raindrop impact etc). Compacted soil layers have high bulk densities, restrict root growth, and inhibit the movement of air and water through the soil. Gülser and Candemir (2012) found that application of organic wastes into a clay soil increased total porosity, water holding capacity with decreasing bulk density and penetration resistance over the control treatment.

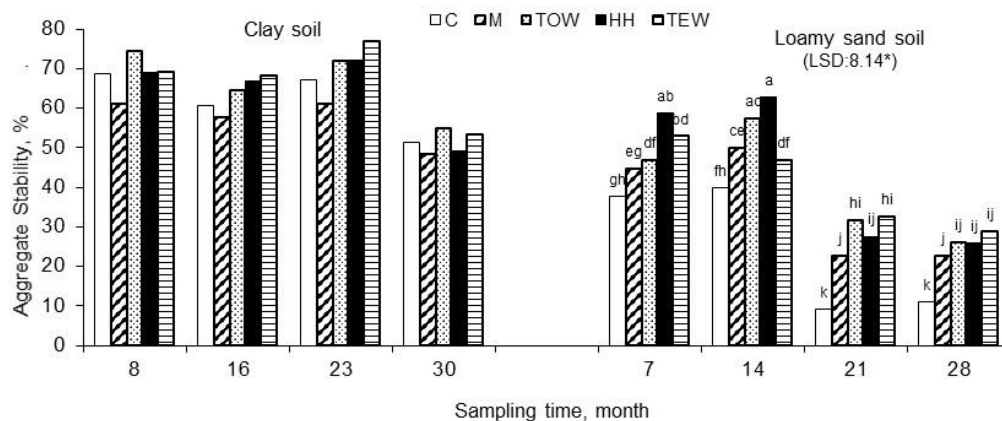

Figure 2. Effects of organic wastes on aggregate stability, in clay and loamy sand soils (C:control; M:manure; TOW: Tobacco waste, HH: hazelnut husk, TEW:tea waste) (Candemir and Gülser 2010).

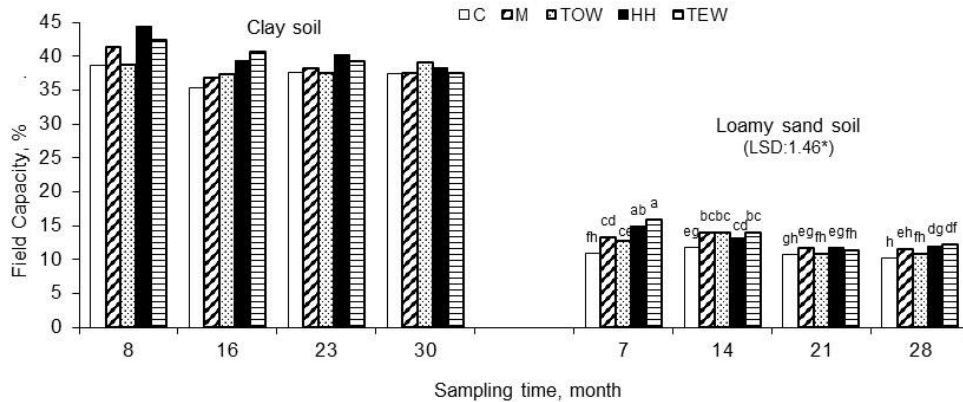

Figure 3. Effects of organic wastes on field capacity in clay and loamy sand soils (C:control; M:manure; TOW: Tobacco waste, HH: hazelnut husk, TEW:tea waste) (Candemir and Gülser 2010).

Aggregate stability is a measure of the vulnerability of soil aggregates to external destructive forces (Hillel, 1982). Candemir and Gülser (2010) reported that addition of organic wastes into fine and coarse textured soils generally increased aggregate stability (Figure 2). Aggregates improve soil quality by protecting soil organic matter entrapped in the aggregates from exposure to air and microbial decomposition, decreasing soil erodibility, improving water and air movement, improving the physical environment for root growth and improving soil organism habitat (USDA 1999). Breakdown of aggregates is the first step to crust development and surface sealing, which impedes water infiltration and increases erosion. Soil aggregation can change over a period of time, such as in a season or year. Aggregates can form, disintegrate, and reform periodically (Hillel, 1982). Organic matter applications increase aggregate stability of soils (Özdemir and Kop Durmus, 2016; Gülser et al. 2015).

An aggregated structure is generally considered best for agricultural activities. Candemir and Gülser (2010) found that addition of organic wastes generally increased field capacity of the fine and coarse textured soils (Figure 3). A good soil structure is defined as an arrangement of soil particles into stable larger units, and of the pore spaces between those units, that allows movement of water through the soil, movement of air into and out of the soil and ease of penetration by roots, and that protects the soil against erosion (Gülser, 2006). Pore size distribution is considered to be a good indicator of the soil structural condition and useful for predicting water infiltration rates, water availability to plants, soil water storage capacity, and soil aeration status (Carter et al., 1997).

In another study, Gülser et al. (2015) found that incorporating compost and hazelnut husk into clay soil at the hazelnut orchard improved soil physical properties. Compost and hazelnut husk applications increased aggregate stability by 2 and 7%, initial infiltration rate by 34 and 436%, and reduced bulk density by 20 and 33%, penetration resistance by 33 and 67% respectively ($P < 0.01$), in comparison to control treatment. They concluded that hazelnut husk application was much more effective on improving the soil quality in hazelnut orchard than compost application in comparison to control treatment.

Conclusion

The assessment of soil quality is an important for defining the sensitivity of soil to damage and need to consider the sustainable management of soils. Soil quality should be defined with a reference to the function of soil because for a soil that is a good quality for one purpose may be a poorer quality for another purpose. Therefore in sustainable land management soil quality should be considered with respect to not only chemical quality indicators but also physical indicators due

to its multifunctionality because of possible change of the land management. Physical soil quality can be improved and managed in fine and coarse textured soils using agricultural wastes.

References

- Arshad, M.A. and Martin, S., 2002. Identifying Critical Limits for Soil Quality Indicators in Agro-ecosystems. *Agriculture, Ecosystems and Environment* 88, 153-160.
- Candemir, F., C. Gülser, 2010. Effects of different agricultural wastes on some soil quality indexes at clay and loamy sand fields. *Comm. Soil Sci. Plant Anal.* 42 (1):13-28.
- Carter, M.R. 1990. Relative measures of soil bulk density to characterize compaction in tillage studies. *Can. J. Soil Sci.* 70: 425-433.
- Carter, M.R., E.G. Gregorich, D.W. Anderson, J.W. Doran, H.H. Janzen, F.J. Pierce, 1997. Concepts of soil quality and their significance. In: Gregorich E.G and Carter M.R. (Eds.) *Soil Quality, For Crop Production and Ecosystem Health*. Elsevier Science Pub. New York.
- Doran, J.W. and Parkin, T.B. 1994. Defining and assessing soil quality. In: J.W. Doran, D.C. Coleman, D.F. Bezedick, and B.A. Stewart, eds. *Defining soil quality for a sustainable environment*. Soil Sci Soc. Am. Special Pub. No. 35, Am. Soc. Agron., Madison, Wise, U.S.A.
- Doran, J.W. and Safley, M. 1997. Defining and assessing soil health and sustainable productivity. In: Pankhurst, C. et al. (eds.). *Biological indicators of soil health*. Wallingford, UK: CAB International. p. 1–28.
- Doran, J.W. and T.B. Parkin. 1996. Quantitative indicators of soil quality: a minimum data set. In Doran, J.W. and A.J. Jones., editors, *Methods for assessing soil quality*. Soc. Sci. Soc. of America Special Publication 49, 25-37.
- Gülser, C. 2006. Effect of forage cropping treatments on soil structure and relationships with fractal dimensions. *Geoderma*, 131:33-44.
- Gülser, C., Candemir, F., 2012. Changes in Penetration Resistance of a Clay Field with Organic Waste Applications. *Eurasian Journal of Soil Science*, 1(1):16-21.
- Gülser C., Kizilkaya, R., Askin, T., Ekberli, I., 2015. Changes in Soil Quality by Compost and Hazelnut Husk Applications in a Hazelnut Orchard. *Compost Science and Utilization*, 23:3, 135-141.
- Hillel, D. 1982. *Introduction to soil physics*. Academic Press, San Diego, CA.
- Karlen, D.L., Mausbach, M.J., Doran, J.W., Kline, R.G., Haris, R.F. and G.E. Schuman. 1997. Soil quality: a concept, definition, and framework for evaluation. *Soil Sci. Soc. A. J.* 61, 4-10.
- Koolen, A.J. 1987. Deformation and compaction of elemental soil volumes and effects on mechanical soil properties. *Soil Till. Res.* 10: 5-19.
- Larson, W.E. and Pierce, F.J. 1991. Conservation and enhancement of soil quality. In: *Evaluation for Sustainable Land Management in the Developing World*, Vol. 2: Technical Papers. IBSRM Proc. No. 12 (2), Bangkok, Thailand.
- Özdemir, N., Öztürk, E., Durmus Kop, O.T., Ekberli, I. 2015. Effects of organic and inorganic amendments on soil erodibility. *Eurasian Journal of Soil Science*, 4(4): 266 - 271
- Özdemir, N., Durmus Kop, O.T., 2016. Organik düzenleyicilerin asit, nötr ve alkalın toprakların agregat stabilitesi üzerine etkileri. *Toprak Bilimi ve Bitki Besleme Dergisi* 4 (1) 22 – 26.
- Richter J. 1987. *The soil as a reactor: modelling processes in the soil*. Cremlingen, West Germany: Catena Verlag. 192 p.
- USDA, 1999. *Soil Quality Test Kit Guide*. Agric. Res. Serv., Natural Resource Cons. Serv., Soil Quality Inst., USDA.
- Wienhold B J Andrews S S and Karlen D L 2004 Soil quality: A review of the science and experiences in the USA. *Environ. Geochem. Hlth.* 26, 89-95.

SPATIAL ANALYSES OF PLANT AVAILABLE PHOSPHORUS CONCENTRATION UNDER DIFFERENT MANAGEMENT PRACTICES

Mesut BUDAK¹, Hikmet GÜNAL², Nurullah ACİR³, İsmail ÇELİK⁴, Hakan YILDIZ⁵

¹Siirt University, Faculty of Agriculture, Soil Science and Plant Nutrition Department, Siirt, Turkey

²Gaziosmanpasa University, Faculty of Agriculture, Soil Science and Plant Nutrition Department, Tokat, Turkey

³Ahievran University, Faculty of Agriculture, Soil Science and Plant Nutrition Department, Kırşehir, Turkey

⁴Cukurova University, Faculty of Agriculture, Soil Science and Plant Nutrition Department, Adana, Turkey

⁵Ministry of Food, Agriculture and Livestock, Remote sensing and Geographic Information System Center, Ankara, Turkey

*Corresponding author: m.budak@gmail.com

Abstract

Phosphorus (P), a dynamic property of soil is one of the absolutely required nutrients for healthy plant growth. Parent materials as well as management practices in a region significantly affect plant available phosphorus (PAP) concentration of soils. The purpose of this study was to determine the PAP concentrations of soils under five different management practices and to analyze and map the spatial distribution of PAP using geostatistical techniques. Soil samples were collected from approximately the corners of 5km*5km size grid cells within 252.000 ha land in South Eastern Region of Turkey. Total of 110 disturbed samples were taken from 0-20 cm depths, and analyzed for PAP, particle size distribution (sand, silt and clay), soil reactions (pH), electrical conductivity (EC), organic matter (OM) and calcium carbonate content. The P₂O₅ concentration ranged from 11.6- 787.9 kg ha⁻¹ with a mean value of 70.9 kg ha⁻¹. The highest P₂O₅ concentration was recorded in forest soils (mean 98.9 kg ha⁻¹) and the lowest P₂O₅ (mean 39.4 kg ha⁻¹) was obtained from soils located in pastures. The highest variation (CV=155.25%) of P concentration was recorded in wheat-barley fields (rainfed) and the lowest CV (CV 61.53%) was obtained in lentil fields (rainfed). Changes in parent material, climate and management practices in the study area probably contributed to the high variation of P concentration. The semivariogram of PAP best fitted to exponential model. The range of the influence calculated for the PAP was 7020 m. The value for nugget/sill of PAP was 2.77% that indicated a strong spatial autocorrelation. High range value and low nugget/sill ratio suggest that PAP concentration of soils was significantly influenced by intrinsic variations such as parent material. The formation of a hole effect structure in semivariogram of PAP indicates a form of cyclicity or periodicity in parent materials of soils.

Keywords: *Spatial analyses, phosphorus, management, geostatistics, mapping.*

Introduction

Phosphorus, an important plant nutrient play a key role in many physiological and biochemical processes that increases the efficiency of agricultural production (Richards and Johnston, 2001). Therefore, PAP concentration in the soil should be at the optimum level. The variability of PAP affected by not only physical (clay content) and chemical (pH, OM, CaCO₃) properties of soils but also fertilizer management, land use system, management practices, parent materials (Wang et al., 2009; Liu et al., 2013; Cheng et al., 2016) and environmental factors (slope, precipitation, elevation and land use) (Gao et al., 2011; Zhang et al., 2012). Besides Gao et al. (2011) reported

that the PAP concentration gradually decreased as the slope, elevation and precipitation and cultivation practices increases. Such factors lead to the heterogeneous distribution of PAP concentration (Umali et al., 2012; Roger et al., 2014). The heterogeneous supply of available P in the field causes variability in plant growth (Corazza et al., 2003). Roger et al. (2014), reported that land use differences have significant impact on soil P reserves. The impact of land use can be evaluated by the determining soil P contents under different land uses.

Spatial variability of PAP may have significant effect on the efficiency of management practices applied. Therefore, determination of spatial variability of PAP concentration is quite important in terms of understanding the complex relationships within and between environmental factors (Liu et al., 2013). Evaluating and mapping the variability of soil properties on a regional scale require high costs, intensive labor and time. Greater variability particularly in the area to be studied results to increase the number of samples to be taken and higher costs, labor, and time (Mulla and McBratney, 2001), therefore, geostatistical methods have been developed as an alternative to existing methods. In this study, the effects of different land uses in an approximately 252.000 ha land on PAP have been investigated and mapped.

Material and Methods

Study Area

Soil samples were collected from an area of about 252.000 ha land located in Diyarbakir Province, Southeast Anatolia Region of Turkey (Figure 1.) Soils in study area have been formed over different parent materials. Soils in the south and south west part of the study have been formed mostly over basalt. The north west and eastern part of the study area mostly composed of alluvium and marl (Çelik 2015). Long term total annual average rainfall of the area is 490.1 mm, and mean soil temperature is 15.8°C (Anonymous, 2016).

Soil Sampling

The study area was divided into 5km*5km square grids, and 250, 750 m and 1750 m sampling intervals were also sampled to analyze the variability in soil properties occur at shorter than 5km distance. Thus, total of 110 soil samples with different parent materials and land uses was taken from 0-20 cm depth. Differences in parent material and land use provided a wide variability in physical and chemical characteristics.

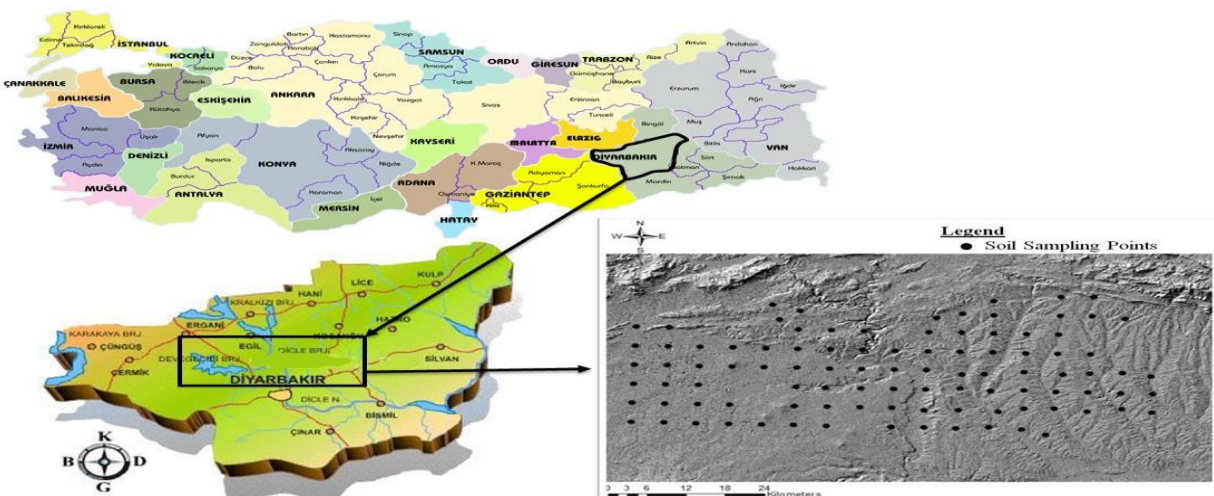

Figure 1. Study area and sampling locations

Physical and Chemical Soil Analysis:

Available P was extracted using 0.5 M NaHCO₃ and using the molybdenum-blue method (Olsen et al., 1954). Particle size distribution was determined by the hydrometer method in a sedimentation cylinder, using sodium hexamethaphosphate as the dispersing agent (Gee and Bauder, 1986). The soil reaction (pH) and electrical conductivity (EC) were measured in saturated paste (Rhoades, 1982). CaCO₃ was determined by using calcimeter method as mentioned by Allison and Moodie (Allison and Moodie, 1965). Organic matter was determined by Walkley and Black (Nelson and Sommer, 1982).

Statistical Analysis

The descriptive statistics of data (minimum, maximum, mean, standard deviation, coefficient of variation, skewness and kurtosis) was performed by SPSS, Version 22.0 (Table 1: Table 2). Geostatistical analysis was performed by the ARCGIS 10.1 (Table 3). The suitability of semi-variogram model was determined by r^2 value and Residual Sum of Squares (RSS). The models with r^2 value close to 1.0 and RSS value close to 0.00 were considered to be suitable (Yang et al., 2011).

Results and Discussion

Soils in the study area have formed over different parent materials such as basal, clay stone, sand stone, gravel and marl. Majority of soils have clay texture (97% of all) and the rest had clayey loam particle size distribution. Other than forest and rangelands, wheat and barley were the dominant crops (48% of the study area), lentils (21%) and maize (9%) are the other crops widely grown in the area. The P₂O₅ concentration ranged from 11.55 to 787.90 kg ha⁻¹. The coefficient of variability for soil properties were 145.05% for P₂O₅, 56.62% for organic matter (OM), 54.44% for sand, 37.63% for silt and 36.62% for electrical conductivity (EC), respectively. The pH had the lowest variability in the study area (Table 1). The P₂O₅ had very high variability within all land uses and the highest variability was obtained in wheat and barley fields (Table 2).

Webster (2001) indicated that skewness value of a soil data can be accepted as an indication of distribution tendency. If skewness value is ≤ 0.5 the data does not require a transformation, if skewness value is > 0.5 and ≤ 1.0 square root transformation is applied and if skewness is > 1.0 log transformation is used to bring the distribution of data to the normal distribution. The skewness value (4.71) of PAP indicated that PAP does not have a normal distribution. The PAP data was log transformed prior to the statistical and geostatistical analyses.

Table 1. Descriptive statistics for physical and chemical characteristics of soils studied at 0-20 cm depth (N=110)

		Minimum	Maximum	Mean	S. Deviation	CV	Skew.	Kurt.
Clay	%	32.70	82.70	63.14	12.21	19.34	-0.59	-0.64
Sand		2.30	47.30	17.91	9.75	54.44	0.77	-0.12
Silt		7.50	47.50	18.95	7.13	37.63	1.62	3.54
CaCO ₃		1.02	49.28	5.25	7.58	144.40	3.50	14.56
OM		0.68	8.90	2.12	1.20	56.62	2.88	11.41
pH		6.76	8.19	7.59	0.31	4.11	-0.86	0.20
EC	dS m ⁻¹	0.37	1.97	0.83	0.30	36.32	1.77	3.55
P ₂ O ₅	kg ha ⁻¹	11.55	787.90	70.90	102.84	145.05	4.71	27.46

The lowest PAP concentration was in pasture land (Table 2). The pastures in the region have mostly been severely degraded due to the intensive grazing. Ozgoz et al. (2013) also reported that

PAP concentration of pastures(27.09 mg/kg) was almost half (56.50 mg/kg) of the adjacent cultivated field.

The model created for PAP concentration and the related parameters have been shown in Table 3. The best fitted model of PAP was exponential. Exponential model exhibits linear increase from the origin and indicates a higher level of short-range variability. The PAP is one of the well-known dynamic properties which is strongly affected by changes in management practices. The management practices applied by the different land users in the study area contributed to the short range variability shown in exponential model represented.

Spatial dependence is widely used to express the variability of soil properties in space. If spatial dependence value is $\leq 25\%$ the attribute is considered strongly dependent, if the value is between 25% to 75% the attribute is considered as moderately dependent and if the value is higher than 75% the attributed is considered to have low spatial dependency (Trangmar et al. 1985; Yang et al., 2011).

Table 2. Descriptive statistics of phosphorus ($\text{kg P}_2\text{O}_5\text{ha}^{-1}$) concentrations under different land uses

Use Land	Minimum	Maximum	Mean	S. Deviation	CV	Skew.	Kurt.	N
Wheat/Barley	10.30	787.90	70.42	115.20	163.59	5.08	30.33	53
Lentil	16.00	102.80	45.50	28.00	61.54	0.70	-0.80	24
Corn	19.40	251.60	77.10	72.00	93.39	1.81	3.46	10
Pasture	11.60	159.00	39.40	40.30	102.28	2.48	6.94	13
Forest	13.30	234.90	98.90	91.40	92.42	0.68	-1.56	10

Pearson correlation showed that P_2O_5 was significantly and positively correlated with both OM and EC while negatively correlated with clay content (Table 3).

Table 3. Correlation analysis among soil properties

	Clay	Sand	Silt	CaCO3	OM	pH	EC
Sand	-0.81**						
Silt	-0.59**	0.00					
CaCO3	-0.46**	0.20*	0.50**				
OM	-0.22*	0.07	0.28**	0.02			
pH	-0.16	0.17	0.03	0.30**	-0.02		
EC	0.14	-0.02	-0.21*	-0.10	-0.10	0.03	
P_2O_5	-0.23*	0.17	0.16	0.17	0.50**	0.04	0.22*

**Correlation is significant at the 0.01 level *Correlation is significant at the 0.05 level

The model revealed that the range value of PAP concentration is 7020 m and PAP has a strong spatial dependency. Wang et al. (2009) reported PAP concentration with a moderate spatial dependence and a range value of 3141 m. They indicated that spatial dependence of PAP has strongly been influenced by particle size distribution, mineralogical composition, soil forming processes, fertilization and soil tillage practices. The changes of slope, direction and management practices (different land use choices, soil tillage, irrigation and fertilization methods) in short distances lead to have a 7020 m range value. The similarity between samples have been significantly decreased after this distance. The model indicated a hole effect in PAP concentration. The structure of hole effect in many case is related to the existence of periodicity or reoccurrence due to the spatial feature of geological material in the region (Pyrzcz et al. 2003).

Table 4 - Fitted semivariogram models and spatial characteristics of PAP

	Model	Co	Co+C	A (m)	SD (Co/(Co+C))*100	R ²	RSS
P ₂ O ₅	Exponential	0.025	0.90	7020	2.77	0.96	0.0087

Co: nugget effect; Co+C: structural variance; A: range (m); RSS: residual sums of squares; SD: spatial dependence (%); R² correlation coefficient

The maps obtained for PAP concentration clearly showed that the PAP concentration in most part of the study area is lower than the threshold value for plant production (Figure 2). However, PAP concentration was much higher than the need of healthy plant growth in certain regions.

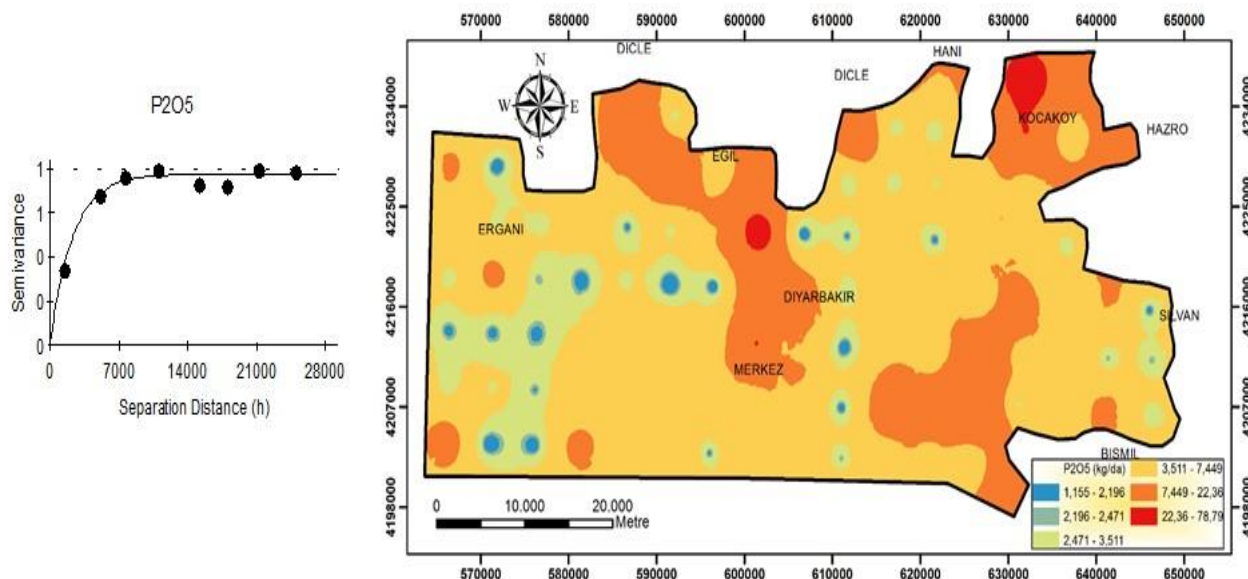

Figure 2. Spatial distribution of P₂O₅ concentration in study area

Conclusions

The results of this study revealed that variation in land use had significant contribution to the spatial structure of PAP. The difference in management practices among farmers particularly for wheat, barley and maize fields resulted to such high spatial variability. The use of fertilizer mainly depends on the financial status of farmers not to any kind of soils test. This results to variable rate of fertilizer use for even adjacent fields.

Acknowledgments

This research was funded by The Scientific and Technological Research Council of Turkey (TUBITAK) (Grant No: 214O374).

References

- Allison, L.E. Moodie C.D.(1965). Carbonate. In: C.A. Black et al. (Ed.) Methods of soil analysis, Part 2. Agronomy 9:ASA. Inc. Madison, Wisc. USA. P: 1379-1400.
- Anonymous, (2016).Ormanve Su İşleriBakanlığı. MeteorolojiGenelMüdürlüğü. <http://www.mgm.gov.tr/> 10.05.2016
- Cheng, Y. Li, P. Xu, G. Li, Z. Cheng, S. Gao, H. (2016). Spatial distribution of soil total phosphorus in Yingwugou watershed of the Dan River, China. Catena, 136, 175-181.
- Corazza, EJ. Brossard, M. MuraokaI, T. Coelho Filho, M.A.,(2003). Spatial variability of soil phosphorus of a low productivity Brachiariabrizantha pasture. Scientia Agricola, 60(3), 559-564.

- Çelik, R.(2015). Temporal changes in the groundwater level in the Upper Tigris Basin, Turkey, determined by a GIS technique. *Journal of African Earth Sciences*. 107 P: 134–143
- Gao, Y. Gao, J. Chen, J. (2011). Spatial variation of surface soil available phosphorous and its relation with environmental factors in the Chaohu Lake Watershed. *International Journal of Environmental Research and Public Health*, 8: 3299-3317.
- Gee, G.W. Bauder, JW.(1986). Particle-size Analysis. In A.L. Page (ed.). *Methods of soil analysis, Part1, Physical and Mineralogical Methods*. Second Edition, Agronomy Monograph 9, American Society of Agronomy, Madison, WI. P: 383 – 411.
- Liu, Z.P., Shao, M.A., Wang, Y.Q.,(2013). Spatial patterns of soil total nitrogen and soil total phosphorus across the entire Loess plateau region of China. *Geoderma* 197, 67–78.
- Mulla, D.J., McBratney A.B.,(2000). Soil Spatial Variability. In: Sumner, M. E. (ed.), *Handbook of Soil Science*. CRC Press, pp. A321-A352.
- Nelson D.W. and Sommer, L.E. (1982). Total carbon, organic carbon, and organic matter. In A.L. Page (ed.) *Methods of Soil Analysis*. 2nd Ed. ASA Monogr. 9(2). Amer. Soc. Agron. Madison, P: 539-579.
- Olsen, S.R., Cole, C.V. Watanable, F.S., Ve Dean, I.A.,(1954). Estimation of available phosphorus in soils by extraction with sodium bicarbonate. USDA, Circ., 939, Washington, D.C.
- Ozgoz, E. Gunal, H. Acir, N.Gokmen, F.Birol, M.Budak, M. (2013). Soil quality and spatial variability assessment of land use effects in a typic haplustoll. *Land Degradation & Development*, 24(3), 277-286.
- Pyrzcz, M. J., & Deutsch, C. V. (2003). The whole story on the hole effect. *Geostatistical Association of Australasia, Newsletter*, 18, 3-5.
- Rhoades, J.D.(1982). Soluble salts. In: A.L. Page et al.(ed.) *Methods of soil analysis: Part2. Agronomy Monogr. 9. 2nded. ASA and SSSA, Madison, WI. P: 167-178.*
- Richards, I.R. Johnston, A.E., Egopt, D.F., Rothamsted, I.A.C.R. (2001). The effectiveness of different precipitated phosphates as sources of phosphorus for plants. Report on work undertaken for CEEP, EFMA (European Fertiliser Manufacturers Association), Anglian Water UK, Thames Water UK and Berlin Wasser Betriebe.
- Roger, A. Libohova, Z. Rossier, N.Joost, S. Maltas, A. Frossard, E.Sinaj, S. (2014). Spatial variability of soil phosphorus in the Fribourg canton, Switzerland. *Geoderma*, 217, 26-36.
- Trangmar, B.B., Yost, R.S., Uehara, G.(1985). Application of Geostatistics to Spatial Studies of Soil Properties. *Adv. Agron.* 38: 45–94.
- Umali, B.P. Oliver, D.P., Forrester, S., Chittleborough, D.J., Hutson, J.L., Kookana, R.S., Ostendorf, B., (2012). The effect of terrain and management on the spatial variability of soil properties in an apple orchard. *Catena* 93, 38–48.
- Wang, Y. Zhang, X. Huang, C. (2009). Spatial variability of soil total nitrogen and soil total phosphorus under different land uses in a small watershed on the Loess Plateau, China. *Geoderma*, 150(1), 141-149.
- Webster, R. (2001). Statistics to support soil research and their presentation. *European Journal of Soil Science*, 52: 331-340
- Yang, F. Zhang, G. Yin, X. Liu, Z.(2011). Field-Scale Spatial Variation of Saline-Sodic Soil and Its Relation with Environmental Factors in Western Songnen Plain of China. *International Journal of Environmental Research and Public Health* ISSN 1660-4601
- Zhang, AM. Chen, ZH. Zhang, GN. Chen, LJ. Wu, ZJ.(2012). Soil phosphorus composition determined by ³¹P NMR spectroscopy and relative phosphatase activities influenced by land use. *Eur. J. Soil Biol.* 52, 73–77.

FACTORS AFFECTING AVAILABLE PHOSPHORUS CONCENTRATION IN NATURALLY FORMED SALINE ALKALINE SOILS

Mesut BUDAK^{1*}, Hikmet GÜNAL²

¹Siirt University, Faculty of Agriculture, Soil Science and Plant Nutrition Department Siirt, Turkey

²Gaziosmanpasa University, Faculty of Agriculture, Soil Science and Plant Nutrition Department, Turkey

*Corresponding author: m.budak@gmail.com

Abstract

Several factors affect the availability of phosphorus (P) concentration in soils. Understanding the factors affecting the soil P content is essential to appropriate use of P sources in agricultural production. This study was aimed to identify the factors important for the plant available P concentration of naturally formed saline alkaline soils and map the spatial distribution of P concentration. Soil samples were collected from 0-30 and 30-60 cm depths by field sampling in a 400m×400m grid. Total of 202 locations were sampled from 2650 ha land. Plant available P (PAP) concentration, soil texture (clay, silt and sand contents), calcium carbonate content, organic matter, soil pH, electrical conductivity, exchangeable Ca, Mg, Na and K, exchangeable sodium percentage and sodium adsorption ratio of soil samples were determined. The PAP concentration in 0-30 cm depth ranged from 2.98 to 89.72 mg kg⁻¹ with an average value of 28.52 mg kg⁻¹. The PAP concentration of 30-60 cm soil depth was between 1.72 and 83.04 mg kg⁻¹ with a mean value of 35.91 mg kg⁻¹. The correlation analyses revealed that available P had a significant negative relationship between clay, calcium carbonate and exchangeable Ca and Mg contents, whereas the P had significant positive correlation between sand and exchangeable K contents of soils. Relatively high clay (mean 52.4%) and low organic matter content (1.87%) of soils increased the P fixation and lowered the availability. In addition to this, high and pH and calcium carbonate content might have induced to the formation of tricalcium and trimagnesium phosphates which significantly reduce the availability of phosphorus. In such cases, plants will have difficulty to utilize the soil P and show the signs of P deficiency. Thus, spatial distribution maps of plant nutrients such as P are important to locate and alleviate the problems encountered in arid regions.

Keywords: *Alkalinity, Available P, Geoistatistical, Salinity, Spatial variability.*

Introduction

Soil salinity and sodicity of agricultural fields in arid and semi-arid regions pose an important constrain on plant productivity (Wang et al., 2015). In addition to the threats of salinity and high sodium concentration, reduction of phosphorus (P) availability and plant uptake in such environment worsen the problem of plant growth (Elgharably, 2011). Precipitation, transformation and fixation of P by soluble salts lower the P concentration in soil solution. Navarro et al. (2001) pointed to the low level of P flux through xylem under saline condition.

Soil pH, organic matter (Schneider and Haderlein 2016), the amount of clay size particles and the type of clay minerals, concentration of certain cations and anions (Elgharably, 2008), exchangeable sodium percentage (Parfitt, 1978), calcium carbonate content (Leytem and Mikkelsen 2005), hydroxides of Al⁺³ and Fe⁺³ (Bhattacharyya et al., 2015) have significant impact on availability of P in saline soils. The concentration of PAP in calcareous soils is

controlled by calcium phosphates in solid form. The P in soil solution can react with calcium (Ca) and magnesium (Mg) ions and form less soluble Ca and Mg-phosphates. Under this circumstances, plants cannot use the P in soil and may suffer severe P deficiency (Leytem and Mikkelsen 2005; Mahmood et al., 2013).

Abundance of factors affecting the concentration of plant-available phosphorus leads to have a very high variability even in a single field (Umali et al., 2012) which requires site-specific fertilization recommendations (Roger et al., 2014). Thus, determining the factors affecting the availability of P in a single field or a larger scale terrain is important to sustain the agricultural productivity. Geostatistical techniques have been widely used to model and map spatial distribution of soil properties. Roger et al (2014) showed that land use plays a significant role in soil P distribution. The purpose of this study was to assess the impact of several soil properties on PAP in saline and sodic soils.



Figure 1. Phosphorus deficiency in a saline and sodic field from Central Anatolia, Turkey

Material and Methods

Study Area

Study area (2.650 ha) is situated in Emen Plain of Central Anatolian Plateau. The annual long term (1971-2000) average precipitation is 322.4 mm and mean air temperature is 11.7 °C. Soil temperature regime is mesic (mean value of 13.5 °C) and soil moisture regime is aridic (Soil Survey Staff, 1999). The dominant plant species were halophytes.

Soil Sampling

The study area was divided into 400m*400m square grids, and soil samples from 152 points of 0-30 cm and 30-60 cm depths were collected. Fifty more soil samples with 5, 20, 50, 125 and 300 m sampling intervals were also sampled to analyse the variability in soil properties occur at shorter than 400m distance. Thus, 202 soil samples have been collected (Figure 1).

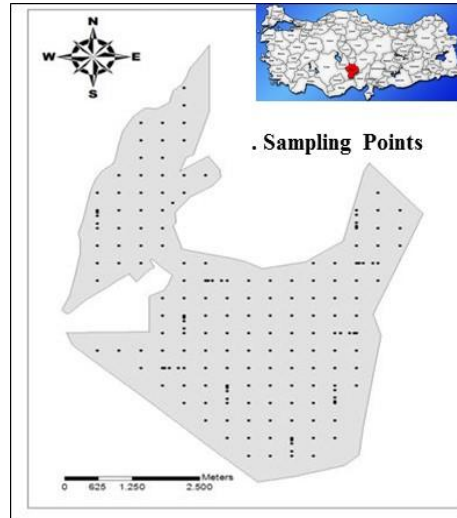

Figure 1. Study area and sampling locations

Physical and Chemical Soil Analysis:

Available P was a method described by Olsen et al. (1954). Particle size distribution was determined by the hydrometer method (Gee and Bauder, 1986). Exchangeable Na, K, Ca and Mg were determined with a method described by Thomas(1982). The exchangeable sodium percentage (ESP) was determined from the concentration of exchangeable cations using Equation 1 (U.S. Salinity Lab. Staff, 1954). The soil reaction (pH) and electrical conductivity (EC) were measured in saturated paste (Rhoades, 1982). Calcium carbonate was determined by using calcimeter method as mentioned by Allison and Moodie (Allison and Moodie, 1965). Organic matter was determined by Walkley and Black (Nelson and Sommer, 1982). Sodium adsorption ratio (SAR) was calculated from the concentration of Na, Ca and Mg concentrations extracted from saturated pastes (U.S. Salinity Lab. Staff, 1954).

$$ESP (\%) = \frac{\text{Exchangeable Na}}{\text{CEC}} * 100 \quad (1)$$

$$SAR = \frac{[Na^+]}{\sqrt{\frac{[Ca^{++}] + [Mg^{++}]}{2}}} \quad (2)$$

Statistical Analyses

The descriptive statistics and correlation test were performed by SPSS, Version 22.0. Geostatistical analysis was performed by ARCGIS 10.1. The suitability of semi-variogram models was determined by r^2 value and Residual Sum of Squares (RSS). The models with r^2 value close to 1.0 and RSS close to 0.00 were considered to be suitable (Yang et al., 2011).

Results and Discussion

Soils in study area have been formed over salt rich marine and volcanic sediments. Soils were found on flat slope, mostly poor in organic matter, high in calcium carbonate, salt and exchangeable sodium (Table 1).

Table 1. Descriptive statistics soil properties for 0-30cm and 30-60 cm depths (N=202)

		Depth (cm)	Minimum	Maximum	Mean	Std.Dev.	CV	Skewness	Kurtosis	
Clay	%	0-30	22.00	81.10	52.40	16.29	31.09	-0.12	-1.27	
		30-60	12.40	82.40	57.86	19.62	33.91	-1.04	-0.17	
Sand		0-30	3.87	61.55	26.08	14.24	54.60	0.43	-0.83	
		30-60	4.70	79.30	26.52	18.32	69.08	1.18	0.36	
Silt		0-30	8.75	55.11	21.52	6.45	29.97	0.67	2.56	
		30-60	5.45	37.20	15.67	5.75	36.69	0.90	0.71	
CaCO ₃		0-30	3.99	49.47	31.43	10.81	34.39	-0.70	-0.60	
		30-60	3.97	62.07	34.06	12.48	36.64	-0.52	-0.49	
OM		0-30	0.32	4.50	1.87	0.70	37.43	0.52	0.60	
		30-60	0.19	2.61	1.11	0.45	40.54	0.35	0.20	
PAP	mg kg ⁻¹	0-30	2.98	89.72	28.52	15.43	54.10	1.18	1.72	
		30-60	1.72	83.04	35.91	20.72	57.70	0.11	-1.27	
pH		0-30	7.50	9.20	8.35	0.28	3.35	0.01	0.01	
		30-60	7.66	10.02	8.47	0.35	4.13	0.72	1.70	
EC		0-30	0.70	82.10	12.44	13.82	111.09	2.16	6.01	
		30-60	0.56	55.20	13.82	10.44	75.54	1.48	2.12	
Ca		0-30	14.98	133.76	35.43	20.35	57.44	2.22	6.81	
		30-60	12.45	53.66	24.38	11.64	47.74	1.08	-0.45	
K		meq 100g ⁻¹	0-30	0.42	11.98	4.14	1.89	45.65	1.55	3.19
			30-60	0.94	12.36	4.14	1.93	46.62	1.30	2.55
Mg			0-30	1.12	17.58	6.85	2.99	43.65	0.61	0.25
			30-60	0.48	18.28	7.62	3.41	44.75	0.69	0.35
Na	0-30		0.55	76.18	14.53	14.38	98.97	1.40	1.69	
	30-60		1.66	74.18	21.39	12.76	59.65	1.02	1.35	
SAR	0-30		0.23	98.23	14.12	14.77	104.60	2.14	5.97	
	30-60		0.22	85.65	16.63	11.70	70.35	2.39	9.12	
ESP	%		0-30	0.49	55.03	12.69	11.24	88.57	1.28	1.27
			30-60	1.47	66.91	25.41	14.70	57.85	0.51	-0.30

The PAP concentrations of surface soils ranged from 2.98 and 89.72 mg/kg with a mean value of 15.43 p mg/kg. The PAP concentrations of subsurface soils were between 1.72 and 83.02 mg/kg with a mean of 35.91 mg/kg (Table 1). The CV values in both depths indicated high variability (54.10% and 57.70%) that probably resulted from the high variability of clay, sand, silt and CaCO₃ contents, EC, SAR and ESP values and exchangeable Ca, Na, Mg and K concentrations. Barros et al., (2005) investigated the effects of clay content on inorganic P cycle and reported a quite high relationship ($r^2 = 0.99$) between clay content and P sorption of soils.

The relationships between the PAP concentration of soils and other soil properties have been evaluated by correlation test (Table 2). Significant negative correlations ($P < 0.01$) indicated that the PAP concentration in surface soils is low where clay, CaCO₃, exchangeable Ca and Mg concentrations are high. In subsurface soils, the PAP concentration had significant negative correlations ($P < 0.01$) with CaCO₃, OM, exchangeable Ca and Mg concentrations (Table 2). The PAP concentration in subsurface soils was high and significantly affected by salinity parameters of EC, exchangeable Na, SAR and ESP. The results revealed that the PAP concentration is high in saline and sodic conditions. The findings of Curtin et al. (1993) support the results of this

study. They claimed that excess Na^+ in saline and sodic conditions replaces Ca^{+2} , Mg^{+2} , and Al^{+3} at the exchange sites. Increased negative charges promotes desorption of P components (HPO_4^- and H_2PO_4^-). In contrast, Khoshgoftarmanesh and Nourbakhsh (2009) found less available P in saline soils due to the increased bicarbonate extractable P.

Table 2. The results of ccorrelationtest among soil properties

	Depth (cm)	Clay	Sand	Silt	CaCO3	OM	pH	EC	Ca	K	Mg	Na	ESP	SAR
PAP	0-30	-.304**	.257**	.201**	-.295**	.032	.009	.059	-.254**	.179*	-.463**	.032	.090	.122
	30-60	-.137	.115	.105	-.236**	-.391**	.044	.168*	-.589**	.023	-.418**	.207**	.330**	.453**

* Correlation is important at 5% level of significance, ** Correlation is important at 1.0% level of significance.

The parameters of best fitted semivariogram model for PAP concentrations were presented in Table 3. The best fitted model of PAP was exponential for both depths. Exponential model exhibits linear increase from the origin and indicates a higher level of short-range variability.

Table 3 - Fitted semivariogram models and spatial characteristics of PAP

	Depth (cm)	Model	Co	Co+C	A (m)	SD (Co/(Co+C))*100	R ²	RSS
PAP	0-30	Exponential	0.001	1.71	354	0.06	0.85	0.0437
	30-60	Exponential	0.32	3.50	339	9.14	0.75	0.33

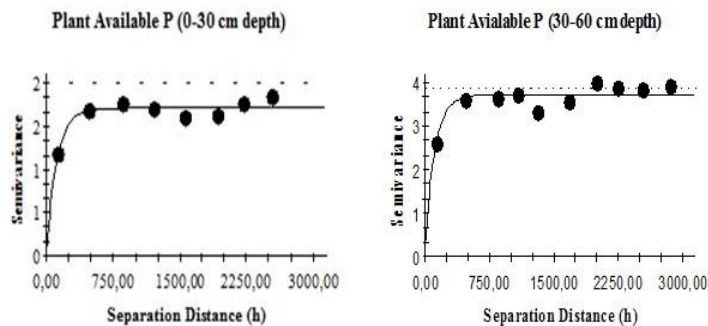

Figure 2. Experimental semivariograms of plant available phosphorus with fitted models

The lowest PAP concentration was found in central part of the study area where CaCO_3 content was almost 40% and OM content was ranging from 0.5 to 1.0% (Figure 2). Negative correlations between PAP concentration and CaCO_3 comply with the distribution maps. The P species in alkaline soils with high exchangeable Ca and Mg concentrations probably have formed less soluble CaPO_4 and MgPO_4 (Lindsay et al., 1989).

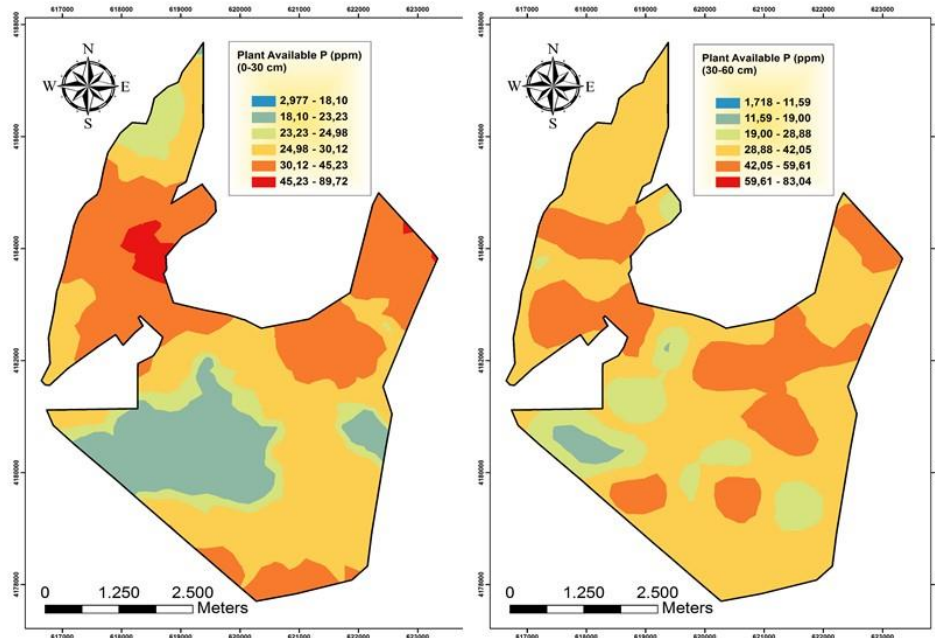

Figure 3. Spatial distribution of plant available phosphorus in 0-30 cm and 30-60 cm depths

Conclusion

The results indicated that the spatial structure of PAP in saline and sodic environment has been markedly affected by salinity/sodicity parameters (EC, exchangeable Na, SAR and ESP), clay, CaCO_3 and exchangeable Ca and Mg contents. Spatial maps are useful to locate the distribution of concentrations in a particular area of interest. This allows to locate the areas need to be precisely managed to correct the deficiency. Controlling the factors affecting the availability of a plant nutrient is also important in precision agriculture.

Acknowledgments

This study was funded by the Scientific Research Projects Commission of Gaziosmanpasa University (GOÜ-2011/101).

References

- Allison, L.E. Moodie C.D. (1965). Carbonate. In: C.A. Black et al. (Ed.) Methods of soil analysis, Part 2. Agronomy 9:. ASA. Inc. Madison, Wisc. USA. P: 1379-1400.
- Barros, N. F., &Comerford, N. B. (2005). Phosphorus sorption, desorption and resorption by soils of the Brazilian Cerrado supporting eucalypt. Biomass and bioenergy, 28(2), 229-236.
- Bhattacharyya, P., Nayak, A. K., Shahid, M., Tripathi, R., Mohanty, S., Kumar, A., & Swain, C. K. (2015). Effects of 42-year long-term fertilizer management on soil phosphorus availability, fractionation, adsorption–desorption isotherm and plant uptake in flooded tropical rice. The Crop Journal, 3(5):387-395.
- Curtin, D., Syers, J. K., & Bolan, N. S. (1993). Phosphate sorption by soil in relation to exchangeable cationComposition and pH. Soil Research, 31(2), 137-149.
- Elgharably, A. G. (2008). Nutrient availability and wheat growth as affected by plant residues and inorganic fertilizers in saline soils. PhD Thesis. Soil and Land Systems Earth and Enviromental Sciences The University of Adelaide. P: 17

- Elgharably, A., (2011). Wheat response to combined application of nitrogen and phosphorus in a saline sandy loam soil. *Soil Sci. Plant Nutr.* 57 (3), 396–402.
- Gee, G.W. Bauder, J.W. (1986). Particle-size Analysis. In A.L. Page (ed.). *Methods of soil analysis, Part 1, Physical and Mineralogical Methods*. Second Edition, Agronomy Monograph 9, American Society of Agronomy, Madison, WI. P: 383 – 411.
- Khoshgoftarmanesh, A. H., & Nourbakhsh, F. (2009). Salinity and plant residue effects on soil available phosphorus. *Journal of plant nutrition*, 32(6), 954-966.
- Leytem, A.B., Mikkelsen R.L., (2005). The Nature of Phosphorus in Calcareous Soils. *Better Crops/Vol. 89* (2005, No. 2).
- Lindsay W L, Vlek P. L. G. veChien S. H. (1989). Phosphate minerals. In *Minerals in soil environment*, 2nd edn. Eds J B Dixon and S B Weed. pp. 1089–1130. SSSA, Madison, WI, USA
- Mahmood, I. A., Ali, A., Aslam, M., Shahzad, A., Sultan, T., & Hussain, F. (2013). Phosphorus Availability in Different Salt-Affected Soils as Influenced by Crop Residue Incorporation. *International Journal of Agriculture and Biology*, 15(3), 472-478.
- Navarro, J. M., Botella, M. A., Cerdá, A., & Martínez, V. (2001). Phosphorus uptake and translocation in salt-stressed melon plants. *Jour. of plant physiology*, 158(3), 375-381.
- Nelson D.W. and Sommer, L.E. (1982). Total carbon, organic carbon, and organic matter. In A.L. Page (ed.) *Methods of Soil Analysis*. 2nd Ed. ASA Monogr. 9(2). ASA. Madison, P: 539-579.
- Olsen, S.R., Cole, C.V. Watanable, F.S., Ve Dean, I.A., (1954). Estimation of available phosphorus in soils by extraction with sodium bicarbonate. *USDA, Circ.*, 939, Washington, D.C.
- Parfitt, R. L. (1978). Anion adsorption by soils and soil materials. *Adv. Agron.* 30(1), 50.
- Rhoades, J.D. (1982). Soluble salts. In: A.L. Page et al.(ed.) *Methods of soil analysis: Part 2. Agronomy Monogr. 9*. 2nd ed. ASA and SSSA, Madison, WI. P: 167-178.
- Roger, A. Libohova, Z. Rossier, N. Joost, S. Maltas, A. Frossard, E. Sinaj, S. (2014). Spatial variability of soil phosphorus in the Fribourg canton, Swit. *Geoderma*, 217, 26-36.
- Schneider, F., & Haderlein, S. B. (2016). Potential effects of biochar on the availability of phosphorus—mechanistic insights. *Geoderma*, 277, 83-90.
- Soil Survey Staff. (1999). *Soil Taxonomy- A Basic System of Soil Classification for Making and Interpreting Soil Surveys*. USDA United States Printing Office, Washington DC, USA.
- Thomas, G.W., (1982). *Methods of Soil Analysis, Part 2. Chemical and Microbiological Properties*, Page, A.L., Miller, R.H. Keeney, DR.(ed) 2nd edition. SSSA Inc. Publ., Mad., Wisc. Pp: 159-164.
- Umali, B.P., Oliver, D.P., Forrester, S., Chittleborough, D.J., Hutson, J.L., Kookana, R.S., Ostendorf, B., (2012). The effect of terrain and management on the spatial variability of soil properties in an apple orchard. *Catena* 93, 38–48.
- U.S. Salinity Laboratory Staff, (1954). *Diagnosis and Improvement of Saline and Alkaline Soils*. Agricultural Handbook No. 60.
- Wang, S., Jiao, L. X., Yang, S., Jin, X., & Yi, W. (2012). Effects of organic matter and submerged macrophytes on variations of alkaline phosphatase activity and phosphorus fractions in lake sediment. *Journal of environmental management*, 113, 355-360.
- Yang, F., Zhang G., Yin X., Liu Z., (2011). Field-Scale Spatial Variation of Saline-Sodic Soil and Its Relation with Environmental Factors in Western Songnen Plain of China. *International Journal of Environmental Research and Public Health* ISSN 1660-4601

SPATIAL DISTRIBUTION OF SOIL SALINITY WITH DIFFERENT INTERPOLATION METHODS

Şeydagül ÖZDEMİR^{1*}, Hikmet GÜNAL², Hakan ARSLAN³, Nurullah ACIR⁴

¹Field Crops Research Institute, Ministry of Food, Agriculture and Livestock of Turkey, Ankara, Turkey

²Gaziosmanpaşa Univ., Faculty of Agric., Soil Science and Plant Nutrition Dept., Tokat 60240 Turkey

³OndokuzMayıs Univ., Faculty of Agric., Agriculture Structure and Irrigation Dept., 55139, Samsun, Turkey

⁴Ahi Evran Univ., Faculty of Agric., Soil Science and Plant Nutrition Dept., Kırşehir Turkey

*Corresponding author: sgozdemir@tagem.gov.tr

Abstract

Salinization is one of the most important limiting problems of plant growth in Turkey as it is in all over the World. Salinity differs from other soil characteristics in terms of spatial distribution structure and has mainly patchy distribution. Therefore, better management of salinity can only be achieved by mapping the salinity of soils. The purpose of this study was to determine the most acceptable method to estimate the values of attributes related to soil salinity in Çerikli Irrigation Planning Area located in central Turkey. The coverage area of study area is 14.924,00 ha. Disturbed soil samples were collected from 0-30 cm, 30-60 cm and 60-90 cm depths of 110 sampling locations. Soil samples were analyzed for soil pH, electrical conductivity (EC), sodium adsorption ratio and water extractable Ca, Mg, Na and K concentrations. The estimation performance of deterministic (Radial Basic Functions(RBF) and Inverse Distance Weighting(IDW)) and Stochastic (Ordinary Kriging, Simple Kriging and Universal Kriging) interpolation methods have been compared for the predication of soil salinity in the project area. Salinity /EC) in 0-30 cm depth ranged from 0.65 and 67.1 dS/m with a mean value of 8.90 dS/m, in 30-60 cm depth EC ranged from 0.86 dS/m and 79.9 dS/m, and in 60-90 cm depth EC ranged from 1.07 dS/m and 98.80 dS/m. The root mean square error (RMSE) of the methods was used to compare and determine the best method. The mean absolute error (MAE) value was used in case of having the same RMSE value. The RBF-ST provided the accurate results for the EC of 0-30 cm and 30-60 cm depths and the RBF-IM was the most appropriate method for 60-90 cm depth. The results obtained are helpful for making effective decisions for protection of soils and sustainability of agriculture. This study is a good example for mapping soil properties by geostatistical methods.

Keywords: *Salinity, Geostatistics, Deterministic, Stochastic, Mapping, Monitoring*

Introduction

Soils may become saline under arid or semi-arid conditions in poor natural drainage conditions. The application of waters containing salts, weathering of primary and secondary minerals containing components of salts, decomposition of organic matter and fluctuating water table may lead to the accumulation of soluble salts in soil profile. Type of soil, climate and agricultural practices determine the rate of salinization in a region (Juan et al., 2011). Unsustainable water management practices at the farm-level cause to raise of groundwater and contributes to salt accumulation, particularly in irrigated fields of arid and semi-arid regions of Turkey (Gunal et al., 2015).

Soil properties in general vary in space and time due to the inherent (parent material, topography, climate, vegetation and time) and dynamic (management practices such as fertilization, irrigation, soil tillage etc.) factors. It is not practical to measure or record the characteristics of soils in every location in an area of interest. Theory in geostatistics addresses to the spatial variability of an individual variable. (Goovaerts, 1997). Geostatistical interpolation techniques can potentially be used to understand the progress in soil salinization. Determining the spatial patterns of salinization in a region helps also predicting areas that may be at high risk and need to be monitored.

Various geostatistical techniques are used widely for prediction of spatial variations of the soil. Kriging is a useful tool of geostatistical techniques. Under certain stationary assumptions, the kriging refers to at least square linear predictor that requires covariance parameters and the functional form for the mean of the underlying random function. Robinson and Metternicht (2006) compared the accuracy of ordinary kriging (OK), lognormal ordinary kriging (LOK), inverse distance weighting (IDW) and splines for interpolating pH, electric conductivity and organic matter. The results indicated that pH in the topsoil was estimated better with OK and LOK performed the best results when applied to ECe in the topsoil. The IDW method provided the greatest accuracy for the interpolation of subsoil pH and for interpolating the soil organic matter spline interpolation method had the highest accuracy. Wang et al. (2016) showed that the estimation precision of IDW method was superior to that of OK. However, the differences obtained between the accuracy in predictions were not significant. In this study; deterministic (Radial Basic Functions (RBF) and Inverse Distance Weighting (IDW)) and Stochastic (Ordinary Kriging, Simple Kriging and Universal Kriging) interpolation techniques have been tested to model and map the parameters associated to the soil salinity.

Material and Methods

The study area is located in the central Anatolia in Turkey. Total area sampled is 14.924,00 ha and irrigated land within the study area is 12.306,00 ha. Soil sampling started from 8 km east of Yerkoy town (Yozgat province) and continue along Delice stream until the junction of Kizilirmak River.

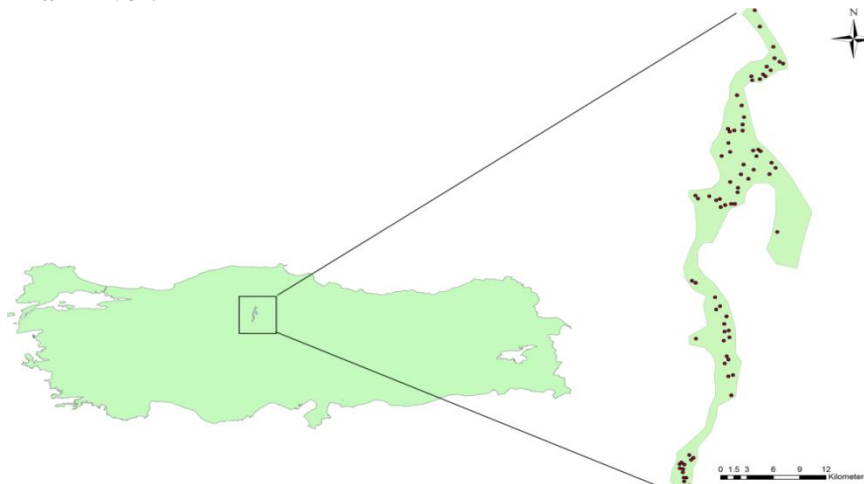

Figure 1. Study area and sampling locations

Soil Sampling and Analyses

Disturbed soil samples were collected from 110 points of 0-30 cm, 30-60 cm, 60-90 cm and 90-120 cm depths. In order to determine the spatial distribution of salinity and related soil attributes, soil samples were analyzed for soil pH and electrical conductivity (Rhoades, 1982), exchangeable cations and exchangeable sodium percentage, cation exchange capacity (Thomas, 1982) and particle size distribution (Bouyoucos, 1962).

Geostatistical Analyses

Five different interpolation techniques have been compared to model and map the parameters associated to the soil salinity. The techniques used were deterministic (Radial Basic Functions (RBF) and IDW) and Stochastic (OK, Simple Kriging (SK) and Universal Kriging (UK)). The interpolating value of a point is highly influenced by the nearby points in deterministic techniques and farther points have less influence. However, the kriging techniques assume the data comes from a stationary stochastic process and rely on the notion of autocorrelation (Webster and Oliver, 2001). The IDW procedure is more simple and fast while kriging provides best linear unbiased estimates (Eldeiry and Garcia, 2011).

Prior to the preparation of spatial distribution maps, the best fitted geostatistical model for each parameter has been conducted and model parameters have been recorded. Cross validation was used to compare these methods by statistical parameters of root mean squared error (RMSE) and mean absolute error (MAE). The calculation of the parameters of RMSE and MAE is described by equations 1 and 2.

$$RMSE = \sqrt{\frac{\sum (z_i^* - z_i)^2}{n}} \quad (\text{Equation 1})$$

$$MAE = \frac{1}{n} \sum_{i=1}^n |z_i - Z| \quad (\text{Equation 2})$$

N: Number of observation points, Z_i : Estimate the value of i points Z_i^* : Average values of observation

The MAE and RMSE are similar to each other, though the sensitivity of MAE is lower to large estimate errors. The MAE is preferred for small or limited data sets. The RMSE indicates the absolute fit of the model to the data, how close the observed data points are to the model's predicted values. The lower value of RMSE indicates a better model fit (Eldeiry and Garcia, 2011).

Results and Discussion

The main statistical parameters for the soil properties are given in Table 1. The EC values in 0-30 cm of the study area vary from non saline 0.65 dS/m to very strongly 67.1 dS/m. Salinity levels of soils increased with increased depth. The EC ranged from 0.86 dS/m to 79.9 dS/m in 30-60 cm, from 1.07 dS/m to 98.8 dS/m in 60-90 cm. The CV values indicated very high variation of EC values within study area.

Table Descriptive statistics of soil properties

Depth/Attribute	Unit	Min.	Max.	Mean	Std.Dev.	Coe Var	Skewness	Kurtosis	Distribution	
0-30 cm	EC	dS/m	0.65	67.1	8.90	14.27	160.34	2.53	8.72	Log normal
	pH		7.5	9.0	8.14	0.275	3.38	0.17	3.24	Normal
	ESP	%	1.43	25.42	7.31	4.07	55.68	1.39	6.40	Log normal
30-60 cm	EC	dS/m	0.86	79.9	11.00	16.43	149.36	2.44	8.37	Log normal
	pH		7.47	8.96	8.23	0.32	3.89	0.11	2.64	Normal
	ESP	%	2.0	25.36	8.73	4.74	54.30	1.02	3.86	Log normal
60-90 cm	EC	dS/m	1.07	98.80	12.06	16.24	134.66	3.02	13.49	Log normal
	pH		6.30	9.30	8.24	0.40	4.85	-0.86	8.63	Normal
	ESP	%	1.82	28.57	8.99	4.84	53.84	1.28	5.16	Log normal
90-120 cm	EC	dS/m	0.99	54.50	13.20	12.76	96.67	1.86	5.76	Log normal
	pH		7.55	9.31	8.26	0.31	3.75	1.14	5.20	Normal
	ESP	%	1.22	26.22	9.00	4.93	54.78	1.27	4.92	Log normal

The RMSE values for EC ranged from 13.827 to 20.348 and MAE values from 8.007 to 10.852. The RMSE values were used to determine the best method. The results showed that sub-functions of IDW, RBF and kriging methods were different from each other. When all methods compared, the RBF-ST method gave the most accurate results in 0-30 cm and 30-60 cm depths. The RBF-IM method was acceptable for 60-90 cm and IDW-1 method for 90-120 cm (Table 2).

Table1. Cross validation results of interpolation methods for EC values.

	0-30 cm		30-60 cm		60-90 cm		90-120 cm	
	RMSE	MAE	RMSE	MAE	RMSE	MAE	RMSE	MAE
IDW1	14.027	8.961	16.101	10.539	15.919	10.054	11.978	8.265
IDW2	14.656	8.708	16.532	10.536	16.052	9.868	12.411	8.530
IDW3	15.445	8.814	17.144	10.627	16.414	9.939	13.045	8.983
IDW4	16.009	8.990	17.581	10.696	16.761	10.074	13.481	9.321
IDW5	16.392	9.139	17.889	10.837	17.062	10.220	13.766	9.521
RBF-CRS	13.881	8.265	16.115	10.079	15.769	9.524	12.050	8.324
RBF-ST	13.827	8.330	16.070	10.087	15.756	9.548	12.008	8.279
RBF-M	14.209	8.401	16.992	10.686	16.005	10.541	12.695	9.073
RBF-IM	14.076	8.923	16.098	10.417	14.568	9.635	12.094	8.488
RBF-TPS	20.348	10.852	29.038	14.372	28.083	13.736	15.497	10.814
OK	15.285	8.007	17.220	9.982	15.589	9.084	12.211	8.261
SK	15.285	8.007	16.899	9.890	15.536	8.589	12.061	8.191
UK	15.380	8.141	17.220	9.982	15.496	8.522	12.211	8.261

Salinity map indicated that salinity is the highest on the northern part of the study area where the altitude is the lowest (Figure 2).

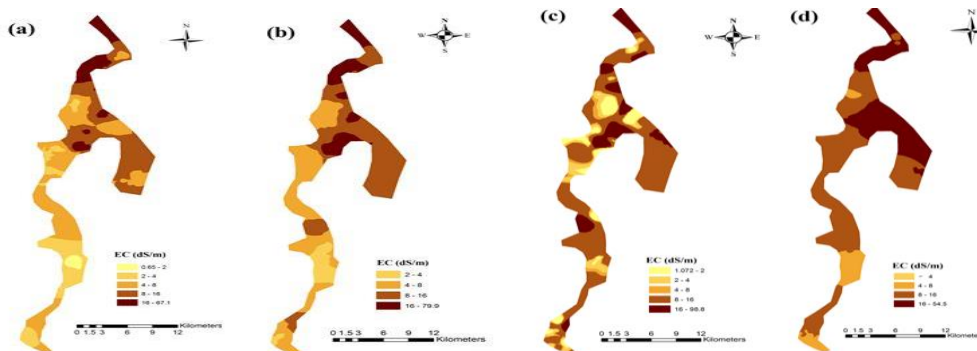

Figure 2. Spatial distribution of EC in (a) 0-30 cm (b) 30-60 cm (c) 60-90 cm (d) 90-120 cm

The RMSE values in 0-30 cm depth changed between 3.942 to 5.228 and MAE values from 2.817 to 3.227. The RBF-IM method gave the best results in 0-30cm and 30-60 cm depths for the ESP values (Table 3). In 60-90 cm depth, RMSE varied from 4.5677 to 5.552

Table 3. Cross validation results of interpolation methods for ESP values.

	0-30 cm		30-60 cm		60-90 cm		90-120 cm	
	RMSE	MAE	RMSE	MAE	RMSE	MAE	MAE	RMSE
IDW1	3.990	2.887	4.461	3.462	4.654	3.582	4.656	3.636
IDW2	4.247	2.943	4.466	3.423	4.700	3.491	4.909	3.831
IDW3	4.578	3.066	4.542	3.458	4.878	3.551	5.225	3.993
IDW4	4.801	3.160	4.628	3.486	5.060	3.647	5.453	4.102
IDW5	4.921	3.227	4.696	3.521	5.199	3.736	5.614	4.198
RBF-CRS	4.068	2.843	4.425	3.389	4.567	3.431	4.698	3.624
RBF-ST	4.037	2.850	4.420	3.395	4.567	3.432	4.663	3.599
RBF-M	4.431	3.055	4.752	3.557	4.657	3.359	5.149	3.807
RBF-IM	3.942	2.956	4.404	3.430	4.675	3.560	4.703	3.642
RBF-TPS	5.228	3.574	5.769	4.189	5.552	4.142	6.544	4.523
OK	4.135	2.827	4.804	3.598	4.637	3.430	4.961	3.624
SK	4.098	2.817	4.708	3.583	4.633	3.432	4.873	3.593
UK	4.135	2.827	4.804	3.598	4.637	3.430	4.954	3.622

and MAE from 3.430 to 4.142. The lowest RMSE value was 4.567 and obtained or RBF-CRS and RBF-ST methods. In this case, the method with a lower MAE value was accepted as the best method to map the spatial distribution of ESP of 60-90 cm. The RBF-CRS method had lower MAE value, and used to prepare the spatial distribution of ESP map (Figure 3).

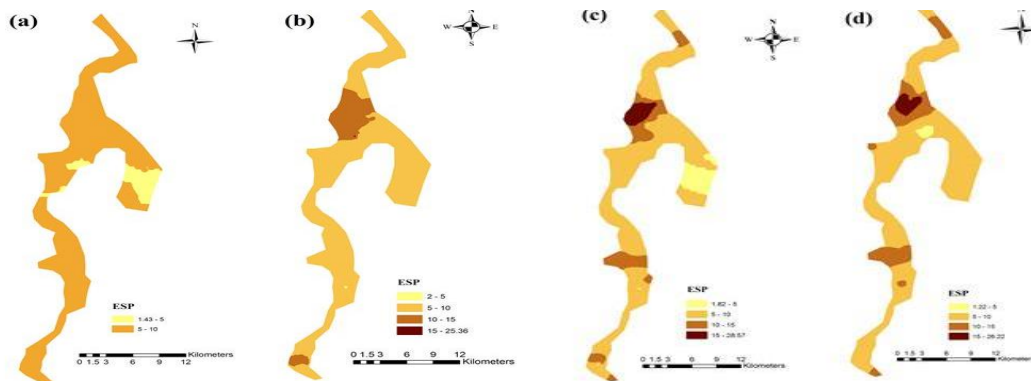

Figure 3. Spatial distribution of ESP values in (a) 0-30 cm (b) 30-60 cm (c) 60-90 cm (d) 90-120 cm

The best methods of soil pH were RBF-IM, SK, RBF-CRS and IDW-1 for 0-30cm, 30-60cm, 60-90cm and 90-120cm depths, respectively (Table 4). The pH values of soils were at highest level in the middle of the study area (Figure 4).

Table 4. Cross validation results of interpolation methods for pH values.

	0-30 cm		30-60 cm		60-90 cm		90-120 cm	
	RMSE	MAE	RMSE	MAE	RMSE	MAE	RMSE	MAE
IDW1	0.266	0.211	0.295	0.242	0.397	0.265	0.285	0.226
IDW2	0.279	0.218	0.300	0.243	0.399	0.264	0.305	0.247
IDW3	0.298	0.230	0.314	0.254	0.404	0.267	0.328	0.265
IDW4	0.313	0.241	0.327	0.266	0.409	0.272	0.343	0.277
IDW5	0.322	0.248	0.336	0.273	0.414	0.278	0.353	0.286
RBF-CRS	0.273	0.218	0.292	0.236	0.389	0.259	0.296	0.237
RBF-ST	0.272	0.217	0.270	0.201	0.390	0.261	0.292	0.234
RBF-M	0.302	0.238	0.290	0.216	0.391	0.261	0.331	0.265
RBF-IM	0.265	0.210	0.270	0.202	0.389	0.260	0.286	0.225
RBF-TPS	0.379	0.287	0.328	0.244	0.419	0.296	0.439	0.335
OK	0.273	0.219	0.266	0.201	0.404	0.271	0.294	0.234
SK	0.271	0.218	0.266	0.200	0.400	0.269	0.289	0.228
UK	0.273	0.219	0.266	0.201	0.398	0.268	0.294	0.234

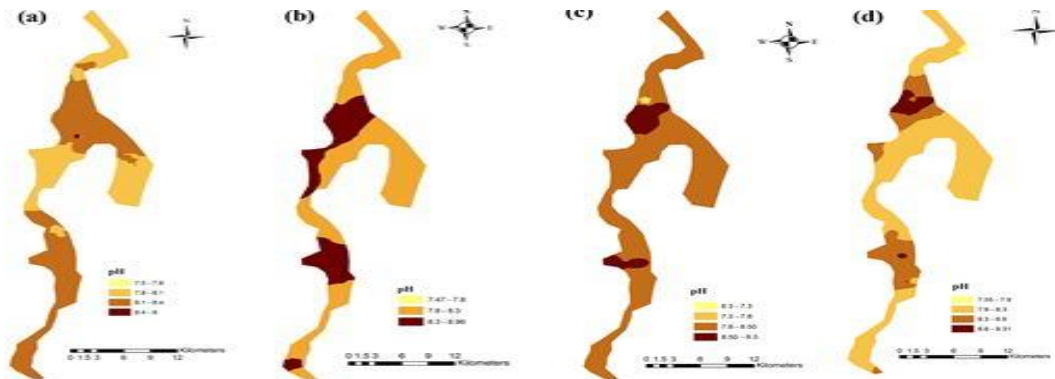

Figure 4. Spatial distribution of pH in (a) 0-30 cm (b) 30-60 cm (c) 60-90 cm (d) 90-120 cm

Conclusions

The study presented the results of a study to evaluate some interpolation techniques for mapping spatial distribution of soil salinity, pH and sodium adsorption ratio in central Anatolia of Turkey. The inappropriate and excessive irrigation without an adequate drainage system, irrigation water quality, a rising water table, climate, local topography and farming practices are the major causes of salinity in the study area.

The results of present study demonstrated that precision of spatial distribution maps can be increased with the use of alternative geostatistical methods. The nature of data has significant effect to determine the best method of interpolation.

Acknowledgement

This study was funded by the General Directorate of Agricultural Research and Policies of the Ministry of Food, Agriculture and Livestock, Turkey. (TAGEM/TSKAD/15/A13/P08/11)

References

Bouyoucos, G.J. 1962. Hydrometer method improved for making particle size analysis of soils. *Agronomy Journal* 54:464-465.

- Eldeiry, A. A., García, L.A. 2011. Using deterministic and geostatistical techniques to estimate soil salinity at the sub-basin scale and the field scale. Proceedings of the 31th Annual Hydrology Days, Fort Collins, CO, USA, 2123.
- Juan, P., Mateu, J., Jordan, M. M., Mataix-Solera, J., Meléndez-Pastor, I., Navarro-Pedreño, J. 2011. Geostatistical methods to identify and map spatial variations of soil salinity. *Journal of Geochemical Exploration*, 108(1), 62-72.
- Robinson, T.P., Metternicht, G. 2006. Testing the performance of spatial interpolation techniques for mapping soil properties. *Comp. and electronics in agric.*, 50(2), 97-108.
- Rhoades J.D. 1982. Cation exchange capacity. In: *Methods of Soil Analysis, Part 2, Agronomy Monograph 9* (ed. by Page A.L., Miller R.H. and Keeney D.R.). American Society of Agronomy, Madison, WI, 149–157.
- Thomas, G.W. 1982. Exchangeable cations. In: A.L. Page (ed.). *Methods of soil analysis. Part 2: Chemical and microbiological properties* (2nd ed.) *Agronomy* 9:159-165.
- Wang, H., Ren, S., Hao, Z., Meng, L., Wei, W., Jing, C. 2016. Quantitative Evaluation and Uncertainty Assessment on Geostatistical Simulation of Soil Salinity Using Electromagnetic Induction Technique. *Journal of Environmental Protection*, 7(06), 844.
- Webster, R. Oliver M.A. 2001. *Geostatistics for Environmental Scientists*. Wiley, Chichester, Hardbound, 271 pp., ISBN 0471965537.

ASSESSMENT OF HEAVY METAL CONTAMINATION IN SEDIMENTS AND VEGETATION OF THE KARAVASTA LAGOON, ALBANIA

Romina KOTO¹, Aida BANI¹, Irena DUKA¹, Marsela ALIKAJ²

¹Agro-Environmental Department, Faculty of Agronomy and Environment, Agricultural University of Tirana, Tirane, Albania

²Department of Biology, Faculty of Natural Sciences, University "Eqrem Çabej", Gjirokastra, Albania
Corresponding author: rominakoto@gmail.com

Abstract

The intensive agricultural production around the area of Karavasta Lagoon in Albania and the discharge of Semani and Shkumbini Rivers in vicinity to it could affect the environmental quality of the wetland and its ability to sustain the living organisms. This paper aims to estimate the quality of water and sediments of the Karavasta Lagoon, through measuring the physicochemical parameters and the presence of heavy metals. Samples of surface water and bottom sediments have been collected in different specific points in the Lagoon in the spring season of 2013 and have been analyzed for their concentration of heavy metals such as Pb, Cr, Cu, Cd, and Hg. The results show high levels of Cr pollution, followed by Cu and Pb and highlight the need for further monitoring of the physicochemical parameters. The application of Enrichment Factor (EF) suggests that Cr originates from the alluvium brought by Shkumbini River that flows through ultramafic areas in Albania rich in this metal, whereas Cu and Pb come from the agricultural drainage channels, urban effluents and tributaries.

Introduction

The quality of lagoon water changes with seasons and geographical areas, even when there is no evident pollution (Abdo MH, 2005). Besides its importance as a natural heritage, Karavasta Lagoon is threatened by several factors. Increase in population, human activities, industries and agriculture around the coastal environment are greatly affecting the neutrality of the water system (Chauvelon P, 2004). Lagoon pollution has been increasingly significant over the recent years and this has been found to contribute significantly to environmental problems (Abowei JFN 2010). Due to intensive agricultural activities in the surrounding area of lagoon, the soils could be subjected to non-point pollution as for relevance to Lagoon environments (Abdo MH, 2005). Karavasta is subject to different factors that would damage its biodiversity and eco-touristic values such as: eutrophication, (Chauvelon P, 2004) urban pollution, illegal constructions, illegal hunting and fishing, weak participation of local communities in decision-making etc. Shkumbini River was strongly impacted by the Metallurgic Complex of Elbasan: about 30 to 35 million m³ year⁻¹ of liquid waste with a high content of toxic compounds were discharged directly into the river, and about 300,000 tones year⁻¹ of solid waste were disposed on its riverbanks (Chauvelon P, (2004). Even if Divjaka urban area is not drained to the lagoon, part of its polluting load discharging from Terbufi Canal may reach the lagoon because its plume is directed mainly southward and close to the coast during spring and summer. In this context, the concentration of heavy metals in the lagoon water stand important at first for measuring the state of pollution of Karavasta Lagoon, and secondly it contributes on designing and implementing scientifically sound based conservation policies and actions. The heavy metals released in the water, eventually

are accumulated in the sediments (Abulude FO, Fapohunda OO, Awanlenhen 2006). Therefore, sediment analyses enable the assessment of the “Chemical Status” of transitional and coastal waters. The occurrence of elevated levels of trace metals especially in sediments can be a good indication of man induced pollution and high levels of heavy metals can often be attributed to anthropogenic influences, rather than natural enrichment of the sediment from geological weathering (Christophoridis A, Stamatis N, and Orfanidis S, 2007). Sediments integrate contaminants over time and are in constant flux with the overlying water column (Lord DA, Thompson GA, 1988). The analysis of heavy metals in the sediments permits detection of pollutants that may be either absent or in low concentrations in the water column (Binning K, Baird D, 2001). Their distribution in coastal sediments provides a record of the spatial and temporal history of pollution in a particular region or ecosystem (Addo MA, 2002). The traces of metal content in the sediment could affect the water quality, the bio-assimilation and bio-accumulation of metals in aquatic organisms, resulting in potential long-term implications on human health and ecosystem in general (Bani A, Imeri A, Echevarria G, Pavlova D, Reeves RD, Morel JL, and Sulçe S, 2013).

In the last years, the levels of the heavy metals the around the Karavasta Lagoon have increased due to human activities. Thus, the exact measuring of heavy metals in aquatic environments is important to control their pollution levels (Bani A, Imeri A, Echevarria G, Pavlova D, Reeves RD, Morel JL, and Sulçe S, 2013).

The main objective of this study is to measure the level of heavy metal contamination in the water, sediment and vegetation of the Karavasta Lagoon in Albania.

Material and Methods

Study area

Karavasta lagoon lies within the Mediterranean Climatic Zone, Central Sub-zone. The average rainfall is 950 – 1200mm during 85 – 100 days of the year, being one of the lowest levels in Albania. Two thirds of this occurs in November to March, with peaks in October and November (Cullaj A, Hasko A, Miho A, Schanz F, Brandl H, Bachofen R, 2005). The winter is mild, with January the coldest month of the year (average temperature 8.5°C). Days of temperature under 0°C are very rare. The mean annual temperature is 19.8°C. The temperature remains > 10°C up to about 9 months (Cullaj A, Hasko A, Miho A, Schanz F, Brandl H, Bachofen R, 2005). The wind has two main directions southeast during autumn and winter and northwest during spring and summer. The average wind speed varies 2.5 m/s to 3.3 m/s.

Sampling

Water samples were collected at eight sites in the Karavasta Lagoon on December 2013 and July 2014. The sampling sites were strategically selected to see the impact of all potential contamination sources. Sampling station 1 was at Dajlan Center (N: 40° 55' 507" and E: 19° 28' 264") 200 m from the quay where fish is processed in order to see the influence of such activity; sampling station 2 was among “Grykederdhje 3” and Bedat village (N: 40° 54' 287" and E: 19° 27' 489"); sampling station 3 in front of Bedat village, closed to Lena channel (N: 40° 53' 451" and E: 19° 28' 247"); sampling station 4 was closed to Mucias village (N: 40° 54' 164" and E: 19° 30' 255"); sampling station 5 closed to the villages of Kamenice and Gur (N: 40° 55' 421" and E: 19° 31' 396"); sampling station 6 is set in a distance of 100m from Kryekuq channel, at the pumping station (N: 40° 55' 242" and E: 19° 30' 562"); sampling station 7 at Kryekuq outlet (N: 40°

55' 421" and E:19° 31' 396"), and the last one sampling station(8) at drainage outlet of Zharneç village (N: 40° 56' 421"and E: 19° 31' 68").

Water sampling 'Ruttner' is used for the sampling of the lagoon water. The water samples for the physico-chemical analysis were taken from the surface of the lagoon (50 cm under the surface) at each sampling location using 1.5 liters polyvinyl bottles and labeled according to the sampling sites. The samples for the trace metal analysis were acidified to pH <2 using 10% analytical grade HNO₃. This was to keep the metals in dissolved state and to prevent bacteria action on them.

The samples were placed in refrigerator boxes (+4 °C) and transported to the laboratory of Faculty of Science, University of Tirana within a day.

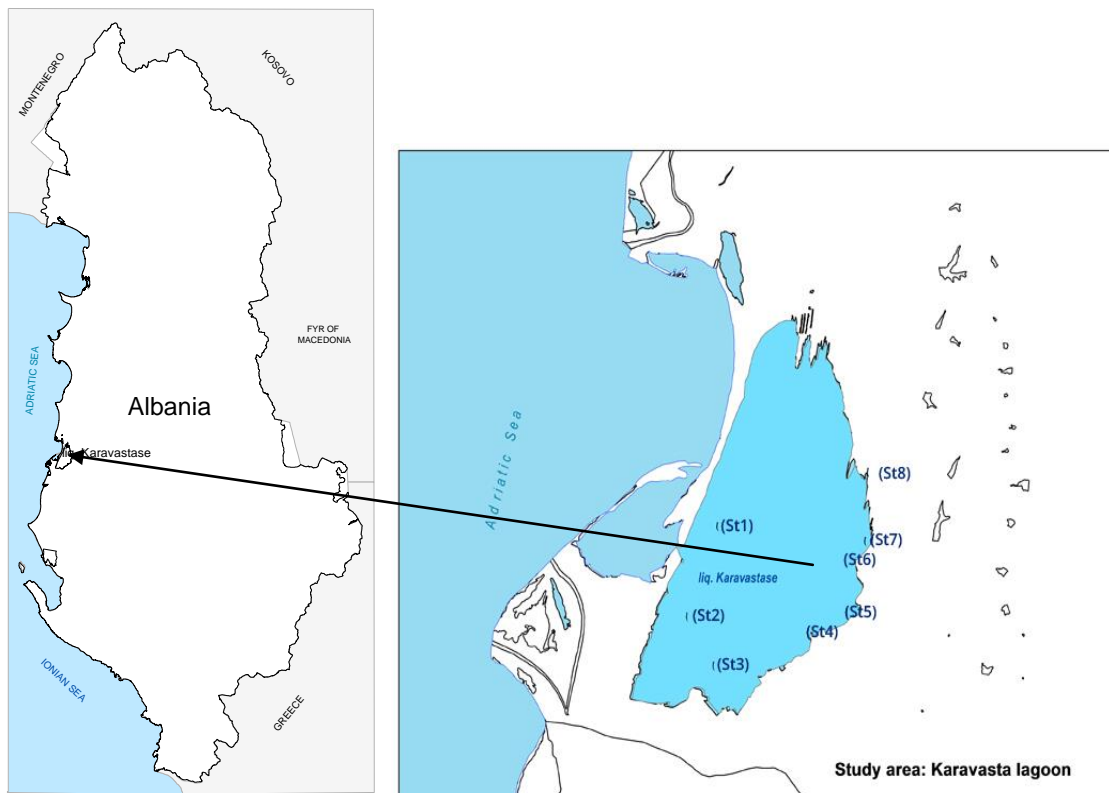

Fig 1 - Map of the location of the study area (Karavasta Lagoon)

Heavy metals analyses

To determine the level of heavy metals in the lagoon's water (Cd, Cr, Cu, Pb, Hg) was used the EPA Method No. 1637. The water samples were treated with nitric acid to reach pH = 2. A volume of 100 ml of sample was put in a 400 ml volume chemical cup and treated with 3 ml of concentrated nitric acid. In addition, the chemical cup was heated without reaching the boiling level in order to evaporate until reaching the 20 ml volume. Then 3 ml of concentrated nitric acid is added again, covering crystal glasses and heating temperature is regulated, so that an acid reflux can be created until the complete digestion of the sample. The samples then evaporated until they almost dried up and were left to cool down. After cooling, nitric acid 1:1 is added and the samples heated until complete dissolution of any residue or precipitation. Samples were centrifuged to remove any insoluble residue and then diluted up to 25 ml volume. The concentration of metals in this fraction was calculated by the method calibration curve and

converted to lagoon water (ppb) concentration according to the formula: $C_m = C_{l.kal} \cdot \frac{25}{100}$. Metals in solution were determined directly by Graphite Furnace AAS.

Results and Discussion

Heavy metals in the water samples of Karavasta lagoon.

We have analyzed the heavy metal values concentration on the lagoon water to know the effects all factors that may have influenced the status of heavy metals in the lagoon (Table 1). The average level of Cu in the water samples ranged from 13.5 to 24.1 $\mu\text{g L}^{-1}$ depending of the season of the sampling. The highest average concentration value of copper in the water for both seasons was measured in sampling stations 3, 7 and 8 affected by contribution of Lena and Zharnec channel that pass along agricultural fields of these village, that were regularly treated with copper-based pesticides. Cu levels in Karavasta lagoon were higher than surface water of Butrinti Lagoon (Topi T, Bani A, Sulce S, 2012) due to the intensive agriculture activities in the field around the Karavasta Lagoon, but close to the standards of EU (Table 1), so it should be monitored. Cd values on the water of Karavasta vary according to the sampling stations and seasons but Cd values in the lagoon water was under the allowed standards ($<1 \mu\text{g L}^{-1}$) (Table 1). The average level of Pb in the lagoon's water ranged from 0.72 to 4.95 $\mu\text{g L}^{-1}$ in December and from 0.33 to 2.9 $\mu\text{g L}^{-1}$ in July while highest value of Pb on the water surface was measured in December and in the sampling stations 1 and 8 respectively influenced by fishing activities and Zharnec channel. Pb value in water lagoon was smaller than the referenced standards (EU-2008 -7.2 $\mu\text{g L}^{-1}$). Results of this study told that Pb values have to be monitored because Pb it is an accumulative poison toxic for living organisms.

The average value of Cr in sampling sample of water in Karavasta lagoon ranged depending of sampling stations but had not big differences between seasons. (Table 1) told us that the average values and in some stations Cr values were higher than the required values from EU standards. In the sampling stations 3, the concentration of Cr in the water of lagoon results to be about twice higher than the EU standard values, whereas in the 4 and 8 stations the values were higher than those of EU standards influenced by alluvium brought by Shkumbini river which passes through areas rich in Cr (Albanian ultramafic sites) (Table 1)

Table 1: Heavy metals concentration in water of Karavasta Lagoon in Winter 2013 and Summer 2014 ($\mu\text{g L}^{-1}$)

Sampling station	Cu		Cd		Pb		Cr	
	December	July	December	July	December	July	December	July
1	12.2	27,4	0.050	0.032	4.95	2.90	16.5	19.0
2	2.98	6.8	0.010	0.001	0.72	0.40	12.1	14.3
3	16.9	48.2	0.010	0.001	1.36	1.10	40.2	45.0
4	12.2	24.0	0.040	0.004	0.65	0.33	22.5	23.5
5	8.5	16.0	0.019	nd	1.61	1.41	10.2	12.5
6	4.5	14.5	0.023	0.01	0.70	0.40	13.5	15.6
7	17.7	28,4	0.064	0.039	0.68	0.34	16.3	14.5
8	33.2	55.4	0.010	0.001	2.66	2.02	31.5	32.0
Average	13.5	24.1	0.028	0.011	1.65	1.11	20.35	22.05
STDEV	9.5	16.6	0.020	0.01	1.40	0.95	10.5	11.2
Max	33.2	55.4	0.050	0.039	4.95	2.9	40.2	45
Min	2.98	6.8	0.019	0.001	0.72	0.33	10.2	12.5
EU Guidelines	50		1		7.2		20	

Vegetation evaluation in Karavasta lagoon

High levels of productivity and biomass of the species *Zoostera nolti*, Floristic impoverishment of these plant associations. Floristically dominant associations are very poor and often like a mono-dominant plant community. Disappear of species with narrow ecological amplitude, and their replacement by mono-dominant association or species with wide ecological amplitude. Species spreader in lagoon *Zoostera nolti*, *Ruppia cirrhosa* (Figure.2/3/4) belongs to the group of wide ecological amplitude. This is shown in the Table.2 through the twelve selected sampling stations.

Table 2. Plant sampling station in Karavasta

Nr.	Sampling stations	Coordinates	Biota	Ab-Dom
1	St 1 (Dajlan 1)	N 41° 02' 57'' E 019° 27' 63''	<i>Ruppiacirrhosa</i> <i>Zoosteranolti</i>	++ ++
2	St 2 (Dajlan)	N 41° 06' 16'' E 019° 21' 64''	<i>Zoosteranolti</i>	++
3	St 3 (new Dajlan)	N 41° 06' 12'' E 019° 24' 48''	<i>Ruppiacirrhosa</i> <i>Zoosteranolti</i>	++++ ++
4	St 4 (Hadar)	N 42° 19' 029'' E 018° 44' 72''	<i>Ruppiacirrhosa</i>	+
5	St 5 (Bedat village)	N 41° 37' 83'' E 018° 44' 72''	<i>Ruppiacirrhosa</i>	+
6	St 6 (Lena channel)	N 39° 40' 46'' E 018° 23' 87''	<i>Ruppiacirrhosa</i>	++
7	St 7 (Karavasta village)	N 39° 58' 62'' E 018° 35' 45''	<i>Ruppiacirrhosa</i>	+++
8	St 8 (Mulqias village)	N 39° 55' 64'' E 018° 35' 55''	<i>Ruppiacirrhosa</i>	++++
9	St 9 (Kamenice village)	N 39° 37' 64'' E 018° 36' 72''	<i>Ruppiacirrhosa</i>	++
10	St 10(Kryekuq village)	N 40° 50' 43'' E 19° 19' 16''	<i>Zoosteranolti</i>	+++
11	St 11 (Miza village)	N 40° 57' 66'' E 019° 24' 77''	<i>Zoosteranolti</i>	+++
12	St 12 (Zharnec village)	N 41° 02' 63'' E 19° 30' 41''	<i>Cladophora sp.</i>	++

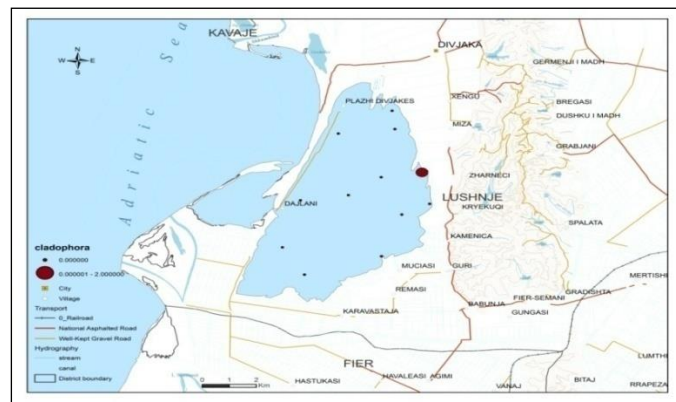

Figure.2 Distribution of Cladophora



Figure.3 Distribution of *Ruppia cirrhosa*



Figure.4 Distribution of *Zoostera noltii*

Flora and vegetation around the lagoon

We have identified approximately 112 plants, which belong to 38 families. This is a considerable resource, if we take in consideration this small extent of the undertaken studied area. Based on the Red book and new electronic variant (2006) we identified 10 species as Rare and threatened plants, mainly of sandy dunes, as well as on aluvional forests, costal wetlands *Panocratium maritimum* L., *Matthiola tricuspidata* (L.)R.Br., *Quercus ilex* L., *Ammophila arenaria* L., *Hypericum perforatum* L., *Origanum vulgare* L., *Lotus cytisoides* L., *Colchicum autumnale* L., *Stachys maritima* Gouan, *Quercus robur*.

Conclusions

Results of this study show that the distribution of heavy metals in the water of the lagoon varies depending on the season and sampling stations. The elements Cu, Pb in some stations are found to be close to the allow able values by the EU standards and represent a potential contamination risk. The average values of Cr in water of Karavasta lagoon in both seasons were higher than the European standards. This can be explained by the flow of Shkumbini River, which runs in ultramafic areas of the country, (Topi T, Bani A, Sulce S, 2012) or passes through the metallurgical site. Considering this study for the state of heavy metals in the lagoon of Karavasta, as a conclusion it could be said that continuous monitoring has to be carried out in order to prevent its pollution.

Based on the Red book and new electronic variant (2006) we identified 10 species as Rare and threatened plants, mainly of sandy dunes, as well as on aluvional forests, costal wetlands *Panocratium maritimum* L., *Matthiola tricuspidata* (L.)R.Br., *Quercus ilex* L., *Ammophila arenaria* L., *Hypericum perforatum* L., *Origanum vulgare* L., *Lotus cytisoides* L., *Colchicum autumnale* L., *Stachys maritima* Gouan, *Quercus robur* L. We have identified approximately 112 plants, which belong to 38 families. This is a considerable resource, if we take in consideration this small extent of the undertaken studied area.

References

Abdo MH, (2005): Physico-chemical characteristics of Abu Za'baal pond. Egypt. Egypt. J. Aquatic Res., 31(2): 1-15.

- Abowei JFN (2010) : Salinity, dissolved oxygen, pH and surface water temperature conditions in Nikoro River, Niger Delta, Nigeria. *Adv. J. Food Sci. Technol*, 2(1): 16-21.
- Addo MA, (2002): An assessment of aspects of environmental impacts of the proposed 'West African gas pipeline project in Ghana'. Thesis, Department of Environmental Science Programme, University of Ghana, Legon-Ghana, pp: 115-116.
- Abulude FO, Fapohunda OO, Awanlenhen (2006): Determination of some heavy metals in *Procambarisclakii*, *Palaemon sp.*, *Macrobrachiumvollenhovenii* and *Penaeusnotalis* from the coastal water of Ondo State, Nigeria. *J. Anim. Vet. Adv.*, 5(1): 38-41.
- Binning K, Baird D, (2001): Survey of heavy metals in the sediments of the Swartkops River Estuary, Port Elizabeth South Africa. *Water*, 27 (4): 461-466.
- Bani A, Imeri A, Echevarria G, Pavlova D, Reeves RD, Morel JL, and Sulçe S, (2013): Nickel Hyperaccumulation in the serpentine flora of Albania. *Fresenius Environmental Bulletin*. Vol 22.Nr. 6Factor impact 0.7.
- EU Framework Water Directive on: environmental quality standart. 2008, 39.
- Environmental Protection Agency Inductively coupled plasma-atomic emission spectrometry: Method 6010B. EPA, Washington D.C, USA.
- Christophoridis A, Stamatis N, and Orfanidis S, (2007): Sediment heavy metals of a Mediterranean coastal lagoon. Agiasma, Nestos Delta, Eastern Macedonia (Greece), *Transitional Waters Bulletin TWB, Transit. Waters Bull*, 4: 33-43.
- Cullaj A, Hasko A, Miho A, Schanz F, Brandl H, Bachofen R, (2005) : The quality of Albanian natural waters and the human impact. *Environment International* 31, 133-146.
- Chauvelon P, (2004): Hydrological functioning and hydraulic management of the Karavasta lagoon system, Albania. FAO, World Bank, Ministry of Environment of Albania, Report 27p.
- Lord DA, Thompson GA, (1988): The Swartkops estuary, Pollution status. In: Baird D, Marias JFK, Marin AP (eds.) *Proc. Symp. Held on the 14 and 15 September 1988 at the Univ. of Port Elizabeth*. S. Afr. Nat. Sci. Programmes Rep. 156: 16-24.
- Topi T, BaniA, Sulce S, (2012): Heavy metals in soil, sediments, mussels, and water from Butrinti lagoon (Albania). *Fresenius Environmental Bulletin*. Vol, 21.

EFFECTS OF ENTOMOPATHOGENIC BACTERIA ON HONEYBEES APIS MELLIFERA INTERMISSA. EVALUATION OF PHYSIOLOGICAL CHANGES.

Hakima OULEBSIR-MOHANDKACI*, Farida BENZINA, Arezki MOHAMMEDI

Laboratory of Valorisation and Conservation of Biological Resources, Department of Biology, Faculty of Sciences,
University M'hamedBougara of Boumerdes, Algeria

*Corresponding author: mohandkacihakima@yahoo.fr

Abstract

Bees have been part of culture and human heritage for millenniums. Yet these useful insects seem increasingly affected by diseases and parasites. Repeated use of synthetic chemical compounds leaves harmful residues in wax and honey. In fact, the use of biological control agents (BACs) is encouraged. In this context, the present work studied the effect of two local bacterial strains of the genus *Bacillus* on honeybees *Apis mellifera intermissa*. Initially we conducted a macroscopic, biochemical, physiological and physicochemical characterization of the two bacterial strains isolated in 2011, from soil in two regions from Algeria (a coastal area and the Sahara Desert). Study of abiotic characteristics of the two bacterial strains showed that growth is better at a temperature between 32 ° C and 45 ° C and pH between 6 and 8. Afterwards, we focused our study on the effect of these bacteria on mortality, feeding activity and production of wax. Hence, the study of the effect on mortality shows a low rate of mortality among bees treated with the two bacterial isolates; whereas the feeding activity demonstrates no effect on the consumption of syrup and pollen. Furthermore, the production of the wax slightly increased in some individuals treated with different concentrations of bacterial strains. Finally, it would be very advantageous for further study on these bacteria about their effects on other biological parameters of the bee.

Keywords: *honeybees, bacteria, mortality, feeding activity, wax.*

Introduction

Pollinators are a key component of global biodiversity, providing vital ecosystem services to crops and wild plants (Le Conte & Navajas, 2008). Among the main pollinators, Bees are a vital component in ecological networks and provide significant social and economic benefits to humans through crop pollination and maintaining the character of the landscape (Breeze *et al.*, 2012). Honey, pollen, royal jelly, propolis and wax are main products which directly benefit humans (Leven *et al.*, 2005). There are several popular races of honey bees raised in Africa. Among the most famous, *Apis mellifera intermissa* (Tellian bee) (Fayet, 2013).

Despite their importance, both to people and the natural environment, unsustainable agriculture, diseases and habitat degradation have placed significant pressures on many species of bees, causing widespread declines (Breeze *et al.*, 2012). Several causes can explain managed honeybee losses, among them, infestations by organisms ranging from arthropod pests such as ectoparasitic mite *Varroa* that feeds their hemolymph (Leven *et al.*, 2005).

Moreover, repeated use over several years of synthetic chemical compounds to treat these bee enemies and the intentional exposure of honey bees to pesticides used in agriculture have resulted in residues in hive products, especially beeswax and honey (Leven *et al.*, 2005). In order to protect honey bees from pesticide poisoning, actually, more than 100 bacteria have been

identified as arthropod pathogens among which *Bacillus thuringiensis* and *Bacillus sphaericus* have received most attention as microbial control agents (Abrol, 2013).

So, the aim of present study is to determine the effects of two strains of *Bacillus sphaericus*, isolated from desert (strain Bss) and coastline (strain Bsn) of Algeria, on honey bee "*Apis mellifera intermissa*". This work is a following of the research works focused on evaluating insecticidal activity of the two bacteria selected against crop pests (MohandKaci & Doumandji-Mitiche, 2011, Oulebsir-Mohandkaci *et al.*, 2015).

Material and methods

Biological material

The study was performed on the local honeybee "*Apis mellifera intermissa*". This strain is derived from apiary of laboratory of Valorisation and Conservation of Biological Resources at the University M'hamed Bougara of Boumerdes (Algeria).

The bees were reared in cages wooden bread (10.5cm x 10.5cm x 7.5cm) placed in incubator at 34 ° C. Feeding of bees consists of a syrup (50% water and 50% sugar), water and pollen mixed with honey and crafted in boule.

Also, we have used 2 strains of *Bacillus sphaericus* isolated from soil in two regions from Algeria ; Boumerdes (a coastal area that has mild winters, warm spring and summers whose heat is not excessive. soil is clay-loam with a pH of 7.5.) and Adrar (located in the Sahara Desert and receives extremely rare rains, characterized by cold winters, hot summers, cold nights and warm days with a sandy texture soil, low organic matter content with low water holding capacity and subjected to a salinisation limiting its productivity). For long-term preservation, isolates were stored at -20°C in 30% glycerol.

Belonging of bacteria isolated to *Bacillus sphaericus* species is confirmed by identification tests, namely: the microscopic appearance rod-shaped, with a Gram and catalase positive, it is spore-forming bacteria, with a positive response to tests nitrate, urease, casein hydrolysis, mobility-mannitol, acid and gas on glucose, and anaerobiosis. As against the tests of starch hydrolysis, gelatine liquefaction and indole gave negative results (Guiraud, 2003).

We assigned codes to the strains used according to initial namely Bsn for *B. sphaericus* (north strain) and Bss for *B. sphaericus* (south strain).

Methods

Study of abiotic characteristics of the two bacterial strains

Growth and survival of bacteria is greatly influenced by the physicochemical nature of the environment. In this part we studied the effect of three physiochemical parameters which are: temperature, pH and salinity. 5 temperatures were chosen for this study: 0 ° C, 8 ° C, 32 ° C, 45 ° C and 60 ° C. The pH chosen are: 3, 4.5, 6, 7, 8 and 9.5. For salinity, 6 different NaCl concentrations were tested: 0 mm, 100 mM, 300 mM, 500 mM, 1000mm and 1500mm.

Study of bacterial growth in different temperatures took place on nutrient agar. The results are reflected in the growth or not of bacterial culture. However for pH and salinity, the study of bacterial growth took place on nutrient broth. Reading the results is done by measuring the optical density at 620 nm after incubation.

Study of the Effect of the bacterial strains of honeybees

- **Sporulation and spore production:** For this, the *Bacillus sphaericus* isolates are cultured, as described by Abbas (2014). Indeed, Bacterial cultures were sub-cultured on nutrient agar for 48 h at 32 ° C. Some bacterial colony were taken and placed into an Eppendorf tube with 1.5ml of

saline solution. The suspension was centrifuged at 4000 rcf for 15 min at 4 ° C, a small pellet was visible at the bottom of the tube. The liquid was removed, and the pellet was nerve recovery and added with 500 µl of saline solution, after this, it was realized heating for 10 minutes at 100 ° C and we subjected to preculture a heat shock for 2 to 3 minutes by ice water. After centrifugation at 4000 rcf for 15 min at 4 ° C, the supernatant was recovered.

- Bioassay of entomopathogenic bacterial strains against honeybees: vegetative cells and spores are used for treating bees. For the calculation of bacterial concentrations, the number of inoculum cells was evaluated from the number of colonies that grew on the culture medium. Assuming that each colony is derived from a single cell, the concentration of bacteria per 1 ml of solution is expressed as " colony-forming unit (CFU or cfu).

3 doses were used: D1 = 2×10^7 cfu / ml, D2 = 10^6 cfu / ml and D3 = 3×10^5 cfu / ml.

For the treatment of bees, bread small cages were used, each consisting of 20 bees and put in an incubator at 34 ° C. Controls were fed with sugar syrup supplemented with 400 µl of saline solution, pollen and water. Moreover, in the treated bees, the sugar syrup was added with 400 ml of each bacterial concentration for 24 hours. After this the treated syrup is replaced by another non-treated syrup. 24 hours after treatment, the daily counting of mortality occurred. The resulting mortality rates were corrected by the formula of Abbot (1925). Consumption of syrup and pollen was evaluated as well as the production of the wax.

Statistical analysis

Experiments were repeated thrice. Dose-related changes in the mortality rates were checked to normality of data distribution. One-way analysis of variance (ANOVA at 5% significant level) and test tucky were used to compare means statistical analysis (XL software. 2009 STAT).

Results and discussion

Abiotic Factors Influencing In Vitro Growth of the bacterial strains

The Effect of Temperature on Growth of bacteria

The effect of temperature on the growth rate was studied in *B.sphaericus* between 0 and 60 degrees C cultivated in solid medium. After incubation, no growth was observed at 0° C, 8 ° C and 60 ° C. Against at 45 ° C the number of colonies obtained is high, at 32 ° C, bacterial growth is better.

Table 1: Growth of the two strains of *B. sphaericus* (Bsn and Bss) at different temperatures

Strain / temperature	0°C	10°C	32°C	45°C	60°C
Bsn	-	-	++	+	-
Bss	-	-	++	+	-

- : absence, + : presence

Bacteria are more tolerant of environmental conditions than other organisms. However, each species has its own characteristic and particular range of values in which it grows and reproduces best. The growth of both strains of *B.sphaericus* (Bss and Bdn), is possible only between 32 ° C and 45 ° C.

According to Cuq (2007), mesophilic bacteria have an optimum growth of 37 ° C, the minimum temperature for growth is between 10 and 20 ° C and the maximum temperature is 45 ° C. The optimum of temperature of grows of bacteria *Bacillus sphaericus* is 28-35 ° C (Brossard *et al.*,

2008). Indeed; the heat causes an increase in rate of metabolic reactions and growth rate, causing denaturation of microbial compounds (Guiraud, 2003).

The Effect of pH and Salt on Growth of bacteria

Each species of microbe has its own characteristic range of pH values in which it grows and reproduces best, The results obtained (figure 1) show that the two bacteria (Bsn and Bss) grow best around neutral pH values (7.0), but Bss thrive in basic conditions (pH 8) and can tolerate a high pH. However, Even though they can live in alkaline environments, its internal pH is much closer to neutral values, this can be explained by the fact that this strain was isolated from soil of the Adrar region located in desert of Algeria which is characterized by basic soils.

However, the results of salt effects in bacterial growth show that both two bacteria (Bsn and Bss) can grow without salt but can also tolerate small amounts of salt in their growth medium. Optimal growth is obtained in the absence of salt, but in the presence of salt they will grow, just at a lower rate.

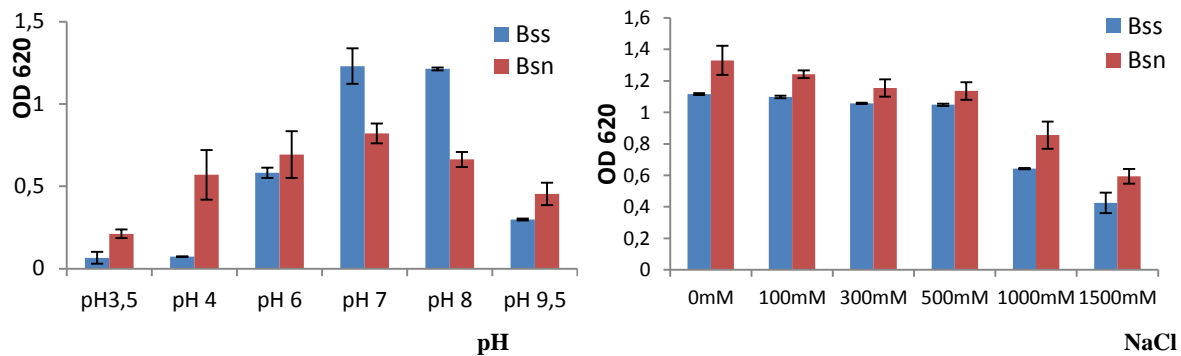

Figure 1: growth of the two strains of *B. sphaericus* (Bsn and Bss) at different pH* and Salt concentrations**

*Analysis of variance show that there is a highly significant difference in the Bsn strain ($F = 0.001$) and very highly significant for the strain Bss ($F = 0.0001$).

**ANOVA indicates a very highly significant difference between the growth rates of the two bacteria depending on the salinity for Bsn strain ($F = 0.0001$) and a significant difference in the Bss strain ($F = 0.030$)

Bacteria are sensitive to the hydrogen ion concentration they find in their environment. Large proteins, such as enzymes, are affected by pH. According to Brossard *et al* (2008), the genus *Bacillus* cultivates at temperature of at (12-45 ° C) and pH (6-8.5).

Most bacteria can grow on media whose pH varies from 4.5 to 9 but the more one deviates from the optimum pH range (6.5 to 7.5) more growth is slow (Nicolas and Daniel, 2007). This confirms our results.

Bacteria are continually adapting to changes in their environment. The majority of bacteria living in a pH around neutrality (6-7), but there are bacteria that produce acid by fermentation, for example, supporting pH 4-5 (Favet, 2013). Similarly, Euzéby (2007), shows that the optimum pH for the genus *Bacillus* is between 6.8 and 7.5, but these bacteria can resist up at a minimum pH of 5.6 and pH of 9.4 to 10.0.

Therefore, the effect to which salt concentration causes changes in bacterial growth depends on the osmotic balance required for such growth. Some bacteria require an astonishingly high level of salt to begin growth, whereas others would be immediately killed in high levels of salt.

Lambin & German (1969) note that most bacteria except those that live in marine waters, grow in the presence of low concentrations of salts.

Bacteria, except Mycoplasmatales, are less sensitive to osmotic pressure variations as they are protected by their cell membranes. However, some marine species are adapted to environments containing about 35 g NaCl per liter (Euzéby, 2007).

Effect of the two bacterial strains of honeybees

Mortality Assessment

The results obtained after treatment with vegetative cells and spores of Bsn (Figure 2) indicate that the corrected mortality rate is very low, they reach a maximum of 2.69%, 1.68%, 3.03% for doses D1, D2 and D3 after 10 days, for vegetative cells and 2.02% for D1 and D2 and 2.35% for the dose D3 for spores.

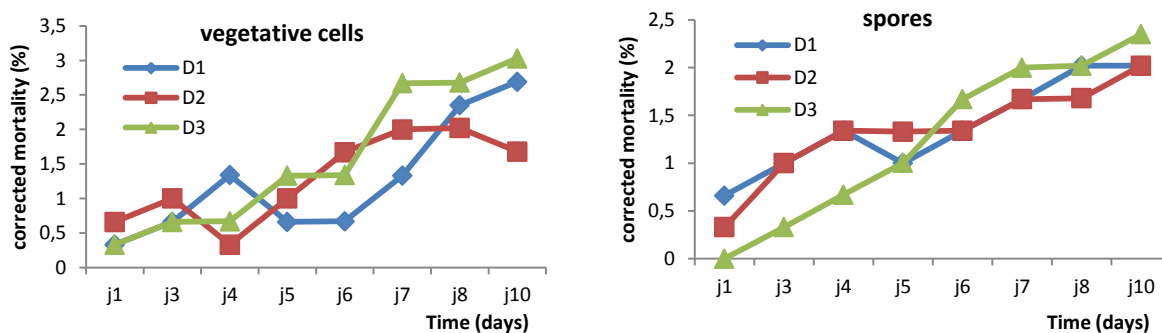

Figure 2: Corrected bee mortality after treatment with the strain Bsn ((D1 = 2×10^7 cfu / ml, D2 = 10^6 cfu / ml and D3 = 3×10^5 cfu / ml)

(No significant effect was observed by analyzing the variance in mortality rates obtained in control bees and treated by the vegetative cells and spores of both strains ($F = 0.1$)).

The results obtained after treatment with vegetative cells and spores of Bss (Figure 3) show that the daily bee mortality increased after the treatment application, but not exceeding 2.35% for D1 to 3.03% D2 and D3 to 2.02% for vegetative cells and 2.69%, 2.5% and 1.34% for D1, D2 and D3 for spores. Consequently, this mortality obtained is not due only to treatment but it may depend on other factors such as: The life span of worker bee, his diet composed only by syrup, water and pollen, its society lifestyle and the experimental conditions.

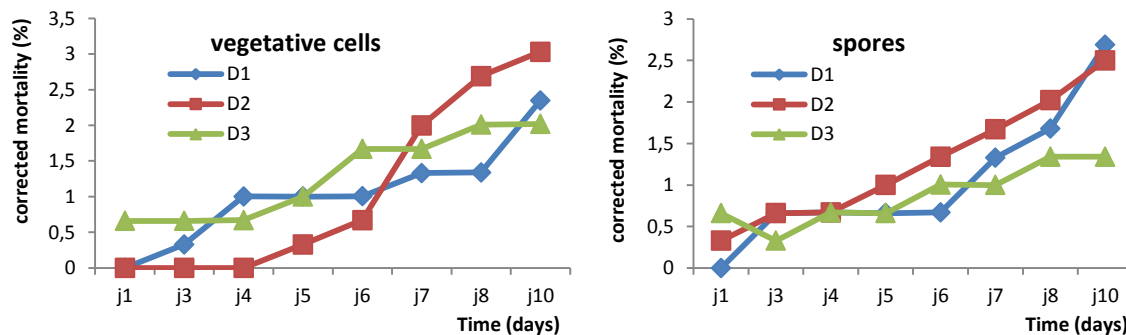

Figure 3 : Corrected bee mortality after treatment with the strain Bss (D1 = 2×10^7 cfu / ml, D2 = 10^6 cfu / ml and D3 = 3×10^5 cfu / ml)

(According to the test of analysis of variance, a non-significant change in mortality rate was noted in the treated bees vegetative cells and spores of Bss compared with controls ($F = 0.052$)).

The research has not ceased to exploit family of Bacillaceae which contains the most promising species in the control of arthropod disease vectors. Among biological insecticides, the most effective and promising in the field, the spore-forming bacterium *Bacillus sphaericus* which targets aquatic larvae of mosquito and blackfly. (Charles & Nicolas, 1986).

When mosquito-larvicidal *B. sphaericus* strain SSII-1 cultures were fed to newly emerged adult honey bees and to bee colonies, no effect was found on the longevity of newly emerged bees nor on the brood production of colonies (Davidson, 1977). These results are in agreement with ours which are also, in agreement with those obtained when treating bees with two Bt commercial formulation containing the same kurstaki strain (Malone *et al.*, 2001); similarly, Mommaerts *et al.*(2010) concluded that no effect on mortality of bumblebees could be attributed to an oral Bt kurstaki treatment. Therefore, Bt var kurstaki (4D1) when ingested, are reported to have an effect on honey bee physiology and immunity (Evans & Lopez, 2004).

The effect on the consumption of syrup and pollen

Syrup consumption

It appears from the results of the consumption of syrup by bees treated by the vegetative cells and spores of the BSN strain (Figure 4) and the Bss strain (Figure 5), that the syrup consumption in the first day is very important and it decreases over time in the control and treated with different concentrations. syrup consumption in controls and in treated bees is almost identical

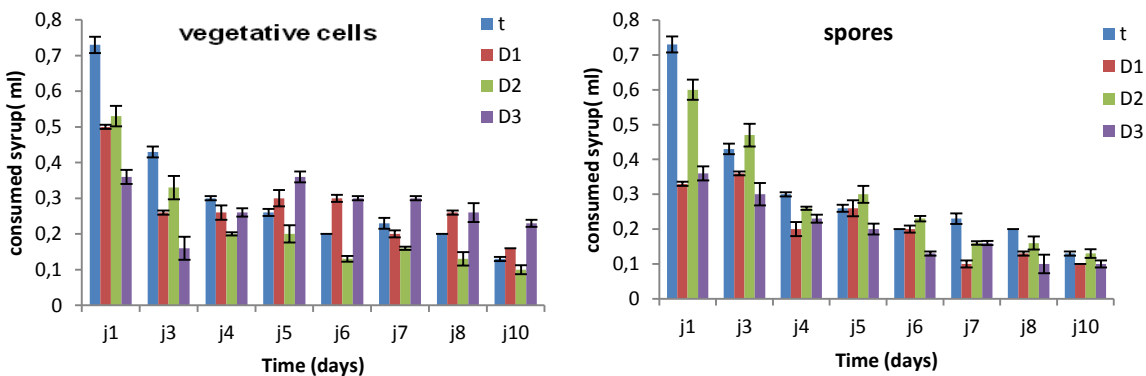

Figure 4: Syrup consumption in honeybee treated with vegetative cells and spores of Bsn (According to the results of the analysis of variance, moderately similar values (not significant) were recorded for the syrup consumption in bees treated by vegetative cells ($F = 0.388$) and spores ($F = 0.054$) and Tukey test showed a non-significant difference between combinations)

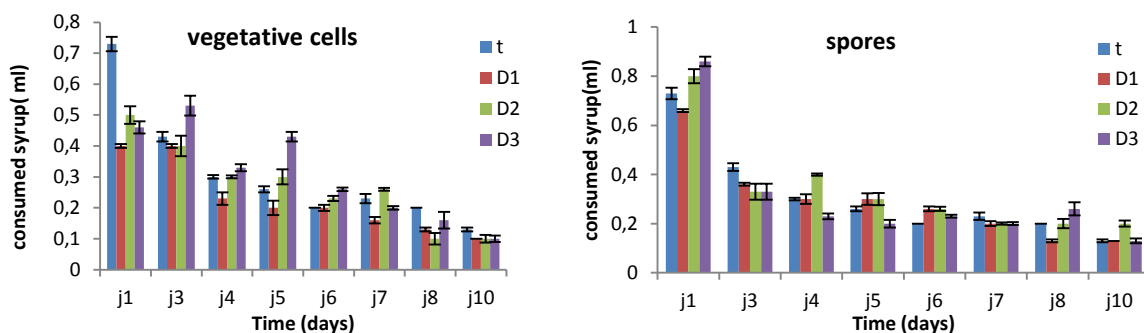

Figure 5 : Syrup consumption in honey bee treated with vegetative cells and spores of Bss (The variance analysis results indicate a non-significant difference for vegetative cells ($Pr = 0.327$) and spores of Bss ($Pr = 0.348$), and the test tukey confirms, with no significant difference between the combinations)

Pollen consumption

The results of the consumption of pollen by bees treated by the vegetative cells and spores of Bsn strain (Figure 6) and Bss strain (Figure 7) show that the consumption of pollen during the first days, is important in cages of bees treated and control, however, in the last days, the amount of pollen consumed decreased at both lots; processed and control.

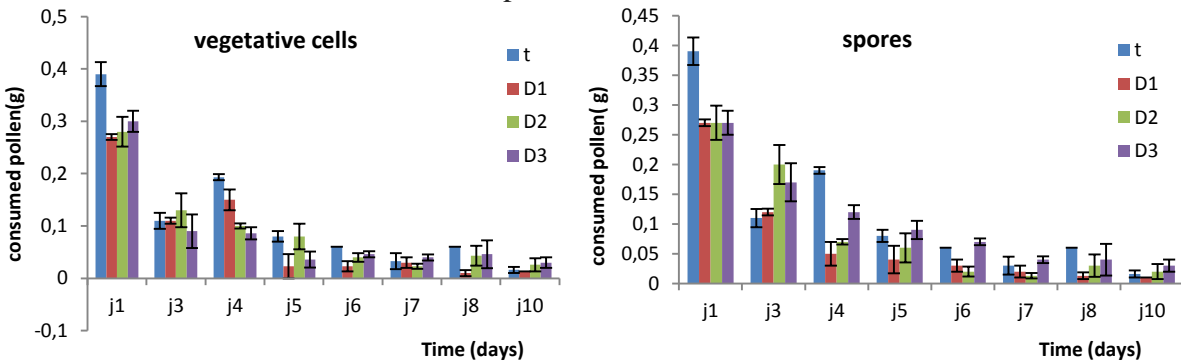

Figure 6: the pollen consumption in honey bee treated with vegetative cells and spores of Bsn (Analysis of variance and the test tucky revealed a non-significant difference for pollen consumption by control and treated by the vegetative cells of Bsn ($F = 0.740$))

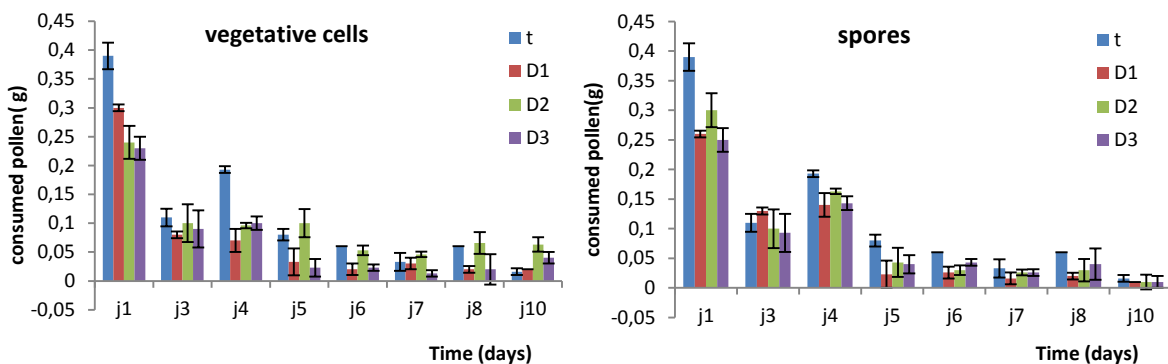

Figure 7: the syrup consumption in honey bee treated with vegetative cells and spores of Bss (ANOVA and tucky indicate a non-significant difference for pollen consumption in control bees and bees treated by the vegetative cells ($F = 0.323$) and spores of Bss ($F = 0.635$)).

During the first days the quantity of syrup consumption is high, it is mainly used for the energy expenditure of the bee, depending on their activity and the development of internal organs. During the last days, the reduction in the syrup and water consumption may be due to reduced nutritional needs.

It is the same for pollen, during the first days, the bees need a large amount since it is considered as a source of protein that is involved in the development of hypopharyngeal glands of young bees and their fat body (Soudek, 1927).

Young bees also need pollen proteins for the formation of internal organs such as the nurturing gland and flight muscles. Imdorf *et al.* (1987) found that young bees consume pollen in abundance during the first days after emergence. During the last days, there is a pollen consumption decrease which is due to the absence of brood, which is a factor that stimulates the development of hypopharyngeal glands by pheromones (Mohammedi *et al.*, 1996).

The effect on wax production

the results of the production of wax by the bees 10 days after treatment vegetative cells and spores of Bsn (Figure 8), show that the production of wax is slightly elevated in the treated small cages with 3 doses compared to controls, by against in treated by spores of the bacterium, this increase is found only in treated by D1. For bees processed by vegetative cells of Bss (Figure 9), the production of the wax is almost the same as compared with controls; however in bees processed by spores of the bacterium, there is an increase of the production of the wax compared to control

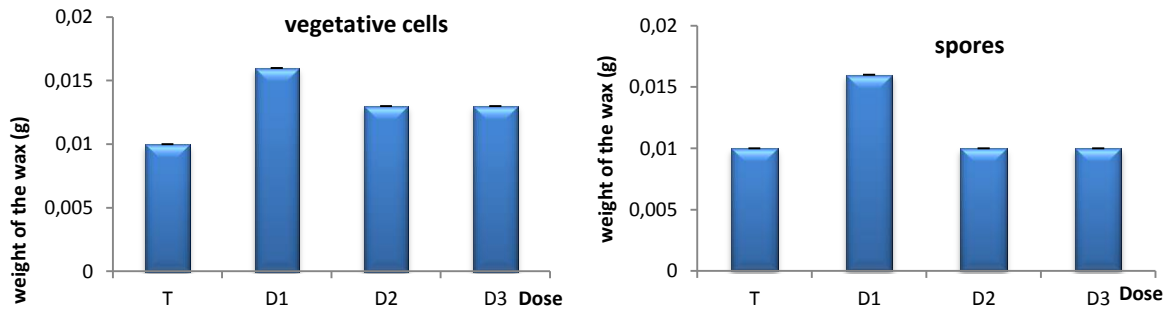

Figure 8 :wax production by *Apis mellifera*, processed by vegetative cells and spores of Bsn (A non-significant difference was demonstrated by the test of variance analysis and Tukey's test for wax production in control bees and bee processed by vegetative cells ($F = 0.222$) and spores ($F = 0.083$))

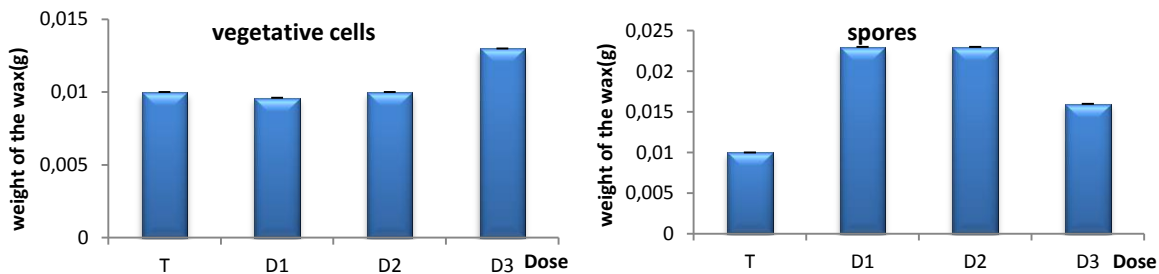

Figure 9 :wax production by *Apis mellifera*, processed by vegetative cells and spores of Bss (Two treatment groups and the control group gave similar mean values ($F = 0.188$ for vegetative cells) and ($F = 0.308$ for spores)).

After treating bees with the two strains of bacteria, it was noted that there is a production of wax in all cages of control and treated individuals which shows that the wax glands develop normally, and they are not affected by entomopathogenic used, against (Whiffler & Hepburn, 1991; Ledoux *et al.*, 2001) have found a decrease in production of the wax.

Conclusion

Bees are an essential functional group both in the natural world and to human societies, providing a broad range of benefits which would be costly to achieve in their absence.

The study of physicochemical characterization of the two strains of *Bacillus sphaericus* (Bsn and Bss), showed that growth is better at a temperature between 32 ° C and 45 ° C and pH between 6 and 8, and that these bacteria tolerate relatively high levels of NaCl but the degree of tolerance to various factors is greater for Bss.

Studies of the potential of biological control of the two strains of *Bacillus sphaericus* (Bsn and Bss) against crop pests showed no adverse effect on the honeybee. Application of bacterial

suspensions at various concentrations (2×10^7 cfu / ml, 10^6 cfu / ml and 3×10^5 cfu / ml), on the newly Emerged workers of *Apis mellifera intermissa* Showed a low mortality rate. The Lack of significant differences Between control groups and the treated groups whatsoever with vegetative cells or spores, confirms their no-involvement in the mortality variability obtained in the honey samples tested and That this variability is Rather related to other factors. Also, feeding activity study demonstrates no effect on consumption syrup and pollen. Moreover, the wax production increased slightly in some individuals treated versus controls.

To complete this research study, it would be very advantageous for further study on these bacteria about their ecological and toxicological impacted and also to study their effects on other biological parameters of the bee among others the wax glands to understand the cause of the increase in the amount of wax produced in the treated bees.

References

- Abbas A.A. (2014). Effet de l'absence d'oxygène sur la capacité de sporulation et les propriétés des spores de *Bacillus cereus* (Effect of the absence of oxygen on the sporulation ability and properties of *Bacillus cereus* spores). Thèse de doctorat, Univ. d'Avignon et des Pays de Vaucluse, Biotechnology and Microbiology , 185 p.
- Abrol D.P. (2013). Integrated Pest Management: Current Concepts and Ecological perspective pp. 2013 - 576, Éd. Academic Press, Elsevier.
- Breeze T.D., Roberts S.P.M., Potts S.G. (2012). The Decline of England's Bees, Policy Review and Recommendations, 43p.
- Brossard H., Leyral G., Terry O. (2008). Activités technologiques en microbiologie (technological activities in microbiology). Ed France, 155p.
- Charles, J. F., Nicolas L. (1986). Recycling of *Bacillus sphaericus* 2362 in mosquito larvae: a laboratory study. *Ann. Microbiol. (Inst. Pasteur)*, 131B:191-2
- Cuq J L. (2007). Microbiologie alimentaire (food microbiology). Ed. Univ Montpellier II. 133p.
- Davidson E.W., Morton H.L., Moffett J.O., Singer S. (1977). Effect of *Bacillus sphaericus* strain SSII-1 on honey bees, *Apis mellifera*. *Journal of Invertebrate Pathology* Volume 29, Issue 3, 1977, Pages 344-346
- Journal of Invertebrate Pathology* , Volume 29, Issue 3, 1977, Pages 344-346.
- Euzéby J.P. (2007). Nutrition et croissance des bactéries (procaryotes). *Abrégé de Bactériologie Générale et Médicale (Nutrition and growth of bacteria (prokaryotes). Abstract OF General and Medical Bacteriology)*. Ecole Nationale Vétérinaire de Toulouse.
- Evans J.D., Lopez D.L. (2004). Bacterial Probiotics Induce an Immune Response in the Honey Bee (Hymenoptera: Apidae). *Journal of Economic Entomology* 97 (3):752-756. *Journal of Invertebrate Pathology* Volume 29, Issue 3, 1977, Pages 344-346
- Effect of *bacillus sphaericus* strain SSII-1 on honey bees, *apis mellifera* 11
- Author links open the overlay panel. Numbers correspond to the affiliation list which can be exposed by using the show more link.
- Opens overlay Elizabeth West Davidson , Opens overlay Howard L. Morton , Opens overlay Joseph O. Moffett , Opens overlay Samuel Singer
- Journal of Invertebrate Pathology* Volume 29, Issue 3, 1977, Pages 344-346
- Effect of *bacillus sphaericus* strain SSII-1 on honey bees, *apis mellifera* 11
- Author links open the overlay panel. Numbers correspond to the affiliation list which can be exposed by using the show more link.

- Opens overlay Elizabeth West Davidson ,Opens overlay Howard L. Morton ,Opens overlay Joseph O. Moffett ,Opens overlay Samuel Singer
- Favet, (2013). Bactéries dans la nature : Rôle et modes de vie (Bacteria in nature: role and lifestyles). Séminaire de Bactériologie 2.6 février 2013. 14p.
- Fayet A. (2013). Le genre *Apis* (The genus *Apis*), fiche pédagogique- Biologie, 18p.
- Guiraud J. (2003). Microbiologie alimentaire: Application à l'étude des principaux groupes microbiens (Food Microbiology: Application to the study of the major microbial groups). Ed. Dunod. 651
- Imdorf A., Bühlmann G., Gerig L., Kilchenmann V., Wille H. (1987). Überprüfung der Schätz methode zur Ermittlung der Brutfläche und der Anzahl Arbeiterinnen in freifliegenden Bienenvölkern (Review of the estimation method to determine the breeding area and number of workers in free-flying bees overpopulate). *Apidologie* 18 (2), 137-146.
- Lambin S., German A. (1969). Précis de microbiologie: technique microbiologique, microbiologie générale (Microbiology precise: microbiological technique, General Microbiology). Ed. Paris. 669p.
- Le conte Y., Navajas M. (2008). Climate change: impact on honey bee populations and diseases, *Rev Sci Tech*. 27(2):485-97, 499-510.
- Ledoux M.N., Winston M.L., Higo H., Keeling C.I., Slessor K.N., Le Conte Y. (2001). Queen pheromonal factors influencing comb construction by simulated honey bee (*Apis mellifera* L.) swarms, *Insectes Soc.* 48, 14–20.
- Leven L.V., Boot J W., Mutsaers M., Segeren P., Velthuis H. (2005). L'apiculture dans les zones tropicales. Ed. NECTAR, Nederland, 94p.
- Malone AL., Elisabeth PJB., Heather SG., Christine RV., Emma LT., Bruce AP. (2001). Effects of ingestion of a *Bacillus thuringiensis* toxin and a trypsin inhibitor on honey bee flight activity and longevity. *Apidologie* 32 (1):57-68.
- Mohammedi A., Crauser D., Paris A., Le Conte Y. (1996). Effect of a brood pheromone on honeybee hypopharyngeal glands. *C.R. Acad. Sci., Sciences de la Vie*, 319, 769-772.
- Mohandkaci H., Doumandji-Mitiche B. (2011). Evidence of the Entomopathogenic Capacity of *Bacillus sphaericus* against the Migratory Locust *Locusta migratoria* (Orthoptera: Acrididae). *Entomol Gener* 33 (4): 289–300.
- Mommaerts V., Jans K., Smagghe G. (2010). Impact of *Bacillus thuringiensis* strains on survival, reproduction and foraging behaviour in bumblebees (*Bombus terrestris*). *Pest Manag Sci* 66 (5):520-525.
- Oulebsir-Mohandkaci H., Khemili-Talbi S., Benzina F., Halouane F. (2015). Isolation and identification of entomopathogenic bacteria from Algerian desert soil, study of their effects against Migratory Locust *Locusta migratoria*. *Egypt J. Biol. Pest Control* 25(3); 739-746.
- Soudek S. (1927). The pharyngeal glands of the honey bee (*Apis mellifica* L.), *Bull. De l'école supérieure d'agronomie Brno* (10): 52-61.
- Whiffler L.A., Hepburn H.R. (1991). The queen in relation to wax secretion and comb building in honeybees, *J. Comp. Physiol. A* 169, 209–214.

STANDARDIZATION OF METHYL ESTERIFICATION PROCESS FOR REFINED COTTONSEED OIL USING RESPONSE SURFACE METHODOLOGY

Jayant SINGH*, Rajesh U. MODI, T.K BHATTACHARYA

Department of Farm Machinery and Power Engineering, College of Technology, GovindBallabh Pant University of Agriculture and Technology, Pantnagar, Uttarakhand, 263145, India

*Corresponding author: jayantsingh07@gmail.com

Abstract

Production of methyl ester cotton seed oil has been accomplished from transesterification process in between cottonseed oil and methanol in the presence of potassium hydroxide (KOH). In this study, the transesterification process was standardized by applying the response surface methodology (RSM) with Box Benhken design for three variables. A quadratic polynomial second order equation was employed to investigate the operating conditions of transesterification to obtain a high conversion of biodiesel as well its kinematic viscosity as a function of methanol/oil molar ratio, catalyst concentration and reaction temperature. The process parameters such as molar ratio, catalyst concentration and reaction temperature were standardized to reduce its kinematic viscosity with maximum possible yield of methyl ester of cottonseed oil. It is recommended that cottonseed oil reacted with 6.9:1 molar ratio and 1.19 percent KOH at 57°C reaction temperature for reaction time of 1h and then settled for 24h to get 98.31 percent yield with 4.85 cSt kinematic viscosity.

Keywords: *Biodiesel, transesterification, yield, cottonseed oil.*

Introduction

Renewable fuels, made from biomass, have enormous potential and can meet many times the present world energy demand. Biomass can be used for energy in several ways; one of these is the conversion into liquid or gaseous fuels such as ethanol and biodiesel. Biodiesel is a type of bio-fuel which is the mono alkyl ester of long chain fatty acid derived from renewable feed stock. Bio-fuels seek to supplement conventional energy resources for meeting rapidly increasing requirement of transportation fuels and meeting energy needs of India's vast rural population by use of non-food feed stocks and as a result to reduce dependence on import of fossil fuels. Biodiesel can be produced from renewable sources such as vegetable oil, animal fat and used cooking oil.

Furthermore, biodiesel contribution to the greenhouse effect is insignificant, since carbon dioxide emitted during combustion is recycled in the photosynthesis process occurring in the plants used as raw materials for biodiesel production (Narayan, 1992).

In the cotton-planted areas, cottonseed oil is a by-product of cotton and seldom used as cooking oil, it is possible to use cottonseed oil as an emergency auxiliary or endemic fuel of diesel engine. (Receptet al., 2001). The world cottonseed oil production is 44.99 MMT out of that India produces 12.9 MMT oil during 2014-15 (USDA, 2015)

Transesterification of triglycerides (the main compounds in vegetable oil and animal fat) with alcohol using a base catalyst is the most common commercial method of biodiesel production. Transesterification involves various phase transitions: it changes from an initial two phase mixture of oil and alcohol to another biphasic system of glycerol and biodiesel-rich phases via a

pseudo single emulsion phase. The optimum ratio of methanol to oil depends on the nature of catalysts and feed stocks. The overall reaction is shown in Figure 1.

Materials and Methods

Materials

Refined cottonseed oil, supplied by Manik Industries, methanol (purity 99.8%) and potassium hydroxide (purity 87.0%) were used as reactants for the transesterification experiments. The refined oil was used to reduce two stage acid- base treatments for the biodiesel production.

Composition and acid value of refined cottonseed oil

The refined cottonseed oil was composed of four types of fatty acid triglycerides, including palmitic acid triglyceride (28.33 wt.%), stearic acid triglyceride (0.89 wt.%), oleic acid triglyceride (13.27 wt.%), and linoleic acid triglyceride (57.51 wt.%). It had the following characteristic: iodine value 114 mg I₂/100 g, acid value 0.6 mg KOH/g, saponification value 199 mg KOH/g. The molecular weight of the cottonseed oil can be calculated from its saponification and acid values, and was 848.3. (Shu et al., 2009). The FFA content of cottonseed oil was found to be less than 0.1% therefore this oil can be used directly for base catalyzed transesterification reaction. The maximum percentage of FFA content allowed is 1%.

Procedure

In order to standardize the process parameters as shown in Table 1, three levels of molar ratios (5:1, 6:1 and 7:1), three levels of catalyst (KOH) concentration (0.5; 1.0 and 1.5 percent) and three levels of reaction temperature (55, 60 and 65^oC) were selected and coded as +1, 0 and -1 in RSM. The esterification was done at different molar ratios in order to obtain maximum recovery of ester with lowest possible kinematic viscosity by preliminary experiments. Esterification was carried out at selected molar ratio at different levels of catalyst concentration for 60 minute at different reaction temperature in shaking water bath and then allowed to settle for 24 h for separation of lighter ester layer at the top and heavy glycerol layer at the bottom. Total 17 ester samples were selected to study the effect of molar ratio by applying the response surface methodology (Table 1), catalyst concentration and reaction temperature on ester recovery.

Results and Discussion

Effect of independent variables on yield of methyl ester of cottonseed oil

Esterification process of cottonseed oil was carried out at different molar ratio, catalyst concentration and reaction temperature using response surface methodology. Yield of methyl ester of cottonseed oil was ranged from 85.45 to 98.40% of over entire experimental conditions. It is evident (Table 1) maximum yield was observed at Experiment No. 11 having processing condition of molar ratio 7:1 ($X_1=1$), catalyst concentration 1% ($X_2=0$) and temperature 55^oC ($X_3=-1$). Minimum was at Experiment No. 16, molar ratio 5:1 ($X_1=-1$), catalyst concentration 1% ($X_2=0$) and temperature 55^oC ($X_3=-1$). For both experiment, the reaction time and settling time was 1h and 24h respectively which was indicating that the mathematical model cover more than 97.0% of the total variations and lack of fit is insignificant; therefore, quadratic polynomial equation is adequate in describing yield of methyl ester of cottonseed oil. Eqn. 1 shows the full order regression model for yield of methyl ester of cottonseed oil.

Table 1 Yield and Kinematic Viscosity of Methyl Ester of Cottonseed Oil under Different Treatments at Constant 1h Reaction Time and 24h Settling Time

Expt. No	Coded factors and level (Original factors and level)			Responses	
	X ₁	X ₂	X ₃	Yield (%)	Kinematic Viscosity (cSt)
1	-1 (5:1)	+1 (1.5)	0 (60)	93.04	5.20
2	0 (6:1)	+1 (1.5)	+1 (65)	93.68	4.94
3	-1 (5:1)	-1 (0.5)	0 (60)	95.40	5.39**
4	+1 (7:1)	0 (1.0)	+1 (65)	92.11	4.90
5	0 (6:1)	+1 (1.5)	-1 (55)	95.15	4.96
6	0 (6:1)	0 (1.0)	0 (60)	96.45	4.78*
7	0 (6:1)	0 (1.0)	0 (60)	95.78	4.80
8	0 (6:1)	0 (1.0)	0 (60)	96.78	4.82
9	+1 (7:1)	-1 (0.5)	0 (60)	98.25	5.16
10	0 (6:1)	-1 (0.5)	+1 (65)	98.20	5.30
11	+1 (7:1)	0 (1.0)	-1 (55)	98.40**	4.88
12	+1 (7:1)	+1 (1.5)	0(60)	97.58	4.90
13	0 (6:1)	0 (1.0)	0 (60)	95.13	4.81
14	-1 (5:1)	0 (1.0)	+1 (65)	95.40	5.08
15	0 (6:1)	0 (1.0)	0 (60)	97.73	4.97
16	-1 (5:1)	0 (1.0)	-1 (55)	85.45*	5.10
17	0 (6:1)	-1 (0.5)	-1 (55)	93.60	5.15

**maximum value, * minimum value

The predicted model is given below

$$Y = 96.37 + 2.13 X_1 - 0.75 X_2 + 0.85 X_3 + 0.42 X_1 X_2 - 4.06 X_1 X_3 - 1.52 X_2 X_3 - 1.31 X_1^2 + 1.01 X_2^2 - 2.22 X_3^2 \quad ..(1)$$

Where,

Y = Yield of methyl ester of cottonseed oil, %

X₁ = Molar ratio, Methanol: Oil

X₂ = Catalyst concentration, % wt. of oil

X₃ = Temperature, °C

Effect of independent variable on kinematic viscosity of obtained ester

Kinematic viscosity of methyl ester of cottonseed oil was attended by esterification process at different selected parameters using response surface methodology. Kinematic viscosity ranged from 4.78 to 5.39cSt of over entire experimental conditions. It is evident (Table 1) minimum kinematic viscosity was observed at Experiment No.6 having processing condition of molar ratio 6:1 (X₁=0), catalyst concentration 1% (X₂=0) and temperature 60°C (X₃=0). Maximum was at Experiment No. 3, molar ratio 5:1(X₁=-1), catalyst concentration 0.5% (X₂=-1) and temperature 60°C (X₃=0). For both experiment, the reaction time and settling time was 1h and 24h respectively.

The kinematic viscosity of methyl ester of cottonseed oil the quadratic polynomial second order equation model (2) was fitted and shows the full order regression model for kinematic viscosity of methyl ester of cottonseed oil. The value of R² for the regression model that was 0.9465 indicating that the mathematical model was adequate to cover more than 94.0% of the total

variations. The lack of fit was non-significant so model can be used to navigate the design; therefore, quadratic polynomial equation model was adequate in describing kinematic viscosity.

The predicted model is given below

$$V_k = 4.84 - 0.12 X_1 - 0.13 X_2 + 0.016 X_3 - 0.017 X_1 X_2 + 0.013 X_1 X_3 - 0.045 X_2 X_3 + 0.11 X_1^2 + 0.21 X_2^2 + 0.042 X_3^2 \quad \dots(2)$$

Where,

V_k = Kinematic Viscosity, cSt

Graphical analysis of yield

From Fig. 1 to Fig. 2 it was observed that yield of methyl ester of cottonseed oil increased (85.45 to 98.40%) with increase in molar ratio (X_1) from -1.00 (5:1) to 1.00 (7:1) at optimum values of catalyst concentration ($X_2 = 0.38$) and temperature ($X_3 = -0.54$).

Figures represent the 3D plot between molar ratio, catalyst concentration and temperature for yield. Response surface contours for yield of methyl ester of cottonseed oil as a function of molar ratio. It indicated that the yield of methyl ester of cottonseed oil increased with increase in molar ratio (from $X_1 = -1$ to $+1$) but lower temperature (55°C) gradual decreases in yield of methyl ester of cottonseed oil was observed as temperature increased. The effect of temperature (X_3) and catalyst concentration (X_2) have exhibited that yield of methyl ester of cottonseed oil goes increasing as catalyst concentration increased (from $X_1 = -1$ to $+1$) at higher temperature (65°C). Whereas with decrease in temperature $X_3 = -1$ (55°C) to $+1$ (65°C) it goes increases at optimum level of molar ratio ($X_2 = 0.9$). At lower temperature (55°C) yield of methyl ester of cottonseed oil was initial gradual decreases and then drastically increased.

This could be attributed to the fact that yield increased due to increase in molar ratio with oil and decrease in the yield of methyl ester of cottonseed oil at higher temperature (65°C) might be due to evaporation of methanol in transesterification process. A similar yield increase trend was observed by Fan *et al.* (2011) for crude cottonseed oil. Patani *et al.* (2013) was found that the cottonseed oil gave a yield conversion of 98% in base catalyzed process. Rashid *et al.* (2009) reported the yield of methyl ester of cottonseed oil was 96.9% while Joshi (2011) found 98.5% using Novozym-435 as a catalyst.

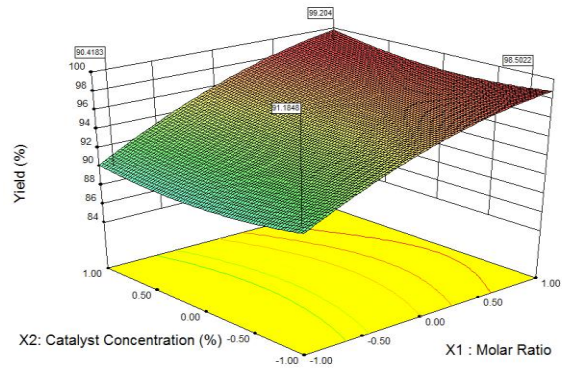

Fig 1 Response Surface Plot of Yield (%) Between Catalyst Concentration and Molar Ratio

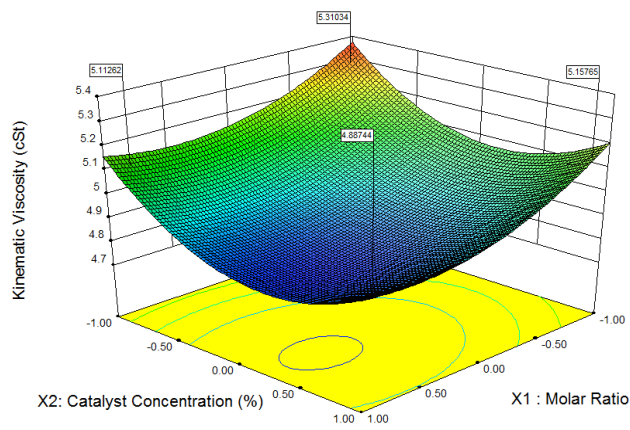

Fig 2 Response Surface Plot of Kinematic Viscosity (cSt) Between Catalyst Concentration and Molar Ratio

Response surface contours for graphical analysis of kinematic viscosity shown in Fig.4. It was observed from figures that the kinematic viscosity of methyl ester of cottonseed oil decreased with increase in molar ratio (X_1) at optimum values of catalyst concentration (X_2) and temperature (X_3). Prescribed figures represent the response surface curve of kinematic viscosity as a function of molar ratio (X_1), catalyst concentration (X_2) and temperature (X_3). It seems that the increase in catalyst concentration from -1 (0.5%) to 1 (1.5%) there was gradual decrease and then increase in kinematic viscosity of methyl ester. The kinematic viscosity decreased from 5.39 to 4.78 cSt as the molar ratio increased (X_1) from -1 (5:1) to 1 (7:1) at optimum values of catalyst concentration ($X_2 = 0.38$) and temperature ($X_3 = -0.54$). The kinematic viscosity decreased with increase in amount of catalyst concentration from $X_2 = -1$ to +1 at optimum level of molar ratio ($X_1 = 0.9$) while gradual decrease and then increases with increase in temperature $X_3 = -1$ (55°C) to +1 (65°C). This could be attributed to the fact that kinematic viscosity decreased due to increase in molar ratio and catalyst as well. The increase in molar ratio during transesterification is associated with reduction of kinematic viscosity of methyl ester of cottonseed oil. Higher kinematic viscosity at lower catalyst concentration may be due to at low catalyst content is not efficient to perform transesterification as a result on kinematic viscosity. Decrease in kinematic viscosity with increase in molar ratio may be due to sufficient amount of methanol present in transesterification process to complete reaction.

Optimization of process parameters for methyl ester of cottonseed oil yield

Goal set as per the response and for independent variable shown in Table 1. Lower limit (-1) shows the lowest value and upper limit (1) shows the highest value selected for parameters in transesterification process. The aim of this study was not only to increase the yield but also to decrease the kinematic viscosity of methyl ester of cottonseed oil. For get closer to goal the variables was set in range and results in coded and actual are depicted in Table.2.

The RSM analyses from Table3 demonstrated that the predicted optimum values of yield and kinematic viscosity of methyl ester of cottonseed oil was 98.40% and 4.81cSt at the molar ratio of methanol to cottonseed oil of 6.9:1, catalyst concentration of 1.19 wt.% and reaction temperature 57°C of below the boiling point of methanol respectively as shown in Table 4.2. Reaction time of 1h and settling time was 24h fixed. In order to test the validity and accuracy of the prediction model, experiments were carried out under the RSM optimized conditions and the actual conversion rate was 98.31 % and kinematic viscosity was 4.85 cSt. Hence, the prediction models were valid.

Table2. Goal Set for Optimization Process

Name	Goal	Lower Limit	Upper Limit
X_1 :Molar Ratio	is in range	-1	1
X_2 :Catalyst Concentration	is in range	-1	1
X_3 :Temperature	is in range	-1	1
Yield	maximize	85.45	98.40
Kinematic Viscosity	minimize	4.78	5.39

Because of lesser acid value in the refined could increase the conversion rate of ester, applied under the RSM optimized conditions. Therefore, the higher ratios of alcohol to oil would be allowed to obtain higher conversion rate of ester.

Table 3. Optimization of Independent Variables

Name	Molar ratio (X ₁)	Catalyst Concentration (X ₂), %	Temperature (X ₃), °C	Yield (%)	Kinematic Viscosity (cSt)
Coded	0.9	0.38	-0.54	98.40	4.81
Actual	6.9	1.19	57	98.31	4.85

Conclusions

RSM was successfully applied to assess the effects of multiple variables, including the alcohol/oil molar ratio, catalyst concentration and temperature for the production of biodiesel from the refined cottonseed oil. The yield of methyl ester of cottonseed oil was significantly affected by process parameters namely molar ratio, catalyst concentration and reaction temperature in transesterification. The maximum obtained yield of methyl ester of cottonseed oil from cottonseed oil 98.31 per cent at minimum kinematic viscosity 4.85 cSt was likely with following standardize parameters optimized by RSM for transesterification reaction. The experimental results suggested the optimal condition as the follows: molar ratio of methanol with oil 6.9:1, catalyst concentration (KOH) 1.19%, reaction time 60 min., reaction temperature 57 °C, settling time 24h.

References

- Fan, X. Wang, X. and Chen, F. 2011. Biodiesel production from crude cottonseed oil: an optimization process using response surface methodology. *The Open and Energy Science Journal*, 4: 1-8.
- Hegde, D. M. 2012. Carrying capacity of Indian agriculture: oilseeds. *Current Science*, 102: 867-873.
- Joshi, H. 2011. Biodiesel production using chemical and enzymatic catalysts and improvement of cold flow properties using additives. Thesis, Ph.D., Clemson University. pp 122.
- Narayan, R., 1992. Biomass (renewable) resources for production of materials, chemicals, and fuels. ACS Symp. Ser. 476, 1–10.
- Patni, N., Bhomia, C., Dasgupta, P., and Tripathi, N. 2013. Use of Sunflower and Cottonseed Oil to prepare Biodiesel by catalyst assisted Transesterification. *Research Journal of Chemical Sciences*. 3(3), 42-47.
- Rashid, U., Anwar, F. and Knothe, G. 2009. Evaluation of biodiesel obtained from cottonseed oil. *Fuel Processing Technology*. 90: 1157–1163.
- Recep, A., Selim, C. and Huseyin, S.Y. 2001. The potential of using vegetable oil fuel as fuel for diesel engine. *Energy Conversion and Management*. 42:529–38.
- Shu, Q., Zhang, Q., Xu, G., Nawaz, Z., Wang, D. and Wang, J. 2009. Synthesis of biodiesel from cottonseed oil and methanol using a carbon-based solid acid catalyst. *Fuel Processing Technology*. 90: 1002–1008.
- United States. Foreign Agricultural Service United States Department of Agriculture USDA. Cotton: World Markets and Trade. 2015. Report.

STUDY ON USE OF COMPOSITE MATERIAL TO REPLACE THE WOODEN COMPONENTS IN ANIMAL DRAWN HILL EQUIPMENT

Jayant SINGH

Department of Farm Machinery and Power Engineering, College of Technology, Govind Ballabh Pant
University of Agriculture and Technology, Pantnagar, Uttarakhand, 263145, India

*Corresponding author: jayantsingh07@gmail.com

Abstract

Yokes and harnesses are the means of attaching the animals to the implements for deriving the power. These days' yokes are developed by using locally available woods in hilly regions of Uttarakhand state (India) like Haldu and Tun etc. It is important to develop and use alternate bio-material to replace wood effectively. Hence, a study on composite material has been undertaken to develop yokes. The resin, cellulose, glass wool, jute net and silica were used in different ratio to prepare composite material for this study. On the basis of this study, the compressive strength, tensile strength and flexural strength of composite material and wood yoke were found 169 and 111.5 N/mm², 26 and 22.1 N/mm² and 44 and 13 N/mm² respectively. The yoke of composite material having resin 87% w/w, silica 10% w/w, 16 numbers of jute net plies 2.5% w/w and 5 numbers of glass wool plies 1.75% w/w is suitable for sustaining the momentary force of 30% force equivalent to body weight of bullock and sufficient to carry out all the agriculture operations those are being performed by animals. The cost of composite material yoke was Rs.325 which is cheaper than the traditional yoke.

Keyword: composite material, resin, silica

Introduction

The population of draft animals in India has reduced from 72 million in 1971-72 to 55.88 million in 2007-08. The major types of draft animals and their population in India is estimated about 55.88 millions out of which Bullock are 49.70, buffalo are 4.27, camel are 0.52, pony are 0.14, horse are 0.47, mithun are 0.26, yak are 0.08, donkey are 0.44 millions. Where as the population of draft animal in Uttarakhand is estimated about 7,11,472 in 2012 out of which bullocks are 6,43,335 buffaloes are 33,467 horses and tattu are 14,632, khachchar are 19,307, donkey are 580 and yakes are 151(19th Livestock census) . In hill region of Uttarakhand only bullocks are used for agricultural draft purpose where as in tarai bhabhar area the buffaloes as well as bullocks are used as draft animal. In hill, khachchar, donkey, yakes are generally used for transportation purpose

Yokes and harnesses are the means of attaching the animals to the implements for deriving the power. There are many types of yokes and harnesses depending on the tradition of the farmers, the type of animal used, the number of animals used and the type of work to be done. The attachment consists of a yoke or a harness (which receives the power directly from the animal) and the linkage which receives the power from the yoke or harness and transfers it to the implement. These days' yokes are developed by using locally available woods in hilly regions of Uttarakhand like Haldu and Tun etc. About 0.7 millions bullocks are being used as draft animals in Uttarakhand. If 60% (approx.) of total population of bullocks is being used as to carry out different agricultural operations in pair, it means 0.21 million (approx.) wooden yokes are required to perform different agricultural operations. If average volume of wood to make a single yoke is 6500 cc (130cm X 10cm X 5cm), then 1360 m³ of wood is required to fulfill the total demand of Uttarakhand. The life of a yoke is about 3-5 years depending upon

the wood material and type of use. This shows that 628 tons of wood would be required every 3-5 years. Composite is a material formed with two or more components, combined as a macroscopic structural unit with one component as continuous matrix, and other as fillers or reinforcements (Gowda *et al.*, 1999). It provides high strength and stiffness as well as resistance to flexural and breaking under the applied stress. Interface bonding between the fillers and the matrix is the key to transfer the stress from the matrix into the fillers across the interface.

Therefore, keeping above points in view, it is important to develop and use alternate bio-material to replace wood effectively. Hence, a study on composite material has been undertaken to develop yokes.

Material and Methods

The material will be used in casting of composite material, and measurement techniques for physical and chemical properties are discussed below.

Material used in moulding

The main material used in moulding were resin, hardener and reinforcing element

Moulding and casting technique

The resin, cellulose and silica were mixed in desired ratio by using mechanical stirrer at room temperature. When proper mixing was completed, the hardener was added in the mixture. Due to addition of hardener, a high viscous solution was obtained, which was remixed manually. The mould was made by using MS sheet as per requirement. Before pouring the mixture of resin, silica, hardener etc into the mould, a thin layer of lubricating material (grease) is applied on the inner surface of mould to avoid the contact between mould surface and composite material. Then after reinforce material will be placed into the mould along with solution of resin, silica and hardener. This process was repeated until it reaches to the recommended ply rating. This whole process was carried out at room temperature. The moulding process was adopted for development of yoke of composite material of the following dimensions and constituents of different models of yoke are given in table 1.

The dimensions of moulded yoke are as follows:

Length = 700 mm, Width = 45 mm, Thickness = 25 mm
Therefore, Net volume of casting = $700 \times 45 \times 25 = 7875 \text{ mm}^3 = 7900 \text{ mm}^3$ (approx)

Table 1 Constituent of different model yokes

Type of treatment	Constituent						
	Jute net	Glass wool	Wire mesh	Silica (%)	Volume of model (ml)	Resin volume (95% of total)	Hardener volume (ml) (2% of resin)
	Number of plies	Number of plies					
T ₁	12	4	4	790	750	15
T ₂	12	4	10	790	750	15
T ₃	12	4	16	790	750	15
T ₄	16	5	10	790	750	15
T ₅	12	4	3	10	790	750	15

Test Procedure

Though there are number of mechanical tests, which are necessary to determine the suitability of a material but the flexural strength test have been performed in the present investigation to optimize the design yoke.

Flexural strength test

Flexural strength are used to determine the ultimate load bearing capacity, flexural strength, yield point, yield strength and other properties. In the present investigation tests are conducted as per ISO test procedure for determination of flexural strength only. The tests are conducted on 100 kN servo hydraulic UTM machine (Model 2008, ADMET make.) All tests are conducted at room temperature.

Results and Discussion

Effect on Mechanical Properties of Yoke

Effect of silica percentage and the number of plies variations had been taken into account then different tests had been conducted on the different models (T₁, T₂, T₃, T₄, T₅ and T₆).

Flexural strength

The Flexural strength of models T₁, T₂, T₃ and T₆ were found 41, 32, 26, 13 N/mm² respectively as shown in table 2. It is also clear from the table that the value of Flexural strength for T₁, T₂, T₃ are 3 times, 2.5 times and 2 times higher than T₆. It is also clear from the table 2 that less silica percentage provided more flexural strength to the model T₁ having 4% of silica and it became more flexible moreover more silica percentage made model T₂ more stiffed, resulted as reduction in flexural strength. Whereas introducing 10% silica into model T₂ provided almost 2.5 times strength as compared to model T₆, thereby model T₂ emerged as more suitable model as compared to all.

Table 2. Effect of silica percentage on flexural strength of yokes

Types of treatment	Effective span length (mm)	Width (mm)	Thickness (mm)	Load (kN)	Flexural strength (N/mm ²)
T ₁	150	43	25	5	40
	150	44	25	5	41
	150	45	25	5	41
	Avg				41
T ₂	150	45	25	4	30
	150	45	25	4	32
	150	46	25	4	33
	Avg				32
T ₃	150	43	25	3	27
	150	44	25	3	26
	150	45	26	3	24
	Avg				26
T ₆	150	87	45	10	13
	150	88	45	10	13
	150	90	45	10	13
	Avg				13

After optimizing the silica up to 10%, tests were performed for analyzing the effect of ply on flexural strength with intention behind increasing more strength. The flexural strength of models T₂, T₄, T₅ and T₆ were found 32, 44, 37 and 13 N/mm² respectively at 10% silica as shown in table 3. It is also clear from the table3 that the value of flexural strength for T₂, T₄, T₅ are 2.5 times, 3.4 times and 2.8 times higher than T₆. From the table, it is evident that more plies impart more strength to the model however T₅ has been made up of taking wire mesh together with cellulose material, it is observed that strength is not increased considerably as compared to the yoke of more plies i.e. T₄. In addition, it was increasing undesired weight of the yoke.

Table 3. Effect of number and type of plies on flexural strength at 10% of silica

Types of treatment	Effective span length (mm)	Width (mm)	Thickness (mm)	Load (kN)	Flexural strength (N/mm ²)
T ₂	150	45	25	4	30
	150	45	25	4	32
	150	46	25	4	33
	Avg				32
T ₄	150	45	25	5	43
	150	45	26	6	43
	150	46	26	6	45
	Avg				44
T ₅	150	45	25	5	39
	150	45	26	5	37
	150	45	27	5	36
	Avg				37
T ₆	150	87	45	10	13
	150	88	45	10	13
	150	90	45	10	13
	Avg				13

Dimension of Yoke

A yoke that is capable of supporting the expected draft force of 6860 N (if an animal utilizes 100% force equivalent to body weight of it overcome the draft) should have dimensions determined by using the ultimate flexural strength of the composite material yoke. The treatment T₄ was selected for the design of yoke and which had the ultimate flexural strength of 44 N/mm² and a density of 1210 kg/m³ will thus be treated as simply supported beam on which load (draft force) is acted at the centre of the beam. The beam is supported at the end by same loads to overcome the load acting at the centre of the beam.

Considering the bullocks' working allowance, size of bullocks and existing yoke dimensions, the designed span length is taken 1100 mm (neck-to-neck distance) and with a thickness (d), half of the width (b) of the yoke (considering the dimensions of pant hill yoke). These two dimensional parameters are the most critical to the designed yoke (Devnni, 1981).

For the simply supported beam, flexural strength-Where,

σ = flexural strength of the beam, N/mm²

P = Load or draft force in Newton, L = Span (length) of yoke beam, mm

b = Width of yoke beam, mm, d = thickness of yoke beam, mm

$$\sigma = \frac{3PL}{2bd^2}$$

In practice, a bullock can generate only force equivalent to 10% of its body weight in sustainable condition. However, bullock can develop 30% momentary force equivalent to its body weight. On this basis, Pant hill yoke was developed for sustaining 30% force equivalent to bullock's body weight. Hence the new composite yoke is designed for sustaining force equivalent to 30% of bullock's body weight.

It is evident from the table 4, the dimensions of the designed yoke are 1280 x71 x 36 mm and mass are 3.90 kg, whereas the wooden yoke has dimensions and mass of 1280 x 106 x 53 mm, and 4.88 kg respectively a force equivalent to 30% of body weight of bullock.

Table 4 Dimensions and mass of the designed yoke at force equivalent to 30 % of body weight of bullock

S.No.	Type of yoke	Strength (N/mm ²)	Length (mm)	Width (mm)	Thickness (mm)	Mass (kg)
1.	Designed (T4)	44	1280	71	36	3.90
2.	Wooden (T6)	13	1280	106	53	4.88

From table 4, it is evident that composite yoke is lighter and stronger than the wooden (Tun) yoke. On the basis of above all studies, it is recommended that newly designed yoke of composite material (T₄) with using resin (87% w/w), silica (10% w/w), 16 numbers of jute net plies (2.5% w/w), 5 numbers of glass wool plies (1.75% w/w) is suitable for sustaining the momentary force of equivalent to 30% of body weight of bullock. However Pant hill yoke having dimensions of 1280 x 90 x 43 mm is less than calculated value of dimensions at force equivalent to 30% of body weight of bullock.

Conclusion

On the basis of above study, it is recommended that the dimensions and mass are 1280 x71 x 36 mm and 3.9 kg at 30% force equivalent to body weight of bullock. The yoke of composite material (T₄) having resin 87% w/w, silica 10% w/w, 16 numbers of jute net plies 2.5% w/w and 5 numbers of glass wool plies 1.75% w/w is suitable for sustaining the momentary force of 30% force equivalent to body weight of bullock. However Pant hill yoke having dimensions of 1280 x 90 x 43 mm is less than calculated value of dimensions of wooden (tun) yoke at 30% force of body weight of bullock. The designed yoke has the flexural strength of 44 N/mm². These figures are more than sufficient to carry out all the agriculture operations those are being performed by animals. It cost is estimated Rs.325 which is cheaper than the traditional yoke.

References

- 19th Livestock census-All India Report (2012). Ministry of Agriculture, Department of Animal Husbandry and Fisheries.
- Devnani R.S., (1981). Design consideration for harness and yokes for draught animals. Technical Bulletin No. CIAE/81/30.CIAE, Bhopal.
- Gowda T.M., Naidu A.C.B., Chhaya R, (1999). Some Mechanical Properties of Untreated Jute Fabric-Reinforced Polyester Composites, Composites Part A: Applied Science and Manufacturing, 30(3), pp. 277-284.
- Sudhakar K., Srinivas Ch.(2014). Investigation of Mechanical Properties of Rice Straw Fibre Polypropylene Composites. Int. Journal of Engineering Research and Applications www.ijera.com, ISSN: 2248-9622, Vol. 4, (1)(Version 2) pp 182-18.

DEVELOPMENT OF A RESOURCE CONSERVATION MACHINE FOR SUGARCANE CULTIVATION

Rajnarayan PATERIYA^{1*}, Himanshu ADHIKARI²

¹Department of Farm Machinery and Power Engineering College of Technology, India

²Farm Machinery and Power Engineering GBPUA&T, Pantnagar Distt. U.S. Nagar, Uttarakhand, India

*Corresponding author: rnpateriya@yahoo.co.in .

Abstract

This paper deals with the development of Resource Conservation Machine for Sugarcane Cultivation. It is reported that poor yield of sugarcane is because of weed can range from 15 to 75 % depending upon field conditions. The initial 90 to 120 days are very critical for poor yield of sugarcane because of weeds. Therefore, these days are very important for weed management to ensure higher yield. In case of sugarcane crop although various type of machinery has been developed, however there is a need of resource conservation machine for better productivity by weeds incorporation and mulching operation.. The developed machine consists of a frame of 2440 mm length and 510 mm wide, the square pipe selected for frame is of 5 mm size. The tines which are 6 in numbers are attached at the front side and blades of trapezoidal shape with rounded corners were attached at the rear side of the frame. The length of blade is 650 mm and thickness is 5 mm. the blades were attached with the help of L shaped legs which were clamped to the frame. The adjustable clamps help to adjust the depth of blades during the operation. The main objective of this study is to find mathematically the thickness of the blade used at the rear end of the machine. The machine is able to perform the inter-cultural and mulching operation efficiently without damaging the sugarcane crop. Hence it very useful for the growth of sugarcane and saves money, time and resource conservation as compared to manual and other inter-cultural methods.

Key words: *Resource conservation, Sugarcane, Intercultural operation, Weeding, Mulching.*

Introduction

Sugarcane is one of the most important cash crops in India. It is cultivated in an area of about 4 million ha, with production of 75 tonnes/ha (The Hindu, Survey of Indian agriculture 2013). The total production of sugarcane has been increasingly steadily from 230 million tonnes in 1993-94 to 300 million tonnes in 2013-14. Sugar availability in the country has been about 18.5 million tonnes (The Hindu, Survey of Indian Agriculture). The energy consumption in production of sugarcane is the highest as compared to many other crops such as wheat, maize, paddy etc. Sugarcane production is labour intensive cultivation. It required about 3300 man-hours for different agricultural operations (Yadav and Chaudhary, 2000). Considering the present trend of availability of labour for sugarcane production, it has been experienced that use of modern machinery is inevitable. Use of machinery helps in labour savings ensures timeliness of operations, reduces drudgery, helps in improving quality of work, reduces cost of operation and ensures effective utilization of resources. In case of sugarcane crop although machinery has been developed, however the machines or implements has not been available for the inter-cultural operations up to the desired level. Thus there is a considerable mechanization gap, especially in the area of sugarcane, inter-cultural operation. Weed control is most critical early in the season. Two to three months after planting, the appropriate weed management must proceed; otherwise the yield reduction could be reduced up to fifty percent (Suwannarak, 1983). Weed can reduce sugarcane yields by competing for moisture, nutrients,

and Sunlight during the growing season. (D. C. Odera, 2009). Weeds also utilize a part of nutrition and water resulting in decrease in sugar content. Heavy weed infestations can also interfere with sugarcane harvest by adding unnecessary harvesting expenses (D. C. Odera, 2009). The optimum chemical management for weed control in sugarcane required 2-3 applications per crop by using the herbicide, however the type of herbicide selection depends on type of weed and there are limited kinds of herbicide appropriate for sugarcane (Suwanarak, 1999). Ideally mechanical weed control should get preference over herbicidal control in sugarcane. At the present mechanical weeding is still in limited use. The optimum tool for control weed should be able to uproot the weeds and break the soil after operation. The present study is based on design and development of a machine for the better productivity with the objective of design and development of suitable machine for Sugarcane inter-cultural operation

Materials and Methods

The methodology which will be adopted for design and development of resource conservation machine for sugarcane cultivation, the procedure followed for testing of design the prototype is discussed in this section. The machine was designed and developed at Farm Machinery and Power Engineering Department of Govind Ballabh Pant University of Agriculture and Technology, Pantnagar, Uttarakhand, India.

Design and fabrication of the machine

A resource conservation technology for sugarcane cultivation was designed and fabricated in the Department of Farm Machinery and Power Engineering Department of Govind Ballabh Pant University of Agriculture and Technology, Pantnagar, Uttarakhand, India. The main parts of the machine are frame, spring loaded reversible tines, trapezoidal blade and hitching system.

Description of the resource conservation machine for sugarcane

The developed machine comprises of a rectangular frame, six spring loaded reversible tines, two legs to hold the blades, two trapezoidal blades and hitch system. The machine consists of a rectangular frame made by square pipe. Six reversible tines are attached at the front part of the machine and two trapezoidal blades are fixed exactly behind the tines. The blades are welded to the frame with the help of L shaped shank. The detailed information regarding the machine has been described in Fig. 1 and 2.

The rectangular frame consisted of two beams of hollow square section. The size of frame was 2440 x 510 x 60 mm. Number of holes were provided in the frame so that the tine spacing can be adjusted. Six cultivator tines were mounted at the front of the frame at 700mm apart from each row and 230mm part from each other with the help of nut and bolts. It was assumed as the draft force experienced by all the six tines is of similar magnitude therefore. The cross section of the beam was designed for the maximum force Fig. 3.

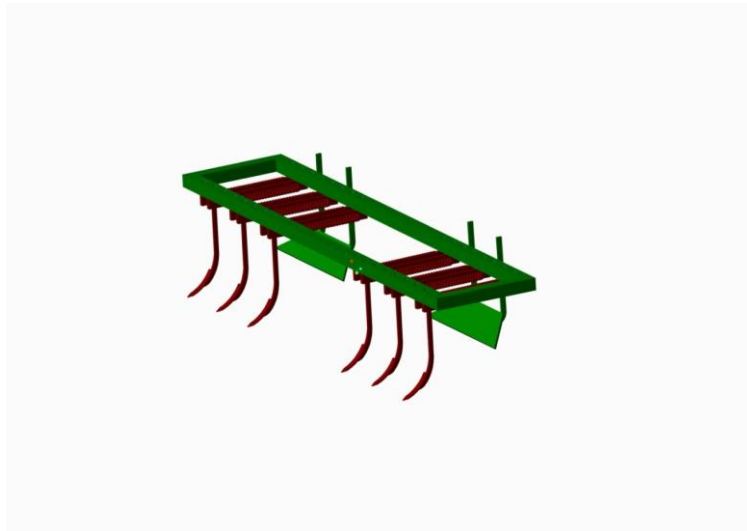

Fig. 1 The Overview of the Machine



Fig. 2 Overview of the developed Machine with hitching system

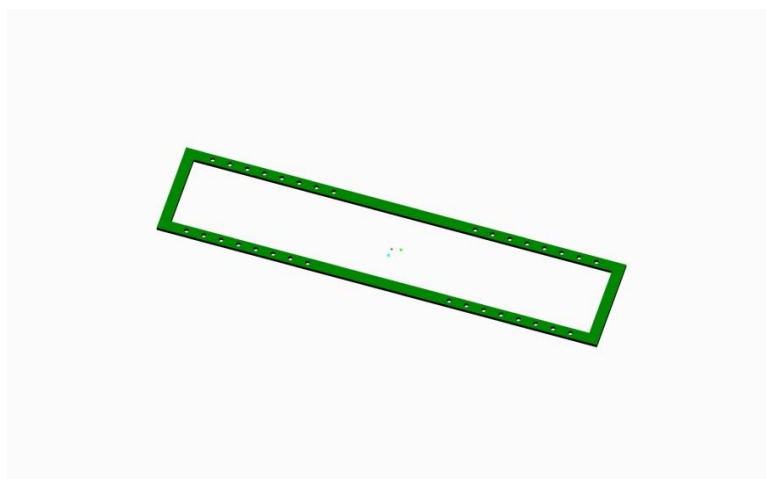

Fig. 3 Frame of the Developed Machine

The shank was designed and fabricated from flat 50×5 mm wide flat. Four shanks were designed and welded at the bottom of blade of identical size to hold the blades attached at the rear side of the frame. In each blade two shanks were welded for holding it. The two shanks

were 350mm apart from each other. Six sets of holes were drilled in each leg at 38 mm apart from each other. By these number of holes the height of the blade can be adjusted Fig.4.



Fig. 4 Shank used in the Machine

Two blades of trapezoidal shape were designed and fabricated from flat of 5mm thick plate. The base length of the trapezoidal blade is 650 mm and height of 170 mm as shown in Fig. 5. The two blades were attached exactly behind the tines attached at the front part of the frame. The distance between the two blades is 700 mm.

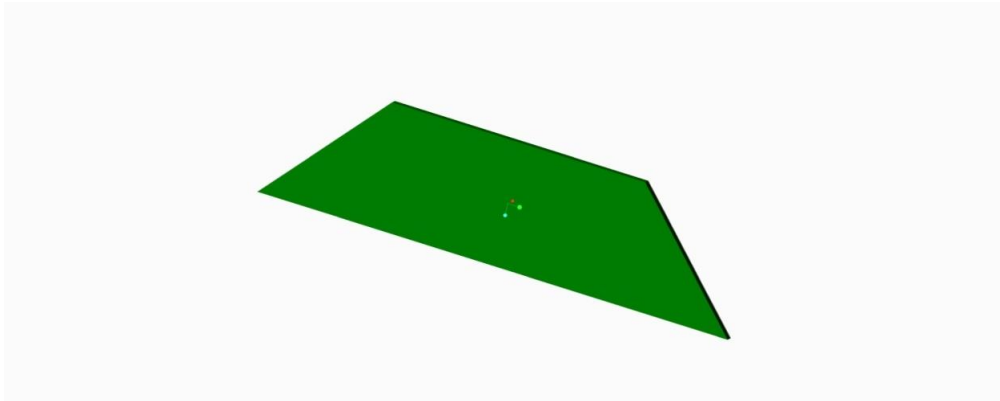

Fig. 5 Trapezoidal blade of the Developed Machine

The angular section is considered as best for clamping legs with the beam. Four ‘U’ shape clamp of size 50x70x14 mm has been provided for each leg to hold it properly with beam with the help of nuts and bolts. The upper angle section becomes the compression member and the bottom section becomes the tension member while working together as a conjugate device.

The hitching system of the developed machine is subjected to normal loads; therefore, the hitch point was made by welding two mild steel flats with the beam at a spacing of 284 mm from the centre of beam. The size of these mild steel flat was kept 730 x 50 x 16 mm with 28 mm diameter holes drilled at 77.5 mm from the front end to connect the upper hitch plates and hitch pins together. The lower hitch point span was kept as 685 mm which was selected as per the recommendation of BIS-4468 – 1997 for second category hitch as shown in Fig.6. A hitching system was made from mild steel flats of 100 mm (width) x 12 mm (thickness) was mounted vertically with the help of nuts and bolts with hitching flats to obtain a mast height of 610 mm which is in conformation with BIS-4468 – 1997. In order to distribute load from the front beam to the entire frame and for better balancing of the planter, the top link point

was supported at the rear beam with the help of 715 mm long mild steel flats of 60 mm (width) x 15 mm (thickness).

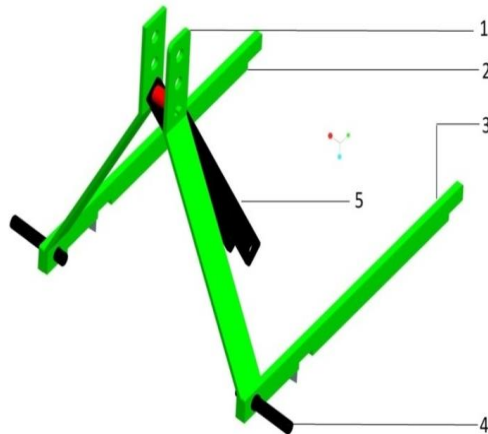

Fig. 6 Hitch system used for the Developed Machine

Where,

S. No.	Components
1	Hitch Plate
2	Supporting plate
3	Supporting end
4	Hitch Pin
5	Top Link

Intercultural operation requires weeding and loosening of the soil by shovel attached to the shank of the reversible tine. The length of the tine is 520 mm as shown below in Fig.7. Results of field investigation on optimum soil moisture content, bulk density, shovel size and depth of tines penetrated formed the design selection for the selection of shovel. Shovel not only pulverizes the soil, it uproots the weeds in between the two rows of planed sugarcane. A suitable shovel was selected having width of 50 mm and length 150 mm and shovel is fitted on lower end of the shank at 220 with nut and bolt. A rigid tine, hinged to the frame and loaded with helical spring so that it swings back when an obstacle is encountered. A curved steel furrow opener with both ends pointed is attached to the lower end of the tine.



Fig. 7 Spring loaded Reversible tine used in the Developed Machine

Draft requirement of the developed machine

The maximum depth of operation of reversible tines (z) was 170 mm. Hence, for the reversible tine working at 170 mm depth and having 50 mm tine width, the aspect ratio z/w = 2.22.

Taking unit draft of soil as 0.55 kg/cm²

Total draft per tine = depth (cm) x width (cm) x unit draft (kg/cm²) of soil ...

$$= 17 \times 6 \times 0.55$$

$$= 56.1 \text{ Kg}$$

$$= 46.75 \times 9.81 \text{ N}$$

$$= 550.34 \text{ N}$$

$$= 0.550 \text{ kN}$$

Draft for six reversible tines = 0.550 x 6

$$= 3.30 \text{ kN}$$

Results and Discussion

Two blades of trapezoidal shape with rounded corners were designed and fabricated from flat of 5mm thick plate. The base length of the trapezoidal blade is 650 mm and height of 170 mm as shown in Fig.2. The two blades were attached exactly behind the tines attached at the front part of the frame. The distance between the two blades is again 700 mm.

$$\text{Area of blade} = \frac{1}{2} \times b \times h$$

Where, b = base of blade

h = height of blade

$$\begin{aligned} \text{Area} &= \frac{1}{2} \times 650 \times 170 \\ &= 55250 \text{ mm}^2 \end{aligned}$$

The blade were attached at an angle of 17° from the horizontal.

The yield strength of mild steel is 248 × 10⁶ N/mm²

The average draft is 1089 kgf

$$\begin{aligned} \text{Draft} &= 1089 \text{ kgf} \\ &= 1089 \times 9.81 \\ &= 10.6 \times 10^3 \text{ N} \end{aligned}$$

Draft on each blade = 5.3 × 10³ N

Component of draft perpendicular to the blade, knowing the angle of blade is 17°
= 5.3 × 10³ × cos73°

$$\frac{\sigma}{FOS} = \frac{\text{Draft on each blade}}{\text{Length} \times \text{thickness}}$$

$$\frac{2.48 \times 10^6}{5} = \frac{5.3 \times 10^3 \times .73}{3.5 t \times 10^{-3}}$$

$$t = 0.004 \text{ m}$$

$$= 4 \text{ mm}$$

So for the designed machine we can take blade of thickness above than 4 mm.

Hence we selected a blade of thickness 5 mm which is easily available in local market.

The results obtained are summarized below.

- It was observed by the initial trial of the developed machine that no plants injury was recorded and the machine worked satisfactorily.
- The calculated thickness of blade was 4 mm. So, any value above than 4 mm can be used for blade thickness. We took the blade thickness 5 mm as it was easily available in the local market.

Conclusions

The machine was able to perform the intercultural and mulching operation efficiently without damaging the sugarcane crop. Hence it is very useful for growth of sugarcane and saves money, time and resource conservation as compared to manual and other intercultural methods. The developed machine comprises of a rectangular frame (2440 x 510 x 60 mm), six spring loaded reversible tines, two legs to hold the blades, two trapezoidal blades with 5 mm thickness and hitch system. There was no plant injuries of sugarcane crop recorded in the initial trials. Thus the developed Resource conservation machine for sugarcane worked satisfactorily and recommended for resource conservation in crop cultivation.

References

- Ahmad , M.H. and Godwin, R.J. 1993. The influence of the wing position on sub soiler penetration and soil disturbance. *J Agri. Engg. Res.*, 28(4) : 489-492.
- Bai, Z.F. and Zhao, Y. (2012) Dynamic behavior analysis of planar mechanical systems with clearance in revolute joints using a new hybrid contact force model. *International Journal of Mechanical Sciences* 54, 190–205.
- Balli, S. S. and Chand, S. (2002) Defects in link mechanisms and solution rectification *Mechanism and Machine Theory* 37 (2002) 851–876.
- Suwanarak, S. K. (1999). Tendency of Decreasing Herbicide Use in Sugarcane Field. *National Conference of Crop Protection Society* (pp. 230-233). Bangkok: Thai National Crop Protection Society.
- Suwanarak, K. (1983). Losses due to weed and weed management in sugarcane. *Newsletter of Weed Science Society of Thailand* No. 3

5. ANIMAL HUSBANDRY

FEASIBILITY STUDY ON USING ZIGBEE NETWORKS IN AGRICULTURAL APPLICATIONS

Temuçin Göktürk SEYHAN*¹, YASIN KAHYA², Sinem ÇAMURCU³

¹Department of Agricultural Machinery and Technology Engineering, Faculty of Agriculture, Ankara University, Turkey

²Department of Animal Science, Faculty of Agriculture, Ankara University, Turkey

³Department of Horticulture, Faculty of Agriculture, Ankara University, Turkey

*Corresponding author: seyhan@ankara.edu.tr

Abstract

With the recent developments on internet and communication technology, IoT (Internet of Things) applications are being common in agriculture. ZigBee is an IEEE 802.15.4-based specification for a suite of high-level communication protocols used to create personal area networks with small, low-power digital radios. A ZigBee network can be created as Star, Tree, Cluster Tree and Mesh topologies. These topologies make ZigBee networks suitable for agricultural applications. With low power consumption and encrypted data transfer, ZigBee networks are also suitable for IoT applications. In this study; a system which collects data from bee hives via ZigBee network is designed. Solar powered under-hive units measure weight, temperature and relative humidity of hives and send all data to network coordinator with communicating one another. Designed system is a low-power, low-cost field data acquisition system which can be used in any agricultural application. Remote control over ZigBee networks are also possible to use in agricultural fields and farm management. With fuzzy logic, autonomous smart farms can be developed.

Keywords: *Internet of things, ZigBee, Bee hive, Wireless Sensor Networks.*

Introduction

With the recent developments in wireless technology, Wireless Sensor Networks (WSN) are being widely used. A Wireless Sensor Network can be used in a remote environmental monitoring application. This is enabled by smaller, cheaper, intelligent and low-power sensor nodes. These sensor nodes communicate via wireless networks with one another (Yick et al., 2008) within an algorithm. Wireless Sensor Networks (WSN) consist of embedded sensing, computing, and communication devices, and are a key technology of the Internet of Things (IoT) concept. WSN have found many applications, including healthcare, environmental monitoring and medicine (Boyle et al., 2011 and Sardini and Serpelloni, 2011). A wireless sensor network is an integration of sensors, microcontrollers, radio frequency (RF) transceivers and power sources (Wang et al., 2006).

There are different wireless standards and devices which are used in wireless sensor networks. Among them, the standards for wireless LAN, IEEE 802.11b (“WiFi”) and wireless PAN, IEEE 802.115.1 (“Bluetooth”) and IEEE 802.15.4 (ZigBee), are more widely for measurement and automation applications (Wang et al., 2006). ZigBee is established by the ZigBee Alliance that is supported by more than 70 members. ZigBee is known for its security, reliability, low power consumption and simple network configuration. Table 1 compares these three wireless standards that are most suitable for wireless sensor network.

Table 1. Comparison between wireless LAN, Bluetooth and Zigbee

Feature	WiFi (IEEE 802.11b)	Bluetooth (IEEE 802.15.1)	ZigBee (IEEE 802.15.4)
Radio	DSSS ^a	FHSS ^b	DSSS
Data rate	11 Mbps	1 Mbps	250 kbps
Nodes per master	32	7	64 000
Slave enumeration latency	Up to 3 s	Up to 10 s	30 ms
Data type	Video, audio, graphics, pictures, files	Audio, graphics, pictures, files	Small data packet
Range (m)	100	10	70
Extendibility	Roaming possible	No	Yes
Battery life	Hours	1 week	>1 year
Bill of material (US\$)	9	6	3
Complexity	Complex	Very complex	Simple

^a DSSS, Direct Sequence Spread Spectrum

^b FHSS, Frequency Hopping Spread Spectrum

*Source: Wang et al., 2006

The wireless standards also address the network issues for wireless sensors. Three types of networks: star network, hybrid network and mesh network, have been developed and standardized. The Bluetooth technology uses star network type, which is composed of piconets and scatternets. Each piconet connects one master node with up to seven slave nodes, whereas each scatternet connects multiple piconets, to form an ad hoc network. The ZigBee technology uses hybrid star network type, which uses multiple master nodes with routing capabilities to connect slave nodes, which have no routing capability (Sensicast, 2004).

The most efficient networking technology uses peer-to-peer, mesh networks, which allow all the nodes in the network to have the routing capability. Mesh networks allow autonomous nodes to self-assemble into the network. It also allows sensor information to propagate across the network with a high reliability and over an extended range. In addition, it allows time synchronization and low power consumption for the “listeners” in the network and, thus, extending the battery life (Wang et al., 2006).

This paper focuses on smart beehives which are using ZigBee-based wireless sensor network. In the paper, a beehive tracking unit is designed.

Material and Methods

A unit is designed and used under every hive and has a sensor pole that sticks into the hive. This unit has load cells on four corners, a temperature and humidity sensor, a microcontroller, a battery and a ZigBee module (Figure 1, Figure 2). 20 Wp rated solar panels are used at the top of hives as power source.

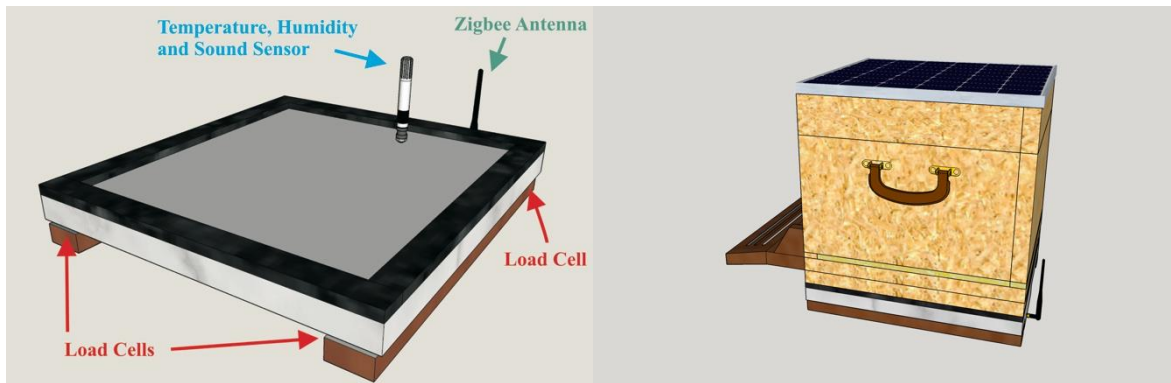

Figure 1. Bottom unit

Figure 2. Bottom unit with hive

Microcontroller

An Arduino UNO is used in bottom units (Figure 3). Technical specifications are in Table 2.

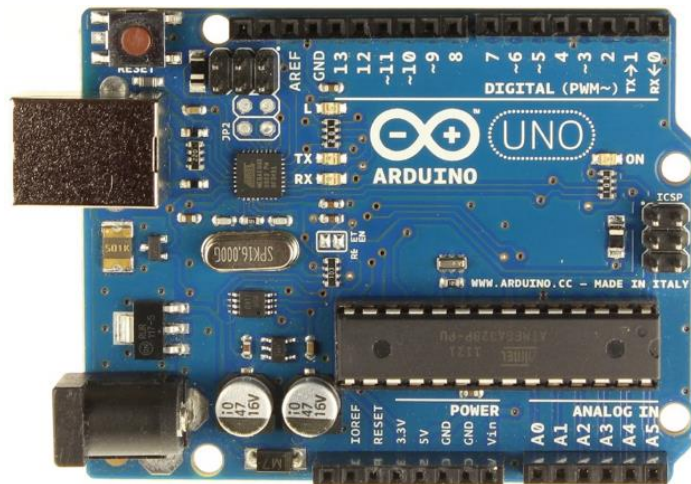

Figure 3. Arduino UNO

Table 2. Arduino UNO Technical Specifications

Microcontroller	ATmega328P
Working voltage	5V
Input voltage	6 to 20V
Digital I/O pins	14
Analog input pins	6
Program memory	32 KB
Working frequency	16 MHz

Load cells

Four load cells are connected as Wheatstone bridge to weigh correctly. Each cell can measure up to 50 kg, total of 200 kg can be weighed (Figure 4).



Figure 4. Load cell

Hive inside temperature and relative humidity sensor

A SHT75 by Sensirion Inc. is used to measure inside temperature and relative humidity. Range and reliability of this sensor is given as -40 to $+123$ °C ± 0.3 °C and 0% to 100% $\pm 1.8\%$ (Figure 5).

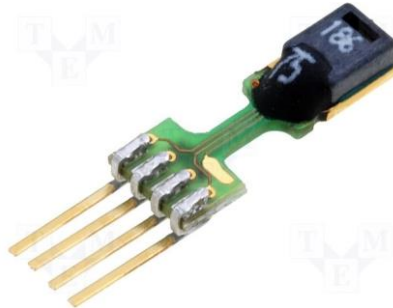

Figure 5. SHT75

ZigBee communication module

XB24-BSIT-004 is an XBee Series 2 OEM RF Module, AT Router/End Device with SMA antenna (Figure 6). Technical specification is given in Table 3.



Figure 6. XB24-BSIT-004 XBee series 2 module

Table 3. Technical specifications of XB24-BSIT-004

Wireless protocol	ZigBee
Data rate	250 Kbps
Module interface	Serial
Supply voltage range	2.1 V to 3.6 V
Working frequency	2.4 GHz ISM
TX current	40 mA @ 3.3 V
RX current	40 mA @ 3.3 V
Range	120 m
TX power	2 mW (+3 dBm)
RX sensitivity	-95 dBm
Network topology	Mesh, Star, Cluster Tree

An example of network between hives and ZigBee Coordinator is shown in Figure 7.

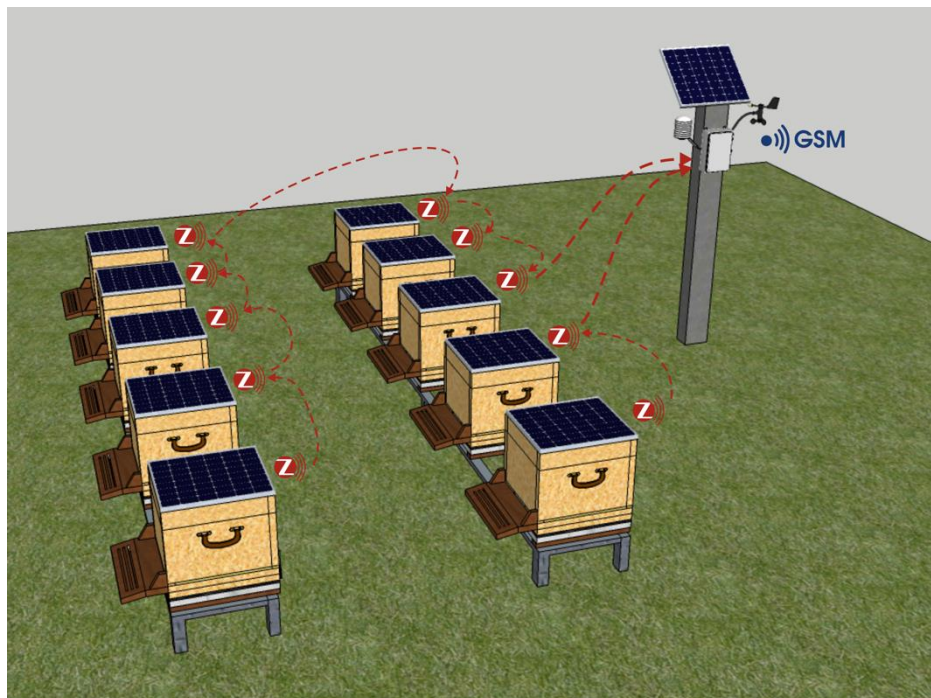

Figure 7. Network between beehives and ZigBee Coordinator

Zigbee Coordinator and Weather Module

A stationary unit is designed to collect data from beehives' network and sends to the remote server with weather data via GPRS connection. GPRS connection is provided by SIM900 GSM GPRS module. This unit is powered by a 50 Wp rated solar panel and this unit works as a ZigBee Coordinator.

Weather data such as temperature, relative humidity, wind speed, wind direction, rain, air pressure, and light is measured.

Data Collection and Analysis

A WEB server with php and MySQL database installed is used during experiments. Data is collected with a php page using GET function and saved into MySQL database (Pierce and Elliott, 2008). Time variable is added to data collected during saving process.

Data analysis is made with a php script. Daily weight change is calculated using the data from the previous day, for the same time because weight can dramatically change any time due to bee population and water amount inside the hive (Meikle and Holst, 2014).

Results and Discussion

With the system developed in this paper, hive data can be collected during both production and sleep states of honeybees, including daily weight change. Meteorological data is also collected by the main network coordinator and all data is sent to a webserver via GPRS connection.

Hourly energy consumption is calculated as in Table 4 considering sleep times.

Table 4. Power consumption of design system.

Arduino UNO	80 mWh
Load cells	0 mWh
SHT75	5 mWh
ZigBee Module	20 mWh
TOTAL	105 mWh

Daily weight change gives an information about how much honey is produced. Temperature, and relative humidity gives information about colony condition. If there are sudden changes in these parameters, beekeeper should be warned about the condition of bee colony.

A screenshot from the developed website is seen in Figure 8. Icons show temperature, wind speed & direction, air pressure, light intensity, average weight change, rain condition, system events and battery, location and communication status in order.

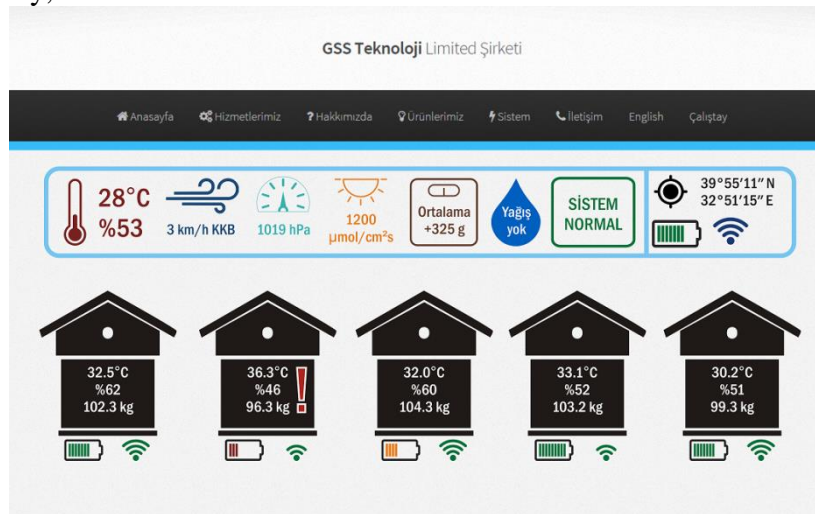

Figure 8. Website screenshot

When clicked on a hive, website shows detailed information. A screenshot from a particular hive is shown in Figure 9.

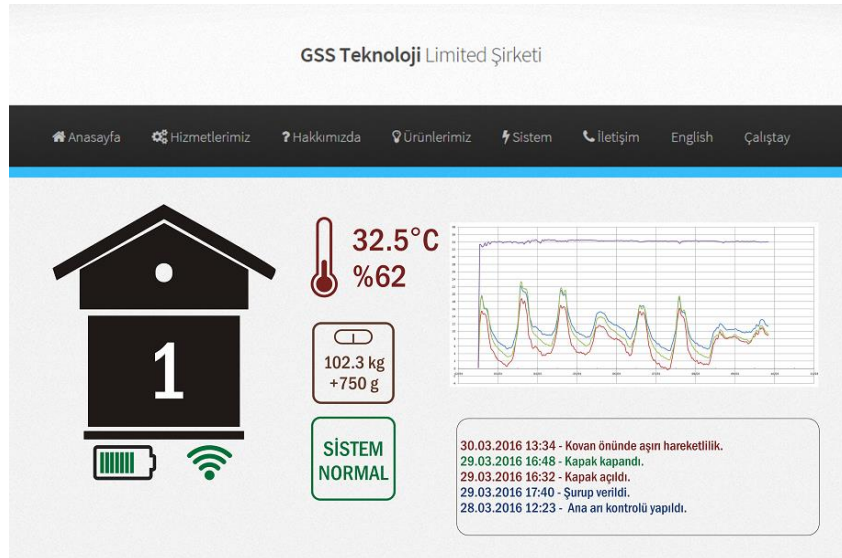

Figure 9. Single hive detailed view from the website

Conclusions

Due to its low power consumption, simplicity, extendibility and Mesh network topology, ZigBee networks can be used in solar-powered field data acquisition systems. ZigBee is suitable to use in Wireless Sensor Networks for agricultural applications. ZigBee can be used for both data acquisition and control network. With using fuzzy logic, autonomous systems such as smart farms can be designed.

As designed system work on solar power, low-power devices and internal power management are important. There have to be sleep times for microcontroller and ZigBee module to reduce power consumption and make time to energy harvesting.

References

- Boyle, D., Magno, M., O'Flynn, B., Brunelli, D., Popovici, E., Benini, L., (2011). Towards persistent structural health monitoring through sustainable wireless sensor networks, 7th International Conference on Intelligent Sensors, Sensor Networks and Information Processing, ISSNIP 2011, Adelaide, pp. 323-328.
- Meikle, W.G., Holst, N. (2014). Application of continuous monitoring of honeybee colonies, *Apidologie*, 46, pp 10-22.
- Pierce, F.J., Elliott, T.V. (2008). Regional and on-farm wireless sensor networks for agricultural systems in Eastern Washington, *Computers and Electronics in Agriculture*, 61(1), pp 32-43.
- Sardini, E., Serpelloni, M. (2011). Self-powered wireless sensor for air temperature and velocity measurements with energy harvesting capability, *IEEE Trans. Instr. Meas.*, 60, pp. 1838-1844.
- Sensicast, (2004). <http://www.sensicast.com/> accessed on 27/07/2016.
- Wang, N., Zhang, N., Wang, N. (2006). Wireless sensors in agriculture and food industry—Recent development and future perspective, *Computers and Electronics in Agriculture*, 50(1), pp 1-1.
- Yick, J., Mukherjee, B., Ghosal, D. (2008). Wireless sensor network survey, *Computer Networks*, 52 (12), pp. 2292-2330.

A COMPARATIVE ANALYSIS OF THE EXTERIOR IN LOCAL GOAT BREEDS FROM SOUTHWEST BULGARIA

Atanas VUCHKOV, Doytcho DIMOV

Department of Animal Science. Agricultural University – Plovdiv, Bulgaria. Corresponding autor: a_vu@abv.bg

Abstract

In the last 15 -20 years there has been a higher interest in the skins of the Kalofer longhaired goats, used for making mummer's costumes, typical for Southwest Bulgaria. As a result, very valuable animals from this indigenous goat breed were brought from its typical habitat (Kalofer region); some of them were killed for their skin, and others left for breeding, mainly in Southwest Bulgaria (Blagoevgrad region). This region (Blagoevgrad region), however, is a natural habitat of another local breed – the Bulgarian Screw-horned long-haired goat. Coexistence and breeding in purebred status of these two indigenous goat breeds, requires clearly distinguished breed types of both of them. For this purpose, we traced typical specimens, with a clearly expressed breed type of Kalofer long-haired and Bulgarian screw-horned goats, reared in herds in Southwest Bulgaria. Full exterior measurements of 100 goats (50 of each breed) and 40 bucks (20 of each breed) were made. The Kalofer long-haired goat is larger than the Bulgarian Screw-horned long-haired goat - the height at the withers in the females, was - 70.76 cm and 66.9 cm, respectively. The height at the withers in the bucks was - 82.2 cm and 73.4 cm, respectively. The differences expressed a high degree of probability. The Bulgarian Screw-horned goat has a light stretched format (bucks' stretchability index was 106.3), while the Kalofer long-haired goat has a square format (bucks' stretchability index was 100.3). The Kalofer long-haired goat has more massive bones (index for the development of bones was 12.99) than the Bulgarian Screw-horned goat (index for the development of bones - 12.12). The differences expressed a high degree of probability.

Key words: *Goat breeding, Autochthonous breeds, local goat breeds, exterior measurements, exterior indices*

Introduction

The local goat breeds in Bulgaria are poorly investigated and fully detailed data about their exterior and productive qualities are scarce. A number of authors who studied local goats in the past described them as low-productive and of heterogeneous exterior. The investigations were initiated mainly because of the opportunity for crossbreeding with highly productive introduced breeds (Kadijski 1958, Balevska and Tjankov 1981, Solomonov, Kadijski and Lazarov 1984, Tjankov et al. 1996, Krastanov, 2003). In most of the papers the different local goat populations are mentioned under the collective term autochthonous goats. However, surviving populations are still to be found in some regions of the country, possessing characteristic and steadily transferred exterior traits. That fact calls for their separate study and description. (Vuchkov et al. 2011). The local Kalofer long-haired goat breed is threatened with extinction. Typical mountain breed. Natural area of the breed are the southern slopes of the Central Stara Planina mountain, near the town of Kalofer (Sedefchev et al. 2011; Vuchkov et al. 2011). In the last 15 -20 years there has been a higher interest in the skins of the Kalofer longhaired goats, used for making mummer's costumes, typical for Southwest Bulgaria. As a result, very valuable animals from this indigenous goat breed were brought from its typical habitat (Kalofer region); some of them were killed for their skin, and others left for breeding, mainly in Southwest Bulgaria (Blagoevgrad region). This region (Blagoevgrad region), however, is a natural habitat of another local breed – the

Bulgarian Screw-horned long-haired goat (Sedefchev et al. 2011; Vuchkov and Dimov 2012). Coexistence and breeding in purebred status of these two indigenous goat breeds, requires clearly distinguished breed types of both of them. For this purpose, we traced typical specimens, with a clearly expressed breed type of Kalofer long-haired and Bulgarian screw-horned goats, reared in herds in Southwest Bulgaria.

The aim of this study was to perform exterior measurements of typical specimens of local goat breeds reared in Southwest Bulgaria - Kalofer long-haired goat (KLg) and Bulgarian Screw-horned long-haired goat (BSg), and to perform a comparative analysis of the exterior features of both breeds. To achieve that aim the following tasks were set:

- to trace purebred specimens with expressed breed type, reared in flocks of Southwest Bulgaria;
- carry out thorough body measurements of fully grown-up bucks and does;
- to calculate some exterior indices in goats and bucks;
- to establish accuracy in the differences in the values of the exterior parameters in both breeds;

Material and methods

For this study were selected 50 goats and 20 bucks of both breeds with clearly expressed breed type in the autumn of 2014 year,. It was formed sample of 100 goats and 40 bucks, reared in 6 herds in the mountainous regions of Southwest Bulgaria. Goats are kept under similar conditions - traditional pastoral technology, with additional feeding of concentrated fodder and meadow hay in winter. In order to perform the body measurements the following tools were used: cane of Lidtin, compasses of Wilckens and a measuring band. The results are processed statistical variation.

Results and discussion

The results shows that the Kalofer Long-haired goats (KLg) are relatively higher at the withers, than the Bulgarian Srew-horned goats (BSg) - 70.76 cm and 66.9 cm respectively. The differences expressed a high degree of probability (Tabl.1.). In comparison with some dairy breeds, the Kalofer Long-haired and has a lower height at withers. According to data from the Ylmaz et al. (2016), the average requirements for Saanen goat height at withers is 73.94 cm, but the height varies from 62.0 cm to 85.0 cm. The height at withers in Shami (a Damascus goat raised in Egypt) females is 69.2 cm and in bucks – 83.1 cm (Helal, 2009). Similar results obtained and Mason (1996) in Valais goats. When compared with the height at withers (68.8 cm) established by earlier authors in other local goats in Bulgaria (Kadijski, 1958; Balevska and Tjankov, 1971) it is clear that the Kalofer Long-haired goats have higher figures for that feature. The measurements of the height at rump and compared with the height at the withers of both breeds, it is clear that Kalofer Long-haired goats (KLg) has higher height at rump, while in the Bulgarian Screw-horned goat (BSg), the height at rump is almost equal to the height at the withers (figs.2,3.). The differences expressed a high degree of probability. It is noteworthy that the KLg has proven broader and deeper chest than the BSg. The coat of the both breeds is long and straight. The quality of the hair while is different - in the BSg hair is dry, harder and slightly wavy. The hair in the KLg is softer and with silky shine.

Table.1. Body measurements of does of the Kalofer Long-haired goat (KLg) breed (n=50), and the Bulgarian Screw-horned long-haired goat (BSg) breed (n=50), reared in Southwest Bulgaria

Body measurements	Height of withers	Height of rump	Diagonal body length	Shoulder width	Chest depth	Width of rump	Rump length	Right back length	Coat length at rump	Coat length at withers	Shin-bone girth	Heart girth
KL s n	50	50	50	50	50	50	50	50	50	50	50	50
X	70,7 6	72,8 2	73,0 8	19,2 8	34,2 2	16,8 6	23,6 8	70,1 6	29,0 6	24,3 4	9,1 7	88,4
SE	0,70	0,52	0,72	0,27	0,39	0,20	0,28	0,62	0,60	0,75	0,0 9	0,79
min	58	62	62	16	28	14	18	61	15	16	8	77
max	79	78	81	24	37	19	26	78	35	32	10	100
BSg -n	50	50	50	50	50	50	50	50	50	50	50	50
X	66,9	66,5 8	70,5 6	17,9 8	30,5 4	15,9 2	21,2 2	63,8 4	23,4 4	17,0 6	8,1 1	82,4 2
SE	0,32	0,32	0,53	0,23	0,32	0,21	0,16	0,49	0,70	0,44	0,0 8	0,54
min	61	60	64	13	21	12	19	54	15	12	7	77
max	71	71	77	23	34	19	23	71	35	25	9	98
P	***	***	**	***	***	**	***	***	***	***	***	***

Table.2. Body measurements of bucks of the Kalofer Long-haired goat (KLg) breed (n=20), and the Bulgarian Screw-horned long-haired goat (BSg) breed (n=20), reared in Southwest Bulgaria

Body measurements	Height of withers	Height of rump	Diagonal body length	Shoulder width	Chest depth	Width of rump	Rump length	Right back length	Coat length at rump	Coat length at withers	Shin-bone girth	Heart girth
KLg - n	20	20	20	20	20	20	20	20	20	20	20	20
X	82,2	83,1	82,42	23,07	39,35	19,5	27,2	81,25	35,45	32,9	11,425	102,87
SE	0,68	0,80	1,16	0,43	0,43	0,26	0,58	1,33	0,95	1,28	0,13	1,23
min	75	76	74	20,5	33,5	17	22	69	26	21	10,5	95
max	88	90	93	27	48	23	31	95	49	42	12,5	112
BSg - n	20	20	20	20	20	20	20	20	20	20	20	20
X	73,4	72,45	78	20,45	34,25	16,25	24,1	69,05	29,25	25,85	9,55	92,4
Se	0,79	0,92	0,90	0,53	0,60	0,22	0,52	0,85	0,76	1,11	0,21	1,31
min	69	68	70	17	30	15	20	63	24	18	8	80
max	83	83	85	24	38	18	28	75	35	32	11	100
P	***	***	**	***	***	***	***	***	***	***	***	***

We recognize the significant superiority of the KLg on the sign length of the hair. The average values of the length of the hair at the rump was 29.06 cm, and the length of the hair at the withers was 24.34 cm. In the BSg values of these signs are with considerably lower values, respectively - 23.44 cm and 17.06 cm. The differences expressed a high degree of probability. The bucks of both breeds has significantly longer hair in compared with the goats (table 2.). The differences between males of both breeds in the signs length hair at the withers, and at the croup expressed a high degree of probability. A clear difference can be seen in the exterior feature shin-bone girth in the bucks (fig.3). The bucks from KLg breed has markedly more massive bones, than the bucks from BSg breed. The shin-bone girth in the bucks from KLg breed was 11.42 cm. In the bucks from BVg breed was 9.55 cm. The difference was demonstrated with a high degree of probability.

Table.3. Measurements of the head in does from Kalofer longhaired (KLg) and Bulgarian Screw-horned goat (BSg) breeds reared in Southwest Bulgaria.

Measurements of the head	Head width	Head length	Ear length	Ear width
KL _g - n	50	50	50	50
X	13,56	19,97	16,2	7,2
SE	0,16	0,18	0,24	0,09
Max	12	18	13	5,5
Min	18	25	19	8
Bsg - n	50	50	50	50
X	12,76	18,32	14	6,06
SE	0,12	0,15	0,16	0,05
min	11	16	12	5
max	14	21	16	7
P	***	***	***	***

Table.4. Measurements of the head in bucks from Kalofer longhaired (KLg) and Bulgarian Screw-horned goat (BSg) breeds reared in Southwest Bulgaria.

Measurements of the head	Head width	Head length	Ear length	Ear width	Distance between peaks of the horns, cm
KL _g -n	20	20	20	20	20
X	14,85	22,2	15,9	7,25	74,72
SE	0,28	0,32	0,48	0,18	4,49
Max	13	20	13	6	47
Min	17	25	20	8,5	108
BSg -n	20	20	20	20	20
X	14	19,5	13,8	6,12	54,2
SE	0,28	0,19	0,15	0,07	2,30
min	12	18	12	6	39
max	16	21	15	7	68
P	*	***	***	***	***

Our results from exterior measurements of the head in both breeds shows that the KLg has broader and longer head, than BSg (Tabl.3,4). The width of the head in KLg was 13.56 cm, and length - 19.97 cm. The width of the head in the BSg was 12.76 cm, and the length is 18.32 cm. The differences are proven with a high degree of probability.

Table.5. Exterior indices in does from Kalofer longhaired (KLg) and Bulgarian Screw-horned goat (BSg) breeds reared in Southwest Bulgaria.

indices	Long leg ndex	Stretchability index	Index of massiveness	Index of bone development
KLg -n	50	50	50	50
X	51,61	103,33	125,20	12,99
SE	0,34	0,47	1,05	0,14
min	48,27	100	113,69	11,42
max	61,64	111,42	139,68	15,51
BSg -n	50	50	50	50
X	54,31	105,47	123,22	12,12
SE	0,49	0,64	0,66	0,12
min	48,48	95,52	116,66	10,29
max	68,65	116,66	140	13,63
P	***	**		***

Table.6. Exterior indices in bucks from Kalofer longhaired (KLg) and Bulgarian Screw-horned goat (BSg) breeds reared in Southwest Bulgaria.

indices	Long leg ndex	Stretchability index	Index of massiveness	Index of bone development
KLg-n	20	20	20	20
X	52,18	100,28	125,26	13,91
SE	0,30	1,31	1,04	0,16
min	44,30	90,85	115,66	12,80
max	59,52	110,12	139,13	15,52
BSg -n	20	20	20	20
X	53,24	106,31	126,00	13,02
SE	0,95	0,93	1,73	0,29
min	45,71	100	108,10	11,26
max	59,45	112,5	133,78	15,94
P		***		*



Fig.1. Heads of the Kalofer long-haired goats (KLg) and Bulgarian Screw-horned long-haired goats (BSg) – does.



Fig.2. Does from the Kalofer Long-haired (KLg) and Bulgarian Screw-horned long-haired (BSg) breeds



Fig.3. Bucks from from the Kalofer Long-haired (KLg) and Bulgarian Screw-horned long-haired (BSg) breeds

Head in BSgt is revatively smaller, triangular in shape, and slightly concave profile. The ears in KLg are large and dropping (fig.1.). The length of the ear was 16.2 cm, width - 7.2 cm. The ears in BSg is a shorter and protruding. The length of the ear was 14.0 cm, width - 6.06 cm width. The differences expressed a high degree of probability.

Conclusions

Coexistence and breeding in purebred status of these two indigenous goat breeds, requires clearly distinguished breed types of both of them. The Kalofer long-haired goat is larger than the Bulgarian Screw-horned long-haired goat - the height at the withers in the females, was - 70.76 cm and 66.9 cm, respectively. The height at the withers in the bucks was - 82.2 cm and 73.4 cm, respectively. The differences expressed a high degree of probability.

The Bulgarian Screw-horned goat has a light stretched format (buck's stretchability index was 106.3), while the Kalofer long-haired goat has a square format (bucks' stretchability index was 100.3). The Kalofer long-haired goat has proven more massive bones (index for the development of the bones was 12.99) than the Bulgarian Screw-horned goat (index for the development of bones - 12.12). The differences expressed a high degree of probability.

Kalofer long-haired goat has broader and longer head. The width of the head in the Kalofer goats was 13.56 cm, and length - 19.97 cm. The width of the head in the Bulgarian Screw-horned goat was 12.76 cm, and the length was 18.32 cm. The differences expressed a high degree of probability.

The Kalofer long-haired goats has large and dropping ears. The length of the ears was 16.2 cm, width - 7.2 cm. The Bulgarian Screw-horned goat has a shorter and protruding ears. The length of the ears was 14.0 cm, width - 6.06 cm. The differences expressed a high degree of probability.

References

- Balevska, R., S. Tjankov. 1971. Study of the Rilomanastirska goat breed. Scientific studies of a Zootech. Faculty, t. XXII, Sofia., Zemizdat. 315 – 323.
- Helal, A. 2009. Body measurements and some coat characteristics of Shammi (Damascus) goats raised in North Sinai, Egypt. *World Journal of Agricultural Sciences* 5 (5): 646-650.
- Kadiiski, E. 1958. Study of the local goats breed. Dissertation.
- Krastanov, Zh. 2003. Status of genetic resource in Bulgaria. *Animal science*, p.1-2, pages 7-9.
- Mason, I.L. 1996. *A World Dictionary of Livestock Breeds, Types and Varieties*. Fourth Edition. C.A.B International. 273 pp.
- Sedefchev, S., A. Vuchkov, A. Sedefchev. 2011. Description and preservation of Bulgarian native goats breeds. *Agricultural Sciences*. No. 6. 67-53.
- Solomonov H., E. Kadijski, I. Lazarov, 1984. *Goat breeding*. Sofia. Zemizdat. p. 133.
- Tjankov, S., I. Stankov, R. Slavov. 1996. *Goat breeding*, St. Zagora. p. 132.
- Vuchkov, A., D. Dimov. S. Sedefchev. 2011. Body measurements of the Kalofer long-haired goat breed in Bulgaria , 8-th Global conference on the conservation of animal genetic resources, Tekirdag, Turkey. 251-259.
- Vuchkov, A., D. Dimov, 2012. Description and measurement of the exterior of the Bulgarian Screw-horned long-haired goat. *Scientific practical conference, Shumen. Agricultural science*, 45 (5-6), 62-68.
- Yılmaz Murat, H. Erbay Bardakcioglu, Tufan Altın. 2016. Comparison of some body measurements for Saanen goats. *Scientific Papers-Animal Science Series:Lucrări Științifice Seria Zootehnie*, vol. 65. 134-137.

ROLE OF INFORMATION AND COMMUNICATION TECHNOLOGIES IN INNOVATION OF LIVESTOCK SYSTEMS AND TERRITORY PROMOTION. A CASE STUDY OF CALABRIA REGION, ITALY

Adriano CIANI^{1*}, Annalisa GAMBARDELLA²

¹Perugia University, Perugia, Italy

²Freelancer, Italy

*Corresponding author: adriano.ciani@unipg.it

Abstract

A big theme at the centre of the global debate but also national one is the environmental issue also linked to intensification of agricultural-livestock production systems. The intensification trend appears to be closely related to the strong demographic and economic growth verified worldwide in recent years. According to forecasts, in 2050 population will reach 9 billion people; taking into account that today records a total of 859 million people living in a state of food insecurity, it obviously increases the demand for animal protein. The methodology of the paper is an empirical approach. By the theoretical framework of the livestock innovative systems and the strategy of valorisation of the internal area the authors produce a concrete possible project to implement at the level of the Calabria Region. The research, ultimately promoting Livestock Innovative Systems, engages in a consistent manner the Strategic Plan for the internal areas of the Calabria Region. Therefore, it aims to strengthen the potential of this region, stemming in particular from the great variability and diversity that characterizes the Region and that can be a great competitive advantage. This paper points out finally that such action must be pursued through the introduction of all possible innovations concerning the production process and the marketing and promotion, as well as services for productive activities, to the world of work and society. The authors conclude that all of this is possible to achieve with a massive introduction of ICT.

Keywords: *Livestock Management, Sustainable Development, Promotion of Territory, ICT, Local Food Chain*

Introduction

The current economic model, based on the strong industrialization of the production systems and thus on the indiscriminate exploitation of resources, brought heavy environmental and social impacts. Animal husbandry, as stated in the FAO report "The State of Food and Agriculture" (FAO, 2010), is one of the sectors of the agricultural economy that records the fastest growth. The cattle also represents 40% of the total value of agricultural production and provides livelihood and food security to over a billion people. Worldwide, it provides 15% of total food energy and 25% of dietary protein. The world economy is anyway directed towards increasingly greater production and thus at growing consumption of animal products. In response to the growing demand for animal products has widespread the intensive farming system, able to ensure greater production in a shorter time frame. However this turns out to be a major contributor to the many environmental changes that in recent decades are being recorded both locally and globally. (IPPC-UNEP, 2014) New strategies are therefore needed so that the livestock sector can meet the growing demand for animal products and at the same time contribute to the food security to the poverty reduction, environmental sustainability and human health. More specifically, in the livestock sector, innovative approaches should be based on controlled ecological cycles, in which the animal plays a key role, thanks to its physiological mechanisms that allow it to increase the value of biomass. (CREA

EXPO, 2015). The livestock sector is one of the most representative activity of the inner and central areas. The latter are patterned by the presence of important environmental resources and valuable agricultural products characterized, by high typicality and appreciation from the market. The most important characteristics of these products come from the link between the territory vocationality and production techniques. It follows that the foodstuff of these areas becomes cultural heritage and local identity element. In this way it's important try to implement innovative project characterized by the strictly linkage between tradition and innovation

Literature on issue

Agriculture and rural areas thus play a crucial role as they are located to perform new functions in society, in a multi-functional operating environment that integrates the strictly agricultural/productive activities "in" the territory to the conduct of business "for" territory, from tourism and recreation and landscape to cultural, educational and social (OECD, 2007). However, rural areas are still deeply marked by the loss of traditions, the resources and uses linked to the cultivation of the land; the need to protect nature and maintain biological diversity in specific areas is critical to the ecological balance, as well as, hand in hand, the need to preserve and pass on country "knowledge and tastes" is essential for the survival and development of rural areas. In fact the Community agri-food products stand out in terms of quality because of the differences and the territorial and historical identities, which make them "attractive" for the consumer (Ciani 2015). Agriculture is a fundamental defense of the territory, a bulwark for the protection of collective goods, territories and rural landscapes, and to preserve the historical memory. The erosion of this heritage entails, however, the loss of cultural identity and farming skills handed down from generation to generation that threatens the very rural economies. (Giuca, 2013). Digital technological innovations and network, and their progressive integration into the world of production, processing and consumption of food, both at a macro level (production and distribution) and at micro-system level (end user enjoyment) are of fundamental importance. Globally, digital technologies are particularly contributing to network individual entities, causing major socio-cultural, political, technological and environmental changes toward the IV Industrial Revolution (Schwab, 2016), The Age of Sustainable Development (Sachs, 2015), and the implementation of Circular Economy. (Webster, 2015) It changes the consumer's relationship with the manufacturers and distributors, but also with his body, his senses and space. The user is transformed from mere spectator to active information manufacturer: change the processes of knowledge and the means of communication that put users in relation with each other. This is confirmed also in the light of a recent article of "Seed and Cheep" (Cinquemani, 2016) which shows that the ten future trends of agribusiness innovation are represented by:

- ***Precision agriculture;***
- ***Controlled environment agriculture;***
- ***3D Printers;***
- ***Nutraceuticals;***
- ***Traceability;***
- ***Packaging;***
- ***Precision nutrition;***
- ***Smart kitchen and precision cooking;***
- ***Sharing economy;***
- ***E-Commerce.***

ICTs have repeatedly demonstrated their potential to combat poverty in developing countries. In many cases, there are experienced benefits in the form of increased income; better health care;

better education and training; access to job opportunities; commitment to public services; contacts with family and friends; business development opportunities(Ciani ,2012); increased agricultural productivity, and so on. " (Meena and Singh, 2013).Among the various advantages offered by the introduction of innovations in agriculture that figure coming from agriculture precision, the use of ICT platforms and processes to promote communication, information exchange and networking among a large number of individuals, organizations and businesses, from monitoring of land use models. Environmental databases can be used to monitor the status of various indicators and impacts for sustainable environmental management and environmental protection. The connection of these roles unleashes the potential that ICT offers to address environmental issues with a high degree of accuracy and timeliness. Public investment in ICT applications will be particularly important in coping with the unpredictability of climate change. (Hall and Dorai, 2010)The change of course is necessary to achieve a sustainable type of development, therefore, requires the transformation of the patterns of production and consumption, supported by a radical technological transformation. The technology will have to go against real changes, so as to become more efficient. The main challenges to start the transition to a green economy include the improvement of use of these technologies, their adaptation to local and sector-specific requirements, extending applications to reduce costs and providing incentives and mechanisms to facilitate their spreading. These challenges require a long-term vision, political will, additional investment and coordination of actions at the global and local level. (Vos and Alacorn, 2016)These issues are closely related to the concept of circular economy, based primarily on the conservation value of materials and energy used in products for durability and minimizing waste and excessive use of resources. It is an economy where the waste of a production and consumption process circulate as a new entry in the same or a different process.(Fig 1 and 2).



Fig 1-Theoretical linear economy scheme
Source:Our Elaboration

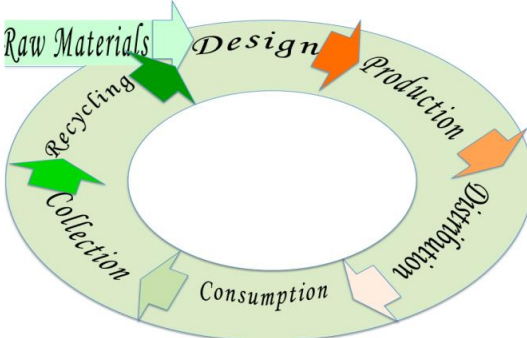

Fig 2- Theoretical circular economy scheme
Source:Our Elaboration

The circular economy can foster competitiveness, innovation, a high level of protection for man and the environment, and bring important economic benefits, thus contributing to the growth and creation of jobs. It can also provide more durable and innovative products that provide consumers with cost savings and increased quality of life. The development of innovative solutions and new markets also need to be supported as key elements of circular economy. Research and innovation should be encouraged in order to effectively take these opportunities forward. (E.U., 2015).In this regard, in July 2014, the European Commission has adopted a circular: "Economy Package" including a Communication entitled "Towards a circular economy: a zero waste program for Europe", accompanied by communications

related to sustainable construction, green jobs, and a legislative proposal for the revision of waste legislation.

Objectives, Materials and Methods and Survey Proposal

Objectives

This paper aims to contribute to outline the possible virtuous combination of a highly innovative and sustainable future of the livestock and the exploitation of the Inner Areas of a region highly representative as is the context of Calabria in the context of National and European reference.

The work has as its reference point the Calabria Region, which has a significant variability for animal husbandry and agriculture, thanks to the typical geographical and productive characteristics of the pastures, and still today allows farmers to maintain traditional techniques of production and processing of foodstuffs, especially for those of animal origin. Faced with this potential another objective of the research is to try to turn the weaknesses of the inland areas into strengths, through triggering the existing strong innovative mechanisms, namely through the implementation of the strategy called “*Tradi-Ovation*”. This is to create a “*New Renaissance*” of these internal areas and to stimulate sustainable land management and the strengthening of circular economy, in line with the sustainable development strategy of “Sustainable Development Goals 2030”, to promote and raise the quality of life.

Materials

The first part of this paper is devoted to a bibliographical study, linked to the role of ICT in the livestock sector and the enhancement of rural areas, in line with the Sustainable Development Goal's 2015-2030. Subsequently a possible in the Region of the sector's recovery program has been outlined with the aim of achieving the implementation of plans and projects enhancement of Inner Areas.

Methods

The method is highly empirical, since the design of the relaunch of the Calabrian livestock program was based on in-depth study of the role of innovation in territorial development. It was developed a spatial analysis of the Inner Areas of the Calabria region and a study of the livestock sector of the territory through the collection of data from recent research projects and studies. Also it was carried out research designed to detect the current territorial situation from the point of view of innovation in the field of agro-livestock and based on these data it was possible to identify an innovative plan that suits real and current necessitated the territory through an approach based on the concept of local growth of type "Bottom-up".

Survey and Proposal

The theme of the development of the inner areas of the Calabrian territory is particularly relevant. The Internal Areas of Calabria, which constitute a large part of the territory, are central to the provision of ecosystem goods and services for the food chain and for the production of energy from renewable sources. However, a substantial proportion of these areas has suffered, over the decades, a gradual process of marginalization. The internal areas of Calabria are characterized by a great and unique variety of natural habitats. Agriculture is the main activity associating also a clear environmental advantage of climate, spread of agriculture and extensive animal husbandry.

Results and Discussion

Everything what has been mentioned above, requires a real effort expected among within the other European Digital Agenda (*Barroso, 2009*) which provides for 2020 to reach 80% of the

population with broadband. Through this innovative infrastructure, that should cover in particular the rural areas it is possible to imagine that an innovative livestock is able to support the great visionary project of a sustainable combination of Smart Cities, Smart Lands and Smart Communities. This offers great chances to take part in the great project of the Sustainable Development Goals 2015-2030 to reach a sustainability measurement approach no longer with the GDP-Gross Domestic Product but through GNH-Gross National Happiness. It is essentially to achieve a goal in which the territory with the approach M2M (machine to machine) is able to communicate with the users in various ways in real time. This approach allows the creation of a new urban-rural relationship, in order to facilitate collective business initiatives, encounter between supply and demand, the development of creative ideas, the protection and defense of the environment and landscape, the stimulus to the emergence of new entrepreneurship in the integration between agricultural activities and maintenance of the territory, the development of a new welfare in urban margins, social and educational farms, low cost tourism, urban forestation to improve the local environment and contribute to action against global climate change (Kyoto Protocol). In this context, this paper tends to make the internal areas of the territories that express the full production potential and supply of related services mainly to tourist use niche. This road will increase the chances of reaching an exaltation of multifunctionality "breeder" of the companies that operate there. A strategic plan for the Internal Areas of Calabria Region must necessarily have an integrated vision that seeks to strengthen the potential of this diversity and variability typical of the area, which the tradition of good practices grafts all possible innovations relating to both the production process and storage, marketing and promotion, as well as services for productive activities, to the world of work and society. It is important, next to a sustainable land management, the widespread introduction of technological innovations at the service of the productive activity and of all the Information and Communication Technology systems, serving the same basic production activities, as well as the activities related to livestock sector and services aimed at the promotion, enhancement and enjoyment of the landscape. For the livestock sector can be highlighted the PLF (*Precision Livestock Farming*), the use of drones and smart and self-milking systems.



Figure 3 Podolica breeding - Sila



Figure 1 Geographic Information System

The first guarantees a better control and monitoring of animals through the use of sensors placed on the animal, which send data of a different kind (environmental and animal) and the breeder who receives them can easily control every single item. The purpose of these technical tools is not to replace, but to act as a support to the figure of the breeder (*Fontana and Guarino, 2015*).

The drones are configured as put into effect tool to provide satellite images, in this case for rearing, improving the company's control, and the continuous monitoring of the animals.

Another innovative technology that can be applied to farm is that of the open source GIS tools and GIS-MCDA (Geographic Information System - based on - Multi-Criteria Decision Analysis) for a territorial analysis(*ERSA, 2012*). It is aimed at collecting geographic

information systems, research, representation and analysis of spatial data. Such a system can ensure the optimal use of *pasture land by the livestock farms, through forecasting models* able to simulate the behavior of components of pastoral systems in order to rationalize their use. This may be an interesting contribution to the development of the territories in particular for those marginal

Conclusions

This study wanted to provide opportunities for enhancement of the Inner Areas through the re-launch of an innovative and sustainable animal husbandry. This was done taking into account the potential benefits offered by the region, from local breeds and by the professionalism of the local operators. The analysis of the existing livestock production showed a variation of the same and an extraordinary force that significantly transmits the sensations of colors, smells, tastes, sounds and even passions and love for the players' attachment to their land. The international reference framework (Sustainable Development Goals 2015-2030) as well as European, Italian and regional ones enabled us to identify on the existing, in a concrete way the confirmation of the hypothesis of the work, which can activate the re-launch of the Internal Areas of Calabria through sustainable and innovative livestock projects. Moreover, the presence of pastureland and transhumance provided in innovative animal husbandry, have had and still have special importance in the context of landscape and biodiversity conservation. They have contributed and contribute to shaping, in time, unique landscaped areas, management models and invaluable know-how and can contribute to the maintenance of plant species and animal breeds that would otherwise be destined for disappearance. This allows to restrict the genetic erosion and cooperate in the development and conservation of biodiversity. All these aspects are going to be important opportunities, especially for Inner Areas, turning weaknesses into strengths of social and economic development of the same. This can happen, considering the current situation, strongly since the beginning of the Industrial Revolution IV, related to the consolidation of circular economy. This is to create a path of modernization, keeping the traditions "*Tradi-Ovation*", that raises the level of professionalism, human capital and quality of life with highly sustainable and characters and with high representativeness of the role of man garrison on the territory. The experience of the project has the character of *repeatability, traceability and transferability* and represents a way of further *transformation of the weaknesses into strengths* of the rural areas of each country including Bosnia –Herzegovina and an innovative *interlocking possible sustainable management and promotion of the territory*.

References

- Barroso J.M, (2009), "A Vision for EU 2020", E.U. Bruxelles
- Ciani A, Voros L.M., Fagioli Fiume F., (2015), The Role of Local Food Chain in the Sustainable Management and Promotion of Territories. A Comparison Case Study of Umbria Region in Italy and the Sub-Region of Pest County in Hungary, in "The Value of Food. Internationalization, competition and local development in agro-food systems", edited by Sorrentino A., Severini S., Cicatiello C., Proceedings of the 52nd SIDEA Conference, Rome/Viterbo, September 17th – 19th, 2015, Rivista di Economia Agraria, Vol. 71, No. 1 (Suppl.), pp. 546-549, ISSN 2281-1559, DOI 10.13128/REA-18671
- Ciani A. (2012). Agro Food Traceability Organization (Territorial) Marketing and Movie Oriented A.T.O.M.O. The 2nd International Conference on Engineering and Met-Engineering, Proceedings – ISBN-978-1-936338-16-0, pp. 141-151.
- CREA-Center for Research in Economics and Agriculture,(2015), EXPO 2015, Press review, "Innovative approaches for sustainable livestock", <http://www.crea.gov.it/wp-content/uploads/2015/10/Zootecnial.pdf>

- ERSA-Ente Regionale di Sviluppo Agricolo–Calabria(*Regional Agency for Agricultural Development of Calabria* (2012), “Progetto Maso-Gis”(Farm Project, GIS) , <http://www.ersa.fvg.it/tematiche/ricerca-e-sperimentazione/zootecnica/progetto-maso-gis>
- E.U.,(2014) Community Led Local Development, Cohesion Policy 2014-2020,Factsheets,http://ec.europa.eu/regional_policy/sources/docgener/informat/2014/community_en.pdf, doi:10.277622575
- E.U. Commission,(2014), Community Led Local Development, Cohesion Policy 2014-2020,Factsheets,http://ec.europa.eu/regional_policy/sources/docgener/informat/2014/community_en.pdf, doi:10.277622575, (2014)
- E.U. Commission(2015), Closing the loop. An EU action plan for the Circular Economy,COM(2015) 614 ,(2.12.2015),Bruxelles
- FAO,(2010)For a sustainable livestock sector, <http://www.fao.org/news/story/it/item/40148/icode/>
- Cinquemani T., (2016,) “Food Innovation, 10 trends that will change the world”, da Seeds&Chips (Milano), <http://agronotizie.imagelinenetwork.com/agricoltura-economia-politica/2016/03/29/food-innovation-ecco-le-10-tendenze-che-cambieranno-il-mondo/48044>
- Fontana I., Guarino M., (2015), “The point on the PLF, Past, Present and Future ”, Department of Veterinary Science for Health, Animal Production and Food Security (Vespa), University of Milan.
- Giuca S., (2013), INEA “Towards sustainable agriculture and consumption”, <http://www.inea.it:8080/documents/10179/157401/INEA%20AGRICOLTURA%20SOSTENIBILE.pdf>
- Hall A., Dorai K., (2010), “The greening of agriculture agricultural innovation and sustainable growth” in OECD Green Growth Studies , AgBioForum, Vol. 14, No. 1.
- IPCC-Intergovernmental Panel for Climate Change , (2014),IV Climate Change Report , New York ; [w.ipcc.ch/pdf/assessment-report/ar5/syr/AR5_SYR_FINAL_SPM.pdf](http://www.ipcc.ch/pdf/assessment-report/ar5/syr/AR5_SYR_FINAL_SPM.pdf)
- Meena H.R., Singh Y.P., (2013), “Importance of information and communication technology tools among Livestock farmers: A review”, <https://www.researchgate.net/publication/236148237>
- OECD, Department for Trade and Agriculture,(2007), Multifunctionality, <http://www.oecd.org/department/0,3355,en_2649_33779_1_1_1_1_1,00.html
- J. Sachs,(2015) The Age of SustainableDevelopment,ColumbiaUniveristy Press, ISBN-13: 978-0231173155,Pag 543, New York , (2015)
- Schwab K., (2016), “The Fourth Industrial Revolution: what it means, how to respond”, World Economic Forum, <https://www.weforum.org/agenda/2016/01/the-fourth-industrial-revolution-what-it-means-and-how-to-respond/>
- Vos R. and Alacorn D., (2016), “Technology and Innovation for Sustainable Development”, The United Nations Series on Development, New York, ISBN – 978 1-4725-8075-7
- VIAGGIART, <http://www.viaggiart.com/it/info>
- UNGASS-UnitedNation General Assembly,TrasformingOurWordl:the Agenda 2030 for Sustainable Development ,25 September 2015, New Yoork, A/RES/70/1
- K, Webster, *The Circular Economy: A Wealth of Flows*, ISBN-13: 978-0992778422, Ellen Macarthur Foundation Publishing, New York , (2015)

DETERMINATION OF SOME EGGS TRAITS OF WHITE AND BRONZE TURKEYS IN A FREE-RANGE SYSTEM

Atilla TASKIN*, Ufuk KARADAVUT, Huseyin CAYAN, Ahmet SAHIN

Department of Animal Science, Faculty of Agriculture, University of AhiEvrان, Kirsehir, Turkey

*Corresponding author: ataskin@ahievran.edu.tr

Abstract

The study was conducted to determine some egg traits of white and bronze turkeys (*Meleagris gallopavo*) reared in a free-range system. A total of 144 female turkeys (72 white and 72 bronze) were used for this study. The turkeys between 32 and 55 weeks of age were used. For measuring egg production and mortality of turkeys, egg weight, shape index, shell weight and shell thickness. In both genotypes, egg production was decreased by age. Moreover, the white turkeys were more vulnerable to free-range conditions in terms of legs problems and consequent liability. The white turkeys laid heavier eggs than the bronze ones (88.7 g vs 80.27, $P < 0.05$). All determined egg parameters were different in the white turkeys compared to those in the bronze turkeys. Furthermore, as animals were getting older, egg weight of both white and bronze turkeys were increased. However, their shell weight and thickness were decreased by age. To conclude, the bronze turkeys showed better performance and egg quality traits compared to the white turkeys.

Keywords: Egg, free-range, genotype, Turkey.

Introduction

Egg production of turkeys has been studied in lower extent since only sixty-ninety eggs are obtained from turkey hens in one ovulation season. The weights of turkey eggs have been reported to be affected by age and season. In this case, the quality properties for turkey eggs have become important (Nestor et al., 1995).

Housing conditions can affect production traits as affected animal welfare (Tuytens et al., 2008; Taskin et al., 2014). The regulations relating to the welfare of farm animals are usually applied on a voluntary basis (Petek, 2012). Poultry are kept usually on cages and small floored areas. All production data have been produced from intensive housing conditions. In particular, recent tendencies on poultry production have been semi-intensive, extensive, free-range and ecological farming. The products obtained from alternative systems are more natural, healthy and produced in accordance with accepted that animal welfare, but expensive (Sarica and Yamak, 2010).

Unlike white turkeys, bronze turkeys are usually black in color, feathers covering the whole body are bright like bronze. This breed is no longer a pure origin in any country, including America, our country is also still producing hybrids with this breed (Camci and Sarica, 1991; Cevher and Turkyilmaz, 1999; Turkoglu et al., 2005).

Turkey is mostly used in the production of semi-intensive and extensive farm but found insufficient in terms of development and reproductive characteristics are needed in the development of these characteristics bronze turkeys. Maurice et al. (1990) did not detect a decrease in body weight in different farming conditions.

When animals are kept in closed areas, they are affected negatively. Naturally illumination and ventilated system in free-range system improve animal welfare and health. Free-range systems outside the shelter, there is a wide area and can take advantage of the sunlight can exhibit natural behavior of animals. Free range system allow animal dust bathing outside. This

opportunity may affect production and live weight (Turkoglu and Sarıca, 2009; Thiele et al., 2008).

With increasing the egg weight, egg shell thickness, the percentage of the total and thick albumen, the ratio of the total, thick and thin albumen to the yolk was elevated, whereas the proportions of the egg shell vs. the whole egg, the percentage of the yolk and the yolk index are reduced in turkeys (Bachev et al., 1970).

Isidahomen et al. (2014) studied egg traits of Local, Exotic and Crossbred turkeys. They found egg weights of 65.85 ± 0.87 , 76.10 ± 1.71 and 70.98 ± 0.92 , respectively. Egg length, egg width, shell weight, shell thickness were determined as 5.85 ± 0.09 , 6.27 ± 0.16 and 6.09 ± 0.09 cm; 4.04 ± 0.05 , 4.32 ± 0.07 and 4.14 ± 0.06 cm; 6.20 ± 0.09 , 7.35 ± 0.10 and 6.55 ± 0.15 g; 0.34 ± 0.00 , 0.36 ± 0.00 and 0.36 ± 0.00 respectively to genotype and parameters.

As give above, the studies on turkey have been quite old. Also, there has been no studies regarding the egg traits of turkey hens in free range condition. Therefore, in this study, two strains of turkeys were compared with respect to egg production traits and live weight changes in free range conditions.

Material and Methods

This study was conducted in Free Range Poultry Unit of Agriculture Faculty of Ahi Evran University, Kirsehir (Turkey). One hundred forty four females were used 72 of them was for white, 72 of them was for bronze turkeys. Bird density was 2 birds/m² indoors and 0.66 birds/m² outdoors. Feed and water were provided *ad libitum* inside the houses only. The pens (indoors) were 2.0 × 6.00 m in size and bedded with fresh wood shavings. They were daily observed for mortality and any abnormalities. Both genotype of the animals, in the first eight weeks, the diet having 28% crude protein and 2800 kcal ME / kg were fed on. Ambient temperature was $32 \pm 1^\circ\text{C}$ throughout the first week and progressively $< 21^\circ\text{C}$ by third week and the relative humidity was well kept in just about 60-70%. 23, 20 and 16 h of light were provided to 7, 12 and 17 weeks of age, correspondingly in the housing. In the upcoming period, the diet having 21% crude protein and 3100 kcal ME / kg were offered. After 17 weeks, a diet including 16% crude protein and 2800 kcal ME / kg were given. All hens were provided feed and water *ad libitum*. All diets were formulated to include sufficient nutrient levels as suggested by the NRC (1994). During experimental period, were divided to tree replications each included 24 females, totally 72 animals for each genotype.

Animals 2x6x2 m (height x length x width) in a closed area and also they can come and go freely from sunrise to sunset again 2x18x2 m (height x length x width) were reared in an open field. In open areas, land is used in its natural state. In this study, round type plastic feeders and drinkers were used. In order to determine egg production, wooden nesting boxes were used. Each box was replaced for three hens.

The birds were fed and reared under uniform conditions. At the age of between 32 and 55 weeks, 30 eggs produced by each line were taken for examination of the following morphological traits: average egg weight (AEW) and egg shell weight (SW) with a precision of 0.01 g. Egg length and egg width of the egg were measured with electronic digital caliper sensitive to 0.01 mm. The shape index was determined according to the formula Shape Index (SI) = [egg width / egg length] × 100 (Anderson et al., 2004). The shell thickness (ST) was determined according to Monira et al. (2003).

All data collected were subjected to Analysis of Variance in a general linear model (GLM) of the Statistical Analysis System Institute (SAS, 1999). Significant differences were computed using Duncan multiple range test (Gomez and Gomez, 1984) to determine the significance of specific classes. Also, linear regression analysis were conducted between weeks and each of egg traits egg weight, shape index, shell thickness and shell weight.

Results and Discussion

According to present results, genotype significantly affected egg weight and some egg traits. Similarly, egg weight variations in different genotypes were reported (Chatterjee et al., 2007). Egg shape index (SI) were affected by genotype significantly ($P < 0.05$). The white turkey showed higher values in SI than that of bronze turkey. Shell weight was significantly ($P < 0.05$) affected by genotype. The egg shell weights were significantly higher in white turkey than that of bronze turkey. Shell thickness varied significantly ($P < 0.05$) between genotypes. The shells of white turkey eggs were thicker than that of bronze hens.

Body weight and egg weight of poultry was positively associated (Shanawany, 1987). The average weight of eggs determined as 80.27 g and 88.7 g in bronze and white hens respectively. This value is similar to values reported by different researchers of turkey eggs (Christensen and Nestor, 1994; Christensen et al., 1996; Anandh et al., 2012).

According to a study of Anandh et al. (2012), there were three turkey mean shape index values 76.10 ± 0.21 , 75.00 ± 0.31 and 75 ± 0.13 , respectively, and turkey egg weight groups were significantly different did not in terms of egg shape index. The present results regarding shape index are consistent with this value.

For both genotypes, the egg production (HHEP) and the live weights of turkey hens decreased by aging as seen in Figure 1.

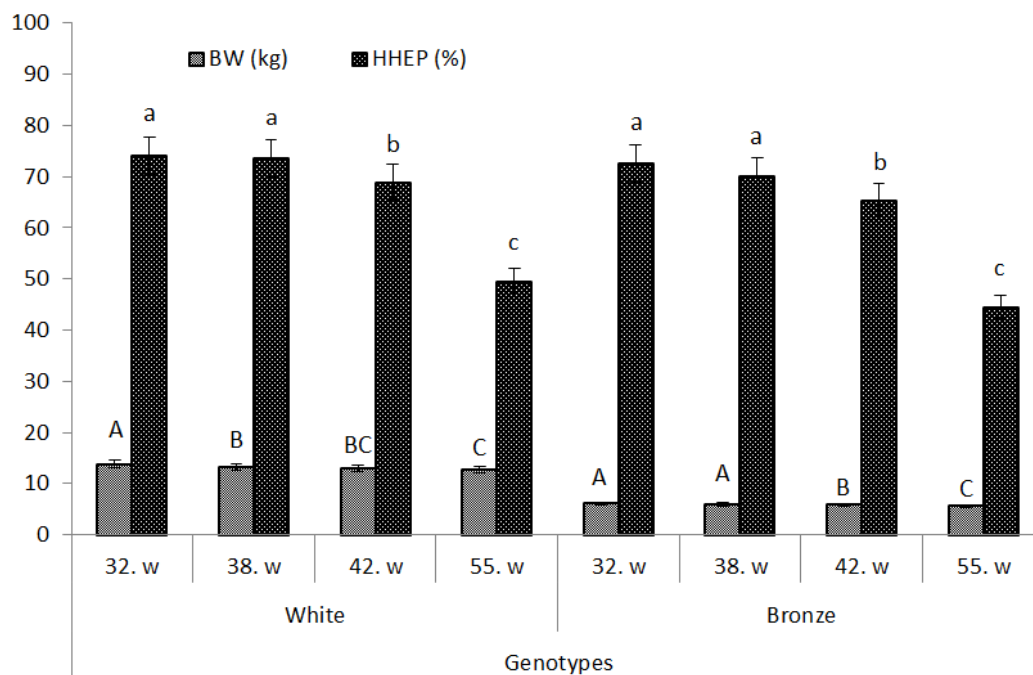

Figure 1. Bodyweight and egg production of female turkey egg production period. BW (Bodyweight, kg); HHEP (Hen housed egg production, %), * $P < 0.05$; the average difference between groups with different letters are statistically significant

In both genotypes, the average egg weight was increased by age. However, the other egg traits decreased by age as given in Figure 2. Between these parameters and the ages of turkey hens, the higher regression coefficients were obtained.

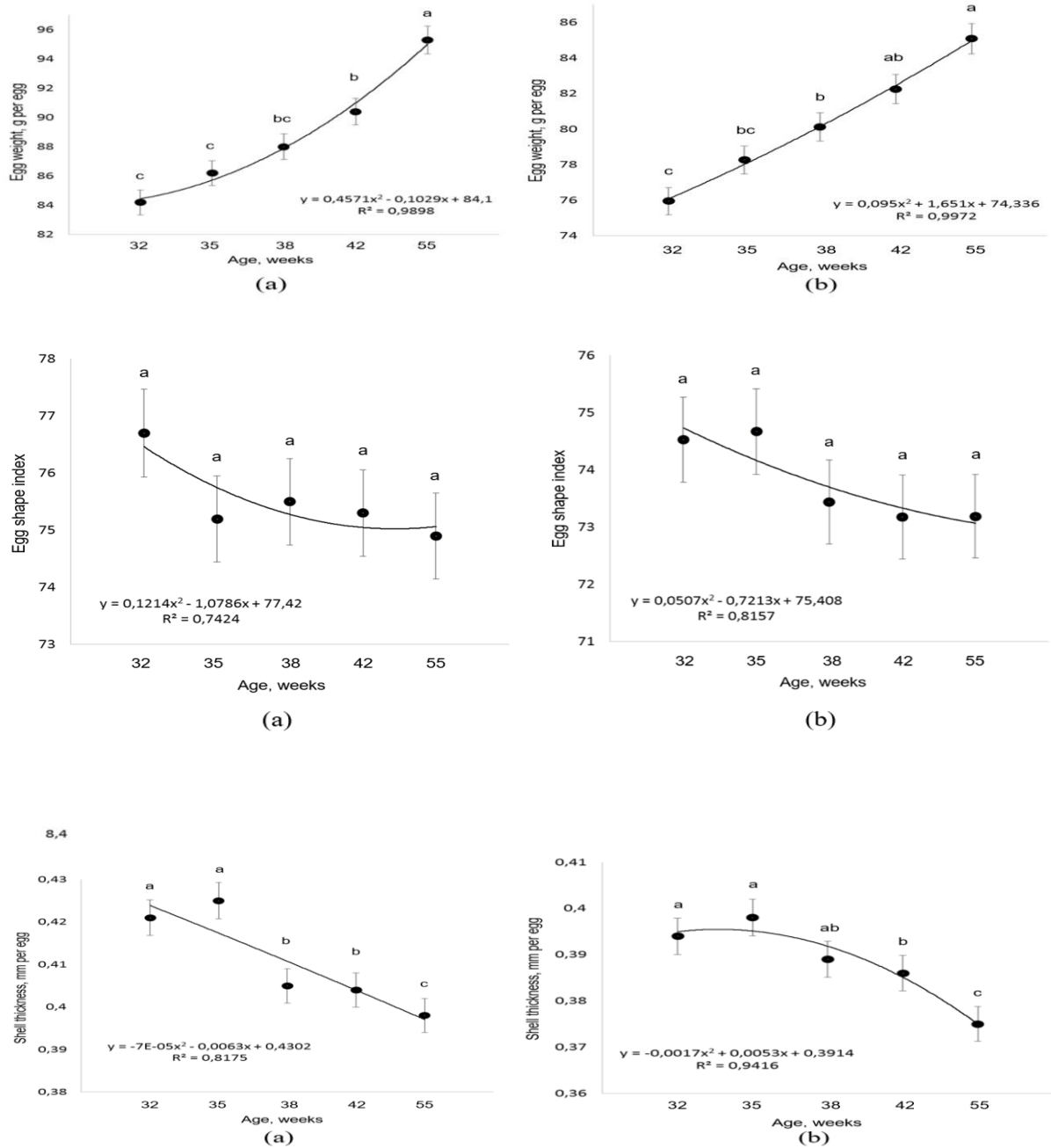

Figure 2. Distribution of egg traits in white (a) and bronze (b) turkeys (n=30). The average difference between groups with different letters are statistically significant.

Conclusion

When bronze and white turkey hens were getting older they produced heavier eggs with losing their qualities in free range housing system. To conclude, the bronze turkeys showed better performance and egg quality traits compared to the white turkeys in free range system.

Acknowledgements

This work was supported by the Ahi Evran University Scientific Research Projects Coordination Unit. Project Number: ZRT.E2.16.016.

References

- Anandh M.A., Jagatheesan P.N.R., Kumar P.S., Rajarajan G., Paramasivam A. (2012). Effect of Egg Weight on Egg Traits and Hatching Performance of Turkey (*Meleagris gallopavo*) Eggs. *Iranian Journal of Applied Animal Science* 2(4), 391-395.
- Anderson, K.E., Tharrington J.B., Curtis P.A., Jones F.T. (2004). Shell characteristics of eggs from historic strains of single comb white leghorn chickens and relationship of egg shape to shell strength. *Int. Jour. Poult. Sci.*, 3:17-19.
- Camci O., Sarica M. (1991). Intensive turkey production. *The Journal of TIGEM* 36:5-19.
- Cevher Y., Turkyilmaz M.K. (1999). Turkey meat and its importance. *The Journal of Veterinarian Union* 70:3-4.
- Chatterjee R.N., Rai R.B., Kundu A., Senani S., Sundar J. (2007). Egg quality traits in indigenous breeds of chicken of Andaman; India. *Vet. J.* 84: 206-208.
- Christensen V. L., Donaldson W.E., McMurtry J.P. (1996). Physiological differences in late embryos from turkey breeders at different ages. *Poult Sci.*, 75(2):172-178.
- Christensen, V.L., Nestor K.E. (1994). Changes in functional qualities of turkey eggshells in strains selected for increased egg production or growth. *Poult Sci.*, 73:1458-1464.
- Isidahomen C.E., Njidda A.A., Adeniji A.A.(2014). The effects of genotype on internal and external egg quality traits, egg proximate composition and lipid profile characteristics of three Strains of layer turkeys. *Inter J AgriBiosci*, 3(2): 65-69.
- Maurice D.V., Jones J.E., Lightsey S.F., Rhoades J.F. (1990). Response of male poult to high levels of dietary niacinamide. *Poult. Sci.* 69: 661-668
- Monira K.N., Salahuddin M., Miah G. (2003). Effect of breed and holding period on egg quality characteristics of chickens. *International Jour. Poult. Sci.*, 2:261-263.
- Nestor K.E., Noble D.O. (1995). Influence of selection for increased egg production, body weight, and shank width of turkeys on egg composition and the relationship of the egg traits to hatchability. *Poultry Sci.* 74:427-433.
- Petek M. (2012). Free range egg production and its importance in Turkey. <http://www20.uludag.edu.tr/~petek/free%20range.doc>.
- Sarica M., Yamak U.S. (2010). Developing slow growing meat chickens and their properties. *Anadolu Jour. Agric. Sci.* 25: 61-67.
- Shanawany M.M. (1987). Hatching weight in relation to egg weight in domestic birds. *W Poult. Sci J.*, 43:107-115.
- Taskin A., Karadavut U., Camci O. (2014). The Effect of Nest Box Curtain Color on the Nest Box Choice of Brown and White Layer Hens Breed in a Free-Range System. *Greener Journal of Agricultural Sciences*. 4(6): 258-264, <http://dx.doi.org/10.15580/GJAS.2014.6.063014284>
- Thiele H.H., Pottgüter R. (2008). Management recommendations for laying hens in deep litter, perchery and free range systems. *Lohmann Information*. 43: 53.
- Turkoglu M., Sarica M. (2009). *Poultry Science, Husbandry, Nutrition, Diseases*. 3rd Ed. Ankara: Bey Ofset Printing Company.
- Turkoglu M., Sarica M., Eleroğlu H. (2005). *Turkey breeding*. Uğurer Agricultural Books, Otak Form Ofset, Samsun.
- Tuytens F., Heyndrickx M., De Boeck M., Moreels A., Van Nuffel A., Van Poucke E., Van Coillie E., Van Dongen S., Lens L. (2008). Broiler chicken health, welfare and fluctuating asymmetry in organic versus conventional production systems. *Livestock Science* 113:123-132.

IDENTIFICATION AND PHENOTYPIC CHARACTERIZATION OF FIVE LOCAL CATTLE OF BUSHA TYPE FARMED IN ALBANIA AND KOSOVO

Naim REXHAJ^{1*}, Lumturi PAPA¹, Kristaq KUME²

¹Agriculture University of Tirana, Albania

²National Coordinator of FarmAnimal Genetic Resources, Albania

Corresponding author: lumturipapa@yahoo.com

Abstract

Busha autochthonous cattle are spread out mainly in the borders between Albania and Kosovo and Kosovo and Macedonia. It is classified in the group of short horn breeds. Most of Busha population is found in remote mountainous areas, and it is well adapted to extensive farming system. Five local populations of Busha cattle type are identified until now in Kosovo and Albania. Their number per farm, rearing system, morphology and morphometrical measurements was registered according to Food and Agriculture Organization guidelines (2012). Albanian populations are characterized by small body size, big head, broad forehead, medium size ears with a lot of hairs inside inward back, and short horns. The data from previous study shows that average milk yield is 300-400 kg per cow and in some cases up to 60-700 kg. Lactation length is 4-5 months. These cows in Kosovo are bigger in body size, comparable in frontal width, shaped and longer horns and ears. The average milk production is 1500-1800 kg per lactation. Lactation length is 240-280 days. Discriminate analysis was used to elaborate morphometric measures. Based on data collected until now three groups are formed with distinguished distances: the first group, Back Rjoll herd of Albania; second group Dragosh herd located in Gjakove, Kosovo and third group Zherger herd of Gjlani, Kososvo. These are preliminary results because the number of measured animals was limited. Increase in the number of monitored animals for population will improve the prediction accuracy of genetic distances between them, as bases for breeding program for their in situ conservation.

Key words: *Busha cattle, morphometric measurement, local differentiation.*

Introduction

The Busha Cattle exists in the Balkans since Neolithic times. It is adapted to harsh environmental conditions and spread out with numerous strains, but in small fragmented relict populations throughout the Balkans. Actually these trans-boundary breed are in high danger of extinction.

Two types of local cattle are found in Albania and Kosovo: Illyrian Dwarf Cattle and Busha Cattle, both of Brachuceros type (Kume et al., 2013; Bytuqi et al., 2013). In lack of a wild ancestor, the local cattle breeds represent a genetic resource (Medugarac et al., 2009). Therefore study of these breeds is with interest to animal genetic diversity and further development. Based on the information gathered up to now the local breeds of cattle in Albania and Kosovo are still present in remote areas. They have not been crossed with exotic breeds because of geographic isolation and harsh conditions. The rural development of mountain region will be based mainly on traditional system. The local breeds of animals are the most suitable for this system and a strong supporting factor for the production of local food and the development of agro tourism in these areas. Small herds of local cattle on family farms will help to protect the natural environment and landscapes that are very attractive for tourism development. Small-scale production units and farmers interested in keeping the

locally adapted cattle to produce local foods is important in both conservation of the breed and rural development to increase the economic diversification and finally to enhance the quality of life for local people (LPP et al., 2010)

In the FAO-EFABIS database, actual data about Busha Cattle are rare. Busha cattle, shows a very high polymorphism. Genetic distance investigations showed, that unselected Busha breeds exhibit a very high degree of diversity within an identified cluster of Brachycerous cattle. Conservation of this genetic diversity is challenging, because these animals are in small rapidly declining subpopulations. Due to lack of information and data, it is difficult to run sustainable conservation programmes.

Consequently, to compile a sustainable breeding strategy, as one of the most important document for compiling and implementation a national or cross border (Albania and Kosovo) conservation program, collection of above information is needed: (I) data about the current status of Busha Cattle in both two countries, (ii) information regarding specific products of Busha cattle and their marketing (iii) services like working power and grazing for nature protection purposes.

Therefore, the study was undertaken to identify and characterize the phenotype of local cattle population of bush type in Albania and Kosovo.

Materials and methods.

Description of the study area.

The study areas were: Back Rjoll village in Velipoja commune of Scuteri region, Albania; Gjilan, Zherger Dragash, Gjakove regions of Kosovo. The sampled areas in Kosovo were well defined in east and west of the country.

Data collection

The study was conducted from May to December 2015. The number of cattle's sampled for phenotypic characterization was 53 of which 45 were females and 8 were males. Region-wise 14, 5, 24, 3, 7 cattle's were sampled from Back Rjoll, Dragash, Gjakove, Gjilan and Zherger.

Linear body measurement including body length, heart girth, pelvic width, ear length, horn length, frontal width, were taken using measuring tape while wither height was measured using a 1.5 m ruler. The measures were done in adult animals only. The linear body measurement were done according to FAO guidelines 2012

Data analyses

The means of morphometric variables were done for animals not divided by sex. Quantitative traits for body measurements were used to calculate correlation coefficient of Pearson's (r). Discriminate analysis model was used to evaluate the level of local differentiation of cattle populations.

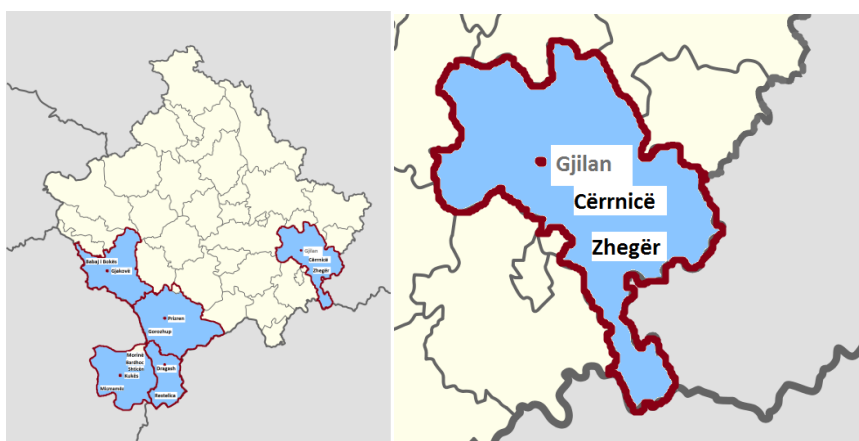



Figure 1. Map of the study area.

Results and discussion

Characterization of quantitative traits.

The average values and standard deviations of body measurements for both sexes in different regions of Albania and Kosovo are presented in Table 1.

Table 1 Average values of quantitative traits.

Population	Back Rrjoll	Dragash	Gjakove	Gjilan	Zherger	Total
Number of animals	14	5	24	3	7	53
Traits	Avergae ±SD					
Frontal width	19.5 ±1.605	19.4±0.89	19.79±0.77	19.67±0.57	19.43±1.39	19.62±1.11
Horn length	16.75 ±5.80	17.4±1.51	19.67 ±1.27	17.333±2.51	18.43±2.37	18.39±3.44
Budy length	113.5±8.83	117.2±3.1 1	117.83±2.07 8	115.67±1.15	126.86±2.96	117.69±6.30
Ear lenth	15.86±1.09	16.6±1.14	17.5±1.063	16.33±1.15	16.43±0.78	16.77±1.23
Pelvic width	37.43±3.17	39.4±1.34	40.13±0.74	41.33±1.15	41.71±1.49	39.62±2.32
Wither height	103.07±3.36	111.2±2.5 88	115.87±3.75	108.33±2.51	116.14±2.11	111.66±6.46
Heart girth	144.64±9.17	162.0±2.7 3	162.79±2.34	145.0±15.0	166.14±2.60	157.36±10.57

The data shows that Albanian population represented in this study by Back Rjoll herd is characterized by small body size, big head, broad forehead, medium size ears inside inward back, and short horns. These caws in Kosovo are bigger in body size, comparable in frontal width, shaped and longer horns and ears. These differences in body measures are reflected in milk production. Previous studies conducted in Albania and Kosovo (Kume et al 2013; Bytyqi et al. 2013) show that respected average milk yield in Albanian populations is 300-400 kg per cow and in some cases up to 60-700 kg. Lactation length is 4-5 months. The average milk production of Kosovo populations is 1500-1800 kg per lactation. Lactation length is 240-280 days.

Correlations coefficients of Pirson that serve to evaluate stochastic relationship between analyzed quantitative traits are presented in table Nr. 2.

Table 2. Correlations coefficients of Pirson

	Frontal width	Horn length	Budy length	Ear lenth	Pelvic width	Wither height	Heart girth
Frontal width	1.0						
Horn length	0.0236	1.0					
Budy length	0.4323	0.3237	1.0				
Ear lenth	0.1095	0.3550	0.3550	1.0			
Pelvic width	0.4480	0.4337	0.7783	0.2295	0.1		
Wither height	0.4210	0.2093	0.4413	0.2081	0.5793	0.1	
Heart girth	0.5194	0.4040	0.751	0.2999	0.7561	0.4573	0.1

Table Nr. 3. The functions used to classify the different individuals (cows) in subpopulations

	1	2	3	4
Frontal width	0.546049	0.423379	-0.231982	0.371377
Horn length	0.164214	0.152747	-0.257056	0.679917
Budy length	0.319443	-1.39375	-0.217598	0.954102
Ear lenth	-0.0409478	0.588522	0.143021	0.0429462
Pelvic width	0.670043	0.463234	1.45049	-1.02132
Wither height	-0.829238	0.0260105	0.31933	0.681957
Heart girth	-1.26974	0.0127438	-0.814982	-0.897886

Gjilan village is excluded because of small number of animals monitored. So four classifying functions corresponding to each region are presented in above table. Using two first discriminate functions the distribution of all cows from four regions is described in Figure Nr. 2.

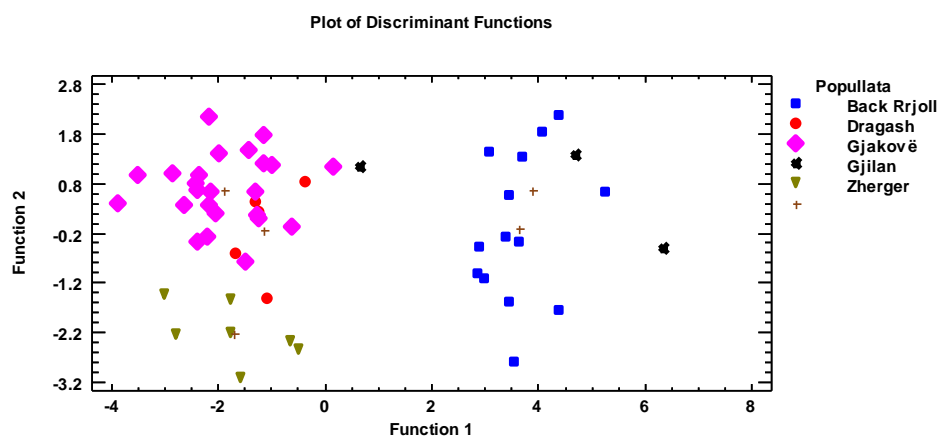

Fig.Nr. 2 The distribution of subpopulations of Busha type cattle.

Three distinguished groups are formed with cows belonging to different populations: In the first group is Back Rrjoll population; the second group is the population of Drag ash, Gjakova; the third group is the population of Zherger. The population of Gjilan that has only three animals is not considered.

Referring to the geographical position to which these populations belong, we note that there are similarities between the distances of cattle populations estimated using morphometric indicators and geographical distance between regions. Consequently the hypothesis it may rise is that in the case of Busha cows, the process of evolution of the morphometric traits and selection have been associated with the presence of isolation in distance, which as a rule is main conditions that affect the establishing of isolated genetic

niches. Obviously such a hypothesis needs further verification. More animals must be included in the study to have more reliable results.

Conclusions

The obtained results are preliminary because the populations number and their size are limited. Involving more animals per population could increase the prediction accuracy of genetic distribution between them. Enriching of data with DNA polymorphism analysis to specify the genetic variability between populations would be a strong base to design the in situ conservation program of local cattle of Busha type both in Albania and Kosovo.

References

- H.Bytyqi, H.Mehmeti, Busha cattle as cattle genetic resources in Kososvo. Evaluation of current status of Busha cattle and develop a regional breeding program for their conservation and sustainable economic use (ERFP-Project) 2013.
- I.Medugorac, A.Medugorac, I Russ, Claudia E, VeitKensch, P.Taberleit, B. Luntz, H.M.Mix, M Forster. Genetic diversity of European cattle breeds highlights the conservation value of traditional unselected breeds with high effective population size. *Molecular ecology* (2009) 18, 3394-3410
- K.Kume, L.Papa. Busha cattle in Albania. Busha old cattle in Balkan. Evaluation of current status of Busha cattle and develop a regional breeding program for their conservation and sustainable economic use (Efra-Project) 2013.
- LLP, LIFE Network, IUCN-WISP and FAO, 2010. Adding value to livestock diversity. Phenotypic characterization of Animal Genetic Resources. FAO Guidelines 20112.

INTESTINAL PARASITES OF SALMO OHRIDANUS (STEINDACHNER, 1892) FROM OHRID LAKE

Katerina BELICHOVSKA^{1*}, Daniela BELICHOVSKA², Dimitar NAKOV¹, Metodija
TRAJCHEV¹

¹Institute of Animal Biotechnology, Faculty of Agricultural Sciences and Food,
Ss. Cyril and Methodius University, Skopje, Republic of Macedonia

²Department of Food Safety, Faculty of Environmental Resources Management,
MIT University, Skopje, Republic of Macedonia

*Corresponding author: kbelichovska@yahoo.com

Abstract

With the aim to investigate the presence of parasites in the gastrointestinal tract of Ohrid belvica (*Salmo ohridanus*, Steindachner, 1892), investigations were conducted on individuals captured in vegetative and reproductive development period of Ohrid belvica, on three localities of Ohrid Lake (located between southwestern Macedonia and eastern Albania): Kalista, Kaneo and Elesec, on depth from 45 to 70 m. Tests were performed on a total of 60 samples with average body mass from 90 to 100 g and average total body length from 217 to 225 mm. It has been established the presence of the following parasites in the gut content of fish: *Cyathocephalus truncatus* (Class Cestoda), *Pseudocapillaria salvelini* and *Salmonema ephemeridarum* (Class Nematoda). *Cyathocephalus truncatus* was present on the locality Kalista, in both stages of the development of Ohrid belvica, and on the locality Elesec only in the reproductive stage. *Pseudocapillaria salvelini* was registered in the samples from locality Kalista and Kaneo in both stages of the development of Ohrid belvica. *Salmonema ephemeridarum* was found in the vegetative stage of Ohrid belvica only in locality Elesec. The presence of parasites was higher during the reproductive phase of development of the Ohrid belvica, i.e during the winter, unlike during the vegetative phase, actually autumn. The highest proportion (100% of the tested fish) of tapeworm *Cyathocephalus truncatus* was found during the reproductive phase of the individuals from the locality Kalista.

Keywords: Lake Ohrid, *Salmo ohridanus*, intestinal parasites

Introduction

Ohrid Lake (located between southwestern Macedonia and eastern Albania) is a rare natural phenomenon of tectonic origin, one of the oldest oligotrophic lakes in the world and represents a complex ecological system, where its wildlife takes a special place. According to its geomorphological and biological values it represents a single entity in which there is a preserved part of the old tertiary world, with numerous archaic forms, such as relics and endemics.

Ohrid belvica (*Salmo ohridanus*, Steindachner, 1892) as one of the representatives of "living fossils" represents tertiary relict and endemic trout species belonging to macrostom salmonids and lives only in Ohrid Lake. It is a small endemic trout which represents expressively a lake and depth type of fish. It feeds mainly on zooplankton, and benthic fauna elements.

Primarily investigations of the parasitofauna of Ohrid belvica were carried out by Šinžar (quoted by Blažeković Dimovska, 2013), who found *Cyathocephalus truncatus* among 2% of examined belvica (*Salmo ohridanus* Steindachner, 1892). Hristivski et al. (1999) were found that the most likely, Ohrid belvica was infected with *Cyathocephalus truncatus*. Blažeković Dimovska et al. (2013) established the following parasites in the intestines of Ohrid belvica: *Nicolla testiobliqua* (Class Trematoda), *Eubothrium salvelini* (Class Cestoda),

Metechinorhynchus truttae, *Metechinorhynchus salmonis*, *Acanthocephalus anguillae* and *Pomphorhynchus bosniacus* (Class Acanthocephala), of which the most common was *Metechinorhynchus truttae* (12.66%). Ohrid belvica is an insufficiently investigated fish. That was the reason for this investigation.

Material and methods

Investigations were conducted on fish species of Ohrid belvica (*Salmo ohridanus*, Steindachner, 1892). The samples were captured in the reproductive phase of development of Ohrid belvica, i.e during the winter, the season of natural reproduction of belvica, when most individuals in the population of belvica participate in the natural breeding – spawning and the period of vegetative phase or autumn, on three localities of Ohrid Lake: Kalista, Kaneo and Elesec, on depth from 45 to 70 m. Tests were performed on 10 samples of each locality and each phase of development or a total of 60 fish.

For the purposes of examination (analyzing) the intestinal parasites of Ohrid belvica it has been performed carefully extracting the digestive tract of the fish after cutting the esophagus and rectum. Then, dissection of the digestive tract was performed and with a spatula gut content was removed. Gut content was fixed in 4% formaldehyde and subsequently determination of the components in the gut content was performed, with stereo-zoom microscope SMC 4 and digital color video camera SONY SSC-DC 54AP, using computer software Metric in the laboratory at the Hydrobiological Institute in Ohrid. Parasites were isolated from the gut content and put into a Petri dishes after which followed procedure of their determination.

The determination of the parasites found was according to: Moravec et al. (1991) and Moravec (1994, 2004).

Results and discussion

The participation of parasites in the digestive tract of the fish during the vegetative and reproductive phase of development of the Ohrid belvica on three localities of Ohrid Lake (Kalista, Kaneo and Elesec) is shown in Table 1.

Table 1. The findings of parasites in the digestive tract of Ohrid belvica in vegetative and reproductive stages of development (n=10)

Taxon	Vegetative stage		Reproductive stage	
	No. of infected fish	% of infected fish	No. of infected fish	% of infected fish
KALISTA				
Cestoda				
<i>Cyathocephalus truncatus</i>	3	30	10	100
Nematoda				
<i>Pseudocapillaria salvelini</i>	2	20	3	30
KANEO				
Nematoda				
<i>Pseudocapillaria salvelini</i>	2	20	6	60
ELESEC				
Cestoda				
<i>Cyathocephalus truncatus</i>	0	0	7	70
Nematoda				
<i>Salmonema ephemeridarum</i>	4	40	0	0

The investigation of the guts of Ohrid belvica showed some presence of parasites in the digestive tract. There were found representatives of the groups Cestoda and Nematoda (Tab.

1). From the group Cestoda it was recorded endoparasite *Cyathocephalus truncatus* (Fig. 1) at the locality Kalista, in both phases of the development of Ohrid belvica, and on the locality Elesec only in the reproductive stage. This parasite was not found in the digestive tract of the samples from the locality Kaneo. The presence of endoparasite *Cyathocephalus truncatus* in the intestines of Ohrid belvica was found by other authors (Šinžar, 1956; Hristovski, 1983; Stojanovski, 1997; Hristovski et al., 1999). *Cyathocephalus truncatus* is widespread in Europe, Asia and North America, in the fish of the families Salmonidae, Thymallidae, Esocidae and others (Čanković et al., 1968).



Figure 1. *Cyathocephalus truncatus*



Figure 2. *Pseudocapillaria salvelini*



Figure 3. *Salmonema ephemeridarum*

In the digestive tract of Ohrid belvica was found the presence of two nematode among individuals collected from all three investigated localities. The first was *Pseudocapillaria salvelini* (Polyansky, 1952) from the family Capillariidae (Fig. 2), the only capillariid known from the intestine of European salmonids. It was registered in samples from Kalista and Kaneo localities in both phases of the development of Ohrid belvica (Tab. 1). *Pseudocapillaria salvelini* is a holarctic species widespread in palearctic Eurasia and North America, where it occurs in many species of various salmonids (*Salvelinus*, *Salmo*, *Brachymystax*, *Hucho*, *Stenodus*, *Oncorhynchus*, *Thymallus*). It was also found in the countries of the former Yugoslavia (Bosnia and Herzegovina, Montenegro) (Moravec, 1994). We could not find evidence that this parasite has been found so far in the digestive tract of Ohrid belvica.

Second isolated nematode was *Salmonema ephemeridarum* (Linstow, 1872) (Fig. 3), with synonymous *Cystidicoloides tenuissima* (Zeder, 1800). It was found in the digestive tract of the samplaes in the vegetative stage from locality Elesec. This parasite in Ohrid belvica for the first time was registered in 1999 (Hristovski et al. 1999). It is a parasite in the digestive tract of holarctic salmonid fish species (Moravec, 1994, 2008; Poulin, 2007).

Varying degree of infection of Ohrid belvca with parasites in the different localities and stages of development was probably due to the different population densities of the Ohrid belvica population and the presence of the intermediate hosts. In larger grouping of fish, the number of parasites present in the digestive tract is greater and vice versa. Lake-dwelling salmonid fish species are known to host several food-transmitted parasites (Kristoffersen, 1993; Knudsen and Klemetsen, 1994; Curtis, 1995; Curtis et al., 1995; Knudsen et al., 1997), some of them having amphipods (*Gammarus lacustris*, *Gammarus pulex*) as their intermediate host (Knudsen, 1995; Amundsen et al., 2003; Atrashkevich et al., 2005; Franceschi et al., 2007).

Conclusion

Based on the research (analysis, investigations) of the intestinal contents of Ohrid belvica (*Salmo ohridanus*, Steindachner, 1892) from three different localities of the Ohrid Lake (Kalista, Kaneo and Elesec) during the vegetative and reproductive stage, it might be concluded that in the gut contents were present the following parasites: *Cyathocephalus truncatus* (Class Cestoda), *Pseudocapillaria salvelini* and *Salmonema ephemeridarum* (Class Nematoda).

Cyathocephalus truncatus was present on the locality Kalista, in both stages of the development of Ohrid belvica, and on the locality Elesec only in the reproductive stage. *Pseudocapillaria salvelini* was registered in the samples from locality Kalista and Kaneo in

both stages of the development of Ohrid belvica. *Salmonema ephemeridarum* was found in the vegetative stage of Ohrid belvica only in locality Elesec.

The presence of parasites was higher during the reproductive phase of development of the Ohrid belvica, i.e. during the winter, the season of natural reproduction of belvica, when most individuals in the population of belvica participate in the natural breeding - spawning, unlike the period of vegetative phase or autumn.

References

- Amundsen, P.-A., Knudsen, R., Kurus, A.M., Kristoffersen, R. 2003. Seasonal and ontogenetic dynamics in trophic transmission of parasites. *OIKOS* 102: 285–293.
- Atrashkevich, G.I., Orlovskaya, O.M., Mikhailova, E.I., et al. 2005. "Helminths of Salmonids from Kronotskoe Lake (Kamchatka)", in Materials of II Interregional Scientific Conference on Parasitological Studies in Siberia and Far East, pp. 8–10.
- Curtis, M.A. 1995. The ecological parasitology of charrs: relationships between parasites and food web structure in northern lakes. *Nordic J. Freshw. Res.* 71: 92–101.
- Curtis, M.A., Bèrubè, M., Stenzel, A. 1995. Parasitological evidence for specialized foraging behaviour in lake-resident arctic char (*Salvelinus alpinus*). *Can. J. Fish. Aquat. Sci.* 52 (Suppl. 1): S186–S194.
- Čanković, M., Delić, S., Kiškarolj, M., Rukavina, J. 1968. Parasite fauna of freshwater fish in Bosnia and Herzegovina (Trematoda, Cestoda, Nematoda, Acantocephala). Academy of Science and Arts of Bosnia and Herzegovina. Department of Natural Sciences and Mathematics, Sarajevo. (In Serbian).
- Hristovski N. D. 1983. Fauna of fish endohelminths in the lakes from Macedonia (PhD thesis) Faculty of Natural Sciences and Mathematics, Novi Sad. (In Serbian).
- Hristovski, N., Stojanovski, S., Kulišić, Z., Cakić, P., Hristovski, M. 1999. Parasitofauna of the Ohrid belvica (*Acantholingua ohridana* Hadžišće, 1961) from Lake Ohrid (Macedonia). *Acta Veterinaria (Beograd)*, Vol. 49, No. 1, 65–84.
- Knudsen, R. 1995. Relationship between habitat, prey selection and parasite infections in Arctic charr (*Salvelinus alpinus* (L.)) in northern Norway. *Can J Zool* 75:2003–2009.
- Knudsen, R., Klemetsen, A. 1994. Infections of *Diphyllbothrium dendriticum*, *D. ditremum* (Cestoda) and *Cystidicola farionis* (Nematoda) in a north Norwegian population of arctic charr (*Salvelinus alpinus*) during winter. *Can. J. Zool.* 72: 1922–1930.
- Knudsen, R., Kristoffersen, R., Amundsen, P.-A. 1997. Parasite communities in two sympatric morphs of arctic charr *Salvelinus alpinus* (L.) in northern Norway. *Can. J. Zool.* 75: 2003–2009.
- Kristoffersen, R. 1993. Parasites in northern salmonids: effects of overpopulation and perturbations in systems with arctic charr (*Salvelinus alpinus* (L.)) and whitefish (*Coregonus lavaretus* L. s.l.) in northern Norway. PhD thesis, Univ. of Tromsø, Norway.
- Moravec, F. 1994. Parasitic Nematodes of Freshwater Fishes of Europe. Kluwer Academic Publishers, Prague, pp. 473.
- Moravec, F. 2004. Metazoan Parasites of Salmonid Fishes of Europe. Kluwer Academic Publishers, Prague, pp. 510.
- Moravec, F., Ergens, R., Našincová, V., Scholz, T. 1991. Parasitic Metazoa. In: Fish Diseases. Diagnostics, Prevention and Therapy of Fish Diseases and Intoxications. FAO, Manual for International Training Course on Fresh-Water Fish Diseases and Intoxications: Diagnostics, Prophylaxis and Therapy, Edited by: Z. Svobodová and B. Vykusová.
- Moravec, F., Santos, M.D., Brasil-Sato, M.C. 2008. Redescription of *Cystidicoloides fischeri* Based on Specimens From Piranhas in Brazil, and Erection of a New Genus (Nematoda: Cystidicolidae). *J. Parasitol.*, 94 (4): 889–897.

- Poulin, R. 2007. Evolutionary Ecology of Parasites: Second Edition. Princeton University Press, pp. 332.
- Stojanovski S. 1997. Ecto- and endoparasites of fishes from Lake Ohrid. Master Thesis, Faculty of Veterinary Medicine, Belgrade, Yugoslavia (In Serbian).
- Šinžar D. 1956. Investigation of intestinal parasites of softmouth trout (*Salmothymus obtusirostris krkensis*) and some other representatives of genus *Salmothymus*. PhD Thesis, Belgrade, Yugoslavia (In Serbian).

RED CLOVER QUALITY AFFECTED BY CULTIVAR, CUT AND STAGE OF GROWTH

Jordan MARKOVIĆ*, Tanja VASIĆ, Mirjana PETROVIĆ, Dragoslav ĐOKIĆ, Zoran LUGIĆ, Dragan TERZIĆ, Bora DINIĆ

Institute for Forage Crops d.o.o. Globoder, Kruševac, Serbia

*Corresponding author: jordan.markovic@ikbks.com

Abstract

Forage quality is affected by many independent factors including maturity, crop species, harvest and storage, environment, soil fertility and variety. Generally, red clover varieties differ in quality according to ploidy level and earliness. This paper provides measurements of the chemical composition of the red clover (a diploid – K 39 and a tetraploid – K 32 cultivar) in different development stages from the first to the third crop production cycle during the second year of growth in the field of Institute for forage crops, city of Kruševac (Serbia). The experiment was designed as three factorial trials: a – cultivar, b – cut and c – stage of development by randomized block system in three replicates. The diploid cultivar of red clover, K 39, had higher content of CP (Crude Protein), NDF (Neutral Detergent Fiber) and ADF (Acid Detergent Fiber) than tetraploid cultivar, K 32, but lower DDM (Digestibility Dry Matter), DMI (Dry Matter Intake) and RFV (Relative Feed Value). The highest content of CP was observed in the third cut (195.5 g kg⁻¹ DM), whereas the highest content of NDF and ADF was in the first cut (512.1 g kg⁻¹ and 377.5 g kg⁻¹ DM, respectively). The results of this investigation indicated that DDM, DMI and RFV declined with advancing maturity, whereas content of NDF and ADF increased. All factors of investigation showed a significant statistical influence on investigated quality parameters. The achieved results show that red clover quality was the best in the third production cycle.

Keywords: *red clover, forage quality, Relative Feed Value*

Introduction

The quality of red clover forage depends primarily on the stage of development and environmental conditions. Taylor and Quesenberry (1996) claimed that the content of crude protein and *in vitro* dry matter digestibility are the two most reliable quality characteristics. Their value decreases with age, as a result of a decreasing portion of leaves in relation to stems and the process of lignification, which are typical for all perennial legumes. The decline in digestibility after budding is associated with increased contents of lignin and structural polysaccharides. Nutritive values of forage crops can be changed among cultivars, ecotypes and genotypes within a plant species for animal nutrition. Differences in quality properties of forage crops within a species have been shown by Job (1996) in eight red clover cultivars, Broderick et al (2004) in 113 red clover cultivars, Yolcu et al (2008) in 12 alfalfa cultivars and Yolcu et al (2009) in 25 red clover genotypes. The tetraploid red clover is characterised by a higher content of protein, WSC (Water Soluble Carbohydrates), potassium and phosphorus and by a lower content of fiber than diploid red clover (Bieniaszewski and Fordonski 1996).

The main objective of this work was to assess the chemical composition and the relative feed value of tetraploid and diploid red clover in different development stages from the first to the third crop production cycle during the second year of growth in Central Serbia.

Materials and methods

The experiment was carried out in the experimental field of Institute for forage crops, city of Kruševac (43°34'58"N, 21°19'35"E), Serbia (2012). The study area was situated at altitude of 166 m above sea level in Central Serbia. The mean annual temperature and the total precipitation for the region are 11.3° C and 636 mm, respectively.

The study was designed in a three factorial arrangement (A-cultivar, B-cut and C-stage of growth) of a randomized complete block with three replications. Three stages of growth of red clover *cv* K-32 (tetraploid cultivar) and *cv* K-39 (diploid cultivar) were examined in the first, second and the third cut during the second year of vegetation. The first stage was cut at the full bud stage, another one when plants were at the beginning of flowering and the third stage of growth was cut when plants were around 50-60% of flowering. The dates of Crude Protein (CP), Neutral Detergent Fiber (NDF), Acid Detergent Fiber (ADF), Digestibility Dry Matter (DDM), Dry Matter Intake (DMI) and Relative Feed Value (RFV) were determined in the result of analyze or calculate. Crude protein (CP = N × 6.25) was measured by Kjeldahl-N analysis on a Kjeltac 1030N autotitrator (AOAC 984.13, 1990). NDF and ADF were determined as filter residue weights after boiling forage samples for 1 h in beakers either in neutral detergent solution or in acid detergent solution, according Van Soest et al. (1991). DDM, DMI and RFV were calculated according to the following equations adapted from common formulas for forages (Schroeder, 1994):

$$\text{DDM \%} = 88.9 - (0.779 \times \text{ADF, \%})$$

$$\text{DMI} = 120 / \text{NDF, \%}$$

$$\text{RFV} = (\text{DDM, \%} \times \text{DMI, \%}) / 1.29$$

Data were processed by the analysis of variance in a randomized block design as three factorial trial. Effects were considered different based on significant ($p < 0.01$) F ratio.

Results and discussion

The variety differences in the contents of CP, NDF and ADF are presented in the Table 1. Our results showed significant variety differences between evaluated forage quality parameters. Following the mean values of CP content diploid cultivar of red clover (182.3 g kg⁻¹ DM) featured higher CP content than tetraploid cultivar of red clover (178.1 g kg⁻¹), but this variety contained higher content of NDF and ADF.

Chemical composition of red clover differed in CP, NDF and ADF content ($p < 0.01$) between cuts. The highest content of CP was found in cut III (195.9 g kg⁻¹ DM) and the lowest in cut I (160.4 g kg⁻¹ DM). Despite the CP content, the level of cell wall components (NDF and ADF) was the highest in cut I (512.1 g kg⁻¹ DM and 377.5 g kg⁻¹ DM, respectively). The content of NDF found in cut II and III did not differ ($p > 0.05$).

Stage of plant development at the cutting had a significant effect ($p < 0.01$). The highest CP content was detected at the beginning of flowering (188.6 g kg⁻¹ DM), and the lowest when plants were around 50-60% of flowering (169.5 g kg⁻¹ DM). The analysis of mean values of NDF and ADF shows that the highest content of NDF and ADF was detected at the third development stage (483.1 g kg⁻¹ DM and 370.9 g kg⁻¹ DM, respectively), whereas the lowest content of cell wall components was at the first stage of plant development (Tab. 1).

The interactions cultivar × cut, cultivar × stage of growth and cut × stage of growth were also significant for crude protein content and content of cell wall components – NDF and ADF.

Table 1. Forage quality parameters of red clover influenced by cultivar, cut and stage of growth

		A ₁				A ₂				
		B ₁	B ₂	B ₃	\bar{x} (AC)	B ₁	B ₂	B ₃	\bar{x} (AC)	
Crude Protein (CP), g kg ⁻¹ DM	C ₁	151.4 ^l	178.5 ^h	179.5 ^{gh}	169.8^e	164.5 ^k	188.4 ^f	233.3 ^a	195.4^a	
	C ₂	198.7 ^c	188.7 ^f	190.8 ^e	192.7^b	151.9 ^l	195.4 ^d	206.3 ^b	184.5^c	
	C ₃	144.5 ^m	175.3 ⁱ	196.0 ^d	171.9^d	151.4 ^l	180.2 ^g	169.5 ^j	167.0^f	
	\bar{x} (AB)	164.9^d	180.8^c	188.7^b		155.9^e	188.0^b	203.0^a		
	\bar{x} (A)		178.1^b				182.3^a			
	\bar{x} (BC ₁)		157.9^g			183.4^d		206.4^a		
	\bar{x} (BC ₂)		175.3^f			192.0^c		198.5^b		
	\bar{x} (BC ₃)		147.9^b			177.7^e		182.7^d		
	\bar{x} (B)		160.4^c			184.4^b		195.9^a		
	\bar{x} (C)		182.6^b			188.6^a		169.5^c		
Neutral Detergent Fiber (NDF), g kg ⁻¹ DM	C ₁	547.5 ^a	442.4 ^m	442.2 ^m	477.4^b	501.1 ⁱ	433.6 ^{ij}	440.4 ⁿ	458.3^d	
	C ₂	443.5 ^{lm}	447.5 ^j	444.0 ^{kl}	445.0^e	513.6 ^d	503.5 ^e	467.4 ^h	494.8^a	
	C ₃	523.5 ^c	445.0 ^k	444.8 ^{kl}	471.0^c	543.5 ^b	453.5 ⁱ	488.5 ^g	495.1^a	
	\bar{x} (AB)	504.8^b	445.0^e	443.6^f		519.4^a	463.5^d	465.4^c		
	\bar{x} (A)		464.5^b				482.8^a			
	\bar{x} (BC ₁)		524.2^b			438.0ⁱ		441.3^h		
	\bar{x} (BC ₂)		478.5^c			475.5^d		455.7^f		
	\bar{x} (BC ₃)		533.5^a			449.2^g		466.6^e		
	\bar{x} (B)		512.1^a			454.2^b		454.5^b		
	\bar{x} (C)		467.8^e			469.9^b		483.1^a		
Acid Detergent Fiber (ADF), g kg ⁻¹ DM	C ₁	365.6 ^f	329.4 ^k	294.5 ^{mj}	329.8^e	362.5 ^g	328.4 ^k	337.6 ⁱ	342.9^d	
	C ₂	298.4 ⁿ	334.4 ^j	301.5 ^m	311.4^f	389.4 ^d	346.0 ^h	385.5 ^e	373.6^b	
	C ₃	425.4 ^a	335.0 ^j	302.4 ^m	354.3^c	423.5 ^b	322.6 ^l	416.6 ^c	387.5^a	
	\bar{x} (AB)	363.1^c	332.9^d	299.5^e		391.8^a	332.3^d	379.9^b		
	\bar{x} (A)		331.8^b				368.0^a			
	\bar{x} (BC ₁)		364.0^b			328.9^f		316.0^g		
	\bar{x} (BC ₂)		343.9^d			340.2^e		343.5^d		
	\bar{x} (BC ₃)		424.5^a			328.7^f		359.5^c		
	\bar{x} (B)		377.5^a			332.6^c		339.7^b		
	\bar{x} (C)		336.4^c			342.5^b		370.9^a		

A₁ – K 32, tetraploid cultivar of red clover; A₂ – K 39, diploid cultivar of red clover; B₁ – cut I; B₂ – cut II; B₃ – cut III; C₁ – first stage, full bud; C₂ – second stage, beginning of flowering; C₃ – third stage – 50-60% of flowering; Different letters denote significantly different means (p < 0.01)

The differences between cultivars in DDM, DMI and RFV were observed in this investigation. Tetraploid red clover cultivar, K 32, had higher DDM ($630.5 \text{ g kg}^{-1} \text{ DM}$), DMI (2.59% BW) and RFV (127.4) than diploid red clover, K 39 ($602.3 \text{ g kg}^{-1} \text{ DM}$, 2.49% BW and 117.0, respectively).

The cut was an important source of variability for DDM, DMI and RFV in this investigation. The evaluated forage quality parameters were the highest in the second cut, and the lowest in the first cut (Table 2).

Forage quality declines with advancing maturity. Significant differences were determined among forage stages of growth in terms of DDM, DMI and RFV for animal feeding (Table 2). The highest DDM ratio was found at the first stage of plant development ($626.9 \text{ g kg}^{-1} \text{ DM}$), and the lowest at the third stage of plant development ($600.0 \text{ g kg}^{-1} \text{ DM}$). Maturity of harvest also influences forage consumption by animals ($p < 0.01$). This is because NDF is more difficult to digest than the non-fiber components of forage. The RFV of red clover hay harvested at different maturity stages ranged from 125.8 to 116.8 ($p < 0.01$).

Table 2. DDM, DMI and RFV of red clover influenced by cultivar, cut and stage of growth

		A ₁				A ₂				
		B ₁	B ₂	B ₃	\bar{x} (AC)	B ₁	B ₂	B ₃	\bar{x} (AC)	
Digestibility Dry matter (DDM), g kg ⁻¹ DM	C ₁	604.4 ^l	632.5 ^e	659.5 ^a	632.1^b	606.5 ^l	633.4 ^e	625.6 ^g	621.8^c	
	C ₂	656.6 ^b	628.7 ^f	654.3 ^c	646.5^a	585.6 ^l	619.5 ^h	588.5 ^k	597.8^e	
	C ₃	557.6 ^{nj}	628.0 ^f	653.5 ^c	613.0^d	559.4 ⁿ	637.5 ^d	564.5 ^m	587.1^f	
	\bar{x} (AB)	606.2^c	629.7^b	655.8^a		583.8^e	630.1^b	592.8^d		
	\bar{x} (A)		630.5^a				602.3^b			
	\bar{x} (BC ₁)		605.5^f			632.9^b		642.5^a		
	\bar{x} (BC ₂)		621.0^d			624.1^c		621.4^d		
	\bar{x} (BC ₃)		558.5^g			632.7^b		609.0^e		
	\bar{x} (B)		595.0^c			629.9^a		624.3^b		
	\bar{x} (C)		626.9^a			622.2^b		600.0^c		
Dry Matter Intake (DMI), % of body weight	C ₁	2.19 ^l	2.71 ^{bc}	2.71 ^{bc}	2.53^d	2.39 ^g	2.77 ^a	2.72 ^{ab}	2.62^b	
	C ₂	2.71 ^{bc}	2.68 ^{cd}	2.70 ^{bc}	2.69^a	3.34 ^h	2.38 ^{gh}	2.54 ^e	2.42^e	
	C ₃	2.29 ⁱ	2.70 ^{bc}	2.70 ^{bc}	2.56^c	2.21 ^j	2.65 ^d	2.46 ^f	2.44^e	
	\bar{x} (AB)	2.39^c	2.69^a	2.70^a		2.31^d	2.60^b	2.57^b		
	\bar{x} (A)		2.59^a				2.49^b			
	\bar{x} (BC ₁)		2.29^f			2.74^a		2.71^a		
	\bar{x} (BC ₂)		2.52^e			2.53^e		2.62^c		
	\bar{x} (BC ₃)		2.25^g			2.67^b		2.58^d		
	\bar{x} (B)		2.35^b			2.64^a		2.64^a		
	\bar{x} (C)		2.58^a			2.55^b		2.50^c		
Relative Feed Value (RFV)	C ₁	102.6 ^h	133.0 ^c	138.7 ^a	124.7^c	112.6 ^f	135.8 ^b	132.3 ^{cd}	126.9^b	
	C ₂	137.8 ^{ab}	130.6 ^d	137.0 ^{ab}	135.1^a	106.0 ^g	115.4 ^e	117.2 ^e	112.8^e	
	C ₃	99.1 ⁱ	131.3 ^{cd}	136.7 ^{ab}	122.3^d	95.7 ^j	130.8 ^{cd}	107.5 ^g	111.3^f	
	\bar{x} (AB)	113.1^e	131.6^b	137.5^a		104.7^f	127.3^c	119.0^d		
	\bar{x} (A)		127.4^a				117.0^b			
	\bar{x} (BC ₁)		107.6^e			134.4^a		135.5^a		
	\bar{x} (BC ₂)		121.9^d			123.0^d		127.1^c		
	\bar{x} (BC ₃)		97.4^f			131.0^b		122.1^d		
	\bar{x} (B)		108.9^c			129.4^a		128.2^b		
	\bar{x} (C)		125.8^a			124.0^b		116.8^c		

A₁ – K 32, tetraploid cultivar of red clover; A₂ – K 39, diploid cultivar of red clover; B₁ – cut I; B₂ – cut II; B₃ – cut III; C₁ – first stage, full bud; C₂ – second stage, beginning of flowering; C₃ – third stage – 50-60% of flowering; Different letters denote significantly different means (p<0.01)

The results for DDM, DMI and RFV obtained in this investigation are lower than values reported by Marković et al. (2011) and Stallings et al. (2005). The decrease in DDM, DMI and RFV are possibly associated with increased NDF and ADF contents (Wilson et al, 1991), and increased lignification and decreased leaf:stem ratio (Hides et al., 1983) as the plant matures.

The NDF is used to predict DMI, and is negatively correlated with DMI, which means that when NDF is high the quality and DMI are low (Horrocks and Vallentine, 1999). The RFV is an index that is used to predict the intake and energy value of the forages and it is derived

from the DDM and DMI. Forage with the RFV value > 151 is considered prime (Horrocks and Vallentine, 1999). In the present experiment, the RFV value was lower than 151, which agrees with the other quality characteristics (NDF, ADF, DDM and DMI).

Adequate fiber levels are needed in the rumen to promote a healthy population of cellulolytic species important to maintain normal lipid metabolism and milk fat levels, and to enhance microbial protein output to the lower digestive tract (Van Soest et al., 1991). Need to harvest early to increase crude protein concentration may sacrifice forage yield and provide insufficient fiber concentration.

Forage producers have special interest in quality improvements to partially offset the decline in nutritive value associated with advancing maturity of the crop when harvest is delayed. Some farmers harvest second growth early to obtain higher protein and lower fiber concentrations during mid-summer when quality values are often lowest of the three harvest.

Conclusions

On the basis of the knowledge about different nutritive values of diploid and tetraploid red clover varieties we compared the assessed varieties also in this respect. From our results we may deduce that diploid cultivar (K-39) can also produce high quality forage. The choice of the harvesting moment is important insuring the forage quality and quantity. Relative Feed Value might be a relevant indicator supporting the decisions of cutting management. It is observable that the relationship between RFV and CP content is inverse, which complicates the choice of the optimal harvest moment. The most adequate decision of cutting might be in the beginning of flowering, when even the RFV is fast decreasing, the crude protein content is substantially increasing.

Acknowledgments

The authors thank the Ministry of Education, Science and Technological Development of Republic of Serbia who funded this research as part of the project TR-31057.

References

- AOAC (1990). Official method 984.13 Crude protein in animal feed, forage, grain and oil seeds. Official methods of analysis of AOAC International, 15th ed., NY.
- Bieniaszewski, T. and Fordonski, G. (1996). Dependence of elementary nutrients in di- and tetraploid clover varieties on time of plant harvest. *Agricultura*, Vol. 62, 97-106.
- Broderick, G. A., Albrecht, K. A., Owens, V. N., Smith, R. R. (2004). Genetic variation in red clover for rumen protein degradability. *Animal Feed Science and Technology*, Vol. 113: 157-167.
- Hides, D. I., Lovatt, J. A., Hayward, M. W. (1983). Influence of stage of maturity on the nutritive value of Italian ryegrass. *Grass Forage Science*, Vol. 38, 33-38.
- Horrocks, R. D. and Vallentine, J. F. (1999). *Harvested forages*. Academic Press, London, UK.
- Job, J. (1996). Proceedings of the Symposium on New Challenges in Field Crop Production, Ljubljana, Slovenia, 367-372.
- Marković, J., Štrbanović, R., Terzić, D., Stanisavljević, R., Đokić, D., Vasić, T., Anđelković, B. (2011). Proceedings of the 3rd International Congress "New Perspectives and Challenges of Sustainable Livestock Production", 5-7 October, Belgrade, Serbia, *Biotechnology in Animal Husbandry*, Vol. 27 (4), 1563-1569.
- Schroeder, J. W. (1994). Interpreting forage analysis. Extension dairy specialist (NDSU), AS-1080, North Dakota State University.
- Stallings, C. C. (2005): Test available for measuring forage quality. *Dairy Publ.*, 124-404, 1-3. www.ext.vt.edu.

- Taylor, N. L. and Quesenberry, K. H. (1996). Red clover Science. Current Plant Sciences and Biotechnology in Agriculture, Vol. 28, 65-67.
- Van Soest, P. J., Robertson, J. B., Lewis, B. A. (1991). Methods for dietary fiber, NDF and nonstarch polyaccharides in relation to animal nutrition. Journal of Dairy Science, Vol. 74, 3583-3597.
- Wilson, J. R., Denium, H., Engels, E. M. (1991). Temperature effect on anatomy and digestibility of leaf and stem of tropical and temperate forage species. Netherland Journal of Agricultural Science, Vol. 39, 31-48.
- Yolcu, H., Tasci, M., Turan, M. (2008). Mineral content of some lucerne cultivars for livestock. Asian Journal of Chemistry, Vol. 20, 3919-3925.
- Yolcu, H., Tavlas, A., Tan, M., Günes, A. (2009). Chemical contents of red clover genotypes on crop improvement systems as livestock feed. Journal of animal and veterinary advances, Vol. 8, 506-510.

IMPACT OF THAWING TEMPERATURE ON MOTILITY PARAMETERS OF BULL'S SEMEN

Stoja JOTANOVIĆ¹, Marija JOVIČIĆ², Đorđe SAVIĆ^{1*}, Marinko VEKIĆ¹, Borut BOSANČIĆ¹, Milenko ŠARIĆ¹, Ivan STANČIĆ³

¹University of Banja Luka, Faculty of Agriculture, Banja Luka, Republic of Srpska, Bosnia and Herzegovina

²Czech University of Life Sciences, Faculty of Agrobiolgy, Food and Natural Resources, Prague, Czech Republic

³University of Novi Sad, Faculty of Agriculture, Department of Veterinary Medicine, Novi Sad, Serbia

*Corresponding author: djordjevet@yahoo.com

Abstract

Aim of study was to examine the impact of thawing temperature on motility parameters of bull's sperms after thawing. A total of 120 commercial doses of deep-frozen bull's semen, originated from three Simmental bulls, were examined. Semen was thawed at 38°C for 30 seconds (n=60 doses, 20 from each bull) or at 50°C for 15 seconds (n=60 doses, 20 from each bull). Motility parameters of sperms (Curvilinear Velocity, VCL, µm/s; Straight Line Velocity, VSL, µm/s; Average Path Velocity, VAP, µm/s, Amplitude of Lateral Head Displacement, µm) were determined as an average for 20 thawed doses of each bull on each of two thawing temperatures, by using Computer Assisted Sperm Analysis (CASA) program in NIS Elements software. All sperm motility parameters in all three bulls were significantly higher at higher thawing temperature (VCL 59.99±0.11, 58.96±0.13 and 56.87±0.16 vs. 52.89±0.14, 52.66±0.13 and 51.99±0.17 µm/s, p<0.001; VSL 52.58±0.11, 49.32±0.12 and 43.33±0.15 vs. 43.28±0.14, 42.13±0.14 and 40.69±0.16 µm/s, p<0.001; VAP 53.96±0.11, 51.00±0.12 and 45.37±0.14 vs. 44.85±0.14, 43.78±0.13 and 42.72±0.16 µm/s, p<0.001; ALH 4.07±0.02, 3.90±0.02 and 4.12±0.03 vs. 3.70±0.02, 3.77±0.02 and 3.51±0.02 µm, p<0.001, respectively). Our results indicate positive impact of higher thawing temperature on bull sperm motility parameters, as an indicators of their fertilisation ability.

Keywords: *bull's sperm, thawing temperature, motility.*

Introduction

Semen analysis and prediction of its fertility potential is key aim of each andrological investigation (Nikolovski et al., 2014). Older methods of semen analyzing are based on semiquantitative visual assessment (Miljković, 1998), and such results are subjective and depends on the evaluator's experience. In order to eliminate that problem, automated systems for the evaluation of semen were developed, from photocytometers for sperm counting to software programs which can count sperms and analyze parameters of their motility, too. One of the currently most popular system for semen evaluation is CASA (Computer Assisted Sperm Analysis) system (Mortimer, 1990). This system consists of phase-contrast microscope with a camera and computer software for the analysis of video recordings. The use of phase-contrast lens makes possible to identify sperm as bright particles on a dark background field, and to digitalize the image of each individual sperm. Recording is performed during a period determined by the software, which makes high number of shots per time unit, in order to track the movement of sperm and reconstruct its trajectory.

CASA system is configured to monitor the actual trajectory of sperm, which should move progressively forward and rotating around its axis at the same time. Based on the images, the software determines the kinetic parameters of sperm movement, such as speed on curvilinear path (Curvilinear Velocity, VCL), average speed (Average Path Velocity, VAP), speed of linear movement (Straight Line Velocity, VSL) and the amplitude of movement sperm head

relative to its direction (Amplitude of Lateral Head Displacement, ALH), as shown in Figure 1.

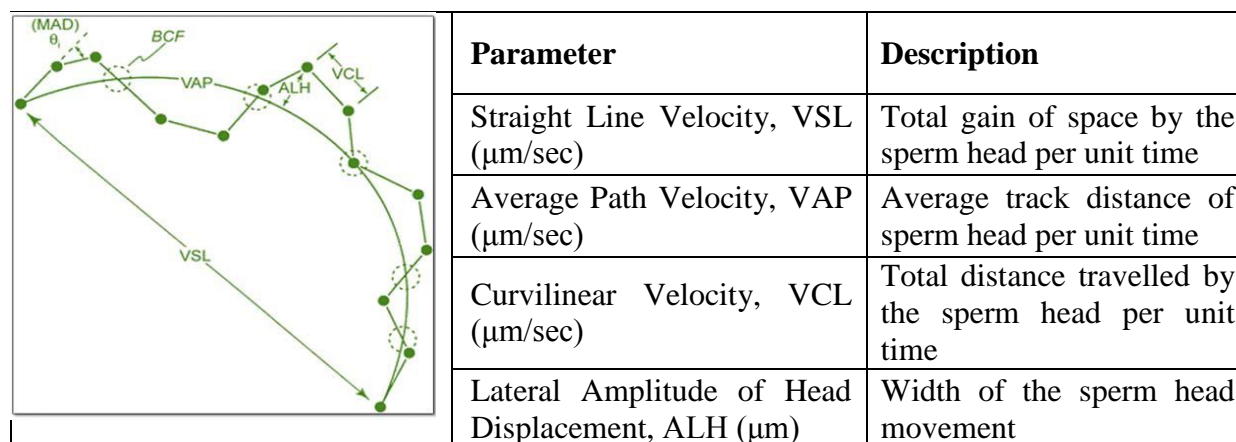

Figure 1. Kinetic parameters of sperm motility in CASA system (modified according to Mortimer, 1990, Mortimer and Maxwell, 2004, Nikolovski et al., 2014).

Sperm motility parameters determined by CASA system are good indicator and predictor of their fertilisation ability (Del Olmo et al., 2013), more precise than sperm count and overall percent of progressive motility. There are many studies that use this system as a precise tool to determine effect of different thawing protocols, extenders or additives to insemination doses and other factors that can influence sperm motility parameters. Assuming that, the aim of this study was to examine the impact of thawing temperature on motility parameters of bull's semen after thawing, assessed by CASA system.

Material and methods

The study included a total of 120 commercial insemination doses of semen, originating from three Simmental bulls (Indurein, Strellas, Polian, 40 doses for each of bulls). Bulls were housed in standard conditions of commercial reprocenter and fed in accordance with the norms for a given breed. In order to avoid the impact of the various terms of ejaculate taking on the parameters of semen quality, all doses from each bull originated from the same ejaculate. Doses of semen were taken during January 2014 from the commercial center for artificial insemination (AD Veterinary Cattle Breeding Center Banja Luka). Their thawing and analysis of quality parameters were carried out in the Laboratory of Genetics and Reproduction, Faculty of Agriculture, University of Banja Luka (Entity of Republic of Srpska, Bosnia and Herzegovina). Half of the selected insemination doses of each bull (n=20) were thawed by using standard procedure (at 38°C for 30 seconds), while the remainder (n=20) was thawed at a temperature of 50°C for 15 seconds.

After thawing, the parameters of sperm motility were determined for each dose, by using a computer program for sperm analysis (Computer Assisted Sperm Analysis, CASA, NIS Elements software). The following parameters were determined: velocity of straight line movement (Straight Line Velocity - VSL, μm/s), velocity of curvilinear movement (Curvilinear Velocity - VCL, μm/s), velocity of average movement (Average Path Velocity - VAP, μm/s) and the deviation from the average trajectory of movement (Amplitude of Lateral Head Displacement - ALH, μm).

The influence of different temperature treatments on sperm motility parameters was tested by combined factorial analysis of variance and Pearsons χ^2 test, with software package SPSS 22 (IBM 2013).

Results and discussion

Sperm motility parameters for insemination doses thawed at different temperatures are shown in Table 1.

Table 1. Sperm motility parameters for insemination doses thawed at different temperatures (M±SE)

Bull	t (°C)	n	Parameter			
			VCL	VAP	VSL	ALH
			µm/s	µm/s	µm/s	µm
Indurein	38	10 408	52,89±0,14	44,85±0,14	43,28±0,14	3,70±0,02
	50	15 971	59,99±0,11	53,96±0,11	52,58±0,11	4,07±0,02
Polian	38	12 684	52,66±0,13	43,78±0,13	42,13±0,14	3,77±0,02
	50	13 972	58,96±0,13	51,00±0,12	49,32±0,12	3,90±0,02
Strellas	38	11 533	51,99±0,17	42,72±0,16	40,69±0,16	3,51±0,02
	50	10 392	56,87±0,16	45,37±0,14	43,33±0,15	4,12±0,03

The values of all parameters determined were higher after thawing at a higher temperature in all three bulls. Average values of all examined parameters of sperm motility were significantly higher after thawing at 50°C compared to thawing at 38°C (VCL 58,60 vs. 52,51 µm/s, F=52,696, p<0,00; VAP 50,11 vs. 43,78 µm/s, F=43,675, p<0,00; VSL 48,41 vs. 42,03 µm/s, F=43,266, p<0,00; ALH 4,02 vs. 3,66 µm, F=17,337, p<0,00), as shown in Figure 2.

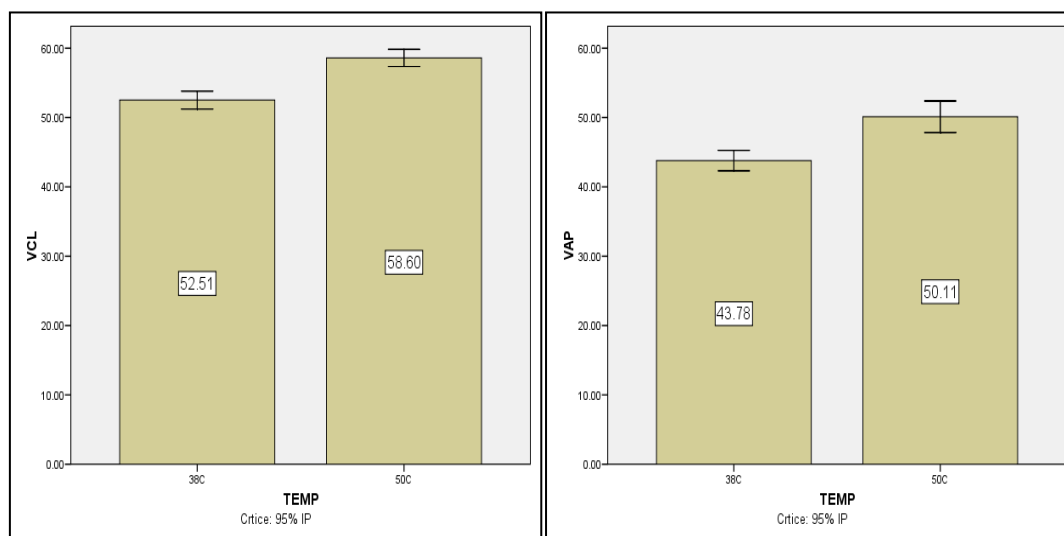

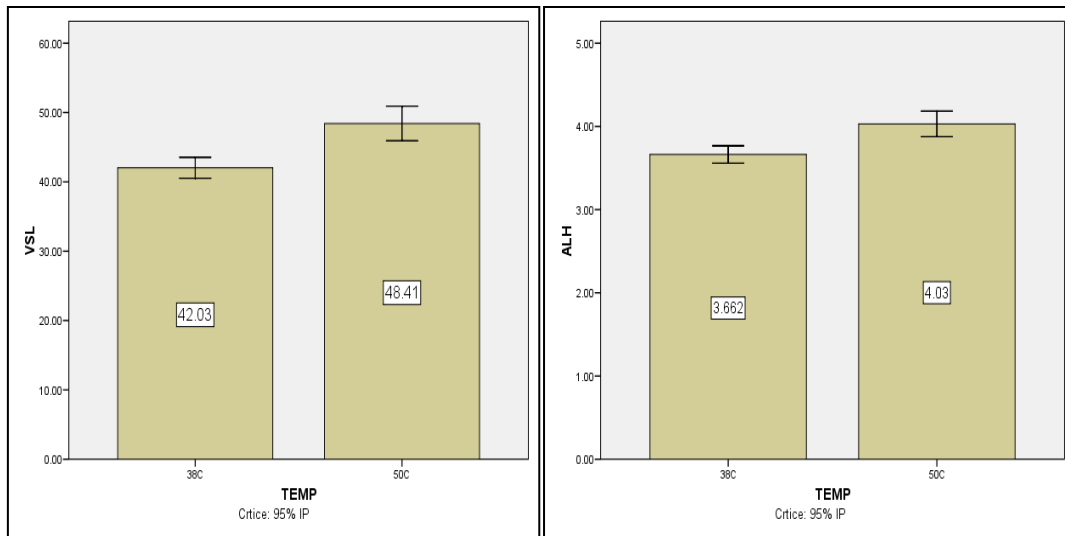

Figure 2. Average values of examined parameters of sperm motility after thawing at different temperatures

The results of the sperm motility parameters obtained with one CASA system can not be reliably compared with the results obtained in other laboratories, given the specificity of each version of the CASA system, as well as the characteristics of semen, such as sperm concentration, extender used, breed and individual studs' characteristics, and experimental protocols used. Najjar et al (2013), pointed to individual bull's characteristics as a factor that influences the values of the sperm motility parameters. These authors examined semen samples from four different bulls, and found significant differences in the obtained values (70, 75, 89 and 59 $\mu\text{m/s}$ for VCL; 83, 86, 109 and 70 $\mu\text{m/s}$ for VAP; 132, 138, 187 and 116 $\mu\text{m/s}$ for VSL). The influence of breed on the values of the sperm motility parameters was examined by Sarastina et al. (2012). These authors found different values of these parameters, depending to breed (from 105,30 to 121,04 $\mu\text{m/s}$ for VCL; from 62,31 do 73,19 $\mu\text{m/s}$ for VAP; from 47,43 to 61,60 $\mu\text{m/s}$ for VSL; from 3,85 to 4,59 μm for ALH). Sariozkan et al. (2010) examined the influence of diluent (Bioxcell, Optidyl, Tris) and breed (Holstein and Brown Swiss) on the sperm motility parameters after thawing at 37°C for 20 seconds. Values of sperm motility parameters in Holstein bulls, according to these authors, depended on the diluent type, and were 208, 218 and 241 $\mu\text{m/s}$ for VCL, 102, 117 and 123 $\mu\text{m/s}$ for VAP, 65.9, 84.8 and 79.9 $\mu\text{m/s}$ for VSL, and 8.20, 9.44 and 9.82 μm for ALH. In the Brown-Swiss bulls values of these parameters were 210, 219 and 213 $\mu\text{m/s}$ for VCL, 108, 115 and 122 $\mu\text{m/s}$ for VAP, 94.6, 85.9 and 87.0 $\mu\text{m/s}$ for VSL and 8.01, 9.29 and 7.82 μm for ALH. Values found by these authors are higher compared to our results, which is most likely due to different experimental protocols and characteristics of CASA system used. The values of the sperm motility parameters similar to those found in this study were reported by Šimoník et al. (2013), who thawed bull's semen at 37°C for 30 seconds and found values of 54.1 $\mu\text{m/s}$ for VAP and 43,7 $\mu\text{m/s}$ for VSL.

Conclusion

Results of this study indicate a generally favorable impact of higher thawing temperatures on sperm motility parameters. According to our results, it can be expected that faster moving of sperms after thawing at higher temperatures can increase fertilization rate, because the traveling time of sperms to fallopian tube should be shortened. On the other hand, the assumption is that faster and more intensely sperm moving after thawing at a higher temperature can lead to faster consuming of limited energy reserves of sperms, and limit their

vitality in female genital organs. Therefore, further research related to the effect of thawing temperature on sperm motility parameters in order to assess their fertilisation ability should be supplemented by examining the survival time and vitality of sperms after thawing at different temperatures.

References

- Del Olmo E., A. Bisbal, A. Maroto-Morales, O.Garcia-Alvarez, M. Ramon, P. Jimenez-Rabadan, F. Martinez-Pastor, A.J. Soler, J.J. Garde, M.R. Fernandez-Santos (2013). Fertility of cryopreserved ovine semen is determined by sperm velocity. *Animal Reproduction Science* 138; 102– 109.
- Miljković, V. (1998): *Artificial Insemination in Animals*. Zavod za udzbenike i nastavna sredstva, Beograd.
- Mortimer, D. (1990). Objective analysis of sperm motility and kinematics. In: *Handbook of the Laboratory Diagnosis and Treatment of Infertility*. (pp. 97–133). Keel, B.A. and Webster, B.W. (eds), CRC Press, Boca Raton
- Mortimer, S. (1997). A critical review of the physiological importance and analysis of sperm movement in mammals. *Human Reproduction Update*, 3, 5, 403–439.
- Mortimer, S.T., Maxwell, W.M.C. (2004). Effect of medium on the kinematics of frozen–thawed ram spermatozoa. *Reproduction* 127, 285–291.
- Najjar A. (2013): Evaluation of post thawed semen motility of Holstein bulls by computer assisted sperm analysis (CASA). *The Experiment*, Vol. 14 (2), 894-896
- Nikolovski M., Mickov Lj., Dovenska M., Petkov V., Atanasov B., Dovenski T. (2014): Influence of glutathione on kinetic parameters of frozen-thawed spermatozoa from Ovchepolian Pramenka rams. *Mac Vet Rev* 37 (2): 121-128.
- Sariozkan S., BarbarosTuncer P., NumanBucak M., Buyukleblebici S., Kinet H., Bilgen A. (2010): Evaluation of post – thaw quality of Brown-Swiss and Holstein bull semen diluted with different extenders. *Eurasian Journal Veterinary Sciences*, 26, 1, 51-55
- Šimoník O., Stádník L., Rajmon R., Beran J., Šichtař J., Ducháček J. (2013): Influence of LDL addititon on cryoprotective properties of bovine semen extenders. IV International Symposium „Agrosym 2013“, Jahorina, Bosnia and Herzegovina, October 3-6, 2013., *Book of Proceedings*, 1027-1032.

DETECTION OF β -LACTOGLOBULIN GENE POLYMORPHISM OF RAISED HAIR GOATS IN ANTALYA PROVINCE BY USING PCR-RFLP METHOD

Taki KARSLI^{1*}, Murat Soner BALCIOĞLU¹, Emine ŞAHİN², Hüseyin Göktuğ FİDAN¹, Kemal KARABAĞ³

¹Department of Animal Science, Faculty of Agriculture, Akdeniz University, Antalya, Turkey

²Korkuteli Vocational School, Akdeniz University, Antalya, Turkey

³Department of Agricultural Biotechnology, Faculty of Agriculture, Akdeniz University, Antalya, Turkey

*Corresponding author: takikarsli@akdeniz.edu.tr

Abstract

Goats one of the most important domestic livestock species and can adapt to extreme climatic and mountain conditions. Goat breeding is the livelihood especially for small farmers living in harsh condition in Turkey like developing countries. DNA technologies have been used extensively in livestock production like in many fields. DNA technologies are used improving of the quality and quantity of economically important traits (reproduction, meat, milk yields etc.) with selection. Genetic polymorphisms are playing an increasingly important role as genetic markers in many fields of animal breeding. β -lactoglobulin (β -LG) is one important protein related to milk quality in different ruminant species. Digestion with *SacII* restriction enzyme of exon 7 the β -LG gene reveals three different genotypes (AA-S₂S₂, AB-S₁S₂ and BB-S₁S₁) associated with milk quality and yield in goat breeds. Polymorphism in β -LG gene can be use for milk yield and quality in Marker Assisted Selection. In this study, β -LG gene polymorphism was investigated by using PCR-RFLP methods. In total 70 samples were used from four populations reared in different regions of Antalya province from Turkey. The amplified products were observed as 426 bp size at exon 7 in β -LG gene. These PCR products were digested with *SacII* restriction enzyme. As a result of PCR-RFLP analysis, frequencies of A and B alleles in β -LG gene were 0.545 and 0.455 respectively, while genotypic frequencies for AA, AB and BB were 0.285, 0.529 and 0.186 respectively.

Keywords: β -lactoglobulin, PCR-RFLP, Polymorphism, Hair Goat, Turkey

Introduction

Goats are usually raised under harsh environmental conditions and have a unique ability to take advantage of marginal areas (Gama and Bressana, 2011). Goats are one of important ruminant species in Turkey like developing countries. Goat breeding is the livelihood especially for small farmers living in harsh condition. According to TUIK (2015) data, there are about 10 million head goats in Turkey of which consist of 98% hair goats and 2% Angora goats (Anonymous, 2016a). Antalya is the largest second province of Turkey made goat breeding with presence of nearly 630.000 head goats. Hair goats are grown for primarily meat and milk later hair and leather. (Anonymous, 2016b).

β -lactoglobulin is one of two major important protein related to milk quality in different ruminant species (Kumar *et al.*, 2006; Lekerpes *et al.*, 2014). β -LG is the first milk protein shown different variants (A and B) in cows by Aschaffenburg and Drewry (1955). Since then, different variants has been shown in farm animals on molecular level. The relationship of between different variants of the β -LG gene with milk yield, composition and cheesemaking traits has been reported in various ruminant species (Rachagani *et al.*, 2006; Kumar *et al.*, 2006; Ramos *et al.*, 2009).

Two new variants have been detected for the goat-lactoglobulin gene at the genomic level by Pena *et al.*, (2000). The two polymorphisms are located on exon 7 of the gene. First

polymorphism is occurred a single nucleotide substitution in position +4601 of gene and can be detected with Polymerase Chain Reaction-Restriction Fragment Length Polymorphism (PCR-RFLP) using *Sac*II restriction enzyme. The other polymorphism is a 10 bp long insertion at position +4641 of gene and can be determined by capillary electrophoresis of amplified PCR products. Also Kumar *et al.*, (2006) reported that two alleles having an effect on 90-day milk production in goats and can be detected by SDS-page electrophoresis. The aim of this study was to investigate β -LG gene polymorphism of raised Hair goats in Antalya province from Turkey by using PCR-RFLP methods.

Materials and methods

Totally 70 blood samples were randomly collected from four hair goat populations reared in different regions of Antalya in February 2016. Blood samples were taken (approximately 5 ml) from the jugular vein, using sample tubes containing K3-EDTA. The blood samples were kept at -20 °C until the isolation of total DNA. Genomic DNA from blood samples was made using method by Miller *et al.*, (1988). DNA quality and quantity were analyzed on agarose gel and measured by spectrophotometric methods. After isolation of DNA it was adjusted 50 μ l/ml using bidistilled water H₂O for the PCR procedure.

Polymerase Chain Reaction-Restriction Fragment Length (PCR-RFLP) was performed for detection of polymorphism on β -LG gene from exon 7 to 3' flanking region. PCR amplification was performed by using forward 5'-CGG GAG CCT TGG CCC TCT GG-3' and reverse 5'-CCT TTG TCG AGT TTG GGT GT-3' primers. The amplification protocol was carried out as follow; initial denaturation at 94 °C for 5 min, followed by 35 cycles consisting of denaturation at 94 °C for 30 sec, annealing 65 °C 40 sec, extension at 72 °C for 30 sec and final extension at 72 °C for 5 min. The PCR reaction was performed in a 50 μ l reaction mixture containing; 50 ng/ μ l genomic DNA, 5 μ l 10 X PCR buffer (containing (NH₄)₂SO₄, pH: 8.8), 2.5 mM MgCl₂, 2.5 mM dNTP mix, 1.0 U Taq DNA Polymerase (Fermantase) and 0.5 μ M of each primer. PCR products resolved by electrophoresis on 1.5 % agarose gel at 100 V for 45 min.

10 μ l PCR products were digested with *Sac*II restriction enzyme (10 U- Fermantase) to determined β -LG A and B alleles overnight at 37 °C. The digestion products were separated on 3% agarose gel.

Allelic frequencies were obtained by direct counting in examined samples (Nei, 1987).

Results and Discussion

After DNA extraction (Figure 1), exon 7 of goat B-Lactoglobulin gene was successfully amplified by PCR process. A result of the PCR process obtained 426 bp size single band (Figure 2) in all samples. According to method proposed by Pena et al (2000) at single nucleotide substitution in position +4601 of exon 7 on β -LG gene, the digestion of these 426 bp size PCR products with *Sac*II restriction enzyme revealed three genotypes. These genotypes were shown as AA (S₂S₂ - undigested single band; size 426 bp), AB (S₁S₂ - three bands; sizes 426, 349 and 77 bp) and BB (S₁S₁-two band; sizes 349 and 77 bp) (Figure 3).

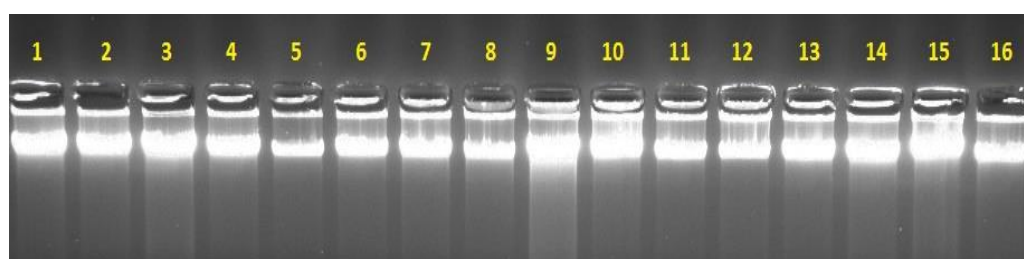

S

Figure 1 Image of DNA extraction on 1% agarose gel



Figure 2 Image of PCR amplification of β -Lactoglobulin gene (Line 1-6: PCR products of 426 bp size, NC: Negative control)

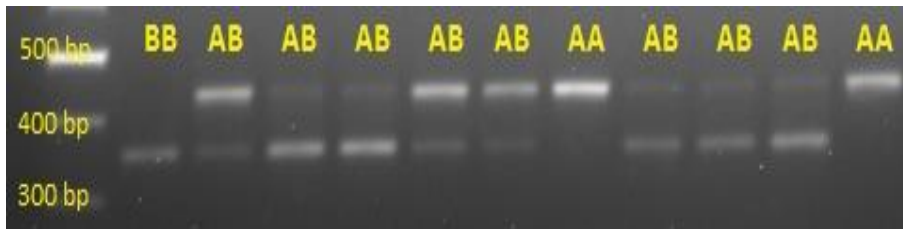

Figure 3 Image of genotypes exon 7 of caprine β -Lactoglobulin gene after digestion with *SacII* restriction enzyme of PCR products

β -Lactoglobulin and other milk proteins (e.g. α_{s1} , α_{s2} , β , k-caseins) are associated with milk production, milk composition and cheesemaking traits. In β -LG gene eight variants in cattle, three variants in ovine (A, B, C), two variants (A or S₂, B or S₁) in goat have been reported in various studies. (Piinzenberg and Erhardt, 1999; Pena *et al.*, 2000; Kumar *et al.*, 2006; Rachagani *et al.*, 2006; Moiola *et al.*, 2007). β -LG AA genotype had higher milk yield than the β -LG AB genotype showed by Kumar *et al.* (2006) in Barbari and Jamunapari goats. Similar findings were obtained in 5 Indian goat breeds by Prakash *et al.*, (2002). These genes can be used as candidate genes for marker-assisted selection in goats.

In this study, frequencies of A and B alleles in β -LG gene were 0.545 and 0.455 respectively, while genotypic frequencies for AA, AB and BB were 0.285, 0.529 and 0.186 respectively. The present study frequency of A allele was found higher than reported by Elmacı *et al.*, (2009) and by Korkmaz Agaoglu *et al.*, (2012) in Hair goat (0.33, 0.42) respectively. In contrast to these studies, frequency of A allele was lower than reported by Yüksel and Akyüz (2014) in Hair goat (0.81). Kumar *et al.*, (2006) reported that frequency of A allele ranging from 0.47-1 in thirteen goat breeds, Lekerpes *et al.*, (2014) reported as 0.23 and 0.13 in Samburu and Narok goat respectively. The frequency of AA genotype (0.245) identified in this study is higher than reported by Elmacı *et al.*, (2009) and Korkmaz Agaoglu *et al.*, (2012) AA genotype frequencies (0.11, 0.13 respectively) in Hair goat. These findings suggest that they may be used in Hair goats reared in Antalya province to improve milk yield and cheesemaking traits in other regions of Turkey.

Conclusions

Nowadays DNA technologies have been used extensively in livestock production like in many fields. DNA technologies are used in the conservation of animal genetic resources, phylogenetic analysis, improving of the quality and quantity of economically important traits (reproduction, meat, milk yields etc.) with selection and gene mapping studies. Genetic polymorphisms are playing an increasingly important role as genetic markers in many fields of animal breeding. In this study, polymorphism in β -LG gene showed in reared Hair goats in Antalya province from Turkey. Polymorphism in β -LG gene can be used for milk yield and quality in Marker Assisted Selection. However, the use of multiple genes is more suitable for

Marker Assisted Selection. Therefore, it is necessary to study polymorphisms other genes related to milk yield and quality in goats. Similar researches should be done again with further samples in β -LG and other milk proteins genes.

References

- Anonymous (2016a). TUIK, Turkish Statistical Institute, http://www.tuik.gov.tr/PreTablo.do?alt_id=1002 Accessed on 05/05/2016.
- Anonymous (2016b). TUIK, Turkish Statistical Institute, <https://biruni.tuik.gov.tr/hayvancilikapp/hayvancilik.zul> Accessed on 05/05/2016.
- Aschaffenburg R., Drewry J. (1955). Occurrence of different β - lactoglobulin in cow's milk. *Nature*, Vol. 176, pp. 218-219.
- Elmacı C., Oner Y., Koyuncu M. (2009). Allelic frequencies of a SacII RFLP at exon 7 of the β -lactoglobulin gene in Turkish hair goat breed, *Asian. Journal of Animal and Veterinary Advances*, Vol. 3, pp. 130-133.
- Gama L.T., Bressena M.C., (2011). Biotechnology applications for the sustainable management of goat genetic resources. *Small Ruminant Research*, Vol. 98, pp. 133-146.
- Korkmaz Agaoglu O., Çınar Kul B., Akyüz B., Elmaz O., Ozcelik Metin M., Saatçi M., Ertuğrul O. (2012). Identification of β -lactoglobulin gene SacII polymorphism in Honamli, Hair and Saanen goat breeds reared in Burdur vicinity. *Kafkas Univ Vet Fak Derg*, Vol. 18, No. 3, pp. 385-388.
- Kumar A., Rout P.K., Roy R. (2006). Polymorphism of β -lacto globulin gene in Indian goats and its effect on milk yield. *Journal of Applied Genetics*, Vol. 47, No 1 pp. 1-5.
- Lekerpes S.S., Jung J.O., Badamana M.S., Rubenstein D.I. (2014). Genetic polymorphism of beta-lactoglobulin in kenyan small east African goat breed using PCR-RFLP and sequencing. *Scientific Journal of Animal Science*, Vol. 3, No 8 pp. 233-239.
- Miller S.A., Dykes D.D., Polesky H.F. (1988). A simple salting out procedure for extracting DNA from human nucleated cells. *Nucleic Acids Research*, Vol. 16, pp. 12-15.
- Moioli B., D'Andrea M., Pilla F. (2007). Candidate genes affecting sheep and goat milk quality. *Small Ruminant Research*, Vol. 68, pp. 179-192.
- Nei M. (1987). *Molecular Evolutionary Genetics*. Columbia University Press., New York.
- Pena R.N., Sanchez A., Folch J.M., (2000). Characterization of genetic polymorphism in the goat beta-lactoglobulin gene. *Journal Dairy Research*, Vol. 67, pp. 217-224.
- Piinzenberg E.M., Erhardt G. (1999). Molecular genetic characterization of ovine β -lactoglobulin C allele and detection by PCR-RFLP, *Journal of Animal Breeding and Genetics*, Vol. 116, pp. 9-14.
- Prakash K., Rout P.K., Shukla S.N., Mandal A., Roy R. (2002). Genetics of milk protein variants in different Indian goats. *Xth Int. Congr.Asian-Austral. Assoc. Anim. Product. Soc., (AAAP)*, September 22-24, 168, New Delhi.
- Rachagani S., Gupta I.D., Gupta N., Gupta S.C., (2006). Genotyping of beta-lactoglobulin gene by PCR-RFLP in Sahiwal and Tharparkar cattle breeds. *BMC Genetics*, Vol. 7, pp. 31-34.
- Ramos A.M., Matos C.A.P., Russo-Almeida P.A., Bettencourt C.M.V., Matos J., Martins A., Pinheiro C., Rangel-Figueiredo T. (2009). Candidate genes for milk production traits in Portuguese dairy sheep. *Small Ruminant Research*, Vol. 82, pp. 117-121.
- Yüksel M., Akyüz B. (2014). Detection of Beta-Lactoglobulin gene polymorphism with PCR-RFLP Method in Hair goat breed raising at Kayserı and province. *Journal of Health Sciences*, Vol. 23, pp. 62-66.

TOLERANCE OF HONEY BEES ON COMMON JUNIPER (*Juniperus communis*) AND SCOTS PINE (*Pinus silvestris*) ESSENTIAL OILS

Nebojša NEDIĆ^{1*}, Miroslav KOSTIĆ², Tatjana MARKOVIĆ², Kazimir MATOVIĆ³, Miša MARKOVIĆ¹

¹University of Belgrade, Faculty of Agriculture, Belgrade, Serbia

²Institute for Medicinal Plant Research "Dr Josif Pančić", Belgrade, Serbia

³Veterinary Specialized Institute "Kraljevo", Kraljevo, Serbia

*Corresponding author: nedicn@agrif.bg.ac.rs

Abstract

The need to provide welfare of bees in alternative systems of the fight against pests without application of chemicals influenced our investigation of application of different substances of natural origin on the honey bees. In order to perceive the common juniper (*Juniperus communis*) and scots pine (*Pinus silvestris*) essential oils of honey bee tolerance and contact residual toxicity was examined in the laboratory conditions. The chemical composition of the oils was determined by standard GC and GC/MC methods. Different doses of the essential oils dissolved in acetone (10 – 40 µl/Petri dish) were applied in Petri dishes and left to dry for 20 minute at a room temperature. Following this period of time, ten honey bees were added in each Petri dish in four replications and maintained in controlled conditions. Survival of examined honey bees was recorded two times, after 24 h and 48 h. The most prominent toxic effect on the examined honey bees was observed with application of 24 µl/Petri dish of common juniper oil and with dose of 15 µl/Petri dish of scots pine oil. Recorded biological activities of the oils tested in different doses, revealed the opportunity to proceed with further investigation by selecting the most appropriate variants for further investigation on both, honey bee and honey bee mite *Varroa destructor*.

Keywords: *Apis mellifera*, essential oils, residual contact toxicity.

Introduction

Honey bees (*Apis mellifera* L.) is exposed to the impact of many pests and diseases; significant loss of bee colonies around the world has been reported since 2006 (Le Conte *et al.*, 2010). As one of the main causes of the syndrome, a colony collapse disorder is an ectoparasite *Varroa destructor*. It causes a great damage to the bees, since it significantly weakens the colony, and it is a vector of numerous viruses (Mond *et al.*, 2011). If during the year the bee colonies are not treated by acaricides against the mites, they use to die (Ruffinengo *et al.*, 2014). For *Varroa* control, several methods were developed and the most commonly used are chemical ones. Their negative effects include the emergence of resistant mites and cumulative deposition of harmful metabolites of their synthetic constituents in the wax, which further migrate into the honey and other bee products (Martel *et al.*, 2007). Consumers consider bee products, primarily the honey, as a healthy and safe food, thus, the occurrence of residues in the bee products creates a negative impression and great doubt in their quality. Therefore, in the fight against *Varroa destructor* the solution require testing and application of so-called "green pesticides", which are mainly based on essential oils or organic acids (Cole *et al.*, 2008). The complex structure of essential oils and a very low tolerance of the honey bee to their application in laboratory testing, makes difficult to discover effective oil that would be harmless to the bee and efficient against the mites (Nedić *et al.*, 2012).

The aim of the initial phase of our research was to examine in the laboratory conditions the honeybee's tolerance to contact residual toxicity of commercial juniper and scots pine essential oils.

Material and Methods

The juniper oil (*Juniperus communis*) and scots pine oil (*Pinus silvestris*), used in this experiment, were purchased as commercial samples from "Elmar d.o.o.", city of Trebinje, Republic of Srpska (Bosnia and Herzegovina). Analytical gas chromatography (GC-FID) was performed on the GC HP-5890 Series II apparatus, equipped with autosampler (ALS), split-splitless injector, attached to HP-5 fused silica capillary column (25 mm × 0.32 mm, 0.52 μm film thickness) and fitted to flame-ionization detector (FID). Identification of individual essential oils' constituents were accomplished by comparison of their mass spectra with those from available MS libraries (NIST/Wiley) and by comparison of their experimentally determined retention indices (calibrated AMDIS) with data from the literature (Adams, 2001). Testing of bees tolerance to contact residual toxicity of essential oils, was conducted in Petri dishes, in four replications, under controlled laboratory conditions (T= 30° C; Relative humidity = 60%). Different essential oils' doses dissolved in acetone (0.1–10 μL/Petri dish) were applied in Petri dishes (11 cm in diameter) and left to dry for 20 minute at a room temperature, and then the dishes was supplemented with 10 newly emerged adult bees (0 to 3 days old). The bees were fed with 3 g of candy and watered with water from a plastic micro tube (1.5 mL). Acetone was used as control. Survival of bees in each Petri dish was recorded twice, after 24 h and 48 h. The obtained results were processed by Analysis of variance (LSD test at the significance level of 5 and 1%). Probit analysis was used to calculate the contact residual toxicity of the essential oils for adult bee at LD₃₀, LD₅₀ and LD₉₅ after 24 and 48 hours.

Results and Discussion

Results of GC-FID and GC/MS analysis of commercial juniper (*Juniperus communis*) and scots pine (*Pinus silvestris*) essential oils are presented in Table 1.

Table 1. Chemical composition of commercial *Juniperus communis* and *Pinus sylvestris* essential oils.

Constituents	RI	<i>Juniperus communis</i>	<i>Pinus sylvestris</i>
Tricyclene	917	0.1	0.1
Pinene<alpha->	930	35.3	88.5
Camphene	943	0.4	1.9
Thuja-2,4(10)-diene	949	0.2	0.2
Sabinene	970	0.2	
Pinene<beta->	972	2.0	1.8
Myrcene	990	27.1	
Phellandrene<alpha->	1002	0.1	
Carene<delta-3->	1007		0.1
Terpinene<alpha->	1014	0.1	
Cymene<para->	1022	0.2	1.0
Limonene	1025	8.3	3.0
Terpinene<gamma->	1056	0.2	
Terpinolene	1085	0.6	
Pinene oxide<alpha->	1094		0.7

Camphenone<6->	1094		0.1
Campholenal<alpha->	1126	0.4	
Sabinol<trans->	1138		0.6
Camphor	1141	0.2	0.4
Myrcenone	1146		0.7
Borneol	1165	0.2	
Terpinen-4-ol	1176	0.2	
Terpineol<alpha->	1187	0.1	
Myrtenal	1195		0.3
Carveol<trans->	1210		0.4
Bornyl acetate	1283	0.2	0.1
Cubebene<alpha->	1337	0.5	
Copaene<alpha->	1371	0.3	
Caryophyllene<trans->	1414	4.1	
Copaene<beta->	1425	0.2	
Humulene<alpha->	1447	2.6	
Muurolene<gamma->	1473	0.7	
Germacrene D	1477	2.2	
Himachalene<gamma->	1482	0.2	
Muurolene<alpha->	1494	0.8	
Cadinene<gamma->	1510	0.5	
Cadinene<delta->	1520	1.9	
Calacorene<alpha->	1541	0.1	
Germacrene B	1553	0.2	
Caryophyllene oxide	1580	0.4	
Thujopsan-2-alpha-ol	1580	0.1	
Humulene epoxide II	1606	0.4	
Cadinol<epi-alpha-> (τ -cadinol)	1640	0.1	
Geranyl linalool<Z,Z->	1949	6.4	
Geranyl linalool<E,Z->	1986	2.2	
<i>Sum of identified compounds</i>		<i>100.00</i>	<i>99.85</i>
<i>Number of identified compounds</i>		<i>38</i>	<i>16</i>

Composition of commercial essential oil depends on the variety used for its production (Marković, 2011). The most dominant components of juniper oil used in this experiment were α -pinene, myrcene, limonene, *cis-cis*-geranyl linalool and *trans*-caryophyllene, which together accounted 81.2% for the entire oil, while in the oil of scots pine the most dominant constituents were α -pinene and limonene, and they accounted for 91.5% of this oil (Table 1). Results of residual contact toxicity observed 24 h and 48 h following the application of different doses of juniper oil, and results of Probit analysis are presented in Tables 2 and 3, respectively.

Table 2. Residual contact toxicity on bee adults caused by application of different doses of *Juniperus communis* essential oil.

N°of variants	Doses assayed (µL/Petri dish)	Mortality after 24h	Mortality after 48h
		$\bar{X} \pm SE$	$\bar{X} \pm SE$
1.	20	0±0a	0±0a
2.	24	2±0.71ab	2±0.71ab
3.	27	3.25±0.49ab	3.25±0.49ab
4.	30	3.25±0.85ab	3.75±0.75b
5.	32	3.75±0.95b	4.5±0.65b
6.	36	7±1.25c	7±1.22c
7.	40	7.5±0.5c	7.75±0.63c
8.	0.0	0±0a	0±0a
		<i>LSD</i> ₀₀₅ =1.91	<i>LSD</i> ₀₀₅ =1.89
		<i>LSD</i> ₀₀₁ =2.60	<i>LSD</i> ₀₀₁ =2.57

Table 3. Probit analysis for residual contact toxicity on bee adults caused by application of *Juniperus communis* essential oil.

Time	Intercept (a)	Slopeb (b) (±SE)	LD ₃₀ (95% CI*)	LD ₅₀ (95% CI)	LD ₉₅ (95% CI)
After 24h	-7.38	8.18(±1.04)	28.19 (25.99-29.99)	32.69 (30.75-35.28)	51.95 (45.15-67.77)
After 48h	-7.75	8.47(±1.04)	27.75 (25.59-29.47)	32.01 (30.17-34.32)	50.07 (43.98-63.63)

*CI (confidence interval)

Results of residual contact toxicity observed 24 h and 48 h following the application of different doses of scots pine oil, and results of Probit analysis are presented in Tables 4 and 5, respectively.

Table 4. Residual contact toxicity on bee adults caused by application of different doses of *Pinus sylvestris* essential oil.

N° of variants	Doses assayed (µL/Petri dish)	Mortality after 24h	Mortality after 48h
		$\bar{X} \pm SE$	$\bar{X} \pm SE$
1.	10	0±0a	0±0a
2.	15	0±0a	1.25±0.63ab
3.	20	1.25±0.95a	3.5±1.44abc
4.	24	3.5±0.96ab	4.75±1.49bcd
5.	27	4.75±0.85bc	7±0.91cde
6.	30	5.75±1.03bc	7.25±0.85cde
7.	32	6±1.08bc	7.75±1.03de
8.	36	6.75±1.44c	8±1.35e
9.	40	6±1.08bc	9±0.71e
10.	0.0	0±0a	0±0a
		<i>LSD</i> ₀₀₅ =2.72	<i>LSD</i> ₀₀₅ =2.99
		<i>LSD</i> ₀₀₁ =3.67	<i>LSD</i> ₀₀₁ =4.04

Table 5. Probit analysis for residual contact toxicity on bee adults caused by application of the *Pinus sylvestris* essential oil

Time	Intercept (a)	Slope (b) (± SE)	LD ₃₀ (95% CI*)	LD ₅₀ (95% CI)	LD ₉₅ (95% CI)
After 24h	-3.30	5.61(±0.67)	24.29 (21.91-26.25)	30.12 (27.97-32.81)	59.19 (49.70-79.97)
After 48h	-3.00	5.81(±0.59)	19.38 (17.14-21.15)	23.85 (21.96-25.65)	45.79 (40.30-55.71)

*CI (Confidence interval)

After the first 24 h, the doses of *J. communis* oil ranging from 20 to 30 ml / Petri dish had no statistically significant effect on the honey bee mortality (Table 2). The highest two oil doses, 36 and 40 ml / Petri dish caused mortality of approximately 7 and 7.5 bees / petri dish, respectively, and their differences were statistically highly significant from the remaining doses of this oil. With increasing oil concentration, the oil became toxic to the bees.

The scots pine essential oil applied at doses of 27, 30, 32, 36 and 40 ml / Petri dish showed pronounced toxicity in comparison to other tested doses, and the average numbers of dead individuals per replication were 4.75, 5.75, 6, 6.75 and 6, respectively (Table 4).

In observation of residual contact toxicity made after 48 hours, the toxic effects of the two tested oils applied was more pronounced comparing to the effects of these two oils expressed after 24 hours (Tables 2 and 4). The scots pine oil applied in doses 30, 32, 36 and 40 µL/Petri dish expressed significant toxicity to the bees; the average numbers of dead adult bees per replication were 3.75, 4.5, 7 and 7.75, respectively (Table 2). The scots pine oil applied in doses 24, 27, 30, 32, 36 and 40 µL/Petri dish expressed the average numbers of dead adult bees per replication of 4.75, 7, 7.25, 7.75, 8 and 9, respectively (Table 4).

Great challenge in the application of essential oils in controlling bee pests is to find the oil which is non-toxic to the host (the honeybee). On the other hand, the insecticidal activity of the oils can vary even if it is originating from the same source. The reasons for this is a great variability of oil chemical composition depending on many factors (the age of the plant, plant organs or tissues used for the oil extraction, type of distillation), as well as due to the type and age of the treated organism (Sampson *et al.*, 2005).

Genda *et al.* (2010) examined the impact of *Eucalyptus globulus* essential oils from different geographic regions of Argentina against honey bee diseases. The content of dominant oil components, eucalyptol and α-pinene, differed and depended on the investigated regions; when treated with 5 uL / cage, the bee mortality after 48 h of treatment with oil from Conlara and Mar del Plata was 8% and 0%, respectively.

Kraus *et al.* (1994) tested a number of different essential oils and came to conclusion that none of them increased the bee mortality when applied at concentrations of 0.1% and 1%, while at the concentration of 10% they always did.

Lindberg *et al.* (2000) have recommended criterion for selection of appropriate chemical for Varroa control; it is supposed to kill more than 70% of mites and less than 30% of bees. If we adhere to this recommendation, the most appropriate calculated doses of the *J. communis* essential oil for the effects observed after 24 and 48 hours, according to our experiment would be 28.19 and 27.75 ml / Petri dish, respectively (Table 3), while in the case of *P. sylvestris*, the best oil doses would be 24.29 and 19:38 uL /Petri dish, respectively (Table 5). The pine oil compared to juniper oil in our experiment showed greater toxicity for the bees.

Conclusion

The emergence of resistance among *Varroa* mites due to application of synthetic chemical agents in its control, as well as the presence of residues in the wax and other bee products, imposed the need to introduce an integrated system to combat organisms that are harmful to the bees.

The oil of *J. communis* applied in doses ranging from 27 to 40 µL caused contact residual toxicity to the bees at an unacceptable level.

The *P. sylvestris* oil applied at doses ranging from 24 to 40 µL expressed toxic effects which caused an unacceptable level of the bee mortality.

Further research will be focused on application of *J. communis* and *P. sylvestris* essential oils at doses below 27.75 µL and 19.38 µL, respectively, and their effects on both, the bees and the mite *Varroa destructor*, will be carefully investigated.

Acknowledgments

The authors are grateful to the Ministry of Education and Science of Republic of Serbia for financial support (Grants N^o III46008 and III46009).

References

- Adams RP. 2001. Identification of Essential Oil Component by Gas Chromatography / Quadrupole Mass Spectrometry. Carol Stream, Illinois, pp.1-456, Allured Publ. Corporation, USA.
- Gende L., Maggi M., van Baren C., di Leo Lira A., Bandoni A., Fritz R., Eguaras M. (2010). Antimicrobial and miticide activities of Eucalyptus globulus essential oils obtained from different Argentine regions. Spanish J. Agri. Res. 8 (3), 642-650.
- Le Conte, Ellis M., Ritter W. (2010). *Varroa* mites and honey bee health: can *Varroa* explain part of the colony losses? Apidologie 41, 353–363.
- Lindberg C.H., Melathopoulos A.P., Winston M.L. (2000). Laboratory evaluation of miticides to control *Varroa jacobsoni* (Acari: Varroidae), a honeybee (Hymenoptera: Apidae) parasite. J. Econ. Entomol. 93, 189–198.
- Koul O., Walia S., Dhaliwal G.S. (2008). Essential oils as green pesticides: Potential and constrains. Biopestic. Int. 4, 63-84.
- Martel A.C., Zeggane S., Aurieres C., Drajnudel P., Faucon JP., Aubert M. 2007. Acaricide residues in honey and wax after treatment of honey bee colonies with Apivar[®] or Asuntol[®] 50. Apidologie 6, 534-544.
- Marković T. (2011). Etarska ulja i njihova bezbedna primena. Institute for Medicinal Plant Research “dr Josif Pančić” Ed., Belgrade, Serbia.
- Mondet F., Goodwin M., Mercer A. (2011). Age-related changes in the behavioural response of honeybees to Apiguard, a thymol-based treatment used to control the mite *Varroa destructor*. J. Comp. Physiol. A 197, 1055-1062.
- Nedić N., Andrić G., Kostić M., Marković T., Kljajić P., Stanković S., Marković M. (2012). Tolerance of honey bees on three commercial essential oils. Proceedings of the Seventh Conference on Medicinal and Aromatic Plants of Southeast European Countries, AMAPSEEC, Subotica, Serbia, pp. 362-369.
- Ruffinengo R.S., Maggi D.M., Marcangeli A.J., Eguaras J.M., Principal J., Barrios C., De Piano F., Giullia M. (2014). Integrated Pest Management to control *Varroa destructor* and its implications to *Apis mellifera* colonies, Zootecnia Trop. 32(2),149-168.
- Sampson B.J., Tabanca N., Kirimer N., Demirci B., Hunsu Can Baser K., Khan I.A., Spiers J.M., Wedge D.E. (2005). Insecticidal activity of 23 essential oils and their major compounds against adult *Lipaphis pseudobrassicae* (Davis) (Aphidae: Homoptera). Pest Manag. Sci. 61, 1122-1128.

TRENDS IN POLISH INTERNATIONAL TRADE IN EGGS PRODUCTS IN THE PERIOD 2006-2015

Dorota PASIŃSKA

Market Research Department, Institute of Agricultural and Food Economics - National Research Institute,
Poland

*Corresponding author: dorota.pasinska@ierigz.waw.pl

Abstract

The main aim of this article is to present the Polish eggs market after accession to the European Union (EU) in the context of foreign trade in eggs products. In the last decade, there has been an increase in the positive trade balance for eggs products and slow processes of concentration of eggs production in Poland. The increase in exports was possible by substantially reducing domestic consumption, which contributed to the improvement of Polish self-sufficiency in the production of eggs. In addition, in the first years after joining the EU, Polish eggs possessed a price advantage on the EU market, and in subsequent years the average prices of Polish eggs were close to average EU prices of eggs. In the analyzed period, Poland was a net exporter of the eggs products. This article is valuable not only to the eggs producers, processing industry of eggs, and customers, but also to the Polish economic policy. The study used a comparative analysis in time and an analysis of the structure of exports and imports of egg products, with particular emphasis on the commodity structure of exports and imports of eggs products. The article includes an analysis of the geographical structure of exports and imports of egg products. The study covers the period 2006-2015. The data comes mainly from the Polish Ministry of Finance and the Central Statistical Office.

Keywords: *eggs market, foreign trade in eggs, Poland, hen-laying*

Introduction

Due to difficulty of transporting poultry eggs in shells, they are not a commonly exported item. The level of egg consumption around the world is very diverse, e.g. in 2005, egg consumption per capita amounted to 320 units in China, 45 eggs in Pakistan, and 11.2 units in Nigeria (Kornakowski, 2007).

The cost of egg production in the EU is higher than in other important producer countries (Ukraine, USA, Argentina, and India) (van Horne, 2014). According to P. van Horne, those countries pose no threat to the EU shell egg market due to import duties and the difficulty of maintaining appropriate quality in long-distance transport (van Horne, 2014).

A decisive majority of research results related to the Polish egg market concerns egg consumption, prices (Świetlik, 2013; Świetlik, 2012a; Świetlik, 2012b, Świetlik 2008) and production (Kapusta, 2014). The studies related to foreign trade primarily provide analysis of trade in eggs (Czyżewski and Danilczuk, 2008) and certain egg products. Moreover, research on geographic directions of foreign trade in eggs and egg products is conducted by the Institute of Agricultural and Food Economics. The principal goal of research by the Institute is to assess short-term changes to the Polish egg market. The results are published each year (IERIGŻ-PIB, MRiRW, ARR, 2006-2015). None the studies in question provide an analysis of the scale of Polish foreign trade in hatching eggs or egg albumins.

Material and Methods

The research uses data from the Central Statistical Office of Poland (GUS) concerning production of eggs for consumption and hatching and the data from the Ministry of Finance concerning foreign trade in egg products, i.e. albumins, hatching eggs, eggs not in shell, egg yolks and eggs in shell. Data concerning foreign trade in 2015 is preliminary data. The research utilises comparative analysis over time and exports and imports structure analysis. The research covers primarily the 2006-2015 period. Deviations from the temporal scope resulted mainly from the unavailability to credible/reliable statistical data or the impossibility to present the structure of the phenomenon.

Results and Discussion

Egg production is an important branch of animal production in Poland. Compared to 2006, increased by about 6% in 2015, which was facilitated by the export demand (Fig. 1). This increase in production was a resultant of the increase in production of eggs for consumption by 3% and increase in hatching eggs production by 32%. Poland produces mainly chicken eggs for consumption, the production of hatching eggs concerns mainly chicken, duck's, goose's and turkey eggs. Production of eggs grew in 2007-2010 and in 2013-2015, while in 2011-2012 a decrease, which resulted from the necessity to withdraw conventional cages from the battery cage system. Producers had 12 years for implementing EU requirements in this regard. (Dybowski, 2013). This led to an increase in cost and thus a decrease in profitability of egg production (Krawczyk, Sokołowicz, 2008). The percentage of eggs for consumption in total production ranged from 87% to 91%, and the percentage of hatching eggs from 9% to 13%. In 2014, the percentage of chicken eggs for consumption in market oriented animal production increased by 1.5 percentage point compared to 2006 to reach 9.7% in 2014 (GUS b, 2009, GUS b, 2015).

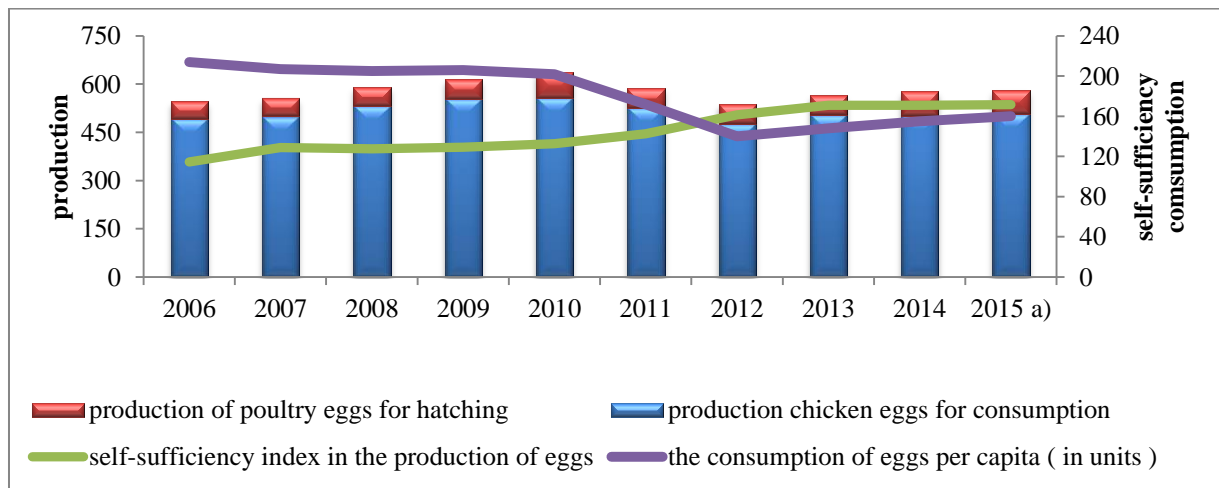

a) estimation

Figure 1. Production of eggs in Poland (in the thousand of tonnes), polish self-sufficiency index in the production of eggs for consumption (in %), the consumption of chicken eggs per capita (in units).

Source: own study on the base: data from Main Statistical Office (GUS) follow by: [(Dybowski 2011, p. 18), (Dybowski 2015, p. 28)], (GUS c, 2007, p. 96), (GUS c, 2010, p. 77) (GUS c, 2015), (Świetlik 2015, p. 37)

In the period in question, eggs were one of the foodstuff groups whose price increased the most, which resulted in a drop in their consumption and growth in consumption of other products that are source of animal protein (Pasińska, 2015). According to household budget studies concerning that period, the decrease in egg consumption was the highest in the case of

self-employed persons' households (to 120 eggs per person in 2015), and the level of egg consumption was the highest in the case of farmers' and pensioners' household, which was related to those two groups' self-supply capability (data from GUS, Pasińska 2015). In 2006, the retail price of hen eggs for consumption was PLN 0.34 per item, in the year when the production of eggs for consumption was the lowest (2012) – PLN 0.60, and in 2015 – PLN 0.51. A significant growth in retail price of eggs in 2012 was accompanied by the least egg consumption per capita in the studied period (140 chicken eggs per capita) (data from GUS, GUS c, 2015). The slowdown of price in the following years (2013-2015) resulted in a growth in consumption (to about 160 eggs per capita - estimation) (Świetlik, 2015). In the period in question, the downward trend in egg consumption contributed to the improvement to self-sufficiency in domestic egg production.

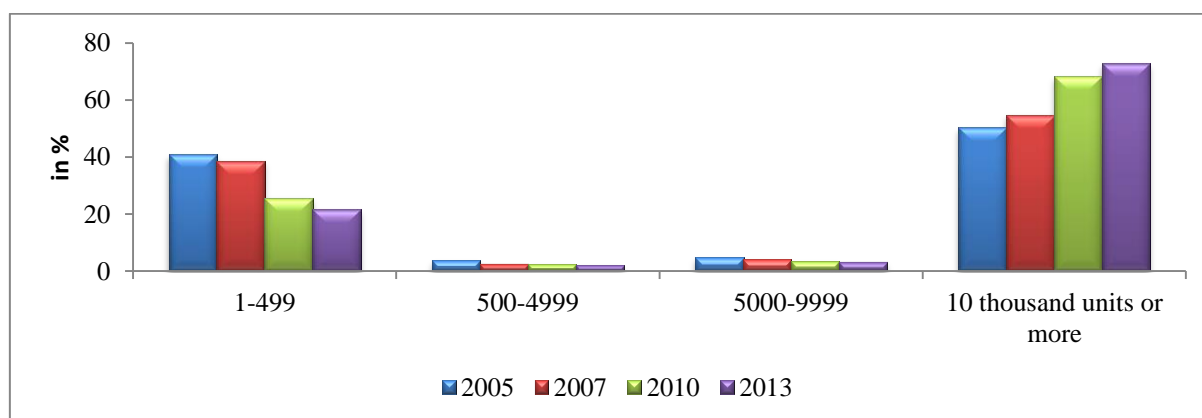

Figure 2. Structure of laying hens stock according to the breeding scale (in %).

Source: own work based on the: (GUS a, 2006 p. 198), (GUS a, 2008 p.188), (GUS a, 2012 p. 232), (GUS a, 2014, p. 124)

Slow concentration of laying hen rearing and breeding can be observed in Poland (Fig 2). This is reflected by the decreasing number of farms that produce eggs for hatching and consumption and the increase in percentage of the domestic chicken stock in chicken flocks of 10,000 laying hens or more units. In 2013 the number of laying hen rearing and breeding farms decreased by about 55% (to 516,000 farms in 2013) compared to 2005 (GUS a, 2006), (GUS a, 2014). At the same time, the proportion of laying hens in flocks of 10,000 or more rose from 50.3% in 2005 to 72.8% in 2013. This increase occurred primarily at the expense of the percentage of laying hens in small flocks of 1-499 from 41.0% in 2005 to 21.7% in 2013. (GUS a, 2006), (GUS a 2014).

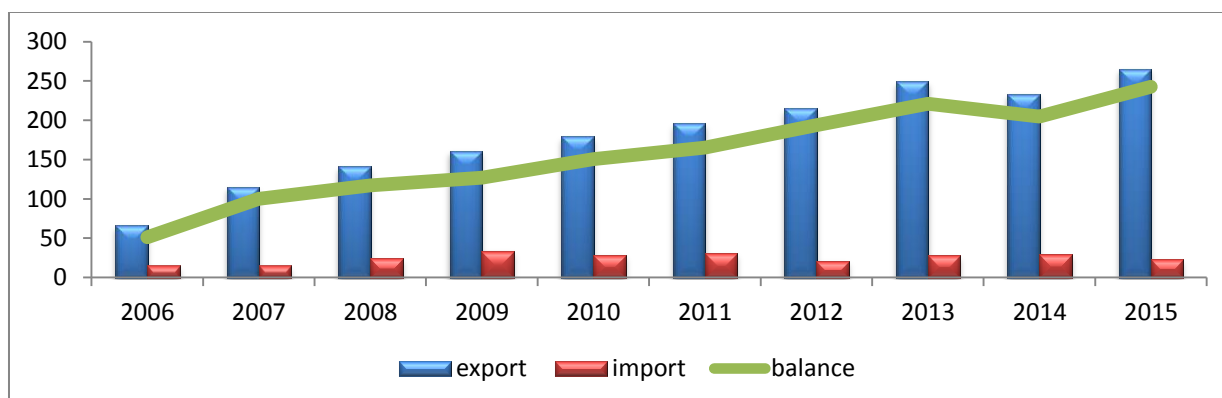

Figure 3. Foreign trade of egg products (in thous. tonnes).

Source: Own calculations based on data from the Ministry of Finance.

In 2006-2015, there was an upward trend in the Polish foreign egg trade turnover (Fig 3). In the relative perspective, the average annual rate of eggs products export growth amounted to about 17%. Egg product exports increased over four times, from 66,000 tonnes to 265,000 in 2015, and the simultaneous about 1.5 times increase in imports from 15,000 tonnes to 23,000 tonnes made Poland the net poultry product exporter in the entire period in question. The increase in egg product exports was possible due to a significant drop in domestic egg consumption.

In the studied period, egg product imports grew over 1.5 times in terms of quantity, and nearly 2.0 times in terms of value, to nearly EUR 50 million (see Fig. 2). The imports were low, particularly compared to Polish poultry product exports. The lower volume dynamics in imports than currency inflows resulted, among other things, from the increase in transaction prices. In spite of the dominant upward trend in egg product imports in the studied period, there were some drops (in 2010, 2012, and 2015). The average imports to Poland in 2006-2015 grew by 5% each year.

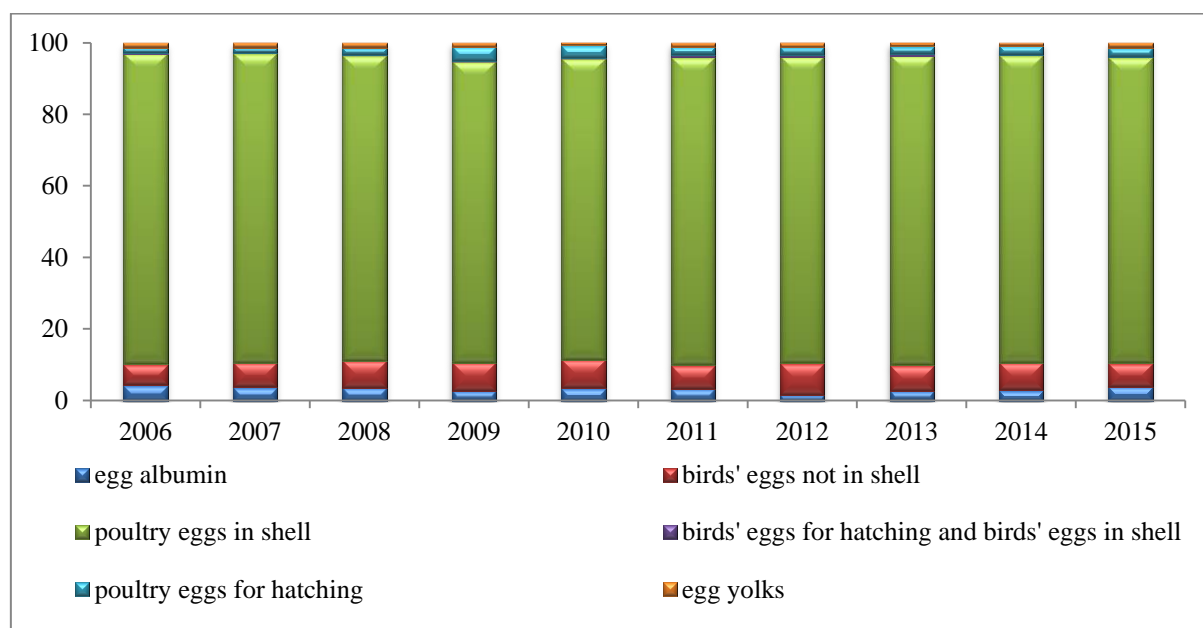

Figure 4. The structure of exports of egg products in the period of 2006-2015 (%).
Source: own work based on data of the Ministry of Finance.

In 2006-2015, the commodity structure of exports was diverse. It was dominated by shell eggs for consumption (over 84%) (Fig. 4). In the year of the Polish accession to the EU, Polish eggs for consumption gained a competitive advantage because their price was about 14% lower than the average EU price for this product range. In the studied period, however, the average L and M class egg prices were lower than the EU average only in 2006, 2007, 2009, 2011, and 2014 (about 2%-3%), while in the remaining part of the period, they were higher (about 1%-9%) (European Commission, 2016). Poland exported shell eggs primarily to the EU countries. The main buyers of Polish shell eggs were: Germany, Netherlands, Italy, Czech Republic, Romania, and Slovakia. In the studied period, the L and M class egg prices in some main buyer countries were significantly higher than in Poland, i.e. in Italy (from 32% to 72%) and Denmark (6%-58%). In 2006-2015, the differences between the average poultry egg (in shell) export prices and import prices were varied, but it were not more than 0.10 EUR / kg. Other groups of products constituted a relatively low percentage of exports: egg albumins – 2% to 4%, egg yolks – about 1%, bird eggs not in shell – 6% to 9%, shelled and hatching eggs of birds – nearly 0% to 1%, poultry hatching eggs – 2% to 4%. In the entire studied period import prices of hatching eggs were higher than the export prices. The highest proportion of exports from Poland in various categories:

- poultry eggs in shells had chicken eggs since 2012,²
- albumins – egg albumin, fit for human consumption (excluding dried {for example in sheets, flakes, crystals, powder}),
- bird eggs, not in shell – birds' eggs, not in shell, fresh, cooked by steaming or by boiling in water, moulded, frozen or otherwise preserved, whether or not containing added sugar or other sweetening matter, suitable for human consumption (excluding dried and egg yolks),
- hatching eggs – chicken eggs since 2012,³
- yolks – egg yolks, liquid, suitable for human consumption, whether or not containing added sugar or other sweetening matter.

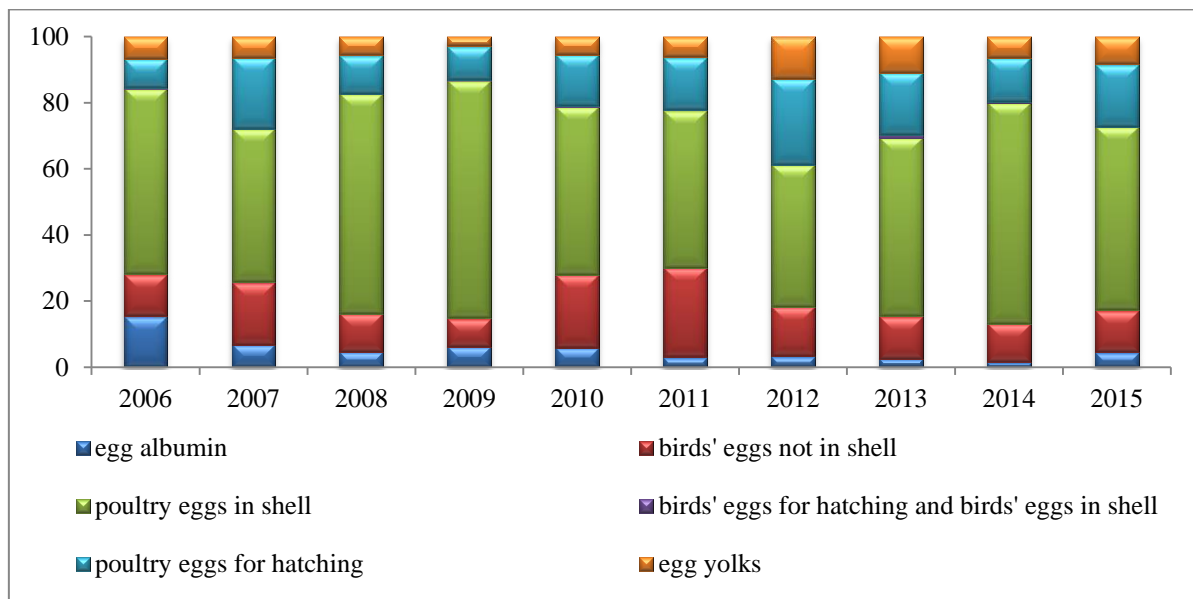

Figure 5. Imports structure of egg products in the period 2006-2015 (%).

Source: own work on the basis of data of the Ministry of Finance.

The commodity structure of Polish egg product imports was diverse and changed (Fig. 5). In the period in question, the most popular product range were shelled poultry eggs (over 42% share). The proportion of albumins dropped from 15% in 2006 to 5% in 2015, the proportion of poultry eggs in shells - from 56% to 55%, the percentage of poultry eggs for hatching grew from 9% to 19%, yolks - from 7% to 8%, the proportion of bird eggs not in shell stayed the same - 13%, and the percentage of birds' eggs for hatching and in shell - nearly 0%. The highest proportion of import to Poland in various categories:

- poultry eggs in shells had chicken eggs since 2012,
- albumin – egg albumin, fit for human consumption (excluding dried {for example in sheets, flakes, crystals, powder}),
- bird eggs, not in shell – birds' eggs, not in shell, fresh, cooked by steaming or by boiling in water, moulded, frozen or otherwise preserved, whether or not containing

² In the years 2006-2011 there was a lack in the Common Customs Tariff Code concerning exclusively chicken eggs, then the CN code 04070030 was used, which included all kinds of poultry eggs in shell – excluding for hatching (including chicken eggs and other species of poultry eggs).

³ In years 2006-2011 lacked code concerning exclusively chicken eggs for hatching in the Common Customs Tariff, then the CN code: 04070019 was applied. This code included hatching eggs of all domestic species apart from goose's and turkey eggs.

added sugar or other sweetening matter, suitable for human consumption (excluding dried and egg yolks),

- hatching eggs – chicken eggs since 2012,
- yolks – egg yolks, liquid, suitable for human consumption, whether or not containing added sugar or other sweetening matter.

Table 1. The balance of foreign trade turnover egg products.

Specification	2006	2007	2008	2009	2010	2011	2012	2013	2014	2015
in thousands of tonnes										
egg albumin	0,6	3,3	4,0	2,3	4,6	5,7	2,9	6,0	6,4	9,4
birds' eggs, not in shell	1,9	5,0	7,9	9,9	7,9	4,5	15,9	14,2	14,5	14,5
poultry eggs in shell	49,0	92,5	104,8	111,0	136,2	154,3	175,2	200,7	181,9	214,2
birds' eggs for hatching and birds' eggs in shell	0,1	0,1	0,1	0,2	0,3	1,3	1,1	0,6	-0,1	0,6
poultry eggs for hatching	-0,3	-1,5	0,2	3,1	1,8	-0,4	-0,9	0,3	2,2	2,5
egg yolks	-0,1	0,5	0,3	0,5	-0,4	-0,1	-0,4	-0,9	-0,2	1,2
in million EUR										
egg albumin	1,7	3,0	4,6	3,3	5,7	6,5	4,6	10,0	11,8	17,4
birds' eggs, not in shell	1,9	6,1	9,2	12,2	10,2	7,8	23,4	17,6	18,1	18,9
poultry eggs in shell	42,9	81,5	100,1	111,9	114,4	121,4	209,3	177,3	169,1	214,8
birds' eggs for hatching and birds' eggs in shell	0,2	0,1	0,2	0,3	0,5	1,7	1,6	0,4	-0,2	0,7
poultry eggs for hatching	-8,1	-9,5	-4,8	-0,5	-2,8	-6,0	-11,1	-5,4	3,5	5,4
egg yolks	-0,5	1,1	0,8	1,2	-0,7	0,1	-2,7	-2,2	-0,9	1,4

Source: own work on the basis of data of the Ministry of Finance.

In 2006-2015 Poland was a net exporter of egg albumins, bird eggs not in shell, poultry eggs in shells, and birds' eggs for hatching and in shell (apart from 2014 in the case of this product range) (table 1). In 2006-2007 and 2011, the poultry hatching egg trade balance was negative both in terms of quantity and value, and it was positive in 2014 and 2015, and the quantitative balance was positive and the balance in terms of value was negative in 2008-2010, and 2013, which was most probably related to export of cheaper product ranges and import of the more expensive ones.

Table 2. The EU's share in Polish foreign trade of selected egg products (in %).

Specification	2006	2007	2008	2009	2010	2011	2012	2013	2014	2015
the share of exports to the EU in exports of individual commodity groups										
egg albumin	68	81	91	93	93	95	96	95	96	98
birds' eggs not in shell	97	100	100	100	100	100	100	100	100	100
poultry eggs in shell	98	100	99	100	98	91	97	96	97	98
birds' eggs for hatching and birds' eggs in shell	99	99	99	100	99	96	92	100	100	60
poultry eggs for hatching	13	42	72	96	85	74	74	77	78	75
egg yolks	99	96	87	89	90	95	97	98	95	97
the share of imports from the EU in imports of selected product groups										
egg albumin	100	100	92	98	98	98	96	97	98	100
birds' eggs not in shell	100	100	100	100	100	100	99	100	100	100
poultry eggs in shell	96	99	100	100	100	100	100	100	100	100
birds' eggs for hatching and birds' eggs in shell	100	100	100	100	100	100	99	100	100	100
poultry eggs for hatching	86	93	92	92	93	94	92	93	92	93
egg yolks	93	91	91	90	98	97	96	100	100	100

Source: own work on the basis of data of the Ministry of Finance.

In the studied period, the primary buyers of various product groups exported from Poland, except hatching eggs in 2006 and 2007, were EU countries (tab. 2). In 2006-2015, Poland imported egg products mainly from the EU.

Conclusions

Currently Poland is self-sufficient in production of eggs for consumption. Poland's accession to the EU contributed to the improvement in egg product trade balance simultaneously resulting in a change to its structure. It may be considered a success of the Polish egg sector, particularly if we take account of the fact that EU was self-sufficient in egg production (European Commission, 2015). The upward trend in export of eggs for consumption was facilitated by the price advantage in the early years following the accession, and in subsequent years the avian influenza affecting laying hens in certain countries, and the good quality of Polish egg products.

In the period in question, Poland was a net exporter of most egg product groups. Dynamic change to the course of trade was accompanied by: the downward trend in domestic egg consumption, quite advanced concentration in laying hen rearing and breeding, and variability of egg production profitability. Factors that may contribute to an increase in export of Polish egg products include: price advantage of Polish egg products on the global market and diversification of export destinations.

Polish eggs for consumption do not have a price advantage on the EU market, so it seems necessary to continuously monitor competitors' activity and cost of egg production, particularly due to the fact that this sector depends on the sales to foreign markets, so measures aimed at higher level of integration of egg producers in Poland may be considered. Such measures may help the sector lower the cost of egg production and face the competition, particularly the EU and CIS countries.

It is predicted that the exports of eggs for consumptions will stay at a relatively high level for a few years provided that there are no market disruptions (e.g. avian influenza). What is more, vertical and horizontal integration will still take place in the sector.

References

- Czyżewski A., Danilczuk J. (2008). Konkurencyjność polskiego rynku drobiu i jaj w wymianie z Unią Europejską (The competitiveness of the Polish market of poultry meat and eggs in exchange with the European Union), *Roczniki Naukowe Stowarzyszenia Ekonomistów Rolnictwa i Agrobiznesu (Annals of the Polish Association of Agricultural and Agribusiness Economist)*, vol. X, book 4, pp. 56-61.
- Dybowski G. (2013). Jaja. Podaż (Eggs. Supply), *Rynek drobiu i jaj. Stan i perspektywy (The market of poultry and eggs. Status and prospects)*, May, No. 43 IERIGŻ-PIB, MRiRW, ARR, pp. (22-24).
- Dybowski G. (2011). Jaja. Podaż (Eggs. Supply), *Rynek drobiu i jaj. Stan i perspektywy (The market of poultry and eggs. Status and prospects)*, No. 39, May 2011, IERIGŻ-PIB, MRiRW, ARR, pp. 18-19.
- IERIGŻ-PIB, MRiRW, ARR. 2006-2015, *Rynek drobiu i jaj. Stan i perspektywy (The market of poultry and eggs. Status and prospects)*.
- Dybowski G. (2015). Jaja. Produkcja (Eggs. Production), *Rynek drobiu i jaj. Stan i perspektywy (The market of poultry and eggs. Status and prospects)*, No. 48, October, IERIGŻ-PIB, MRiRW, ARR, pp. 28-31.
- European Commission (2015). *Prospects for EU agriculture markets and income 2015-2025*, December.
- European Commission (2016). *Weekly price report on Broiler carcass and Eggs prices in the EU*, Week 23, http://ec.europa.eu/agriculture/eggs/presentations/index_en.htm, date of access: 17.06.2016.
- GUS a (2006). *Charakterystyka gospodarstw rolnych w 2005 r. (Characteristics of farms in 2005)*, Warsaw
- GUS a (2008). *Charakterystyka gospodarstw rolnych w 2007 r. (Characteristics of farms in 2007)*, Warsaw
- GUS a (2012). *Charakterystyka gospodarstw rolnych w 2010 r. (Characteristics of farms in 2010)*, Powszechny Spis Rolny, Warsaw
- GUS a (2014). *Charakterystyka gospodarstw rolnych w 2013 r. (Characteristics of farms in 2013)*, Warsaw
- GUS b (2009). *Produkcja i handel zagraniczny produktami rolnymi w 2008 r. (Production and foreign trade in agricultural products in 2008)*, Warsaw.
- GUS b (2015). *Produkcja i handel zagraniczny produktami rolnymi w 2014 r., (Production and foreign trade in agricultural products in 2014)*, Warsaw.
- GUS c (2007). *Rynek wewnętrzny w 2006 r. (Internal market in 2006)*, GUS, Warsaw.
- GUS c (2010). *Rynek wewnętrzny w 2009 r. (Internal market in 2009)*, GUS, Warsaw.
- GUS c (2015). *Rynek wewnętrzny w 2014 r., (Internal market in 2014)*, <http://stat.gov.pl/obszary-tematyczne/ceny-handel/handel/rynek-wewnetrzny-w-2014-r-7.20.html> (odczyt: 07.12.2015).
- Kapusta F. (2014). *Produkcja i zużycie jaj w Polsce – ocena samowystarczalności (The production and consumption of eggs in Poland - evaluation of the self-sufficiency)*, *Polityki Europejskie, Finanse i Marketing (European Policies, Finance and Marketing)*, 11 (60), pp. (65-77).
- Kornakowski D. (2007). *Zmiany w światowej produkcji jaj spożywczych (Changes in world production of eggs)*, *Polskie Drobiarstwo (Polish Poultry)*, October, pp. (48-50).
- Krawczyk J., Sokołowicz Z. (2008). *Implementacja unijnych regulacji do polskiego prawodawstwa w aspekcie konkurencyjności krajowej produkcji jaj (Implementation of EU regulations to the Polish legislation in the aspect of the competitiveness of the domestic production of eggs)*, *Roczniki Naukowe Stowarzyszenia Ekonomistów Rolnictwa i*

- Agrobiznesu (Annals of the Polish Association of Agricultural and Agribusiness Economist), Vol. X, Book 1, pp. (208-213).
- Pasińska D. (2015). Jaja (Eggs), [w] K. Świetlik (ed.), Konsumpcja żywności w Polsce w latach 2004-2014. Uwarunkowania i tendencje (Food consumption in Poland in the years 2004-2014. Conditions and tendencies), Wydawnictwo Instytutu Ekonomiki Rolnictwa i Gospodarki Żywnościowej - PIB, Warsaw 2015, pp. (350-362).
- Świetlik K. (2008). Ceny żywności w procesie rynkowych przemian polskiej gospodarki (1994-2004) (Food prices in the process of market transformations of the Polish economy (1994-2004)), Instytut Ekonomiki Rolnictwa i Gospodarki Żywnościowej - PIB, Warsaw, pp. (231-234).
- Świetlik K. (2015). Jaja. Popyt (Eggs. Demand), Rynek drobiu i jaj. Stan i perspektywy (The market of poultry and eggs. Status and prospects), No. 48, październik (October), IERIGŻ-PIB, MRiRW, ARR, s. 34-39.
- Świetlik K. (2013). Konsumpcja jaj na równi pochyłej (Consumption of eggs on an inclined plane), Polskie Drobiarstwo (Polish Poultry), No. 8, pp. (2-6).
- Świetlik K. (2012 a). Popyt na żywność – zmiany poziomu i struktury (Demand for food - changes in the level and structure), Biuletyn Informacyjny ARR (Information Bulletin of Agricultural Market Agency), No. 3, pp. (1-15).
- Świetlik K. (2012 b). Rynkowe determinanty konsumpcji jaj w Polsce w ostatnich latach (Market determinants of egg consumption in Poland in recent years), Polskie Drobiarstwo (Polish Poultry), No. 9, pp. (14-18).
- Van Horne P. L. M. (2014). Competitiveness of EU egg sector. International comparison base year 2013, LEI WAGENINGENUR, Wageningen, December.

PROTECTIVE ACTIVITY OF RONCOLEUKIN® - IN COMBINED DRUG AGAINST SECONDARY ECHINOCOCCOSIS MULTILOCLARIS INFECTION

Olga V. RUDNEVA¹, Vera K. BEREZHKO¹, Marina R. SASIKOVA²

¹ All-Russian Scientific Research Institute of Fundamental and Applied Parasitology of Animals and Plants named after K.I. Skryabin, Bolshaya Cheremushkinskaya Street, 28, 117218, Moscow, Russia

² Veterinary Service Federal Penitentiary Service of Russia for the Kabardino-Balkarian Republic, Nalchik, Russia

*Corresponding author: rudneva.olga79@gmail.com

Abstract

To assess the protective efficiency of immunization against secondary alveolar echinococcosis, with an antigen from *Echinococcus multilocularis* protoscolexes in combination with Roncoleukin® - recombinant interleukin-2 (rIL-2) immunostimulation, an assay was carried out on 48 white outbred mice. These were divided into four groups of twelve mice each. The antigen was isolated from the metabolism products of *Echinococcus multilocularis* protoscolexes, cultured in RPMI-1640 medium enriched with 6% fetal bovine serum in a CO₂ incubator. The mice were immunized via two subcutaneous injections, administered with a ten day. The formulations consisted of antigen protein (60 µg) and/or rIL-2 (180 IU/per mouse) in 0.2 ml of sterile 0.9% NaCl per injection. The group 1 were treated with the Roncoleukin®; the group 2 - Roncoleukin® and antigen formulation. The group 3 received the antigen and the group 4 were the control, receiving 0.2 ml of sterile 0.9% NaCl. After a 20 day regimen, the groups were inoculated with a dose of 750 ± 50 units of *Echinococcus multilocularis* protoscolexes per mouse. After 90 days of incubation, the mice were euthanized and dissected for evaluation. The maximum protection was obtained in mice immunized with the combination of antigen and Roncoleukin® (83,3%). The protective effect in the group immunized by protoscolex antigen was 66,7%; in the group treated with Roncoleukin® was 58,3%. In conclusion, the use of immunostimulation in combination with specific antigens for the immunoprophylaxis against experimental alveolar echinococcosis has a synergistic effect.

Keywords: *Echinococcus multilocularis*, immunomodulatory, antigen protective effect.

Introduction

Alveolar hydatid disease (AHD), is a parasitic zoonosis resulting from *Echinococcus multilocularis*, tapeworm that belongs to the class Cestoda, family Taeniidae. AHD is found worldwide, mostly in northern latitudes in central Europe, Russia, China, Central Asia, Japan, and North America. The life cycle of these parasitic tapeworm requires two mammalian hosts. First - definitive host, such as foxes and dogs (and other canids) in which the adult or strobilar phase develops in the small intestine, and second - intermediate host, in which the alveolar stage develops in different organs in the body by tumor-like or cyst-like metacestode. The larval stage of *Echinococcus multilocularis* causes alveolar echinococcosis, the serious helminthozoonosis with a high mortality in patients with late treatment (Wilson, 1995). Alveolar echinococcosis is a serious disease has a significantly high fatality rate. The therapy of this disease represents an important problem. Scientific research for effective means of protection against this deadly disease is conducted throughout the world. *E. multilocularis* induces parasite-specific cellular and humoral immune response in intermediate host (Gottstein and Hemphill, 1997). Cell-mediated immune response depending

on interaction of macrophages and T lymphocytes is regarded as protective against *E. multilocularis* infection (Reimann and Kaufmann, 1997). Also, in the scientific literature there are sufficient data on the effectiveness of various adjuvant agents such as Freund's adjuvant, aluminum hydroxide, BCG vaccine and others. These drugs are used in vaccines against parasitic infections, including larval hydatid disease (Li *et al.*, 2007; Dang *et al.*, 2012; Tuerxun *et al.*, 2013). There is a lot of references about strengthening the body's resistance to helminth infection by the application of non-specific immune stimulating agents (Berezhko *et al.*, 2004; Rudneva *et al.*, 2014; Smolencev *et al.*, 2011). Application of immunomodulatory substances could improve host immune status during *E. multilocularis* infection and limit the growth of the parasite (Dvorožňáková, 2015). The combination of specific and non-specific stimulation means provides natural resistance and increased immunoreactivity to specific antigens *E. multilocularis* (Rudneva *et al.*, 2005).

In our study, we focused on the study of immunoprophylaxis activity of immunomodulatory preparation Roncoleukin® - recombinant interleukin-2 (rIL-2) in complex excretory-secretory antigen of protoscolex cells of *Echinococcus multilocularis* in enhancing of the host antiparasite defence in alveolar echinococcosis. Also we evaluated the protective effect immunostimulant Roncoleukin® in experimental secondary alveolar echinococcosis of albino outbred mice.

Material and methods

To assess the protective efficiency of immunization against secondary alveolar echinococcosis, with an antigen from *Echinococcus multilocularis* protoscolexes in combination with Roncoleukin®, an assay was carried out on 48 white outbred mice, males, weighing 20–25 g. These were divided into four groups of twelve mice each. Mice were kept under a 12-h light/dark regime at room temperature (21±3°C) and 50–60% relative humidity on a commercial diet and water. The experimental protocols complied with the current Russian ethics law.

E. multilocularis metacestodes (an Asian genotype circulating in the Central region of Russia; strain provided by Department of immunodiagnostic and cellular technology, All-Russian research institute of fundamental and applied parasitology of animals and plants of name K.I. Scriabina, Moscow, Russia) was obtained from the wild foxes (*Vulpes vulpes*) (Andreyanov *et al.*, 2015) and was passaged in our laboratory by intraperitoneal injection of laboratory albino outbred rats *Rattus norvegicus*.

Parasite cysts were isolated 6 months post infection (p.i.) and cut into pieces in sterile 0.9% NaCl with antibiotics, 8 µg/100 ml Gentamycinum (Paneco-ltd, Russia), and passed through a nylons mesh using apertures ranging №033. Protoscolexes obtained after the last filtration were subjected to grinding and homogenization. Primary cell cultures were obtained by gentle hand-homogenization and passed through nylons cell mesh using apertures ranging from 220 to 50 µm.

The antigen was isolated from the metabolism products of *Echinococcus multilocularis* protoscolexes cells, cultured in RPMI 1640 medium (Sigma-Aldrich, Germany) enriched with 6% fetal bovine serum. Culturing cells were performed in 6-well culture plates placed in a Heraeus CO2 incubator under conditions of high humidity, temperature of 37 °C and a CO2 level of 5% [12].

Roncoleukin® - recombinant interleukin-2 (rIL-2) - is a structural and functional analogue of endogenous human interleukin-2.

The efficacy of immunoprophylaxis was evaluated by the cyst development in infected mice. *E. multilocularis* cysts were isolated from sacrificed mice and parasite cysts were weighed and proved pathogenicity of metacestodes by a biological test on other mice.

The mice were immunized via two subcutaneous injections, administered with a ten day interval between them. The formulations consisted of antigen protein (60 µg) and/or Roncoleukin® (180 IU/per mouse) in 0.2 ml of sterile 0.9% NaCl per injection.

The group 1 mice were treated with the Roncoleukin® formulation only. The group 2 mice were treated with the Roncoleukin® and antigen formulation. The group 3 mice received the antigen formulation only and the group 4 mice were the control, receiving only 0.2 ml of sterile 0.9% NaCl. After a 20 day regimen, the groups were inoculated with a dose of 750 ± 50 units of E.multilocularis protoscolexes per mouse.

After 90 days of incubation, the mice were euthanized and dissected for evaluation.

Results and discussion

Evaluation of the data of the experiment shows that all drugs used to stimulate the body's defensive response of mice against E.multilocularis with varying degrees of protective effect.

Data of the experiment are presented in Table 1.

Table 1. Representative data for calculation evaluation the protective efficiency of immunization against secondary alveolar echinococcosis with Roncoleukin® immunostimulation in combination an antigen from Echinococcus multilocularis protoscolexes

<i>Group</i>	<i>n</i>	<i>infected animals</i>	<i>percent of uninfected animals</i>
1	12	5	58,3%
2	12	4	66,7%
3	12	2	83,3%
4	12	12	0 %

The above table shows that the maximum protection against the Echinococcus multilocularis infection from total number of animals was obtained in mice immunized with the combination of antigen and Roncoleukin® (83,3 %). Only two mouse in this group (16,7%) showed singular metacestodes in the liver, with no infective egg elements. This was proved by a biological test on other mice.

The mice immunized with the protoscolex antigen only showed a protective effect of 66,7% In 4 mice from this group (33,3%), metacestodes with diameters of up to two mm were found but there were no egg elements. The protective effect in the group treated with Roncoleukin® only was less than 58,3%. The majority of mice infected in this group (41,7%) showed fertile parasite metacestodes. The protective effect in the group treated with sterile 0.9% NaCl was 0%. All mice were infected in this group (100%), showed fertile parasite metacestodes

Research results presented below graphically.

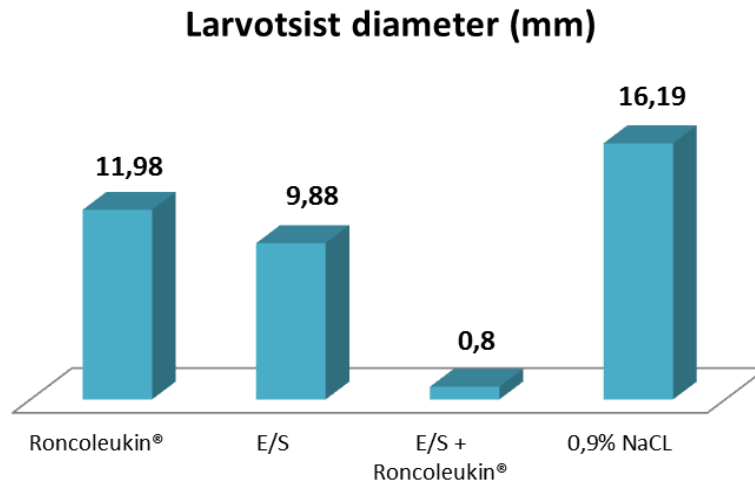

Fig. 1 Diameter of cysts found in infected mice

Figure 1 shows the results of measurements parasite cysts size in millimeters.

We can see that the largest diameter metacestodes was found in control group. In the first group of mice metacestod's diameter was 1,35 times less than in control group. Metatsetod's diameter in the second and the third group of mice was 1,64 and 20,24 times less than in the control group, respectively.

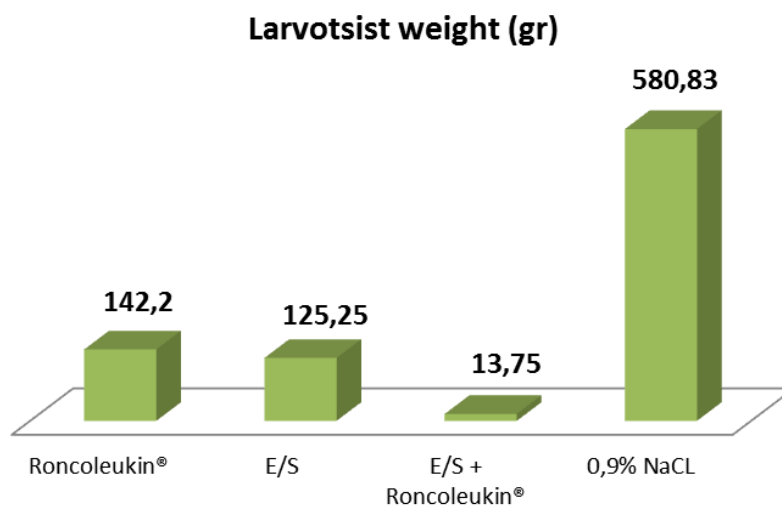

Fig. 2 Cysts weight cysts found in infected mice

The above figure 2 presents the results of measurements of total cysts weight in grams found in infected mice. We can see that the maximum weight of cysts achieved was in control group. Cysts weight in the first group was 4,08 times lower than in the control group. A light weight cysts observed. In the second group weight of cyst was lower, and in the third group was the lowest, and 42,24 times less than in the control group.

However, only weight and size don't give a complete picture of the protective protection products. The presence of pathogenic elements in secondary cysts that can cause infestation in the secondary - intermediate hosts is one of the most important factors in evaluating the

protective effect of complex immunization formulations. Infective material obtained in the course of the experiment from the experimental mice we studied by bioassay in other laboratory mice.

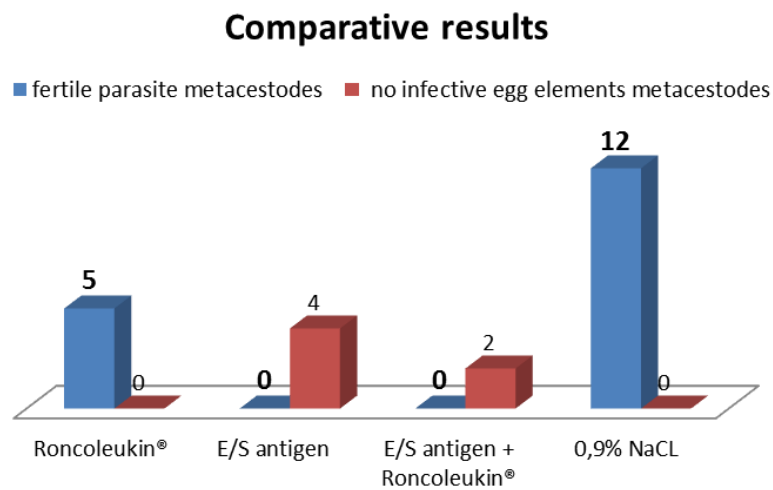

Fig. 3 Comparative results between the presence of mature pathogens and non-invasive elements in metacestodes in secondary experimental echinococcosis.

Figure 3 presents results of the comparison between the presence of invasive pathogens and undeveloped elements in metacestodes in the secondary echinococcosis. There are significant differences between metacestodes with no infective egg elements and fertile parasite metacestodes. The greatest positive influence of immunoprophylaxis was found in third group, where only two mouse developed singular metacestodes in the liver, which didn't contain infective egg elements. The use of the E-S antigen had a positive effect too. The number of animals having developed cysts was higher in this group than in the third group, but these metacestodes were small and didn't contain the invasive elements. Application of Roncoleukin® decreased number of metacestodes in the first group of mice, but all the elements were fertile and invasive the highest number of mature cysts was found in control group. All mice in this group were infected, all developed fertile parasite metacestodes.

Conclusion

Our experiment showed that the use of immunostimulators in combination with specific antigens for the immunoprophylaxis against secondary alveolar echinococcosis has a synergistic effect on the treatment. Thus, in all the experiments it was clearly demonstrated the advantage of the drug complex comprising the specific antigen and immunostimulating agents, to achieve the best protective effect.

Our data are actually not inconsistent with the results of other researchers which have used various immunomodulating and adjuvant agents. That enhance the immunogenicity of antigens as a means of increase potentiation animal body defense mechanisms against helminthiasis.

Acknowledgments

We thank Dr. V.K. Berezhko for her help in our work in all time. We wish to thank Dr Sinisa Berjan and Dr. Nouredin Driouech for providing valuable comments and corrections on the manuscript. We also want to express our gratitude Rudnev family to provide support for the

publication of this work, and participation in the 7th International Symposium Agrosym 2016. As well as the staff of the Federal State Budget Institution "All-Russian Scientific Research Institute of Fundamental and Applied Parasitology of Animals and Plants named after K.I. Skryabin" for the invaluable help, support research and mutual assistance. Thank you.

References

- Andreyanov O., Berezhko V., Rudneva O., Haidarova A., Timofeeva O. (2015) *To Technology of the Operating Time of Echinococcus multilocularis Antigen*. "The Russian Veterinary Journal. Farm animals" No 4, 2015. – P. 26-28 [in Russian].
- Berezhko V. K., Klenova I. F., Rudneva O. V., Sivkova T. N., Kovalenko F. P. (2004) *IPC classes for russian patent Method for preventing secondary alveolar echinococcosis (hydatidosis) (RU 2279274)*. DOI: 10.13140/RG.2.2.18454.14405
- Dang Z, Yagi K, Oku Y, Kouguchi H, Kajino K, Matsumoto J, Nakao R, Wakaguri H, Toyoda A, Yin H, Sugimoto C. (2012) *A pilot study on developing mucosal vaccine against alveolar echinococcosis (AE) using recombinant tetraspanin 3: Vaccine efficacy and immunology*.- PLoS Negl Trop Dis. 2012;6(3):e1570. doi: 10.1371/journal.pntd.0001570. Epub 2012 Mar 27. PMID: 22479658
- Dvorožňáková Emília (2015). *Immunotherapy Can Enhance Anthelmintic Efficacy in Alveolar Echinococcosis, Current Topics in Echinococcosis*, Dr. Alfonso Rodriguez-Morales (Ed.), InTech, DOI: 10.5772/60763. Available from: <http://www.intechopen.com/books/current-topics-in-echinococcosis/immunotherapy-can-enhance-anthelmintic-efficacy-in-alveolar-echinococcosis>
- Gottstein B, Hemphill A. (1997) *Immunopathology of echinococcosis*. In: Freedman DO.(ed.) Immunopathogenetic Aspects of Disease Induced by Helminth Parasites. Book Series: Chem Immunol, 1997,66:177-208.
- Li WG, Wang H, Zhu YM. (2007) *Change of splenocyte lymphokines in mice induced by recombinant BCG-Eg95 vaccine against Echinococcus granulosus* - Zhongguo Ji Sheng Chong Xue Yu Ji Sheng Chong Bing Za Zhi. 2007 Apr 30;25(2):109-13. Chinese. MID: 17633820;
- Reimann J, Kaufmann She. (1997) *Alternative antigen processing pathways in anti-effective immunity*. Curr Opin Immunol 1997;9(4) 462-469.
- RONCOLEUKIN® <http://www.biotech.spb.ru/main.php?menu=england>
- Rudneva O., Berezhko V. (2005) *Immoprophylactic properties of Echinococcus multilocularis protoscolices "cell" antigens of different age*// Theory and practice of parasitic diseases of animals. 2005. № 6 - P .306-309. [in Russian] DOI: 10.13140/RG.2.2.27537.43366
- Rudneva O., Napisanova L., Berezhko V., Tkhakahova A. (2014) *Protective effects of modern immunostimulating agents on rates of Trichinella spiralis infection* // Theory and practice of parasitic diseases of animals. 2014. №15, - pp. 257-260 [in Russian] DOI: 10.13140/RG.2.2.14050.12481
- Smolencev S. (2011) *Correction of Immunological status of cow and cales application of preparation «IMMUNOFERON» and «RIBOTAN»* // AVU. 2011. №12-1. URL: <http://cyberleninka.ru/article/n/korreksiya-immunologicheskogo-statusa-korov-i-telyat-primeneniem-preparatov-immunoferon-i-ribotan>
- Tuerxun Z, Yimiti D, Cao CB, Ma HM, Li YJ, Zhou XT, Zhu M, Ma XM, Wen H, Ding JB. (2013) *Construction and expression of the Echinococcus granulosus recombinant BCG-EgGIY162*// Zhongguo Ji Sheng Chong Xue Yu Ji Sheng Chong Bing Za Zhi. 2013 Apr;31(2):110-3. Chinese.PMID: 24809190

Wilson JF, Rausch RL, Wilson FR. *Alveolar hydatid disease. Review of the surgical experience in 42 cases of active disease among Alaskan Eskimos.* Ann Surg 1995;221(3) 315-323.

IMPORTANCE OF THE GOAT BREEDING IN SOUTHEASTERN ANATOLIA REGION (TURKEY)

Ali Murat TATAR¹, H. Deniz ŞİRELİ¹, S. Seçkin TUNCER^{2*}

¹Department of Animal Science, Faculty of Agriculture, Dicle University, Diyarbakır, Turkey

²Department of Plant and Animal Production, Vocational School of Ozalp, Yuzuncu Yil University, Van, Turkey

*Corresponding author: selcukseckintuncer@gmail.com.tr

Abstract

Due to many reasons, the number of goats has decreased in nearly 20 years in Turkey. However, economic and geographical conditions are very suitable for effective goat breeding in Turkey. The 17.3% of Turkey's goat population is raised in the Southeastern Anatolia Region (SAR). The bred of goat in the Southeastern Anatolia Region is hair goat and a small number of mohair goat. Goat breeding business are usually located on mountainous and rugged terrain. The coat color of hair goats is mostly black. Goat breeding is usually conducted in tandem with sheep raising, while there are some albeit few farmers which only breed goats. The milking is performed almost entirely by hand. Kilis goat, originated in Southeastern Anatolian, are the major dairy breeds which have an important role in the regional economy. The purpose of this study was to determine the present situation of goat breeding in the Southeastern Anatolian Region of Turkey. It is thought that the results of this research will form important database for future research about development of goat breeding in the Southeastern Anatolia.

Keywords: *Turkey, Southeastern Anatolia, Goat, Production trait*

Introduction

According the 2013 data, the number of goat, amount of goat milk and goat meat are 1 006 785 725 heads, 18 422 372 tonnes and 5 417 407 tonnes in the World. In the World, Turkey is the 20th in the number of goat (10 347 159 heads), the 9th in the amount of goat milk (415 743 tonnes) and the 11th in the goat meat production (56 480 tonnes). (FAO, 2013).

The Southeastern Anatolia Region comprises 9.5% of the area of Turkey, while 10.7% of the population live in this area. The Southeastern Anatolia Region (SAR) includes the Adiyaman, Batman, Diyarbakir, Gaziantep, Kilis, Mardin, Siirt Sanliurfa, and Sirnak provinces.

Goat breeders constitute one of the lowest income groups in Turkey. Goat breeding in the SAR is dependent on pasture and nature conditions. Therefore goat breeders live on a nomadic and semi-nomadic basis. The dependence on nature of breeders particularly on mountainous areas is of much greater significance. Goat breeders living in regions with unfavorable environmental conditions make their living on limited income (Picak, 2007; Kaymakci, 2006; Ertugrul, 2001; Sireli, 2012).

The number of goat in Turkey has decreased nearly 50% between 1991 and 2009, down to 5.1 million heads. The number of goat in the SAR has registered a higher rate than the Turkey average, decreasing by 57% during the same period. One of the important causes of the decrease in the number of goat in the area is the extraordinary events that are experienced in the region. With the contribution of the Ministry of Food, Agriculture and Animal Husbandry had implemented in 2005, the goat population in Turkey has increased after 2009 and risen to 10.4 million heads in 2015. Approximately 23% of Turkey's goat population lives in the SAR (Anonymous, 2015a).

In this study, the current status of goat breeders in the SAR and the manner of utilization of the products obtained from goats was presented, and suggestions were made for developing potential.

The goat populations and products in Southeastern Anatolia Region of Turkey

Goat breeding in the SAR is usually based on pasture and partially on stubble grazing, and is generally concentrated on the level of small - scale farming business, extensively and on mostly mountainous and rugged terrain (Özcan, 1984). Small-scale farmers which take advantage of pastures (79%) usually utilize shared village pastures (69%). Changes have also been observed in goat breeding systems over recent years. It is seen that the nomadic animal husbandry is not found in goat breeders in the SAR provinces and that the transhumance livestock is 15-24% and that the settled farms rearing goat is 75% (Tekel, 2012).

Male goat addition occurs during September-October in the region. The fertilization occurs in the form of free mounting and male goats are not supplied with extra feed. The number of female goat per male is adjusted to 15-20 heads (Arac and Daskiran, 2010). Small-scale farmers usually obtained their shepherd requirements from family members. Owners of large herds employ shepherds from outside. Births occur during the months of February and March. The lactation period is 6-7 months, and the milk yield during lactation is around 450-500 kg. The age of weaning for kids are 2.5-3.0 months. Kids are weaned at around 2.5-3 months and pasture - based feeding is applied. (Arac and Daskiran, 2010). One of the local breeds in Turkey is Kilis breed. Their total number is estimated to be around 60000 heads. The goats are known with high milk yield. Lactation milk yields of Kilis goat are 200-300 kg in lactation periods of 190-230 days (Güzeler et al., 2010). Sales of kid, milk, and dairy products are the income of the farmers.

Examining the quantities of the goat products hair and angora wool, a total of 9.3 million heads of goat were sheared Turkey wide in 2015, generating 5569 tonnes hair and 325 tonnes angora wool were obtained from goats. The number of sheared animals in the SAR is 2.1 million heads and the quantity of hair obtained is 1151 tonnes, which accounts for 20.7% of total production. The yield of hair and angora wool per goat has been calculated as 596 g, 1.71 kg, and 540 g and 1.42 g for Turkey and the SAR, respectively. Approximately 2 million goat leather are produced nationwide in Turkey (Anonymous, 2015a).

The goat populations in Turkey and the SAR are shown in Table 1. The total goat population in the SAR is 2.4 million heads, and a large majority -98.5%- of which is made up of hair goat and the rest (1.5%) are Colored Mohair Goats.

Table 1. Goat populations (head) in Turkey and the Southeastern Anatolia Region (SAR) (Anonymous, 2015a)

Provinces in SAR	2011		2012		2013		2014		2015	
	Hair Goat	Mohair Goat	Hair Goat	Mohair Goat	Hair Goat	Mohair Goat	Hair Goat	Mohair Goat	Hair Goat	Mohair Goat
Adiyaman	106321		125112		126616		162541		165506	
Batman	78989		138919		173660		157862		180605	
Diyarbakir	197277	1000	220440		231415		334345		329158	
Gaziantep	152802		168384		199998		218587		216622	
Kilis	69970		111623		116637		124263		121366	
Mardin	307850	3010	340389	5110	373545	5137	382145	3670	401294	4266
Siirt	270255	9008	297902	12112	346609	13749	390991	13521	441748	12713
Sanliurfa	174915		176125		224134		193121		230091	
Sirnak	185576	2044	179445	1540	253010	1800	292586	8628	250703	19380
SAR	1543955	15062	1758339	18762	2045624	20686	22564414	25819	2337093	36369
TURKEY	7 126 862	151 091	8 199 184	158 102	9 059 259	166 289	10 167 125	177 811	10 210 338	205 828

Table 2. The number of milked goat (head) and amount of milk produced (tonnes) in Turkey and the Southeastern Anatolia Region (SAR) (Anonymous, 2015b)

Provinces in SAR	2010		2011		2012		2013		2014		2015	
	Goat	Milk	Goat	Milk	Goat	Milk	Goat	Milk	Goat	Milk	Goat	Milk
Adiyaman	30113	3493	48437	5619	60759	7048	56675	6574	64288	7457	68973	8001
Batman	18981	1784	36875	3466	77752	7309	90276	8486	97069	9124	96951	9113
Diyarbakir	49483	5196	71457	7503	80113	8412	82581	8671	125779	13207	128700	13513
Gaziantep	53941	5826	64035	6916	75097	8110	82333	8892	91640	9897	101537	10966
Kilis	21000	2142	33768	3444	47698	4865	53676	5475	48509	4948	47991	4895
Mardin	145356	15689	144053	15586	148129	15998	189296	20484	197855	21469	209107	22708
Siirt	111139	11558	100260	10473	117636	12332	165072	17394	184572	19543	220550	23545
Sanliurfa	38323	4062	80313	8513	76515	8111	102777	10894	75261	7978	89143	9449
Sirnak	54815	5741	66503	6955	65498	6852	123284	12916	131728	13289	142905	13644
SAR	543151	55491	645701	68475	749196	79036	945967	99786	1016703	106912	1105855	115835
TURKEY	2582539	272 811	3033111	320 588	3502272	369 429	3943318	415 743	4400168	463 270	4578494	481174

The number of milked goat and amount of milk produced in Turkey and the SAR are shown in Table 2. While the number of milked goat rapidly decreased until 2009, it has increased by 41-250% between 2010 and 2015, reaching 2.6 - 4.6 million heads. The total milk production in Turkey is 18.7 million tonnes. Goat milk accounts for 2.6% (481 000 tonnes) of total milk. 24.1% of the obtained goat milk (116 000 tonnes) is produced in the SAR.

The number of slaughtered goat and amount of meat produced in Turkey and the SAR are shown in Table 3. Turkish Statistical Institute (TUIK) data for the number of slaughtered goats and goat production covers the years 2007-2009. No information is available for later years. While the number of slaughtered goat rapidly decreased until 2009, it increased by 201-330% between 2010 and 2015, reaching 1.22 - 2 million heads (Table 3). Meat production also increased by 197-291% between 2010-2015 and reached 23-34 thousand tonnes. The total red meat production in Turkey is 1.15 million tonnes. Goat meat accounts for 3.0% of the total red meat production in Turkey. 2.0% of the total goat meat obtained is produced in the SAR.

Table 3. The number of slaughtered goat (head) and amount of meat produced (tonnes) in Turkey and the Southeastern Anatolia Region (SAR) (Anonymous, 2009)

Provinces in SAR	2007		2008		2009	
	Slaughtered goat	Meat	Slaughtered goat	Meat	Slaughtered goat	Meat
Adiyaman	33631	610	20492	345	9512	152
Batman	33	0.6	26	0.4	21	0.4
Diyarbakir	9810	162	4264	76	2935	60
Gaziantep	11242	236	4654	97	3872	74
Kilis	7200	143	6023	108	3454	68
Mardin	173	3.3	121	1.9	46	0.9
Siirt	13106	167	3163	39	3238	40
Sanliurfa	4385	75	6124	78	2493	30
Sirnak	1250	18	11125	151	10500	188
SAR	80830	1415	55992	897	36071	613
TURKEY	1256348	24136	767522	13752	606042	11675

Conclusion

Hair goat and a small number of angora goats are bred in the SAR . Goat breeding business are usually located on mountainous and rugged terrain. The color of hair goats is mostly black, while brown hair goats can also be encountered. Goat breeding is usually conducted in tandem with sheep raising, while there are some albeit few small - scale farmers which only breed goats. The milking is performed almost entirely by hand.

For goat breeding to develop in the region, animal husbandry farmers should be supported first. Measures should be taken against animal diseases, and the use of high quality roughage and concentrate feed should be supported. Organizations of breeders should be provided. Joint strategies and forward-looking projections should be created by public organizations and institutions serving in the region's provinces, and the needed significance should be given to goat breeding, in order to utilize the available goat potential of the region.

References

- Anonymous, 2009. Turkish Statistical Institute. Web: <http://www.tuik.gov.tr>. Accessed on 04/05/2016.
- Anonymous, 2015a. Turkish Statistical Institute. Web: <http://www.tuik.gov.tr>. Accessed on 05/05/2016.
- Anonymous, 2015b. Turkish Statistical Institute. Web: <http://www.tuik.gov.tr>. Accessed on 05/05/2016.
- Arac, B., Daskiran, I., 2010. Diyarbakır İli Keçicilik İşletmelerinin Yapısal Özellikleri (Structural Properties of Diyarbakır Goat Farming Business). Journal of Tekirdag Agriculture Faculty. pp:173-179.
- Ertugrul, M., 2001. Küçükbaş Hayvan (Koyun-Keçi) Yetiştiriciliği ve Islahı Çalışma Grubu (Working Group of Small Ruminant animals (sheep and goat) Growing and Breeding. DPT Sekizinci Beş Yıllık Kalkınma Planı (Eighth Five-Year Development Plan) Ankara . pp: 60-74.
- Güzeler, N., Say, D., Kacar, A., 2010. Compositional Changes of Saanen X Kilis Goats' Milk during Lactation. The Journal of Food. 35(5): 325-330.
- FAO, 2013. Livestock primary data base production. Web: <http://www.faostat3.fao.org>. Accessed on 13/08/2016.
- Kaymakci, M., 2006. Keçi Yetiştiriciliği Kitabı (Goat Breeding Book). Bornova İzmir.
- Ozcan, L., 1984. Türkiye’de Süt Keçiciliğinin Geliştirilmesi Semineri (Seminar for development of dairy goat business in Turkey). Tarım ve Orman Bakanlığı, Teşkilatlandırma ve Destekleme Genel Müdürlüğü (Ministry of Agriculture and Forestry, General Directorate of Organization and Support) Publication number: 145, TEDGEM: 13, (16-20 April) Adana.
- Picak, M., 2007. Güneydoğu Anadolu Bölgesinde Hayvancılığın Gelişimi ve Türkiye İçerisindeki Konumu Üzerine Bir Değerlendirme (Livestock development and evaluation on the location in Turkey for . Southeastern Anatolia Region). GAP V. Tarım Kongresi (GAP V. Agriculture Congress). 17-19 October.
- Sireli, H.D., 2012. Güneydoğu Anadolu Bölgesi Keçi Yetiştiriciliğinin Genel Özellikleri ve Geliştirme Olanakları (General characteristics of goat breeding and development facilities). Ulusal Keçicilik Kongresi (National Goat Conference). 24-26 Haziran 2010 pp: 130-134.
- Tekel, N., Dellal, G., 2012. Türkiye’de GAP Bölgesinde Keçi Yetiştiriciliğine İlişkin Bazı Yapısal ve Teknik Özellikler (Some structural and technical characteristics of goat husbandry in the GAP region in Turkey) Ulusal Keçicilik Kongresi. (National Goat Conference). 24-26 June pp: 198-201. .

PRELIMINARY DATA ON GROSS MARGIN ANALYZE OF DAIRY FARMS IN KOSOVO

Medin ZEQRIRI^{1*}, Ylli BIÇOKU¹, Grigor GJEÇI^{1,2}, Ergent PIRE³

¹Agricultural University of Tirana, Tirana, Albania

²Ministry of Agriculture, Rural Development and Water Administration of Albania, Agricultural University of Tirana, Tirana, Albania

³Researcher at Development Solutions Associates (DSA), Tirana, Albania

*Corresponding author: medinzeqiri@yahoo.com

Abstract

The purpose of the study was to analyze the economic efficiency of dairy farms in Kosovo. This was a descriptive and quantitative survey and the target population was the dairy farmers registered with the Kosovo Paying Agency. The random sampling technique was used to select the respondents (n=138). Two methods of data analysis were used, namely; descriptive statistics, and gross margin analysis. The annual farm income, the cost of milk production, and the problems faced by the farms were studied. Data on milk production, farm expenses and returns, use of milking machine, artificial insemination, fodder production, and feed bought in the market for each farm were recorded during 2015. The milk cost ranged from 0,166 to 0,696 euro cents/kg and milk price ranged from 0,220 to 0,600 euro cents/kg. About 12 percent of the farms are selling the milk directly to the market getting a higher price than selling to processors. In variable cost, feed took the highest share by 69,2 percent. The Gross Margin per Cow, for all the farms monitored, have positive values: 76.1 Euro/cow for the GMpC milk+meat and 4.17 Euro/cow for the GMpC milk. However 35,5% of the farms have negative values for the GMpC milk+meat while 12,3% of the farms have negative values for GMpC milk. This is one of the reasons, emphasized by MAFRD, that the analysis of the competitiveness of agriculture of Kosovo shows that currently only a small share of farms can compete in the regional market, EU and international level.

Key words: *dairy farm, gross margin, farm income, income per cow, medium and large sized farms.*

Introduction

Kosovo continues to be a predominantly rural economy with 12 percent of GDP generated by agriculture, which is also the largest employing sector, accounting for approximately 35% of total employment (World Bank, 2011; IPA, 2013; Qeveria, 2013).

Agriculture still remains subsistence-oriented due to a very small average size of farms, on average, the farm size is 3.2 ha agricultural land (including common land/pasture) and about 3.9 cattle (about 2 milking cows). Most of the farms are mixed ones and only 1-2 percent of agricultural land is used by commercial farms, more than 10 ha/farm (MAFRD, 2014).

According to Agriculture Census in Kosovo, there are 130,775 agricultural farms, which are breeding 261,689 cattle (51 percent of which milking cows). It is estimated that today there are about 91,200 livestock farms in Kosovo (ASK, 2015).

According to the MAFRD (2014), farms with more than 5 milking cows, which are consider commercial farms, during 2014 were 5,472 (7.8 percent of the dairy farms), These farms are the main suppliers to the dairy processing industry with a total of about 62 million liters of milk per year, or about 18 percent of the milk produced in the country (AAD, 2015; MAFRD, 2015; and authors' calculation). The rest is used for feeding calves, for own consumption, sold as raw milk or white cheese on the various local unregulated (green) markets (Nushi & Selimi, 2009; Nushi, 2010; Bytyqi et al., 2014).

Direct payments for dairy cows started in 2009 and were given to farmers that owned at least 5 ears tagged dairy cows and registered in Identification and Registration system (I&R system). In 2013, direct payments for dairy cows were distributed to 5,075 farmers with a total of 42,119 heads and the amount was 50 Euro/cow (MAFRD, 2014).

In Kosovo, very few studies are conducted on the milk production profitability; therefore the present study was undertaken to evaluate the gross margin of medium and large dairy farms. According to Delgado et al. (2003) larger producers may survive with low unit profit because of the large volume of business; in fact, such producers may deliberately push unit profit to low levels to squeeze out smaller producers from the market. Returns in dairy farming are deeply determined by variable cost and production cost and the correlations existing between farm size, milk yield, variable cost, total cost and milk price are important to be studied and keep under control by farmers (Dhuyvetter, 2010).

The findings of this study are important because they reveal some information to help dairy farmers and all stakeholders in the dairy industry to try and improve economic inefficiency.

Methods and Materials

This study was conducted to collect farm data pertaining to revenue and expenses on medium and large sized¹ dairy farms and make an economic analysis based on gross margin. In brief, the gross margin is the total income minus the total expenses (variable cost). Variable cost includes the cost of: feed (from farm fodder production and feed bought in the market), labor (from family member and hired labor), veterinary service, water, electricity, transportation, and miscellaneous.

The random sampling techniques were used to select the respondents. One hundred-thirty-eight dairy farms were monitored and interviewed in the seven regions of Kosovo.

Data collection: A structured questionnaire was used for collection of all information related to dairy farming. According to the questionnaire the following data were recorded:

- **Income and expenses:** (i) Milk yield per cow; (ii) Milk production per farm; (iii) Quantity and price of milk sold; (iv) Quantity and price of meat sold (live body weight); (v) Expenses for the fodder production; (vi) Expenses for the animal feed bought in the market; (vii) Expenses for veterinary service and cow's insemination; (viii) Expenses for fuel, electricity, water, trips, lease on the land, and the land tax; (ix) estimated cost of labor needed per year. (x) Incomes per Farm from sales of milk and meat (IpF milk+meat); (xi) Incomes per Farm from sales of milk (IpF milk); (xii) Gross Margin per Cow from sales of milk and meat (GMpC milk+meat); (xiii) Gross Margin per Cow from sales of milk (GMpC milk).

Data analysis: For data analysis was developed a model in Microsoft Excel program, while the statistical data processing was done with Statgraphics Centurion XVI.

¹ In Kosovo, the dairy farms are breeding one to 50 cows and does not exist any definition of small, medium and large farms. The authors for the data comparison have called the farms breeding 5-10 cows as medium sized farms and those breeding 11-50 cows as large sized farms.

Results and discussions

Data on number of cattle and cows per farm, milk yield, IpF milk + meat, IpF milk, Gross Margin per Cow (GMpC milk+meat and GMpC milk), and milk cost, are summarized in Table 1, as shown below:

Table 1: Technical data

Number of heads	No of Farms	No of cattle per farm	No of Cows per farm (average)	Milk yield (liter)	IpF (milk + meat) Euro	IpF (milk) Euro	Variable cost per farm	GMpC (milk + meat) Euro	GMpC (milk) Euro	Milk cost (Euro/kg)
5-10 cows (small size farms)	68	12,54	7,25	3166	8168	7799	8486.4	-45.2	-96.4	0,369
11-50 cows (medium size farms)	70	37,85	20,93	3932	29974	28086	24992.7	193.93	101.83	0,298
Total	138	25,38	14,19	3555	19228	18089	16859	76.1	4.17	0,333

Source: Data from the farm visits and interviews.

The milk yield of large sized farms (ranged from 2000 to 6238 kg/cow) is 24.2 percent higher than the medium sized farms (ranged from 1633 to 5742 kg/cow). The milk cost of medium farms is 23.8 percent higher than large farms. About 12 percent of the farms in both medium and large sized are selling the milk directly to the market and getting the highest price of 0.50-0.60 euro cents/kg.

In variable cost, feed took the highest share by 69.2 percent, ranged from 66.4 percent for the medium farms to 71.8 percent of the large farms, because the large farms are spending more on concentrate feed as the milk yield is higher compared with medium farms.

The returns of the dairy farms came from the sale of milk and meat. The highest share of total returns for all categories of farms came from the sale of milk (93.7-95.5%) and sale of calves (4.5-6.3%).

The GMpC milk+meat and GMpC milk have negative values for the medium sized farms - 45.2 Euro/cow and -96,4 Euro/cow, respectively, while the large farms have positive value (193.93 Euro/cow and 101.83 Euro/cow, respectively). However, for the all farms monitored, the values are positive 76.1 Euro/cow for the GMpC milk+meat and 4.17 Euro/cow for the GMpC milk. According to MAFRD (2015b) analysis of competitiveness of agriculture of Kosovo shows that currently only a small share of farms can compete in the regional market, EU and international level.

The IpF milk+meat in the large sized farms are 267 percent more than the medium ones (29974 Euro vs. 8168 Euro) while the IpF milk of large farms is 260 percent more than the medium farms (28086 Euro vs. 7799 Euro). These significant differences are coming as the result of the number of cows, milk yield, the price of milk and meat sold, that in most of the cases are higher at large sized farms compare with medium sized ones. The IpF milk+meat, IpF milk, GMpC milk+meat and GMpC milk are several times higher at large farms compared with medium ones because most of the medium farms are losing money from milk production, as the cost of production is very high. With respect to dairy, some studies have found a negative relationship between expenditures for purchase feed per cow and measures of financial profitability (Gloy et al, 2001). A higher milk yield requires a higher production cost, an aspect that farmers should take into consideration and handle in the most efficient way (Popescu, 2014).

Statgraphics Centurion XVI was used for statistical data processing, comparing medium and large farms for: IpF milk+meat vs. Number of cows/year; IpF milk vs. Number of cows/year; and Milk Cost (cent/Euro) vs. Milk Yield, and results are shown below:

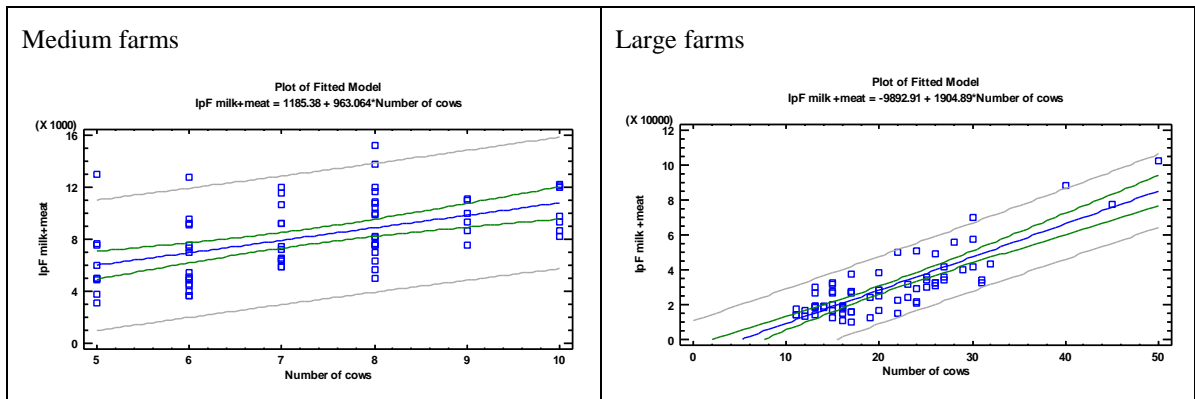

Fig. 1: Medium and Large farms IpF milk+meat vs. Number of cows/year

For the medium farms: $\text{IpF milk+meat} = 1185.38 + 963.064 \times \text{Number of cows}$. The correlation coefficient equals 0.51032, indicating a moderately strong relationship between the variables.

For the large farms : $\text{IpF milk +meat} = -9892.91 + 1904.89 \times \text{Number of cows}$. The correlation coefficient equals 0.840564, indicating a moderately strong relationship between the variables. Since the P-value in the ANOVA table is less than 0.05, for both groups of farms, there is a statistically significant relationship between IpF milk+meat and Number of cows at the 95.0% confidence level.

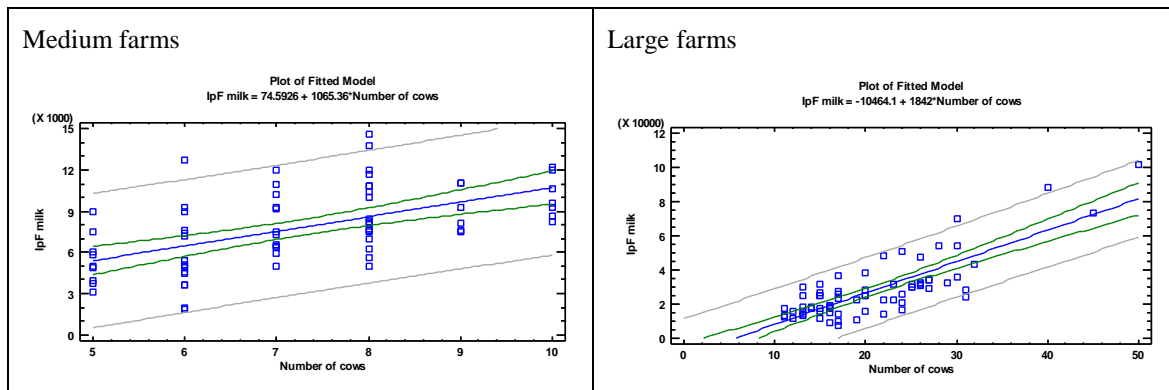

Fig. 2: Medium and Large farms IpF milk vs. Number of cows/year

Medium farms $\text{IpF milk} = 74.5926 + 1065.36 \times \text{Number of cows}$. The correlation coefficient equals 0.559758, indicating a moderately strong relationship between the variables.

Large farms: $\text{IpF milk} = -10464.1 + 1842 \times \text{Number of cows}$. The correlation coefficient equals 0.815097, indicating a moderately strong relationship between the variables. Since the P-value in the ANOVA table is less than 0.05, for both groups of farms, there is a statistically significant relationship between IpF milk and Number of Cows at the 95.0% confidence level.

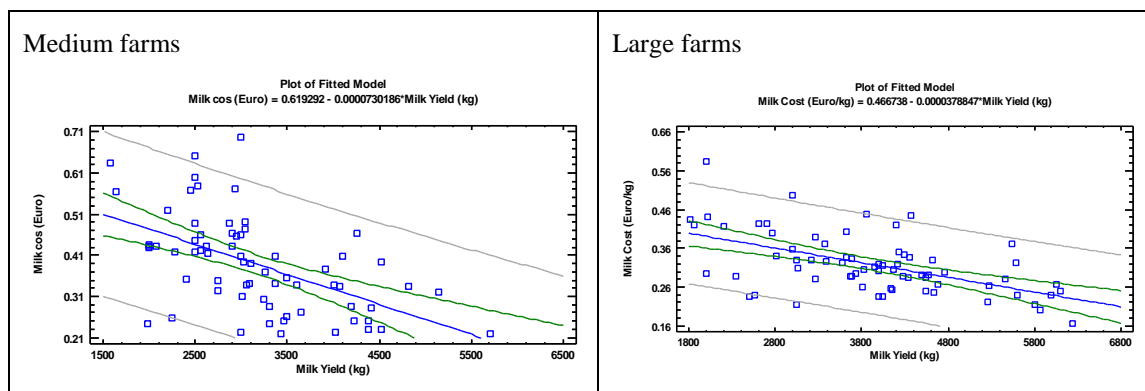

Fig 3. Medium and Large farm Milk Cost (euro cents/kg) vs. Milk Yield (kg)

Medium Farms : Milk cost (euro cents/kg) = $0.619292 - 0.0000730186 \cdot \text{Milk Yield (kg)}$. The correlation coefficient equals -0.545522 , indicating a negative moderately strong relationship between the variables.

Large farms: Milk Cost (euro cents/kg) = $0.466738 - 0.0000378847 \cdot \text{Milk Yield (kg)}$. The correlation coefficient equals -0.557623 , indicating a negative moderately strong relationship between the variables. Since the P-value in the ANOVA table is less than 0.05, for both groups of farms, there is a statistically significant relationship between Milk Cost (euro cents/kg) and Milk Yield at the 95.0% confidence level.

These data of our study show that large sized farms had better results than the medium sized farms for milk yield, production cost, incomes per farm, incomes per cow, and gross margin per cow.

Conclusion

The economic results of our study are much better for large sized farms than for medium sized farms such as milk yield (24.2 % higher); milk cost (23.8% less); better access to artificial facilities (62.9 percent vs 55.9 percent) and milking machine (88.6 vs 55.9). The GMpC milk+meat and GMpC milk have negative values for the medium sized farms -45.2 Euro/cow and $-96,4$ Euro/cow, respectively, while the large farms have positive value (193.93 Euro/cow and 101.83 Euro/cow respectively). The IpF milk+meat and IpF milk in the large sized farms are 267% and 260%, respectively, more than the medium ones. The farm inefficiency decreased as farm size increased, it means that there is ample scope to raise farm profitability by improving economic efficiency and minimizing the profit loss.

In our opinion, maybe the farmers are satisfied with their situation because they are supported from MAFRD with direct payments of 50 Euro/cows. In addition, they have profited from other crops of their farms (cereals and/or vegetables) and they do not understand that they are losing money from milk production.

As the medium sized farms have negative incomes for the milk production is a must for extension service to train farmers to keep the financial record separate for milk, and other crops. Developing a better understanding of the factors that influence dairy farm profitability is potentially important to many parties. Farm managers should be able to use this knowledge to improve their operations and increase profitability. Extension educators and other firms that interact with farmers can use the results to assist farmers in improving the profitability and long-term viability of their operations. The results may also serve to guide extension programming as topics are prioritized for educational emphasis.

References

- AAD, 2015. Raporti Vjetor 2014- Agjencia per Zhvillimin e Bujqesise (Annual Report 2014- Agency for Agricultural Development). <http://azhb.rks-gov.net/images/files/Raportet%20e%20AZHB-s/Raporti%20vjetor%20i%20Azhb-se%202014.pdf>
- ASK, 2015. Rregjistrimi i Bujqesise ne Republiken e Kosoves 2014, Rezultate perfundimtare (Agriculture Census in Republic of Kosovo 2014, Final Results).
- Bytyqi H., Thaqi M., Hoxha F., Misini A., Haxhija B., Cabrera, V, (2014): Economic Assessment of Dairy Farm Production in Kosovo. The 11th European IFSA Symposium, 1-4 April 2014 in Berlin, Germany
- Delgado C., Narrod C. and Tiongco M. (2003). Policy, technical and environmental determinants and implications of the scaling-up of livestock production in four fast-growing developing countries: A synthesis. Final Report of IFPRI-FAO Livestock Industrialization Project. Phase II. IFPRI (International Food Policy Research Institute), Washington, DC, USA.
- Dhuyvetter, K, (2010): Factors Impacting Dairy Profitability: An Analysis of Kansas Farm Management Association Dairy Enterprise Data. Longman Scientific and Technical Publishers.UK.
- Gloy BA., Hyde J., LaDue, E.L., (2001): Dairy Farm Management and LongTerm Farm Financial Performance. *Agricultural and Resource Economics Review* 31: 233-247
- IPA (2013): Annual Program Agriculture and Food Safety: 08-2013/02. 2013: 1-42.
- MAFRD (2015): Program for Agriculture and Rural Development for 2015
- MAFRD (2014): Green Report Kosovo 2014. Ministry of Agriculture, Forestry and Rural Development. 2014: 1-143.
- Nushi M, (2010): Review of Agriculture and agricultural Policy in Kosovo under UNSCR 1244/99. Agriculture in the Western Balkan Countries. Studies on the Agricultural and Food Sector in Central and Eastern Europe. IAMO: 2010: 123-144. ISSN 1436-221X ISBN 978-3-938584-51-4.
- Nushi M., Selimi F, (2009): An assessment of the Competitiveness of the Dairy Food Chain in Kosovo. AgriPolicy Enlargement Network for Agripolicy Analysis. 2009: 4-21.
- Popescu, A., (2014): Research on Milk Cost, Return and Profitability in Dairy Farming. Scientific Papers Series Management, Economic Engineering in Agriculture and Rural Development Vol. 14, Issue 2, 2014. Print ISSN 2284-7995, E-ISSN 2285-3952
- Qeveria (2013): Deklarata e Politikave Prioritare Afatmesme 2014-2016. Zyra e Kryeministrit. 2013: 4-40.
- World Bank, (2011): Agriculture and Rural Development Project. Document of the World Bank Report No. 61497-XK. 2011: 1-55

INTRA AND INTER-POPULATION VARIABILITY OF HIND WINGS ANGLES IN HONEYBEE FROM SERBIA

Goran JEVTIĆ^{1*}, Bojan ANĐELKOVIĆ, Mića MLADENOVIĆ², Kazimir MATOVIĆ³,
Nebojša NEDIĆ², Zoran LUGIĆ¹, Bora DINIĆ¹

¹Institute for forage crops, Kruševac, Serbia

²Faculty of agriculture, University of Belgrade, Zemun-Belgrade, Serbia

³Specialist Veterinary Institute, Kraljevo, Serbia

*Corresponding author: goran.jevtic@ikbks.com

Abstract

The nervature of honey bee wings is constructed from chitine and its function is to support and strengthen the honeybee wings. The linear distances and angles that are formed by branching wing nervature are considered to be very accurate taxonomic parameters and are extensively researched through morphometric studies. The aim of this study was to determine the variability within and between honeybee colonies of morphometric parameters of the angles between the nerves on the hind right wing. Three angles were measured on prepared hind right wings (W1, W2 and W3). The study included 20 honeybee colonies from apiary of the Institute for forage crops (Serbia) and the measurements were done on 50 individual honeybees per colony. Each individual honeybee colony presents individual population due to its isolation and different genetic heritage in relation to other colonies. Using descriptive and ANOVA statistics it was determined that there was variability between colonies, meaning that there was clearly distinguished homogenous groups. Considering angles W1 and W3 two homogenous groups were distinguished, while the angle W2 showed the existence of three homogenous groups. The intrapopulation variability was relatively, where the angle W3 had the highest average coefficient of variance.

Key words: *honeybee, variability, angles, morphometry*

Introduction

Serbia as a country has excellent conditions for development of beekeeping because it is characterized by variable relief, favorable climate and abundant honey bee pasture. For the intensive development of beekeeping it is necessary to provide adequate biological material that will be the basis for the development of both the individual apiaries and beekeeping as a whole (Mladenovic and Mirjanić, 2003). In order to precisely determine the differences between races, ecotypes and populations of honey bees in the selection programs the biometric methods are used. Biometrics is a method that can detect differences within taxa. This method is very powerful for identification of honey bee species and subspecies (Francoy et al., 2006). The first biometric characteristics that were studied (size and color) led to the fact that what is now considered that a good biometric characteristics should include a number of different morphological parameters. In addition to morphometric characteristics (tongue length, length and width of the wings and tarsus, size of abdominal rings, etc.). DuPraw (1965) introduces the measurement of eleven angles on the front right wing (A4, B4, D7 E9 G18, J10, J16, K19, L13, N23 and O26). Later he introduced the measurement and for three angles of hind right wing (W1, W2 and W3). Considering carniolan honey bee, Rutner (1988) points out that, by precise morphometric studies, several ecotypes can be recognized within this race. Elements of external morphology of carniolan honey bee from Serbia were studied by Krunic (1967), Stojanović (1992), Plužnjikov (1994), Georgijev (2000), Stevanović

(2002), Jevtić (2007), Mladenović i Simeonova (2010), Nedić et al., (2011), Jevtić et al., (2015), etc. In these studies it was found that there is considerable variation in almost all observed morphometric characteristics of honey bees from this region. Variation of certain characteristics is so high that it differentiated certain populations (local populations - ecotypes) compared to colonies from near or further surroundings.

Given that most of the previous studies mainly consider only angles of the front wing, in this paper the priority was given to angles of the hind right wing. The objective of this study was to determine the variability of wing angles in nervature of hind wing.

Material and methods

In this study, the bees from 20 colonies from the apiary of Institute for forage crops in Kruševac were analyzed. The experiment was conducted during 2014. These colonies were previously collected from 6 different sites from all over Serbia: Bečej (Banat), Pešter, Kopaonik, Tupižnica near Negotin, Kraljevo and Kruševac. These colonies were situated on the same apiary for several years and were subjected to selection with free queen bee reproduction. Fifty honey bees were sampled from each colony. After sampling, bees were kept in 96% ethyl alcohol and stored in a refrigerator at a temperature of -4°C until measurement.

Following angles of chitinous nervature of hind right wing were measured: W1, W2 and W3. Morphometric measurements of angles were performed by standard method by Ruttner et al., (1978). Temporary isolated anatomical preparations were first scanned under a resolution of 9600 dpi and then processed using computer software Motic Images Plus 2.0.

After measurement, values of descriptive statistics for all parameters were determined: average value, extremes, standard deviation and coefficients of variation. In addition, the analysis of variance was performed for the studied angles.

Results and discussion

Based on the results (Table 1) it can be seen that the angle W1 had an average value of 132.48° and that it also had the highest standard deviation and variation interval. However, the values of this angle had the lowest coefficient of variation (1.07%). Other observed angle (W2) had an average value of 71.05° and had lower deviation and variation interval and higher coefficient of variation compared to the previous one. The angle W3 had an average value of $28,03^{\circ}$. This angle had the highest coefficient of variation (4.11%), while the standard deviation was the same as in the previous one. In studies by Mladenović and Simeonova (2010) very similar values for angles W1 and W2 were determined. A significant difference in their results appears for the angle W3 which value is lower and the average is 26.23° . In their research, there are significant variations between colonies which are taken from different locations, and between colonies from the same locality. The average value of the coefficient of variation for them ranged from 3.4% (W1) to 6.4 (W2 and W3). In similar studies on bees from South Serbia (Bosilegrad, Surdulica and Vladičin Han) the average value of the angle W1 was 134.77° , 72.80° in angle W2 and 26.43° in angle W3 (Mladenović and Simeonova, 2010), with even higher coefficients of variation (CV = 5.2 to 8.0%). While Nedić (2009), in his research, stated the following values: W1 = 132.871° , W2 = 70.821° , W3 = 26.034° . These results are very similar to our research, but also show that there are considerable differences in sizes of the hind wing angles. This may indicate to the belonging to different races or eco-types of honey bees as was stated in the researches of Abou-Shaara and Al-Ghamdi (2012).

Table 1. Average values for angles (°), standard deviation, coefficient of variation (CV%), extremes (min, max) and interval of variation (IV)

Parameter	W1	W2	W3
Average	132.48	71.05	28.03
Standard deviation	1.42	1.15	1.15
CV	1.07	1.62	4.11
Min	130.01	69.00	26.03
Max	135.00	73.00	29.98
IV	4.99	4.00	3.95

By testing the values for the angle W1, it was found that there were two homogeneous groups of colonies (Table 2). The colony number 15 had the lowest value for this angle 132.14 ° and differed significantly from other colonies. The colony number 14 (132.70°) and number 10 (132.72°) had the highest values for angles and were also significantly different from other colonies. Other colonies were not significantly different. By comparing the values of the angle W2 it has been found that there were three homogeneous groups of colonies. The lowest value for this angle was determined in colonies 7, 14, 10 and 15 (70.87° to 70.90°).

Companies that belong to the same group do not differ between themselves but are different when compared to other groups. Considering the angle W3, two homogenous groups are also separated. The lowest value was measured in the colony number 6 (27.63°).

The highest value for this parameter was found in the colony number 12 (28.23°). When analyzing all three observed angles it can be seen that the colonies that had the maximum and minimum values for one of the angles do not have high values for the other two angles. Colony that had the lowest or the highest value for one angle had a completely average values for the other two angles.

Table 2. T-test for angles of the hind wing of the observed colonies

Angles					
W1		W2		W3	
Colony	Average	Colony	Average	Colony	Average
15	132.14 ^a	7	70.87 ^a	6	27.63 ^a
20	132.22 ^{ab}	14	70.88 ^a	14	27.91 ^{ab}
11	132.30 ^{ab}	10	70.89 ^a	7	27.93 ^{ab}
8	132.35 ^{ab}	15	70.90 ^a	4	27.95 ^{ab}
19	132.39 ^{ab}	12	70.94 ^{ab}	17	27.96 ^{ab}
2	132.39 ^{ab}	8	70.95 ^{ab}	13	27.96 ^{ab}
7	132.44 ^{ab}	4	70.96 ^{ab}	3	27.99 ^{ab}
5	132.44 ^{ab}	3	70.97 ^{abc}	19	28.00 ^{ab}
13	132.46 ^{ab}	9	70.97 ^{abc}	5	28.03 ^{ab}
17	132.49 ^{ab}	20	70.98 ^{abc}	15	28.05 ^{ab}
16	132.50 ^{ab}	19	70.99 ^{abc}	18	28.06 ^{ab}
18	132.53 ^{ab}	6	71.01 ^{abc}	10	28.06 ^{ab}
9	132.53 ^{ab}	1	71.01 ^{abc}	8	28.06 ^{ab}
3	132.53 ^{ab}	11	71.04 ^{abc}	16	28.10 ^b
12	132.61 ^{ab}	17	71.12 ^{abc}	11	28.12 ^b
6	132.61 ^{ab}	5	71.12 ^{abc}	2	28.13 ^b
1	132.63 ^{ab}	13	71.25 ^{abc}	20	28.17 ^b
4	132.66 ^{ab}	2	71.30 ^{abc}	9	28.17 ^b
14	132.70 ^b	18	71.36 ^{bc}	1	28.20 ^b
10	132.72 ^b	16	71.42 ^c	12	28.23 ^b

Conclusion

Based on the measurements of angles performed on the 50 individual honey bees from 20 colonies from the Institute for forage crops, the following conclusions can be derived:

- The average value of the angle W1 = 132.48 °, angle W2 = 71.05 ° and for angle W3 = 28,03°.
- The maximum variance and standard deviation were determined for the angle W1, and the highest coefficient of variation was in the angle W3 (4.11%).
- Analysis of variance in single-factor experiment showed that the differences between the values of angles was significantly affected by the colony from which the bees were sampled.
- By testing the obtained differences it was found that in the angles W1 and W3 two homogeneous groups of colonies were distinguished, and in the angle W2 3 homogeneous groups of colonies were distinguished.

Acknowledgments

The authors thank the Ministry of Education, Science and Technological Development of Republic of Serbia who funded this research as part of the project TR-31057.

References

- Abou-Shaara H. F. and Al-Ghamdi A. A. (2012): Studies on wings symmetry and honey bee races discrimination by using standard and geometric morphometrics. *Biotechnology in Animal Husbandry* 28 (3), p 575-584.
- Dupraw E.J. (1964): Non-Linnean. *Nature*, 202, 849-852.
- Francoy T.M., Prado R.R.P., Goncalves S.L., Costa F.L., De Jong D. (2006): Morphometric differences in a single wing cell can discriminate *Apis mellifera* racial types. *Apidologie*, 37, 91-97.
- Georgijev Aneta (2000): Biometrijske karakteristike medonosne pčele (*Apis mellifera carnica* Pollmann) timočkog regiona (Biometric traits of honey bees (*Apis mellifera carnica* Pollmann) from Timok region). Specialist thesis. Faculty of Agriculture, Zemun, Belgrade University, p.1-120.
- Jevtić G. (2007): Varijabilnost ekotipova medonosne pčele (*Apis mellifera carnica* Poll.) i njihov značaj u oprašivanju lucerke (Variability of honey bee (*Apis mellifera carnica* Poll.) ecotypes and their significance in alfalfa pollination). PhD thesis, Faculty of Agriculture, Zemun, Belgrade University, p. 139.
- Jevtić, G., Anđelković, B., Mladenović, M., Nedić, N., Matović, K. (2015): Variability of wing nervature angles in honey bees (*Apis mellifera carnica* Poll) from various locations of Rasina district. Book of Abstracts VI International Scientific Agricultural Symposium "Agrosym 2015", Jahorina, 15-18 October 2015, Bosnia and Herzegovina, 644.
- Krunić M. (1967): Varijabilitet *Apis mellifica* L. u Jugoslaviji sa posebnim osvrtom na diferencijaciju populacija u panonskoj niziji (Variability of *Apis mellifica* L. in Yugoslavia with special emphasis on differentiation of populations in Panon valley). PhD thesis. Faculty of biology, University of Belgrade, p. 1-64.
- Mladenović M. and Mirjanić, G. (2003) In: Proceedings of XI Scientific symposium with international participation "Quality of the honey bee products and honey bee selection", 8-9. February, Faculty of agriculture - Zemun, Serbia, p. 65-74.
- Mladenović M. and Simeonova V. (2010a): The variability of wing nervature angles of honey bee from north Kosovo area. Second Balkan Conference on Biology, 21-23 May 2010., Plovdiv, Bulgaria, *Biotechnology & Biotechnological Equipment* 24, 2, 427-432.
- Mladenović M., Valentina Simeonova (2010b): Uglovi krilne nervature autohtone medonosne pčele sa područja južne Srbije (Angles of wing nervature of indigenous honey bee from area of Southern Serbia). *Agroznanje*, vol. 11., no. 3. 2010, p. 91-97.
- Nedić N. (2009): Biološko-proizvodne osobine medonosne pčele *Apis mellifera carnica* Poll. na teritoriji Srbije. Doktorska disertacija, Poljoprivreni fakultet Beograd, str. 1-159.
- Nedić N., Jevtić G., Jež G., Anđelković B., Milosavljević S., Kostić M. (2011): Forewing differentiation of the honey bees from Serbia. *Biotechnology in Animal Husbandry* 27 (3), p 1387-1394 ,
- Плужников Л.А. (1994): Характеристика морфологических и хозяйственных признаков пчел Югославии (Morphological and production traits of honey bees from Yugoslavia). PhD thesis, The State Agrarian University, Chisinau, Moldova .
- Ruttner F., Tassencourt L., Louveaux J. (1978): Biometrical statistical analysis of the geographic variability of *Apis mellifera* L. I: Materials and methods, *Apidologie*, 9, 363-382.
- Ruttner F. (1988): Biometrical-statistical analysis of the geographic variability of *Apis mellifera* L. *Apidologie*, 9, 363-381.
- Stevanović Jevrosima (2002): Istraživanja morfometrijske i hromozomske varijabilnosti u funkciji očuvanja diverziteta kranjske medonosne pčele (*Apis mellifera carnica* Pollmann, 1879) na teritoriji Srbije (Research of morphometric and chromosomal variability in function of conservation of biodiversity of carniolan honey bee pčele (*Apis mellifera*

carnica Pollmann, 1879) in the territory of Serbia). MSc thesis, Faculty of veterinary science, Belgrade, 1-190 str.

Stojanović Roza (1992): Izučavanje biometrijskih karakteristika elemenata spoljašnje morfologije medonosne pčele (*Apis mellifica* L.) sa različitih geografskih područja naše zemlje (Study of biometric traits of elements of outside morphology of honey bee (*Apis mellifica* L.) from different areas of our country). MSc thesis, Faculty of veterinary science, Belgrade, 1-100 str.

UTILIZATION OF ENZYMES IN NON RUMINANT'S ANIMAL NUTRITION, AS A BIOTECHNOLOGY FOR REDUCING POSPHORUS IN ANIMAL MANURE

Rezana PENGU¹, Etleva DELIA², Edmond HALA²

¹Faculty of Agriculture, F. S. Noli University Korce, Albania

²Faculty of Agriculture and Environment, Agricultural University of Tirana, Albania

Corresponding author: rezanap@yahoo.com

Abstract

One of the important reasons of soil and water pollution in Albania is the agricultural techniques and animal manures. Soil and water are compounding parts of agriculture and face the risks of presenting pollution problems of environmental equilibrium change. Nevertheless the agriculture is always in front of difficulties from the influence of agronomic techniques and the animal wastes. Excessive animal manure and fertilizer inputs do cause various environmental problems, related to the accumulation and elevated leaching, runoff of nutrients (N and P) and heavy metal to ground water and surface water. This is particularly true in areas where animal production has been geographically concentrated. The P-excretion on the pigs and poultry faeces is potential source for soil and water pollution, due to his high level on the subsoil water and destruction of the ecosystem. Interest in phytase for non-ruminant animals take place in regions, where soil and groundwater pollution due to animal wastes is a serious problem and phosphorus is a major concern. The aim of this study was to test the effects of the microbial phytase (*Aspergillus niger*, NATUPHOS) 750 FTU/kg on the increase of P availability and animal performance, as well as in the reducing of environmental pollution. The microbial phytase preparation (*Aspergillus niger*, was supplemented to a basal ration 750 FTU/kg feed and the effects on P digestibility and animal performance have been well documented. The P-excretion was reduced by 20-25%.

Key-words: *Livestock development, Environment, Water and soil pollution, Animal manure, Enzymes.*

Introduction

It's important to evidence that Albania is a mountainous country and only 16% of its territory is located at elevations of less than 100 m a.s.l. The agricultural land is distributed as follows: 43,3% in the plan or flat areas, 34% in the hilly zones and the remaining, 22,7% in the mountainous region. Albania continues the reforms and developed good institutional and regulatory capacities for managing environmental issues. (Borici et al, 2005)

The roles of the public and private sectors need to be considerer according the pollution intensity (solid pollution, the potential collapse of water, water contamination from agricultural or industrial pollutants, energy inefficiency, and threats to natural resources.

Groundwater contamination by nitrate-nitrogen and eutrophication of surface waters by phosphorus originating from land application of fertilizers and animal manure are well documented in some most populated areas like, Durres, suburb of Tirana, Lushnja, Fier etc.

Nonpoint source nutrient pollution of ground water and surface water by agriculture is a major, longstanding environmental issue in the United States (Sims, 2005).

As comprehensive nutrient management planning has become more widespread in the U.S., it has become increasingly apparent that the primary causative factor for nonpoint nutrient pollution in many regions is nutrient imbalance. Nutrient surpluses, usually due to imports of

feed and fertilizer far in excess of exports in crops and animal products, lead to the buildup on nutrients in soils and increase the likelihood of poorly timed applications of manures. It is now widely accepted that a fundamental tenet of agro-environmental policy must be restoring nutrient balance on farms, especially those referred to as "Concentrated Animal Feeding Operations" (CAFO-s). To achieve nutrient balance on farms or in watersheds requires a number of political, social, economic and logistic challenges (Sims, 2005).

Case Study-Durrës.

Durrës is one of the biggest cities in Albania. Also, there are the most concentrated poultry, pig farms and industries in this area. There are nearly: 1 million broiler chickens, 16.000 cattle and swine industry. Population in this area is nearly 200,000 habitants and arable surface: 16. 000 ha.

Table 1. The average quantity of organic fertilizer belongs to the species in Albania (Piu and Locher, 2001).

Species	Live weight (kg)	The quantity (ton)/year
Cow	300	7
	400	8
	500	10
Sow with piglets in maternity	200	2
Pigs	100	1.2
Piglets	30	0.9
Chicken	2	0.07
Sheep	40	0.6
Goat	30	0.4
Horse	500	6

Table 2. N and P amended in the cultivated soils with manure (Sulce and Veizaj, 2006)

	Number of livestock	Annual manure production (in 000/tons)	N (tons)	P (tons)
Cattle	32 000	170 (35% moisture)	1300	380
Chicken	977 000	70 (60% moisture)	1200	300
Pigs	4 000	4 (45% moisture)	150	25
Sheeps/goats	40 000	20	600	100
Total			3250	805

Table 3. The composition of organic fertilizer in Kg/ton. (Piu and Locher, 2001).

	N	P ₂ O ₅	K ₂ O	Mg
Organic manure				
Cow manure	2	3		
Horse manure	2,4	3	6,3	1

Sheep manure	3,2	3,3	8	0,8
Poultry manure	10	28	16	4
Pig manure	3,3	3,2	2,3	0,6
Liquid manure	6	5	5	3

Animal nutrition and Environmental problems.

As a result of growing concern about the environment, intensification of animal production in many European countries is considered as potential source of air pollution and threat to soil and drinking water quality. (Eeckhout and De Paepe, 1994).

Cereals composition

Nutritive ration of non ruminant animals (pigs and poultry) contains 90% cereals seed (corn, wheat, barley, rye, and oat). The majority of “P” in cereal grains is organically bound as phytic acid or phytate. This form of P is nutritionally unavailable to non-ruminant animals due to the lack of phytase in their digestive tract. Indeed, plant phytate is the major form of plant phosphorus and phytate phosphorus itself has low availability (Kirby and Nelson, 1988).

The P-excretion on the pigs and poultry faeces is potential source for soil and water pollution, due to his high level on the subsoil water and destruction of the ecosystem. In such situation the solution is utilization of phytase on pigs and poultry nutritive rations.

Material and Methods

Forty piglets (Large White x Landras) of four litters were transferred after weaning to flat-decks and allocated to 2 groups (A and B) with 20 animals, respectively. Two piglets from different litters (1 male and 1 female), with the same body weight were housed in every box (experimental unit). The control group (A) was feed with a balanced diet, containing mono calcium phosphate. The experimental group (B) was feed with low level of P, without inorganic phosphorus. All the phosphorus in this group originates from soybean meal. This group was supplemented with NATUPHOS phytase 750 FTU/kg feed. Ambient room temperature was maintained at 25⁰C for three first weeks and lowered by 1⁰C for each week thereafter. The photoperiod was controlled to provide 12 hour of light and 12 hour of dark in the stall. The ventilation also was provided to ensure good air quality. The basal diet mainly contained maize and soybean meal and the nutrient contents met or exceeded nutrient requirements recommended by (NRC, 1998). The diets were offered ad-libitum and animals (group A and B) had free access to water during experiment period.

Results and Discussions

Table 4. Efficacy of supplemented phytase in low phosphorus diet for piglets.

Parameters		Control group	Experimental group
Production	n ¹	X±SE	X±SE
Initial BW,kg	20	12.2 ± 0.90	12.6 ± 0.48
Final BW,kg		23.2 ± 1.06	24.5 ± 0.96
DWG,g		369 ± 10.0	396 ± 7.33
FCR		2.44 ± 0.11	2.43 ± 0.10

The supplementation of microbial phytase preparation (*Aspergillus niger*, NATUPHOS) 750 FTU/kg feed was reduced the N and P-excretion. The P-excretion was reduced by 20-25%, provided that pig's diets can be supplemented with an economical and efficacious level of phytase that will allow all of the supplemental inorganic P to be removed from the diet (Cromwell and Coffey, 1991).

With the industrial production of phytase, application of this enzyme to pig's diet to increase P availability and improve animal performance, as well as reducing environmental pollution has gained widespread attention. The beneficial effects of supplementary phytases on P digestibility and animal performance have been well documented (Rao et al., 1999, Ravindran et al., 1999). The efficacy of any enzyme preparation depends not only on the type, inclusion rate and level of activity present, but also on the ability of the enzyme to maintain its activity in the different conditions encountered through the gastrointestinal tract and the conditions used for the pre-treatment of a feedstuff or diet.

Conclusions

Agricultural techniques and animal rest is a serious problem for soil and water pollution, especially in the areas with a big concentration of livestock farms. An original solution is the utilization of microbial phytase on the nutritive rations of non ruminant animals. Nowadays, phytase supplementation is considered as a good way to reduce phosphorus excretion in non ruminant animals.

The inorganic phosphates in faeces, harmful for the environment, were reduced by 25-30%. This new technology offer substantial benefits to swine production by reducing the potential for environmental problems associated with excess N and P excretion. Supported by these conclusions, some of the best known companies of swine production in our country have actually included this technology in the everyday practice of the pig's diet.

References

- Boriçi J., Canco G., Veizaj E., (2005). Soil and water pollution as a result of agriculture techniques and animal rests. Abstract on the International Conference: Element balances as a Tool for Sustainable Land Management.
- Cromwell G. L., Coffey R.D., (1991). Phosphorus -a key essential nutrient, yet a possible major pollutant –its central role in animal nutrition. In: Biotechnology in the Feed Industry. (Edited by T.P. Lyons). Nicholasville, USA; Alltech Technical Publications. Pg 133-145.
- Eeckhout W., De Paepe M., (1994). Total phosphorus, phytate-phosphorus and phytase activity in plant feedstuffs. *Animal Feed Science and Technology*, 47. pp 19-29.
- Kirby L., Nelson T., (1988). Total and phytate phosphorus content of some feed ingredients derived from grains. *Nutr. Reports Intl.* 37: 277-280.
- NRC (1998). *Nutrient Requirements of Swine*. 10 th Edition. National Academic Press
- Piu Th., Locher E., (2001) The annual statistical manual of Livestock in Albania 2: 28-31.
- Rao R.S.V., Ravindran V., Reddy V. R. (1999). Enhancement of phytate phosphorus availability in the diets of commercial broiler and layers. *Animal Feed Science and Technology* 79: 211-222.
- Ravindran V., Cabahug S., Ravindran G., Bryden W.L., (1999). Influence of microbial phytase on apparent ileal amino acid digestibility of feedstuffs for broilers. *Poultry Science* 78: 699-706.
- Sims J T., (2005). Element balances: A review and critical analysis of their application to United States environmental policy. Abstract on the International Conference: Element balances as a Tool for Sustainable Land Management, pg 34.
- Sulce S., Veizaj E., (2006). Evaluation of potential pollution from agricultural activities at Durrës region (Albania).

TOTAL BILIRUBIN CONCENTRATION AND AST ACTIVITY IN SERUM OF SIMMENTAL COWS IN DIFFERENT GEOGRAPHIC REGIONS OF BOSNIA AND HERZEGOVINA

Jelena NIKITOVIC^{1*}, Tatjana PANDUREVIC², Marko LAZIC³

¹University of Banja Luka, Genetic Resources Institute, Banja Luka, Republic of Srpska, Bosnia and Herzegovina

²University of East Sarajevo, Faculty of Agriculture, Republic of Srpska, Bosnia and Herzegovina

³Eco Zupa Agriculture Cooperative, Aleksandrovac, Serbia

*Corresponding author: jelena.nikitovic@grunibl.rs.ba

Abstract

The objective of this study was to evaluate serum bilirubin concentration and AST activity in Simmental cows in two different geographic regions (Lijevce Polje lowlands and high altitude Nevesinje). A total of 42 healthy cows, 21 per farm, were tested. Cows were allocated to three groups viz. late pregnant or dry cows (7 animals), cows in the first days post-calving (7 animals), and cows in the second to third month of lactation (7 animals). The study was conducted during the autumn-winter period (2008) and repeated during spring (2009) involving the same cows. Blood samples were collected for analysis by puncture of the coccygeal vein (vena coccigea) using sterile needles into sterile single-use vacuette blood collection tubes without an anticoagulant. After 24 hour storage at room temperature, serum was separated, deep-frozen, and transported within 48 days to the laboratory for further biochemical assays. Blood (serum) bilirubin concentration was within the physiological range in all experimental cows in both locations. The results related to AST activity showed a slight increase above the physiological limit in all groups of cows, with late pregnant cows (Nevesinje location, winter period) exhibiting significantly higher values.

Key words: *Concentration, Serum, Geographic area, Bilirubin, AST*

Introduction

The importance of assays for the determination of serum biochemical parameters in high-yielding dairy cows and the interpretation of their levels as the supporting evidence for identifying some diseases have been explained in detail by many authors who have addressed this issue for many years (Brugere-Picoux and Brugere, 1987; Lotthammer, 1991; Klinkon et al., 2007; Radojicic et al., 2001; Radojicic et al., 2007; Radojicic, 2008; Samanc et al., 2004). Some researchers have focused on analyzing hepatographic data such as glucose, urea, albumin and bilirubin levels and AST activity, which can serve as indicators of both nutritional and metabolic equilibrium and the functional status of the liver (Kasagic, 2005; Radojicic et al., 2007).

The determination of AST activity as an important indicator of the hepatic status in cows showed stable physiological values of AST activity in the blood serum of older cows after peroral administration of propylene glycol via feed (as an energy precursor, but also as a hepatoprotective) seven days prepartum and seven days postpartum (Kasagic, 2005).

Table 1. Physiological values of bilirubin and AST in the blood of high-yielding dairy cows (according to different authors)

Author	Bilirubin (mmol/l)	AST(U/I)
Kaneko (1989)	2.0-8.0	Up to 60
Blood (1994)	0.1-9.0	80
Lotthammer (1991)	1.0-5.7	80
Radojicic et al. (2007)	0.1-8.0	80

Material and Methods

The research was conducted on two dairy farms. Twenty-one animals aged 3-5 years were selected from each farm and allocated to three groups: late pregnant or dry cows, cows in the first days post-calving and lactating cows, each consisting of 7 animals. The experiment was conducted during the autumn-winter period of 2008 and repeated on the same animals in spring 2009 when many of them belonged to different categories of dairy cattle. The Livac Agricultural Cooperative operating the dairy farm covers about 2.5 ha of land. The cooperative runs its own production of breeding young stock. The high-altitude Nevesinje farm estate employs a closed housing system.

Blood samples were collected for analysis by puncture of the coccygeal vein (vena coccigea) using sterile needles into sterile single-use vacuette blood collection tubes without an anticoagulant. After 24 hour storage at room temperature, serum was separated, deep-frozen and transported within 48 hours to the laboratory for further biochemical assays.

Serum analyses were performed at the accredited Laboratory of Hematology and Biochemistry, Hexalab Institute, Belgrade, Serbia, using a modern spectrophotometer and commonly used standardized reagents, with values calibrated for veterinary use.

The data obtained were statistically analyzed using a factorial analysis of variance and LSD test. Comparisons were made across production statuses and locations. The statistical analysis of the results was performed using the Prisma Pad 4.00 statistics package and MS Excel.

Results and Discussion

Data showing mean values and the factorial analysis of variance are presented in the tables below.

Table 2. Serum parameters across locations and production statuses – comparison I

Location	Production status	\bar{X} for Bilirubin	\bar{X} for AST
Lijevece	Late pregnant	3.04	74.00
	Lactation II/III	1.50	97.58
Nevesinje	Late pregnant	2.50	112.57
	Lactation II/III	1.01	69.31

Parameter	F_{exp}			LSD _{0,05}
	Location	Production status	Interaction (Location × Production Status)	Interaction (Location × Production Status)

Bilirubin	1.66	14.35**	0.01	
AST	0.22	0.82	9.43	31.76

*Source: Authors' original data

A statistically highly significant difference was observed in blood bilirubin concentration depending on the production status regardless of location.

The interaction shows a highly significant difference in blood AST concentration in late pregnant cows and cows in the second/third month of lactation in the two locations.

Table 3. Serum parameters across locations and production statuses – comparison II

Location	Production status	\bar{X} for Bilirubin	\bar{X} for AST
Lijevo	Late pregnant	5.56	94.57
	Lactation II/III	1.41	96.14
Nevesinje	Late pregnant	4.26	90.57
	Lactation II/III	1.36	72.86

Parameter	F_{exp}		
	Location	Production status	Interaction (Location \times Production Status)
Bilirubin	0.75	20.12**	0.63
AST	5.09**	1.78	2.54

*Source: Authors' original data

A statistically highly significant difference was observed in blood bilirubin concentration depending on the production status regardless of location.

The difference in blood AST concentration was statistically highly significant depending on the location, regardless of the production status.

Table 4. Serum parameters across locations and production statuses – comparison III

Location	Production status	\bar{X} for Bilirubin	\bar{X} for AST
Lijevo	Late pregnant	2.56	72.14
	Lactation II/III	1.24	94.86
Nevesinje	Late pregnant	2.84	77.86
	Lactation II/III	1.42	80.49

Parameter	F_{exp}		
	Location	Production status	Interaction (Location \times Production Status)
Bilirubin	1.02	35.98**	0.06
AST	0.37	3.21	2.01

*Source: Authors' original data

Blood bilirubin concentration showed a highly significant difference depending on the production status regardless of location.

Bilirubin, the main coloring matter of the bile, is a breakdown product of hemoglobin in the liver, more precisely the hepatocytes. Total bilirubin includes direct and indirect bilirubin i.e. conjugated and unconjugated bilirubin. Both forms of bilirubin can be separately measured in the serum, but total bilirubin is used for the analysis of the functional ability of the liver. Elevated levels of serum bilirubin imply three aspects of hepatocyte decay, the most important and common being the so-called hepatocellular icterus (icterus hepatocelulare). The production of bilirubin itself comes from the catabolism of hemoglobin or microsomatic cytochromes. Bilirubin is produced in the reticuloendothelial system, spleen, Kupffer cells and bone marrow. There are two forms: conjugated (direct) and unconjugated (indirect) bilirubin. Unconjugated bilirubin is lipid soluble, toxic and bound to plasma albumin. Conjugated bilirubin is insoluble and excreted from the body by the kidneys i.e. in the urine.

The liver can process bilirubin concentrations that are manifold higher than the physiological concentration without expending conjugation mechanisms, and only extremely high blood bilirubin concentrations lead to elevated levels of unconjugated bilirubin in the blood. However, in hepatic or hepatocellular jaundice, the damaged hepatocytes are unable to process all the produced bilirubin, and even the processed bilirubin flows back into the bloodstream, leading to elevations in both conjugated and unconjugated bilirubin in the blood. In obstructive jaundice, for instance, the amount of conjugated bilirubin in the blood is directly dependent on the degree of obstruction of the bile ducts.

Bilirubin levels should be assessed as soon after blood sampling as possible. Serum must not be exposed to sunlight. It is not affected by the anticoagulant used.

Samanc et al. (1993) found that serum bilirubin level in older cows was 14.3 $\mu\text{mol/l}$ on average. However, in first-calvers, the value was lower i.e. 6.59 $\mu\text{mol/l}$ on average in early puerperium, and significantly higher than in the last stage of pregnancy, when it was 4.85 $\mu\text{mol/l}$ (Samanc et al., 1993). Djokovic (1989) proved that there is a correlation between fatty liver and elevated blood bilirubin level in ketotic cows compared to healthy cows ($x=6,79:5,80 \mu\text{mol/l}$). Radojicic et al. (2001) reported an average bilirubin value of more than 8 $\mu\text{mol/l}$ in ketotic cows, which is in agreement with the values reported by Kaneko (1989) and Blood (1994) which can be as high as 9 $\mu\text{mol/l}$ for the upper physiological limit.

Aspartat aminotransferase or AST is not the key enzyme which can on its own serve as an indicator of hepatocyte status or as the so-called biomarker of liver status, but it plays an important role when correlated with increased bilirubin and urea levels and decreased albumin concentration (Brugere-Picoux and Brugere, 1987; Radojicic, 2008). Changes in its amount and activity occur in cases of myopathies, damage and injury to the skeletal striated muscle, heart and liver. Also, these values are increased in hepatopathies, but are compared along with other parameters. For example, in hepatitis, AST values are increased, whereas a more moderate increase is observed in chronic liver cirrhosis. In organophosphate poisoning, toxic liver injury results in the release of high transaminase levels i.e. the increase in serum transaminase activity. Although quite disparate AST values have been reported, the increase of over 80 U/L in cattle and up to 120 U/L in sheep is deemed physiological in a number of studies (Kaneko, 1989; Blood, 1994; Lotthammer, 1991; Brugere-Picoux and Brugere, 1987; Radojicic et al., 2007; Radojicic, 2008).

Conclusions

Aspartat aminotransferase or AST is not the key enzyme which can on its own serve as an indicator of hepatocyte status or as the so-called biomarker of liver status, but its activity when correlated with bilirubin, urea and albumin plays an important role in evaluating the

functional activity of the liver (Brugere-Picoux and Brugere, 1987; Radojicic, 2008). Changes in its amount and activity occur in cases of myopathies, damage and injury to the skeletal striated muscle, heart and liver. Also, these values are increased in hepatopathies, but are compared along with other parameters. Although quite disparate AST values have been reported, the increase of over 80 U/L in cattle and up to 120 U/L in sheep is deemed physiological in a number of studies (Kaneko, 1989; Blood, 1994; Lotthammer, 1991; Brugere-Picoux and Brugere, 1987; Radojicic et al., 2007; Radojicic, 2008). In this study, there was a slight increase in AST activity above the physiological limit in all groups of cows, with late pregnant cows (Nevesinje location, winter period) exhibiting significantly higher values i.e. $x=112.57$.

In many studies, total bilirubin level in the blood serum is considered the most important indicator of liver status and, even, the key biomarker. Also, many authors have studied the importance of changes in the peripartum period i.e. the correlation between bilirubin level and the degree of liver cell damage (Lothammer, 1991; Samanc et al., 1993; Djokovic, 1989; Kovacevic, 2000; Radojicic et al., 2001). These results are supported by the present findings, as the presence of bilirubinemia in this study was within the physiological range in all experimental cows in both locations.

References

- Blood C. D. (1994): Pocket Companion of Veterinary Medicine. Chapter VII. Baillere Tindall, ISBN 0-70020-1695-0
- Brugere-Picoux Jeane, H. Brugere (1987): Particularites de la biochemie clinique des ruminantes. *Rec. vet. Med.*, 163 (11), 1043-1053
- Djokovic R. (1989): Blood lipid, triiodothyronine, thyroxine, insulin and cortisol levels and histological changes in the liver of periparturient cows, Doctoral Dissertation, University of Belgrade, Faculty of Veterinary Medicine (in Serbian)
- Ivanov I. (1993): Macroelement metabolism disorder in cows during late pregnancy and early lactation. *Veterinarski glasnik*, 47, (4-5), 329-331 (in Serbian)
- Jovanovic et al. (1987): A contribution to the study on the metabolic profile in lactating cows, *Veterinarski glasnik* 41, (6), 449-454 (in Serbian)
- Jovanovic R., Dujic D., Glamocic D. (2000): Animal nutrition (in Serbian)
- Kaneko J. Jiro (1989): Clinical Biochemistry of Domestic Animals. Fourth Edition, Academic Press, Inc. New York
- Kasagic D. (2005): Blood serum concentrations of triiodothyronine, thyroxine, insulin-like growth factor 1 and biochemical indicators of metabolism in heifers prepartum and postpartum. M. Sc. Thesis. University of Belgrade, Faculty of Veterinary Medicine (in Serbian)
- Klinkon M., Namac M., Jezek J. (2007): Blood serum concentrations of some biochemical parameters in calves. Proceedings, 5th Symposium "Nutrition, Reproduction and Health of Cattle", Banja Kanjiža, r 55-63 (in Serbian)
- Kovacevic M. (2000): Liver function and hormonal status in cows of different body condition scores during pregnancy and early lactation. Doctoral Dissertation, Faculty of Veterinary Medicine, University of Belgrade (in Serbian)
- Lotthammer K. H. (1991): Einfusse und Folgen unausgeglichener Fütterung auf Gesundheit und Fruchtbarkeit des Milchschrindes. *Zbornik radova XX seminara za inovaciju znanja veterinara, Fakultet veterinarske medicine, Beograd*
- Matarugic et al. (2007): Physiology and pathology of cattle reproduction. University of Banja Luka, Faculty of Agriculture (in Serbian)
- Radojicic B. (2008): General clinical diagnostics in domestic ungulates. "Naucna KMD", Belgrade, ISBN- 978-86-84153-76-2 (in Serbian)

- Radojicic B., Bojkovski J., Jankovic D. (2001): Some biochemical parameters to control the metabolism of high-yielding dairy cows. *Veterinary Journal of Republic of Srpska*, 2 (1-2), 31-35 (in Serbian)
- Radojicic B. et al. (2007): Concentrations of cortisol insulin, glucose and lipids in the blood of calves of various ages, *Acta veterinaria* 45, (3) 23-28
- Samanc A.H., Radojicic B., Kovacevic M., Djokovic R. (2004): Some endocrine metabolic parameters in the blood serum of healthy and ketotic cows. Book abstract 14,12th Congress of Mediterranean Federation of Healthy and Production of Ruminants, 16-19 September, Istanbul, Turkey
- Samanc et al. (1993): Endocrine regulation of metabolic processes in cows during pregnancy and lactation, *Veterinarski glasnik* 47, (4-5) 319-327 (in Serbian)

BEHAVIORAL PATTERNS OF GOATS

S. Seçkin TUNCER^{1*}, H. Deniz ŞİRELİ², Ali Murat TATAR²

¹Department of Plant and Animal Production, Vocational School of Ozalp, Yuzuncu Yil University, Van, Turkey

²Department of Animal Science, Faculty of Agriculture, Dicle University, Diyarbakır, Turkey

*Corresponding author: selcukseckintuncer@gmail.com

Abstract

Goat is one of the species widespread raised among the domestic animals. Goats are raised in many different environments almost everywhere in the world. It is important to have knowledge relating to goat and other livestock behavior to ensure better health care, nutrition and environment conditions. Knowledge and interpretation of animal behaviour will also enable a rise in yield levels. The rise will provide income to farmers and protein to consumers. The position of the animal in the social hierarchy also affects productivity. In this sense, an animal can be assumed to be unproductive due to being lower in the social hierarchy. Knowledge of animal behavior is important for safety and for decreasing the stress on both the producer and the animal. In this way, animal from being excluded from breeding stock, it may be incorporation again.

In this review, the aim was to reveal the various types of goat behavior in order to perform the raising of goat farming easily and improve yield.

Keywords: *Goat, Behavior patterns*

Introduction

Living organisms live in harmony with their environment. Organisms' reaction to the changes around them, and the behaviours exhibited when living organisms encounter each other are subjects that should be studied.

Ethology (the science of behaviour): It is the branch of science which studies the behaviour of living organisms in their natural environments.

Stimulus: Physical, chemical, and biological changes that occur in the internal or external environment and can cause a reaction in the living organism.

Reaction: The response given by effector organs to stimuli. Behaviour is a result of stimuli and reactions.

Behaviour: It is the whole of activities which the organism brings about in response to stimuli received from the internal and external environment. Behaviour helps the living organism find a mate, water, food, and shelter or avoid unfavorable environmental conditions (enemies, scarcity, fire, flood, etc.). Behaviour can be studied in three groups which are inherent behaviour, learned behaviour, and social behaviour (Anonymous, 2016).

Knowledge about animal behaviour is important for raising the productivity of domesticated species that are cultivated as well as for optimizing the welfare of animals. Behaviour is a very important criterion in evaluating animal welfare (Akcapinar and Ozbeyaz, 1999; Unal, 2004; Yakan et al., 2007). The position of the animal in the social hierarchy is known to have an influence in their productivity. In this sense, an animal can be assumed to be unproductive due to being lower in the social hierarchy. In order to prevent these animals from being excluded from breeding stock, it would be beneficial to consider the ranking in social hierarchy as an environmental factor in breeding programs. Variations are observed in the nature and levels of aggressive behaviour observed in animals. Studies on animal

temperament are required which study aggressive behaviour of animals on an individual basis, in order to determine these variations in breeding efforts (Tolu and Savas, 2006).

In this review was undertaken to be compiled some behaviour characteristic of goats (Grazing and watering, modes of social, sexual, parturition and maternal, abnormal sexual behaviours).

Factors which influence animal behaviour

Genetics: Genetics plays an important role in animal behaviour. Many behaviours of animals of genetically similar species are similar.

Environment: Some environmental factors which influence animal behaviour are:

- Periods of high and low environmental temperature
- Day length (photoperiod) is influential in the goat entering the mating season.
- The availability of feed - The amount and type of available coarse feed influences grazing models.
- Social grouping - The size of the social group, the age of its members and the sex of animals influences behaviour.
- Behaviour of humans - Animals usually respond with a docile reaction to kind treatment and a combative one to harsh treatment by their caretakers.

Domestication: The selection of brood animals with economically significant characteristics for the sake of profitable production has caused these species to exhibit different behaviour than their ancestors. Today, most farm animals live in more comfortable environmental conditions that are controlled by humans.

Physiology: Nervous and endocrine systems play an important role in animal behaviour. The nervous system receives, processes, and stores information received from external stimuli. The endocrine system creates important influences on behaviour via hormones.

Sensory systems: Animals receive information created by the stimuli received via their visual, auditory, olfactory, taste, and tactile senses. The capacities of these systems for receiving and processing information varies among species. Generally, information received from multiple sensory systems are used to generate an appropriate response.

Modes of behaviour in goats

1. Grazing and watering behaviour: Daily feed ingestion activities in goats comprise 1/3 of all activities. Although goats ingest feed more rapidly than sheep, their grazing period takes longer than sheep. The reason for this is that they are excessively selective and mobile while grazing (Ngwa et al., 2000). Since front incisors in goats have a higher outward inclination, they can gnaw tree barks and trunks. They detach grass with the aid of their tongues and front incisors, and complete their grazing behaviour by shredding them between their teeth (Yakan et al, 2007).

Goats conduct their watering behaviour in the form of sucking. As is the case in all animals, water requirement in goats varies according to the variety and condition of feed, and lactation and pregnancy status. Water intake in goats increased at increased environmental temperature, and during periods such as during pregnancy and lactation (Haenleinet et al., 1992). Goats mostly graze at lower and flat places, but they also like to roam and graze at steep hillsides and rocky inclines. They are also capable of treading 14-15 km a day at the pasture. Goats can take advantage of low quality pastures, maquis and bushes. They can stand on their rear legs and eat the sprouts, buds, and leaves on the branches of leaves (Schwartz, 1981). There are many factors which influence the grazing period. These are respectively: climate conditions, the quality of the pasture where the animals graze, live weight, race, size of herd, age, health condition, the condition of the goat's hair cover and the parasite status, and many other factors. During periods where air temperatures increase, goats deliberately decrease their intake of feed to compensate for heat stress. They tend to graze more during early morning

and late evening during warm seasons (Yakan et al., 2007). Furthermore, the central and peripheral nervous systems as well as hormones are also known to have an influence on the grazing behaviour of goats (Hafez and Hafez, 2000). Since adult goats are better able to distinguish the weeds to which they are accustomed, and that are nourishing they can obtain them in a shorter period of time than young goats. There are also variations between races with respect to grazing period. For instance, goats that are bred for angora yields graze for longer periods as compared to milk goats (Quick and Dehority, 1986; Hoste et al., 2001). Goats display selective behaviour toward their favorite plants while grazing at the pasture. The taste and smell of plants plays an important role in their selection. Another factor which is influential in the selection of feeds at pasture is the nutrient and toxic content of plants. During studies, goats have been observed to have a higher preference for plants with high nutritious content. Physiological conditions such as lactation and pregnancy are also influential in goats' feed preferences (Wittenberger, 1981; Hoste et al., 2001). Pregnancy and lactation have been reported to increase the total daily time of feeding, the frequency of feeding, the total daily time of rumination, and the frequency of rumination (Wittenberger, 1981).

2. Modes of social behaviour in goats:

2.1. Hierarchical behaviour: Goats are animals with herd instincts. Their relationships with other individuals within the herd leads to the formation of a hierarchical structure among them. This condition which we call social hierarchy allows them to live together. Factors such as temperament, live weight, and the presence of horns play an influential role in the social hierarchy amongst goats. Especially the presence of horns has a significant place in determining the individual's place within the herd. Animals that are placed high in the hierarchy fully exhibit, grazing, resting, mating, and general activity behaviour (Lickliter, 1984; Shackleton and Shank, 1984; Craig, 1986).

2.2. Agonistic (combative) behaviour: Agonistic behaviour in goats are behaviours such as attacking, escape, threatening, and defense. The reason for these behaviours in goats is the instinct to protect both themselves and their food sources (Mc Glone, 1986). Agonistic behaviour is observed to be 50% higher in males. The most important cause of this is the fact that females have no horns or weak horns (Unal and Akcapinar, 1994). Agonistic behaviour modes in goats are observed mostly in the form of attacking, threatening, and submission. Knowledge of these behaviours is important for breeding and handling of animals (Shackleton and Shank, 1984; Barroso et al., 2000; Yakan et al., 2007).

2.2.1. Threatening behaviour: As the number of living creatures in a population rises, competition for food, living space, and mate increases. Competition leads to the emergence of social hierarchy among animals which make up the group. The individual which proves its superiority has the chance to meet its vital needs before others. These individuals exhibit symbolic threatening behaviour. Animals which are dominant within the herd try to have their superiority recognized by other animals through certain sounds and motions to express their intent to the other animal (Anonymous, 2016).

2.2.2. Attacking behaviour: It is perhaps the most important of agonistic behaviours. Environmental factors have a fairly high influence in the emergence of these behaviours. We could list herd size and physical amenities (shelter, feed, area for water etc.) among these factors. For instance increased herd size can increase attacking behaviour since it will limit food, water, and shelter areas (Unal and Akcapinar, 1994; Yakan et al., 2007). Attacking behaviour also increase with sexual maturity. These behaviours mostly manifest in the form of head-butting (Craig, 1986; Barroso et al., 2000; Yakan et al., 2007).

2.2.3. Submissive Behaviour: This mode of behaviour mostly manifests in the form of accepting defeat following threatening and aggressive behaviour (Yakan et al., 2007).

3. Sexual behaviour in goats: In goats, these can be listed as courting, estrus, mating, and pregnancy-related behaviour. Factors such as sex, race, feeding, and day length are important in terms of behavioural differences. For instance in bucks this activity emerges most during periods when day length shortens (Hafez and Hafez, 2000; Imwalle and Katz 2004).

Female goats in their mating season secrete some chemicals called pheromones from their urine and vaginal secretions in order to increase the interest of the opposite sex. Male goats which detect this pheromone extend their head upwards, back their upper lip, which is called the Flehmen movement. In some cases male goats cause an erection in their penis and urinate toward their front legs, and can secrete pheromones from their own body by smelling this urine kokmasıdır (Delgadoillo and Malpoux, 1996; Hafez and Hafez, 2000; Imwalle and Katz, 2004).

3.1. Estrus behaviour in goats: Goats which approach rutting or are already rutting exhibit a marked decrease in their feed consumption and milk production. They are quite mobile during this period, constantly moving their tail while bleating and seek male goats within the herd. They constantly pounce on other goats and allow other goats to pounce on them. When they meet with the buck, they let him pounce on them. Buck on the other hand secrete odors to attract goats in rut. During this period bucks are aggressive and display a constant wish for mounting. They also sniff and lick the vaginal section of the goat and make grunting sounds. They kick the sides of the goat with their front legs (Chemineau 1983; Cupps, 1991).

3.2. Buck goat effect: Buck that had been isolated from the goat herd for a long time (4-6 weeks) prior to the addition of male goats are observed to influence the reproductive mechanisms of goats upon being re-introduced into the herd through pheromones they secrete from their skin and around their eyes, and female goats are similarly observed to influence buck through some pheromones in their vaginal secretions and urine (Hafez and Hafez, 2000; Martin, 2001; Ungerfeld, 2003).

3.3. Courting behaviour in goats: Courting behaviour is of great importance for successful mating in goats. These behaviours include the male goat sniffing the rutting female's perineal region; and hitting the goat's flank with front legs and making noises in the meantime. Female goats respond to these behaviours by urinating and by moving forward. The male goat on the other hand sniffs the urine, sometimes licks it and shakes his head from side to side while making the Flehmen movement. Courting behaviours that are rarely seen in female goats is to sidle up to the male, trying to hide under his chest, and leaning her body along the male goat's flank (Imwalle and Katz, 2004; Yakan et al., 2007).

3.4. Mating behaviours in goats: The male goat pounces the goat which he had found to be in rut, and exhibits the mounting behaviour by grasping it firmly from its buttocks. Mating is achieved through repetitive pushing motions to the rear of the goat. Ejaculation occurs after the mounting movement and the male goat unmounts from the goat and concludes the mating (Kilgour and Dalton, 1984).

4. Parturition and maternal behaviour in goats: The behaviour of during birth period can be studied under three headings. They are prenatal, during the birth and postnatal behavior (Lickliter, 1984; Kilgour and Dalton, 1984; Craig, 1986; Haenlein, et al, 1992). Major behaviours observed in goats before birth are a decrease in the desire to feed, keeping the male goat away, slower movements, and frequent urination (Kaymakci, 2013). Also moving away from other goats (76%), discomfort and frequent changes in position (72%), frequent bleating (57%), chasing away or head-butting animals in its proximity, and aggressive behaviour can also be observed (42%) (Yakan et al., 2007). Behaviour during the birth itself are the following; the period between the onset of uterine contractions in the goat and the expulsion of the kid are defined as birth, and occur over a period of approximately three hours

without help in a standing or prone position (Cupps, 1991; Hafez and Hafez, 2000; Kaymakci, 2002; Yakan et al., 2007) .

Postnatal behaviour and the relationship between the mother goat and kid are behaviours that begin immediately after birth. Maternal bonding begin with birth and end with the weaning period. Age, number of births, the kid's need for nutrition, race, birth type, and stimulus by the kid (warmth, sucking, moving) are influential on mothering behaviour. The mother goat immediately beginning to lick her kid and allowing the kid to suckle herself are the first indications of mothering behaviour (Unal and Akcapinar,1994; Kaymakci, 2002).

5. Abnormal sexual behaviours in goats

5.1. Homosexuality: Homosexuality is a behaviour that is observed among domesticated sexually mature male mammals and manifests in the form of mutual mounting behaviour. Isolation of male animals from female promotes homosexual behaviour. When males in this condition are once again introduced to females heterosexuality emerges again (Kaymakci, 2002).

5.2. High sexual activity: High sexual activity is more than normal numbers of mounting, mating, and ejaculation by male mammals (Kaymakci, 2002).

5.3. Low sexual activity: Low sexual activity is less than normal numbers of mounting, mating, and ejaculation by male mammals. This condition is always observed in the form of an absence of desire to mount or mate.

5.4. Masturbation: Masturbation is erection or ejaculation of male mammals on their own (Kaymakci, 2002).

Conclusion

Goat breeding is an animal husbandry activity that has economical significance. Goats are the most important farm animals which can consume many foods that are hard to digest, converting them to animal production. Furthermore, goat is also an indispensable source of income with its ability to adapt to highly varied geographical regions and climate conditions. Knowledge and interpretation of animal behaviour will also enable a rise in yield levels. The increasing number of studies on the behavior of goats and informing to farmers, it will be rendered more profitable and attractive in goat breeding.

In conclusion, it should be known of goats behavior patterns for economically goat breeding . In this way, animal products will be increased. This increase will provide income to farmers and protein to consumers.

References

- Akcapinar, H.,Ozbeyaz, C.,1999. Hayvan Yetiştiriciliği Temel Bilgileri (Basics of Animal Husbandry). Ankara, pp.: 9- 35.
- Anonymous, 2016. <http://mebk12.meb.gov.tr>. Accesed on 10/02/2016.
- Barroso, F.G., Alados, C.L., Boza, J., 2000. Social hierarchy in the domestic goat: effect on food habits and production. *Applied Animal Behaviour Science* 69, 35–53.
- Chemineau, P., 1983. Effect of oestrus and ovulation of exposing creole goats to themale at three times of the year. *J. Reprod. Fertil.* 67, 65-72.
- Cupps, P.T., 1991. *Reproduction in Domestic Animals*. 4th Edition, Academic Press Inc., San Diego, New York, Boston.
- Craig, J.V., 1986. Measuring social behavior. *J. Anim. Sci.* 62, 1120–1129.
- Delgadillo, J.A.,Malpaux, B., 1996. Reproduction of goats in the tropics and subtropics. *Proceedings of Sixth International Conference on Goats, Beijing, China, 6-11 May 1996*, pp. 785-793.

- Haenlein, G.F.W., Caccese, R., Sammelwitz, P.H., 1992. Behavior. Goat Extension Handbook. University of Delaware, Newark, pp. 1–7.
- Hafez, B., Hafez, E.S.E., 2000. Reproduction in Farm Animals (Seventh edition). Lippincott Williams & Wilkins. Pennsylvania, Chapter 12.
- Hoste, H., Leveque, H., Dorchies, P.H., 2001. Comparison of nematode infections of the gastrointestinal tract in Angora and dairy goats in a rangeland environment: relations with the feeding behaviour. *Veterinary Parasitology*, 101: 127- 135.
- Imwalle, D.B., Katz, L.S., 2004. Development of Sexual Behavior Over Several Serving Capacity Tests in Male Goats. *Appl. Anim. Behavior Sci.* 89:315-319.
- Kaymakci, M., 2002. Üreme Biyolojisi (Reproductive Biology). *E.Ü.Z.F.*, 503: 305. İzmir.
- Kaymakci, M., 2013. İleri Keçi Yetiştiriciliği (Advanced Goat Breeding). ISBN 978-605-85998-0-2. Bornova-İzmir.
- Kilgour, R., Dalton, C. 1984. *Livestock Behaviour*. Granada Publishing. pp: 90-93.
- Lickliter, R.E. 1984. Hiding behaviour in domestic goats. *Appl. Anim. Behav. Sci.* 1984; 12:245–251.
- Martin, G.B., 2001. Role of Pheromones in Wild and Domesticated Mammals. *Advances in Ethology (Supplement to Ethology)* 36, 29.
- McGlone, J. J., 1986. Agonistic behavior in food animals: review of research and techniques. *Journal of Animal Science*, 62: 1130- 1139.
- Ngwa, A.T., Pone, D.K., Mafeni, J.M., 2000. Feed selection and dietary preferences of forages by small ruminants grazing natural pasture in the Sahelian zone of Cameroon. *Anim. Feed Sci. Technol.* 88, 253–266.
- Quick, C.T., Dehority, A.B., 1986. A comparative study of feeding behavior and digestive function in dairy goats, wool sheep and hair sheep. *Journal of Animal Science*, 63: 1516-1526.
- Schwartz, H.J., 1981. Dietary preferences of goats and nutritive value of forage on semi-arid and pastures in northern Kenya. In: Morand-Fehr, P., Bourbouze, A., de Simiane, M. (Eds.), *Nutrition et systemes d'Alimentation de la chevre*, Vol. 1. International Symposium, Tours, France. May 1981. ITOVIC-INRA, Tours, pp. 515±524.
- Shackleton, D.M., Shank, C.C. 1984. A review of the social behaviour of feral and wild sheep and goats. *J. Anim. Sci.* 1984;58:500–509.
- Tolu, C., Savas, T., 2006. Çiftlik Hayvanlarında sosyal sıra ve agonistik davranışlar (Social order and agonistic behavior in livestock). *Hayvansal Üretim (Animal Production)* 47(2): 26-31.
- Ungerfeld, R., 2003. Reproductive responses of anestrus ewes to the introduction of rams. PhD thesis, Swedish University of Agricultural Sciences. http://dissepsilon.slu.se/archive/00000393/0_1/Thesis.PDF
- Unal, N., 2004. Hayvan refahı (Animal Welfare). I. National Veterinary Animal Science Congress, Elazığ, 347. Turkey.
- Unal N, Akcapinar, H., 1994. Koyunlarda davranış (Behaviour of sheep). *Journal of Lalahan Livestock Research Institute*, 4(2): 113- 123.
- Wittenberger, J.F., 1981. *Animal Social Behavior*. Duxbury Press, Boston.
- Yakan, A., Unal, N., Akcapinar, H., 2007. Keçilerde Davranış (Behaviour of Goat). *Journal of Lalahan Livestock Research Institute*, 47 (1) 39 – 47.

THE EFFECTS OF MICROBIAL PHYTASE ON IMPROVING OF GROWTH PERFORMANCE AND DIETARY PHYTATE-PHOSPHORUS UTILIZATION BY PIGLETS

Rezana PENGU¹, Etleva DELIA²

¹Faculty of Agriculture, F. S. Noli University Korce, Albania

²Faculty of Agriculture and Environment, Agricultural University of Tirana, Albania

Corresponding author: rezanap@yahoo.com

Abstract

Pigs and poultry diets are primarily on cereals, legumes and oilseed products. About two-thirds of phosphorus (P) in these feedstuffs occur as phytates (mio-inositol heksakisphosphate, InsP₆), the salts of phytic acid. Phytate P in plants is a mixed calcium-magnesium-potassium salt of phytic acid that is present as chelate and solubility is very low. Phosphorus in this form is poorly digestible/available for simple-stomached animals. The aim of this study was to test the effects of the microbial phytase (NATUPHOS) on the performance parameters and faecal excretion phosphorus of piglets. The microbial phytase preparation (*Aspergillus niger*, NATUPHOS) was supplemented to a basal ration 750 FTU/kg feed and the effects on growth performance of weaned piglets were studied. The supplementation of microbial phytase improved slightly daily weight gain, feed conversion ratio and increases the digestibility and bioavailability of phosphorus from phytate, reduces the amount of inorganic phosphorus needed to maximize growth and bone mineralization and markedly reduces fecal excretion of phosphorus. Overall a positive effect of the microbial phytase on performance parameters was observed. The P-excretion in the faeces was reduced by 20%.

Keywords: *Faeces, Microbial phytase, P-reduction, Performance parameters, Piglets.*

Introduction

Excessive animal manure and fertilizer inputs do cause various environmental problems, including the accumulation and elevated leaching and runoff of nutrients (N and P) and heavy metal to ground water and surface water (de Vries et al, 2005). Groundwater contamination by nitrate-nitrogen and eutrophication of surface waters by phosphorus originating from land application of fertilizers and animal manure are well documented in some most populated areas like, Durres, suburb of Tirana, Lushnja (Borici et al, 2005), (Sulce and Veizaj, 2006).

Animal nutrition and Environmental problems.

As a result of growing concern about the environment, intensification of animal production in many European countries is considered as potential source of air pollution and threat to soil and drinking water quality, (Eeckhout and de Paepe, 1994).

Nutritive ration of non ruminant animals (pigs and poultry) contains 90% cereals seed (corn, wheat, barley, rye, and oat). The majority of "P" in cereal grains is organically bound as phytic acid or phytate. This form of P is nutritionally unavailable to non-ruminant animals due to the lack of phytase in their digestive tract. The P-excretion on the pigs and poultry feces is potential source for soil and water pollution, due to his high level on the subsoil water and destruction of the ecosystem. In such situation the solution is utilization of phytase on the nutritive ration of pigs and poultry.

Sometimes the farmers in my country have distributed the animal manure in everywhere, because there is not government law, which not allows this distribution. In such situation the

government has no control on the quantity of phosphorus and nitrogen in the arable soil and ground water. Actually in Albania, the problems of soil and water pollutions are very important (Lushaj and Suljoti, 2005) (Bregasi and Veizaj, 2007).

Some of the pigs and poultry farms in Albania are in the suburb of the cities, but some others are near the living center, like as in Tirana, Durres, Vlore, Shkoder etc. The fecal excretion only by the poultry farms in Albania are nearly 41450 T per year.

Interest in phytase for non ruminant animals take place in regions, where soil and groundwater pollution due to animal wastes is a serious problem and phosphorus is a major concern. Indeed, plant phytate is the major form of plant phosphorus (Kirby and Nelson, 1988) and phytate phosphorus itself has low availability. For this reason swine and poultry diets must be supplemented with highly available, inorganic sources of P to meet their P requirements.

Studies in the early 1990s at Kentucky and Michigan showed that feeding pigs a low-P, corn-soy diet supplemented with phytase from a mutant strain of *Aspergillus niger* improved the bioavailability of P. At about the same time, research in the Netherlands also demonstrated the efficacy of phytase produced by recombinant *Aspergillus niger* in studies with pigs and chicks. In November, 1995 a commercial source of recombinant-produced phytase (Natuphos) was approved for use in the USA. Since then, other sources and forms of phytase have been developed and evaluated. From 1992 to 2001, 82 papers involving phytase were published in Poultry Science (N=55) and the Journal of Animal Science (N=27) with 48 of these published in the last 4 years. The studies clearly show that phytase increases the digestibility and bioavailability of P from phytate, reduces the amount of inorganic P needed to maximize growth and bone mineralization, and markedly reduces fecal excretion of P. Phytase seems to increase the bioavailability of Ca, Z, and other divalent cations that otherwise bind to phytate. Some studies suggest that phytase may improve ideal digestibility of amino acids slightly, but other studies have not shown this response. This new technology offer substantial benefits to swine and poultry production by reducing the potential for environmental problems associated with excess P excretion.

Material and Methods

Thirty six piglets (Large White x Landras) of four litters were transferred to flat-decks and allocated to 2 groups (A and B) with 18 animals (9 male and 9 female), respectively. Two piglets from different litters (1 male and 1 female), with the same body weight were housed in every box (experimental unit). The litter origin was taken into account, avoiding that piglets from the same litter were allocated in the same treatment. There were nine replications per control group and nine also per treated group. The control group (A) was feed with a balanced diet, containing mono calcium phosphate. The experimental group (B) was feed with low level of phosphorus, without inorganic phosphorus. All the phosphorus in this group originates from soybean meal. This group was supplemented with NATUPHOS phytase 750 FTU/kg feed.

Ambient room temperature was maintained at 24⁰C for three first weeks and lowered by 1⁰C for each week thereafter. The ventilation also was provided to ensure good air quality. The basal diet mainly contained maize and soybean meal and the nutrient contents met or exceeded nutrient requirements recommended by NRC. The diets were offered ad-libitum and animals had free access to water.

Table 1. The calculated nutrient concentration of diet.

Nutrient concentration (g/kg feed)		
	Control group (A)	Experimental group (B)
ME (MJ/kg)	12.75	12.80
Crude protein	190.1	191.1
Crude fibre	38.4	38.1
Calcium	6.90	6.45
Phosphorus	6.0	4.2
Lysine	2.1	1.9
Metionine+Cystine	6.4	6.5

During six weeks experimental period Body Weight (BW), Daily Weight Gain (DWG) and Feed Conversion Ratio (FCR, kg feed/kg Body Weight Gain were measured weekly. Data are presented as arithmetic means with standard deviation of the mean (Mean \pm SD). One-way analysis of variance and Student's *t*-test ($P < 0.05$) were performed to test the differences between two groups.

Results and Discussion

Feeding phytase NATUPHOS was slightly improved the production parameters respectively: Final Body Weight (FBW) by 1.76% and Daily Weight Gain (DWG) by 1.4%, compare with control group.

Table 2. The effect of phytase on production parameters.

Parameters		Control group	Experimental group
Production	n ¹	X \pm SD	X \pm SD
-Initial BW, kg	18	8.1 \pm 1.01	8.3 \pm 1.07
-FBW 6 th week ²		22.6 \pm 2.10	23.0 \pm 2.33
DWG, g ³		345.2 \pm 23	350 \pm 27
FCR ⁴		1.90 \pm 0.48	1.83 \pm 0.31

¹ Number of animals, (18 piglets/ every group, at the beginning of the experiment)

² FBW at the end of the trial.

³ DWG for whole experimental period.

⁴ FCR for whole experimental period.

Feed Conversion Ratio (FCR) was reduced (-3.8%) to compare with control group, but the differences were not significant. The phosphorus excretion was reduced by 20%, provided that pig's diets can be supplemented with an economical and efficacious level of phytase that will allow all of the supplemental inorganic phosphorus to be removed from the diet.

The effect of microbial phytase use as a partial replacer of the bi calcium phosphate in the layers and weaned piglets, aiming a better utilization of the phytic phosphorus and decrease of the environment pollution was documented by (Piu et al, 2008). Utilization of microbial phytase (Natuphos) on the nutritive ration of weaned piglets (28 days old), was accompanied with improved performance parameters. In the experimental group, treated with Natuphos (750 FTU/kg), the excreted phosphorus amount in the dropping is decreased by 6,8%, while the excreted nitrogen amount is decreased by 5,2%. So, there is a positive output towards the minimizing of the environmental pollution with non degradable Phosphorus and Nitrogen.

In general, the performance potential and the specialization in production (e.g. pregnant sows, lactating sows, growing pigs) may have a considerable influence on the efficiency of a

phytase supplementation. Thus (Jongbloed et al, 1993) reported that the greatest effect of microbial phytase was on lactating sows and least on breeding sows in early gestation, whereas the reaction of piglets and growing pigs were in the middle range. (Cromwell and Coffey, 1991) concluded that a 50% reduction of excreted phosphorus would mean that 100.000 fewer tons of phosphorus would be excreted into the environment annually in the United States (Fodor and Szabo, 2005). Obviously, this could have a major impact and would be especially significant in countries, where livestock production is restricted because of environment pollution (Sims, 2005)

Conclusions

Concerns about pollution of environment with P from intensive livestock production facilities has led to diet modifications to reduce the amount of P excreted, such as supplementing diets only to required phosphorus levels and adding microbial phytase. Effectiveness of supplemental microbial phytases for swine in improving phytate phosphorus bioavailability and reducing manure phosphorus excretion has been demonstrated by many researcher groups around the world. Our study demonstrated that the use of phytase reduced the amount of phosphorus excreted and improved the production parameters.

References

- Boriçi, J., Canco, G., Veizaj, E. (2005). Soil and water pollution as a result of agriculture techniques and animal rests. Abstract on the International Conference: Element balances as a Tool for Sustainable Land Management.
- Bregasi, M., Veizaj, E. (2007). The environmental impact of livestock development and animal farms. The Albanian case. Journal of Central European Agriculture, Nitra, Slovak Republic. pg 23.
- Cromwell, G. L., Coffey, R. D. (1991). Phosphorus -a key essential nutrient, yet a possible major pollutant-its central role in animal nutrition. In: Biotechnology in Feed Industry. Nicholasville, USA; Alltech Technical Publications, pg 133-145.
- de Vries.,W, Romkens, P., Kros, H. (2005). Critical nutrient and heavy metal fluxes for agricultural soils in the Netherlands in view of adverse impacts on food, soil and water quality. Abstract on the International Conference: Element balances as a Tool for Sustainable Land Management, pg 33.
- Eeckhout, W., de Paepe, M. (1994). Total phosphorus, phytate-phosphorus and phytase activity in plant feedstuffs. Animal Feed Science and Technology, 47. 19-29.
- Fodor, L., Szabo, L. (2005). Effect of soil pollution on the microelement composition of crops. Abstract on the International Conference: Element balances as a Tool for Sustainable Land Management, pg 53.
- Jongbloed A W, Kemme P A and Mroz, Z (1993). The role of microbial phytases in pig production. In: Wenk C and Boessinger M (Eds) Enzymes in Animal Nutrition. Proceedings of the 1st Symposium Kartause Ittingen, Switzerland, pp 173-180.
- Kirby, L.-K., Nelson, T.-S. (1988). Total and phytate phosphorus content of some feed ingredients derived from grains. Nutr. Rep. Int. 37: 277-280.
- Lushaj, S., Suljoti, V. (2005). Land planning and suitable management of natural resources using GIS application. Abstract on the International Conference: Element balances as a Tool for Sustainable Land Management.
- Piu, Th., Sena, L., Veizaj, E. (2008). The effect of microbial phytase on the monogastric animals. The buletin of Agricultural Science, Nr.1, pg 84-89.

- Sims, J T (2005). Element balances: A review and critical analysis of their application to United States environmental policy. Abstract on the International Conference: Element balances as a Tool for Sustainable Land Management, pg 34.
- Sulce, S., Veizaj, E. (2006). Evaluation of potential pollution from agricultural activities at Durrës region (Albania). Conference on Water Observation and Information System for Decision Support. BALOW, Ohrid, Macedonia.

PHOTOMETRIC EVALUATION OF EFFECT OF CLAW DISORDERS ON CLAW CONFORMATION

Michal VLČEK^{1*}, Ján TOMKA², Radovan KASARDA¹

¹Department of Animal Genetics and Breeding Biology, Slovak University of Agriculture in Nitra, Slovakia

²Research Institute of Animal Production - NPPC, Nitra, Slovakia

*Corresponding author: xvlcek@uniag.sk

Abstract

The aim of the study was to evaluate the influence of claw disorders on claw conformation by computer image analysis. The occurrence of claw disorders, as interdigital dermatitis and heel erosion, digital dermatitis and separately sole ulcer were observed. The measurements of lateral right claw (n=127) after functional trimming were evaluated. Computer image analysis in NIS Elements and the statistical analysis in SAS were performed. Following average values of claw conformation were found: claw angle 54.22 °, claw length 8.11 cm, heel index 4.15 cm, claw height 6.97 cm, diagonal 13.17 cm, claw width 5.26 cm, total area 42.86 cm² and functional area 27.87 cm². Analysed group of cows consisted of 9 cows affected by interdigital dermatitis and heel erosion, 11 by digital dermatitis and 12 by sole ulcer. Healthy cows had statistical significantly (P<0.05) larger total area and functional area than cows affected by digital dermatitis, but high statistical significantly (P<0.01) smaller total area than cows affected by sole ulcer. The highest positive correlations were found in claw length to claw height and of total area to functional area. Study has proved that the photometry of the claw can be successfully implemented into dairy management, with results significantly reflecting impact of disorders on claw formation.

Keywords: *photometry, claw disorder, claw conformation.*

Introduction

Claw disorders and lameness in dairy cattle are an increasing problem of the modern dairy industry (Van der Tol et al., 2004). The impact of the lameness is that reduce milk production (Bicalho and Oikonomou, 2013), disrupt animal welfare (Bicalho et al., 2009, Vermunt, 2007), cause economic losses (Warnick et al., 2001) and reduce productive efficiency and increase culling rates (Bicalho and Oikonomou, 2013). DeFrain et al. (2013) reported that infectious lesions of the foot skin and soft tissues as digital dermatitis (DD) and foot rot predominate in early lactation and during cooler months of the year, and non-infectious lesions as white line disease, sole ulcer (SU) and toe ulcer predominate during the 3 months following summer heat stress and their distribution follows a typical lactation curve. Baird et al. (2009) reported the associations of genetic, environmental and infectious factors with claw pathologies in dairy cows. Šárová et al. (2011) reported that farm managers underestimated the level of lameness. The economic value of claw disorder incidence was -26.73€ per case per cow and year as found Krupová et al. (2016).

The goal of preventive trimming is to promote natural loading by increasing the weight-bearing contact area of the claws and improving the balance between the medial and lateral claw as reported Van der Tol et al. (2004). Leach et al. (2012) reported the high effectivity of regular claw trimming as prevention to claw disorders and lameness.

Polák (2005) reported that photometry is objective, noninvasive method, which works on principle of computer image analysis. The use of the digital image analysis to determination of the body measurements and live weight of Holstein cows reported Tademiret al. (2011).

The aim of the study was to evaluate the influence of claw disorders on claw conformation by computer image analysis.

Material and Methods

Into the study, 127 Holstein dairy cows from university farm (SUA Nitra) were included. Cows were free stall housed. During the functional trimming the occurrence of claw disorders as interdigital dermatitis and heel erosion (IDHE), digital dermatitis (DD) and separately sole ulcer (SU) were observed. Claw disorders were evaluated as 0 (absence) or 1 (presence). Digital images of lateral right claw (n=127) from the bottom and right side with ruler by digital camera Olympus SP-600 UZ after functional trimming were made. Computer image analysis in NIS Elements 3.0 was performed. Claw measurements as claw angle, claw length, heel index, claw height, diagonal and claw width according to the methodology of Vermunt and Greenough (1995) were made. The statistical analysis and the evaluation of differences between groups with t-test in SAS (version 9.2, SAS Institute Inc., Cary, NC) were performed.

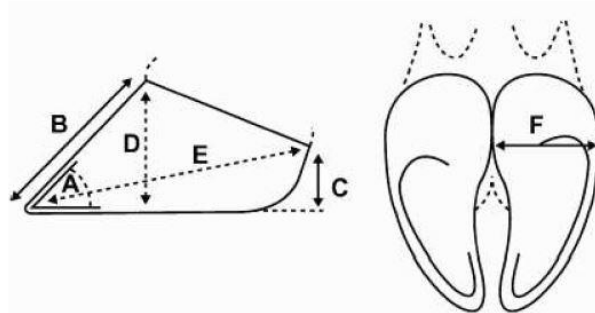

Figure 1 Claw measurements (Vermunt and Greenough, 1995)

A- claw angle, B- claw length, C- heel index, D- claw height, E-diagonal, F- claw width

Results and Discussion

In total, 127 lateral right claws of Holstein cows after functional trimming were evaluated. Analysed group of cows consisted of 9 cows affected by IDHE (the frequency 7.09 %), 11 by DD (8.66 %) and 12 by SU (9.45 %). DeFrain et al. (2013) reported that only 31.17 % of cows out of 17 confinement dairies (mainly from USA) had any lesions. 27.83 % were affected by DD and 13.29 % by SU. In Slovakia, Kasarda et al. (2015b) reported that the occurrence of IDHE, DD and SU was almost 16 % for each one.

Following average values of claw measurement were observed: claw angle 54.22 °, claw length 8.11 cm, heel index 4.15 cm, claw height 6.97 cm, diagonal 13.17 cm, claw width 5.26 cm. The size of total claw area was 42.86 cm² and the size of functional claw area was 27.87 cm². The results are in accordance with Kasarda et al. (2015a), who reported the size of total area 41.76 cm² and the size of functional claw area 28.98 cm².

Width of claw was 4.91 cm and in present study it was 5.26 cm. Cows affected by IDHE had by 1.34 mm significantly (P<0.05) longer diagonal than healthy cows. On the other hand, cows affected by DD had significantly (P<0.05) smaller values of claw height, diagonal, claw width, total area, functional area and high significantly (P<0.01) smaller values of heel index than healthy cows. Gomez et al. (2015) found significant differences between healthy and DD affected heifers in claw angle, heel index, depth of the interdigital space, level of interdigital hygiene and incidence of heel horn erosion. Cows housed on concrete flooring had shorter claw length and higher claw angle as cows on rubber- matted flooring (Kremer et al., 2007). Observed cows affected by SU had high significantly (P<0.01) larger total area than healthy cows.

Table 1 Estimated phenotypic correlations between claw measurements

	A	B	C	D	E	F	Total Area	Functional Area
A	1							
B	-0.16414 0.0652	1						
C	0.2691 0.0022	0.29865 0.0006	1					
D	0.13148 0.1406	0.73555 <.0001	0.63342 <.0001	1				
E	-0.34651 <.0001	0.62735 <.0001	0.46355 <.0001	0.61112 <.0001	1			
F	-0.04055 0.6508	0.29285 0.0008	0.24539 0.0054	0.23722 0.0072	0.33628 0.0001	1		
Total Area	-0.29951 0.0006	0.23652 0.0074	0.05767 0.5196	0.1717 0.0536	0.48722 <.0001	0.61485 <.0001	1	
Functional Area	-0.2309 0.009	0.13537 0.1292	0.01204 0.8932	0.09597 0.2831	0.27465 0.0018	0.44626 <.0001	0.67441 <.0001	1

A- claw angle, B- claw length, C- heel index, D- claw height, E-diagonal, F- claw width

In this study the highest positive correlations were found in claw height to claw length and of total area to functional area. In both, correlations were highly significant ($P < 0.01$). The highest negative correlation was between claw angle and claw width ($P > 0.05$). Similar results found Riecka et al. (2008), who reported the highest positive correlations of claw height to claw length and of diagonal to heel index. Both were highly significant ($P < 0.01$). DeFrain et al. (2013) found that digital dermatitis and foot rot were greatest in the first 60 days in milk and differed across lactation number. Baird et al. (2009) found in first and second lactations the higher total lesion scores between 71 and 150 days in milk. Almost half of problems recorded were before 180 days in milk, indicating the need to focus on factors known to cause lameness between dry period and mid-lactation (DeFrain et al., 2013). The significant claw conformation changes occurred in heifers affected by DD before lameness symptoms were detected (Gomez et al., 2015). Bicalho and Oikonomou (2013) highlighted the importance of prevention of the disease through improved management and housing.

Conclusion

As confirmed in previous studies, claw disorder incidence has high economic impact on dairy cow's profitability. Within high intensity farming conditions all tools providing up to date and accurate information's essential for the successful farm management. Use of photometry in evaluation of claw formation after functional trimming and evaluation of effect of claw disorders on claw proportions were studied. Study has proved that the photometry of the claw can be successfully implemented into dairy management, with results significantly reflecting impact of disorders on claw formation. Further implementation of photometry is foreseen as tool for data collection as part of the precision livestock farming management.

Acknowledgement

This study was supported by the Slovak Research and Development Agency under the Contract No. APVV-14-0054.

References

- Baird, L.G., O'Connell, N.E., McCoy, M.A., Keady, T.W.J., Kilpatrick, D.J. (2009). Effect of breed and production system on lameness parameters in dairy cattle. *Journal of Dairy Science*, vol. 92, pp. 2174-2182.
- Bicalho, R.C., Machado, V.S., Caixeta, L.S. (2009). Lameness in dairy cattle: A debilitating disease or a disease of debilitated cattle? A cross-sectional study of lameness prevalence and thickness of the digital cushion. *Journal of Dairy Science*, vol. 92, pp. 3175-3184.
- Bicalho, R.C., Oikonomou, G. (2013). Control and prevention of lameness associated with claw lesions in dairy cows. *Livestock Science*, vol. 156, pp. 96-105.
- DeFrain, J.M., Socha, M.T., Tomlinson, D.J. (2013). Analysis of foot health records from 17 confinement dairies. *Journal of Dairy Science*, vol. 96, pp. 7329-7339.
- Gomez, A., Cook, N.B., Rieman, J., Dunbar, K.A., Cooley, K.E., Socha, M.T., Döpfer, D. (2015). The effect of digital dermatitis on hoof conformation. *Journal of Dairy Science*, vol. 98, pp. 927-936.
- Kasarda, R., Tomka, J., Vlček, M., Ofúkaný, M. (2015a). Use of photometry in evaluation of hoof trimming. *Proceedings of the Third DairyCare Conference 2015, Zadar, Croatia, October 5th and 6th 2015.*
- Kasarda, R., Vlček, M., Ofúkaný, M., Chudej, P. (2015b). Detailed view on claw formation. *Miniinfo* apríl 2015, pp. 16-19. <http://www.holstein.sk/domain/holstein/files/infomagazin/Miniinfo%20April%202015%20web.pdf>
- Kremer, P.V., Nueske, S., Scholz, A.M., Foerster, M. (2007). Comparison of claw health and milk yield in dairy cows on elastic or concrete flooring. *Journal of Dairy Science*, vol. 90, pp. 4603-4258.
- Krupová, Z., Krupa, E., Michaličková, M., Wolfová, M., Kasarda, R. (2016). Economic values for health and feed efficiency traits of dual-purpose cattle in marginal areas. *Journal of Dairy Science*, vol. 99, pp. 644-656.
- Leach, K.A., Tisdall, D.A., Bell, N.J., Main, D.C.J., Green, L.E. (2012). The effects of early treatment for hindlimb lameness in dairy cows on four commercial UK farms. *The Veterinary Journal*, vol. 193, pp. 626-632.
- Polák, P. 2005. Evaluation of beef production of cattle by sonography and photometry. PhD. Thesis. Nitra: SUA.
- Riecka, Z., Kasarda, R., Candrák, J. (2008). Analysis of relationships between claw formation and production and reproduction traits. *Acta fytotechnica et zootechnica*, vol. 11, pp. 73-77.
- Šárová, R., Stěhulová, I., Kratinová, P., Firla, P., Špínka, M. (2011). Farm managers underestimate lameness prevalence in Czech dairy herds. *Animal Welfare*, vol. 20, pp. 201-204.
- Tasdemir, S., Urkmez, A., Inal, S. (2011). Determination of body measurements on the Holstein cows using digital image analysis and estimation of live weight with regression analysis. *Computer and Electronics in Agriculture*, vol. 76, pp. 189-197.
- Van der Tol, P.P.J., Van der Beek, S.S., Metz, J.H.M., Noordhuizen-Stassen, E.N., Back, W., Braam, C.R., Weijs, W.A. (2004). The effect of preventive trimming on weight bearing and force balance on the claws of dairy cattle. *Journal of Dairy Science*, vol. 87, pp. 1732-1738.
- Vermunt, J.J. (2007). One step closer to unravelling the pathophysiology of claw horn disruption: For the sake of the cows' welfare. *The Veterinary Journal*, vol. 174, pp. 219-220.

- Vermunt, J.J., Greenough, P.R. (1995). Structural characteristics of the bovine claw: Horn growth and wear, horn hardness and claw conformation. *British Veterinary Journal*, vol. 151, pp. 157-180.
- Warnick, L.D., Janssen, D., Guard, C.L., Gröhn, Y.T. (2001). The effect of lameness on milk production in dairy cows. *Journal of Dairy Science*, vol. 84, pp. 1988-1997.

CLASSIFICATION OF SCIENTIFIC INTEREST IN SERBIAN ANIMAL HUSBANDRY

Marko LAZIC^{1*}, Zvonko SPASIC², Jelena NIKITOVIC³, Milun PETROVIC¹, Nikola STOLIC⁴, Gjoko BUNEVSKI⁵, Bratislav PESIC⁴

¹ University of Kragujevac, Faculty of Agronomy, Cara Dusana 34, 32000 Cacak, Republic of Serbia

² University of Pristina, Faculty of Agriculture, Kopaonicka nn., 38219 Lesak, Republic of Serbia

³ University of Banja Luka, Genetic Resources Institute, Bulevar vojvode Petra Bojovica 1A, 78000 Banja Luka, Republic of Srpska, Bosnia and Herzegovina

⁴ College of Agriculture and Food Technology, Cirila i Metodija 1, 18400 Prokuplje, Republic of Serbia

⁵ Ss. Cyril and Methodius University in Skopje, Faculty of Agriculture Sciences and Food, Blvd. Aleksandar Makedonski nn., P.O. Box 297, 1000 Skopje, Republic of Macedonia

*Corresponding author, e-mail: msc.lazic@gmail.com

Abstract

In this study, the term "a national scientific paper" refers to an article published in a national journal belonging to category M50. In addition to the categorization for the purpose of quantification of scientific and research results, scientific papers are classified according to the Universal Decimal Classification (UDC) scheme and system. In the UDC, animal husbandry and breeding in general are placed under agriculture and related sciences and techniques. Given the above, the aim of this study was to quantitatively show scientific interests in the field of animal husbandry and breeding in general at the national level, based on the categorization of journals and classification of scientific papers. M51, M52 and M53 national journals and UDC codes assigned to published articles were used for the analysis. All national journals dedicated to scientific research that meet the requirements of bibliometric analysis were covered. Within these journals, all articles published in the past few years (from 2009. to 2014.) and containing UDC codes beginning with 636 were analyzed. Apart from the fact that UDC is an important scheme and a highly flexible classification system based on which national catalogues and national bibliographies are being organized, the results of this study can be used in creating new and more complex scientific questions arising from current and future problems. Overall, despite the fact that scientific interest in animal husbandry and breeding in general is focused on economically important animal species, the results of the present study may stimulate future research into neglected areas.

Keywords: *categorization, comparison, livestock rearing, UDC.*

Introduction

Given the concept of science and scientific work as the result of creator's mental activity, classification of scientific interest can be helpful principally to scientists in the earliest period of their creativity. The fact that plant production is the primary determinant of the character of livestock production places special emphasis on the importance of classifying scientific interest in this branch of agriculture.

The preparation of scientific research generally has seven stages, as follows: general introduction to the problem and its setting, collection of scientific materials on the subject being studied, coordination and interpretation of scientific data, hypothesis and the choice of working hypotheses, proving the working hypothesis, drawing conclusions and making recommendations, description of results (Spasic and Milosevic, 2011). Research plan includes the following elements: object of research, funds required for the implementation of research,

research directions, executors of the plan, as well as other important elements for the success of the research team (Veljovic, 2001).

In Serbia there are several publishers of scientific journals of different quality ranks in the field of animal husbandry as a branch of agricultural production. Journal categorization results are published annually on the Ministry of Education, Science and Technological Development website (MPNTR, 2009a, 2010, 2011, 2012, 2013, 2014). The final decision on the categorization of journals that are published in Serbia is passed by the Minister upon proposal of the scientific committee inside the Ministry in charge of research activities (KoBSON, 2001). Category (type) of work may be suggested by reviewers and members of the editorial board or section editors, but the responsibility for categorization shall be borne exclusively by the editor-in-chief (MPNTR, 2009b). In order to improve the quality of periodic publishing, the Ministry has passed the Act on Editing Scientific Journals (KoBSON, 2001). Articles in journals are classified into the following categories: scientific articles (original scientific article, review article, short or preliminary communication, scientific critique or controversy and review) and technical articles (technical paper, informative contribution, review) (MPNTR, 2009b). National journals are categorized as follows: scientific journals (category M53), journals of national importance (category M52) and leading journals of national importance (category M51) (Official Gazette of the RS, 2016). However, despite the different analyses and reports, little has been said about scientific interest in agricultural science, and even less about its neglected subfields.

Given the above, the aim of this study was to quantitatively show scientific interests in the field of animal husbandry and breeding in general at the national level, based on the categorization of journals and classification of scientific papers.

Materials and Methods

According to the UDC, animal husbandry and breeding in general are placed under agriculture and related sciences and techniques. Animal husbandry and breeding in general are further divided into: domestic equines (636.1), large ruminants (636.2), small ruminants (636.3), pigs (636.4), poultry (636.5), birds (except poultry and game) bred or kept by humans (636.6) dogs (636.7), cats (636.8) and other animals kept by humans (636.9) (*UDC Summary, 2009*). In addition to these divisions, animal husbandry includes the subdivision of special auxiliary subdivision for animal husbandry (636.01/.09). M_{51} , M_{52} and M_{53} national journals and UDC codes assigned to published articles were used for the analysis. All national journals dedicated to scientific research that meet the requirements of bibliometric analysis were covered. Categorization of domestic scientific journals (M_{50}) in biotechnology and agro-industry is available on the Ministry of Education, Science and Technological Development website (MPNTR, 2009a, 2010, 2011, 2012, 2013, 2014) for the period 2009-2014. Given that no journal categorization proposal for 2015 has been published, the analysis presented includes articles published during the abovementioned period. Within these journals, all articles published in the past few years (from 2009. to 2014.) and containing UDC codes beginning with 636 were analyzed. The results of the research were analyzed using ANOVA (Maletic, 2005; Stankovic *et al.*, 1990; Spasic *et al.* 2006), as well as their percentage.

Results and Discussion

Based on the annual number of published papers, the results presented in Table 1 show that scientific interest in the field of animal husbandry and animal breeding in general is highest in 2009, followed by 2014. The results for the analyzed period indicate that in 2012 somewhat fewer articles were published at the national level in the field of animal husbandry and animal breeding in general. However, it should be noted that some of the leading journals of national significance (category M_{51}) were verified by a special decision for 2012 (category M_{24}),

based on which they were categorized among journals of international importance in this year (MPNTR, 2009a, 2010, 2011, 2012, 2013, 2014).

Given the results (see Table 1), the difference in UDC classification across years was statistically significant ($F_{(8,45)} = 15.01$, $p \leq 0.01$), which indicates significant differences between scientific interest in animal husbandry and animal breeding in general in the period 2009–2014. However, differences in UDC codes between published articles and journals were statistically non-significant (F_{exp} , $p > 0.05$).

Table 1. ANOVA and percentage values of published articles and journals according to UDC classification and categorization during the period 2009–2014.

Item	Animal husbandry and breeding in general (UDC: 636)								
	636.1	636.2	636.3	636.4	636.5	636.6	636.7	636.8	636.9
Category	$F_{(8,18)} = 2.25$, $p > 0.05$								
M51	47.62	55.93	77.78	64.20	67.09	-	42.86	50.00	83.33
M52	33.33	32.20	15.87	29.63	16.46	-	52.38	50.00	0.00
M53	19.05	11.86	6.35	6.17	16.46	-	4.76	0.00	16.67
Total, %	100	100	100	100	100	-	100	100	100
Article	$F_{(8,27)} = 1.06$, $p > 0.05$								
Original	61.90	72.88	80.95	77.78	83.54	-	61.90	0.00	50.00
Review	9.52	10.17	11.11	11.11	10.13	-	23.81	0.00	50.00
Professional	4.76	5.08	1.59	6.17	1.27	-	0.00	50.00	0.00
Another	23.81	11.86	6.35	4.94	5.06	-	14.29	50.00	0.00
Total, %	100	100	100	100	100	-	100	100	100
Years	$F_{(8,45)} = 15.01$, $p \leq 0.01$								
2009.	19.05	27.12	22.22	19.75	30.38	-	23.81	25.00	16.67
2010.	14.29	18.64	14.29	9.88	10.13	-	14.29	0.00	16.67
2011.	28.57	15.25	14.29	17.28	22.78	-	4.76	0.00	0.00
2012.	4.76	5.93	4.76	11.11	8.86	-	14.29	25.00	16.67
2013.	9.52	16.95	11.11	14.81	13.92	-	14.29	25.00	0.00
2014.	23.81	16.10	33.33	27.16	13.92	-	28.57	25.00	50.00
Total, %	100	100	100	100	100	-	100	100	100
Percentage	5.34 %	30.03 %	16.03 %	20.61 %	20.10 %	-	5.34 %	1.02 %	1.53 %

A desirable and acceptable scientific paper always involves good preparation, research and drawing conclusions, with quality primarily being affected by acquired skills and innovative capacity of researchers. Despite the fact that experienced researchers characteristically show scientific interest in particular disciplines, the results obtained, inter alia, can focus scientific research on neglected animal species and research priorities (see Table 1).

Based on available and analyzed UDC codes in the field of animal husbandry and animal breeding in general, it can be concluded that scientific interest in the period 2009–2014 was focused primarily on large ruminants (30.03%), followed by pigs (20.61%), poultry (20.10%) and small ruminants (16.03%) (see Table 1). Other animal species are not and/or are considerably less dealt with in published articles in the field of animal husbandry and animal breeding in general. Moreover, contemporary scientific literature on agriculture tends towards a higher level of scientific knowledge primarily in under-researched areas, but also towards information of recent date. The results presented (see Table 1 and Graph 1) show that the highest number of published articles are found in leading journals of national importance

(category M51), and that original scientific papers make the highest contribution to the contents of national scientific journals and, hence, account for the largest portion of primary scientific literature (Spasic and Milosevic, 2011).

Results on percentage change as regards national categorization for journals and articles published during 2009–2014 are presented in Graph 1.

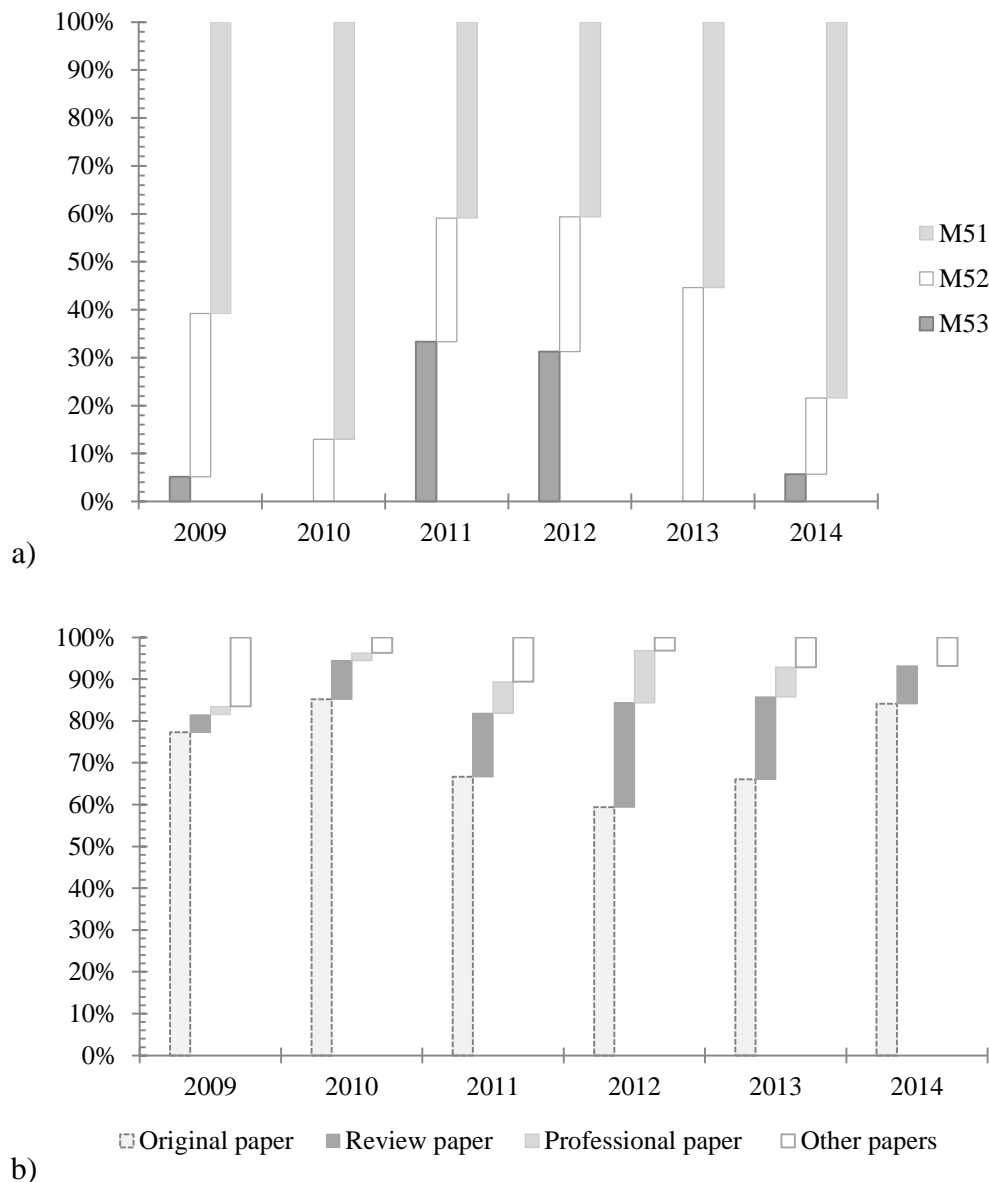

Graph 1. Percentage change in national categorization for scientific journals (a) and published articles (b) during the period 2009–2014

Furthermore, in the field of animal husbandry and animal breeding in general, there are some published articles whose UDC code consists only of 636 (Aleksic *et al.*, 2009; Nikiton, 2009; Petrovic *et al.*, 2013; Pusic *et al.*, 2011; Umetsu *et al.*, 2011). There are also papers in the field of animal husbandry and animal breeding in general which addressed different species of animals (Bojkovski *et al.*, 2011; Lilic *et al.*, 2009; Radulovic *et al.*, 2013).

In addition to scientific interest and nature of the research project, potential research teams should be formed in accordance with both the topical area under study and the approach taken. Scientific engagement both in the laboratory and in the field, and computer-related

activities should be specifically determined. In addition to experience in planning, conducting and reporting on research work, properly defined activities of potential team members can lead to the development of advanced skills in a particular field of science, especially when it comes to long-term agricultural experiments.

Conclusion

In the field of animal husbandry and breeding of animals in general, each livestock species has a role to play; however, based on the available national and analyzed articles in recent years, research interests are primarily focused on economically important animal species, especially large ruminants, followed by pigs, poultry and small ruminants. The obtained results, inter alia, indicate that differences in UDC classifications across study years are statistically significant, suggesting significant differences between scientific interest in animal husbandry and animal breeding in general in the period 2009–2014. Also, it should be emphasized that the highest number of published articles are found in leading journals of national significance, and that original scientific papers make up the largest portion of the contents of national scientific journals. Given that the focus of scientific interest can primarily be helpful for scientific workers in the earliest period of their creativity, attention in further analyses should be paid to some other parameters that indicate the value and / or impact of published articles.

References

- Aleksic S., Pantelic V., Radovic C. (2009). Livestock production - Present situation and future development directions in Republic of Serbia. *Biotechnology in Animal Husbandry* 25 (5-6), 267-276.
- Bojkovski J., Petrujkic T., Mirilovic M., Relic R., Stankovic B., Savic B. (2011). Citogenetičke metode kao deo planova biosigurnosti na farmama goveda i svinja (*en.* Cytogenetic methods as a part of biosecurity plans on cattle and pig farms). *Zbornik naučnih radova Instituta PKB Agroekonomik* 17 (3-4), 121-130.
- KOBSON (2001): Serbian library consortium for coordinated acquisition [online in Serbian]. http://kobson.nb.rs/nauka_u_srbiji/kategorizacija_casopisa_.33.html [10/04/16]
- Lilic S., Jankovic S., Matekalo-Sverak V., Turubatovic L., Okanovic D., Radicevic T., Stefanovic S. (2009). Mogućnost korišćenja jetre i bubrega goveda i svinja u ishrani ljudi (*en.* Possibility of use of bovine and pigs' liver and kidneys in human nutrition). *Tehnologija mesa* 50 (5-6), 358 - 365.
- Maletic R. (2005). *Statistika (en. Statistics)*. Faculty of Agriculture, Belgrade. pp. 171-273.
- MPNTR (2009a): Kategorizacija naučnih časopisa 2009.: National ID Scientific Committee for biotechnology and agro-industry [online in Serbian]. www.mpn.gov.rs/wp-content/uploads/2015/10/Kategorizacija-casopisa-2009.pdf [10/04/16]
- MPNTR (2009b): Act of editing scientific journals [online in Serbian]. http://kobson.nb.rs/upload/documents/MNTR/Dokumenti/akt_o_uredjivanju_casopisa.pdf [10/04/16]
- MPNTR (2010): Categorization of domestic scientific journals for biotechnology and agriculture for 2010. [online in Serbian]. <http://www.mpn.gov.rs/wp-content/uploads/2015/10/Kategorizacija-casopisa-2010.pdf> [10/04/16]
- MPNTR (2011): Categorization of domestic scientific journals for biotechnology and agriculture for 2011. [online in Serbian]. <http://www.mpn.gov.rs/wp-content/uploads/2015/10/Kategorizacija-casopisa-2011.pdf> [10/04/16]
- MPNTR (2012): Categorization of domestic scientific journals for biotechnology and agriculture for 2012. [online in Serbian]. <http://www.mpn.gov.rs/wp-content/uploads/2015/10/Kategorizacija-casopisa-2012.pdf> [10/04/16]

- MPNTR (2013): Categorization of domestic scientific journals for biotechnology and agriculture for 2013. [online in Serbian]. www.mpn.gov.rs/wp-content/uploads/2015/10/Kategorizacija_naucnih_casopisa_2013-1.pdf [10/04/16]
- MPNTR (2014): Proposal categorization of domestic scientific journals for biotechnology and agriculture for 2014. [online in Serbian]. http://www.mpn.gov.rs/wp-content/uploads/2015/10/Predlog__kategorizacije_nau%C4%8Dnih_%C4%8Dasopisa_2014-1.doc [10/04/16]
- Nikiton A. V. (2009). Some trends of livestock farming development in 2008: Overall results of the state program of agricultural development in Russia. *Biotechnology in Animal Husbandry* 25 (5-6), 597-604.
- Official Gazette of the RS (2016): Rules on the procedure, the method of valuation and quantification of scientific research results of researchers [online in Serbian]. www.mpn.gov.rs/wp-content/uploads/2016/03/PRAVILNIK-1.pdf [10/04/16]
- Petrovic M.M., Aleksic S., Petrovic M.P., Petrovic M., Pantelic V., Novakovic Z., Ruzic-Muslic D. (2013): Potentials of Serbian livestock production: Outlook and future. *Biotechnology in Animal Husbandry* 29 (1), 1-17.
- Pusic I., Prodanov-Radulovic J., Dosen R., Stojanov I., Stojanovic D., Petrovic T. (2011). Epizootical characteristics of Aujeszky's disease in Vojvodina region and biosecurity concerns. *Biotechnology in Animal Husbandry* 27 (3), 875-882.
- Radulovic S., Markovic R., Milic D., Jakic-Dimic D., Sefer D. (2013): Degree of mycotoxicological contamination of feed and complete feed mixtures for pigs and poultry during the period 2007-2012. on the territory of the Republic of Serbia. *Zbornik Matice srpske za prirodne nauke* 124, 153-169.
- Spasic Z., Milosevic B., Milenkovic M. (2006). Oplemenjivanje domaćih životinja-praktikum (*en.* Breeding of domestic animals - practicum). University of Pristina, Faculty of Agriculture in Lesak, Serbia. pp. 23-30.
- Spasic Z., Milosevic B. (2011): Pisanje i prezentacija naučnih radova (*en.* Writing and presentation of scientific articles). Faculty of Agriculture in Lesak, Serbia. pp. 6.
- Stankovic J, Lakic N, Ljubanovic-Ralevic I. (1990): Zbirka zadataka iz statistike (*en.* Collection tasks of statistics). Faculty of Agriculture, University of Belgrade, Serbia.
- UDC Summary (2009). Universal Decimal Classification Summary [online]. UK:UDC Consortium. Available at: www.udcsummary.info [10/04/16]
- Umetsu K., Ying C., Kikuchi S., Iwasaki M., Takeuchi Y., OI M., Shiroishi K., Uematsu T., Yasui S. (2011). Integration of centralized biogas plant in cold-snowy region in Japan. *Biotechnology in Animal Husbandry* 27 (3), 405-414.
- Veljovic P. (2001). Metode naučnog rada (*en.* Methods of scientific work). University of Kragujevac, Faculty of Agronomy in Cacak, Serbia. pp. 7.

EFFECT OF ENSILING MILK THISTLE (*SILYBUM MARIANUM* L. GAERTH) WITH MOLASSES OR UREA ON SILAGE QUALITY AND *IN VITRO* DIGESTIBILITY

Hatice BASMACIOĞLU MALAYOĞLU^{1*}, Pınar OZDEMİR², Hasan Hüseyin IPCAK¹, Bora UNLU¹, Amir Hasan TAGHILLOOFAR³, Emine BAYRAM³

¹ Ege University, Agriculture Faculty, Department of Animal Science, Bornova-İzmir, TURKEY

² International Center for Livestock Research and Training, Lalahan-Ankara, TURKEY

³ Ege University, Agriculture Faculty, Department of Crop Fields, Bornova-İzmir, TURKEY

*Corresponding author: hatice.basmacioglu@ege.edu.tr

Abstract

The aim of this study was to effects of the addition of 5% molasses or 0.5% urea into milk thistle on silage nutrient content, pH, lactic acid (LA), acetic acid (AA) and butyric acid (BA) concentrations and *in vitro* digestibility with Ankom Daisy II method.

The addition of urea to milk thistle silage significantly ($P<0.05$) increased crude protein (CP) and ether extract (EE) content, but decreased the organic matter (OM) content compared with control. While the addition of urea to milk thistle increased acetic acid concentration of silages, molasses addition to milk thistle decreased the butyric acid concentration compared to control ($P<0.05$). The lactic acid concentrations in milk thistle silages were not affected by treatments. The quality classes of milk thistle silage with or without additives were considered as "fair-quality". *In vitro* digestibilities of CP in milk thistle silages were increased by addition of additives, but NDF digestibility was decreased compared the control. The addition of molasses increased OM digestibility and energy value of silages compared with control ($P<0.05$).

In conclusion, urea addition to milk thistle at 0.5% level improved the CP and EE content and *in vitro* OM digestibility of the silages. The addition of 5% molasses to milk thistle silages improved the *in vitro* digestibility of OM and CP content and energy values of the silages.

Keywords: *Milk thistle, silage quality, in vitro digestibility, molasses, urea.*

Introduction

Annual forage requirement of Turkey is approximately 52 million tons based on existing number of animals. Existing pasture, range amount of forage produced can be accounted for 80% (Anonymous, 2016). It is also very important to improve feeding quality of these animals. This production was provided from 25% of the grassland area, 20% of the forage cultivation, 17% of the silage, 13% of the pasture, 25% with low feed as hay and stubble. Use of silage has a great importance for requirement the high quality forage our country (Anonymous, 2016).

Silybum marianum L. Gaerth, also known as milk thistle, is a medicinal plant containing hepatoprotectant flavonolignans. The flavonolignans in *Silybum* that exhibit these medicinal properties are collectively known as silymarin. Milk thistle (*Silybum marianum* L. Gaerth) has been used for over 2000 years as a remedy for various types of liver disease and it has hepatoprotective, anti-inflammatory, cytoprotective and anti-carcinogenic effects (Manna et al., 1999).

Due to its hepatoprotective effects, silymarin was tested as a natural treatment in ketotic cows (Vojtíšek et al., 1991), in lactating dairy cows exposed to dietary aflatoxin contamination and

in periparturient cows subjected to subclinical fatty liver (Tedesco *et al.*, 2003, 2004a,b), in broiler exposed to dietary aflatoxin B₁ contamination (Dumari *et al.*, 2014).

Basmacıoğlu-Malayoğlu *et al.* (2015) reported that milk thistle plant is possible to use as an alternative forage source in animal nutrition. But, the livestock can not directly consume the milk thistle because of their spines. Also, milk thistle is source of slowly fermentable fibre and contains high level fibrous fractions which using in ruminant feeding (Maccarana *et al.*, 2013). The most important problem in ruminant nutrition issue is the low digestibility of forages like milk thistle, which contain high amounts of fiber. To improve the digestibility, nitrogen, and easily digestible carbohydrates in milk thistle silages, molasses and urea additives are necessary, which are proved to have positive effects, as additives on roughage forages (Yokota *et al.*, 1992; Bolsen *et al.*, 1996).

The objective of the current study was to evaluate the effects of the addition of 5% molasses or 0.5% urea into milk thistle on silage nutrient contents, silage quality and *in vitro* digestibility.

Materials and Methods

Milk thistle (*Silybum marianum* L. Gaerth) was grown in the experimental site of Field Crops Department, Faculty of Agriculture, Ege University. In this trial, *Silybum marianum* L. Gaerth cv. Budakaszi (registered in Hungary) seeds obtained from Iranian Biological Resource Center were used. The experiment was set in randomized complete block design with four replications and started in 2015. Plot size was 2×3 m, inter and intra row spacing of the plants were 50 cm. Plants were harvested at the flowering stage. They were dried to approximately 40% dry matter. Silymarin content of the plants was 10.4%. The experimental treatments included: milk thistle silage with no additive (control), milk thistle silage treated with 5% molasses (control+5% molasses), milk thistle silage treated with 0.5% urea (control+0.5% urea). There were four replicates of each treatment. The milk thistle plants was ensiled in a 1 kg vacuumed nylon bag silos using a vacuum packaging machine and incubated for 60 days.

The silages were opened at the end of 60 d. The pH levels were measured immediately by a digital pH meter (HANNA HI 2211-02). The volatile fatty acids (LA, AA and BA) were determined by the Lepper method (Alçiçek and Özkan, 1996). Fleig point was calculated as described by (Kılıç, 1986).

Fleig point = $220 + (2 \times \% \text{Dry Matter} - 15) - 40 \times \text{pH}$

In the silage samples prepared, dry matter (DM), organic matter (OM), crude protein (CP), ether extract (EE) and crude ash analyses were made according to Weende analyses method (Menke and Huss, 1975; DLG, 1997), acid detergent fiber (ADF) and neutral detergent fiber (NDF) analyses according to Van Soest (Goering and Van Soest, 1970). Chemical analyses were performed in duplicate.

The *in vitro* digestibility measurements were made using Ankom Daisy II method according to Damiran *et al.* (2008). *In vitro* fermentation was carried out for 48 h using the Daisy II incubator. Each incubator housed four 2-L digestion vessels. The inoculum was obtained from three rumen-cannulated lactating dairy cows that were fed 60% roughage 40% concentrated feed. Rumen fluid was collected 2 h after feed delivery into a pre-warmed thermos and strained through four layers of cheesecloth into a preheated flask. All samples were tested in triplicate. Two solutions were mixed in a 5:1 ratio, and 1.800 mL of the mixed buffer solution was added to each vessel. Vessels were placed in the incubator which was equilibrate to 39°C. The samples were weighed into the bags (triplicate per treatment) at a mass of 0.5±0.01 g per bag, sealed by an impulse bag sealer. After the incubation the filter bags were gently rinsed with cold tap water until the water ran clear and then placed in a 105°C forced-air oven to dry for 2-4 h. Feed samples were also analyzed for *in vitro* dry matter digestibility (DMD),

organic matter digestibility (OMD), crude protein digestibility (CPD), neutral detergent fiber digestibility (NDFD) and acid detergent fiber digestibility (ADFD) while metabolizable energy (ME) was determined, using the OMD (NRC, 1981).

$$\% \text{ In vitro digestibility} = 100 - \frac{(\text{Final bag weight} - (\text{Bag tare weight} \times \text{Blank bag weight})) \times 100}{\text{Sample weight}}$$

$$\text{Digestible energy (DE, Mcal/kg)} = \text{TDN} \times 0.04409$$

$$\text{ME (Mcal/kg)} = \text{DE} \times 0.82$$

$$\text{Net energy lactation (NEL, Mcal/kg)} = 0.0245 \times \text{TDN} - 0.12$$

The statistical analysis of the results included one-way analysis of variance and Duncan's multiple range test, which were applied to the results using the SPSS (IBM SPSS Statistics 20.0). Probabilities of $P < 0.05$ were considered statistically significant.

Results and Discussion

Data on the nutrient content, pH, volatile fatty acids and quality classify values, *in vitro* digestibility and energy value of the milk thistle silages are presented in Table 1, Table 2 and Table 3, respectively.

Table 1. Nutrient content of milk thistle silages with or without additives (DM%)

Nutrient content*	Control	Control+5% Molasses	Control+0.5% Urea	SEM	P-values
DM	35.18	36.16	34.32	0.56	0.082
OM	79.50 ^a	79.99 ^a	77.77 ^b	0.42	0.002
CP	8.71 ^b	8.76 ^b	9.29 ^a	0.16	0.028
EE	5.07 ^b	4.71 ^b	5.98 ^a	0.22	0.001
Crude ash	15.97	15.85	16.41	0.35	0.507
NDF	50.84	50.07	50.65	0.78	0.771
ADF	43.84	41.84	43.43	0.84	0.229

*DM: dry matter; OM: Organic matter; CP: crude protein; EE: ether extract; CA: crude ash; NDF: neutral detergent fiber; ADF: acid detergent fiber

^{a,b} Means in the same row not sharing a common superscript differ significantly ($P < 0.05$)

Table 2. pH, volatile fatty acids values and quality classify of milk thistle silages with or without additives

Parameters	Control	Control+5% Molasses	Control+0.5% Urea	SEM	P-values
pH	5.51	5.68	5.70	0.10	0.396
Lactic acid, %	2.57	2.26	2.19	0.12	0.126
Acetic acid, %	2.27 ^b	2.38 ^b	2.77 ^a	0.09	0.014
Butyric acid, %	1.45 ^a	1.10 ^b	1.61 ^a	0.06	0.002
Flieg point	55.02	50.12	45.77	4.73	0.420
Quality classify*	Fair	Fair	Fair	-	-

^{a,b,c} Means in the same row not sharing a common superscript differ significantly ($P < 0.05$)

*Excellent (81-100 point), Good (61-80), Fair (41-60 point), Medium (21-40 point), Bad (0-20 point)

Table 3. *In vitro* digestibility (%) and energy values (Mcal/kg) of milk thistle silages with or without additives

Digestibility*	Control	Control+5% Molasses	Control+0.5% Urea	SEM	P-values
DMD	38.34	40.82	39.53	0.63	0.061
OMD	30.31 ^b	33.89 ^a	30.19 ^b	0.72	0.008
CPD	39.90 ^b	46.54 ^a	47.56 ^a	0.96	0.001
NDFD	31.95 ^a	27.71 ^b	27.00 ^b	1.14	0.027
ADFD	27.78	27.02	29.71	1.48	0.449
DE	1.27 ^b	1.42 ^a	1.27 ^b	0.03	0.008
ME	1.04 ^b	1.17 ^a	1.04 ^b	0.03	0.008
NEL	0.59 ^b	0.67 ^a	0.58 ^b	0.02	0.008

* DMD: Dry matter digestibility; OMD: Organic matter digestibility; CPD: Crude protein digestibility; NDFD: Neutral detergent fiber digestibility; ADFD: Acid detergent fiber digestibility; DE: Digestible energy; ME: metabolizable energy; NEL: Net energy lactation

^{a,b} Means in the same row not sharing a common superscript differ significantly ($P<0.05$)

After 60 days of ensiling, the DM content of the silages was within the range 34.32%-36.16%. There were no significant differences between treatments regarding DM, crude ash, NDF and ADF levels (Table 1; $P>0.05$). The OM content of silages significantly decreased (-2.2%; $P<0.05$) with the addition of urea compared the control. The addition of urea significantly increased ($P<0.05$) the CP (9.29%) and EE (5.98%) contents of milk thistle silages compared with control (8.71% and 5.07%, respectively). This finding is in agreement with the findings of other researchers who reported that adding urea increases the amount of crude protein (Güney *et al.*, 2007). Similarly, Konca *et al.* (2003) and Yokota *et al.* (1992) who reported that molasses addition to sunflower silage and wilted napier grass did not change silage DM, NDF and ADF compared the control.

The changes in pH of milk thistle silage due to additives are shown in Table 2. In this research, the pH of milk thistle silage was not affected by treatments ($P>0.05$). The pH value of 5.51-5.70 obtained in this study was in agreement with 4.5-5.5 reported by Meneses *et al.* (2007) but higher than 4.2-5.0 reported by Babayemi (2009). Similar finding was observed that urea addition to silages made of citrus peels and peanut shells and molasses addition to Italian ryegrass did not change silage pH (Hadjipanayiotou, 1988; Islam *et al.*, 2001). Other researchers reported that adding urea and molasses or urea to the sorghum silage does increase the pH (Demirel *et al.*, 2004). According to Weinberg and Muck (1996), if forage with too high moisture content is ensiled, Clostridia fermenting lactic acid to butyric acid and amino acids to ammonia might become active, resulting in an increase in pH value and a large loss of silage dry matter.

The lactic acid contents of the silage were not affected by silage additives compared to the control (Table 2; $P>0.05$). While the acetic acid content in milk thistle silage increased ($P<0.05$) with urea addition, but the butyric acid content in milk thistle silage decreased with molasses addition. The increases in acetic acid content may be attributed to a decrease in yeasts and molds, which have the ability to assimilate organic acids. Although there are no studies in literature with milk thistle silage, in another study Singh *et al.* (1996) reported that the addition of urea to sorghum silage increases the concentration of acetic acid. In contrast to our result, Bureenok *et al.* (2012) reported that lactic acid content is very high in the Napier

grass silage with additional molasses. The evaluation results showed that silages with or without additives were 'fair-quality'. Milk thistle has needle sharp spines on all parts of the plant. Therefore chopping and pressing should be done very well in the silage making process.

The OMD of the milk thistle silage treated with molasses (33.89% vs 30.31%) was higher than that of control (Table 3; $P<0.05$). There were no significant differences between the control and control+0.5% urea with respect to OMD ($P>0.05$). Also, the addition of molasses or urea to milk thistle silage significantly increased ($P<0.05$) the CPD compared the control. On the other hand, NDFD of the silage with additives were lower than control ($P<0.05$). The additives did not affect the DM and ADF digestibility of the silages (Table 3). The energy value of DE, ME and NEL value (1.42 Mcal/kg, 1.17 Mcal/kg and 0.67 Mcal/kg, respectively) the milk thistle silage treated with molasses was higher than that of control (1.27 Mcal/kg, 1.05 Mcal/kg and 0.59 Mcal/kg, respectively) ($P<0.05$). Similarly to this study, use of urea as silage additive to sorghum silage did not accelerate OMD of the silages (Güney *et al.*, 2007). In another study (Bureenok *et al.*, 2012), the *in vivo* OM, CP and NDF digestibility of the Napier grass (*Pennisetum purpureum*) silage treated with molasses was higher than the silage without additives. Arbabi and Ghoorchi (2008) reported that addition the molasses to foxtail millet silage increases the ME, compared to the control group, which is the same in this research.

Conclusions

In conclusion, milk thistle silage with or without additives are fair-quality. The addition of urea to milk thistle improved the CP and EE content and CPD of the silages. The addition of molasses improved the *in vitro* digestibility of OM and CP and energy values of the silages. The addition of molasses or urea to milk thistle could be evaluated with regard to nutrient digestibility.

References

- Alçiçek A., Özkan K. (1996). Silo yemlerinde destilasyon yöntemi ile süt asidi, asetik asit, bütirik asit tayini. Ege Üniversitesi Ziraat Fakültesi Dergisi 33(2-3): 191-198.
- Anonymous (2016). <http://www.tzob.org.tr/Basin-Odasi/Haberler/ArticleID/1320/ArtMID/470>. Date of access: 05.05.2016.
- Arbabi S., Ghoorchi T. (2008). The effect of different levels of molasses as additives on fermentation quality of Foxtail millet (*Setaria italica*) Silage. Journal of Animal Science, 2(2): 43-50.
- Babayemi O.J. (2009). Silage quality, dry matter intake and digestibility by African dwarf Sheep of Guinea grass (*Panicum maximum* cv ntchisi) harvested at 4 and 12 week regrowths. African Journal of Biotechnology, 8: 3988-3989.
- Basmacıoğlu-Malayoğlu H., İpcak H.H., Ajalli S., Taghiloofar A.H. (2015). Nutrient and metabolic energy content of different originated milk thistle grown under Izmir conditions. 7th Balkan Conference on animal science. Balnimalcon, Sarajevo, June 3–6, 2015, pp:147.
- Bolsen K.K., Ashbell G., Weinberg Z.G. (1996). Silage fermentation and silage additives. Asian Australasian Journal of Animal Sciences, 9: 483-493.
- Bureenok S., Yuangklang C., Vasupen K., Schonewille J.T., Kawamoto Y. (2012). The effects of additives in napier grass silages on chemical composition, feed intake, nutrient digestibility and rumen fermentation. Asian Australasian Journal of Animal Sciences, 25(9): 1248-1254.

- Damiran D., DelCurto T., Bohnert D.W., Findholt S.L. (2008). Comparison of techniques and grinding size to estimate digestibility of forage based ruminant diets. *Animal Feed Science and Technology*, 141(1-2): 15-35.
- Demirel M., Deniz S., Yılmaz İ., Nursoy H. (2004). Hamur olum döneminde biçilen kimi sorgum çeşitlerine üre ya da üre ve melas katkısının silaj kalitesi ile sindirilebilir kuru madde verimine etkisi. *Turkish Journal of Veterinary and Animal Sciences*, 28(1): 29-37.
- DLG (1997): Futterwerttabellen Wiederkäuer: 7. erweiterte und überarbeitete Auflage. Frankfurt am Main: DLG-Verlag, 212p, ISBN 3-7690-0547-3.
- Dumari M.A., Sarir H., Makki O.F., Afzali N. (2014). Effect of milk thistle (*Silybum marianum* L.) on biochemical parameters and immunity of broiler chicks fed aflatoxin B₁ after three weeks. *Iranian Journal of Toxicology*, 8(26): 1098-1103.
- Goering H.K., Van Soest P.J. (1970). Forage Fiber Analysis (apparatus, reagents, procedures and some applications). USDA Agricultural Handbook No. 379.
- Güney M., Demirel M., Celik S., Bakıcı Y., Levendoğlu T. (2007). Effects of urea, molasses and urea plus molasses supplementation to sorghum silage on the silage quality, in vitro organic matter digestibility and metabolic energy contents. *Journal of Biological Sciences* 7(2): 401 -404.
- Hadjipanayiotou M. (1988). The feeding value of peanut hay and silage made from peanut shells and citrus pulp with the addition of urea. *Miscellaneous reports 33, Nicosia-Cyprus*, ISSN 0253-6749.
- Islam M., Enishi O., Purnomoadi A., Higuchi K., Takusari N., Terada F. (2001). Energy and protein utilization by goats fed Italian ryegrass silage treated with molasses, urea, cellulase or cellulase+lactic acid bacteria. *Small Ruminant Research*, 42(1): 49-60.
- Kılıç A. (1986). Silo Feed (Instruction, Education and Application Proposals). Bilgehan press, Izmir, pp: 327
- Konca Y., Büyükkılıç-Beyzi S., Kaliber M., Ülger I. (2015). Chemical and nutritional changes in sunflower silage associated with molasses, lactic acid bacteria and enzyme supplementation. *Harran Tarım ve Gıda Bilimleri Dergisi*, 19 (4): 223-231.
- Maccarana L., Cattani M., Bailoni L. (2013). Rumen in vitro gas production of combinations between slowly and rapidly fermentable fibre sources. *Agriculturae Conspectus Scientificus*, 78 (3): 229-233.
- Manna S.K., Mukhopadhyay A., Van N.T., Aggarwal B.B. (1999). Silymarin suppresses TNF-induced activation of NFkappa B, c-jun N-Terminala kinase and apoptosis. *Journal of Immunology*, 163(12):6800-6809.
- Meneses M., Megías M.D., Madrid J., Martínez-Teruel A., Hernández F., Oliva J. (2007). Evaluation of the phytosanitary, fermentative and nutritive characteristics of the silage made from crude artichoke (*Cynara scolymus* L.) by-product feeding for ruminants. *Small Ruminant Research*. 70: 292-296.
- Menke K.H., Huss W. (1975). *Tierernährung und Futtermittelkunde*. Verlag Eugen Ulmer, Stuttgart, pp:74-79.
- Singh A., Edward J.C., Mor S., Singh K. (1996). Effect of inoculation of lactic acid bacteria and additives on ensiling MP chari (*Sorghum bicolor*), *Indian Journal of Animal Research*, 66: 1159-1165.
- Tedesco D., Tameni M., Steidler S., Galletti S., Di Pierro F. (2003). Effect of silymarin and its phospholipid complex against AFM₁ excretion in an organic dairy herd. *Milchwissenschaft*, 58: 416-419.
- Tedesco D., Domeneghini C., Sciannimanico D., Tameni M., Steidler S., Galletti S. (2004a): Silymarin, a possible hepatoprotector in dairy cows: biochemical and histological observations. *Journal of Veterinary Medicine A-Physiology, Pathology, Clinical Medicine*, 51: 85-89.

- Tedesco D., Tava A., Galletti S., Tameni M., Varisco G., Costa A., Steidler S. (2004b): Effects of silymarin, a natural hepatoprotector, in periparturient dairy cows. *Journal of Dairy Science*, 87: 2239-2247.
- Weinberg Z.G., Muck R.E. (1996). New trends and opportunities in the development and use of inoculants for silage. *FEMS. Microbiology Reviews*, 19: 53-68.
- Vojtíšek B., Hronová B., Hamřík J., Janková B. (1991): Milk thistle (*Silybum marianum*, L., GAERTN.) in feed rations administered to ketotic cows. *Veterinární Medicina*, 36: 321-330.
- Yokota H., Kim J.H., Okajima T., Ohshima M. (1992). Nutritional quality of wilted napiergrass (*Pennisetum purpureum* Schum.) ensiled with or without molasses. *Asian Australasian Journal of Animal Sciences*, 5: 673-679.

MOLECULAR DETECTION OF PROTOZOAN PATHOGENS IN COMMERCIAL BUMBLEBEE (*B. terrestris* L.)

Bahar ARGUN KARSLI*, Fehmi GÜREL

Faculty of Agriculture, Department of Animal Science, Akdeniz University, Antalya, Turkey

*Corresponding author: bhrargun@akdeniz.edu.tr

Abstract

Bumblebees are important pollinators of greenhouse and field crops. They are therefore reared commercially on a large scale. *Bombus terrestris* is the most reared bumble bee species for commercial pollination since 1987 and has been used outside its natural distribution area. Commercially produced *B. terrestris* colonies often have higher levels of pathogens than wild bumble bee populations. These pathogens can spread to wild bees and may lead to decline in wild bee species. The most commonly reported bumblebee protozoan pathogens are the microsporidium *Nosema bombi*, *Crithidia bombi* and *Apicystis bombi*. These parasites have also detrimental effects on colonization, survival and reproduction of *B. terrestris* queens. Therefore, the correct identification of *B. terrestris* parasites is very important. Nowadays, in order to identify infected bumblebees, various molecular methods have been developed to provide highly sensitive, reliable and fast results. In this study, a total of 130 *B. terrestris* queens who died in the colony initiation period after diapauses were obtained from the commercial company. DNA was extracted from bumblebee gut tissues using a modified Chelex 100 method. ITSf2/r2, Nbombi-SSU-Jf1/Jr1 and SSU-rRNA-Ff1/Rr1b primer pairs for *N. bombi*, SEF/SER, CB-ITS1-F / CB-ITS1-R primer pairs for *C. bombi* and NeoF/NeoR, ApBF1/ ApUR2 primer pairs for *A. bombi* were tested by PCR amplification, but these parasites were not detected in the examined samples. In conclusion, more samples should be investigated to detect infected bumblebees with *N. bombi*, *C. bombi* and *A. bombi*.

Keywords: *Bumblebee*, *PCR*, *Nosema bombi*, *Crithidia bombi*, *Apicystis bombi*

Introduction

Bumblebees are among the most important natural pollinators in northern temperate and may provide superior pollination services than the honeybees for many plant species. There are about 250 species of bumble-bees (Williams, 1998). Currently five species of bumble-bees (*Bombus terrestris*, *Bombus lucorum*, *Bombus occidentalis*, *Bombus ignitus* and *Bombus impatiens*) are reared commercially on a large scale mainly for greenhouse pollination in many countries (Velthuis and van Doorn, 2006). The main commercially reared species is the Eurasian *Bombus terrestris* L. Commercial rearing of bumble bee colonies for pollination services first started in the 1980s. Today, it is estimated that the current worldwide sales of commercially produced bumble bee colonies has reached over one million colonies per year and has been used as pollinator of many crops mainly in tomatoes (Banda & Paxton, 1991; Velthuis and van Doorn, 2006).

Bumblebees are also important natural pollinators for a wide range of wild plants. On the other hand in recent years, the natural abundance and diversity of bumblebee species is in decline all over the world (Goulson, 2003). This decline may lead to severe effects on natural populations of flowering plants and agricultural production (Memmott *et al.*, 2004). There are many factors regarding the causes of bumblebees decline such as climate change, habitat fragmentation with diminished floral resources and pathogens. The most important of these factors is considered as pathogens (van Engelsdorp *et al.*, 2009; Cameron *et al.*, 2011).

Pathogens play a role in the decline of bumblebee species and can also affect the ecology and distribution of bumblebees (Schmid-Hempel, 2001; Cameron *et al.*, 2011). Pathogens have also caused economic losses in commercially managed bumble bees populations. Commercially reared bumblebee colonies can function as parasite reservoirs, which can lead to the spillover of pathogens to wild bee species. They are able to interact with wild pollinators, since commercially reared bees often escape from greenhouse to wild. A recent report by the National Academy Sciences stated that, a possible cause of bumble bee declines is pathogen spillover from commercially reared bumblebee colonies. Therefore, pathogens loads of commercially reared bee colonies could be important for wild bee species.

Many methods have been developed for the diagnosis of microsporidia in hosts, including immunofluorescent staining, electron microscopy, and antigenic or biochemical analysis (Weber *et. al.*, 1999). Molecular techniques, particularly involving the PCR and the based on the amplification of rRNA and rDNA gene fragments, seem to be superior because of their high specificity and sensitivity (Weiss and Vossbrinck, 1993) as well as their ability to detect all microsporidian developmental stages. Here, we used a rapid, specific and sensitive method for the detection of *N.bombi*, *C.bombi* and *A. bombi* in commercial reared *B. terrestris* by PCR amplification.

Bumble-bee parasites and diseases

Natural and commercially bumblebee colonies are exposed to many pathogenic internal and external parasites. The most commonly reported bumblebee protozoan pathogens are the microsporidium *Nosema bombi*, *Crithidia bombi* and *Apicystis*. Generally, these parasites have detrimental effects on colonization, survival and reproduction. Therefore, the accurately identification and control of bumble bee diseases and parasites are very important.

Nosema bombi Fantham and Porter 1914 is obligate, intracellular and spore forming microsporidian parasite that infects the Malpighian tubules, the ventriculus, the fat tissue and and even nerve tissues, including the brain of bumble-bees (Larsson, 2007). The effects are generally chronic, including reduction in individual reproductive rate (Otti and Schmid-Hempel, 2007, 2008), life span, and colony growth (Rutrecht and Brown, 2009).

Crithidia bombi is extracellular trypanosomatid parasites and it is a widespread parasite of bumble-bees. This parasite targets the gut and results in large numbers of parasite cells lining the wall of the midgut lumen and rectum from where cells are shed for further transmission (Schmid-Hempel, 1998). Replication of *C. bombi* in the host is rapid but the effects on individuals are usually complicated, such as decrease pollen loads carried in foraging trips, variation in foraging behavior and increase ovaries development in workers (Otterstatter and Thomson, 2006). Furthermore, on the colony level, *C. bombi* leads to decrease colony growth rate and colony fitness (Brown *et. al.*, 2003).

Apicystis bombi, first discovered in Italy in 1988, is a neogregarine parasite and has now been recorded in nearly 20 bombus species (Lipa and Triggiani, 1992; 1996) and commercially produced bumble-bee colonies (Murray *et. al.*, 2013). The fat body of infected bumble-bees is destroyed due to the proliferation of the pathogen, and its presence correlates with high mortality in infected spring queens, preventing them from establishing colonies (Rutrecht and Brown, 2008). Therefore, the potential spread of the neogregarine *A. bombi* should be carefully monitored.

Materials and Methods

Samples

We were collected 130 bumblebee queens from commercially produced *Bombus terrestris* colonies in different nests in order to investigate the occurrence of pathogenic diseases in august 2014. Samples of queen who died in the colony initiation period after diapauses were

obtained from the commercial company. All samples were stored in 95% ethanol at -20 °C until DNA extraction.

DNA extraction

Genomic DNA of bumblebee was extracted from infected intestinal tissues using a modified Chelex 100 method (Walsh *et. al.*, 1991). All intestinal tissues of bumble-bee were put into large centrifuge tube. First, 800 µl 10% Chelex resin solution was added and completely crushed with sterile plastic types. Second, 10 µl Proteinase K (20 mg/ml) was added in each tube and vortexed. The sample was incubated at 56 °C for 4 h, followed by 95 °C for 15 min to denature enzymes. Samples were centrifuged (2 min, 12.000 g) and the supernatant was stored at -20 °C until needed as DNA template in PCRs.

Primers

rRNA primers of *Nosema bombi* were designed on conserved rRNA regions of microsporidian species. *Crithidia* and *Apicystis* primers were designed from the 18S rDNA sequences. An internal amplification control was designed; different 18S rDNA sequences Apidae species. (Table 1).

Table 1. List of oligonucleotide primer used in PCR

Primer's name	Sequence (5' → 3')	T _a °C	Fragmen t size (bp)	References
Nbombi-SSU- Jf1-F Nbombi-SSU- Jr1-R	CCATGCATGTTTTGAAGATTATTAT CATATATTTTTAAAATATGAAACAA TAA	50	323	Klee <i>et.al.</i> ,2006
ITSf2-F ITSr2-R	GATATAAGTCGTAACATGGTTGCT CATCGTTATGGTATCCTATTGATC	48	118-122	Tay <i>et.al.</i> ,2005
SSU-rRNA-Ff1 SSU-rRNA- Rr1b	CACCAGGTTGATTCTTCTGCCT TGTTTCGTCAGTCAGGGTCA	64	545	Tay <i>et.al.</i> ,2005
Apidae-F Apidae-R	AGATGGGGGCATTCGTATTG ATCTGATCGCCTTCGAACCT	57	130	Meeus <i>et.al.</i> ,2009
SEF SER	CTTTGGTCGGTGGAGTGAT GGACGTAATCGGCACAGTTT	60	420	Meeus <i>et.al.</i> ,2009
CB-ITS1-F CB-ITS1-R	GGAAACCACGGAATCACATAGACC GGAAGCCAAGTCATCCATCGC	55	276	Schmid Hempel and Tognazzo, 2010
NeoF NeoR	CCAGCATGGAATAACATGTAAGG GACAGCTTCCAATCTCTAGTCG	57	260	Meeus <i>et.al.</i> 2009
ApBF1 ApUR2	CGTACTGCCCTGAATACTCCAG TTTCTCATTCTTCAGATGATTTGG	60	850	Meeus <i>et.al.</i> 2009

Polymerase Chain Reaction (PCR)

PCR reactions were performed using a TC3000 (Techne) in 50 µl volume containing 5.0 µl of template DNA, 4 µl of 10x PCR buffer, 4 µl of MgCl₂, 2 µl of dNTPs, 0.2 µl of Taq polymerase and 0.25 µl of each forward and reverse primer, plus 34.3 µl of water. PCR parameters for amplification were as follows: initial DNA template denaturation at 95 °C for 4 min, 40 cycles of denaturation at 95 °C for 1 min, primer annealing at the primer specific temperature (Table 1) for 1 min and primer extension at 72 °C for 1 min, followed by a final extension at 72 °C for 5 min. Then 10 µl of the PCR products were resolved on % 1.5 agarose gels (1x TBE) and visualized by ethidium bromide staining. For each PCR experiment,

negative (water) and positive (previously identified positive sample) controls were run along with treatments.

Results and Discussion

We collected and analysed a total of 130 commercial *B. terrestris* queens in order to detect of microsporidia. Currently, many different primer pairs are available for the detection of *N. bombi*, *C. bombi* and *A. bombi* in host gut tissues. We tested seven different primer pairs (Table 1) but it did not happen in any amplification. The amplification occurred only in the positive controls and Apidae primers. This result was mainly due to the small number of samples used in this study. Indeed, the number of samples used in previous studies was greater than 130. For example, Cordes *et al* (2012) analyzed 9909, Li *et al* (2012) 1009 and Blaker *et al* (2014) 1036 bumblebee samples. Therefore, it can be concluded that more samples should be used to analyses.

Tay *et al* (2005) characterized the entire rRNA gene of a *N. bombi* from 11 isolates in 8 different European *Bombus* species using 9 primer pairs including ITSf2- ITSr2 and SSU rRNA Ff1-Rr1b. Li *et al* (2012) screened a large sample of workers of 27 different *Bombus* spp. using SSU rRNA Ff1-Rr1b primer pairs in China and found that 13 different *Bombus* spp., approximately half of the examined species, carried microsporidia. In North America, nearly 10,000 samples of 36 bumblebee species were collected and evaluated for the presence and prevalence of two *Bombus* pathogens, the *N. bombi* and *Crithidia* (Cordes *et al.*, 2012). In this study, widely used primer sequences were tested.

PCR, qPCR and multiplex PCR based methods were developed for the specific and sensitive diagnosis of the microsporidian parasites in bumble bees. Klee *et al* (2006) conducted the first study of the specific and sensitive molecular diagnosis of *N. bombi* in bumble bees. To detect *N. bombi*, they used primer pair Nbombi-SSU-Jf1/Jr1, which amplifies partial SSU rRNA of the *N. bombi* genome. This primer pair seems to be specific for *N. bombi*. Primer pair ITS-f2/r2 was extremely sensitive (as few as 10 spores per 100 µl homogenate) in the detection of *N. bombi* spores. This work is similar to the first comparative quantitative real-time PCR study of nine *Nosema* spp. primers within the framework of primer specificity and sensitivity (Erler *et al.*, 2012). Another study was performed by multiplex PCR method. Meeus *et al* (2009) were reported the development of a multiplex PCR using two broad-range primer pairs for PCR- based protozoa detection including a universal Apidae control. In this study, SEF-SER, NeoF- NeoR and ApBF1- ApUR2 primer pairs were used for detection *C. bombi* and *A. bombi*, respectively.

Conclusion

In conclusion, PCR- based molecular methods and primers should be continuously developed and tested. Also, the screening of parasite in natural and commercial reared bumblebees should be done regularly.

Acknowledgment

We thank Elizabeth A. Blaker of the Department of Biology at the University of Northern Arizona for sending positive *N. bombi* controls (*N. bombi* DNA samples).

References

Banda H.J., Paxton R.J. (1991). Pollination of greenhouse tomatoes by bees. *Acta Hort.*, 288, 194-198.

- Blaker E.A., Strange, J.P., James R.R., Monroy F.P., Cobb N.S. (2014). PCR reveals high prevalence of non/low sporulating *Nosema bombi* (microsporidia) infections in bumble bees (*Bombus*) in Northern Arizona. *Journal of Invertebrate Pathology*, 123, 25-33.
- Brown M.J.F., Schmid-Hempel R., Schmid-Hempel P. (2003). Strong context-dependent virulence in a host parasite system: reconciling genetic evidence with theory. *J. Anim. Ecol.*, 72, 994-1002.
- Cameron S.A., Lozier J.D., Strange J.P., Koch J.B., Cordes N., Solter L.F., Griswold T.L. (2011). Patterns of widespread decline in North American bumble bees. In: *Proceedings of the national academy of sciences of the United States of America*.
- Cordes N., Huang W.F., Strange J.P., Cameron S.A., Griswold T.L., Lozier J.F., Solter L.F. (2012). Interspecific geographic distribution and variation of the pathogens *Nosema bombi* and *Crithidia* species in United States bumblebee populations. *Journal of Invertebrate Pathology*, 109, 209-216.
- Erler S., Lommatzsch S., Lattorf G.M.H. (2012). Comparative analysis of detection limits and specificity of molecular diagnostic markers for three pathogens (Microsporidia, *Nosema spp.*) in the key pollinators *Apis mellifera* and *Bombus terrestris*. *Parasitol Res*, 110, 1403-1410.
- Fantham H.B., Porter, A., 1914. The morphology, biology and economic importance of *Nosema bombi*, parasitic in various bumble bees (*Bombus spp.*). *Ann. Trop. Med. Parasitol.* 8, 623-638.
- Goulson D. (2003). The effects of introduced bees on native ecosystems. *Annu. Rev. Ecol. Syst.*, 34, 1-26.
- Klee J., Tay W.T., Paxton R.J. (2006). Specific and sensitive detection of *Nosema bombi* (Microsporidia: Nosematidae) in bumble bees (*Bombus spp.*; Hymenoptera: Apidae) by PCR of partial Rrna gene sequences. *J. Invertebr. Pathol.*, 91(2), 98-104.
- Larsson J.I.R. (2007). Cytological variation and pathogenicity of the bumble bee parasite *Nosema bombi* (Microspora, Nosematidae). *Journal of Invertebrate Pathology*, 94, 1-11.
- Li J.L., Chen W., Wu J., Peng W., An J., Schmid-Hempel P., Schmid-Hempel R. (2012). Diversity of *Nosema* associated with bumblebees (*Bombus spp.*) from China. *Int. J. Parasitol.*, 42, 49-61.
- Lipa J.J., Triggiani O. (1992). A newly recorded Neogregarine (Protozoa, Apicomplexa), parasite in honey bees (*Apis mellifera*) and bumblebees (*Bombus spp.*). *Apidologie*, 23(6), 533-536.
- Lipa J.J., Triggiani O. (1996). *Apicystis* gen nov and *Apicystis bombi* (Liu, Macfarlane & Pengelly) comb nov (Protozoa: Neogregarinida), a cosmopolitan parasite of *Bombus* and *Apis* (Hymenoptera: Apidae). *Apidologie*, 27(1), 29-34.
- Liu H.J., Macfarlane R.P., Pengelly D.H. (1974). *Mattesia bombi* n. sp. (Neogregarinida: Ophrocystidae); a parasite of *Bombus* (Hymenoptera: Apidae). *J. Inv. Parthol.*, 23, 225-231.
- Meeus I., de Graaf D.C., Jans K., Smaghe G. (2009). Multiplex PCR detection of slowly-evolving trypanosomatids and neogregarines in bumblebees using broad-range primers. *J. Appl. Microbiol.*, 109, 107-115.
- Memmott J., Waser N. M., Price M.V. (2004). Tolerance of pollination networks to species extinctions. *Proceedings of the Royal Society London Series B*, 271, 2605-2611.
- Murray T.E., Coffey M.F., Kehoe E., Horgan F.G. (2013). Pathogen prevalence in commercially reared bumble bees and evidence of spillover in conspecific populations. *Biol. Conserv.*, 159, 269-276.
- Otterstatter M. C. & Thomson J. D. (2006). Within-host dynamics of an intestinal pathogen of bumble bees. *Parasitology*, 133, 749-761.

- Otti O., Schmid-Hempel P. (2007). *Nosema bombi*: a pollinator parasite with detrimental fitness effects. *Journal of Invertebrate Pathology*, 96, 118-124 .
- Otti O., Schmid-Hempel P. (2008). A field experiment on the effect of *Nosema bombi* in colonies of the bumblebee *Bombus terrestris*. *Ecological Entomology*, 33, 577-582.
- Rutrecht S.T. and Brown M.J.F. (2008). Within colony dynamics of *Nosema bombi* infections: disease establishment, epidemiology and potential vertical transmission. *Apidologie*, 39, 504-514.
- Rutrecht S.T., Brown M.J.F. (2009). Differential virulence in a multiple-host parasite of bumble bees: resolving the paradox of parasite survival? *Oikos*, 118, 941-949.
- Schmid-Hempel P. (1998). *Parasites in social insects*. Princeton University Press, Princeton N.J.
- Schmid -Hempel R., Tognazzo M. (2010). Molecular divergence defines two distinct lineages of *Crithidia bombi* (Trypanosomatidae), parasites of bumblebees. *J. Eukaryot Microbiol.*, 57, 337-345.
- Tay W.T., O'Mahony E.M. and Paxton R.J. (2005). Complete rRNA gene sequences reveal that the microsporidium *Nosema bombi* infects diverse bumblebee (*Bombus spp.*) hosts and contains multiple polymorphic sites. *Journal of Eukaryotic Microbiology*, 52, 505-513.
- Van Engelsdorp D., Evans J.D., Saegerman C., Mullin C., Haubruge E., Nguyen B.K., Frazier M., Frazier J., Cox-Foster D., Chen Y., Underwood R., Tarpay D.R., Pettis J.S. (2009). Colony collapse disorder: a descriptive study. *PLoS ONE*, 4(8), e6481
- Velthuis H.H.W., Doorn A. (2006). A century of advances in bumblebee domestication and the economic and environmental aspects of its commercialization for pollination. *Apidologie*, 37, 421-451.
- Walsh P.S., Metzger D.A., Higuchi R. (1991). Chelex 100 as a medium for simple extraction of DNA for PCR-based typing from forensic material. *BioTechniques*, 10, 506-13.
- Weber R., Schwartz D.A., Deplazes P. (1999). Laboratory diagnosis of microsporidiosis. In: Wittner, M., Weiss, L.M. (Eds.), *The Microsporidia and Microsporidiosis*. American Society for Microbiology, Washington, DC, pp. 315-362.
- Weiss L.M., Vossbrinck C.R. (1999). Molecular biology, molecular phylogeny, and molecular diagnostic approaches to the microsporidia. In: Wittner, M., Weiss, L.M. (Eds.), *The Microsporidia and Microsporidiosis*. American Society for Microbiology, Washington, DC, pp. 129-171.
- Williams P.H. (1998). An annotated checklist of bumblebees with an analysis of patterns of description. *Bulletin of the Natural History Museum, Entomology Series* 67, 79-15.

NATIVE DOG BREEDS OF TURKEY

Orhan YILMAZ

Ardahan University, Vocational High School of Posof, 75500, Ardahan, Turkey.

*Corresponding author: zileliorhan@gmail.com

Abstract

This paper describes eleven such, five of which are molossers, one is a sighthound, two are scenthounds, one is watch dog and two are small Spitz types. Two of the molossers (Kangal and Akbash) have local breed societies or associations and are well known and have breed societies internationally but are not recognized by the Fédération Cynologique Internationale (FCI). One molosser (Kars) is registered by the Turkish Standards Institute and another (Koyun) has been recently identified. Karaman is another molosser type dog and has been identified yet. The sighthound (Tazi) is similar to other Near and Middle East greyhounds. The scenthound (Tarsus Catalburun also known in English as Fork-nose and Turkish Pointer) is little known outside Turkey but is celebrated in its home area for its skills and is finding employment as a sniffer dog for narcotics, explosives and live and dead people. The other scenthound of Turkish Chaser Dog of Zagar is the last registered dog breed by the Turkish Standards Institute. The Spitz-type (Dikkulak and Fino of Tonya) is employed mainly as a household guard dog as are two other breeds of indeterminate type. Zerdava dog is a watch dog and locally bred in northeast of Turkey.

Keywords: Working dogs, morphometry, breed societies, animal legislation, welfare

Introduction

Situated at the junction of Europe and Asia, Turkey is a geographic bridge that has been traversed by traders, travellers, treasure seekers and trespassers for thousands of years. It is thus also a cultural bridge imbued within the DNA of many civilizations. Because of such history, Turkey is a repository of a rich array of domestic livestock resources that includes animals for food, for work and for companionship. The present day inhabitants of modern Turkey arrived in the country with the expansion of the Turkic Empire out from Centra Asia in the middle of the eleventh century. They travelled with their herds and flocks and were accompanied by the guard dogs that protected these livestock and the present day inhabitants of modern Turkey arrived in the country with the expansion of the Turkic Empire out from Centra Asia in the middle of the eleventh century. They travelled with their herds and flocks and with the guard dogs that protected these animals and hunting dogs that assisted in the search for food. In the one thousand years since the Turkish arrival in Asia Minor and Thrace several dog breeds have developed. Whilst Turkish hunting dogs are analogous with those of much of Europe the “shepherd” dogs of Turkey are guard dogs bred for and trained to protect the flocks and not to control the sheep. This review is part of a series of papers that will eventually cover most species of domestic livestock in Turkey (Wilson et al 2011, Yilmaz et al 2011a, 2011b, 2012a, 2012b, 2012c, 2012d). The paper builds in part on an earlier review (Reed 1996) but provides information breed organization, registration and welfare in addition to describing and providing other information on ten identified types of which five are molossers, one is a sighthound, one is a scenthound and one is a Spitz type.

Breeds

Turkish Kangal (Karabash) Shepherd

It is believed that the Kangal, a molosser flock guard dog, is believed to have originated in Central Asia (Kirmizi 1994, Yilmaz 2007a, 2007b, Derbent and Yilmaz 2008, Yilmaz 2008) and is genetically distinct from other Turkish dogs (Altunok et al 2005). The Kangal dog has historically been associated with the town of Kangal - a district town in Sivas Province in eastern Anatolia where Akkaraman sheep production is an important activity -- but Kangal is not the original name of this breed but came into use in Turkey via discussions at the United Kingdom's Kennel Club in the 1970s (Broadhead 2003, Reed 2003). The original name of Karabash (Dikmen 1936, Tellioglu 1973, Oncul 1983) means blackhead in Turkish and derives from the black muzzle (Figure 1). The Kangal can withstand the extremes of the cold harsh climate of its homeland. Courage, faithfulness and sensitivity are the foremost characteristics of the breed. It is a fearless and capable protector of its own flock, herd and its human family with whom it forms bonds yet it is a formidable fighter against large dogs and other predators (Pugnetti 2001, Kazak and Bakir 2002, Derbent and Yilmaz 2008, Yilmaz 2008).

The Kangal has a strong, sturdy body with a black mask and muzzle and black around the ears and around eyes. The tail hangs low and has a slightly upward and forward curl (Gulec 1996, Galand 1997, Yesilyurt 1999, Kartay 2002, Yilmaz 2007a, 2007b). The true Kangal dog colour is solid dun or slightly paler shades of fawn or cream but never snow white ('boz' in Turkish) (Robinson 1989, Yilmaz 2007a, 2007b). Colour is an important breed trait and in Turkey non-standard colours or patterns are indicators of outside blood (Yilmaz 2007a, 2007b, Derbent and Yilmaz 2008, Yilmaz 2008). The dense double coat is moderately short. Average mature live weights are 47.6 kg for males and 43.5 kg for females with shoulder heights of 75.9 cm for males and 73.3 cm for females (Yilmaz 2007a).

The Kangal was registered with the Turkish Standards Institute as Notification Number 11172 in 1997 (Anon 1997b). It is supported nationally by Coban Kopeci Irki Dernegi (Kangal Dog Club of Turkey) and government and academic institutions operate kennels where Kangal dogs are bred and pedigrees are carefully maintained. Its iconic status is confirmed by its appearance on a Turkish postage stamp. Outside Turkey there is the Kangal Dogs International the breed is supported in the UK by the Kangal Dog Trust. Kangal dogs are recognized by the Kennel Club of the United Kingdom, the United Kennel Club of the USA and by the national kennel clubs of South Africa, New Zealand and Australia. The first Kangal litter was born in the United Kingdom in 1967 and purebred programmes were established in the USA in the 1980s. Kangals are bred in Germany mainly by immigrant Turkish workers and are registered as Anatolians but most are unregistered. There are Kangal clubs or breed societies in Belgium, Bulgaria, France, the Netherlands and Sweden (Yilmaz and Ertugrul 2011c, Yilmaz 2007b). In Namibia, where Kangals are used to guard sheep flocks, almost 300 Kangals have been given to farmers by the Cheetah Conservation Fund since 1994 (Anon 2010). The Turkish Kennel Club is petitioning the FCI for recognition of both the Kangal Dog and the Akbash Dog.

The Akbash (Figure 2) is another molosser that is widely used as a flock guardian dog. The origin of this ancient breed is unclear but it is believed that, as for the Kangal, it originated in Central Asia. In Turkey the breed is now mainly found in plains and mountains of Ankara, Afyon, Eskisehir and Konya Provinces which is known as the Salt Lake Plateau (Yilmaz 2007b, Yilmaz 2008).

Turkish Akbash Shepherd

Akbash translates as “white head” and the main colour is a solid milk white (Qadiri 1998, Sims 2006, Yilmaz 2006, 2007a, 2007b, Derbent and Yilmaz 2008, Yilmaz 2008). Purebred Akbash are free of pinto, skewbald and brindle markings or other indeterminate colours although a cream stripe from the ears to the rump is acceptable. Compared with the fawn coated Kangal, the Akbash has a more refined appearance with a pointed muzzle and a softer coat with medium to long. Weight and height at the shoulders are similar to or slightly less than the Kangal with a mean weight of 44.9 kg and shoulder height of 75.3 cm (Yilmaz and Ertugrul 2012a). The Akbash has a natural protective instinct and is equally as brave and faithful as the Kangal and possibly even more so in fighting with predators. Temperamentally it is calm, quiet, alert, courageous and independent. It is a very agile dog capable of jumping over obstacles as high as a man. Great stamina is coupled to great speed (Anon 1997a, Kartay 2008, Yilmaz 2008).

The Akbash was registered with the Turkish Standards Institute as Notification Number 12891 in 27.11.2002 (Anon 2002a). Akbas Coban Kopegini Koruma ve Arastirma Dernegi (AKAD) (Akbash Shepherd Dog Conservation and Research Association) is the effective breed society in Turkey. It has links with and a representative on the board of Akbash Dogs International in the USA which is the successor to the North American Akbash Dogs Club. There are also members of Akbash Dogs International in Canada and the Netherlands.

Kars (Caucasian) Shepherd

This regional breed (Figure 3), another molosser type, was first defined 1996 (Nelson and Nelson 1996). It has several alternative names including ‘Killi’ (shaggy) in Ardahan, Erzurum and Kars Provinces, ‘Sacakli’ (fringed) in Ardahan Province and ‘Tuylu’ (hairy) in Artvin Povice (Yilmaz 2008) and these localities are its main areas of distribution but it also extends to Igdir Province (Yilmaz 2012b).

In appearance the Kars resembles the Caucasian Ovcharka (Mountain Dog). Its coat exhibits many colours and patterns. Colours include black, reddish brown, agouti, grey, mixtures of black and brown, white, piebald and white with grey patches. White markings are very common in otherwise solid colour dogs. Also common are white forequarters, chests and neck collars. The head is usually dark. The usually long coat – there are some short-coated dogs – is important under severe winter conditions but when it is shed it gives the dog a dishevelled motley appearance. The hairs on the neck and the back of the hindquarters are long and this mane makes it appear larger from the front. The Kars is a somewhat smaller dog than either the Kangal or the Akbash with a mean weight of 44.6 kg and a mean height at the shoulder of 72.4 cm (Kirmizibayrak 2004, Yilmaz 2012b). Local anecdotes relate that a small group of Kars can cope with and even kill a smaller-sized bear. In general the Kars is a “one-man dog” but it an ideal courageous and faithful guard dog (Yilmaz 2006, 2007a, 2007b, 2008).

The Kars has a breed standard provided by the Turkish Standards Institute as Notification Number 12892 in 27.11.2002 but this seems unreliable in some respects and especially for weight (Anon 2002b).

Rize Koyun Shepherd

Newly described (Yilmaz and Ertugrul 2012b) from Rize Province on the eastern shore of the Black Sea in northeast Turkey the Rize Koyun (Figure 4) is a flock and herd guardian dog of molosser type. Koyun dogs are also present in Ordu Province to the west of Rize.

The dog is met in various colours but dark grey is the most common. Bi-coloured animals also occur. Rize Koyun dogs have a solid body structure and strong legs which make for easy traverses of the hilly areas of the Canik Mountains where they are found. The tail is normally pendent but is raised in an alert posture up. Shoulder heights of dogs are about 70 cm and

those of bitches about 1-2 cm lower. The Rize Koyun is not a pet and in addition to guardian duties it assists its human owners in giving vociferous or even physical warning of the presence of intruding people or animals (Yilmaz and Ertugrul 2012b).

Karaman Shepherd

Found mainly in Karaman, Konya and Aksaray Provinces in Central Anatolia where the herding of Akkaraman sheep is widespread the Karaman (Figure 5) is Turkey's fifth type of molosser flock guardian dog. In some respects the breed resembles the Kangal (Karabash) type but the Karaman occurs in many different coat colours. It has a sturdy body constitution and strong legs and is adapted to the harsh climate and geographic conditions of Central Anatolia (Yilmaz 2007a).

The Turkish Tazi (Figure 6) is a classic sighthound-greyhound that is generally concentrated in Konya Province in Central Anatolia and in Sanliurfa Province in Southeast Anatolia. There are smaller numbers in Igridir, Kars, Karaman, Ankara and Istanbul Provinces (Yilmaz and Ertugrul 2011a). It is asserted that the Turkish Tazi is descended from the Kirghiz Taigan and was brought to Anatolia by Turks during the Great Migration (Yilmaz 2008). It also resembles but is larger than the Saluki. The breed is historically better documented than many other Turkish breeds despite being fewer in number (Yilmaz 2007a, Yilmaz 2007b). One of Sehzades (Sultan's son) of Sultan Suleiman (King Solomon) the Magnificent in hunting with greyhounds was illustrated in a miniature dated from the 16th Century (Yilmaz 2008).

Turkish Tazi (Sighthound)

The Turkish Tazi possesses long forequarters and hindquarters, a slim body, a thin tail without hairs, a long and slender skull, a long neck, deep chest and a flexible and curved spine. Coat colour is very variable with black (35.2 per cent), being most common followed by dun (25.4 per cent), brown (12.3 per cent), tan (10.7 per cent), white (8.2 per cent) and pied (8.2 per cent). Body weights are about 18.4 kilograms and height at shoulder about 62 cm (Yilmaz and Ertugrul 2011a.). These dogs are reared for their superior skills, mainly in wetlands in Central and South Anatolia, in hunting quail, partridge, rabbits and foxes for detecting and bringing back the prey shot [they hunt prey by running/chasing them down] (Yilmaz 2007a, Derbent and Yilmaz 2008, Yilmaz 2008). The Turkish Tazi is extremely fast (speeds of up to 65 km/hr over 1 km) it is not hyperactive (Serpell 1996, Palika 2007, Yilmaz 2008). The Tazi makes a good pet because of its loyal, mild and affectionate character and gets along well with children and other family pets including cats. The thin coat renders the Tazi susceptible to cold weather and, as with greyhounds elsewhere, most owners cover their dogs with a rug in winter (Anon 2002c, Yilmaz 2007a, Yilmaz 2008).

Tarsus Catalburun (Fork-nose)

The Catalburun (Figure 7, Figure 8) is the only recognized scenthound in Turkey. In English it is known as the Tarsus Fork-nose dog and sometimes known as the Turkish Pointer. The breed is mainly located in Icel Province in the extreme south of Asian Turkey in the Mediterranean Region (Dinçer 2006, Yilmaz 2007a, Yilmaz 2007b, Yilmaz 2008, Yilmaz and Ertugrul 2011d, Yilmaz 2012d).

The Catalburun has a fully split nose, essentially resulting in a double nose, that is quite a rare feature in dog breeds and arises from the nostrils being separated vertically by a band of skin and fur dividing the nose all the way to the upper lips. The hair is short and the coat is of various colours, brown being the most common (52.7 per cent) followed by brown and white (23.6 per cent), black and white (14.6 per cent) and black (9.1 per cent). Live weights average 21.7 kg and height at shoulders 48.5 cm (Yilmaz and Ertugrul 2012c). In the Catalburun dogs

the live weight was 21.7 kg, and height at shoulders was 48.5 cm (Yilmaz and Ertugrul 2012c). The Catalburun has a very acute sense of smell that is arguably heightened by the peculiar nose structure and is therefore particularly good at hunting by scent and indicating the prey as a pointer dog. In addition to traditional hunting the Catalburun is being increasingly used by the police as a sniffer dog for narcotics, explosives and for finding living and dead people. The dog tends to be hunted as a singleton rather than in couples or packs. Catalburun dogs are very friendly and get along well with humans in addition to other dogs but are not suitable as pets in confined spaces as they prefer lots of space (Dinçer 2006, Yilmaz 2007a, 2007b).

Dikkulak (Erect-ear)

The Turkish Dikkulak (Erect-ear) dog (Figure 9) is a typical Spitz type of small compact body size with erect ears. It is also variously known as ‘dikkulak’ (erect ear), ‘çivikulak’ (nail ear) and ‘zagar’. Dikkulak dogs are raised in the same area as the Kars Dogs in Agri, Ardahan, Erzurum, Iğdir and Kars Provinces. In appearance the Dikkulak resembles the Pembroke Welsh Corgi (Yilmaz and Ertugrul 2011b) that is beloved of Her Majesty Elizabeth the Second, by the Grace of God of the United Kingdom of Great Britain and Northern Ireland and of Her other Realms and Territories Queen, Head of the Commonwealth, Defender of the Faith".

The coat colour is variable with some 29.5 per cent being white, 23.0 per cent black, 19.7 per cent brown and white, 18.0 per cent brown and 9.8 per cent tan. Live weight averages 10.6 kg with the height at the shoulder being 27.8 cm (Yilmaz and Ertugrul 2011b). Spitz types were originally bred as cattle dogs but in Turkey the Dikkulak is used as a small size watch dog. Although incapable of attacking or restraining intruders they bark loudly to alert their owners of unwarranted intrusion. In its watchdog role the Dikkulak is either tethered or allowed to run loose in an enclosure area (Yilmaz 2008).

Türk İzci Kopeği Zagar (Turkish Chaser Dog fo Zagar)

Zagar (Figure 10) is also called as Kopay, Kopoy, Tavsancı (Hare hunter), İzüren (Chaser), Cakir. It is bred by Yoruk people in region of Thrace and provinces of Bursa, Manisa, İzmir, Aydın, Denizli, Muğla and Afyon. This dog is especially used for hare hunting. Coat colour is generally black or brown. It is a smart, loyal and energetic dog breed. It is resistance against bad management and feeding. Height at withers is about 52.2 cm for male and 48.8 cm for female. Live weight is 19.5 kg for male and 17.6 kg for female (Anon 2012).

Zerdava (Kapi)

The Zerdava (Figure 11) is bred in provinces of Trabzon and it's around (pers. observ.). There is lack of information about Zerdava's history. Some owners claim that this breed originally came from Georgia. It was bred in province of Artvin, and later than it was spreaded to other provinces of Giresun, Rize and Trabzon (pers. commun.). The Zerdava has a unique colour pattern. The base colour is dark or liver brown but the chest, legs and point of tail are white with small dark spots. The white-coloured and spotted area around the neck is called ‘peskir’ (can be translated in English as hand towel) and the small dark spots themselves are known as ‘pul’ (stamp pattern). The eyes are yellowish-brown rather than brown. Shoulder height averages 51.2 cm (Yilmaz 2012c). The Zerdava was originally a hunting dog for smaller prey and vermin such as wild pig, foxes and jackals but its principal role in the twenty-first century is as a watch dog. The dog is brave, energetic and agile dogs and according to Zerdava owners they will pursue a lure for several days.

Zedava dogs are themselves hunted by wolves which may account in part for declining numbers in recent several years (pers. commun.).

Fino of Tonya (Kobi)

There is lack of information about history of Fino of Tonya (Figure 12), but some owners claim that origin of this dog came from Ukraine by sailors (pers. commun.). Actually Fino of Tonya closely resembles to spitz type dogs such as German White Spitz, Japanese Spitz, and Volpino Italiano. White is the only colour of this dog. The shoulder height is about 31.1 cm, height at rump 30.1 cm, and weight is about 9.7 kg. Mainly kept as a vociferous watch dog and suspicious of intruders it is nevertheless playful, energetic and friendly to children (Yilmaz 2012a).

Conclusin

The Kangal and the Akbash are the two major dog breeds of Turkey. Not only are they widespread in the country but also elsewhere in the world where they continue to be used as guard dogs in addition to their new role as “fashion accessories”. None of the other breeds is widespread within Turkey and they are generally little known outside the country. Turkish dog owners complain that local breeds are in constant decline and this anecdotal evidence is supported by the records of the Turkish Dog Federation in which only two of 21 member associations are of native breeds. The Turkish Dog Federation is, however, providing support to nascent groups of owners who wish to promote local breeds. Three breeds of dogs have been registered with the Turkish Standards Institute but in general there is little Government (at either national or regional level) support for dog breeding although support is provided for other domestic animal species through its “In Vitro Conservation and Preliminary Molecular identification of some Turkish Domestic Animal Genetic Resources (TURKHAYGEN-I)” (Arat 2011). There are possibilities that an extension of TUKHAYGEN into a second phase will include some dog breeds but most support will need to come from the private sector as breeders groups and as individuals. As household incomes in Turkey are likely to rise in the future and aspirations for a more “modern” lifestyle increase the prognosis for important cultural and genetic resource that is the dog is not too negative.

References

- Altunok V, Koban E, Chikhi L, Schaffer A, Pedersen NC, Nizamlioglu M and Togan I. 2005. Genetic evidence for the distinctness of Kangal dogs. *Bulletin of the Veterinary Institute, Pulawy* 49: 249-254.
- Anon. 1997a. The Akbash dog; premier livestock guardian. *Canis Max* 4 (Spring 1997): 11-14. Akbash Dog Association of America Inc.
- Anon. 1997b. The Standard of Kangal Dog. Turkish Standard Institution, Registration number: 12172, March 1997, TSI Printhouse, Ankara). Kangal Kopeci Standardi. Turk Standartlari Enstitusu, TS 12172, Mart 1997. TSE Matbaasi, Ankara.
- Anon. 2002a. The Standard of Turkish Akbash Shepherd Dog. Turkish Standard Institution, Registration number: 12891, November 2002, TSI Printhouse, Ankara). Akbaş Turk Coban Kopeci Standardi. Turk Standartlari Enstitusu, TS 12891, Kasim 2002. TSE Matbaasi, Ankara.
- Anon. 2002b. The Standard of Turkish Kars Shepherd Dog. Turkish Standard Institution, Registration number: 12892, November 2002, TSI Printhouse, Ankara). Kars Turk Coban Kopeci Standardi. Turk Standartlari Enstitusu, TS 12892, Kasim 2002. TSE Matbaasi, Ankara.
- Anon. 2002c. The Standard of Turkish Tazi (Sighthound). Turkish Standard Institution, Registration number: 12893, November 2002, TSI Printhouse, Ankara). Turk Tazisi Standardi. Turk Standartlari Enstitusu, TS 12893, Kasim 2002. TSE Matbaasi, Ankara.

- Anon. 2010. The Livestock Guarding Dog Program. http://www.cheetah.org/?nd=guarding_dog_program (erişim 11.10.2010)
- Anon, 2012. Turkish Chaser Dog of Zagar, The Government Gazette, Issue Number: 28036, Ankara (Turk Izci Kopeci Zagar, Resmi Gazete, Yayin No: 28036, Ankara).
- Arat S. 2011. In Vitro Conservation and Preliminary Molecular identification of some Turkish Domestic Animal Genetic Resources (Turkhaygen-I). Genetic Engineering and Biotechnology Institute: Gebze, Kocaeli, Turkey. <http://www.turkhaygen.gov.tr/data> (Accessed 22.12.2011)
- Broadhead, P. 2003. The Karabash Kangal Dog. First International Kangal Dog Symposium, 11 July 2003. Devran Printhouse: Ankara. 30-41.
- Derbent, S. and Yilmaz, O. 2008. Le Karabash. Oztepe Basimevi, Ankara.
- Dikmen, C. F. 1936. War and police dog. Turkey Basimevi: Istanbul (Savas ve Polis Kopeci. Turkiye Basimevi, Istanbul).
- Diñer, U. R. 2006. Hunting Dog of Tarsus Catalburun. Alevi Dikici Printhouse, Adana (Tarsus Catalburun Av Kopekleri, Alev Dikici Matabaasi, Adana).
- Galand, G. 1997. Le Berger Anatolien. Concraid Edition: Mons, Belgium.
- Gulec, E. 1996. Turkish Kangal dog. Anatolian Horse Racing Survival and Development Association, Print out edition, ISBN 975-95931-6-5, Ankara (Anadolu At Irklarini Yasatma ve Gelistirme Dernegi Yayinlari. Elde basim. Ankara).
- Kartay, D. 2002. Step watcher of Kangal dog (Publication No 2922). Ministry of Culture Publishing: Ankara (Bozkirin Gozcusu Kangal Kopeci, Kultur Bakanligi Yayinlari, Yayin No:2922, Ankara).
- Kartay, D. 2008. Turkish Shepherd Dog Akbash. Ilya Izmir Basim Yayin: Izmir (Turk Coban Kopeci Akbas. Ilya Izmir Basim Yayin, Izmir).
- Kazak, Y. and Bakir, B. 2002. Handbook of Kangal Dog Breeders. Ulas TIGEM Yayinlari: Sivas. (Kangal Kopeci Yetistirici El Kitabi, Ulas TIGEM Yayinlari: Sivas).
- Kirmizi, E. 1994. Turk Coban Kopeklerinin Tarihcesi. Turk Veteriner Hekimlisi Dergisi 1(6): 39-41. (The history of Turkish shepherd dogs. Journal of Turkish Veterinary Medicine 1(6): 39-41.)
- Kirmizibayrak, T. 2004. Some morphological characteristics of Kars dog. Turkish Journal of Veterinary and Animal Science 28: 351-353.
- Koban E. 2001. Genetic identity of Anatolian shepherd dog (ASD) population using microsatellites. (Unpublished Msc.Thesis). Middle East Technical University: Ankara. (Mikrosatellit yöntemini Kullarak Kangal Coban Kopeci Populasyonunda Genetik Tanımlama, 'Yayinlanmamis yuksek lisans tezi' Orta Dogu Teknik Universitesi: Ankara).
- Nelson, D.D. and Nelson J.N. 1996. A general classification of the shepherd dogs of Turkey. In: Tekinsen C and Tepeli C (eds) International Symposium on Turkish Shepherd Dogs, 23 October 1996, Konya. Veterinary Print Unit, University of Seljuk: Konya, Turkey. 19-97.
- Oncul, O. 1983. Sadik Dostumuz Kopekler Ailesi. Donmez Ofset: Ankara. (Our loyal friends the dog family. Donmez Ofset: Ankara.)
- Palika, L. 2007. The Howell book of dogs: the definitive reference to 300 breeds and varieties. Wiley Publishing: New Jersey, USA.
- Pugnetti, G. 2001. Kopek Ansiklopedisi, Arkadas Yaynevi: Ankara. (Dog Encyclopaedia. Arkadas Printhouse: Ankara.)
- Qadiri, R. 1998. Die Turkischen Hirtenhunde Akbas und Kangal (Turkish Akbash and Kangal Shepherd Dogs), Ballrechten, Germany.
- Reed S. 1996. The history of Turkish shepherd dogs. In: Tekinsen C and Tepeli C (eds) International Symposium on Turkish Shepherd Dogs, 23 October 1996, Konya. Veterinary Print Unit, University of Seljuk, Konya, Turkey. 97-109.

- Reed, S. 2003. Turkish dogs in UK and Europe. First International Kangal Dog Symposium, 11 July 2003, Kangal, Sivas. Devran Printhouse: Ankara, 147-163.
- Robinson, R. 1989. Inheritance of coat colour in the Anatolian Shepherd dog. *Genetica* 79: 143-145.
- Serpell J.A. 1996. The origins of the domestic dog. In: Tekinsen C and Tepeli C (eds) International Symposium on Turkish Shepherd Dogs, 23 October 1996, Konya. Veterinary Print Unit, University of Seljuk: Konya, Turkey. 7-18.
- Sims, D. (2006) A brief history of the Akbash dog. www.whitelands.com
- Tellioglu, S. 1973. Taninmis Kopek Irklari ve Ozellikleri, Ataturk Universitesi, Ziraat Fakultesi Yayinlari. Erzurum. (The wellknown dog breeds and their characteristics. Ataturk University, Faculty of Agriculture Publishing: Erzurum),
- Wilson, R.T., Yilmaz, O. and Ertugrul, M. 2011. The domestic livestock resources of Turkey: Pigs. *Pig Journal*, 66: 26-30.
- Yesilyurt, H. 1999. Kangal Coban Kopegi Tanitim El Kitabi, Kangal Kaymakamligi. (The handbook of Kangal shepherd dog. Governership of Kangal County: Sivas, Turkey.
- Yilmaz, O. 2006. Breeds of Livestock Guarding Dogs (Unpublished PhD seminar). Institute of Science and Technology, Ankara University: Ankara, pp 82. (Suru Koruyucu Kopek Irklari 'Yayimlanmamis doktora semineri'. Ankara Universitesi Fen Bilimleri Enstitusu, Ankara, s. 82.)
- Yilmaz, O. 2007a. Some morphological characteristics of Kangal dogs raised in various parts of Turkey (Unpublished PhD thesis). Institute of Science and Technology, Ankara University: Ankara.
- Yilmaz, O. 2007b. Turkish Kangal (Karabash) shepherd dog (In English). Impress Printhouse: Ankara.
- Yilmaz, O. 2008. Turk Kangal (Karabas) Coban Kopegi. Bilge Kultur Sanat Printhouse: Istanbul. (Turkish Kangal (Karabash) shepherd dog. Bilge Kultur Sanat Yayınevi: Istanbul.)
- Yilmaz, O. and Ertugrul M. 2011a. Some morphological characteristics of Turkish Tazi (Sighthound). *Journal of Animal and Plant Sciences, Pakistan* 21: 794-799.
- Yilmaz, O. and Ertugrul, M. 2011b. Some morphological traits of the Zagar (erect-ear) dog in Turkey. *Journal of the Institute of Science and Technology, Iğdir University* 1: 107-112.
- Yilmaz, O. and Ertugrul, M. 2011c. Spread story of Kangal (Karabash) shepherd dogs in the world. *Iğdir University Journal of Institute of Science and Technology*. 1(3): 116-120.
- Yilmaz, O. ve Ertugrul, M. 2011d. Some Morphological Traits of the Tarsus Fork-nose Dog in Turkey. 2-3.June.2011, 21st International Scientific Conference of Union of Scientist in Stara Zagora, Bulgaria.
- Yilmaz, O., Ertugrul, M. and Wilson, R.T. 2011a. The domestic livestock resources of Turkey: Water buffalo. *Tropical Animal Health and Production* 44 (4): 707-714.
- Yilmaz, O., Ertugrul, M. and Wilson, R.T. 2011b. The domestic livestock resources of Turkey: Camel. *Journal of Camel Practice and Research* 18 (2): 21-24.
- Yilmaz, O. 2012a. Determination of Fino of Tonya Dog. *Journal of Animal and Plant Sciences*, (In process).
- Yilmaz, O. 2012b. Determination of Kars shepherd dog raised in Turkey. *Online Journal of Canine, Feline and Exotic Pets* (In press).
- Yilmaz, O. 2012c. Determination of Zerdava Dog. *Journal of Animal and Plant Sciences*, (In process).
- Yilmaz, O. 2012d. Some Morphological Traits of the Tarsus Fork-Nose Dog in Turkey. *Bulgarian Journal of Agricultural Science*. 18(1): 111-115.
- Yilmaz, O. and Ertugrul, M. 2012a. Determination of Akbash shepherd dog raised in Turkey. *Bitlis Eren University Journal of Science and Technology* 2(1): 6-9.

- Yilmaz, O. and Ertugrul M. 2012b. Determination of the Rize Koyun (sheep) dog in Turkey. *Canadian Journal of Applied Sciences* 2: 216-221.
- Yilmaz, O. and Ertugrul M. 2012c. Some morphological characteristics of the Tarsus Fork-nose dog in Turkey. *Bulgarian Journal of Agricultural Science* 18(1): 111-115.
- Yilmaz, O., Akin, O., Yener, S.M., Ertugrul, M. and Wilson, R.T. 2012a. The domestic livestock resources of Turkey: Cattle breeds and types and their conservation status *Camel. Animal Genetic Resources* in press.
- Yilmaz, O., Kor, A., F., Ertugrul, M. and Wilson, R.T. 2012b. The domestic livestock resources of Turkey: Goat breeds and types and their conservation status *Camel. Animal Genetic Resources* in press.
- Yilmaz, O., Cengiz, F., Ertugrul, M. and Wilson, R.T. 2012c. The domestic livestock resources of Turkey: Sheep breeds and crossbreeds and their conservation status. *Animal Genetic Resources* submitted.
- Yilmaz, O., Akin, O., Wilson, R. T. and Ertugrul, M 2012d. An Overview of Domestic Livestock Resources of Turkey and Some Conservation Policies. *Livestock Science*, (In process).

HONEY BEE BIOLOGY IN TURKEY

Orhan YILMAZ^{1*}, Y. Erdal ERTURK²

¹Ardahan University, Vocational High School of of Technical Sciences Ardahan, Turkey.

²Iğdir University, Faculty of Agriculture, Department of Agricultural Economics, Iğdir, Turkey.

* Corresponding author: zileliorhan@gmail.com

Abstract

Honey bee (*Apis mellifera* L.) provides honey and honey products which contribute to a healthy diet to human. Honey bees are common live social insects which are called as colony. They provide 85% of pollination among whole pollination of the World. From this side honey bees are crucial for maintaining of nature life. Anatolia which is Asian part of Turkey is one of the most important bee husbandry centre which is origin of several bee breeds. Those breeds are Anatolian Bee (*Apis mellifera anatolica* Maa, 1953) which is the most common breed, Caucasian Bee (*Apis mellifera caucasia* Gorbachew, 1916), Armenian Bee (*Apis mellifera armenica* Skorikov, 1929), Persian Bee (*Apis mellifera meda* Skorikov, 1929), and Macedonian Bee (*Apis mellifera macedonia* Ruttner, 1988). In this review morphology, biology, colony structure and social life of honey bees which live in Turkey were summarized.

Key words: *Apis mellifera anatoliaca*, native breed, genetic resource, genetics, morphology.

Introduction

Anatolia which is Asian part of Turkey is one of the most important bee husbandry centre in the World and it is origin of Anatolian Bee (*Apis mellifera anatolica* Maa, 1953) and Caucasian Bee (*Apis mellifera caucasia* Gorbachew, 1916) (Guler, 2009). Common Honey Bee (*Apis mellifera*) (Table 1) is also domesticated B.C. 5.000 in Central Anaolia (Arslangundogdu, 2011). Turkey has a great advantage of beekeeping potential because of available natural conditions, proper climate and rich flora. Especially beekeeping is available between April and September in the most part of Turkey (Sirali, 2002). In the long history, human used numerous kinds of insects for them such as honey bees. Turkey is like a bridge between Asia and Europe. Hence Turkey includes various kinds of climate, habitat and geographical conditions which is origin of numerous kinds of vegetable and animal species.

Table 1. Scientific classification of the honey bee (Akbay 1982).

Phyluym	<i>Artropoda</i>
Class	<i>Insecta/Hexapoda</i>
Ordo	<i>Hymenoptera</i>
Subordo	<i>Apocrita</i>
Super Family	<i>Apoidea</i>
Family	<i>Apidae</i>
Genus	<i>Apis</i>
Species	<i>A. mellifera</i> L. 1758

(Nalbantoğlu, 2009). Honey bees contributed to plants to give more yield. For example the benefit obtained from the pollination of flowers is 6-10 times more than the benefit obtained from honey harvest (Kansu 1994, Arslangundogdu 2011). There is a reciprocal indispensable

relationship between plants and bees which plants need bees for pollination, on the other hand bees need pollination for feeding (Yuce 2011). Aim of this paper is to review honey bee biology in Turkey under perspective of genetics, morphology, biology, and pathology.

Genetics

Among honeybees there are variation about Mitochondrial DNA which provides to be determined different breed groups. The first group is called as Western (or 'W'). Western and northern European populations are in this group such as *A. m. mellifera* and *A. m. iberiensis*. The second group can be called as Eastern (or 'C') and southeastern European plus northern and eastern Mediterranean populations are in this group such as *A. m. carnica*, *A. m. ligustica*, *A. m. caucasia*, and *A. m. anatoliaca*. North and south of the Sahara populations in Africa consist of the group African (or 'A'). *A. m. capensis*, *A. m. intermissa*, *A. m. litorea*, *A. m. monticola*, *A. m. sahariensis*, and *A. m. scutellata* are in the group 'A'. The last group was discovered recently and called as Middle Eastern (or 'M'). *A. m. syriaca* is in this group 'M' (Smith 2002, Kence 2006). In a study six enzyme systems were studied to investigate the genetic variability in honeybee populations in Turkey. 10 morphometric characters were also measured to determine the extent of morphometric variation. Out of six enzyme systems, four were found to be polymorphic with 16 allozymes. In the populations the average heterozygosity was calculated as 0.072 ± 0.007 . Morphometric and electrophoretic variables were equally effective in discriminating honeybee populations. Anatolian and European honeybees were separated on the first axis, and Anatolian honeybees were further separated along a second canonical axis. The observation of rare alleles in isoenzymes, detection of high genetic diversity and the presence of four known subspecies supported the argument that Anatolia had been a genetic center for honeybee populations in the Near East (Kandemir et al. 2000). In a research study the Central Anatolian honeybees (*A. mellifera* L.) were electrophoretically examined at six enzyme loci. Although four loci were polymorphic (Est-3, Pgm, Hk, and Mdh) and two loci were found to be monomorphic (Pgi and Me). Genotypic frequencies of enzymes agreed Hardy-Weinberg expectations. Low levels of genetic variability were detected. Heterozygosity was calculated as 0.033 ± 0.005 . Gene frequencies gained for Pgm, Est, Hk and Mdh were compared with those of the studies carried out in other countries, especially in neighboring countries (Kandemir and Kence 1995).

Morphology and Biology

Enzyme polymorphism was investigated in honey bees which were collected from four different Anatolian regions. Three enzyme systems were analyzed and results showed that malate dehydrogenase and malic enzyme systems were monomorphic in all populations, but Esterase enzyme system was found to be polymorphic only in West Anatolia (Asal et al. 1995). In a study general protein (P-3) system was searched in 15 honey bee (*A. mellifera* L.) colonies from 3 different localities. Horizontal starch gel electrophoresis was performed on dark-eyed pupae (13-19 days old) using Poulik's (1) discontinuous buffer system. The frequencies of P-3F allele in three apiaries were 0.658, 0.333 and 0.442 (Yildiz and Asal 1996).

Some ecotypes and crossbreeds were investigated in Beypazari and Tokat regions. According to results the following means were gained: 6.62 ± 0.008 mm for proboscis length, 0.36 ± 0.002 mm for length of cover hair on tergite 5, 9.15 ± 0.014 mm for wing length and 3.13 ± 0.007 mm for the width, 4.38 ± 0.004 mm for width of tergite 4, 4.40 ± 0.114 pigmentation on tergite, 2.12 ± 0.028 for cubital index, 34.21 for forewing index and 56.47 for metatarsal index (Karacaoglu and Firatli 1998). In a field study a total of 42 honey bee colonies collected from 5 apiaries at 4 different localities in the Central Anatolia and breeder stock of Turkish Development Foundation (Turkiye Kalkinma Vakfi) was searched to define some

morphologic traits in ecotype of Central Anatolia and breed of Caucasian Bees. As a result 32 morphological characteristics were determined for the Central Anatolian ecotypes (*A. m. anatoliaca*) obtained from Kirsehir, Beypazari, Cankiri and Eskisehir and for the Caucasian breed (*A. m. caucasica*). In additional 25 workers from each colony of Central Anatolian ecotypes and Caucasian race constituted two distinct groups. The Central Anatolian ecotypes formed an intermingled cluster when individual bee values were considered whereas colony averages made possible the discrimination of the regional population into corresponding ecotypes. According to analyses results the 57.62 % of the individual bees and 97.62 % of the colonies were included in their own groups. In conclusion, it was clear that Central Anatolia with its natural advantages preserved some original honey bee populations despite the extensive use of replacement queen bees and migratory beekeeping (Gencer and Firatli 1999). A field study was conducted to define some morphological characters of some important honeybee (*A. mellifera L.*) races and ecotypes in Turkey. Samples were collected from six different regions of Central Anatolia Region (Beypazari), North Eastern Anatolia Region (Posof), Marmara Region (Gokceada), Thrace Region (Saray), Aegean Region (Fethiye) and Mediterranean Region (Erdenli). 41 morphological characters were measured and twenty one morphological characters were evaluated in this research. There were not any variation between genotypes regarding length of tibia, length of metatarsus, length of 6th sternit, metatarsal, sternum index, length of fore wing (longitudinal), width of fore wing (transversal), cubital vein distance a, cubital vein distance b, angles of wing venation A4, B4, D7, E9, G12, J10, J16, K19, N23 and O26, pigmentation of tergite 2, 3, 4 and scutellum. In additional there were significant variation between genotypes in terms of other 16 characters. It was also found that there were not any variation between genotypes regarding forewing weight, wing venations B4, E9, J10 and N23. However, there were significant variations between genotypes as for 16 characters. The results showed that some genotypes have differentiation characters regarding their morphological structure (Guler and Kaftanoglu 1999^{a,b}).

Table 6. Diseases and harmful creatures of honey bees (Akbat 1982, Tuncer and Yesilbag 2009, Celik et al. 2013, Demir and Eseceli 2013, Anon 2014).

Bacterial diseases	1. American foulbrood (Amerikan Yavru Curuklugu) 2. European foulbrood (Avrupa Yavru Curuklugu)
Fungal diseases	1. Chalkbrood (Kirec Hastaligi) 2. Stonebrood (Tas Hastaligi)
Viral diseases	1. <i>Chronic Paralysis Virus</i> (Kronik Ari Felci Virusu) 2. <i>Acud Bee Paralysis Virus</i> (Akut Ari Felci Virusu) 3. <i>Israeli Acud Bee Paralysis Virus</i> (Israil Akut Ari Felci Virusu) 4. <i>Kashmir Acud Bee Paralysis Virus</i> (Kasmir Akut Ari Felci Virusu) 5. <i>Black Queen Cell Virus</i> (Siyah Kralice Hucre Virusu) 6. <i>Cloudy Wing Virus</i> (Bulanik Kanat Virusu) 7. <i>Sacbrood Virus</i> (Tulum/Torba Hastaligi) 8. <i>Deformed Wing Virus</i> (Deforme Kanat Virusu) 9. <i>Kakugo Virus</i> (Kakugo Virusu) 10. <i>Varroa Destructor Virus 1</i> (Varroa Virusu) 11. <i>Invertebrate Iridescent Virus</i> (Salkim Hastaligi) 12. <i>Tobacco Ringspot Virus</i> (Tutun Halkali Leke Virusu)
Pests and parasites	1. Varroa (Varoa) 2. Acarine (Tracheal) mites (Akar) 3. Nosema (Nozema) 4. Small hive beetle (Kucuk Kovan Bocegi) 5. Wax moths (Petek Guvesi)

	<p>6. <i>Tropilaelaps</i> (Ari Biti)</p> <p>7. Others: Ant (karınca), wasp (esek arisi), bear (ayi), mouse/rat (fare/sican), bird (kus), spider (oruncuk), frog (kurbaga), hedgehog (kirpi)</p>
--	---

A field study was conducted to investigate the morphological characteristics and moreover to identify the honeybee (*A. mellifera L.*) genotypes in the Artvin and Ardahan regions of the northeastern Anatolia Region. A total of 84 worker bee experimental samples was collected from 8 apiaries in different locations. For every sample 20 workers were used and 19 morphological characteristics were measured biometrically. The samples used were collected from 3 regions of Ardahan (Ardahan-Center, Posof-Yenikoy and Posof-Sungulu) and from 5 different regions of Artvin province (Hamurlu, Kasikci, Borcka-Camili, Savsat-Kocabey and Muratli). As a result there was no variation between bees from different areas in T4 and cubital vein length a on the front wing. Although seven discriminant functions were analysed, the first three functions accounted for 84.1% of the total variation. The 24 samples taken from Artvin Borcka-Camili and 10 samples from Ardahan-Center and 10 samples from Ardahan Posof-Yenikoy were completely classified into their real groups. The those samples were distinguished from other groups and formed a distinct group. On the other hand the same samples overlapped in the Hamurlu, Kasikci, Savsat-Kocabey and Muratli populations (Guler et al. 2002).

Pathology

Adequate nutrition supports the development of healthy honey bee colonies. Larvas are strongly affected by shortages of nutrient. Larval starvation, alone or in combination with other stressors, can weaken colonies (Akbyay 1982, Brodschneider and Crailsheim 2010). In Turkey there is sudden loss of bees since 2006 by agreeing the other world countries which threatens beekeeping of Turkey (Giray et al. 2010, Demir and Eseceli 2013). In the near past 600.000 of 2.500.000 bee colonies of USA died suddenly. The same ratio was about 30% in Turkey and 60% in Spain and Poland. About 5 million bee colonies died just in two days in Croatia. Bee colonies die also in Canada, Australia, Greece, Switzerland, Italy, Germany, and Portugal (Celik et al. 2013). Among all bee diseases (Table 6), viral diseases are the mostly responsible of the bee diseases in Turkey, but there are not enough information and research about viral bee diseases in Turkey (Akbyay 1982, Kurt 2005, Tuncer and Yesilbag 2009). In a study foulbrood diseases were investigated about 153 colonies from different places of Bursa province. According to results there were no evidence about American or European foulbrood diseases (Borum et al. 2010).

Conclusions

Anatolia have had a significant role on evolution of most spicies. Because of having various climate conditions, having jeological structure that changes according to different geographic regions and being a naturel bridge among Africa, Europe and Asia (Kence 2006). Even if the nature is very generous, using the naturel sources depends on some genetic factors of the colony. Positive correlation between qalified breed features and honey yield can not be ignored. Queen's ovulation rate, worker bees' collecting nectar, polen, propolis efficiency and fry rearing ability, colony's tend of swarming, having resistance to illnesses and parasites, defensive behaviors are some important qualified breed featutes. Honey bees have adapted to local climate conditions and flora while evolving. Man have used this adaptation as economical opportunity. As a result of existing honey bee colonies for tens of thousands years at Anatolia, it's known that they have adaptated to the local ecological conditions and have had differentiation. The most productive ecotype for a specific region is also the honey bees

that well adapted that region. Honey bee have evolved for thousands years in our country and have adapted the regions thus a lot of breeds and ecotype have been occurred. To maintain ecological balance honey bees that adapted the regional flora, microorganisms, bee enemies and climate conditions to be conserved. Honey bee subspecies and ecotypes have to be improved in their region and variation of honey bee genetics have to be conserved to use by farmers for now and future.

References

- Akbay, R. 1982. Ari Yetistirme (Bee Breeding). Ankara Universitesi Ziraat Fakultesi Ders Notlari: 79. Ankara.
- Anonymous. 2014. List of diseases of the honey bee http://en.wikipedia.org/wiki/List_of_diseases_of_the_honey_bee (accessed on 21.1.2014)
- Arslangundogdu, Z. 2011. Bal Arisi (*Apis mellifera L. 1758*). *Acta Turcica*. 1 (1): 118-129.
- Asal, S., Kocabas, S., Elmaci, C. and Yildiz, M. A. 1995. Enzyme Polymorphism in Honey Bee (*Apis mellifera L.*) from Anatolia. *Turkish Journal of Zoology*. 19: 153-156.
- Borum, E., Ulgen, M., Aydin, L. and Ozakin, C. 2010. Bursa'da Bal Arilarında Gorulen, Yavru Curuklugu Hastaliklarinin Incelenmesi (Investigating of Some Diseases in Bees Raised in Bursa Province). IV. Uluslararası Katılımlı Marmara Arıcılık Kongresi (Bildiri Özetleri), 2-4 Aralık 2010, Canakkale.
- Brodshneider, R. and Crailsheim, K. 2010. Nutrition and Health in Honey Bees. *Apidologie*. 41: 278-294.
- Celik, K., Uzatici, A. and Coskun, B. 2013. Bal Arisi Hastalik, Zararlilarinin Tanımlanması ve Kontrolü (Definition and Control of Bee Diseases). *Favori Reklam*, Canakkale.
- Demir, E. and Eseceli, H. 2013. Ari Hastalik ve Zararlilari (Diseases and Pestilents of Bees). *Favori Reklam*, Canakkale.
- Gencer, V. and Firatli, C. 1999. Orta Anadolu Ekotipleri (*A. m. anatolica*) ve Kafkas Irki (*A. m. caucasica*) Bal Arilarinin Morfolojik Ozellikleri (Morphological Characteristics of the Central Anatolian (*A. m. anatolica*) and Caucasian (*A. m. caucasica*) Honey Bees). *Turkish Journal of Veterinary and Animal Sciences*. 23: 107-113.
- Giray, T., Kence, M., Oskay, D., Doke, M. A. Kence, A. 2010. Scientific Note: Colony Losses Survey in Turkey and Causes of Bee Deaths. *Apidologie*. 41: 451-453.
- Guler, A. and Kaftanoglu, O. 1999a. Turkiye'de Onemli Balarisi (*Apis mellifera L.*) Irk ve Ekotiplerinin Morfolojik Ozellikleri – I (Morphological Characters of Some Important Races and Ecotypes of Turkish Honeybees (*Apis mellifera L.*)-I). *Turkish Journal of Veterinary and Animal Sciences*. 23: 565-570.
- Guler, A. and Kaftanoglu, O. 1999b. Turkiye'de Onemli Balarisi (*Apis mellifera L.*) Irk ve Ekotiplerinin Morfolojik Ozellikleri – II (Morphological Characters of Some Important Races and Ecotypes of Turkish Honeybees (*Apis mellifera L.*)-II). *Turkish Journal of Veterinary and Animal Sciences*. 23: 571-575.
- Guler, A., Akyol, E., Gokce, M. and Kaftanoglu, O. 2002. Artvin ve Ardahan Yoresi Balarilari (*Apis mellifera L.*)'nin Bazi Morfolojik Ozellikler Yonunden Iliskilerinin Belirlenmesi (The Discrimination of Artvin and Ardahan Honeybees (*Apis mellifera L.*) Using Morphological Characteristics). *Turkish Journal of Veterinary and Animal Sciences*. 26: 595-603.
- Guler, A. 2009. En Verimli Arı Sizin Arılığınızda Arıdır (The Most Productive Bee Colony is in Yours). *The Journal of Beekeeping Research*, 1(1), 12-14, Ordu.
- Kandemir, I. and Kence, A. 1995. Allozyme Variability in a Central Anatolian Honeybee (*Apis mellifera L.*) Population. *Apidologie*. 26: 503-510.

- Kandemir, I., Meixner, M. D., Ozkan, A. and Sheppard, W. S. 2000. Genetic and Morphometric Variation in Honeybee (*Apis mellifera* L.) populations of Turkey. *Apidologie*. 31: 343-356.
- Kansu, I. A. 1994. Genel Entomoloji (General Entomology). Kivanc Basimevi, Ankara.
- Karacaoglu, M. and Firatli, C. 1998. Bazi Anadolu Bal Arisi Ekotipleri (*Apis mellifera anatoliaca*) ve Melezlerinin Ozellikleri. 1. Morfolojik Ozellikler (Studies on characteristics of Anatolian honey bee ectotypes (*A. m. anatoliaca*) and their crosses: I. Morphological Characters). *Turkish Journal of Veterinary and Animal Sciences*. 22: 17-21.
- Kekecoglu, M. 2009. Bal Arısı, Biyoçeşitlilik ve Koruma Çalışmaları (Honey Bee, Biodiversity and Some Conservation Studies). *The Journal of Beekeeping Research*, 1(2), 3-5, Ordu.
- Kence, A. 2006. Turkiye’de Balarilarinin Genetik Cesitligi ve Korunmasinin Onemi (Genetic Diversity of Honey Bees in Turkey and the Importance of its Conservation). *Uludag Bee Journal*. 1: 25-32.
- Kurt, M. 2005. Arilarin Viral Hastaliklari (Viral Diseases in Honey Bees). Samsun Veteriner Kontrol ve Arastirma Enstitusu Mudurlugu. Samsun.
- Nalbantoglu, S. 2009. Tarımsal Araştırmalar Genel Müdürlüğü Arıcılık Faaliyetleri (Beekeeping Studies in General Directorate of Agricultural Researches). *The Journal of Beekeeping Research*, 1(1), 38-39, Ordu.
- Sirali, R. 2002. General Beekeeping Structure of Turkey. *Uludag Bee Journal*. 2 (4): 30-39.
- Smith, D. R. 2002. Genetic Diversity in Turkish Honey Bees. *Uludag Bee Journal*. 2 (3): 9-17.
- Tuncer, P. and Yesilbag, K. 2009. Bal Arilarinin Viral Hastaliklari (Viral Diseases in Honey Bees). *Uludag Bee Journal*. 9 (4): 149-161.
- Yildiz, M. A. and Asal, S. 1996. General Protein (P-3) Polymorphism in Honey Bee (*Apis mellifera* L.) from Central Anatolia. *Turkish Journal of Veterinary and Animal Sciences*. 20: 379-381.
- Yuce, R. 2011. Balarisi (*Apis mellifera* L. 1758)’nin Uremesi ve Sosyal Yasantisi (The Social Life and Reproduction of The Honey Bee - *Apis mellifera* Linnaeus, 1758). *Acta Turcica*. 1 (1): 109-117.

CHEMICAL COMPOSITION AND TANNIN CONTENT OF AGRO-INDUSTRIAL BY-PRODUCTS AS SUITABLE FOR RUMINANT FEED

Myriam R. VENTURA*, Marta BARBERÁ, Pedro SAAVEDRA, Luis REY, J. Ignacio R. CASTANON

Department of Animal Science, University Las Palmas de Gran Canaria. 35416, Arucas, Spain

*Corresponding author: myriam.rodriiguezventura@ulpgc.es

Abstract

In recent years, the use of agro-industrial by-products in animal nutrition has been successfully adopted as a strategy for reducing feeding costs and also coping with a need for recycling of waste material that is costly to be disposed of. Agro-industrial by-products are cheap and widely available in Mediterranean countries, and suitable for sheep and goat nutrition. Many of these alternative feed resources contain secondary compounds, such as tannins. For instance, tannin-containing feeds could cause effects on meat and milk quality, when consumed in large quantities by animals (Vasta et al., 2008). The objective of this study was to contribute to the characterization of nutritional potential of some agro-industrial by-products informally used in Mediterranean countries for ruminant feeding. The species selected were: *Vitis vinífera* (vine plant), *Ipomea batata* (sweet potato), *Musa acuminata* (banana by-products), *Cucúrbita pepo* (pumpkin), *Solanum lycopersicum* (tomato plant) and *Olea europaea* (olive plant). Crude protein (CP) ranged from 10% on banana by-products to 21% on *Cucúrbita pepo* leaves, whereas neutral detergent fiber (NDF) ranged between 26.5% on *Cucúrbita pepo* and 58% on banana leaves. Condensed tannins ranged from 0.10% on banana by-products to 1.2% on olive plant, and total phenols ranged from 0.50% on banana by-products and 7.3% on olive plants. The organic matter digestibility (OMD) ranged from 43% banana by-products to 85% on *Cucúrbita pepo*. Current results show that some agro-industrial by-products have potential to be used in the ruminant feeding system, supplementing the existing diets.

Keywords: *Vitis*, *Ipomea*, *Musa*, *Cucúrbita*, *Solanum*.

Introduction

The use of agro-industrial by-products in animal nutrition has been successfully adopted as a strategy to reduce feeding costs and also to cope with the need to recycle waste material which is costly to dispose of. Moreover when the use of cereals and soybean in animal's diets creates a competitive conflict with human nutrition's and is expensive. Further the future of arid and semiarid regions depends on the development of sustainable agricultural systems and on the cultivation of appropriate crops that must cope successfully with water shortage, high temperature, and poor soil fertility (Nefzaoui, and Ben Salem, 2002). Thus the development of innovative mixed-farming systems that reconnect livestock and crop production on various territorial scales, can reduce the negative impacts of agriculture on the environment, produce valuable ecosystem services and achieve acceptable economic efficiency for farming enterprises. Mixed-farming systems with unconventional starch sources increase the possibilities of better recycling of nutrients within systems, limiting recourse to the purchase of increasingly expensive inputs and safeguarding the biodiversity of agricultural ecosystems. Some agro-industrial by-products (e.g. olive cake, tomato forages, banana by-products...), can be successfully used as supplements in small ruminant diets, without compromising animal performance. In several studies, olive cake (Martin Garcia et al., 2003), banana by-

products (Pieltain et al., 1998-1999) or tomato (Ventura et al., 2009) have been successfully used as supplements for small ruminant diets. *Ipomea batatas* (sweet potato) forage is mainly a source of protein and contains about 15-30% CP in the DM, but the forage quality depends on the proportion of leaves and stems, thus stems containing much less protein than the leaves (Le Van, 2004). Unlike legume forages, it does not contain notable quantities of ant nutritional factors. Olive leaves (*Olea europae*) are suitable forage for ruminants as a bulky feed in maintenance and low-production systems. They are rich in long fiber and require nitrogen and phosphorus supplementation. *Cucurbita pepo* (Pumpkin) was found to have potential as a ruminant feed with a ME value of 16.9 MJ/DM and a crude protein higher than those of beet pulp (Enishi et al., 2004).

Most species are widely distributed in the world exist numerous crops. Some of them cultivated mainly in Mediterranean climates (*Vitis vinifera* (vine plant), *Olea europae* (olive plant), *Cucurbita pepo* (pumpkin), *Solanum lycopersicum* (tomato plant) or in the tropical and subtropical areas as *Ipomea batatas* (sweet potato) and *Musa acuminata* (banana by-products). However, some of these alternative feed resources contain secondary compounds, such as condensed tannins that, when present in high concentrations in the diet, can negatively affect feed intake, animal productivity or even affect the quality of the products (eg. milk, meat...) Vasta et al., (2008).

Materials and methods

The species used in this study were *Vitis vinifera* (vine plant), *Ipomea batata* (sweet potato), *Musa acuminata* (banana by-products), *Cucurbita pepo* (pumpkin), *Solanum lycopersicum* (tomato plant) and *Olea europaea* (olive plant) from different localities in Gran Canary (Latitude 27° 55' 45''; Longitude 15° 23' 20''). The original plants were randomly selected from crops which have been harvested for human feed for farmers and recycling residues of plants for feed animals and crops cultivated on the Cabildo's Experimental Farm in Gran Canary. Samples were collected from the basal, medium and apical parts of several representative plants, at the same time during the spring season, when all forages are in similar and optimum phenologic stage for forage production. Fresh samples were weighed, cut and dried at 60 °C to about 90 g/kg dry matter (DM). They were then ground to pass a 1mm screen prior to duplicate chemical analyses. Dry matter, ash and crude protein (CP) were determined according to standard methods as described in AOAC (2000) (methods 930.15, 942.05, and 976.05, respectively). Ash-free neutral detergent fibre (NDFom) was determined using sodium sulfite in the ND according to Van Soest et al. (1991). The acid detergent fibre (ADF) and acid detergent lignin (ADL) were determined following the procedure of Van Soest et al. (1991). Condensed tannin (TC) analysis and total phenolic content (PC) were performed by the vanillin-HCL method of Burns (1963) and the technique of Makkar, H. and Al. (1993) respectively; *In vitro* dry matter digestibility (DMD) and organic matter digestibility (OMD) was determined according to the two stage pepsin-cellulase method (Pepcel) (Aufreere, 1982). Based on digestible OM, digestible energy (DE, MJ/kg DM) content of the species was estimated as $0.0185 \times \text{digestible OM}$ (NRC, 1988). To assess the content of nutrients according to the type of plant, an analysis model of variance with a factor of variation (ANOVA-1) was used (SAS, 2000).

Results and discussion

However, little information is available on the effects of some of these agro-industrial by-product, there are resources that can be used as feedstuff in this semi-arid conditions, which provides the necessary nutrients to improve the nutritional status of the animals, some of them have been selected and analyzed in this study to compare nutritive value among them; The objective of this study was to assess the nutritive value of some unconventional feed (agro-industrial by-products), species which could used to feeding animals, specially taking into account their profiles on phenolic compounds and condensed tannins for select properly the species and the variety of the by-products for animal nutrition.

The chemical composition of the species used is shown in Table 1. The dry matter (DM) content of the species was 130–506 g/kg fresh forage. There was a great difference in the DM content of the original raw materials, been higher on *Vitis vinifera* and olive plant sources. In practice, this fact could make a difference in the manipulation and conservation in favor of this species. However, it will depend on local availability of the other species as well as the high market price of cereals, oleaginous products and forages as occur in the Canary Islands (Spain). Moreover taking account the high number of small farms of goats and sheep for cheese production, encourage continued work on the rational and more intensive use of such local feed resources for concentrate and diet formulation at small scales. Pieltain et al., 1998-1999 reported similar results of chemical composition on banana by-products while Ventura et al., 2009 found high crude protein (CP) and organic matter digestibility (OMD) on tomato by-products.

Table1. Chemical composition on conventional and unconventional feed (g/kg DM)

SPECIES	DM	OM	CP	NDF	ADF	ADL	ASH	PT	TC
<i>Vitis vinifera</i>	506	840	131	421	311	130	83	2.10	0.50
<i>Ipomea batata</i>	130	756	173	367	256	84	157	0.80	0.10
<i>Musa acuminata</i>	177	776	100	580	387	105	140	0.50	0.10
<i>Curcubita pepo</i>	140	872	214	265	183	35	162	0.85	0.12
<i>Solanum lycopersicum</i>	209	747	153	466	335	60	162	0.70	0.10
<i>Olive plant</i>	501	884	87	399	278	164	61	7.30	1.20

(DM) dry matter; (OM) organic matter; (CP) Crude protein ;(NDF) Neutral detergent fibre; (ADF) acid detergent fibre; (ADL) acid detergent lignin; (ASH) ash in g/kgDM. (PT) Total Phenols (% of tannins as tannic acid equivalent), (TC) Condensed Tannins content (% of tannins as catechin equivalent),

CP content ranged from 87 to 214 g/kg DM. The CP contents of *Cucúrbita pepo* were greater than the respective values found in the other species and it was lower in the olive plants. Although similar results of chemical composition were described by Alibes and Tisserand, 1990 and Gomez Cabrera, 2009 for *Cucúrbita pepo* and Olive forages respectively, the OM digestibility reported by them it was lower in both species. On the other hand similar results of chemical composition are reported on AFZ, 2011; URZ, 2009 for *Ipomea batatas* while condensed tannins contents (6.2 g /Kg DM tannins as catechin equivalent) were quite high than our values.

Condensed tannins contents (TC) ranged from 0.10% to 1.2% of tannins as catechin equivalent, and total phenols contents (PT) ranged from 0.5% to 7.3 % of tannins as tannic acid equivalent. Both TC and PT contents were higher in the olive plant while, but an exception of *Vitis vinifera* no differences occurred for the rest of species in the condensed tannins contents. Nevertheless just in case of concentrations greater than 50 g/kg DM, tannins can decrease food intake (Barry et al., 1983) and this should limits the use of feedstuffs even though they may have high protein content. For instance, tannin-containing feeds cause adverse effects on meat and milk fatty acid composition, depending on the amounts of

condensed tannins ingested by the animals, while meat color is evidently paler when condensed tannins are present in the diet (Vasta *et al.*, 2008).

Table 2. Dry matter digestibility (DMD), organic matter digestibility (DMD), digestible organic matter (DOM) in g/kg DM and estimate digestible energy (DE) in MJ/kg DM.

SPECIES	DMD	OMD	DOM	DE
<i>Vitis vinifera</i>	0.56	0.53	445	8.2
<i>Ipomea batata</i>	0.81	0.77	588	10.8
<i>Musa acuminata</i>	0.56	0.43	339	6.2
<i>Curcubita pepo</i>	0.87	0.85	740	13.7
<i>Solanum lycopersicum</i>	0.71	0.65	490	9.0
<i>Olive plant</i>	0.67	0.65	580	10.7

The *In vitro* organic matter digestibility (IVOMD) (Table 2) ranged from 0.430 (Banana plant) to 0.850 in the *Cucúrbita pepo*, were it was the higher value. Moreover IVOMD was similar among tomato plant and olive plant.

Finally, based on IVOMD, digestible energy of the different species was estimated to range from 6.2 to 13.7 MJ DE/kg DM. It was lower in the banana by-products and higher in *Cucúrbita pepo*. ED was similar among *Ipomea batata* and olive plant. Estimated DE of the species analyzed was similar to unconventional starch sources and forage legumes shrubs such as *Bituminaria* varieties, *Medicago arborea* or tagasaste reported by Ventura *et al.* (2002; 2004; 2009). Moreover DE content of all species analyzed was higher and in the range (6.9-9.2 MJ DE/kg DM) estimated by INRA (1988) for cereals, legumes straws and medium quality alfalfa hay.

Current results support the thesis that, some alternative local feedstuffs have potential to be used in ruminant feeding systems strategies.

Conclusion

The value of forages as supplements is mainly depending on their capacity to provide essential nutrients to the rumen microbial population and/or critical nutrients (anti-nutritive factors) to meet the host animal requirements, thus increasing or reducing the efficiency of feed utilization (Elliot and McMenimen, 1987). In this study we can see that there are many differences in chemical composition, in the condensed tannins and in the total phenols contents within the different species analyzed. Condensed tannins and total phenols contents were low in the different species analyzed a exception of total phenols contents in the *Olea europaea* (olive plant) were it was quite high and medium PT content on *Vitis vinifera*. Although, more research should be done on the relation between the quantity of total phenols and tannins and the possible toxic effects on animals or the reduction on voluntary dry matter intake, palatability and productive effect on meat and milk.

Based on CP, IVOMD and digestible energy results, all the species analyzed are within the range estimated by INRA (1988) for cereals, legumes straws and medium quality alfalfa hay. Current results support the thesis that, these alternative local feedstuffs have potential to be used in ruminant feeding systems strategies, although diets supplemented with agro-industrial by-products should be carefully formulated, in order to guarantee small ruminants their nutritional requirements and to avoid the presence of anti-nutritional factors on the rations, nevertheless more research is needed to see productive responses on animals feeding these agro-industrial by-products.

Acknowledgments

The authors acknowledge the technical team of INRA for their assistance, and the laboratory technicians of the CIRAD for their help in samples analyses.

References

- AFZ (2011). La Banque de données de l'Alimentation Animale / French feed database. (The Data Bank of Animal Feed / French feed database.) Association Française de Zootechnie.
- A.O.A.C. (2000). Official Methods of Analysis, 17th ed. Association of Official Analytical Chemists, Gaithersburg, MD, USA.
- Alibes X., Tisserand J. (1990). Tables of the nutritive value for ruminants of Mediterranean forages and by-products. Options Méditerranéennes : Série B Etudes et recherches ; numero 4. CIHEAM 152 p.
- Aufrere J. (1982). Etude de la prévision de la digestibilité des fourrages par une méthode enzymatique. Annales de Zootechnie, 31 (2), 111-130.
- Barry, T., Manley T., Duncan, S. (1986). The role of condensed tannins in the nutritional value of *Lotus pedunculatus* for sheep. British Journal Nutrition, 55, 123-137.
- Burns, R. (1963). Methods of tannins analysis for forage crop evaluation. University Ga. Agric. Exp. Stn. Tech. Bull. N.S. 32.
- Elliot R., McMeniman N. (1987). Supplements of ruminant diets with forages. The nutrition of herbivores. Academic Press Sidney
- Enishi O., Yoshioka T., Nakashima K., Saeki M., Kawashima T. (2004). Analysis of **in situ** ruminal digestive characteristics and nutritive value of pumpkin and carrot juice residue for ruminant feeds. Grassland Science, 50 (4): 360-365
- Gomez A. (2009). Banco de muestras Pastos españoles. Servicio de Información sobre Alimentos (Bank Pastures Spanish samples. Food Information Service), Universidad de Cordoba.
- INRA Institute National de la Recherche Agronomique. (1989). Ruminant Nutrition, (Jarrige edn; John Libbey Eurotext, London).
- Le Van A. (2004). Sweet potato leaves for growing pigs: biomass yield, digestion and nutritive value. Doctoral thesis, Swedish University of Agricultural Sciences, Uppsala, Acta Universitatis Agriculturae Sueciae Agraria 470.
- Makkar, H. and Al. (1993). Gravimetric determination of tannins and their correlations with chemical and protein precipitation methods. J. Science Food Agriculture, 61, 161-165.
- Martín García, A.I., Moumen, A., Yanez Ruiz, D.R., Molina Alcaide, E., 2003. Chemical composition and nutrients availability for goats and sheep of two-stage olive cake and olive leaves. Animal Feed Science and Technology, 107, 61-74.
- N.R.C. (1988). Nutrient requirements for dairy cattle, 6th ed. National Academy Press, Washington, DC.
- Nefzaoui A., Ben Salem H. (2002). Forage, fodder and animal nutrition. En: P.S. Nobel, editor, Cacti: biology and uses. University of California Press, Berkeley, California, USA. p. 190-210.
- Pieltain, M.C.; J.I.R. Castañón, M.R.Ventura and M.P.Flores.(1998). The nutritive value of banana (*Musa acuminata*) fruits for ruminant. Animal Feed Science and Technology, 73:187-191.
- Pieltain, M.C.; J.I.R. Castañón, M.R.Ventura and M.P.Flores.(1999). The nutritive value of banana (*Musa acuminata*) by-products for ruminant. Animal Science, 69:213-216.
- SAS. Statistical Analysis Systems Institute, (2000). In SAS language guide for personal computers. Institute Inc, Cary, NC, USA, Version 8.1.
- URZ. (2009). Données 2009. INRA Centre de Recherches Antilles Guyane, Unité de Recherches Zootechniques (Data 2009. INRA Research Centre Antilles Guyane, Animal Production Research Unit).

- Van Soest, P., Robertson, J., Lewis, B. (1991). Methods for dietary fiber, neutral detergent fiber, and non starch polysaccharides in relation to animal nutrition. *J. Dairy Science*, 74, 3583–3597.
- Vasta V., Nuddab A., Cannasb A., Lanzac M., Prioloc A. (2008). Alternative feed resources and their effects on the quality of meat and milk from small ruminants. *Animal Feed Science and Technology* 2008; 147: 223-147
- Ventura M., Castanon J., Mendez P. (2009). Effect of season on teder (Bituminaria bituminosa) intake by goats. *Animal Feed Science and Technology*, 153,314 -319.
- Ventura M., Castanon J., Rey L., Flores M. (2002). Chemical composition and digestibility of tagasaste (*Chamaecytisus proliferus*) sub-species for goats. *Small Ruminant Research* 46, 207–210.
- Ventura, M., Castanon, J., Pieltain, M., Flores, M. (2004). Nutritive value of forage shrubs: *Bituminaria bituminosa*, *Rumex lunaria*, *Acacia salicina*, *Cassia sturtii* and *Adenocarpus foliosus*. *Small Ruminant Research*, 52, 13–18.

METHOD OF MOVING HIVES WHEN PREPARING HONEYBEE COLONIES FOR ACACIA FLOW

Duška SLIJEPAC*, Dejan POPOVIĆ

Faculty of Agriculture, University of Banja Luka, Republic of Srpska, Bosnia and Herzegovina

*Corresponding author: sljepac.duska@yahoo.com

Abstract

The acacia is the most significant honey plant on the territory of the Republic of Srpska (RS). From the very beginning, honeybee colonies have been good at using acacia flow in the best possible way. The objective of this paper is to examine the influence of moving hives as an important method in preparing honeybee colonies for acacia flow, in order to increase the total yield of honey in an apiary and at the same time to use good productive queen bees to a greater extent. The research was made in an experimental apiary of the Faculty of Agriculture in Banja Luka in April, May and July 2010. Twelve (12) hives were chosen for the research and divided in strong, medium and weak honeybee colonies. Strength of a honeybee colony was determined by the number of bees in a beehive and the percentage of surface area related to honey, pollen, bee nests as well as how many hive frames were occupied. As a condition for maximal readiness of honeybee colonies for the following acacia flow, colonies were fed with sugar syrup in the period from 6th April 2010 to 10th May 2010. During the experiment, the weather favoured the growth of the honeybee colonies. Based on the results, it can be concluded that the method of moving hives leads to an increase in the surface area of honey, pollen and bee nests, while the honeybee colonies remain strong. The number of scout bees in the colonies increased when additional colonies were added by the method of moving hives, which also increased productive results in the apiary. This practice is not very often used in the RS but it is very efficient and can be used all year long.

Key words: *acacia flow, honeybee colony, yield, moving hives*

Introduction

On the territory of the RS the beekeeping industry has been present for a long time. However, the number of beekeepers decreased in this area because young people today are not interested in this industry. There are 50 beekeeping associations with 130 000 hives registered in the RS (MAFW, 2010). The registered beekeepers in the RS produce 2 400 tons of honey per year if optimum conditions for collecting honey are satisfied (SORS, 2010). The false acacia is the most important honey plant on the territory of the Republic of Srpska. The false acacia is a deciduous tree originated in North America (Maceljski et al., 2001). The white flowers with strong fragrance hanging in loose clusters are congregated together. The flowers usually bloom from the beginning of May to the end of June, 40 to 45 days after the first signs of bud movement (Klašnja et al., 2011). An altitude, a type and a sunny area under the false acacia are crucial to the beginning of blossoming process. Consequently, two or even three false acacia flows can be used in one season, significantly increasing the yield of honey (Slijepac, 2015). The false acacia flowers secrete the strongest nectar at temperatures from 2°C to 25°C, when there is no wind, only morning dew and the temperature above 16°C. Daily bearing of this flow can be up to 15 kg of nectar and the total yield of one flow can be 70 kg honey per hive. Beekeepers should insist on preserving the available area under the false acacia and planting new trees. The false acacia is very sensitive to late spring frosts and sometimes the buds completely freeze, so that the flowering lack in some locations (Umeljić,

1999). Heavy rains in late autumn, heavy snowfalls in winter and enough sunny days in spring are conditions required for good honey (Vraštanović, 2013). From the very beginning honeybee colonies have to be good and strong at using acacia flow in the best possible way. All preparations have to be completed promptly in order to achieve that objective. If the phenological calendar states that the false acacia trees flower in an area on 10th May, the bees hatched from the eggs laid by the queen between 15th March and 25th April are going to participate in that flow (Zečević, 2011). At the end of winter and at the beginning of spring, daily temperatures begin to increase and the bees begin with their daily contact in the area, and thus the conditions are satisfied for the first inspection of honeybee colonies in detail. From that time, the total activity of bees and beekeepers has begun (Umeljić, 2010). The first spring flow starts with hazel flowers in February (Svatok, 2004). The equalization of bee colonies is made in April and May. If a beekeeper doesn't replace old combs before winter, then spring is the right time for replacing them (Belčić et al., 1989). In this period, space for expanding brood is created by demareeing (replacing honey supers) and the method of moving hives (replacing hives) is the most important method in preparing bees for flow in order to increase the yield of honey in an apiary.

Materials and methods

The research was carried out in an experimental apiary of the Faculty of Agriculture, the University of Banja Luka (RS, Bosnia and Herzegovina). Out of the total number of bee colonies 12 hives of the different strength were selected. The apiary was sheltered from the wind, surrounded by a fence and the hive entrances were faced south – south-east. The bee colonies in the experimental apiary were placed in LR - hives. During the research out of the total number of bee colonies 12 hives were selected and divided into strong, medium and weak bee colonies. The bee colony strength was determined by the number of bees in a hive and the percentage of surface area related to honey, pollen and bee nests, calculated in (dm²), as well as how many hive frames were occupied. The experiment was carried out in six inspections at the intervals of ten days. The research was carried out in April, May and June 2010. During the first inspection based on the surface of honey, pollen and bee nests, the equalization of the bee colonies was made in each group. All colonies were fed with sugar syrup prepared in the ratio of water to sugar (2:1) in order to instigate the queen for higher productivity, as a condition for maximal readiness of honeybee colonies for the following false acacia pasture in the period from 6th April 2010 to 10th May. The honeybee colonies were fed with 0.25 L of sugar syrup, fifteen times at the intervals of every second evening. Old and deformed honeycombs were taken away from the hives and replaced by comb foundations in order to reach the optimum readiness of honeybee colonies for the main flow and to satisfy the conditions favoured the entry of pollen, honey and development of brood. The method of moving was made within three groups according to which honeybee colonies divided into strong, medium and weak i.e. the replacement of hives between groups (strong with medium, strong with weak, medium with strong, medium with weak, weak with strong and weak with medium). When conducting research, the weather conditions prevailing in the area of Banja Luka (HSRS, 2010) favoured the spring development of bee colonies. The average temperatures in 2010 were 12C ° in April, 16.5C ° in May and 20.4C ° in June. The relative humidity was 71% in April, 72% in May and 75% in June. There were three sunny days in April, one sunny day in May and five sunny days in June. There were 17 rainy days in April, 18 rainy days in May and 14 rainy days in June.

Results and discussion

Based on the achieved results described in the table 1, it can be concluded that the number of scout bees decreased in bee colonies which were moved in medium and weak groups, and consequently the surface area of honey changed of (0.70 dm²). The result was higher compared to the unmoved honeybee colonies where the average value of the difference on the surface of honey was (-7.91 dm²). Those changes occurred because scout bees decreased, and therefore the surface of bee nests decreased as well as nurse bees changed their activity from processing pollen to processing honey.

Table 1. Surface area of honey expressed in dm²; Group – strong bee colonies

No. hive	Position of colonies	Initial state (dm ²)	Final state (dm ²)	Difference in value	Difference in honey surface (dm ²)
3.	Unmoved	11.37	5.36	-6.01	-7.91
10.	Unmoved	20.13	10.85	-9.82	
9.	Moved	13.99	13.09	-0.90	0.70
11.	Moved	21.46	20.96	-0.50	

Based on the achieved results described in the table 2, it can be concluded that the number of scout bees decreased in bee colonies which were moved in medium groups and weak groups, and consequently the surface area of pollen changed of (-3.74 dm²) which was smaller compared to unmoved colonies where the average pollen surface was (0.20 dm²). The number of scout bees decreased in moved colonies, and therefore the input of pollen also decreased but the consumption of pollen increased due to the necessity of feeding brood nest.

Table 2. Surface area of pollen expressed in dm²; Group – strong bee colonies

No. hive	Position of colonies	Initial state (dm ²)	Final state (dm ²)	Difference in value	Difference in pollen surface (dm ²)
3.	Unmoved	9.18	8.27	-0.91	0.20
10.	Unmoved	0.86	2.17	+1.31	
9.	Moved	6.13	2.58	-3.55	-3.74
11.	Moved	11.79	7.86	-3.93	

Based on the achieved results described in the table 3, it can be concluded that the number of scout bees decreased in colonies which were moved in medium and weak groups, and consequently the surface area of brood nest changed as seen in the figure (-12.95 dm²). The result was smaller compared to unmoved colonies where the average of change related to brood nest increased as seen in the figure (11.21 dm²). The number of scout bees decreased in moved colonies, the input of pollen also decreased, and consequently the surface of brood nest decreased. Because of the fact that the surface under brood nest decreased, nurse bees changed their activity from processing pollen to processing honey.

Table 3. Surface area of pollen expressed in dm²; Group – strong bee colonies

No. hive	Position of colonies	Initial state (dm ²)	Final state (dm ²)	Difference in value	Difference in brood nest surface (dm ²)
3.	Unmoved	22.33	30.66	+8.33	11.21
10.	Unmoved	15.76	30.66	+14.09	
9.	Moved	29.78	4.79	-24.99	-12.95
11.	Moved	17.51	16.59	-0.92	

Based on the research, it can be seen in the moving method of medium honeybee colonies that colonies moved in the strong group increased the number of scout bees but the number of scout bees decreased in the colonies moved in the weak group. As a result, the average surface of honey changed as seen in the figure of (17.73 dm²) which was higher compared to unmoved colonies as in the average surface of honey (-16.26 dm²). The number of scout bees increased during moving colonies in the strong group, but the number of scout bees decreased during moving colonies in the weak group as resulted in the change on the average surface of pollen (3.74 dm²) which was higher compared to unmoved colonies with the average of (-1.11 dm²). The number of scout bees increased during moving colonies in the strong group, but the number of scout bees decreased during moving colonies in the weak group as resulted in the change on the surface of brood nest (12.48 dm²). That was higher compared to unmoved colonies which had the average of brood nest (3.77 dm²). Moving hives led to an increase in the surface area of honey, pollen and nests but only where medium and weak colonies were moved into strong colonies. The number of scout bees increased when weak and medium colonies were installed in strong colonies, the input of pollen also increased and the queen bee was encouraged to expand brood nests.

Table 4. Surface area of honey expressed in dm²; Group - weak colonies

No. hive	Position of colonies	Initial state (dm ²)	Final state (dm ²)	Difference in value	Difference in honey surface (dm ²)
1.	Unmoved	19.68	7.85	-11.83	-6.91
7.	Unmoved	23.87	21.87	-2.00	
6.	Moved	6.08	26.71	+20.63	5.06
5.	Moved	10.93	0.43	-10.50	

Based on the achieved results described in the table 4, it can be seen in the example of colonies which were moved in medium and strong colonies that scout bees were added as resulted in the change on the average surface of honey (5.06 dm²) which was higher compared to unmoved colonies with the average surface of honey (-6.91 dm²).

Table 5. Surface area of pollen expressed in dm²; Group - weak colonies

No. hive	Position of colonies	Initial state (dm ²)	Final state (dm ²)	Difference in value	Difference in pollen surface (dm ²)
1.	Unmoved	6.80	6.53	-0.27	0.95
7.	Unmoved	11.79	13.96	+2.17	
6.	Moved	7.43	3.91	-3.52	-3.17
5.	Moved	10.22	7.40	-2.82	

Based on the achieved results described in the table 5, it can be seen in the example of colonies which were moved in the groups of medium and strong that scout bees were added as resulted in the change on the average surface of pollen (-3.17 dm²), which was smaller compared to unmoved colonies with the average pollen of (0.95 dm²).

Tabela 6. Surface area of brood nest expressed in dm²; Group - weak colonies

No. hive	Position of colonies	Initial state (dm ²)	Final state (dm ²)	Difference in value	Difference in brood nest surface (dm ²)
1.	Unmoved	5.66	10.06	+4.40	1.95
7.	Unmoved	5.25	4.36	-0.89	
6.	Moved	15.33	30.67	+15.34	17.31
5.	Moved	1.30	20.58	+19.28	

Based on the achieved results described in the table 6, it can be seen that scout bees were added during moving colonies moved in the groups of medium and strong. As a result the change on the surface of brood nest (17.31 dm²) appeared which was higher compared to the unmoved colonies where the average surface of brood nest was (1.95 dm²). The number of scout bees increased by moving and the conditions were satisfied for higher input of pollen. Increasing the surface of pollen made the preconditions for expanding the surface of brood nest and its feeding.

Conclusion

Based on the results in this research, it can be concluded that bee colonies, in which scout bees were added by the method of moving, produced the higher amount of honey and pollen. Adding scout bees in colonies brought the higher amount of pollen. Therefore, the production of honey increased and the bee queen was blocked. The colonies, where scout bees were taken by the moving method, produced less honey and pollen but more brood nests. In those colonies, queen bees tried to recover the number of lost scout bees by laying a greater number of eggs and the higher amount of pollen was used to feed young bees. Based on the results during the research, it is concluded that this apitechnal procedure can be recommended in achieving better results in the yield of honey and pollen, while the bee colonies still remain strong. Apart from the main bee colonies for producing honey, apiaries need to have additional colonies which can be used to increase the number of scout bees by the method of moving which can increase the production results.

References

- Belčić, J., Katalinić, J., Dragutin, L., Lončarević, S., Peradin, L., Sulimanović, Đ., Šimić, F., Tomašević, I. (1985) *Beekeeping [Pčelarstvo]* Nastavni Zavod Znanje, Zagreb.
- Klašnja, B., Orlović, S., Galić, Z., Novčić, Z. (2011) Institute for lowland forestry. *Physical and Structural Properties of Wood in Some False Acacia at Different Age [Fizičke i strukturne osobine drveta nekoliko klonova bagrema različite starosti]* Zbornik radova Topola, Novi Sad.
- Maceljčki, M., Mešić, A. (2001) Department of Agricultural Zoology, Faculty of Agriculture University of Zagreb. *Phyllonorycter robiniella Clemens (Lep. Gracillariidae)-New Pest of False Acacia in Croatia [Phyllonorycter robiniella Clemens (Lep. Gracillariidae)- novi štetnik bagrema u Hrvatskoj]* Agriculturae Conspectus Scientificus, Vol. 66 No. 4 pp. 225-230.
- MAFW (2010) Beekeepers' Database of the RS. Ministry of Agriculture, Forestry and Water Management.
- HSRS (2010) Database of the RS. Hydrometeorological Service of the RS.
- SORS (2010) Archive data on the beekeeping production in 2010. Statistical Office of the RS.
- Slijepac, D. (2015) *Possibility to use three acacia pastures*. VI International Scientific Agricultural Symposium. Agrosym 2015. p. 465.
- Svatok, T., Daljević, M. (2004) *Beekeeping at Weekends for Health Improvement [Pčelarenje vikendom u funkciji zdravlja]*. Nolit, Beograd.
- Umeljić, V. (1999) *In the World of Flowers and Bees [U svetu cveća i pčela]*. Štampa, Kragujevac.
- Umeljić, V. (2010) *Beekeeping: from a Beginner to a Professional [Pčelarstvo od početnika do profesionalca]*. Štampa, Kragujevac.
- Vraštanović, M. (2013) *Beekeepers' calendar [Pčelarski kalendar]*. Biznisklub, Beograd.
- Zečević, B. (2011) *Belgrade beekeeper [Beogradski pčelar]*. Beograd.

EFFECTS OF TANNIN-RICH EXTRACT (FARMATAN) ON GROWTH PERFORMANCE, CARCASSES AND MEAT QUALITY TRAITS OF FATTENING BOARS

Diana BILIĆ-ŠOBOT^{1*}, Marjeta ČANDEK-POTOKAR^{1,2}, Valentina KUBALE³, Dejan ŠKORJANC¹

¹University of Maribor, Faculty of Agriculture and Life Sciences, Pivola 10, 2311 Hoče, Slovenia

²Agricultural Institute of Slovenia, Hacquetova ulica 17, 1000 Ljubljana, Slovenia

³University of Ljubljana, Veterinary Faculty, Gerbičeva ulica 60, 1000 Ljubljana, Slovenia

*Corresponding author: diana.bilic@outlook.com

Abstract

In the past, tannins are often described to have negative effects on animals, such as feed intake depression and growth reduction, as they reduce digestibility of proteins and lower the activity of digestive enzymes. On the other hand, health enhancing properties, such as antibacterial, anti-parasitic, antioxidant, antidiarrheal and anticarcinogenic were also confirmed. The effect of tannin supplementation on growth performance, carcasses and meat quality traits of fattening boars was studied. A total of 51 entire males which were divided in four groups: control group (BEK-2, 12.9 MJ ME/kg, 15 % proteins with no tannin supplement, T0, n=12), and three groups feed with same diet supplemented with 1 % tannin Farmatan® (Tanin Sevnica d.d., Sevnica, Slovenia) supplementation (T1, n=13), 2 % tannin Farmatan® supplementation (T2, n=13) and 3 % tannin Farmatan® supplementation (T3, n=13) were studied. Boars were housed in group pens and the study was carried out respecting the Slovenian law on animal protection. Experiment started when boars reached approx. 60 kg of live weight, entered the fattening stage and received experimental diets. Increased body weight ($P < 0.002$) and daily gain ($P < 0.000$), was followed with addition of tannin supplementation. Addition of tannin supplementation increased carcass weight ($P < 0.005$) and for meat parameters, thawing ($P < 0.000$) and cooking ($P < 0.001$) loss was statistically decreased between T0 and T1, T2 and T3, whereas difference between T1 and T2 group was not noticed. Present results suggest that 3% tannin supplementation in boars diet had significant influence on body weight and daily gain, carcass and meat quality traits.

Keywords: *hydrolysable tannins; growth performance traits; carcass and meat traits; entire males*

Introduction

Tannins play a protective role in the crops defines to be eaten by herbivores (Jansman 1993). They are synthesized by a wide variety of plants and trees and several of these have been used as feeds or diet supplements. The response of ruminants and non-ruminants animals on tannins are lower feed intake, protein and dry matter digestibility's, live weight gains, milk yield and wool growth (Jansman et al. 1994a,b, Reed 1995). Tannins are known to have a astringent taste which reduces palatability and consequently negatively affect pigs voluntary feed intake and growth performance inhibits specific gastric enzymes (Murakami et al. 1992), lowers proteolytic enzymes activity in small intestine (Van Leeuwen et al. 1995), reduces protein digestibility (Smulikowska et al. 2001) and decrease the excretion of endogenous protein (Jansman et al. 1995). Potential effects of tannins were also reported from Mediterranean countries where they have extensive pork productions with a pigs diet rich in tannins, where acorns (*Quercus*) represents the main energy source (Cantos et al. 2003, Cappai et al. 2014). Also they use chestnuts (*Castanea sativa* Mill.) which are valued source of amino acids, minerals and fatty acids for free ranging pigs (Borges et al. 2008). For some

autochthonous breed such as Celta have traditional diet consist of chestnut fruit (*Castanea sativa*) lasted three months on the end of fattening period (Franco et al. 2006). Another traditional finishing system is known for Iberian pigs and it is based on grazing acorns and grass during autumn and winter (*montanera*) in the dehesa (*Quercus ilex* open woodlands) without any supplementary feed or mineral complement (Rodríguez-Estévez et al. 2011).

Some other authors, reported no effects of hydrolysable tannins on growth rate, carcass traits and meat quality with 0.2% of tannins in pig diet (Prevolnik et al. 2012). Influence of hydrolysable tannins on pigs and boars performance are scarce, resent published study from Čandek-Potokar et al. (2015) reported that diet supplemented with hydrolysable tannins with chestnut wood extract had no negative effect on growth performance for groups with 1% or 2% of added tannin, but a diet containing 3% resulted with reduced feed intake. The present study is aimed to evaluate the effects of hydrolysable tannins on growth performance, carcasses and meat quality traits on fattening boars.

Materials and Methods

The experiment was performed in commercial family farm in the eastern part of Slovenia, respecting the Slovenian law on animal protection (Uradni list Republike Slovenije 43/2007). Total of 51 entire male pigs (boars), which were divided in four groups: control group (without tannin supplement) (T0, n=12), treatment group with 1 % addition of tannin extract Farmatan® (Tanin Sevnica d.d., Sevnica, Slovenia) in the feed (T1, n=13), treatment group with 2 % addition of tannin extract Farmatan® in the feed (T2, n=13) and treatment group with 3 % addition of tannin extract Farmatan® in the feed (T3, n=13). The experiment start when boars has reach 55 kg of live weight (126 days of ages), entered the fattening stage and received experimental diets. Diet for control group was standard feed mixture for fatteners (BEK-2, 12.9 MJ ME/kg, 15 % proteins), whereas tannin supplemented pigs received standard diet with specified amount of added tannins. When boars reach slaughter weight 126.7 ± 13.3 kg (at approx. 200 days of age), experiment was ended, and boars were transported to the commercial abattoir.

Measurements of feed intake and body weight

The voluntary feed intake was recorded on group/pen basis. Boars were weighed at the beginning (at 53.0 ± 5.3 kg live weight) and at the end of experiment (at 126.7 ± 11.3 kg live weight) which lasted 77 days. Daily gain (individual) was calculated based on these two measurements and represents growth rate (g/day) for the experimental period. The feeding was monitored and the same quantity of feed was offered daily to all pigs.

Carcass and meat quality measurements

At slaughter line, carcass classification (lean meat content, %) was performed by the approved control organization, carcass weight was recorded and dressing percentage calculated as the percentage of carcass in relation to live weight. Samples of *longissimus dorsi* (LD) were taken at the level of last rib, for measurement od muscle and fat thickness, by the usual procedure approved in Slovenia. Basic parameters and measurements of pH were performed after 24 hours with glass electrode (MP120 Mettler-Toledo, GmbH, 8603 Schwarzenbach, Switzerland). Water holding capacity was measured using standard EZ-Drip loss method according to Christensen (2003). Thawing and cooking loos and shear force measurements were evaluated as described by Batorek et al. (2012). Minolta Chroma Meter CR-300 (Minolta Co. Ltd, Osaka, Japan) was used for colour measurements of CIE Lab colour parameters.

Statistical data processing

Data were analyzed using GLM procedures of the statistical software SAS (SAS Inc. Cary, USA). Data is presented as LS means with respective standard errors. The main effect of tannin supplement treatment was used in the statistical model for growth, carcass and meat characteristics,. GLM was used to evaluate differences among treatment groups and its traits. In case that *F*-test was significant ($P < 0.05$) differences between treatment groups were evaluated using Tukey test.

Results and discussion

Increased body weight, daily gain and carcass weight was followed with addition of tannin supplementation (Table 1). Boars from control group had lower body and carcass weight and daily gain in comprising with 1%, 2% and 3% treatment groups ($P < 0.05$). The results of previously published studies from Čandek-Potokar et al. (2015), reported significantly reduced feed intake in 3% supplemented group with Farmatan, likewise in study Lee et al. (2016), reduction of feed intake with chestnut tannins, was followed. In the study Štukelj et al. (2010), 0.15% of Farmatan addition in pigs, did not improve growth performance, but also was not violated.

Table 1. The effects of diet supplemented with tannin-rich extract (Farmatan) on growth performance and carcasses traits

Traits	Treatment group				<i>P</i>
	T0 (n=12)	T1 (n=13)	T2 (n=13)	T3 (n=13)	
Body weight, kg	117.9±4.2 ^a	125.4±2.3 ^a _b	129.7±1.7 ^b	133.2±2.3 ^b	0.002
Daily gain, g/day	0.8±0.04 ^a	0.9±0.03 ^b	1.1±0.02 ^b	1.1±0.03 ^b	0.000
Carcass weight, kg	88.1±3.3 ^a	93.7±1.5 ^{ab}	97.2±1.5 ^b	98.8±1.6 ^b	0.005
Dressing percentage, %	74.7±0.4	74.8±0.4	74.8±0.5	74.2±0.3	0.710
Muscle thickness, mm	6.6±0.6	7.5±0.5	9.1±0.8	9.1±0.8	0.179
Fat thickness, mm	64.2±0.4	63.5±0.5	62.7±0.6	62.8±0.6	0.030

P < 0.5 statistically significant differences between the treatment groups are denoted by different superscript letters. T0 = control group; T2 = 1% supplemented tannin; T3 = 3% supplemented tannin; T3 = 3% supplemented tannin.

Reports about influence of hydrolysable tannins as feed to fattening boars are scarce, but some reports of condensing tannins are examined.

Different addition of faba beans (FB) (hulled faba beans protein and starch concentration) 16% and 17.5% in barrows and gilts diet depress feed intake and daily gain (Gunawardena et al. 2010). Likewise condense tannins from *Acacia tortilis* (CTA) in high diet doses as pigs supplement, reduce growth performance (Khanyile et al. 2014, Ndou et al. 2015). In the diet for weaned pigs, addition of different concentration of FB (0.25, 0.5, 0.75 and 1.0 g/kg) did not affect the growth performance in trial (Emiola and Gous et al. 2011). Chemical composition of sweet chestnut such as, regions, cultivars, genetic diversity between cultivars and different concentration added in animals diet can affected growth performance (Pereira-Lorenzo et al. 2006). It is assumption, that growing pigs can have some mechanisms of neutralizing of toxic effect up to certain level (Čandek-Potokar et al. 2015). On the other side, in the study Rodríguez-Estévez et al. (2010) has been showed that, Iberian pigs were relatively resistant to a tannin-rich diet, which can be explained with the fact that proline rich proteins from salivary gland, have a good protective role.

Table 2. The effects of diet supplemented with tannin-rich extract (Farmatan) on meat quality traits

Traits	Treatment group				P
	T0 (n=12)	T1 (n=13)	T2 (n=13)	T3 (n=13)	
pH	5.3±0.2	5.4±0.2	5.4±0.1	5.4±0.1	0.247
Drip loss after 24h, %	9.8±0.9	8.6±0.7	9.3±0.5	9.8±0.7	0.582
Minolta L	57.8±1.4	54.2±0.7	55.1±0.6	56.8±1.5	0.076
Minolta a	7.1±0.4	7.5±0.3	7.2±0.3	7.7±0.4	0.583
Minolta b	2.6±0.3	2.5±0.2	2.5±0.3	3.2±0.5	0.445
Thawing loss, %	15.8±0.2 ^{ab}	13.1±0.4 ^a	14.1±0.3 ^a	18.2±0.8 ^b	0.000
Cooking loss, %	35.8±1.1 ^b	34.1±0.5 ^{ab}	33.4±0.3 ^a	32.2±0.5 ^a	0.001
WB shear force, N	156.6±25.3	149.4±6.1	132.7±9.3	125.3±14.4	0.313

P < 0.5 statistically significant differences between the treatment groups are denoted by different superscript letters. T0 = control group; T2 = 1% supplemented tannin; T2 = 3% supplemented tannin; T3 = 3% supplemented tannin.

Thawing and cooking loss were significantly reduced between treatment groups. Thawing loss was statistically different between control and 1%, 2% and 3% supplemented groups, where difference between 1% and 2% supplement groups were not noticed (Table 2). Meat quality parameters Minolta a, b and shear force were not statistically different (Table 2). In animals oxidative stress can cause the degradation of lipids and proteins as important factors that contribute to the deterioration of meat and meat products (Prevolnik et al, 2012). Tannins in pigs diet are demonstrated as potential ant-oxidative additives (Frankič and Salobir 2011), and in this trial Farmatan addition did not affect meat quality traits. Positive effects on meat tarts are reflected in reduced thawing and cooking loss % with Farmatan additions in boars diet, likewise in study Liu et al. (2012), where sweet chestnut supplementation increase cooking loss in rabbit meat.

The color of pork for human perception is linked with lightness, which is usually affected by pH and water holding capacity, whereas redness and chroma appear to be less important (Zanardi et al. 1999). In the current study, meat color parameters (L, a and b) were not affected by Farmatan supplementation, and results are in agreement with study Prevolnik et al (2012) and Liu et al. (2012).

Conclusions

Results from presented trial indicate that high concentration of hydrolysable tannins significantly improve growth performance, without effects on meat quality parameters, except for decreased thawing loss and increased cooking loss. It can be speculate that, high dosages of hydrolysable tannins had no negative effects on growth and fattening characteristics as it described in some prewise studies. Future investigations (with larger number of animals) need to confirm presented results.

Acknowledgement

The authors would like to thank for the financial support of Slovenian Research Agency (grant P1-0164, P4-0133 for core financing and project grant L4-5521) and Slovenian Ministry of agriculture, forestry and food. Diana Bilić-Šobot was supported by a doctoral fellowship from ERASMUS MUNDUS Action 2 - Strand 1 - Lot 6 Project *JoinEU-SEE IV*.

References

- Batorek, N, Škrlep, Š, Prunier, A, Louveau, I, Noblet, J, Bonneau, M, Čandek-Potokar, M. (2012). Effect of feed restriction on hormones, performance, carcass traits, and meat quality in immunocastrated pigs, *J. Animal Sci.*, (90), pp, 4593-4603.
- Borges, O, Gonçalves, Soeiro de Carvalho, J.L, Correia, P, Silva A.P. (2008). Nutritional quality of chestnut (*Castanea sativa* Mill.) cultivars from Portugal. *Food Chem.*, (106), pp, 976-984.
- Čandek-Potokar, M, Škrlep, M, Batorek, Lukač N, Zamaratskaia, G, Prevolnik Povše, M, Velikonja Bolta, Š, Kubale, V, Bee, G. (2015). Hydrolysable tannin fed to entire males affects intestinal production, tissue deposition and hepatic clearance of skatole. *Vet. J.*, (204), pp, 162-67.
- Cantos, E, Espín J.C, López-Bote, C, de la Hoz, L, Ordóñez, J.A, Tomás-Barberán, F.A. (2003). Phenolic compounds and fatty acids from acorns (*Quercus spp.*), the main dietary constituents of free-ranged Iberian pigs. *J. Agric. Food Chem.*, (51), pp, 6248-6255.
- Cappai, M.G, Wolf, P, Dimauro, C, Pinna, W, Kamphues J. (2014). The bilateral parotidomegaly (hypertrophy) induced acorn consumption in pigs is dependent on individuals age but not on intake duration. *Livest Sci.*, (167), pp, 263-268.
- Christensen, L.B. (2003). Drip loss sampling in porcine m. longissimus dorsi. *Meat Sci.*, (63), pp, 469-477.
- Emiola, I.A and Gous, R.M. (2011). Nutritional evaluation of dehulled faba bean (*Vicia faba* cv. Fiord) in feeds for weaner pigs. *S. Afr. J. Anim. Sci.*, 4, (2), pp, 79-86
- Franco I, Escamilla, M.C, García, J, Camino, G.F, Carballo, J. (2006). Fatty acid profile of the fat from Celta pig breed fattened using a traditional feed: Effect of the location in the carcass. *J Food Comp. Anal.*, (19), pp, 792-799.
- Frankič, T and Salobir, J. (2011). *In vivo* antioxidant potential of sweet chestnut (*Castanea sativa* Mill.) wood extract in young growing pigs exposed to *n*-3 PUFA-induced oxidative stress. *J Sci. Food Agric.*, (91), pp, 1432-1439.
- Gunawardena, C.K, Zijlstra, R.T, Goonewardene, L.A, Beltranena, E. (2010). Protein and starch concentrates of air-classified field pea and zero-tannin faba bean for weaned pigs. *J. Anim. Sci.* (88), 8, pp, 2627-2636.
- Jansman, A.J.M, Frohlich, A.A, Marquard, R.R. (1994b). Production of proline-rich proteins by the parotid glands of rats is enhanced by feeding diets containing tannins from faba beans (*Vicia faba* L.). *J Nutr.*, (124), pp, 249-258.
- Jansman, A.J.M, Verstegen, M.W.A, Huisman, J, Berg van der, J.W.O. (1995). Effects of hulls of faba beans (*Vicia faba* L.) with a low or high content of condensed tannins on the apparent ileal and fecal digestibility of nutrients and the excretion of endogenous protein in ileal digesta and feces in pigs. *J. Anim. Sci.*, (73), pp, 118-27.
- Jansman, A.J.M. (1993). Tannins in feedstuffs for simple-stomached animals. *Nutr. Res. Rev.*, (6), pp, 209-36.
- Khanyile, M, Ndou S.P, Chimonyo, M. (2014). Influence of Acacia tortilis leaf meal-based diets on growth performance of pigs. *Livest. Sci.*, (167), 1, pp, 211-218.
- Liu, H.W, Zhou, D, Tong, J.M, Vaddella, V. (2012). Influence of chestnut tannins on welfare, carcass characteristics, meat quality, and lipid oxidation in rabbits under high ambient temperature. *Meat Sci.*, (90) 1, pp, 164-169
- Murakami, S, Muramatsu, M, Otomo, S. (1992). Inhibitory effect of tannic-acids on gastric H⁺, K⁺-ATPase. *J Natur. Prod.*, (55), pp, 513-16.
- Ndou, S.P, Khanyile, M, Chimonyo, M. (2015). Growth performance and nutrition-related serum metabolites in growing pigs fed on Acacia Tortilis leaf meal. *Livest. Sci.*, (182), pp, 22-27.

- Pereira-Lorenzo, S, Ramos-Cabrera, A.M, Díaz-Hernández, M.B, Ciordia-Ara, M, Ríos-Mesa, D. (2006). Chemical composition of chestnut cultivars from Spain. *Sci. Hortic.*, (107), 3, pp, 306-314.
- Prevolnik, M, Škrlep, M, Brus, M, Pugliese, C, Čandek-Potokar, M, Škorjan, D. (2012). Supplementing pig diet with 0.2% sweet chestnut (*Castanea sativa* Mill.) wood extract had no effect on growth, carcass or meat quality. 20th International Symposium „Animal Science Days“, Kranjska gora, Slovenian., (3), pp, 83-88.
- Reed, J.D. (1995). Nutritional toxicology of tannins and related polyphenols in forage legumes. *J. Anim. Sci.*, (73), pp, 1516-1528.
- Rodríguez-Estévez, V, Sánchez-Rodríguez, M, García, A, Gómez-Castro, AG. (2010). Feed conversion rate and estimated energy balance of free grazing Iberian pigs. *Livest. Sci.*, (132), 1-3, pp, 152-156.
- Rodríguez-Estévez, V, Sánchez-Rodríguez, M, García, AR, Gómez-Castro, AG. (2011). Average daily weight gain of Iberian fattening pigs when grazing natural resources. *Livest. Sci.*, (137), pp, 292-95.
- Smulikowska, S, Pastuszewska, B, Świąch, O, Ochtabińska, A, Mieczkowska, A, Nguyen, V.C, Buraczewska, L. (2001). Tannin content affects negatively nutritive values of pea for monogastrics. *J Anim. Feed Sci.* (10), pp, 511-23.
- Štukelj, M, Valenčak, Z, Krsnik, M, Nemeč Svete, A. (2010). The effect of the combination of acids and tannin in diet on the performance and selected biochemical, haematological and antioxidant enzyme parameters in grower pigs. *Acta Vet. Scand.*, (52), 19, pp, 1-8.
- van Leeuwen, P, Jansman, A.J, Wiebenga, J, Koninkx, J.F, Mouwen, J.M. (1995). Dietary effects of faba-bean (*Vicia faba* L.) tannins on the morphology and function of the small-intestinal mucosa of weaned pigs. *Brit. J. Nutr.*, (73), 1, pp, 31-9.
- Zanardi, E, Novelli, E, Nanni, N, Ghiretti, G.P, Delbono, G, Campanini, G, Dazzi, G, Madarena, G, Chizzolini, R. (1998). Oxidative stability and dietary treatment with vitamin E, oleic acid and copper of fresh and cooked pork chops. *Meat Sci.*, (49) 3, pp, 309-320.

THE RATE OF INFECTION OF DOMESTIC AND WILD CARNIVORES BY TAENIA HYDATIGENA CESTODES IN KABARDINO-BALKARIA

Amina THAKAHOVA^{1*}, Vera BEREZKO¹, Asiyat BITTIROVA²

¹All-Russian scientific research institute of fundamental and applied parasitology of animals and plants of name
K.I. Scriabin, Russia, Moscow

²Kabardino-Balkarian State Agricultural University named after V.M. Kokova, Russia, Nalchik

*Corresponding author: amina7161@yandex.ru

Abstract

The results of monitoring of rates of infection by *Taenia hydatigena* in domestic and wild carnivores were given. Our work revealed the widespread prevalence of the infection both in domestic and wild canids (wolves, jackals, foxes). In 2011-2015 15 domestic, 43 stray and 33 pasture dogs were examined by the method of complete helminthological autopsy. All these dogs (irrespective of their keeping conditions or economic purpose) were infected by *Taenia hydatigena* and the extensity of infection (EI) was very high. The highest EI was registered in stray dogs (100%) and pasture dogs (94%); in domestic dogs EI was slightly lower (73.3%). The analysis of the rate of infection by *Taenia hydatigena* in 27 wolves, 38 jackals and 21 foxes was carried out by a similar method. EI in these animals was 29.6; 36.8 and 23.8%, respectively. It was found that dogs aged 1 to 4 years were most susceptible to infection by *Taenia hydatigena*; the high EI was maintained all year round and no marked seasonal changes were observed. Nevertheless, it was possible to note a slight increase of infection rate in the fall. It was connected with a period of mass slaughter of sheep and uncontrolled feeding dogs by animal organs infected by *Taenia hydatigena* larvae, which aggravated epizootological situation. The obtained results allow us to conclude that concerning this helminthosis the epizootological process is developing dynamically. High rates of infection in stray dogs and pasture dogs (in presence of their intermediate hosts – sheep or other farm animals) provide not only dynamics, but also biological activity and protection of parasitic system for a long time.

Keywords: *Taenia hydatigena*, domestic and wild carnivores, infection, epizootology

Introduction

Taenia hydatigena infection in dogs is widely spread in the Russian Federation. One has recorded that 80-100% of stray dogs in the Volgograd Region are infected with *T. hydatigena* [1]. In the Rostov Region *T. hydatigena* infection extensity (EI) among stray dogs varies 60% to 80% [6] and in the Kuban the value of EI reaches 70% to 100% with intensity of infection (II) - 2-6 specimens/animal according to the data of Mitnikova O.V. One notes 100% *T. hydatigena* infection rate in herding dogs in Kalmykia [3]. There are some data on the high infection level in dogs from different sheep farms with helminths attributed to the family *Taeniidae* [5]. Taking into account such situation the purpose of our study has been to determine *T. hydatigena* infection rates among domestic and wild carnivores in the Kabardino-Balkar Republic.

Materials and Methods

T. hydatigena infection prevalence in dogs was studied based on animal's maintenance and practical application. The small intestines of domestic, stray and herding dogs (15, 43, 33 dogs respectively) were subjected to helminthological necropsy.

The infection extensity and intensity values were estimated based on the results of helminthological necropsy of small intestines followed by statistical analysis and calculation of mean values. 27 wolves, 38 jackals and 21 foxes have been examined in the same way.

Results and Discussion

Based on the results of necropsy 11 of 15 domestic dogs were infected with *T. hydatigena* what appeared to be 73,3%. The infection extensities in stray and herding dogs were 100% and 94,0% respectively. The results of those experiments revealed that dogs used in sheep husbandry in that region were infected with *T. hydatigena* practically with the equal high infection rates (73,3%-100%), what evidenced about an insignificant effect of dog maintenance on their infection rates (Table 1).

In the conditions of complete absence of scheduled dehelminthization and sanitary norms dogs infected with *T. hydatigena* and other cestodes can represent a significant epizootological danger not only for sheep but also for other farm animals.

Table 1
Comparative rates of *Taenia hydatigena* infection in domestic, stray and herding dogs

Examined dogs	Number of necropsied dogs	Number of dogs infected with <i>Taenia hydatigena</i>	Extensity of infection, %	Intensity of infection, specimens/animal	Number of eggs per <i>Taenia hydatigena</i> proglottid, specimens
Domestic	15	11	73,3	2,80±0,50	800±20,0
Stray	43	43	100	3,40±0,27	1030±25,8
Herding	33	31	94,0	3,81±0,13	922±18,6

Based on the results of necropsy in addition to the study of *T. hydatigena* infection extensity in dogs we determined the intensity of infection, which varied 1 to 5 specimens/animal in domestic dogs as while the same indices in stray and herding dogs appeared to be 1 to 9 and 1 to 7 specimens/animal respectively. The number of eggs per one excreted proglottid was 800±20,0; 1030±25,8 and 922±18,6 eggs respectively (Table 1).

These results confirm the high biological and epizootological potential of *T. hydatigena* providing the stability of natural infection foci. In general stable maintenance of natural infection foci can be the result of sheep owner and herder sanitary incompetence as they feed all affected organs of slaughtered sheep to dogs.

As the diagnostic surveys on *T. hydatigena* prevalence in dogs are conducted irregularly and in some regions are not carried out at all, it is difficult to evaluate the epizootological situation without account of such indices as seasonal and age dynamics of infection. Therefore, we studied the seasonal and age dynamics of *T. hydatigena* infection in dogs and estimated that dogs aged 1-4 years appeared to be the most susceptible to this helminth infection. The infection extensity in dogs of that age was in the range of 79,3%-88,6%. The highest infection rate (88,6%) was recorded in puppies aged under 1 year. In dogs older than 7 years the extensity of infection did not exceed 22,7%. Nevertheless the results of epizootic monitoring revealed that in recent years the situation on *T. hydatigena* infection among dogs of all age groups had deteriorated significantly, what was indirectly confirmed by a significant rate of *T. hydatigena* larvae infection in sheep originated from different farms in that region [2].

Table 2
Taenia hydatigena infection rates in dogs depending on the age according to the results of necropsy

Dog's age	Number of dogs examined in the period of 2011 to 2015	Number of dogs infected with <i>T. hydatigena</i>	Infection extensity, %
Under 1 year	79	70	88,6
Under 2 years	108	93	86,1
Under 4 years	82	65	79,3
Under 6 years	29	11	37,9
Under 7 years and older	22	5	22,7

The highest rate of *T. hydatigena* infection in dogs was observed in winter and spring. During the period of 2011–2015 the level of *T. hydatigena* infection prevalence in dogs increased depending on the season: in winter – by 2,3 times; in spring – by 2,4 times; in summer – by 3,2 times; in autumn – twice respectively what characterized the epizootological process of infection as dynamically growing one with a stationary stable biological mechanism. The high level of that helminth infection in dogs was recorded practically all year round and no clear seasonality for that infection was noted. Although the characteristic epizootological feature of *T. hydatigena* infection in the region is infection of dogs in autumn when the mass slaughtering of sheep and uncontrollable feeding of internal organs of slaughtered sheep infected by larval cysts to dogs occur.

In wild carnivores the infection extensity and intensity values were relatively lower compared with dogs what was due to the smaller number of infected animal organs (sources of infection) come into their feed.

Over the whole research period (2011-2015) 27 wolves, 38 jackals and 21 foxes were subjected to helminthological necropsy. According to the results of necropsy *T. hydatigena* infection extensities in wolves, jackals and foxes were 29,6%; 36,8% and 23,8% respectively; the indices of infection intensity appeared to be 1-2; 1-3 and 1-2 specimens/animal respectively which were comparably lower than in dogs.

Table 3
Indices of *Taenia hydatigena* infection in wild carnivores

Animal species	Number of necropsied animals	Number of animals infected with <i>T. hydatigena</i>	Extensivity of infection, %	Mean intensity of infection, specimens/animal	Number of eggs per one <i>Taenia hydatigena</i> proglottid, specimens
Wolf	27	8	29,6	1,75±0,5	1236±27,4
Jackal	38	14	36,8	2,1±0,2	1420±24,4
Fox	21	5	23,8	1,6±0,2	1183±25,7

However the number of *T. hydatigena* eggs per one proglottid was higher in wolves, jackals and foxes than in dogs (1236±27,4; 1420±24,4 and 1183±25,7 eggs respectively) what evidenced about a high biological activity and reproductive capacity of *Taenia* in wild carnivores (Table 3).

Conclusions

The results of monitoring revealed the wide prevalence of *T. hydatigena* infection in dogs at the territory of the Kabardino-Balkar Republic. The high extensivity level of *T. hydatigena* infection (73,3%-100%) was recorded in dogs applied in sheep husbandry. In wolves, jackals and foxes infection extensivities were 29,6%; 36,8% and 23,8% respectively; as while the infection intensity values appeared to be 1-2; 1-3 and 1-2 specimens/animal. In addition one noted a tendency over the last 5 years for increase of infection rates by 2,5 times. The highest rate of *T. hydatigena* infection in dogs was observed in winter and spring. However no exact seasonality of that infection in dogs had been noted as infection with *T. hydatigena* was possible all year round what characterized the epizootological process of infection as a dynamically growing with a stable stationary biological mechanism. The high rate of *T. hydatigena* infection in dogs was provided by increasing of stray dog population and absence of sanitation and hygiene education of the population.

References

1. Averin V.A. Biogeography of cestode *Taenia hydatigena* in herding and stray dogs under conditions of Volga delta pastures in the Volgograd Region. Bulletin of Veterinary Medicine. Kostroma, 1998, N 3, pp. 28-31.
2. Berezhko V.K., Thakahova A.A. *Cysticercus tenuicollis* infection in sheep from farms of the Kabardino-Balkar Republic, serological monitoring of infection. Veterinary Pathology, 2015, N. 2, pp. 34-41.
3. Durdusov S.D. Epizootology of helminthoses of sheep and cattle in the arid zone of the Kalmykia and control measures. Abst. doct. diss. vet. sci., Moscow, 1999. 41 p.

4. Mitnikova O.V. Seasonal and age dynamics of *Taeniidae* infections in dogs in the Krasnodar Region. Proc. All-Russ. Sci. Res. Inst. of Expr. Vet. Med. named after Ya. R. Kovalenko, RAS, 1995, vol. 67, pp. 59-62.
5. Thakahova A.A. Serological monitoring of cystic echinococcosis and *Cysticercus tenuicollis* infection in sheep in the Kabardino-Balkarian Republic. Abst. doct. diss. biol. sci., M., 2013. 26 p.
6. Shipilin S.N. Biogeographical review and *Taenia hydatigena* infection rates in stray dogs in the Rostov Region. Scientific Notes of the Rostov State University, 1994, no. 75, part 1, pp. 111-112.

IMPORTANCE OF HUMAN RESOURCES ACTIVITIES IN THE FISH MEAL AND FISH OIL FACTORIES IN THE LIGHT OF TECHNOLOGICAL DEVELOPMENTS

Günseli ACAR^{1*}, Şennan YÜCEL²

¹ Sinop University, Ayancık Vocational College, Sinop, Turkey

² Sinop University, Faculty of Fisheries, Department of Fisheries Basic Science, Sinop, Turkey

*Corresponding author: gunseli26@hotmail.com

Abstract

Nowadays, the technological progress is affecting many industries. One of them is the aquaculture industry. In this study, it is aimed to exert the significance of the human resources in the production of the fish meal and fish oil factories which is an important component of the aquaculture industry in order to be adequate both by quality and by quantity for the social necessities and based on the science and modern technologies. The population of the survey is composed of the owners of fish meal and fish oil factories operating in Turkey, professional managers and other employees in these factories. In this research, with questionnaire method, data gathering is provided. Descriptive statistical methods have been used for the purpose of determining the relationships among the variables. Regarding sex, 16% of the employees involved in research are female; employers/managers are all male. In companies, considering the question whether there is a separate department carrying out human resources activities it is found that 44% of companies have human resources department and 23% of companies perform this function through administrative department. Male employers/managers consider themselves as persons using technology in about 73%. To hire new staff in business, a priority criterion is recruitment of staff to implement technological improvements. It is assumed that the technological progress and the human resources can be used more effectively with the help of implementing theory based on information acquired from research findings. Like any other industry, the most important resource for the fisheries and aquaculture industry to stay sustainable and be in competition with the other industries, is the qualified human resources. Thus, it is suggested that the education and training of the human resources should be an event of special interest.

Keywords: *Fish meal and fish oil factories, technology, human resources management.*

Introduction

Unprecedented technological developments and changes of today affect culture of societies, life style and socio-economic situation. Working life is also reshaped the in the light of these developments.

Technology has led to extinction of some profession groups and caused emergence of some professions and jobs. In particular, professions requiring mostly physical activity have been y machines. Therefore, companies ensure competitive edge with technology and employees using technology. For this purpose, the technology and human resource management must be utilized efficiently.

In this context, reviewing the structure of traditional organizations and taking advantage of modern management techniques managers create new policies to improve efficiency and effectiveness of human resources. These activities related to human resources of companies are dealt with human resources management.

There are many relations be it direct or indirect between technological developments and human resource management practices. With impact of technological developments

sometimes it may be necessary to make radical changes in human resources function (Küçükköseleci, 2009).

To get most effective benefits from human resources, primarily it is necessary to make a rational human resources planning in organization (Ekinçi, 2008). While making this planning technological advances should be used in recruiting and employment process and this planning activity should be at a level that can provide a competitive advantage against other companies. In addition, it is necessary to organize training activities for existing employees and new employees participating to company in order to follow developments in modern business world and in the sector and to improve their qualifications. Necessary works should be performed for employees to use knowledge they gained in trainings and to interpret results of these trainings.

In this study, the technological developments in the aquaculture industry and its impact on human resources activities aimed to reveal the importance of these activities.

Material and Methods

The research population is formed of owners of fish flour and oil factories in Turkey, professional managers and other employees. Survey data collection method has been adopted. At the time of the survey (in July 2014), it has been found 15 factories in the Ministry's list. There weren't active two of them. The questionnaire was conducted with other factories of employers / professional managers (15 people) and employees (43 people) .

In the study, employers / professional managers and employees to different questionnaires were administered. Employer / professional manager applied to questionnaire consists of 38 questions. The first 8 questions include demographic factors.

Employee questionnaire consists of 29 questions. The first 8 questions include demographic factors.

The reliability of questionnaires were tested. The data gathered was tested with SPSS 21 ve Minitab 16 Pocket Programmes. Descriptive statistical methods were used in determination of relationship of variables with each other.

Results and Discussion

Questionnaire was applied to employees, employers/managers separately. 1 male and 16% of employees were women. When education status was investigated; 6% of employers/managers had primary education and 40% had university graduates and there is no employer/manager without education. 2% of employees don't have education, 28% have primary school and 51% have secondary school and 7% have undergraduate and 12% have university education. 50% undergraduates were aquaculture engineer.

Age distribution of employers/managers was as 33% 26-35 years, 7% 36-45 years, 40% 46-55 years, and 20% 56 years and above. 11% of employees are 18-25 years, 40%, 26-35 years, 35% 36-45 years, 12% 46- 55 years and 2% 56 and above.

In companies, considering the question whether there is a separate department carrying out human resources activities it is found that 44% of companies have human resources department and 23% of companies perform this function through administrative department.

It is determined that in recruitment advices of acquaintances were effective primarily (31%), secondly Work and Employment Authority (24%) was effective. On the other hand, it was found that no support was obtained from human resources consulting companies (Table 1).

Keklik (2007) in her research on SMEs; the usage of internet was found out to be the least preferred method of candidate selection.

İrez (2009), has identified the impact of technological developments to provide human resources and selection process. benefit from the technology level of the survey respondents is not related to the sectors in which they apply. In addition, respondents have been found to be

a meaningful difference between age and job applicants in the to benefit from technology levels.

Table 1. Resources used by companies in recruitment

<i>Resources</i>	<i>%</i>
Listing and announcements	20
Human resources consulting companies	-
Internet	10
Turkey Work and Employment Authority	24
Professional institutions and education institutions	5
Advices of acquaintances	31
Other	10

*Source: Author's elaboration based on the questionnaire survey results.

While 22% of employers/managers specified that they didn't make any change in recruitment and selection strategies, 30% specified that spread of new technology was effective in determining personnel selection and recruitment strategy.

Despite all these, when employers/managers compare period when they started working and today they put forward that today more quipped and qualified personnel are employed (87%).

It is understood that in companies among criteria used for selection of new employees primary criterion is personnel able to apply technological developments (26%).

When employees assessed their levels of information technology 37% of them described themselves as moderate, 40% as adequate and 14% as expert. 19% of employees received training on the use of technology in their workplaces.

In the aquaculture industry, almost all of the employees seem to prefer to benefit from new technology. This situations important for universities and also sectors.

On the other hand, expertise and work of 40% of managers are not related to each other.

Achieving the expected benefits from technology is proportional to personnel who use it. Legislation should be made for stipulating in-house training mandatory about forcing employers/managers to work in their expertise area and use of technology by employees. Thus, "dismissal fear" of 28% of employees will be eliminated and employees will work with peace of mind and work peace will be reinforced.

Employers/Managers specify that through the use of new technologies in addition to formation of new departments in companies, work accidents and occupational diseases will be reduced and employee performance will increase (Table 2).

Table 2. Opinions of employers / managers and employees on use of technology

	Employer/Manager		Employees	
	<i>I disagree (%)</i>	<i>I agree (%)</i>	<i>I disagree (%)</i>	<i>I agree (%)</i>
Technological change has resulted in the formation of new departments in company.	7	93	-	-
Technological developments reduced occupational accidents.	13	87	-	-
Technological developments reduced the occupational diseases.	7	93		
Using new technology and machines in company makes a positive impact on my performance.	-	-	14	86

*Source: Author's elaboration based on the questionnaire survey results.

Conclusion

In this study it is aimed to disclose importance of human resources in ability of production in fish flour and oil factories as one of the important components of fishery sector to satisfy social needs based on modern science and technology in terms of quality and quantity. Furthermore, this study is also important as an example of interdisciplinary cooperation. It is believed that it is possible to utilize technology and human resources more effectively by application of theoretical knowledge derived from research findings. As in all sectors it is advised that growing fully qualified staff is the most valuable resource to ensure the sustainability and increase competitiveness in fishery sector. Employee job descriptions should be made within the system, powers should be increased, ergonomic work environment must be created and salaries should be improved taking into account economic structure of the country and sector. Moreover, it is recommended to take measures for occupational health and safety under the legislation, training staff about new technologies and other issues and improvement of career management for continuation of service of qualified staff in company.

References

- Ekinci, F. (2008). Kamu Personel Yönetiminden İnsan Kaynakları Uygulamasına Geçişin Çalışanların Verimliliğine Etkisi. *Maliye Dergisi*, July-December 2008 ,No 155, pp. 175-185.
- İrez 2009. The Effects Of Technological Progress To The Process Of Recruitment And Selection Of Human Resources And An Application. Master Thesis. Gazi University Institute of Educational Sciences, Ankara, 124 p.
- Keklik, B. 2007. Efectiveness of Techniques Used to Employ Human Resources: A Research in SME's and Model Proposal. PhD Thesis, Süleyman Demirel University Institute of Social Sciences, Isparta, 239 p.
- Küçükköseleci, E. 2009. The Effect of Technological Improvements to the Functions of Human Resources Management and a Research. Master Thesis. İstanbul University Institute of Social Sciences, İstanbul, 247 p.

EFFECT OF NON-GENETIC FACTORS ON 305-DAYS MILK YIELD IN SIMMENTAL COWS REARED IN SUBTROPICAL CLIMATE CONDITION

Yahya ÖZTÜRK^{1*}, Memis BOLACALI²

¹ Mehmet Akif Ersoy University, Burdur Vocational School, Program of Meat and Meat Products, Burdur, Turkey

² Siirt University, Faculty of Veterinary Medicine, Department of Animal Husbandry, Siirt, Turkey

*Corresponding author: yozturk@mehmetakif.edu.tr

Abstract

This study was carried out to determine 305-days milk yield of Simmental cows grown in a private farm in Çorum private center (Black Sea Region of Turkey) which is classified as subtropical climate region according to Trewarta climate classification and as CSB according to Köppen-Gieger system, and to investigate effects of non-genetics factors on these parameters. For this purpose, a total of 1904 lactations records of 706 Simmental cow raised at Çorum province particular farm between 2001 and 2014 were used. Eight age groups were formed beginning from 2 years and ending 9 years and older for calving age, 4 groups for calving season, 14 groups (between 2001 and 2014) for calving year, 2 groups for birth type, and 2 groups for parity. The 305-days milk yield was estimated from milk yields. To determine non-genetic effects of calving years, lactation number, calving season, calving age, birth type, and parity on 305-days milk yield, general linear model was applied by using SAS program. Duncan's multiple range tests was used for multiple comparisons in important subgroups. In this research, 305-days milk yield were detected as 6060.30 kg. The effect of calving year, lactation number, calving age, birth type and parity on 305-days milk yield were statistically determined with different levels of significance ($P < 0.001$, $P < 0.05$, $P < 0.05$, $P < 0.05$, $P < 0.001$, respectively); but the effect of calving season on 305-days milk yield was statistically determined non-significant ($P > 0.05$). Consequently, when Simmental cows are applied ideal growing conditions and care-feeding, milk yield parameters at world standards can generally be obtained in subtropical climates.

Keywords: *Simmental cow, 305days milk yields, non-genetic factors.*

Introduction

Cattle population of Turkey is approximately 14.2 million based on 2015 TÜİK's animal data. Total number of cattle milked is approximately 5.5 million and amount of milk produced per year is about 16.9 million tons/year. Approximately 82.6% milk produced in World and 90.77% milk produced in Turkey come from cattle (TÜİK 2016; FAO, 2016). Even though Turkey has been ranked as 23rd in the Word in terms of number of cattle owned, Turkey has been ranked as. 63.rd in terms of productiveness (FAO, 2016). To improve animal production, in addition to improving animal genetics, it is also important to provide optimum environmental conditions for animals.

The Simmental cattle breed is one of the oldest and most widely spread of all cattle breeds in the world. And an official herd book opened in 1806, the total numbers are estimated between 40 and 60 million Simmental cattle worldwide, with more than half in Europe (Huyghe et al., 2014).

Genetic and environmental factors have great impact on milk yield. Environmental factors can be listed as lactation period, calving season, dry period, body weight, nutrition, calving age, estrus, pregnancy, ambient temperature and etc. (Alpan and Aksoy, 2009; Özbeyaz and Küçük 1999).

This study was carried out to determine 305-days milk yield of Simmental cows grown in a private farm in Çorum private center which is classified as subtropical climate region according to Trewarta climate classification and as CSB according to Köppen-Gieger system, and to investigate effects of non-genetics factors on 305-days milk yield.

Material and Methods

A total of 1904 lactations records of 706 Simmental cow raised in a private farm at Çorum province. Cows (Black Sea Region of Turkey) were milked twice a day.

Lactation days less or more than 305 days were adjusted for 305-day lactation. An adjustment factor has been applied for lactation days less or more than 305 days. Lactation milk yields of cows that were culled off without any reason (such as sickness etc.) were assumed as 305 lactation milk yield. Then, standard 305-day lactation milk yield were adjusted according to mature age using calculated correction factors based on age and twice milking for Simmental breed cows (Çilek and Tekin, 2006).

General linear model of SAS program (SAS, 1998) were applied to determine non-genetic effects of calving years, lactation number, calving season, calving age, birth type, and parity on 305-d milk yield.

Following model was used for milk yield traits. The model: $Y_{ijklmno} = \mu + Y_i + L_j + S_k + A_l + B_m + D_n + e_{ijklmno}$ was used to analyze effective factors on milk yield and where: μ = mean milk yield traits of Simmental cow population, Y_i = effect of calving years ($i = 2001, 2002, \dots, 2014$), L_j = lactation number ($j = 1, 2, \dots, 8$), S_k = effect of calving season ($k =$ winter, spring, summer, autumn), pA_l = effect of calving age ($l = 2, 3, 4 \dots 9$), B_m = effect of birth type ($m =$ single, twin), D_n = effect of parity ($n =$ heifer, cow), $e_{ijklmno}$ = error term. It was assumed that there was no significant interaction among evaluated factors and the sum impact of factors on their sub-group was zero.

Results and discussion

Least square means, significance and multiple comparison test results for 305-d milk yield of Simmental cows are presented in Table 1. Mean 305-day lactation milk yield was 6060.30 kg.

Table 1. Least squares means, significance and multiple comparison test results belong to 305-day milk yield.

Factors	n	305-Day Milk Yield (kg)		Factors	n	305-Day Milk Yield (kg)	
		$\bar{X} \pm S \bar{x}$				$\bar{X} \pm S \bar{x}$	
<i>Overall Mean</i>	1904	6060±33.0		<i>Overall Mean</i>	1904	6060±33.0	
<i>Year of calving</i>		***		<i>Lactation Parity</i>		*	
2001	13	4420±385.1 ^f		1 st	607	6059±262.8 ^{bc}	
2002	14	5126±372.3 ^{de}		lactation	484	6301±202.3 ^{ab}	
2003	29	5192±265.1 ^e		lactation	334	5930±174.9 ^a	
2004	37	5253±236.0 ^{de}		lactation	179	5700±166.4 ^a	
2005	168	5285±127.4 ^{ed}		lactation	125	5555±187.3 ^{ab}	
2006	180	5699±122.6 ^{bcd}		lactation	101	5314±224.3 ^{bc}	
2007	185	5525±118.3 ^{cde}		lactation	47	5042±301.6 ^c	
2008	156	5599±125.6 ^{cde}		lactation	27	5486±421.0 ^{ab}	
2009	177	5950±123.4 ^{bc}		<i>Age at calving</i>		*	
2010	153	6631±130.3 ^a		2	575	5025±273.7 ^c	
2011	219	6174±119.0 ^{abc}		3	439	5084±221.6 ^{abc}	
2012	187	5935±126.0 ^{bc}		4	310	5593±199.0 ^{ac}	
2013	237	6254±112.7 ^{ab}		5	202	5910±185.4 ^a	
2014	149	6382±136.4 ^a		6	142	6092±179.5 ^{ac}	
<i>Season of calving</i>		NS		7	122	6031±202.4 ^{bc}	
Spring	536	5642±99.7		8	70	5853±257.0 ^c	
Summer	515	5577±101.4		9	44	5797±331.9 ^c	
Autumn	415	5747±102.7		<i>Birth Type</i>		*	
Winter	438	5727±101.7		Single	1765	5827±69.4 ^a	
<i>Parity</i> [#]		***		Twin	139	5520±130.1 ^b	
Heifers	607	5798±58.0					
Cows	1297	6183±39.7					

NS: Non-Significant (P>0.05); *: P<0.05; **: P<0.01; ***: P<0.0012

a, b, c, d, e, f: Subscripts with different letters within columns significantly (P<0.05) differ.

[#]Heifers (parity 1) or cows (parity ≥2); for example, a gestation that produced a second calving is parity 2.

In this study, adjusted 305-day lactation milk yield was 6060.30 kg. The effects of calving year (P<0.001), lactation parity (P<0.05), calving age (P<0.05), birth type (P<0.05) and parity (P<0.001) on 305-day lactation milk yield were significant but the effect of calving season were not significant (P>0.05). The results of the current study were in agreement with the results of Çilek and Tekin (2005), and Pantelić et al (2010); Petrović et al., (2015); Çilek and Tekin (2005); Özkan and Güneş (2011) regarding the effects of calving year, lactation parity, calving age and birth type, calving season on 305-day lactation milk yield, respectively but different from the results of Pantelić et al (2014), and Petrović et al.,(2015) with regards to birth type, calving season on 305-day lactation milk yield.

Conclusion

In conclusion, it was observed that Simental cows can produce milk yield at World standard for Simental cows at subtropical climate conditions with ideal feeding and management strategies. Moreover, considering that the lactation period was longer in the current study, more efficient and profitable farming can be performed with keeping the lactation period in normal standard.

References

- Alpan O. and Aksoy AR (2009). Cattle Breeding and Fattening. Zafer Offset Press, Erzurum, Turkey, In Turkish.
- Çilek, S. and Tekin M.E., (2005). Environmental factors affecting milk yield and fertility traits of Simmental cows raised at the Kazova state farm and phenotypic correlations between these traits. *Turkish J. Vet. Anim. Sci.*, 29: 987–993
- Çilek, S. and Tekin, M. E. (2006). Calculation of adjustment factors for standardizing lactations to mature age and 305-day and estimation of heritability and repeatability of standardized milk yield of Simmental cattle reared on Kazova state farm. *Turkish Journal of Veterinary and Animal Sciences*, 30(3), 283-289.
- FAO (2016). Food and Agriculture Organization of the United Nations, Live Animals Statistics, Retrieved March 21, 2016, from <http://faostat.fao.org/site/573/default.aspx#ancor>
- Huyghe, C., De Vliegher, A., Van Gils, B. and Peeters, A. (2014). Grasslands and herbivore production in Europe and effects of common policies. Editions Quae, RD 10, 78026 Versailles Cedex, France. ISBN: 978-2-7592-2156-1.
- Özbeyaz, C., and Küçük, M. (1999). Milk Yield Traits in Brown Swiss Herd at Malya State Farm. *Lalahan Hay. Araşt. Enst. Derg.*, 39(2), 7-16.
- Özkan, M., and Güneş, H. (2011). Effects of Some Factors on Milk Yield Characteristics of Simmental Cows On Commercial Farms in Kayseri. *J. Fac. Vet. Med. Istanbul Üniv*, 37(2), 81-88.
- Pantelić, V., Aleksić, S., Stojić, P., Đurđević, R., Samolovac, L., Janković, D. and Nikšić, D. (2010). The effect of breeding region and year on milk traits of Simmental bull dams. *Biotechnology in Animal Husbandry*, 26(5-6), 287-295.
- Pantelić, V., Petrović, M. M., Ostojić-Andrić, D., Ružić-Muslić, D., Nikšić, D., Novaković, Ž. and Lazarević, M. (2014). The effect of genetic and non-genetic factors on production traits of Simmental cows. *Biotechnology in Animal Husbandry*, 30(2), 251-260.
- Petrović, D.M., Bogdanović, V., Milan Petrović, M., Bogosavljević-Bošković, S., Đoković, R., Đedović, R. and Rakonjac, S. (2015). Effect of Non-Genetic Factors on Standard Lactation Milk Performance Traits in Simmental Cows. *Annals of Animal Science*, 15(1), 211-220.
- SAS (1998). SAS Users Guide: Statistics., Inc., 1998.
- TUİK (2016). Turkish Statistical Institute, Livestock Statistics. Retrieved February 26, 2016, <https://biruni.tuik.gov.tr/hayvancilikapp/hayvancilik.zul>

INFLUENCE OF BITUMINARIA BITUMINOSA FEED FORM (FRESH AND DRIED) ON PREFERENCE AND VOLUNTARY INTAKE IN POULTRY

Marta BARBERÁ*, María P. FLORES, José I.R. CASTANON, Erik DIAZ-AVILA, María.C. MUÑOZ, Myriam R. VENTURA

Department of Animal Science, Universidad de Las Palmas de Gran Canaria. 35416, Arucas, Spain

*Corresponding author: marta.barbera101@alu.ulpgc.es

Abstract

Preference and feed intake on poultry is normally affected by physical feed form and require attention when producing poultry diets. Tedera or psoralea (*Bituminaria bituminosa* C.H Stirt) is a drought tolerant legume that grows in African and Mediterranean areas traditionally used as forage for ruminant with high protein and nutritive value. This study was conducted to evaluate the effects of tedera feed form on voluntary intake and preference in male growing chicks. The two dietary forms of tedera offered were fresh and dried, with the same particle size during 15 consecutive days. The preference and voluntary intake were investigated with a total of 10 chicks divided on five replicates (n=2) and compared with the control group (only commercial diet). Two chicks from each group (control and experimental) were randomly chosen for blood sampling at the end of the study. Control group average daily feed intake (ADFI) shown significant differences compared to tedera group. However, average daily gain (ADG) did not. Hematocrit and total plasma protein values from each group were similar. However, this research demonstrated that the intake was affected by the tedera feed form (dry or fresh): the poultry preference for fresh tedera was significantly higher than for dry tedera (p<0.01).

Key words: *Bituminaria bituminosa, feed-form, poultry diets, preference, intake.*

Introduction

Tedera (*Bituminaria bituminosa* C.H. Stirt.) is a perennial legume well-adapted to Mediterranean climatic conditions and a diverse range of soil types (Real and Verbyla, 2010). Tedera is as a drought-tolerant legume enables to produce biomass under low-rainfall conditions and add symbiotic nitrogen that improve soil structure (Moore et al., 2006; Real et al., 2009; Real and Verbyla, 2010). Most recent studies have focused on tedera as a forage for ruminants. This report takes a new look at tedera as a promising new forage for poultry. An important aspect of poultry diet composition is the protein content (Carré et al., 2008). Intensive poultry production systems tend to deprive chicks of leguminous plants that are readily available. However, supplementing diets with leguminous feeds containing high crude protein could contribute significantly to meeting the protein requirements for growth (Willianson et al., 1989). Moreover, the higher price of the main poultry feed production ingredients that not are available in arid areas make necessary a search for alternative feedstuff (Babiker et al., 2012; Dei et al., 2007). Recent studies observed that feed cost is 60% of the total cost of broiler production in Nigeria and 70% in Cameroon (Tegui et al., 2005; Iyayi et al., 2005). In addition, in the poultry industry, broiler rations contain 60–65% maize, that competing with the world-wide demand for human consumption. For that reason is important to search alternative feed sources for poultry production (Shiferaw et al., 2011; Diarra et al., 2014). Thus, tedera could be a good alternative protein source in African and Mediterranean arid areas.

Poultry are able to consume 10-20% of their dietary requirements from fresh, dried, or ensiled grass. Various authors have reported that daily plant intake can reach up to 30 g of dry matter

(DM) in laying hens (Hughes and Dun, 1983), and soil intake also can reach up to 23% of the ingested DM (Jondreville et al., 2010) or even 30 g per day. Diet presentation can also impact the ability of birds to consume feed as well as its palatability for consumption (Latshaw, 2008).

There are no reports on the effects of feeding tederas on poultry. This paper reviews the chemical composition of tederas and investigates the influence of tederas feed form (fresh or dried) on the preference, average daily feed intake (ADFI), average daily gain (ADG) and feed conversion ratio (FCR).

Materials and methods

Experimental procedures were conducted with a total of 12 male chicks (15 days-old), individually weighed and randomly allocated into six groups. Each pen measured about 1-3m with diurnal temperature ranging between 24 and 30°C. Thus, ten male chicks were then housed for 15 days in five pens, where they had free access to 15 feeders. In this way, in each pen, 2 chicks had daily access to 3 feeders each containing dried tederas, fresh tederas and commercial diet. Additionally, another group with two chicks that only have access to commercial diet, was utilized as a control group. Tederas (dried and fresh) and the commercial type poultry diet were introduced to the pens simultaneously on a daily basis. The experimental diets were offered *ad libitum* during 15 days and the water was freely available. Tederas (dried and fresh) was offered in the same particle size, because it is known that poultry distinguish the differences in feed particle size (Amerah., et al., 2007, Chewing et al., 2012).

For the chemical composition of commercial diet and tederas, fresh samples were weighed, cut and dried at 60°C to about 90g/kg dry matter (DM). They were then ground to pass a 1 mm screen prior to duplicate chemical analyses. Dry matter, ash and crude protein (CP) were determined according to standard methods as described in AOAC (2000) (methods 930.15, 942.05, and 976.05, respectively). Ash-free neutral detergent fibre (NDF) was determined using sodium sulfite in the ND according to Van Soest et al. (1991).

The chicks were monitored for feed intake and weighed, individually, at the start of the experiment and daily. Feed offered and refusals were weighed and recorded daily in all groups to determine the average daily gain (ADG). Finally, two birds per replicate were, randomly, selected at the end of the study of blood samples. ADFI, body weight gain (BWG), feed conversion ratio (FCR) and ADG, were calculated.

The results were subjected to analysis of variance (ANOVA) to determine differences. Differences were considered to be significant at $P < 0.05$.

Results and discussion

The proximate composition of commercial diet and tederas are summarized in Table 1. Tederas resulted to have higher CP than commercial diet (241,0 and 140,0 g/kg, respectively), as well as the DM (91,3 and 85,7 g/kg, respectively), OM (83,8 and 73,8 g/kg, respectively), FND (306,1 and 167,6 g/kg, respectively) and FAD (173,1 and 45,2 g/kg, respectively). On the contrary, the Ash content of the commercial diet was higher than that of the tederas (118,8 and 75,9 g/kg DM, respectively). The crude protein content obtained in this study for tederas was slightly higher than values reported in literatures (Ventura et al. 2004; 2009).

The chemical compositional result has shown that tederas is a good source of protein according to the nutritional requirements of poultry (NRC., 1994). However, the fibre component is also a major fraction of the dry matter (DM), but it was a similar lignified fibre compared with the commercial diet. According with Awosanya et al., (1998), fresh green feeds, especially leguminous, could supply protein and contribute significantly to improved performance of birds

Table 1. Proximate analysis of commercial diet and tедера.

Constituent	Commercial	Tедера	SEM
DM (g/kg)	85,71	91,37	4,00
CP (g/kgDM)	140,00	241,00	71,42
Ash (g/kgDM)	118,83	75,96	17,37
OM (g/kgDM)	73,82	83,77	3,94
FND (g/kgDM)	167,60	306,11	51,27
FAD (g/kgDM)	45,21	173,08	57,87
LAD (g/kgDM)	20,85	21,36	0,51

The effects of supplemented with tедера on poultry performance are shown in Table 2. Overall, the chicks showed a preference for the commercial diet. Only an interaction for ADFI was significant between groups ($p < 0,01$).

Table 2. Effects of tедера on average daily feed intake, feed intake of commercial diet, body weight, feed conversion ratio, hematocrit and total plasma protein values.

Parameter	Control group	Experimental group	SEM	p-value
ADFI (g/d)	170,00	147,14	16,16	<0,01
FI commercial diet (g/d)	170,00	111,60	24,18	<0,02
Initial BW (g)	664,00	665,70	3,56	0,66
Final BW (g)	984,00	931,30	39,14	0,12
Total BW gain (BWG) (g)	320,00	265,60	41,22	0,12
ADG (g/d)	21,33	17,71	2,63	0,14
FCR	7,97	8,31	0,24	0,6
HCT (g/dl)	3,50	3,25	0,18	0,15
TPP(%)	29,00	28,00	0,71	0,55

Chicks fed only commercial diet consumed more than those supplemented with tедера. However, both groups had no significant differences in average daily gain, feed conversion ratio or performance parameters. However, the results for average daily gain were lower than the reported by Etela et al. (2006), who investigated supplementation of poultry diet with fresh centrosema, pueraria and waterleaf, reported highly ADG (35 g/d, 33,9 g/d and 37,7 d/d, respectively).

In all the experimental groups there was no sign of toxicity or mortality reported in the course of the experiment. The values obtained for hemoglobin (Hb) and total plasma protein (TPP) was in the normal ranges and there were no significant differences ($P < 0,05$) observed between treatment means.

Feed preferences are presented in Table 3. A significant interaction between tедера feed form was observed. Voluntary intake of fresh tедера was significant higher than dried tедера for all experimental groups given the same feed with the same particle size during the same period (15 days).

Table 3. Effects of teder feed form on preference and voluntary intake.

Experimental groups	Fresh teder	Dried teder	p-value
1	30,08 ± 9,17	4,33 ± 7,71	<0,01
2	23,79 ± 11,40	5,17 ± 6,16	<0,01
3	28,00 ± 6,12	4,83 ± 4,14	<0,01
4	34,92 ± 10,01	3,50 ± 2,76	<0,01
5	33,83 ± 6,83	3,08 ± 1,72	<0,01
Mean	30,124 ± 4,52	4,181 ± 0,88	<0,01

The results of this study showed that teder feed form affected the preference. This supported the findings of Bricked et al., (2004), who reported that the feed form of the diet had a significant effect on intake and results are also according to Latshaw et al. (2008), who reported the impacts of feed form of the poultry diet on palatability.

Conclusion

The dietary inclusion of teder decreased average daily feed intake. However, resulted in a similar body weight gain, average daily gain and feed conversion ratio. The results demonstrated that the teder feed form (dry or fresh) had a greater effect on poultry intake and preference. Voluntary intake of fresh teder was significantly higher than for dry teder and daily plant intake can reach up to 30 g. First results suggest that teder is a promising new legume for poultry diets. This knowledge may be important for increasing the local and alternative resource utilization on poultry diets. Although, more results are needed to perform the dietary effect of teder supplementation on carcass and egg quality of poultry.

References

- Awosanya, B. and Abikoye, O.O. (1998). Response of finishing broilers to dietary inclusion of *Pueraria phaseoloides* seed meal. *Animal Agriculture in West Africa: The Sustainability Question*, Proceedings of the Silver Anniversary Conference of the Nigerian Society for Animal Production (NSAP) and the Inaugural Conference of the West African Society for Animal Production (WASAP), Gateway Hotel, Abeokuta, Nigeria, 21–26 March 1998. NSAP, Shika-Zaria, Nigeria. p. 212–213.
- Amerah, A. M., Rvindrana, V., Lentle, R. G., & Thomas, D. G. (2007). Feed particle size: Implications on the digestion and performance of poultry. *World's Poultry Science Journal*, 63(3), 439-455.
- A.O.A.C., 2000. *Official Methods of Analysis*, 17th ed. Association of Official Analytical Chemists, Gaithersburg, MD, USA.
- Babiker, M. S. (2012). Chemical composition of some non-conventional and local feed resources for poultry in Sudan. *International Journal of Poultry Science*, 11(4), 283-287.
- Brickett, K., & Classen, H. (2004). Effect of dietary nutrient density, feed form, and lighting on the growth performance of broiler chickens. *Poultry Science*, 83, 106-106.
- Carré, B., Mignon-Grasteau, S., & Juin, H. (2008). Breeding for feed efficiency and adaptation to feed in poultry. *World's Poultry Science Journal*, 64(3), 377-390.
- Chewning, C. G., Stark, C. R., & Brake, J. (2012). Effects of particle size and feed form on broiler performance. *Journal of Applied Poultry Research*, 21(4), 830-837.
- Dei, H. K., Rose, S. P., & Mackenzie, A. M. (2007). Shea nut (*Vitellaria paradoxa*) meal as a feed ingredient for poultry. *World's Poultry Science Journal*, 63(4), 611-624.

- Diarra, S. (2014). Potential of mango (*mangifera indica* L.) seed kernel as a feed ingredient for poultry: A review. *Worlds Poultry Science Journal*, 70(2), 279-288.
- Etela, I., Kalio, G. A., Monsi, A., & Ezieshi, E. V. (2007). Feed intake, growth rate and some anatomical characteristics of broilers fed commercial diets supplemented with green feeds. *Renewable Agriculture and Food Systems*, 22(4), 241-245.
- Hughes, B. O. Dun, P. (1983) Production and behaviour of laying domestic fowls in outside pens. *Applied Animal Ethology*. 1983. 11: 2, 201.
- Iyayi, E.A. and Fayoyin, F.K. 2005. Effect of feeding cassava fruit coat meal on the nutrient digestibility and performance of broilers. *Livestock Research for Rural Development*. Available at Web site: <http://www.cipav.org.co/lrrd/lrrd17/1/iyay17009.htm> (verified 4 April 2005).
- Jondreville, C., A. Travel, J. Besnard, M. Dziurla, C. Feidt, 2010: Intake of herbage and soil by free-range laying hens offered a complete diet compared to a whole-wheat diet. XIII European Poultry Conference, Tours, Frankreich, 23.–27. August
- Latshaw, J.D., 2008. Daily energy intake of broiler chickens is altered by proximate nutrient content and form of the diet. *Poultry Science* 87, 89–95.
- Moore G., Sanford P., Wiley T. (2006) Perennial pastures for Western Australia. Bulletin 4690 . Perth, Australia: Department of Food and Agriculture.
- NRC. Nutrient Requirements of Poultry. (9th rev. ed.) National Academies Press, Washington DC (1994)
- Real D, Correal E, Mendez P, Santos A, Rios S, Sternberg Z M, Dini-Papanastasi O, Pecetti L and Tava. A (2009) *Bituminaria bituminosa* CH Stirton. In: *Grassland Species*.FAO.http://www.fao.org/ag/AGP/AGPC/doc/GBASE/new_species/tedera/bitbit.htm. Accessed September 2011.
- Real D., Verbyla A.(2010). Maximizing genetic gains using a plant model in the Tecera (*Bituminaria bituminosa* var. *albomarginata* and var. *crassiuscula*) breeding program in Australia. In : Porqueddu C. (ed.), Ríos S. (ed.). *The contributions of grasslands to the conservation of Mediterranean biodiversity*. Zaragoza : CIHEAM / CIBIO / FAO / SEEP, 2010. p. 87-95 (*Options Méditerranéennes : Série A. Séminaires Méditerranéens*; n. 92).
- Shiferaw, B., Prasanna, B. M., Hellin, J., & Bänziger, M. (2011). Crops that feed the world 6. past successes and future challenges to the role played by maize in global food security. *Food Security*, 3(3), 307-327.
- Teguaia, A. and Beynen, A.C. 2005. Alternative feedstuffs for broilers in Cameroon. *Livestock Research for Rural Development*, Vol. 17, Art. No. 34. Available at Web site: <http://www.cipav.org.co/lrrd/lrrd17/3/tegu17034.htm> (verified 4 April 2005).
- Ventura, M. R., Castañón, J. I. R., Pieltain, M. C., & Flores, M. P. (2004). Nutritive value of forage shrubs: *Bituminaria bituminosa*, *rumex lunaria*, *acacia salicina*, *cassia sturtii* and *adenocarpus foliosus*. *Small Ruminant Research*, 52(1), 13-18.
- Ventura, M.R., Castanon, J.I.R., Mendez, P. (2009) Effect of season on Tecera (*Bituminaria bituminosa*) intake by goats(Report), *Animal Feed Science and Technology* V153, p.314.
- Williamson, G. and Payne, W.J.A. 1989. *An Introduction to Animal Husbandry in the Tropics*. 3rd ed. ELBS, Longman, Hong Kong. OAC International

THE EFFECT OF THE USE OF CRUDE SOYBEAN IN THE FINAL MIXTURES FOR BROILER CHICKEN ON CHEMICAL AND AMINO ACID COMPOSITION OF MEAT

Veselin PETRIČEVIĆ^{1*}, Miloš LUKIĆ¹, Zdenka ŠKRBIĆ¹, Snežana BOGOSAVLJEVIĆ-BOŠKOVIĆ², Vladimir DOSKOVIĆ², Simeon RAKONJAC², Maja PETRIČEVIĆ¹

¹Institute for Animal Husbandry, Belgrade-Zemun, Republic of Serbia

²Faculty of Agronomy, University of Kragujevac, Čačak, Republic of Serbia

*Corresponding author: veselin5@live.com

Abstract

The aim of this study was to determine the effects of using different varieties and levels of participation of raw soybeans in the final mixtures for broiler chickens on chemical and amino acid composition of dark and white meat. The research was conducted at the experimental farm of the Institute for Animal Husbandry in Zemun using Hubbard F15 heavy line hybrid broilers. A total of 2000 one-day broilers were distributed in 40 equal boxes reared on deep litter (50 chickens per box, 4 boxes replicates per treatment diet). Chickens in all groups had uniform requirements in terms of population density, food area, temperature and light. Until the age of 35 days all birds in the experiment were fed the same diets. The study was carried out on chickens at the age of 35-42 days, according to the principle of two-factorial trial 2 x 5 (2 varieties of domestic varieties x 5 levels of participation of raw grains in the mixture) with a total of 10 treatments. At the end of the experiment, 6 broilers per each tested treatment and gender were randomly selected, a total of 120 chickens, from which the sample of breasts and thigh muscle tissue was taken after the slaughter in order to determine the quality of the meat. It was established that increased concentration of trypsin inhibitor in the final mixtures for chicken had no negative impact on the quality of meat (basic chemical and amino acid composition of dark and white meat).

Key words: *nutrition, soybean, trypsin inhibitors, broiler chicken, chemical and amino acid composition of meat*

Introduction

The nutrition of broilers, in addition to genetics, is the most important factor that can influence the chemical composition of chicken meat. The soybean in chicken diet is the number one protein component and is valuable feed in terms of amino acid composition (*Tan Wilson et al., 1987; Kho and Lumen, 1988*). In comparison with grains and leguminous species, soybean has the highest percentage of proteins (on average of about 38%, with 2.1 to 2.5% lysine). The nutritional value of raw soybean is reduced by the presence of numerous anti-nutritive substances such as trypsin inhibitors (TI) (*Palacios et al., 2004*) and lectins (*Douglas et al., 1999*). The nutritional value of soybean can be increase by proper heat treatment and deactivation of anti-nutritional factors which are mainly proteins, but this procedure also increases its price.

Selection/breeding work has resulted in soybean varieties with reduced content of certain anti-nutritional substances. Variety Lana was developed by *Srebrić and Perić (2008)* as a result of domestic soybean breeding program aimed at reducing the activity of TI. Variety Lana has a lower TI level by 50% compared to conventional soybean varieties. The use of raw soybeans (especially varieties with reduced TI content) influences primarily the reduction of feeding costs and improves the economy of broiler production.

Comparing the nutritional value of soybeans with lower TI level in the diet of broiler chickens, *Petričević et al. (2015)* have found better production results compared to soybeans with standard level of TI, however no significant differences in the quality of the carcasses were identified. Comparing raw and heat-treated soybeans, *Beuković et al. (2012)* have established better quality of chicken carcass, expressed by dressing percentages, in chickens fed heat-treated soybeans. *Petričević et al. (2016)* have determined that the increased levels of raw soybeans in the final mixtures for broiler chickens hinder the utilization of protein in the ration, resulting in weaker development of the most valuable parts of the carcass, primarily the breast.

The aim of this research was to investigate the effects of replacing a part of heat processed soybean of standard variety "Lydia" and variety with reduced TI content "Lana" with raw soybean grains in the final mixtures for broiler chickens on chemical and amino acid composition of dark and white meat.

Materials and methods

The research was conducted at the experimental farm of the Institute for Animal Husbandry in Zemun municipality (Belgrade, Serbia) using Hubbard F15 heavy line hybrid broilers. In the final mixtures for broilers two local varieties were used, variety "Lana" with reduced TI level and variety "Lydia" with standard TI level, extruded and raw (Table 1).

Table 1. Level of trypsin inhibitor in soybean

Treatment	Raw soybean		Heat-treated (extruded) soybean	
Variety	Lana	Lydia	Lana	Lydia
TI (mg/g)	17.71	36.74	4.38	14.03

A total of 2000 one-day broilers were distributed in 40 equal boxes reared on deep litter (50 chickens per box, 4 boxes replicates per treatment diet). Chickens in all groups had uniform requirements in terms of population density, food area, temperature and light. Until the age of 35 days all birds in the experiment were fed the same diets. Finisher as the final mixture contained 17.5% crude protein and 13.2 MJ/kg metabolic energy in all experimental groups, it was available to broiler chickens from 35 to 42 days and differed for all the tested treatments in regard to soybean varieties and the participation of the heat-treated and the raw soybean. (Table 2).

Effect of different levels of raw soybeans in diets was determined in a two-factorial trial 2 x 5 (2 varieties of soybean x 5 levels of participation of raw grains in the mixture) with 10 dietary treatments.

Table 2. Trial design/plan and extruded and raw soybean ratio in the final mixtures

Treatment	Broilers	% of soybean in the diet (Extruded : Raw)	Soy bean ratio % (Extruded : Raw)
Lana - 0% (K)	200	20% (20% : 0%)	100/0
Lana - 5% (I)	200	20% (15% : 5%)	75/25
Lana - 10% (II)	200	20% (10% : 10%)	50/50
Lana - 15% (III)	200	20% (5% : 15%)	25/75
Lana - 20% (IV)	200	20% (0% : 20%)	0/100
Lydia - 0% (K)	200	20% (20% : 0%)	100/0
Lydia - 5% (I)	200	20% (15% : 5%)	75/25
Lydia - 10% (II)	200	20% (10% : 10%)	50/50
Lydia - 15% (III)	200	20% (5% : 15%)	25/75
Lydia - 20% (IV)	200	20% (0% : 20%)	0/100

At the end of the experiment, broilers were selected randomly, 6 for each test treatment and gender - total of 120 chickens, from which post-slaughter samples of breast and thigh muscle tissue were taken in order to determine the chemical and amino acid composition of meat. The basic chemical and amino acid composition samples of white and dark meat was determined:

- Moisture content was determined according to standard SRPS ISO 1442/1998;
- The content of free fat was determined according to standard SRPS ISO 1444/1998;
- Content of total ash was determined according to standard SRPS ISO 936/1999;
- The nitrogen content was determined according to standard SRPS ISO 937/1992 and protein content according to the following formula: CP (%) = N (%) x 6.25;
- The amino acid composition was determined by HPLC (IC with electrochemical detector).

The software package STATISTICA Version 6 (StatSoftInc.) was used in the statistical analysis.

Results and discussion

Table 1 shows data on the basic chemical composition of dark and white meat of broiler chickens of both genders.

Table 3. Chemical composition of chicken meat (%)

Treatment	Dark meat				White meat			
	Water	Fat	Ash	Protein	Water	Fat	Ash	Protein
Soybean variety								
Lana	76.41	2.58	1.09	20.32	75.04	0.69	1.17	23.07
Lydia	76.15	2.63	1.11	19.90	75.29	0.68	1.16	23.17
Level of raw soybean, %								
0 (K)	75.52	2.71	1.09	20.52	74.85	0.54	1.18	24.16
5 (I)	77.43	2.38	1.09	20.15	75.25	0.68	1.15	22.92
10 (II)	76.07	2.74	1.08	19.68	75.30	0.70	1.16	22.81
15 (III)	76.14	2.74	1.10	20.00	75.10	0.74	1.16	22.99
20 (IV)	76.25	2.45	1.12	20.21	75.32	0.77	1.16	22.73
p value								
Soybean variety	0.571	0.749	0.381	0.056	0.075	0.855	0.386	0.783
Level of raw soybean	0.129	0.338	0.675	0.180	0.181	0.143	0.740	0.078
Variety x Level	0.237	0.118	0.984	0.709	0.406	0.499	0.609	0.683

Statistical analysis of the data obtained for the chemical composition of dark and white meat of broiler chickens of both genders showed absence of significant differences under the

influence of investigated factors ($p>0.05$). The use of raw soybean with reduced TI levels in mixtures for broilers did not affect the significant changes in the content of water, fat, ash and protein in the dark and white meat compared to soybean of variety Lydia. Increasing the level of raw soybeans in the final mixture did not cause poorer quality of meat. Also, the interaction of investigated factors did not influence the chemical composition of meat.

The quality of chicken meat is determined by sensory properties and nutritional value i.e. chemical composition (water content, protein, minerals and fats). The favourable chemical composition, high content of protein with low fat content, is what makes the chicken meat very desirable food of animal origin (*Kralik et al., 2007*). The chemical composition of poultry meat, in addition to diet, can be influenced by other factors: genotype, age, gender (*Ristić et al., 2008*). In the literature, there are few results that are directly related to the impact of increased TI concentrations on the chemical composition of chicken meat. Similar to our results, *Sardary (2009)* have found no statistically significant differences in the chemical composition of dark and white meat of chickens fed diets with different amounts of heat-treated whole soybean and raw soybean. *Marcu et al. (2009)* and *Haščik et al. (2011)* have found a slightly higher water content and lower content of fat in the breast meat as compared to our results. *Lonergan et al. (2003)* suggest that breast meat contains 24.02% protein, 73.42% water and 1.08% fat. *Ristić (2007)* point out that the protein content of the breast meat is by 3.5% higher than in the thigh meat, which is consistent with our results.

Data for the amino acid composition of chicken meat of broilers of both genders under the influence of tested factors are shown in Table 2. The contents of valine, leucine, lysine and tryptophan in dark and white meat are determined.

Table 4. Amino acid composition of chicken meat (%)

Treatment	Dark meat				White meat			
	Valine	Leucine	Tryptoph.	Lysine	Valine	Leucine	Tryptoph.	Lysine
Soybean variety								
Lana	1.04	1.59	0.24	1.81	1.03	1.57	0.24	1.80
Lydia	1.05	1.61	0.25	1.81	1.04	1.59	0.24	1.81
Level of raw soybean, %								
0 (K)	1.04	1.59	0.25	1.81	1.06	1.61	0.25	1.82
5 (I)	1.03	1.61	0.25	1.82	1.03	1.57	0.25	1.82
10 (II)	1.05	1.61	0.26	1.82	1.05	1.60	0.23	1.80
15 (III)	1.06	1.58	0.24	1.82	1.01	1.55	0.23	1.78
20 (IV)	1.06	1.62	0.25	1.82	1.05	1.57	0.25	1.81
p value								
Soybean variety	0.461	0.530	0.451	0.756	0.373	0.353	0.516	0.564
Level of raw soybean	0.339	0.438	0.275	0.346	0.292	0.148	0.370	0.194
Variety x Level	0.185	0.218	0.382	0.619	0.152	0.254	0.339	0.484

The analysis of the data reveals that the soybean variety and different levels of soybean grain in chicken final mixtures exerted no statistically significant impact on the amino acid composition of dark and white meat ($p>0.05$). It was also determined that the interaction effect of studied factors had no significant effect on the content of valine, leucine, tryptophan and lysine in the dark and white meat.

The chicken meat is a rich source of biologically valuable protein, essential amino acids, minerals and vitamins in the human consumption. Compared to other types of meat chicken meat represents a significant source of essential polyunsaturated fatty acids, especially omega-3 (*Losso, 2002*).

Conclusions

Based on the results of the study of the individual impact of the variety and level of participation of raw soybeans and interactive influence of both factors in the diet of broiler chickens aged from 35 to 42 days, it can be concluded that the increased concentration of trypsin inhibitors in the final mixtures for chickens had no negative impact on the quality of chicken meat. The use of soybean of variety Lana did not influence ($p>0.05$) achieving of more favourable chemical and amino acid composition of dark and white meat compared to soybean with a standard TI level. The 20% of raw soybean grains in mixtures did not cause poor results of the tested parameters of chicken meat quality in relation to groups with lower participation and without the raw soybeans ($p>0.05$).

Acknowledgments

The research was funded by the Ministry of Education, Science and Technological Development, Republic of Serbia, project TR-31033.

References

- Beuković, D, Beuković, M, Ljubojević, D, Stanačev, V, Bjedov, S, Ivković, M, (2012). Effect soybean heat treatment on broiler slaughter traits, Third International Scientific Symposium "Agrosym Jahorina 2012", 541-547.
- Douglas, M, Parsons, C, Hymowitz, T, (1999). Nutritional evaluation of lectin-free soybeans for poultry, *Poultry Science*, (78), 91-95.
- Haščik, P, Kačaniova, M, Bobko, M, Pochop, J, Mihok, M, Arpasova, H, (2011). Effect of probiotic preparation for chemical composition of meat cocks different combinations of hybrid chicks, *Acta Universitatis Agriculturae et Silviculturae Mendeleianae Brunensis* (5), 83-94.
- Kho, C, Lumen, B, O, (1988). Identification and isolation of methionine-cysteine rich proteins in soybean seed *Jurnal Nutrition*, (134), 1213-1219.
- Kralik, G, Škrčić, Z, Maltar, Z, Hanžek, D, (2007). The properties of meat production and meat quality of Ross 308 and Cobb 500 chickens, *Krmiva* 49 (2), 59–71.
- Lonergan, S, M, Deeb, N, Fedler, C, A, Lamont, S, J, (2003). Breast Meat Quality And Composition in Unique Chicken Populations, *Poultry Science*, 82 (12), 1990-1994.
- Losso, N, J, (2002). Preventing degenerative diseases by anti-angiogenic functional foods, *Food technology*, 56 (6), 78-87.
- Marcu, A, Vacaru-Opris, I, Marcu, A, (2009). The influence of feed protein and energy level on meat chemical composition from different anatomical regions at "Cobb 500" hybrid, *Lucrari stiintifice Zootehnie si Biotehologie*, 42 (1), 147-150.
- Palacios, M, F, Easter, R, A, Soltwedel, K, T, Parsons, C, M, Douglas, M, W, Hymowitz, T, Pettigrew, J, E, (2004). Effect of soybean variety and processing on growth performance of young chicks and pigs, *Jurnal Animal Science*, (82), 1108–1114.
- Petričević, V, Lukić, M, Škrbić, Z, Bogosavljević-Bošković, S, Dosković, V, Rakonjac, S, Petričević M. (2016). The effect of raw soybean in the final mixtures for broilers on the conformation measures and share of major carcass parts, *Biotehologie in Animal Husbandry*, 32 (1), 37-44.
- Petričević, V, Lukić, M, Škrbić, Z, Jokić, Ž, Vitorović, D, Rakonjac, S, Petričević, M, Stanojković, A, (2015). The effect of raw soybean in the final mixtures for broiler chickens on the performance and carcass yield, *Proceedings of the 4th International congress "New perspectives and challenges of sustainable livestock production" Belgrade, Republic of Serbia 7-9 October 2015*, 176-184.
- Ristić M., Freudenreich P., Damme K. (2008). Chemical composition of poultry meat - a comparison broiler chickens, turkeys, ducks and geese, *Meat Technology*, 49 (3-4), 94-99.

- Ristić M. (2007). The chemical composition of broiler meat depending of origin and production, *Meat technology*, 48 (5-6), 203-207.
- Sardary, S, Y, T, (2009). Performance of broiler chickens fed locally grown full-fat soybean based diets in Iraq, *Jurnal Animal Science*, 5 (1), 111-125.
- Srebrić, M, Perić, V, (2008). Breeding of Kunitz-free soybean genotypes, *Proceedings of 18th Eucarpia General Congress Modern Variety Breeding for Present and Future Needs*, Valencia, Spain, 9-12 September 2008, 640.
- Tan Wilson, A, L, Chen, J, C, Duggan, M, C, Chapman, C, Obach, R, S, Wilson, K, A, (1987). Soybean Bowman–Birk trypsin isoinhibitors: Classification and report of a glycine-rich trypsin inhibitor class, *Journal of Agricultural and Food Chemistry*, 35 (6), 974–981.

THE EFFECT OF LAYERS FEED SUPPLEMENTATION WITH ORGANIC SELENIUM ON THE QUANTITATIVE AND QUALITATIVE INDICATORS OF PRODUCTION

Vezir JANUZI, Lumturi SENA*

Faculty of Agriculture and Environment, Agricultural University of Tirana, Albania

*Corresponding author: lumturisena@yahoo.com

Abstract

The experiment was conducted for a period of 13 weeks in a poultry farm near Podujevo. 400 Lohman Brown layers, were divided into four groups as following: Control Group (C), Experiment 1 (E1), Experiment 2 (E2) and Experiment 3 (E3). The same food formula was applied for the four groups, but if the control group was fed with the basic diet, the food formula of the consequent other three was supplemented with Organic Selenium (Se) Sel-Plex®, Alltech, inc., 0.2, 0.3 and 0.4 ppm respectively. During the experimental period the following parameters were consistently recorded, monitored and evaluated: live weight, egg production, egg mass, egg quality and food conversion ratio (FCR). At the end of the study, it was concluded that different levels of organic selenium did not significantly influenced ($P < 0.05$ level) neither on the egg production nor on the egg's quality and on the body weight. In the group supplemented with 0.4ppm Selenium, a tendency for the production increased and FCR's improvement was observed. The increasing dose of Se in the food, as it was observed, had a tendency to improve egg weight. E3 group eggs resulted in a higher weight; 3.7, 3.6 and 2.1% respectively than Control one, E1 and E2. The egg mass, slightly improved in the group supplemented with 0.4 ppm Selenium.

Key Words: *Selenium, poultry production, egg production, egg weight, chicken*

Introduction

Selenium is an essential microelement for poultry. Various authors have studied that the food with Se supplementation may affect egg quality parameters, the freshness of eggs (Arpasova H, et al, 2009) and in improving the quality of egg white (HU). Se supplementation of food affects not only improve the health and performance of production, but also can be a natural way to produce functional products - eggs rich in selenium (Chinrasri O, et. Al, 2009; Gorgovska N., et al, 2011). So far indicate that information in the form of organic selenium has a series of important advantages compared with selenite. Organic selenium absorbed as an amino acid similar to methionine. Based on what has already been highlighted in this study proved the use of dietary supplementation with organic Se with different concentrations in poultry production.

The aim of the study was to determine the effect of supplemented feed formulas in laying hens in different concentration of organic Selenium Sel-Plex - Alltech, on performance indicators.

Material and Methods

The study was conducted in a commercial layers' farm in Podujevo within a 13 weeks period of time. Based on the principle of comparative analogy of body condition, age, production and health condition, 4 groups of 100 chicken/each were established. Hybrids chickens for eggs were Lohman Brown. During the entire experiment the chickens were hold in the same ambient, in a 4 tier cage, with 5chickens/cage and in environmental conditions of equal treatment and service.

The feed composition was the same for every group, while the difference was in the level of Selenium's inclusion. The control (C), the basal diet contained a trace mineral premix that provided no Supplemental Se, while for the other 3 groups of experiment the feed was supplemented respectively 0.2ppm (experiment 1 - E1), 0.3ppm (experiment 2 - E2) and 0.4ppm (experiment 3 - E3) organic Selenium. The feed was prepared in the feed mill, near poultry operation. Sel-Plex, Alltech, Inc. organic selenium was used.

Table 1. Composition of the ration

Ingredients	Structure (%)
Corn	60
Soybean meal	20
Sunflower meal	10
Calcium carbonate	8.75
Premix	1.25

At the end of the experiment, by randomly selecting 10 eggs/group were collected in order to determine both internal and external qualitative parameters.

It was determined the weight of the egg, the weight of the white, yolk weight, the shell and the shell thickness, index format and intensity of egg yolk.

While the egg mass (EM) for each group was calculated with the following formula:
 $EM = EW \text{ (Egg Weight)} \times EN \text{ (Egg Number)} / NH \text{ (Number of hens)}$

Recorded indicators were:

1. The daily production of eggs for each group
2. The egg weight/group;
3. Internal and external egg quality;
4. Feed consumption/group in kg;
5. Feed Conversion Rate/egg unit;
6. Body weight; For this, 5% of the flock was weighed every week.

The obtained results were statistically processed via ANOVA and descriptive analysis, for the comparison tTest was applied.

Results and discussion

Egg production for each group

As seen in the table 2, a slight superiority of E3 on all groups is noted, starting from the 4th – 9th week of the study and as a weekly average for the whole period of the study. Although these differences are statistically non-significant, for $p \leq 0.05$. Also, a decline of egg production each week until the week 13 is evidenced, respectively 30% at the control group, 31.6% at E1, 27.5% at E2 and 28.8% at E3. It needs to be mentioned that the layers are at the second phase of production (experiment started at week 38), meaning that this declination is acceptable.

Table 2. Average daily egg production weekly by each group

Week	Control	Experiment 1	Experiment 2	Experiment 3
1	94.2	97	93.7	93.9
2	97	91.9	91.1	91.7
3	88.9	85.7	85	87.7
4	76.9	76.7	77.6	84.3
5	75	74.7	78.4	77.6
6	71.9	70	74	74.4
7	71.9	71.9	74.9	76
8	71.7	71.7	72.7	74.3
9	67.1	67.3	74.3	73.6
10	65.6	68	69.9	69.7
11	71.4	71.9	72.3	72.9
12	69.7	69.4	66.9	66.7
13	66.6	66.4	67.7	66.9
Egg production/day	76±10.52	75.6±9.80	76.8±8.36	77.7±8.99
Egg/hen /week	5.48±0.58	5.46±0.59	5.46±0.56	5.51±0.59
Egg/hen total	71.3	70.93	71	71.67

Our results for egg production agree with those of Cantor et al. (2000) and Patton (2000) who reported no difference in egg production when hens were fed a basal diet supplemented with 0 or 0.30 ppm of Se. In accordance with our results Chinrasri et al. (2009) have not found any significant effects of additions' of Se yeast.

Indicators of egg quality

Table 4. The weight of the components of the egg and it's qualities by group

Egg quality indicators	Control	Experiment 1	Experiment 2	Experiment 3
Egg weight (g)	61.02±5.04	61.09±3.47	62±5.15	63.28±5.34
The white weight (g)	37.89±4.88	37.77±2.68	39.10±4.29	38.92±3.14
The yolk weight (g)	14.95±1.05	15.37±1.18	15.15±0.90	15.91±1.32
Shell weight (g)	8.18±0.93	7.95±0.97	8.05±0.61	8.45±0.68
Shell thickness (mm)	0.58±0.04	0.60±0.04	0.59±0.03	0.59±0.01
Shape index	1.36±0.00	1.35±0.00	1.40±0.00	1.40±0.00
The intensity of the yolk (Roche)	11	11	11	11
Egg mass (kg)	4.35	4.33	4.40	4.54

A tendency is noticed for improving the quality of eggs by increasing the Se dose. The eggs of Group E3 respectively have a weight of 3.7, 3.6 and 2% larger than those of control (C), E1 and E2. However, it can be said that there is a tendency for larger weight of eggs and their components in the group that got 0.4 ppm Se dose, since the differences are statistically non significant ($P < 0.05$). This can also be confirmed by other studies (Arpasova, et al., 2009; Skrivan et. al., 2006; Utterback et. Al., 2005).

Even the shape index appears to be better in E2 and E3. As for the intensity of yolk, it is the same for all groups. The egg mass in the best group (E3) respectively is 190g bigger than Control, 210g bigger than E1 and 140g bigger than E2.

The eggs for incubation or for the market should be of oval form, a characteristic which is expressed by the index of shape, which is 1.32. -1.40 for chicken eggs (Sena L, Stefi G, 2009). This indication was within the limits in all groups.

The intensity of egg yolk for the four groups in experimental period was defined with special calorimeter for this purpose (Roche calorimeter). It results that the yolk intensity for all groups was the same 11 Roche degree. Intensity of the yolk is within normal in two groups.

So, supplementation of food ration with organic Selenium for chickens in mass 0.2, 0.3 and 0.4 ppm doesn't show impact on weight and eggs quality.

Feed Consumption

Feed consumption was monitored and the feed conversion rate (gr. feed/egg) was calculated for four groups during the experiment:

Table 5. Feed Conversion Ratio (FCR)

Week	Control	Experiment 1	Experiment 2	Experiment 3
1	121.96	118.56	122.71	122.53
2	125.59	125.19	125	125.39
3	128.18	134.17	133.94	131.11
4	143.75	146.90	146.90	135.07
5	147.17	150.75	143.75	145.31
6	152.17	157.84	152.17	151.32
7	152.17	153.63	150.47	148.25
8	152.46	152.46	155.11	151.60
9	162.63	162.30	151.60	153.04
10	166.67	160.68	161.32	161.64
11	153.04	152.17	156.01	154.81
12	156.6	157.23	168.41	169.12
13	164.29	164.62	166.32	168.41
Average	148.21±14.64	148.96±14.34	148.75±14.32	147.51±15.17

During the experiment confirmed a worsening of FCR in all groups. E3 group has the best result for FCR. E3 used the food with more efficiency. In E3 is saved 0.45% food/ egg compared with Control, 0.97% compared to E1 and 0.83%, compared to E2. However, the differences were not significant. The result achieved at E3 is close to other studies regarding this factor. Ševčíkova et al. (2006) reported that the FCR was not affected by Se supplementation. Results of studies Jiakui and Xialong (2004), Utterback et al. (2005), De Lange L.L.M. and G. Oude Elferink (2005), and Leeson et al. (2008) indicated no differences in egg production, and FCR of laying hens due to inorganic and organic Se supplementation.

Body weight

Table 6. Body weight of poultry (kg) per week group (M ± SD)

Week	Control	Experiment 1	Experiment 2	Experiment 3	Standart
day 1	1.44±0.08	1.52±0.11	1.52±0.04	1.53±0.21	1.843-2.037
1	1.45±0.09	1.54±0.08	1.61±0.11	1.66±0.19	1.846-2.040
2	1.49±0.13	1.56±0.07	1.66±0.04	1.66±0.20	1.848-2.042
3	1.49±0.10	1.56±0.09	1.66±0.08	1.67±0.17	1.851-2.045
4	1.50±0.14	1.57±0.16	1.67±0.09	1.68±0.20	1.853-2.049
5	1.52±0.14	1.60±0.10	1.67±0.12	1.69±0.18	1.855-2.051
6	1.53±0.13	1.60±0.13	1.68±0.07	1.70±0.13	1.857-2.053
7	1.54±0.16	1.60±0.07	1.69±0.11	1.76±0.15	1.860-2.056
8	1.64±0.15	1.61±0.10	1.70±0.13	1.78±0.15	1.862-2.058
9	1.66±0.14	1.69±0.05	1.71±0.11	1.81±0.16	1.865-2.061
10	1.76±0.12	1.67±0.14	1.74±0.09	1.84±0.19	1.867-2.063
11	1.79±0.15	1.75±0.09	1.74±0.11	1.86±0.15	1.870-2.066
12	1.79±0.12	1.76±0.11	1.85±0.11	1.88±0.14	1.872-2.070
13	1.80±0.16	1.81±0.10	1.87±0.04	1.90±0.11	1.874-2.072
Body weight gain (Kg)	0.36	0.29	0.35	0.37	

During the weeks of study, a tendency for higher weight was noticed in group that got 0.4ppm Se (E3). However the differences aren't significant ($P < 0.05$), especially in the last six weeks of study. However, even the hens of the best Group (E3) reached lower weight, compared to those hybrid standard (Management Guide Layers Lohman Brown-Classic.), with exception for those in the last two last weeks. Even the addition in weight for whole period of study, was close to that in control group, E2 and E3, with exception to E1, which had a lower weight.

Conclusion

Supplementation of layers diet with organic Selenium with different concentration 0.2, 0.3, 0.4ppm didn't show any effect on performance indicators. The group that the diet was supplemented Selenium in 0.4ppm shows tendency for improving of egg production, weight of eggs and its compounds, egg mass and for higher body weight.

A tendency for slight improvement of FCR was evidenced in this Group.

References

- Arpasova H., M. Mellen, Kacaniova M., Hascik P., V. Petrovic, K. Chobanov, LengL .: Effects of dietary supplementation of sodium selenite on selected yeast and selenized Qualitative parameters of laying hens eggs. *Slovak J Anim. Sci* 2009, Vol. 42: 27-33.
- Cantor, A. H., M. L. Straw, M. J. Ford, A. J. Pescatore, K. and M. Dunlap. 2000. Effect of feeding organic selenium in diets of laying hens on egg selenium content. Page 473 in *Egg Nutrition and Biotechnology*.
- Chinrasri O., P. Chantiratikul, Thosaikham W., P. Atiwetin, Chumpawadee S., S. and Chantiratikul Saenthaweesuk A.: Effect of selenium-enriched selenium bean sprout and other sources on Productivity and selenium concentration in eggs of laying hens. *Asian-Aust J AnimSci* 2009, Vol. 22: 1661-1666.
- De Lange L.L.M. and G. Oude Elferink: Producing selenium enriched eggs by using organic and inorganic Se-sources in the feed. XI th European Symposium on the Quality of Eggs and Egg Products Doorwerth, The Netherlands, 23-26 May 2005

- Gjorgovska N. and Filev K. : Multi-enriched eggs with omega 3 fatty acids, vitamin E and selenium. *Archive Zootechnica*, 2011, Vol. 14: 28-35;
- Jiakui L., Xiaolong W. (2004): Effect of dietary organic versus inorganic selenium in laying hens on the productivity, selenium distribution in egg and selenium content in blood, liver and kidney. *Journal of Trace. Elements in Medicine and Biology*, 18, 65–68.
- Leeson S., Namkung H., Caston L., Durosoy S., Schlegel P. (2008): Comparison of selenium levels and sources and dietary fat quality in diets for broiler breeders and layer hens. *Poultry Science*, 87, 2605–2612.
- Management guide layers. Lohman Brown-Classic commercial layers. Lohman Tierzucht
- Patton, N. D. 2000. Organic selenium in the nutrition of laying hens: Effects on egg selenium content, egg quality and transfer to Developing chick embryos. Ph.D. Diss., Univ. Kentucky, Lexington
- Sena L, Stefi G, 2009. *Poultry Rearing*. P 50.
- Ševčíková S., Skřivan M., Dlouha G., Koucky M. (2006): The effect of selenium source on the performance and meat quality of broiler chickens. *Czech Journal of Animal Science*, 51, 449–457.
- Skřivan M., J. Simane, G. Ves, Doucha J. (2006): Effect of dietary sodium selenite, Se-enriched yeast and Se-enriched Chlorella on egg Se concentration, physical parameters of eggs and laying hen production. *Czech J AnimSci*, Vol. 51: 163-167.
- Utterback P.L., Parsons C.M., I. Yoon, Butler J. (2005): Effect of supplementing selenium yeast in diets of laying hens on egg selenium content. *Poul.Sci*, Vol. 84: 1900-19

IMPACT OF THAWING TEMPERATURE ON QUALITY PARAMETERS OF BULL'S SEMEN

Stoja JOTANOVIĆ¹, Marija JOVIČIĆ², Đorđe SAVIĆ^{1*}, Marinko VEKIĆ¹, Borut BOSANČIĆ¹, Ivan STANČIĆ³

¹University of Banja Luka, Faculty of Agriculture, Banja Luka, Republic of Srpska, Bosnia and Herzegovina

²Czech University of Life Sciences, Faculty of Agrobiolgy, Food and Natural Resources, Prague, Czech Republic

³University of Novi Sad, Faculty of Agriculture, Department of Veterinary Medicine, Novi Sad, Serbia

*Corresponding author: djordjevet@yahoo.com

Abstract

Aim of study was to examine the impact of thawing temperature on quality parameters of bull's semen. A total of 120 commercial doses of deep-frozen bull's semen, originated from three Simmental bulls, were examined. Semen was thawed at 38°C for 30 seconds (n=60 doses, 20 from each bull) or at 50°C for 15 seconds (n=60 doses, 20 from each bull). Thawing temperature did not have effect on average percent of progressive motility and sperm concentration (66.08% and 24.03x10⁶ at 38°C, vs. 66.05% and 24.11 x10⁶ at 50°C, respectively). Live sperm percent and dead sperm percent in each bull's semen samples was lower after thawing at lower temperature (55.74%, 44.14% and 55.29% vs. 56.08%, 44.67% and 57.68%; 6.78%, 10.67% and 4.26% vs. 7.88%, 10.90% and 5.72%, respectively). Percent of sperms died during staining in each bull's semen samples was lower after thawing at lower temperature (20.02%, 21.92% and 27.13% vs. 20.83%, 23.31% and 25.67%, respectively). Total percent of damaged sperms in each bull's semen samples was higher after thawing on lower temperature (17.46%, 23.27% and 13.31% vs. 15.20%, 21.10% and 10.99%, respectively). Percent of sperms with intact membrane damage in each bull's semen samples was higher after thawing at lower temperature (49.67%, 53.12% and 45.97% vs. 41.39%, 46.03% and 43.15%, respectively), contrary to percent of sperms with other types of damage (50.33%, 46.88% and 54.03% vs. 58.61%, 53.96% and 56.85%, respectively). Our results indicate positive impact of higher thawing temperatures on bull's semen quality parameters, and consequently its fertilisation ability.

Keywords: *bull's semen, thawing temperature, quality.*

Introduction

The percentage of progressive motility of sperm is considered to be the most important parameter of insemination doses quality (Miljković, 1998), as only a vital and progressive motile sperms are able to pass through the female sex organs to the fallopian tubes and carry out insemination. To assess the quality of the ejaculate, or preservation of spermatozoa fertile ability after thawing, progressive motility should be evaluated immediately after taking of ejaculate and also immediately after thawing.

Vakanjac et al. (2013) state that the lower limit of sperm motility for ejaculate acceptance immediately after taking is 70%, while that value after thawing should be at least 50%, since one part of sperms are irreversibly damaged during the cryopreservation and thawing. An additional factor that ensures high fertilisation ability of insemination doses is sperm count, ie. number of sperms in the dose, which should be from 10 to 20 millions (Snoj, 2014). A critical point in the semen cryopreservation and thawing is passing through a temperature range between -60°C and -80°C, because of intensive formation of ice crystals, which can severely damage sperms (Miljković, 1998). Therefore, in both phases of work with the semen, it is necessary to ensure that the semen pass through that temperature range as fast as it can, to

reduce the number of damaged sperms. The process of cryopreservation of bull's semen is standardized and mainly automated, so damage of sperms during the freezing process can not be reduced by changing the conditions, while in the process of thawing it can be modified by changing of thawing temperature and exposure time, as found by many authors.

The aim of this study is to examine the impact of two different thawing temperature on quality parameters of bull's semen.

Material and methods

The study included a total of 120 commercial insemination doses of semen, originating from three Simmental bulls (Indurein, Strellas, Polian, 40 doses for each of bulls). Bulls were housed in standard conditions of commercial reprocenter and fed in accordance with the norms for a given breed. In order to avoid the impact of the various terms of ejaculate taking on the parameters of semen quality, all doses from each bull originated from the same ejaculate. Doses of semen were taken from the commercial center for artificial insemination (AD Veterinary Cattle Breeding Center Banja Luka), and their thawing and analysis of quality parameters were carried out in the Laboratory of Genetics and Reproduction, Faculty of Agriculture, University of Banja Luka (Republic of Srpska, Bosnia and Herzegovina). Half of the selected doses of each bull (n=20) were thawed by using standard procedure (at 38°C for 30 seconds), while the remainder (n=20) was thawed at a temperature of 50°C for 15 seconds. After thawing, concentration of sperms, percentage of progressively motility and morphological integrity of sperms were determined for each dose of semen.

The concentration of spermatozoa for each dose was determined using the standard method in Burkher's sperm counting chamber. Sperm counting was done under a microscope, magnified 20 times, in five fields of mesh. Percentage of progressive sperm motility was assessed semi-quantitative, by visual observation of thawed semen drops under a microscope at 10x magnification. As the lower limit of progressive sperm motility after thawing, to take dose into further consideration, value of 50% was taken. Evaluation of the morphological integrity of sperm (percentage of dead sperm, deformities and defects that are potentially incurred during the thawing procedure), was performed using HOS (Hypoosmotic Swelling) test or supravital staining sperm after Blom with eosin-nigrosine. At least 200 sperms were counted in each dose.

The influence of different temperature treatments on sperm quality parameters was tested by combined factorial analysis of variance and Pearsons χ^2 test, with software package SPSS 22 (IBM 2013).

Results and discussion

Average values of progressive motility and sperm count in insemination doses thawed at different temperatures are shown in Table 1.

Table 1. Average values of progressive motility and sperm count in the insemination doses thawed at different temperatures

Parameter	t (°C)	n	X	Sx	Min.	Max.	CV
Progressive motility (%)	38	60	66,08	0,78	55,00	75,00	9,14
	50	60	66,05	0,68	55,00	75,00	7,96
Sperm count (x10 ⁶ in dose)	38	60	24,03	0,14	22,50	25,00	4,50
	50	60	24,11	0,13	22,50	25,00	4,25

The thawing temperature had no statistically significant effect on the average percentage of progressive sperm motility, as well as the average number of sperm in the examined semen doses. The results indicate a satisfactory effect of both thawing protocols on the fertilisation ability of semen and its preservation after thawing. Similar results were found by Suljkanović and Šabanović (2002), who did not find significant differences in the percentage of progressive motility after thawing bull's semen at 35°C for 15 seconds or 55°C for 7 seconds (74 vs. 71.7%). Nur et al. (2003) found a favorable effect of the thawing temperature on the percentage of progressive motility (59.8% at 55°C vs. 56.6% at 37°C). In both of these studies the percentage of progressive motility of sperms was lower compared to our results. Zobel et al. (2009), investigating the relationship of the thawing temperature and the results of conception in cows, found that semen thawing in a temperature range from 10°C to 37,5°C had no significant effect on sperm survival and conception results.

To take native ejaculate for insemination doses preparation, the concentration of spermatozoa should be at least 500x10⁶ sperms per ml. The commercial insemination doses are packaged in straws of 0.25 ml, with at least 10 to 20 million sperms (Vakanjac et al., 2013). Most commercial centers produce doses with 20-30 million sperm in each dose, in order to provide a satisfactory fertilisation ability of dose in the field conditions. Results of this study indicate high average number of sperm in the examined insemination doses, and the absence of impact of thawing temperature on the sperm count (24.03 vs. 24.11 x 10⁶ at a dose), which, together with the high percentage of progressive motility, should provide high fertility of these doses.

Processes of cryoconservation and thawing of semen are cause of damaging the one part of sperms morphological integrity, and consequently losing of their fertilisation ability. Thawing protocol is one of the main factors that affect the intensity of damage or preserve the morphological integrity of sperm during freezing and thawing, primarily due to appearance of ice crystals (Miljković, 1998). With this in mind, it is important that the semen pass through the temperature range between -60°C and -80°C as quickly as it is possible, to reduce the percentage of damaged sperms. That can be achieved by increasing the temperature of thawing. On the other hand, high temperatures also lead to sperm damage, because of protein denaturation, so the exposure time of semen to high temperatures during thawing must be reduced to a minimum.

Table 2 shows the results of the morphological integrity of sperms after thawing at different temperatures.

Table 2. Parameters of the morphological integrity of the sperms after thawing at different temperatures.

Bull	t (°C)	n	Distribution of sperms (%)					
			live	dead	died during staining	damaged		
						total	damaged intact membrane	other damages
Indurein	38	20	55,74±0,29	6,78±0,34	20,02±0,23	17,46±0,20	49,67±0,87	50,33±0,87
	50	20	56,08±0,37	7,88±0,26	20,83±0,23	15,20±0,30	41,39±0,66	58,61±0,66
Polian	38	20	44,14±0,42	10,67±0,32	21,92±0,58	23,27±0,43	53,12±1,03	46,88±1,03
	50	20	44,67±0,22	10,90±0,17	23,31±0,24	21,10±0,18	46,03±0,55	53,96±0,55
Strellas	38	20	55,29±1,13	4,26±0,53	27,13±0,98	13,31±0,78	45,97±3,69	54,03±3,70
	50	20	57,68±0,64	5,72±0,43	25,67±0,79	10,99±0,38	43,15±1,88	56,85±1,88

The present data indicate the beneficial effect of thawing temperature on the percentage of live sperm in all three bulls, but also the impact of individual bull on the percentage of live bull spermatozoa after thawing, regardless of temperature. Higher temperature of thawing adversely affected the percentage of dead sperm in all three bulls, with influence of the bull again. The percentage of sperms died during staining was approximately the same in all three bulls, regardless of thawing temperature. Higher temperatures of thawing decreased the percentage of damaged sperms, and within it reduce the percentage of sperm with damaged intact membrane, as the main consequence of ice crystals damaging.

Statistical data analysis, by using multivariate analysis of variance, found that there is a statistically significant difference in the frequency of certain categories of sperm in relation to the applied thawing protocol ($\chi^2=56.91$, $p<0.01$). Generally favorable impact of higher temperature thawing parameters on morphological integrity of sperm is indicated by a higher percentage of live sperm in all three bulls and a smaller percentage of sperm with damaged intact membrane ($\chi^2=44.96$, $p<0.01$), as confirmed by Suljkanović and Šabanović (2002), which found a higher percentage of live sperms after thawing at 35°C in relation to the doses thawed at 50° C (80.7 vs. 78.8%). Favorable impact of higher temperatures of semen thawing for preservation of the sperm morphological integrity was also found by Chandler et al. (1984), Nur et al. (2003), Muino et al. (2008) and Pace et al. (2013). At the same time, higher percentage of dead sperms indicate the need for shortening the period of semen exposure to higher temperatures ($\chi^2=6.93$, $p<0.01$).

Conclusion

The thawing procedure is a key factor affecting the preservation of the semen quality and its fertilisation ability. Literature data indicate a beneficial effect of higher thawing temperatures on the preservation of fertile ability of insemination doses, through the increase in the live sperm percentage with preservation of progressive motility, which was confirmed in this study. Our results of the morphological integrity of sperms after thawing on different temperatures indicate that the resistance of spermatozoa to cryoconservation and thawing is individual characteristic of each bull, so it should be considered before choosing the optimal thawing procedure, in order to preserve the overall fertile ability of insemination dose.

References

- Chandler J.E., Adkinson R.W., Nebel R.L. (1984): Thawing optimums for bovine spermatozoa processed by three methods and packaged in continental and French Straws. *J. Dairy Sci.* 67, 2, 398-404
- Miljković, V. (1998):, *Artificial Insemination in Animals*. Zavod za udzbenike i nastavna sredstva, Beograd.
- Muino R., Rivera M.M., Riqua T., Rodriques-Gil J.E., Pena A.L (2008): Effects of different rates on post-thaw sperm viability, kinematic parameters and motile sperm subpopulations structure of bull semen, *Animal. Reprod. Sci.* 109 (1-4): 50-64
- Nur Z., Dogan I., Soylu M. K., AK K.(2003): Effect of different thawing procedures on the quality of bull semen. *Revue Med. Vet.* 154, 7, 487-490
- Pace M. M., Sullivan J. J., Elliott E. F. Graham., Coulter G. H. (2013): Effects of Thawing Temperature, Number of Spermatozoa and Spermatozoal Quality on Fertility of Bovine Spermatozoa Packaged in 0.5-ml French Straws. *Journal of Animal Science*, 53:693-701.
- Snoj T.(2014): Bull Semen Quality Parameters and Impact of Exogenous Factors on Semen Quality, *Vet. glasnik* 68 (3-4) 229 - 239.
- Suljkanović A., Šabanović M. (2002): The occurrence of abnormal sperms depending on the thawing temperature of deep frozen bulls semen, *Zbornik naučnih radova Instituta PKB Agroekonomik*, 307-317
- Vakanjac S., Pavlović V., Pavlović M., Nedić S. (2013). Evaluation of quality cytology and microbiology bull semen, *Scientific Symposium „Reproduction of Domestic Animals, Book of Proceedings*, 91-99
- Zobel R., Gračner D., Pipal I., Buić V. (2009): Influence of Sperm Thawing Temperature on Conception Rate in Dairy Cows, *Veterinarska stanica* 40 (1),11-16.

EFFECTS OF PARTIAL REPLACEMENT OF FISH MEAL BY DDGS ON BLOOD HEMATOLOGICAL AND BIOCHEMICAL PARAMETERS OF RAINBOW TROUT

Baki AYDIN*, Erkan GÜMÜŞ

Fisheries Faculty, Akdeniz University, Antalya, Turkey

*Corresponding author: bakiaydin@akdeniz.edu.tr

Abstract

The present study investigated the effects of distillers dried grains with solubles (DDGS) meal as a partial replacement to fish meal on hematological and serum biochemical parameters of rainbow trout (*Oncorhynchus mykiss*) fry. Four isoproteic (45.47% CP) and isocaloric (3570 kcal DE/kg) diets were formulated: DDGS0 as a control group and DDGS10, DDGS20 and DDGS30 which included 0%, 10%, 20% and 30% DDGS meal, respectively. Fish were stocked in each of 12 fiberglass tanks with a water volume of 200 litres and a flow rate of 10 litres/min. The fish were fed to apparent satiation three times daily for 84 days. Blood sample of two fish from each tank (6 fish per treatment; mean fish weight 103.9 g) was drawn gently from the caudal vein by 5-mL sterile syringe. The first part of the collected blood was transferred to a tube coated with EDTA as anticoagulant and was used for hematological indices. The second part was transferred to an tube without EDTA for serum biochemical indices. At the end of experiment, DDGS had no significant ($P>0.05$) effect on hematological parameters such as RBC, WBC, hemoglobin, hematocrit, MCV, MCH and MCHC. Significant decreases ($P<0.05$) in the biochemical parameters such as glucose were found with increasing in DDGS, whereas alkaline phosphatase, alanine aminotransferase, total protein, albumin, globulin, triglyceride, cholesterol, blood urea nitrogen, and creatinine concentrations were not significantly different between groups ($P>0.05$). Partial replacement of fish meal with DDGS could not affect haematological and biochemical parameters (except glucose) in rainbow trout.

Keywords: *Fish meal, DDGS, Rainbow trout, Haematological, Biochemical*

Introduction

Fish meal is the main protein source in fish feeds especially for carnivorous fish species such as rainbow trout (*Oncorhynchus mykiss*). However, fish meal is the most expensive protein source in fish feed and limited availability (Hardy, 2010). Hence, sustainable, lower-cost protein sources are needed to replace fish meal with alternative protein sources in fish diets. After removal of ethanol by distillation, the remaining non-fermentables are centrifuged, dewatered, mixed, and finally dried to produce the particulate co-product known as distiller's dried grains with solubles (DDGS) (Welker *et al.*, 2014). DDGS, a major by-product of the dry mill ethanol industry, is currently readily available and competitively priced relative to other alternative protein sources. DDGS derived has a relatively high protein content (24-37% crude protein) without the presence of antinutritional factors commonly found in most plant protein sources and high lipid (3-15% crude lipid). DDGS has been tested in some diets for several fish species, such as rainbow trout, *Oncorhynchus mykiss* (Cheng and Hardy, 2004; Stone *et al.*, 2005; Barnes *et al.*, 2012; Revecó *et al.*, 2012), European seabass, *Dicentrarchus labrax* and meagre, *Argyrosomus regius* (Magalhães *et al.*, 2015), Nile tilapia, *Oreochromis niloticus* (Wu *et al.*, 1994; Schaeffer *et al.*, 2010; Salama *et al.*, 2011). These studies demonstrating its potential as an alternative ingredient in fish feed.

The objective of this study was to evaluate the effects of replacement of fish meal protein with DDGS protein on hematological and serum biochemical parameters of rainbow trout (*Oncorhynchus mykiss*) fry.

Material and Methods

Feed formulation and preparation

Four isoproteic (45.47% crude protein) and isocaloric (17.42 MJ/kg digestible energy) diets were formulated using DDGS (0, 10, 20 and 30%; Control, DDGS10, DDGS20 and DDGS30) to meet NRC (2011) requirements for rainbow trout (Table 1). All feed were thoroughly mixed until homogenous, extruded (3.0 mm diameter) using a Double Screw Inflating Food Machine (Jinan Eagle Machine Co., Ltd., DP65-II Double Screw Inflating Food Machine, Jinan, China), dried in an oven, then cooled to room temperature, and stored at -20 °C until needed.

Table 1. Feed ingredients and proximate composition of the experimental diets

	Experimental diets			
	DDGS0 (Control)	DDGS10	DDGS20	DDGS30
Ingredients (%)				
Fish meal	65.00	61.38	57.77	54.16
DDGS ¹	0.00	10.00	20.00	30.00
Corn starch	25.50	19.57	13.63	7.67
Fish oil	6.00	5.55	5.10	4.67
Vitamin premix ²	1.00	1.00	1.00	1.00
Mineral premix ³	1.00	1.00	1.00	1.00
CMC ⁴	1.00	1.00	1.00	1.00
Cr ₂ O ₃ ⁵	0.50	0.50	0.50	0.50
Proximate composition⁶				
Dry matter (%)	89.24	89.14	88.84	88.54
Crude protein (%)	43.79	43.32	43.44	43.87
Crude lipid (%)	12.18	12.48	12.96	13.24
NFE (%) ⁷	22.69	22.25	20.67	19.12
DE (kcal kg ⁻¹) ⁸	4035	4023	4018	4010

¹ DDGS: Distiller's dried grains with solubles

² Per kg vitamin mix: 16 000 000 IU vitamin A, 1 600 000 IU vitamin D3, 170 000 mg vitamin E, 10 800 mg vitamin K3, 16 000 mg vitamin B1, 25 500 mg vitamin B2, 17 000 mg vitamin B6, 43 vitamin B12, 170 000 mg vitamin C, 170 000 mg niacin, 5 100 mg folic acid, 42 500 mg calcium D-pantothenate, 425 mg D-biotin, 255 000 mg inositol

³ Per kg mineral mix: 42 500 mg manganese, 42 500 mg iron, 42 500 mg zinc, 8 500 mg copper, 128 mg cobalt, 680 mg iodine, 128 mg selenium

⁴ Carboxymethyl cellulose

⁵ Chromium oxide

⁶ Proximate composition values are mean of triplicate analyses (% , wet weight basis)

⁷ Nitrogen-free extract =100-(%crude protein + %crude lipid + %crude ash + %crude fiber + %moisture)

⁸ Digestible energy of experimental diets was calculated according to values 4.9 kcal g⁻¹ protein, 9.01 kcal g⁻¹ fat, and 3.49 kcal g⁻¹ carbohydrate (NRC, 1993)

Rearing conditions of fish and feeding

This study was conducted at the Toklu Balık Çiftliği Co., Ltd. (Antalya, Turkey), from January 01, 2015 to March 29, 2015. Rainbow trout (*Oncorhynchus mykiss* Walbaum, 1792) were obtained from Aydemir Alabalık Co., Ltd. (Isparta, Turkey). Prior to the start of the

experiment, all fish were acclimated to experimental conditions for 2 weeks and fed a commercial diet three times daily during the acclimation. At the beginning of the experiment, each 12 cylindrical fiberglass tanks (200 L water/tank) were randomly stocked with 25 fry with an initial mean weight of 19.88 g with three replicate tanks for each dietary treatment (4 treatments x 3 replicates). Each tank was supplied with 10 L/min flow-through freshwater with temperature, dissolved oxygen and pH at 14.3 ± 1.2 °C, 8.4 ± 0.4 mg L⁻¹ and 7.19 ± 0.10 respectively. Fish were fed by hand up to apparent satiation with experimental diets three times a day (09:00 13:00 and 17:00 h) for 84 days. A photoperiod was set at natural conditions.

Sample collection and analysis

All fish were anaesthetized with clove oil to ensure ease in handling during the blood collection. Blood sample of two fish from each tank (6 fish per treatment; mean fish weight 103.9 g) was drawn gently from the caudal vein by 5-mL sterile syringe. The first part of the collected blood was transferred to a tube coated with EDTA as anticoagulant and was used for hematological indices. The second part was transferred to an biochemical tubes without anticoagulant for serum biochemical indices. The haematological parameters such as red blood cell count, white blood cell count, hematocrit value, hemoglobin value and trombocytes value were determined using the blood cell counter (Beckman Coulter AcT Diff 2, California, USA) (Fazio *et al.*, 2012). The mean corpuscular volume (MCV), mean corpuscular haemoglobin (MCH) and mean corpuscular haemoglobin concentration (MCHC) were calculated using the total red blood cell count, hemoglobin value and hematocrit value (Fazio *et al.*, 2012). Blood chemical parameters, such as alkaline phosphatase, alanine transaminase, total protein, albumin, globulin, glucose, cholesterol, triglyceride, creatinine, blood urea nitrogen were determined using bioanalytic test kits (Bioanalytic Diagnostic Industry, Co) and measured spectrophotometrically with an automated analyzer (Vet Test 8008 idexx, Europe).

Statistical analysis

The data (means±SD, standard deviation) were analyzed statistically by one-way analysis of variance (ANOVA) and Duncan's multiple range tests to determine significant differences using $P<0,05$. All statistical analyses were performed using SPSS Statistics Base v23 statistical software.

Results and Discussion

The hematological and serum biochemical parameters of experimental fish fed different diets throughout the experiment are given in Table 2 and Table 3. The survival of experimental fish ranged between 96.3% and 98.7%, and there was no significant difference among survival values of experimental groups. DDGS had no significant effect on hematological parameters such as red blood cell count, white blood cell count, hematocrit value, hemoglobin value, trombocytes value, MCV, MCH and MCHC ($P>0.05$) (Table 2), similar to the findings in Nile tilapia (Li *et al.*, 2011). In our study, red blood cells, white blood cell counts, and hemoglobin value did not differ significantly among the groups, and they were in normal range as reported by Blaxhall & Daisley (1973) for healthy trout. Whereas in another study (Hemre *et al.*, 2005), significant reduction in MCV on increase in the content of soybean meal in salmon diet was observed. Soltan *et al.* (2008) observed that fish meal replaced by mixture of plant proteins in Nile tilapia diets that lead to the lower haematocrit values. In this study, fish meal replacement with DDGS had no significant effect on haematocrit values ($P>0.05$).

A significant decreases ($P<0.05$) in the biochemical parameters such as glucose were found with increasing in DDGS, whereas alkaline phosphatase, alanine aminotransferase, triglyceride, cholesterol, creatinine and blood urea nitrogen were not significantly different between groups ($P>0.05$) (Table 3). Similar results except glucose were obtained in meagre (*Argyrosomus regius*) juveniles when carob seed germ meal was used in diets (Couto *et al.*, 2016). The concentration of total protein in blood serum is used as a basic index for health status of fish. The increase of total protein, albumin and globulin levels indicates the increase

in innate immune response of fish (Yilmaz *et al.*, 2015). There were no significant differences in the serum total protein, albumin and globulin values among the groups in this study.

Table 2. Effects of experimental diets on the haematological parameters in the blood of rainbow trout (*Oncorhynchus mykiss*) juveniles

Parameters	Experimental diets			
	DDGS0 (Control)	DDGS10	DDGS20	DDGS30
RBC ($10^6/\text{ul}$)	1,82±0,50	1,76±0,66	1,52±0,58	1,76±0,36
WBC ($10^3/\text{ul}$)	45,66±7,02	49,33±34,38	48,33±12,05	38,33±5,51
Hb (g/dL)	10,00±0,17	9,27±1,27	10,23±1,27	11,07±0,57
Hct (%)	31,87±3,67	31,33±8,62	31,33±5,03	33,00±6,56
TC ($10^3/\text{ul}$)	40,33±6,66	56,66±9,07	44±67±22,14	47,67±11,15
MCV (fL)	115,33±14,15	102,00±23,64	97,33±21,73	95,00±1,00
MCH (pg)	84,00±7,00	78,33±10,26	85,33±2,08	80,67±1,15
MCHC (g/dL)	78,10±4,19	84,33±17,21	90±00±10,44	88,33±4,16

Values are mean (n = 3) ± standard deviation

Mean values in the same column with different superscripts differ significantly (P < 0.05).

RBC, red blood cell; WBC, white blood cell; Hb, hemoglobin; Hct, hematocrit; TC, trombocytes;

MCV, mean corpuscular volume; MCH, mean corpuscular haemoglobin; MCHC, mean corpuscular haemoglobin concentration

Table 3. Effects of experimental diets on the serum biochemical parameters in the blood of rainbow trout (*Oncorhynchus mykiss*) juveniles

Parameters	Experimental diets			
	DDGS0 (Control)	DDGS10	DDGS20	DDGS30
ALP	389,00±172,50	181,33±127,03	266,33±62,04	409,33±100,51
ALT	73,33±14,57	58,00±34,22	78,33±20,53	80,00±20,95
TP (mg dl ⁻¹)	5,80±0,10 ^a	3,53±1,16 ^b	4,67±0,65 ^{ab}	5,07±0,90 ^{ab}
ALB (mg dl ⁻¹)	*2,05±0,07	2,20±1,13	1,73±0,06	1,90±0,44
GLO (mg dl ⁻¹)	*3,80±0,14 ^a	1,73±1,50 ^b	2,93±22,14 ^{ab}	3,20±0,46 ^{ab}
GLU (mg dl ⁻¹)	77,33±17,62 ^a	50,67±17,16 ^{ab}	41,33±6,51 ^b	35,00±19,05 ^b
CHOL (mg dl ⁻¹)	208,33±117,38	235,00±34,22	280,00±49,00	307,00±48,54
TRI (mg dl ⁻¹)	*123,00±1,41	141,33±59,18	122±33±19,50	94,67±9,29
CRE (mg dl ⁻¹)	0,53±0,58	0,10±0,00	0,03±0,06	0,00±0,00
BUN (mg dl ⁻¹)	2,33±0,58	2,67±0,58	2,33±0,58	2,33±0,58

Values are mean (n = 3) ± standard deviation; *Values are mean (n = 2) ± standard deviation

ALP, alkaline phosphatase; ALT, alanine transaminase; TP, total protein; ALB, albumin; GLO, globulin;

GLU, glucose; CHOL, cholesterol; TRI, triglyceride; CRE, creatinine; BUN, blood urea nitrogen

Conclusions

In conclusion, the results of the present study indicate that dietary corn DDGS at levels of 10, 20 and 30 % had no effect rainbow trout haematological and biochemical parameters (except glucose).

References

Barnes M.E., Brown M.L., Rosentrater K. (2012). Replacement of fish meal with high protein distillers dried grain in juvenile rainbow trout diets. *Journal of Aquaculture Feed Science and Nutrition*, 4: 39-47.

- Cheng Z.J., Hardy R.W. (2004). Nutritional value of diets containing distiller's dried grain with solubles for rainbow trout, *Oncorhynchus mykiss*. *Journal Applied Aquaculture*, 15: 101-113.
- Couto A., Barroso C., Guerreiro I., Pousão-Ferreira P., Matos E., Peres H., Oliva-Teles A. Enes P. (2016). Carob seed germ meal in diets for meagre (*Argyrosomus regius*) juveniles: Growth, digestive enzymes, intermediary metabolism, liver and gut histology. *Aquaculture*, 451: 396-404.
- Fazio F., Filiciotto F., Marafioti S., Stefano V.D., Assenza A., Placenti F., Buscaino G., Piccione G., Mazzola S. (2012). Automatic analysis to assess haematological parameters in farmed gilthead sea bream (*Sparus aurata* Linnaeus, 1758). *Marine and Freshwater Behaviour and Physiology*, 45: 63-73.
- Hardy R.W. (2010). Utilization of plant proteins in fish diets: Effects of global demand and supplies of fishmeal. *Aquaculture Research*, 41: 770-776.
- Hemre G.I., Sanden M., Bakke-Mckellev A.M., Sagstad A., Krogdahl A°. (2005). Growth, feed utilization and health of Atlantic salmon fed genetically modified compared to nonmodified commercial hybrid soybeans. *Aquaculture Nutrition*, 11: 157-167.
- Li E., Lim C., Cai C., Klesius P.H. (2011). Growth response and resistance to *Streptococcus iniae* of Nile tilapia, *Oreochromis niloticus*, fed diets containing different levels of wheat distiller's dried grains with solubles with or without lysine supplementation. *Animal Feed Science and Technology*, 170: 246-255.
- Magalhães R., Coutinho F., Pousão-Ferreira P., Aires T., Oliva-Teles A., Peres H. (2015). Corn distiller's dried grains with solubles: Apparent digestibility and digestive enzymes activities in European seabass (*Dicentrarchus labrax*) and meagre (*Argyrosomus regius*). *Aquaculture*, 443: 90-97.
- NRC (National Research Council) (1993). Nutrient requirements of fish. National Academy Press, Washington, DC, USA.
- NRC (National Research Council) (2011). Nutrient requirements of fish. National Academy Press, Washington, DC, USA.
- Reveco F.E., Collins S., Randall K.M., Drew M.D. (2012). Aqueous fractionation improves the nutritional value of wheat distillers grains for rainbow trout (*Oncorhynchus mykiss*). *Aquaculture Nutrition*, 18: 202-210.
- Salama F.A., Ali M.N., Mahmoud S.H., et al (2011) Effect of Radish root extract on improving the utilization of corn DDGS in tilapia fry diets. *American-Eurasian Journal of Agricultural & Environmental Sciences*, 10: 938-946.
- Schaeffer T.W., Brown M.L., Rosentrater K.A. and Muthukumarappan K. (2010). Utilization of diets containing graded levels of ethanol production co-products by Nile tilapia. *Journal of Animal Physiology and Animal Nutrition*, 94: e348-e354.
- Soltan M.A., Hanafy M.A., Wafa M.I.A. (2008). Effect of replacing fish meal by a mixture of different plant protein sources in Nile tilapia (*Oreochromis niloticus* L.) diets. *Global Veterinaria*, 2: 157-164.
- Welker T.L., Lim C., Barrows F.T., Liu K. (2014). Use of distiller's dried grains with solubles (DDGS) in rainbow trout feeds. *Anim Feed Science Technology*, 195: 47-57.
- Wu Y.V., Rosati R., Sessa D.J., Brown P. (1994). Utilization of protein-rich ethanol co-products from corn in tilapia feed. *Journal of the American Oil Chemists' Society*, 71: 1041-1043.
- Yilmaz E., Ergün S., Yilmaz S. (2015). Influence of carvacrol on the growth performance, hematological, non-specific immune and serum biochemistry parameters in rainbow trout (*Oncorhynchus mykiss*). *Food and Nutrition Sciences*, 6: 523-531.

PRELIMINARY DATA ON DAIRY FARMERS' LEVEL OF EDUCATION: THE CASE OF ALBANIA

Grigor GJEÇI^{1,2*}, Ylli BIÇOKU², Medin ZEQIRI²

¹Ministry of Agriculture, Albania

²Agricultural University of Tirana, Tirana, Albania

*Corresponding author: Grigor.Gjeci@bujqesia.gov.al

Abstract

The objective of this exploratory study was to assess the impact of farmers' education on dairy farming knowledge, national food safety standards, animal diseases, and farm production practices. Farmers' lack of awareness is likely a contributing factor to food standards not being met in most cases. 144 interviews were carried out on randomly selected larger farms. These farms were selected from Shkodra and Lushnje regions; and the data were collected through face-to-face interviews and personal visits based on a structured questionnaire. In regard with knowledge about Brucellosis and TBC diseases, significant differences were found among farmers (higher level of education compared with primary education) 50-58.6% vs 25.6-27.9%, respectively. In addition, the farmers with a higher level of education use more milking machines and cooling tanks than the farmers with a lower level of education. The farmers with a higher education level have a slightly better result (yet not significant) for animal identification, farm register, food safety standards and institutions, etc. Based on these and other findings, extension and veterinary services must plan and implement activities that increase farmers' awareness. They also need to commence teaching and training programs for dairy farmers, specifically targeted at improving safety standards at farm level. Finally, public and donors' farmer-support schemes should be strongly linked to the implementation of food safety standards.

Key words: *education level, dairy farming, dairy farming knowledge, Albania.*

Introduction

Agriculture is one of the most determinative sectors of the Albanian national economy with a contribution to GDP of about 17%, which is high, when compared to EU and neighboring countries (DSA, 2011). Animal husbandry in general and especially cattle (milk and meat) activities have a long tradition in Albania due to the favorable natural resources and the last two decades has signed a positive development of the production. Generally, livestock production is seen as the backbone of Albania's agriculture. The value of livestock production is almost 50 percent of the total value of agricultural production (MAFCP, 2012). Within the livestock sector, the primary output is cow milk (42% by volume), followed by bovine meat 21% (Foy Reed and Skreli, 2013). Livestock products constitute a main source of food and a high share of production still serves subsistence purposes. The livestock sector is an important source to farm income and to market supply, with raw and processed products, and engages a significant part of the labor force in rural areas. The number of larger farms has increased during the last years; however the sector is still dominated by small farms, whereas larger farms represent only a small percentage of the farming structure (about 1% in cattle). Approximately 214 000 farm household are managing cattle for milk and meat production (MAFCP, 2012). The majority of cow milk and beef production units are very small with 2 or 3 cows per farm and their off-springs. In small dairy farms (1 to 10 cows) cows are usually milked by hand, which affects negatively hygiene and food safety. Only dairy farms, specialized in milk production (normally more than 10 cows) started to use the mobile

milking machines over the last years. Farms with more than 50 cows usually have milk storage tanks with cooling system and farms with more than 100 milking cows have milking parlor.

There are limited or no financial incentives to increase milk quality, since prices are determined mainly by quantity and fat content. The majority of the milk producers have no information about the microbiological status of their raw milk. (MARDWA, 2014)¹.

Regarding farmers education only 3% of the farm holders have university education and 37% have upper secondary or tertiary education, while the remaining 63% have lower secondary, primary or no education. About one-third of the farm holders have agricultural education background. These are likely to be the older farmers, who have accomplished agricultural vocational high schools in the past. (MARDWA, 2014).

The weak knowledge of modern production technologies and animal welfare and health requirements are the main problems faced by farmers and where the advisory service needs to work in the future. The extension service suffers from lack of qualified field staff and dissemination means. In the short-run, an overall increasing of rural income due to larger farm operations is less likely to occur. Upgrading farmers' knowledge becomes important to keep pace with technological progress in the field, implement good farm management practices and take appropriate decisions, become responsive toward market behavior and challenges following correct information. The main source for farmers to receive the new agricultural knowledge is the public extension service, through Agriculture Technology Transfer Centers, as the main source of information, as well as from Agriculture University of Tirana. In addition several projects and private extension services provider are working to a less extent to train farmers and provide the information needed by them. Extension and Veterinary Services must plan awareness, teaching and training programs for dairy farmers to improve safety standards at farm level.

Several authors (Hicks, 1987; Hanushek E A and Wößmann L, 2010;) emphasized that education and training are not only acknowledged as contributors to national economic wellbeing and growth but also as: (i) a major factor in explaining differences in productivity and income between countries; (ii) facilitators of the diffusion and transmission of knowledge needed to understand and process new information and to successfully implement new technologies, which again promotes economic growth. The objective of this exploratory study was to assess the impact of farmers' education on dairy farming knowledge, national food safety standards, animal diseases, and farm production practices.

Material and Methods

The present study was conducted in the regions of Albania, Lushnje and Shkoder. The data were collected during 2014. The questionnaire was designed based literature review including national minimum standards - the draft questioner was consulted with various experts and was tested in the field with 8 farmers. 144 interviews were carried out on randomly selected larger farms. In principle interviewers were instructed to interview farmers with more than 3 cattle; thus focusing on market oriented rather than subsistence farms (which typically have 1 cow) - the average sample farm size having been 8.5 cows (Table 1).

The questionnaire was designed to capture information related to general characteristics of the farm, situation of milk production and marketing, milk yield in different farm sizes, age and education level of household head, family size, experience in dairy production, numbers of dairy cow, farmer training, farmers' awareness on animal health and food safety issues.

¹ Ministry of Agriculture full name was Ministry of Agriculture, Food and Consumer Protection (MAFCP) until 2013 and as of 2013, following institutional changes, it is named Ministry of Agriculture, Rural Development and Water Administration (MARDWA).

The obtained data was stored in Excel and imported to software SPSS for analysis. Stored data were tabulated and arranged as a percent value. Descriptive statistics (i.e. means, frequencies, etc.) was done to estimate the different variables.

Results and discussion

The data collected are analyzed with focus the relationship between level of formal education and farmers practices, in Lushnje and Shkoder regions of Albania. For this purpose education is included by using six point Likert scale: 1-no education, 2- primary education (up to 4 years of school), 3-obligatory education (up to 9 years of school), 4- agricultural middle school (12 years of school), 5- other middle school(12 years of school), and 6-university degree.The results of group 1-3 (primary education) are compared with those of better educated farmers' group 4-6 (secondary + education).

Sample socio-demographic and farm indicators

Table 1: Main sample socio-demographic and farm indicators.

Education level	Sample farm household indicators					
	Age		Working experience		No. of cows	
	Mean	Std.Dev.	Mean	Std. Dev.	Mean	Std. Dev.
Primary education	50.49	12.285	25.94	12.156	9.77	10.837
Secondary+ education	51.38	9.799	24.19	12.066	7.17	5.648

In this research are targeted market oriented farms (7.17-9.77 cows) as usually they are more aware of the standards;could invest more in the future, toward improving standards; and compare with small subsistence farms (1-2 cows) are more likely to “survive” the growing competition in the future.

As it is mentioned by MAWARD (2014) many farms are continued to be run by older people, and the average age of head of farm household is increased (more than 30 percent of farm operators in 2010 were above 65 years old as compared to 23 percent in 2006), which implies a migration of younger generation outside agriculture. The older farmers have knowledge limitation in feeding, breeding, animal health care practices and national minimal standards.

The mean age of primary education farmers is 50.49 years (20 to 78 years) and their farm experience is 25.49 years (4 to 64 years) while the mean age of secondary + education group is 51.38 years (28 to 72 years) and farm experience of 24.19 years (1 to 54 years).

Animal diseases. Most of the farmers of the primary education group stated that they don't know the symptoms of Brucellosis (72.1%) and TBC (74.4%) (Table 2). Farmers of the secondary+ education group have a much better knowledge of the symptoms Brucellosis (58,6%) and TBC (50%). People who are infected with Brucellosis and TBC might significantly impede from seeking medical services as result of poor knowledge of zoonosis.

Table 2: “Do you know the symptoms of the following diseases?”

Education level	Brucellosis				TBC			
	Primary education		Secondary+ education		Primary education		Secondary+ Education	
	Freq.	Percent	Freq.	Percent	Freq.	Percent	Freq.	Percent
Yes	24	27.9	34	58.6	22	25.6	29	50
No	62	72.1	24	41.4	64	74.4	29	50
Total	86	100	58	100	86	100	58	100

Milking and cooling tank. 53.5 percent of the farmers of the secondary + education level group are using milking machine, in addition, 19 percent of the farmers, of this group, are using milk cooling tank which shows us for better milk quality and less risk for diseases (Table 3).

Table 3: Do you use hand or machine milking? and “Do you have milk cooling tank”?

Education level	Machine milking				Milk cooling tank			
	Primary education		Secondary+ education		Primary education		Secondary+ education	
	Freq.	Percent	Freq.	Percent	Freq.	Percent	Freq.	Percent
Yes (machine)	32	37.2	31	53.5	8	9.3	11	19.0
No (hand)	54	62.8	27	46.5	78	90.7	47	81.0
Total	86	100	58	100	86	100	58	100

The secondary + education group compare with the primary education group have slightly better result of the knowledge (yet not significant) according to the:

- institution in charge with food control (31% vs. 25.6%);
- institution in charge with issuing the animal health certificate (44.8% vs. 36%);
- keeping book register on livestock (58.6% vs 50%);
- notification of the veterinary service before slaughter of animals (15.5% vs. 8.2%);
- use of the feed ration of cows according to the milk production (93.1% vs. 91.9%).

The primary education group compares with the secondary + education group have slightly better result of the knowledge according to the:

- use of ear tags for livestock identification (69.8% vs. 60.3%);
- consulting with extension service for the production technologies (73.2% vs. 55.2%).

Conclusions

This is an exploratory study, aiming at assessing the impact of farmers’ education on dairy farming knowledge, national food safety standards, animal diseases, and farm production.

The mean age of primary education farmers is 50.49 years and their farm experience is 25.49 years while the mean age of secondary + education group is 51.38 years and farm experience of 24.19 years. According to the survey, most of the farmers of the primary education group stated that they don’t know the symptoms of Brucellosis and TBC, while farmers of the secondary+ education group have a much better knowledge of the symptoms of both diseases. About 54 percent of the farmers of the secondary + education level group are using milking machine, in addition, 19 percent of the farmers, of this group, are using milk cooling tank which shows us for better milk quality and less risk for diseases. The lack of cooling tank for storing the milk is a prerequisite for attaining milk safety and quality standards.

A major key of raising animal agricultural production to a sustainable level is building an agricultural education system for farmers however in Albania there has been little progress in the area of food safety and veterinary policy. There is a need to coordinate actions between extension and veterinary services. This is needed to develop institutional coordination and inter-organizational communication; keys to providing useful information and effective support to farmers; those farmers needed for implementation of the National Minimum Standards and GAPs. Otherwise small scale farms will face difficulties in selling their dairy products as they fail to meet market and statutory hygienic standards. Except raising the awareness, there should be scaled up financial support towards investments that enable improvement of safety standards at farm level.

Acknowledgment

The authors thankfully acknowledge the Professor Associated Dr. DriniImami and Development Solutions Associates for providing facilities and valuable guidance for the research work.

References

- DSA, (2011): Agribusiness sector survey, Final report for Italian Cooperation”, Tirana, Albania.
- Foy Reed, B., Skreli, E., (2013): Agricultural Markets in a Transitioning Economy. An Albanian Case Study. ISBN-: 9781780641003.
- Hanushek, E. A., Wößmann, L., (2010): Education and Economic Growth. In: Penelope Peterson, Eva Baker, Barry McGaw, (Editors), International Encyclopedia of Education. volume 2, pp. 245-252. Oxford: Elsevier.
<http://hanushek.stanford.edu/sites/default/files/publications/Hanushek%2BWoessmann%202010%20IntEncEduc%202.pdf>
- Hicks, N., (1987): Education and economic growth. In G. Psacharopoulos (Ed), Economics of Education: Research and Studies, Oxford, Pergamon Press, pp. 101-107.
- MAFCP, (2012): Vjetari Statistikor 2011. Tirane, 2012.
- MARDWA, (2014): Strategjia Ndersektorale per Zhvillimin Rural dhe Bujqesor, 2014-2020. (Inter-Sectoral Rural Development Strategy of Albania).

TAENIIDOSES IN DOGS AND LARVAL CESTODOSES IN SHEEP AT FARMS IN KABARDINO-BALKARIA

Vera BEREZKO, Amina THAKAHOVA*

All-Russian scientific research institute of fundamental and applied parasitology of animals and plants of name K.I. Scriabin, Russia

*Corresponding author: amina7161@yandex.ru

Abstract

Taking into account the fact that infected dogs were the main source of infection of sheep by *Taenia hydatigena* larvae we conducted research in this field in different climatic zones of Kabardino-Balkaria paying special attention to pasture, domestic and stray dogs. The results of coproscopic analysis of these 3 categories of dogs were given for different climatic zones of the republic. 44 domestic, 55 pasture and 29 stray dogs were tested. Coproscopic analysis showed that the rate of infection in different dogs by parasites of the family *Taeniidae* average reached 45.5% in domestic dogs, 76.03% – in pasture dogs and 90.5% in stray dogs. In order to determine species composition of helminths 19 dogs were tested by the method of postmortem examination. The results of this test also showed high extensity of infection (EI) in dogs by *Taenia hydatigena* and *Echinococcus granulosus* which amounted to 73.3% and 57.9%, respectively. Studies carried out at slaughter houses in different regions of the republic demonstrated that *cystic hydatidosis* and *Taenia hydatigena* larvae in sheep were registered at all farms. According to the results of our work the average EI by *E. granulosus* larvae and *T. hydatigena* larvae amounted to 33.0% and 24.6% respectively in the region. Based on the analysis of the obtained data we found out that EI of sheep by *Taenia hydatigena* larvae was almost as high as in the case of *larval hydatidosis* and also was a widespread helminthosis at farms of Kabardino-Balkaria. Such a situation depended on the high rates of infection by *E. granulosus* and *T. hydatigena* in dogs.

Keywords: *Taenia hydatigena*, *Echinococcus granulosus*, dog, sheep, infection.

Introduction

Infections caused by parasites attributed to the *Taeniidae* family have a special place among dog and sheep parasitic diseases. According to the data of different researchers *larval cestodoses* are widely spread in domestic and farm animals throughout the world and such situation depends on high rates of infection with *Taeniidae* parasites in dogs and wild carnivores. Dog infections caused by these parasites (in particular *E. granulosus*) represent a serious problem not only for agricultural animals but also for people. Harm from *larval cestodoses* as well as from other helminthoses consists of mortality, forced slaughter, reduction of productivity and production quality shortfall of animal offspring, considerable expenses for preventive and therapeutic measures (Safiullin, 1997; Melnikova, 2008; Samuel, Zewde, 2010). There are many reports on wide spread of these helminths in the Southern Federal area and particularly at farms of Kabardino-Balkaria Republic (Bittirov et al., 2009; Elkanova, 2010; Khaidarova, 2013).

Taking into account the absence of concrete targeted research on estimation of epizootological situation concerning these parasitoses in Kabardino-Balkaria the purpose of our study has been to determine the rates of infection of dogs by *Taeniidae* and sheep by *Echinococcus granulosus* larvae and *Taenia hydatigena* larvae in different nature and climatic areas of the Republic.

Materials and methods

As infected dogs of different economic purposes are the main sources of *larval cestodoses* prevalence we have tested coproscopically 128 dogs for presence of *Teniidae* parasites (44 – domestic, 55 – pasture and 29 – stray dogs). There were 14 dogs from flatland, 17 – from foothill zone and 13 – from mountain area, 18, 16, 21 – pasture dogs and 9, 11, 9 – stray dogs respectively. To determine the species composition of parasites helminthofaunistic analysis was carried out by necropsy of 19 dogs corpses. The recovered parasites were counted, the species – identified. We also estimated the extensity and intensity of infection by each parasite species.

The prevalence of *larval cestodoses* (*E. granulosus* larvae and *T. hydatigena* larvae) in different natural and climatic zones of the Republic was studied on the basis of detection of infection rates of slaughtered sheep by necropsy of parenchymal organs and mesentery. For this purpose 215 and 235 slaughtered sheep were examined in order to detect *E. granulosus* cysts and *T. hydatigena* cysts respectively. At the same time we took into account the rates of sheep infection with the both parasite species, recorded the number of such animals in each zone, extensity and intensity of infection with *E. granulosus* (l) and *T. hydatigena* (l) on average in the Republic.

Results and Discussion

Based on the results of necropsy analysis it was found that the rates of infection in pasture dogs with parasites of the family *Taeniidae* were 72.2% in the flatland region, 75.0% – in the foothill zone and 80.9% – in the mountain area of the Republic; on average – 76.03%. And zonal analysis was carried out in the similar way for domestic and stray dogs; their rates of infection with *Taeniidae* parasites were 35.7%, 47.05%, 53.8% respectively (on average – 45.5%) and 88.9%; 81.8%, 100% respectively (on average – 90.2%) (Table 1.). These results convincingly proved the high rates of infection with different species of *Taeniidae* parasites in dogs (especially in pasture and stray dogs). Taking into account that pasture dogs are necessary in sheep breeding process we can say with reasonable certainty about high rates of infection with *larval cestodoses* in sheep. Based on this we carried out similar tests to determine the rates of infection with *Taenia* in pasture dogs at farms from different areas.

Table 1. Infection rates with the *Taeniidae* family parasites in dogs of different practical application and in stray dogs in natural-climatic zones of the Republic

Zones	Pasture dogs			Domestic dogs			Stray dogs		
	Examined	Infected	Extensity of infection, %	Examined	Infected	Extensity of infection, %	Examined	Infected	Extensity of infection, %
Flatland	18	13	72,2	14	5	35,7	9	9	88,9
Foothill	16	12	75,0	17	8	47,05	11	9	81,8
Mountain	21	17	80,9	13	7	53,8	9	9	100
In total	55	42	-	44	20	-	29	27	-
On average	-	-	76,03	-	-	45,5	-	-	90,2

*calculation based on the results of coproscopy

As our further studies needed monitoring of sheep *larval echinococcosis* and *larval cysticercosis* it was necessary to identify species of helminths in dogs and find out whether their rates of infection with *T. hydatigena* and *E. granulosus* could be epizootologically

dangerous. The results of necropsy of 19 dog corpses gave answers to these questions and showed that in the region dogs were infected not only by different *Taenia species* such as *T. hydatigena* (extensity of infection – 73.7%; intensity of infection – 3.0 ± 0.2); *E. granulosus* (extensity of infection – 57.9%, intensity of infection – 2.4 ± 0.2); *Multicepsmulticeps*(extensity of infection – 31.5%, intensity of infection – 1.9 ± 0.3); but also with *Toxocara canis* (47.3%; 6.2 ± 0.4) and *Toxascaris leonina* (36.8%; $4,1 \pm 0.3$) (Figure 1).

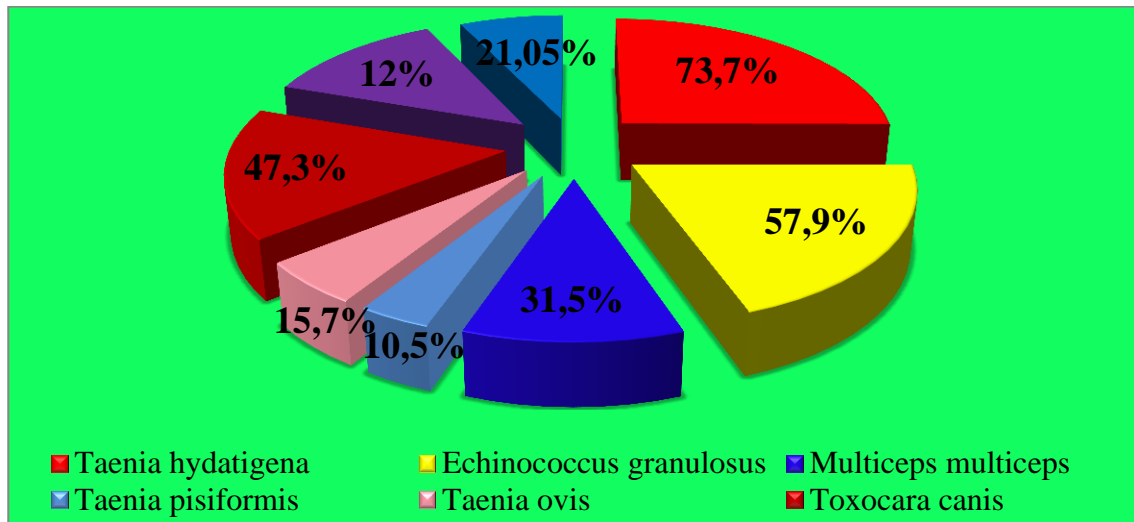

Fig. 1. Species composition and values of extensity level of infection in dogs with helminths according to the results of necropsy

While working at slaughterhouses of different areas of the Republic we found out that sheep *larval cestodoses* were registered at all farms. At that, differences in extensity and intensity level of infestation with these helminth species were inconsiderable with regard to natural-climatic zones and sheep breed. According to our data on average extensity of *E. granulosus* (*l*) and *T. hydatigena* (*l*) infections amounted 33.0% and 24.6% respectively. As for zonal aspect, examinations of parenchymal organs of slaughtered sheep from farms of different regions of the Republic showed that the values of extensity of infestation with *E. granulosus* (*l*) and *T. hydatigena* (*l*) were 34.7%; 27.3% – in flatland area, 32.6%; 25.3% – in foothill region and 31.4%; 20.6 – in mountain region respectively. (Table. 2).

Table. 2 *Echinococcus granulosus* larvae and *Taenia hydatigena* larvae infection rates in sheep at farms of different natural-climatic zones in the Kabardino-Balkarian Republic (according to necropsy data)

<i>Echinococcus granulosus</i> larvae				
Zones	Sheep dissected	Of which infected	Extensity of infection, %	Intensity of infection, sp/
Flatland	75	26	34,7	13,7±1,52
Foothill	89	29	32,6	17,8±1,52
Mountain	51	16	31,4	14,8±1,5
In total	215	71		
On average			33,0	15,4±1,6
<i>Taenia hydatigena</i> larvae				
Flatland	88	24	27,3	6,2±0,4
Foothill	79	20	25,3	5,7±0,5
Mountain	68	14	20,6	4,8±0,6
In total	235	58		
On average			24,6	5,6±0,5

According to Table 2 the values of the rate of infection with *E. granulosus* (*l*) in sheep were slightly higher at farms in foothill and mountain regions where conditions of grazing system with a great number of animals per area unit and a large number of pasture and stray dogs infected with *E. granulosus* provided maintenance of epizootic process.

As for the rate of infection with *T. hydatigena* (*l*) in sheep its extensity and intensity was almost as high as in *larval echinococcosis* and was widely spread at farms of the Republic.

At necropsy, we also payed attention to sheep with mixed infections by *E. granulosus* (*l*) and *T. hydatigena* (*l*). As a rule, the number of such animals appeared to be 5-10% of the total number of the examined ones. The results of our tests were convincing evidences of a problem at farms in Kabardino-Balkarian Republic concerning infection of agricultural animals with *Taeniidae* parasites and *cestode larvae*. Moreover, the analysis of similar works of other authors showed that the situation regarding parasitoses infection in animals was not improved in the region but became even worse in case of *echinococcosis* and that affected epidemiological situation. According to the Federal Service for Supervision of Consumer Rights Protection and Human Welfare analysis of multi-year rates of infection with *E. granulosus* among population also showed that this index remained higher in Kabardino-Balkaria than the average one in Russia.

This situation is the result of complete absence of planned preventive measures such as scheduled dehelminthizations of pastures dogs, capture and placement into special shelters of stray dogs and sanitary-educational work among personnel and population.

Conclusion

Our work demonstrated the presence of all components for maintenance of epizootic process in case of *E. granulosus* (*l*) and *T. hydatigena* (*l*) at farms in all natural-climatic zones of the Republic. The high extensity and intensity of infection with *Taeniidae* family parasites in dogs were observed all year round in the region in presence of the object of infection providing dynamics, biological activity and parasitic system protection for a long time. The conducted analysis convincingly demonstrated that *echinococcosis* in dogs was registered at all farms of the region and was not only serious ehpizootological problem but also a social one. The last statement was confirmed by considerable deterioration of the epidemiological situation conserving human *echinococcosis*. According to the data of medical statistics and the results of medical epidemiological service the rate of infection with echinococcosis in people

since 2012-2013 increased from 0.00046 to 0.0061 per 100000 people. Studies of rates of infection with *Echinococcus* in sheep carried out at farms of all climatic zones of the Republic with the consideration of welfare technology did not reveal any significant differences because contact with infected dogs could not be excluded in any technology especially if one had in mind that the main republic technologies were based on distant-pasture grazing and pasture-stable maintenance.

References

- Bittirov A.M. Chilayev S.S., Balkizova Z.V. Biogeographical features *Taenia hydatigena* larvae small cattle and *hydatid teniasis* domestic and wild carnivores in the Northern Caucasus // Russian Journal of parasitological. – 2009. – № 3. – p. 54-58.
- Elkanova Z.Z. Epizootological and epidemiological characteristics of *echinococcosis* foci in animals and humans in the ecosystem of the Kabardino-Balkarian Republic // Diss ... cand. biol. Sciences. – M. – 2010. – 169 p.
- Safiullin R.T. Distribution and economic losses from major helminth infections of ruminants // Veterinary Medicine. – 1997. – № 6. – p. 28-32.
- Melnikova L.E. Monitoring epizootic situation on the main helminthiasis of farm animals in the Mozhaisk district of Moscow region // Theory and practice of control of parasitic diseases. – M. – 2008 – p. 292-294.
- Khaidarova A.A. Serological monitoring of *Echinococcus granulosus* cysts and *Taenia hydatigena* cysts sheep in Kabardino-Balkaria // Diss ... cand. biol. Sciences. – M. – 2013. – 148 p.

PROTECTIVE EFFECT OF IMMUNOSTIMULATORY DRUGS IN EXPERIMENTAL TRICHINOSIS OF MICE

Liudmila A. NAPISANOVA, Olga V. RUDNEVA*, Vera K. BEREZHKO, Amina A.
THAKAHOVA

All-Russian Scientific Research Institute of Fundamental and Applied Parasitology of Animals and Plants named
after K.I. Skryabin, Moscow, Russia

*Corresponding author: rudneva.olga79@gmail.com

Abstract

The immunostimulatory drugs in recent years are widely used for helminthiasis in veterinary medicine. In our study we evaluated the protective effect of cycloferon and roncoleukin in experimental trichinosis of mice. We used 30 mice weighting 16-18 g, divided into 3 groups of 10 animals in each. The first group was injected with cycloferon; the second group was injected with roncoleukin; the third control group was injected with 0.9% NaCl. The drugs were injected twice with an interval of 48 hours. The cycloferon was injected intramuscularly in the dose of 2.16 mg/mouse. The roncoleukin was injected subcutaneously in the dose of 100 U/mouse. After 48 hours the mice were infected by *T. spiralis* larvae in the dose of 80±5 larvae/mouse. Analysis of the data indicates that in the experiment in the application of these drugs has been significant protective effect. The number of *T. spiralis* larvae detected in animals was 733.5 ±25.1 and 869.5 ±16.61 larvae/mouse respectively. This was 6.1 and 5.2 times less than in the mice of control group (4485 ± 430.6 larvae/mouse. Based on this, we consider it expedient to continue the study of immunostimulatory drugs in the complex immunoprophylaxis of trichinosis.

Keywords: *Immunostimulatory drugs, Trichinosis, Immunoprophylaxis.*

Introduction

The immunostimulatory drugs in recent years are widely used for helminthiasis in veterinary medicine. The use of these drugs increases immunoreactivity to specific antigens, increases the resistance of animals, which leads to a decrease and in some cases prevents infection of animals.

So, there are scientific data about the use of biologically active drugs in the literature. On the model system of *nippostrongylus* invasion it has been shown that the drug T-activin shows protective effect in the range of 51.8-60.8%. Subsequently, the stimulating effect of T-activin was revealed in the combined treatment of strongylatosis of the digestive tract of sheep. The application of T-activin with helminthicide panacur not only increased the therapeutic effect, but allowed to prevent the development of undesirable reactions of the immune system of the host by stimulation of cellular immunity factors (Mamykova O.I., 1997, 2004). And it was established on the model of mice trichinellosis that roncoleukin at dose level of 10 000 IU/kg of body weight enhanced nonspecific antiparasite resistance. The tendency to potentiation of helminthicide albendazole action and reliable increased level of specific antibody in serum by administration roncoleukin with albendazole was revealed (Mamykova O.I. and Napisanova L.A., 2012). There is also evidence of modeling effect on the immune status of cows of immunomodulators (ligfol, ligavir and seledant) in combination with a vaccine against parainfluenza-3 and infectious rhinotracheitis in cattle, manifested by increased bactericidal,

lysozyme and complementary activity of blood serum, phagocytic activity of leukocytes and titers of specific antibodies (Shakhov A. G. et al., 2013).

Based on these data, there is a certain confidence that the effectiveness of protective activity of specific antigens of helminths can be improved if to use immunostimulatory drugs, which provide the increase of antiparasitic resistance. This is the basis for their use in complex immunoprophylaxis of helminthiasis.

Therefore, the purpose of this study was to evaluate the protective effect of two immunostimulatory drugs in experimental trichinosis.

Materials and methods

We used in our study 30 albino mice weighing 16-18 g, divided into 3 groups of 10 animals in each. The first group was injected with cycloferon; the second group was injected with roncoleukin; the third control group was injected with 0.9% NaCl. The cycloferon related to the group of antiviral and immunostimulatory drugs. It is the inducer of interferon synthesis. The roncoleukin is from the group of interleukins and it possesses antitumor and immunomodulatory activity. The drugs were injected twice with an interval of 48 hours. After 48 hours the mice were infected by *T. spiralis* larvae in the dose of 80 ± 5 larvae/mouse. Evaluation of the protective effect of immunostimulatory drugs was carried out 45 days after invasion. The mice of each group including controls were slaughtered humanely and digested separately in artificial gastric juice. Detected then in sedimentary fluid of *T. spiralis* larvae were washed water separately and counted for each mouse in the group separately.

The counting of larvae of *T. spiralis* in sedimentary fluid was performed by a binocular microscope. We have defined the arithmetic mean of the number of larvae in each group of experimental animals to evaluate. Investigations were performed in All-Russian Scientific Research Institute of Fundamental and Applied Parasitology of Animals and Plants named after K.I. Skryabin in Moscow.

Results and discussion

The number of *T. spiralis* larvae detected in animals was 733.5 ± 25.1 and 869.5 ± 16.61 larvae/mouse respectively (Table 1.). The degree of protection of mice injected with roncoleukin was slightly lower than that of mice administered cycloferon. Even so, this was 5.2 times less than in the mice of control group (4485 ± 430.6 larvae/mouse). The number of larvae of mice injected with cycloferon was 6.1 times less than in the mice of control group. In this case, the use of these drugs activates the immune response and the injection of these drugs significantly reduces subsequently infected of parasitic animals.

Table 1. Evaluation of the protective properties of immunostimulatory drugs in experimental trichinellosis of mice

The group of animals	The drug	A dose of drug	The multiplicity of the drug and method of administration	The average number of larvae; larvae/mouse
I (n=10)	cycloferon	2,16mg/mouse	twice, intramuscularly, the interval 48 hours	733,5±25,1
II (n=10)	roncoleukin	100 U/mouse	twice, subcutaneously, the interval 48 hours	869,5±16,6
III (n=10) controls	0.9% NaCl	0.2 ml/mouse	twice, intramuscularly, the interval 48 hours	4485,0±430,6

Our data are considered with the data of other researchers, which worked in these scientific areas. So, according to Adelshin F. K. (1993), timalin stimulates the immune response in infected by alveococcosis in mice and rats. Protective action of the immunostimulating drug of ribotan in experimental alveolar echinococcosis was revealed by Klenova I. F. (1999). Rudneva O. V. and Berezhko V. K. (2005) founded that the antigen from *Echinococcus multilocularis* protoscoleces 2 and 6 months of age in combination with an immunostimulatory ribotan have a greater protective efficacy in experimental secondary alveolar echinococcosis than the only antigen from *E. multilocularis* protoscoleces of age 2 and 6 months. Protective action of immunomodulator roncoleukin (within 40%) was showed against echinococcosis in dogs (Berezhko V. K. and Sasikova M. R., 2010). The combined use of anti-parasitic drugs and immunomodulators, according to Ismagilov A. M. (2010), help to the quick recovery of animals in melophagus.

Numerous experimental studies have found that immunization of worms is very real, especially with tissue invasion (Golden O. et al., 2010; Dalton J. P. et al., 2013).

Also it is many references about the successful use of vaccines. Feng S. et al. (2013) successfully used of vaccines based on recombinant antigens derived from *T. spiralis*. According to Gu Y. et al. (2013) multi-epitope recombinant vaccines provided better protective effect than individual epitopes, causing a higher level of IgG.

Thus, the immunostimulatory preparations have stepped up protective reactivity and the administration of drugs reduces subsequent contamination of animals.

Conclusion

Analysis of the data indicates that in the experiment in the application of these drugs (cycloferon and roncoleukin) has been significant protective effect. Based on this, we consider it expedient to continue the study of immunostimulatory drugs in combination with a specific antigen in the complex immunoprophylaxis of trichinosis.

References

Adelshin F. K. (1993). Approaches to immunotherapy of experimental alveococcosis of linear mice and rats with the use of immunomodulators. Actual problems of medical and: veterinary parasitology: [Aktual'nyye problemy med. i vet. Prazitologii, Tezisy dokladov mezhdunarodnoy nauchnoy konferencii]. Proc. Intern. Scientif. Conf., Vitebsk (Belarus), (22).

- Berezhko, V. K., Sasikova M. R. (2010). Antigen of *Echinococcus multilocularis* protoscolices cell culture in immunoprophylaxis of *E. granulosus* infection in dogs. Proc. Mat. Scientif. Conf. "The theory and the practice of prevention parasitic diseases", All-Russian Institute of Helminthol., ["Teoriya i praktika profilaktiki parazitarnykh bolezney", Mat. nauch. Conf., Vseros. Institut. Helminthol.], Moscow (Russia), vol. 11, (55-58).
- Dalton J.P., Robinson M.W., Mulcahy G., O'Neill S.M., Donnelly S. (2013). Immuno modulatory molecules of *Fasciola hepatica*, candidates for both vaccine and immune therapeutic development, *Veterinary Parasitology*, 195, (272-285).
- Feng S., Wu X., Wang X., Bai X., Shi H., Tang B., Liu X., Song Y., Boireau P., Wang F., Zhao Y., Liu M. (2013). Vaccination of mice with an antigenic serine protease-like protein elicits a protective immune response against *Trichinella spiralis* infection, *J Parasitol.*, Jun; 99(3):426-32. doi: 10.1645/12-46.1. Epub 2012 Dec 19.
- Golden O., Flinn R.J., Read C., Sekiya M., Donnelly S.M., Stack C., Dalton J.P., Mulcahy G. (2010). Protection of cattle against a natural infection of *Fasciola hepatica* by vaccination with recombinant cathepsin L1 (rFhCL1), *Vaccine*, 28, (5551-5557).
- Gu Y., Wei J., Yang J., Huang J., Yang X. et al. (2013). Protective Immunity against *Trichinella spiralis* Infection Induced by a Multi-Epitope Vaccine in a Murine Model. *PLoS ONE* 8(10): e77238. doi: 10.1371/journal.pone.0077238.
- Ismagilov A. M. (2010). Immunomodulation by beekeeping products. Proc. Mat. Scientif. Conf. "The theory and the practice of prevention parasitic diseases", All-Russian Institute of Helminthol., ["Teoriya i praktika profilaktiki parazitarnykh bolezney", Mat. nauch. Conf., Vseros. Institut. Helminthol.], Moscow (Russia), vol. 11, (217-218).
- Klenova I. F. (1999). Development of cell technology for production of antigens of cestodes (for example, *Coenurus cerebralis* and *Echinococcus multilocularis*), Ph. Diss. Veterinary Sciences, All-Russian Institute of Helminthol., [Razrabotka tekhnologii proizvodstva kletok dlya antigenov tsestod (naprimere, *Coenurus cerebralis* i *Echinococcus multilocularis*), Diss. cand. veterinar. nauk, Vseros. Institut. Helminthol.], Moscow (Russia), (125).
- Mamykova O.I. (1997). The protective features of some immune stimulators in mice experimentally infected with *Nippostrongylus braziliensis*. Proc. All-Russian Institute of Helminthol., [Trudy Vseros. Institut. Helminthol.], Moscow (Russia), vol. 33, (110-120).
- Mamykova O. I. (2004). Therapeutic and immunological evaluation of combination treatment of gastrointestinal strongylata infections in sheep. Proc. All-Russian Institute of Helminthol., [Trudy Vseros. Institut. Helminthol.], Moscow (Russia), vol. 40, (163-175).
- Mamykova O.I., Napisanova L.A. (2012). Efficacy of using roncoleukin in combined therapy of experimental trichinellosis in mice. *Russ. Agricult. Sci.* (2012) 38: 153. doi:10.3103/S1068367412020152 [Original Russian Text © O.I. Mamykova, L.A. Napisanova, 2012, published in journal "Doklady Rossiiskoi Akademii Sel'skokhozyaistvennykh Nauk", №2, (51-54).]
- Rudneva O.V., Berezhko V.K. (2005). Immuno prophylactic properties of *Echinococcus multilocularis* protoscolices "cell" antigen of different ages. Proc. Mat. Scientif. Conf. "Theory and the practice of prevention parasitic diseases", All-Russian Institute of Helminthol., ["Teoriya i praktika profilaktiki parazitarnykh bolezney", Mat. nauch. Conf., Vseros. Institut. Helminthol.], Moscow (Russia), vol. 6, (306-309). doi: 10.13140/RG.2.2.27537.43366
- Shakhov A. G., Masyanov Yu. N., Retskiy M. I., Brigadirov Yu. N., Pershin S. I., Lebedev I. M., Batishcheva E. V., Zolotarev A. I. (2006). Actual problems of infectious pathology and immunology of animals. Mat. Intern. Scientif.-pract. Conf., [Aktual'nyye problemy infektsionnoy patologii i immunologii zhivotnykh, Mat. mezhdun. nauch.-prakt. Conf. (Moscow, 16-17 May 2006)], Moscow (Russia), (519).

DIAGNOSIS OF METABOLIC DISORDERS IN TRANSITIONAL DAIRY COWS BASED ON CHANGES IN CHARACTERISTIC BLOOD BIOCHEMICAL INDICATORS

Radojica DJOKOVIC^{1*}, Marko CINCOVIC², Vladimir KURCUBIC¹, Zoran ILIC³, Milun PETROVIC¹, Miroslav LALOVIC⁴, Milos PETROVIC¹

¹Department of Animal Science, Faculty of Agronomy, University of Kragujevac, Cacak, Serbia

²Department of Veterinary medicine Faculty of Agriculture, University of Novi Sad, Novi Sad, Serbia

³Department of Animal Science, Faculty of Agronomy, University of Priština, Lešak, Serbia

⁴Department of Animal Science, Faculty of Agriculture, University of East Sarajevo, Bosnia and Herzegovina

*Corresponding author: radojicadjokovic@gmail.com

Abstract

The objective of this experiment is to diagnose the metabolic disorders of late pregnant and early lactation dairy cows based on changes in characteristic blood biochemical indicators. Blood samples were collected from 15 late pregnant cows and 15 early lactation cows to measure beta-hydroxybutyrate (BHB), non-esterified fatty acids (NEFA), triglycerides (TG), glucose, and the activity of aspartate transaminase (AST). Cows in early lactation had significantly higher ($p < 0.05$) levels of serum BHB, NEFA and AST, and lower ($p < 0.05$) glucose and TG compared to late pregnant cows. High lipomobilization (NEFA > 0.4 mmol/l) was detected in 6 (40%) of early lactation cows but in none of late pregnant cows, while subclinical ketosis (BHB > 1.2 mmol/l) was detected in 14 (94.4%) of early lactation cows and 4 (26.6%) of late pregnant cows. AST activities above 100 U/l were detected in 2 early lactation cows and in none of late pregnant cows. TG levels below 0.12 mmol/l and glucose below 2.5 mmol/l were found in 7 (44%) and 10 (66.6%) of early lactation cows, respectively, and in none of late pregnant cows. Results on blood serum levels of glucose, TG, BHB, NEFA and AST in early lactation cows suggest metabolic disorders associated with ketosis, and some degree of hepatic lesions, probably due to fat infiltration. These serum parameters may have a key role in diagnose the metabolic disorders of late pregnant and early lactation dairy cows.

Keywords: *blood metabolites, subclinical ketosis, hepatic lipidosis, dairy cows, transitional period*

Introduction

Production diseases i.e. diseases associated with improper nutrition or management are common in dairy cows. The diseases listed in this include: the fat liver syndrome, ketosis, laminitis, mastitis, milk fever, retained placenta, metritis and infertility. Ketosis and fatty liver are closely linked and are responsible for severe economic losses in dairy farms due to drop in milk yield, reproductive performance and increase in culling rates (Gross et al. 2001, Oetzel 2004). Clinical ketosis in dairy cows usually occurs between the second and seventh week of lactation. Nevertheless, most of cows in this stage of lactation may suffer a subclinical form of ketosis defined as increased blood ketone bodies without any other symptoms but accompanied by considerable decrease in milk yield and susceptibility other diseases (Duffield et al. 1997). Dairy cows suffer from negative energy balance (NEB) during the first week of lactation because of energy expenditure due to milk production and limited feed intake. As a consequence, such a state caused NEB, a high mobilization of lipids from body fat reserves as well as hypoglycaemia in early lactation (Veenhuizen et al. 1991, Djokovic et al. 2007). Lipomobilization characterized by high blood NEFA concentrations starts within late pregnancy and reaches a high intensity in the early lactation and during lactation

(Djokovic et al. 2007, Civelek et al. 2011, Gonzalez et al 2011). NEFA are preferentially and greatly accumulated as TG in the liver cells (Sevinc et al 2003, Djokovic et al. 2007). The main blood indicators of lipomobilization in ruminants are BHB, the most important and abundant ketone body, and NEFA (Civelek et al. 2011, Gonzalez et al. 2011). Consequently, physiological situations leading to a NEB (fasting, parturition and lactation) are coupled to an increased uncontrolled rate of body fat mobilisation and the increased NEFA accumulation in hepatocytes, resulting in disturbances of the morphological and physiological liver integrity (Veenhuizen et al.1991, Bobe et al. 2004). However, when an important steatosis occurs, the endogenous liver syntheses are lowered leading to decreases in blood concentrations of glucose, total protein, albumin and globulins, cholesterol, TG and urea. (Veenhuizen et al.1991; Sevinc et al. 1998, 2003, Bobe et al. 2004). The fatty liver infiltration and the hepatocyte degeneration involve cell membrane damage and hepatocyte destruction coupled to the release of cytoplasm enzymes (AST, GGT, LDH) and marked increases in the circulating activities (Pechova et al. 1997, Lubojacka et al 2005; Stojevic et al.2005). Diagnosing liver lipidosis and susceptibility of ketosis in dairy cows may include liver biopsy or ecography, but a less invasive and more economical analytical method may be the measurement of blood biochemical indicators (Bobe et al.2004). According to blood biochemical indicators, ketosis in cows may be diagnosed when the following values match the clinical signs: BHB > 1.2 mmol/l, glucose < 2.5 mmol/l, and TG < 0.12 mmol/l, and blood values: NEFA > 0.7 mmol/l and AST activity above 100 U/l, which is indicative of hepatic lipidosis. (Sevinc et al.,1998, Oetzel, 2004; Xu et al., 2008, Gonzalez et al., 2011). The objective of this experiment is to diagnose the metabolic disorders of late pregnant and early lactation dairy cows based on changes in characteristic blood biochemical indicators.

Material and methods

Animals: This experiment was carried out at dairy herd of Simmental cows. The cows (n=30) were middle-yielding with a preceding lactation about 6,500 l. Two groups of cows were chosen from herd of dairy cows. One group consisted late pregnant cows in period from 25 to 1 days to partus (n = 15), and a second group included early post-partum cows in the first month of lactation (n = 15). The experimental cows were kept in tie-stall barns. The diet and the housing facilities were adapted to research purposes. The diet suited the energy necessary for cows in late pregnancy and early lactation. The cows in late pregnancy were fed with a diet consisting of 6 kg lucerne hay, 15 kg maize silage (30% DM) and 3 kg concentrate (30% crude proteins, CP). The cows in early lactation were fed with a diet consisting of 7 kg lucerne hay, 20 kg maize silage (30% DM) and 5 kg concentrate (30% CP). Dietary nutrient contents for dairy cows in late pregnancy and in early lactation are given in Table 1.

Table 1. Nutrient contents in daily ration for dairy cows in late pregnancy and early lactation.

	Late pregnancy	Early lactation
Dry Matter (DM) (kg)	11.94	16.05
Net energy of lactation (NEL) (MJ)	65.25	87.15
Crude protein (CP) (% of DM)	12.55	13.58
Rumen undegradable protein (RUP) (% of CP)	30.86	35.91
Fat (% of DM)	3.27	3.15
Fiber (% of DM)	25.28	23.26

Biochemical analysis: The blood samples were collected at 10:00 h or 4 to 6 hours after milking and feeding, by puncture of the jugular vein into sterile disposable test tubes without anticoagulant. After clotting for 3 hours at 4°C and centrifugation (1500g, 10 minutes, 4°C), sera were carefully harvested and stored at -20°C until analysis. Blood samples collected on fluoride were immediately centrifuged according to the same modalities and plasmas were assessed for glucose concentrations. The following biochemical blood components were measured by different colorimetric techniques using a spectrophotometers (Cobas Mira and Gilford Stasar): BHB and NEFA levels were measured using a kit from Randox (Ireland), AST and glucose were measured using kits from Human (Germany), and TG) using kits from Elitech (France).

Statistical analysis: The statistical analysis of the obtained data was carried out by ANOVA-procedure (Statgraphic Centurion, Statpoint Technologies Inc. Warrenton, Va, Virginia, USA). The LSD test were used to evaluate the probability of the significance of the statistical differences between mean parameter values in each group and the Pearson test was performed for evidencing significant correlations. Differences were considered as significant when p values were below 0.05 or 0.01.

Results and Discussion

The present experiment compared the metabolic status of dairy cows during transitional period. Results of the serum biochemical analyses for both groups of cows are shown in Table 2.

Table 2. Blood biochemistry in transitional dairy cows (n=15 in each group). Results are expressed as mean standard \pm deviation.

Parameter	Late pregnant cows	Early lactation cows	p
Glucose (mmol/l)	3.36 \pm 0.30	2.29 \pm 0.48	< 0.05
BHB(mmol/l)	1.14 \pm 0.36	1.59 \pm 0.25	< 0.05
NEFA(mmol/l)	0.17 \pm 0.06	0.38 \pm 0.29	< 0.05
TG(mmol/l)	0.29 \pm 0.07	0.12 \pm 0.02	< 0.05
AST (U/l)	33.55 \pm 9.38	69.46 \pm 30.89	< 0.05

Table 3. shows the correlation coefficients among the biochemical parameters calculated for all cows in this experiment.

Table 3. Correlation coefficients for the biochemical parameters calculated for all cows in the present study. Significant correlations ($p < 0.05$) are indicated in bold letters.

	NEFA	BHB	TG	AST
Glucose	$r = -0.35$	$r = -0.47$	$r = 0.65$	$r = -0.23$
NEFA		$r = 0.39$	$r = -0.21$	$r = 0.34$
BHB			$r = -0.36$	$r = 0.15$

In early lactation animals, NEFA and BHB values were significantly higher ($p < 0.05$) than of late pregnant cows. NEFA concentrations > 0.40 mmol/l indicate problems with energy balance and subsequent intensive lipomobilization (Oetzel, 2004). According to this report, 6 early lactating cows (40%) and none of the late pregnant cows in the present study had NEFA concentrations above the value indicative of subclinical ketosis. Given the fact that concentrations of serum NEFA > 0.70 mmol/l are associated with ketosis (Oetzel, 2004), 2 early lactating cows (13.3%) and none of the late pregnant cows in the present study had NEFA concentrations above the value indicative of subclinical ketosis. Subclinical ketosis may also be diagnosed at serum BHB concentrations above 1.2 mmol/l, while clinical ketosis is associated with BHB concentrations above 2.6 mmol/l (Duffield, 2000, Oetzel, 2004). In the present experiment, 14 early lactation cows (94.4%) and 4 late pregnant cows (26.6%) had serum BHB concentrations above 1.2 mmol/l. These data suggest that serum NEFA levels are most likely less efficient indicators of subclinical ketosis (13.3%) compared to serum BHB (94.4%) in dairy cows during the periparturient period. This is in agreement with Duffield (2000), who stated that the use of NEFA is a better indicator of energy imbalance in prepartum animals compared to BHB, which is more useful postpartum. In this study, a significant positive correlation ($r = 0.39$, $p < 0.05$) was observed between NEFA and BHB in the sera tested, suggesting that both parameters are helpful indicators of energy balance during the periparturient period. Blood glucose values in late pregnant cows were within the physiological range of 2.5-4.2 mmol/l (Oetzel, 2004), whereas hypoglycemia was detected in early lactation cows. In the present study, 10 early lactation cows (66.6%) and none of the late pregnant cows had blood glucose concentrations below 2.5 mmol/l. According to the serum parameters, ketosis in cows may be diagnosed when the following values match the clinical signs: BHB > 1.2 mmol/l, glucose < 2.5 mmol/l, and TG < 0.12 mmol/l (Sevinc et al. 1998, Oetzel, 2004, Xu et al. 2008, Gonzalez et al. 2011). Given this criterion, 7 cows in early lactation (44%) and no late pregnant cow had the indicative values, but did not display any clinical signs, suggesting that they had a typical subclinical condition, compared to the results of Gonzalez et al. (2011), who showed that a typical subclinical condition was detected in 22% of high-yielding cows in early lactation. Serum TG levels were significantly lower ($p < 0.01$) in ketotic cows compared to healthy cows (Djokovic et al. 2007). These results showed that TG accumulate in the liver cells of ketotic cows and cause their blood values to decrease. The present experiment showed that 7 early lactation cows (44%) and no late pregnant cow had TG concentrations below 0.12 mmol/L. In addition, no significant correlation ($r = -0.21$, $p > 0.05$) was found between TG and NEFA, suggesting that TG values may not be considered as an adequate indicator for lipomobilization in dairy cows. The values of AST in the present study were statistically higher ($p < 0.05$) in early lactation cows than in late pregnant cows. Given that AST activity higher than 100 U/l is indicative of hepatic lesions (Gonzalez et al. 2011), 2 early lactation cows (13.3%) in our study suffered from some degree of hepatic lesions, probably due to fat infiltration. These animals included 2 out of 7 cows considered to be ketotic according to our criteria and with blood NEFA values above 0.70 mmol/l. Meanwhile, none of the late pregnant cows had AST values higher than 100 U/l. A positive correlation between AST activity and lipomobilization (NEFA values) was observed by the significance coefficient ($r = 0.34$, $p < 0.05$). In the present study, all data

regarding liver enzymes suggested that the process of lipomobilization was sufficient to cause liver lesions in 13.3% of the early lactating cows. Possible alterations in liver function may have deleterious effects on the metabolism of these animals, and may adversely impact milk production or reproduction.

Conclusion

Biochemical evaluation suggested that early lactation cows had metabolic disturbances associated with ketosis, and some degree of hepatic lesions, probably due to fat infiltration. Serum levels of BHB, NEFA, TG, glucose and AST activities may have a key role in diagnose the metabolic disorders of late pregnant and early lactation dairy cows.

Acknowledgment

This work was financed by Ministry of Education and Science, Republic of Serbia, projects TR. 31001.

References

- Bobe G., Young J.W., D.C. Beitz D.C. 2004. Pathology, etiology, prevention, treatment of fatty liver in dairy cows. *Journal of Dairy Science*, vol. 87, 3105-3124.
- Civelek T., Aydin I., Cingi C., Yilmaz, O, Kabu M. 2011. Serum non-esterified fatty acids and beta-hydroxybutyrate in dairy cows with retained placenta. *Pakistan Veterinary Journal* vol. 31, 341-344.
- Djoković R., Šamanc H., Jovanović M., Nikolić Z. 2007. Blood concentrations of thyroid hormones and lipids in the liver in dairy cows in transitional period. *Acta Veterinaria. Brno*, vol.76, 525-532.
- Duffield T.F., Kelton D.F., Leslie K.E., Lissemer K.D., Lumsden J.H.1997. Use of test day milk fat and milk protein to detect subclinical ketosis in dairy cattle in Ontario. *Canadian Veterinary Journal*, vol. 38, 713–718.
- Duffield T. 2000. Subclinical ketosis in lactating dairy cattle. *Veterinary Clinics of North America: Food Animal Practice*, vol.16, 231–253.
- González F.D., Muiño R., Pereira V., Campos R. 2011. Relationship among blood indicators of lipomobilization and hepatic function during early lactation in high-yielding dairy cows. *Journal of Veterinary Science*, vol. 12, 251–255.
- Gross J., Van Dorland H.A., Bruckmaier R.M., Schwarz F.J.2001. Performance and metabolic profile of dairy cows during a lactation and deliberately induced negative energy balance with subsequent realimentation. *Journal of Dairy Science*, vol.94, 1820-1830.
- Lubojacka V., Pechova A., Dvorak R., Drastich P., Kummer V., Poul J. 2005. Liver steatosis following supplementation with fat in dairy cows diets. *Acta Veterinaria Brno* vol.74, 217-224.
- Oetzel, G.R.2004. Monitoring and testing dairy herds for metabolic disease. *Veterinary Clinics of North America: Food Animal Practice*, vol. 20, 651–674.
- Pechova A., Llek J., Halouzka, R. 1997. Diagnosis and control of the development of hepatic lipidosis in dairy cows in the peri-parturient period. *Acta Veterinaria Brno*, vol.66, 235-243.
- Sevinc M., Basoglu A., Oytok I., Sandikci M., Birdane F. 1998. The clinical-chemical parameters, serum lipoproteins and fatty infiltration of the liver in ketotic cows. *Turkish Journal of Veterinary and Animal Science*, vol.22, 443–447.
- Sevinc M., Basoglu A., Guzelberta H.2003. Lipid and lipoprotein levels in dairy cows with fatty liver. *Turkish Journal of Veterinary and Animal Science*, vol. 27, 295-299.

- Stojevic Z., Pirsljin J., Milinkovic-Tur S., Zdelar-Tuk M., Ljubic B.B. 2005. Activities of AST, ALT and GGT in clinically healthy dairy cows during lactation and in the dry period. *Veterinarski Arhiv*, vol.75: 67–73.
- Veenhuizen J.J., Drackley J.K., Richard M.J., Sanderson TP., Miller L.D., Joung J.W. 1991. Metabolic changes in blood and liver during development and early treatment of experimental fatty liver and ketosis in cows. *Journal of Dairy Science*, vol. 74, 4238-4253.
- Xu C., Wang Z., Liu G., Li X., Xie G., C. Xia C., Zhang H.2008. Metabolic characteristic of the liver of dairy cows during ketosis based on comparative proteomics. *Asian Australian Journal of Animal Science*, vol.21, 1003-101

SURVIVAL ANALYSIS AND APPLICATION IN ANIMAL SCIENCE

Ercan EFE^{1*}, Burcu KÜLEY²

¹Department of Animal Science, Agriculture Faculty, KahramanmarasSutcuimam University, Turkey

²Department of Animal Science, Science Institute, KahramanmarasSutcuimamUniversity, Turkey

*Corresponding author: eefe1960@gmail.com

Abstract

Survival analysis is a commonly used method in medical fields. It is a tool for examining possibilities of an event defined by the researcher and time until that event occurs. In medical fields, it is generally used to determine the length of time until the symptoms occurred, the response to the treatment or death. Additionally, it is used in industrial area in order to determine the first-failure-lifespan or total-economical-lifespan of machinery. Although it is rarely seen in agricultural researches, survival analysis has the potential to take place in many agricultural applications. In this study, life curves obtained by survival analysis, Kaplan-Meier method, and log-rank are compared along with a numerical example of quails data in animal science. For the last sixteenth week, in first group, survival probability and cumulative survival probability were become 0.991 and 0.9236 respectively. In second group, these probabilities were also become 0.993 and 0.897. In that example, log-rank value was obtained as 4.7 and the null hypothesis of similar survival plots was rejected ($P < 0.05$).

Keywords: *survival analysis, Kaplan-Meier, log-rank*

Introduction

Survival analysis is a commonly used method in medical fields (Agarwal, 2012; Gunbatar et al., 2012; Inceoglu, 2013; Kartsonaki, 2016; Miettinen, 2008). It is a tool for examining possibilities of an “event” defined by the researcher such as the length of time until occurrence of the symptoms, the response to the treatment or death. Additionally, it is used in industrial area in order to determine the first-failure-lifespan or total-economical-lifespan of machinery. Although it is rarely seen in agricultural or some other fields (Hutchison, 1988; Woodall, 2005), survival analysis have the potential to take place in many agricultural applications. In this study, life curves obtained by survival analysis, Kaplan-Meier method, and log-rank (Yuklu, 2013) are compared along with a numerical example of quails data in animal science (Ozdemir (Aktas), 1994; Doğan and Dundar, 2002).

Material and Methods

Because the main purpose of the study is to show that the method may be applied in animal science, hypothetical data from two groups, each containing 1000 quails are used (Table 1).

Table 1. Death records of two quail groups* .

		Group 1		Group 2				Group 1		Group 2	
<i>i</i>	<i>t</i>	<i>d_{1i}</i>	<i>k_{1i}</i>	<i>d_{2i}</i>	<i>k_{2i}</i>	<i>i</i>	<i>t</i>	<i>d_{1i}</i>	<i>k_{1i}</i>	<i>d_{2i}</i>	<i>k_{2i}</i>
1	1	20	0	40	0	9	9	15	0	0	0
2	2	7	0	19	0	10	10	0	0	5	0
3	3	0	0	10	0	11	11	10	0	0	0
4	4	0	0	10	0	12	12	1	0	0	0
5	5	9	0	0	0	13	13	0	0	8	0
6	6	0	0	0	0	14	14	1	0	0	0
7	7	0	0	0	0	15	15	0	0	0	0
8	8	5	0	5	0	16	16	8	0	6	0

* *t* : time (week), *d* : event (death), *k* : censored

Survival analysis can be investigated in two categories. These are:

- 1) Life tables analysis,
- 2) Kaplan-Meier survival analysis.

Basically, these two type of analysis are related to death and survival probabilities versus time. In Kaplan-Meier analysis, censored data does not affect the survival probability contrary to life tables analysis (Chung et. al., 1991; Harrel, 2001, Karasoy and Tuncer, 2015; Machin and Gardner, 1988).

In Kaplan-Meier analysis, *t* is a time period known as the survival time, *d_i* is number of deaths and is *k_i* number of censored individuals up to point *i* and *n_i* is number of individuals at risk just prior to *t_i*. *P_i* is survival probability and *P_{t_i}* is cumulative survival probability for any particular one of the *t_i* time periods. If *P_i* and *Q_i* are used for survival and death probability respectively, equation *P_i + Q_i = 1* is written. Here *P_i = 1 - Q_i* or *Q_i = 1 - P_i* and *P_i = (n_i - d_i) / n_i*. Cumulative survival probability is *P_{t_i} = P_{t_(i-1)} * P_i*. For *i=1* and *i>1*, *P_{t₁} = P₁*.

Comparing survival curves for two groups can be done by using log-rank test given below.

$$\text{Log-Rank} = \frac{(G_1 - B_1)^2}{B_1} + \frac{(G_2 - B_2)^2}{B_2} .$$

This test statistic is approximately distributed as a chi-square random variable with one degree of freedom ($\chi^2_{1, \alpha}$).

Results and Discussion

Kaplan-Meier analysis for group 1 data is given in Table 1.

Table 2. Kaplan-Meier analysis for group 1.

	time (week)	number of individuals at risk (at the beginning of time t_i)	event (death)	number of censored data at the end of time t_i	number of alives at the end of time t_i	survival probability at the end of time t_i	cumulative survival probability
i	t_i	n_i	d_i	k_i	y_i	P_i	P_{ti}
1	1	1000	20	0	980	0,980	0,980
2	2	980	7	0	973	0,993	0,973
3	3	973	0	0	973	1	0,973
4	4	973	0	0	973	1	0,973
5	5	973	9	0	964	0,991	0,964
6	6	964	0	0	964	1	0,964
7	7	964	0	0	964	1	0,964
8	8	964	5	0	959	0,995	0,959
9	9	959	15	0	944	0,984	0,944
10	10	944	0	0	944	1	0,944
11	11	944	10	0	934	0,989	0,934
12	12	934	1	0	933	0,999	0,933
13	13	933	0	0	933	1	0,933
14	14	933	1	0	932	0,999	0,932
15	15	932	0	0	932	1	0,932
16	16	932	8	0	924	0,991	0,9236

* t : time (week), d : event (death), k : censored

At the beginning of the first week, there are 1000 quails. At the end of this week, 20 deaths (d_1) were observed and the rest of individuals, number of alives (y_1), was 980. Hence survival probability (P_1) and cumulative survival probability (P_{t1}) can be evaluated as 0.980. At the beginning of the second week, there are 980 quails and at the end of that week, 7 deaths (d_2) were observed and number of alives was 973. Survival probability (P_2) and cumulative survival probability (P_{t2}) will be evaluated as $P_2=(980-7)/980=0.993$ and $P_{t2}=0.980*0.993=0.973$ respectively. As an example, one can say that any individual has the probability of being alive 99.3% at that week.

For example, in second week, while a quail was alive at the beginning of that week, its survival probability is 99.3% during that week. In other words, one can say that 99.3% of quails that they are alive at the beginning, will be alive at the end of the week. Moreover, one can also say that 97.3% of quails are alive from the beginning of trial to the end of the second week. At the beginning of the last sixteenth week while 932 ($=n_{16}$) quail was alive, 8 ($=d_{16}$) deaths or 924 ($=y_{16}$) alives were observed at the end of that week. So, survival probability was become 0.991 ($=(932-8)/932=P_{16}$) at that week and cumulative survival probability was become 0.9236($=0.991*0.932=P_{t16}$) from the beginning of trial to the end of the last week.

Table 3.Kaplan-Meier analysis for group 2.

	time (week)	number of individuals at risk (at the beginning of time t_i)	number of event (death)	number of censored data at the end of time t_i	number of alives at the end of time t_i	survival probability at the end of time t_i	cumulative survival probability at the end of time t_i
i	t_i	n_i	d_i	k_i	y_i	P_i	P_{ti}
1	1	1000	40	0	960	0,960	0,96
2	2	960	19	0	941	0,980	0,941
3	3	941	10	0	931	0,989	0,931
4	4	931	10	0	921	0,989	0,921
5	5	921	0	0	921	1	0,921
6	6	921	0	0	921	1	0,921
7	7	921	0	0	921	1	0,921
8	8	921	5	0	916	0,995	0,916
9	9	916	0	0	916	1	0,916
10	10	916	5	0	911	0,995	0,911
11	11	911	0	0	911	1	0,911
12	12	911	0	0	911	1	0,911
13	13	911	8	0	903	0,991	0,903
14	14	903	0	0	903	1	0,903
15	15	903	0	0	903	1	0,903
16	16	903	6	0	897	0,993	0,897

From Table 3, it can be seen that survival probability is 96% at the end of the first week and is 98% at the end of the second week. For the third week, cumulative survival probability will be 0.931 (=0,941*0,989). If one desires to evaluate the death probability, it can be found as 1-0,989=0,011.

Pre-calculations necessary for comparing the groups using by log-rank test that it needs sums of observed and expected values of survival probabilities for two groups, were given in Table 4.

Table 4.Pre-calculations for log-rank test

		1'st GRUP		2'nd GRUP		Total			1'st GRUP		2'nd GRUP	
		G1		G2					B1		B2	
Total		76	0	103	0	179			90,54		88,46	
i	t	d_{1i}	k_{1i}	d_{2i}	k_{2i}	D_i		D_i/N_i	n_{1i}		n_{2i}	
NO	week	death	censored	death	censored	death	N	Q_i		death		death
1	1	20	0	40	0	60	2000	0,030	1000	30	1000	30
2	2	7	0	19	0	26	1940	0,0134	980	13,13	960	12,87
3	3	0	0	10	0	10	1914	0,00522	973	5,08	941	4,92
4	4	0	0	10	0	10	1904	0,00525	973	5,11	931	4,89
5	5	9	0	0	0	9	1894	0,00475	973	4,62	921	4,38
6	6	0	0	0	0	0	1885	0,000	964	0	921	0
7	7	0	0	0	0	0	1885	0,000	964	0	921	0
8	8	5	0	5	0	10	1885	0,00531	964	5,11	921	4,89
9	9	15	0	0	0	15	1875	0,008	959	7,67	916	7,33
10	10	0	0	5	0	5	1860	0,00269	944	2,54	916	2,46
11	11	10	0	0	0	10	1855	0,00539	944	5,09	911	4,91
12	12	1	0	0	0	1	1845	0,00054	934	0,51	911	0,49
13	13	0	0	8	0	8	1844	0,00434	933	4,05	911	3,95
14	14	1	0	0	0	1	1836	0,00054	933	0,51	903	0,49
15	15	0	0	0	0	0	1835	0,000	932	0	903	0
16	16	8	0	6	0	14	1835	0,00763	932	7,11	903	6,89

When the table investigated, it can be seen that there are 1000 quails in each group, totally 2000, at the beginning of trial. In first week, 20 deaths from first group and 60 deaths from second group, totally 80 deaths, were observed. These values are also called observed frequencies (G_{1i} and G_{2i} respectively). Death probability over two groups is 0.030 ($=Q_1=D_1/N_1=60/2000$). If this probability is multiplied by the total number of alives for two groups at the beginning of the first week, same expected value (B_{1i} and B_{2i}) of death for two groups is found as 30 ($=1000*0.030$). Expected values in other weeks can be evaluated similarly. Then, for two groups, sum of expected and observed frequencies over all weeks are obtained as $B_1=90.54$, $B_2=88.46$, $G_1=76$ and $G_2=103$ respectively. Using this sums, log-rank test can be obtained as below;

$$\text{Log-rank}=(76-90.54)^2/90.54+(103-88.46)^2/88.46=2,334+2,389=4,7230 .$$

At 0.05 and 0.01 significance levels chi-square values are $\chi^2_{1, 0,05}= 3,841$ and $\chi^2_{1, 0,001}= 6,635$ respectively. Hence, null hypothesis of “trends of death probabilities are similar” is rejected at 0.05 significance level while it is failed to reject at 0.01.

Cumulative survival probability curves for two groups were showed in Figure 1.

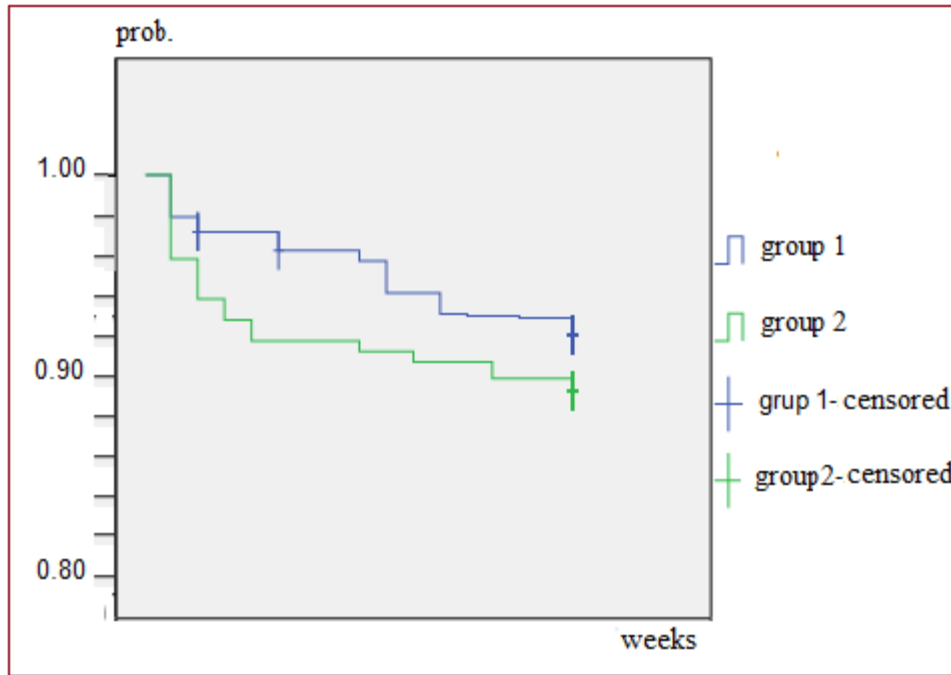

Figure 1.Cumulative survival curves.

Conclusion

In this study, a survival analysis method Kaplan-Meier is investigated using a hypothetical sample of quails data in Animal Science. Death probabilities between two groups were compared using log-rank test. Results showed that death probabilities of two groups were not found to be similar ($P < 0.05$). When the survival curves are examined, one may conclude that this difference is due to the drastic drop within the first four weeks.

Death, survival and cumulative survival probabilities were also shown for each week in Table 1 and 2. Even though the censored observations are all zero in this study, they are included in the tables as separate columns since it is quite natural that some studies may have censored data. Censored data does not affect death or survival probabilities; however, it must be considered while calculating the number of alive at the beginning of the next week.

In the study, sixteen weeks were examined separately. Time variable might be in different scales (hour, day, month, year, etc.) in some studies. If there are great number of rows in a table, it is possible to reduce it using groups as, for example, 1-3, 4-6, 7-9 month. Grouping the time variable does not change the way of calculation.

It is expected that this study will be useful for Animal Science researchers as it is for medical field.

References

- Agarwal G. G., (2012). Statistics for Surgeons – Understanding Survival Analysis. *Indian J Surg Oncol*, 3(3):208–214.
- Chung C-F., Schmidt P. And Witte A. D., (1991). Survival Analysis: A Survey. *Journal of Quantitative Criminology*, 7(1):59-98.
- Doğan I. and Dundar Y., 2002. Sustainable Animal Husbandry and Life Table Analysis. *Uludag University, J. Fac. Vet. Med.*, 21:71-75.
- Gunbatar H.; Sertogullarından B., Ozbay B., Sunnetcioglu A and Ekin S. (2012). Evaluation of Three Years Lung Carcinoma Events. *Van Medical Journal*, 19 (1): 13-20. (In Turkish).

- Harrell F. E. (2001). *Regression Modelling Strategies with Applications to Linear Models, Logistic Regression and Survival Analysis*. Sf.568, Springer Science + Business Media Inc., New York.
- Hutchison D. (1988). Event history and survival analysis in the social sciences. *Quality & Quantity* 22:203-219.
- Inceoglu F. (2013). *Survival Analysis Methods and its Application Using Liver Transplantation Data*. Inonu University, Medical Science Institute, Biostatistics and Medical Enformatcs Section. MSc Thesis. (In Turkish).
- Indrayan A. And Bansal A. K. (2010). The Methods of Survival Analysis for Clinicians. *Indian Pediatrics*, (47):743-748.
- Karasoy D. and Tuncer N. (2015). Outliers in Survival Analysis. *Alphanumerical Journal*, 3(2):139-152. (In Turkish).
- Kartsonaki C, (2016). *Survival analysis. Diagnostic Histopathology*, (in press).
- Machin D. and Gardner M. J. (1988). Calculating confidence intervals for survival time analyses. *British Medical Journal*, (296)1369-1371.
- Miettinen O. S. (2008). Survival analysis: up from Kaplan–Meier–Greenwood. *Eur J Epidemiol*, 23:585–592.
- Ozdemir (Aktas) A. (1994). *Survival Analysis Methods*. Ankara University, Science Institute, Animal Science Department. MSc Thesis. (In Turkish).
- Sainani K. L. (2016). Introduction to Survival Analysis. *PM&R Journal*, 8(6):580-585.
- Woodall C. W., Thomas W. and Moser W. K. (2005). Survival Analysis for a Large-Scale Forest Helth Issue: Missouri Oak Decline. *Environmental Monitoring and Assessment*, 108: 295–307.
- Yuklu E. E. (2013). *Log-Rank Test Statistics and an Application*. Ondokuz Mayıs University, Science Institute, Statistics Section. MSc Thesis. (In Turkish).

GENETIC POLYMORPHISM AT CSN1S2 LOCUS IN HAIR GOATS REARED IN ANTALYA

Murat Soner BALCIOĞLU^{1*}, Taki KARSLI¹, Emine ŞAHİN², Eymen DEMİR¹, Kemal KARABAĞ³

¹Department of Animal Science, Faculty of Agriculture, Akdeniz University, Antalya, Turkey

²Korkuteli Vocational School, Akdeniz University, Antalya, Turkey

³Department of Agricultural Biotechnology, Faculty of Agriculture, Akdeniz University, Antalya, Turkey

*Corresponding author: msoner@akdeniz.edu.tr

Abstract

Casein polymorphisms are related to milk quality and milk composition. In goat milk, four casein (α S1, α S2, β and k-casein) coded by four autosomal gene were identified. One of these casein is calcium-sensitive casein 2 (α S2-CN) coded by CSN1S2 gene. Presence of seven alleles (A, B, C, D, E, F and O) has been identified at CSN1S2 locus. In this study, three different alleles (CSN1S2^F, CSN1S2^O and CSN1S2^D) at CSN1S2 locus in Hair goats were investigated by PCR-RFLP method. In total, 70 samples were used from four populations reared in different regions of Antalya. Digestion results with Alw26I restriction enzyme showed that specific F/F genotype (0.057), F/N genotype (0.157) and N/N genotype (0.786) are present where N non F allele (one of A, B, C, D, E and O alleles). Also O and D alleles couldn't be determined at CSN1S2 locus, according to digestion of *Nco*I restriction enzyme. F allele at CSN1S2 locus has been shown in Hair goats reared in Turkey for the first time.

Keywords: *Casein*, CSN1S2, PCR-RFLP, Polymorphism, Hair Goat

Introduction

In many developing countries, goats have gained an important role in livestock production. While goats in the past were preferred for subsistence of poor people underestimating their economic roles and potentials, today goat production has gained importance in the area acknowledged as modern civilization because their milk plays a vital role in human nutrition. Also, the importance of goat milk in infant diets is growing for it is less allergenic than cow's milk (Haenlein, 2004).

Protein is one the most valuable goat milk components. Casein in caprine milk accounts for approximately 80% of total proteins synthesized by cells of the mammary gland during lactation and whey proteins cover for the remaining 20% (Ambrosoli *et al.*, 1988).

Table 1. Approximate average milk composition of different species (% w/w) adapted from Walstra *et al.*, (2006).

Animal	Dry Matter	Casein	Serum Protein	Fat
Goat	13,3	3,0	0,6	4,5
Sheep	18,8	4,6	1,0	7,5
Cow	12,7	2,6	0,6	3,9
Buffalo	17,5	3,6	0,7	4,8
Horse	10,8	1,3	1,2	1,7
Camel	13,4	2,7	0,9	4,5
Reindeer	35,0	8,5	2,0	18,0

It knows that casein polymorphisms are associated with milk quality, milk composition and technological properties. Also, casein genes have high polymorphism and in this case affects the casein and protein content of the milk in goat species. Therefore, the genetic

polymorphism of goat caseins has drawn attention to the use of molecular markers in this field. As reported by Hayes *et al.*, (1993), casein genes are located cluster region spans about 250kb on goat chromosome 6. Caseins are divided into four main groups; α S1-casein, α S2-casein, β -casein, κ -casein. These caseins are coded by CSN1S1, CSN1S2, CSN2 and CSN3 autosomal genes, respectively. It is known that the amount of CSN1S2 was associated with allergenic properties of milk. A, B, C, E and F alleles displayed more high allergenic potency in comparison with D and O alleles (Marletta *et al.*, 2004).

The goat CSN1S2 gene is 18.5 kb long and consists of 18 exons, this locus is characterized by a total of eight alleles including A, B, C, D, E, F, G and O alleles (Boulanger *et al.*, 1984; Bouniol *et al.*, 1994; Ramunno *et al.*, 2001; Erhardt *et al.*, 2002). The alleles A, B, C, E, F and G have been associated with a normal synthesis level of α S2-casein protein per allele (about 2.5 g/l). D allele is associated with lower synthesis level while O allele determines null synthesis level (Ramunno *et al.*, 2001). Thus, the alleles occur with the differentiation in point mutations by determining the amino acid substitutions at the protein level (Bouniol *et al.*, 1994).

Ramunno *et al.*, (2001) identified that CSN1S2^F allele is characterized by a G - A transition at the 13th nucleotide of exon 3 in the goat CSN1S2 gene. This mutation affects a *Alw26I* restriction site and leads to changes the GTC^{Val} \rightarrow ATC^{Ile} codon. The CSN1S2^D allele is characterized by a 106-bp deletion, involving the last 11 bp of the exon 11 and the first 95 bp of the following intron.

In the present study, three different alleles (CSN1S2^F, CSN1S2^O and CSN1S2^D) at CSN1S2 locus were investigated by PCR-RFLP method in Hair goats used from four populations reared in different regions of Antalya.

Materials and Methods

Total of 70 blood samples were randomly collected from four hair goat populations reared in different regions of Antalya, Turkey. Blood samples were taken (approximately 5 ml) from the jugular vein, using sample tubes containing K3-EDTA. The blood samples were kept at -20 °C until the isolation of total DNA. Genomic DNA from blood samples was made using method by Miller *et al.*, (1988). DNA quality and quantity were analyzed on agarose gel and measured by spectrophotometric methods. After isolation of DNA it was adjusted 50 μ l/ml using bidistilled water (H₂O) for the PCR procedure.

The primer sequences and annealing temperatures were given in Table 1. DNA was amplified initial denaturation at 95°C for 5 min, followed by 30 cycles consisting of denaturation at 95°C for 1 min, annealing (temperatures for each primer pair are shown in Table 2) for 2 min, extension at 72°C for 2 min, with final extension 72°C for 10 min on Thermocycler (Thermo Fisher Arktik). The PCR reaction was performed in a 50 μ l reaction mixture containing; 50 ng/ μ l genomic DNA, 5 μ l 10 X PCR buffer (containing (NH₄)₂SO₄, pH: 8.8), 2.5 mM MgCl₂, 2.5 mM dNTP mix, 1.0 U Taq DNA Polymerase and 0.5 μ M of each primer. PCR products were separated by electrophoresis on 2 % agarose gel at 80 V for 75 min.

To determine polymorphism at CSN1S2^F allele 310 bp size PCR products digested with *Alw26I*, and for CSN1S2^O, with CSN1S2^D alleles 301 bp size PCR products digested with *NcoI* restriction enzyme (Table 2). 10 μ l PCR products were digested with *Alw26I* and *NcoI* restriction enzyme (5U- Fermantase) to determined CSN1S2^F and CSN1S2^O, with CSN1S2^D alleles overnight at 37 °C. The digestion products were separated on 3% agarose gel.

Allelic frequencies were obtained by direct counting in examined samples (Nei 1987).

Table 2. Primer sequences, annealing temperatures and restriction enzymes for CSN1S2^F,

CSN1S2^O and CSN1S2^D alleles

Allele	Primer Sequence 5'.....3'	Annealing Temp. (°C)	PCR Product size	R. E.	References
0 and D	F: GAC ACA TAG AGA AGA TTC R: CGT TGG GAC ATT TTA TCT	51	301bp	<i>NcoI</i>	Ramunno <i>et al.</i> , (2001)
F	F: TCT CTT GCC ATC AAA ACA R: TGG TCT TTA TTC CTC TCT	54	310bp	<i>Alw26I</i>	Ramunno, <i>et al.</i> , (2001)

Results and discussion

The results of the genomic analysis of 70 samples belonging to the hair goat reared in different regions of Antalya are reported in Table 3. To detect F allele, a specific fragment of about 310 bp in length by the PCR-RFLP technique was obtained. Digestion of the amplified DNA fragment with *Alw26I* restriction enzyme showed an undigested fragment of 310 bp for the CSN1S2^F allele. On the other hand, N alleles (non F alleles) showed two fragments of 179 bp and 131 bp for the other alleles (A, B, C, D, E and O) of this locus (Figure 2). Analysis results showed that F/F genotype frequency is 0.057, 0.157 for F/N and 0.786 for N/N where N non F allele (one of A, B, C, D, E and O alleles).

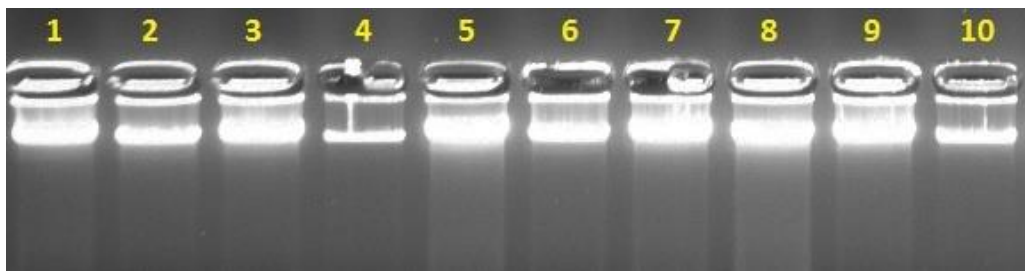

Figure 1. Image of DNA extraction on 1% agarose gel

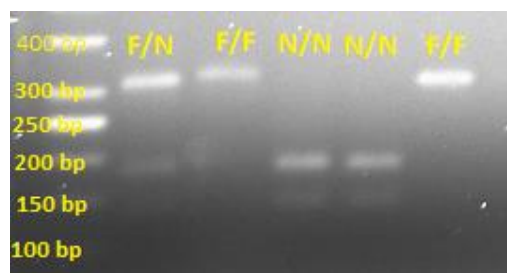

Figure 2. Observed genotypes for CSN1S2^F allele after cutting the PCR products with *Alw26I* restriction enzyme. N/N genotype, where one of A, B, C, D, E and O alleles (DNA Ladder; Thermo Scientific, Cat. No: SM0371, 50 bp)

Table 3. Observed genotypes and allelic frequencies at CSN1S2 locus in hair goat population reared in Antalya.

	α S2-casein genotype			Gene frequencies	
	F/F	F/N	N/N	F	N
Hair Goat	4	11	55	0.1357	0.8643
Genotype frequencies	0.0570	0.1570	0.7860		

F allele at CSN1S2 locus has been shown in Hair goats reared in Turkey for the first time. F allele frequency of hair goat population in present study were lower than allele frequencies reported in previous studied population (Ramunno *et al.*, 2001; Marletta *et al.*, 2004; Sacchi *et al.*, 2005; Kusza *et al.*, 2007; Vacca *et al.*, 2009; Yue *et al.*, 2013; Sztankoova *et al.*, 2013). Ahmed and Othman (2009) reported that FF genotype was not displayed in tested Egypt goats.

When PCR products digested by *NcoI* restriction enzyme, two fragments 168 bp and 133 bp size were obtained. Namely, O and D alleles were not observed in any of the digested samples by *NcoI* restriction enzyme (Figure 4).



Figure 3. Image of PCR amplification for CSN1S2^O and CSN1S2^D alleles



Figure 4. Observed genotypes for CSN1S2^O and CSN1S2^D alleles after cutting the PCR products with *NcoI* restriction enzyme. N/N genotype, where one of A, B, C, F and E alleles (DNA Ladder; Thermo Scientific, Cat. No: SM0242, 100 bp)

In study by Bozkaya *et al.*, (2008) in goat reared in Şanlıurfa, Siirt and Kilis region of Turkey, D and O alleles were not displayed like in this study. Similar results were found in several studies on used goat breeds as Vallesana, Roccaverano, Girgentana, Garganica and Egypt goats (Marletta *et al.*, 2004; Sacchi *et al.*, 2005; Othman and Ahmed, 2006; Kusza *et al.*, 2007; Ahmed and Othman, 2009; Vacca *et al.*, 2009), on the other hand, in some goat breeds like Hungarian milking (D:0.005; O:0.146), Italian (D:0.019; O:0.08), Naples (D:0.019; O:0.08) D and O alleles were detected (Ramunno *et al.*, 2001; Kusza *et al.*, 2007). Also, Sacchi *et al.*, (2005) reported that D allele were detected in Maltese and Jonica goat breeds as 0.007 and 0.005, respectively.

Conclusion

As a conclusion, couldn't determined O or D alleles but F allele at CSN1S2 locus has been shown in Hair goats reared in Turkey for the first time. Further studies are required other milk proteins (as β -Lactoglobulin) genes and other casein loci. These genes can be use as candidate gene for marker assisted selection in goats.

References

- Ahmed S., Othman E.O. (2009). Genotyping analysis of milk protein genes in different goat breeds reared in Egypt. *Journal of Genetic Engineering and Biotechnology*, Vol. 7, No 2 pp. 33-39.
- Ambrosoli R. (1988). Content of α S1-casein and coagulation properties in goat milk. *Journal of Dairy Science*, Vol. 71, pp. 24-28.
- Boulanger A., Grosclaude F., Mahé M.F. (1984). Polymorphisme des caséines α s1 et α s2 de la chèvre (*Capra hircus*), *Genetics Selection Evolution*, Vol. 16, pp. 157–176.
- Bouniol C., Brignon G., Mahé M.F., Printz C. (1994). Biochemical and genetic analysis of variant C of caprine α s2-casein (*Capra hircus*), *Animal Genetics*, Vol. 25, pp. 173–177.
- Bozkaya F., Mundan D., Karabulut O., Yerturk M., Gurler S., Aral F. (2008). An investigation on the distribution of O and D alleles of CSN1S2 gene in goat populatios raised in southeastern region of Turkey. *Small Ruminant Research*, Vol. 78, pp. 193-196.
- Erhardt G., Jager S., Budelli E., Caroli A. (2002). Genetic polymorphism of goat α s2-casein (CSN1S2) and evidence for a further allele. *Milchwissenschaft*, Vol. 57, pp. 137–140.
- Haenlein G.F.W. (2004). Goat milk in human nutrition. *Small Ruminant Research*, Vol. 51, pp. 155-163.
- Hayes H., Petit E., Bouniol C., Popescu P. (1993). Localization of the alpha S2-casein gene (CASAS2) to the homologous cattle, sheep and goat chromosomes 4 by in situ hybridization. *Cytogenetics and Cell Genetics*, Vol. 64, pp. 281–285.
- Marletta, D, Bordonaro, S, Guastella, A M, D'Urso, D (2004). Genetic polymorphism at CSN1S2 locus in two endangered Sicilian goat breeds, *Journal of Animal Breeding and Genetics*, Vol. 121, pp. 52–56.
- Kusza S., Veress G., Kukovics S., Javor A., Sanchez A., Angiolillo A., Bosze Z. (2007). Genetic polymorphism of α s1 and α s2-caseins in Hungarian Milking Goats. *Small Ruminant Research*, Vol. 68, pp. 329–332.
- Miller S.A., Dykes D.D., Polesky H.F. (1988). A simple salting out procedure for extracting DNA from human nucleated cells. *Nucleic Acids Research*, Vol. 16, 12-15.
- Nei M. (1987). *Molecular Evolutionary Genetics*. Columbia University Press., New York.
- Othman O.E., Ahmed S. (2006). Analysis of genetic polymorphisms in the Egyptian goat CSN1S2 using polymerase chain reaction. *Journal of Biological Sciences*, Vol. 6, No 2 pp. 238-241.
- Ramunno L., Cosenza G., Pappalardo M., Longobardi E., Gallo D., Pastore N., Di Gregorio P., Rando A. (2001). Characterization of two new alleles at the goat CSN1S2 locus. *Animal Genetics*, Vol. 32, pp. 264-268.
- Sacchi P., Chessa S., Budelli E., Bolla P., Ceriotti G., Soglia D., Rasero R., Cauvin E., Caroli A. (2005). Casein haplotype structure in five Italian goat breeds. *Journal of Dairy Science*, Vol. 88, pp. 1561-1568.
- Sztankoova Z., Rychtařová J., Kyselová J., Mátlová V., Štipková M., Matejíčková J., Marková M. (2013). Effect of the α s1-, α s2-, β - and κ -casein genotypes on the milk production parameters in Czech goat dairy breeds. *Grant Journal*, Vol. 2, No 2 pp. 76-80.
- Vacca G.M., Ouled Ahmed Ben Ali H., Pazzola M., Sanna M., Dettori M.L., Carcangiu V. (2009). An investigation on allele frequency at the CSN1S2 locus and its relationship with

milk parameters in the Sarda goat. *Journal of Animal and Feed Sciences*, Vol. 18, pp. 628-637.

Walstra P., Geurts T.J., Noomen A., Jellema A., Walstra P., Geurts T.J., Noomen A., Jellema A., Boekel M. AJS Van Boekel M.A.J.S. (2006). *Dairy technology. Principals of milk properties and processes*, Marcel Dekker, New York.

Yue X.P., Fang Q., Zhang X., Mao C.C., Lan X.Y., Chen H., Lei C.Z. (2013). Effects of CSN1S2 genotypes on economic traits in Chinese dairy goats. *Asian Australasian Journal Animal Science*, Vol. 26, No 7 pp. 911-915.

USING OF CYPHENOTHRIN FOR ECTOPARASITOSE TREATMENT FARM ANIMALS

Mihail V. ARISOV, G.M. MAGOMEDSHAPIEV, E.A. RUDAKOVA

Federal State Budget Research Institution (FGBNU)

"Skryabin All-Russian Scientific Research Institute of Fundamental and Applied Parasitology", 117218

Moscow, B. Cheremushkinskaya St., 28

*Corresponding author: vigis@ncport.ru

Summary

In the laboratory of arachnoentomology of FGBNU «Skryabin All-Russian Scientific Research Institute of Fundamental and Applied Parasitology» the formulation of «d-cyphenothrin 5%-emulsion» was complied and composition of this medicinal product was prepared in the form of an emulsion. The drug belongs to anti-parasitic medications and is active for animal myiasis and acarinoses. Tests of various concentrations of aqueous solutions of the drug «d-cyphenothrin 5%-emulsion» were completed. The aqueous solutions of 0.025%, 0.005% and 0.01% concentrations with rate of application of 50 - 100 ml per animal were tested. The results have shown that concentration of 0.005% of working solution is optimal and gives a high acaricidal effect. 100%-therapeutic effect was confirmed by using concentration of 0.005% working aqueous solution of drug «d-cyphenothrin 5%-emulsion» in working environment when sheep scab and cattle ixodidosis take places. Persistence of acaricidal drug action was 30 days after a single application in case of ixodidosis. During and after the treatment of the animals no abnormalities were observed.

Keywords: *d-cyphenothrin, ixodidosis, psoroptosis, sheep, cattle.*

Introduction

Animal ectoparasitoses are commonly spread. For example, more over 25000 species of ticks are recognized all over the world. In veterinary practice representatives of the following families: Psoroptidae (Canestrini, 1892); Sarcoptidae (Murray, 1877); Demodicidae (Nicolet, 1855); Psorergatidae (Dubinin, 1954) and Ixodidae (Murray, 1877) have the high value for studying.

Arachnomyiasis do the huge economic harm such as reduction of milk yields of cattle, goats, etc.; reduction in weight gaining, decrease in hides and wool clip as well as death of animals with high degree of animal damage because of demodectic ticks and sarcoptidae.

It should also be noted that ixodic ticks are carriers of contagious, viral and parasitic diseases of any kinds, which are dangerous for animals and humans such as encephalitis, plague, tularemia, tick-borne relapsing fever, Q-fever, Crimean-Congo hemorrhagic fever, piroplasmoses etc.

Now there is a huge number of domestic and imported drugs of different classes of chemical compounds for arachnomyiasis control, which can be used for animal protection. Despite this fact, development and the implementation of science-based effective schemes for cattle and domestic animals protection from ectoparasites, allowing minimize production limitation and costs, remains the relevant task.

In general, drugs the most frequently used in veterinary practice for external work are based on pyrethroids: permethrin, deltamethrin, cypermethrin, etc. These pyrethroids are the second generation. The main disadvantages of pyrethroids are restrictions to manufacturing and toxicity.

On the basis of Skryabin All-Russian Scientific Research Institute of Fundamental and Applied Parasitology the formulation was complied and composition of the medicinal insectoacaricide drug «d-cyphenothrin 5%-emulsion» was prepared in the form of an emulsion. The drug belongs to anti-parasitic medications and is active for animal entomoses and acaroses

The mechanism of D-cyphenothrin's action contains the prolonged inhibition of sodium channels nerve conduction, depolarization of cell membranes, which leads to irreversible paralysis and death of the arthropods. D-cyphenothrin has a fast knockdown effect on insects and ixodic ticks that occurs at the first contact with the surface of the treated animal (destroys before the bite). It has a repellent effect on the bloodsucking flying insects.

Pursuant to the degree of impact on the body «d-cyphenothrin 5%-emulsion» falls into the category of moderately hazardous substances (hazard class 3 according to GOST 12.1.007-76). It does not have local irritative, resorbative toxic or sensitizing effect as well as embryotoxic action, if it is used in recommended doses; has slightly eye irritation in case of contact with eye. The drug is well tolerated by animals of different breeds and ages.

The drug is made up for sheep, cattle, pigs, rabbits and dogs in case of arachnomyiasis and disinsection and disacaridisation of livestock buildings and other objects of veterinary supervision.

Extended testing of the drug's efficiency in case of cattle ixodidosis, sheep and cattle psoroptosis were conducted.

Materials and methods of research

Acaricide efficiency of "D-cyphenothrin 5%-emulsion" of different concentration of working solution was examined under cattle ixodidosis of cattle in the Republic of Dagestan. For the experiment 4 groups of 30 animals were selected, 3 of them were experimental groups and 1 was the control group. The animals from different groups were treated aqueous solutions of 0.0025%; 0.005%; 0.01%. Before the experiment and then after 24 hours and 2, 7 and 30 days, all cows were carefully examined, number of ticks was counted and extensive efficiency was calculated (EE, %). Extensive production tests of D-cyphenothrin 5%-emulsion's efficiency using aqueous solution in concentration of 0.005% were carried out on the basis of farm firm "Shangoda", APC "Choh" and PFC "Bukhty" located in Gunibskiy district of the Republic of Dagestan from September 2013 to May 2014, age of Red Steppe Breed cattle was 2-3 year, weight was 450-500 kg, all cattle was naturally infected with ixodic ticks. 200 beasts in each farm, 170 from experimental group and 30 from control group, were totally treated.

Initial studying of the efficiency and commission tests of the drug " D-cyphenothrin 5%-emulsion" under sheep sarcoptosis were carried out in a private farms dealing with breeding of sheep breed "Prekos" and "Edilbaevskaya" in the territory of Danilovsky district of Volgograd region. The work was held in the period of September-October 2015 in accordance with the plan of treatment and preventive measures for parasitic arthropods using naturally infected 2-3 years old sheep (diagnosis of sarcoptosis) weighing 65-75 kg and the lambs, aged of 5-6 months. Condition of animals living was loose in the open.

Research of the drug efficacy in case of cattle psoroptosis was held on the basis of farm JSC "Gorbatovskoe" located in Pavlovsky District of Nizhny Novgorod Region, Popad'ino village from March 1 to March 20, 2016. 40 breeds of 2-3 years old cattle weighing 400 - 450 kg were chosen. Animals were naturally infected with ticks (*Psoroptes bovis*). Concentration of the aqueous solutions of 0.001%, 0.005% and 0.01% was tested.

For preparation of the working solution with active substance in concentration of 0.001%, 0.005% and 0.01% the medication was diluted with water in a ratio 1:5000; 1:1000; 1:500 respectively immediately before use. Animals were treated by low-volume spraying with rate of

application rate of 50 - 100 ml per animal. Milk-cows were treated at least 7 - 8 hours before the next milking.

After treatment daily monitoring of general conditions of the animals, eating and water delivery as well as behavior, were held and skin covering for ticks detecting was examined.

Research results

1. The study of medical and preventive efficiency of "D-cyphenothrin 5%-emulsion" in case of cattle ixodidosis

Table 1. Efficiency of "D-cyphenothrin 5%-emulsion" in different concentrations in case of cattle ixodidosis

Groups		The concentration of the aqueous solution of "d-cyphenothrin 5%-emulsion", %			Monitoring
		0,0025	0,005	0,01	
Before the experiment	II, spec./animal	184,7	166,2	184,8	173,1
	AR, spec.	184,7	166,2	184,8	173,1
After 24 hours	II, spec./animal	10,9	2,4	0	169,8
	AR, spec.	7,6	0,8	0	169,8
	EE, %	30	67	100	0
After 2 days	II, spec./animal	3,8	0	0	124,3
	AR, spec.	2,0	0	0	124,3
	EE, %	47	100	100	0
After 7 days	II, spec./animal	0	0	0	114,0
	AR, spec.	0	0	0	114,0
	EE, %	100	100	100	0
After 30 days	II, spec./animal	0	0	0	103,6
	AR, spec.	0	0	0	103,6
	EE, %	100	100	100	0

Under conditions of farm firm "Shangoda" 4 groups of animals were formed, 30 animals in each group. Cows of the first group were treated the working solution of 0.0025%, the second - 0.005% and the third - 0.01% of the test drug. Before the experiment, and then after 24 hours and 2, 7 and 30 days all cows were carefully examined and the number of ticks was counted (II – invasion intensity, AR - abundance rate) and calculated extensive efficiency (EE, %).

When we used aqueous solution of D-cyphenothrin 5%-emulsion of concentration of 0.005%, the animals unloaded of ticks in a day. It was found that this concentration retains acaricidal properties during one month. Several ixodic ticks were found on animals in 35-40 days after treatment.

The researches of the drug efficiency of concentration of D-cyphenothrin 5%-emulsion were held under the conditions of farm firm "Shangoda", APC "Choh" and PFC "Bukhty". Total number of the treated animals amounted to 200, 170 of them were in the experimental group and 30- in the control group. Extensity of animal infection was 100%, the abundance rate in the experimental groups varied from 118.6 to 139.2, in the control group- from 106.8 to 142.8. Parasites were mostly founded in the udder, groin, chest and forelegs. We have founded that animals had anxiety, itch, skin thickening and dermatitis, crusting and cracking, average rate of daily milk yields were significantly reduced.

Table 2. Efficiency of "D-cyphenothrin 5%-emulsion" in concentration of 0.005% in case of cattle ixodidosis

Farm name		Farm firm "Shangoda"		APC "Choh"		PFC «Bukhty»	
Animal group		Exp.	Cont.	Exp.	Cont.	Exp.	Cont.
Number of animals	In the experiment	170	30	170	30	170	30
	Recovered	170	0	170	0	170	0
AR, spec.	Before treatment	185,8	201,4	210,2	196,8	118,6	108,9
	After 24 hours	0	196,6	0	179,6	0	115,8
	After 2 days	0	183,5	0	163,5	0	103,8
	After 7 days	0	190,6	0	185,2	0	114,7
	After 30 days	0	184,2	0	169,6	0	108,5
Efficiency, %		100	-	100	-	100	-

Note: Exp. – experimental (group), cont. – control (group)

Under production conditions of three livestock farms in case of treatment of aqueous solution D-cyphenothrin 5%-emulsion of concentration of 0.005% 100% acaricide efficiency in total tick invasion of cattle was observed, preventive efficiency amounted to 30 days.

During the experiment we monitored the animals and their conditions. The essential markers were body temperature, heart rate and respiratory rate. Table 3 contains this information.

Table 3. Control of body temperature, pulse and respiration rate of cattle before and after the experiment (n = 30; P ≥ 0,05)

Farm name	Group	Index		
		T, °C	P, b/min	R, br/min
Before experiment				
Farm firm "Shangoda"	Experimental	38,5±0,06	65,7±0,74	22,3±0,51
	Control	38,4±0,07	66,4±0,77	22,3±0,39
APC "Choh"	Experimental	38,3±0,07	69,1±0,70	23,9±0,50
	Control	38,5±0,06	71,2±0,43	23,3±0,35
PFC «Bukhty»	Experimental	38,4±0,08	68,2±0,71	22,8±0,48
	Control	38,3±0,06	70,5±0,44	23,0±0,41
15 days after treatment				
Farm firm "Shangoda"	Experimental	38,4±0,07	69,9±1,04	21,9±0,47
	Control	38,5±0,05	71,3±0,48	22,3±0,44
APC "Choh"	Experimental	38,3±0,08	68,9±1,19	23,4±0,49
	Control	38,4±0,07	67,7±0,80	23,7±0,53
PFC «Bukhty»	Experimental	38,5±0,06	71,7±0,53	24,8±0,35
	Control	38,4±0,06	70,6±0,49	23,4±0,60
30 days after treatment				
Farm firm "Shangoda"	Experimental	38,3±0,08	68,5±0,52	22,8±0,50
	Control	38,5±0,05	67,7±0,69	23,2±0,37
APC "Choh"	Experimental	38,6±0,06	65,9±0,61	24,4±0,33
	Control	38,5±0,05	66,5±0,64	23,9±0,33
PFC «Bukhty»	Experimental	38,3±0,08	69,0±0,65	22,3±0,30
	Control	38,5±0,06	68,6±0,76	22,6±0,40

Note: here and elsewhere T – temperature, P – pulse, R – respiration.

Before and during the experiment all animals from the experimental and the control groups had indexes, studied in Table 3, that were statistically unreliable and were within the reference values.

2. The study of efficiency of "D-cyphenothrin 5%-emulsion" in case of sheep psoroptosis

Initial study of efficiency of "D-cyphenothrin 5%-emulsion" in case of sheep psoroptosis was held in a private farms engaged in breeding and raising business of sheep breeds "Prekos" and "Edil'bai" in the territory of Danilovsky district of Volgograd region. Extensity of invasion ranged from 70 to 100%. We observed that sheep had itch, skin scratching, sheep hair tangled in the affected areas, lambs had slightly itching. Psoroptosis diagnosis was made on the basis of epizootiological data, clinical signs and results of acarological analysis of skin scrapings in case of *Psoroptes ovis* ticks detecting. The material for the research was taken from fresh lesions, on the border between the modified and the formally healthy skin.

40 goals of sheep and lambs infected by Psoroptosis were selected and they were divided into two groups: the control group and the experimental group, each group contained 20 goals. The animals of the experimental group were treated by means of group wet inspection for whole skin cover using the aqueous solution of the drug twice with an interval of 10 days. Sheep were treated by low-volume spraying with a rate of application of 50-100 ml per animal. Spraying was performed by spraying device, making small-drop air-spraying. The control group was not treated.

After treatment daily monitoring of the general condition of animals as well as eating and water delivery, behavior was held. Skin cover was examined, dynamics of affected areas recovery was fixed. 10 days after the second treatment, laboratory test of skin scrapings was held. During the experiment neither complications related to drug using nor adverse effects were detected.

As a result, it was found that the efficiency of the drug "D-cyphenothrin 5%-Emulsion" confirmed by the negative results of two-fold negative results of acarological researches and clinical data, was 100% in case of psoroptosis of sheep and lambs.

Tests for drug efficiency was performed in subdivision "Chernorechenskiy cattle-breeding complex», dealing with breeding and rearing of sheep breed "Edil'bai and located within the territory of Beloprudskoe rural settlement, Danilovsky district of Volgograd region. 110 animals from clinically infected sheep and lambs were chosen and then they were divided into two groups: the control group of 10 beasts and the experimental group of 100 beasts. The animals were treated by means of group wet inspersion for whole skin cover using the aqueous solution with concentration of 0.005% of the drug twice with an interval of 10 days. Sheep were treated by low-volume spraying with a rate of application of 50-100 ml per animal. The control group was not treated.

In order to confirm the therapeutic efficiency we randomly chose 25 animals and in 10 days after the second treatment we performed acarological tests for skin scratching. Thus, the drug efficiency was 100% and was confirmed by the absence of clinical signs and two negative results of acarological tests of skin scrapings. In the control group, according to microscopy data ticks *Psoroptes ovis* were founded.

3. The study of efficiency of "D-cyphenothrin 5%-emulsion" in case of cattle psoroptosis

Researches of the drug efficiency under cattle psoroptosis was carried out in Nizhny Novgorod region. The animals had anxiety, itch, scratching areas on the skin, crusting, level of milk production was reduced. Diagnosis was made on the basis of results of clinical examination and detection of ticks *Psoroptes bovis* under laboratory conditions.

4 groups of 10 animals were formed: the first group was treated with working solution of drug with concentration of 0.001%, the second group - 0.005%, the third group - 0.01%, and the fourth group was considered as the control one. After treatment daily monitoring of the general condition of animals, eating and water delivery as well as behavior was held. Skin cover was examined.

During the experiment and the drug's using there were neither adverse effects nor complications. After 7 days, there were no ticks *Psoroptes bovis* in the second and third groups, animals had no anxiety symptoms, crusts were dry and fell down. In first group in scrapings of two cows live ticks *Psoroptes bovis* were detected. After 15 days there were no ticks in all groups as well as no clinical signs, hair began growing at affected areas. The animals of the control group remained infected during all research.

Thus, drug's efficiency of "D-cyphenothrin 5%-emulsion" in working concentration of 0.001%; 0.005% and 0.01% after 15 days was 100% in case of cattle psoroptosis. However, after 7 days live ticks *Psoroptes bovis* were detected on animals, treated with working concentration of 0.001. In connection with the results founded the concentration of 0.005% of aqueous solution «D-cyphenothrin 5%-emulsion» was considered optimal.

Conclusion

In this paper we offered a medicinal product for veterinary use in case of ectoparasites of farm animals. Tests of various concentrations of aqueous solutions of drug "D-cyphenothrin 5% -emulsion" were hold. Concentrations of 0.0025%, 0.005% and 0.01% with rate of application of 50 - 100 ml per animal were examined. The results have shown that the concentration of 0.005% of aqueous solution is optimal and has a high acaricidal effect.

100% therapeutic effect was confirmed by using a working concentration of 0.005% of aqueous solution of the drug "D-cyphenothrin 5% -emulsion" under production environment in case of Psoroptosis and Ixodidosis of cattle and sheep. Persistence of drug acaricidal action after single use under Ixodidosis was 30 days. During and after the treatment no abnormalities have observed.

References and researches used

1. Alekseev A.N., Kondrashova Z.N. The body of arthropods as the habitat of excitants - Sverdlovsk: Ural Scientific Center of Academy of Sciences of the USSR, 1985.- 181 p.
2. Balashov Yu.S. Bloodsucking ticks (Ixodidae) are vectors of animal and human diseases. - L., 1967. - 317 p.
3. Beklemishev V.N. Circle of the natural carriers of transmissible diseases affecting human // Zool. J. - 1955. - T. 34., Number. 1. pp. 3-16.
4. Berdyev A.B. Ecology of ticks, inhabiting in Turkmenistan, and their role in the epizootiology of natural focal disease. - Ashgabat, 1981.-281 p.
5. Vasilevich F.I. Sarkoptoses of farm animals. - M.: MVA, 1986. - P. 1-17.
6. Vasilevich F.I. Animal Demodectoses. - M.: MVA, 1993. - 21 p.
7. Vodyanov A.A. Question of species specificity of *Psoroptes* // Diagnosis, treatment and prevention of farm animals infectious diseases. - Stavropol, 1986.- pp. 72-76.
8. Galuzo I.G. Bloodsucking ticks inhabiting in Kazakhstan (*Boophilus*, *Haemaphysalis* and *Ixodes*). - Almaty, 1950. - T. 4. – 338 p.

9. Kerbabayev E.B., Skosyrskikh L.N. Damage caused by ixodic and demodectic ticks of leather industry // *Parazitologiya*. - 1988. - V. 22, Issue. 2. - pp. 182-184.
10. Kerbabayev E.B. Fundamentals of Veterinary acarology. Techniques and methods of ticks control // *Tr. All-R.. Inst. of gelmintol.* - 1998. - V. 34. – 218 p.
11. Klochko R.T. Epizootology of pig sarcoptic mange and its control development: Author. Cand. of vet. Sciences Dis. - 1983. - 23 p.
12. Remez V.I. Comparative efficiency of acaricides in case of sheep and pig sarcoptoses // *Coll. tr. Stavropol Agricultural Institute.* - 1985. - pp. 25-27.
13. Mueller R.S. Update on the diagnosis and treatment of fleas and mites // *Proc. of the WSAVA Congress, Sydney.* - 2007. - pp. 22-24.

THE EFFECT OF THE AGE ON SOME OF THE REPRODUCTIVE TRAITS IN HOLSTEIN-FRIESIAN COWS

Jelena ČABARKAPA^{1*}, Tatjana PANDUREVIĆ¹, Miroslav LALOVIĆ¹, Svjetlana MIČIĆ²,
Jelena VLAČIĆ², Darko VUJIČIĆ¹

¹Department of Animal Husbandry, Faculty of Agriculture, University of East Sarajevo,
Republic of Srpska, Bosnia and Herzegovina

²Ministry of Agriculture, Forestry and Water of the Republic of Srpska, Bosnia and Herzegovina

*Corresponding author: jelenaleki@gmail.com

Abstract

In order to investigate the effect of the age of cows on some of the reproductive traits, 30 Holstein-Friesian cows, cultivated on the 'Spreča' farm in Kalesija, have been investigated. Based on the data obtained from the records for 30 cows, these reproductive features have been analyzed: age of cows during their first conception, gestation length, duration of service period and inter-calving interval and the weight of calves in the first three calving, or first two lactations. According to the analyses and statistic processing of mentioned reproductive parameters, the conclusion is that the average age of cows during their first conception was 22.29 month and the average gestation, for both genders, was longer for the second conception. The average duration of service period and inter-calving interval was 172.88 days and 448.98 days, after which it can be concluded that these parameters lasted long. Male calves, in all three calving, were heavier than female calves and when it comes to both genders, the highest average weight of calves was in the second calving (42.53 kg).

Keywords: *age, reproductive traits, Holstein-Friesian cows.*

Introduction

Fertility of cattle is a trait that other productive segments are dependable on, like economic value of milk and meat production. Reproduction field of the cattle is the most important but also the most expensive phase of the production in comparison to other phases. During this process, throats for replacement in the herd, production of milk and production of meat is processed. Considering the fact that the reproduction of the cows is very important segment in the cattle field, all phases of the reproduction need to be organized. Knowing more influences to certain reproductive features, fertility can easily be improved (Trifunović, 2004). Focus should be on the proper raising of heifers, their age in the first year of fertilization and the period between two calving, with the goal of one calf per year. In Bosnia and Herzegovina, we are seeing more and more of the black and white Holstein-Friesian species, which is the most superior species when it comes to production of milk.

Materials and methods

Research of the reproductive features of Holstein-Friesian cows, conducted on the contemporary 'Spreča' farm (Kalesija, entity of Federation of Bosnia and Herzegovina), that owns high quality dairy cows. Capacity of farm is 2500 throats, from which 1500 are dairy and 1000 different categories. Yearly production of milk on this farm is around 12 million liters of milk. With a random sampling for this research, 30 Holstein-Friesian cows have been chosen, in their first three lactations. The most basic reproductive indicators have been monitored: gestation length, service period, inter-calving interval and the weight of calves. Basic data processing and testing of the importance of the differences between these indicators are shown by the application of common variation and statistical methods

(Hadživuković, 1991), and calculation of the coefficients phenotypic correlation connection between the parameters is made by the form for correspondent sample (Latinović, 1996).

Results and discussion

To establish fertility it is important to evident all of the phenomenon and activities related to reproductive features, and that's why in this paper the results of all these traits of 30 Holstein-Friesian cows, can be found. Throats have been bred on the 'Spreča' farm and have been chose by random sample method from the farm's records. Parameters that have helped to come to results related to reproductive features that are shown in the tables below. Results in the tables represent reproductive parameters like: the age of the heifer during their first, second and third insemination, gestation length, duration of service period and inter-calving interval and the weight of the calves during the first, second and third delivery.

Table 1. Average values and variability of age of cows, inter-calving period and service period in the first three lactations

Lactation	Indicators	\bar{x}	$S_{\bar{x}}$	S	C.V. (%)
I	Age of cows – first insemination (months)	22,29	0,77	4,23	18,97
	Service period (days)	158,2	11,69	63,96	40,42
	Inter-calving period (days)	437,66	11,46	62,69	14,32
II	Age of cows – second insemination (months)	36,53	0,99	5,45	14,91
	Service period (days)	187,56	15,46	84,62	45,11
	Inter-calving period (days)	460,30	15,67	85,75	18,62
III	Age of cows – third insemination (months)	52,06	1,28	7,02	13,48

Average age of all of the heifers during their first insemination was 22.29 months, while the average age during the second and the third insemination was 36.53 months (second) and 52.06 (third).

Perišić et al. (2004) have come to a conclusion that the average age during the first insemination was 17.89 months (536.70 days), which is below the results that have been gathered in this paper. From table 1 we can see that the variability of the service periods was very expressed during both of the service periods (C.V. % = 40.42 and C.V. % = 45.11).

Basic parameter that is used to measure reproductive efficiency of herd of dairy cows is the duration of the interval between two constant deliveries. (So called inter-calving interval) (Stančić and Košarčić, 2007).

The results show that there are differences between the first two inter-calving intervals, and also during the service periods, the second one (460.30) inter-calving interval lasted longer than the first one (437.66).

In the table 2 average values and the variability of the duration of pregnancy have been shown. When we consider the fact that the duration of pregnancy is a biological constant, there have not been much of the differences in the first three calving. There is an ascertainment in the table that pregnancy period for the second time (both sexes) lasted longest (275.20), while the shortest was during the first calving (269.66). Also, the accent should be at the pregnancies with cows that had male calves lasted longer than with the cows that gave birth to female calves.

Kosovac (1984) states that the pregnancy for the Holstein-Friesian cows is 281.78 days and for the black and white (Holland-Friesian) cows 277.60 days which is longer comparing to the results in this paper.

Table 2. Average values and the variability of the duration of gestation depending on the age of the cow and gender of the calf (days)

Gestation	Calf gender	n	\bar{x}	$S_{\bar{x}}$	S	C.V. (%)
I	♂	9	288,11	0,77	2,15	0,75
	♀	6	288,33	0,66	1,63	0,56
	♂ + ♀	15	288,20	0,49	1,90	0,66
II	♂	8	287,25	0,45	1,28	0,45
	♀	7	287,14	0,59	1,57	0,55
	♂ + ♀	15	287,20	0,35	1,37	0,48
III	♂	6	288,50	0,56	1,38	0,48
	♀	9	287,67	0,60	1,80	0,63
	♂ + ♀	15	288,00	0,43	1,65	0,57

Table 3 shows the average value and variability of the weight of calves at birth in kilograms. Both sexes had the highest weight during the second calving and it was 42.53 kg, and the smallest weight was found at the cows giving birth for the first time (39.93). Looking at the results from the table, we came to a conclusion that male calves in all three calving weighted more than female calves.

Table 3. Average values and the variability of the weight of calves at birth (kg)

Order of calving	Calf gender	n	\bar{x}	$S_{\bar{x}}$	S	C.V.%
I	♂	12	41,58	1,06	3,67	8,82
	♀	18	38,83	1,07	4,55	11,71
	♂ + ♀	30	39,93	0,79	4,37	10,94
II	♂	14	41,64	1,44	5,41	12,99
	♀	16	43,31	1,45	5,83	13,46
	♂ + ♀	30	42,53	1,02	5,61	13,19
III	♂	14	42,28	1,14	4,30	10,17
	♀	16	39,18	0,75	3,01	7,68
	♂ + ♀	30	40,63	0,71	3,93	9,67

The differences between the most reproductive traits that are confirmed in previous tables are statistically confirmed and those parameters have been shown in the table below (table 4).

Table 4. The significance of differences in gestation length, inter-calving interval duration, service period duration and weight of calves in the first three lactations

Indicators	Lactation	Average	Difference	Significance
Gestation length (days)	I-II	269,66 – 275,20	-5,540	***
	I-III	269,66 – 272,83	-3,170	***
	II- III	275,20 – 272,83	2,37	**
Inter-calving interval (days)	I-II	437,66 – 460,30	- 22,64	***
Service period (days)	I-II	158,20 – 187,56	-29,36	***
Weight of calves (kg)	I-II	39,93 – 42,53	-2,600	***
	I-III	39,93 – 40,63	-0,700	ns
	II-III	42,53 – 40,63	1,900	*

***P<0.001; **P<0.01; *P<0.05; ^{ns} P>0.05

In the presentation we have mentioned that the longest pregnancy was the second one (275.20) and the shortest was the first one (269.66). Statistically, highly significant differences (P<0.001) have been found between the first and the second pregnancy, and between the first and the third pregnancy, while the differences between the second and the third pregnancies were very significant (P<0.01).

Looking at the results from the tables for the parameters of the service period and the inter-calving interval, we conclude that the differences of 29.36 (for the service period) and 22.64 (for inter-calving period) were statistically highly significant and confirmed on the level of (P<0.001).

Confirmed differences between the weights of the calves at birth during first three lactations are also shown in the table 4. We conclude that there are differences highly significant between the weight at first (39.93 kg) and second (42.53 kg) calving and that difference (2.60) has been confirmed on the level (P<0.001). Difference from 0.70 between weight of the calves during the first and the third calving, did not show statistical significance (P>0.05), while the difference between the weight of the calves at the second and the third calving was significant at the level of P<0.05.

Conclusion

Based on the analyses and statistic processing of mentioned reproductive parameters, the conclusion is that the age and lactation, respectively, had the effect on the most of the reproductive features. The other conclusion is that in the aspect of the reproductive features there hasn't been satisfying results, considering the fact that the service period and the inter-calving interval lasted long. From detailed analyses, one can see that the selection plan of the farm 'Spreča' was to get the production rate to the highest level, affecting the fertility and shortening the lifetime of the cows.

References

- Hadživuković S. (1991): Statistical methods in agriculture and in biological research. Novi Sad.
- Kosovac, O. (1984). The examination of fertility and duration of the productive life of the Holstein-fresian population at PP "KULA" – Kula.. Master's thesis, Faculty of Agriculture, Belgrade-Zemun.
- Latinović D. (1996): Population genetics and breeding of domestic animals. Practicum, University of Belgrade, Belgrade.

- Stančić, B., Košarčić, D. (2007): Reproduction of cattle. University of Novi Sad, Faculty of Agriculture, Novi Sad.
- Trifunović G., Latinović D., Mekić C., Đedović R. (2004): Influence of the level of yield of the milk to the fertility features. *Biotechnology in Animal Husbandry*, vol. 20 (5-6), 35-40.

POTENTIAL TARGET SPECIES FOR SURVEILLANCE ON A BOVINE TUBERCULOSIS ENDEMIC AREA

Agnes CSIVINCSIK^{1*}, Zsuzsanna RÓNAI², Gábor NAGY³

¹Institute of Diagnostic Imaging and Radiation Oncology, University of Kaposvár, Kaposvár, Hungary

²Department of Animal Nutrition, University of Kaposvár, Kaposvár, Hungary

³Veterinary Diagnostic Directorate, National Food-chain Safety Office, Budapest, Hungary

*Corresponding author: csivincsik.agnes@sic.ke.hu

Abstract

The main threat for bovine tuberculosis (bTB) officially free qualification of cattle herds is the presence of a wildlife reservoir species around livestock farms. Without a regular and systematic surveillance, the epidemiological risk caused by the disease cannot be estimated; hereby plan of action is hard to work out. In Hungary, the Southwestern part of the country is known as a bTB endemic area. Our study aimed to identify those species, which can be a target of a systematic surveillance. For this purpose, we investigated 238 specimens of six species between 2014 and 2016 to look for visible lesions of bTB; and then we cultured all investigated specimens. During evisceration we carried out a visual-only game meat inspection, and then we collected lymph nodes (submandibular, retropharyngeal, tracheobronchial, mediastinal, hepatic, mesenteric) and submitted those to bacteriological examination. Our results confirmed that the wild boar (*Sus scrofa*) and the red fox (*Vulpes vulpes*) showed the highest infection prevalence inside the endemic area (21.7% and 22.2%, respectively), although during our investigation, the red fox never showed visible lesions of bTB. Nevertheless, among wild boars, the prevalence of post-mortem lesions proved to be 63.4%. All of the examined wild boar carcasses with visible lesions contained lesions inside the submandibular lymph node, as well. These findings suggest that wild boar can be a good target species for bTB surveillance. The observation that the submandibular lymph node was affected in each case, suggests that game meat processing plants, where the head can be accessible, should be a place of a systematic surveillance on bTB in wildlife.

Keywords: *Bovine tuberculosis, Wildlife, Surveillance, Hungary.*

Introduction

Bovine tuberculosis (bTB) is a re-emerging infectious disease all over Europe. The former method, test and slaughter (tuberculin testing of cattle herds and removing all the reactors), cannot be successful to reach and maintain freedom from the disease, where natural reservoir exists in the close surroundings of free-ranging livestock (Cvetnic *et al.*, 2006; Meng *et al.*, 2009).

Dense wildlife populations serve as both animal health and husbandry problems that can threaten the efficacy of both wildlife management and livestock health (Gortázar *et al.*, 2008, Naranjo *et al.*, 2008; Schöning *et al.*, 2013; Vicente *et al.*, 2006), furthermore, bTB doubts the sustainability of intensive wildlife management systems (Vicente *et al.*, 2006).

Special ecological factors determine the maintenance or spill-over roles of a host. These factors might be population density, social behaviour, feeding ecology of the host species; moreover, other characteristics of the local ecosystem (Rhyan and Spraker, 2010; Martin *et al.*, 2011).

Former studies consider the badger to be an important reservoir species on the British Isles exclusively (Gallagher and Clifton-Hadley, 2000; Sobrino *et al.*, 2008), whereas on the Continent the species which may play a significant role in the epidemiology of bTB is wild

boar (Naranjo *et al.*, 2008). Moreover, other species, such as the red deer (*Cervus elaphus*), fallow deer (*Dama dama*) and red fox are investigated as a reservoir of bTB (Fitzgerald and Kaneene, 2012, Martín-Atance *et al.* 2005; Matos *et al.* 2014; Schoepf *et al.*, 2012).

Mycobacterium caprae has proven to be the major cause of bTB in central European livestock and wildlife (Prodinger *et al.*, 2005). In the last decade several investigations confirmed that wild boars can maintain bTB infection even in the absence of another susceptible species (Naranjo *et al.*, 2008).

Although, diseases are not the most important mortality factors in wildlife species, there were several attempts to control bTB in wildlife (Gortázar *et al.*, 2011; Schoepf *et al.*, 2012; Vicente *et al.*, 2006). It is confirmed that without an appropriate surveillance system disease management cannot be successful (Hadorn and Stärk, 2008). In the course of surveillance planning it is essential to select the most eligible target species. In this point of view scavenger species that act as bio-accumulators of infectious agents, can come into question (VerCauteren *et al.*, 2008).

The aim of our study was to determine the most appropriate target species for bTB surveillance inside an endemic area. Therefore we investigated six potential host species and we searched for visible lesions of bTB. We hypothesized that among the most abundant mammal species, we could find one, in which the prevalence of infection and the visibility of the lesions should allow to be the base of a surveillance system.

Materials and methods

Our study was carried out in Somogy County inside the south Transdanubian region of Hungary, which is known as a bTB endemic area (Prodinger *et al.*, 2005).

Between 2014 and 2016 we collected 238 samples from six species (wild boar, red deer, fallow deer, roe deer (*Capreolus capreolus*), red fox and golden jackal (*Canis aureus*)) during hunting events. All examined animals were hunter-harvested as a part of management practice and not for animal health purpose. During group hunting events game animals were shot randomly without any special selection for age, gender and health status. In a certain hunting event each carcass was examined without any selection in order to keep the randomization provided by non-selective hunting. Roe deer were harvested individually, but we made an effort to collect as many specimens of this species as we could. Carcasses in which regional lymph nodes of the head, neck and chest cavity were destroyed by the shot were excluded.

Post-mortem examination and sample collection were carried out in the field during evisceration. The regional lymph nodes, lung, liver, spleen, kidney were examined visually, by palpation and all were dissected to 2 mm slices. Individual samples submitted to bacterial culture included all organs with suspect bTB lesions (Vicente *et al.*, 2006) and the submandibular, retropharyngeal, tracheobronchial, mediastinal, hepatic, mesenteric and caecal lymph nodes (independently of post-mortem findings).

These individual samples were homogenized in a pool and decontaminated in 5% oxalic acid solution for 15 min; then centrifuged at 3000× g for 10 min. The sediment was re-suspended in 2 mL sterile phosphate buffered saline and inoculated into Middlebrook broth and onto Herrold's, Lowenstein-Jensen and pyruvate supplemented Lowenstein-Jensen slants; which were incubated for at least 8 weeks at 37 °C and checked for contamination and mycobacterial growth weekly, while Middlebrook broth was checked by Ziehl-Neelsen (Z-N) staining every month. All isolates were tested in a multiplex amplification system (Wilton and Cousins, 1992).

Bacterial culture results were defined as *M. caprae*, MAC, MAP and NTM, if *M. caprae*, *M. avium* complex without *M. avium ssp. paratuberculosis*, *M. avium ssp. paratuberculosis* and non-tuberculous (environmental) mycobacteria were isolated, respectively.

Results and discussion

Among the investigated species the red fox didn't show any visible signs of bTB, even at high prevalence of infection. Deer species always showed visible lesions in the case of infection but the prevalence was relatively low. The golden jackal proved to be free from the infection during our study; although the sample size was small. Our study confirmed that the wild boar could be the best target of a surveillance system, because both visible lesions and culture positivity occurred at a high prevalence in the species (Table 1).

Table 1. Post-mortem and culture results by species

Species	Number of examined	Number of positives by necropsy	Number of culture positives	Prevalence of lesions	Prevalence of <i>M. caprae</i>
Wild boar (<i>Sus scrofa</i>)	175	111	38	63.43%	21.7%
Red deer (<i>Cervus elaphus</i>)	25	5	3	20.0%	12.0%
Fallow deer (<i>Dama dama</i>)	23	3	2	13.0%	8.7%
Roe deer (<i>Capreolus capreolus</i>)	3	2	0	66.7%	0.0%
Red fox (<i>Vulpes vulpes</i>)	9	0	2	0.0%	22.2%
Golden jackal (<i>Canis aureus</i>)	3	0	0	0.0%	0.0%

Our results were in accordance with other European experiences as the wild boar, especially the submandibular lymph nodes, showed visible lesions, which could be detected by post-mortem examination of carcasses (Naranjo *et al.*, 2008). In our study, all of the examined wild boar carcasses with visible lesions contained lesions inside the submandibular lymph nodes.

The role of the other scavengers, the red fox and golden jackal, could not be ascertained by our investigation. The complete absence of lesions in the red fox and the apparent freedom from the infection in the golden jackal might have been due to the smaller sample size in these species. Study results from the Iberian Peninsula confirm that the red fox can develop advanced stages of bTB (Martín-Atance *et al.* 2005; Matos *et al.* 2014). Notwithstanding, canids as bio-accumulators of infectious materials proved to be good sentinels of bTB as well (VerCauteren *et al.*, 2008).

In this regard canids need more considerations.

Cervids as a host of bTB was confirmed by this study; nevertheless, the relatively low prevalence of infection could not allow these species of being a good indicator of epidemics in the natural environment.

Conclusions

Wild boar as a natural reservoir of bTB in Europe is well known. Our study confirmed that within an endemic area, this species could become infected at a higher rate and it could show visible lesions of bTB, especially inside the submandibular lymph nodes.

In Europe thousands of wild boars are hunter-harvested and processed by the game meat industry. Carcasses enter the game meat processing plants with the head; accordingly with submandibular lymph nodes. These plants should be adequate places for large-scale screening of wild boars by post-mortem examination. The data yielded from this survey can be applied in planning of an epidemiological strategy against bTB in free-ranging cattle herds.

References

- Cvetnic Z., Spicic S., Katalinic-Jankovic V., Marjanovic. S., Obrovac M., Benic M., Mitak M., Pavlik I. (2006). *Mycobacterium caprae* infection in cattle and pigs on one family farm in Croatia: a case report. *Veterinarni Medicina*, 51: 523–531.
- Fitzgerald S.D., Kaneene J.B. (2012). Wildlife reservoirs of bovine tuberculosis worldwide: Hosts, pathology, surveillance, and control. *Veterinary Pathology*, 50: 488-499.
- Gallagher J., Clifton-Hadley R.S. (2000). Tuberculosis in badgers; a review of the disease and its significance for other animals. *Research of Veterinary Science*, 69: 203-217.
- Gortázar C., Vicente J., Boadella M., Ballesteros C., Galindo R.C., Garrido J., Aranaz A., de la Fuente J. (2011): Progress in the control of bovine tuberculosis in Spanish wildlife. *Veterinary Microbiology*, 151: 170-178.
- Gortázar C., Torres M.J., Vicente J., Acevedo P., Reglero M., de la Fuente J., Negro J.J., Aznar-Martín J. (2008). Bovine tuberculosis in Doñana biosphere reserve: the role of wild ungulates as disease reservoirs in the last Iberian lynx strongholds. *PLoS ONE*, doi:10.1371/journal.pone.0002776
- Hadorn D.C., Stärk K.D.C. (2008). Evaluation and optimization of surveillance systems for rare and emerging infectious diseases. *Veterinary Research*, 39: 57.
- Martin C., Pastoret P., Rochier B., Humblet M.F., Saegerman C. (2011). A survey of the transmission of infectious diseases/infections between wild and domestic ungulates in Europe. *Veterinary Research*, 42:70.
- Martín-Atance P., Palomares F., Gonzáles-Candela M., Revilla E., Cubero M.J. (2005). Bovine tuberculosis in a free ranging red fox (*Vulpes vulpes*) from Doñana National Park (Spain). *Journal of Wildlife Diseases*, 41:435-436.
- Matos A.C., Figueira L., Martins M.H., Matos M., Morais M. (2014): Disseminated *Mycobacterium bovis* infection in red foxes (*Vulpes vulpes*) with cerebral involvement found in Portugal. *Vector Borne and Zoonotic Diseases*, Epub 2014 Jun 5
- Meng X. J., Lindsay D. S., Sriranganathan N. (2009). Wild boars as sources for infectious diseases in livestock and humans. *Philosophical Transaction of the Royal Society B*, 364: 2697–2707.
- Naranjo V., Gortazar C., Vicente J., de la Fuente J. (2008), Evidence of the role of the European wild boar as a reservoir of *Mycobacterium tuberculosis* complex. *Veterinary Microbiology*, 127: 1-9.
- Prodinger W.M., Brandstätter A., Naumann L., Pacciarini M., Kubica T., Boschioli M.L., Aranaz A., Nagy G., Cvetnic Z., Ocepek M., Skrypnik A., Erler W., Niemann S., Pavlik I., Moser I. (2005). Characterization of *Mycobacterium caprae* Isolates from Europe by Mycobacterial Interspersed Repetitive Unit Genotyping. *Journal of Clinical Microbiology*, 43: 4984-4992.
- Rhyan, J. C., Spraker T. R. (2010). Emergence of diseases from wildlife reservoirs. *Veterinary Pathology*, 47: 34-39.

- Schoepf K., Prodinger W.M., Glawischnig W., Hofer E., Revilla-Fernandez S., Hofrichter J., Fritz J., Köfer J., Schmoll F. (2012). A two-years' survey of the prevalence of tuberculosis caused by *Mycobacterium caprae* in red deer (*Cervus elaphus*) in the Tyrol, Austria. ISRN Veterinary Science, doi: 10.5402/2012/245138
- Schöning J. M., Cerny N., Prohaska S., Wittenbrink M.M., Smith N.H., Bloemberg G., Pewsner M., Schiller I., Origi F.C., Ryser-Degiorgis M.-P. (2013). Surveillance of Bovine Tuberculosis and Risk Estimation of a Future Reservoir Formation in Wildlife in Switzerland and Liechtenstein. PLoS ONE, doi:10.1371/journal.pone.0054253
- Sobrino, R., Martin-Hernando M.P., Vicente J., Aurtenetxe O., Garrido J. M., Gortazar C. (2008). Bovine tuberculosis in a badger (*Meles meles*) in Spain. Veterinary Record, 163: 159-160.
- Vicente J., Höfle, U., Garrido J.M., Fernandez-De-Mera I.G., Juste R., Barral M., Gortázar C. (2006): Wild boar and red deer display high prevalences of tuberculosis-like lesions in Spain. Veterinary Research, 37: 107-119.
- VerCauteren K.C., Atwood T.C., DeLiberto T.J., Smith H.J., Stevenson J.S., Thomsen B.V., Gidlewski T., Payeur J. (2008). Sentinel-based surveillance of coyotes to detect bovine tuberculosis, Michigan. Emerging Infectious Diseases, 14: 1862-1869.
- Wilton S., Cousins D. (1992). Detection and identification of multiple mycobacterial pathogens by DNA amplification in a single tube. Genome Research, 1: 269-273.

THE EFFECT OF REPLACING CORN AND SOYA BEANS BY WHITE SORGHUM AND HORSE BEANS ON RUMEN METABOLISM AND IN SITU DEGRADABILITY IN SHEEP

Imtiaz BOUZARRAA^{1,2*}, Abdulbaset Zidane SHRIF³, Hammadi ROUISSI⁴

¹High Institute of Agricultural of Chott Mariem, Tunisia

²National Institute of Agricultural Research of Tunisia (INRAT), Tunisia

³University of Tripoli, Libya

⁴Hight School of Agriculture of Mateur, Tunisia

*Corresponding author imtiaz.bouzouraa@live.fr

Abstract

Four 4.5±1.2 years old male Sicilo-Sarde local sheep ruminally cannulated and with live weight 45.25±3.5kg were used to evaluate the effect of replacing corn and soya beans by white sorghum and horse beans on the parameters of facies fermentation, protozoa and degradability. Each animal received, during a first period of the experience, 1.5 kg of oat hay and 500 g of concentrate (C) to basis of corn (43.3%), barley (25%), soybean meal (17.7%) and mineral and vitamin supplement CMV (4%). Then, in the second period, these rams received 1.5 kg of oat hay and 500 g of concentrate (S) to basis of white sorghum (66%), horse beans (30%) and mineral and vitamin supplement CMV (4%). The rams were lodged in individual pens. The result of the replacing revealed that feed intake was not significantly affected (1.54vs. 1.53 kg DM/d, for C and S, respectively). Rumen pH was significant (P<0.05) before the distribution of the morning feed and 2 hours after while the diet doesn't affect it after in 5 and 8 hours. Ammonia nitrogen and gas production were not affect by the diet (P>0.05) The dry matter digestibility was significant (P<0.05) in 3, 6, 12, and 36 hours but the diet didn't affect it in 24 and 48 hours. Total ciliate protozoa counts was little higher for (C) than (S) while the different genus of protozoa were comparable for (C) and (S) but the diet did not affect the number and genus of protozoa.

Key words: *Sicilo-Sarde Rams, local feed resources, facies fermentation, degradability*

Introduction

Sheep are considered to be one of the most important animals that can affect the social and economic status of people inhabiting arid and semi-arid regions. The development of ruminant livestock uses different sciences (nutrition, reproduction, genetics, health) need to conduct in parallel, in an integrated manner in a culture system. Indeed, ruminants can transform highly diversified plant biomass, in particular fiber materials, animal proteins. So to improve and increase the productivity of livestock (meat, milk, egg) which is among the main objectives of agricultural policies in the world in response to increasing populations, it is particularly clear understanding of the technical and rationing know the scientific basis of the components of food - animal -system.

The feeding of sheep is based on forages with a low nutritional value and undiversified and concentrated formed by imported raw materials (corn and soybeans) even their price is high. So the farmer must look for the local raw materials to feed his livestock to cover their needs. The purpose of this present study was to focus on the effects of the local raw materials on rumen metabolism and in situ degradability in sheep.

Materials and methods

Animals and management

The experiment was carried on 2010 out at the experimental station of the higher school of agriculture of Mateur in Tunisia. Four 4.5 ± 1.2 years old male Sicilo-Srade local sheep ruminally cannulated with live weight at the beginning of the trial 45.25 ± 3.5 kg were used in this experiment. The rams were housed in individual pens (length 1.6 m and width 1 m) where fresh water was freely available. Each animal received 1.5 kg of oat hay/ram/day and daily supplemented with 0.500 kg /ram/day of two concentrates (C) and (S), different by the nature of protein and energy ingredient. Rams received in the first period the concentrate (C) and in the second period the concentrate (S) during a 30 days separated by an adjustment period of fourteen days. Feeds were offered twice daily at 9:00 and 17:00 hr. Samples of different meals distributed and refuse were weighted and sampled daily (10% per day from each animal). The samples were dried at 50°C for 48 hours and preserved for later analysis.

Rumen fermentation

The rumen liquor was taken 0 hour before serving meals and 2, 5 and 8 hours after via a plastic rod. The pH was measured on the rumen contents just after collection with a digital pH meter. Before each measurement of pH, the electrode was rinsed with distilled water and wiped dry.

For counting different protozoa genera a volume of 5 ml of unfiltered samples juice and 5 ml of a solution composed of 500 ml glycerol and 20 ml formaldehyde and 480 ml distilled water were stored in a refrigerator set at 4°C until the count. With a HAWSKLEY counting room, we were determined the enumeration and the genera of protozoa after several dilutions and using a microscope with a lens 100X.

The method of Conway (1962) was used to measure the concentration of ammonia nitrogen (NH₃-N). after filtering the rumen liquor with four layers of cheesecloth 1 ml of sample was acidified with one drop of sulphuric acid (0,1N) and kept frozen until analyzed. the concentration of ammonia nitrogen was determined using this formula:

$$\text{NH}_3\text{-N mg/ml of juice} = (V (\text{HCl E}) - V (\text{HCl T})) * N (\text{HCl}) * 14 \text{ g}$$

Where:

V (HCl E): volume of the sample.

V (HCl T) : volume of the witness.

N (HCl) : HCl normality.

Gas production

A filtered rumen liquor, collected before the morning feeding was used to determine the gas production (CO₂ and CH₄) following the method described by Menke and Steingass (1988). 0.5 g (DM) of substrate (oat hay milled at 1 mm) was weighted into glass syringes with 10 ml of rumen fluid and 40 ml of artificial saliva and incubated at 39°C. The gas production was determined every 2 hours until 24 hours. At the end of incubation a 5 ml NaOH was injected in each syringe, the piston moves back, the difference in volume reflects the amount of methane produced.

In situ rumen degradability

Samples of 3 g DM of oat hay were placed in nylon mesh bags calibrated (5 × 15 cm; pore size of 50 μm) and sealed. the weight of each bag is determined before each use. the bags were fixing to a plastic rod of about 20 cm long bearing at its ends a counter weights about 100 g so it does not float in the rumen. The 0 h bags (bags witnesses) and the bags attached were washed under running water for 5 minutes. After that the bags witness were placed an

oven at 60°C while the bags were incubated in the rumen for 3, 6, 12, 24, 36 and 48 hours. One bag was taken per pet, per stay time. After removal from the rumen, the bags containing forage residues were rinsed with water until no further colour appeared. Then these were dried at 60°C for 24h. Digestibility was determined as follows:

$$\text{Dg DM (\%)} = \frac{(\text{DMC} - \text{DMR})}{\text{DMC}} * 100$$

Where:

DMC: Dry matter corrected (g)= DM x (1-loss rate)

DMR: Dry residue (g) of the bag incubated in the rumen.

Statistical analysis

The parameters measured were subjected to analysis of variance by GLM procedure of SAS (1989) and compared by Duncan's test (1955).

Results and discussion

Composition of diets

The chemical composition of different diets is documented in Table 1.

Table 1. Chemical composition (% DM basis)

Nutrient	Concentrate		hay
	C	S	
Dry matter	94.7	94.7	92
Organicmatter	91.0	88.3	92.1
Crude fibre	12.7	3.7	35.6
Crude protein	16.3	14.65	4.9

C: 10% barley; 43.3% corn; 25% wheat bran; 17.7% soybean meal and 4% CMV; S: 66% white sorghum; 30% horse bean and 4% of CMV;

The results of this analysis show that the hay is low in CP (4.9%) and rich in crude fibre (35.6%) confirming the results reported by several studies (Mahouachi and Khaldi, 1987). The CP and crude fibre concentrations in the diets containing corn were greater than diet containing sorghum.

Feed intakes

Table 2 shows that feed intakes of hay oat (g/Kg^{0.75}/d) was 1,07 ± 0,08 for (C) and 1,06 ± 0,1 for (S). Feed intake of animals was not affected by diet. This result is similar to this of Mason (1981).

Table 2. Effect of diet on feed intake

	Mean	P
M	1.07 ± 0.08	ns
S	1.06 ± 0.1	ns

ns = non-significant; SEM = Standard error of means.

Rumen fermentation

The effect of diet on rumen metabolites are shown in tables 3, 4 and 5. The diet tended to decrease rumen pH during the day. The pH before serving meals and after 2 hours was significantly ($P < 0.05$) for diet M and S 6.67 ± 0.34 and 6.28 ± 0.22 at 0h and 6.48 ± 0.38 and 6.18 ± 0.13 after 2 hours. Fabiao et al (2008) previously observed similar results that were also coherent with those of Dayani et al (2007). After 5 hours there was a difference but without a significant difference. It was a decrease in pH to 2 and 5 H, this trend could be attributed to the negative correlation between rumen pH and the concentration of volatile fatty acid end products of digestion of carbohydrates (Cuvelier et al, 2005). At 8H, the pH increased, this can be explained by the stabilizing effect of ciliated protozoa in degrading starch that comes from horse beans. These findings agree with those reported by Santra and Karim (2007) and Hammami et al (2009).

Table 3. Effect of diet on rumen fluid pH

	<i>Time(h)</i>			
	0	2	5	8
M	6.67 ± 0.34	6.48 ± 0.38	6.22 ± 0.42	6.25 ± 0.34
S	6.28 ± 0.22	6.18 ± 0.13	5.97 ± 0.22	5.99 ± 0.31
Diet effect	*	*	<i>ns</i>	<i>ns</i>

ns = non-significant;

Before the meal NH₃-N concentration was 9.21 ± 2.63 mg/100 ml of rumen fluid for diet corn and soyabeans while it was 8.05 ± 2.93 mg/100 ml for diet sorghum and horse beans. Then after 2 hours the ammonia reached his peak for two diets. Kayouli et al (1991) explained this that the ruminal pH is favourable to the proliferation of ciliated protozoa and high microbial activity. Hammami et al (2009) reported similar findings, which confirmed the previous findings of Rouissi et Guesmi (2004) and Castillejos et al (2007). On the other hand Jouany and Senaud (1982) explained this by significant correlation observed between the concentration of NH₃-N and the total number of ciliates. After 5 and 8 hours, NH₃-N concentration in the rumen decreased for the two diets. This may be due to the absorption through the rumen wall and use by bacteria to synthesize their own proteins (Hammami et al., 2009). However, NH₃-N concentration was not affected by the diet ($P > 0.05$)

Table 4. Effect of diet on ammonia nitrogen (mg/100ml)

	<i>Time (h)</i>			
	0	2	5	8
RM	9.21 ± 2.63	12.83 ± 3.76	6.4 ± 2.47	5.23 ± 3.08
RS	8.05 ± 2.93	11.66 ± 3.00	7.4 ± 2.88	6.3 ± 3.01
P	<i>ns</i>	<i>ns</i>	<i>ns</i>	<i>ns</i>

ns : Non Significant.

As shown in Table 5, for the diet C, the total number of protozoa was between 5.80×10^5 / ml to 6.35×10^5 /ml with an average of 6.08×10^5 / ml. While for the S oscillated between 5.73×10^5 /ml to 6.38×10^5 /ml and with an average of 6.06×10^5 /ml. For Entodiniomorpha genus, The percentage of Entodinium was $55.64 \% \pm 6.21$ and $54.86 \pm 15.00 \%$ while for Ophryoscolex was $10.95\% \pm 1.32$ and $8.06 \pm 2.62 \%$ (for RM and RS respectively). While the group of Holotriches which was represented by the Isotricha, the percentage was $27.31\% \pm 6.46$ and 29.7 ± 15.29 to C and S respectively. However, the total number of protozoa and genus were not affected by the nature of the diet. Rouissi (1994) and Selmi et al (2009) reported similar findings

Table 5. Effect of diet on protozoa number ($\times 10^5$ /ml) in lambs (n=4)

Diet	Protozoa number (10^5 /ml)	Genus(%)			
		Entodinium	Isotricha	Ophryoscolex	Polyplastron
C	6.08 \pm 0.23	55.64 \pm 6.21	27.31 \pm 6.46	10.95 \pm 1.32	7.82 \pm 1.32
S	6.06 \pm 0.22	54.86 \pm 15.00	29.7 \pm 15.29	8.06 \pm 2.62	5.73 \pm 3.93
P	<i>ns</i>	<i>ns</i>	<i>ns</i>	<i>ns</i>	<i>ns</i>

ns : Non Significant..

Gas production

The data represented in table 6 showed, the gas production was evolved gradually after 6 hours of incubation 19.16 ± 7.03 ml for C 15.66 ± 7.80 ml and S. then after 12 hours of incubation, an acceleration gas production was recorded for both plans but with superiority for the C. The maximum gas production for C and S respectively was 77.66 ± 11.65 ml and 78.41 ± 16.61 ml at 36 hours (Selmi et al.,2009). The proportion of methane (CH₄) produced for the two diets was 22.08 ± 4.18 and $21.16 \pm 3.21\%$ of the total gas volume. The gas production and the proportion of methane (CH₄) were not significantly affected by diet.

Table 5. Effect of diet on protozoa number ($\times 10^5$ /ml) in lambs (n=4)

	T6	T12	T24	T36	CH ₄	
					V (ml)	%
C	19.16 \pm 7,03	39.75 \pm 9.64	66.41 \pm 11.53	77.66 \pm 11.65	22.08 \pm 4.18	28.43
S	15.66 \pm 7.80	35.25 \pm 13.65	64.33 \pm 16.37	78.41 \pm 16.61	21.16 \pm 3.21	26.98
P	<i>ns</i>	<i>ns</i>	<i>ns</i>	<i>ns</i>	<i>ns</i>	<i>ns</i>

ns : Non Significant.

In situ rumen degradability

To characterize the feed for animal, we use in situ degradability like a test. In table 6, the data of DM degradability of oat hay was presented. After 3 hours, the digestibility was 9.815 ± 4.69 % DM for C and 14.56 ± 3.13 % DM for S. then the degradability was evolved to reach $36.04 \% \pm 6.12$ and 39.91 ± 5.4 % respectively for C and S. At 48 hours of incubation, the digestibility was relatively low for two diets ($36.04 \% \pm 6.12$ and 39.91 ± 5.4 % respectively for C and S) in comparative with those were advanced by Kayouli et al. (1992) and Rouissi

(1994). The degradation of DM demonstrated a significant difference ($P < 0.05$) at T3, T6, T12 and T36. The results agree with those reported by Andrade et al. (2004).

Table 6. Effect of diet on rumen degradability

	<i>Temps (h)</i>					
	T3	T6	T12	T24	T36	T48
RM	9,815±4,69	15,20±4,31	20,12±3,76	25,14±4,60	30,62±5,12	36,04±6,12
RS	14,56±3,13	18,95±2,10	22,83±2,43	27,09±3,52	36,18±5,11	39,91±5,49
P	*	*	*	<i>ns</i>	*	<i>ns</i>

ns : Non Significant.; * = $P < 0.05$.

Conclusion

The current study revealed that the effect of the incorporation of local raw materials in the alimentation of animal can improve some rumen parameters and the degradability of the dry matter of the ration. The pH rumen is between 6 and 7 favourable for the development of rumen microorganisms with no significant difference between the two diets. The ammonia nitrogen concentration is the same throughout the day for both. A similar total gas production for both diets and the amount of methane produced. Digestibility of the basic diet is more important for the regime based white sorghum and horse beans. The total of protozoa and percentages of different genus are similar for both diets.

References

- Andrade P.V.D., Giger-Reverdin S., Chapoutot P. and Pierres J.L., 2004. Liaison entre la dégradabilité « in sacco » des aliments et les paramètres fermentaires ruminants des animaux fistulés. *Rencontre Recherche Ruminants*. 11, 203-207.
- Castillejos L., Calsamiglia S., Ferret A. and Losa R., 2007. Effects of dose and adaptation time of a specific blend of essential oil compound on rumen fermentation. *Anim. Feed Sci. Technol.* 132, 186-201.
- Cuvelier C., Cabaraux J.-F., Dufrasne I., Istasse I., Hornick J.-L., 2005. Production, digestion et absorption des acides gras chez le ruminant. *Ann. Méd. Vét.*, 2005, 149, 49-59.
- Dayani O, Ghorbani GR, Alkhani M, Rahmani HR, Mir PS., 2007. Effect of dietary whole cottonseed and crude protein levels on rumen protozoal population and fermentation parameters. *Small Rumin. Res.* 69:36-45.
- Fabio, Z., Calabró, S., Piccolo, V., Durso, S., Tudisco, R., Bovera, F., Cutrignelli, M.I. & Infascelli, F., 2008. Diets with different forage/concentrate ratios for the Mediterranean Italian Buffalo: In vivo Digestibility. *Asian- Australasian J. Animal Sci.* 21: 75.
- Hammami M., Rouissi H., Selmi H., Rekik B. and Ben Gara A., 2009. Effects of replacing Soya with Vicia faba beans on fermentation in the rumen of the ovine Sicilo- Sarde breed. 6th International Symposium on Ruminant Physiology. Clermont- Ferrand. France.
- Hammami M., Rouissi H., Selmi H., Rekik B. and Ben Gara A., 2009. Effects of replacing Soya with Vicia faba beans on fermentation in the rumen of the ovine Sicilo- Sarde breed. 6th International Symposium on Ruminant Physiology. Clermont- Ferrand. France.
- Jouany J.P. and Senaud J., 1982. Influence of ruminal ciliates on digestion of various carbohydrates in sheep. I. The use of parietal carbohydrates (cellulose and hemicellulose) and starch. *Reprod. Nutr. Dev.* 22, 735-752.
- Kayouli C., Jouany J.P., Demeyer D.I., Ali-Ali H., Taoueb H., Dardilut C., 1992. Comparative studies on degradation and mean retention time of solid and liquid phases in the forestomachs of the dromedary and the sheep fed on low-quality roughages from Tunisia. *Ani. Feed Sci. and Technol. Ref* : ANIFEED 640.
- Kayouli C., Jouany J.P. and Ben Amor J., 1991. Comparison of microbial activity in the forestomachs of the dromedaries and the sheep measured in vitro and in Sacco on mediterranean roughages. *Anim. Feed Sci. Technol.* 33, 237-245.
- Mahouachi, M. et Khaldi, G., 1987. Seasonal variations in sperm production in rams of Barbarine and Noir de Thibar breeds. *Annals of INRAT* , Vol. 60, 11, pp. 3-27.
- Mason I. L., 1981. Classification and distribution of goat breeds. In: *Genetic Resources of Pig, Sheep and Goats* (Ed. K. Majjala). World Animal Science B8. Elsevier, Amsterdam, pp. 405-411.
- Menke K.H. and Steingass H. 1988. Estimation of the energetic feed value obtained from chemical analysis and in vitro gas production using rumen fluid. *Anim. Res. Dev.* 28, 7-55.
- Rouissi H. and Guesmi A., 2004. Comparative study of the ciliated protozoa population in the rumen of sheep and goats. *Options méditerranéennes* 1, 57-59.
- Rouissi H., 1994. Comparative study of microbial activity in the rumen of camels , sheep and goats. Ph D Thesis. University of Gent, Belgium.
- Santra A., Karim S.A. and Chaturvedi O.H., 2007. Rumen enzyme profile and fermentation characteristics in sheep as affected by treatment with sodium lauryl sulfate as defaunating agent and presence of ciliate protozoa. *Small Rumin. Res.* 67, 126-137.
- Selmi H., Hammami M., Rekik R., Salah N., Ben Gara A. and Rouissi H., 2009. effect of replacing of soybean by faba bean on ciliated protozoa in the rumen of rams Sicilo- Sarde. *Lives. Res. Rural. Dev.* 21(9), 103-109.

EFFECTS OF EGG WEIGHT AND SHAPE INDEX ON INCUBATION RESULTS OF THE WHITE ITALIAN GOOSE

Sreten MITROVIĆ¹, Tatjana PANDUREVIĆ^{2*}, M. MILOJEVIĆ¹, Živan JOKIĆ¹, Vladan ĐERMANOVIĆ¹, Svjetlana MIČIĆ², Jelena VLAČIĆ²

¹University of Belgrade, Faculty of Agriculture, Institute of Zootechnic, 11080 Belgrade - Zemun, Republic of Serbia

²University of East Sarajevo, Faculty of Agriculture, 71123 East Sarajevo, Republic of Srpska, Bosnia and Herzegovina

³Ministry of Agriculture, Water and Forestry of the Republic of Srpska, 78000 Banja Luka, Republic of Srpska, Bosnia and Herzegovina

*Corresponding author: t.pand@yahoo.com

Abstract

Based on the monitored and acquired results related to reproductive traits of the parent flock of the White Italian Goose kept on the private commercial farm “Trijesnjica”, Bijeljina city area, entity of Republic of Srpska (Bosnia and Herzegovina), following was established: fertilisation of eggs was 88.99 %; hatchability of goslings from laid and fertilised eggs was 79.00 % and 89.77 %, respectively; average egg mass before incubation was 169.31 g; average egg width was 5.84 cm, and average length 8.90 cm; average egg shape index for both sequences was 66.51 %; average mass of one-day old goslings 112.50 g; absolute correlation was established between average egg mass before incubation and mass of one day old goslings, in both sequences and calculated phenotype correlation coefficients ($r_p = 0.958$ – first sequence and $r_p = 0.988$ – second sequence) were statistically confirmed at $P < 0.001$; in both sequences, a very weak positive correlation was established between egg mass and shape index, with the correlation coefficient between these traits ($r_p = 0.154$) not statistically significant in the first sequence ($P > 0.05$), while in the second sequence the correlation coefficient ($r_p = 0.197$) was statistically confirmed at $P < 0.05$.

Key words: goose, egg weight, incubation, gosling, correlation.

Introduction

It is well established that the composition of eggs supports embryonic development. Namely, weight and other physical (external) and structural (internal) characteristics have a significant effect on embryonic development of poultry (Mitrović *et al.*; 1996, 2010; Moran, 2007, Đermanović *et al.*; 2008, 2016). The main difference between the reproduction of birds/poultry and mammals, is that birds do not give birth to live offspring. Instead, in birds the new organism develops outside the womb, in the egg, i.e., the poultry reproduction implies that eggs are fertilised in order for offspring to be developed from them. Actually, a well fertilised egg is a “package” consisting of an embryo and necessary nutritional matter which facilitates its development until the hatching and for a few days afterwards.

In relation to this, Whiting *et al.* (1983), Shanawany (1984), Yannakopoulos and Tserveni-Gousi (1987) and Altan *et al.* (1995) report that the egg weight and shape index affect incubation results and subsequently weight of hatched offspring of different kinds of poultry. Puchajda *et al.* (1988), Willin (1995), Saatci *et al.* (2005) and Đermanović *et al.* (2008) have established in different goose breeds, stocks and cross-breeds (Bilgoraj goslings; various lineages of domestic Turkish geese according to feather color, two-breed geese, etc.) positive correlation between the egg weight and gosling weight. For example, Đermanović *et al.* (2008) have established statistically significant total correlation ($r_p = 0.987^{***}$) between the

egg mass before laying into the incubator and the mass of one day old goslings of two-breed geese. The average egg mass was 150.79 g and average of one day old goslings was 103.07 g. It should be taken into account that, in comparison with chicken, geese and ducks have significantly lower reproductive potential, primarily due to the reason that the number of eggs they produce during the production cycle is considerably lower than the number produced by hens and also because the embryonic mortality during incubation is significantly higher (Rosinski i Bednarczyk, 1997.).

There is a lack of data in international and particularly in the national literature about the incubation of goose eggs (goslings are mostly bred naturally), as well as about the influence of certain genetic and para genetic factors on goose reproduction. For this reason the main purpose of this research was to establish the optimal egg weight and shape index, gosling weight, as well as correlation between examined traits of White Italian Geese. The geese examined were from a 4 year old flock kept on a registered family farm "Anser" (Triješnjica, Bijeljina, Republic of Srpska) where the main activity is goose breeding (semiintensive management system), production of hatching eggs and production of one day goslings as the final product.

Materials and Methods

"Anser" family farm acquired 2000 male and female geese four years prior to this study, i.e. one parent flock of the White Italian Geese. The farm has an adequate number of housing installations for the geese to use at night and during the periods of bad weather, while they spend the rest of time outdoors where there is abundance of grass for grazing so the need for additional feeding is moderate (consisting mostly of cereal grains).

Apart from keeping daily records of production/reproduction indicators of the parent flock, an experiment was conducted with the purpose of acquiring better understanding of above mentioned traits of the White Italian Geese. Two hundred eggs were collected randomly in February and then again in March (400 in total) and then incubated during this same period.

During the incubation period the number and percentage of fertilised eggs was determined as well as the number and percentage of goslings hatched from the incubated and from fertilised eggs. All eggs were individually weighed before being put into the incubator (egg mass, width and length), the shell was marked with pencil, and eggs were disinfected with formaldehyde vapors. The gosling mass was measured immediately upon hatching and drying.

Eggs were laid into incubators in two sequences of 200 eggs each. Before transferring eggs from the incubator to the hatcher (25. day of incubation) fertilisation was determined and the percentage of fertilised eggs out of the number of laid eggs was calculated. At the end of the incubation period, the number and percentage of hatched goslings from both laid and fertilised eggs was calculated.

Based on these measurements, average egg mass before laying, as well as egg width and length were determined and based on this data, egg shape index (ESI) was calculated according to the following formula: $ESI = (\text{egg width, cm} / \text{egg length, cm}) \times 100$. At the end of the incubation period, average mass of one day goslings was determined for both sequences.

Basic data processing was carried out applying the ordinary variational statistics methods which means that the elementary indicators of descriptive statistics were calculated: arithmetic mean value (\bar{x}), standard error of arithmetic mean value ($s_{\bar{x}}$), standard deviation (S) and variation coefficient (VC). Furthermore, established differences between the sequences related to monitored traits were evaluated using the Student's t-test for different levels of probability risk. Finally, correlation coefficients (r_p) between monitored traits were calculated and their level of significance was determined (Latinović, 1996.).

Results and Discussion

Two hundred eggs were incubated in February (first sequence) and then additional 200 in March (second sequence) i.e, a total of 400 eggs of White Italian Goose were incubated. Egg fertilisation and gosling hatchability from the laid and fertilised eggs is given in Table 1.

Table 1. Fertilisation and hatchability of goose eggs per sequence

Indicators	1 st sequence	2 nd sequence	Total
No. of laid eggs	200	200	400
No. of fertilised eggs	174	178	352
% of fertilised eggs	87.00	89.00	88.00
No. of hatched goslings	150	166	316
% of hatched goslings from laid eggs	75.00	83.00	79.00
% of hatched goslings from fertilised eggs	86.21	93.26	89.77

Generally speaking, data given in Table 1 show that the eggs of the White Italian Goose demonstrated good incubational values, particularly in terms of gosling hatchability, both in relation to the number of laid eggs and to the number of fertilised eggs. Fertilisation of eggs amounted to 87.00 % (first sequence) and 89.00 % (second sequence), i.e. 88 % for both sequences. As shown in Table 1, hatchability of goslings from the number of laid and fertilised eggs amounted to 75.00 % and 86.21 % respectively (first sequence), 83.00 % i 93.26 % (second sequence), while the percentage for both sequences was 79.00 % and 89.77 % respectively.

Similar but somewhat worse incubation results of half-bloods obtained by reciprocal crossbreeding of several goose breeds (White Italian being one of them) have been reported by Mazanowski and Chelmonska (2000), Mazanowski and Adamski (2002), Mazanowski and Bernacki (2006). Poorer and considerably lower fertilisation of eggs and hatchability of goslings of the White Italian Goose and two-breeds were reported by Rosinski (2000) and Đermanović et al. (2008).

Average egg mass before incubation was 173.99 g (first sequence – 200 eggs), 164.64 g (second sequence – 200 eggs) and 169.31 g (both sequences – 400 eggs). From a commercial aspect, it is desirable to have as many fertilised eggs with a healthy and vital embryo that the goslings will be hatched from. In this particular case, out of the total of 400 eggs (200 per sequence), 150 from the first sequence and 166 from the second sequence were fertilised eggs from which goslings were hatched. Mean values, absolute and relative variation measures of certain indications of this most significant group of eggs, as well as significance of differences, are given in Table 2.

Table 2. Mean values, variability and significance of differences of several egg traits from which goslings were hatched

Egg traits	Statistical indicators	1st sequence	2nd sequence	Total	Difference/Significance
Egg mass 1st day (g)	x	173.47	164.79	168.91	8.68***
	n	150	166	316	
	sx	1.39	1.22	0.95	
	S	17.02	15.1	16.91	
	C.V	9.81	9.53	10.01	
Egg width (g)	x	5.89	5.79	5.84	0.10***
	n	150	166	316	
	sx	0.03	0.02	0.02	
	S	0.35	0.21	0.29	
	C.V	5.94	3.63	4.97	
Egg length (g)	x	8.98	8.83	8.90	0.15***
	n	150	166	316	
	sx	0.03	0.02	0.02	
	S	0.3	0.32	0.35	
	C.V	4.12	3.62	3.93	
Shape index (%)	x	65.66	65.58	65.62	0.08***
	n	150	166	316	
	sx	0.18	0.18	0.13	
	S	2.16	2.30	2.24	
	C.V	3.29	3.51	3.41	
One-day old gosling weight (g)	x	115.69	109.61	112.50	6.08***
	n	150	166	316	
	sx	0.94	0.93	0.73	
	S	13.26	11.93	12.94	
	C.V	11.46	10.88	11.50	

*** P<0.001; ^{ns}P>0.05.

In the first sequence, goslings were hatched from 150 eggs out of 200 eggs laid into the incubator, while in the second sequence, the number was considerably higher – 166. The average egg mass before laying (1. day) was 173.47 g (first sequence) and 164.79 g (second sequence), i.e. 168.91 g for both sequences. Eggs from the first sequence were heavier than

the eggs in the second sequence by 8.68 g and the established difference was statistically confirmed at $P < 0.001$ (Table 2).

Some authors have reported considerably lower egg mass (under 151 g) than shown in this study - Saatci *et al.* (2005) in all breeds (white, yellow, multicolor and black) - and Đermanović *et al.* (2008) in two-breed geese. Depending on the mixbreed, Mazanowski and Chelmonska (2000), Mazanowski and Adamski (2002) and Mazanowski and Bernacki (2006) have reported both higher average egg mass (184 g) then reported in this study (168.91 g), and significantly lower average egg mass (148 g). Similarly, Razmaitè *et al.* (2014) have established higher (186.69 g - 3rd year of breeding) and also lower (123.40 g - 1st year of breeding) egg mass in case of Lithuanian Vishtinė Goose. Somewhat lower egg mass in case of White Italian Goose (under 168 g), as well as considerably lower, in case of a strain of Kuban goose (under 143g) have been reported by Bednarczyk and Rosinski (1999).

Data given in Table 2 show that the eggs incubated in the first sequence, apart from being larger, were also statistically significantly ($P < 0.001$) longer and wider than the eggs incubated in the second sequence. Egg width was 5.89 cm (first sequence) and 5.79 cm (second sequence) and the length was 8.98 cm (first sequence) and 8.83 cm (second sequence), i.e. for both sequences: width was 5.84 cm and length was 8.90 cm.

Contrary to the egg mass, egg width and length which were significantly larger in the first sequence, egg shape index was similar in both sequences (65.66 % - 65.58 %) and the difference was not statistically significant ($P > 0.05$). Egg shape index mean value was 66.51 % for both sequences (Table 2).

Insignificantly higher egg shape index (66.19 % and 67.12 %) was reported by Saatci *et al.* (2005) and significantly higher (67.5 %) or significantly lower (64.9 %) were reported by Mazanowski and Chelmonska (2000), Mazanowski and Adamski (2002) and Mazanowski and Bernacki (2006). Apart from the goose eggs, Salahuddin and Holidier (1991) as well as Halaj and Veterany (1998) report different mean values of egg shape index of various chicken breeds and hybrids, Ksiazkiewicz *et al.* (1998) also report different mean values of egg shape index of three different breeds of ducks, and Altan *et al.* (1995) of the Japanese quail.

Similar to the egg mass, mass of one day goslings was larger in the first sequence, and for both sequences the average mass amounted to 112.50 g. Average gosling mass of the first sequence goslings (115.69 g) in comparison to the second sequence goslings (109.61 g) was higher by 6.08 g and the difference was statistically confirmed at ($P < 0.001$) (Table 2).

Somewhat lower average mass of hatched goslings (103.07 g) were reported by Đermanović *et al.* (2008), while Saatci *et al.* (2005) report significantly lower mass of one day old goslings in all goose breeds (the highest average mass of hatched goslings was observed in breeds with white feathers – 98.41 g, and the lowest in breeds with multi color feathers – 92.95 g).

Based on the coefficient values of the phenotype correlation between the average egg mass before the incubation and the mass of one day goslings in both sequences, total correlation was established and correlation coefficients calculated ($r_p = 0.958$ – first sequence and $r_p = 0.988$ – second sequence) were statistically confirmed at $P < 0.001$. Furthermore, a very low positive correlation was established between the egg mass and egg shape index in both sequences. Established correlation coefficient between these traits ($r_p = 0.154$) in the first sequence was not statistically significant ($P > 0.05$), while the correlation coefficient in the second sequence ($r_p = 0.197$) was statistically confirmed at $P < 0.05$.

Many authors studied the correlation between egg mass before incubation and the mass of hatched offspring of various types of poultry, eg. Skewes *et al.* (1988), Altan *et al.* (1995) in quails; Shanawany (1984, 1987) and Đermanović *et al.* (2008), and in most cases established positive correlation coefficients which were statistically significant. Shanawany (1984, 1987) and Đermanović *et al.* (2008) have also established total correlation ($r_p = 0.980$ and $r_p = 0.987$) between average gosling egg mass and one day old goslings. In contrast to our results,

Đermanović *et al.* (2008) have established negative correlation between egg mass before incubation and the chicken percentage in the egg mass ($r_p = -0.425^*$).

Conclusion

Based on the monitored and acquired results related to reproductive traits of the parent flock of the White Italian Goose, and on the established traits of incubated eggs and hatched goslings and their correlation, following can be concluded concisely and chronologically:

- Fertilisation of eggs amounted to 87.00 % (first sequence) and 89.00 % (second sequence), i.e. 88.00 % for both sequences.

- Hatchability of goslings from the number of laid and fertilised eggs was 75.00 % and 86.21 % respectively (first sequence), 83.00 % and 93.26 % respectively for the second sequence, and for both sequences 79.00 % and 89.77 respectively.

- Average egg mass before incubation was 173.99 g (first sequence – 200 eggs), 164.64 g (second sequence – 200 eggs) and 169.31 g (both sequences – 400 eggs).

- Eggs incubated in the first sequence, apart from being larger, were also significantly ($P < 0.001$) longer and wider than the eggs incubated in the second sequence. Egg width was 5.89 cm (first sequence) and 5.79 cm (second sequence) and the length was 8.98 cm (first sequence) and 8.83 cm (second sequence), i.e. for both sequences width was 5.84 cm and length was 8.90 cm.

- Contrary to the egg mass, egg width and length which were significantly higher in the first sequence, egg shape index was similar in both sequences (65.66 % - 65.58 %) and the difference was not statistically significant ($P > 0.05$). Egg shape index mean value was 66.51 % for both sequences.

- Similar to the egg mass, mass of one day goslings was significantly ($P < 0.001$) larger in the first sequence, and for both sequences the average mass amounted to 112.50 g. Average mass of the first sequence goslings (115.69 g) was higher by 6.08 g in comparison to the second sequence goslings (109.61 g).

- Total correlation was established between the average egg mass before the incubation and the mass of one day goslings in both sequences, and phenotype correlation coefficients calculated ($r_p = 0.958$ – first sequence and $r_p = 0.988$ – second sequence) and were statistically confirmed at $P < 0.001$.

- A very weak positive correlation was established between the egg mass and egg shape index in both sequences. Established correlation coefficient between these traits ($r_p = 0.154$) was not statistically significant ($P > 0.05$) in the first sequence, while the correlation coefficient in the second sequence ($r_p = 0.197$) was statistically confirmed at $P < 0.05$.

These conclusions indicate that incubation values, as well as egg traits (particularly egg mass) and hatched goslings are also variable during the laying season. This should be given particular attention in practice in order to produce the maximum number of eggs per goose, i.e. achieve the maximum number of hatched goslings (final product).

Acknowledgement

The authors are grateful to the Ministry of Education, Science and Technological Development of the Republic of Serbia for sponsoring part of the study within project TR – 31033.

References

- Altan O., Oguz I., Settar P. (1995): Effect of egg weight and specific gravity on hatchability and chick weight in Japanese quail. *Turk. J. Agric. For.*, 19: 219-222.
- Bednarczyk M., Rosinski A. (1999): Comparison of egg hatchability and In Vitro survival of goose embryos of various origins. *Poultry Science*, 78: 579-585.

- Đermanović V., Anđelić-Buzadžić G., Rajović M., Purić V., Mitrović S. (2008): The analysis of goose eggs incubation results of biracely half-breeds of geese. *Proceedings of Research Papers*, Vol. 14, 3-4, 135-142.
- Đermanović V., Mitrović S., Stanišić G., Đekić V. (2016): Influence of external egg quality traits on body weight of day old broiler chicks. *Proceedings of Research Papers*, Vol. 22, 3-4, 89-93.
- Halaj M., Veterany L. (1989): The effect of hen weight on hatching losses and hatched chick weight. *Czech J. Anim. Sci.*, 43: 263-266.
- Ksiazkiewicz J., Antosik P., Plontek D. (1998): The effect of origin on relationship between internal traits of incubation eggs and some traits of hatched ducks. *Rosznicki Naukowe Zootechnicki*, 25: 37-49.
- Latinović D. (1996): *Populaciona genetika i oplemenjivanje domaćih životinja / Population genetics and breeding of domestic animals/ (praktikum)*. Poljoprivredni fakultet, Univerzitet u Beogradu, Beograd.
- Mazanowski A., Adamski M. (2002): Evaluation of reproductive traits and egg quality in Astra G geese during the first reproductive period. *Ann. Anim. Sci.*, 2 (2), 67-78.
- Mazanowski A., Bernacki Z. (2006): Characteristics of reproductive traits and egg traits in Graylag goose (*Anser anser* L.) crossbreeds. *Arch. Geflugelk.*, 70 (2), 56-63.
- Mazanowski A., Chelmonska B. (2000): The effects of reciprocal crossing of White Koluda and Greylag crossbred geese with Slovakian geese. *Ann. Anim. Sci. – Roczn. Nauk. Zoot.*, 27 (4), 85-103.
- Mitrović S., Bogosavljević-Bošković S., Vitorović D., Vukičević S. (1996): Effect of egg mass and Turkey genotype on incubation results. *Acta Agriculturae Serbica*, Vol II, 2, 49-57.
- Mitrović S., Pandurević T., Milić V., Đekić V., Đermanović V. (2010): Weight and egg quality correlation relationship on different age laying hens. *Journal of Food, Agriculture & Environment*, Vol. 8, (3&4):580-583.
- Moran E.T. (2007): Nutrition of the developing embryo and hatchling. *Poult. Sci.*, 86: 1043-1049.
- Puchajda H., Weis J., Faruga A., Siekiera J. (1988): The effect of the weight and shape of goose eggs on their hatchability, sex and weight of goslings. *Acta Zootek. Univ. Agri. Nitra*, 44: 149-158.
- Razmaitė V., Šveistienė R., Švirnickas G.J. (2014): Effect of laying stage on egg characteristics and yolk fatty acid profile from different-aged geese. *Journal of Applied Animal Research*, Vol. 42, 2, 127-132.
- Rosinski A. (2000): Analysis of direct and correlated effects of selection in two goose strains (in Polish). *Roczn. AR Poznan*, 309, 5-107.
- Rosinski A., Bednarczyk (1997): Influence of genotype on goose egg hatchability. *Arch. Geflugelkd.* 61(1):33-39.
- Saatci M., Kirmizibayrak T., Aksoy A.R., Tilki M. (2005): Egg weight, shape index and hatching weight and interrelationships among these traits in native Turkish Geese with different coloured feathers. *Turk. J. Vet. Anim. Sci.*, 29, 353-357.
- Salahuddin M., Howlader, M.A.R. (1991): Effect of breed and season on egg quality traits of fowl. *Indian J. Anim. Sci.*, 61: 859-863.
- Shanawany M.M. (1984): Inter-relationship between egg weight, parental age and embryonic development. *Brit. Poult. Sci.*, 25: 449-455.
- Whiting T.S., Pesti G.M. (1983): Effect of the dwarfing gene on egg weight, chick weight, and egg weight ratio in commercial broiler strain. *Poult. Sci.*, 62: 2297-2302.
- Willin S.E. (1995): Relation between egg weight and intensity of growth in geese. 10th European Symposium on Waterfowl, Halle, Germany, 443-446.
- Yannakopoulos A.L., Tserveni-Gousi A.S. (1987): Effect of breeder quail age and egg weight on chick weight. *Poult. Sci.*, 66: 1558-1560.

INFLUENCE OF PLANT OILS ON CERTAIN PHYSICO-CHEMICAL CHARACTERISTICS OF FRANKFURTERS

Daniela BELICHOVSKA^{1*}, Zlatko PEJKOVSKI², Katerina BELICHOVSKA², Aleksandra SILOVSKA-NIKOLOVA³

¹Department of Food Safety, Faculty of Environmental Resources Management, MIT University, Skopje, Republic of Macedonia

²Institute of Animal Biotechnology, Faculty of Agricultural Sciences and Food, Ss. Cyril and Methodius University, Skopje, Republic of Macedonia

³Department of Quality Control, Rimes MS Group, Skopje, Republic of Macedonia

*Corresponding author: daniela.belichovska@gmail.com

Abstract

With the aim the effect of pork adipose tissue substitution with plant oils and fats in poultry frankfurters production to be investigated, six variants of frankfurters were produced: control – with pork fat, with olive oil, rapeseed oil, sunflower oil, palm fat and a mixture of 12% rapeseed oil and 8% palm fat. Cooking loss, pH-value and basic chemical composition were tested on the final product. It was found that palm and pork fat, as well as sunflower oil significantly ($P < 0.01$) influenced the reduction of cooking loss of frankfurters. Frankfurters with palm fat, a mixture of 12% rapeseed oil and 8% palm fat and those with rapeseed oil had a lower pH than the other three variants ($P < 0.01$). Regarding the content of water and ash there were no significant differences, while in the content of protein there was significant difference ($P < 0.01$) only between variants with pork fat and sunflower oil. Frankfurters with olive oil and those with pork fat had significantly ($P < 0.01$) higher fat content than all the other variants. Frankfurters with palm fat contained significantly ($P < 0.01$) lower fat percentage compared to other variants, except that with a mixture of 12% rapeseed oil and 8% palm fat. Total pork fat replacement with plant oils and fats in poultry frankfurters production is possible.

Keywords: *frankfurters, plant oils, cooking loss, pH, chemical composition*

Introduction

Fats play an important role in meat products. Historically, meat rich in fats was used mainly for the production of sausages which increased the value of used meat (Bishop *et al.*, 1993). However, diets rich in animal fats is associated with obesity, hypertension, cardiovascular and coronary heart disease (Özvural and Vural, 2008; Vural and Javidipour, 2002). The recommended dietary intake of fat should be no more than 20 to 35 % of total caloric intake (National Academy of Science, 2011). As a result of this, the popularity of meat products with high content of animal fat is reduced (Vural and Javidipour, 2002). Consumers are becoming increasingly aware of the nutritional quality and health effects of the food they consume. Lipid composition, particularly of the products from animal origin, has become the primary area of interest to consumers. This is due to the increased awareness regarding the link between the quantity and composition of fats in the human diet and increased coronary heart disease as well as certain forms of cancer (Arihara, 2006; Pike, 1999).

One approach to develop healthier meat products is through reformulation of meat products during processing (Jiménez-Colemenero, 2007). Modification of the fats is mainly based on the replacement of animal fat with oils that meet dietary recommendations (Fernández-Ginéset *al.*, 2005). Vegetable oils are free of cholesterol and have a high content of

unsaturated fatty acids. Thus, vegetable oils have positive effects for the cardiovascular system (Özvural and Vural, 2008).

Frankfurters are non-fermented, emulsion type sausages (Gonzalez-Vinaset *et al.*, 2004). They are very popular, frequently-consumed meat products with significant economic importance worldwide (Jiménez-Colmenero *et al.*, 2010). However, their consumption has a negative health effect regarding the amounts and types of animal fats that they contain (Bloukas and Paneras, 1993).

This was an occasion to perform replacement of pork fat with several plant oils in chicken frankfurters and to examine their influence on certain physico-chemical characteristics of the product.

Material and Methods

Frankfurters made from chicken (boneless breast and thigh) were used in the present research. As an alternative to pork fat plant oils were used as: olive, rapeseed and sunflower oil, as well as palm fat. Six different frankfurters were produced whose compositions are given in Table 1. The control frankfurters were prepared with pork backfat (Po). The other five treatments were prepared with olive oil (O); rapeseed oil (R); sunflower oil (S); palm fat (Pa), and a mixture of 12 % rapeseed oil and 8 % palm fat (Mi).

Table 1. Frankfurter formulation (%)

Ingredients	Treatments					
	Po	O	R	S	Pa	Mi
Chicken breasts without skin	23	23	23	23	23	23
Chicken thighs without skin	23	23	23	23	23	23
Pork backfat	20					
Olive oil		20				
Rapeseed oil			20			12
Sunflower oil				20		
Palm fat					20	8
Nitrite curing salt	1.7	1.7	1.7	1.7	1.7	1.7
Ice	32	32	32	32	32	32
Sodium tripolyphosphate	0.2	0.2	0.2	0.2	0.2	0.2
Mixture of spices	0.2	0.2	0.2	0.2	0.2	0.2
Sodium isoascorbate	0.075	0.075	0.075	0.075	0.075	0.075
Soy protein isolate	2	2	2	2	2	2

Artificial collagen edible casings, 23 mm in diameter, product of Naturin GmbH, Weinheim, Germany were used for stuffing the batter.

Heat treatment was performed in smokehouse at a temperature of 78°C until achieving an internal temperature of 72°C.

pH value was measured by pH meter Testo 230. The cooking loss during heat processing of frankfurters represents the difference in weight before and after heat treatment, expressed as a percentage of the initial weight.

Chemical composition was determined using AOAC (1997). The water content according to official method 950.46; protein according to 928.08; fat according to 991.36 and ash according to 920.153.

The program package SAS/STAT (SAS Software. Version 8.01, 1999) was used for statistical processing of data and significance, means were separated using the Duncan test.

Results and Discussion

Cooking loss and pH

During heat processing and chilling of frankfurters the lowest cooking loss (9.04%) was established in frankfurters produced with pork backfat (Po), and the highest (10.21%) in those with rapeseed oil (R). Palm and pork fat, as well as sunflower oil significantly ($P<0.01$) influenced the reduction of cooking loss in the heat treatment of frankfurters (Table 2). Cooking losses during thermal processing of low-fat frankfurters with vegetable oils were high, whereby the type of oil did not influence the loss, while the amount of fat had a major impact (Paneras and Bloukas (1994). Somewhat lower values for cooking loss of chicken frankfurters were obtained by Kratovalieva (2007).

Cooking loss during thermal processing is influenced by cooking method (Yoo *et al.*, 2005), cooking temperature and time (Kim and Chin, 2007; Vasanthiet *al.*, 2007; Banonet *al.*, 2008), the type and the amount of fat (Choi *et al.*, 2010; Choi *et al.*, 2009; Hong *et al.*, 2004; Fernández-Ginés *et al.*, 2004), ingredients (Huang *et al.*, 2005), the casing (Choi *et al.*, 2008). Great number of factors affecting the amount of cooking losses during thermal processing of meat products is a reason for diversity of the data published in the literature.

Table 2. Cooking loss during thermal processing and pH of frankfurters (mean \pm standard deviation)

Parameters	Treatments					
	Po	O	R	S	Pa	Mi
Cooking loss, %	9.04 \pm 0,31 ^b	10.18 \pm 0.17 ^a	10.21 \pm 0.35 ^a	9.38 \pm 0.09 ^b	9.38 \pm 0,09 ^b	10.18 \pm 0.17 ^a
pH	6.38 \pm 0,01 ^a	6.38 \pm 0.01 ^a	6.37 \pm 0.01 ^b	6.38 \pm 0.01 ^a	6.36 \pm 0,00 ^b	6.36 \pm 0.01 ^b

^{a,b}– Means within a row with different superscript letters are significantly different ($P<0.01$)

Po – Pork back fat (control);

O – Olive oil;

R –Rapeseed oil;

S – Sunflower oil;

Pa – Palm fat;

Mi – Mixture of 12% rapeseed oil and 8% palm fat.

Frankfurters with palm fat (Pa), a mixture of 12% rapeseed oil and 8% palm fat (Mi) and those with rapeseed oil (R) had a lower pH than the other three variants ($P<0.01$). Kratovalieva (2007) reported similar results (6.34 – 6.38 %) for chicken frankfurters. According to Paneras and Bloukas (1994) pH in frankfurters produced with vegetable oils is usually in the range of 6.30 to 6.46 and in those with pork fat is higher. In Turkish type beef frankfurter with different percentage of sunflower oil (12.5 – 20%) pH ranged from 6.02 to 6.07, and in those with 20 % beef fat pH accounted 6.21 (Yilmaz, 2004). The pH value of beef frankfurters produced with 10 % beef fat (control treatment) or 10 % interesterified oils or oil blends was ranged from 6.28 to 6.38, although there were found significant differences between the treatments (Özvural and Vural, 2008).

Chemical composition

The water content in all variants of frankfurters was almost equivalent (60.06 – 60.85 %), so the differences between variants were statistically insignificant (Table 3). In terms of protein content significant difference ($P < 0.01$) was found only between Po (with pork backfat) and S (with sunflower oil) variants. Higher differences were observed in the fat content. Frankfurters of the variant Po (pork fat) and O (olive oil) contained significantly ($P < 0.01$) more fat than the other variants. Furthermore, variant S (sunflower oil) contained significantly ($P < 0.01$) more fat than variant R (rapeseed oil). The ash content was approximately the same in all variants (2.71 – 2.81%).

Table 3. Chemical composition of frankfurters (mean \pm standard deviation)

Parameters (%)	Treatments					
	Po	O	R	S	Pa	Mi
Water	60.18 \pm 0.73 ^a	60.18 \pm 0.44 ^a	60.06 \pm 0.37 ^a	60.35 \pm 0.46 ^a	60.85 \pm 1.26 ^a	60.55 \pm 0.34 ^a
Protein	13.08 \pm 0.38 ^a	12.65 \pm 0.19 ^{ba}	12.73 \pm 0.20 ^{ba}	12.28 \pm 0.47 ^b	12.72 \pm 0.56 ^{ba}	12.81 \pm 0.58 ^{ba}
Fat	25.34 \pm 0.40 ^a	25.45 \pm 0.18 ^a	23.88 \pm 0.17 ^{cb}	24.13 \pm 0.07 ^b	23.38 \pm 0.35 ^d	23.62 \pm 0.27 ^{cd}
Ash	2.79 \pm 0.10 ^a	2.71 \pm 0.07 ^a	2.75 \pm 0.27 ^a	2.81 \pm 0.12 ^a	2.74 \pm 0.07 ^a	2.77 \pm 0.13 ^a

^{a-d} – Means within a row with different superscript letters are significantly different ($P < 0.01$)

Po – Pork back fat (control);

O – Olive oil;

R – Rapeseed oil;

S – Sunflower oil;

Pa – Palm fat;

Mi – Mixture of 12% rapeseed oil and 8% palm fat.

Similar content of water and ash, and slightly lower of protein and fat in chicken frankfurters were found by Kratovalieva (2007). Jiménez-Colmenero *et al.* (2010) reported that there were no differences in the water content (range from 60.6 to 62.3 %) of the different frankfurters formulations. This is consistent with the fact that the amount of added water was similar in all the treatments. Addition of interesterified oil and oil blends affected the moisture (56.98 – 60.85 %) and fat (19.55 – 24.08 %) content of frankfurters (Özvural and Vural, 2008). Frankfurters with pork fat contain more protein than that with vegetable oils (Stevanović, 1993).

Future developments will be dictated by the marketplace and the ability of the meat industry to deliver products with high nutritional value (Barbut, 2011).

Conclusion

In terms of cooking loss during thermal processing, pH and basic chemical composition, total pork fat replacement with plant oils and fats in poultry frankfurters is possible. In order to produce low fat frankfurters, further research is needed to reduce the total amount of fat.

References

- AOAC. (1997). Official Methods of Analysis of AOAC International, 16th Edition. Washington, USA: Association of the Official Analytical Chemists International.
- Arihara K. (2006). Strategies for designing novel functional meat products. *Meat Science*, 74, 219-229.
- Banon S., Diaz P., Nieto G., Castillo M., Alvarez D. (2008). Modeling the yield and texture of comminuted pork products using color and temperature. Effect of fat/lean ratio and starch. *Meat Science*, 80, 649-655.

- Barbut S. (2011). In Reducing saturated fats in foods: Saturated fat reduction in processed meat products. Woodhead Publishing Limited, 211-233.
- Bishop D.J., Olson D.G., Knipe C.L. (1993). Pre-emulsified Corn Oil for Pork Backfat Affects Quality of low-fat Frankfurters. *Journal of Food Science*, 58, 484-487.
- Bloukas J.G. and Paneras E.D. (1993). Substituting olive oil for pork backfat affects quality of low-fat frankfurters. *Journal of Food Science*, 58, 705-709.
- Choi J.H., Jeong J.Y., Han D.J., Choi Y.S., Kim H.Y., Lee M.A., Lee E.S., Paik H.D., Kim C.J. (2008). Effects of pork/beef levels and various casings on quality properties of semi-dried jerky. *Meat Science*, 80, 278-286.
- Choi Y.S., Choi J.H., Han D.J., Kim H.Y., Lee M.A., Kim H.W., Jeong J.Y., Kim C.J. (2009). Characteristics of low-fat meat emulsion systems with pork fat replaced by vegetable oils and rice bran fiber. *Meat Science*, 82, 266-271.
- Choi Y.S., Choi J.H., Han D.J., Kim H.Y., Lee M.A., Kim H.W., Lee J.W., Jeong J.Y., Chung H.J., Kim C.J. (2010). Effects of replacing pork back fat with vegetable oils and rice bran fiber on the quality of reduced-fat frankfurters. *Meat Science*, 84, 557-563.
- Fernández-Ginés J.M., Fernández-López J., Sayas-Barberá E., Pérez-Alvarez, J.A. (2005). Meat products as functional foods: A review. *Journal of Food Science*, 70, 37-43.
- Fernández-Ginés J.M., Fernández-López J., Sayas-Barberá E., Sendra E., Pérez-Álvarez J.A. (2004). Lemon albedo as a new source of dietary fiber: Application to bologna sausages. *Meat Science*, 67, 7-13.
- Gonzalez-Vinas M., Caballero A., Gallego I., García Ruiz A. (2004). Evaluation of the physico-chemical, rheological and sensory characteristics of commercially available frankfurters in Spain and consumer preferences. *Meat Science*, 67, 633-641.
- Hong G.P., Lee, S., Min S.G. (2004). Effects of Substituted Level of Added Water for Fat on the Quality Characteristics of Spreadable Liver Sausage. *Food Science and Biotechnology*, 13, 397-402.
- Huang S.C., Shiau C.Y., Liu T.E., Chu C.L., Hwang D.F. (2005). Effects of rice bran on sensory and physico-chemical properties of emulsified pork meatballs. *Meat Science*, 70, 613-619.
- Jiménez-Colmenero F. (2007). Healthier lipid formulation approaches in meat-based functional foods. Technological options for replacement of meat fats by non-meat fats. *Trends in Food Science and Technology*, 18, 567-578.
- Jiménez-Colmenero F., Herrero A., Pintado T., Solas M., Ruiz-Capillas C. (2010). Influence of emulsified olive oil stabilizing system used for pork backfat replacement in frankfurters. *Food Research International*, 43, 2068-2076.
- Kim S.H., Chin K.B. (2007). Physico-chemical properties and changes of sarcoplasmic protein bands of chicken meat cuts with or without salt during cooking temperature. *Korean Journal of Animal Science and Technology*, 49, 269-278.
- Kratovalieva M. (2007). Possibilities of nitrite, phosphate and pork fat substitution in poultry frankfurters. Master of Science thesis. Ss. Cyril and Methodius University, Faculty of Agricultural Sciences and Food, Skopje (in Macedonian).
- Liu M.N., Huffman D.L., Egbert W.R. (1991). Replacement of beef fat with partially hydrogenated plant oil in lean ground beef patties. *Journal of Food Science*, 56, 861-862.
- National Academy of Science. (2011). Dietary Reference Intakes for Energy, Carbohydrate, Fiber, Fat, Fatty Acids, Cholesterol, Protein, and Amino Acids. Institute of Medicine of the National Academies. The National Academies Press, Washington, D. C.
- Özvural E.B., Vural H. (2008). Utilization of interesterified oil blends in the production of frankfurters. *Meat Science*, 78, 211-216.
- Paneras E.D., Bloukas J.G. (1994). Vegetable oils replace pork backfat for low-fat frankfurters. *Journal of Food Science*, 59, 725-733.

- Pike H.W. (1999). Health benefits from feeding fish oil and fish meal: the role of long chain omega-3 polyunsaturated fatty acids in animal feeding. *Infoma*, 28, 1-18.
- SAS/STAT (1999). Version 8.01. Cary, SAS Institute Inc. Software.
- Stevanović M. (1993). Sensory, chemical and instrumental properties of dietary frankfurters. Master of Science thesis. University of Ljubljana, Biotechnical Faculty, Ljubljana (in Slovenian).
- Vasanthi C., Venkataramanujam V., Dushyanthan K. (2007). Effect of cooking temperature and time on the physico-chemical, histological and sensory properties of female carabeef (buffalo) meat. *Meat Science*, 76, 274-280.
- Vural H., Javidipour I. (2002). Replacement of beef fat in frankfurters by interesterified palm, cottonseed, and olive oils. *European Food Research and Technology*, 214, 465-468.
- Yilmaz I. (2004). Quality characteristics and fatty acid composition of turkish type frankfurter made with sunflower oil addition. *Fleischwirtschaft International*, 1, 52-54.
- Yoo S.S., Kook S.H., Park S.Y., Shim J.H., Chin K.B. (2005). Evaluation of curing and flavor ingredients, and different cooking methods on the product quality and flavor compounds of low-fat sausages. *Food Science and Biotechnology*, 14, 634-638.

EFFECTS OF NATURAL PIGMENT SOURCES AND STORAGE DURATIONS ON EGG QUALITY

Esin UNVER, Aylin AGMA OKUR*

Namik Kemal University, Faculty of Agriculture, Department of Animal Sciences,
Tekirdag, 59030, Turkey.

*Corresponding author: aagma@nku.edu.tr

Abstract

Egg and egg quality is one of the most important issues for egg industry and consumers worldwide. This review contains the information of the internal and external quality of eggs, effects of storage conditions and natural pigment sources on hen's egg. Internal quality of egg has been measured for many years as albumen height (Haugh Unit) and weight, yolk index and air cell. The external quality of egg has been measured as egg weight, egg shape, shell thickness, breaking strength and specific gravity. And Haugh Unit werewas evaluated to reveal albumen quality. Environmental factors such as storage time and temperature affected egg quality. During storage of egg, vitelline membrane quality will decrease. Therefore, egg yolk elasticity will be destroyed and finally broken up. Strain and age of laying hens are also important parameters, thatparameters that affect egg quality. Egg yolk is the most important criterion taken into account by consumers and it has been preferred close to amber to red-yellow in many countries. According to consumer preferences to obtain the yellow egg yolk, synthetic or natural pigment sources are used in diets. Yellow color is obtained from yellow-lutein and zeaxanthin-gold (marigold, alfalfa etc.). Red color is provided by substances such as capsanthin and capsorubin (red pepper etc.). This review focuses on the hen's egg and effects of natural pigment sources and storage conditions on egg quality.

Keywords: *Egg quality, storage, egg yolk color, red pepper*

Introduction

The eggs have always been an excellent source of nutrients and very important in human nutrition (Li-Chan and Kim, 2008). Besides its nutritional value, It has been ovulated from hen in a special package and this feature is also an advantage for marketing.

Eggs consist of three main parts, such as the shell (9-12%), albumen (60%) and yolk (30-33%) (Li-Chan and Kim, 2008; Roberts, 2004). The eggshell has three different layers; Cuticle, Spongy (calcium carbonate), Mammillary. Li-Chan and Kim (2008) mentioned that albumen was composed of four layers: outer thin white (23.3%), outer thick white (57.3%), inner thin white (16.8%), and a inner thick (2.7%) layers (Figure 1; Figure 2).



Figure 1. Side view of fresh egg



Figure 2. Top view of fresh egg

Nutrient Composition of Eggs

Table 1 reveals nutrient composition of a large egg. Although water composition of edible parts of egg was approximately 75% (Li-Chan and Kim, 2008). Egg proteins are found 56% at albumen and 44% at yolk according to Table 1.

Table 1. Nutrient composition of a whole egg (WPSA, 2016)

Nutrient	Albumen	Egg yolk	Whole egg
Calori, (kcal)	17.00	59.00	75.00
Protein, (g)	3.52	2.78	6.25
Total Lipid, (g)	-	5.12	5.01
Total Carbohydrate, (g)	0.30	0.30	0.60
Lipids			
Fatty Acids, (g)	-	4.33	4.33
Saturated fat, (g)	-	1.55	1.55
Monounsaturated fat, (g)	-	1.91	1.91
Polyunsaturated fat, (g)	-	0.68	0.68
Cholesterol, (mg)	-	213.00	213.00
Vitamins			
Thiamin, (mg)	0.002	0.028	0.031
Riboflavin, (mg)	0.151	0.103	0.254
Niacin, (mg)	0.031	0.005	0.036
Vitamin B6, (mg)	0.001	0.0069	0.070
Vitamin B9 (Folate), (mcg)	1.00	22.50	23.50
Vitamin B12, (mcg)	0.07	0.43	0.50
Vitamin A, (IU)	-	317.00	317.50
Vitamin E, (mg)	-	0.70	0.70
Vitamin D, (IU)	-	24.50	24.50
Choline, (mg)	0.42	214.6	215.10
Biotin, (mcg)	2.34	7.58	9.98
Minerals			
Calcium, (mg)	2.00	23.00	25.00
Iron, (mg)	0.01	0.59	0.72
Magnesium, (mg)	4.00	1.00	5.00
Copper, (mg)	0.002	0.004	0.007
Iodine, (mg)	0.001	0.022	0.024
Zinc, (mg)	-	0.52	0.55
Sodium, (mg)	55.00	7.00	63.00
Manganese, (mg)	0.001	0.012	0.012

Egg Quality

Layer strain, hen age, nutrition, rearing systems, stress, storage durations and storage temperature are separately well defined as the major factors affecting egg quality parameters (Silversides and Scott, 2001; Roberts, 2004; Barbosa Filho et al., 2005; Li-Chan and Kim, 2008; Bozkurt and Tekerli, 2009).

Bozkurt and Tekerli (2009) investigated the effects of two commercial hybrids (Isa brown and Lohman white), hen age, egg storage conditions on quality of eggs. They found some differences between brown and white eggs. Fresh egg weights affected by hen genotype and age. Also, increasing storage temperature and storage durations have negative effects on egg weights. However, genotype had no significant effect on weight loss during storage. Older hens' eggs found heavier than young hens. Although these heavy eggs lost more weight by storage. Also, internal quality parameters were significantly affected by hen genotype ($P < 0.05$) and age ($P < 0.01$). Shell thickness decreased and shell weight increased with hen age ($P < 0.01$). The hen age and strain did not affect shell weight (Bozkurt and Tekerli, 2009).

The most important internal and external egg quality traits have been shown such as; egg weight, egg shape, shell thickness, breaking strength, specific gravity, air cell height, albumen height and weight, yolk index, yolk color, Haugh Unit, albumen and yolk pH (Samli et al., 2005b; Agma Okur and Samli, 2014). Monitoring egg quality parameters are considered as an important economic policy in egg production. However, External and internal egg quality traits of the breeds that affect performance changes between generations (Islam et al., 2001).

Factors Affecting Egg Yolk Color

Egg yolk color may be influenced by the dietary ingredients, such as natural and synthetic carotenoids. However, in some countries such as Sweden, there is a ban on synthetic carotenoid usage in feeds.

The yolk color is an important feature which is determinative for consumers' choices. Spada et al. (2016) asked panelists which egg characteristic was important for them. Yolk color was mentioned by 85% of the panelists. However, consumers' preferences change all over the world. For example; in Australia desired yolk color is about 11 on the Roche Scala. Some countries prefer lighter or darker yolk color (Roberts, 2004).

Egg yolk color; might change from light yellow to dark orange and it is covered with vitelline membrane (Agma Okur and Samli 2014). Egg yolk color affected by β -carotene, xanthophylls and oxycarotenoids (Samli et al. 2005b, Agma Okur and Samli 2014). Shape, weight, strength of the shell, freshness and the structure of the egg as well as the quality measurement standards are among the most important characteristics to estimate the egg yolk color (Gouveia et al. 1996). Egg yolk color can be determined by subjective and objective methods (Roche Color Fan, Colorimeters).

Also, housing systems might affect egg yolk color. Van Den Brand et al. (2004) found that yolk colour was considerably darker in the outdoor group compared to the cage group (11.0 vs 9.3). It was an expected result, because laying hens reared at the outdoor and/or free range systems can consume grass and herbs in the pasture.

Carotenoids are lipid soluble compounds responsible for the orange-yellow color of the egg yolk. The health promoting properties of carotenoids are well documented (Nimalaratne and Wu, 2015). Chickens can not synthesize carotenoids and must be obtained through the diet (Rossi et al., 2015).

Natural Pigment Sources in Diets

Natural pigment sources are; corn, gluten meal, alfalfa meal, red pepper, marigold, algae, tomato powder, fresh green hay etc.

Rossi et al. (2015) used (0, 75, 125, 225 ppm) sweet green pepper as a natural colorant. While increasing usage ratio of red pepper, performance did not affected, but yolk color affected positively.

Some studies showed that natural antioxidants does not have an effect on antioxidant composition of yolk, only do have an effect on yolk color. Spada et al. (2016) researched the effects of syntnetic and natural carotenoids. The experimental design was conducted of 8 treatments with 2 strains (Carijo-Barbada and Isa-Brown) and 4 dietary treatments (1.5 and 2.0% fresh annatto, 0.001% of Carophyll yellow, 0.006% of Carophyll red). In the trial they were analyzed raw, boiled and fried eggs (fresh and 36 days stored). They found no effect of strains and carotenoids on lipid oxidation of raw eggs. However, boiled and fried eggs had higher lipid oxidation after storage. The color analysis revealed theat control groups are lighter compared to to the treatments. the highest a* values were found in treatments with synthetic additives. Sensorial panel results of boiled eggs demonstrated that color of fresh eggs were significantly found darker at treatment groups. However in fried eggs, control groups had higher values.

Storage Conditions and Egg

The results Albumen height and Haugh units decrease with increasing storage time, and this sharp decline occurs more quickly at higher temperatures (Roberts 2004; Shin et al. 2012).

Rapid cooling of eggs with carbon dioxide was found to improve Haugh Units of stored eggs (Keener et al., 2000). During storage of eggs, the pH of the albumen increases and this is thought to be related to the deterioration of albumen quality (Benton and Brake, 2000). The changes occurring in albumen quality during egg storage to be related to changes occurring in ovomucin, particularly the thick albumen (Kato et al., 1981; Toussant and Latshaw, 1999). During egg storage, the quality of the vitelline membrane declines, making the yolk more susceptible to breaking (Kirunda and McKee, 2000).

Bozkurt and Tekerli (2009) investigated the effects of two commercial hybrids (Isa brown and Lohman white), hen age, egg storage conditions on quality of eggs. They concluded that internal egg quality parameters deterioration during the increasing storage time was dramatic in brown eggs, laid by younger hens and stored at 24°C. However, Samli et al. (2005) conducted that HU, pH of albumen, and air cell size were parameters greatly influenced by storage period and temperature of eggs from aged laying hens.

Shin et al. (2012) stored eggs at different temperatures, such as -1.1, 0.6, 2.2, 3.9, 5.6, 7.2°C for 0, 2, 7, 14, 21, 28 days. This experiment demonstrated that eggs stored at 0.6 and 2.2°C had the highest Haugh Unit values. Albumen pH values increased by the effect of storage time and temperature, because of the gas diffusion from inside the eggs.

Unver (2016) examied the effects of storage time and temperature on the quality parameters of eggs obtained from free range reared laying hens fed with 0.75% red pepper supplemented to diet. Red pepper supplementation statistically had no effect on external egg quality parameters ($P > 0.05$). The highest egg weight loss was observed at room temperature stored eggs by extension of the storage time up to 3 wks. In addition, storage time and temperature had statistically an important effect on the air cell size (ACS). The highest ACS values was determined at 2 and 3 wks stored eggs at room temperature. Red pepper supplementation, storage time and temperature were observed to be effective on Roche color fan (RCF) score, Hunter L* (lightness) and b* (yellowness and blueness) values ($P < 0.001$). The fresh egg's yolk colour was determined as 12.07 and 9.60 by RCF at the groups fed with/without red pepper supplementation. However, HunterLab colorimeter analysis evaluated that a* (redness and greenness) values of red pepper supplemented groups were found the highest for all storage times and temperatures. Red pepper supplementation had no effect on some of internal egg quality parameters, such as yolk height, albumen height, Haugh unit, albumen

weight, yolk pH, albumen pH, yolk diameter, yolk index, yolk viscosity and albumen viscosity ($P>0.05$). The results indicate that 0.75% red pepper supplementation to layer diets had positive effect and could lead to desired yolk colour. Because of that, red pepper might be used as natural pigments. Also, Unver (2016) reported that storage conditions and durations have also negative effects on egg yolk color.

Conclusions

The consumers tend to prefer natural products for health concerns, animal welfare and environmental conscious. Also, consumers' demands and regulations guide producers to change chickens rearing systems and use of natural feed additives. The experiments reveal us, natural pigment sources might be used in layer diets, safely and effectively without any deterioration in performance.

References

- Agma Okur A, Samli HE (2014). Yumurthanın Besin Değeri ve Kalite Kriterleri. Yumurta Haber Bülteni, Mayıs, 20: 16-17(Nutritional Value and Quality Parameters of Egg. Egg Newsletter, May, 20: 16-17)..
- Barbosa Filho JAD, MAN Silva, IJO Silva, AAD Coelho, (2005). Egg Quality in Layers Housed in Different Production Systems and Submitted to Two Environmental Conditions. Brazilian Journal of Poultry Science, 8(1): 23-28.
- Benton, C.E., Jr., J. Brake, 2000. Effects of atmospheric ammonia on albumen height and pH of fresh broiler eggs. Poultry Science, 43:261-269.
- Bozkurt Z, M Tekerli (2009). The Effects of Hen Age, Genotype, Period and Temperature of Storage on Egg Quality. Kafkas Univ Vet Fak Derg, 15 (4): 517-524.
- Gurbuz Y, Yasar S, Karaman M (2003). Effects of Addition on the Red Pepper from 4th Harvest to Corn or Wheat Based Diets on Egg-yolk Colour and Egg Production in Laying Hens. International Journal of Poultry Science, 2(2): 107-111.
- Kato, A., S. Ogato, N., Matsudomi, K. Kobayashi, 1981. A Comparative Study of the Aggregated and Disaggregated Ovomucin During Egg White Thinning. Journal of Agricultural and Food Chemistry, 29:821-823.
- Keener, K.M., J.D. LaCrosse, P.A. Curtis, K.E. Anderson, B.E. Farkas, 2000. The Influence of Rapid Air Cooling and Carbon Dioxide Cooling and Subsequent Storage in Air and Carbon Dioxide on Shell Egg Quality. Poultry Science, 79: 1067-1070.
- Kırkpınar F, Erkek R (1999a). 1. Beyaz Mısır ve Buğday Temeline Dayalı Karma Yemlere İlave Edilen Bazı Doğal ve Sentetik Renk Maddelerinin Yumurta Sarısının Rengi ve Verim Üzerine Etkileri. Tr J of Veterinary and Animal Sciences, 23: 9-14(The Effects of Some Natural and Synthetic Pigment Materials on Egg Yolk Pigmentation and Production in White Corn and Wheat Based Diets. Tr J of Veterinary and Animal Sciences, 23: 9-14)..
- Kirunda, D.F.K., S.R. McKee, 2000. Relating Quality Characteristics of Aged Eggs and Fresh Eggs to Vitelline Membrane Strength as Determined by a Texture Analyzer. Poultry Science, 79: 1189-1193.
- Li-Chan ECY, Hyun-Ock Kim (2008). Chapter 1. Structure and Chemical Composition of Eggs. In: Egg Bioscience and Biotechnology, Ed. Y. Mine. Wiley-Interscience, p. 320.
- Nimalaratne, C., J. Wu, 2015. Hen Egg as an Antioxidant Food Commodity: A Review. Nutrients, 7: 8274-8293.
- Roberts JA (2004). Factors Affecting Egg Internal Quality and Egg Shell Quality in Laying Hens. Journal of Poultry Science, 41: 161-177.
- Rossi, P., J.K. Nunes, F. Rutz, M.A. Anciuti, P.V.D. Moraes, S.E. Takahashi, A.L.B. Bottega, J.M. Dorneles, 2015. Effect of Sweet Green Pepper on Yolk Color and Performance of Laying Hens. J. Appl. Poult. Res. 24:10-14.

- Samli HE, A Ağa, N Senkoylu, 2005. Effects of Storage Time and Temperature on Egg Quality in Old Laying Hens. *J. Appl. Poult. Res.* 14:548–553
- Shahsavari K (2014). Influence of Different Sources of Natural Pigmenting on Egg Quality and Performance of Laying Hens. *Jordan Journal of Agricultural Sciences*, 10(4): 786-796.
- Shin D, C Narciso-Gaytán, JM Regenstein, MX Sánchez-Plata (2012). Effect of Various Refrigeration Temperatures on Quality of Shell Eggs. *J Sci Food Agric*, 92: 1341-1345.
- Silversides FG, TA Scott (2001). Effect of Storage and Layer Age on Quality of Eggs From Two Lines of Hens. *Poultry Science*, 80: 1240-1245.
- Spada FP, MM Selani, AAD Coelho, VJM Savino, AA Rodella, MC Souza, FS Fischer, DEA Lemes, SG Canniatti-Brazaca (2016). Influence of Natural and Synthetic Carotenoids on the Color of Egg Yolk. *Scientia Agricola*, 73 (3): 234-242.
- Şamlı HE, Şenköylü N, Akyürek H, Ağa A (2005b). Doğal Pigmentlerin Yaşlı Tavuklarda Yumurta Sarısına Etkileri. *Tekirdağ Ziraat Fakültesi Dergisi*, 2(3): 281-286 (Effects of Natural Pigments on Old Hens' Yolk. *Journal of Tekirdağ Agricultural Faculty*, 2(3): 281-286).
- Şenköylü N (2001). Modern Tavuk Üretimi (Gözden Geçirilmiş ve Genişletilmiş). Trakya Üniversitesi Tekirdağ Ziraat Fakültesi Yayınları 3. Baskı, 55s Tekirdağ (Modern Poultry Production (Checked and Expanded). Trakya University Publications of Tekirdağ Agricultural Faculty 3rd ed, p.55, Tekirdağ)..
- Toussant, M.J., J.D. Latshaw, 1999. Ovomucin Content and Composition in Chicken Eggs With Different Interior Quality. *Journal of the Science of Food and Agriculture*, 79: 1666-1670.
- Tunçer P (2006). İki Farklı Ticari Yumurtacı Tavuk Genotip'ine Ait Yumurtalarda Kalite Kriterlerinin Depolama Süresine Göre Değişimi. Yüksek Lisans Tezi, Sağlık Bilimleri Enstitüsü, Afyonkarahisar (Changes in the Quality Criteria of Eggs from two Commercial Laying Hen Strains by the Storage Period. MSc Thesis, Graduate School of Health Sciences, Afyonkarahisar)..
- Unver, E., 2016. Effects of Red Pepper Supplementation to Free Range Laying Hens' Diets on Egg Storage Performance. (MSc. Thesis) Namık Kemal University Graduate School of Natural and Applied Sciences Department of Animal Science, p.46, Tekirdağ.
- Van Den Brand, H., HK. Parmentier, B. Kemp, 2004. Effects of Housing System (Outdoor vs Cages) and Age of Laying Hens on Egg Characteristics. *British Poultry Science*, 45(6): 745-752.
- WPSA (World's Poultry Science Association) (2016). Production of eggs and egg products. <http://www.wpsa-foodsafety.com/index.php?item=13> (17.06.2016).

6. RURAL DEVELOPMENT AND AGRO-ECONOMY

PROTECTION AND PROMOTION OF DOMESTIC EGG PRODUCTION:EXAMPLES FROM THE REPUBLIC OF CROATIA

Dubravka ŽIVODER, Josipa PAVIČIĆ*

Department of Market and Agricultural Products Marketing, Croatian Agricultural Agency, Croatia

*Corresponding author: jpavicic@hpa.hr

Abstract

Food production has a strategic importance for the economy of any country, including the Republic of Croatia. Unfortunately, the food market is not sufficiently developed. On the one hand there are problems with product placement on the market while on the other hand the external trade balance is also unfavorable, because the imports of agricultural products are increasing. For that very reason and with the aim of protecting and promoting domestic agricultural production there is a strong need for the introduction of food marketing. The application of all elements of the marketing mix - product, price, place and promotion - will create distinctive products. The main goal of marketing projects and putting recognizable labels on domestic agricultural products is to promote domestic production, as well as informing consumers about the origin of products, with the aim of protecting and strengthening the agricultural production in the Republic of Croatia. Several institutions in the country are working in the field of food marketing, and one of them is the Croatian Agricultural Agency. Department of market and agricultural food marketing, in Croatian Agricultural Agency, has developed eight marketing projects so far, and one of them which will be described in this paper is branding fresh eggs for human consumption with protected label *Eggs from Croatian farms*. The paper contains a positive example of consuming domestic local products produced on Croatian farms, and we will also show the path of egg production, and provide the research results of egg producers whose products are labeled with the protected label.

Keywords: *food marketing, domestic production, label, eggs*

Introduction

Nowadays, the need for stronger promotion and protection of domestic agricultural products is increasing because the market is overflowing with products that are extremely diverse in terms of declarations and origin, and consumers demands are growing too.

Marketing in agriculture and food production in the Republic of Croatia is not sufficiently present. Marketing methods are applied in big companies involved in the food production, but small agricultural farms are not familiar with marketing business principles.

Marketing has a great meaning because it is connecting producers with consumers, it helps food producers to better understand consumers needs, and also helps all producers to decide which product will be produced and offered on the market.

Production chain, Producers – Processors – Consumers, is essential to ensure that the products can be protected and that the marketing projects are going to be successful.

For all reasons mentioned above, the Croatian Agricultural Agency, as a government institution with a long tradition in agriculture, has launched a new marketing project named *Eggs from Croatian farms*.

The main goal of labelling fresh eggs for consumption with the label *Eggs from Croatian farms* is to promote domestic production of fresh eggs produced on Croatian farms, to

increase their production, but also to inform consumers about the origin of fresh eggs that are systematically controlled.

The Department of Market and agricultural products marketing, which is responsible for the implementation and control of marketing projects, made the *Terms of use* for project *Eggs from Croatian farms*, which prescribes the procedure for getting and using the protected label. The permission to use the label is given to the egg producers who produce eggs by Croatian laying hens on Croatian farms. To ensure the traceability, egg producers and egg packing stations must keep a record about breeding method on a weekly basis. All label users must fulfill the terms prescribed by the *Terms of use* for the voluntary labelling of eggs with the protected label *Eggs from Croatian farm*. They also have to sign a contract for using protected label with Croatian Agricultural Agency.



Figure 1. Steps to getting the label *Eggs from Croatian Farms*

In collaboration with the Ministry of Agriculture, the Croatian Agricultural Agency conducts a control of the project through VETI applications and additional controls are carried out on the basis of prescribed documentation by the Terms of Use for using the label *Eggs from Croatian farms*.

Since the project was established, the Agency signed contract with twelve egg farms for using of the protected label, and those twelve egg producers achieved more than 80% of the total national production of fresh eggs in the Republic of Croatia.

In the period from 1 May 2015, when the project started, until 1 January 2016, 4.012,942 packing box of eggs were marked with the label *Eggs from Croatian farms*.

In order to better inform the consumers, the Croatian Agricultural Agency created the web application for the project *Eggs from Croatian farms*, through which consumers have possibility to check the producer code of the eggs on www.hpa.hr and where they can find all important information about the egg producers.

According to the Regulations of the egg quality, prescribed under the legislation, each egg on the market must be properly marked. Marking of eggs is a form of egg labeling that includes an *egg code* stamped on the egg itself. The EU has defined an egg code that consists of a number indicating the method of production, a two letter code for the country of origin, and a unique farm number ID.

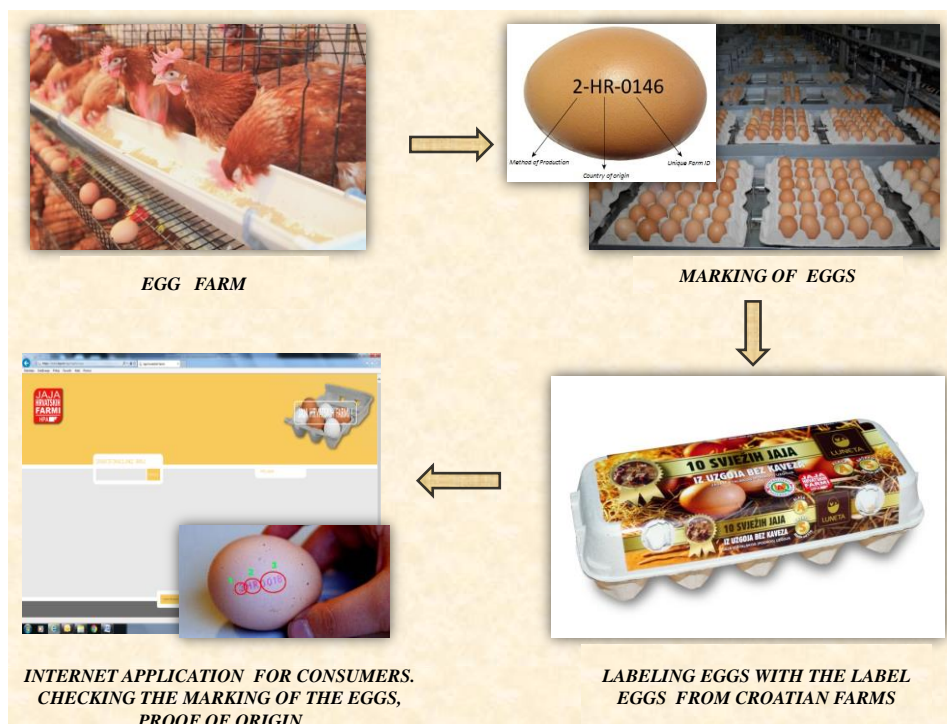

Figure 2. Traceability of labeled eggs

Materials and methods

The research was focused on the egg producers, our label users. The plan was to investigate their motivation, their thinking, and does the voluntary labeling of their products with protected label – *Eggs from Croatian farms* - helps their production.

The study used a method of primary data collection through a questionnaire as an instrument of research, and the questionnaire contained 7 questions of closed type and it was sent by email in January 2016.

The questionnaire was sent to all 12 label users, representatives of companies / managers, middle-aged people who have a university degree. Completed questionnaire was returned by 10 respondents. The study was conducted using quantitative research methods. Quantitative research is focused on the figures resulting from statistical analysis. The main characteristic of quantitative research is to standardize identical questions to all respondents which helps with statistical data processing.

The results were processed through a statistical data analysis, and the results are presented graphically.

Results and discussion

Marketing project *Eggs from Croatian farms* was launched in February 2014, and it is the sixth marketing project implemented by Croatian Agricultural Agency. The largest egg producers approached the project from the very beginning, and according to the results of our study we can conclude that the majority of our users are satisfied with its implementation. The questionnaire that was sent to label users was summarized at only 7 questions of great importance for our research.

We received the following answers:

1. What is your total annual production of eggs for human consumption? Average annual production of eggs for human consumption of label users *Eggs from Croatian farms* is 46.000,000 eggs.

- When did you start to participate in the project *Eggs from Croatian farms*?
All respondents participate in the project from the beginning of the project, February 2014.
- Why did you join the project *Eggs from Croatian farms*?

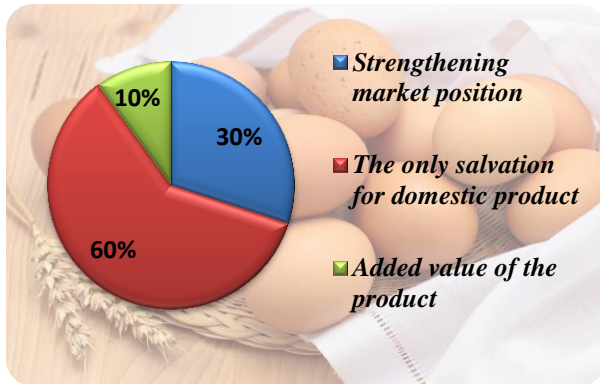

Figure 3. Why did egg producers joined the project *Eggs from Croatian farms*

Marketing project *Eggs from Croatian farms* was partly created on the initiative of egg producers, so it was no surprise that 60% of respondents find that such project is the only salvation for the domestic product as we can see on the Figure 3. Why did egg producers joined the project *Eggs from Croatian farms*. 30% of respondents thought that the label brings stronger position on the market, while 10% considered that the label brings added value to the product.

- Have you noticed positive changes after the application of a protected label on your products?

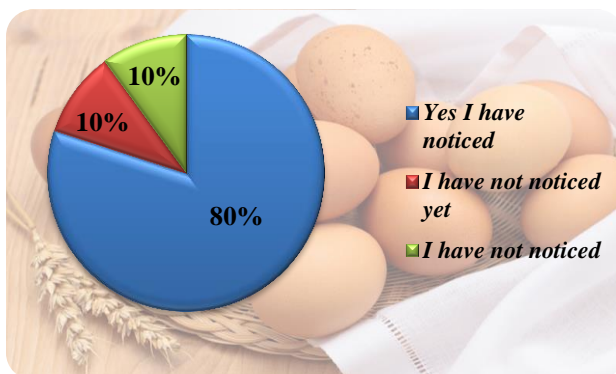

Figure 4. Did egg producers noticed positive changes after the application of a protected label

On the question, if the egg producers have noticed positive changes after the application of a protected label, 80% of users said they did, as the Figure 4 shows, because the label promotion has reached higher level and consumers started to recognize the label. Only 10 % of respondents said that they have not noticed any changes.

5. Did you increase the price of your products marked with the label *Eggs from Croatian farms*?

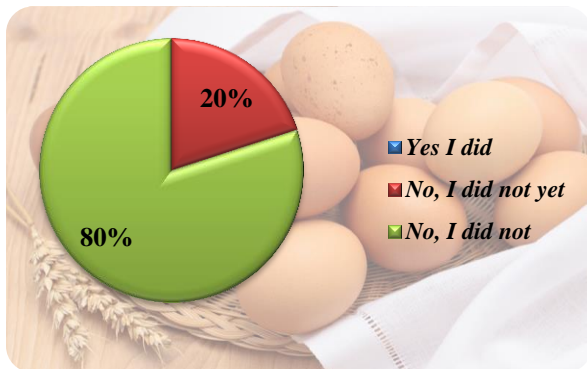

Figure 5. Did egg producers increase the price of their products marked with the label *Eggs from Croatian farms*

Figure 5. Did egg producers increase the price of their products marked with the label *Eggs from Croatian farms*, shows that none of the label users increased the price of their products marked with the protected label. Reason for this is that egg producers want consumers to get familiar with this label and what it represents, so the product could become competitive on the market. Because of the difficult economic situation, egg producers will wait with price increase.

6. Have you noticed a positive trend in the consumption of labeled products?

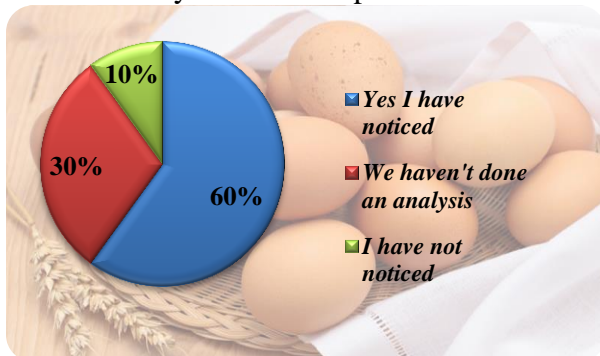

Figure 6. Did egg producers notice a positive trend in the consumption of labelled products

When we asked if label users have noticed positive trend in the consumption of labeled products, 60% of users said they have noticed, 30% of them have not done any analysis, and 10% have not noticed positive trend in consumption. The results are shown in the Figure 6. Did egg producers notice a positive trend in the consumption of labelled products

7. Are you satisfied with the marketing project for voluntary labeling of eggs implemented by Croatian Agricultural Agency?

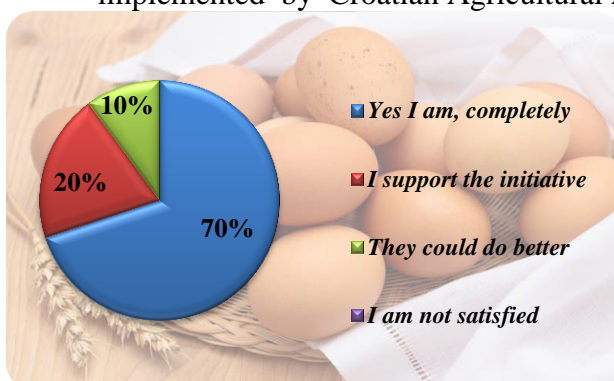

Figure 7. Are the label users satisfied with the marketing project for voluntary labelling of eggs implemented by Croatian Agricultural Agency

It was a great pleasure to see that 70% of our label users are satisfied with implementation of the project *Eggs from Croatian farms*. 20% of users responded that they support the initiative, but only 10% of users believe that the project could be implemented in a better way. As the Figure7. shows none of egg producers said that they are not satisfied with the project.

Conclusion

We are aware that nowadays, especially since the Republic of Croatia joined the EU, there is an abundance of food on the market and the quality and origin of the products has a great importance for consumers.

For this very reason marketing labels on domestic agricultural products are extremely necessary, because in this way we help consumers to identify domestic product and by recognizing these labels the way to conscious shopping is insured.

Also, marketing labels are salvation for domestic agricultural production as they strengthen the market of domestic products as the questionnaire showed.

It is clear that after launching of marketing projects a certain time is required for positive trends to appear, but our research proved that consumers are becoming more aware of the label *Eggs from Croatian farms* and its meaning.

Also, by buying these products consumers directly affect the increase of consumption of the same, which encourage the preservation of local agricultural production and national identity, preserve jobs and ensure the future of our children.

References

Castells, M.(2002): The power of identity, golden Marketing

Cerjak, M., Mesić, Ž. (2007), Does the consumers know the pepper of Virovitica and what are they expecting from its protection with the label of geographic origin, 42 Croatian and 2nd International Scientific Symposium on Agriculture, Proceedings, Opatija, pp. 104-108.

Croatian Chamber of Economy: Buy Croatian (2011), CCC

Leko Šimić, M. (2002), Marketing of food, textbook, J.J.Strossmayera University, Faculty of Economics, Osijek.

<http://amainfo.at/ama-siegel/ama-guetesiegel/>, accessed 04.05.2016.

<http://assurance.redtractor.org.uk/standards/search>, accessed 15.03.2016.

<http://www.mps.hr/default.aspx?id=5853>, accessed 02.05.2016.

POSITION OF THE POLISH FOOD PROCESSING IN THE FOOD CHAIN

Agnieszka JUDZIŃSKA*, Robert MROCZEK

Department of Food Industry, Institute of Agricultural and Food Economics – National Research Institute,
Warsaw, Poland

*Corresponding author: judzinska@ierigz.waw.pl

Abstract

Polish food industry is one of the main components of the food economy. It is the largest recipient of unprocessed agricultural commodities, and, at the same time, the main supplier to the food trade (both wholesale and retail). The importance of the food industry is also due to the fact that processing plants integrate the entities involved at all stages of food chain (from farm to table). This process is favored by a steady increase of Polish agriculture marketability, as well as the growing demand for highly-processed foods. In the past decade, has occurred a rapid growth of the Polish food industry. The number of processing plants certified to sell their products on the EU market has significantly increased. It was also noted a large (more than three-quarters) increase in the sold production value of the whole food industry (including tobacco). After the Polish accession to the European Union a strong growth of food exports took place. Its value, in the years 2004-2014, accounted for more than a half of the sold production value of the whole food industry. At present, the Polish food industry employs approx. 415 thousand people, while its share in the creation of GDP (measured by gross value added) is fairly stable at 2.7-2.9% on average. The main objective of the study was to determine the position of Polish food industry in the food chain.

Key words: *Food industry, food processing, agriculture, trade, Poland.*

Introduction

The food industry is, apart from agriculture, the main element of food economy. It is an important link of the food chain which integrates its other elements, i.e. agriculture, purchase and trade in agricultural products, as well as trade in food. Position of the food industry in the food chain results from its main function which is processing of agricultural products in order to make them suitable for consumption or sale, hence, to increase their usability for the final consumer. The food industry in Poland is one of the most important sectors of economy. It has a significant share in the national economy, for instance, in gross value added, number of companies, employment or sold production. This sector uses in the production premium raw materials, the technological level of processing is considered as one of the most advanced, and Polish food enjoys growing interest of the foreign recipients (Firlej et al. 2015).

The food industry occupies the central place in the Polish food economy. Its main purpose is to fulfil basic needs of population which are, on the one hand, determined by the needs and expectations of consumers and, on the other hand, by production capabilities of agriculture. The food sector is characterised by a large diversity of conducted operations, where initial processing of crops exists side by side with production of high degree of processing (Kapusta 2008). The significance of the food industry in the food chain increases along with the growing urbanisation, i.e. increasing distance between the regions of consumption and the agricultural regions and along with increased agricultural production and progressing specialisation and globalisation.

Currently the main problem in most branches of the food industry is excess of supply over demand, large number of market participants and strong competition, in particular on the part of large global industrial companies and retail chains. The primary purpose of the entities of

food industry is maximisation of profit and raising the value of company. Every branch solving the basic problem of distribution, which is to ensure the maximum availability of their products at the possibly lowest costs, without jeopardising its quality in the course of trade, uses different strategies, which results from the specific nature of production of particular branches of food industry. Basically, manufacturers develop cooperation with retail chains mainly in terms of their dominant share in the market and the possibility to reach consumer faster, as well as benefits from cooperation with significant recipients (reliability of payment, lower costs of transportation) (Morkis et al. 2010).

Materials and methods

The purpose of this study was to demonstrate the role and importance of food industry, one of the main links of the food chain, as compared to its other two important elements, namely agricultural manufacturers (suppliers of raw materials for processing) and trade. The comparison includes, among others: number of entities and their size, value of production (sold, commodity), value of sales, employment and share in gross domestic product.

The work has a form of comparative analysis in which secondary source materials were used. The study used, first of all, published and unpublished data of the Central Statistical Office and publications on matters related to the broadly understood food economy. The collected data were analysed with the use of descriptive method. Appropriate indicators were used to determine changes over time. The results are presented in tabular form and depicted by graphs.

Results and discussion

Processing as one of the major elements of food chain

The ISO 22000 Standard defines the food chain as a sequence of stages and processes taking place in production, processing, distribution, storage and handling of food and its components, starting from primary production until its consumption. The main elements of food chain are: food processors, manufacturers of crops and sellers. This chain is, however, more complex, as basic cells thereof cooperate with other entities providing means of production or services, e.g. producers of feeds, fertilisers or providers of banking or repair services. A significant element of the chain is also an information flow accompanying all of these processes, i.e. from the mere creation of product until a good being found at the final recipient's (Szymanowski 2008)

Food products in modern economy are the result of cooperation of the whole food chain a significant part of which is food industry. The food chain is subject to continuous transformations. Not only do its constituent cells evolve, but also its participants. Along with evolution of food chain, which is closely linked to the social and economic development, its leading link is changing. Currently, the main regulator of relations between particular links of food chain are market mechanisms (Chechelski 2015). The inflow of foreign capital, increase in domestic demand and concentration of processing companies have resulted in the fact that the food industry became the most important link of the food chain.

The food industry, agriculture and trade differ from one another not only by the character of conducted operations, but also by economic parameters describing their potential and business performance or work efficiency (table 1).

Diverse economic parameters result from the following phenomena:

- the value of global production of food industry is two times greater than the agriculture's, and the value of production sold of this industry is over 2.5 times greater than goods production of agriculture and by ca. 1/10 lower than retail sale of food,
- the gross value added of food industry is by ca. 1/5 greater than the one generated by agricultural manufacturers and comparable to the one from retail sales of food,
- the number of employed persons in food industry is 5 times smaller than of those involved in agriculture and comparable to the number of persons working in retail trade.

Table 1. Basic economic parameters of the Polish farming, the food industry and the retail trade with foodstuffs in 2014.

Specification	Agriculture	Food industry	Retail trade ^a
Number of entities in the thousand in it: goods, industrial and supermarkets	1413 294 ^b	14,6 6,1	354,8 11,8
Number working in the thousand of persons in it in goods, industrial companies or supermarkets ^c	2331,4 450	445,6 400	490 48
Production value in current prices (in bln PLN)			
▪ global,	105,3	220,0	.
▪ goods,	76,7	204,4	.
▪ retail	.	.	220,4 ^d
Gross value added in the bln PLN	41,3	50,4	48,5
Export in the bln PLN	13,4	73,9	10,0
Import in the bln PLN	19,2	40,7	8,0-10,0
Value of the food consumption, drinks and tobacco products in the bln PLN	248,9 ^e		

a - stores with large sales area (supermarkets, hypermarkets, department stores),

b - farms where the production value exceeds 15 thousand euro,

c - stores with sales area of 401 m² or larger,

d - retail sales value of food, beverages and tobacco products including sales at wholesale and processors,

e - the sum of private consumption, ie. consumption in households, non-profit institutions, as well as in central and local government institutions.

*Source: The Statistical Yearbook of the Central Statistical Office 2015 and own calculations on the basis of Eurostat and unpublished data of the Central Statistical Office about the number of food industry companies.

All the basic links of food chain involve the processes of production concentration, as a result of the growing value of production, sales, and the decreasing value (though to a various extent) of overall number of companies, agricultural farms or stores. At the same time the number of the largest entities in all sectors increases. In the years 2006-2014 the value of sold food industry production (along with tobacco) increased by 57.8% from PLN 129.5 billion to PLN 204.4 billion (in current prices), value of agricultural goods production increased by 67.0% from PLN 45.9 billion to PLN 76.7 billion, and value of retail sale of food increased by 31.2% from PLN 168.0 billion to PLN 220.4 billion. In this period, the number of processing companies (together with micro enterprises) decreased from PLN 17 thousand to ca. PLN 12.6 thousand, (6% decrease) and the number of food industry plants decreased from 6.4 thousand down to 6.1 thousand (14.9% decrease). Insofar as the agriculture is concerned the number of farms (above 1 ha) decreased from 1,810 thousand to 1,413 thousand (21.9% decrease) at the increase of commodity farms to ca. 300,000. In retail trade the number of shops selling only food supplies reduced by 22.5% (from 145.8 thousand to ca. 113 thousand), with addition that there is ³/₄ more large-area stores (growth from ca. 6.7 thousand

to 11.8 thousand, including double growth in the number of hypermarkets and supermarkets from ca. 3.5 thousand to ca. 7.1 thousand

Every sector of economy is dominated by the largest entities, as they have the greatest share in the market. As regard the food sector, already more than half (55%) of the value of sold production falls on large industrial companies, employing more than 250 persons. In the years 2006-2014 the average value of production of one industrial company (without micro enterprises) increased by 71.0% from PLN 18.3 million to PLN 31.3 million. Assuming that ca. 80% of production (goods) comes from ca. 300 thousand agricultural farms, the average value of sold agricultural products increased by ca. PLN 200 thousand up to ca. PLN 256 thousand per farm.

Average work efficiency in food industry companies measured by the value of production sold in 2014 amounted to PLN 451.3 thousand/employee and was more than 3 times higher than in commodity farms. Work efficiency measured by gross added value ¹ in the food sector amounted in 2014 to PLN 113.5 thousand and in agriculture to PLN 17.1 thousand/employee. Since Poland's accession to the European Union, the value added of the Polish food industry increased more than twice from PLN 24.1 billion to PLN 50.4 billion, and in the value added of the Polish agriculture increased by 62% from PLN 25.5 billion to PLN 41.3 billion.

The past decade was characterised by dynamic changes in the area of retail trade, an expression of which was fast increase in number of large-area stores, including hypermarkets and supermarkets. In the years 2005-2014 the value of retail sale of food stores in Poland increased from PLN 129 billion to PLN 192 billion (net). At that time discount stores increased sales over five times, contributing along with supermarkets and small store networks to a decline in the importance of traditional food trade² the market share of which decreased from 56.6% to 23.2%, i.e. by 33.4 percentage point (Fig. 1). According to the estimations of the Polish Organisation of Trade and Distribution the value of Polish products (including food and beverages) exported by means of retail chains amounted in 2014 to approx. PLN 10 billion, i.e. ca. 11.5% of the whole Polish export of food (agricultural raw materials and food products).

¹ The value added in the food industry consist of: the cost of remuneration along with loads, depreciation, taxes encumbering costs (without VAT and excise), financial costs and gross financial result.

² it is generated, first of all, by independent food stores and specialist food stores

Figure 1. The value of retail sale of food stores^a in Poland (net, in PLN billion)

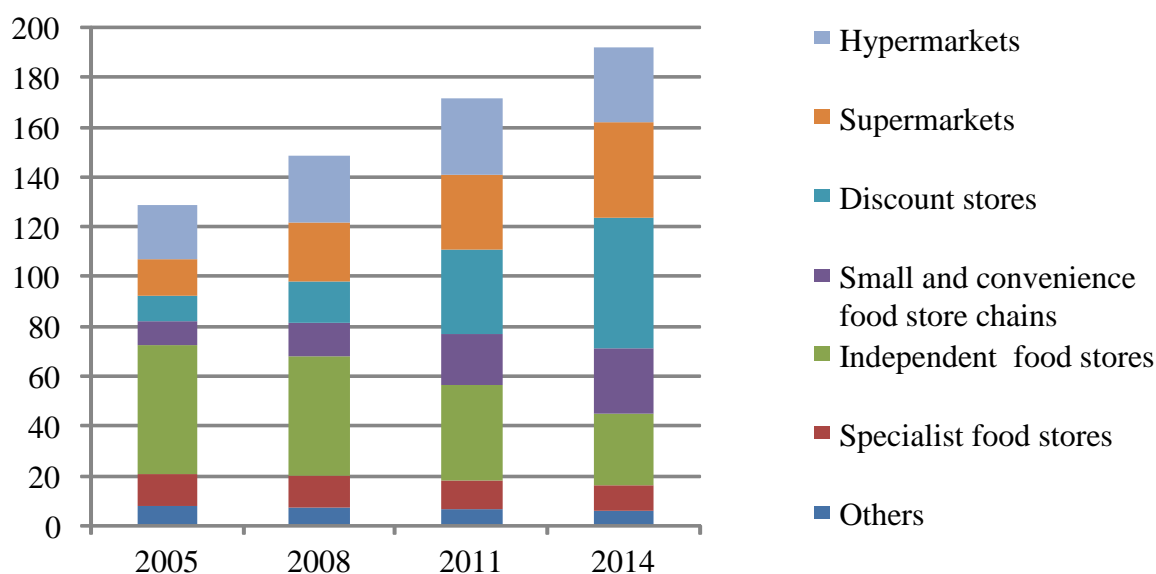

a – data takes account of the whole sales of a given channel (not only food products), gas stations and cash&carry were omitted.

*Source: Own study on the basis of the KPMG's study "At the crossroads". Challenges and priorities of food chains in Poland. Warsaw 2015, p.16.

Large number of participants of food chain results in formation of various types of connections and sometimes also conflicts of interest. The purpose of every entity, whether it is a farmer, processor or merchandiser, is to sell produced or purchased product and make money from it. This dictates the conditions of who is stronger or better organised. Various types of slotting fees imposed by large retail chains on food suppliers generate additional costs, hence they reduce profits of food processors. In extreme cases this can resemble a situation where processors become fully dependent on large retail chains. Such risk is present especially in the case of those manufacturers and processors who will bind themselves with only one recipient (one retail chain).

The role and importance of food industry in the food chain

The role and importance of food industry in the food chain can be considered in various aspects. The following can be distinguished: economical, socio-economic and health (food safety). From the economic point of view food industry companies are focused on making profit and raising value. Companies having profits find it easier to develop, invest, strengthen their position on the market and compete with other entities (national and foreign). Furthermore, in economic terms, the food industry, like many other economy sectors, contributes to gross domestic product the share of which, measured by gross added value, amounted in recent years to 2.7-2.9%.

A dynamic development of export of agricultural and food products after Poland's accession to the European Union contributed to limitation of Poland's trade deficit and at present, it improves a positive trade balance. It should be emphasised that the balance of trade exchange of food products is positive, whereas it is negative for trade in raw agricultural materials. It results from the fact that export of food industry products exceeds the import. In 2006 the positive balance of trade in food articles amounted to PLN 10.7 billion to increase in 2014 to PLN 33.2 billion (for comparison, a negative trade balance was recorded in export of agricultural products which in 2006 amounted to PLN 2.6 billion and in 2014 to PLN 5.9

billion)¹. By developing the export, processing plants make use of current production surpluses and effectively promote Polish food on foreign markets. In the years 2006-2014 the export was "responsible" for 72.4% of growth in the sold production value of food industry which increased at that time from PLN 33.1 billion to PLN 87.2 billion.

Considering the socio-economic aspect, an important role of the food industry is to create and provide workplaces. In 2014 ca. 445 thousand persons were employed in the food industry. The food sector substantially contributes also to creating changes in the quality of manufactured agricultural raw materials by setting higher requirements for their producers. An example is the dairy industry which within a relatively short period of time (few years) succeeded in its effort to deliver to dairies only milk of extra grade. It would not be possible without economic stimuli in the form of, among others, favourable prices of high quality raw material and improvement in efficiency. Number of milk manufacturers decreased from 1.092 thousand in 2010 to 181 dairies in 2014 at relatively stable milk production. At the present time, the national offer of dairy products apart from high quality, is characterised also by rich assortment and considerable price competitiveness on the EU market. The second example is meat industry which actions resulted in improvement in meat content of pork livestock produced in the country, which amounts now to ca. 55%. Rewarding of larger batches of uniform raw material of desired qualitative parameters contributes to the growth in marketability of agricultural farms as well as significant interest in Polish food on the part of foreign recipients.

The Polish food industry appeared to be resistant to the recent world economic crisis. Despite fears, no mass bankruptcy of processing plants and dismissals of employees or remuneration reductions were recorded and the lower level of investments and profits appeared to be only a temporary phenomenon.

An important thing is also the fact that the food industry alleviates rapid increases in purchase prices of agricultural products, as price changes on its side are usually much lower, also from those in retail trade (table 2).

Table 2. Changes in prices on the agricultural and food market in 2006-2014 years.

Specification	Prices annual changes (%)		
	Agricultural	Food processing	Consumer (retail)
Average price growth rate on the agro-food market	3,05	2,13	3,24
in it: meat,	3,39	2,37	2,82
cereal,	7,28	2,49	4,48
dairy	4,42	2,97	3,23
Average changes in prices (+/-) on the agro-food market	6,02	2,79	3,10
in it: meat,	8,54	3,93	3,84
cereal,	20,48	8,89	4,48
dairy	8,99	4,56	3,57

*Source: Own calculations on the basis of purchase prices of agricultural products, indicators of changes in the sold production value of food industry (food and non-alcoholic beverages) and indicators of retail prices of food established by the Central Statistical Office.

The comparison of average rate of increase of prices on the market of agricultural and food products suggests that in years 2006-2014 the average growth rate of prices of processors amounted to 2.13% annually and was lower than the growth rate of prices paid to farmers (3.05%), as well as lower than the growth rate of retail prices of food and beverages (3.24%).

¹ Negative balance of commercial exchange of Poland in 2006 amounted to ca. PLN 50.4 billion; in 2010 it increased to PLN 55.2 billion, and in 2014 decreased to PLN 11.1 billion.

These spans varied from one market to another. Average changes in the market of agricultural and food products were similar for processing and retail trade and were the highest in agriculture. For cereals the variability of purchase prices amounted to as much as +/-20.5% annually and was more than twice as high as the selling prices of processors and 4.5 times higher than the average changes in retail prices. A great instability of the growth rate of prices (their changeability) was a problem also on the meat and dairy market, especially for farmers. Average changes of prices on this market were higher than the average changes in prices of agri-food products at the level of processor and consumer. It can be concluded from this short analysis that the food industry was in the past decade a link mitigating the effects of high volatility of prices paid to farmers, hence, stabilising the food sector.

The basic role of food industry is manufacturing of food and beverages from agricultural raw materials which, subjected, in lesser or greater degree, to processing at subsequent distribution stages of food chain (trade, gastronomy), are offered to the consumer. In this way the processing along with the agriculture and trade secures one of basic living needs of human, namely hunger satisfaction.

Food industry entities in an increasingly larger scale meet tastes and expectations of consumers as to the range and diversity of the assortment of produced food. At the same time, the awareness and responsibility of manufacturers for ensuring the appropriate quality of offered food and care for safety of consumers' health is growing systematically. Contemporary thinking about the quality consists in the fact that the desired quality of product should be achieved at every stage of production, starting from the selection of relevant raw material through processing, storing, distribution to final recipient. This approach is reflected in a constant increase in the level of implementation of obligatory systems of quality management companies of food industry (figure 2). This process proceeds most rapidly in large and medium enterprises, and relatively slow in micro enterprises.

Figure 2. State of implementation of obligatory safety and quality management systems in the total number of food industry enterprises (in %).

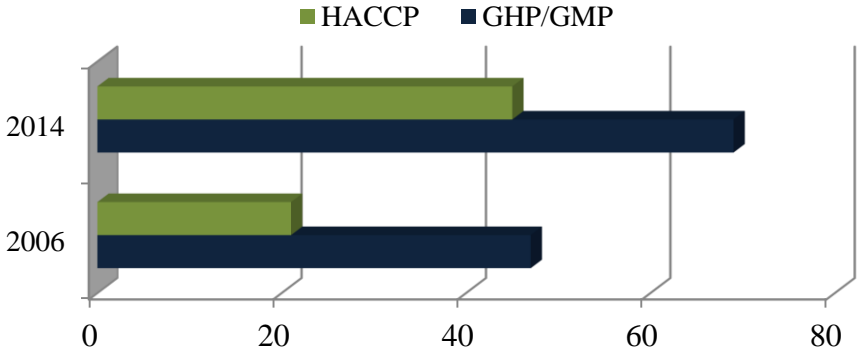

*Source: Own calculations on the basis of unpublished data of the Veterinary Inspection and State Sanitary Inspection.

A pursuit of continuous improvement of effectiveness of quality management and food safety results in the fact that Polish manufacturers more and more often invest also in implementation of non-obligatory systems of quality management, mainly in the one consistent with ISO 22000 Standard and in BRC standard required by foreign retail chains. Food industry plants often act as an integrator of entities involved in the manufacturing process from field to table. However, as R. Urban notices, this function, more and more often,

may be taken over by trade and large retail chains, as they begin to play a dominant role in the food chain (Urban 2012).

Growing position of hypermarkets and supermarkets on the market (apart from the fact that a large foreign capital is present there) results also from low prices of sold goods and large commercial offer, which effectively attracts customers. In the period of last ten or so years shopping preferences of Poles have substantially changed with regard to the place where they buy food products. Hypermarkets and supermarkets have gained the most while the biggest loss concerned small stores and kiosks, where products are served directly by the seller, as well as bazaars and marketplaces. In 2010 more than a half of respondents (54%), indicated hypermarkets and supermarkets as the most common place for buying food (increase by 35 percentage points as compared to 1997). 40% of the surveyed declared buying of foodstuffs in small shops and kiosks, which means a decrease by 32 percentage points as compared to 1997. Only 8% of persons indicated bazaars and marketplaces as places of buying food (31% in 1997). Small and medium self-service stores (up to three cash registers) retained quite stable group of buyers (ca. 35%). In these studies one person could indicate different places of purchasing as preferred ones. (Sobocińska 2011). Currently the pace of opening new commercial areas (supermarkets and hypermarkets) has slowed down. Some networks see the possibility for further expansion in taking over of the already existing retail outlets (stores). Internet shopping also enjoys the increasing popularity among consumers.

Conclusions

The food industry belongs to one of the major links of food chain. Its position is important because:

- ca. 14.6 thousand companies operate on the market, of which 6.1 thousand are industrial companies employing more than 9 members of staff,
- overall employment in the food industry amounts to ca. 450 thousand persons,
- the share of food industry (including production of tobacco products) in gross domestic product of Poland is ca. 3%,
- the food industry is the main recipient of agricultural goods production,
- the Polish food industry became a leading food producer on the European market, and Polish food processing plants are considered as one of the most advanced in the EU,
- together with agriculture and trade it meets one of the essential living needs of human which is to satisfy hunger.

Polish food industry has made the most of the opportunity which opened up after our accession to the European Union. In the years 2006-2014 the value of production of food industry (including tobacco) increased by 57.8% . The export was "responsible" for more than 70% of the growth in the value of sold production of food industry, which value, at that time increased by 2.5 times.

In the studied period the variability of product trading prices at the food processor's was lower than the variability of prices paid to agricultural manufacturers. Therefore, the food industry was a link stabilising the food sector.

Along with the progress of consumption and development of export of products with higher degree of processing the significance of food industry in the food chain will continue to grow, whereas agriculture will become mainly a raw material department of national economy.

However, a noticeable development of global retail chains may, in the future, contribute to another shift in power in the food chain. The progressive globalisation, manifesting, among others, in the prevailing share of corporations in food trade, results in slowly weakening of a strong position of manufacturing companies. Currently, commercial corporations are able to affect with its activities food industry companies (force them to reduce costs, imposing branding, etc.), agriculture (production of low-cost raw materials or organic food),

merchandisers (eliminating them from the market), as well as consumers (change of preferences and habits through advertising and other marketing activities).

References

- Czechelski P. (2015). The evolution of the food chain, [in:] Szczepaniak I., Firle K. (eds) *Food industry - macro-environment, investment, foreign expansion*. Publisher CUE, IAFE-NRI, Krakow - Warsaw, pp. 45-63.
- Cabbage F. (2008), *Agribusiness*. Difin, Warsaw.
- KPMG (2015). *At a crossroads. Challenges and priorities of food chains in Poland*. Warsaw, pp. 16.
- Morkis G., Nosecka B., Seremak-Bulge J. (2010). *Monitoring and analysis of changes in Polish food chain*. (Synthesis of topic III). Multi-Annual Program 2005-2009, Report No 179. IAFE- NRI, Warsaw, pp. 57-59.
- Sobocińska M., Kłosiewicz-Górecka U., Skowronek-Mielczarek A., Kurczewska L., S. Tajer, Feldy M., Frost B., Pokorska M., Dybka S., Mikolajczyk J., Nowacki R. (2011). *Domestic trade in Poland 2006-2011*. Report. The Institute for Market, Consumption and Business Cycles Research, Warsaw.
- Statistical Yearbook 2014, 2015. The Central Statistical Office, Warsaw.
- Szymanowski, W. (2008). *Managing of food supply chains in Poland. Directions of changes*. Difin, Warsaw.
- Urban R. (2012). *Assessment of cohesion of development processes occur in agriculture and food industry*. Problems of Agricultural Economics, No 1, IAFE-NRI, Warsaw, pp. 3-17.

DEVELOPING GOAT KID MEAT VALUE CHAIN BASED ON GEOGRAPHIC INDICATIONS: AN APPROACH FOR RURAL DEVELOPMENT IN ALBANIA

Petrit DOBI*¹, François LERIN², Roland BARDHI³, Claire BERNARD², Besmira MEDOLLI², Alice GARNIER²

¹Agricultural University of Tirana, Tirana, Albania

²CIHEAM-IAM Montpellier, France

³Mainutain Area Development Agency, Tirana, Albania

*Corresponding author: petrit@rasp.org.al

Abstract

Albania is well known for its very rich in its agro-biodiversity. In the North of Albania, the Hasi goat breed is a good example of using agro-biodiversity as a resource for local development. Animals of this breed have a clear genetic profile, are well-adapted to harsh conditions and to abundant pastoral and sylvio-pastoral resources in the karstic plain. Products as goat kid meat and milk have a good reputation. In order to address the territorial dimension of local value chains; Geographical Indication (GI) was identified as a possible adequate sign of sustainability and origin to be developed. The objective of this work is to identify the specifics of the product (Hasi goat kid meat) in order to complete a successful GI building process and direct support to the value chains. For this purpose it was implemented a territory-based study mainly based on bibliography, interviews of farmers but also morphological measurements of animals. Four main points of attention have been identified; (1) a strong delimitation of the area of origin based on geo-morphological criteria where sinkhole agricultural and forage production is an important part of this; (2) the specificities of the breed including genotypic and phenotypic characteristics as well as the quality and reputation of its products, especially kid-meat goat. (3) the environmental issue and management of the pastoral resources in naturalist terms and their relation to the quality of meat;(4) the traditional management, breeding system and pastoral practices; and specifications to be potentially included in the Code of Practice (of the GI).

Keywords: *Albania, Geographic Indication, Territory, Value chain, Hasi goat*

Introduction

Landscape patterns' diversity in the north-eastern part of Albania have been a good foundation for development of a very rich biodiversity. Moreover, combination of landscape and biodiversity with a wide variety of production systems and traditional practices have produced a very rich agro biodiversity. Agro biodiversity is a great potential for economic development of rural areas, which actually are the most poor and marginalized. This very rich agro biodiversity and diversity in mountain areas have not yet affected the living standards, even in developed urban areas local products of mountain origin are preferred and requested. This appreciation is not reflected in higher prices because of lack of consolidated Value Chains (VC), as well as lack of identification and standardization of these products. One of these products is the meat from Hasi goat kids. Even this product has very good reputation for its quality and taste, this hasn't been sufficient to build sustainable VC that may increase income for population in remote areas.(Kipi, B. et al. 2013) One of most successful strategies in this case could be building value chains based on Geographic Indications.(Bernard, J-P. et al. 2014) To complete a successful GI building process in Albania and direct support to the value chains with a territory-based action it is necessary to explore and identify linkages between the product, in our case Goat kid meat, with the territorial elements, geo morphologic

characteristics of the territory, local goat population, environment and management of pastoral resources and traditional breeding and management practices.

Materials and methods

The methodology used is an essential part of this study. In order to identify all elements of the GI building process we have used previous research as well as studies and research completed during this project.

Data production. Data were collected in two different ways: extensive literature review and field research (semi-directive interviews, survey, and direct field observation) on which inductive method was applied.

During the bibliographic research phase there were used: scientific publications, the grey literature which represents all the documentation except scientific ones.

Collective field work and interviews. The collective fieldwork was organized based on the ECRIS method-guidelines for investigation in social situations. A socio-anthropological approach of the field consisting in comprehensive and semi directive interviews. interviews were made all around the Hasi region (Albania) in order to have the largest panel of interviewees possible.

Interviews and Survey were made with the population of villages, Cahan, Mujaj Kishaj, Domaj, Pus I Thate, Gjinaj, Vlahen, Golaj and Vranisht in the region. A survey grid was prepared in order to have the same questions for each people interviewed. The questionnaire has 51 questions, 9 of them have multiple answer options with check boxes and two were open ones with descriptive answers

Delimitation of the territory is mainly based on its geographic and morphological structure, as well as on traditional links and connections of the local communities.

Specifics of the goat breed are based on DNA analysis for the genotype and on morphological evaluation of goats according to Food and Agriculture Organisation (FAO) criteria for local breeds and populations (FAO 2012).

Traditional management and pastoral practices and breeding system have been described based on interviews and partly opened questionnaires made on 24 farmers having more the 100 goat per farm. The selection of these farms' size is based on the fact that such farms are more market oriented. Those farms have together, more than 50% of goat population in Hasi region. Before each interview, a free open discussion was made in order to get confidence of farmers and avoid non-realistic information especially on farm production.

Results and discussion

Product characteristics are based on several elements which have been thoroughly studied and analysed:

1) a strong delimitation of the area of origin

Hasi goat breed is endemic to the region and has a strong link with its territory and has been affected by its characteristics. The breed and its products have been identified as the most adequate first step toward a sustainable rural development strategy (Medolli, 2013). Homogeneous flocks had been identified especially in the plateau area, characterized by its geomorphologic "sinkhole" system.

According to bibliographic study (Garnier, A. 2013), Hasi area is composed by several geomorphological parts:

- A mountain ridge along the entire Northern Has. It forms a crescent stretching from Mount of Shkami on the west, Mount Suka southeast, passing by Pashtriku Mountain where there is the highest peak of Hasi (1998m). The mountainsides are covered with trees, scrubland, and grassland in the soft slopes.

- A sinkhole plain, where villages Cahan, Mujaj and Kishaj are located. The plain is extended in the South-Eastern Has, with an altitude between 1000 and 1500m. Karst formations such as sinkholes are characteristic of this plateau. They are formed due to the presence of limestone structures (basement) in this area.
- A hilly area, at an altitude between 300 and 800 m. This hilly area is divided by rivers and streams that meander through the plateau. Land of the area is mainly composed of sedimentary soil allowing the cultivation of cereals, vegetables, and forage.

Fig. 1 division of Hasi territory in characteristic geographic areas. (Garnier, A. 2013)

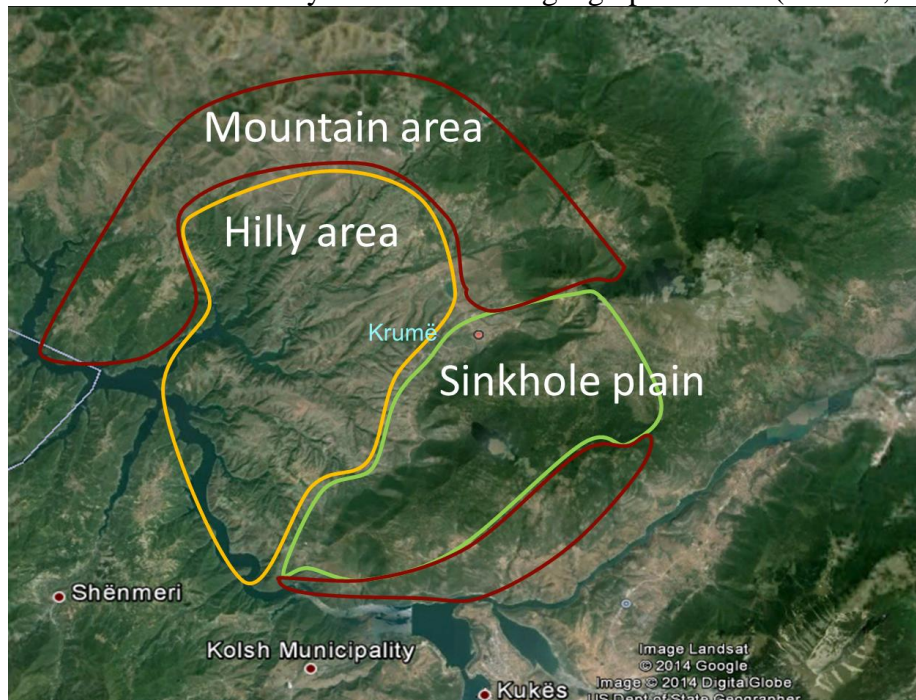

The above geographical features (according to Garnier, A. 2013), have been crucial for the development of three types of villages in Hasi:

- **Hilly area villages with high production capacity** (Red Lake, Zaharisht, Krumë, Golaj). These villages are located in the plateau of Kruma where there are abundant hilly pastures, and capacities to develop agricultural and animal production
 - Access to hillside pastures;
 - Good capacity for agricultural and forage production;
 - Little purchase of forage and concentrates.
- **Hilly area villages with poor production capacity** have almost no arable land (Gjinaj, Domaj) or they are unproductive and production costs are higher than the price of products in the market (Letaj).
 - access to hilly pastures, and possibly to mountain pastures;
 - Low forage production capacity and very low capacity for agricultural production;
 - Purchase of forage and concentrate
- **Villages of sinkhole plain (Cahan, Kishaj).**
 - Access to mountain pastures;
 - Good ability to forage production, but almost no agricultural production;
 - Purchase of concentrates, little purchase of forage.

The common characteristic of goats living in this area is that all of them use for almost all or part of the year pasturing and browsing in the sinkhole plain.

2) **The specificities of the breed.**

Hasi goat is recognized as an endemic breed (Dobi et al., 2006). Based on the results of this study and results of previous studies (Ajmone Marsan P. et al 2008) microsatellite markers (Hoda et al., 2014) and SNP markers (Hyka et al. 2013) it was concluded that.... "*Albanian goat breeds are important reservoir of genetic diversity, have a low level of differentiation and high level of admixture...*". Anyway, Hasi goat has a distinct morphological traits which are main identification sources and selection criteria. Animals are.... "*Adapted to harsh environment and extensive management. Strong and rustic even during winter season. Well-developed body, long legs, well developed udder. Reddish, long hair. Pending ears of middle size, backward curled horns*" (Dobi et al., 2006)

The phenotypic differentiation is based on traditional selection criteria applied by farmers. Even nowadays they continue to select goat kids for replacement based on: "Reddish colour, medium size pending ears, and backward curled horns, high milk productive mothers with good developed teats, as well as the ability to browse high branches". Proud of their breed, farmers don't accept crossing their goats with other local or imported goat breeds, guaranteeing in this way the purity of the population. Morphological uniformity of Hasi goat breed in this territory is an important element of differentiation. This is one of criteria introduced in the Code of Practice.

3) **The environmental issue and management of the pastoral resources**

The current situation in Hasi district can be defined as a sort of "residual pastoral system", based on a multitude of very small mixed crop and livestock holdings. As grazing areas are not a limiting factor in this "last remaining people" situation, feeding strategies are mainly based on pasture or non-cultivated land. Nowadays, livestock farming activities are reshaping a new agrarian landscape around different evolution patterns. The systems of funnel-shaped hollows in a karst region allow higher forage production on a poor limestone soil, but also a diversity of plants, so important for a pastoral system.

Livestock development that relies mainly on the exploitation of natural pastures has as challenge to maintain or improve the productive potential of the environment and quality of available resources. Currently pasture resource management are driven by the individual strategies and it is not organized or regulated, and therefore, there is pressure in certain areas, especially near villages, while in other areas we have a situation of under grazing.

For this purpose, the project it is focused on the promotion of modern grazing methods, application of appropriate stocking rate, and taking measures for the regeneration of damaged or overgrazed grasslands. This can be enabled through farmers group decision-making, organized around a quality mark and the implementation of the Code of practice drawn up by farmers themselves.

4) **The traditional management, breeding system and pastoral practices;**

Farm typology is strongly related with geomorphology and natural resources. Based on their interaction with the market the farms are classified into four main types:

□ Auto-consumption farms (<10 heads). Products from this type of farm are consumed by the family. Goat farming is a secondary activity, complementary to other agricultural or non-agricultural activity. This type of farms concerns 26% of the 153 goat farms of Hasi region.

□ Subsistence farms (10-50 heads). These little flocks (27% of the goat farms), are producing less than 25 kids per year, supplying a low income when kids are sold. The family often combine another activity (mainly sheep and/or cattle farming) giving additional income. Feeding is mostly based on the use of natural resources as pastures, scrublands and oak leaves, and very few cereals.

□ Semi-specialized farms: (50-100 heads). Beyond 50 goats, animals and milk commercialization may supply a decent income for a family. But the marketing issue is crucial and is, in our diagnosis based on field-work enquiries, a limiting factor for increasing the number of animals in this type of farm, which actually concerns 21% of the goat farms.

□ Specialized farms: (>100 heads). Those farms often have high means of production (workforce, capital, agricultural capacity) and are supported by the state through the subsidy of 500 lekë (3.6 Eur) per breeding goat. They are mainly located within the sinkhole plateau, where the trade opportunities are facilitated by the settled partnerships with goat-dealers. This type of farm may concern 26% of goat farms in Hasi region and the flocks seem to grow, particularly in sinkhole plateau.

Breeding season is short and starts in second half of October, defining in this way lambing season in the second half of March. Farmers have chosen to breed goats in this season in order to save food they need for goat kids for their second month of life, so new goat kids may start browsing in their second month of life when new leafs burst in April and May. Weaning is made during the third month of age, but in some cases farmers prefer to keep goat kids with their mothers for longer with the argument that this produces better meat quality with lighter colour. This breeding season gives to farmers the opportunity to sell goat kids during summer months, when farmers from other areas have already sold their product.

Feeding strategy in Has, is mainly based on natural forage resources such as low oak forests, scrublands and pastures. Goat breeding is the only way to valorise those ligneous resources, converting them into foods products and substantial farm incomes. During part of winter animals are kept indoor and fed with dried oak leafs collected during summer and autumn, hay harvested in rich pastures as well as small quantities of cereals produced on the farms or purchased in the market. From 24 farmers' interviews, appeared that the average of pasturing time in one year is 10.34 month, but no one uses pasturing less than 10 months per year. One of them says *“the goats may die if we keep them inside the barn... if the snow layer is under the goat knees, they should go to browse in shrubs”*

Most of farmers use pastures around their village, in the distance they may reach in one day. From all interviewed, only one applies transhumance, this mainly because of lack of water supply in pastures but also because of availability of pastures close to villages. Considering these management elements as specifics of the area and the production process, they have become crucial elements for the Code of practice. This document was prepared in very close collaboration with the Hasi goat farmers association, considering that the collective action is the only way to implement common production standards and develop GI. This process brings shareholders and stakeholders together with a common understanding of these challenges, and finds the best fit between private interests, management of the common good (labels), and public good (agro-biodiversity conservation).

Conclusion

A comprehensive sustainable development approach – agro-biodiversity valorisation and conservation– requires a reflexive and practical interactive method all along the collective action process. Geographical Indication building is a complex process that has to combine collective action and knowledge-based product specification of such silvo-pastoral systems.

This process brings shareholders and stakeholders together with a common understanding of these challenges, and finds the best fit between private interests, management of the common labels, and public good (agro-biodiversity conservation). It has to be complementary to the breed identification process, environmental assessment, production system analyses and support to appropriate pastoral practices.

All above mentioned elements which gives specific profile to the product are crucial for developing the GI. These elements are already part of the code or practice, which is a standard of the product.

Acknowledgment

This work is made in the frame of BIODIV Balkan project financed by FFEM, CIHEAM-IAM and MADA.

References

- Ajmone Marsan Paolo, Hoda Anila , Dobi Petrit, Dunner, Susana, Obexer-Ruff Gabriela, and Econogene Consortium “*Genetic diversity of 6 Albanian local goat breeds based on microsatellite analysis*” Symposium “Animal husbandry, veterinary medicine and economy in the healthy and food safety production” Montenegro, Herceg Novi 22-29 of June, 2008.
- Bernard, J-P. Boutonnet, A. Garnier, F. Lerin, B. Medolli (2014). “*Quality labels: a way to support the development of pastoral resources*” Methodological insights based on the monographic analysis of Hasi Region – Northern Albania Options Méditerranéennes, A, no. 109,
- Dobi, P, Hoda, A, Sallaku, E, Kolaneci, V. (2006) “Local small ruminant breeds” Agricultural University of Tirana, Albania.
- FAO “*Phenotypic characterization of animal genetic resources*” 2012 FAO Animal Production and Health Guidelines No. 11. Rome
- Garnier A. (2013). *Analyse descriptive d'un terroir du Nord de l'Albanie : le Has. Systèmes d'élevage et ressources pastorales.* (Descriptive analysis of a region in Northern Albania: Has. Farming systems and pastoral resources) Ciheam-IamM/Université Montpellier III. Ingénierie et Gestion des Territoires (IGT), Montpellier. 76 p.
- Garnier A. (2014). *Pratiques d'élevage et diversité paysagère dans le Has Albanais.*(Farming practices and landscape diversity in Albanian Has) Master of Science: Ciheam-IamM, Montpellier (France). 116 p.
- Hoda Anila, Biçoku Ylli & Dobi Petrit “*Genetic diversity of Albanian goat breeds revealed by mtDNA sequence variation*” Biotechnology & Biotechnological Equipment“ Volume 28, Issue 1, 2014
- Hykaj, Gentian, Hoda Anila, Dobi Petrit, Papa Lumturi, Bakiu Rigers and Novaku Mariol * “*Population structure and genetic distances between six Albanian local goat breeds using 26 SNP markers*” Livestock Research for Rural Development Volume 25, Number 4, April 2013
- Kipi, B. Mersini, K. “*Study on the potentials of the goat meat and cheese in the area of Hasi district (Region of Kukes) In the context of quality signs and development of the respective value chains*” June 2013
- Medolli B. (2013). *Analyse descriptive d'un terroir au Nord de l'Albanie : le Has. Mise en marché et dynamiques des filières des produits animaux.* (Descriptive analysis of a region in Northern Albania: Has. Marketing and dynamics of animal product's chains) _ Ciheam-IamM/Université Montpellier III. Ingénierie des projets et des politiques publiques (I3P), Montpellier. 78 p.

OPTIMIZATION OF ENZYMATIC SACCHARIFICATION FOR QUALITY IMPROVEMENT OF BIO-OIL FROM RICE STRAW

Khan CHAND*, Manish PANT

Department of PHP&FE, College of Technology, G B Pant University of Agril& Tech, Pantnagar, India

*Corresponding author: kcphpfe@gmail.com

Abstract

The reducing sugar ranged from 25.1 to 34.8 g/L and glucose content ranged from 15.1 to 28.9 g/L, lignin ranged from Bio-oil, another category of renewable energy has gained significant interest of scientist in recent years. The major problem in production of bio-oil is its increase in density with the passage of time. The reason for such phenomenon is the cross-linking of lignin which was bound to bio-oil after pyrolysis. The aim of this work was to reduce the content of lignin in rice straw and study the effects of decreased lignin content in bio-oil. Additionally enzymatic saccharification of rice straw was also conducted after pre-treatment to estimate optimum conditions for bio-oil production. The independent variables for the optimization of enzymatic saccharification were, time (24, 48, 72 hours), Enzymatic loading ratio (5:10, 10:10, 15:10), substrate concentration (4, 5, 6% w/v) were taken into account. Designed experiments were conducted randomly to find the effect of these variables on reducing sugar, glucose concentration, lignin, ash, cellulose, hemicelluloses. The analysis of variance for each sample was calculated. The reducing sugar increased with increase in time and enzyme loading ratio while lignin content increased with increase in substrate concentration 48.1 to 51.1% w/w and 9.1 to 12.1 w/w. Optimum value of levels of predicted variables obtained by compromise optimization of the responses were; 64.8 h time, 15:10 enzyme loading ratio and 4.62 substrate concentrations.

Key words: *Rice straw, lignin, ash, cellulose, bio-oil and reducing sugar*

Introduction

Lignocellulosic substrates are regarded as one of the most important sources of carbon and related carbohydrates. Its subsequent bioconversion and utilisation into useful products can be regarded as better sources of energy and fuel. Rice straw consists of three main components: cellulose, hemicellulose, and lignin. The complexity of these components leads to the stability of its biomass and results in the difficulty of its enzymatic disassembly. Rice straw consists of cellulose (35–40% w/w) and hemicellulose (25–30% w/w) in close association with lignin (10–15% w/w), is one of the most abundant lignocellulosic crop residues (Thygesenet al. 2003).

In terms of total production, rice is the third most important grain crop in the world behind wheat and corn. As per commodity profile for rice (March 2015), world annual rice production in 2014-15 was estimated about 475 million tons (Source: International Grains Council). Similarly for commodity profile of rice (March 2015), India's annual rice production in 2014-15 was estimated about 103.04 million tons (Source: Directorate of Economics and Statistics). Rice production in Uttarakhand in 2014-15 was estimated to about 5.5 lakh tonnes (Mani, 2015). Every kilogram of grain harvested is accompanied by production of 1–1.5 kg of the straw (Maiorella et al. 1985). It gives an estimation of about 480–720 million tons of rice straw produced per year globally and a large part of this is going as cattle feed and rest as waste. The options for the disposition of rice straw are limited by the low bulk density, slow degradation in the soil, harbouring of rice stem diseases, and high mineral content. Nowadays, field burning is the major practice for removing rice straw, but it

increases the air pollution and consequently affects public health (Mussatto and Roberto, 2004). As climate change is extensively recognized as a threat to development, there is growing interest in alternative uses of agro-industrial residues for energy applications. In this context, rice straw would be a potential candidate for our future energy needs.

Bio-oil is normally derived from biomass such as rice straw. The benefit of energy generation is often offset by the increased emissions, thus restraint its value as fuel for incineration. Therefore, alternative technologies should be invented in order to transform this beneficial renewable biomass into useful products. Liquefaction of rice straw using thermo chemical conversion process such as pyrolysis offers an option for conversion of solid biomass into liquid bio-oil. Bio-oil is easier to transport, store, and can be upgraded to improve its quality. Bio-oil is also utilized as specialty chemicals like flavourings, renewable resins and slow release fertilizers (Baratieriet al. 2008, Abdullah and Gerhauser 2008). However, bio-oil cannot be used as a direct substitution for petroleum and chemical feedstock since it has high viscosity, high content of unstable oxygenated molecules and high density (1.2 kg/L). Therefore, upgrading of bio-oil into higher quality liquid product with wider applications is necessary. Various upgrading methods have been reported including solvent fractionation, steam reforming, hydrogenation, and catalytic cracking.

The main objective of this thesis is to investigate the potential of chemically pretreated rice straw as a promising endeavour for bio fuel production. The usage of alkaline chemical in the pre-treatment of rice straw and enzymatic hydrolysis to degrade lignocelluloses biomass and saccharification of cellulose is expected to alter the original biomass structure.

Response surface methodology by Box–Behnken design employing the multivariate approach enables substantial improvement in the method development using fewer experiments, without wastage of large volumes of organic solvents, which leads to high analysis cost (Waniet al. 2012) it can be used to get an optimum process conditions considering single response or multiple responses. It encompasses statistical and mathematical techniques. In view of the above, present study was undertaken with the following objectives:

1. To study the effect of alkali treatment on rice straw after drying and mechanical treatment.
2. To identify optimum operating conditions for enzymatic saccharification.
3. To prepare the bio-oil after pyrolysis of untreated and pre-treated rice straw.

Materials and Methods

Rice straw (*Oryza Sativa L.*) was procured from Crop Research Centre (C.R.C.) of GovindBallabh Pant University of Agriculture and Technology, Pantnagar. Chemicals and enzymes used in the sample preparation for the pre-treatment of rice straw and for proximate analysis chemicals were purchased from Himedia Pvt. Ltd.

Drying of Rice Straw

The procured rice straw was dried in a hot air oven simultaneously moisture content was also evaluated. The rice straw was dried at 115°C until it kept constant weight during estimation of moisture content (Zhang et al. 2008). After that the rice straw was bone dried for size reduction process.

Determination of moisture content:

The moisture content of the sample was calculated using the following equation:

$$\%W = [(A-B)/B] * 100 \quad \text{.....(1)}$$

Where:

%W = Percentage of moisture in the sample,

A = Weight of wet sample (gm), and

B = Weight of dry sample (gm)

Size Reduction of Rice Straw

The dried rice straw was subjected to size reduction process in hammer mill. The mesh size being used was of 2 mm size. The size reduction process was done for better availability of grounded straw to alkali during pre-treatment process.

Alkali Pre-treatment

The alkali pre-treatment was used for reduction of lignin content in the sample. The alkali pre-treated samples were used for enzymatic saccharification. The rice straw was treated with 2% (w/v) NaOH solution at 85°C for 1 hours. Then the treated rice straw was washed with water until neutral pH achieved and then oven dried.

Enzymatic Saccharification

Preliminary experiments

Preliminary trials were conducted for subjection of enzymes to the pre-treated rice straw. The objective of this experiment was to examine the effects of one step enzyme addition and two step enzyme addition during saccharification process. The one step enzyme addition included the addition of enzymes viz. cellulase (10 FPU) and β glucosidase (10 IU) at conditions mean to their optimum activity in individual action for 24 hours. On the other hand in two step enzyme addition the enzyme in similar amounts were added but at varied conditions as provided by manufacturer's recommendation on optimum activity of individual enzymes in the intervals of 12 hours. The substrate used in the experiment was cellulose powder (5% w/v concentration) with the two enzymes viz. cellulase and β -glucosidase. The operating conditions of each enzyme and used in one step enzyme addition are shown in Table 1.

Table 1 Operating conditions of preliminary experiments

Method	Temperature	pH
One step enzyme addition	37°C	4.8
Two step enzyme addition:		
Cellulase	40°C	4.5
β -glucosidase	35°C	5.0

Enzymatic saccharification

The experiments designed by Design-Expert software included 17 experiments. The enzymatic saccharification process was based on independent parameters. The parameters of process was introduced in software are in numeric forms varied over 3 levels.

Thus here, designs are format of Box-Behnken design of response surface methodology. Various experiments to be conducted were accordance to the ratio included in the RSM with Run time analysis.

Experimental Design

Experimental design, defined as a specific set of experiments which are defined by a matrix, a matrix composed by the different level of combination variables. Response surface methodology (RSM) was used for the design and analysis of all experiments for three predicted variables at three levels. It also helps to reduce the number of experiments without affecting the accuracy of results and to decide the interactive effects of influencing factors on the response. Box-Behnken model was selected for the optimization of the process variables (Sharma 2014). Box-Behnken is a class of rotatable second order design based on thoursee levels incomplete factorial design. This design does not contain for which all factors are simultaneously at their highest and lowest levels. So this design is useful in avoiding experiments performed under extreme conditions for which unsatisfactory results might occur (Bezzerat al. 2008). The detailed values of independent and constant variables of experimental design are given in Table 2 and 3.

The number of experiments (N) required for development of Box-Behenken Design. This design is defined as:

$$N=2K(K-1)+C_0 \quad \text{..... (2)}$$

where,

N= Total no. of experiments

K = No. of variables

C₀= Centre point

In order to determine a critical point (maximum, minimum or saddle) it is necessary for the polynomial function to contain the quadratic terms. According to the equation presented below:

$$y = \beta_0 + \sum_{k_i=1} \beta_i X_i + \sum_{k_{ii}=1} \beta_{ii} X_i^2 + \sum_{k_{1<i<j}} \beta_{ij} X_i X_j \quad \text{..... (3)}$$

where

β_{ii} , β_0 and β_{ij} are the coefficients of regression. (i=1, 2, 3,n) (j=1, 2, 3,n)

Table 2. Values of level of independent variables

Independent variables	Values		
	-1	0	+1
Reaction time (hours)	24	48	72
Enzyme loading ratio	5:10	10:10	15:10
Substrate concentration (% w/v)	4	5	6

Table 3. Values of constant variables

Variables	Values
Temperature	37°C
pH	4.8
Buffer concentration	0.1M

Experimental Procedure

The whole experiment was conducted in three phases. Experiments were planned with a view to develop pre-treated, enzymatically hydrolysed agricultural waste, which could be a better method for bio-oil extraction by pyrolysis. In the first phase experiments were carried out by already optimised pre-treated conditions for rice straw for maximum breakdown of lignin. The said conditions utilised in alkali pretreatment were NaOH at 85°C for 1 hours. The analysis of sample was done on the basis of proximate parameters which are important for the sample analysis.

During the second phase, enzymatic hydrolysis was carried out and the independent variables (reaction time, enzyme ratio, substrate concentration) were optimised for best reducing sugar yield. Again, the analysis of sample was done on the basis of proximate parameters which were important for the sample analysis.

Reducing sugars

The DNS method for estimating the concentration of reducing sugars in a sample was originally invented by G. Miller in 1959. Reducing sugars have the property to reduce many of the reagents. A reducing sugar is one that in a basic solution forms an aldehyde or ketone. The aldehyde group of glucose converts 3,5-dinitrosalicylic acid (DNS) to 3-amino-5-nitrosalicylic acid, which is the reduced form of DNS. Water is used up as a reactant and oxygen gas is released during the reaction. The formation of 3-amino-5-nitrosalicylic acid results in a change in the amount of light absorbed, at wavelength 540 nm. The absorbance measured using a spectrophotometer is directly proportional to the amount of reducing sugar (Miller, 1959).

Ash estimation

Samples of air dried, ground (0.5 mm) lignocellulosic biomass (0.7 g each) were boiled with 5 mL of 72% w/w H₂SO₄ solution for 4.5 hours in order to hydrolyze the cellulose and hemicellulose. The suspension remaining after the above treatment was filtered through a crucible and the solid residue dried at 105°C for 24 hours and weighed (W1). The residue was then transferred to a pre-weighed dry porcelain crucible and heated at 600°C for 5 hours. After cooling down, it was weighed (W2) and ash content (%) was determined (Ververiset al. 2007).

Lignin estimation

The lignin can be estimated gravimetrically by klason or 72% w/w H₂SO₄ Method. The most widely used method for lignin determination by chemists is probably the simplest and overall the most reliable, despite its limitations. Samples were digested with 72% w/w sulphuric acid, then with dilute sulphuric acid, to hydrolyze and solubilise the polysaccharides; the insoluble residue

were dried and weighed as lignin (Liu, 2004). Following from ash estimation, acid insoluble lignin was then calculated by the difference (W1-W2) (Ververiset *al.* 2007).

Results and Discussion

Effect of independent variables on reducing sugar

Experimental data in Table 4 shows that in case of enzymatic pretreatment, the reducing sugar ranged from 25.1 to 35.2 g/L. Maximum reducing sugar was found 35.2 g/L for experiment number 17, with the combination of time 48 hours, enzyme loading ratio 10:10 and substrate concentration 5% w/v. Minimum reducing sugar was found 25.1 for experiment number 3, with the combination of time 48 hours, enzyme loading ratio 5:10 and substrate concentration 4% w/v. It can be concluded that enzyme activity for an optimum time proves highly significant in release of reducing sugar.

Effect of independent variables on lignin

Experimental data in Table 4 shows that in case of enzymatic pretreatment, the lignin ranged from 7.7 to 10.8% w/w. Maximum lignin was found 10.8% w/w for experiment number 9, with the combination of time 24 hours, enzyme loading ratio 10:10 and substrate concentration 6% w/w. Minimum lignin was found 7.7% w/w for experiment number 5, with the combination of time 48 hours, enzyme loading ratio 15:10 and substrate concentration 4% w/v. Lignin showed no significant reduction by enzymes. Lignin was directly proportional to substrate concentration.

Effect of independent variables on ash

Data tabulated in Table 4 shows that ash ranged from 7.8 to 9.8 % w/w. Maximum ash was found 9.8 % w/w for experiment number 11, with the combination of time 48 hours, enzyme loading ratio 5:10 and substrate concentration 6 % w/w. Minimum ash was observed 7.8 w/w for experiment number 5, with the combination of time 48 hours, enzyme loading ratio 15:10 and substrate concentration 4% w/w. Losses of ash content could be concluded from activity from enzymes because of conversion of cellulose to reducing sugar.

Table 4 Experimental data of independent parameters of enzymatic saccharification

	Factor1	Factor2	Factor3	Response1	Response3	Response4
Run	Time	ELR	Subs. Conc.	R. S.	Lignin	Ash
	hr	IU:FPU	%w/v	g/L	%w/w	%w/w
1	-1	-1	0	28.8	10.2	9.2
2	-1	0	-1	26.1	8.4	9
3	0	-1	-1	25.1	8.5	8.4
4	1	0	-1	27.9	8.1	7.9
5	0	1	-1	27.1	7.7	7.8
6	-1	1	0	27.9	9.7	8.4
7	1	-1	0	27.1	9.6	8.8
8	0	0	0	34.8	9.5	9.1

9	-1	0	1	25.8	10.8	9.1
10	0	1	1	30.8	10.6	9.4
11	0	-1	1	25.6	9.4	9.8
12	1	1	0	32.3	9.7	8
13	0	0	0	35	10.5	8.9
14	0	0	0	34.1	10	8.9
15	1	0	1	29.3	10.5	9.6
16	0	0	0	34.6	9.7	8.8
17	0	0	0	35.2	9.2	8.9

Statistical analysis of dependent variables

Reducing sugar

The statistical analysis of reducing sugar was given in Table 5. The model of reducing sugar was found highly significant ($P < 0.01$) because it had higher F-value (44.63). It was also observed that the effect of independent variables on reducing sugar was highest at quadratic level due to highest calculated F-value (99.15) followed by linear level and interactive level.

Table 5. Analysis of variance for reducing sugar

SOURCE	DF	SS	MS	F _{value}
Model	9	218.59	24.29	44.63*
Linear	3	28.04	9.34	17.30*
Quadratic	3	160.62	53.54	99.15*
Interactive	3	12.58	4.19	7.76**
Residual error	7	3.81	0.54	
Lack of fit	3	3.1	1.03	N.S.
Total	16	222.4	24.83	

*, ** and *** Significant at 1, 5 and 10% level of significance respectively.

From **Fig. 1** at linear level, observed the effect of time on reducing sugar at optimum point of enzyme loading ratio 1.0 (15:10) and at substrate concentration -0.38 (4.62 % w/w) for producing quality improved bio-oil. It depicted that reducing sugar increased rapidly with increased level of time from -1 to 0.5. While it is constant with respect to time. Afterwards reducing sugar decreased with increased time and this point quality of bio-oil could decrease. The readings were supported by **Hsu et al. 2008**

From **Fig. 2** at linear level, observed the effect of enzyme loading ratio on reducing sugar at optimum point of time 0.7 (64.8 hours) and at substrate concentration -0.38 (4.62 % w/w) for producing quality improved bio-oil. It depicted that reducing sugar increased rapidly with increased level of enzyme loading ratio from -1 to 0.5. While it is constant with respect to enzyme loading ratio. Afterwards reducing sugar decreased with increased enzyme loading ratio and this point quality of bio-oil could decrease. The readings were supported by **Hsu et al. 2008**

From **Fig. 3** at linear level, observed the effect of substrate concentration on reducing sugar at optimum point of time 0.7 (64.8 hours) and at enzyme loading ratio 1 (15:10) for producing quality improved bio-oil. It depicted that reducing sugar increased rapidly with increased level of substrate from -1 to 0.25. While it is constant with respect to substrate concentration. Afterwards reducing sugar decreased with increased substrate and this point quality of bio-oil could decrease. The readings were supported by **Hsu et al. 2008**

Fig. 4 shows the variation of reducing sugar with time and enzyme loading ratio at optimum point of substrate concentration -0.38 (4.62%, w/v) in interactive level of the model. The reducing sugar increased with increase in the level of time and after some time it decreased steeply from -1(24 hr) to 1(72hr) while reducing sugar increases with increase in the level of enzyme loading ratio. The readings were supported by **Hsu et al. 2008**

Fig. 5 shows the variation of reducing sugar with substrate concentration and enzyme loading ratio at optimum point of time 0.7 (4.62%, w/v) in interactive level of the model. The reducing sugar increased with increase in the level of substrate concentration and after some time it decreased steeply from -1 (4% w/v) to 1 (6% w/v) while reducing sugar increases with increase in the level of enzyme loading ratio. The readings were supported by **Hsu et al. 2008**.

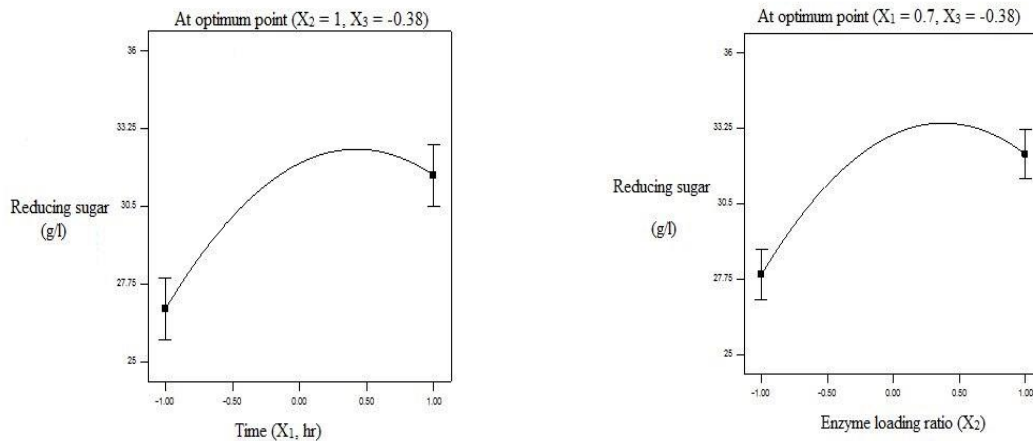

Fig 1 Effect of time on reducing sugar at optimum point
 Fig 2 Effect of enzyme loading ratio on optimum point reducing sugar at optimum point

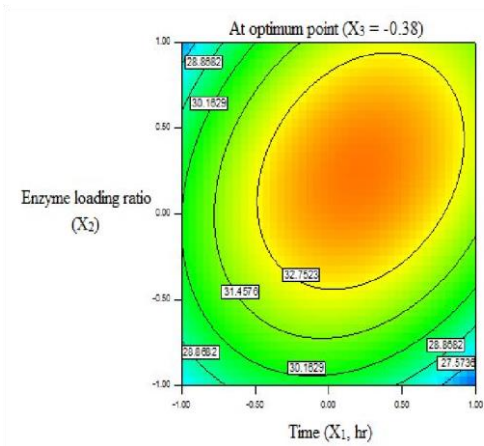
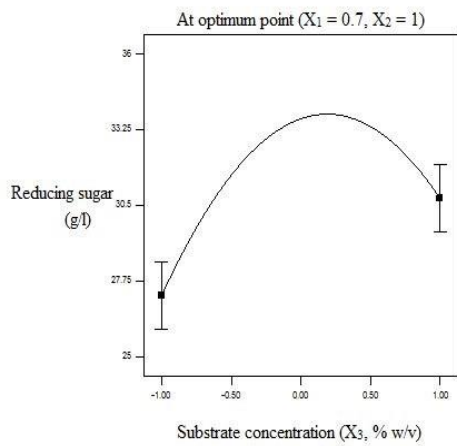

Fig 4.3 Effect of substrate concentration on reducing sugar at optimum point
 Fig 4.4 Effect of enzyme loading ratio and time on reducing sugar at optimum point

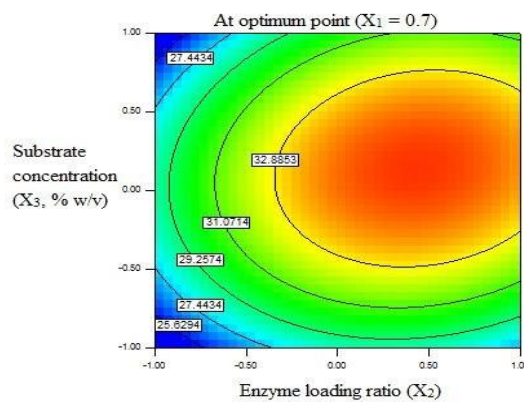

Fig 5 Effect of enzyme loading ratio and substrate concentration on reducing sugar at optimum point

Lignin

The statistical analysis of lignin was given in Table 6. The model of lignin was found highly significant ($P < 0.01$) because it had higher F-value (7.87). It was also observed that the effect of independent variables on lignin was highest at linear level due to highest calculated F-value (18.47) followed by quadratic level and interactive level.

Table 6 Analysis of variance for lignin

SOURCE	DF	SS	MS	F _{value}
Model	9	12.07	1.34	7.87*
Linear	3	9.43	3.14	18.47*
Quadratic	3	1.57	0.52	3.05
Interactive	3	1.09	0.36	2.11
Residual error	7	1.19	0.17	
Lack of fit	3	0.21	0.068	N.S.
Total	16	13.26	1.51	

*, ** and *** Significant at 1, 5 and 10% level of significance respectively.

From **Fig. 6** at linear level, observed the effect of substrate concentration on lignin at optimum point of enzyme loading ratio 1 (15:10) and at time 0.7 (64.8 h) for producing quality improved bio-oil. It depicted that lignin increased regularly with increased level of time from -1 to 1. While it is constant at point A with respect to enzyme loading ratio. More of the substrate concentration analysed provided for the increased lignin content.

Fig. 7 shows the variation of lignin with substrate concentration and enzyme loading ratio at optimum point of time 0.7 (64.8 h) at interactive level of the model. The lignin increased steeply with increase in the level of substrate concentration (X_3 , %, w/v) and the lignin is reduced with increasing enzyme loading ratio.

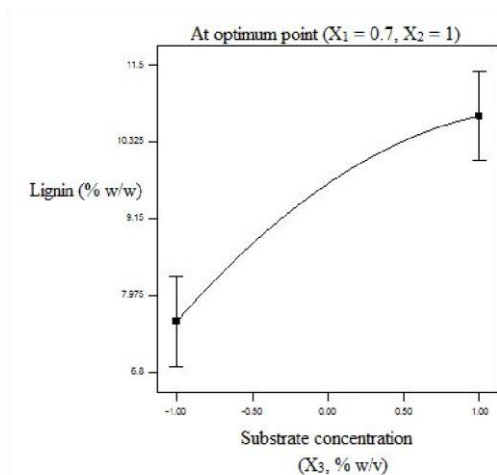

Fig 6 Effect of substrate concentration point

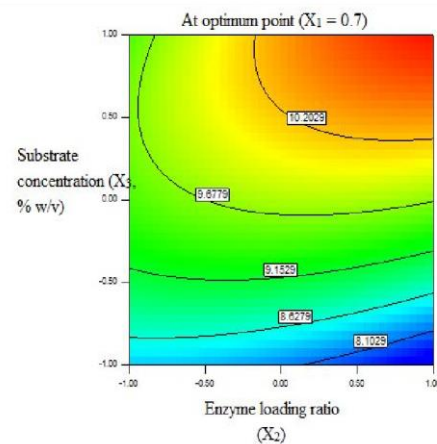

Fig 7 Effect of enzyme loading ratio and substrate concentration on lignin at optimum

Ash

The statistical analysis of ash was given in Table 7. The model of ash was found highly significant ($P < 0.01$) because it had higher F-value (13.69). It was also observed that the effect of independent variables on ash was highest at linear level due to highest calculated F-value (33) followed by interactive and quadratic level.

Table 7 Analysis of variance for ash

SOURCE	DF	SS	MS	F _{value}
Model	9	4.89	0.54	13.69*
Linear	3	3.96	1.32	33*
Quadratic	3	0.273	0.091	2.27
Interactive	3	0.65	0.21	5.25
Residual error	7	0.28	0.04	
Lack of fit	3	0.23	0.077	N.S.
Total	16	5.17	0.58	

*, ** and *** Significant at 1, 5 and 10% level of significance respectively.

From **Fig. 8** at linear level, it was observed that ash decreases with increase in regressor of time at optimum values of enzyme loading ratio 1 (15:10), time 0.7 (64.8 h).

From **Fig. 9** at linear level, it was observed that ash decreases steeply with increase in regressor of enzyme loading ratio and then decreases at optimum values of time 0.7 (64.8 h), enzyme loading ratio 1 (15:10).

From **Fig. 10** at linear level, it was observed that ash increases steeply with increase in regressor of substrate concentration -0.38 (4.62%, w/v) at optimum values of time 0.7 (64.8 h), enzyme loading ratio 1 (15:10).

From **Fig. 11** shows the variation of ash with time and substrate concentration at optimum point of enzyme loading ratio 1 (15:10) at interactive level of the model. The ash decreased with increase in the level of time from -1(24 h) to 1(72h) while ash increased in the level of substrate concentration.

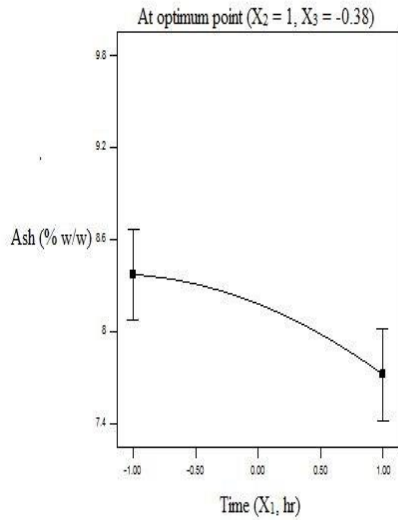

Fig 8 Effect of time on ash

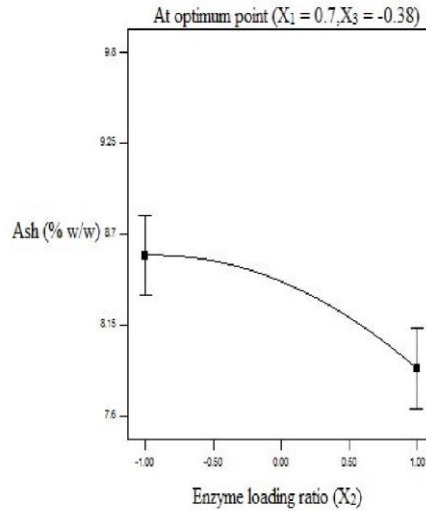

Fig 9 Effect of enzyme loading ratio on ash at optimum point

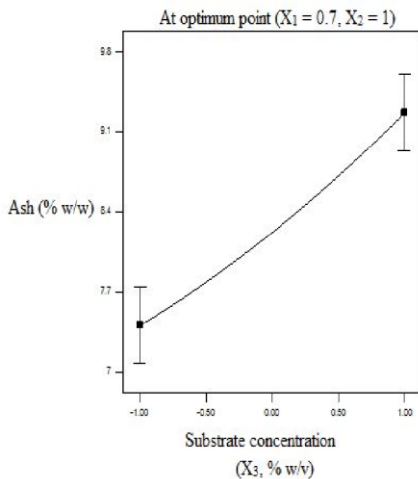

Fig 10 Effect of substrate concentration

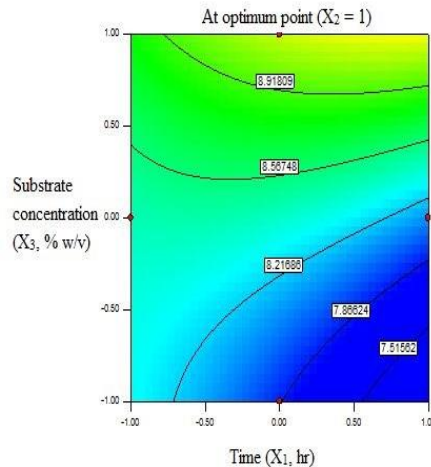

Fig 11 Effect of time and substrate concentration on ash at optimum point

Conclusions

The present study was aimed at removal of lignin and saccharification of rice straw for quality improvement of bio-oil. In the proposed work, lignin removal was achieved upto 10% and saccharification resulted in high yields of reducing sugar. Experiments were planned and carried out on size reduced and alkali pretreated rice straw. The best suited set of experiments were used to optimise the process. RSM was used for designing of the experiments and to select the optimum levels of independent variables. Box-Behnken was chosen to design and to determine the combination and levels in each experiments. The three levels of independent variables were time (24, 48, 72 hr), enzyme loading ratio (5:10, 10:10, 15:10) and substrate concentration (4, 5, 6 % w/v). Data obtained from statistical analysis was utilised to get the optimised set of predicted variables. Graphical optimisation was done drawing contours.

On the basis of the experimental results and data analysis shows following conclusions:

The enzymatic saccharification released reducing sugar may have multiple fates viz. Bio-ethanol, Biogas, Bio-oil, Bio-diesel. Reducing sugar yields describe its effects from all three independent variables. Moreover interactive effects were also seen in both numerical and

graphical analysis. Lignin showed responses from substrate concentration. Although little effects were observed from both time and enzyme loading ratio. Ash showed linear effects from all three independent variables.

Hence it could be recommended that for production for better quality of bio-oil, the best suitable saccharification condition of independent variables should be: time 64.8 hours, enzyme loading ratio 15:10, substrate concentration 4.62% w/v. The future scope of this study could show a path towards sustainable, renewable and pollution free energy source.

References

- Arvanitoyannis IS, Kassaveti A (2007a). Current and potential uses of composted olive oil waste. *International Journal of Food Science and Technology*, 42(3): 281 – 295. doi: 10.1111/j.1365-2621.2006.01211.
- Ates F, Putun E, Putun AE (2004) Fast pyrolysis of sesame stalk: yields and structural analysis of bio-oil. *Journal of Analytical and Applied Pyrolysis*, 71:779–90.
- Ayşe E. Putun, Esin Apaydın, Ersan Putun (2004) Rice straw as a bio-oil source via pyrolysis and steam pyrolysis. *Energy*, 29 ;2171–2180.
- Baig M.M.V., M.L.B. Baig, M.I.A. Baig and Majeda Yasmeen (2004) Saccharification of banana agro-waste by cellulolytic enzymes. *African Journal of Biotechnology*, Vol. 3 (9), pp. 447-450.
- BakJinSeop, Ja Kyong Ko, Young Hwan Han, ByungCheol Lee, In-Geol Choi and KyoungHeon Kim, (2008) Improved enzymatic hydrolysis yield of rice straw using electron beam irradiation pretreatment. *Bioresource Technology* 100, 1285–1290
- Baratieri M, Baggio P, Fiori L and Grigiante M.(2008) Biomass as an energy source: Thermodynamic constraints on the performance of the conversion process. *Bioresource Technology*; 99:7063-7073.
- Bezerra M.A., Santelli E.R., Oliveira P.E., Villar L.S. and Escaliera A.E. (2008) RSM as a volumetric tool for optimization in analytical chemistry. *Talanta*, 76:965-977
- Binod Parameswaran, Raveendran Sindhu, Reeta Rani Singhanian, Surender Vikram, Lalitha Devi, Satya Nagalakshmi, Noble Kurien, Rajeev K. Sukumaran, Ashok Pandey, (2010) Bioethanol production from rice straw: An overview. *Bioresource Technology* 101;4767–4774
- Zanariah, C. W., Ngah, C. W. and Yahya, M. A. (2012) Optimisation of digestion method for determination of arsenic in shrimp paste sample using atomic absorption spectrometry.
- Zheng Ji-lu (2007) Bio-oil from fast pyrolysis of rice husk: Yields and related properties and improvement of the pyrolysis system. *Food Chemistry*, 134(4), 2406–2410.
- Zhang QiuZhuo and Wei Min Cai, (2008) Enzymatic hydrolysis of alkali-pretreated rice straw by *Trichoderma reesei* ZM4-F3. *Biomass and bioenergy* 32,1130–1135
- Zhang, Y.H.P., Ding, S.Y., Mielenz, J.R., Cui, J.B., Elander, R.T., Laser, M., Himmel, M.E., McMillan, J.R. and Lynd, L.R., (2007) Fractionating recalcitrant lignocellulose at modest reaction conditions. *Biotechnology and Bioengineering* 97, 214–223.

DESIGN OF A SMALL-SIZE MILKING PARLOR AND ITS MANAGEMENT VIA PROGRAMMABLE DIGITAL CONTROLLERS

Metin DEMIRTAS¹, Yasin AYDIN², Seydi DOĞAN¹, Ayhan ISTANBULLU³, Suat ONUR¹, Cevdet KELOGLU⁴

¹Department of Electrical and Electronics Engineering, Balıkesir University, Balıkesir, Turkey

²Vocational High School, Electric and Energy Department, Celal Bayar University, Manisa, Turkey

³Department of Computer Engineering, Balıkesir University, Balıkesir, Turkey

⁴Balıkesir Industrial Zone, Balıkesir, Turkey

*Corresponding author: mdtas@balikesir.edu.tr

Abstract

In extracting the highest possible amount of milk from a dairy animal, it is important that the functional and structural features of the milking machines used do not cause irritation to the animal or discomfort to their udders. To ensure that the highest quality of milk is extracted from the milking machines, it is key that a hygienic milking process is employed using hygienic devices. As part of this hygienic process, system cleaning is performed through imitation milking, where milking clusters are attached to artificial milking liners that are connected to a washing boiler, instead of a milking animal. With the system operating in washing mode, detergent and rinse water, rather than milk, are delivered through hoses. The use of a fully automated milking system to minimize errors and reduce the amount of human labor involved in the milking process benefits both manufacturers and consumers. In this paper, a 2x5 (for ten animals) milking unit, operated using Programmable Logic Controllers (PLCs) was designed. The necessary power and control circuits were controlled by software installed on the PLC. With this technology, the milking process can be programmed to automatically stop once the milking is completed. The operator can intervene to stop the system. The system can also be operated manually.

Keywords: *Milking parlor, Programmable Logic Controller, Automatic Washing System*

Introduction

Milk is defined as a whitish liquid, with a specific taste, smell and texture, which is secreted from the mammary glands of mammals immediately following the birth of offspring. Milking is the process of obtaining milk, which is a primary source of income for a dairy plant. Consistency in performance, meaning that the milking is continued until the milking animal is completely dried up, is the key feature of the milking process (Aliç & Yener, 2006).

Turkey is among the fifteen largest milk producing countries in the world, with a total annual milk production of 10 billion liters. Of this production, 90% is derived from cows, with the remaining amount produced from among a distribution of goats, sheep and buffalos lower rates (Demir et al., 2012). In terms of production values, milk production constitutes 15% of the dairy industry (Sağlam et al., 2014). Given the significant economic value of milk and its importance in food products, competitive advantages have been determined by high quality, efficient production practices (Aliç & Yener, 2006). In securing greater operational efficiency to improve profit margins, attention has been increasingly focused on obtaining a high quality and high amount of milk through automated control of the milk production process (Özer, 2014).

In businesses engaging in dairy farming, the milking process constitutes 65% of internal operations, making it a time consuming and demanding production phase (Demir & Öztürk, 2010; Numan & Kadir, 1997). A quickly performed milking process has importance in terms

of operating cost. Failure to perform the milking process in an even manner can significantly affect the health of the milking animal. The style, method and technical performance of milking has both direct and indirect impacts on udder health and milk quality (Hülya & Bilgen, 2004). To increase productivity and quality in milk production, any problems that are present must first be properly addressed, particularly those involving matters related to the hygienic production of milk, which can be overcome by milking as many milking animals as possible in a healthy, clean way, using less manpower and energy, and by following the latest advances made in milking machine technology to develop a strong infrastructure and make favorable investments (Işık & Ünal, 2003).

Today, various types of milking systems are used. These can be grouped under four main classes: hand milking, milking parlors, robotic milking and single-machine milking (Ordolff, 2001; Rossing & Hogewerf, 1997). Out of all the types, hand milking is the poorest quality milking method, as it almost always leaves a little milk in the animal's udder. This milk left in the udder spoils, causing a decrease in the milk productivity of the milking animal, which over time results in major economic losses (Nedret & Tülay, 1997).

In contrast to hand milking, machine milking offers a higher quality of milking. Milking parlors, which feature the use of machines and have a complex structure, have become an indispensable system for milk producers due to their ability to perform mass milking and to conduct hygienic, fast and efficient cleaning.

Material and methods

The Programmable Logic Controllers (PLCs) used in industrial systems provide very effective solutions for general purpose control and automation procedures in all areas of industrial practices (Gök, 2008). The PLC systems have gained an advantage over classical control systems thanks to the flexibility of its software. PLCs can be divided into three main units: Input, Program and Output. The program unit processes the data received by input units via sensors, using a program installed in the memory by the process unit. Outputs are then sent to output units, which enable machine control (Özdem & Samurkaş, 2003). As part of the industrial development that has taken place in the agricultural sector, these control devices have proven to be effective in producing successful results (Tekin & Değirmencioğlu, 2010).

Figure 1 presents a block diagram demonstrating the PLC input/outputs. A total of seven inputs are used start button, stop button, washing boiler level sensor, transfer boiler level sensor, washing direction button, milking direction button and emergency stop button—matched by a total of seven outputs—vacuum pump, transfer pump, waste water pump, cold water valve, hot water valve, detergent pump and emergency stop.

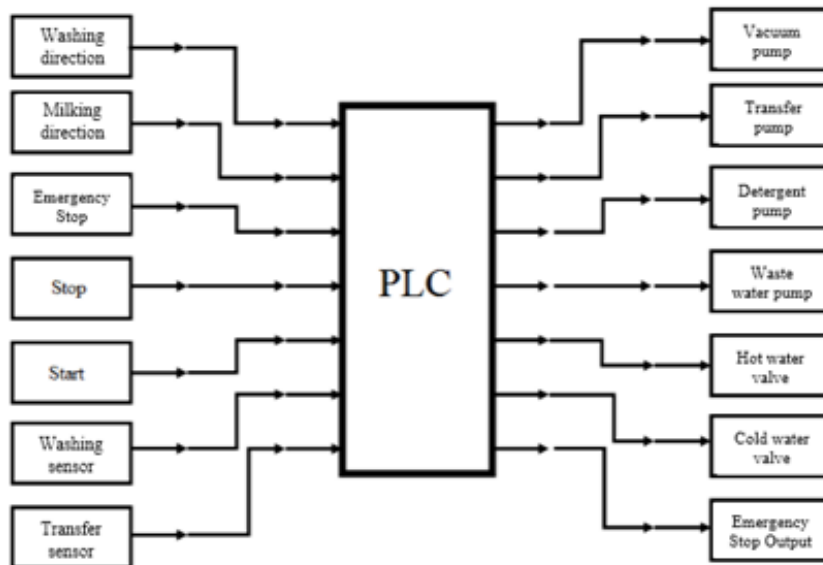

Figure 1. Inputs and Outputs of PLC for Milking Parlor

The system involves two main processes: washing and milking. In the milking mode, the vacuum pump directly activates the milking process once the milking machine liners are attached to the teats of the animal. The milk suctioned from the vacuum hose pours into the transfer boiler. When the transfer boiler is filled up, the milk is transferred into a cooling tank. During the milking process, the transfer boiler is filled up and discharged an average of 10-12 times, depending on the number of milking animals. This process continues until the milking is completed, at which point the milking animals are removed from the milking area.

Once the milking process is finished, the system must be cleaned. System cleaning is done by performing imitation milking, which involves attaching the milking clusters to artificial milking liners that are connected to a washing boiler instead of a milking animal. When the system operates in washing mode, detergents and rinse water, rather than milk, are delivered through the hoses.

The washing procedure is somewhat more complicated than the milking procedure, as it requires more manual actions to be taken. To begin, the milking clusters need to be attached to the artificial milking liners connected with the washing boiler. Next, the pipe between the transfer motor and the cold water tank need to be connected to the washing boiler before switching the routing configuration to the washing mode. When the washing process starts, the washing boiler starts to fill with cold water. Once the washing boiler is filled up, the system-connected sensor activates the vacuum motor by sending a signal to the PLC, and the water inlet is closed. The vacuum motor starts to spin water into the vacuum hose by drawing cold water from the system. Like the milking process, the water discharges into the transfer boiler, and when the transfer boiler is filled up, it sends water back into the washing boiler via transmission of a signal to the PLC (during the milking process, this line is connected to the cold water tank and the milk pours into this tank). This washing cycle continues until completion of the time entered on the PLC screen. When the prescribed time is up, the vacuum motor stops and the transfer boiler transfers all residual water from the hose to the washing boiler, regardless of whether it is completely filled. Any dirty water that has accumulated in the washing boiler is removed from the system via a waste water pump and is sent to the sewage or other proper waste area. The first washing is concluded upon completion of this procedure. The reason for spinning the cold water when performing the first washing is due to the fact that cold water softens solid wastes and prevents them from adhering to the inside of the hoses.

The second washing, which the PLC software automatically proceeds to perform once the first washing is complete, should be done using detergent and hot water. This cycle starts with the simultaneous activation of the hot water pump and the detergent pump. When the detergent, in the amount entered into the PLC system, is poured into the washing boiler, the detergent motor stops and stays open until the hot water washing boiler is filled. Once the washing boiler is filled with detergent and hot water, the sensor directs the vacuum motor to activate again by resending the command to the PLC. The only difference between the first and the second washing is that in the latter hot water is spun into the system instead of cold water. The detergent decomposes the milk and has a chemical structure that inhibits bacterial growth and is effective in breaking down food. When the time entered in the system has been completed, the vacuum motor stops and the transfer pump transfers all detergent water from the system to the washing boiler, and the waste water pump discharges the dirty water out of the system.

The third washing involves rinsing using warm water and is required to remove the detergent from the system. The rinsing process starts as soon as the waste water motor discharges the detergent from the system. Both cold and hot water simultaneously start to flow into the washing boiler. When the washing boiler fills up, the vacuum motor activates and the hot and cold water inlets close. The same washing cycle as mentioned above is exactly repeated. Finally, one more rinsing process is carried out by circulating only cold water. When the entire cycle is completed, the transfer boiler transfers any residual water in the system to the washing boiler. The waste water pump discharges the residual water from the system, marking the end of the washing process. Time, type and number of washings can be changed by entering the desired values onto the PLC screen.

The entire washing process, from the use of detergent, hot water and cold water inlets, activation and deactivation of the vacuum motor to the filling/discharging of the washer boiler and the entering/removing of waste water in/from the system, begins by simply pressing one single button and is automatically controlled by the PLC. Operator does not need to stand over the milking parlor machines while the washing process is in progress.

Although the milking process can be controlled by the PLC, it is important that an operator always be present in the milking parlor throughout the entire course of the milking process, including after performing liner attachment and in the intervening time before removing them from the animal, in order to manage any problems that may occur. While the operator should remain in the milking parlor until the milking process is completed, this, however, is not necessary for the washing process, which only requires that the operator push the button on the screen indicating washing mode and then manually redirect the hoses that are connected to the cooling tank to the washing boiler and attach milking liners to the washing clusters. The washing process lasts between an average of 60 and 90 minutes. Assuming that the washing process is done twice a day, a milking parlor with PLC control saves an average of 2 or 3 hours for the operator.

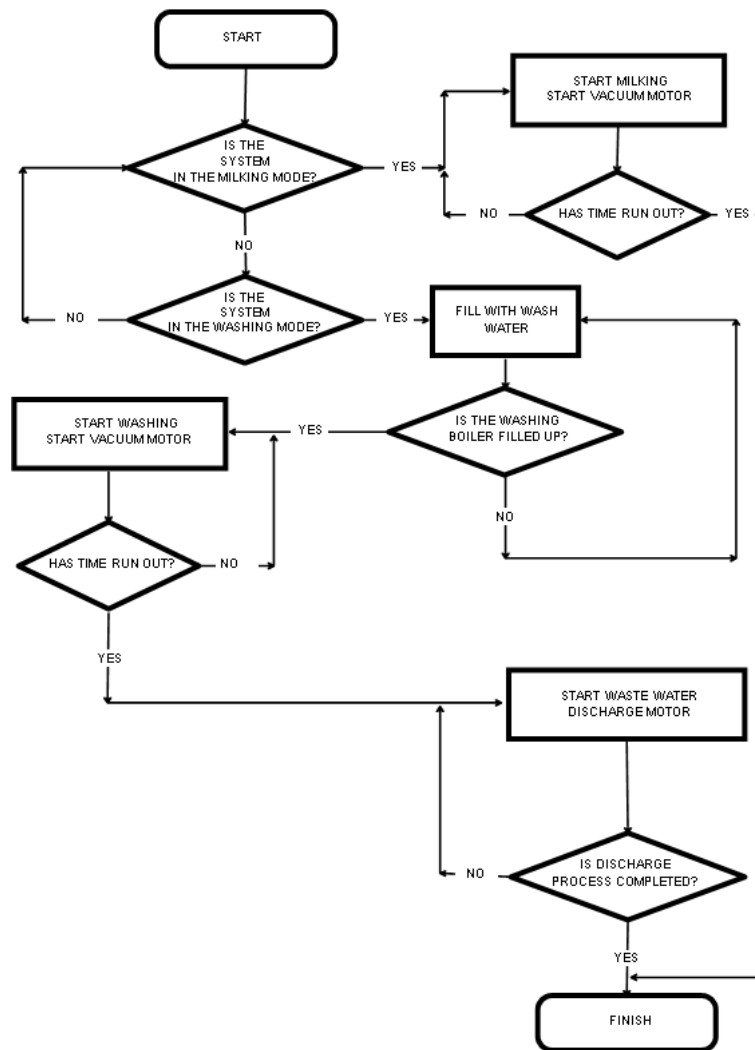

Figure 2. The PLC Process Flow Diagram

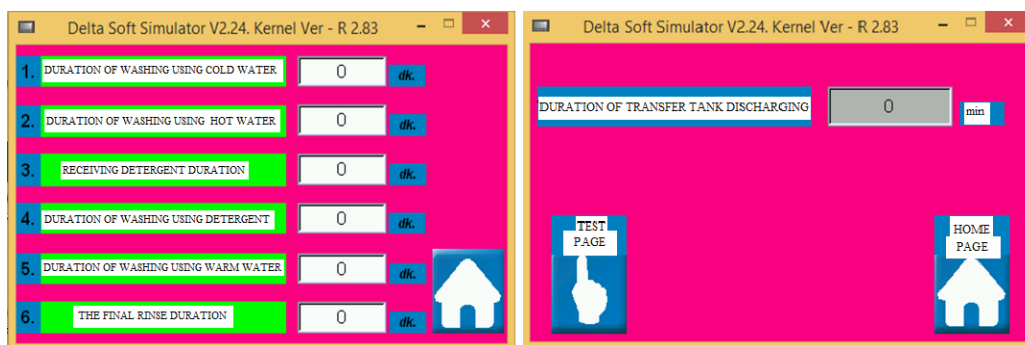

Figure 3. Interface view of Touch Screen Software Developed for the Milking Parlor

The PLC system features a touch screen interface. The screens below are input unit pages which allow operators to assign values to different functions, such as detergent amount, and time, duration and numbers of washing.

Results and discussion

The dairy livestock sector in Turkey has experienced rapid growth over recent years, as it has transitioned from an individual dairy plant system into a much larger system whereby many animals can be fed and milked on one single farm occupying a large area of space. However, the increase in the number of milking animals generates many challenges, such as the loss of time and money that results from having to milk a large number of milking animals by hand or via single machines. To address this particular challenge, milking parlors located on farms can be used for performing the milking process. However, this still leaves the cleaning of the system, which is labor intensive, once the milking process is completed. The cleaning process takes between 60 and 90 minutes on average to complete, and considering that the milking process is done twice a day, this would mean that the cleaning tasks last between a total average of 120 and 180 minutes. Operators in milking parlors generally initially monitor the minutes allotted to the cleaning process; however, in cases when the allotted time for cleaning needs to be reduced for whatever reason, the quality of cleaning is diminished. By performing both the washing and the milking processes with the PLC system, the former of which can be performed simply by entering into the system values for functions such as detergent amount, and times and numbers of washing, major time-saving benefits are realized. On top of that, the benefit of having a hygienic milking parlor, one that is ready for the next milking process, will result in a higher quality of milk.

Conclusion

Cleaning the milking machine is very important in view of milk quality and life of milking equipment. An efficient wash up will remove milk residues and bacteria from the milking plant. No matter which system is used, the milking machine will not be cleaned unless wash up solutions come into contact with all soiled parts of the plant. In the cleaning process of the system, wash up removes any remaining soil, rinse removes milk residues after milking and disinfectant kills bacteria remaining in the cleaned plant. Therefore the sequence of the process is important. Manual systems can execute these processes but the control is depending on the person's experience working in the farm. When suitable program for PLC is prepared, cleaning process can automatically be started after milking. In this way, wash cycle, degree of hot water, cleaning and circulation time can be adjusted in accordance with the manufacturers' recommendations. The wash up system with PLC is more flexible and useful when compared to manual systems.

Acknowledgement

This study was supported by the Turkish Republic's Ministry of Science, Industry and Technology (Project No: 0607.STZ.2013-2).

References

- Alıç, D., & Yener, M., (2006). Süt Sığırcılığı İşletmelerinde Robotlu Sağım Sistemi (Robotic Milking System in Dairy Cattle Farms), *Tarım Bilimleri Dergisi*, 12(4), 369-380.
- Demir, B., & Öztürk, İ. (2010). Robotlu Sağım Sistemleri(Robotic Milking Systems), *Alınleri Ziraat Bilimler Dergisi*, 19(2), 21-27.

- Demir, C., Gönülol, E., & Ülger, P., (2012). Merkezi Köy Süt Sağım Tesislerinin Uygulanabilirliği(Applicability of Center Village Milking Facility), *Tarım Makinaları Bilimi Dergisi*, 8(1), 13-18.
- Gök, A. D. (2008). *PLC temelleri ve uygulamaları(PLC Fundamentals and Applications)*, Ankara, Okutman Yayıncılık.
- Hülya, Ö., & Bilgen, H. (2004). Kovalı Süt Sağma Makinalarında Yaş (Suyla) Deneme Düzeni(Bucket Milking Machine in wet (Water) Trial Order), *Ege Üniversitesi Ziraat Fakültesi Dergisi*, 41(2), 123-131.
- Işık, E., & Ünal, H. (2003). Yerli Yapım Süt Sağma Makinasının Performans Değerlerinin Saptanması(Determination of Indigenous Production Milking Machine Performance Value). *15(1)*, 79-93.
- Nedret, A., & Tülay, B. (1997). *Mastitis İle Mücadele Programının Uygulanması Üzerinde Çalışmalar(Studies on Mastitis Control Program and Implementation)*. Türkiye Bilimsel ve Teknik Araştırma Kurumu PROJE NO:VHAG-989.
- Numan, S., & Kadir, Y. (1997). *Yerli Yapım Süt Sağma Makinalarının Yapısal ve İşlevsel Özelliklerinin Saptanması(Determination of Structural and Functional Characteristics of the domestic construction Milking Machines)*. Türkiye Bilimsel ve Teknik Araştırma Kurumu Proje No:TOAG-592.
- Ordolff, D. (2001). Introduction of electronics into milking technology, *Computers and electronics in Agriculture*, 30(1), 125-149.
- Özer, A. S. (2014). Seyyar Süt Sağım Makinasının Gömülü Sistem İle Otomasyonu (Automation of Embedded Systems with Portable Milking Machines). Master Thesis, Selcuk university, Institute of Science and Technology.
- Özerdem, Ö. C., & Samurkaş, T. (2003). KKTC Üniversitelerinde Programlanabilir Lojik Kontrolörlerin (PLC) Eğitimi ve PLC Kontrollü Taşıma Amaçlı Bir Laboratuvar Düzeneği Tasarımı(Education of Programmable Logic Controllers(PLC) in the University of Cyprus and PLC Controlled Laboratory Apparatus for Transport), *Elektrik, Elektronik, Bilgisayar Müh. Eğitimi 1. Ulusal Sempozyumu*, 144-148.
- Rossing, W., & Hogewerf, P. (1997). State of the art of automatic milking systems. *Computers and electronics in Agriculture*, 17(1), 1-17.
- Sağlam, C., Kuş, Z. A., & Yılmaz, S. (2015). Evaluation of Milking Facilities and Machinery in Dairy Operations of Central Anatolia. *Turkish Journal of Agriculture, Food Science and Technology*, 3(2), 63-66.
- Tekin, A. B., & Değirmencioğlu, A. (2010). Tarımsal Bilişim(Agricultural Informatics), İleri Tarım Teknolojileri(Advanced Agricultural Technologies). *Akademik Bilişim Konferansı, Muğla Üniversitesi, Muğla*, 9(1), 351-359.

FRUIT GROWING IN EAST MARMARA REGION OF TURKEY: KOCAELI SAMPLE FROM PAST TO FUTURE

Melekber SULUSOGLU DURUL^{1,2*}, Bahar AYDIN CAN¹, Serdar MEMIS³

^{1*}Kocaeli University, Arslanbey Agricultural Vocational School, Kocaeli, Turkey.

²Department of Horticulture, Graduate School of Natural and Applied Sciences, Kocaeli University, Kocaeli, Turkey.

³Kocaeli Province Directorate of Food, Agriculture and Livestock, Kocaeli, Turkey.

Corresponding author: meleksl@kocaeli.edu.tr

Abstract

Turkey is one of the main fruit producing countries in the world, which is bestowed with very good topography, soil, and climate conditions that highly support growing of fruit cultivars. In Turkey, more than 85 fruit species are grown naturally. The East Marmara Region had been an important transmission route of trade and cultural interaction through the regions of the Asia and Europe during the past. This study used a questionnaire to obtain data from 97 enterprises about the situation of fruit culture and also employed secondary data of fruit production for the Kocaeli Province, and investigated fruit cultivation opportunities. The information about current and past grown cultivars, technical conditions, and traditions was collected via face-to-face interviews with growers. Frequency distributions, variance analysis, and chi-square tests were performed by using SPSS 22 data analysis program. The results are presented as percentages. In the study, the main problems, we determined, are industrialization and unplanned construction, which have negatively impacted fruit culture. The reported facts in favor of fruit cultivation are increasing awareness of nature and mechanization. Walnut and sweet cherry production has potential value for the future.

Keywords: *Kocaeli, East Marmara Region, Turkey, fruit growers, questionnaire, survey*

Introduction

Turkey is one of the few self-sufficient countries in the world in terms of agricultural produce, which is one of the major income activities of Turkish people. Farming is carried out in all regions in Turkey, and Kocaeli is an important city in the Marmara Region in agriculture field. The geographical location of Kocaeli is between 40°–41° N and 29°–31° E, surrounded by the Gulf of İzmit at south, Istanbul and the Sea of Marmara at west, the Black Sea at north, and Sakarya at east. The climatic conditions in Kocaeli are very suitable for fruit cultivation. The average temperature is 14.8 °C, the number of sunny and frozen days is 75 and 15.1, respectively, and total average rainfall is 798.6 mm in a year (Anonymous, 2007). Precipitation is high and evenly distributed throughout the year. The favorable conditions, such as fertile soil, adequate climate, and abundant rainfall, allow growing of almost all kinds of fruits. Kocaeli includes total twelve districts, and of them, fruit orchards are mostly common in six: Karamürsel, Gölcük, Kartepe, Başiskele, İzmit, and Körfez. Total cultivated area in Kocaeli is 156.759 ha and around 19.239 ha of the cultivated land is irrigated. Fruit produce accounts for 12374 ha of the total agricultural production (Anonymous, 2013). Sweet cherry, walnut, olive, and apple are among the most common fruit products, while hazelnut is common in Kandıra district, but was not taken into consideration in this study. Since, in Turkey, natural conditions are very suitable for agriculture and it is the main source of income for Turkish people, the main objectives of the current study were:

- To study the enterprise structure of fruit growing farms in Kocaeli;
- To examine the cultural and technical properties of enterprises;

- To determine the conflicts and opportunities, to suggest possibilities and make recommendations for improving the fruit cultivation in the study area.

Material and Methods

This study was conducted between the years 2013 and 2014 in two phases. In the first phase, the data about fruit production in Kocaeli Province were collected and from this, the secondary data (statistical data) were obtained. In the second phase, fruit cultivation was investigated for technical and social aspects in Kocaeli region. A questionnaire-based survey was carried out for the enterprises to determine the situation of fruit culture, and the major limiting factors for quality production were determined. In a historical and current scenario, the grown cultivars, technical conditions, evaluation, and traditions were investigated. For this purpose, face-to-face interviews were conducted with 97 growers individually. The data were evaluated for frequency distributions, variance analysis, and chi-square tests using SPSS 22. The obtained data were analyzed in the light of literature. The study was carried out in six districts of Kocaeli region: Karamürsel, Kartepe, Gölcük, Başiskele, İzmit, and Körfez. These areas are important and rich in fruit cultivation around the İzmit Gulf (Figure 1).



Figure 1. Kocaeli Province map and districts of the province

Source: https://en.wikipedia.org/wiki/Kocaeli_Province

Results and Discussion

Most of the participants are between 61 and 70 years of age, more than 50% of growers are over 50 years. Among the participants, 68.04% are graduated from primary school. Only six participants are having university degree (Table 1). Table 1 shows that most of enterprise owners are solely involved in fruit growing only, and few of them are involved in other jobs. It was observed, while examining the past of agricultural activities, that the fruit cultivation was started 70–80 years ago with apple, pear, and sweet cherry and walnut. Of the enterprises, 35% were established 31–45 years ago, and most of the growers acquired this as their parental business (Table 2). The various modern agricultural tools used by most of the enterprises in the study area are tractors, mechanization, insecticides, fungicides, herbicides, fertilizer, grafted saplings, and modern harvesting. Tillage, pruning, and spraying are common cultural practices in all enterprises; however, modern irrigation system has recently started to be used. Generally, flood irrigation is common and irrigation water is supplied from irrigation channel, artesian, and natural stream (survey results).

For the surveyed enterprises, the different cultural criteria were compared with chi-square analysis, and a significant relationship between the owners' job and the preferred irrigation system was found. Flood irrigation system is the most preferred system among the farmers (39.8%) and factory workers-farmers (60%), while tradesman-farmers prefer to use sprinkler irrigation system. It also depends on available time of the people. Farmers have much more time than other owner groups, so if water resources are enough, flood irrigation is preferred owing to its low cost (Table 3). There is a relationship between the job of owners and irrigation system (Table 3).

Table 1. Demographic characteristics of enterprises by districts of Kocaeli***

Demographic characteristics		Districts of Kocaeli City							Total	%
		Başiskele (2 e. *)	Karamürsel (4 e.)	Gölcü k (46 e.)	Kartep e (32 e.)	İzmit (12 e.)	Körfez (1 e.)			
Age group (years)	21-30	-	-	-	1	-	-	1	1.03	
	31-40	-	--	2	3	1	-	6	6.19	
	41-50	1	2	8	8	3	-	22	22.68	
	51-60	-	1	11	7	2	1	22	22.68	
	61-70	1	1	13	7	6	-	28	28.86	
	≥71	-	-	12	6	-	-	18	18.56	
Education	Illiterate	-	-	1	-	-	-	1	1.03	
	Primary	2	4	30	21	8	1	66	68.04	
	Primary +secondary	-	-	8	5	1	-	14	14.43	
	High school	-	-	5	4	1	-	10	10.31	
	University- or higher	-	-	2	2	2	-	6	6.19	
monthly Income(TL ^{**})	Irregular	1	-	4	8	1	-	14	14.43	
	<100	-	-	8	7	-	1	16	16.49	
	101-250	-	-	-	-	-	-	-	-	
	251-500	1	-	18	7	-	-	26	26.81	
	501-1000	-	-	6	1	2	-	9	9.28	
	1001-2000	-	-	8	6	8	-	22	22.68	
	>2001	-	4	2	3	1	-	10	10.31	

Job	Farmer	2	4	41	29	11	1	88	90.72
	Worker	-	-	4	1	-	-	5	5.16
	Civil servant	-	-	-	1	1	-	2	2.06
	Tradesman	-	-	1	1	-	-	2	2.06
	Unemployed	-	-	-	-	-	-	-	-

*e: Enterprises number

**1 TL=0.309 Euro (June 2016)

***Source: Data obtained from the questionnaire based survey

Table 2. Experience on fruit cultivation of enterprises by districts of Kocaeli*

Experiences (year)	Districts of Kocaeli City							
	Başiskele (2 e. *)	Karamürşel (4 e.)	Gölcük (46 e.)	Kartepe (32 e.)	İzmit (12 e.)	Körfez (1 e.)	Total	%
1-15	-	-	9	3	-	1	13	13.40
16-30	-	2	9	5	2	-	18	18.56
31-45	1	1	12	13	7	-	34	35.05
46-60	1	1	12	9	3	-	26	26.80
≥61↑	-	-	4	2	-	-	6	6.19
Average	42.50	36.00	37.72	40.66	38.25	10.00	38.50	

*Source: Data obtained from the questionnaire based survey

Table 3. The relationship between owned job and used irrigation method**

Irrigation system	Job Groups				Chi-Square value	df	p value *
	Farmer (%)	Worker (%)	Civil servant (%)	Tradesman (%)			
Drip	19.3	40.0	0.0	0.0	32.354	9	0.000
Flood	39.8	60.0	0.0	0.0			
Sprinkler	5.7	0.0	50.0	100.0			
No irrigation	35.2	0.0	50.0	0.0			

*p<0.05 is significant;

**Source: Data obtained from the questionnaire based survey

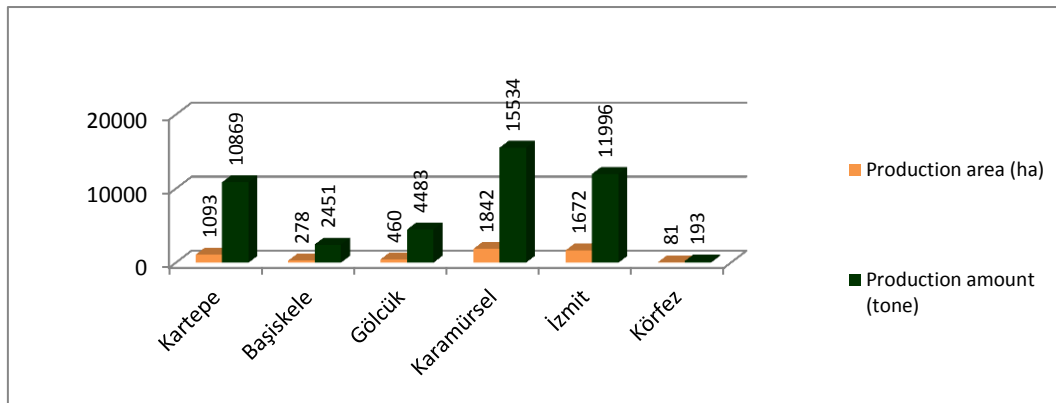

Figure 2. Distribution of fruit growing in districts *

* Source: Kocaeli Provincial Directorate of Food, Agriculture and Livestock, 2013.

The highest fruit production area and the production amount were reported for Karamürsel district in Kocaeli region (Figure 2). The maximum fruit production area and production amount were reported for hazelnut.

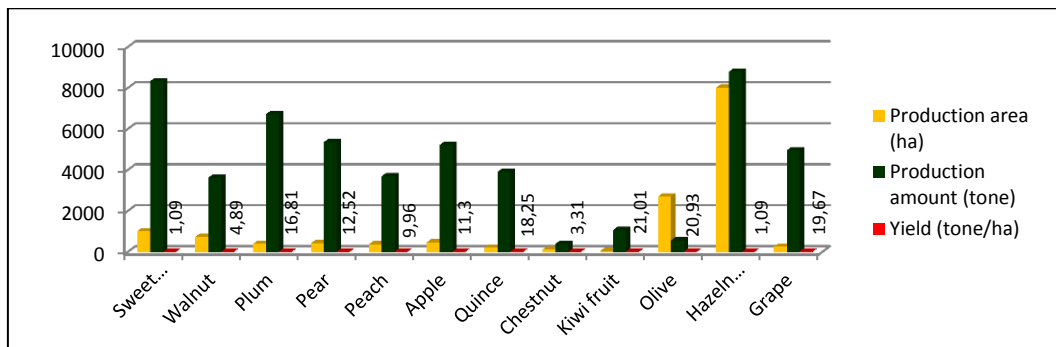

Figure 3. Fruit production in Kocaeli Province according to fruit species **

* Hazelnut production is common in Kandıra district while other fruits are cultivated at low level. Kandıra was not studied herein.

** Source: Kocaeli Provincial Directorate of Food, Agriculture and Livestock, 2013.

Sweet cherry is the most produced fruit in the studied field and plum production is the second one (Figure 3). Most of the studied enterprises are located in Gölcük (sweet cherry and pear are the most grown products) and Kartepe (pear, walnut, and apple are the most grown products); and fruit cultivation is an important income activity in these places (Table 4). The major cultivars grown in these areas are given in Table 5. Chestnut is mostly cultivated in forest land, and modern chestnut orchards have recently been planted.

Pruning is common in Gölcük and Kartepe orchards. Among the farmers, 93.81% accepted practicing pruning. Regular pruning is done every year in all districts except Başiskele (Figure 4). Some pruning courses were organized in these districts in the recent years. There is a relationship between the experience level of growers and the soil analysis for fertilization (Table 6).

Table 4. Distribution of cultivated fruit species in the studied enterprises**

Fruit species	Number of enterprises in the districts*					
	Başiskele	Karamürsel	Gölcük	Kartepe	İzmit	Körfez
Apple	-	-	16	15	5	1
Pear	-	4	26	18	2	-
Quince	-	-	-	2	5	-
Sweet cherry	-	3	28	13	10	1
Peach	-	4	8	-	-	-
Plum	-	-	14	6	8	1
Walnut	2	-	18	15	-	-
Hazelnut	-	-	5	7	-	-
Chestnut	-	-	5	-	-	-
Kiwi fruit	-	-	1	1	-	-
Olive	-	4	14	-	-	-
Grape	-	1	6	-	9	-

**Source: Data obtained from the questionnaire based survey

Table 5. Important species and cultivars in the study area*

Species	Cultivars
Apple	Granny smith, Starking Delicious, Golden Delicious, Fuji, Galaxy Gala, Amasya
Pear	Mustafa Bey, Akça, Santa Maria, Abbe Fetel, Deveci
Sweet cherry	0900 Ziraat, Bing, Regina, Van, Star Giant, Lambert, Starks Gold, Noble
Peach	J.H.Hale, Dixired, R-1
Plum	Kastarca, Mürdüm, Papaz, President, Havra, Angelino
Walnut	Yalova 1, Yalova 2, Yalova 3, Pedro, Sapanca, Bilecik, Şebin, Kaman, Yavuz 1
Hazelnut	Tombul, Uzun, Mincane, Foşa, Çakıldak
Chestnut	Hacı Ömer
Olive	Kalamata, Samanlı, Tirilye

*Source: Data obtained from the questionnaire based survey

Table 6. Relationship between the experiences level of growers and soil analysis for fertilization**

	Yes			No			F Degrees	P*
	n ₁	X	S _d	n ₁	X	S _d		
Experience level (year)	56	35.6	17.8	41	40.6	16.5	0.650	0.920

*p<0.05

**Before determining the relationship between the variables, soil-analysis and experience of the growers, was tested with normal distribution test, and both parameters were found normally distributed. However, no significant difference between these parameters was found as a result of variance analysis. Experience levels of growers who carried out soil analysis are less than others.

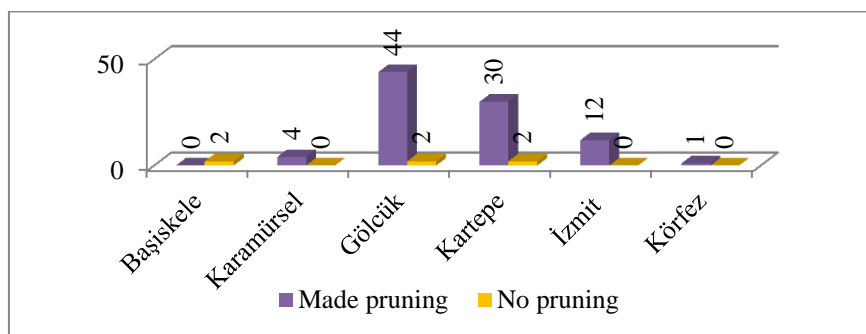

Figure 4. The distribution of pruning practice in orchards in the surveyed districts

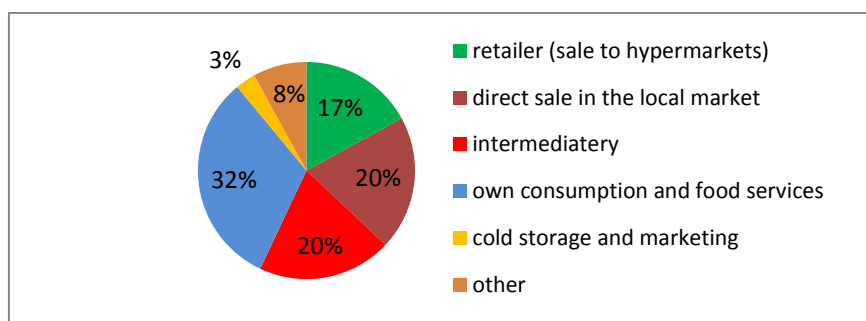

Figure 5. The marketing means of produced fruits in Kocaeli

The products are mostly used for own consumption or sale for jam or other processed products. Of the produce, 20% is sold as fresh in local markets by the growers, and 20% is sold to intermediaries.

Cold storage is limited in the study area and only 3% of the produced fruits are stored by the growers and sold at higher prices out of the season (Figure 5). This study revealed that the wholesale market is the most preferred marketing channel for fresh agriculture produce, followed by local market.

Conclusion

The main supporting factors for fruit cultivation are ecological conditions (climate and soil fertility), people's knowledge level, and environmental awareness. The greatest strength of fruit cultivation in the surveyed area is the willingness of the people and widespread use of mechanization. The survey results indicate that the environmental awareness is high among the growers. The measures of plant protection against pests are taken in due time with implementation of integrated pest management. The lack of enough credit to support a small enterprise was found as the most important weakness of the growers. The uncontrolled construction is the most important threat to agricultural fields. Industrial pollution is another threat to agriculture, especially for production of sensitive fruits. The division of agricultural land by inheritance is increasing the production costs. Input cost is very high and credit supports are limited. Based on these results, it can be concluded that fruit production has a vital role in the surveyed area. The important strategies need to be employed for a sustainable fruit cultivation include,

- The development of infrastructure for modern fruit cultivation;
- The planting of economical varieties with high economic values;
- The development of governmental supports;
- Considering the quality of crops and development of marketing programs based on farmers' needs.

References

Anonymous (2007). TR4 East Marmara Region Master Plan, 2007. T.C. Tarım ve Köyişleri Bakanlığı Strateji Geliştirme Başkanlığı.

Anonymous (2013). kocaeli.tarim.gov.tr/Belgeler/pdf_dosyalar_/Kocaeli%20Tarim%20Istatistigi.pdf

DETERMINANTS OF RURAL TOURISM: A CASE STUDY OF KASTAMONU, TURKEY

Ilknur ZEREN^{1*}, Hakan SEVIK², Mehmet CETIN³

¹Kastamonu University, Faculty of Forestry, Department of Forestry Engineering, 37150, Kastamonu, Turkey

²Kastamonu University, Faculty of Engineering and Architecture, Department of Environmental Engineering, 37150, Kastamonu, Turkey

³Kastamonu University, Faculty of Engineering and Architecture, Department of Landscape Architecture, 37150, Kastamonu, Turkey

*Corresponding author: ukizeren@gmail.com

Abstract

Tourism is an economic event that provides a balance between natural, social, cultural and economic values. It is a sector that leads to recognition of other communities and individuals. In Turkey, the draw of tourism is primarily the sun in the summer; tourism is perceived as a type of triangle formed by the sea and sand. In recent years, in rural areas of Turkey, rural tourism has been adopted as a new approach that shows rapid progress. The rapid progress is what makes rural tourism be included in the regional analysis. Rural tourism must say that talking about the importance of making the regional analysis. This study examines the status of rural tourism areas and aims to determine the existing and potential rural tourism value of Kastamonu by the GIS method. GIS modeling of mapped areas shows the rural tourism potential of the area. Identification of regional opportunities for rural tourism in general is very important in terms of determining more realistic tourism strategies. The development potential of rural tourism is determined based off of the details of the strengths and weaknesses of the region, exposing the threats and opportunities. The main aim of this study is based on this idea. Turkey will be an important area in terms of rural tourism. This study will evaluate the rural tourism potential of Turkey in 2023 based on a study of the Kastamonu province, highlight the importance of the tourism strategy and make recommendations for improvement.

Keywords: *Rural tourism, Kastamonu, GIS, SDG 2015-2030*

Introduction

Oppermann (1996) researched that the negations of researches on rural tourism is joined further by the absence of a mostly accepted description as to what creates rural tourism. The large variety of rural areas with respect to size and type further perplexes what creates rural tourism. In an attempt to sieve the incoherency surrounding the notion of nonurban, farm, and rural tourism, a cognitive model may be advised (Redclift 1992; Sidali et al. 2015; Marzo-Navarro et al., 2016). Peng & Lin (2016) concluded that it considered to the cultural and economic well-being of rural societies, the protection of the environment or the addition of local citizens in decision-making (Sidali et al. 2015; Guzman-Parra et al. 2015; Kim & Jamal 2015). Briedenhann & Wickens (2004) studies that tourism has been determined as a catalyst to revive economic development ascend the property of being viable of undeveloped areas and develop the normal of living of local societies, In Eastern Europe, where cases of the last ten years have launched a sudden increase in rural unemployment (Redclift 1992; Jepson & Sharpley 2015; Nair et al. 2015; Marzo-Navarro et al., 2016). According to the forecasts of the World Tourism Organization, the tourism sector has been recognized as an industry that will continue to grow and develop quickly over the next 20 years. As of 2020, the world-wide tourism pie is estimated to be approximately \$7.6 trillion (WTTC, 2015). Described as a service industry, the tourism sector takes an important place in the economies of developing

countries such as Turkey. Tourism is one of the important dynamics in the spreading of income because it enables balanced regional development in terms of economic and social development (Cetin & Sevik 2016a; Cetin & Sevik 2016b; Cetin, 2016a, Cetin, 2016b).

The development of industrialization has considerably changed the direction of the demand experienced today with rapid urbanization, tourism and people moving away from tiring and unhealthy environments. The ocean areas and mountainous, forested regions have turned to rural areas. The richness of traditional culture stresses the natural environment and causes the recreational needs of urban people today to demand the tourism aspects of the sea, sand and sun (Bramwell, 1994; Fleischer & Felsenstein, 2000; Sharpley, 2002; Wilson et al. 2001; Cetin, 2015c; Cetin, 2015d; Cetin, 2016a, Cetin, 2016b). On the other hand, the increasing of development between rural and urban areas in Turkey is deepening. This has led to an increased population migration from rural to urban areas. One of the leading sectors of rural development seen as a way to resolve the disparities is rural tourism. Especially in rural areas where the density of the geographic care of promoting rural tourism in rural areas of agricultural organizations using both agriculture and tourism resources as a significant contribution to economic growth and development of rural areas will be provided. In the determination of tourism policies and plans, the economic and social functions of rural tourism should be considered carefully (Fons et al., 2010; Getz & Carlsen; 2000; Cetin, 2015c; Cetin, 2015e;Cetin & Sevik 2016c; Cetin & Sevik 2016d; Cetin, 2016a, Cetin, 2016b). Because of its rich geography, Turkey is ready to be evaluated in regards to rural tourism in rural areas, and there are a lot of options. Kastamonu is one of the locations with rural tourism potential that is waiting to be assessed. In the province of Kastamonu, in the north of Turkey, is the city center. It gets away from crowded places. It has types of tourism that should be considered in the city but that have been neglected for several reasons: cave tourism, plateau and mountain tourism and cultural tourism include watching endemic plants.

The aim of this work follows this direction: The potential of Kastamonu rural tourism to the identification of potential problems so it can take its rightful place in tourism. Tourism resources are a sustainable way to develop suggestions as to what should be done in order to make an impact on development in the countryside. According to a study done by the European Union (EU), rural tourism includes agricultural areas or tourists who nested to be purpose nicely spend time with local values, stay in line with expectations, food, drinks and other services that small where small-scale business settlement is defined as a set of implemented activities (Bramwell, 1994; Fleischer & Felsenstein, 2000; Sharpley, 2002; Wilson et al. 2001).

Rural tourism, which integrates rural culture, the natural environment and agriculture, is a type of tourism that can be extremely easy to integrate with other types of tourism. On the other hand, there is a correct relationship between rural tourism and rural development. Rural tourism in non-agricultural diversification of rural areas is a symbol of success. The richness and diversity of natural and cultural assets in rural areas pose a significant potential in terms of tourism and the development of recreation activities. Rural tourism development, while ensuring a balance of history, provides for the protection of cultural and natural tourist attractions. It is characterized by the maintenance of more sustainable mass tourism (Fons et al., 2010; Getz & Carlsen; 2000;Wilson et al. 2001;Cetin, 2015a; Cetin, 2015b; Cetin, 2015c; Cetin, 2015d). However, tourism should not be considered as an alternative to agricultural activities in rural areas. Rather, it should be a complementary position. Because there used to be important agricultural production in this region, it is opened to tourism. By leaving agricultural activities such as farming and forestry, however, that region has crafts and architecture, and the cultural structure is protected from degradation. From this point of view, rural tourism is the most compatible type of tourism with a sustainable tourism approach. The protection of tourist attractiveness is something essential for sustainable tourism (Getz &

Carlsen; 2000; Wilson et al. 2001; Cetin, 2015a; Cetin, 2015b; Cetin, 2015c; Cetin, 2015d; Cetin & Sevik 2016b; Cetin, 2016a; Cetin, 2016b).

Ecotourism, which may be referred to as sub-category of sustainable tourism, requires responsible travel to natural areas in order to ensure the sustainability of the welfare of the local people and environmental protection. Although travel is very popular, it cannot protect or improve the attractiveness of a destination if it cannot keep its place in the international market. The concept of sustainability indicates that without putting in danger the future of tourism resources, the best way to benefit is of paramount importance (Cetin & Sevik 2016a; Cetin & Sevik 2016c; Cetin & Sevik 2016d).

Sustainability is not only true of natural resources; it is also an aspect of a long-term cultural resources (Cetin, 2015b). The continuation of the attractiveness of tourism in a region is possible with sustainable tourism development. Tourism development, a market share in international markets and the added value created in the sectors connected to tourism between growth and conservation are seen as a development model that allows benefits to be transferred to future generations through efficient use of tourism resources and the present generation but also aims for the maximum satisfaction of future generations.

Materials and methods

Kastamonu is a research area that is rich in natural, rural areas. In order to put forward the research area of Kastamonu as having rural tourism potential, visits to the region have been made at different times in order to obtain detailed information.

The northern part of the Kastamonu, Turkey province is located in the Black Sea region as shown in Figure 1. There are provinces in the north of the Black Sea coast. The province of Kastamonu also has a city of the same name.

All of the northern part of the province creates the Black Sea coast; the province's coastline length is 170 km. Kastamonu Black Sea coast has the longest coastline length of this province, 13 108 km², located in Kastamonu, Turkey, and accounts for 1.7% of the territory. The city center is 780 meters above sea level. The average height of land in the province is 775 m above sea level. The province forms the highest point of the hill with Çatalılgazat 2,565 m. Mountains across the province extend parallel to the sea; they cover a large portion of Turkey's projection extending towards the Black Sea (Municipality, 2016).

Obtained in the field of research photos and documents has been reached.

Data analysis in research, synthesis and evaluation play basic base as of 2015 Tape 10 × 10 m spatial resolution satellite imagery, digital elevation models (DEMs) image of 1:25,000 scale topographic maps are used in the study to support the creation of the necessary methodological approach to the planning of a landscape-oriented system. In this context, the research method used consisted of main phases: (1). Determination of the areas to be the focus of shots, (2). To reveal the weight of the rural tourism potential of this focus, (3). consists of three sub-stages, according to the classification of focal potential rural tourism shooting weight.

This study was formed after a detailed review of the literature as well as related issues; it has also benefited from various Internet sources. All data obtained from the survey was transferred to this work.



Figure 1. Location of Kastamonu

Results and discussion

In regards to developments in Turkey and the uniform distribution of cases between regions, uneven distribution of the level of development of tourism between regions is a sector that can have the maximum level of importance. However, a well-planned structure can minimize disparities between provinces, districts and even counties.

A very important responsibility for local managers at this point is reduced because local officials have more information on local issues and can decide quickly about them. In addition, a local manager of development policies and economic development, according to the rules of good governance in the region, will also provide socio-cultural development. In order to eliminate disparities in the region, tourism planning should be structured to include both the rural and the urban areas of the province.

In Kastamonu and the surrounding area, in addition to cultural tourism and nature tourism there are many suitable alternative tourism areas of potential. However, tourist arrivals to Kastamonu do not know enough about the potential of rural tourism alternatives, because the tourism potential has not been introduced to the visitors. Therefore, the majority of tourists are daily visitors from Kastamonu.

In order to solve these problems for the tourist and increase the value of Kastamonu, there needs to be a sustainable tourism plan with a holistic perspective. As is known, tourism is an important sector in terms of social welfare and development. If the relevant institutions and organizations identify and target their efforts in this direction, it will determine the future situation of Kastamonu tourism.

Conclusions

Rural tourism conducted with this research subjects in Europe, in Spain in Malaysia, In Korea that rural tourism model created and redefining rural tourism perspective (Sidali et al. 2015; Jepson & Sharpley 2015; Nair et al. 2015; Guzman-Parra et al. 2015; Kim & Jamal 2015)

In accordance with data obtained under investigation, the city is ready to be evaluated in regards to the rural tourism potential so it can take the place it deserves and recommendations can be made to make an impact on the development of rural tourism resources. Figure 2 shows those rural potential areas.

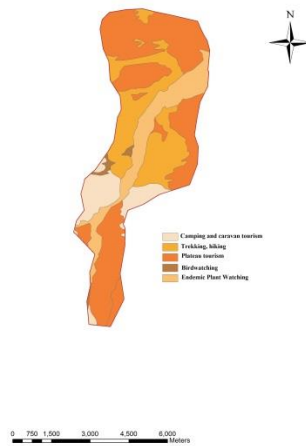

Figure 2. Potential of Kastamonu rural tourism

Cooperation and coordination between tourism stakeholders should be ensured. Kastamonu in general, tourism businesses local governments should all act together with universities and Non-Governmental Organizations in planning what should be done, because tourism planning should be limited to the sector itself. The planning of tourism should strengthen the local people's priorities and values while integrating public participation.

The city's infrastructure and superstructure facilities must be reviewed and conditions improved accordingly. In addition to tourism in a way that will not harm the environment, infrastructure and superstructure facilities should be brought to the appropriate level to meet the expectations of tourists.

Local people should be trained regarding the city's tourism value, and local people must also be respectful to ensure awareness of protection for this resource value. Awareness is of great importance to the sustainability of tourism.

Each destination has the property of being unique in itself. However, it is important to realize the development of tourism and planning, understanding that the differences are the uniqueness and value. The most important factor affecting the success of a tourist destination and its accurate positioning is a strong brand image created by a viable and attractive areas.

A destination brand is the transmission of a certain image to tourists and is an effective and popular tool to the destination becoming placed in a key role. The words brand destinations based on the quality and high service performance and are located in the fulfillment of these promises.

Region-specific products (food, drinks, crafts, etc.) must be converted into tourist products. In rural areas, studies on the preparation of a comprehensive inventory of culture and folklore studies in regards to development, handicrafts, local festivals, traditions, etc. should be performed in regards to the value to tourism. As understood from botanical research, the region is rich in endemic plant diversity. Rural areas across the surface flora

Revealing the research and inventory is recommended.

Historic houses with their own unique aesthetic architecture of the city should be restored and transformed into places that display of the value of the region. Authentic regional dishes for tourism activities can be offered in locations.

Making some arrangements without destroying the cave is recommended for tourism, because improvements being made in and around the cave is of vital importance for the evaluation of a future tourist city.

Arrangements for some of the needs of visitors while maintaining the charm of the plateau should be made, and it should be opened to tourism. In rural areas, cool, fresh-air springs are

springs with high landscape value needed for tourism and nature, with clean, potable water sources.

As a result, the basic economics of tourism in rural areas complement and increase the employment of women supporting the use of local products. Visitors play an important role in supporting rural development that enables participation in local events. Diverse natural and cultural tourism resources are located in the city. However, these resources will make an impact on rural charm when used for tourist development. A holistic perspective of Kastamonu tourism city planning and the potential of rural areas directing a rational evaluation of potential tourism resources can be an important tool for the rural development of the existing tourism resources in the city.

References

- Bramwell B. (1994). Rural Tourism and Sustainable Rural Tourism. *Journal of Sustainable Tourism* 2.1–6.
- Briedenhann, J., & Wickens, E. (2004). Tourism routes as a tool for the economic development of rural areas—vibrant hope or impossible dream?. *Tourism management*, 25(1), 71-79.
- Cetin, M. (2015a). Using GIS analysis to assess urban green space in terms of accessibility: case study in Kutahya. *International Journal of Sustainable Development & World Ecology* 2015; 22 (5): 420-424. DOI: 10.1080/13504509.2015.1061066
- Cetin, M. (2015b). Evaluation of the sustainable tourism potential of a protected area for landscape planning: a case study of the ancient city of Pompeipolis in Kastamonu. *International Journal of Sustainable Development & World Ecology* 2015; 22 (6): 490-495. DOI: 10.1080/13504509.2015.1081651
- Cetin, M. (2015c). Determining the bioclimatic comfort in Kastamonu City. *Environmental Monitoring and Assessment*. 2015; 187 (10): 640. DOI: 10.1007/s10661-015-4861-3
- Cetin, M. (2015d). Consideration of permeable pavement in landscape architecture. *Journal of Environmental Protection and Ecology* 16 (1), 385–392.
- Cetin, M. (2015e). Chapter 55: Using Recycling Materials for Sustainable Landscape Planning. *Environment and Ecology at the Beginning of 21st Century*. Ed.: Prof. Dr. Recep Efe, Prof. Dr. Carmen Bizzarri, Prof. Dr. İsa Cürebal, Prof. Dr. Gulnara N. Nyusupova, ST. Kliment Ohridski University PRESS, Sofia; 2015. p. 783-788, ISBN: 978-954-07-3999-1.
- Cetin, M. & Sevik, H. (2016a). Evaluating the recreation potential of Ilgaz Mountain National Park in Turkey. *Environmental Monitoring and Assessment* 2016; 188 (1): 52. DOI: 10.1007/s10661-015-5064-7
- Cetin, M. & Sevik, H. (2016b). Chapter 5: Assessing Potential Areas of Ecotourism through a Case Study in Ilgaz Mountain National Park, *Tourism - From Empirical Research Towards Practical Application*. In Tech, Eds: Leszek Butowski, pp.190, ISBN: 978-953-51-2281-4, Chapter pp. 81-110
- Cetin, M. & Sevik, H. (2016c). The change of air quality in Kastamonu city in terms of particulate matter and CO₂ amount. *Oxidation Communications* pp. 0–0. (In press)
- Cetin, M. & Sevik, H. (2016d). Measuring the Impact of Selected Plants on Indoor CO₂ Concentrations. *Polish Journal of Environmental Studies* 25: (3), 973–979.
- Cetin, M. (2016a). A Change in the Amount of CO₂ at the Center of the Examination Halls: Case Study of Turkey. *Studies on Ethno-Medicine* 10: (2), 146–155.
- Cetin, M. (2016b). Peyzaj Çalışmalarında Kullanılan Bazı Bitkilerde Klorofil Miktarının Değişimi. *Kastamonu Üniversitesi Orman Fakültesi Dergisi* 16: (1), 239–245.
- Fleischer, A. and Felsenstein, D. (2000). Support For Rural Tourism Does it Make a Difference. *Annals of Tourism Research*, Vol. 27, No. 4, pp. 1007-1024.

- Fons, M.V.S. Fierro, J.A.M. Patiño, M.G. (2010). Rural Tourism: A Sustainable Alternative. *Applied Energy*, 88(2), pp:551-557.
- Getz, D.; Carlsen, J. (2000). Characteristics And Goals Of Family And Owner-Operated Businesses In The Rural Tourism And Hospitality Sectors. *Tourism Management* 21, pp:547-560.
- Guzman-Parra, V. F., Quintana-García, C., Benavides-Velasco, C. A., & Vila-Oblitas, J. R. (2015). Trends and seasonal variation of tourist demand in Spain: The role of rural tourism. *Tourism Management Perspectives*, 16, 123-128.
- Jepson, D., & Sharpley, R. (2015). More than sense of place? Exploring the emotional dimension of rural tourism experiences. *Journal of Sustainable Tourism*, 23(8-9), 1157-1178.
- Kim, S., & Jamal, T. (2015). The co-evolution of rural tourism and sustainable rural development in Hongdong, Korea: complexity, conflict and local response. *Journal of Sustainable Tourism*, 23(8-9), 1363-1385.
- Marzo-Navarro, M., Pedraja-Iglesias, M., & Vinzón, L. (2016). Development and validation of the measurement instruments of the determinant elements of integrated rural tourism. *Journal of Hospitality & Tourism Research*, 40(4), 476-496.
- Municipality (2016), KastamonuMunicipality <http://kastamonu.bel.tr/v2/>, (Accessed: 11/06/2016)
- Nair, V., Munikrishnan, U. T., Rajaratnam, S. D., & King, N. (2015). Redefining rural tourism in Malaysia: A conceptual perspective. *Asia Pacific Journal of Tourism Research*, 20(3), 314-337.
- Oppermann, M. (1996). Rural tourism in southern Germany. *Annals of tourism research*, 23(1), 86-102.
- Peng, K. L., & Lin, P. M. (2016). Social entrepreneurs: innovating rural tourism through the activism of service science. *International Journal of Contemporary Hospitality Management*, 28(6).
- Redclift, M. (1992). The meaning of sustainable development. *Geoforum*, 23(3), 395-403.
- Sharpley, R. (2002). Rural Tourism and the Challenge of Tourism Diversification: The Case of Cyprus. *Tourism Management*, 23, 233-244
- Sidali, K. L., Kastenholz, E., & Bianchi, R. (2015). Food tourism, niche markets and products in rural tourism: combining the intimacy model and the experience economy as a rural development strategy. *Journal of Sustainable Tourism*, 23(8-9), 1179-1197.
- Wilson, Suzanne; Fesenmaier, Daniel R.; Fesenmaier, Julie; Van Es, John C. (2001). Factors For Success in Rural Tourism Development *Journal of Travel Research*, 40: 132-138.
- WTTC (2015). World Travel & Tourism Council. Travel & Tourism economic impact 2015 world. (Accessed: 12/08/2016) <https://www.wttc.org/-/media/files/reports/economic%20impact%20research/regional%202015/world2015.pdf>

RURAL ECONOMIC DEVELOPMENT STRATEGY THROUGH PRIORITY RURAL SECTORS IN THE REPUBLIC OF MACEDONIA

Blagoj GORGIEVSKI^{1*}, Marija GJOSHEVA KOVACHEVIKJ²

¹ University "St. Kliment Ohridski", Bitola, Faculty of law, R Macedonia,

² Institute of Sociological, Political and Juridical Research University, Skopje, R Macedonia

Abstract

The rural areas of development strategy is an inhabited territory where the social, economic and residential evolutions are led within the framework of an integrated and prospective project of development. The rural pole is not a small town, an agglomeration, but they are treated as a whole and guided by an integrated project of territory. Initially, this study are focused to priority regional sub-sectors in R. Macedonia in order to identify the major weaknesses to be addressed and potentials to be boosted. Furthermore, the elaboration refers to assessment development strategy of priority economic sectors in the rural areas, defining the main problems, possible solutions to solve them. The analysis of the regional differences is also included in the paper as well as the differentiation and prioritisation in itself . In terms of the structural adjustment through priority rural areas of the country's, the emphasis of study will be placed in particular on increased production competitiveness and higher quality of products. For that goal have to pay attention to measures at improving the competitiveness of economically viable agricultural holdings and food industry in selected sub-sectors through proper investment policies.

Keywords: *rural, strategy, development, policy, sectors, strategy.*

Introduction

The theories of economic geography primarily address issues of relevance for the spatial distribution of the production, they also contain clear connections to growth. The endogenous growth theory constitutes the bridge between agglomerated production structures and growth. According to the latter theory, growth is primarily increasing in the accumulation of knowledge through spillover to other users, i.e. it is only partially excludable and appropriated by the firms investing in knowledge. Economic geography contends that proximity is essential in order to access spillovers, pecuniary and non-pecuniary, originating in the interaction between people, firms and institutions, through vertical and horizontal linkages. Furthermore, concentrated production also gives rise to external scale effects. Thus there would appear to be a clear link between growth and densely concentrated production. This has preciously been discussed in the theoretical literature (Fujita and Thisse, (2002) Perroux, Kaldor (1961), Myrdal (1957) and Hirschman (1958)).

The recognition of the rural areas as development poles, and neither only as natural and agricultural spaces, is a precondition to stimulate advantageous and balanced exchanges between the urban and rural poles and to motivate the convergent mobilization of the urban and rural actors.

The rural pole of development is an inhabited territory where the social, economic and residential evolutions are led within the framework of an integrated and prospective project of development. The rural pole is not a small town, an agglomeration, but a rural areas as a whole and guided by an integrated project of territory.

Also, the emergence and the animation of these rural issues of development must be based on the principal following elements:

- a rural territory with a project built on a common political ambition and on shared economic and social interests;
- an integrated project of sustainable rural development, including means and measures within the scope of a multiannual programming;
- collective implementation and local partnership based on a co-operation between public and private institutions;
- co-operation between rural areas and between rural and urban areas, with a networking approach which favours a process of continuous training ;
- a framework of evaluation, to enhance the effectiveness and the efficiency of the of rural development trough rural areas and its sustainability.

This paper study rural development of priority rural sectors in the regional structure in the country, defining the main problems, possible solutions on the basis of the priorities set forth. Analysis of the regional differences is also included in the paper as well as the differentiation and prioritisation thereof. A detailed summary of priorities and support measures are also included. At first it makes identification of sectors in the rural areas in certain regions with the greatest formative development potentials. Further are elaborate policies, programs and measures to help reinforce existing economic potential in the respective rural sectors. Hence the need to develop appropriate institutional structure that will enable full support for rural regional development.

Material and methods

In the first stage of elaboration, the principal priorities were identified priority rural sectors in consultation with various rural sector stakeholders. Initially, this study was prepared for priority sub-sectors in the regions (milk and dairy, meat and meat products, fruit and vegetables and wine and grapes) to identify the major weaknesses to be addressed and potentials to be boosted. The four sub-sectors were selected based on their importance in the agricultural GDP and according to the process of adoption of the EU acquis according to the NPAA and institutions related (Self-governments, regional agricultural departments, regional offices of the National Extension Agency, Farmers Federation and Non-governmental organisations). The programme was based on the National Development Plan (NDP), the National Strategy for Agriculture and Rural Development and the National Programme for Adoption of the Acquis (NPAA), as well as the Multi-annual Indicative Planning Document (MIPD), framework of available measures under Instrument for Pre-accession Assistance for Agriculture and Rural Development (IPARD) and the results of the independent sub-sector analysis.

Results and Discussion

Regional development in the R. Macedonia is a process of identification, promotion, management and use of development potentials of the planning regions and the areas with specific development needs. The policy for regional development, on the other hand, is a system of goals, instruments and measures directed towards a decrease of regional disparities, and the achievement of equal and sustainable development in the Republic of Macedonia.

General feature for all regions are that rural areas show much better results from urban because of the collapse of obsolete industrial plants. The regional disparity analyses shows an greater participation in GDP formation in the regions with predominantly participation of agriculture as an economic activity (Pelagonija, Polog and Southeastern regions) of the country.

For administrative purposes, the differentiation between rural and urban areas in the country is based on the local territorial divisions according to the Law on Territorial Organization of the Local Self-Government (OG 55/2004, 12/2005) i.e. Article 6. The common method,

which will be applied for the purpose of this investigating is defining rural areas as being located outside of urban area and characterised by three main characteristics:

- settlements placed in municipalities based in rural centers (rural Municipalities),
- settlements placed in municipalities based in town centers with predominantly agricultural and forests land use systems (urban versus agriculture land (incl. forests, pastures, marshland, fishponds) and
- towns with population of less than 30,000 inhabitants with predominantly agricultural and forests land use systems (urban versus agriculture land (incl. forests, pastures, marshland, fishponds) and has rural identity of the community

According to the National Agricultural and Rural Development Strategy (NARDS), has translated the overall development vision into following long-term sectoral strategic objective as the basis for agricultural and rural development and formulation of future agricultural policy: “To strengthen the ability of the country's agriculture to compete in the integrated regional markets of the European Union and south-eastern Europe through measures to increase the efficiency of agricultural production, processing and marketing, and to build appropriate, effective public and private institutions; to improve farm incomes; to ensure that consumers have access to safe, healthy food; to optimize the use of scarce land, forest and water resources, in an environmentally sustainable manner; and to build viable rural communities through sustainable rural development.”¹

The main general objective (figure 1) of the rural development is to: “Improve the competitiveness of agricultural holdings and the food industry developing them to comply with Community standards, while ensuring sustainable environmental and socio-economic development of rural areas through increased economic activities and employment opportunities.”

¹ Nacional strategy for agriculture and rural development 2007-2013, p. 210

Figure 1 – National Agriculture and Rural Development Objective

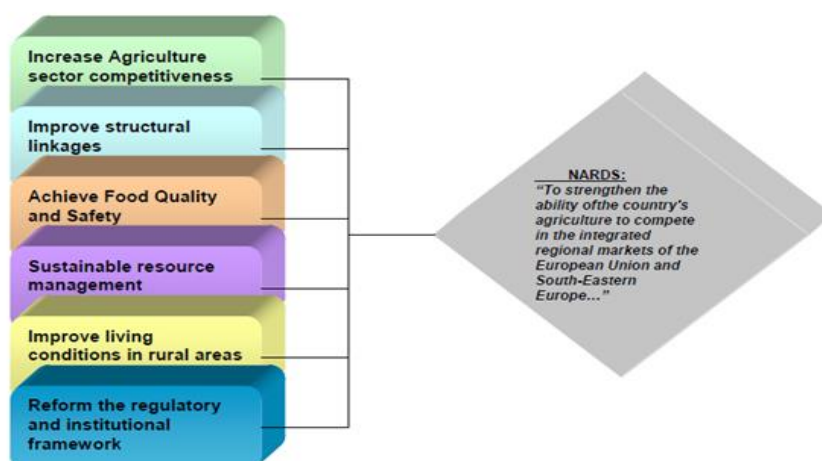

Final version of the IPARD programme for the Republic of Macedonia

This shall be achieved through following specific objectives:

- Improving the technological and market infrastructure of commercial agricultural holdings and food processing industry aimed at increased added value of agri-food products and achieved compliance with EU quality, health, food safety and environmental standards
- Improved quality of life of rural population, increased income and creation of new employment opportunities,

The main priority are planning the agricultural development and the development of the rural areas, agricultural policy measures and the holders of the right to benefit from those measures, minimum quality and designations of the agricultural products, setting up of databases and supervision over its implementation.

In support to the structural adjustment of the country's agricultural sector (the main sub-sector in the rural economic sector), the emphasis will be placed in particular on increased production competitiveness and higher quality of products. For that goal have to pay attention to measures at improving the competitiveness of economically viable agricultural holdings and food industry in selected sub-sectors through investment policies to improve technological and market infrastructure aimed at increased added value of agricultural products and achieved compliance with EU quality, health, food safety, animal welfare and environmental standards.

The investments per priority sectors (wine and grapes; fruits and vegetables; milk and dairy; and meat products) broadly cover costs for replanting the areas covered with perennials (vineyards and orchards), construction and reconstruction of farm buildings and installations for farm buildings as well as auxiliary buildings, purchase of equipment for farm buildings, improvement of on-farm irrigation systems and specialised agricultural machinery as well as on-farm manure handling to upgrade the agriculture holding to meet EU environmental requirements.

The investments per priority sectors broadly cover costs for improvement and optimisation of production flows in processing and marketing of agricultural products; setting up or modernisation of local collecting networks, of reception capacities, storing, conditioning, sorting and packing of agricultural products of agriculture products .

For that goal must be fulfilled the certain priority measures as is : improving the technological and market infrastructure of commercial agricultural holdings and food processing industry

aimed at increased added value of agri-food products and achieved compliance with EU quality, health, food safety and environmental standards. For achieve that it is necessary to investments in agricultural holdings to restructure and to upgrade to Community standards and investments in processing and marketing agriculture products to restructure and to upgrade to Community standards.

The potential key issues to be addressed are investments in agricultural production to restructure and upgrade the sector to Community standards and to increase competitiveness and improving market efficiency and implementation of Community standards. Therefore the upgrading of the farms and the food establishments to meet the environmental, hygiene, food safety and animal welfare standards is of high importance.

Ongoing task is improved quality of life of the rural population, increased income and creation of new employment opportunities The potential key issues to be addressed in country are investments to develop and to diversify economic activities in rural areas which creating additional income sources and employment opportunities in rural areas. Priority sectors and the type of eligible investments concern to support to micro enterprises in the rural areas (reconstruction of on-farm houses for rural tourism activities complemented with recreational facilities; construction of catering premises, outdoor accommodation camping sites and recreational facilities; reconstruction of old traditional on-farm buildings for rural tourism activities complemented with recreational facilities) and promoting rural tourism activities.

Well-placed and developed general targets and measures to achieve them but lacking public rural institutions to established capacity to design and implement appropriate rural policies in priority rural sectors. Lacking also appear in identification and evaluation of rural areas as a pole of rural development and built of rural policies and programs for their support. Furthermore, it is necessary the emphasis role of young rural labor in the rural areas as one of the determining factors of rural development in the country not given sufficient attention. Not sufficiently designed policies and programs for the use of scientific knowledge (especially in the field of modern agricultural technologies) for the purpose of rural development

Conclusion

The rural development is to improve the competitiveness of agricultural holdings and the food industry developing them to comply with Community standards, while ensuring sustainable environmental and socio-economic development of rural areas trough improving the technological and market infrastructure of commercial agricultural holdings and food processing industry. In this way is increased added value of agri-food products and achieved compliance with EU quality, health, food safety and environmental standards as and improving quality of life of rural population, increased income and creation of new employment opportunities.

In support to the structural adjustment of the country's agricultural sector, the emphasis will be placed in particular on increased production competitiveness and higher quality of products. For that goal have to pay attention to measures in order to improving the competitiveness of economically viable agricultural holdings and food industry in selected sub-sectors through development investment policies.

The investments per priority sectors broadly cover costs for improvement and optimisation of production flows in processing and marketing of agricultural products; setting up or modernisation of local collecting networks, of reception capacities, storing, conditioning, sorting and packing of agricultural products of agriculture products .

The potential key issues to be addressed are investments in agricultural production to restructure and upgrade the sector to Community standards and to increase competitiveness

and to *develop and to diversify economic activities in rural areas* which creating additional income sources and employment opportunities in rural areas

References

- Acs, Z., 2002, *Innovations and the Growth of Cities*, Edward Elgar, Cheltenham and Northampton (MA).
- Black, D. and Henderson, V., 1999, "A Theory of Urban Growth", *Journal of Political Economy*, 107, 252–284.
- Cvetanovska B. and Angelova B. (2012), Establishment and organization of regional development in Macedonia. Challenges and perspective, PECOB Portal on Central Eastern and Balkan Europe University of Bologna – Forli Campus, Bologna, p.11
- Fujita, M., Krugman, P. and Venables, A., 1999. *The Spatial Economy: Cities, Regions and International Trade*. MIT Press, Cambridge, Ma.
- Fujita, M and Thisse, J.-F., 2002, *Economics of Agglomeration. Cities, Industrial Location and Regional Growth*, Cambridge University Press, Cam
- Jacobs, J., 1969, *The Economy of Cities*, Random House, New York.
- Perroux, F., 1955, "Note Sur la Notion de Pôle de Croissance", *Economique Appliquée* 1–2, 307–320.
- Krugman, P., 1991b, "Increasing Returns and Economic Geography", *Journal of Political Economy*, 99, 483–499.
- Myrdal, G., 1957, *Economic Theory and Underdeveloped Regions*, Duckworth, London.
- Maggioni, M., 2002, *Clustering Dynamics and the Location of High-Tech-Firms*, Physica-Verlag, Heidelberg and New York.
- National plan for agriculture and rural development 2007-2013, MAFWE, Skopje, 14 December 2007
- Nacional strategy for agriculture and rural development 2014-2020, MAFWE, Skopje, December 2014
- Stojanova V., Milchevski T., Nikiforovska I., Stojanovski M. and Chaloski T.(2012) Improving Regional Policy in Macedonia - Sharing the German and Slovenian Experience,EFB,New Business Education Foundation, Skopje, p.30
- Strategy for regional development of the Republic of Macedonia, Official Gazette of the republic of Macedonia 119/09
- Hirschman, A.O., 1958, *The Strategy of Development*, Yale University Press, New haven, CN.

THE COMPETITIVENESS OF POLISH FOOD PRODUCTS ON THE INTERNATIONAL MARKET

Małgorzata BULKOWSKA

Institute of Agriculture and Food Economics, National Research Institute, Poland

Abstract

The enlargement of the European Union (EU) resulted in a significant increase in trade in agri-food products within the EU, particularly among the new Member States. The purpose of this article is to evaluate to what extent an increase in trade in Poland's agri-food products, which took place between 2003 and 2014, translated into the strengthening of its position in EU trade in agri-food products. First, there is a brief presentation of results of Polish foreign trade in agri-food products, broken down into agricultural products and food industry products, that are the main subject of Polish foreign trade. Then, the paper presents Poland's position in agri-food trade after accession and among 28 European Union Member States. Furthermore, changes in the level of competitiveness in Polish exports were assessed on the basis of two indices: the revealed comparative advantage index (RCA) and the trade coverage index (TC). The analysis was conducted on the basis of trade data from the WITS Comtrade database, expressed in USD.

Keywords: food industry, foreign trade, competitiveness, competitive position

Introduction

Foreign trade in agri-food products has played an important role in Polish foreign trade for years, but it has become even more important during Poland's membership in the European Union. The share of agri-food exports in total Polish exports ranged between 8-9% prior to EU accession, increased to nearly 10% in the following years and has fluctuated around 12-13% since 2009 (13.2% in 2015). The share of agri-food imports in total Polish imports was lower and ranged between 6-7% in 2003-2008. Since 2009, the share of agri-food products in total imports has stood at 9% (9.1% in 2015). These changes are due to a clearly higher growth rate in trade in agri-food products than in trade in products of other sectors of the economy (Tereszczuk, 2016).

Polish foreign trade in agri-food products is primarily trade in food industry products which account for nearly 85% of Polish exports. This index is one of the highest in the EU (Szczepaniak, 2014). In 2015, approx. 40% of food industry production was exported. The food sector is one of few sectors of the national economy that enjoys a positive trade balance. Surplus trade in food products has a very large impact on the total trade balance. This means that exports became not only an important sales channel for surplus production, but also an increasingly important factor in the development of the food industry in Poland and an important factor in the stabilisation of the internal market. The purpose of this article is to evaluate to what extent an increase in trade in Poland's agri-food products, which took place between 2003 and 2014, translated into the strengthening of its position in EU trade in agri-food products.

Material and methods

The article assesses results of trade and changes in the competitive position of individual sectors of the Polish food industry in 2003-2014. Trade flows were analysed based on statistics from the United Nations (UN) Comtrade database. Agri-food products were

considered as commodities marked in the customs tariff with HS (Harmonized System) codes 01-24. The article divides agri-food products into food industry products and agricultural products and the former are further broken down into 17 individual sectors, i.e. meat, fish, fruit and vegetables, oilseed, dairy, milling and starch, bakery and pasta, sugar, confectionery, coffee and tea, concentrates, feed, spirits, wine, brewing, soft drinks and tobacco sectors.

The competitiveness of Polish trade in food products on the world market was assessed by comparing values of two indices, i.e. TC (trade coverage index) and RCA (revealed comparative advantage index).

RCA indices were calculated according to the following formula:

$$RCA = \frac{x_i / \sum_{i=1}^N x_i}{x_{iw} / \sum_{i=1}^N x_{iw}}$$

where:

RCA_{ij} – revealed comparative advantage index in Polish exports of the i^{th} product group to the j^{th} market,

X_{ij} – Polish exports of the i^{th} product group to the j^{th} market,

X_{iw} – world exports of the i^{th} product group to the j^{th} market,

N – number of product groups (here: total food exports).

The essence of the RCA index is to determine whether the share of a given commodity group in the export of a given country is higher/lower than the share of this commodity group in the world export to the specific market. When the index is greater than 1 (the share of the given commodity group in the export of a country is higher than the respective share in the world export) – a given country has revealed comparative advantage in the export to the specific market. Otherwise, when the index is lower than 1 (the share of the given commodity group in the export of the country in question is lower than the share of this product group in the world export) – the analysed country does not have revealed comparative advantages in the export to the specific market [Ambroziak 2015].

Another index used to examine the competitiveness of Polish agri-food exports is the trade coverage index (TC)

$$TC_{ij} = \frac{X_{ij}}{M_{ij}} \cdot 100$$

where:

TC_{ij} – trade coverage index in exports of the i^{th} product group to the j^{th} market,

X_{ij} – Polish exports of the i^{th} product group to the j^{th} market,

M_{ij} – Polish imports of the i^{th} product group to the j^{th} market.

TC index determines the extent to which expenses on imported goods are covered by the revenue from their export. The TC index is used to study the relationship between the export and the import at the level of entire trade, sector or product. The TC index greater than 1 means that the export value exceeds the import value, thus the given country has the relative competitive advantage over partners [Ambroziak 2015].

Results and discussion

Trade in food products in Poland

In 2003-2014, there was a dynamic increase in trade throughout the European Union which was an immediate result of the successive enlargements in 2004 and 2007 as well as the progressive liberalisation of world trade. In the period under analysis, the value of exports of EU food industry products increased 2.5-fold and reached USD 453 billion in 2014 (table 1). The share of the new Member States in EU food exports increased as well, from 5.6% in 2013 to 12.8% in 2014. The share of processed products in sales in the "old" Member States was higher than in the EU-13 by 5-6 percentage points on average. Against this background, Poland stands out with its share of food industry products which is much higher than the EU and EU-15 average, standing at nearly 85% in 2014 (in the period under analysis, the share of food industry products in EU exports was similar – 76%). Such structure of exports is very beneficial, as the food sector entities, pursuing higher added value, make better use of available resources and achieve higher profits [Ambroziak, Bułkowska 2014].

Table 1. Share of food industry products in Polish and EU agri-food exports in 2003 and 2014

	Exports (USD '000 000)	Share in agri-food exports	Share in exports of EU food products	Exports (USD '000 000)	Share in agri-food exports	Share in exports of EU food products
	2003			2014		
EU-28	198 144	75.6	100.0	452 781	76.2	100
EU-15	187 109	75.7	94.4	398 110	76.8	87.9
EU-13	11 035	74.8	5.6	54 670	71.7	12.1
Poland	3 653	82.6	1.8	23 682	84.7	5.2

Source: Own calculations based on UN COMTRADE data.

In the period under analysis, not only the importance of food industry products in Polish foreign trade, but also the role of Poland as a food exporter among EU Member States increased. In 2014, Poland was the 8th largest exporter of food industry products (Figure 1). However, higher sales revenues were recorded in Germany, the Netherlands, France, Italy, Belgium, Spain and the United Kingdom (in 2013, Poland was ranked 11th with its 1.8% share).

Figure 1. Share of individual countries in exports of EU food industry products in 2003 and 2014

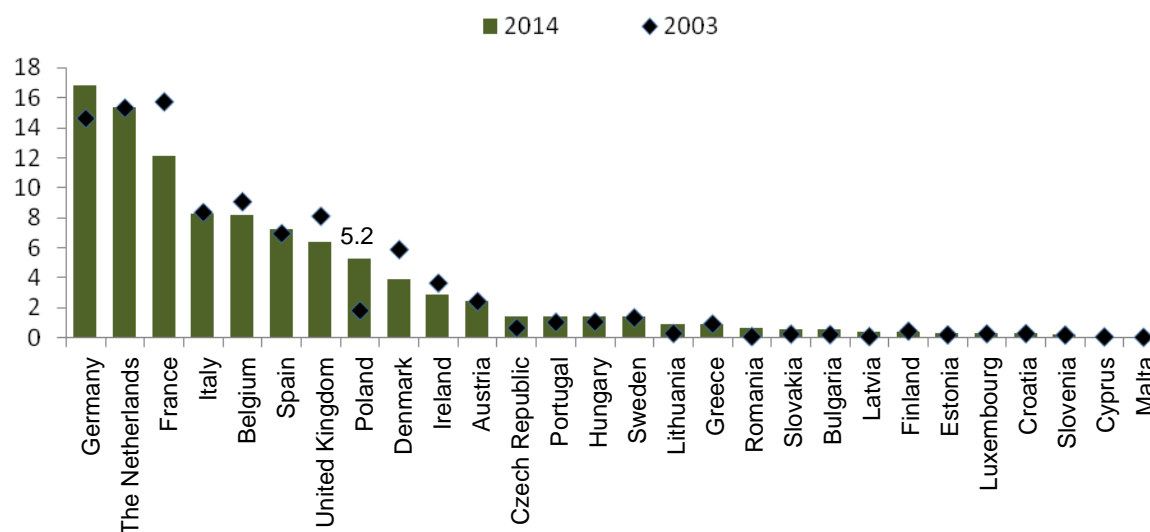

Source: Own calculations based on UN COMTRADE data.

The EU market is the largest and most important destination of exports of Polish food products, but its absorption is limited. Unfavourable external circumstances related to the embargo imposed by Russia in mid-2014 and growing competition on the EU market forced food producers to seek alternative outlets for their products. In recent years, the dynamic development of Polish exports to non-EU countries, in particular Asia, the Middle East and Asia, has been observed. It can be expected that the role of these outlets for Polish food will increase in the future, but it is still minor [Bułkowska 2016].

Commodity structure of Polish exports of food products

In 2014, the value of Polish exports of food industry products reached USD 23.7 billion which accounted for 85% of total agri-food exports. The largest share in Polish exports of food products was that of the meat sector (nearly 24%) which was followed by dairy and tobacco sectors (10.6% each), the concentrates sector (8.3%), the fish sector (7.9%), the confectionery sector (7.7%) and the fruit and vegetables sector (7.1%). Compared to 2003, the largest increase in exports was recorded in tobacco, wine, oilseed and brewing sectors. Despite this, the share of alcoholic products in Polish exports is still low and stands at less than 1%. In 2014, the share of oilseed industry products was slightly higher – 3.8%. Although each of the 17 analysed sectors increased the value of exports in the period under analysis, the share of 5 of them dropped. The largest drop in importance was recorded in the fruit and vegetables sector (by 11.6 percentage points), the soft drinks sector (by 3.8 pp) and the sugar sector (by 2.2 pp).

Table 2. Results of trade in food products by food industry sectors

Sector	Value of exports		Average annual export growth rate		Value of imports		Average annual import growth rate	
	2014	2014, 2003=100	Value (%)	Value (USD '000 000)	2014	2014, 2003=100	Value (%)	Value (USD '000 000)
meat	5 630	739	18.1	443	2 199	903	20.1	178
fish	1 874	656	17.0	144	1 124	362	11.3	74
fruit and vegetables	1 671	245	7.7	90	878	556	15.4	65
oilseed	900	2 349	30.1	78	2 226	373	11.6	148
dairy	2 510	689	17.4	195	990	1 678	26.5	85
milling and starch	513	662	17.1	40	472	602	16.1	36
bakery and pasta	1 170	711	17.8	91	452	903	20.1	37
sugar	321	249	7.9	17	161	740	18.2	13
confectionery	1 822	641	16.7	140	1 161	412	12.5	80
coffee and tea	814	768	18.5	64	510	348	11.0	33
concentrates	1 971	800	18.9	157	1 163	367	11.5	77
feed	492	709	17.7	38	530	572	15.6	40
spirits	210	426	12.8	15	192	793	18.8	15
wine	27	2 820	32.1	2	288	319	10.2	18
brewing	213	1 166	22.7	18	122	184	5.2	5
soft drinks	1 044	348	10.9	68	317	384	11.9	21
tobacco	2 500	3 391	34.1	221	262	1 963	28.2	23
in total	23 682	648	16.9	1 821	13 045	496	14.3	947

Source: Own calculations based on UN COMTRADE data.

In 2014, the balance of trade in food industry products amounted to USD 10.6 billion. Only 3 of the 17 analysed sectors achieved a negative trade balance, i.e.: oilseed, wine and feed sectors (in 2003 – 8 sectors). The largest trade surplus was recorded in meat, tobacco and dairy sectors.

Assessment of the competitiveness of Polish trade in food industry products

The assessment of Poland's competitive position in trade in food products on the world market, which was conducted based on RCA and TC indices, reveals that the number of sectors, in which Poland had comparative advantages on the world market, rose in 2003-2014 from eight to ten. In 2014, exports of products of these sectors accounted for 89% of total food exports (75% of agri-food exports).

Products of meat, fruit and vegetables, fish, dairy, bakery, confectionery, coffee and tea, concentrates, soft drinks and tobacco sectors may be considered as strongly competitive in Polish trade in food products. Polish food producers did not have comparative advantages on the world market in exports of wine and oilseed industry products. However, the assessment of the competitive position of the other five sectors, i.e. milling, sugar, feed, spirits and brewing sectors, is unclear due to different values of both indices.

Compared to 2003, the competitive position of producers in meat, coffee and tea, concentrates and tobacco sectors increased, while that of producers in the sugar industry was lost.

Table 3. Assessment of the competitive position of Polish food producers

		TC	
		TC>100	TC<100
RCA	RCA>1	meat fruit and vegetables fish dairy bakery confectionery coffee and tea concentrates soft drinks tobacco	feed
	RCA<1	milling sugar spirits brewing	oilseed wine

Conclusions

Foreign trade in agri-food products has played an important role in Polish foreign trade for years, but it has become even more important during Poland's membership in the European Union. Polish foreign trade in agri-food products is primarily trade in food industry products which account for nearly 85% of Polish exports.

Compared to 2003, the value of Polish exports of food industry products grew 6.5-fold and thus Poland increased its share in EU exports of this product group from 1.8 to 5.2%. The largest share in Polish exports is that of products of meat, tobacco, dairy, fish, confectionery and concentrates sectors.

Poland had comparative advantages on the world market in trade in food products of meat, fruit and vegetables, fish, dairy, bakery, confectionery, coffee and tea, concentrates, soft drinks and tobacco sectors. Polish food producers did not have comparative advantages on the world market in exports of wine and oilseed industry products.

References

- Ambroziak Ł., Bułkowska M., (2014), Role of Poland in foreign trade in agri-food products of the European Union, in: Szczepaniak I. (ed.), Assessment of the competitiveness of Polish food producers in the European Union, series „Multiannual Programme 2011-2014”, no 126.1, Institute of Agricultural and Food Economics – National Research Institute, Warsaw, Poland, pp. 28-47.
- Ambroziak Ł., (2015). The competitive position of the new EU member states in trade in food industry products, Bucharest: Faculty of Agro - Food and Environmental Economics - Bucharest University of Economic Studies, pp 55-65.
- Bułkowska M., (2016), Otwarcie polskiego sektora rolno-spożywczego poza UE, Przemysł Spożywczy, No 5.
- Szczepaniak I., (2014), Wyniki handlu zagranicznego produktami rolno-spożywczymi (The results of foreign trade in agri-food products), [in:] Szczepaniak I. (ed.), Monitoring i ocena konkurencyjności polskich producentów żywności (5), Synteza, seria „Program Wieloletni 2011-2014”, nr 115, Instytut Ekonomiki Rolnictwa i Gospodarki Żywnościowej – Państwowy Instytut Badawczy, Warsaw, Poland, pp. 25-50.

Tereszczuk M., (2016), Handel zagraniczny produktami rolno-spożywczymi w 2015 r. (Foreign trade in agri-food products in 2015), *Przemysł Spożywczy*, No 3, pp. 6-10.
[\(10.06.2016\)](http://wits.worldbank.org).

SELECTION OF FARMS FOR THE FARM ACCOUNTANCY DATA NETWORK SYSTEM IN THE REPUBLIC OF SERBIA

Mirjana BOJCEVSKI^{1*}, Zorica VASILJEVIĆ², Vlado KOVACEVIC¹

¹Ministry of Agriculture and Environmental Protection of the Republic of Serbia, Belgrade, Serbia

²Department of Agricultural Economics, University of Belgrade - Faculty of Agriculture, Belgrade, Serbia

* Corresponding author: mirjana.bojcevski@minpolj.gov.rs

Abstract

The aim of this paper is to analyze the process of selecting farms in the Farm Accountancy Data Network (FADN). All European Union countries through the FADN system collect technical, financial and economic data from over 82 thousand farms. In some countries, FADN system was introduced back in 1965. Over the years FADN has developed as a unique system that provides information on agriculture in the member states; FADN is arranged by the common EU regulations. The biggest challenges within FADN system is the implementation of the methodology for the selection of farms in terms of the number, type and certain economic size, as well as the motivation of farmers to agree to be part of the system. FADN research is a very complex and delicate one because the collected data include all activities on farms during the twelve-month period. Selected farms from which are received detailed financial information are very important sectors of agriculture and therefore represent an important source of information for agricultural policy. The collection of FADN data can provide valid data to be used for the purpose of managing agricultural holdings and therefore is valuable tool for farm advisory services and farmers' associations assisting farmers in improving the profitability and competitiveness. Methodology for farm selection has to be standardized at the level of the European Union and the candidate countries for accession. Standardized and uniform sample allows standardized results which can be compared between countries. Results of this study showed the importance of the process of selection of farms in FADN which includes a methodology development and implementation of the chosen methodology.

Keywords: *FADN, selection plan, farm sample, agriculture.*

Introduction

FADN system is based on the collection of production, financial and other relevant data on farms (Vasiljević, 2012). FADN is mandatory for all EU member states and for all candidate counties. There is a prescribed uniform standard methodology so that the data can be processed at the EU level and also standardization allows the comparison between situations in the agricultural sectors of individual EU member states. Considering the fact that it is almost impossible to cover all the farms in the EU, a representative sample is used for the report drafting.

The Republic of Serbia is a country with the status of candidate for EU membership. The negotiation process for accession of the Republic of Serbia to the European Union, include the establishment of a system of accountancy data on agricultural holdings in the Republic of Serbia i.e. FADN (Vasiljevic et al., 2012).

The first data were collected in 2011 from 41 farms. In 2012 the data were collected from 172 farms, in 2013 from 497 farms, while in 2014 from 989 farms.

In the coming period the sample of farms is expected to continuously increase according to the EU FADN methodology requirements. This will fully ensure the representativeness of the FADN research and meet the EU FADN requirements.

Furthermore, taking into consideration that the FADN system in the Republic of Serbia is still in the phase of establishment, the current FADN sample size does not reflect the real economic situation of the agricultural sector due to its logical uncertainty. Therefore, the conclusion concerning the Standard Results of FADN research in Serbia should be made with regards to EU requirements and national needs. The paper objectives are to evaluate process of the selection of farms for the FADN.

Materials and Methods

For the purpose of this paper, the desk research method and method of interview with relevant experts have been used. This research covers the 3-years' period (from 2013 to April 2016). In order to provide objective results, the method of descriptive statistics, interviews with relevant experts and the comparative method were also used.

Further, has been used unique replicable European Union (EU) methodology that has been applied and adjusted in accordance with national conditions in the Republic of Serbia. More specifically, in this paper has been used the FADN methodology described in the following Regulations:

- Council Regulation (EC) No 1217/2009 of 30 November 2009 setting up a network for the collection of accountancy data on the incomes and business operation of agricultural holdings in the European Community;
- Commission Implementing Regulation (EU) 2015/220 of 3 February 2015 laying down rules for the application of Council Regulation (EC) No 1217/2009;
- Commission Implementing Regulation (EU) 2015/2323 of 11 December 2015 amending Implementing Regulation (EU) 2015/220;
- Regulation (EU) No 1318/2013 of the European Parliament and of the Council of 22 October 2013 amending Council Regulation (EC) No 1217/2009.

Results and Discussion

Data collected in FADN are used for the calculation of Standard Output as well as Economic Accounts for Agriculture. Standard Output is calculated by the Liaison Agency, following the methodology set up in the Annex 4 of the Commission Regulation (EC) No 220/2015, while Economic Accounts for Agriculture is calculated by the Statistical office.

Data collected by the FADN system are used to calculate the standard value of production as well as for the economic accounts for agriculture. Standard production value is calculated by the FADN agency, according to the methodology established in the Regulation (EC) No. 220/2015.

There are several requirements of the European Union in terms of methodology. These requirements are as follows:

- Connection / relations with other statistical data and research;
- Determination of sample / selection of farms;
- Requirements in terms of the data collected and results;
- Requirements in terms of data processing.

The selection of farms for the FADN sample is based on data from the official statistical farm register. The Statistical Register of Agricultural Holdings contains data collected in the Agricultural Census and it can be updated with information collected from other sources¹.

¹ Regulation (EC) No 1166/2008 of the European Parliament and of the Council of 19 November 2008 on farm structure surveys and the survey on agricultural production methods and repealing Council Regulation (EEC) No 571/88.

The Regulation (EC) 220/2015 lays down the rules for the implementation of Council Regulation (EC) No 1217/2009 defining the rules for creation a detailed plan for the selection of farms applied by all Member States.

Models and methods relating to the form and content of the data referred to in Article 5a paragraph 4 of Regulation (EC) No. 1217/2009, are set out in Commission Regulation (EC) No 220/2015 in Annex III. According to the Article 3 of this Regulation, FADN sample stratifies according to three different criteria:

- FADN region,
- Type of production,
- Economic size of agricultural holdings.

The definitions and breakdowns in the typology and economic size are according to Article 4 of Commission Regulation (EC) 220/2015, which defines the part of establishing a Community typology for agricultural holdings, and Annex IV and V.

Council Regulation (EC) No 1217/2009 and No 1318/2013 oblige Member States to draw up a plan for the farms selection for the FADN system, and will be developed on the basis of the latest statistical data and presented in accordance with the farm typology.

To avoid biased results, the farms within the FADN sample must be selected according to statistical rules of the statistical farm register. Usually, the Statistical office prepares a list of farms that should be chosen for each stratum while local governments collect data, or employed in local units should contact farms and agree with them on their voluntary participation.

The development of the plan for the selection should start in the spring, and to be submitted to the National Committee in early June, the first reading needs to be held in late June, the second reading in September, and the third, if necessary, no later than mid-October.

The selection plan is made on the basis of data from Agricultural Census 2012, which has to be conducted every 3 years².

In order to draft a plan for the selection of farms it is necessary to prepare:

- a) The coefficient for the calculation of the standard output (SO) of production,
- b) The total of standard production value,
- c) Classes of economic size of agricultural holdings,
- d) The typology of agricultural holdings,
- e) The SO in 2007 for all types of production, accounted for two regions.

The coefficient for the calculation of the standard output (SO) is the average unit value of production of agricultural products (crops, multi-annual plantations or livestock). This ratio has been calculated as follows:

- a) according to the manufacturer's price (loco farm);
- b) for each product separately;
- c) taking in account the five-years' average;
- d) per unit of product (ha, throat, etc.);
- e) with exclusion of the direct payments (subsidies), taxes on products and similar;
- f) expressed in Euros.

² The first comprehensive Agricultural Census was conducted in 2012, while research on the structure of agricultural holdings is planned for 2017 and will be carried out on the basis of a sample (FSS- Farm structure survey).

The economic size of the farms is measured as a total output value of the property, or the sum of the individual SO of agricultural products represented on the farm, expressed in Euros. It is expressed in the "European unit size" (European Size Unit - ESU).

The most recent Regulation (EC) No 220/2015 prescribed the use of FADN methodology for the preparation of a detailed plan for the selection of farms, defines methodology for determination of the economic size and type of farms. Therefore, it is important to analyze the sensitivity of the plan for the selection of farms.

The typology of farms is precisely defined by Regulation (EC) No 220/2015 laying down the types of agricultural production. The type of agricultural production is determined by the relative contribution of the standard values of individual lines of production in relation to the total value of agricultural production.

There are 3 types of agricultural production:

- 1) General types of farming;
- 2) The main types of agricultural production;
- 3) Special types of agricultural production.

For creating a detailed plan for the selection of farms, the FADN methodology stipulates that it is necessary to fulfill the following requirements in defining the criteria for determining the FADN field of research as follows:

- 1) "Commercial farms"
 - > 90% of agricultural land;
 - > 90% of output (value of production);
 - Thresholds are defined for each country.
- 2) Representativeness
 - At the state level;
 - At the regional level.
- 3) Participation is voluntary
 - The number of farms for each country (Serbia around 2000);
 - Agricultural producers may refuse to participate;
 - Included the farms that have and have no based accounting.

The National Plan for the selection of farms must contain:

- a) FADN regions;
- b) Threshold of economic size of the research field;
- c) Types of agricultural farms, the representativeness;
- d) Number of holdings in the FADN survey.

Once established criteria for developing a plan for the selection of farms, the next step is to compile a list of farms that are included in the plan.

In accordance with the Article 5a paragraph of Regulation (EC) No 1217/2009, the table that defines the model and methods for implementing the plan for the selection of farms should be submitted to the Commission. This table consists of:

- a) Information Sheet;
- b) Plan for selection tables.

Detailed information on the reference population and sample for the relevant accounting year should be submitted on the basis of the following tables:

- a) Table 1. Rules that apply for the selection of farms;
- b) Table 2. Sample Coverage;

c) Table 3. Distribution of farms in the population;

d) Table 4. Plan Selection.

It is necessary to ensure that the sample is representative in all aspects relevant to the national level. For example, sectoral analysis based on FADN survey can be compared with data in agencies for payment or statistics on the total number of animals, the total area under different crops or total production of various agricultural products and farm economy classes. The structure of FADN sample in 2014 is shown in Table 4.

Table 1. Structure of the FADN sample by type of farming and economic size classes in Serbia, 2014

		Economic size classes					Total	%
		3	4+5	6+7	8+9	10+11		
1	Specialist and general field cropping	36	116	139	23		314	<i>33.3</i>
2	Specialist horticulture indoor	1	19	5		1	16	<i>1.7</i>
3	Specialist horticulture outdoor	6	4	6			16	<i>1.7</i>
4	Specialist vineyards	4					4	<i>0.4</i>
5	Specialist fruit	24	10	5			39	<i>4.1</i>
6	Specialist dairying	25	114	50	5		194	<i>20.6</i>
7	Various grazing livestock combined	16	95	30	4		105	<i>11.1</i>
8	Specialist pigs		4	4	3		11	<i>1.2</i>
9	Specialist poultry		6	15	4		25	<i>2.7</i>
10	Various crops and livestock combined	33	121	60	5	1	219	<i>23.2</i>
	Total	145	439	314	44	0	943	<i>100</i>
	%	<i>15.4</i>	<i>46.6</i>	<i>33.3</i>	<i>4.7</i>		<i>100</i>	

Source: Ministry of Agriculture and Environmental Protection.

Upon completion of data collection and verification of all data, FADN unit analyzes and prepares a report on the implementation of the plan for the selection of farms that provides accounting information. This plan is sent to the National Committee for approval, and the European Commission's checks by predefined RICA tests.

The farmers' motivation to participate in FADN is very important and it is necessary to motivate farmers to participate in the FADN survey. It turned out that the main motivation of farmers to cooperate and to submit the information is trust and good cooperation with advisors at the local level. The main motive of agricultural producers is to ensure a successful farm business and realize efficiency and productivity by using FADN feedback, which is an excellent instrument to compare individual farm with average results for same type of farms.

Conclusion

During 2013 and 2014, in Serbian FADN were included about 1,000 farms of different economic sizes and types. FADN results indicate that the selection of farms in the Republic of Serbia is appropriate and that the choice of farms is in accordance with EU rules. In the coming period the methodology of the FADN research should be further developed and adapted in accordance with the EU requirements, and the FADN organizational structure should be further improved and strengthened as well.

In the next period Serbia will gradually increase the number of farms included in the FADN sample corresponding to the established plan for the selection of farms. Based on the total

number of farms in Serbia, and in order to ensure the representativeness of different agricultural sectors, the Serbian FADN sample size should be finally 1,800-2,000 farms.

References

- EU Commission web page - FADN unit DGAGRI –Available at: <http://ec.europa.eu/agriculture/ricaprod/> Accessed: 08.08.2015.
- European Union official FADN web Available at: http://ec.europa.eu/agriculture/rica/legalbasis_en.cfm accessed on: 22.march 2016.
- FADN Serbia: Available at: <http://www.fadn.rs/>. Accessed: 5th April 2016.
- Regulation (EC) 220/2015 lays down the rules for the implementation of Council Regulation (EC) No 1217/2009.
- Regulation (EC) No 1166/2008 of the European Parliament and of the Council of 19 November 2008 on farm structure surveys and the survey on agricultural production methods and repealing Council Regulation (EEC) No 571/88.
- The Statistical Office of the Republic of Serbia, Available at: <http://popispoljoprivrede.stat.rs/?lang=en>, Accessed: 05 April 2016.
- Vasiljevic, Z. (2012). Establishing a network of accounting data network on family farms in Serbia, The Journal of Law and Economics of European Integration "Challenges of European Integration" Topic of "Agriculture of Serbia in the European integration process", Number 18 Publisher Public Enterprise Official Gazette with the support of GIZ, Editor Nikola Jovanović, ISSN 1820-9459, COBISS.SR-ID 1511881740, UDK 657: 631.115.11, pp. 27-40.
- Vasiljevic, Z., Zaric, V., Ivkov, I. (2012). Recording of Accountancy Data at the Family Farms in Serbia. Third International Scientific Symposium "Agrosym 2012". November 15-17, 2012, Jahorina; Faculty of Agriculture, University of East Sarajevo; ISBN 978-99955-751-0-6: COBISS.BH-ID 3336984; pp. 599-604.

KNOWLEDGE-BASED ECONOMY: THE POLISH CASE

Bożena NOSECKA, Łukasz ZAREMBA

Institute of Agricultural and Food Economics - National Research Institute, Warsaw, Poland

*Corresponding author: zaremba@ierigz.waw.pl

Abstract

Knowledge is considered a basic factor defining the scope of economic growth and an improvement in efficiency and at the same time the level of competitive advantages in the present world. Virtually key features of knowledge-based economy are narrowed to a common use of information and communication technologies, implementation of innovations and increasing role of human capital. The implementation of knowledge-based economy assumptions was approved as a common objective of development in the European Union (EU). In the Strategy 2020, the development model concerns three mutually complementing priorities, i.e. intelligent development based on knowledge and innovations, sustainable development and the development supporting social inclusion. Poland occupies one of the lowest positions among the EU countries in the world and the EU ranking in respect of the knowledge-based economy development. Relatively low level of the indicators concerning knowledge-based development in Polish economy and other new member countries largely reflects the situation in agriculture. The pace of innovative progress in agriculture is much lower than in other sectors of Polish economy. The support for “intelligent” development of agriculture in Poland is provided by the Rural Development Program (RDP). Over the period 2014-2020, the share of total support for the activities targeted at the implementation of first pillar of the Strategy 2020 (intelligent development) is fixed at 40% of the total RDP budget. Broad implementation of innovative solutions and knowledge-based actions to Polish agriculture requires primarily the rise in financial allocations for R&D and better use of the EU support.

Keywords: *position of Poland in the EU, indicators, agriculture, support*

Introduction

In the post-industrial stage of development of the global economy, which is characterised by globalisation of economic activities and flows of goods, broadly defined capital and services, accumulated knowledge becomes the primary development factor and even the material foundation for the industrial economy (Kleer, 2003). This material basis for the development and competitiveness in the modern world is defined as a "knowledge-based economy" (KBE)¹.

The basic features describing and distinguishing a knowledge-based economy boil down to: treating knowledge as the most important production (manufacturing) factor, a widespread use of information and communication technologies, creating new or improved products on the basis of knowledge using innovative solutions, increasing the role and significance of the quality of human capital in the process of development and building competitive advantages, highlighting the role and importance of the demand factor and an intrinsic shift in influences from the producer to the consumer (Dworak et al., 2014), but also increased uncertainty and risk in doing business (market acceptance of new or improved products).

¹ The concepts of a knowledge society and knowledge economy have been introduced to the economic literature by Drucker (1995). By formulating these concepts, Drucker based on the experience of developed countries, mainly the US and the Japanese economies.

Knowledge-based economies mainly tend to build competitiveness by conveying features to products to "distinguish" them from the products offered by competitors. According to Porter (1980), it is a basic factor, apart from unit costs of production, of a market presence greater than other competitors. Modern technical, technological or organisational solutions also have an impact on the level of production costs.

It is obvious that the modern development paradigm, i.e. developing the economy and building the competitiveness on the basis of knowledge, does not make obsolete the economic order contained in the hitherto research theories on the factors of economic development and improvement in the competitiveness.

Implementation of the assumptions of a knowledge-based economy has been adopted as the primary objective of the development strategy of the EU Member States. The development plan for the entire EU on the basis of KBE was defined for the first time at the European Council Summit in Lisbon in March 2000. The development strategy adopted in Lisbon was to make the Community the most competitive knowledge-based economy in the world, capable of sustainable and balanced development.

A continuation of the Lisbon Strategy (and the revised Lisbon Strategy) is represented by the Europe 2020 strategy adopted for implementation in the EU in 2010. (Europe 2020 strategy (12 September 2012))The current development model is based to a greater extent than before on three mutually complementary priorities (pillars). They include:

- I. smart growth – based on knowledge and innovation;
- II. sustainable growth – aimed at increasing the importance of a low-carbon, resource-efficient and competitive economy;
- III. inclusive growth – supporting employment growth with economic, social and territorial cohesion at the same time.

Materials and methods

The study uses data from the European Commission and the World Bank, the Polish Rural Development Programme (RDP) and the information from the Central Statistical Office (CSO) in Poland. The research method was to make comparative analyses of expert assessments. There were also used indicators methods, as well as descriptive statistics to conduct evaluation of position of Poland among other countries.

Results and discussion

Measurement of the development of knowledge-based economies

A commonly used measure of the development of a knowledge-based economy is represented by the share of expenditure on research and development in GDP (a ratio that has been adopted as one of the basic ones in the assessment of the implementation of the 2020 Strategy). Some economists (e.g. Kodama, 1995) tend to measure the development of a knowledge-based economy by means of the level of expenditure on R&D in relation to expenditure on fixed capital. The economy or economic operators can be considered knowledge-based when the investment in R&D is higher than the investment in fixed assets.

The most extensive research covers the studies on the development of knowledge-based economies conducted by the World Bank since 1998 in relation to over 100 countries. The assessment of the progress in the implementation of the 2020 Strategy is also fostered by the research and rankings conducted by the European Commission. The research of the World Bank and the European Commission has resulted in the development of a synthetic indicators to assess the development of a knowledge-based economy. These are: the Summary Innovation Index (SII) developed by the European Commission and the KEI (Knowledge Economy Index), which is prepared annually by the World Bank.

When calculating the indices referred to individual pillars, dozens of variables are taken into account. The key parameters of the three pillars of a knowledge-based economy – i.e. education and human resources, innovation and information and communication technologies – are the basis for determining the level of the Knowledge Index (KI).

Table 1. Evaluation pillars of a knowledge-based economy in the KEI, KI and SII indicators

Indicators	Pillars			
	I	II	III	IV
KEI	Legal and institutional regime	Education and human resources	Innovation	Information and communication technologies
KI	-	Education and human resources	Innovation	Information and communication technologies
SII	Human capital	Financial support	Openness and attractiveness of the research system	-

Source: Own compilation on the basis of: KEI <http://info.worldbank.org/etools/kram2/kram>; Innovation Union Scoreboard (IUS) 2010 r. Pro Info Europe, 1 February 2011; The World Competitiveness Scoreboard; The Global Competitiveness Yearbook.

Position of Poland in the results of the measurement of the knowledge-based economy

In 2012 (latest available data), Poland was ranked 25th in the EU in terms of the KEI level, ahead of Romania and Bulgaria only (Fig. 1). The highest ranked countries included, just like in the previous years covered by the study, the Nordic countries – Sweden, Finland and Denmark as well as the Netherlands and Germany. Among the new Member States, the highest position in the ranking in 2012 was occupied by Estonia (11th place) and the Czech Republic (14th place).

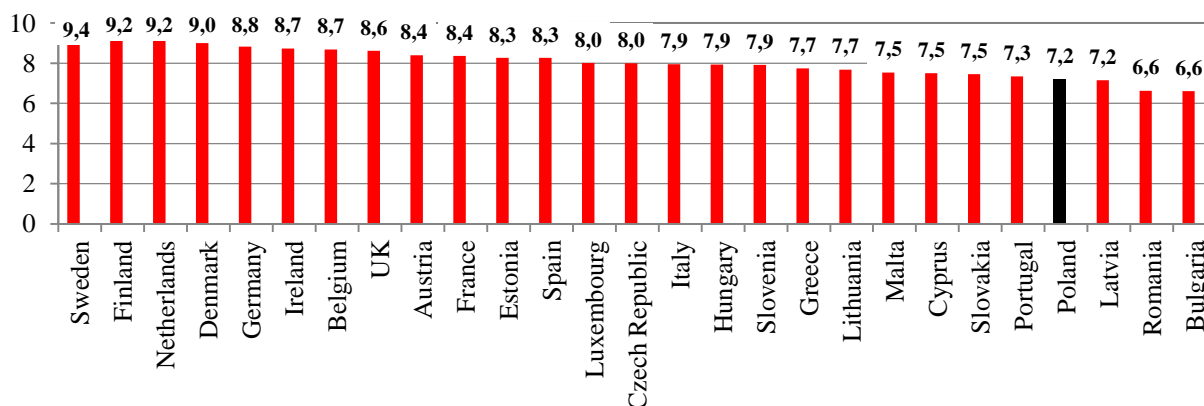

Figure 1. Ranking of the EU-27 on the basis of the KEI index in 2012

Source: www.worldbank.org/kam

The rankings developed on the basis of the KI listed Poland on the 24th position ahead of Romania, Bulgaria and Latvia.

The place of Poland in the development and innovation ranking developed by the European Commission in the EU (SII) is also low. In all the years of the Polish presence in the Community, this index was lower than in Poland only in Bulgaria, Romania and Latvia (Fig. 2). The highest SII level is observed in Sweden, United Kingdom, Finland, the Netherlands, Germany, Denmark and Belgium. The Summary Innovation Index in Sweden in 2014 was 2.4 times higher than in Poland, and in Germany it was 2.2 times higher. Poland, beside most new member states, as well as the southern EU-15 countries (Greece, Portugal, Italy, Spain), is considered a moderate innovator. By far the largest distance can be found between Poland and

most EU-15 in terms of the level and the development of information and communication technologies, the implementation of innovative solutions, the development of research networks and co-operation of academic and scientific institutions with production plants. Poland comes out relatively well only in terms of the level of education in society. The SII level in Poland in 2005-2014 has not changed significantly and fluctuated around 0.27-0.31². Just like in Poland, the SII level has not changed significantly only in Lithuania.

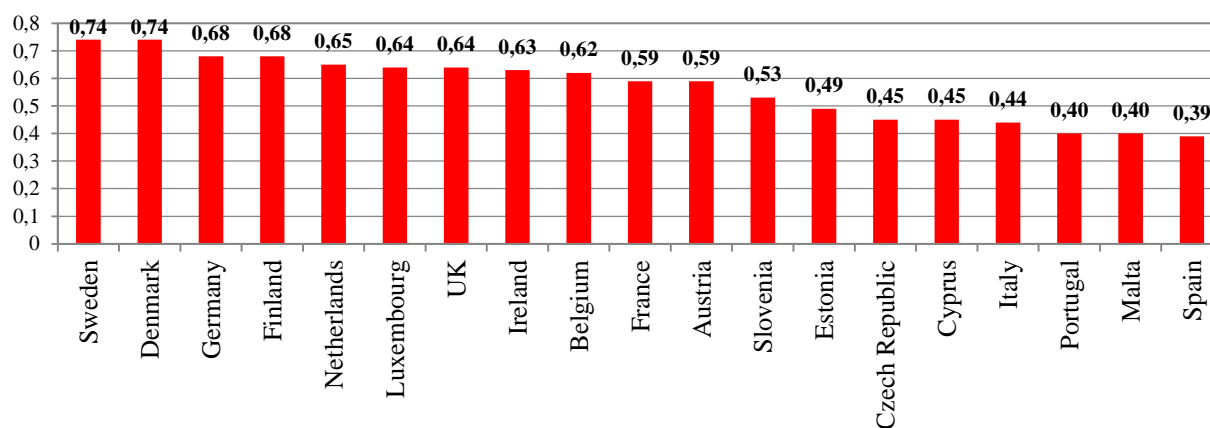

Figure 2. The level of SII indicators in EU Member States in 2014

Source: *Innovation Union Scoreboard (IUS) 2014*, <http://www.proinno-europe.eu/metrics>

The distant position of Poland in the rankings covering the development of knowledge-based economies in the EU results mainly from the relatively low level of development of ICTs and innovation, but what is not quite advantageous in comparison with most of the countries in the EU, including the new Member States, is the institutional environment, which creates incentives first of all for the implementation of innovation. This environment includes administrative, legal and financial procedures. Obviously, however, the scale of the development of a knowledge-based economy depends on the economic condition of the market players and the wider society as a whole, and this condition depends on the scale of economic development of individual countries.

Selected indicators of a knowledge-based economy in the Polish agriculture

The indicators concerning the development of a knowledge-based economy in the Polish agriculture are worse than for other sectors of the national economy. This applies to all areas taken into account when assessing the smart growth, i.e. the quality of human capital, the condition and the use of information and communication network (information society) and the level of implementation of broadly defined innovative solutions. The lower level of development indicators based on the knowledge in agriculture is evident due to the worse income situation of farmers in comparison with other sectors of the economy and, consequently, their lower chances and opportunities for introducing innovative solutions, access to information or the level of education. This means a very strong dependence of agriculture on the basis of modern factors of competitiveness on external factors – mainly the financial, but also organisational and managerial support.

According to the Polish statistical data, 9.9% of the rural population over the age of 13 (in urban areas 21.4%) had higher education level in 2014. 25.5%, 26.5% and 31.6% respectively of the population in rural areas had secondary, vocational and primary or lower secondary education. Among the persons running farms, only 2.6% had higher agricultural education, 25.3% had secondary education (vocational, primary and post-secondary education), and

² Indicators calculated from 0-1.

20.2% completed agricultural courses. Among the managers of farms with an area over 15 ha (15% of the total number of farms), 6.3% of people had higher education, and 47.6% had secondary education. In the smallest farms (1-1.99 ha – 20% of farms), these indicators in 2013 amounted to 1 and 13% respectively (CSO Statistical Yearbooks 2014, CSO Warsaw).

The percentage of the rural population having primary and secondary education is higher in Poland, just like in most new member states, than in the EU-15. On the other hand, the share of people with higher education is higher in the countries of the "old" Community. These disparities are similar with reference to the agricultural population (there are no data on the level of education of the rural population in the EU Member States).

The absence of research methods associated with the selection of evaluation criteria and measurement methods makes it difficult to determine the scale of the current innovation progress in agriculture. However, it is estimated that what is primarily disseminated in this sector are the results of the achievements used in farms in economically developed countries (an imitative progress). This applies mainly to the storage system for agricultural products, the use of modern machinery for the harvest and the improvement of the genetic potential of plants and animals. The development of the genetic potential in agriculture is fostered by a high supply and availability of innovative means of production for agriculture – agricultural equipment, plant protection products, yield-enhancing products, seed and seedlings. The problem is still a low (compared to many EU countries) scale of their use in farms in Poland. This is due to the relatively poor economic condition of most farms, a small degree of their organisation and the still small scope of co-operation with entities operating in the agricultural environment – mainly with academic and research centres and counselling entities.

Expenditure on research and development in agriculture in 2014 amounted to 1.0 billion Polish Złoty (PLN) and was higher than in 2000 by PLN 0.6 billion (Table 2). At the same time, however, the share of expenditure on research and development in the total expenditure on the R&D in Polish agriculture has been steadily decreasing since 2005. In 2000, this share amounted to 8.3%, in 2010 to 7.7% and in 2014 to barely 6.2%.

Among EU Member States, the share of expenditure on R&D in agriculture in the total expenditure on R&D in Romania, Bulgaria, Hungary, Slovakia, Latvia, Cyprus, Estonia, the Czech Republic is higher than in Poland, and among the EU-15, it is higher in Spain, Greece and Ireland.

Table 2. Employment and expenditure on R&D

Item	Employment in the R&D sector (thousand persons)				Expenditure on the R&D sector (PLN billion)			
	2000	2005	2010	2014	2000	2005	2010	2014
Total	78.9	76.8	81.8	104.4	4.8	5.6	10.4	16.2
In the agricultural sector	8.2	6.5	5.4	5.9	0.4	0.5	0.8	1.0
Share of agriculture (%)	10.4	8.5	6.6	5.7	8.3	8.9	7.7	6.2

Source: Central Statistical Office (CSO) - Statistical Yearbooks (2007 and 2015).

A still small scale of vertical linkages of agricultural producers and processing units results in a negligible impact of food industry stakeholders on the implementation of scientific and technical progress in the agricultural production and improvement in the quality of the supplied products.

Support for the development of the knowledge-based economy in Poland

The implementation of the 2020 Strategy in the Polish agriculture and in a broader sense in the agri-food sector is carried out on the basis of the funds provided under the Rural Development Programme (RDP).

The following measures are directly connected with the first pillar of the 2020 Strategy (smart growth): Transfer of knowledge and information measures, Consulting and Co-operation. Implementation of the first two measures, which are oriented towards training centres (academic institutions, agricultural advisory centres, agricultural chambers, private advisory entities), is primarily aimed at developing the knowledge and skills of farmers, disseminating of innovation and good practice in the field of agricultural production and processing of agricultural products. The measure Co-operation applies only to innovative projects, and the support is oriented towards the European Innovation Partnership (EPI) operational groups, which are created in order to develop efficient and sustainable agriculture.

The support provided under the Modernisation of farms in measure “*Investment in fixed assets*” is very strongly connected with the implementation of the first pillar of the Strategy. Modernisation is understood as implementation of innovation, but also as improvement in product quality. Modernisation is unrealistic without proper knowledge of farm managers. The improvement in the quality of labour force in agriculture by changing the age structure of farm managers and the opportunities for supplementing the education is fostered by the support in the form of premiums for young farmers.

Approximately EUR 13.5 billion, i.e. ca. PLN 55 billion, are expected in 2014-2020 for the implementation of all RDP measures (ca. PLN 43 billion were disbursed in 2007-2013 under the RDP funds). The financial plan for 2014-2020 for measures that can be directly referred to a knowledge-based economy (transfer of knowledge, advisory services, co-operation) provides for a budget of approx. EUR 191 million. The share of the overall support for the measures directly and indirectly associated with the implementation of the first pillar of the 2020 Strategy in relation to the agri-food sector is projected in 2014-2020 at ca. 40% of the RDP budget. Just like in the previous RDP implementation period, the largest funds (EUR 2.4 billion) will be allocated for the modernisation of farms.

Conclusions

Wider implementation of innovative solutions in the Polish economy, in particular in agriculture and support for the development on the basis of knowledge requires primarily increased expenditure on R&D and better use of EU support funds. When it comes to agricultural entities, it is necessary to increase the scope of co-operation with the entities operating in the environment of agriculture – mainly food processing entities, advisory centres and research institutions.

The role of the participants in the agri-food sector boils down first of all to maximising the use of EU and national support funding under the Rural Development Programme. The scale of obtaining support by agricultural producers depends to a very large extent on the organisational support by institutions operating in the environment of agriculture, but also on the willingness of producers to operate in larger economic organisations – mainly in producer groups and associations and in the system of clusters.

The measures conducted by government administration should come down mainly to: creating favourable conditions for the operation of market players in the aspect of innovative measures and extension of the scope of knowledge (tax and legislative instruments, making the access of market entities to the EU and national support funds more flexible).

References

- Drucker P.H. (1995). *Zarządzanie w czasach burzliwych*. (the management in turbulent times) AE Kraków, Czytelnik.
- Dworak E., Grabia T., Kasperkiewicz W., Kwiatkowska W. (2014). *Gospodarka oparta na wiedzy, innowacyjność i rynek pracy*. (Knowledge based economy, innovativeness and labor market) Wydawnictwo Uniwersytetu Łódzkiego, Łódź.
- Innovation Union Scoreboard (2010, 2014) <http://www.proinno-europe.eu/metrics>
- Kleer J. (2003). *Co to jest GOW* [in:] *Gospodarka oparta na wiedzy*, (What is Knowledge Based Economy) Ed. A. Kukliński. KBN, Warsaw.
- Knowledge Economy Index (KEI) <http://info.worldbank.org/etools/kram2/kram>
- Kodama E. (1995). *Emerging Patterns of Innovation: Sources of Japan's Technological Edge*. p. 5, Boston.
- Porter M. E. (1980). *Competitive Strategy: Techniques for Analyzing Industries and Competitors*. The Free Press, A Division of Macmillan Inc., New York.
- Rural Development Programme 2014-2020.
- CSO Statistical Yearbooks for 2002-2014, CSO Warsaw.
- CSO Statistical Yearbook of Agriculture 2006, 2014. CSO Warsaw.
- Europe 2020 strategy (12 September 2012)
<http://www.mg.gov.pl/Bezpieczenstwo+gospodarcze/Strategia+Europa+2020>
www.worldbank.org/kam

IMPACT OF TOURISM DESTINATION ENVIRONMENT ON COMPETITIVENESS OF RURAL DESTINATIONS IN VOJVODINA (SERBIA) AND HUNGARY

Dunja DEMIROVIĆ^{1*}, Adriana RADOSAVAC², Marko PETROVIĆ³

¹University of Novi Sad, Faculty of Sciences, Department of Geography, Tourism and Hotel Management, Novi Sad, Serbia

²University of Business Academy, Faculty for Economy and Engineering Management, Novi Sad, Serbia

³Serbian Academy of Sciences and Arts (SASA), Geographical Institute „Jovan Cvijić“, Belgrade, Serbia

*Corresponding author: demirovic.dunja2@gmail.com

Abstract

The competitiveness of tourism destination is conditioned or limited by the influence of many factors that appear outside of a destination or are in its immediate environment. In accordance with the strategic management concepts, elements of the external environment of rural tourist destinations are analyzed on two levels: macro and micro. The aim of this paper is to explore how destination environment – economic stability, characteristics of demand and socio-cultural changes, community participation and attitudes, cooperation between stakeholders in tourism (intra-industry interactions) and incentives and financial support for the development of tourism by the government and local authorities - affects competitiveness of rural tourism destinations in Vojvodina (Serbia) and selected counties in Hungary. Tourism experts from Serbia (136) and Hungary (138) were asked to evaluate the current condition of 17 attributes which affect the competitiveness of rural tourism destinations. Likert scale of five marks was used in order to determine the effect of the environment on the competitiveness of Vojvodina/Hungary as a rural tourism destination. Selected tourism experts were interviewed from September 2015 until the end of January 2016. The research in this paper examined the relative importance of actions taken by the industry stakeholders and government efforts to improve the competitiveness of the sector. It was found that companies have a greater impact, because they have a major role in providing services to visitors and enable tourists to experience the rural areas, while state and provincial institutions are responsible for managing and supervising the work of different rural tourism enterprises and providing appropriate support.

Keywords: *Rural destination, Competitiveness, Vojvodina (Serbia), Hungary*

Introduction

In the tourism industry, the competition between tourist destinations and products has become very intense which has contributed to greater market transparency, price and other elements of products and services (Cracolici, Nijkamp, Rietveld, 2008). Global competition in the tourism industry has become a challenge for many countries that are competing to become a desirable tourist destination, so understanding the factors that contribute to the competitiveness of destinations is essential to maintain the current level of development of tourist destination, its growth and vitality (Ritchie, Crouch, 1993; Hassan, 2000). Therefore, measurement of competitiveness can be considered as a key factor in ensuring the success of tourist destinations.

Rural tourism is one of the priorities in tourism development in many European countries. Rural tourism market is on the rise, while at the same time the future of many rural areas is uncertain, due to changes in agricultural production and the attractiveness of urban areas due to higher living standards. Rural tourism is considered to be one of the appropriate instruments for the revitalization of rural areas. Individual tourism enterprises in rural tourism

are interdependent and connected, and those are primarily small and medium-sized enterprises. Problems in rural tourism which contribute to the reduction of competitiveness are reflected in the existence of strong competition instead of cooperation among providers of tourist products and services in rural areas. Given the importance of tourism to rural areas, determining the factors that influence the improvement of the competitive position of the tourism market is of great importance for their further development.

In this paper, the focus is on one of the three components of the competitiveness of rural tourism destination, and that is tourism destination environment. The aim of this paper is to analyze the tourism destination environment - factors (Economic stability; The characteristics of demand and socio-cultural changes; Participation of local communities and their attitudes; Cooperation between stakeholders in tourism; Incentives and financial support for the development of tourism by the government and local authorities) and 17 attributes belonging to this determinant affecting the competitiveness of Vojvodina (Serbia) and Hungary as a destination of rural tourism. Theoretical framework of the tourism destination environment is described in the next chapter and after that, results and discussion are presented. In the end, conclusions are made.

Tourism destination environment – theoretical framework

The competitiveness of tourist destinations is conditioned or limited by the influence of many factors that appear outside the destination or are in its immediate environment. As for the company, the external environment of the tourist destination consists of two parts: macro (global) and micro (competitive) environment. External environment of destination includes economic, technological, environmental, political, legal, socio-cultural and demographic changes, while the competitive (micro) environment consists of suppliers, marketing intermediaries, consumers, tourism and hospitality companies, related and supporting industries, local organizations of destination management and public services.

In accordance with the strategic management concepts, elements of the external environment of rural tourism destinations are analyzed on two levels: macro and micro. At the macro level, a number of macro trends have the potential to affect the rural destinations, both positively and negatively. Among them, of vital importance for the development of rural tourism in Vojvodina are economic stability and socio-cultural changes. According to the author Dwyer and others (2000), socio-economic factors are an important generator of tourism turnover. Leisure time, income level, and more importantly, the level of economic growth and economic stability are prerequisites. At the micro level, competition and cooperation between destinations, demand conditions, and community participation and attitudes affect the competitiveness of the tourism sector. This is because stakeholders in tourism are tourists, businesses and local communities in which the industry operates (Williams, Lawson, 2001). They are key players in destination who are interested in tourism development, or are exposed to its influence.

Derived from Crouch-Ritchie and Dwyer-Kim model of destination competitiveness, this paper discusses the factors of the destination strategy through:

1. **Economic Stability** - Analysis of the economic environment involves monitoring of changes in the macroeconomy and its impact on companies and consumers (Evans, Campbell, Stonehouse, 2003). The phenomenon of rapid economic growth in Serbia (and Vojvodina) has implications for the tourism industry. The average gross salary has been increased from 8,691 RSD in 2001 to 61,420 RSD in 2014, thus increasing the opportunity and inclination to travel. The number of people who are more educated is increased and they have higher incomes and appreciate the value of travel (traveling to rural areas). However, although the average salary is increased, the economic situation in Serbia - high unemployment rate of 17.9%, a reduction of salaries and pensions, the growth rates of

absolute poverty, an increase in consumer prices, have impact on reducing the opportunities for citizens to travel for leisure and entertainment. Therefore, the increase in disposable income and general economic stability of the Serbian economy can contribute to fostering the development of the tourism market, where rural tourism, as a form of tourism whose development depends on the domestic market, will benefit from this growth and will acquire a significant share of the tourism market.

2. *Characteristics of demand and socio-cultural changes* - In the context of tourism, a new group of people, changes in attitudes and flexible free time are among the most significant social changes. These social trends have reduced the importance of standardized mass tourism in favor of tourism which is characterized by diversity, segmentation and customized travel experience. The demand for differentiated tourism products and experiences has led to a number of tourist destinations that focus on specific activities. Rural tourism can be an example of such a trend. Customers and their needs and desires, are still one of the driving forces in the environment of the tourist destination. Consumers are no longer a homogeneous group of people with the same motives for the trip. They are becoming more heterogeneous and more sophisticated, and affect the competitive activities of tourism enterprises and operation of tourism in the destination as a whole. According to Porter (1990), more sophisticated and demanding customers are the foundation of competitiveness, because it puts pressure on companies to achieve high standards in terms of quality products and services. In addition, the size and characteristics of demand growth can boost competitiveness by leveraging on for example, the investment policy. Also, the conditions of demand, especially domestic demand and its internationalization in foreign markets, provide a basis for economic development of a nation.

3. *The participation of local communities and their attitudes* - Community is a group of people who live in the same region with common interests and identity. The community is a major player in the development of tourism because tourism industry “benefits the community as a resource, as well as product and in the development process affects the quality of their life” (Murphy, 1988, p. 97). Authors Sheldon and Abenoja (2001) argue that there must be a broad involvement of local communities and the continuous evaluation of the perception of residents in order to ensure the development of a tourist destination, but also should be in accordance with the local character and values. Understanding the attitudes of local community on tourism development and their involvement in as many aspects of development, can create a welcoming and friendly environment, which will bring benefits to the tourism industry and to the local community, and therefore will improve the quality of the tourist experience.

4. *Cooperation between the stakeholders in the tourism industry* - Stakeholders in the tourism are representatives of government institutions and local authorities, owners of tourism and tourism-related businesses, local community and visitors (tourists) (Conaghan, Hanrahan, 2010; Byrd, Bosley, Dronberger, 2009). Also, the stakeholders in the tourism industry can be divided into tourists (demand), industry (offer) and “hosts” (local community and the environment of destinations) (Pavlovich, 2003). The knowledge and experience held by stakeholders in the tourism industry, and their involvement in the process of tourism planning and development and involvement of local communities in the long term has a significant role in the management of tourist destinations. The participation of all relevant stakeholders in planning the development of tourism can contribute to increased efficiency in achieving sustainable development of tourism in a destination. Also, the greater involvement of stakeholders will allow each of the actors to increase their self-confidence, gain a better overview and awareness of the problems that need to be solved in the area, and very often to facilitate a compromise among actors who have conflicting interests.

5. Incentives and financial support for the development of tourism by the government and local authorities - In rural tourism, small businesses are the most common, and even small businesses are faced with a small amount of resources for management than other companies on the market, they are more flexible, more responsive and can faster adapt to changes. Small businesses are particularly dominant in the tourism industry where they make up 95% of the total number of enterprises, and are especially present in rural tourism where entrepreneurs develop a personalized relationship with customers of products and services (with tourists). One of the important characteristics of agritourism enterprises is that their work depends on their own resources and they are responsible for all services provided to tourists. Decision-making is characterized by informality, but this can be an advantage, because small businesses can be easier established than the larger, but also new ideas are easier to implement (Aragon-Sanchez, Sanchez-Marin, 2005). Survival, growth and development of small (and medium) enterprises is primarily determined by the possibilities of financing from the budget sources. Limited access to sources of funding, particularly in terms of price and conditions of use, is perhaps the most important and the biggest problem of these companies.

Materials and Method

Tourism experts from Serbia and Hungary were asked to assess the current state of 17 attributes which affect/could affect the competitiveness of rural tourism destinations in Vojvodina/Hungary. Likert scale of five scores was used, where "1" means very bad condition of the attribute, score "2" bad condition, "3" average condition, "4" very well and "5" excellent condition of the attribute. Respondents were not offered to assess the current state of the attribute in relation to the set or a competitive destination (which tourism experts would identify by themselves) because it would not give a true picture of the competitiveness of Vojvodina/Hungary, because experts would compare rural tourism in Vojvodina/Hungary with several different destinations.

In this paper, survey research covered all those tourism experts who have the knowledge and/or experience relevant to the subject, and whose area of research and action is related to rural tourism and competitiveness of tourist destinations. In Vojvodina and selected districts in Hungary, interviewed tourism experts are as follows: teaching staff at higher education institutions, employees of the tourist organizations, employees of national and provincial institutions of importance for the development of tourism, tourism managers of travel agencies, owners of tourism enterprises in rural areas (farms, restaurants, ethno-houses, museums, wineries, souvenir shops, event organizers) and others (societies, associations, clusters).

The survey was conducted in two ways - a personal interview (technique of "face to face") and by sending a questionnaire via e-mail. Research in Vojvodina was conducted in the framework of its three regions - Bačka, Banat and Srem, while research in Hungary was conducted in seven counties - Somogy, Baranya, Tolna, Bács-Kiskun, Csongrád, Békés and Jász-Nagykun-Szolnok. These seven districts in Hungary have similar rural tourism offer as Vojvodina. Selected tourism experts in Vojvodina and Hungary were interviewed in the period from September to the first half of December 2015. The response rate in both countries is about 50%. Statistical analysis of the data collected through the survey will be done in the software statistical program SPSS 17.

Results and discussion

Respondents from Hungary and Vojvodina assessed the state of the factors within the determinant “Tourism destination environment” of the five subscales (factors) and there is a statistically significant difference at the level $p < 0.01$ (Table 1), except for the factor “Participation of local communities and their attitudes”. Rural areas of Vojvodina have achieved lower scores compared to districts in Hungary.

Table 1. T-test for dependent samples - comparison of results between Vojvodina and selected Districts in Hungary for the determinant “Tourism destination environment”

Factor	Region/ Country	AS	SD	T	Relevance
Economic stability	Vojvodina	2.3051	.74826	-7.856	.000
	Hungary	3.0912	.89775		
The characteristics of demand and socio-cultural changes;	Vojvodina	3.3544	.63338	-5.857	.000
	Hungary	3.7912	.59846		
Participation of local communities and their attitudes	Vojvodina	3.3431	.62320	-.880	.380
	Hungary	3.4112	.65463		
Cooperation between stakeholders in tourism	Vojvodina	2.4877	.78453	-6.271	.000
	Hungary	3.1290	.90048		
Incentives and financial support for the development of tourism by the government and local authorities	Vojvodina	2.5423	.77433	-3.896	.000
	Hungary	2.9599	.98343		

Source: Authors based on analysis of data from the survey

When it comes to economic stability, as an important factor that allows traveling, tourists in Hungary have a higher portion of income that is available for travel to rural areas, while differences in the economic situation in the countries were not assessed significantly different. Tourist demand in Hungary is characterized by tourists who share vacation in several short trips during the year (which may be the impact of higher standards of living and of awareness for travel in relation to Vojvodina), as well as tourists who visit the rural areas have heightened awareness of the importance of health, so they will choose one destination that will enable them active recreation (walking, hiking, swimming, running ...) in the preserved nature (visit protected natural areas, the choice of units that operate in a sustainable way, etc.). What is common for rural tourism Vojvodina and Hungary is that tourists who visit rural areas belong to all age categories, and the domestic tourists are dominant in this form of tourism. Cooperation between all stakeholders is a significantly better evaluated by participants from Hungary, which indicates that they recognized the importance of association and trade of capacities and experiences among all stakeholders involved in the development of rural tourism. Also, financial support for the development of rural tourism in Hungary is more intensive and efficient, but it takes place not only by the state institutions, but stakeholders were trained to apply for European funds and thus receive significant funds to improve all aspects of tourism offer.

Conclusion

The research in this paper has examined the relative importance of action by the industry and government efforts to improve the competitiveness of the sector. It was found that companies have a greater impact, because they have a major role in providing services to visitors and allow tourists to experience the rural areas, while state institutions and provincial governments are responsible for managing and supervising the work of different rural tourism enterprises and provide appropriate support. The role of the government sector is to act as a regulatory body and to assume responsibility for the strategic planning of development of rural destinations, and should undertake a systematic review of the destination attribute. Also,

the work of national and provincial institutions should have the aim to ensure that the destination has clear ideas where its development is going and what it takes to become successful in the long run. The attitudes of residents towards the development of rural tourism, their approval and participation in activities related to tourism, are often the key that contributes to the sustainable development of rural tourism. The absence of community participation and their support in the decision making process of planning the development of rural tourism destinations may result often in reduced level of support from the local population for the development of tourism in their community; reduced tolerance of the host to tourists; and increased sensitivity towards the further development of tourism. However, the participation of local people in the planning of tourism development is not easy in practical terms. Encouraging community members to participate in the management and provision of tourist services companies in their midst is one possible approach. Competition and cooperation should contribute to greater efficiency in service delivery and to improve rural tourism products, which in turn can strengthen the competitiveness of the sector. Comparing the results of research between Vojvodina and selected districts in Hungary, it was concluded that the level of development of rural tourism in Hungary is at a significantly higher level than in Vojvodina, as there is a statistically significant difference in the assessment of all attributes. Tourism experts from Hungary do not see Serbia (and Vojvodina) as its competitors, suggesting that carriers of tourism policy and tourism offer should look to Hungary as a market that requires higher investment and significant efforts in order to meet the sophisticated demands of their rural tourists, which can not happen in a short period of time. Hungary, in the future, should be seen as partner and try to develop joint projects which will contribute to increased quality of rural tourist offer in Vojvodina.

References

- Aragón-Sánchez, A., Sánchez-Marín, G. (2005). Strategic orientation, management characteristics, and performance: A study of Spanish SMEs. *Journal of Small Business Management*, Vol. 43(3), pp. 287-308.
- Byrd, E.T., Bosley, H. E., Dronberger, M.G. (2009). Comparisons of stakeholder perceptions of tourism impact in rural eastern North Carolina. *Tourism Management*, Vol. 30(5), pp. 693 – 703.
- Conaghan, A., Hanrahan, J. (2010). Global Conformity of Indicators for Eco-Certification Programs. In: *Contemporary Issues in Irish and Global Tourism and Hospitality* (ed. G.Gorman and Z Mottiar), pp. 93-106, DIT, Dublin.
- Cracolici, M.F., Nijkamp, P., Rietveld, P. (2008). Assessment of tourism competitiveness by analysing destination efficiency. *Tourism economics*, Vol. 14(2), pp. 325-342.
- Dwyer, L., Forsyth, P., Rao, P. (2000). The price competitiveness of travel and tourism: a comparison of 19 destinations. *Tourism Management*, Vol. 21(1), pp. 9-22.
- Evans, N., Campbell, D., Stonehouse, G. (2003). *Strategic Management for Travel and Tourism*, Butterworth-Heinemann, Oxford.
- Hassan, S. S. (2000). Determinants of Market Competitiveness in an Environmentally Sustainable Tourism Industry. *Journal of Travel Research*, Vol. 38(3), pp. 239-245.
- Murphy, P. E. (1988). Community Driven Tourism Planning. *Tourism Management*, Vol. 9(2), pp. 96-104.
- Pavlovich, K. (2003). The evolution and transformation of a tourism destination network: The Waitomo Caves, New Zealand. *Tourism Management*, Vol. 24(2), pp. 203-216.
- Porter, M. (1990). The Competitive Advantage of Nations. *Harvard Business Review*, pp. 73-91.
- Ritchie, J. R. B., Crouch, G. I. (1993). Competitiveness in International Tourism: A Framework for Understanding and Analysis. In *Proceedings of the 43 Congress of the*

- Association Internationale d'Experts Scientifique due Tourisme on Competitiveness of Long-Haul Tourist Destinations, San Carlos de Bariloche, Argentina, pp. 23-71.
- Sheldon, P. J., Abenoja, T. (2001). Resident Attitudes in a Mature Destination: The Case of Waikiki. *Tourism Management*, Vol. 22(5), pp. 435-443.
- Williams, J., Lawson, R. (2001). Community Issues and the Resident Opinions of Tourism. *Annals of Tourism Research*, Vol. 28(2), pp. 269-290.

MOVING TOWARDS SUSTAINABLE RURAL DEVELOPMENT: GENDER EQUALITY AND RURAL WOMEN EMPOWERMENT

Rosanna QUAGLIARIELLO¹, Atef HAMDY^{2*}, Chiara CIANNAMEA¹

¹Gender division, CIHEAM/Mediterranean Agronomic Institute, Bari-Italy

²International Centre for Advanced Mediterranean Agronomic Studies of Bari (CIHEAM-Bari), Valenzano (Bari), Italy

*Corresponding author: hamdy@iamb.it

Abstract

On the international women's day 8 march 2016, the world reaffirms that gender equality is first of all human right. Women have the right to live in dignity and enjoy the same rights and opportunities as men. However, despite many international agreements affirming their human rights, women all over the world have less access to the economy, credit, training and employment than men. They are far less likely than men to be politically active and to have access to leadership positions. Such persistent gender inequalities incur high costs for many countries around the world and particularly the developing ones. Great strides have been made to reduce gender gaps and improve the states of women and girls over past three decades, yet, significant gender gaps remain across sectors in all countries and are often greater among the poor developing ones and particularly in rural areas where socio economic disparities between men and women are the most acute. Experiences gained and learned lessons are evidently showing how important is the role played by rural women in improving economic growth, increasing food production and achieving sustainable development of their communities. Aware of this, nowadays to improve gender equality and to promote women empowerment an increasing wide range of institutions from business, civil society and governments have committed resources, rhetoric and political capital to realize both goals, but, due to the surrounding difficulties, the progress is still limited far away from the expectations. The presented paper will mainly focus on describing the needed actions to be implemented for moving towards sustainable rural development through the promotion of gender equality and rural women empowerment.

Keywords: *rural development, gender equity, women empowerment, needed actions.*

Introduction

Gender equality and female empowerment are core development objectives, fundamental for the realization of human rights and key to effective and sustainable development outcomes. Moving successfully towards sustainable rural development can not be reached without providing equitable opportunities, resources and life prospects for males and females.

The cited review and the learned lessons from most case studies evidently indicate that no society can develop sustainability without increasing and transforming the distribution of opportunities, resources and choices for males and females so that they have equal power to shape their own lives and contribute to their communities. Nowadays, it is well recognized that long-term sustainable development will only be possible when women and men enjoy equal opportunities to their potential. But today, women and girls continue to working sector. Unless women and men are able to attain their social, economic and political aspiration, and contribute to and shape decisions about the future, the global community will not successfully promote peace and prosperity. World Bank/IFAD/FAO (2009) UN women (2013) and FB (2009)

Rural women and sustainable development

In most countries rural women are not equal partners in the development process despite the fact that approximately one person in four falls in this demographic. Although rural women make essential contribution to the rural economy of all development opportunities are still remaining limited. Women are still held back by many education, unequal workloads and prosperity rights, limited control over resources and limited participation in decisions that affect their capacity to improve their lives and to better contribute to the economic growth and sustainable development of their countries. (FAO, 2009, 2011). Most published reports confirm that women face a surprisingly consistent gender gap in access to productive assets inputs and services. FAO in her response to such women's inequality taking as an example the agricultural sector showed that if women have the same access to productive resources as men, they could increase yield on their farms by 20-30 percent. This could raise total agriculture output in developing countries by 2.5 – 4.0 percent, which could in turn reduce the number of hunger people in the world by 12-17 percent. Actually many countries are taken several steps to close the gender inequality gap by reforming marital and property rights laws, but, the implementation and enforcement are inconsistent. (World Bank, World development report (2012). Lessons learned from numerous case studies evidently indicated that no society will progress satisfactory unless women, who contribute almost half of their population are given equal opportunities. Now, women are influencing the course of social change in society, having their aspiration, abilities and qualities as a man does have. It is quite true that once women are on the move, the family moves, the community moves and the nation moves. (Abu Zeid and Hamdy (2010).

Women empowerment: An overview

Globally, the essential role that women play in sustainable development is well recognized (The international conference on population and development, 1994; the Beijing Declaration of Action, 1995; The World Summit on Sustainable Development, 2002 and 2005). Such international conferences and world summits highlighted the need to involve women activity in environmental decision making at all levels; integrate gender concerns and strengthen or establish mechanism at the national, regional and international levels to assess the impacts of development and environmental policies on women (UN, 2008). Empowerment occurs when people, women and men take control of their own lives. Empowered people set their own agendas, gain skills, build self confidence, solve problems and develop self reliance. Women's empowerment is when women develop confidence in their own capacities and gain political, social or economic strength. No one can empower another but it is possible to support processes that nurture the self empowerment of individuals and groups, there is no single path to strengthening women's empowerment. Experiences and lessons learned demonstrated that progress towards gender equality and women's empowerment is prerequisite for realizing human rights and achieving inclusive development, democratic governance, social and economic justice and peace for all. (Kabeer, 2012, Best Essays (2012; USAID, 2012; and GEF 2014,2015)

Women empowerment: what does it refer to?

It refers to strengthen the social, economic and educational powers of women. It refers to an environment where there is no gender bias and has equal rights in community, society and work places. The women empowerment means to authorize power or increase the overall position, status and condition of women in every sphere of life. Women empowerment definition is given in (Box 1).

Box 1- Women Empowerment definition

It is defined as “women ability to make strategic life choices where that ability had been previously denied them (Kabeer, 1999) it is achieved when women and girls acquire the power to act freely, exercise their rights and fulfil their potential as full and equal members of society.

Empowerment of women must be ranked as our top priority for achieving our development goals as its main advantage is the overall development of the society. There are several reasons which give greatest importance to women empowerment (Box 2). AFDB, (2008), Hamdy et al (2010)

Box 2- Women empowerment and its importance to sustainable development: Major-reasons:

- Under employed and unemployed women population constitute around 50% of the world population.
- Equally competent and inelegant like men in many socio economic activities.
- Talented: women are talented as men, and by showing their talents will benefit not only her individually but equally the whole world.
- Reduce poverty: the added earning of women due to their empowerment helps their families to come out of poverty trap.
- Economic progress: empowering women lead them to stand on their own, become independent and also to earn for their family which grows the society's economy.

Women empowerment: the barriers

Barriers for women empowerment could be outlined in: (IFAD 2012)

- The inherent superiority complex among the male, they often doesn't allow their female counter-part to rise as high as them.
- High level of domestic responsibilities.
- Restrictions to participate in social economic and religious activities.
- In most societies particularly in rural areas, the boy child often gets preference for education and healthy diet over the girl child. In fact, preference for male child still exists among many families in the society.

How does one really empower women? The solution

There are several tools which we have in our hands among them: (Hamdy 2005)

- Education through mass communities is very important. Both women and men should be made aware of the responsibilities to promote and practice—gender equality.
- Gathering national data and identifying the areas where gender inequality is the most. This data should be worked and deeply analyzed by government's NGOs, and field workers to raise the status of women and to overcome the women empowerment constraints.
- Awareness is vital part of the solution. The society should be made aware that both boy child and girl child are equal and they both should have equal access to resources.
- Efforts should be focusing on key programmes and projects that could generate significant results for gender equality and women's empowerment to contribute to achieving the goals of global environmental benefits.

Gender equality

Over the past two decades several efforts were taken to narrow gender gaps, yet in developing low income countries and among disadvantaged groups, sustainable inequalities are still remaining in most working sectors, seriously and negatively constraining any sustainable rural development. Gender inequality refers to the gender based inequality against women. Women are often denied their social, cultural, economic, and political rights leading to a decline in the condition of women Gender equality definition is given in Box 3.

Box (3). Gender equality definition

It concerns women and men and it involves working with men and boys, women and girls to bring about change in attitudes, behaviours, roles and responsibilities at home, in work place and in the community. Gender equality means expanding freedoms and improving overall quality of life so that equality is achieved without sacrificing gains for males or females.

There are several reasons which are behind the inequality against women, among them we would like to highlight the followings

- The glass ceiling effect: it refers to the invisible barrier that obstruct a women to rise to higher position inspite of having merits on the basis of education, ability, and reporting records.
- The feminization of poverty. It also reflects the different treatment that women face through the world. It is unfortunate that women constitutes a greater proportion of world poor.

Inequality against women: The cost

The persistent gender inequalities incur high costs for many countries around the world and particularly the developing ones. As an example the OECD estimates that gender inequality costs the MENA region at least 25% of its GDP. This is also the case for most developing countries of the Mediterranean where most case studies demonstrated how great those countries are losing due to women empowerment and gender inequality. Gender and water alliance (2003 a, b)

Gender equality and female empowerment: the policy

The new update policy on gender equality and women empowerment should be designed to enhance women empowerment and reduce gender gaps, the policy should affirm the critical role women play in accelerating progress in development and developing global prosperity and security. The updated policy should reflect policy the requirement for all UN entities to adopt the gender mainstreaming methodology, as mandated by the 1995 Beijing platform for action, defined by ECOSOC 1997 and reinforced by the chief Executives board for coordination (2006) and the terminal comprehensive policy review 2007. The new policy have to provide guidance on pursuing more effective, evidence-based investments in gender equality and women empowerment. Under this policy a strong emphasize should be placed on building high impact partnerships, harnessing the power of innovation and conducting rigorous programme evaluation to deliver meaningful results. Equally, it should ensure that the composition of the proposed policy is reflecting our principles, creating a work environment that empowers and rewards women and men fully and equitably, as well as reflecting our values and commitments enduring meaningful results for all. WFP (2009)

For this policy, national, regional and international investments should be aiming to the following two overarching outcomes mainly: UNICEF (2010)

- Reduce gender disparities inaccess to control over and benefit from resources, welth, opportunities and services- economic, social, political and cultural.
- Increase capability of women and girls to realize their rights, determining their life outcomes, and influence decision making in households, communities and societies.

The policy guiding principles those principles those principles characterizing the policy to advance gender equality and women empowerment could be outlines in the following. (Box. 4) USAID policy 2012.

Box. 4. Policy guiding principles

- | |
|---|
| <ul style="list-style-type: none"> • Integrating approaches and actions • Pursue an inclusive approach for faster equality • Build partnership across a wide range of stakeholders • Harness science, technology and innovation • Promote women’s participation in all work sectors and running efforts • Show successes and failure from learned lessons and disseminate best practices • Onsider contribution and collective commitment of involved stakeholders |
|---|

Strengthening women’s empowerment, gender equality and women’s rights: the several paths.

According to the anthers in order to achieve our collective efforts towards gender equality, women’s empowerment and women’s rights, there are several paths to be followed among them:

Information and communication technology: ICT are emerging as a powerful tool for women empowerment in many developing countries around the world. It is now a potent force in transforming social, economic and political life globally. Lack of access to information and communication technologies becomes a significant factor in the further marginalization of women from the economic, social and political mainstream of their countries. Indeed, ICT can be a powerful catalyst for political, social and types of empowerment and the promotion of gender equality.

Mainstreaming gender issues: It is vital for the empowerment of women due to its role in:

- 1-Understanding the institutional systems and how they really work.
- 2- Identifying, enabling and disabling agencies and actors that can work to improve the livelihood of members of local community, their roles, motivations, organizational culture and behaviour.
- 3- Establishing a dialogue with both women and men, besides facilitating the role of enabling actors.

Legal institutions to improve the status of women: Legal institutions must be changed to create a level playing field for men and women and an environment in which women can realize their full potential. Change is needed in property rights laws. Equally it is needed to enhance partnerships among government institutions, gender specific ministries, organizations and agencies; and gender experts in order to promote gender mainstreaming in developing and implementing environmental and sustainable development programmes and policies. But, those legal changes do not automatically translate into changes on the ground. Having an effective change requires that both who implement the laws the public are aware of the changes. Here it is to be emphasized that the institutional framework for sustainable development should be gender-responsive. Policies and programmes to empower women can strengthen and better in the rate of the economic, environmental and social standards of sustainable development.

A critical look to policy formation process:

Gender policy must have the following three strategic objectives:

- 1- Promote economic empowerment to enable rural women and men to participate in and benefits from profitable economic achieving.
- 2- Enable women and men to have equal voice and influence in rural institutions.
- 3- Achieve more equitable balance in workloads and in the sharing of economic and social benefits between women and men.

The existing cultural divide separating gender staff from technical staff and economic staff needs to be narrowed by increasing mutual understanding of the concepts, priorities, strategies and instruments developed by both groups. It would be crucial to intensify research and impact assessments that bring into the picture the impact of gender relations on the achievement of policy reforms and rural development.

Education:

Education is the most powerful weapon which we can use to change the actual women situation. Emphasis on women's education, including incentives and scholarships form women in science and policy is important to ensure a pipeline of well-qualified women candidates for senior positions in public and private organizations.

Training for women:

Training and skills development: women with low levels of literacy find it impossible to participate in decision making processes. Their capacity to participate meaningfully in the drafting of micro projects requests and participatory procurement mechanisms is thus seriously constrained. This can be done through training and by removing barriers to the productive use of women's time and energy. In this respond, it is also required special outreach and training for poorer and less educated women and for those who hesitate to voice their needs in front of men for cultural reasons. (Hamdy et al (2004)

Concluding remarks and recommendations

- The topic of women empowerment is a burning issue all over the world. Women empowerment and women equality with men is a universal issue.
- Nowadays, all nations are working hard to overcome both economic and social crisis. They are facing and crossing the road towards sustainable development. However, technical solutions all admit clearly that there are greater efforts to promote gender equality and women empowerment. It should be well understood that sustainable development cannot be imposed from the outside but must come from within the country side.
- Global efforts to reduce gender gaps have met only partial success. Across every development priority worldwide - from education to economic inclusion - gender inequity remains a significant challenge.
- To fulfill gender gaps, it is needed a coherent, relevant and up to date policy on gender equality and female empowerment that provides an overarching frame work for gender integration through out all aspects related to the work sectors.
- Gender inequality cannot be fully eliminated merely by the legal administrative measures. The educated people consciousness of the positive impact of gender equality. There is need for changes in perception towards women. The human society would be most advantaged only if women are treated equally and are not deprived of their rights.
- Now it is quite understood that gender equality among adults, expressed in equal enjoyment of rights and mutually respectful relationships in both the public and

private spheres, provides an essential context in which girls and boys can learn the gender equal attitudes and behaviors that will sustain human development and development goals.

- Empowering millions of women who live in poverty is essential for their intrinsic human rights and bread benefits for global development and economic growth.
- To promote women's empowerment, while this goal has been a challenge to realize in the past, the current convergence of commitment and shifting paradigms provides an unprecedented opportunity to forge new alliance and unleash innovation to achieve women's empowerment and gender equality, which have proved difficult to realize.
- The key issues to be addressed for strengthening women empowerment have to include: financial inclosing for women in agribusiness, capacity development across value chains, knowledge sharing platforms and up-scaling of models that can facilitate partnership between government, industry and academic to promote women's rights, empowerment and decent employment.
- Promotion of women's empowerment and gender equality to be achieved there is an urgent need to strengthen the capacities of rural institutions beside continues supporting efforts to harness sciences technology and innovation with talented men and women.

References

- Abu-Zeid, M and Hamdy, A. (eds) (2010). Encyclopaedia on water resources development and management in arid and semi arid regions of the Arab World: Volume 10 –Gender and Resources Management and Development pp, 250
- Best Essays (2012). Gender equality and women empowerment. <http://basent1992.blogspot.it/2012/03/gender-equality-and-women-empowerment.html>
- ECOSOC 1997, Report of the Economic and Social Council for 1997. A/52/2 Chapter IV, "Special Session on Gender Mainstreaming"
- FAO (2009) BRIDGING the Gap: FAO's Programme for Gender Equality in Agriculture and Rural Development. Rome, FAO
- FAO (2011). Women in a agriculture: Closing the gender gap, State of Food and Agriculture Report _2010_11 ,Rome FAO.
- Gender and water alliance, (2003 A), The gender and water developments report 2003: Gender perspectives on policies in the water sectors. [http://www.genderandwateralliance.org/reports/GWA %20 ANNUAL 20%REPORT PDF](http://www.genderandwateralliance.org/reports/GWA%20ANNUAL%20REPORT.PDF).
- Gender water alliance (2003 B). The gender approach to management: Lessons learned around the globe.
- Gender Water Alliance (2003). THE gender approach to management: Lessons learned around the globe.
- Global environment facility (2015). Update on the implementation of the gender equality action plan. (GEAP) GEF/C.49/Inf. 07.september (2015).
- Global environment facility (GEF 2014). Gender equality Action plan, GEF/C.47/09 Rev. 01, October 2014
- Hamdy, A. (2005). Gender Mainstreaming in the Water Sector: theory, practices, monitoring and evaluation. Ed. Atef Hamdy, pp. 157.
- Hamdy, A., Sagardoy, J.A., El Kady, M., Quagliariello, R., Bogliotti, C. (ed) (2004). Training of Trainers in Integration of Gender Dimension in Water Management in the Mediterranean Region. Ingedi Project, The Gender Dimension in Training at the Institute of Water Technology. Options Méditerranéennes : Série A. Séminaires Méditerranéens; n. 64, CIHEAM-IAM BARI, Cairo. Egypt.

- Hamdy, A., Trisorio Liuzzi, G., Rosanna, Q. (2010). Gender and Sustainable Rural Development in Africa and Semi-Arid Regions of the Arab World. In: Abuzeid, A., Hamdy, A. (eds). Gender and Water Resources Management and Development, page (215-231).
- IFAD (2012). Gender Equality and Women's Empowerment: Policy, International Fund for Agricultural Development.
- Kabeer, N. (2012) Women's Economic Empowerment and Inclusive Growth: Labour Markets and Enterprise Development. SIG Working Paper, Ottawa, Canada: International Development Research Center. <http://www.idrc.ca/EN/Documents/NK-WEEConcept-Paper.pdf>
- UN Chief Executives Board for Coordination 2006 United Nations system-wide policy on gender equality and the empowerment of women: focusing on results and impact. CEB/2006/2
- UN women (2013). Advancing gender equality: promising practices. Case studies from the millennium development goals achievement fund. Secretarial and UN women, <http://www.women.org/mdgf/downloads/mdg-f/casestudies.pdf>.
- UNICEF (2010) Policy on gender equality and the empowerment of girls and women-working for an equal future. Pp (1-15).
- United Nations 2007. Report of the Triennial Comprehensive Policy Review of Operational Activities of the United Nations Development System. Paragraphs 72-84
- USAID (2012). Gender equality and female empowerment. Policy Washington, DC. (2012)
- WFP (2009). WFP Gender Policy Promoting Gender Equality and Empowerment of Women in Addressing Food and Nutrition Challenges Rome: WFP http://onr.wfp.org/eb/docs/2009/wfp_194044-2.pdf.
- World Bank/IFAD/FAO(2009). Gender and agriculture Sourcebook: Investing in women as drivers of agricultural growth, Washington, DC. World Bank.
- World Bank, World Development Report 2012: Gender equality and development. (Washington, D.C. The World Bank 2011.
- WSSD (2002). Commitments with reference to gender and water. Johannesburg. Sep. 2002. www.Johannesburg.org.

ECONOMIC BUSINESS ANALYSIS OF DAIRIES FROM PESTER AREA

Mersida JANDRIĆ*, Zoran RAJIĆ, Dragić ŽIVKOVIĆ, Milovančević ZORAN

University of Belgrade, Faculty of Agriculture, Belgrade-Zemun, Serbia

*Corresponding author: mersida.jandric@hotmail.com

Abstract

This paper presents the results of business analysis from the dairy areas of Pester which produces, purchases, processes and sales milk and milk products. The analysis of business results involves business incomes and expenses of financing and financial incomes and expenses, i.e. financial result from continuing operations for the period from 2011 to 2014. year, while other income and expenses are excluded for they are generally unique, and as such are not essential for the survival and growth of the company. The goal of the analysis is to identify untapped potentials and current problems, and more rational use of available resources in order to improve the business. In this paper were used the original dairy data (financial report for the period from 2010 to 2013, and related accounting records). The main conclusion is that the dairy despite the achieved business results hasn't fully exploited the resources at its disposal.

Key words: *business analysis, business result, business risk, dairy*

Introduction

Dairy farming is the largest sector of the world's agriculture production. It is an important industry sector in many countries. For example, in the USA, dairy farming contributes with more than 160 billion \$ in total economic output and provides more than 90,000 jobs (Junaid *et al.*, 2013).

The share of milk production in total value of agricultural production in EU is 14%. Although the dairy industry made significant investments (Pavlović *et al.* 2011), trends in milk production sector are not moving towards the direction that promises for Serbia to be on the list of important producers of milk and dairy products after joining the EU. Trends show that milk production is filled with structural problems and it is high time for sector to make serious reforms to increase its competitiveness and enable to initiate sustainable growth from negative trends of decrease / stagnation. Inadequate resolution of these issues will not only disable the potential benefits of the European integration process, but will cause further deterioration of the situation in the dairy industry.

It should be emphasized the fact that the quota system for milk, present in the EU countries, will be abolished in 2015. In conceptual terms, this system proved to be a weaker solution than a system of free pricing of milk and dairy products. In addition to stabilizing the price of milk and dairy products, reduced budgetary costs and preserving the income levels of farmers, there was an increase in production costs, which is particularly reflected in the stagnation of exports and higher prices than the competition and world (Grbić *et al.*, 2010). Production diversification could be a chance for Serbian producers, given that the production quantities of milk can hardly compete with European producers.

One of the goals of the Republic of Serbia in the dairy sector is the creation of stable producer who can cope with the turbulence in the free market.

Organizational problem is one of the major obstacles at improvement in milk production. The situation in processing industry is such that several dairies process 80% of milk, while the rest amount processes nearly two hundred small dairies. Large ones mostly have an elaborate system of suppliers, while small ones operate randomly. In the future, small dairies will

remain suppliers to the local market for milk, yoghurt and their products. One of the fundamental determinants of effective and efficient business operation, regardless of their size is appropriate organizational form complied with the environment and the conditions prevailing in the market. Experiences from other EU countries point to the fact that most of the small dairies would not survive the coming period for they will not have the economic ability to align its business according to the requirements and standards of the EU. Many of the problems we face in the economy, particularly those related to business organizations, typically include request of optimal, from various aspects, use, or allocation of resources that are available at limited quantities.

Materials and methods of paper

The subject of study is a that manufactures, purchases, processes and sales of milk and milk products, its supply chain and distribution channels, as well as the company actions taken in order to identify untapped potential and current problems and all this for business improvement. Standard methodological procedures were applied in the research (indices, comparisons, tabulation, calculation methods), methods of analysis and balance, risk factors analysis in the achievement of financial results and threshold profitability. The analysis of business operations, analysis of organizational and economic conditions and all available resources, that dairy disposes with was done. Performed analysis could be used to plan further dairy work. In this paper were used the original dairy data (financial report for the period from 2011 to 2014 and related accounting records) and appropriate literature sources.

Results with discussion

Basic characteristics of the region in which analyzed dairy operates are: a large number of raised cattle and sheep, the tradition of the region in dairy production, a large number of young agricultural households, exceptional natural conditions for the development of livestock, availability of raw materials base, short supply dairy lines existence of HACCP, ISO and HALAL certificates and segmented market.

The dairy started its operation 20.05.1996, with a modest production in family owners circle. At the beginning was bought off 900 liters of milk per day from farmers. With great enthusiasm and with a lot of invested labor, the dairy continually developed and expanded the scope of its production. A new technology for the collection and processing of milk was introduced. During its work the dairy has expanded the scope of its production, range of products and number of employees. In a record time it has grown into a company which is one of the leading manufacturers of the region. The main activity is the purchase of milk and production of dairy products. With its personnel and technical potential is able to fully meet the expectations of customers in terms of product quality, price, service quality and delivery. As a recognized manufacturer in the region with a tendency of assortment expand and continuous monitoring of produced products quality , the use of high quality raw materials with constant monitoring and updating of technological processes, as well as the daily product quality control , are safe guarantee that the products are completely correct and safe for consumers. By the end of 2014, the dairy employed 22 workers, with a tendency for capacity expand and hiring more employees. At this level of company development such management proved to be successful. However, for further expansion is necessary to upgrade the existing organization as the only way to realize ambitious growth plans.

In this type of activity basic raw material is raw cow's milk, but nevertheless accessories such as rennet for cheese, yeast for yogurt, salt and more are procured. Raw milk is provided by small farmers with 3-4 milking cows and exclusively from the area of Pester. Milk purchase is done in its close proximity, which significantly reduces transport costs. The raw material is delivered by transport vehicles to company storage units. By internal transport are delivered

to production capacities, where is, after a quality check, implemented a process of refinement and development of the final product. Final products are stored until the moment of delivery. The main advantages are favorable purchase prices, for the real battle is fight for suppliers of fresh milk, and then the speed of milk delivering to the customer. Certainly, one should add quality and rational organization at minimal costs.

The most common problems that occur are market opportunities that have been identified as a problem with customers (payment of products itself), difficult terrain conditions when purchasing, expressed gray market and the lack of logistics.

The business concept is based on collection and purchase of milk from a wider area, its processing and distribution and sale to interested buyers. The entire product range is reduced to a few items: fresh milk, yogurt, white cheese, butter, paprika in sour cream and cream.

Core segments are: Equipment for milk reception (cold room, gauges and chamber); Line for fermented products (pasteurization machine, cooler, and duplicator); Line for pasteurized milk production (separator, packing machine, pasteurization machine); Line for cream production; Line for cheese production.

Table 1. Equipment that dairy disposes with

	Equipment name	Pieces	Year of production	Value	Total value
1.	Line for milk reception	1	2000	2.430 000	2.430 000
2.	Line for milk pasteurization and homogenization	1	2002	3.240 000	3.240 000
3.	Packing machine	3	2002	1.350 000	4.050 000
4.	Line for fermentation	1	2007	2.900 000	2.900 000
5.	Cooling chambers	4	2003	405 000	1.620 000
6.	Vehicles for transport and distribution	8	1995	637 500	5.100 000
7.	Line for cheese	1	2008	1.800 000	1.800 000
8.	Total				21.140 000

Source:Internal data

Production capacities are utilized 50%. Line for milk reception can accommodate 6.000 000 liters annually, and in 2014. the dairy has processed 3.000 000 liters of milk. In 2014., the utilization level of production capacities was slightly increased and amounted to 53.33%.

Table 2. Production capacities

	Description	Measure unit	Daily capacity
1.	Milk reception	l	20.000
2.	Milk pasteurization	l	500
3.	Fermented products	l	10.000
3.1.	Yogurt 1 l	l	3.000
3.2.	Yogurt in cup 0,18 l	l	7.000
4.	Cream production	kg	20
5.	Cheese production	kg	600
6.	Paprika in sour cream production	kg	500
7.	Butter production	kg	140

Source: Internal data

Strategic raw material of dairy is milk. Cost market and the most important of dairy suppliers for raw milk, are the agricultural producers from Pester territory. The criteria by which the suppliers were selected are raw milk quality as well as reliability of delivery and quantity. The advantage of this dairy is that its subcontractors offer milk obtained from the area of ecologically health environment.

Table 3. The packaging purchase prices

no.	Packaging	Price in RSD
1.	Carton for yogurt	10,00
2.	PET bottle	10,00
3.	PVC glass	2,00
4.	PVC for milk	2,00
5.	Box for cheese, cream and paprika in sour cream	20,00
6.	Can (Bulgaria import)	140,00
7.	Foil for butter	3,50

Source: Internal data

The analysis of business results included business income and expenses of financing and financial income and expenses, i.e. the financial result from continuing operations, while other income and expenses are excluded for they are generally unique, and as such are not essential for the survival and growth of the company. The aim of financial result review is the assessment of financial result as a difference of two opposite flows - income and expenses. Breakdown of financial results provide information from which income group improves financial result (Živković et al., 2013).

Business company risk is the risk of achievement business loss as the gross yield of total capital, i.e. the *risk of coverage* from all business revenue expenditures, other than financing expenditure. This risk is measured by a factor of business risk, and is obtained from cover margins and operating profit relation. Height of business risk depends on sales volume, parity of sales and purchase prices, cost-effectiveness of material consumption, energy, services and labor, and the rationality of investment in capital assets and generally rationalization of all functions of company.

Business risk factor indicates how many times business profit changes faster at each change in operating income, i.e. at any change in margin of coverage. As a risk factor of business risk lower, it is a risk of business achievement profit lower.

Factor of business risk - business leverage is obtained from the ratio of coverage margin and operating profit relation. The dairy has realized positive results in all previous four years and a factor of business risk is lower every year.

Factor of financial risk - is calculated from the ratio of business profit and regular profit activities, i.e. from relation of business result and gross financial result. It shows how to change faster the gross financial result when the business result changes by 1%. Factor of financial risk in our example is, for analyzed years, from 1.02 to 1.05.

Overall risk factor is obtained by multiplying the previous two risks. Overall riskfactor for the analyzed Dairy is 2011/1,88; 2012/1,64; 2013/1,54 and for 2014/1,52 which indicates that each year gets better results. As a overall risk factor is lower even more the overall risk of business achievementprofit is lower, and vice versa.

Table 4. Risk of financial results achievement (in 000)

	Position	2011	2012	2013	2014
1	Business income	97.952,00	115.843,00	133.219,90	159.863,88
2	Variable expense	82.353,00	91.976,00	101.173,50	121.408,20
3	Coverage margin (1-2)	15.599,00	23.867,00	32.046, 40	38.455,68
4	Fixed and mainly fixed costs	7.113,00	9.035,00	10.842,00	11.950,00
5	Business results (3-4)	8.486,00	14.832,00	21.204,40	26.505,68
6	Net financing expense (income financing-expenditure financing)	- 141,00	- 254,00	- 560,00	- 1.310,00
7	Gross financial result	8.354,00	14.578,00	20.674,40	25.195,68
8	Business risk factor (3/5)	1,84	1,61	1,51	1,45
9	Financial risk factor (5/7)	1,02	1,02	1,02	1,05
10	Total risk factor (8x9)	1,88	1,64	1,54	1,52
11	% participation of margin coverage in business income (3/1)x100	15,92	20,60	24,06	24,05
12	Required operating income for the realization of a neutral business result (4/11)x100	44.680, 00	43.859,00	45.062,34	49.688,14
13	Required business income for the achievement of neutral gross financial result ((4+6)/11)x100	45.565,00	45.092,00	42.734,82	44.241,16
14	% utilization of business income for the achievement of neutral business result (12/1)x100	45,61	37,86	33,83	31,08
15	Elasticity rate of neutral business result achievement ((1-12)/1)x100	54,38	62,14	66,17	68,92
16	%utilization of business income for the achievement of neutral gross financial result (13/1)x100	46,52	38,93	32,08	27,67
17	Elasticity rate of gross financial result achievement(1-13)/1x100	53,48	61,07	67,92	72,33

Source: calculation by authors

Negative rate of elasticity occurs when is realized business loss, and it shows for how much percentage is realized business income lower than required, for achieving business income of neutral regular activities profit. In case of analyzed diary these items are positive and have recorded an increase.

The lower break-even point is the point at which incomes equal with expenditures, which means that at this point financial result is neutral. In our example two lower break-even points are determined.

- *The point of neutral business result* is the point in which business income equals with fixed and mainly fixed expenses and partially variable costs, which are included in income which provides neutral business result.
- *The point of neutral gross financial result* is the point in which business income equals with fixed and mainly fixed expenses, net financing expenses and partially variable expenditures that are included in income which provides neutral gross financial result.

Figure 1. Gross financial result in period of 2011-2014. year

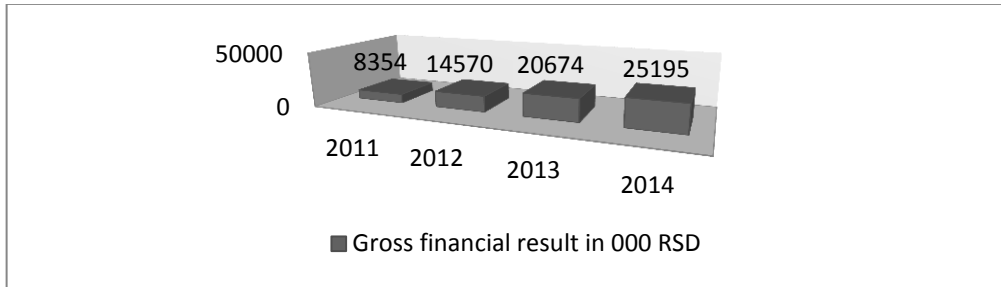

Source: calculation by authors

Figure 2. The percentage share of product in the achievement of gross results for 2013

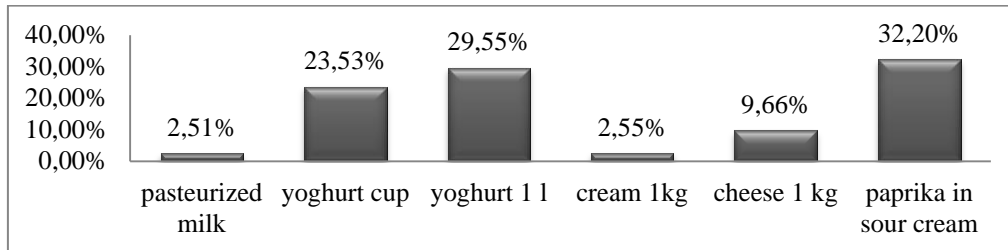

Source: calculation by authors

The percentage share of margin coverage in business period of 2011-2014 is increasing as a result of lower variable costs.

Required business income for achieving neutral business result is, in all four years, lower than the actual business income

Required business income for achieving gross financial result is also lower than the actual business income. The percentage of business income utilization for achieving neutral business result is in decline - which is good.

Paprika in sour cream has the highest percentage of participation in the achievement of gross financial result in 2014.

Gross financial result clearly shows that the dairy is moving upwards.

Global parity has increased, and since we have no global parity of competition, the position of the company cannot be inferred in the market in comparison to the competition.

Table 5. Global parity (in 000 RSD)

	Position	2011	2012	2013	20134
1.	Business income	97.952,00	115.843,00	133.219,90	159.863,90
2.	Variable material incomes	82.353,00	91.976,00	101.173,50	121.408,20
3.	Global parity (1/2)	1,1894	1,2595	1,3167	1,3167

Source: calculation by authors

Conclusion

By business analysis of Dairy, which is located in the southwestern part of Serbia led to the conclusion that the dairy, in the period from 2011 to 2014., operated with positive financial results and the best financial result were achieved in 2014. Although the dairy operated with a positive financial result, the data clearly indicate that the available resources are underutilized. Production capacity of the dairy were used only about 50%, product diversification is weak, and the market to which the analyzed dairy is mostly oriented, is mainly at the level of local. Given the availability of raw materials base, short lines of supply, reduced costs and a high percentage of young working-age population, in the next period of dairy work should be to work on the optimization of production.

In recent years, there is evidence of a growing domestic demand for products of yoghurt, flavored yoghurt and fermented milk products with added probiotics. The analyzed dairy production should be focused on this group of products, where the greatest degree of products and packaging diversification could be achieved.

The proposed measures could be directed towards greater diversification of products. Special emphasis should be given to a product that stands out as a specific product of the area i.e. peppers in sour cream, which percentage of participation in the achievement of gross financial result is highest. Of course, that with all of the above is needed to develop quality of products and marketing activities should be directed towards developing markets beyond the local area.

Literature

- Andrić, J., Vasiljević Z., Sredojević, Z. (2005): *Investments*, Faculty of Agriculture Belgrade
- Crnobrnja, M., Trbovich, A. (2009): *Impact assessment of Serbia's EU accession*, 209, pp. 27., Faculty of economics, finance and administration (FEFA), Singidunum University, Belgrade.
- Gogić, P. (2005): *The theory of the cost of with calculations in the production and processing of agricultural of products*, Faculty of Agriculture Zemun
- Grbić, V., Milanović, M., Đorović, T. (2010): *Economic analysis of milk quota system in the European Union agricultural policy*, Economics of Agriculture, vol 57, no. 4, pp. 515-527, Belgrade.
- Junaid, A., Zeeshan, A., Imran, C. (2013): *Livestock Valuation in a Dairy Business*, Issues in Accounting Education, Vol. 28, No. 4 pp. 873–886, DOI: 88610.2308/iace-50549, American Accounting Association.
- Pavlović, V., Muminović, S., Grbić, V. (2011): *The effects of stock repurchase on the market value and on the company's financial position of dairies in Serbia*, Economics of Agriculture, vol 58, no. 4, pp. 577-594, Belgrade.
- Rodić, J., Vukelić G., (2003): *Theory and Analysis of balance*, Faculty of Agriculture Zemun
- Statutory financial statements of Zornić Dairy*
- Živković, D. (2012): *Management of human resources*, Faculty of Agriculture Belgrade
- Živković, D., Munćan, P. (2004): *Management of work and production in agriculture*, Faculty of Agriculture Zemun
- Živković, D., Rajić, Z., Jelić, S., Jandrić, M. (2013): *Organizational and economic characteristics of production and meat processing company*, Economics of Agriculture, vol 59, no. 2, pp. 419-426, Belgrade.

ECONOMIC DIVERSIFICATION OF RURAL HOUSEHOLDS IN THE REPUBLIC OF MACEDONIA

Marija GJOSHEVA KOVACHEVIKJ^{1*}, Blagoj GORGIEVSKI²

¹Institute of Sociological, Political and Juridical Research, Skopje, Republic of Macedonia

²University "St. Kliment Ohridski", Faculty of Law, Bitola, Republic of Macedonia

*Corresponding author: marija9272@yahoo.com

Abstract

Sustainable rural development is vital to the national social and economic situation of the Republic of Macedonia since 43% of the population lives in rural areas, which make up 86.7% of the total territory. Most of the rural households are engaged in agriculture (primarily family farms) and very small portion in other activities. Agricultural wages tend to be significantly lower than other sectors and almost half of the labour force is consisting from unpaid family members. To that end, modern understanding of rural development exceeds the concept that agriculture is the only non-urban element of territorial areas and move to a broader concept that refers to all resources of the territory and its entire economic structure: natural and human resources, crafts, small industrial facilities, tourism, recreation, etc. The goal of this paper is to review the new direction of rural development in Macedonia - income diversification, focused on contribution of non-farm activities to total rural household incomes. The methods of descriptive statistics of data analysis were used to process official data for incomes, from the State Statistical Office. The findings demonstrate that the number of rural households with incomes from non-agricultural activities accounts for only 16%, with highest proportion (69%) of households with share of only up to 10% of non-farm incomes in total turnover. Policy for strengthening of the conditions for development of the rural diversification activities, as one of the tool for economic stability of rural households, is recommended to be one of the highest governmental strategic priorities for rural development.

Keywords: *rural development, income, diversification*

Introduction

The rural households compared to urban areas, have more limited economic opportunities and undeveloped markets as well as other socio-economic problems (World Bank, 2008). Distinguishing between the rural and urban economy occurs because the specifics of the rural way of life and work of the rural population (Čustović et al., 2013). Viewed globally, the majority of poor households lives in rural areas in developing countries and depend mainly on agriculture and related activities for providing life existence. The pressures of limited available resources and environmental degradation create additional challenges to the well-being of the population in rural areas and accelerating rural-urban migration (Čustović et al., 2013). Therefore, it is important that the members of rural households, through a good management way, to combine their abilities, skills and knowledge with the resources at their disposal to create activities that will enable better living conditions (Messer and Townsley, 2003).

Rural households that operate farms often provide, in addition to their reward from farming, income from running non-agricultural businesses, from waged employment, from social transfers, etc. Hence, the rural non-farm economy (RNFE) may be defined as comprising all those non-agricultural activities which generate income to rural households (including income in-kind and remittances), either through waged work or in self-employment. In some contexts,

rural non-farm activities are also important sources of local economic growth (e.g. tourism, mining, timber processing, etc.) (Davis, 2004). The RNFE is of great importance to the rural economy because of its production linkages and employment effects, as well the non-farm income represents a substantial and sometimes growing share of rural incomes. Often this share is particularly high for the rural poor. There is evidence that these contributions are becoming increasingly significant for food security, poverty alleviation and farm sector competitiveness and productivity (Davis, 2004).

In the Republic of Macedonia, agriculture and income from agriculture and related processing and services are still sustainable source of income for rural population. The country's rural areas are home to 43 per cent of the population and two thirds of its poor people (IFAD, 2016). Most rural households depend largely on crop and livestock production for their income. Poor people in rural areas are either members of traditional small-scale agricultural households eking out a livelihood at subsistence level, or they are among the poor rural unemployed, who may be even more disadvantaged than poor landholders (IFAD, 2016). Approximately 60% of the villages are affected by de-population, particularly the sensitive hill and mountain regions (Jakimovski, 2002). Food security and poor nutrition are not critical development issues in the country, but rural households are extremely vulnerable to external economic shocks. Because of economic transition and regional instabilities the reliability of local food production is far from assured (IFAD, 2016).

Therefore, the non-farm sector is crucial to rural households in transition economies as it is Macedonian economy, since it offers employment, reduces urban migration and can contribute to poverty reduction, economic growth and a more equal income distribution (Mollers *et al.*, 2006).

Assessment of the Ministry for agriculture, forestry and water economy in Macedonia (MAFWE, 2014) indicates that efforts to promote entrepreneurship and crafts in rural areas outside agriculture are constrained by low educational status labor and lack of professional experience (cf. National Strategy for agricultural and rural development, 2014-2020). Application of measures for encouraging entrepreneurship in rural areas through grant support capital investments from the Instrument for Pre-accession Assistance for Rural Development (IPARD) establishment of micro and small businesses in rural areas identified that there is a lack of mature business ideas, entrepreneurial skills and knowledge. New businesses are constrained by low incomes and low purchasing power of rural residents and saturation of activities that require low initial capital (small shops, restaurants, services) (Mollers *et al.*, 2006).

Materials and methods

In order to determine the differences between urban and rural household income, data for three-year period, 2012-2014, from survey on Income and Living Conditions from State Statistical Office (SSO) has been used. Data are collected, from 5030 households, through using of questionnaires and direct interviews. The same database was used to calculate share of incomes from non-farm activities in rural households in the total turnover.

In order to review the standard output and to calculate share of economic size by types of the agricultural holdings, data from the survey of the State Statistical Office (SSO) conducted in 2013, for typology and structure of agricultural holdings, has been used. The economic size is determined on the basis of the total standard output of the holdings taken as the average monetary value of the agricultural output at farm-gate price. The agricultural holdings are classified according to their economic potential in 14 economic size classes.

Results and discussion

Data for disposable household income in the table 1 shows that the total average income of rural households for period of three years (2012-2014) is lower for 12% compared to

households in urban areas, with dominance of incomes from wages and salary (49% in rural and 61% in urban areas). This indicates that people living in rural and urban areas have a similar standard, especially taken into account 2014 where the difference is only 5.5%. However, separate field surveys demonstrate higher differences between rural and urban incomes values than the data from the State Statistical Office, what fits with the fact that two thirds of poor people lives in rural areas. As a source for income, wages and salary in urban areas are higher by 30% compared to rural. However, there is a visible difference in source of income from self-employments in rural households (share of 28% in rural and 11% in urban areas), due to the large scope of agricultural activities, accounting for 128% higher average income share compared to urban areas, whose part of the income is mostly exposed to high production and market volatility of agricultural production. This is in fact the main potentials for development of rural diversification activities. Positive corrections in this part can be done through using of available resources and creating non-farm activities. Also, the difference in income received from remittances are almost twice higher in rural than in urban areas.

Table 1: Total disposable household income by types in urban and rural areas, 2012 – 2014, annual average per household in euros.

Indicator	2012			2013			2014			Average		
	All house.	Urban area	Rural area	All house.	Urban area	Rural area	All house.	Urban area	Rural area	All house.	Urban area	Rural area
Total income	4,890	5,293	4,263	5,109	5,340	4,791	5,213	5,338	5,047	5,071	5,324	4,701
Wages and salary	2,852	3,327	2,113	2,840	3,257	2,268	2,909	3,237	2,476	2,867	3,274	2,285
Income from self-empl	781	542	1,152	967	644	1,411	903	538	1,384	883	575	1,315
Income from property	52	82	5	6	7	5	6	7	6	22	32	5
Pensions	978	1,105	780	1,037	1,184	836	1,181	1,371	931	1,065	1,220	849
Social transfers	182	203	149	187	206	161	134	139	127	168	183	146
Received private transfers	60	49	75	86	58	123	97	66	137	81	58	112
Other income	1	2	-	1	2	0	1	1	0	1	2	0
Paid private transfers	(15)	(18)	(10)	(16)	(18)	(13)	(18)	(21)	(14)	(16)	(19)	(12)

Source: State statistical office, 2016

In regards to agricultural activities, according to the last executed derivative classification of agricultural holdings as a result of structural survey in 2013, the largest portion (34.4%) shares agricultural holdings specialist in manufacture of cereals and industrial crops within 9 structured agricultural holdings groups according to type of agricultural production. The second place shares agricultural holdings with mixed crops-livestock production, with 18.2%, followed by specialist for permanent crops (mostly in vineyards and fruits) with 17.3%, 10.3% are classified in the type - mixed cropping, and 9.6% specialised in grazing livestock (cattle, sheep, goats). The smallest share or 2.1% are specialist in horticulture production. The high percentage of holdings with multifunctional or mixed farming is mostly due to the reduction of the risk of climate and market volatility.

According to the classification of economic size of the farm (SSO, 2015), 49.6% of farms are classified in the first lowest category, EUR 2,000 standard gross margin or 1.5 units of economic size which is equivalent to about 1.8 ha cereals or 2 cows or 25 sheep or a combination thereof according to the categorization of the European Union. The biggest number of agricultural holdings with highest economic size, from VII till IX class (from 50,000-500,000 euros), are in group of specialised grazing livestock, however mixed farms with plant and livestock production takes third place in this group. The agricultural holdings in the European Union are on average more than five times the economic size of the agricultural holdings in Macedonia. These figures indicate unfavorable level of economic power of agricultural households in Macedonia, what has negative impact on boosting of entrepreneurship and creating of new businesses within farm households.

In terms of gainful activities, data in Figure 1 shows that only 10,467 rural households (16% of total number of rural households) are dealing with non-agricultural production activities, mainly focused on processing of animal production (39%) and picking of forest plants (24%). Very small portion (less than 1%) takes households with aquaculture, tourism and accommodation and handicraft activities, which from globally perspectives represents the most often potential diversified activities out of agriculture. Data for non-farm activities in Macedonia, compared with EU countries where over one third of EU-27 family farmers (36.4%) carry out another gainful activity with increasing tendency (European Commission, 2014), implies very low diversified rural economy in the country.

In terms of the share of rural nonfarm incomes in total rural incomes in Macedonia, analysed data in figure 2 demonstrates that the biggest portion (69%) of the rural households that are dealing with non-agricultural production has only 10% income source of the non-farm activities and only 9% of this group of rural households with non-farm activities has non-farm income accounting for more than 50% in total income sources. This data conforms that in the most cases, other gainful (non-farm) activities has low influence in the total income in the rural households.

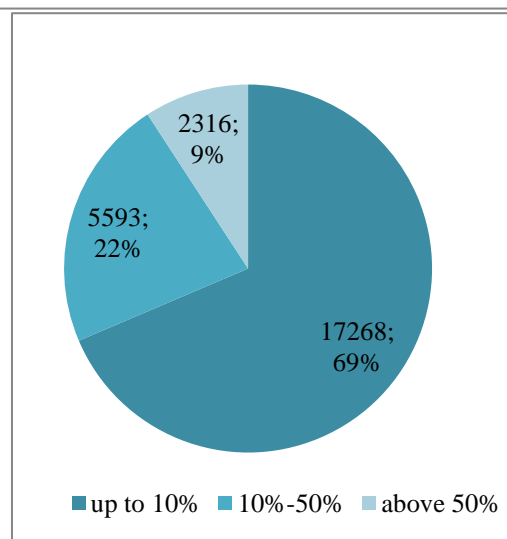
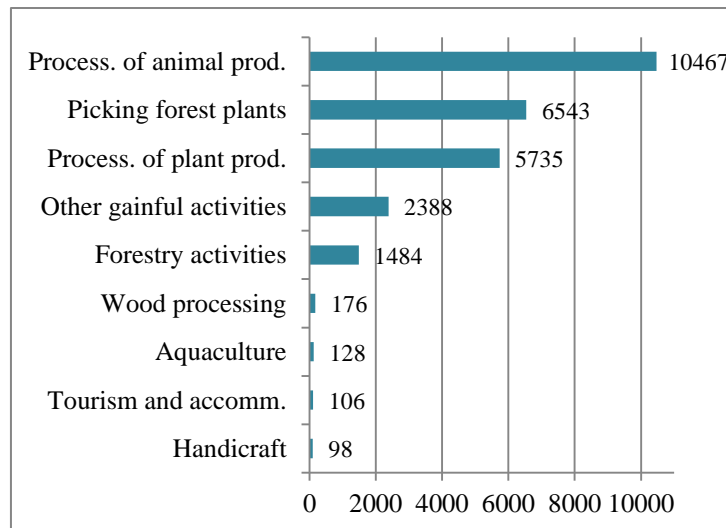

Figure 1. Number of individual agricultural holdings with other than agriculture gainful activities, by type of activity.
Source: SSO, 2014

Figure 2. Share of turnover of other gainful activities in total income.
Source: SSO, 2014

Much of the rural non-farm economy literature highlights the role of the following determinants of capacity to engage in rural non-farm (RNF) employment household composition (availability of surplus labour, gender constraints and patterns, decision-making responsibility), education and skills (appear to be a stronger determinant of higher income in the non-farm sector than in on-farm incomes); access to finance (closely linked to land ownership and farm size in rural areas in some but not all countries); infrastructure (helps create the conditions for growth – and also improves access to employment); and social capital, vertical and horizontal network issues and differential conditions of access due to socio-economic status (Gordon, 1999).

Conclusion

The rural economic development in Macedonia is very important as 43% of the total population lives in rural areas, but also two third of poor population are coming from these areas. Many villages in the Republic of Macedonia have suffered from demographic, economic and social decay over the past decade.

The rural households' incomes compared to incomes in urban areas are smaller due to less economic opportunities and undeveloped market in rural areas. In addition, the weather, especially climate change, market conditions and other factors can significantly affect the yields and incomes from agricultural activities, which implies high risks for sustainability of rural households. The rural economy in Macedonia is mainly characterised with large portion of traditional small scale farms, with agricultural activities as main source of income. The most of farms are specialised in field crop production but also mixed farms, with both, plant and livestock production are dominant, in order to alleviate climate and market risks. Although Macedonian rural areas and rural population possess huge potential and have available investment opportunities in IPARD programme, non-farm activities are insufficiently developed, deploying only 16% of the total rural households, with insignificant share in total income.

The competitive part in rural income structure can be found in self-employment activities showing only stronger position compared with urban incomes from these activities, where are the mainly human potentials for non-farm activities.

In order to boost entering the rural non-farm economy, affordable finance means need to be made available in rural areas; as well education and quality extension services are also necessary in order to encourage people to start competitive and sustainable businesses. In addition, the public infrastructure and services such as utilities, health and roads are of great importance for development of diversified households' incomes and diversified rural economy.

References

- Čustović H., Kovacevic Z., Tvica M. (2013). Rural Ecology. University of Sarajevo, Faculty of Agriculture and Food Sciences, Sarajevo.
- Davis, J. R. (2004). The Rural Non-Farm Economy, Livelihoods and their Diversification: Issues and Options. Chatham, UK: Natural Resources Institute.
- European commission (2014). Developments in the income situation of the EU agricultural sector. Directorate-General for Agriculture and Rural Development, Brussels.
- International Fund for Agricultural Development (IFAD) (2016). Rural poverty in The former Yugoslav Republic of Macedonia. IFAD, Rome, Italy (<http://www.ruralpovertyportal.org>).
- Gordon, A. (1999). Diversity in rural incomes: Issues affecting access at household level. Paper presented at a World Bank Seminar on the Rural Non-farm Economy, 7 June 1999. Washington: World Bank. Chatham Maritime, UK: Natural Resources Institute (<http://www.nri.org/rnfe/papers.htm>).
- Jakimovski J. (2002). Rural Development: Does Macedonia Need a New Approach. Institute for Sociological, Political and Juridical Research, Skopje, Macedonia.
- Martinovska S. A., Georgiev N., Erjavec E. (2008). Farm income analysis of agricultural holdings in Macedonia using FADN methodology. Faculty of Agricultural Sciences and Food, Skopje.
- Messer N., Townsley P. (2003). Local institutions and livelihoods: Guidelines for analysis. Rural development division, Food and agriculture organization of the United Nations, Rome.
- Mollers J., Heidhues F., Buchenrieder G. (2006). Non-Farm Diversification Decisions of Rural Households in Macedonia. University of Hohenheim, Stuttgart, Germany.
- MAFWE (Ministry of Agriculture, Forestry and Water Economy) (2014). National Strategy for agricultural and rural development 2014-2020. MAFWE, Skopje, Macedonia.
- SSO (State Statistical Office) (2016). Economic accounts in agriculture, 2009-2014. SSO of Republic of Macedonia, Skopje.

- SSO (State Statistical Office) (2015). Typology and Structure of agricultural households 2013. SSO of Republic of Macedonia, Skopje.
- SSO (State Statistical Office) (2016). Survey on income and living conditions, 2014. SSO of Republic of Macedonia, Skopje.
- World Bank (2008). World development report 2008 - Agriculture for development. Policy. Brief, Washington DC.

STATUS OF AGRICULTURAL TOOLS AND MACHINERY CAPITAL IN TURKISH AGRICULTURAL ESTABLISHMENTS AND EVALUATION OF ADEQUACY

Mehmet Arif ŞAHINLI¹, Ahmet ÖZÇELİK²

¹Ankara University, Agricultural Economics Department, Ankara, Turkey, Phone: +(90) 312 596 14 77, Ankara 06110 Turkey, e-mail: asahinli@ankara.edu.tr (Corresponding Author)

²Ankara University, Agricultural Economics Department, Ankara, Turkey

Abstract

The active capital in agricultural enterprises consists of land (farm) capital and tenant capital. One of the most important elements of the tenants capital is tools and machinery capital. The presence of the tools and machinery capital repeatedly helps to provide employment in the manufacturing of many products in agricultural establishments. This capital is mainly assessed as lifeless stock or inventory. Capital consisting of all kinds of the tools and machinery is found to increase the success of work in business and makes indirect impact on production. The tools and machinery capital in accordance with the activities of agricultural enterprises is essential to work with sufficient capacity and regularity. In this study, we discuss the conditions of tools and machinery capital in the agricultural sector of Turkey. Quite a number of studies have been carried out on machinery capital. Some secondary data have been obtained for the purpose of this study. One of the most important database belong to the tools and machinery capital of Turkish Statistical Institute and other different Institutions and Organizations in national and international arena. The data obtained would be used to evaluate the level of the tools and machinery capital in the agricultural sector and appropriate proposals suggested.

Keywords: *Agricultural tools and machinery, Tractor and the combine harvester statistics, Turkey*

Introduction

The Turkey Gross Domestic Product (GDP) by production based approach increased by 9.0% in 1998 prices increased by 15.9% at current prices in 2010 compared to the previous year. As a result, GDP was 105.738.813 thousand TL in 1998 prices and 1.103.749.801 thousand TL at current prices in 2010. At of 1998 prices, agriculture sector value was 9.999.429 thousand TL and current price value was 92.739.021 thousand TL. Agriculture sector grew by 2.4 percent in 2010 compare to the previous year. Agriculture sector share in GDP is 10.1 percent in 2000 and 8.4 percent in 2010. According to this statistics, the share of agriculture are observed to decline (Turkstat, 2014).

As could be expected the 2008 global economic crisis effected the Turkish economy greatly. During the 2010 year, private sector fixed capital investments were observed to increase by 20 percent and then the shares of agriculture in the private sector fixed capital investment was also seen to increase. At the same time, public sector fixed capital investments were observed at 8.6% in 2008, 9.8% in 2009 and 12.8% in 2010 that these shares were increasing steadily. In 2010, the central government budget investments of 19.3 billion TL, which accounted for 69.3 % of the 27.8 billion TL investment budget allocated. Agriculture sector has 17.8% in this central government budget investment (Mod, 2014).

As part of the EU accession process, ensuring competition in markets and providing sustainability in sectors are taken into account. It is of important that agriculture supports be

differentiated on product and area basis and their implementation and control will be based on areas. The prices of agricultural crops which are subject to activities of Agricultural Sales Cooperatives and Associations and State Economic Enterprises increased at an average rate of 9.5% and 7% in 2008 and 2009, respectively. The primary objective in the agricultural sector is to ensure food security, reliability and an established organized and highly competitive structure while observing the sustainable use of natural resources. During the EU accession process, necessary institutional and administrative transformation would be given priority in order to increase the competitiveness after full membership (Mod, 2014).

Şahinli (2014) in his study emphasizes food and agriculture trade and used data belonging to Food and Agriculture Organization (FAO) for the years 2000 to 2011. The Revealed Comparative Advantage Index (RCA) was calculated for the 601 agricultural firms in Turkey. The RCA greater 1, indicated that *i*th goods in the *j*th country has a comparative advantage. On the condition that only 78 selected agricultural firms were found to have over one value for the RCA. Turkey's economy has been steadily growing since the year 2002. Turkey has many well-qualified agricultural engineers, employees, sufficient and necessary infrastructure, and good geographic conditions, which create important opportunities for Turkey in the current global market. However, in order to maintain and further improve its competitiveness Turkey should give priorities to improving existing infrastructure and productivity.

Materials and method

This study employed data of Turkish Statistical Institute for the period from 2000 to 2015. In mechanization of agricultural practices, the most widely used power source is tractor and the combine harvester statistics. Start with, we examine the combine harvester statistics indicator. By using these statistics, base year (2000=100 and 2001=100) and the previous year values are calculated. Regarding with these statistics and indicators are preliminary examined and compared to the years.

According to the Table 1, combine harvester numbers are given by age group. These groups are categorized into four different age groups and total number of combine harvester is given, too. For the base year 2000=100, Turkey's combine harvester numbers and previous years' increasing are calculated. According to the base year, combine harvester numbers have been increasing from 2000 and onwards. Especially after 2008, this value has been steadily increasing. When we use the previous year's value of combine harvester, combine harvester values have been slowly increasing since 2005.

(Gokdogan, 2012) explained the indicators of the level of mechanization of agriculture in Turkey and these indicators have been compared with indicators of the European Union. This study examines Turkey and the European Union's agricultural structures and mechanization properties. This study elaborates the current situation of Turkey and the European Union's agricultural structures and agricultural mechanization properties. Indicators of the level of mechanization in Turkey are 1.68 kW ha⁻¹; 24.80 ha/tractor; 40 tractors/1,000 ha; 5.20 equipments/tractor; 4.20 tons/tractor; in the European Union however 6 kW ha⁻¹, 11.30 ha/tractor; 89 tractors/1,000 ha; 10 equipments/tractor; 12 tons/tractor. According to these comparisons, the level of mechanization in Turkey in terms of the degree of mechanization of the indicator values is higher than the EU average.

Table 1. Number of combine-harvester, 2000-2015

Year	Total	Age group				2000=100	% (Previous year)
		0 - 5	6 - 10	11- 20	20+		
2000	12 578	-	-	-	-	-	-
2001	12 053	-	-	-	-	-4.17	-4.17
2002 ⁽¹⁾	11 539	1 213	2 125	3 526	4 675	-8.26	-4.26
2003	11 721	1 352	2 214	3 545	4 610	-6.81	1.58
2004	11 519	1 430	2 298	3 489	4 302	-8.42	-1.72
2005	11 811	1 659	2 405	3 551	4 196	-6.10	2.53
2006	12 359	2 036	2 598	3 596	4 129	-1.74	4.64
2007	12 775	2 338	2 739	3 652	4 046	1.57	3.37
2008	13 084	2 558	2 873	3 657	3 996	4.02	2.42
2009	13 360	2 643	2 950	3 669	4 098	6.22	2.11
2010	13 799	2 820	3 116	3 721	4 142	9.71	3.29
2011	14 313	3 038	3 293	3 834	4 148	13.79	3.72
2012	14 813	3 160	3 483	3 960	4 210	17.77	3.49
2013	15 486	3 431	3 722	3 882	4 451	23.12	4.54
2014	15 899	3 604	3 812	3 852	4 631	26.40	2.67
2015	15 998	3 815	3 750	3 780	4 653	27.19	0.62
Source: Ministry of Food, Agriculture and Livestock							
(1) Data related to age group have been compiled since 2002.							

Figure 1. Number of combine-harvester 2000-2015

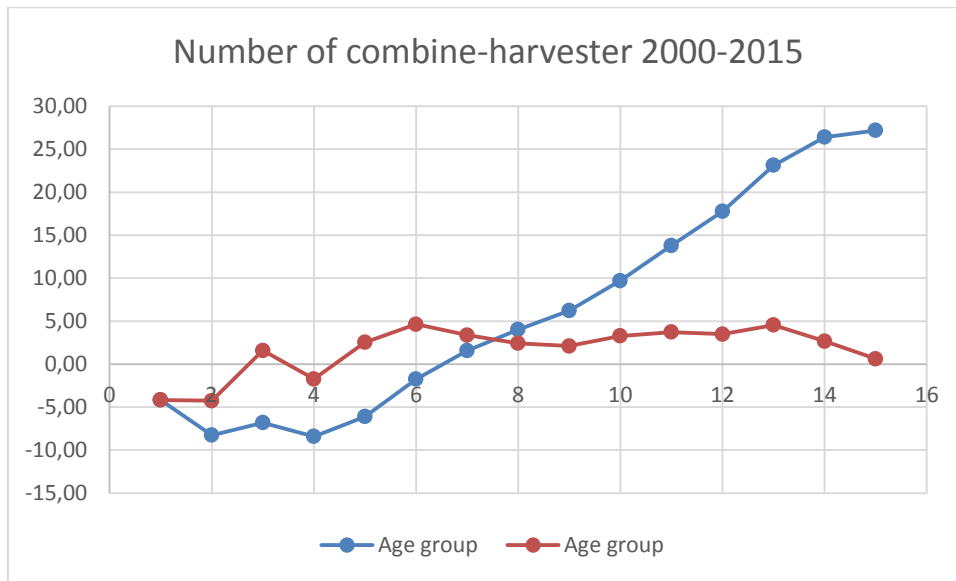

According to the Table 2, tractor numbers are given by the years. These values show that the tractor numbers have been smoothly increasing. By using this number, we calculated to examine the differences for the base year (2001=100) and previous years' ratio. As you see from these tractor numbers, these values have been sharply increasing according to the base year.

(Durgut and Arın, 2005) in their study carried out in Trakya Region (Provinces of Edirne, Kırklareli and Tekirdağ). Parameters of the mechanization level were found to be 33.73 kW/ha, 4.1 equipment unit/ enterprise and 5.02 equipment unit/tractor. Mechanic energy usage for the most applications except tillage and sprayers was found to be insufficient because of inappropriate plantation for agro-technique needed.

Table 2. Agricultural equipment and machinery

Year	Number of tractor	2001=100	% (Pervious year)
2001	948.416		
2002	970.083	2.28	2.28
2003	997.620	5.19	2.84
2004	1.009.065	6.39	1.15
2005	1.022.365	7.80	1.32
2006	1.037.383	9.38	1.47
2007	1.056.128	11.36	1.81
2008	1.070.746	12.90	1.38
2009	1.073.538	13.19	0.26
2010	1.096.683	15.63	2.16
2011	1.125.001	18.62	2.58
2012	1.178.253	24.23	4.73
2013	1.213.560	27.96	3.00
2014	1.243.300	31.09	2.45
2015	1.260.358	32.89	1.37

Source: Ministry of Food, Agriculture and Livestock

Figure 2. Agricultural equipment and machinery (Number of tractor)

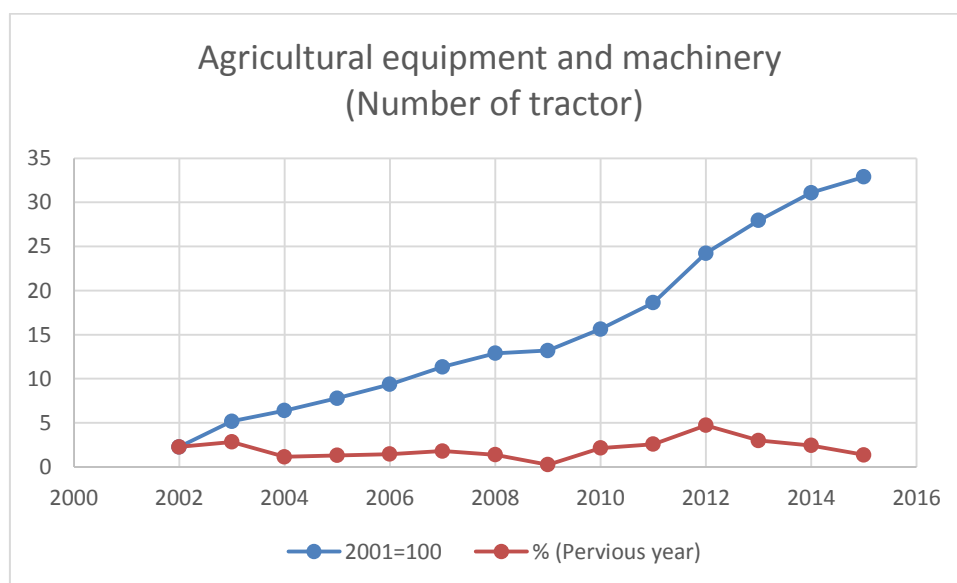

According to the Table 3, total utilized agricultural land in Turkey is given by hectares. As can be seen from this Table 3, 2001=100 base year and % (Previous year) are calculated. According to the base year, total utilized agricultural land have been slightly decreasing from 2006 and onwards. Compared to the previous year, total utilized agricultural land value has been increasing from 2012 and onwards.

As I mentioned earlier, tractor power per hectare is an important indicator of mechanization. Statistical indicators emphasized that average tractor number per area in Turkey increased from 2001 to 2015. A strong relationship between tractor number and agricultural productivity was observed in the situation of Turkey.

Table 3. Total utilized agricultural land (Thousand Hectares)			
Year	Hectares	2001=100	% (Previous year)
2001	40.967		
2002	41.196	0.56	0.56
2003	40.644	-0.79	-1.34
2004	41.210	0.59	1.39
2005	41.223	0.62	0.03
2006	40.493	-1.16	-1.77
2007	39.504	-3.57	-2.44
2008	39.122	-4.50	-0.97
2009	38.912	-5.02	-0.54
2010	39.011	-4.77	0.25
2011	38.231	-6.68	-2.00
2012	38.399	-6.27	0.44
2013	38.423	-6.21	0.06
2014	38.558	-5.88	0.35
2015	38.566	-5.86	0.02

Source: For land under permanent meadows and pastures 2001 General Agricultural Censuses, for other Ministry of Food, Agriculture and Livestock

Figure 3. Total utilized agricultural land (Thousand Hectares)

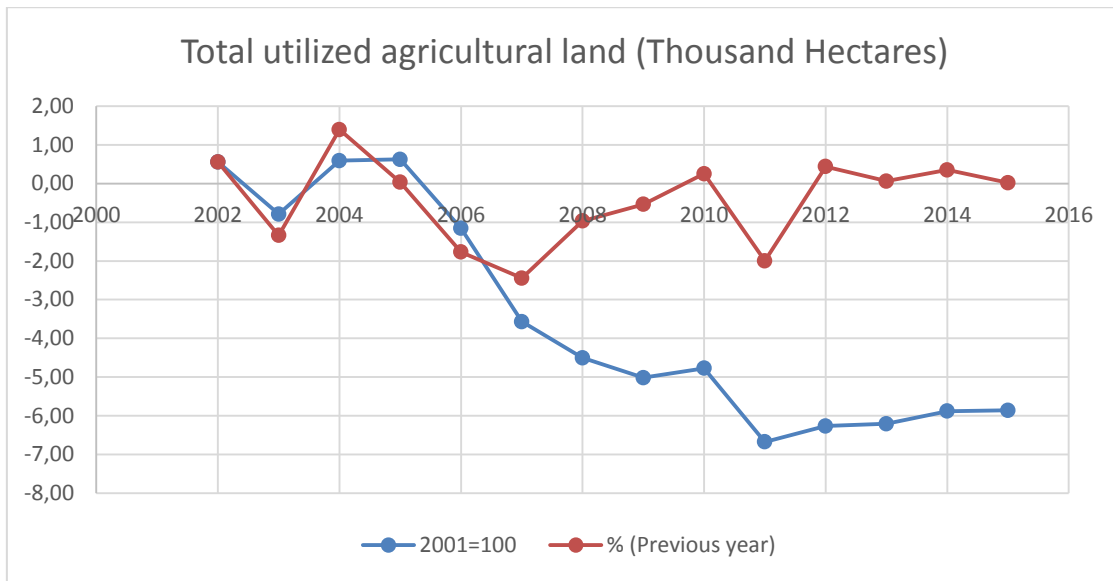

According to the Table 4, there are two indicators, combine-harvester number / total utilized agricultural land and tractor number / total utilized agricultural land. Approximately, while combine-harvester number has 3 per total utilized agricultural land (10000 hectare), tractor number has 25 per total utilized agricultural land (1000 Hectar). As a conclusion, tractor numbers are more superior than the combine-harvester numbers in Turkey.

(Baran et. al. 2016) in their study explained that machinery-equipment group has been included under the scope of grants by the state in Turkey since 2007. Under the grants scheme, 50% grant assistance in the form of machines were distributed. In all from 2007 to 2013 about 221.620 machine-equipment from 41 different tool machine types were distributed to the 81 provinces of Turkey in a period of 7 years. The grants assistance programme does not only enable farmers to park the old machines but it also presented the opportunity for farmers to use high-tech new machinery.

Table 4. Calculated values of combine-harvester and tractor

Year	Combine-harvester Number / Total utilized agricultural land (10000 Hectar)	Tractor Number / Total utilized agricultural land (1000 Hectar)
2001	3	23
2002	3	24
2003	3	25
2004	3	25
2005	3	25
2006	3	26
2007	3	27
2008	3	27
2009	3	28
2010	4	28
2011	4	29
2012	4	31
2013	4	32
2014	4	32
2015	4	33

Figure 4. Calculated values of combine-harvester and tractor

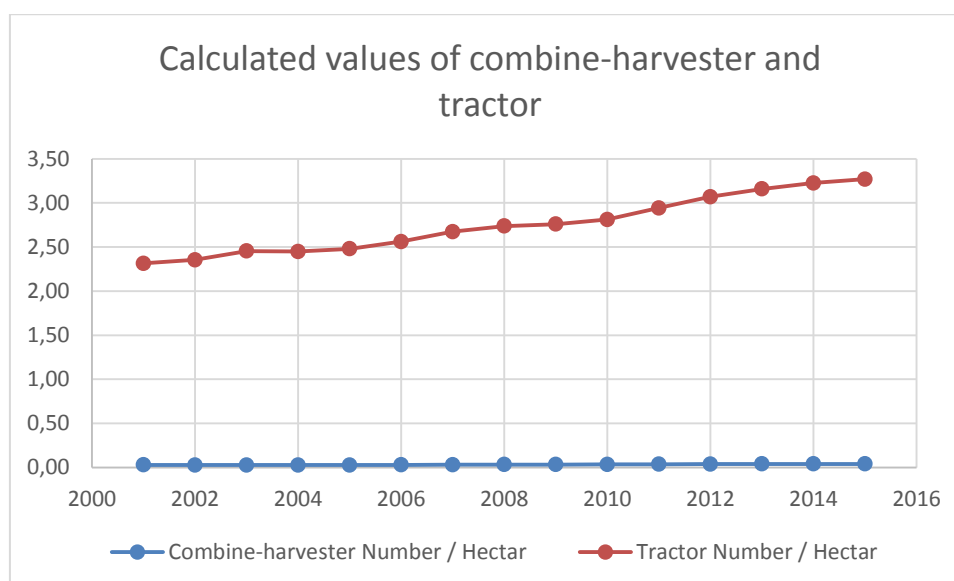

Conclusions

Agricultural mechanization has a vital role as far as the improvement of total agricultural production by farmers. There are many important technologies and inputs which are the most important elements are tractor numbers and the other mechanization. By increasing the mechanization and technological devices, agricultural production will be increased in Turkey before the years. In this study, mechanization level of tractor numbers and the other machines in Turkey were examined and compared using statistical indicators.

The increase in the agricultural production is generally depend on mechanization as such agricultural mechanization stands as one of most important agricultural production technologies and inputs. This study concludes that the main reason of the increasing tractor numbers has been attributed to the increasing Purchasing Power Parity (PPP) of the agricultural farmers in Turkey.

It has been observed that not all the regions have larger numbers tractors and engine powers. Due to this efforts should be made to examine the available tractor and power equipment in every province before new allocations.

Agricultural subsidies should be allocated to farmers to enable them acquire strong machinery for production. Also, if interest rate are reduced, economically and socially disadvantage farmers can afford machines and thereby increase mechanization and also enhance their productivity and efficiency in production. This would have a positive effect on their income levels.

References

- Baran, M., Gokdogan, O., Lule, F. and Koyuncu, T. (2016). Effect Of Agricultural Machinery Grant Scheme On The Agricultural Mechanization Development In Turkey, *Journal of Multidisciplinary Engineering Science and Technology (JMEST)* ISSN: 3159-0040, 3, 1.
- Durgut, M.R. and Arın, S. (2005). Level and Problems of Trakya Region Vineyard Mechanization, *Journal of Tekirdag Agricultural Faculty*, 2 (3).
- Gokdogan, O. (2012). Comparison of Indicators of Agricultural Mechanization Level of Turkey and the European Union, *Journal of Adnan Menderes University Agricultural Faculty*, 9(2): 1 - 4.
- Mod (2014). Database. <http://mod.gov.tr>. (Accessed to web: 23 April 2014).

Turkstat (2014). Database. <http://turkstat.gov.tr>. (Accessed to web:22.04.2014).
Turkstat (2016). Database. <http://turkstat.gov.tr>. (Accessed to web:03.08.2016).
Şahinli, M.A. (2014). Revealed Comparative Advantage And Competitiveness: Turkey
Agriculture Sector. Yuzuncu Yil University Journal of Agricultural Sciences, 24(3).

THE SHORTAGE OF AGRICULTURAL LABOUR FORCE IN ALGERIA: A CASE STUDY

Slimane BEDRANI*, Marouane CHAAMI, Fatma Zohra TAIBI, Bochra BOUHENDJEUR

National Agronomic School, Algiers, Algeria
s.bedrani@ensa.dz

Abstract

In Algeria, over the past fifteen years, more and more farmers are complaining about the lack of labor. To measure the phenomenon, give plausible explanations and report the behavior of farmers facing this problem, two surveys were conducted with farmers in two rural areas geographically and climatically very different: one covers an agro-pastoral area and the other an irrigated plain. After compilation and analysis of the surveys, it appears that the lack of labor is felt by the majority of farmers, especially by those who have no, or little, family labor. There are several causes to this: the state aid to the unemployed that does not encourage them to accept agricultural work, remuneration levels made by farmers are perceived as unattractive, the employment opportunities in the informal sector are numerous and provide interesting and earned income with less effort than that required by the agricultural work. Farmers are responding to this by increasing the mechanization of their work.

Keywords: Algeria, Agricultural Workers, Rural Development

Introduction

Algeria has a relatively high unemployment rate: 10.6% of the labor force in September 2014, with 11.4% in urban and 8.9% in rural areas. 27% of the unemployed population is in rural areas. In addition, 25.2% of young people (16-24) declare to be unemployed. During recent years, the press reported that more and more farmers complain about the lack of manpower to carry out the field work (APS, 2014; Benabbou, 2014; Bencherki, 2016, W.O.H, 2015).

What is the extent of the lack of agricultural labor phenomenon? If it is real, does it exist in all regions with the same intensity? What might be the main causes?

Materials and methods

In the attempt to answer these questions, two surveys were conducted in two agricultural regions which differ in both climate and farming systems. The first covers the municipality of *Hadj Mechri* which lies northwest of the *wilaya* of Laghouat; about 470 km southwest of Algiers. The second covers the four municipalities of the *Yellel daïra (Relizane)* which is 270 km west of Algiers.

The town of *Hadj Mechri* has a semi-arid climate with harsh winter due to its high altitude (1250 m). The area experiences a dry period from late April to late October, low rainfall (215 mm per year), which is very irregular not only intra- but also inter-annual.

With a density of 12 inhabitants per square kilometer, the town of *Hadj Mechri* is rural, largely dominated by the scattered settlements which include 75.6% of the population (24.4% living in secondary towns). In 2013, the population consisted mainly of young people (31.9% of 15-29 years old and 36% under 15 years), while the age groups of 30-59 years and over 60 years, form 26.1% and 6% of the population, respectively.

Nomadism - dominant in the fifties and still present in the seventies - has completely disappeared. The pastoral small ruminants (sheep and goats) are the main economic activity, 85% of the total agricultural area of the municipality consisting of rangelands. The cereal rainfed mode (low yields and very random) and irrigated agriculture from boreholes occupy

only 5% of the total agricultural area. Agriculture holds 35% of the employed population and the services and administration 62%. The industry is almost nonexistent (1% of the employed population) while the “building and public works” sector holds only 3% of the employed population.

In 2013, official statistics had an unemployment rate of 8.4% of the workforce.

Hadj Mechri surveys were conducted with a sample of herders and farmers and local administrative authorities. The sample size is 50 farmers forming 18% of the parent population (consisting of pastoralists and farmers rearing sheep). The sample was drawn by the *Hazard* Excel software. For farmers practicing irrigation (but not having sheep), the sample is not random because of the absence of the list of these farmers. Key informants designated 10 of the farmers to inquire.

The *Yellel daïra* consists of a plain with an altitude of 135 meters. The climate of the region is hot and dry in summer and cool and wet in winter. The average rainfall is 350 mm / year over the last decade (2004-2014) with a strong inter- and intra-annual irregularity.

With a density of 327.1 inhabitants per km², the *Yellel daïra* conceals a highly rural population (74% of the population).

In *Yellel*, a sample of 100 farms randomly drawn was investigated. Interviews were also conducted with some local authorities.

Results and discussion

Agricultural labor shortage is a reality. This is the first result of our investigations.

About *Hadj Mechri*, analysis by the hierarchical clustering method (CAH) identified two classes among respondents in our sample. These two classes cover the different production systems in a perspective that expresses the existence or not of difficulties in hiring of labor, the causes of these difficulties and the type of work needed by farmers.

Table 1 below shows that overall 30% of the surveyed farmers express a lack of manpower. But from this point of view, the differences are considerable between the different production systems.

The farmers of the “pastoral and agro-pastoral” production systems are the least affected by the phenomenon: only 13% of them complain about the lack of manpower. Yet this lack manifests itself acutely with landless farmers (without agricultural area). The trade of sheep, that is considered as requiring a good qualification (which is acquired in the area only by practice), does not find candidates for reasons which will be below exposed.

The farmers of the production system “polyculture-farming” associate extensive rangelands with irrigated agriculture (potato, onion, other vegetables), some with a few plots in rain-fed agriculture. 70% of these farmers suffer from lack of work force.

Table 1. Number of farmers by production system and lacking manpower

Production system	Structure*	Farmers with lack of manpower	Farmers without lack of manpower
Pastoral and agro-pastoral system (40 farmers)	E	5	6
	E+S	0	25
	E+S+A	0	4
Mixed farming (agriculture and livestock) (10 farmers)	E+PT+O+C+M+A	1	0
	E+PT+O+C	3	0
	E+PT+C	1	0
	E+PT	1	1
	E+PT+M+A+S	1	1
	E+PT+M+S	0	1
Irrigated crops without livestock rearing (10 farmers)	PT+O+C+M+A	1	0
	PT+O+C	2	0
	PT+O	0	4 nomads ¹
	PT+C+M	1	0
	PT+C	2	0

* PT: potatoes ; O: onion; C: irrigated cereals; M: mixed (cucurbits, small-pea, other vegetable crops); A: fruit growing; S: rainfed grain; E: Livestock.

Among the farmers lacking labor force, 55% lacked workers for land preparation, planting, spreading fertilizers, hoeing, weeding and mounding. 65% lack laborers for irrigation and 80% for harvesting. It should be noted that these farmers only need unskilled seasonal workers.

Farmers of the "Irrigated crops without sheep» production system all lack manpower but four of them. But these four are "itinerant" farmers from the region of *Mascara* (in the north) who bring with them their own workers (for fear of not finding workers in the area of *Hadj Mechri*).

In *daïra Yellel*, 67% of 100 surveyed farmers say that there is existence of a labor shortage; shortage affecting everyone, whatever the size of farm. However, correspondence analysis shows that the variables "agricultural area" (UAA) and "irrigated area" are the determining factors of the lack of manpower. This means that whenever the UAA and the irrigated area increase, the problem of lack of labor force increases, mainly for the following crops: cereals and olive growing. Farmers need labor especially for harvesting operations (about 40% of farmers surveyed), soil preparation (32%), sowing and planting (10.8%) and weeding (7.7%). For *Yellel* like *Hadj Mechri* for gardeners, farmers need mostly unskilled seasonal labor. In

¹ The itinerant farmers are originating in the area of *Mascara*. They rent plots of land in *Hadj Mécheri* to cultivate there mainly potato and onion under irrigation. The blue-collar workers whom they use (for plantation, irrigation and harvest) come from *Mascara* and spend all the period from March to September in huts near the cultivated plots.

fact, only 8% need permanent workforce and 15% skilled workers. Overall, the labor shortage appears with crop intensification through irrigation and extensive sheep breeding herds of a hundred heads or more.

The causes of labor shortages in agriculture and livestock

The labor shortage has been - and still is - a problem especially in developed countries, which have been forced early to import labor from abroad. In France, for example, industrialization has caused a massive rural exodus. Cities attract - thanks to high wages - the poorest rural workers. As Darpeix (2013) pointed out “*The lack of arms is therefore felt in the cities, but especially in the countryside, mainly manual jobs, hard and low-paid*”. Even now - despite their inclination to curtail immigration - all European countries import Seasonal Agricultural Workers: Spain mainly from Morocco, France from Morocco and Tunisia, Italy from Albania and Tunisia, Germany and the UK countries from Poland, Romania, Bulgaria... (Morice and Michalon, 2008). But, already, one announces in these countries the possibility of immigrant workers shortage, that being due to the very bad terms of recruiting and employment of this workers. These bad conditions are denounced by the defenders of the farm workers, defenders who push the States to enforce the labor law strictly. Now these poor conditions (low wages, flexibility, lack of social security, undeclared contracts, ...) are needed to make profitable fruit and vegetable crops for which immigrants are hired (Michalon and Morice, 2008). If the labor law of the host country is strictly observed, there is a risk that farmers abandon the intensive crops workforce, predict these authors.

By comparison, what about in Algeria?

Industrialization as a phenomenon that attracts rural workers to the cities and therefore reduces the available labor force in agriculture cannot be questioned in Algeria. Indeed, the industrial sector - after more than half a century of independence - is small. It contributes only 4.6% to GDP (2012) and includes only 10% of economic entities identified in 2011 (ONS, 2012). However, the trade sector powerfully attracts labor not only in its formal part but also, especially, in its informal part, which dominates the sector in question. In its only formal part (therefore traders with the commercial register), it forms 55% of economic entities recorded in 2011. If we add the service sector, it gathers 89% of economic entities.

The poor conditions of life and work in agriculture and livestock, as the second cause of the agricultural workforce shortages exist relatively in strong way in Algerian agriculture. Indeed, in both surveys, any agricultural worker hired - whether permanent or seasonal - is declared to social security (no dues for retirement, no health insurance and work injury). In addition to this lack of benefits, the drudgery of farm work is not the least because of the refusal of this work. According to 57% of respondents in *Hadj Mécheri* this causes workforce shortage. This is especially the case of the employees in sheep transhumance. The shepherd family moves very often (wife and children) staying in a tent, away from health services, schools, administrative services, undergoing the rigors of winter and the heat in summer, often far from camping water points for watering livestock and domestic needs. Given these working conditions, the monthly remuneration received (about 300 dinars per sheep or 30,000 dinars for a herd of 100 head) is well below the average net salary of a supervisor paid by an employer in non-agricultural sectors (around 41,236 AD²). At this price, it is not surprising that it is difficult to find a shepherd. In general, workers in agriculture are highly underpaid compared to workers in other sectors of the economy as revealed by the investigation of the National Statistics Office on wage income, which shows that the first receive only 59% of the overall average net salary (ONS, 2011).

² US \$ 1 is worth 165.5 AD (Algerian Dinar) on the informal market and 111.3 AD at the official exchange rate.

Another cause of the labor shortage is, according to 60% of respondents in *Hajj Mechri*, in the social policy of the state (Table 2). This policy would offer many opportunities for the unemployed either to create their own jobs [through loans and grants from the National Agency for Youth Employment Monitoring (ANSEJ) and the National Micro-Credit Management Agency (ANGEM)], or to receive unemployment benefits, either in temporary employment positions in administrations, temporary jobs that can turn, over time, into permanent jobs.

Table 2. Causes of agricultural labor shortage given by farmers surveyed in *Hajj Mechri* (% of respondents)

Causes of the agricultural labor shortage	% of respondents
State policies for youth employment and the unemployed	60%
Preferences of labor forces to other areas	57%
Poor working conditions	57%
Refusal of agricultural work by young people	55%
Education of children and rural exodus	40%
Decreased family labor	32%

Source: *Hadj Mechri Survey*

In *daira Yellel*, farmers give as reasons for the labor shortage, first, refusal by young people to work the land, second, preference among young people for “easy work” (almost 60% of responses to the two reasons). These two other reasons must be added: too much drudgery of farm work and the non-recognition by young people of the importance for the nation’s agricultural sector. Considering all these reasons, it is almost three-quarters of respondents who think that agricultural work has a repellent effect for young people. The other big reason, as to *Hajj Mécheri*, is the policy to support youth employment implemented by the state (Table 3).

If young people “do not want to work the land” and “prefer easy jobs” is also, no doubt, because they believe that agricultural work is paid too little, given its vulnerability, its arduousness and given the fact that they are never reported to social security and receive no social benefit. According to the declarations of farmers surveyed in *Yellel*, the farm laborer receives about 1,000 dinars per working day (time period of 6 to 8 hours), amount slightly higher than the legal minimum wage (about 930 DA including social charges). In *Hadj Mechri*, the daily wage is 1200 DA for 6-7 hours per day). It should be noted that very few formal employees are paid with the guaranteed minimum wage tariff, including in the public service. Indeed, the least skilled workers in economic sector – either public or private - (“executing agents” in the list of official statistical services) in 2013 receive an average net monthly salary of 26,843 DA.

Table 3. The causes of labor shortages according to weary farmers in Yellel (% of respondents)

Causes	%	
Young people do not want to work the land	36.20%	73.80%
Young people prefer the easy work	21.70%	
Young people ignore the importance of the agricultural sector	11.60%	
The working conditions are perceived as too harsh	4.30%	
Support to youth employment implemented by the state	15.90%	15.90%
Many farmers are looking to hire agricultural workers	10.10%	10.10%
Total	100.00%	100.00%

Source: Yellel Survey.

Conclusion

The analysis of the results of the surveys conducted in two agricultural regions, which differ in both climate and farming systems, reveals that the labor shortage in the agricultural activities is very real. Both main causes of this labor shortage are the hard conditions of the agricultural work (to which is added a weak remuneration) and the opportunities which offer the policies of the State to the unemployed persons.

References

- APS (Algérie Presse Service) (2014). « La main d'œuvre agricole a atteint plus de 2,5 millions d'emplois en 2013 » (Agricultural labor has reached more than 2.5 million jobs in 2013). Daily Newspaper El Watan du 21.01.14.
- Benabbou N. (2014). « La main-d'œuvre agricole fait défaut » (The agricultural workforce is lacking). Daily Newspaper Liberté du 22-4-2014.
- Bencherki O. (2016). « Chlef: Le Bâtiment et l'Agriculture en quête de main-d'œuvre » (Chlef: The Building and Agriculture seeking labor). In Daily Newspaper le Quotidien d'Oran du 26-3-2016.
- Darpeix A. (2013). « La main-d'œuvre salariée en agriculture : histoire d'une invisibilité » (The wage labor in agriculture: the story of invisibility). Le Demeter 2013 « Economie et stratégie agricole ».
- Morice A, Michalon B, 2008. « Les migrants dans l'agriculture: vers une crise de main-d'œuvre ? Introduction» (Migrants in agriculture: towards a labor crisis? Introduction). Etudes rurales 2/2008 (n° 182), pp. 9-28.
URL: www.cairn.info/revue-etudes-rurales-2008-2-page-9.htm Accessed on 6-4-2016.
- Musette S.M. (2013). Employment Policies and Active Labour Market Programs in Algeria. (European Training Foundation - ETF, Algiers.
- ONS (Statistical National Office) (2012). « *Le premier recensement économique. Résultats définitifs de la première phase* » (.The first economic census. Final results of the first phase) In Série E : Statistiques Economiques, n° 172.
- ONS (Statistical National Office) (2011). Rapport de Revenus salariaux et caractéristiques individuelles en 2011 (Wage income ratio and individual characteristics in 2011). Série S, n° 189.
- W.O.H. 2015. « *Agriculture. Vers le recours à la main-d'œuvre étrangère* » (*Agriculture. To the use of foreign labor*). In Daily Newspaper Horizons du 14-3-2015

POSSIBILITIES DEVELOPMENT OF NEW RISK MANAGEMENT TOOLS IN AGRICULTURE

Joanna PAWŁOWSKA-TYSZKO^{1*}

¹Agricultural Finance Department, Institute of Agricultural and Food Economics – National Research Institute, Poland

Corresponding author: tyszko@ierigz.waw.pl

Abstract

The experience of countries of the Community clearly indicate that the existing risk management instruments (including insurance subsidized) are not fully utilized, and what more do not guarantee fully the financial stability of farms. Hence appear the new needs for innovative risk management tools in agriculture. The aim of the study will attempt to assess past experience in the implementation of risk management tools (including agricultural insurance subsidized) in Poland in terms of the possible the development of new risk management instruments. For the analysis of the legal status were used the Polish insurance regulations and EU legislation in the range of the functioning of risk management tools recommended by the CAP. Conducted analyzes indicate that the market for crop insurance and livestock is poorly used by Polish farmers. It is estimated that only 12% of farms in Poland insures the their crops. In the case of animals the situation is even more unfavorable, because in Poland we have insured only 5% of the animals. Moreover, the level of the utilization of subsidies for agricultural insurance is low. The analysis shows that many farmers do not decide to buy insurance. Lack of comprehensive system solutions for the protection of risk in agriculture will force the need to introduce the new instruments such as the: indexed insurance, Mutual Fund (MF) or Income Stabilisation Fund (ISF).

Keywords: *Risk management tools, Risk management in agriculture, Common Agricultural Policy, Poland.*

Introduction

The risk accompanies virtually every field of economic life and is an indispensable attribute of the business activity. In this regard, agriculture is not any exception. Śmigiel-Krajewska notes that in relation to the agricultural production the risk is a particularly complex phenomenon, not only due to the size of threats, fragmentation of production entities, but also due to the unpredictable variability of phenomena [Śmigiel-Krajewska, 2014].

Acquisition of the responsibility for the effects of such the risk by an agricultural holding seems to be a heavy burden, not only in the psychological, but, first of all, in the financial dimension, which makes this behavior unprofitable. In order to avoid greater losses, of essential importance is public aid as regards access to a properly organised – according to the needs of a given country – system of risk management instruments in agriculture geared towards mainly to stabilising farmers' income. This is indicated by the studies conducted by Cordier, who notes that the modern state policy should focus on instruments limiting the risk of a decline in income [Cordier, 2009]. These may be market instruments e.g. futures contracts, coordinated production systems supported by the state, inter alia, by creating commodity exchanges or supporting integration processes in agriculture. In case of large-scale losses, the role of the state should be to create crop and livestock insurance schemes supported by subsidies, or to create of a legal framework for the functioning of special funds in case of natural disasters or crises in the food market. Among the instruments that can play

an important role in mitigating the effects of the risk and stabilising agricultural income, we should mention those to which the European Commission pays particular attention within the framework of the CAP. They include subsidised crop and livestock insurance in case of natural disasters, mutual funds and income stabilisation funds. These instruments place a particular emphasis on reducing losses and stabilising income by means of funds based on the principles of reciprocity and solidarity. However, experiences of the Community countries clearly indicate that the risk management instruments (including subsidised insurance) are little used, and what is more, they do not guarantee fully the financial stability of the country. The objective of this study was to attempt to assess the risk management system existing in Polish agriculture in terms of the use of existing instruments. An analysis of statistical data has been developed based on the FADN database, covering the years 2009-2014. The analysis used the methods of descriptive statistics as well as tabular and graphic summaries.

Risk management in agriculture as part of the CAP

The existence of risk in agriculture creates a need to search for an alternative way of protecting against its occurrence and effects. Farmers deal with the risk in a different way: by appropriate shaping of the activity in their agricultural holding (diversification, avoiding risky activities, flexible shaping of crop structures) and by a strategy, in which the risk is distributed over other entities, over the entire or a part of the community (insurance, contracting, etc.) [Adamowicz, 2002].

The issues related to the risk reduction are raised at the national, EU and global levels. At each of them, various legal instruments may be applied, which, primarily, should not preclude each other. The issues of risk management in agriculture have been raised under the common agricultural policy for many years. The need to support the agricultural sector by providing relevant risk management instruments, which are adequate to the modern needs of agriculture was noticed in 2006. So far, farmers have managed the risk by means of national programmes. Pursuant to the Regulation of the European Commission of 15 December 2006, the public aid rules have been established in a form of covering losses or subsidies to insurance contributions [Regulation, 2006]. In the new perspective 2014-2020, the European Commission pays special attention to the risk management tools from the so-called 2nd pillar of the CAP, which are allocated for rebuilding the potential of the agricultural production damaged by natural disasters [Regulation of the European Parliament and of the Council (EU), 2013]. These tools include:

- indexed insurance – is applied in case of losses caused by adverse climatic events, occurrence of animal or plant diseases or pest invasion. The mechanism consists in co-financing insurance contributions paid by farmers or support for national reinsurance schemes.
- mutual investment funds – their concept is to encourage farmers to share risk. They are financial compensation to farmers for losses caused by animal or plant diseases or environmental incidents.
- income stabilisation fund – financial compensation for farmers suffering a serious decline in income. The fund guarantees basic income insurance in case of crisis situations.

In the EU countries, the most frequently applied solutions are various types of insurance, including subsidised insurance and *ad hoc* compensation coming usually from the state budget and paid at the time of a disastrous event and their amount depends on the financial possibilities of the state budget. Only few Member States introduce other solidarity instruments, i.e. mutual funds and income stabilisation funds, which is presented in Table 1.

Table 1. Risk management tools in the selected EU countries carried out within the framework of the National Rural Development Programmes (as of 1.01.2015)

Country	Insurance	Mutual funds	Income stabilisation fund
Belgium	X		
Croatia	X		
France	X	X	
Greece	X		
Hungary	X		X
Italy	X	X	X
Lithuania	X		
Malta	X		
The Netherlands	X		
Portugal	X		
Romania	X	X	

Source: own elaboration based on ee.europa.eu

The risk management instruments in agricultural holdings, as presented in Table 1, shall be financed from the resources of the 2nd pillar of the CAP. However, it should be clearly stressed that many states, including Poland, finance this type of tools from the national policy resources [Act on crop and livestock insurance..., 2005]. An overview of the risk management tools in the EU countries clearly indicates that in case of a disastrous event the most frequently used is subsidised insurance of crops and farm animals (it is most heavily subsidised in Spain and Italy). Subsidised insurance is also the most common form in countries such as the USA, Japan, Canada and Brazil. The tools to secure farmers' income are very rarely used (Hungary, Italy, outside the EU – Canada), so are mutual investment funds. Little interest in mutual funds may result from legal and financial restrictions. However, it should be noted that many states finance this type of instruments from the national policy resources, including, inter alia, the Netherlands, where mutual funds have already a long tradition. This situation results from the fact that such institutions may be formed pursuant to the general rules (provided that they exist).

The application of individual risk management tools is largely determined by the type of the risk occurring in the EU Member States. Therefore, the states, within the framework of available financial resources, assess the imminent risk on themselves and make a decision on the adoption of the most beneficial solution. The general mechanisms based on general insurance supported usually by national budgets, have been applicable in all countries of the Community since 2010. Each Member State has an opportunity to develop its own legal system governing this issue. So far, in most EU countries insurance has been general, but voluntary.

Risk management policy in Poland

Risk management in Polish agriculture has a long tradition, however, both a set of used instruments and their universality, is not satisfactory. As it results from the existing studies, it is an area which is rarely used [Florek, 2012; Śmiglak, 2007]. The most common solutions are various types of insurance and *ad hoc* aid. Another commonly used, indirect form of securing against the effects of the risk is to exempt farmers from all sorts of fees. For example, reliefs in agricultural tax, in social security contributions or preferential loans are applied. Among insurance, the most common forms of risk protection is property insurance. It covers with protection the assets in the form of goods or economic position. The object of insurance is financial interest understood as the economic value or any kind of goods protected by law [Ronka-Chmielowiec 2002, Kowalewski 1997].

The basic provisions governing the issues of compulsory insurance coverage (including, *inter alia*, crops, livestock and movable property) in agricultural holdings appeared in Poland in the 1950s. Securing farmers against the effects of weather changes by means of crop insurance was at a satisfactory level. Free market policies in agricultural insurance were introduced as late as in the 1990s, thus cancelling the obligation to insure crops, livestock and movable property, which resulted in a drastic reduction in policies in the insurance market and large non-renewable damage to agricultural holdings. In 1990, only 5,000 policies were taken out, which, when compared to 1989, meant a five-fold decrease. Not before 2005, were system solutions introduced, consisting in subsidising the contribution for crop and livestock insurance by the state so as to increase the scope of using this insurance by farmers (Crop Insurance Act, 2005).

According to the Polish legislation, some types of insurance addressed to the agricultural sector are compulsory (third-party liability insurance, motor third party liability insurance, insurance of buildings, insurance for 50% of the cultivation area and livestock – quasi compulsory) [Act on compulsory insurance, 2003], while some are voluntary (insurance of the agricultural holding's property, forest stand, perennial plantations). The largest part of the collected agricultural insurance contribution is compulsory insurance. From the FADN data analysis it results that in 2014 a fee due to the contribution for compulsory insurance of buildings was paid by 97% of individual agricultural holdings, and for third party liability insurance – 99%. Similar values also apply to paying contributions for compulsory motor insurance. Against this background, the situation in case of taking out voluntary or quasi-compulsory insurance policies is much worse. Insurance for movable property is taken out by only about 30% of farmers and 21% of farmers insure their crops (Table 2). The results of analyses carried out based on the FADN data are also confirmed by the PFSA.

Table 2. Agricultural holdings paying contributions for economic insurance (compulsory and voluntary) (%)

Type of insurance	% of all holdings
Insurance of buildings	97
Farmer's liability insurance	99
Insurance of movable property	29
Motor third party liability insurance	92
Specific crop insurance	21
Specific livestock insurance	1
Production insurance	3
Insurance of forest stand	0
Insurance of perennial plantations	1
Other insurance	8

Source: own elaboration based on the FADN data.

In Poland, the market of risk management instruments in agriculture is only at the initial phase of development. The most developed are compulsory insurance or insurance with state budget subsidies. However, similarly as in the EU Member States the scale of implementation (cultivation area covered by insurance, number of farmers taking out policies) of these instruments in the Polish market is small.

An analysis of the FADN data indicated that from among about 12 thousand holdings being the FADN database, in the years 2009-2014 contributions for crop insurance with state subsidies were paid only by about 21% of holdings (Table 3). This means that about 80% of holdings still remain uninsured, in particular very small and small holdings. The largest group of entities insuring their crops were very large holdings (from about 37% in 2009 to about 40% in 2012). Very small holdings (up to 5 ha) had virtually no crop insurance, in the total number of holdings they accounted for, on average about 2%. It is worth noting that the number of those paying contributions for crop insurance in the group of very small holdings decreased over the analysed period by about 50%. Against this background, the other groups of holdings, in which the number of those paying contributions from 2009 to 2014 remained almost unchanged, look a bit different.

Table 3. Share of holdings according to area groups paying contributions to crop insurance in the total number of agricultural holdings of the FADN (%)

Area of AL	2009	2010	2011	2012	2013	2014
Very small (<=5 ha)	2.7%	2.8%	3.1%	2.2%	1.6%	1.9%
Small (5<=10 ha)	7.9%	8.2%	8.9%	7.1%	6.8%	6.3%
Medium small (10<=20 ha)	11.8%	13.1%	12.9%	13.3%	13.8%	12.7%
Medium large (20<=30 ha)	19.3%	20.6%	19.6%	18.5%	17.8%	18.7%
Large (30<=50 ha)	24.7%	26.1%	26.3%	27.3%	28.1%	27.4%
Very large (>50 ha)	36.5%	38.5%	39.9%	40.1%	39.1%	38.9%
TOTAL	19.2%	20.7%	21.0%	21.2%	21.1%	21.0%

Source: own elaboration based on the FADN data 2009-2014.

An analysis of the data by FADN regions showed that the largest group of holdings insuring their crops are the entities located in the region of Wielkopolska and Śląsk (from about 32% to about 38%, depending on the analysed year), and then holdings from the region of Pomorze and Mazury (from about 20% to more than 23%). The smallest group are holdings

representing the region of Mazowsze and Podlasie, where only about 7-8% of the analysed entities take out insurance (Table 4). It is worth mentioning that in these regions there is the largest number of holdings engaged in the large-scale agricultural activity. This is related mainly to the production facilities in a form of good quality soils. It should be stressed that regardless of the region, the most numerous group paying contributions for crop insurance are large and very large holdings, which is shown in Fig. 1.

Table 4. Share of holdings in the agricultural regions of the FADN paying contributions to crop insurance in the total number of agricultural holdings of the FADN (%)

FADN regions	2009	2010	2011	2012	2013	2014
Pomorze and Mazury	19.9%	20.2%	21.4%	23.5%	22.6%	21.5%
Wielkopolska and Śląsk	31.9%	35.5%	35.7%	36.8%	37.6%	37.4%
Mazowsze and Podlasie	8.8%	8.7%	8.6%	7.7%	7.2%	7.2%
Małopolska and Pogórze	11.8%	13.2%	13.3%	11.8%	12.9%	13.4%
TOTAL	19.2%	20.7%	21.0%	21.2%	21.1%	21.0%

Source: own elaboration based on the FADN data 2009-2014.

In 2014, small holdings (up to 5 ha of AL) practically did not use the insurance offer. This situation looked worst in the region of Pomorze and Mazury, where no such holding paid contribution for crop insurance. However, it should be added that those holdings did not also insure (as part of compulsory insurance) their buildings, as well as did not pay contributions for farmer's liability insurance. As the area of the holding grows, interest in taking out crop insurance policies is also increasing. Most insurance policies were taken out by large and very large holdings. They most widely represented the regions of Wielkopolska and Śląsk (from 45% to 51% of households paying contributions).

Fig. 1. Share of holdings classified by their area, insuring their crops in the FADN regions in 2014

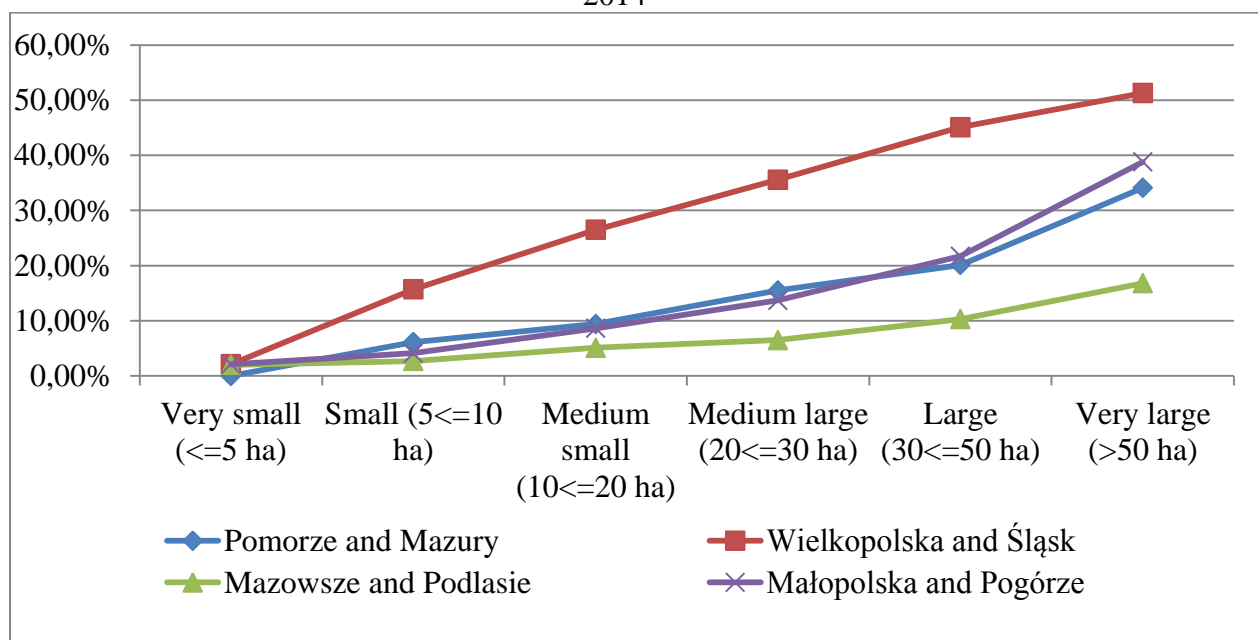

Source: own elaboration based on the FADN data 2014.

This little interest in taking out crop insurance policies results from their specific nature, requiring from an insurer specific knowledge of loss adjustment and of the agricultural industry. What is more, there are problems related to the low profitability of crop insurance, adverse selection of risk, seasonality of products and high price of insurance.

Conclusion

The studies conducted indicate that the most common financial form of securing Polish farmers against the effects of the risk in agriculture is insurance. From the risk management instruments recommended by the EC only subsidised insurance is used. Other forms of security in a form of mutual funds or income stabilisation funds are not used by farmers. Little interest in these instruments may result from legal and financial restrictions (the need for the existence of general provisions), as well as the need to reduce support for other measures within the framework of the 2nd pillar of the CAP in case of increased support for mutual funds or income stabilisation funds.

Analyses showed that the most popular form of insurance are property insurance and farmer's liability insurance, due to their compulsory nature. It turns out that the insurance obligation is so far the best form of making holdings conclude contracts securing them against the effects of risk. This is evidenced by the abolition in the 1990s of compulsory insurance of crops, which resulted in a drastic reduction in crop insurance policies (from about 25 thousand to 5 thousand).

From the analyses it results that many agricultural producers do not take out crop insurance (despite the fact that it is subsidised). Only about 21% farmers insure their crops. This situation particularly applies to small and very small holdings, especially from the region of Mazowsze and Podlasie.

The fact that farmers do not secure themselves from the effects of various types of risk may have serious consequences in the future, as the EU makes the Member States pay ad hoc aid, in case of damage to the insured, only to these farmers who have concluded contracts with an insurance company.

References

- Adamowicz M. (2002), Risk and insurance in agriculture, WULS publishing house, Warsaw.
- Śmigiel-Krajewska M. (2014). Methods to reduce the risk in agricultural holdings from the Kujawsko-Pomorskie Voivodeship. *Annals of Agricultural Economics and Rural Development*, vol.101, b. 4, Warsaw pp. 136-143.
- Cordier J. (2008). Etude des risques de marché agricole en France: cadre d'analyse, modélisation et organisation des instruments de gestion. EConseil de Prospective Européenne et Internationale pour l'Agriculture et l'Alimentation (COPEIAA), May.
- Commission Regulation (EC) No 1857/2006 of 15 December 2006 on the application of Articles 87 and 88 of the Treaty to State aid to small and medium-sized enterprises active in the production of agricultural products and amending Regulation (EC) No 70/2001. OJ L 358/3 of 16 December 2006
- Regulation of the European Parliament and of the Council (EC) No 1305/2013 of 17 December 2013. OJ L 347 of 20 December 2013, Article 36, pp. 487-548.
- Act of 7 July 2005 on crop and livestock insurance (Journal of Laws No 150, item 1249, as amended)
- Ronka-Chmielowiec W. (joint publication), Insurance. Market and risk, PWE, Warsaw 2002, p. 44
- Kowalewski E., Introduction into the theory of insurance interest [in:] Insurance in the market economy, Part 3, Oficyna Branta publishing house, Bydgoszcz 1997.
- Śmiglak M. (2007). Identification and application of market risk management methods in agricultural holdings in Wielkopolska. PhD thesis. Poznań Agricultural University.
- Florek J. (2012). Methods to reduce the risk in the cereal industry operators. *Annals of the Polish Association of Agricultural and Agribusiness Economists*. vol. 14, b. 1, pp. 159-164.
- Act of 22 May 2003 on compulsory insurance, Insurance Guarantee Fund and Polish Motor Insurers' Bureau (Journal of Laws No 124, item 1153, as amended).

ENZYMATIC PRE-TREATMENT FOR QUALITY IMPROVEMENT OF BIO-OIL FROM SUGARCANE RESIDUE

Abhishek KUMAR, Navin C.SHAHI*

G B Pant University of Agril & Tech., Pantnagar, India

Corresponding author: ncshahi2008@gmail.com

Abstract

The lingo cellulose post-harvest sugarcane residue (tops + leaves) is a good feedstock for bio-oil production after conversion of its insoluble carbohydrates, mainly cellulose, to simple sugars. Main focus of the present investigation was therefore, to reduce the lignin content and to determine the optimum conditions, for enzymatic pre-treatment of post-harvest sugarcane residue using enzyme cellulose with β -glucosidase after physical and alkaline pre-treatment.

The independent variables for enzymatic pre-treatment of sugarcane residue, time (24, 48, 72h) enzyme loading ratio (5:10, 10:10, 15:10) and substrate concentration (1.5, 2.5, 3.5% w/v) were taken into account. Designed experiments were conducted randomly to find the effect of these variables on reducing sugar, glucose concentration, lignin, ash, cellulose and hemicelluloses. Data obtained from RSM were subjected to the analysis of variance (ANOVA) and analysed using a second order polynomial equation. The reducing sugars increased with increase in time, enzyme loading ratio and substrate concentration (48h, 10:10, 2.5%) and then decreased while lignin decreased with increasing enzyme loading ratio. The reducing sugar varied from 30.1 to 39.8 g/L and glucose concentration was in range of 20.1 to 33.9 g/L while lignin varied from 7.2 to 10.3% w/w and ash ranged from 6.6 to 8.6% w/w while the cellulose ranged from 55.3 to 52.5% w/w and hemicelluloses varied from 9.2 to 6.4% w/w/ Under optimized conditions (substrate concentration 2.11% w/v, time 64.56 h and enzyme loading ratio of 15:10).

Keywords: Sugarcane residue, lignin, ash, cellulose and enzyme loading

Introduction

Biomass which is third largest global source of energy in world could be one of suitable renewable resource to solve this problem (Hyeonet *et al.* 2010). Biomass is an abundant renewable source from which fuels can be obtained in relatively short span, reliable and eco-friendly manner (Roedl, 2010). It provides energy efficient fuels in the form of bioethanol and bio-diesel which makes up first generation biofuels. Bio-oils are obtained through a single step thermo-chemical conversion of nearly all kinds of wood biomass into a chemically complex liquid product. An estimated increase of nearly four to seven folds in energy density is readily achieved during this process termed pyrolysis (Badger *et al.*, 2006). During past three decades, researchers across the globe have emphasized upon evolving bio-oils as a potential substitute of petroleum (Czerniket *et al.*, 2004). Considerable efforts are being continuously put in to develop upgrading strategies to transform it to engine fuel applications. Bio-oils are often termed 'clean' compared to fossil fuels since they offer several ecological benefits (Mohan *et al.*, 2006).

Extensive research in this area reveals a high level of diversity in selecting biomass comprising agricultural and forest scrap such as barley straw and hulls, rice husk, wheat straw, corn (stalks, leaves and husks), coconut and peanut shells, fruit bunches and pulps, waste furniture and wood (eucalyptus, pine etc.), forage crops, tea waste, bagasse, sewage sludge, swine manure and many more. Another important sugarcane residue is the leaves, which are usually left in agricultural fields during sugarcane harvesting. Sugarcane leaves

consists of cellulose (35.2% dry weight) and hemicellulose (23.4% dry weight) in close association with lignin (12.6% dry weight), is one of the most abundant lignocellulosic crop residues (Teerapatret al. 2013). Sugarcane is the world's largest crop by production quantity. In 2012, FAO estimates it was cultivated on about 26.0 million hectares, in more than 90 countries, with a worldwide harvest of 1.83 billion tons. India's annual sugarcane production in 2013-14 was estimated about 352.14 million tons from 50.12 lakh hectares area with a yield of 69.84 tonnes/hactares (Source: Directorate of Food & Public Distribution and Agricultural Statistics). Sugarcane production in Uttarakhand in 2012-13 was estimated to about 6.72 million tonnes from 1.10 lakh hectare area (Source: Department of Agriculture and Cooperation). Sugarcane shoots and leaves obtained after harvesting the crop, are used neither as animal feed (because of the rough texture of them), nor as fuel. Generally, leaves are burnt in the fields, which produce fly ash, severely damages soil microbial diversity, and raise environmental concerns. (F.A.O., 2014). It is a cost-effective way to remove the fibrous content of sugarcane residue from field. (Boopathyet al. 2002). These leaves can be used for bio-oil production.

The main objective of this research was to remove lignin chemically and enzymatically in sugarcane residue to improve the bio-oil quality. The usage of alkaline chemical in the pre-treatment of sugarcane leaves and enzymatic hydrolysis to degrade lignocelluloses biomass and saccharification of cellulose is expected to alter the original biomass structure. In view of the above, this study was focus on effect of alkali treatment on sugarcane residues after drying and physical treatment. These data are required to optimize the enzymatic treatment for saccharification and prepare bio-oil after pyrolysis of untreated and treated sugarcane residues.

Materials and methods

Preparation of sugarcane residue

Dry leaves and tops of sugarcane (*Saccharum officinarum* Linn) also called postharvest sugarcane residue were collected in the month of February, 2015 from the field at the harvest of the sugarcane crop growing at the farm of C.R.C. (Crop Research Center), G. B. Pant University of Agriculture & Technology, Pantnagar, India located at 29° N, 79° E and 243.8 m above the sea level. The residues were washed in running water to remove the dust, the foreign particles and air dried treatments. The dried residue was subjected to size reduction process in hammer mill. The mesh size being used was of 2 mm size. The size reduction process was done for increasing the surface area of residue for alkaline treatment process. The milled residues was analysed for its proximate (moisture content, ash, volatile matter and fixed carbon) and chemical composition (cellulose, hemicellulose, lignin and ash).

Alkali pre-treatment

The alkali pre-treatment was used for reduction of lignin content in the sample. The alkali pre-treated samples were used for enzymatic saccharification. The sugarcane residues were treated with 2% (w/v) NaOH solution and autoclaved at 121 °C on 15 psi for 15 minutes. The treated sugarcane residues were washed with water to obtain neutral pH and then oven dried at 80 °C for 24 hours

Enzymatic saccharification

The experiments designed by Design-Expert software included 17 experiments. The enzymatic saccharification process was based on independent parameters. The parameters of process was introduced in software are in numeric forms varied over 3 levels.

Thus here, designs were in format of Box-Behnken design of response surface methodology. Various experiments were conducted in accordance to the ratio included in the RSM with Run time analysis.

Preliminary trials were conducted for subjection of enzymes to the pre-treated sugarcane residues. During the process, Cellulase + β -glucosidase, Cellulase and β -glucosidase enzymes are used at 37.5, 40 and 35 °C respectively. The objective of this experiment was to examine the effects of one step enzyme addition and two step enzyme addition during saccharification process.

Experimental Design

Experimental design, defined as a specific set of experiments which were defined by a matrix, a matrix composed by the different level of combination variables. Response surface methodology (RSM) was used for the design and analysis of all experiments for three predicted variables at three levels. It also helps to reduce the number of experiments without affecting the accuracy of results and to decide the interactive effects of influencing factors on the response. Box-Behnken model was selected for the optimization of the process variables (Sharma et al. 2014). Box-Behnken is a class of rotatable second order design based on three levels incomplete factorial design. This design does not contain for which all factors are simultaneously at their highest and lowest levels. So this design is useful in avoiding experiments performed under extreme conditions for which unsatisfactory results might occur (Bezera et al. 2008).

The number of experiments (N) required for development of Box-Behnken Design. This design is defined as:

$$N=2K(K-1)+C_0$$

Where,

N= Total no. of experiments

K = No. of variables

C₀= Centre point

In order to determine a critical point (maximum, minimum or saddle) it is necessary for the polynomial function to contain the quadratic terms. According to the equation presented below:

$$y = \beta_0 + \sum_{k=1}^K \beta_i X_i + \sum_{k=1}^K \beta_{ii} X_i^2 + \sum_{k=1 < i < j} \beta_{ij} X_i X_j$$

Where,

β_{ii} , β_0 and β_{ij} are the coefficients of regression. (i=1, 2, 3,n) (j=1, 2, 3,n)

Values of level of independent variables

Independent variables	Values		
	-1	0	+1
Reaction time (hrs)	24	48	72
Cellulase- β -Glucosidase enzyme ratio (FPU:IU)	5:10	10:10	15:10
Substrate concentration (% w/v)	1.5	2.5	3.5

The constant variables were as under Temperature 37.5 °C, pH 4.8 and Buffer concentration 0.1 M.

Experimental procedure

The whole experiment was conducted in three phases. Experiments were planned with a view to develop pre-treated, enzymatically treated sugarcane residue, which could be a better method for bio-oil extraction by pyrolysis. In the first phase experiments were carried out by already optimised pre-treated conditions for sugarcane residues for maximum breakdown of lignin (Teerapatret al. 2013). Sugarcane residue (2mm mesh size) was taken in 25 gram quantity and alkali treated with 2% w/v NaOH and autoclaved at 121°C on 15psi for 15 min. The samples were analysed for its proximate (moisture content, ash, volatile matter and fixed carbon) and chemical composition (cellulose, hemicellulose, lignin and ash).

During the second phase, enzymatic treatment was carried out and the independent variables (reaction time, enzyme ratio, substrate concentration) were optimised for release of reducing sugar. These samples were also analysed for proximate parameters. During the third phase, pyrolysis was carried out by fast pyrolysis reactor for the extraction of bio-oil.

The following dependent variables were considered to check the quality of end product. Samples used for compositional analysis were prepared accordingly:

Reducing sugars

The total reducing sugars were estimated by DNS method, modified according to National Renewable Energy Laboratory, USA.

Glucose concentration

The glucose concentration was estimated using glucose estimation kit.

Cellulose estimation

The filtrate from the H₂SO₄ treatment that contained the sugars released from cellulose and hemicellulose was thoroughly stirred and homogenized. Glucose (C1) and reducing sugar (C2) concentrations in the filtrate were determined according to a glucose oxidase–peroxidase assay kit (Autospan, India) and the DNS method (Miller, 1959), respectively.

Following these measurements, the cellulose content in the starting material was calculated using the following equation:

$$\% \text{ w/w cellulose content} = (0.9/0.96) \times C1 \times (V/M) \times \alpha \times 100$$

Where 0.9 is the coefficient that results from the molecular weight ratio of the polymer and the monomer hexose. The saccharification yield was taken as 0.96, C1 as the glucose concentration (g/L), V the total volume of sugar solution (L), M the dry weight of the sugarcane residue sample (g) and α the dilution of the sample (Ververiset al. 2007).

Bio-oil extraction

Bio-oil from both untreated and treated sugarcane residue was prepared at Central Institute of Agricultural Engineering, Bhopal, Madhya Pradesh, India. 1 kg each of untreated and treated sugarcane residue was taken for the pyrolysis process. Conventional pyrolysis of each sample was carried out at 500°C temperature for 30 minutes of time (Plate 3.7). The gases were condensed as it passed through the water jacket and the pyrolysis liquid was collected (Plate 3.8). Two samples of Bio-oil were collected and they were evaluated for different properties viz: Kinematic viscosity, Dynamic viscosity, Relative density and Flash and fire point.

Results and discussion

Experiments were conducted for optimizing enzymatic treatment of postharvest sugarcane residue (sugarcane tops + leaves). Enzymatic treatment characteristic responses of post-harvest sugarcane residues were determined in terms of reducing sugars, glucose concentration, and cellulose.

Characterization of Treated and Untreated Post-harvest Sugarcane Residue

The proximate analysis of sugarcane residue showed that the raw materials contain higher percentage of volatile matter and less amount of moisture and ash content. The results showed that the raw material have potential for sugar production by conversion from their cellulose

Proximate analysis of untreated and treated Sugarcane residue

Raw material	Moisture (Wt. %)	Volatile matter (wt. %)	Ash (wt. %)	Fixed Carbon (wt. %)
Untreated sugarcane residue	8.4	72.6	8.1	10.9
2% w/v NaOH treated sugarcane residue	7	80.73	7.24	5.03

The moisture of biomass has a marked effect on the conversion efficiency and heating value. Higher moisture of biomass has a more tendency to decompose resulting in energy loss during storage. Volatile matter evolves in the form of gas, light, hydrocarbon and tars. Volatile matter of the biomass is higher than the coal (around 75%). Higher volatile matter of the biomass makes it more readily devolatilized than solid fuel. Liberating less fixed carbon hence makes them more useful for pyrolysis and gasification (Pitarelo, 2007). Ash content and moisture content affect the heating value. The ash content in the bio mass is an integral part of plant structure which consists of a wide range of mineral matter such as salt of calcium, potassium, silica and magnesium. Ash content depends upon the plant and soil condition in which the plant grows (Sila, 2014). The values of ash content were lower in untreated raw material than the reported by Pitarelo, 2007. This difference could be due to the varietal difference or soil condition of the sugarcane crop.

Effect of Alkaline Treatment on Sugarcane Residue:

The sugarcane residues were alkali treated which reduced 48.97% of the total weight of the sample. The lignin in the sample initially was 19.2 % which is reduced after pre-treatment to about 9.5 %. So revealed that, pre-treatment is removes half of the lignin in the sample. It has also reported by that the digestibility of NaOH-treated hardwood increased from 14% to 55% with a decrease of lignin content from 24-55% to 20% (Millet et al. 1976).

Chemical compositions of untreated and treated sugarcane residue

Treatment with 2% NaOH solution reduced lignin to 9.5 wt. % in sugarcane residue. The amount of cellulose was higher compared to hemicellulose (8.8 wt %) and lignin content (9.5 wt %). These findings were found close to the composition determined by Pitarelo, 2007. The cellulose, hemicellulose and lignin was determined as 34.4, 28.4 and 20.7 respectively. This difference could be due to the varietal difference of the sugarcane crop and environmental factors.

Table 1. Chemical composition of untreated and treated Sugarcane residue

Raw material	Hemicellulosewt%	Cellulose wt%	Ligninwt%
Untreated sugarcane residue	28.3	36.1	19.2
2% w/v NaOH treated sugarcane residue	8.8	57.2	9.5

Effect of Independent Variables on Various Responses

Effects of independent variables i.e. time, enzyme loading ratio and substrate concentration on responses viz. reducing sugar, glucose concentration, and cellulose was determined and statistically analysed.

Reducing Sugar

Experimental data shows that in case of enzymatic pre-treatment, the reducing sugar ranged from 30.1 to 40.2 g/L. Maximum reducing sugar was found 39.8 g/L for experiment number 17, with the combination of time 48 hours, enzyme loading ratio 10:10 and substrate concentration 2.5% w/v. Minimum reducing sugar was found 30.1 g/L for experiment number 3, at time 48 hours, enzyme loading ratio 5:10 and substrate concentration 1.5% w/v. The enzyme loading ratio and substrate concentration had a clear effect on the amount of reducing sugar. Similar results were also obtained by **Teerapatret *al.* (2013)**. Maximum reducing sugars released in the experiments having the centre values of enzyme loading ratio and substrate concentration and 48 hours of reaction time. The reducing sugar profile from NaOH pre-treatment of sugarcane shoots and leaves after enzymatic saccharification was higher than an unwashed pre-treated solid residue. The results showed that washing of solid residue could improve enzymatic saccharification.

Numerical analysis of reducing sugar

Second order regression was fitted into the reducing sugar data and the results of the regression analysis are reported. The model was checked using a numerical method employing the coefficient of determination R^2 , adjusted R^2 , LOF and then calculated as shown in equation (4.1), R^2 indicates how much of the observed variability in the data was accounted by the model. The response surface model was developed with values of R^2 higher than 90% and the goodness of fit of model was high showing high R^2 (0.9835) for reducing sugar, with least residual error (0.99) in the fitted quadratic model. Furthermore, R^2 -adj (0.9632) value relatively satisfactory adjustment of the quadratic model to the experimental data also indicates the best fit of the model.

Predicted regression equation having significant terms given below

$$\text{Reducing sugar} = 39.74 + 1.01 X_1 + 1.45X_2 + 0.66X_3 + 1.50X_1X_2 + 0.80X_2X_3 - 2.81 X_1^2 - 2.93X_2^2 - 4.66 X_3^2$$

Where,

The predicted variables of the model are response variable; X_1 , time; X_2 , enzyme loading ratio; X_3 , substrate concentration. In eqn, the coefficients with one factor i.e. the ones in front X_1X_3 , X_1X_2 , X_2X_3 and those with second order terms i.e. X_1^2 , X_2^2 and X_3^2 represents the interaction between two factors and the quadratic effects, respectively the positive in front of the terms indicates a synergistic effect while the negative shows the antagonistic effect.

The model was found significant ($p < 0.01$). The highest effect of substrate concentration on reducing sugar was observed and highly significant ($p < 0.01$) because it had high calculated F-value (46.34) than tabulated F-value (6.71). The effect of enzyme loading ratio followed by time was also found significant ($p < 0.01$). It was clear that time, enzyme loading ratio and substrate concentration increased the reducing sugar of the material.

Glucose Concentration

The glucose content ranged from 20.1 to 33.9g/L. Maximum glucose content was found 33.9 g/L for experiment number 17, at time 48 hours, enzyme loading ratio 10:10 and substrate concentration 2.5% w/v. Minimum glucose content was observed 20.1 g/L for experiment number 2, having time 24 hours, enzyme loading ratio 10:10 and substrate concentration 1.5% w/v. The reaction time and substrate concentration has a clear effect on the amount of glucose concentration. Similar results were also obtained by Teerapatret al. (2013). Maximum glucose released in the experiments having the centre values of enzyme loading ratio and substrate concentration and 48 hours of reaction time. The glucose concentration profile from NaOH pre-treatment of sugarcane shoots and leaves after enzymatic saccharification was higher than an unwashed pre-treated solid residue. The results showed that washing of solid residue could improve enzymatic saccharification.

The statistical analysis of glucose concentration was given. The model of glucose concentration was found highly significant ($P < 0.01$) because it had higher Fvalue (20.44). It was also observed that the effect of predicted variables on glucose concentration was highest at quadratic level due to highest calculated F-value (45.150) followed by linear level and interactive level. The model was highly significant

Numerical analysis of glucose concentration

Second order mathematical model was fitted into the glucose concentration data and the results of the regression analysis are reported. The model was checked using a numerical method employing the coefficient of determination R^2 , adjusted R^2 , LOF and then calculated as shown in equation (4.1), R^2 indicates how much of the observed variability in the data was accounted by the model. The response surface model was developed with values of R^2 higher than 90% and here the goodness of fit of model was high showing high R^2 (0.9633) for glucose concentration, with least residual error (1.93) in the fitted quadratic model. Furthermore, R^2 -adj (0.9162) value relatively satisfactory adjustment of the quadratic model to the experimental data also indicates the best fit of the model.

Predicted regression equation having significant terms is given below

$$\text{Glucose concentration (Y)} = 31.98 + 1.26 X_1 + 1.22X_2 + 1.90X_1X_2 + 2.35X_2X_3 - 4.25X_1^2 - 3.03X_2^2 - 5.90X_3^2$$

Positive coefficient of the model at the linear level indicates an increase in responses with increase in regressor of its influencing factors and vice versa. Positive quadratic terms give the minimum response at the centre. While negative quadratic terms give the maximum response at the centre. The negative interaction suggested that the regressor of one variable of the interaction can be increased while the other decreased to get the same response. At linear level X_1 , X_2 and X_3 , at interactive level X_1X_2 , X_2X_3 and at quadratic level X_1^2 , X_2^2 and X_3^2 are highly significant with the value ($p < 0.01$) showed. While the effect of predicted variables at interactive level X_1X_3 was not significant.

Cellulose

The cellulose content ranged from 52.5 to 55.3% w/w in case of enzymatic pretreatment. Maximum cellulose was found 55.3% w/w for experiment number 3, at time 48 hours, enzyme loading ratio 5:10 and substrate concentration 1.5% w/w. Minimum cellulose was found 52.5% w/w for experiment number 10, at time 48 hours, enzyme loading ratio 15:10 and substrate concentration 3.5 % w/w. These findings are close to the results found by Chandelet al. 2011 showed the cellulose conversion into sugars increases with the increase in enzyme loading ratio. More amounts of enzymes hydrolysed the cellulose efficiently.

The model of cellulose was found highly significant ($P < 0.01$) because it had higher F-value (10.62). It was also observed that the effect of predicted variables on cellulose was highest at linear level due to highest calculated F-value (23.77) followed by quadratic and interactive level. The model was highly significant.

Numerical analysis of cellulose

The model was checked using a numerical method employing the coefficient of determination R^2 , adjusted R^2 , LOF and then calculated as shown in equation (4.1), R^2 indicates how much of the observed variability in the data was accounted by the model. The response surface model was developed with values of R^2 higher than 90% and here the goodness of fit of model was high showing high R^2 (0.9318) for cellulose, with least residual error (0.32) in the fitted quadratic model. Furthermore, R^2 -adj (0.8440) value relatively satisfactory adjustment of the quadratic model to the experimental data also indicates the best fit of the model.

Predicted regression equation having significant terms is given below

$$\text{Cellulose} = 54.68 - 0.54 X_1 + 0.96X_2 - 0.35X_3 - 0.77 X_2^2$$

Positive coefficient of the model at the linear level indicate an increase in responses with increase in regressor of its influencing factors and vice versa. Positive quadratic terms give the minimum response at the centre. While negative quadratic terms give the maximum response at the centre. The negative interaction suggested that the regressor of one variable of the interaction can be increased while the other decreased to get the same response. At linear level X_1 , X_2 and X_3 and at quadratic level X_2^2 was highly significant with the value ($p < 0.01$). While the effect of predicted variables at interactive level X_1X_3 , X_1X_2 , X_2X_3 , X_1^2 , X_3^2 were not significant.

Optimization of Experimental Parameters

The experimental values of enzymatic pre-treatment of all samples are reported. Results of regression analysis are given. Numerical optimisation was carried using Design-Expert 8.0.7.1 statistical software. The individual goals for different predicted factors

Table 2. Constraints for optimization of variables for enzymatic pre-treatment

Factors	Goal	Lower limit	Upper limit
Time (X_1 , h)	In range	-1	1
Enzyme loading ratio (X_2)	In range	-1	1
Substrate concentration (X_3 , %, w/v)	In range	-1	1
Reducing sugar (g/L)	Maximize	30.1	40.2
Glucose concentration (g/L)	Maximize	20.1	33.9
Lignin (% , w/w)	Minimize	7.2	10.3
Ash (% , w/w)	Minimize	6.6	8.6
Cellulose (% , w/w)	Minimize	52.5	55.3
Hemicellulose (% , w/w)	Minimize	6.4	9.2

Recovery of Bio-oil

Bio-oil obtained from both untreated and treated sugarcane residue (Plate 4.1) after pyrolysis was collected. The bio-oil from untreated and treated sugarcane residue yielded 24.6 % and 25.2% respectively

Evaluation of Properties of Bio-oil from Sugarcane Residue

The properties such kinematic viscosity, dynamic viscosity, density, relative density, flash and fire point, pH and moisture content were measured for untreated and treated bio-oil to compare their properties with diesel fuel.

Table 3.Characteristic properties of diesel, bio-oil from untreated and treated sugarcane residue

Sl.No.	Property	Diesel	Bio-oil from untreated sugarcane residue	Bio-oil from treated sugarcane residue
1	Kinematic Viscosity (cSt)	4.12	0.31	0.64
2	Dynamic viscosity (cSt)	3.35	0.313	0.68
3	Density (g/ml)	0.812	1.013	1.039
4	Relative density (g/ml)	0.826	1.031	1.058
5	Flash point (°C)	61	69	95
6	Fire point (°C)	65	72	97
7	Moisture content (wt %)	0.05	29.9	27.8
8	pH	5.6	3.3	2.9

The kinematic and dynamic viscosity at 38°C of diesel, bio-oil from untreated and treated sugarcane residue in terms of centistokes is presented in Table. Bio-oil from treated sample recorded viscosity more close to viscosity of diesel fuel. It may be due to the presence of higher oil percentage in the bio-oil from treated sugarcane residue. Table also shows the relative density of diesel, bio-oil from untreated and treated sugarcane residue at 15°C. Oil from treated sugarcane residue found to have density more near to the diesel fuel than the untreated sugarcane residue. Fuel density increases with increasing molecular weight of the fuel molecules. Similar kind of results for relative density was 2.31 cSt.

The flash and fire point of diesel was found as 61 and 65°C. The bio-oil from untreated and treated sugarcane residue had flash point as 69, 95°C and fire point as 72, 97°C respectively. The flash and fire point of both oils were found more as compared to diesel fuel. Similar kind of results for fire point of diesel reported by Patil (2008) and Admuthe (2009) is 62 and 65°C respectively. Dinesh et al. (2006) reported flash and fire points of bio-oil as 92 and 97°C.

Conclusion

The present study was aimed at removal of lignin and saccharification of sugarcane residue for quality improvement of bio-oil. In the proposed work, lignin removal was achieved nearly up to 50% and saccharification resulted in high yields of reducing sugar. Experiments were planned and carried out on size reduced and alkali pre-treated sugarcane residue. The best suited sets of experiments were used to optimise the process. Physical treatment to the sugarcane residue in hammer mill reduced the size up to 2 mm which broke down the crystallinity of the cell structure making the substrate more accessible for chemical and enzymatic treatments. Alkaline treatment with 2% w/v NaOH at 121°C, 15 psi for 15 minutes resulted in weight loss of the substrate. It reduced 48.97% of the total weight of the sample. The lignin in the sample initially was 19.2% which is reduced after pre-treatment to about 9.5%. Nearly half of the amount of lignin is reduced. Reducing sugar yields describe its effects from all three independent variables. Moreover interactive effects were also seen in both numerical and graphical analysis.

Glucose concentration also showed similar results as in cases of reducing sugar with depending on all three independent variables. Maximum reducing sugar was found 40.2 g/L for experiment number 8, with the combination of time 48 hours, enzyme loading ratio 10:10 and substrate concentration 2.5% w/v.

Bio-oil is prepared from both untreated and treated post-harvest sugarcane residue by employing conventional pyrolysis process carried out at 500°C temperature and for 30 minutes of time. Both samples of bio-oil was evaluated for different properties.

From the preceding discussion, it may be concluded that the chemical and the enzymatic treatments used have significant effect on the bio-oil quality as the bio-oil from treated sugarcane residue found having fuel properties more close to diesel fuel as compared to the bio-oil from untreated sugarcane residue.

References

- Admuthe, S.S. 2009. Performance of multicylinder CI engine on methyl ester of karanja oil-ethanol blends. Unpublished Thesis, M.Tech. Department of Farm Machinery and Power Engineering, G.B. Pant University of Agriculture and Technology, Pantnagar, India.
- Badger P.C., P. Fransham (2006), Use of mobile fast pyrolysis plants to densify biomass and reduce biomass handling costs-a preliminary assessment, *Biomass Bioenerg.* 30 321–325.
- Bezerra M.A., Santelli E.R., Oliviera P.E., Villar L.S. and Escaliera A.E. (2008) RSM as a volumetric tool for optimization in analytical chemistry. *Talanta*, 76:965977
- Boopathy, R., Asrabadi, B.R., Ferguson, T.G., (2002). Sugar cane (*Saccharum officinarum* L.) burning and asthma in southeast Louisiana, USA. *Bulletin of Environmental Contamination and Toxicology* 68, 173–179.
- Chandel A.K., Silvio Silverio da Silva and Om V. Singh, (2011), Detoxification of lignocellulosic hydrolysates for improved bioethanol production, ISBN: 978-953307-478-8, In Tech
- Czernik S., A.V. Bridgewater (2004), Overview of applications of biomass fast pyrolysis oil, *Energy Fuels* 18 590–598.
- Hyeon Su Heo, Hyun Ju Park, Jong-In Dong and Sung Hoon Park (2010), — Fast pyrolysis of rice husk under different reaction conditions ||, 16, 27-31.
- Miller GL. (1959). Use of dinitrosalicylic acid reagent for determination of reducing sugars. *Analytical Chemistry*. 31:426–428.
- Millet, M. A.; Baker, A. J.; Scatter, L. D. (1976) Physical and chemical pretreatment for enhancing cellulose saccharification. *Biotech. Bioeng. Symp.*, 6, 125–153.
- Mohan D, Pittman Jr CU, Steele PH. (2006), Pyrolysis of wood biomass for bio-oil: a critical review. *Energy Fuels*; 20: 848–89.
- Patil, R.P. 2008. The effects of methyl ester of rice bran oil-ethanol blends on performance and emission characteristics of multicylinder CI engine. Unpublished Thesis, M.Tech. Department of Farm Machinery and Power Engineering, G.B. Pant University of Agriculture and Technology, Pantnagar, India.
- Pitarelo A. P., Avaliac (2007), Evaluation of susceptibility of sugarcane bagasse and straw on the bioconversion by steam explosion and enzymatic hydrolysis M.S. thesis, Federal University of Paran´a, Paran´a, Brazil.
- Roedl A. (2010), Production and energetic utilization of wood from short rotation coppice – a life cycle assessment, *Int. J. Life Cycle Assess.* 15 567–578.
- Sharma, L., Grover, H.K., Bharadwaj, M. and Kaushal, I. 2014. Comparison of Engine Performance of Mixed Jatropha and Cottonseed Derived Biodiesel Blends with Conventional Diesel. *International Journal on Emerging Technologies*. 3(1): 29-32

- Silla, (2014).Pre-treatment of Rice husk with acid and base for its effect on Pyrolysis Products. Unpublished Thesis, Department of chemical engineering, National Institute of Technology, Rourkela, India
- TeerapatrSrinorakutara, SuthkamolSuttikul and NassapatBoonvitthya, (2013).Effect of Different Pre-treatment Methods on Enzymatic Saccharification and Ethanol Production from Sugarcane Shoots and Leaves.Journal of Food Science and Engineering 3 (2013) 309-316
- Ververis C, K. Georghiou, D. Danielidis, D.G. Hatzinikolaou, P. Santas, R. Santas c, V. Corleti (2007) Cellulose, hemicelluloses, lignin and ash content of some organic materials and their suitability for use as paper pulp supplements, Bioresource Technology 98;296–301

AGRICULTURAL ADVISORY SERVICES AS A FACTOR OF ECONOMIC DEVELOPMENT OF AGRICULTURE IN NORTH KOSOVO

Tatjana IVANOVIĆ*, Goran MAKSIMOVIĆ

University of Pristina, Faculty of Agriculture, Lešak, Serbia

*Corresponding author: tatjana.ivanovic@pr.ac.rs

Abstract

The best way to implement scientific achievements in agricultural production in practice on country farms is through the Agricultural Extension Service. The main objective of the Agricultural Extension Service is education and training of farmers to improve production and other economic indicators on the farm. In Serbia there is state organized and financed Agricultural Extension Service and this advisory model is currently in accordance with the socio-economic conditions due to the fact that agriculture in Serbia is almost entirely organized on the family farms. The authors analyze the current state of Agricultural Extension Service in Serbia by the method of descriptive statistics. Particularly they analyzed the work of Agricultural Extension Service in the north of Kosovo. To assess the overall situation of Agricultural Extension Service in Serbia was used the available statistical data, and to analyze the work of the *Agricultural Extension Service Kosovska Mitrovica*, data of this institution was used. Agricultural advisory and professional services of the Republic of Serbia today number 34 with 251 advisors; 22 departments and 166 advisors on the territory of central Serbia and 12 departments and 85 advisors in the area of Autonomous Province (AP) of Vojvodina. In the area of northern Kosovo, Agricultural Extension Service encourages the development of agriculture and improves the economic effects on the farm, contributing to the education of farmers and the need is to involve as many farmers as possible.

Keywords: *advisors, Agricultural Extension Service, economic development*

Introduction

Objective of this paper is to determine the status of Agricultural Extension Service in Serbia and analyze the work of these services in the north of Kosovo.

Agricultural Advisory Services (or Agricultural Extension Services) deal with the application of scientific and professional achievements in agriculture and transfer of knowledge into immediate practice (Novković and Šomođi, 2001). Agricultural Advisory Service is one of the organizational development actions of agricultural policy and strengthens the connections between advisory agents, farmers, researchers and should be in line with the strategy of development of agrarian policy.

Improving the Extension Service of our country is very important, especially because agriculture has long been in a precarious position, as much as 85% of the Republic of Serbia consists of rural areas. It is therefore of particular importance to strengthen extension services and their role in rural development of Serbia and linking relevant institutions and agricultural producers in these areas. In the area of northern Kosovo advisory services should encourage the development of agriculture and improve the economic effects on the farm, education of farmers, production of healthy food and many other activities that should contribute to the further development of this area.

Materials and methods

The authors use the method of descriptive statistics to perceive the current state of agricultural extension in Serbia. They analyze the work of agricultural extension services *Kosovska Mitrovica* in northern Kosovo and the role of these services in the development of agriculture

in this region. To assess the overall situation of agricultural advisory services in Serbia they use the available statistical data, and for analyzing the work of the *Agriculture Extension Services Kosovska Mitrovica* (AES-KM) data of this institution were used.

Results and Discussion

The law about the provision of advisory and professional activities in the field of agriculture was published in the "Official Gazette of the Republic of Serbia" No. 30/10 dated on 07.05.2010. It deals with many issues relating to agricultural extension. In addition, for the development of agricultural advisory services in the territory of the Republic of Serbia is relevant also the "Strategy of development of agricultural extension services in Serbia" which was created in 2009 as part of a joint project of the Ministry of Agriculture, Forestry and Water Management (MAFWM), the International Bank for Reconstruction and Development (World Bank) IBRD/WB and the Global environment Facility (GEF).

Agricultural advisory and professional services of the Republic of Serbia today number 34 advisory services and 251 advisors of which 22 departments and 166 advisors in central Serbia and 12 departments and 85 advisers in the Autonomous Province (AP) of Vojvodina. In Serbia, the present service is state organized and financed by AES (Agriculture Extension Service), although there are a number of farmers ready to pay the advisory services they need. At national level, the Ministry of Agriculture has the role of supervision and control of agricultural advisory services, as well as the role of providing the funds for the activities of agricultural advisory services. The Institute for Science Application in Agriculture (ISAA) role is to coordinate, control and evaluate of the work of consultants. Current number of advisers is less than the number of advisors who was in service in 2002 (cf. 326), when suddenly there was an outflow of advisers as a result of the unfavorable economic situation in the period 1997-2002 (Ševarlić, 2003). Petrović and Janković (2010) monitored the situation in Serbian Agricultural extension service and according to survey data from 2008, in the AES of the Republic of Serbia were engaged a total number of 206 advisors (134 in central Serbia and 72 advisors from Vojvodina). Today's state of extension service in the Republic of Serbia - compared with about 310 people who are engaged in extension service in Republic of Slovenia, whose arable land and the number of producers, as well as the overall importance of agriculture for the country is much lower than is the case in Serbia - suggests at what level is our extension service. In Croatia, the situation is similar to the situation in our country (Petrović and Janković, 2010).

Gender structure of advisers in the territory of the Republic of Serbia shows that men are more than 60% of total number of advisors and it means more than 150 advisors are men compared to women whose representation in advisory work is 40% or 101 advisors. This is situation in central Serbia and Vojvodina, which means that men are generally more present as advisers.

On the territory of the Republic of Serbia prevail advisory experts in farming and vegetable growing, then come advisers in the field of animal husbandry and finally advisers in the field of plant protection. In the structure of consultants by specialty is important that there are no specialists for agricultural machinery, and their number in 2002 was 8, in relation with total number of 326 advisors in that year (Ševarlić, 2003). The lack of specialists for agricultural machinery is same on the territory of central Serbia and Vojvodina.

Table 1. Structure of consultants by specialty on the territory of the Republic of Serbia

Specialty advisory	Number of advisors	%
Animal husbandry	61	24
Field and veget. production	67	27
Fruit growing and viticulture	39	16
Plant protection	46	18
Agro-economics	15	6
Land reclamation	7	3
Other	16	6
Total	251	100

Source: Agricultural advisory and professional services of the Republic of Serbia - ISAA, 2014.

So that agricultural extension service in the future could transmit modern solutions in agriculture it must provide a sufficient number of appropriate staff profiles that will fulfill all the tasks that their work organization and development department imposed. It must also work to increase the number of farms involved in the advisory process. Agriculture Census of 2012 shows that from registered 631,552 households in extension work are included 41500 households, of which part consists of selected households (4000 in central Serbia and 2500 in Vojvodina) and other farms that are included in the advisory system in other ways, mainly through participation in group sessions and through occasional visits to farms. This type of training covered 25,000 households in central Serbia and 10,000 in Vojvodina (Strategy of Agriculture and Rural Development of the Republic of Serbia 2014-2024, MAFWM, 2013). Agricultural Advisory Service "Kosovska Mitrovica" Ltd. was founded on 04.05.1996 and its founder is of MAFWM (Ministry of Agriculture, Forestry and Water Management). AES *Kosovska Mitrovica* work in premises that they received on 01.01.2009 from the municipality of Kosovska Mitrovica in its northern part, because after the bombing in 1999 there were no suitable premises. All premises and equipment for the work of service remained in the southern part of *Kosovska Mitrovica*. AES *Kosovska Mitrovica* conducted advisory work in agriculture in the area which includes the municipalities of Leposavic, Zvecan, Kosovska Mitrovica, Zubin Potok and enclaves in the municipalities of Vucitrn and Srbica. The total area that contains these municipalities covers an agricultural area of 58890 hectares, has 180 villages, 7864 farms in which live 61000 residents. The work of this advisory service is carried out in difficult conditions, field visits is linked with security risk and data are collected mainly from the bigger farms in the larger towns of the enclaves, as well as in visits of villages in the northern part Kosovo.

Data of the area of operation, agricultural land, arable and cultivated land are given in the table below.

Table 2. Data on the area of operation of the *AES Kosovska Mitrovica*

Municipality	Agricultural land in ha	Area of arable land in ha	Area non-arable land in ha
Kosov. Mitrovica	2150	540	1610
Vucitrn (enclave)	9442	5247	4168
Srbica (enclave)	5692	303	5389
Zubin Potok	11175	4106	7069
Zvecan	7446	2077	5369
Leposavic	22985	6754	16231
Total	58890	19054	39836

Source: *AES Kosovska Mitrovica* – Work program, Year 2014

In the implementation of the Annual program of advisory services in agriculture, are engaged 4 advisory experts – advisors, 2 specialists for field and vegetable producing, one of them has a specialization in plant protection, one in animal husbandry and one in viticulture. In *Kosovska Mitrovica AES* there are two women and two men of four advisors employed. Therefore, gender structure is 50% to 50%.

Intensity of agricultural extension in *Kosovska Mitrovica AES* is displayed in the following table.

Table 3. Indicators of intensity of extension in *AES Kosovska Mitrovica* - average

Area of arable land in ha	Number of farms	The number of employed advisers	The average arable land (in ha) per advisor	Number of farms per adviser
19054	7864	4	4763	1966

Source: processing of the author based on data of *AES Kosovska Mitrovica*

Advisors provide expert advice, recommendations, services and assistance to selected farms (100 farms), but also to other farms and make written and electronic records on special forms. In addition to individual working methods, consultants provide expert advice and through group work methods. In the district covered by this service there is only one agricultural cooperative, a specialist advisor - fruit grower specialist visiting a cooperative a minimum of 4 times per year. As one of the activities of advisors stands out and work with associations and informal groups of farmers. Advisors during the year as a group organized lectures, like group method, on current issues important for agricultural producers. For these lectures are invited they experts from universities and institutes. In addition to lectures, advisers *AES Kosovska Mitrovica* undertake other activities: practical lectures - "Field Days"; stands (lectures with discussion) workshops; winter school for farmers; experimental farms; mass media (TV shows, radio shows, articles on the portal of the Agricultural Advisory Service), print media (local newsletters).

AES Kosovska Mitrovica mainly implements new varieties in plant production through the demonstration experiments on the ground that handles Agriculture School Lešak or plots on selected farms. In the territory covered, *AES Kosovska Mitrovica* keep records for 3 farms that serve as experimental farms (demonstration). Sample farms serve as demonstration farms and they are the result of good agricultural practices, economic performance management holdings, the application of new and modern technologies of production and effects of the use of advisory services. *AES Kosovska Mitrovica* also implement monitoring and reporting on seasonal agricultural work in crop and vegetable production. Annual crops (winter and spring

grain crops, corn, alfalfa, potatoes, vegetables, etc.) and also perennial crops (plum, apple, pear, etc.) are plants that prevail in the production of the region.

The number of registered farms that are covered by the advisory activities *AES Kosovska Mitrovica* at the end of 2014 was as shown in table 4.

Table 4. The number of registered farms in municipalities covered by AES-KM

Municipality	registered farms
Kosovska Mitrovica	124
Vucitrn (enclave)	174
Srbica (enclave)	28
Zubin Potok	370
Zvecan	180
Leposavic	1601
Total	2477

Source: *AES Kosovska Mitrovica* - records of extension agents for 2014

Although the registration of farms is performed since 2005, on Kosovo and Metohija, as well as in the Kosovska Mitrovica district, major problem in the registration is unresolved property relations.

Livestock in the Kosovska Mitrovica district in relation to the post-war period slightly increased, but in relation to the condition it was before the bombing in 1999 is significantly lower (table 5). One advisor is responsible to monitor the situation in this production.

Table 5. Livestock in the territory of *Kosovska Mitrovica AES*

Cattle	6615
Sows	7400
Sheep	8317
Poultry	90000

Source: *AES Kosovska Mitrovica* - Personal records of adviser, 2014.

Data books about selection of livestock would help to improve the breed composition of livestock, and thus enhance and improve the health of the animals, but there is no responsible livestock registry office to perform this. In livestock production there is no contract production between producers and processors. There is no cooperative relation, especially in the fattening of calves and pigs. To improve the breed composition and selection of livestock is necessary to work on the technical and technological modernization of cattle-handling facilities and equipment in the barns, better use of genetic potential of livestock, the application of new technologies in livestock feed and more.

Conclusion

In Serbia is necessary to work on a gradual increase in the number of agricultural advisors and to take into account their distribution by AES to provide better coverage of the territory by the advisory service included in their work. At the same time we must work on systematic planning and implementation of extension activities by using group work methods which allow coverage of larger target groups of farmers. The unstable political situation is a significant factor in the slow development of agricultural production of the northern Kosovo, regardless of the role of agricultural extension in its development. Expanding the scope of work of the agricultural advisory services to other Serbian enclaves in Kosovo can contribute to the improvement of agricultural production in this area. Agricultural extension service and

interest association of agricultural producers should be decisive in the improvement of primary agricultural production and the general progress of the economy of this region.

Reference

- Institute for Science Application in Agriculture (ISAA) (2014): Poljoprivredne savetodavne i stručne službe Republike Srbije 2014 godine (Agricultural advisory and professional services of the Republic of Serbia), Belgrade.
- Ministry of Agriculture, Forestry and Water Management of the Republic of Serbia (2013): Strategija poljoprivrede i ruralnog razvoja Republike Srbije 2014-2024. (Strategy for Agriculture and Rural Development of the Republic of Serbia 2014-2024). November 2013.
- Novković, N., Šomodi, Š. (2001): Organizacija u poljoprivredi (Organisation in agriculture). Faculty of Agriculture, Novi Sad.
- Petrović, Ž., Janković, D. (2010): Poljoprivredno savetodavstvo Srbije – stanje, problemi i mogućnosti reforme (Agricultural extension Serbia - situation, problems and reform possibilities). Faculty of Agriculture, Novi Sad.
- Agriculture Extension Services Kosovska Mitrovica (2014): Program rada poljoprivredne savetodavne i stručne službe Kosovska Mitrovica za 2014 godinu (Work program of Agricultural Advisory and professional services Kosovska Mitrovica for Year 2014). Kosovska Mitrovica, 2014.
- Ševarlić, M. M. (2003): Nova uloga poljoprivredne savetodavne službe u razvoju sela Srbije (The new role of Agricultural Extension Services in rural development of Serbia). *Agricultural Economics*, vol. 50, No. 2, pp. 129-157.

THE SENSITIVITY OF NET FARM INCOME IN THE ZLATIBOR DISTRICT (SERBIA) TO CHANGES IN GOVERNMENT SUPPORT

Vladimir JOVANOVIĆ^{1*}, Danijela PETKOVIĆ², Julijana MIJAILOVIĆ³, Vlade ZARIĆ⁴

¹NIRAS International Consulting, Belgrade, Serbia

²Galenika Fitofarmacija a.d., Belgrade, Serbia

^{3,4}Faculty of Agriculture, Belgrade, Serbia

*Corresponding author: vlj@niras.com, vlada.f.jovanovic@gmail.com

Abstract

In this paper we have analysed the impact of the changes in government support on net income of the agricultural holdings in Zlatibor district in the period 2015 - 2016. In 2015 total subsidies per ha for crop production were approximately EUR 100, while in 2016 they have been reduced to only EUR 33. Subsidies for dairy and livestock production have also been changed compared to the previous year. Objective of this paper is to demonstrate out the immediate consequences of these changes by pointing out their impact on the farmer's income and farming structure in the short time. Starting hypothesis is that these sudden changes in agricultural policy measures will have negative effects on farm net income and farming practices. Methodology used for writing this paper consists of the structure and sensitivity analysis of the net income, based on existing data and the data collected directly from agricultural holdings in Zlatibor district. Results show that farm net income will be reduced, as a consequence of reduced subsidies. Second, reactions on the farm activities show that the farmers are unable to adjust to sudden changes in government support and there is a clear need to have more sensitive policy measures. Also are presented the factors that need to be reconsidered in creation of agricultural policy measures and expectations from the latest changes in agricultural policy.

Keywords: *subsidies, Serbia, agricultural policy, farm net income.*

Introduction

In the period of accession to the European Union (EU), Serbia is facing the serious challenges of harmonizing the agricultural and rural development policy to the European Union Common Agricultural Policy EU CAP, but at the same time preparing its agricultural sector for competing in large EU market. At the same time, rural areas are mostly affected by poverty¹. During this period, many changes have been made in agricultural policy regarding subsidies. Serbian agricultural sector is highly affected by these changes and inconsistency in agricultural and rural development policy. These frequent and, in many cases sudden changes, make participants in the market of agricultural and food products, especially farmers, unable to plan their business in the long or even medium term, which can make their production questionable².

Importance of financial support in agriculture is well described by the fact that almost every country in the world, with the exception of New Zeland, strongly regulates agricultural market

¹ Source: Bogdanov, N., 2007: Small Rural Households in Serbia and Rural Non-Farm Economy, UNDP Serbia, Belgrade

² Source: Zarić, V., 2008: Analysis of the competitiveness of agri-food products in the Republic of Serbia (Analiza konkurentnosti poljoprivredno-prehrambenih proizvoda Srbije), University in Belgrade, Faculty of Agriculture, Belgrade

by state measures³. One of the main purposes of interventionism and market regulations in agricultural sector is provision of sufficient quantities of food. When trying to provide food security, government must take into consideration food security in most affected, rural areas. In February 2016 Serbian government has adopted the new Regulation on the Distribution of Support in Agriculture and Rural Development in the Year 2016. This regulation reduces, until than valid payments per hectare of arable land, from 100 EUR/ha to approximately 33 EUR/ha. These subsidies belong to the group of direct payments.

Authors have analysed impact of these changes in agricultural policy measures on 45 agricultural holdings in Zlatibor District. Zlatibor District covers ten municipalities: City of Užice, Bajina Bašta, Kosjerić, Požega, Čajetina, Arilje, Priboj, Nova Varoš, Prijepolje and Sjenica. All of these municipalities, except Priboj are covered by the survey. Zlatibor District mostly consists of mountain area, where livestock production and mixed farming are the most represented types of agriculture.

Starting hypothesis is that these changes will have significant negative impact on farm net income, and consequently quality of life of farmers affected. Social importance of this paper lays in the analysis of the impact of changes in agricultural policy on farm net income and quality of life in rural areas. Scientifically, this paper intends to initiate and set the basis for wider and more comprehensive research on the same topic, that should be very valuable in agricultural policy making process.

This paper will emphasize the importance of consistency in measures made by policy makers in the agricultural sector.

In order to conduct needed analysis before introducing new policies, Ministry of Agriculture and Environmental Protection should use available statistics from the instruments like FADN (Farm Accountancy Data Network), gross margin and similar calculations on farm level conducted by agricultural extension agents and similar data at their disposal.

From the Government Regulation on the Distribution of Support in Agriculture and Rural Development in the Year 2016 from February 2016, it is clear that none of such analysis has been made and that the Regulation was purely “office made”, without any hint of using bottom-up principle in its creation. This statement is supported by the fact that the Ministry of Agriculture and Environmental Protection still does not use available FADN data for any kind of operative or public analysis.

Materials and methods

In order to test the starting hypothesis, authors have conducted the field survey on 45 agricultural holdings, collecting information about use of subsidies granted per hectare of arable land, which includes: payments per hectare for crop production, recourse for diesel fuel and recourse for fertilizers. Besides these, authors have also collected, processed and analysed data on utilized agricultural area, type of production and on indicators that define farm net income. Farm net income has been calculated by following procedure:

Total output – (Specific costs + Farm overheads) + Balance of current subsidies and taxes* = Gross farm income⁴

Gross farm income – Depreciation = Farm net value added

Farm net value added – External factors** = Farm net income

³ Source: Koester, U., Zaric, V., 2009: Trade in agri-food products – principles and policy (*Trgovina poljoprivredno-prehrambenim proizvodima – principi i politika*), University in Belgrade, Faculty of Agriculture, Belgrade

⁴ Source: Gogic, P., 2009: Theory of costs with calculations in agri-food production (*Teorija troškova sa kalkulacijama u proizvodnji i preradi poljoprivrednih proizvoda*), University of Belgrade, Faculty of Agriculture, Belgrade

*Balance of current subsidies and taxes is the difference between subsidies except subsidies on investments and taxes.

**External factors include: paid salaries, paid rent and paid interest and other costs of financing.

Based on the changes included in the Government Regulation, where recourse for diesel fuel has been completely abolished, expected changes on farm net income have been analysed. Authors have started with assumption that the farms will apply for subsidies in 2016 for the same areas of arable land (same number of units/hectares) as they did in 2015. Farms that did not use subsidies granted per hectare of arable land in 2015 were not included in the sample, since the analysis of the effect of changes in regulation on these farms would be irrelevant. Authors have used the simple questionnaire for the field survey and collected data directly from agricultural holdings. Zlatibor District has been chosen due to good contacts of authors with farmers in this area and limited budget for the survey. Besides field survey, authors have conducted desk research of available statistics and literature.

Results and discussion

After processing the collected data and analysing results of the calculations conducted, authors have come out with following findings:

- a) Expected overall decrease in used subsidies granted per hectare of arable land in Zlatibor District is 50.78 % in average, comparing to 2015.
- b) Expected decrease in farm net income, as a consequence of changes in granted subsidies per hectare of arable land is 14.25 % in average.
- c) Farms with different types of production are differently affected by changes.
 - Expected average decrease in granted subsidies per hectare on farms specialized for livestock production is 50.85 % comparing to 2015 (29 farms);
 - Expected average decrease in granted subsidies per hectare on farms with mixed livestock and crop production is 46.58 % comparing to 2015 (22 farms);
 - Expected decrease in farm net income is 5.42 % on farms specialized for livestock production, as a consequence of changes in subsidies per hectare, and 38.98 % on farms with mixed livestock and crop production, comparing to 2015.

Farms specialized for plant production, such as fruit farms or crop farms, were not analysed individually, since there are only 4 of them in the sample, which would make results of such analysis irrelevant and confidentiality of individual data from agricultural holdings would be jeopardized.

From the results above, we may conclude the following:

- a) Changes in subsidies per hectare introduced by the Government regulation from February 2016 are significant in terms of value comparing to 2015;
- b) Changes in subsidies per hectare introduced by the Government regulation from February 2016 are significant in terms of their share in total current subsidies and consequently, in their impact on farm net income. This means that regardless the fact that share of subsidies in farm net value added (FNVA) in Serbia is relatively small comparing to EU average, changes in current subsidies can still highly impact the farm net income (FNI).

Share of subsidies in FNVA in Serbia in 2014 was estimated at only 13%, while the EU average was 41%.⁵

⁵ Presented at Final Conference of FADN Conference for the Data Collectors, September 2015, Belgrade, Serbia

- c) Changes in subsidies per hectare have much smaller impact on livestock farms, comparing to mixed farms (mixed livestock and crop production).

These conclusions confirm the starting hypothesis that these changes will have significant negative impact on farm net income, and will consequently influence quality of life of the affected farmers.

Conclusion

Latest changes in subsidies per hectare introduced by the Government regulation from February 2016 are only one of many examples of sudden and frequent changes in agricultural policy measures. This especially refers to the policy measures dealing with financial support from public funds.

Results of the conducted research proof that the farmers can hardly cope with sudden and frequent changes of agricultural policy measures, especially in the area of financial support from public funds. Based on the results presented above, we may draw the conclusion that changes in current subsidies directly influence farm net income, and consequently, the quality of life of agricultural producers. When trying to secure food security, government first needs to take into consideration food security in most affected, rural areas. Adjusting to sudden and frequent changes in agricultural policy is especially challenging if we take into consideration biological nature of agricultural production.

Taking all of this into consideration, it is clear how serious task is to create and distribute financial support for agricultural production. First, it is necessary to make a wide and comprehensive analysis of current situation in agricultural sector and to set the goals that are to be achieved by implementing policy measures. It is also needed to conduct sensitivity analysis of each of the measures. This paper is just an example for one of the analysis that should be conducted on state level.

Methods and results described in this paper are intended to serve as an idea and, maybe, starting point for wider and more comprehensive analysis of the situation in agricultural sector on yearly basis. They may also give an idea for using such analysis in agricultural policy making, since all of the policies and measure in the area of agriculture should be in the best interest of agricultural sector and agricultural producers. Therefore, agricultural producers should be encouraged to take a part in decision making process and in keeping precise and reliable records on their farm activities and economic indicators. After that, it is up to responsible institutions to use available data and statistics, in order to respond to actual needs of agricultural sector in the proper way and create attractive business environment for all participants in the market of agricultural and food products.

References

- Bogdanov, N., 2007: Small Rural Households in Serbia and Rural Non-Farm Economy, UNDP Serbia, Belgrade
- Gogic, P., 2009: Theory of costs with calculations in agri-food production (Teorija troškova sa kalkulacijama u proizvodnji i preradi poljoprivrednih proizvoda), University of Belgrade, Faculty of Agriculture, Belgrade
- Koester, U., Zaric, V., 2009: Trade in agri-food products – principles and policy (Trgovina poljoprivredno-prehrambenim proizvodima – principi i politika), University in Belgrade, Faculty of Agriculture, Belgrade
- Zaric, V., 2008: Analysis of the competitiveness of agri-food products in the Republic of Serbia (Analiza konkurentnosti poljoprivredno-prehrambenih proizvoda Srbije), University in Belgrade, Faculty of Agriculture, Belgrade

Web sites:

<http://www.mpzss.gov.rs/> Accessed on 26/06/2016

http://ec.europa.eu/agriculture/cap-overview/index_en.htm Accessed on 25/06/2016

http://ec.europa.eu/agriculture/ricaprod/methodology1_en.cfm# Accessed on 29/05/2016

ENERGY EFFICIENCY FOOD RETAILERS

Radojko LUKIC¹, Srdjan LALIC²

¹ Faculty of Economics, Belgrade, University of Belgrade, Serbia

² Faculty of Economics, Brcko, University of East Sarajevo, Bosnia and Herzegovina

*Corresponding author: rlukic@ekof.bg.ac.rs

Abstract

In this paper the emphasis is put on the specifics of energy efficiency impact on the profitability of the service sector, with special insight into food retail. The theoretical and methodological presentations are illustrated by applying the comparative approach, on the original empirical data of food retailers. Because of the importance of energy costs in the retail food, it is important to take appropriate measures to ensure their reduction as a very important factor in increasing profits. These measures may be of a different nature. Thus, for example, sustainable ways to save energy costs in the retail food are: efficient lighting, cooling, heating, energy management and initiative for increasing the renewable energy sources use. This certainly includes the use of new energy efficient technologies and construction of energy efficient office buildings and stores in food retail sector (with continual improvement of existing ones). Energy costs are significant component of operating costs and profits in trade, especially in food retailing. The size and structure of energy costs in retail is influenced by numerous controlled and uncontrolled factors (climate zones, location, age and isolation of building, the size of store, type of commodity, energy system, caring staff, energy prices, the amount of energy consumed and others). Acquaintance of the effects of individual factors is important for efficient energy management in (food) retail. In recent years, the key factor for improving energy efficiency in (food) retail is usage of renewable energy sources. Due to this, the goal of global retailers in perspective is more use of renewable energy sources in total energy consumption. Likewise, it is the reduction of carbon dioxide with respect to energy consumption. All this will decrease the energy costs of the global retailers. (JEL classification: Q40, Q44, Q32, Q57)

Key words: *energy intensity, renewable energy sources, energy management, green energy, final energy consumption*

Introduction

In the context of the analysis of the impact of energy efficiency on the performance in service sector, special attention is given to the specifics of the trade energy efficiency, primarily the leading global food retailers, such as Tesco. In order to increase customer satisfaction, profits, and to achieve greater application of *the concept of sustainable development*, global food retailers develop special strategies for improving energy efficiency management, water consumption, carbon dioxide emissions and food waste treatment. In order to achieve fully integrated accounting information system reports, special public reporting known as - sustainable reporting became a business practice in recent years. *Sustainable reporting* of the global food retailers (e. g. *Wal-Mart*) is increasingly becoming an integrated part of their annual reporting for which the public is interested in. The research presented in this paper are the energy costs in trade with special reference to food retailers. The *goal* is to get as complete with the character looks, size and structure of energy costs in the retail food. This is a prerequisite for the efficient management of energy costs in the retail food. The effects of this are food retailers increase profits.

There is growing body of *literature* on energy efficiency analysis in recent years. It is understandable when one takes into account the fact that energy efficiency is a key factor in the profitability of all companies (Lukic, et al. 2013, 2014,2015, 2016a,b; Christina, 2015). Nevertheless, existing literature dedicated primarily to the issues of energy efficiency in the service sector, with particular reference to food trade is not extensive (Lukic, 2011a, b, 2012, 2016).

Material and Methods

All relevant issues are still not sufficiently *theoretically, methodologically and empirically researched*. In that we find the scientific and professional opportunity for writing this article. It seeks to draw attention to most significant aspects of managing energy in the service sector, with special insight into food trade. In order to draw attention to the researched issues, *theoretical and methodological* presentations are illustrated with original *empirical data* from different countries, especially the *European Union* and *Serbia*.

The research conducted in this and other studies show that the efficient management of energy can significantly reduce costs (total costs and energy costs), and thus increase profits in the service sector, including trade. The paper presented *hypothesis* that efficient energy management significantly affects the improvement of the profitability of the companies, including service and trading. *The research methodology of issues in this paper is based on the theory, norm and, in particular, comparative analysis of empirical data (indicators) of service sector energy efficiency, with a special insight into food trade of selected countries with developed market economy and Serbia*. Within the applied research methodologies, indicators of energy intensity are very important, and to some extent specific to the service sector, trade and food retail. Based on their comparative analysis it is very easy to perceive the energy efficiency and its impact on the profitability of the observed service companies, for example, food retailers (such as *Wal-Mart* or *Tesco*).The *empirical data* were collected from different sources: literature, Eurostat, annual reports and other relevant statistics. To some extent, they undergo secondary processing in accordance with the aim of the research issues.

Results and Discussions

Energy costs are significant component of operating costs and profits in trade, especially in food retailing (USDA's Economic Research Service's Food Dollar Series, accessed July 23, 2015 at: www.ers.usda.gov/data-products/food-dollar-series/documentation.aspx). The size and structure of energy costs in retail is influenced by numerous controlled and uncontrolled factors. These are: climate zones, location, age and isolation of building, the size of store, type of commodity, energy system, caring staff, energy prices, the amount of energy consumed and others. Acquaintance of the effects of individual factors is important for efficient energy management in retail. In recent years, the key factor for improving energy efficiency in (food) retail is usage of renewable energy sources. Due to this, the goal of global retailers in perspective is more use of renewable energy sources in total energy consumption. Likewise, it is the reduction of carbon dioxide with respect to energy consumption. All this will decrease the energy costs of the global retailers. Positive economic effects of reducing energy costs in retail are: further increase in sales, profits and return on investment. Energy consumption, carbon dioxide emissions and loss of food in the food supply chain (agricultural production, processing, distribution, retail and consumption) is significant. For example, in the United Kingdom - UK energy consumption (in % of the total) in the food chain is 18%, carbon dioxide emissions is 176 MtCO₂e and 15 Mt of food loss (Tassou, 2011, 2014). In food chain, retail is significant consumer of energy and producer of carbon dioxide emissions. In developed countries it participates between 3 and 5% of total energy consumption. In the UK, retail food sale participates with 3% in total energy consumption (Tassou, 2014). According to estimates, the carbon dioxide emissions, arising from retail operations, ranges between 6

and 9.5 MtCO_{2e} (Tassou, 2014). The reduction of energy consumption and carbon dioxide emissions is therefore a significant factor in increasing profitability in food retailing. In the United Kingdom, major supermarkets, such as Tesco, ASDA, Sainsbury's and Morrisons, achieved in 2005 lower operating margin of 4.2% on average based on the reduction in energy consumption (Spyrou et al., 2014). The primary sources of energy in the food retail are electricity and gas. On the research on hypermarkets it is established that in the structure of energy consumption gas accounts for 20% (Spyrou et al., 2014). In the food retail, carbon dioxide emission is very significant seen from the standpoint of energy consumption. Thus, for example, the total annual CO₂ emissions related to the consumption of energy in major food stores in the United Kingdom is about 4.0 MtCO₂ (Tassou, 2011). In the United Kingdom food retail sector accounts for more than 3% of the total energy consumption and approximately 1% of the total emission of carbon dioxide (Spyrou et al., 2014). The research on the case in 2570 food retailers which account for about 30% of the total number in the United Kingdom has found that 10% of energy savings contributes to reducing 355,000 tons of CO₂ emissions (Tassou, 2011, 2014). It is estimated that the retail sector in Australia will produce about 2,52% of the total carbon dioxide emissions of greenhouse gases in 2020. It is associated with the consumption of energy (gas, wood, fuel and electricity) for heating, cooling, lighting and appliances (Low Carbon Growth Plan for Australia, Retail Sector Summary Report, June 2011, Climate Works, Australia. Available at http://www.climateworksaustralia.org/sites/default/files/documents/publications/climateworks_lcgpa_australia_retail_sector_summary_june2011_0.pdf). (Accessed March 1, 2016).

Energy consumption and carbon dioxide emissions are significantly higher in the wholesale and retail trade sector in China than in Japan (Yokoo et al., 2015). In Japan, retail sales participate with about 40% of total energy consumption in the commercial sector. Primary consumption of energy in food retail in Japan is 6,000 MJ / (m² per year) (Suzuki et al., 2011). In any case, in order to efficiently manage the energy costs in the retail food it is necessary to know their size - the percent of their participation in sale. Thus, for example, energy costs in Canadian supermarkets are around 1% of sales (Available at: <http://www.nrcan.gc.ca/energy/efficiency/buildings/energy-benchmarking/17188>). (Accessed March 1, 2016). In the *United Kingdom*, in major food retail chains (*Tesco, ASDA, Sainsbury's, Morrisons and small chains such as Somerfield, Waitrose, Iceland, co-ops and other multiple chains and independent*) energy consumption of electricity is 8385 GWh, gas 2,477 GWh, and the total carbon dioxide emissions are 4.0 MtCO₂ (Table 1).

Table 1. Annual energy consumption and carbon dioxide emissions in the 10 largest food retailers in the United Kingdom

	Supermarket electrical energy consumption (GWh)	Gas energy consumption (GWh)	CO ₂ Emission electrical power (tonnes)	CO ₂ Emission gas (tonnes)	CO ₂ Total Emissions (tonnes)
10 major UK retail food chains	8385	2477	3538470	470630	4009100 (4,01 MtCO ₂)

Source: Tassou et al., (2011)

Energy consumption and carbon dioxide emissions vary widely between supermarkets. This is affected by many factors, such as type and size of store, business politics and product range, cooling, as well as used environmental control systems. By applying appropriate measures 10% of energy can be saved, or 840 GWh, which represents a reduction of 350,000 tons of carbon dioxide (Tassou et al. 2011). As in other countries, trade in *Serbia* has very significant energy costs. Table 2 shows the energy costs of selected trading companies in 2013. The first three deal with food products selling, and the remaining two with fuels and petroleum derivatives.

Table 2. Energy costs of selected trading companies in Serbia, 2013

	Sales revenue (in 000 dinars)	Fuel and energy costs (in 000 dinars)	Share of fuel and energy costs in sales revenue, (%)*
Delhaize Serbia	75,817,380	840,390	1,24
Mercator-S	59,252,435	930,213	1,56
IDEA	55,072,112	770,036	1,49
Knez Petrol	37,289,281	320,250	0,85
OMV Srbija	30,937,667	156,577	9,50

Note: * Calculation performed by the Author

Source: Annual Reports - Business Registers Agency

According to the data presented in the table, the costs of fuel and energy are much higher in the retail chains that sell food (ranging from 1.24% to 1.56%) compared to ones that sell fuel and petroleum products (in which it is less than 1 percent). Based on these data (Table 2) we can conclude that the energy cost in Serbian trade are higher than in countries with developed market economy. (See: Eurostat) The results of empirical research show that energy efficiency in the food retail sector in Serbia is considerably lower than in the European Union and other countries with developed market economy. (Thus, for example, energy costs in Canadian supermarkets are around 1% of sales (Available at: <http://www.nrcan.gc.ca/energy/efficiency/buildings/energy-benchmarking/17188>). (Accessed March 1, 2016) Given that, it is necessary to introduce appropriate measures to improve energy efficiency of the food retail sector in Serbia in the future. These are: modern energy technologies, increase of renewable energy share in total final energy consumption, reduction of energy consumption throughout the entire supply chain, reduction of carbon dioxide emissions related to the energy consumption, construction of energy efficient office buildings and retail facilities, and improvement of the existing. The ultimate effects of this are to improve profitability in the food retail sector in *Serbia*. The reasons for this are very low energy management efficiency, insufficient use of modern energy-efficient technology and

equipment, unsatisfactory improvement of energy efficiency in existing and slowed construction of new energy-efficient office buildings and retail facilities, as well as a slight use of renewable energy sources. All global food retailers devote considerable attention to the reduction of carbon dioxide emissions related to energy consumption in order to improve their overall efficiency. We will illustrate this on the example of the famous retailer *Tesco*, which devotes significant attention to sustainable development and environmental protection. In *Tesco* company food losses in the retail and distribution centres in the *United Kingdom* amounted to 55,400 tons, or 0.9% of total sales in the stores in 2014. Compared to the previous year they were reduced for 1,180 tons (Tesco - Annual report 2015. Available at: http://www.tescopl.com/files/pdf/reports/ar15/download_annual_report.pdf). (Accessed March 1, 2016). Table 3. shows the dynamics of carbon dioxide emissions in the company Tesco for the period 2006 - 2014.

Table 3. Emissions of carbon dioxide in Tesco company, 2006 - 2014

	2006	2013	2014
Global net carbon dioxide intensity (total net emissions kg CO ₂ e/m ²)	64,33	39,71	37,99

Source: Tesco - Annual report 2015 (Available at: http://www.tescopl.com/files/pdf/reports/ar15/download_annual_report.pdf) (Accessed March 1, 2016)

The *Tesco* company total carbon dioxide emissions in 2014 amounted to 5.6 million tons of CO₂e. That same year, global net carbon dioxide intensity in stores and distribution centres in the *Tesco* decreased by 4.3% compared to the previous year, and by 40.9% in comparison to 2006 (Tesco - Annual report 2015. Available at: http://www.tescopl.com/files/pdf/reports/ar15/download_annual_report.pdf). (Accessed March 1, 2016). Thus, the objective to reduce the carbon dioxide in this company is accomplished and the situation in this company is similar with its competition, such as *Wal-Mart*. Energy consumption and carbon dioxide emissions depend on many factors, such as: type and size of store, business manner, assortment and interlinked cooling, climate zones and environment control system. Due to its economic importance, the majority of global retailers developed their own models of energy efficiency (Alcott, 2014), power management strategies and established special centres responsible for energy management. On this basis, they accomplish significant energy savings, lower energy costs, what positively affects their overall performance (Määttänen, 2014). Special system of indicators of energy performance is developed for retailers. These are: specific energy generators expressed in kWh/m² per year, primary energy use expressed in kWh/m² per year, specific energy consumption expressed in kWh/m² per year, consumption of green energy %, and carbon dioxide emission (expressed in appropriate measure unit, for example, kg). Also, internal energy performance indicators in retail are developed (such as, monitoring of power consumption by purpose: heating/cooling surface, cooling, lighting, etc., with detailed control of each energy segments, such as heating/cooling surface - heating loss in office building and shop, W/m²) (Martos-Galvey, J.-L., et al., 2013). There are a number of actions to improve energy efficiency in the context of sustainable development in retail (The Food Retail Industry An innovative, sustainable retail environment, 2011 LG Electronics USA, Inc., Englewood Cliffs, NJ .Available at: http://www.lg-vrf.com/Assets/LG%20Retail%20-%20Why%20LG%20in%20Retail%20Space%202012%20V1_20111109090350.pdf). Accessed March 1, 2016). These are: energy efficiency of operations; use of renewable

energy sources in business; increase of product portfolio within the energy efficiency; collaboration with suppliers to improve energy efficiency of the supply chain; and reduction of packaging and packaging waste (Sustainable Energy for All: Opportunities for the Retail Industry, 2012, Accenture. Available at: https://www.accenture.com/t20150523T052048_w_us-en/acnmedia/Accenture/Conversion-Assets/DotCom/Documents/Global/PDF/Strategy_2/Accenture-Sustainable-Energy-All-Opportunities-Retail-Industry.pdf). (Accessed March 1, 2016).

Integral application of these measures contributes significantly to improving energy efficiency in retail sales, which had a positive impact on its overall performance.

All retail companies increasingly use so called, "green energy" due to its economic importance. All global retailers have increasingly implemented best practices for sustainable development. In that context, significant attention is paid to energy management. This certainly has a positive impact on their overall performance. The company is *Wal-Mart*, as well as its major competitors, also devotes significant attention to sustainable development in order to continually improve its performance. The objective is to achieve long term 100% use of renewable energy, zero losses and sell products that fit consumers and the environment. *Wal-Mart* increases the share of renewable energy in total energy consumption (Table 4), and rapidly replaces the existing with new more efficient energy installation. Electricity is 26% used from renewable energy sources, and the share of renewable energy in the total energy consumption is 21% (*Wal-Mart* - 2015 Global Responsibility Report. Available at: <http://cdn.corporate.walmart.com/f2/b0/5b8e63024998a74b5514e078a4fe/2015-global-responsibility-report.pdf>). (Accessed March 1, 2016).

Table 4. Total renewable energy (GWh) in Wal-Mart, 2011 - 2015

	FY2011	FY2012	FY2013	FY2014	FY2015
Total renewable energy (GWh)	640	1,200	1,080	2,250	3,021

Source: *Wal-Mart* - 2015 Global Responsibility Report (Available at: <http://cdn.corporate.walmart.com/f2/b0/5b8e63024998a74b5514e078a4fe/2015-global-responsibility-report.pdf>) (Accessed March 1, 2016)

Considerable attention in *Wal-Mart* is given to reduction of carbon dioxide emissions. Table 5 shows the emissions of carbon dioxide and retail areas in *Wal-Mart* for the period 2005 - 2013. It is noticeable tendency for lower emissions carbon dioxide emissions related to energy consumption in recent years.

Table 5. Emissions of carbon dioxide and retail areas in Wal-Mart, 2005 - 2013

	2005	2006	2007	2008	2009	2010	2011	2012	2013
Carbon dioxide emissions (in million tons CO ₂ e)	740	805	867	921	952	985	1,037	1,072	1,102
Retail area (in million square meters)	18,9	19,3	20,1	20,8	20,3	20,6	20,8	20,12	20,10

Source: Wal-Mart - 2015 Global Responsibility Report (Available at: <http://cdn.corporate.walmart.com/f2/b0/5b8e63024998a74b5514e078a4fe/2015-global-responsibility-report.pdf>) (Accessed March 1, 2016)

Generators (i.e. sources) of carbon dioxide in *Wal-Mart* are: purchased energy 72,0%, refrigerants 12.0%, transport fuel 8.5%, on-site fuel 8%, and mobile refrigerants 0.1% (Wal-Mart - 2015 Global Responsibility Report. Available at: <http://cdn.corporate.walmart.com/f2/b0/5b8e63024998a74b5514e078a4fe/2015-global-responsibility-report.pdf>). (Accessed March 1, 2016). Continuous improvement of total energy efficiency has positive effect on the profitability of the company. *Wal-Mart* pays considerable attention to continuous improvement of energy efficiency in existing retail outlets and on that basis expects reduction up to 20% in energy consumption per square meter in 2020 (Wal-Mart - Saving Energy, Saving Money Through Comprehensive Retrofits, the US Department of Energy, Energy Efficiency & Renewable Energy, Commercial Building Efficiency Energy, Available at: <http://www.nrel.gov/docs/fy15osti/63782.pdf>). (Accessed March 1, 2016). All in all, the increasing application of the concept of sustainable development has a significant impact on the profitability of this company.

Conclusion

Energy costs are significant component of operating costs and profits in trade, especially in food retailing.. The size and structure of energy costs in retail is influenced by numerous controlled and uncontrolled factors. These are: climate zones, location, age and isolation of building, the size of store, type of commodity, energy system, caring staff, energy prices, the amount of energy consumed and others. Acquaintance of the effects of individual factors is important for efficient energy management in retail. In recent years, the key factor for improving energy efficiency in (food) retail is usage of renewable energy sources. Due to this, the goal of global retailers in perspective is more use of renewable energy sources in total energy consumption. Likewise, it is the reduction of carbon dioxide with respect to energy consumption. All this will decrease the energy costs of the global retailers.

In food trade, energy costs participate in sales with around 1%. In this respect, there are differences from country to country. They are, according to the analyzed empirical data, much higher in the food trade in *Serbia* than in countries with developed market economy. In order to increase profitability, reduction of energy costs should be implemented. This can be achieved by replacement of existing heating, refrigeration and cooling systems with new energy efficient, and improving energy efficiency by better insulation in existing and new office buildings and food stores. All in all, greater application of the concept of sustainable development in trade *Serbia* also results in increasing energy efficiency.

References

- Allcott, H. and Sweeney, R. (2014). Can Retailers Inform Consumers about Energy Costs? Evidence from a Field Experiment. Working paper, New York University, 1-52.
- Christina, S. et al., (2015). A socio-technical approach to improving retail energy efficiency behaviours. *Applied Ergonomics*, 47, 324-335.
- Lukic, R. (2011a). Evaluacija poslovnih performansi u maloprodaji. Beograd: Ekonomski fakultet.
- Lukic, R. (2011b). Estimates of economic performance of organic food retail trade. *Economic research*, 24 (3), 157-169.
- Lukic, R., Djojo Arsenovic, Dj. and Lalic, S. (2013). The Analysis of Environmental costs in the Foods Retail. 4th International Agronomic Symposium "Agrosym 2013" Jahorina, 3-6 October 2013, 765-770.
- Lukic, R. (2012). Sustainable Development of Retail in Serbia. *Review of International Comparative Management*, 13 (4), 574-586.
- Lukic, R., Vojteski-Kljenak, D. and Jovancevic D. (2014). Food waste management. *Management Research and Practice*, 6(4), 23-39.
- Lukic, R, Lalic, M. S. and Matovic, I. (2015). The role of sustainable reporting to performance management in the retail food. 5th International Agronomic Symposium "Agrosym 2015" Jahorina, 15-18 October 2015, 1848-1854.
- Lukic, R. (2016a). Energy efficiency in the food retail. *Business Excellence and Management*, 6(1), 16-35.
- Lukic, R. (2016b). The impact of energy efficiency on performance in service sector. *Economic and Environmental Studies*, 16(2) 169-190.
- Määttänen, E., Kyrö, R. and Aaltonen, A. (2014). Remote energy management benefits in retailing building portfolios. *Journal of Facilities Management*, 12 (1), 56-71.
- Martos-Galvey, J.-L., Styles, D. and Schoenberg, H. (2013). Identified best environmental management practices to improve the energy performance of the retail trade sector in Europe. *Energy policy*, 63, 982-994.
- Spyrou, M. S., Shanks, K., Cook, M.J., Pitcher, J. and Lee, R. (2014). An empirical study of electricity and gas demand drivers in large food retail buildings of a national organisation. *Energy and Buildings*, 68, 172-182.
- Suzuki, Y., Yamanuchi, Y., Shiraishi, K., Narumi, D., Shimoda, Y. (2011). Analysis and Modeling of Energy Demand of Retail Stores. *Proceedings of Building Simulation 2011: 12th Conference of International Building Performance Simulation Association*, Sydney, 14-16 November, 1824-1831.
- Tassou, S.A., Hadawey, A. and Evans, J. (2011). Energy consumption and conservation in food retailing. *Applied Thermal Engineering*, 31, 147-156.
- Tassou, S.T., Kolokotroni, M. and Gowreesunker, B. et al. (2014). Energy demand and reduction opportunities in the UK food chain. *Energy*, 167(3), 162-170.
- Tassou; S.A., Ge, Y., Hadawey, A. and Marriott, D. (2011). Energy consumption and conservation in food retailing. *Applied Thermal Engineering*, 31, 147-156.
- Vojteski Kljenak, D. Lukic, D. and Jovancevic, D. (2015). Labor costs analysis in the trade market of Serbia. *Management Research and Practice*, 7(3), 59-79.
- Yokoo, N., Oka, T., Yokoyama, K., Sawachi, T. and Yamamoto, M. (2015). Comparison of Embodied Energy/CO₂ of office Buildings in China and Japan. *Journal of Civil Engineering and Architecture*, 9, 300-307.

AGRICULTURAL COOPERATIVE AS A FACTOR OF INCREASING AGRICULTURAL PRODUCTION IN NORTHERN KOSOVO

Goran MAKSIMOVIĆ*, Božidar MILOŠEVIĆ, David JOVOVIĆ, Tatjana IVANOVIĆ

University of Prishtina, Faculty of Agriculture, Lesak, Serbia

*Corresponding author: goran.maksimovic@pr.ac.rs

Abstract

Agriculture has always been the primary activity of the inhabitants of Serbian enclave in northern Kosovo. Among agricultural sectors dominated by farming, there are good conditions for fruit growing, especially for the production of berries (raspberries, blackberries, blueberries). The mountainous landscape of the entire territory of northern Kosovo favours the development of animal husbandry. Qualitative method of observation and analysis method, were used during field research carried out in 2015. to examine the current operations of agricultural holdings. Using the method of synthesis, a solution for more harmonious economic development and prosperity of the Serbian population in the enclave in the north of Kosovo and Metohia is given in the paper. The authors upon research in the field suggest the reconstruction of existing and formation of new cooperatives in order to develop agriculture in the Serbian enclave in northern Kosovo in the field of production, processing, supply of inputs, services and marketing. Agricultural cooperatives despite the economic functions play a dominant role in the overall development of Serbian communities in northern Kosovo.

Key words: *agricultural cooperatives, production, economic development.*

Introduction

Agriculture is always being primary activity of the population in Serbian enclaves in north of Kosovo. Farming dominates among agricultural branches, there are good conditions for fruit growing of berries (raspberry, blackberry, blueberry). Entire territory of the municipality, by its configuration, is the hilly and mountainous, thus it is suitable for development of animal husbandry. Serbian population looks for an economic survival perspective in efficient dealing with agriculture. Intensive and economically justified agricultural production in Serbian enclaves has been disabled by a series of factors over many years. This paper defines problems in agricultural production and previous association of agricultural households.

Materials and methods

In this paper, we used qualitative method of observation to observe current situation of agricultural production in Serbian enclaves in Kosovo and Metohia. We used analysis method to study the performance of agricultural households and by synthesis method we provided the assumptions and options for more successful work and functioning of agricultural households in the Serbian enclaves in north of Kosovo and Metohia. Empirical research was realised through visits to family agricultural and existing cooperatives where we determined existing situation in the field in enclaves and interviewed the household owners and managers of cooperatives (where this wasn't possible, we obtained the information on cooperatives from the citizens of enclaves). Through interview, we got information on problems in performance of agricultural households and we will try to provide answers, propositions and solutions in order to help Serbian people in enclaves, at least a little, to remain and function in their ancestral homes. In addition to the data collected in the field, we also used the desk researching method (published materials and existing literature.)

Results and discussion

Through the interviews we carried out in the field in Serbian enclaves in north of Kosovo and Metohia, we analyze agricultural households, reach conclusions and list factors that have a significant effect on volume and structure of agricultural production after the war (1999.):

1) the households with small number of members dominate, 2) households whose members are rather old dominate (migration of younger population to central Serbia is expressed), 3) average surface of household is small, with great number of small parcels, which makes the use of mechanization significantly expensive and it makes more efficient production difficult, 4) impossibility to purchase varietal seeds and seedlings, as well as artificial fertilizers and rather difficult supply (due to administrative difficulties and safety), 5) lack and obsolescence of mechanization, 6) lack of bred livestock, 7) no organized purchase of agricultural products, 8) insufficient information about the use of funds meant for subsidies, premiums, regresses and crediting that is paid from the budget of the Republic of Serbia, which makes development of entrepreneurial initiatives in agriculture more difficult. The above mentioned factors point to the necessity of developing agricultural cooperatives and association of small agricultural households that have no perspective in the aspect of independent survival. Small agricultural households in Serbian enclaves in north of Kosovo and Metohia are economically powerless, exhausted, worn, obsolete and old and for that reason they should be joined and organized into agricultural cooperatives. They could jointly contribute to survival of Serbian population in ancestral homes and improvement of household's business, that will give the following: 1) contribution to the improvement of household supply (in supply of cooperative aimed at specific production needs for material and agricultural equipment, cooperative supply is cheaper and it involves lower margin), 2) contribution to the improvement of household's goods sale (cooperatives have more successful placement of greater amount of joint goods from family households), 3) contribution to more favourable use of services (avoiding irrational investments, cooperatives provide agricultural machines and vehicles in order to provide services for agricultural households). Cooperatives are specific organizations and for that reason they are simultaneously the enterprises that deal with business and the associations that have both economic and social goals (Zamagni, 2012. Dasgupta, 2012.). According to this organization, cooperative is an autonomous association of persons voluntarily associated, with the aim to achieve their common economic, social and cultural needs and desires, through jointly owned and democratically controlled enterprise. There are two different organizations in cooperative: cooperative itself and enterprise. Cooperative as an enterprise is a market entity, i.e. organization of different business activities. On the other hand, cooperative is the association of persons organized from the bottom according to principles of voluntariness, equality, democracy, solidarity of members, shareholders (Pejanović, 2013). Contributions that cooperatives achieve at local level can be classified into three categories: (1) employment increase, (2) local infrastructure improvement and (3) processing of agricultural products within local community (Lorendahl 1996). Principle by which the existing and newly formed cooperatives in Serbian enclaves in Kosovo and Metohija should do business is the principle of inter-cooperative cooperation. Cooperative as individual organization is alone and relatively powerless before big industrial systems and trade chains that are increasingly winning the market of rural areas. Therefore, it is required for the cooperatives to join the alliances because, when connected in this manner, they become a significant factor that can regulate the flows in local market and wider, depending on the number of cooperatives that joined the alliance, i.e. the volume of their business (Erokhin, 2009). This is the only way for alliances to represent a more adequate response of cooperative movement to globalization process. Joined in alliances, cooperatives remain consistent to their principles and respect

towards local community, but they are simultaneously able to economically more successfully confront gigantic enterprises in the market (Nikolić, and Popović, 2006). Development of agricultural households would be improved by activating the existing agricultural cooperative and purchase stations for agricultural products that would be placed to the factories for further processing. Agricultural cooperative „Leposavić“ in Leposavić in recent years does not work although it has potentials. It owns an administrative building, 2 warehouses (one in Leposavić and one in Sočani), 4 stores, equipment for dairy. It has about 50ha of agricultural land, about 30ha of which is arable land. For revival of agricultural cooperative it is necessary to use the existing potential (business and warehousing space, agricultural mechanization). It is necessary that the Republic of Serbia, through the Office for Kosovo and Metohija and local government provides financial funds primarily for the repair of the existing and supply of new mechanization, as well as purchase of consumable materials. Activation of cooperative is vital for the development of north Kosovo valley and it would have a positive impact on: 1) increase of production volume, 2) reduction of unemployment of population by employment on own households, 3) survival of existing and arrival of new returners, 4) self-sustainable development of this part of Kosovo

Agricultural cooperative “Zubin potok“ in Zubin Potok is the only cooperative in Kosovo and Metohija that hasn't stopped working and that is still active. This cooperative owns a building of 900m², hangars 800m², stables 600m², auxiliary buildings 800m² and 1,30ha of arable land. Cooperative has a fishpond whose capacity is 60-80t and it operates with its full capacity, animal food factory, laying hens farm. Animal and green markets have begun to work within the cooperative. In addition, this cooperative owns a refrigerator whose capacity is 1.500 tons in one turn. Capacity of refrigerator owned by this cooperative is such that it could take entire market surplus of agricultural products from serbian enclaves of entire Kosovo and Metohija and sell them to familiar buyers in northern Kosovo (student canteen, clinical center, canteen for workers in Trepča). It is required from the local government in Zubin Potok to predict the subsidies of such projects in its budget through the existing agricultural cooperative which enables the members of local community to achieve business goals more easily.

Conclusion

Today, the agricultural cooperative “Zubin Potok” in Zubin Potok is the only functioning one. We believe that other eight agricultural cooperatives should be restructured in the following aspects: organizational structure, managerial structure, financial structure (part of the capital is already owned by cooperatives that would, with consent of the Republic of Serbia, transfer to cooperative's ownership, part of the capital would be provided by members themselves from their shares and one part of the capital would come from the subsidies from local government) and human resources that will lead to enabling the cooperative to function in market business conditions. In town of Zavečan there are no cooperatives, although they have both resources and potentials, thus we propose the formation of new modern multifunctional cooperatives that could include: dairies, bakeries, mixers of animal feed, refrigerators. Principle by which already formed, restructured and newly formed cooperatives should operate in Serbian enclaves in Kosovo and Metohija is the principle of intercooperative cooperation. The necessity that motivates individual producers to join the cooperatives, because it is easier for them to face the market challenges, simultaneously affects the cooperatives. By promoting and developing cooperatives and cooperative alliance, by their activities, we achieve wider economic, social and general social interests of Serbian community from the employment increase in rural areas, stimulation of young people to survive in Kosovo and Metohia, to the improvement of agricultural production and preservation of living environment, as well as other aspects in rural areas.

References

- Dasgupta, P. (2012): New Frontiers of Cooperation in the Economy, Journal of Entrepreneurial and Organizational Diversity, Vol. 1, No. 1 (2012), 7-20
- Erokhin, V. (2009): Cluster Development of Regional Production Integration on the Basis of Cooperative Interaction of Agricultural Enterprises, Almanac of Modern Science and Education, vol. 3, pp. 60-62.
- Lorendahl, B.(1996): New Cooperatives and local Development: A Study of Six Cases in Jamtland, Sweden, Journal of Rural Studies, 12(2).
- Nikolić, M., Popović, V. (2006), Cooperatives as an initiator of local community development in rural areas, Agricultural Economics, Belgrade TB(53), (525-532).
- Pejanović, R. (2013) Agrarian Cooperative as an entrepreneurial organization in the rural and local community, Views from the agricultural and rural economy, Faculty of Agriculture, Novi Sad. Pp..345-362.
- Zamagni, V. (2012): Interpreting the Roles and Economic Importance of Cooperative Enterprises in a Historical Perspective, Journal of Entrepreneurial and Organizational Diversity, Vol. 1, No. 1 (2012), 21-36.

COMPARATIVE ANALYSIS OF AGRICULTURAL PRODUCTION SYSTEMS PERFORMANCES: CASE OF MILLET AND SORGHUM IN MALI.

Penda SISSOKO^{1,2*}, Philippe LEBAILLY¹

¹ University of Liège – Gembloux Agro-Bio Tech, Economy and Rural Development Unit, Belgium

² Institut of Rural Economy, CRRRA-Sotuba, Bamako, Mali

*Corresponding author: sissokopenda@hotmail.com

Abstract

This study was carried out to compare the performances of agricultural production systems based on millet and sorghum in Sahelian and sudano-Sahelian areas of Mali in 2014. The two systems compared were production techniques of micro-dosing fertilizer and traditional cropping called conventional cropping system of millet and sorghum. One hundred and eight farmers (108) were selected and interviewed in the two areas. The techniques of micro-dosing used were manual and mechanical fertilizers distribution. The tools used for analysis were descriptive statistics (frequency, average, standard deviation) and analytical method (ANOVA). The software's used were EXCEL, SPSS 20 and STAGRAPHS. The results of this survey show significant differences of mean at the plots levels. The production system based on fertilizer micro-dosing techniques is more efficient than traditional system of millet and sorghum through high yielding, lowering costs of fertilizers, diminution of farming operation work times and, high net profit at the plot level. The percent of yield obtained with manual technique is 41% and 52% with mechanical distribution (placement) for millet and respectively for sorghum 45% and 56%. The calculated cost ratio values (CRV>1) show that micro-dosing techniques are profitable for millet and sorghum production.

Keywords: *performance, production systems, millet and sorghum, Sahelian and sudano-Sahelian areas, Mali.*

Introduction

Agriculture in Mali occupies 70% of population workforce and provides 42% of gross income and 75 to 80% of annual exports constituted by agricultural and livestock products (MA/PNIP-SA, 2010). Millet and sorghum crops occupy an important position in the country food security system, supported since 2009 by the government as part of the Rice Initiative in the frame of inputs subsidies (USAID/MSU, 2011). With a total production of cereal estimated at 6,674,427 tons in 2013-2014, millet occupied the second rank with 1,802,095 tons followed by sorghum 1,201,397 tons (MA-CPS-SDR, 2015). These cereals are most consumed and used as basic food of rural populations (whole grain or processed into flour for porridge, couscous, bread and alcoholic beverages).

Although constant advances research on millet and sorghum, achieving substantial efficiency gains in unstable environment become a challenge. Their production and yields during the past 20 years (between 1990/91 and 2008/09) have slightly increased compared to rice and maize. The productions grew for millet to 68% and 42% for sorghum, compared to 224% for maize and 228% for rice (USAID/MSU, 2011). Their yields are strongly linked to the rainfall, but also locust attacks and the lack of agricultural equipment (Traoré *et al.*, 2002). From these identified factors, climate variability is quoted in the generality of cases as the main constraint of cropping systems in Mali (MAEP/CPS, 2004).

To solve these constraints, several technologies have been developed by Agricultural Research in collaboration with international research institutions such as ICRISAT. Improved

varieties and appropriate crop management technologies are part of the released technologies on-farm for their adoption by farmers.

The technique of fertilizer micro dosing which involves applying a small amount of mineral fertilizer (complex cereal, DAP) in bunches crop planting is cited as a method that has the potential to increase cereal yields under dry farming conditions (Aune et al 2008; Hayashi et al 2008).

In Mali, the technique is practiced on millet and sorghum crops in the Sahelian and Sudano-Sahelian rainfall zones between 400-600 mm and 600-800 mm. It is realized manually or mechanically with the use of the hopper called mechanical placement technique (Coulibaly and al. 2012). This study evaluates the performance of these techniques compared to traditional system production in the Sahelian and Sudano-Sahelian of Mali.

Materials and methods

Zone and samples

The study was conducted in the Sahelian and Sudano-Sahelian regions with a sample of 108 farms in three regions (Koulikoro, Segou and Mopti) of which 36 farms by region (Figure 1).

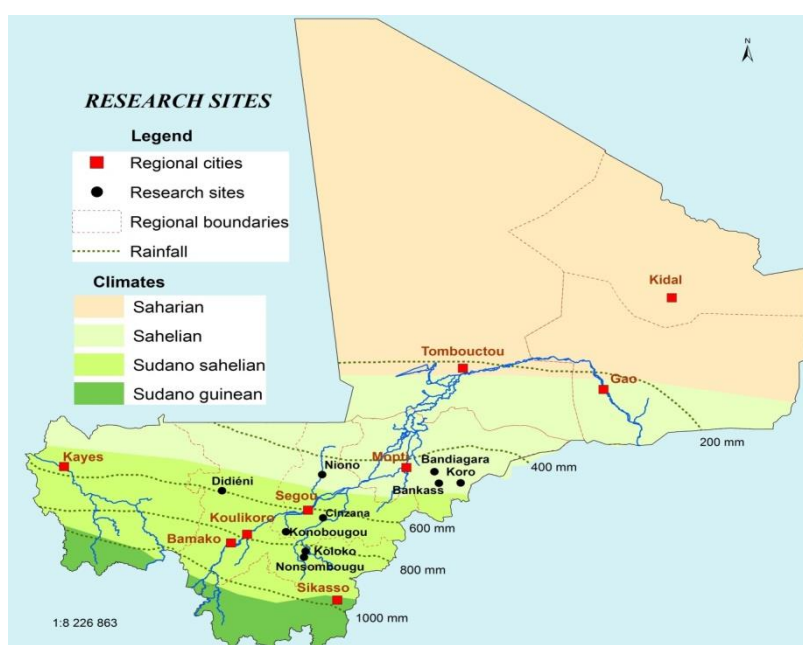

Figure 1: Map of regions and research sites in Mali.

Source: LABOSEP, IER-Mali, 2014.

Data collection and analysis

Data's were collected using semi-structured interviews (SSI) with farm heads. A previously established questionnaire was used as interview guide. The main data's collected are farm characteristics and production systems of which total and cultivated area farms, cultivated areas of millet and sorghum crops, quantities and costs of biochemical inputs used (seeds, fertilizers, insecticides and other, the labors (family and outside family) and agricultural equipments utilizations and their amortization. The descriptive statistics (average, frequency) and analytical methods (ANOVA analysis) were used for data's analysis with the software's SPSS and STAGRAPHICS.

Results and discussion

Socioeconomic characteristics and adoption technics by the farms

Surveys in research sites identified two (2) cultivation systems of millet and sorghum practiced by farmers. These are culture system with micro dosing techniques of fertilizer, and traditional culture or conventional culture system of millet and sorghum, called the farmer practice. The system with the micro dosing fertilizer is represented by two techniques: the manual and mechanical techniques. The mechanical called mechanical placement involves the simultaneous application of seed and fertilizer in the planting hole with hopper utilization. In all research sites, the adoption rate of these techniques is 69 % for mechanical against 31% for farmer practice.

Comparative performance of millet and sorghum production systems

Performance can be defined by search for high income, for the technical and economic profitability, employment and farms sustainability (Levallois, 2010). The concept of performance in objective or operational purpose is established by two other concepts, namely the effectiveness and efficiency. Efficient farm achieves the fixed goals and efficient farm maximizes the results with minimum resources and resources are managed with lower cost. The farm is successful, if it simultaneously efficient and effective, in other words it achieves its objectives while minimizing the use of its resources.

In this study, the performance of production systems is determined by the profitability and economic technique of identified systems on millet and sorghum crops. This profitability is assessed at agricultural plots of millet and sorghum. This is to compare the production system with fertilizer micro-dosing techniques and the traditional cultivation system of millet and sorghum.

Technical performance

Technical or agronomical performance of production systems in comparison is evaluated on millet and sorghum production and on the timework of farming operations.

Comparison of millet and sorghum production

- *Millet plots*

The results on millet plot show higher average yields on plots with fertilizer micro-dosing techniques than those obtained with the traditional farmer practice or system plots (Table 1). Average yields are respectively 1551kg/ha for micro-dosing technique with mechanical placement, 1256 kg/ha for micro-dosing technique with manual system and 741kg/ha for farmer practice. Increases in yields observed with the fertilizer micro-dosing technology compared with farmer practice are respectively 41% for the manual technique and 52% for technical mechanical placement.

The ANOVA test on yields shows a statistically significant difference between the yields in comparison techniques, indicated by the value P-value of statistic F test (table 2). The differences in average yields observed between techniques are 295kg/ha between the technique of mechanical placement and technique of manual micro-dosing, 514kg/ha between technical manual micro-dosing and farmer practice, and 810 kg/ha between the technique of mechanical placement and farmer practice.

Table1: Compared millet yields (kg.ha⁻¹) using three technics, 2014.

Technics	Count	Average	Standard deviation	Coeff. of variation	Minimum	Maximum
Manual microdo-sing	32	1256	320,84	25,55%	800	2200
Mechanical micro-dosing	15	1551	446,94	28,81%	1125	3000
Farmer practice	24	741	211,84	28,57%	400	1067
Total	71	1144	443,91	38,80%	400	3000

Table 2: Yield Statistics for millet, 2014. Method: 95,0 percent LSD.

Statistics tests	Valeur	Probabilité (P Value)
ANOVA F – statistic	32,81	0,000
Test on averages yields		
Contrast	Signification	Différence
Placement – Manual	*	295
Manuel – farmer practice	*	514
Placement - farmer practice	*	810

* significant at 5%.

Sorghum plots

The results on sorghum plot show higher average yields on plots with fertilizer micro-dosing techniques than those obtained with the traditional farmer practice or system plots (table 3 and 4). Increases in yields observed with the fertilizer micro-dosing technology compared with farmer practice are respectively 45% for the manual technique and 56% for technical mechanical placement.

Statistical tests on yields (Table 4) show a statistically significant difference between the techniques in comparison (P value of statistic F test). Average differences observed between techniques are significant. They are respectively 295 kg/ha between the technique of mechanical placement and technique of manual micro-dosing, 514 kg/ha between technical manual micro-dosing and farmer practice, and 810 kg/ ha between the technique of mechanical placement and farmer practice.

Table 3: Compared sorghum yields (kg.ha⁻¹) using three technics, 2014

Technics	Count	Average	Standard deviation	Coeff. of variation	Minimum	Maximum
Manual micro-dosing	22	1242	255,38	20,563 %	800	2000
Mechanical micro-dosing	17	1569	457,34	29,154 %	1033	2500
Farmer practice	11	686	295,97	43,122 %	300	1233
Total	50	1231	469,40	38,137 %	300	2500

Table 4: Yield Statistics for millet, 2014. Method: 95,0 percent LSD.

Statistic tests	Valeur	Probabilité (P value)
ANOVA F – statistic	58,59	0,000
Test on averages yields		
Contrast	Signification	Différence
Mechanical – Manual	*	327
Mechanical – Farmers practice	*	556
Manual – Farmer practice	*	882

* significant at 5%.

Compared farming operations work times

The performance of techniques in comparison has been evaluated for farming work times operation's that are sowing and weeding times, evaluated in man day per hectare (Hoe.j/ha). The results show a reduction of work times achieved with the technique of mechanical micro-dosing (placement), compared to those of the farmer practice (Figure 2).

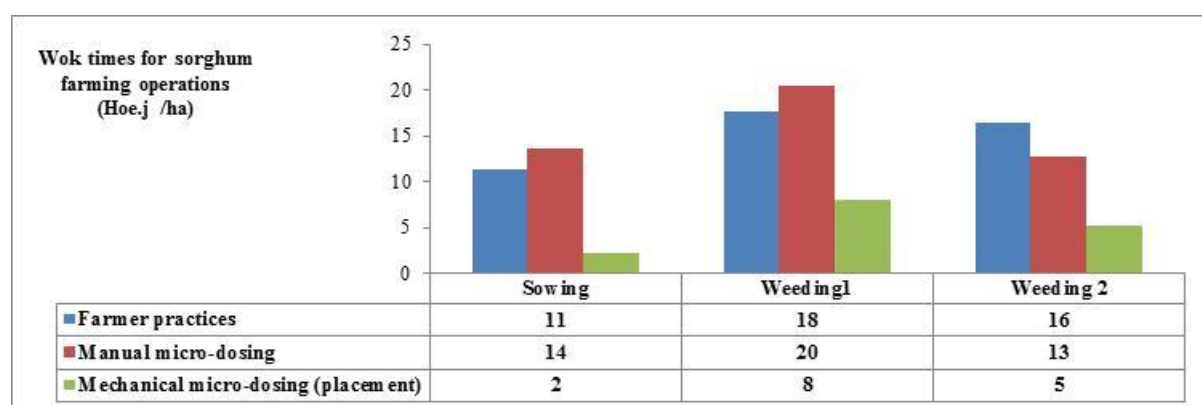

Figure 2: Wok times for sorghum farming operations (Hoe.j/ha)

Compared economic performance of technics

The benefit costs analysis (Ferraton and Touzard, 2009) were used to determine the economic performance of different production systems in comparison for millet and sorghum crops. The calculated performance indicators are in table 5.

- **The Gross value (GV):** is the value of crop system, calculated from the production quantity by area unit multiplied by the product market price. The market price during harvesting time for millet is 150 FCFA by kg, and 125 FCFA by kg for sorghum.

- **Variable charges (VC):** are represented by the cost of intermediate consumption (IC) which consist of input costs used (seeds, fertilizers , herbicides, pesticides and fungicides) and the labor costs (domestic and external) on millet and sorghum plots.

- **Gross margin (Gm):** is equal to the gross product (GP) minus variable charges (VC).

$$Gm = GP - VC$$

- **Net margin or benefit (Nm):** is the GVA minus the value of amortization (Am) (or fixed costs) of agricultural machineries used on parcels.

$$Nm = Gm - Am$$

Economic amortization is calculated by dividing the acquisition value of the equipment (excluding inflation) by the number of years during which it is really used before being replaced, either its useful life (Ferraton and Touzard, 2009).

- **Value Cost Ratio (VCR)** was used as an indicator to compare the profitability of the two production systems. It is defined as the ratio between the value of the additional production and additional costs. In this study, the value-cost ratio is calculated from the ratio of production value on all charges (variable and fixed).

On millet and sorghum, the estimated economic performance indicators show that the fertilizer micro-dosing techniques allow generating on millet and sorghum parcels higher profits or margins compared to the farmer practice (table). The calculated cost ratio values show that these techniques are profitable (CRV > 1). A CRV equal to 2 is generally accepted as critical threshold (Henk Kieft et al., 1994).

Table 5: Economic performance indicators on sorghum and millet using cropping systems technics (FCFA/ha).

Economic indicators (FCFA ¹ /ha)	Millet			Sorghum		
	Farmer practice	Manual microdosing	Mechanical microdosing	Farmer practice	Manual microdosing	Mechanical microdosing
1. Gross Value	111 213	188 343	232 667	85 796	155 245	196 091
2. Variables charges (VC)	91 420	80 360	44 894	102 983	92 461	58 843
Inputs	14 436	15 369	7 632	22101	11999	7811
Labor	76 984	64 991	37 262	80 882	80 462	51 032
Amortization (fixed charges)	5 468	3 392	3 937	3 087	3 617	1 891
Total charges (CT)	96 888	83 752	48 831	106 070	96 078	60 734
3. Gross margin	19 793	107 983	187 773	-17 187	62 784	137 249
4. Net margin or benefit	14 325	104 592	183 837	-20 274	59 167	135 357
5. C RV (value cost ratio)	1,1	2,2	4,8	0,8	1,6	3,2

Source : data survey, 2014.

Conclusion

Comparative analysis of millet and sorghum production systems in the Sahelian and Sudano Sahelian zones of Mali permitted to lay in evidence that the production system based on fertilizer micro-dosing techniques is more efficient than the traditional system cultivation of millet and sorghum. The technical and economic indicators assessed at crop parcels level show that these techniques can increase yields of millet and sorghum crops, reduce the work time of cultural operations and increase the profits of producers. The percent of yield obtained with manual technique is 41% and 52% with mechanical distribution (placement) for millet and respectively for sorghum 45% and 56%. The calculated cost ratio values (CRV > 1) show that micro-dosing techniques are profitable for millet and sorghum production.

References

- Aune, J.B., and Bationo, A. (2008), 'Agricultural intensification in the Sahel – the ladder approach', *Agricultural Systems*, Vol 98, No 2, pp 119–125.
- « Coulibaly A., Aune. B J., Sissoko P., Shinohara T., Caldwell. J S. Introduction of the technic of mechanical (placement) of fertilizer and seed microdoses. Technical Manual 8. IER-JIRCAS ., on 2012.»

¹ 1€= 656 F CFA

- Hayashi, K., Abdoulaye, T., Gerard, B., and Bationo, A. (2008), 'Evaluation of application timing in fertilizer micro-dosing technology on millet production in Niger, West Africa', *Nutrient Cycling in Agroecosystems*, Vol 80, No 3, pp 257–265.
- Kieft H., N Keita et van der Heide. 1994. Engrais fertiles? Vers une fertilité durable des terres agricoles au Mali, 99 p. ETC, Leusden, The Netherlands
- « MA/PNIP-SA. National plan of Priority Investment in the agricultural sector in Mali, 2011-2015. Report of PNIP-SA, in August. Cellule CEDEAO »
- « MAEP/CPS (Ministry of Agriculture, Breeding and Fishing)/Cellule of Planning and Statistics). Agro-ecological zoning and typology of farms, in January, 2004.»
- « MAEP/CPS (Ministry of Agriculture, Breeding and Fishing)/Cellule of Planning and Statistics). Annual report, 2015.»
- « Nicolas Ferraton and Isabelle Touzard. Understand agricultural family, CTA agronomic, Press of Gembloux, 2009 »
- « Raymond Levallois. Management of the agricultural company. Of the theory in the practice. 2010. Press of Laval University, 392p.».
- Samba Traoré, Minamba Bagayoko, Birama S. Coulibaly et Adama Coulibaly, 2002. Amélioration de la gestion de la fertilité des sols et celle des cultures dans les zones sahéliennes de l'Afrique de l'Ouest : une condition sine qua none pour l'augmentation de la productivité et de la durabilité des systèmes de culture à base de mil. 22p.
- « USAID/MALI/MSU. Evaluation of the agricultural sector in Mali 2001. MSU, définitif version, November, 2011 ».

SERVICES IN RURAL TOURISM IN THE REPUBLIC OF SERBIA

Gordana RADOVIĆ^{1*}, Radovan PEJANOVIĆ², Dunja DEMIROVIĆ³, Zoran NJEGOVIĆ²

¹„Dnevnik-Poljoprivrednik“ AD Novi Sad, Novi Sad, Serbia

²University of Novi Sad, Faculty of Agriculture, Department of Agricultural Economics and Rural Sociology, Novi Sad, Serbia

³University of Novi Sad, Faculty of Sciences, Department of Geography, Tourism and Hotel Management, Novi Sad, Serbia

*Corresponding author: gordana.radovic09@gmail.com

Abstract

The Republic of Serbia has comparative advantages for the development of rural tourism and the affirmation of the development of this type of tourism is supported if we observe the availability of resources, the relative development of agriculture as well as the possibility of rural development based on a multisectoral approach. The aim of this paper is to present the types of services provided by rural tourism subjects in the Republic of Serbia. In order to analyze the characteristics, authors have realized survey covering 104 rural tourism subjects in the 11 districts in the Republic of Serbia. The database of the National Association “Rural Tourism of Serbia” is used to form the sample. The sample was formed by random sampling. The instrument used in the study is a questionnaire. Methods that are used in this paper are: methods of analysis and synthesis, comparative method, field research and statistical methods. For the statistical analysis of data obtained by survey research, methods of descriptive statistical analysis and χ^2 (Chi-square) test are used and the SPSS software package. The authors analyze the results of research and propose measures and actions.

Keywords: *rural tourism subjects, services, the Republic of Serbia*

Introduction

The Republic of Serbia (RS) has great potentials for rural tourism development considering that 85% of its territory, according to the categorization of the Organization for Economic Cooperation and Development (OECD), make rural areas. Also, the Republic of Serbia has a favorable geographical position, rich historical and cultural heritage, preserved traditional rural architecture and attractive ethnic characteristics. In rural areas, numerous ethnographic and culinary events, and the population is characterized by traditional hospitality.

Factors which affect the growth of rural tourism offer are complex and according to some authors “the development of rural tourism is a long-term project” and its elements are: (a) people (expert) and the environment (clean); (b) a multi-sectoral approach to development; (c) engaging the local population in the drafting of development plans because “the local population has a better vision for the development of their region than the state authorities” (Koščak, 1995). A key feature of rural tourism is a rural identity, which “is crucial for the arrival and stay of tourists in rural areas”, and on the other hand, this type of tourism has a key role in preserving the identity of rural communities (Ružic, 2011). According to Pejanović (2013) rural tourism is a factor for stopping the migration from rural to urban areas.

There are significant linkages between agriculture and tourism. These economic activities are mutually complementary and multiply connected, because agriculture is producer, and tourism is consumer of agricultural product. According to Todorović and Štetić (2009), tourism is a factor in development trends of rural areas, additional activity to the rural population, agricultural markets, factor of agricultural development and “softener” of depopulation trends. According to the same authors, constraints affecting the development of

tourism and agriculture correlations can be divided into two categories: (1) the limitations that arise in the context of the agricultural households (lack of ambient tourist value of households, tourism offer, respectively accommodation and food supply with defined geographical origin); (2) limits of the community (non-existence of the concept of tourism development, legal vagueness and lack of adequate promotion of rural tourism).

According to Ciani (2003), appearance of rural tourism, or agritourism, and connecting these activities to existing agricultural activities, improved the quality of life on farms. Rural tourism development “cannot be seen only as economic growth, but also in terms of ecological and social development” (George et al., 2009). Sustainable development of rural tourism is part of integrated rural development, and it is defined as “a modern concept which represent a complex development of certain rural areas on the basis of available natural, financial, human resources and infrastructure, that need to be managed with due care to preserve the balance between man and nature” (Njegovan and Pejanović, 2009).

The affirmation of the development of rural tourism in the Republic of Serbia is supported if we observe the availability of resources, the relative development of agriculture, as well as the possibility of rural development based on a multisectoral approach. However, the average occupancy rate in rural tourism in the Republic of Serbia is only 4% (Program of sustainable development of rural tourism in the Republic of Serbia, 2011), while the average occupancy rate in rural tourism in the territory of the European Union is 25% (Bartlet, 2006). In order to achieve greater tourist traffic, as well as for the development of all forms of rural tourism in the Republic of Serbia, it is necessary to investment in: (a) the development of tourist facilities; (b) development of rural infrastructure; (c) the development and training of staff; (d) promotion (e) the development of sales channels of the rural tourism product in the domestic and international tourism market (Radović et al., 2015).

The aim of this paper is to present the types of services provided by operators of rural tourism in Serbia.

Materials and Methods

The starting hypothesis in the survey is: subjects of rural tourism, which provide both accommodation and food services, generate more revenue. In order to prove the thesis, survey research was realized on 104 rural tourism subjects. Sources of data in the completion of the survey are the subjects of rural tourism: rural tourism households, handicrafts, ethno houses, ethno villages, farmsteads, hotels that are located in rural areas, as well as other service providers in rural tourism in the Republic of Serbia. The research was conducted in 2012 and 2013, in 11 districts and 30 municipalities in Serbia. Surveyed respondents are located in the districts of: South Bačka, South Banat, Kolubara, Mačva, Moravički, Pirot, North Bačka, Srem, Šumadija, West Bačka and Zlatibor. Within these districts surveyed rural tourism subjects are located in the municipalities: Arilje, Aranđelovac, Bajina Bašta, Čajetina, Užice, Gornji Milanovac, Irig, Ivanjica, Kosjerić, Kragujevac, Kovin, Kula, Kovačica, Knić, Loznica, Ljig, Ljubovija, Mali Idoš, Mionica, Novi Sad, Nova Varoš, Osečina, Prokuplje, Prijepolje, Pirot, Požega, Sombor, Subotica, Srbobran and Valjevo. Districts were selected according to the level of rural tourism development in their area.

The database of the National Association “Rural Tourism of Serbia” is used to form the sample, because their database is the most complete, due to the fact that in Serbia there are no official data on the total number of entities engaged in rural tourism. The sample was formed by random sampling. The instrument used in the study is the questionnaire which contained 11 parts (groups of questions). The survey was conducted through a questionnaire, using a “face to face” technique and by sending the questionnaire by an email or post.

Methods that are used in this paper are: methods of analysis and synthesis, comparative method, field research and statistical methods. For the statistical analysis of data obtained by

survey research, methods of descriptive statistical analysis and χ^2 (Chi-square) test are used and the SPSS software package.

Results and Discussion

Sources of data in the survey are rural tourism subjects: rural tourism households, ethno houses, ethno villages, farms, hotels that are located in rural areas, as well as other service providers in the Republic of Serbia.

Table 1. Rural tourism subject classified by districts

District	Rural tourism Household	Homecraft	Ethno house	Ethno village	Farm	Rural hotel	Other service provider	Total
South Bačka District	1				6			7
South Banat District	7							7
Kolubarski District	9	1		1				11
Mačvanski District	4			1				5
Moravički District	10	1						11
Pirotski District	4	2						6
North Bačka District					3	1	1	5
Sremski District		5						5
Šumadijski District	8	2	1					11
West Bačka District	3	6	1		1			11
Zlatiborski District	18	2		4		1		25
Total:	64	19	2	6	10	2	1	104

Source: Radović, 2015 (Author s' elaboration based on the questionnaire survey results.)

Analyzing the structure of service providers in rural tourism in the Republic of Serbia (Table 1), it can be concluded that most of them are rural tourist households (62%). The entities listed by the current regulatory framework in the homecraft, account for 18%, 10% of farms, ethno villages 6% and 1.9% are ethno house and rural hotels, while 0.2% are other service providers. The dominant share of rural households is important in terms of the analysis of the types of services provided by subjects in rural tourism in the Republic of Serbia, especially the connection between agriculture and tourism, and the possibility of earning greater revenue by synergies these two activities. The sample is representative with respect to the fact that the survey covered 10.95% of the total number of providers in rural tourism in the Republic of Serbia.

Rural tourism subjects in the Republic of Serbia provide tourists services: (a) full board (accommodation and three meals); (B) half-board; (C) accommodation with breakfast; (D) lodging only, and (E) food only. According to the survey results, presented in Table 2, the majority of subjects (67.3%) provides the full board, which is the most cost-effective and economically, and provides them with the greatest potential for self-financing.

Table 2. Type of service that rural tourism subjects provide

Type of service:	Frequency (Number of providers)	Percentage (%)
– food only	2	1.9
– lodging only	15	14.4
– accommodation with breakfast	14	13.5
– half-board	3	2.9
– full board	70	67.3
Total:	104	100,0

Source: Radović, 2015 (Author s' elaboration based on the questionnaire survey results.)

Based on the results, we can conclude that the lowest number of surveyed rural tourism subjects (1.9%) provides food services only. We believe that this indicator is low, it shows little interest of agricultural producers to be involved in rural tourism activities, although providing food is a good start in tourism industry. Also, according to the results of realized research, 2.9% subjects provide half-board, bed and breakfast 13.5% and lodging 14.4%.

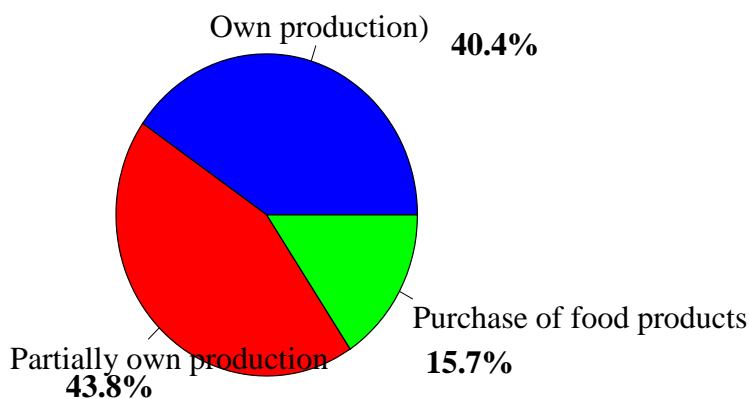

Figure 1. Relationship between food production and rural tourism

Source: Radović, 2015.

According to the results presented in Figure 1, the majority (40.4%) of the surveyed subjects in rural tourism have self-produced food products. Based on this data it can be concluded that there is a significant relationship between agriculture and rural tourism in the Republic of Serbia. Foodstuffs for tourist activity partly independently produce 43.8% subjects, while 15.7% surveyed subjects purchase food from other agricultural subjects or in retail stores. Based on the results of Chi-square test, it can be concluded that there is a statistically significant relationship between the amount of realized income and the food service providing (Table 3). This result confirms the basic hypothesis that rural tourism subjects, which provide both accommodation and food services, generate more revenue. If the rural tourism subjects are also agricultural producers too, in this way, they will achieve a double benefit. This is because selling agricultural products through rural tourism creates a higher income than if agricultural products are sold independently on the markets.

Table 3. Crossbreeding of gross income and food service providing

Food service	Results	Annual income (RSD)					Total
		to 150.000	to 300.000	to 500.000	to 1.000.000	Over 1.000.000	
No	Number	33	23	13	8	9	86
	Expected number	30.6	20.7	12.4	7.4	14.9	86.0
	%	38.4%	26.7%	15.1%	9.3%	10.5%	100%
Yes	Number	4	2	2	1	9	18
	Expected number	6.4	4.3	2.6	1.6	3.1	18.0
	%	22.2%	11.1%	11.1%	5.6%	50%	100%
Total	Number	37	25	15	9	18	104
	Expected number	37	25	15	9	18	104
	%	35.6%	24%	14.4%	8.7%	17.3%	100%

Source: Radović, 2015 (Author s' elaboration based on the questionnaire survey results.)

Result: The value of Chi-square test is statistically significant ($\chi^2=16,453$, $df=4$, $p=0,002$).

Conclusion

The development of rural tourism in Serbia is a possibility, but also the necessity, taking into account available resources, viewing the process of economic underdevelopment and depopulation of rural areas. The development of rural tourism would enable diversification of the rural economy, additional income for rural population, would reduce unemployment, and reduce differences in economic development between rural and urban areas. The development of rural tourism would allow the development of agriculture, if the rural tourism subjects are engaged in tourism and agriculture in parallel, or if they would provide both accommodation and food services, while through catering sell their own agricultural products.

According to the survey, 67.3% rural tourism subjects in the Republic of Serbia provide full board (accommodation and food). This is economically most profitable, and provides them with the greatest potential for self-financing. Based on the results of statistical analysis (Chi-

square test), the hypothesis is confirmed - rural tourism subjects, which next to the accommodation provide food services to tourists, generate higher revenues from those rural tourism operators who do not sell food.

Also, according to the results, majority (40.4%) of the surveyed subjects in rural tourism, self-produce foodstuffs, which suggest that in Serbia there is a significant relationship between agriculture and rural tourism. We believe that there needs to be a higher percentage of rural tourism subjects who produce agricultural products by themselves. To this end, it should be introduced a legal obligation, as in some European countries, that the majority of food products household produce by themselves, or to buy from neighbors farmers. This would also enable benefit for those rural tourism households that do not have accommodation facilities.

References

- Bartlet, T. (2006). Rural Tourism development in Europa, International Forum on Rural Tourism, China, 4-6. September 2006., Final Report World Tourism Organization.
- Ciani, A. (2003). The Multifunctionality into Managerial Approach as the Challenge towards the Renaissance of Rural Areas in the 21th Century, the Role of Rural Tourism and Agritourism. Zbornik radova, Drugi Forum: Ruralni turizam i održivi razvoj Balkana, Kragujevac, 07.-09.maj 2003. godine, str. 5-24.
- George, W., Mair, H., Reid, D. (2009). Rural tourism Development Localism and Cultural Change. Channel view Publicatios, Toronto, Canada.
- Košćak, M. (1995). Razvoj ruralnog turizma u Sloveniji (Development of rural tourism in Slovenia), Turizam, broj 7-8/1995, str. 134-142.
- Njegovan, Z., Pejanović, R. (2009). Ruralna regionalizacija AP Vojvodine (Rural regionalization of Vojvodina province). University of Novi Sad, Faculty of Agriculture, Novi Sad.
- Pejanović, R. (2013). Ogledi iz agrarne i ruralne ekonomije (Views from the agricultural and rural economy). University of Novi Sad, Faculty of Agriculture, Novi Sad.
- Program development of sustainable rural tourism in the Republic of Serbia, Official Gazette of the Republic of Serbia No.85 / 2011.
- Radović, G. (2015). Modaliteti finansiranja ruralnog turizma u Republici Srbiji (The modalities of financing of rural tourism in the Republic of Serbia), PhD thesis. University of Novi Sad, Faculty of Agriculture, Novi Sad.
- Radović, G., Pejanović, R., Demirović, D., Njegovan, Z. (2015). Forms of rural tourism in the Republic of Serbia. In: Book of Proceedings, Sixth International Scientific Agricultural Symposium: „AGROSYM 2015“, Jahorina, October 15-18.,2015., pp. 1943-1948.
- Ružić, P. (2011). Ruralni turizam Istre (Rural tourism in Istra). Institute for Agriculture and Tourism, Department of Tourism, Poreč.
- Todorović, M., Štetić S. (2009). Ruralni turizam (Rural tourism). University of Belgrade, Faculty of Geography, Belgrade.

THE IMPORTANCE OF RURAL AREAS FOR RURAL TOURISM DEVELOPMENT OF SERBIA

Jelena PREMOVIĆ^{1*}, Agneš BOLJEVIĆ², Ljiljana ARSIĆ³

¹Municipality of Vrbas, Serbia

²Faculty of Economics Subotica, University of Novi Sad, Serbia

³Faculty of Economics Kosovska Mitrovica, University of Kosovska Mitrovica, Serbia

Corresponding author: jelena.premovic@gmail.com

Abstract

The largest part of the Serbian territory (around 85%) belongs to the so-called rural areas, with a variety of ecosystem and biodiversity. The share of population living in the countryside is around 55%. Rural tourism has been identified as a key factor that can help in promoting Serbian rural areas as ecological oases with specific cultural, national and historic heritage. Grosso modo, rural tourism represents every tourism activity that takes place in rural areas. The basic premise on which is based this paper is that rural areas have significant potential for rural tourism development and for sustainable economic development of Serbia. Starting from this premise, authors analyze the basic characteristics of rural tourism, rural areas of Serbia and their real touristic potential. Work is based on several methods: induction and deduction, the method of analysis and synthesis, comparative method as well as historical method. Although the Serbian rural areas spread over a large part of its territory, they are facing numerous problems. Based on the results of the research conducted within the rural areas on the territory of Serbia, it was concluded that Serbian rural areas are characterized by a high degree of differentiation. This differentiation is reflected also in the field of social development, demographic trends, economic development, quality of life, environmental and other characteristics.

Keywords: *rural areas, rural tourism, ecology, sustainability, rural development.*

Introduction

Tourism represents one of economically most perspective activities in world. “Tourism industry” is rapidly evolving, creating a huge profit, which provides expansion of the material base and employment of a large number of people (Milenković, 2009). Tourism participates in the world gross domestic product with around 10%; over 6% of total exports in the world and about 30% of world trade in services are gained through tourism (UNWTO, 2016).

The most interesting destinations for modern tourists are rural areas with untouched nature and specific anthropogenic values. Therefore, tourism in rural areas- rural tourism is becoming an increasingly important form of tourism.

Rural tourism can be defined in many different ways. One of the first definitions of rural tourism was proposed by the European Commission in 1986: „Rural tourism is a broad concept that includes not only farm tourism or agritourism—accommodation provided by farmers—but all tourist activities in rural areas“ (European Commission, 1986). Daugstag (2008) defined the discovery of the rural land as “a refuge from urban life”. That is, it represents an alternative to embracing globalization. Cawley and Gillmor (2008) argued that we could speak of rural tourism when there were strong links with the land’s economic and productive activities, and three main features were in evidence: integration, sustainability, and endogeneity. Schubert (2006), on the other hand, believed that rural tourism represented a key strategy for regional development. Zhou (2014) asserted that rural tourism was by nature mainly “domestic, and positioned as a small-scale activity” (Garau, 2015).

What is common to all of these definitions is that rural tourism offers the visitor a "rural environment", offering him a combination of experiences in nature, culture and people with typically rural character. Rural tourism is a specific form of tourism that includes a complexity of all activities and aspects of an integrated tourist product such as recreation in the countryside, enjoying environment and peace of rural areas, enjoying nature, national parks as well as nature parks, cultural tourism, tourism on rural households.

Materials and methods

Rural tourism takes place in a rural area, outside the city. Residents of large cities are increasingly seeking rest and relaxation in some of the rural areas far from the city and the city noise. Many villages- rural areas provide an opportunity for development of rural tourism, within existing as well as those partly or completely abandoned. The concept of village could be defined as an area where the majority of population makes a living by a primary agricultural production and mostly breeding animals and growing plants. Natural heritage such as arable land, forests, rivers, lakes and climatic conditions are usually the main factor that influences the development of a country (Radosavac et al., 2013).

The basic premise on which is based this paper is that rural areas have significant potential for rural tourism development and for sustainable economic development of Serbia. Starting from this premise, authors analyze the basic characteristics of rural tourism, rural areas of Serbia and their real touristic potential. The main objective of this paper is to determine basic characteristics of Serbian rural areas and their real possibilities for the rural tourism development.

Analyzes of the role and importance of tourism in preserving and promoting rural areas and fostering rural development in the Republic of Serbia are based on contemporary national and international theoretical knowledge and relevant sources. Work is based on several methods: induction and deduction, the method of analysis and synthesis, comparative method as well as historical method.

Results and discussion

In view of global economic dynamics, planning and programming for the development of sustainable rural tourism represents one of the new challenges for strengthening and revitalizing lands that are otherwise not competitive (Garau, 2015).

The basic assumption of the development of rural tourism consists of favorable natural and demographic conditions. Attractiveness of rural tourism is assessed by the availability of healthy food, unpolluted air and water, healthy climate and the environment, peace and tranquility, preserved nature, preserved social and cultural heritage, restaurants, good infrastructure, picturesque region and others. According to the World Tourism Organisation (UNWTO), the concept of rural tourism is based on rich natural resources, rural heritage, rural lifestyle and rural activities. Natural resources include mountains, rivers, lakes, forests, and rural heritage includes traditional architecture, industrial heritage, history, castles, churches, villages. Rural life is related to entrepreneurship, local events, gastronomy, traditional music, rural activities related to horse riding, cycling, fishing, hiking and sports (Radosavac et al., 2013).

The largest part of the Serbian territory as much as 85%, according to OECD criteria, belongs to the so-called rural areas, where live 55% of the total population in Serbia and where are most natural resources with rich ecosystems and biodiversity. Rural tourism has been identified as a key catalyst that should activate the differentiation in the rural economy by starting new business initiatives and by finding synergies between the existing agricultural production and tourism (UNWTO, Tourism & Leisure Advisory Services, 2011). Tourism can play a significant role in promoting Serbian rural areas as a kind of ecological oasis with a

specific nature and cultural and historical heritage. Given that sustainable tourism depends mostly on the geographical physiognomy of rural areas, comparative advantages for the development of this type of tourism in Serbia are obvious.

There are various definitions of rural areas - environments, depending on the country. When it comes to rural areas, the practice of the EU goes in favour of the fact that it is primarily necessary to define a rural area. By definition of the European Commission, the rural region is a territorial unit with coherent economic and social structure of diversified activities. This entity can include villages, small towns and regional centres. According to the OECD, typology of rural regions are divided into three groups:

1. Regions in which over 50% of population lives in rural communities – rural regions,
2. Regions in which 15% to 50% of population lives in rural communities – significant rural regions, or rural regions,
3. Regions in which less than 15% of population lives in rural communities – predominantly urban regions.

Using the OCED typology of regions on the example of EU, we get data according which rural regions are consisted around 55% of territory, significant rural regions of 37% of territory and 8% territory of EU can be considered as predominantly urban areas.

Nevertheless, rural areas are determined based on population density, land use and community identity. Based on these characteristics, rural areas can be defined as areas with a low concentration of the population whose primary occupation is agriculture, characterized by special customs and rural identity. Considered from the perspective of the modern business environment, rural areas are not only rounded agricultural areas intended solely primary production, but represent areas with significant potential for tourism development through meeting the various needs, such as environmental protection, preservation of traditional values, recreation, leisure, sports, different cultural and historical content, etc.

The Republic of Serbia does possess the comparative advantages, but they are insufficiently exploited for the purpose of rural tourism development. This is backed up by the fact that the average occupancy is only 4%, as well that it varies significantly throughout the year (Radović et al., 2012). Although the Serbian rural areas spread over a large part of its territory, they are in a very precarious position and are facing numerous problems.

The rural areas of Serbia are characterized by a high degree of differentiation in terms of size and morphology of the settlement, the natural conditions and infrastructure. This differentiation is sustaining on the plan of social development, demographic trends, economic development, quality of life, environmental and other characteristics.

In addition to the intense differences between the rural areas of Serbia, what they have in common, unfortunately, is „dying“ villages due to large migrations from rural to urban areas. As a result of migration from rural to urban areas, there is a so-called „depopulation“ of the village. Not only from the village leaving the working age population, thereby reducing the available workforce, but leaving young professionals and educated people that their knowledge could affect economic development and improving the current situation. Therefore, in solving the existing problems must start from the rural development policy and strategy formulation, but also from the lowest level - the level of rural municipalities. Using the appropriate instrument for stimulating local economic development, directly affects the rural development and development of the country as a whole (Pejanović and Njegovan, 2011; Premović and Pejanović, 2016).

The rural areas of Serbia, with its great variety of tourist resources, wants to become challenging for tourism development. That could achieve with the greatest inventiveness of their local communities, entrepreneurial initiatives, on clearly feasible target innovation in rural tourism. Also, in future development, rural areas of Serbia, in order to satisfy multiple challenges, must realize cluster grouping and systematization of themed rural-tourist entities,

so that all regions of rural areas in Serbia together become competitive in the tourism market without unfair competition tourist destinations within them.

Rural areas of Serbia provide many challenging activities. The most important can be marked the following:

- a. challenge of the independent tourism offer, with complete rural-tourist facilities;
- b. challenge of the compatibility of rural-tourist area, with mountain centers, spas, urban and similar forms of tourism;
- c. challenge of marketing mix of rural-tourist area, with the promotion of tourism products facilities in rural areas of Serbia;
- d. challenges of transition rural-tourist area, through the valorization of tourism next to tourist traffic corridors in the area;
- e. challenges of excursion activities in rural areas, through the development of tourism in mainly hilly area of the space;
- f. challenges of the specific integrity of tourist-rural areas of Serbia, through diffuse resorts, didactic farms, ethno-villages and bio-tourism garden, as well as through identified „the country“ (e.g., The fifth country in Italy), etc.; and
- g. all other challenges, which are a mix of forms and sub forms of tourist activities with „the central leader“ rural tourism in rural areas of Serbia“ (Milenković, Utvić, 2013).

In identifying real opportunities for activation of rural areas and their placement in the function of encouraging sustainable rural tourism in Serbia and local economic development, an important role must be handed over to local communities in these areas, primarily raising awareness and educating local rural population about the cultural, historical and natural attractions of the rural communities in which they live. Local municipalities, but also individuals in them are becoming increasingly important factors for success and effectiveness of rural development policy (Pejanović, Njegovan, 2011).

Practice has shown that the financial instruments are an extremely important tool for stimulating local economic development, and therefore rural development. Through the use of various financial instruments, such as financial assistance programs through micro-credit, guarantees, loans, various funds and instruments of public finance, self-taxation, public administration, foreign direct investment, international donations etc., can be influenced by the local economic development of rural areas, and thus indirectly on the economic development of Serbia overwhole (Premović, Pejanović, 2016).

In order to rural areas of Serbia could realize all the distinctive challenges of tourism development, must comply with accepted systems of standardization and product quality in rural tourism, as well as at each position, with ratified certificates, to allow unimpeded growth and development of tourism as an integral part of the economic system (Milenković, Utvić, 2013).

Taking into account the results of various studies that have been carried out in the country and the region, it can be assumed that for every eight new tourists to rural areas in Serbia a new direct job position is generated, additionally each 25 daily visitors present an opportunity for a new direct job position. Based on 10 years projections made on creating new jobs in Serbia arising from rural tourism that were made for the purpose of the Master Plan for sustainable development of rural tourism in Serbia, is expected to create realistic presumptions for as much as 250,000 new jobs in rural areas (Premović, Pejanović).

These are all reasons why rural tourism is emerging as a real possibility of development of rural areas and as an element of a better utilization of the comparative advantages of rural areas in Serbia.

Conclusion

The positive effects of sustainable development of rural tourism are numerous. Based on the research of basic characteristics of sustainable tourism and rural areas of Serbia, as the most important benefits of sustainable rural tourism are seen to be following:

- protection and preservation of natural, cultural, national and historical heritage
- keeping the local population in rural area and prevention of migration to urban areas
- development of related economic and non-economic activities, primarily agriculture and services
- an increase of employment of the local population
- increase in income (and/or additional opportunities for income)
- sustainable rural development and sustainable economic development of Serbia as a whole.

Research that is on Serbian territory enforced by the ministry responsible for tourism have shown that the key of success of rural tourism development should be sought in the optimal utilization of the potential of rural areas, active effort, modern approach, quality staff and managers, and in good use of known instruments of stimulating local economic development. Therefore, rural tourism is emerging as a real possibility of development of rural areas and as an element of a better utilization of the comparative advantages of rural areas in Serbia. It can be concluded that Serbian rural areas have important role in fostering rural tourism and sustainable economic development of Serbia.

References

- Daugstad, K. (2008). Negotiating landscape in rural tourism, *Annals of Tourism Research*, vol. 35, issue 2, pp. 402–426.
- Cawley, M., Gillmor, A.D. (2008). Integrated rural tourism: Concept and practice. *Annals of Tourism Research*, vol. 35, issue 2, pp. 316–337.
- Garau, C. (2015). Perspectives on Cultural and Sustainable Rural Tourism in a Smart Region: The Case Study of Marmilla in Sardinia (Italy), *Sustainability* 2015, 7, pp. 6412-6434, doi:10.3390/su7066412.
- European Commission (1986). Community action in the field of tourism: Commission communication to the Council, *Bulletin of the European Communities*, Supplement, vol. 4/86.
- Milenković, S. (2009). *Tourism and economy*, monography, University of Kragujevac, Faculty of Economics, Kragujevac.
- Milenković, S., Utvić, S. (2013). The challenges of rural areas in Serbia promising tourist activities, *Economics of Agriculture*, The Balkan Scientific Association of Agrarian Economists, Belgrade, Institute of Agricultural Economics, Belgrade, Academy of Economic Studies, Bucharest, Belgrade, vol. LX, no. 1, pp. 65-76.
- Pejanović, R., Njegovan, Z. (2011). *Rural development and local economic development of Vojvodina*, monography, University of Novi Sad, Faculty of Agriculture, Novi Sad.
- Premović, J., Jovanović, D., Arsić, Lj. (2015). The role of tourism in fostering rural development, Book of Proceedings: VI International Scientific Agricultural Symposium „Agrosym 2015“, Jahorina, October 15-18, 2015, pp. 1949- 1954.
- Premović, J., Pejanović, R. (2016). *Green economy in the function of sustainable tourism development of Serbia*, Thematic Proceedings II: The First International Scientific Conference: Tourism in function of development of the Republic of Serbia, University of Kragujevac, Faculty of Hotel Management and Tourism in Vrnjačka Banja, Vrnjačka Banja, 2-4 June, 2016, pp. 394-411.

- Premović, J. (2016). Characteristics of human resources in Serbian rural tourism, *Economics of Agriculture* 2/2016, UDC: 005.96:338.48-44(1-22)(497.11), EP 2016, (63) 2 pp. 633-647.
- Radosavac, A., Jović, N., Jašić, M., Premović, J. (2013). Rural tourism and food production in Bosnia and Herzegovina, Book of Proceedings: IV Interantional Scientific Symposium „Agrosym 2013“, Jahorina, October 3-6, 2013, pp. 1385-1391.
- Radović, G., Pejanović, R., Njegovan, Z., Košić, K. (2012). Event tourism as a potential generator of development of the rural tourism in the Republic of Serbia, Book of Proceedings: Third International Scientific Simposium „Agrosym Jahorina 2012“, Jahorina, November 15-17, 2012, pp. 698-704.
- Schubert, D. (2006). Active regions–shaping rural futures: A model for new rural development in Germany. In *Coherence of Agricultural and Rural Development Policies*, OECD Publishing, Paris, France, pp. 333–352.
- UNWTO. (2016). *Tourism Highlights*, 2016 Edition, pp.1-16.
- Zhou, L. (2014). Online rural destination images: Tourism and rurality. *Journal of Destination Marketing & Management*, pp. 227–240.

DISTRIBUTION CHANNELS OF APPLES IN THE REPUBLIC OF SERBIA

Marija UROSEVIC^{1*}, Borislav RAJKOVIC¹, Vladimir JOVANOVIC², Vlade ZARIC¹

¹Faculty of Agriculture, University of Belgrade, Belgrade, Serbia

²NIRAS International Consulting

*Corresponding author: uro.marija@gmail.com

Abstract

This paper aims at analysing distribution channels of apples in the Republic of Serbia in 2015, with particular focus on export of fresh apples. Apple production of Serbia in 2015 is increased compared to the year before. Concurrently, apple export is increased when comparing the same intervals. Apples found in export originate mostly from orchards owned by big companies or from a well known fruit growing regions in Serbia (Grocka and Smederevo). Introduction and popularisation of Ultra Low Oxygen (ULO) keeping facilities had the big part in export development in Serbia since 2005. Efficiency of all business decisions is affected by choice of marketing channel. Serbia is a leading regional producer and exporter of apples. One of the biggest export problems is obsolete assortment. The most common variety is "Ajda red", followed by Golden Delicious, Red Delicious and Granny Smith. Other varieties are less frequent. Apples can be found in different types of distribution channels, such as processing, selling at green market, wholesale or retail, but more than a half of apple production is exported and this percent increases every year. Large quantities of fresh apples are processed into apple juice. Other types of processed apples products are puree, jams, dried apples, and apple brandy. These product categories has low share in total quantities of processed apple products in Serbia.

Keywords: *Distribution channels, apples, export, Serbia*

Introduction

Marketing mix includes several elements, and one of them is place, or distribution channel. Distribution is achieved by using one or more distribution channels, including retailers, distributors, wholesalers or direct selling. The choice of marketing channel affects the efficiency of all the other marketing and business decisions (Zaric, 2013). Agricultural products can be delivered to consumer by direct or indirect distribution channels. Direct selling contains advantages and disadvantages. Some of the advantages are: good way to meet new people and the environment, the possibility of flexible working hours, products demonstration, and positive image of product sold in this way (Stankovic and Djukic, 2013). On the other hand, the main disadvantages are: statutory requirements for higher hygiene, increased workload on the farm, distance market. Direct sales require additional work, like making calculations, sales planning, packaging and storage, delivery and invoicing, processing, which leads to increased costs.

Green market is one of the examples for direct distribution channels, where some of the agricultural products, like fruits and vegetables, have a large share of turnover. Individual producers, with low production, mostly sell their products at green market. Agricultural products at the markets are mostly fresh, with different quality, and consumers have habit to taste them (Miljkovic and Alcakovic, 2015).

When choosing indirect distribution channels, producers need to pay attention about reputation, credibility and strength of the trader, as well as consumer preferences and company goals.

Overall, the objective of this paper is to determine the direct and indirect distribution channels of apples in the Republic of Serbia.

Material and Methods

The paper is based on a review of Statistical Yearbooks issued by Statistical Office of the Republic of Serbia and on a review of data issued by Ministry of Agriculture and Environmental Protection. Other sources which are used in this paper are websites of different organizations and institutions, such as: Food and Agriculture Organization of the United Nations (FAO), International Trade Centre (INTRACEN), and The World Economic Forum (WEF). Information is also collected from several different scientific journals, magazines and newspapers. Collected data are related for 2015.

Methods used in this paper were collecting, arranging and analysing the relevant data. Data are analysed by calculating mathematical-statistical indicators (annual growth rate, share of total), after which they were presented in diagram.

Results and Discussion

Serbia is a regional leader in apple production and export. Apple production in 2015 was 355.664t and has increased for 1.06% compared to 2014. In Vojvodina province, apple production is mainly based on intensive cultivation. The most of fruit growers have over 10 ha of orchard areas (Vlahovic and Puskaric and Velickovic, 2015). In this region importance of big companies is significant. During the recent years, they have begun intensive modern production. One of them is company Delta Agrar which has a modern apple orchard that extends over 400 ha. The other significant regions are Grocka and Smederevo. Producers with similar selling types are also in Topola and Cacak. Apple orchards in these areas are less than those in Vojvodina (2-10 ha). Producers from Grocka, Smederevo, Topola and Cacak usually sell their apples at local markets, the wholesale market in Belgrade, or through retailers.

State incentives help agricultural producers in raising orchards, and also provide institutional support for organic production and processing. Serbia became a significant exporter due to construction of the Ultra Low Oxygen (ULO) refrigerators in 2005.

Based on collected data, different types of distribution channels of apples have been found. The following diagram shows the distribution channels with their share in apple production.

Diagram 1. Distribution channels of apples in Serbia in 2015

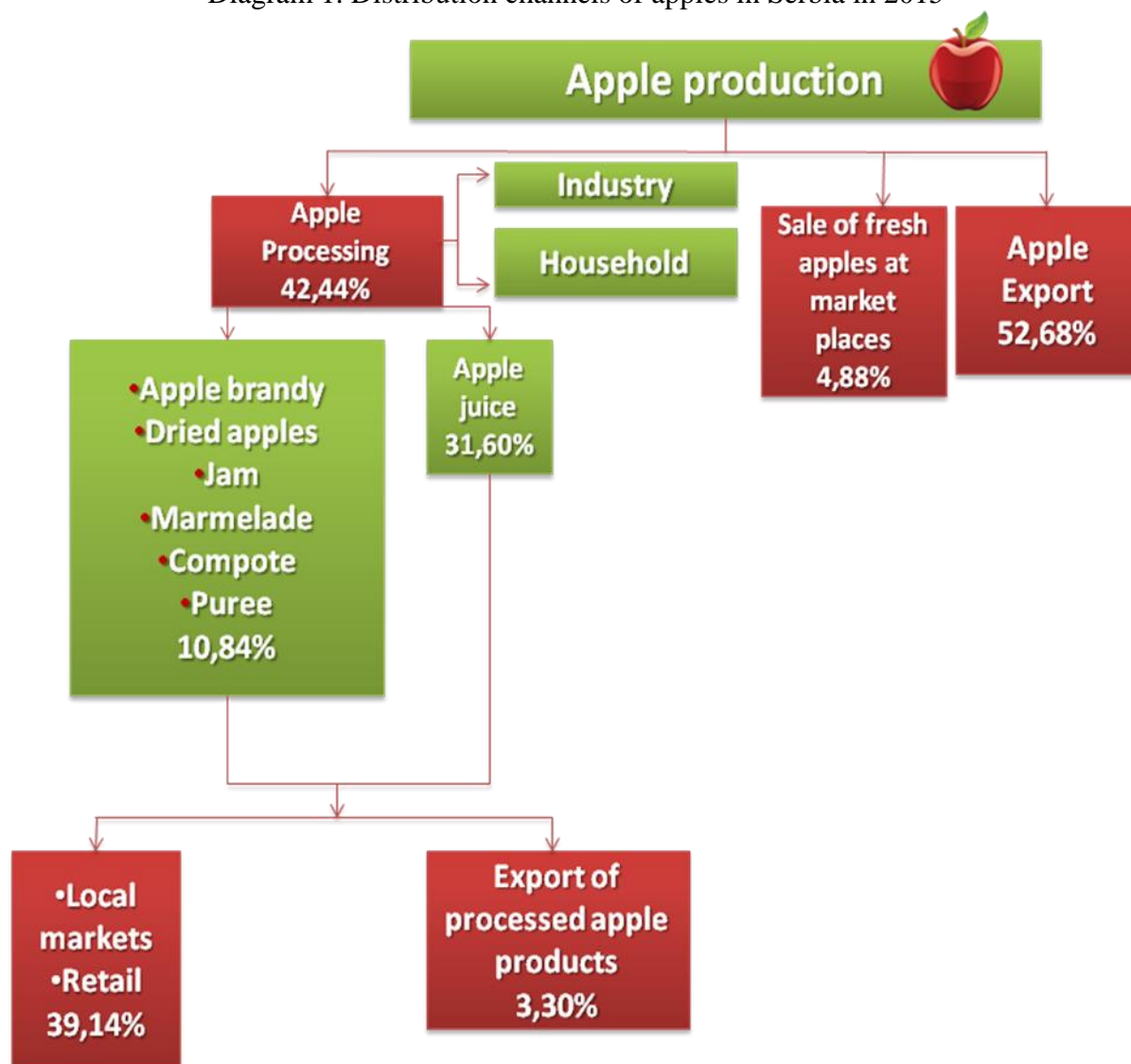

*Source: Author's elaboration based on analysed data.

Compared to the total apple production (355.664t) in 2015, only 4.88% was sold through green market (i.e., about 17.000t). Apples at the green markets are mostly fresh, with different quality, meant for consumers with different purchasing power. Even though the share of green markets in selling apples is low, individual producers will sell their products directly, as long as appropriates the difference above the lower purchase and higher retail prices (Miljkovic and Alcakovic, 2015). Apples processing has share of 42.44%. The main processed products are: apple brandy, dried apples, jam, marmalade, compote, puree, and apple juice. Large quantities of apples were processed into juice (Djuric, 2009). The share of apple juice in total processed apple products is about 31.60%. Only 1-2% of produced apple juice was exported. The rest of processed products (apple brandy, jam, dried apples etc.) had only 1% of share in total export of apple processed products. About 39.14% of processed apple products were sold through local green markets and retailers. Quality standards in the European Union (EU) and other countries have become very high. Consumer's requirements for high quality products caused significant changes concerning quality standards that exported products have to fulfil. More than a half of produced apples (i.e., 52.68%, or around 178.000 t) were exported. Share of fresh apples in total export was 50%, while apples for brandy accounted for only 2%. It is

assumed that apples for brandy are of lower quality. Around 90% of exported apples were exported to the Russian Federation and this figure increases every year. To export any product to Russia certain specific standards have to be fulfilled. These standards are regulated by GOST R certificate. Exporting large quantities of some product to one country implies big risks. Example is the Russian embargo that had significant impact on several countries. Thus, it is important to diversify export markets.

Conclusion

Agricultural products can be delivered to consumer by direct or indirect distribution channels. Serbia is the leader in apple production and export in region, but still has a lot to improve, in order to become competitive with the biggest world producers and exporters. More than a half of produced apples are exported (90% of is exported to Russia). Rest of the produced apples were processed, mostly into apple juice. Most of the processed products were sold in domestic markets. Only 5% of produced apples were sold on green markets. Green markets are still present, but their share in total sales of produced apples is decreasing every year. Exporting of processed products quantitatively is low, but value of processed products is high and it should not be ignored. Use of new production methods, like organic production, and modern varieties, such as Gala, Pink Lady, Fuji etc, shall be the first step in increasing of quality.

References

- Djuric D., (2009): Analysis of the competitiveness of fruit and fruit products in the light of foreign trade of the Serbian economy, Business School, No. 1, Novi Sad Business School
- Miljkovic M., Alcakovic S., (2015): Distribution channels of agricultural products with focus on green markets in Serbia, Synthesis, Singidunum University, Belgrade, pp. 599-601.
- Stankovic Lj., Djukic S. (2013): Marketing, Faculty of Economics, University of Nis, pp. 431-436.
- Vlahovic B., Puskaric A., Velickovic S., (2015): Export of apples from the Republic of Serbia – status and trends, Original scientific paper, Agrieconomica, No. 65, pp. 11-18.
- Zaric V., (2008): Analysis of the competitiveness of the agri-food products of Serbia, Faculty of Agriculture, University of Belgrade, pp. 94-97.
- Antic A. (2014, September 15): Da li su ruske sankcije sansa za srpske jabuke? Retrieved May 17, 2016, from <https://agroavantura.wordpress.com/tag/izvoz-jabuke/>
- Rusi uveli potpuni embargo hrane iz EU i SAD (2014, August 8). Retrieved June 25, 2016, from <http://www.bizlife.rs/vesti/71680-rusi-uveli-potpuni-embargo-hrane-iz-eu-i-sad/>
- Rusi izvoze iz Srbije poljske jabuke. (2015, March 25). Retrieved June 25, 2016, from <http://www.blic.rs/vesti/ekonomija/prevara-rusi-izvoze-iz-srbije-poljske-jabuke/jmchqn7>
- <http://faostat3.fao.org/home/E> 14.04.2016.
- <http://www.intracen.org/> 17.05.2016.
- http://www.paragraf.rs/propisi/zakon_o_potvrđivanju_sporazuma_izmedju_savezne_vlade_s_avezne_republike_jugoslavije_i_vlade_ruske_federacije_o_slobodnoj_trgovini_izmedju_s_avezne_republike_jugoslavije_i_ruske_federacije.html 20.06.2016.
- <http://www.pks.rs/PrivredaSrbije.aspx?id=13&p=2&> 20.06.2016.
- <http://www.pks.rs/SADRZAJ/flash/PKSnajvecisrpskiizvoznicien.swf> 20.06.2016.
- <http://webrzs.stat.gov.rs/WebSite/> 12.04.2016.
- <https://www.weforum.org/> 17.05.2016.

THE POTENTIALS AND PERSPECTIVES OF ORGANIC AGRICULTURE IN FRUŠKA GORA (VOJVODINA PROVINCE, SERBIA)

Sanja ĐUKIĆ*, Radovan PEJANOVIĆ, Mirela TOMAŠ-SIMIN, Danica GLAVAŠ-TRBIĆ

University of Novi Sad, Faculty of Agriculture, Novi Sad, Serbia

*Corresponding author: djukasanja@gmail.com

Abstract

The authors analyze the potential and future trends of organic agriculture in the area of Fruška gora national park. A special characteristic of this area is the presence of a national park and conservation area that require the application of sustainable solutions in the management of this area. Due to the specific nature-climatic and economic conditions, Fruška gora has an extraordinary potential for the application of organic agricultural production. Production potentials of this region are located in its protection zone in the following branches of production: fruit growing, viticulture, vegetable growing, animal husbandry, beekeeping, fishing, and medicinal herbs growing. However, despite the existing potentials, organic agricultural production in Fruška gora is at the beginning of development. The authors point out several significant factors that affect the further development of organic agriculture in Fruška gora. One of these factors is the inadequate sustainable management of this area so that organic agricultural production is not sufficiently represented and economically valorized in Fruška gora. Some of the other limiting factors of underdeveloped organic agricultural production in Fruška gora are the insufficient education of producers about organic production systems, inadequate level of incentives and subsidizing of organic farming, the insufficient number of processing and distribution companies, unfavourable demographic trends, insufficient organization of agricultural producers, etc. In order to define the optimum strategies for the further development of organic agriculture, the authors suggest a potential TOWS matrix.

Keywords: *Organic agriculture, potentials, perspective, Fruška gora, Vojvodina.*

Introduction

The region of Fruška gora is a unique geographical location in the Autonomous Province of Vojvodina (Republic of Serbia) and covers an area of approximately 139,430.01 hectares. In the middle of Fruška gora on the surface of about 25,525 km² is located National Park "Fruška gora", while in the broader scope are settlements and agricultural areas. Administrative-territorial units which are parts of this region are seven municipalities (Sremski Karlovci, Beočin, Irig, Indija, Šid, Bačka Palanka, Ruma, Petrovaradin) and the city of Sremska Mitrovica. On entire area is performed the protection of natural resources and cultural values, according to the principles of sustainable development. The main economic activity in the region is agriculture of conventional type, organic agriculture is very little represented. In the area of Fruška gora are present negative demographic tendencies (Pejanović et al, 2012; Đukić, 2015), expressed through the depopulation and increasing ageing of the population. According to Spatial Plan for the special purpose of Fruška gora until 2022, the areas of agricultural land have high participation (97,157.84 ha or about 70%), while the remaining area consists of forests (about 21%), and unfertile land (about 9%). This area has significant comparative advantages for the development of viticulture, fruit production, animal husbandry, as well as for growing medicinal herbs. The area of Fruška gora is singled out as one out of 35 ideal locations for organic agricultural production in Serbia (Arsić et al, 2012).

According to the Master Plan for Sustainable Development of Fruška gora, despite these comparative advantages, organic farming is not yet developed in this area.

Materials and methods

In order to identify the determinants of the development of organic agriculture of Fruška gora, a survey was conducted during 2014. The main topics for research were related to the role and importance of agriculture in the sustainable development of Fruška gora. A research surveyed selected 117 examinees from different socioeconomic groups (municipal/city administration, regional organization, the media, non-government organization, financial organization, a public company, the private sector: industry, service sector, agriculture, hunting, forestry, fisheries, water management. The questions in a survey are close-ended type. In order to identify the degree of agreement of respondents with certain statements, the five point Likert scale was used. Data were analyzed with the SPSS software package. Techniques of descriptive statistical method were applied in a research (frequency, percentage, arithmetic mean, median and mode, standard deviation). In order to identify the key factors that influence the potentials and trends in the further development of organic agriculture in the area was used SWOT analysis and on that basis was formed TOWS matrix.

Results and discussion

Survey results show that among the key benefits of the implementation of organic agriculture in the region of Fruška gora are the proximity of the national park (mean 4.22, and mode 5) and the existence of the unpolluted natural resources (mean 4.07, and mode 5) in the area of Fruška gora. The least estimated variables are higher prices of agricultural products from the organic production model, the agricultural orientation and the willingness of producers for engaging in organic farming, and adequate expertise of agricultural advisors (table 1). According to the survey, respondents did not highly rate the importance of small farms for the development of organic agriculture.

Table 1. Advantages of the area of Fruška gora in terms of organic farming

Variables	Mean	Median	Mode	Standard Deviation
The unpolluted natural resources	4.07	4.00	5.00	1.187
The proximity of the national park	4.22	5.00	5.00	1.253
Tradition in agricultural production	4.04	4.00	4.00	1.125
Orientation of inhabitants of Fruška gora for performing agricultural activities	3.43	4.00	4.00	1.255
The willingness of producers to engage in organic farming	3.56	4.00	4.00	1.234
Higher prices of agricultural products from organic production model	3.31	4.00	4.00	1.399
Organic farming is an opportunity for small farmers	3.86	4.00	5.00	1.266
Adequate expertise of agricultural advisors	3.44	4.00	4.00	1.447

The research results show that the main disadvantages of this area for the development of organic agriculture are as follows: the poor financial condition of agricultural producers, limitation of subsidies and other incentives, high costs of certification and product control, as well as the low level of cooperation between the public and private sectors. Limitations that have less impact on the development of organic production of Fruška gora are a limited market for agricultural products originating from organic agriculture, as well as the lack of

implementation of the legislative framework relating to food safety and consumer protection (table 2).

Table 2. Disadvantages of the area of Fruška gora in terms of organic farming

Variables	Mean	Median	Mode	Standard Deviation
Limited experience of farmers with the techniques of organic agriculture	3.92	4.00	4.00	1.100
Poor financial condition of agricultural producers	4.10	5.00	5.00	1.199
The low level of education of farmers	3.84	4.00	5.00	1.259
Limitation of subsidies and other incentives	4.01	4.00	5.00	1.148
The long-term crisis in agriculture	3.85	4.00	Multiple	1.186
The limited market for agricultural products originating from organic agriculture	3.62	4.00	4.00	1.264
The lack of implementation of the legislative framework relating to food safety and consumer protection	3.65	4.00	4.00	1.213
High costs of certification and product control	4.01	4.00	5.00	1.126
The low level of cooperation between the public and private sectors	4.00	4.00	5.00	1.160

The majority of respondents emphasize viticulture (about 32.5%) and fruit growing (about 29.1%) as the most important sectors in the future development of organic agriculture, which should have better strategic support, and growing medicinal herbs (16.2%) and beekeeping (11.1%) (Figure 1). Highlighting the growing of medicinal plants as one of the branches of agriculture is surprising, because it is about a production that has not been present in this area.

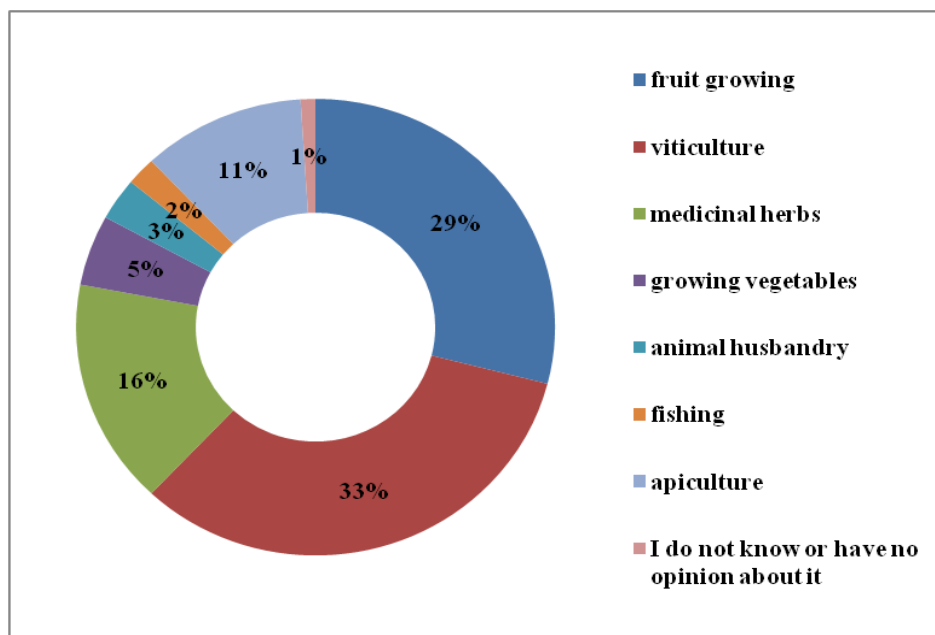

Figure 1. Rank of individual branches of agriculture in the future strategic support of organic agriculture in the area of Fruška gora

In terms of realization of priority investment (table 3), the survey results indicate that they should be directed to perennial plantings (fruit growing and viticulture - about 56.4 %), and then to the mechanization and equipment on farms (10.3%), as well as the expansion of farms (8.5%). In terms of providing funds for the improvement of organic agriculture, the survey results indicate that a large number of respondents believe that the funds from the agricultural budget of the Republic of Serbia (70.1%), as well as through credit lines (credits with subsidized interest rates, credits of commercial banks, development funds...) are not sufficient (50.4%).

Table 3. The realization of priority investments, the availability of funds from the agricultural budget of the Republic of Serbia, as well as through credit lines for the development of organic agriculture in Fruška gora

Variables	Absolute frequency	%
<i>Priority investments</i>		
for perennial plantings (fruit growing and viticulture)	66	56.4
for greenhouses	5	4.3
for storage	2	1.7
for livestock	5	4.3
for facilities in animal husbandry	1	0.9
for mechanization and equipment	12	10.3
for irrigation systems	4	3.4
for expansion of farms	10	8.5
do not know or do not have an opinion	12	10.3
<i>Availability of funds of the agricultural budget of the Republic of Serbia</i>		
yes	13	11.1
no	82	70.1
do not know or do not have an opinion	22	18.8
<i>Availability of funds through credit lines</i>		
yes	25	21.4
no	59	50.4
do not know or do not have an opinion	32	27.4
other	1	0.9

Small farms size, up to 5 ha, are the most numerous, and partly this may be a limiting factor in the future development of organic farming in Fruška gora (Đukić, 2015). However, small farms may have some advantages during the transition to organic agriculture because of the conversion period is short (Pejanović et al, 2010).

Fruška gora is mainly a rural area (Njegovan and Pejanović, 2009; Đukić, 2015), with the exception of municipalities of Sremski Karlovci and Petrovaradin that have the attributes of urban communities. This area is marked by negative demographic trends, which are manifested in decreasing population and senilisation. From these results is defined SWOT analysis of the potentials for organic production of Fruška gora (table 4). Perspectives for further development of organic agriculture in the Fruška gora are displayed as a possible strategy in the TOWS matrix (table 5).

Table 4. SWOT analysis of the potential for development of organic agriculture in the area of Fruška gora

Strengths	Weaknesses
<ul style="list-style-type: none"> • Proximity of the national park • Favourable geographical location and wealth of natural and cultural resources • Fruit growing and viticulture region • Tradition in agricultural production 	<ul style="list-style-type: none"> • Small family farms • Insufficient self-organizing producers • Insufficiently represented certified organic agricultural production • The process of depopulation and senilisation • Insufficient number of processing and distribution companies
Opportunities	Threats
<ul style="list-style-type: none"> • National and regional strategic documents (organic production, agriculture) • European integration processes and inclusion in EU funds 	<ul style="list-style-type: none"> • Insufficient interactions of institutions and the agricultural sector (extension...) • Insufficient state financial support (loans, subsidies...) • Insufficient visibility on market for organic agricultural products due to difficulties in certification of agricultural products • The competitive position of the other national parks in the country and the region

Table 5. TOWS matrix as perspectives for further development of organic agriculture in Fruška gora

SO (Strengths-Opportunities) strategy	ST (Opportunities-Threats) strategy
<ul style="list-style-type: none"> • Development and promotion of local capacities of Fruška gora for organic agriculture 	<ul style="list-style-type: none"> • Using positive experiences of small farms in the development of organic agriculture
W (Weaknesses-Opportunities) strategy	WT (Weaknesses-Threats) strategy
<ul style="list-style-type: none"> • The possibility of using European financial support in the promotion of organic farming in Fruška gora 	<ul style="list-style-type: none"> ▪ Maximum and efficient utilization of existing resources of Fruška gora for organic agriculture ▪ Strengthening local initiatives to develop organic agriculture

Conclusion

The research results of the existing strengths of the area of Fruška Gora in the development of organic agriculture, show that economic development and organizational factors are less pronounced (higher prices of agricultural products from organic production model, orientation of inhabitants of Fruška gora for performing agricultural activities, willingness of producers to engage in organic farming, as well as an adequate expertise of agricultural advisors). The most important advantages of Fruška gora for the development of organic agriculture are natural values and proximity to the national park. Key disadvantages for the further development of organic agriculture of Fruška gora are of a financial-organizational character. Fruit growing and viticulture are the optimum choices for the development of organic agriculture in Fruška gora, which is confirmed by the declaration of the respondents regarding the realization of priority investments. Also, the survey results indicate the limited availability

of funds for the realization of investments. Negative demographic trends and the dominance of small farms are additional limitations in the development of organic agriculture in Fruška gora. Further development of organic farming in Fruška gora should be based on the model of development that takes into account the existing potential and limits.

Acknowledgements

The paper is the result of research within the project entitled "The right to the first chance", funded by the Provincial Secretariat for Science and Technological Development of the Autonomous Province of Vojvodina.

References

- Arsić, S., Kljajić, N., Ivić, M. (2012). Livestock and the development of organic livestock production in hilly and mountainous areas on the basis of available resources in Serbia. In: D. Cvijanović, Z. Floriańczyk (Eds.), Rural development policies from the EU enlargement perspective. Rural areas and development - vol. 9. European Rural Development Network, Institute of Agricultural and Food Economics – National Research Institute, Institute of Agricultural Economics, Belgrade, Warsaw, pp. 121-138.
- Đukić, S. (2015). *Agroekonomski faktori održivog razvoja regiona Fruške gore* (Agrieconomic factors of sustainable development of the region of Fruška gora). Unpublished doctoral dissertation, Faculty of Agriculture, Novi Sad. In Serbian.
- Njegovan, Z., Pejanović, R. (2009). *Ruralna regionalizacija AP Vojvodine–novi teorijsko metodološki pristupi upravljanju ruralnim razvojem* (Rural regionalization of AP Vojvodina-new theoretical and methodological approaches to rural development). Monograph, Faculty of Agriculture, Novi Sad, pp. 178. In Serbian.
- Pejanović, R., Đukić, S., Njegovan, Z., Glavaš-Trbić, D. (2012). Demographic Problems of Rural Development of the Region of Fruška gora. Book of Proceedings, Third International Scientific Symposium "Agrosym 2012", Faculty of Agriculture, University of East Sarajevo, Republic of Srpska, Bosnia, Jahorina, 15-17 November 2012, pp. 619-624.
- Republika Srbija, Autonomna Pokrajina Vojvodina, Skupština Autonomne Pokrajine Vojvodine (2004). *Prostorni plan područja posebne namene Fruške gore do 2022. „Službeni list APV“, br. 18/04* (Spatial Plan for the special purpose of Fruška gora until 2022. "Official Gazette of the Autonomous Province of Vojvodina", no. 18/04). The Republic of Serbia, Autonomous Province of Vojvodina, Assembly of the Autonomous Province of Vojvodina. In Serbian.
- Tomaš, M., Pejanović, R., Popović-Vranješ, A., Maksimović, G. (2010). *Organska proizvodnja kao faktor ruralnog razvoja AP Vojvodine* (Organic production as a factor of rural development of Vojvodina). *Agrieconomica*, vol. 47-48, pp. 67-79. In Serbian.
- Univerzitet u Novom Sadu (2011). *Master plan održivog razvoja Fruške gore 2012-2022.* (Master Plan for Sustainable Development of Fruška gora 2012-2022."). Scientific study, University of Novi Sad, Novi Sad. In Serbian.

ACCREDITATION IN HIGHER EDUCATION IN THE FIELD OF AGRICULTURE IN SERBIA

Sofija PEKIĆ QUARRIE*, Ratko NIKOLIĆ, Slavica SPASIĆ

Commission for accreditation and quality assurance, Belgrade, Serbia

*Corresponding author: pekicq@gmail.com

Abstract

The paper presents comparative analysis of the accreditation outcomes in the sector of agriculture in 2 accreditation cycles: the first cycle done in the period 2007-2011 and the second cycle done in the period 2012-2016 run by Serbian accreditation body. The following parameters have been used for the analysis: higher education institutions (HEIs) and study programs (SPs) number in state and private sector, number of students enrolled in the first year, type of studies (professional or academic), level of studies (basic, master or PhD). Study programs in the area of agriculture and related sciences are held in 6 faculties, 3 higher professional schools and in their HEI units. Analysis has shown that higher education sector of agriculture in general stable in number and type of programs in 2 cycles of accreditation. Around 80% of programs belong to academic studies and contribution of the private sector in this area small. Total number of students in the sector of agriculture increased in the second cycle for about 10%. Higher demand for some programs in the second cycle is observed in both: sector of agriculture and its area agronomy.

Keywords: *CAQA, Accreditation, Higher education, QA, agriculture*

Introduction

Commission for accreditation and quality assurance (CAQA) is the national body for quality assurance (QA) in higher education in Serbia founded in 2006. Since then CAQA has developed standards and procedures and implemented 2 cycles of accreditation of higher education institutions (HEIs) and study program and one cycle of external quality control (audit) of HEIs. In 2013 CAQA become full member of 2 European associations for quality assurance in higher education: ENQA and EQAR. This confirmed that national system of QA in Serbian higher education is in compliance with European standards and guidelines (ESG). CAQA has also analysed the impact of its activities by comparative analysis of accreditation outcomes in 2 cycles of accreditation in several thematic and system-wide analysis including 2 sectorial analysis (1,2). This paper presents such analysis for the field of agriculture and its areas: agronomy, food technology, agro-economy, agro-machinery and soil sciences. Analysis was also made within the most abundant area – agronomy.

Accreditation review on HEIs and programs in the sector of agriculture

Study programs in the area of agriculture and related sciences are held in faculties, higher professional schools and in their HEI units. Faculties mostly run academic studies at all 3 levels (basic, master and doctoral), higher professional schools run professional studies at basic and specialist level. Agricultural HEIs are geographically spread from the north to the south of the country.

There are 6 faculties with accredited academic programs in the area of agriculture:

1. Faculty of Agriculture in Zemun, Belgrade University
2. Faculty of Agriculture in Novi Sad, University of Novi Sad
3. Faculty of Agronomy in Čačak, University of Kragujevac
4. Faculty of Agriculture in Lešak, University of Kosovska Mitrovica
5. Faculty of Ecological Agriculture in Novi Sad, University EDUKONS
6. Faculty for Biofarming, HEI unit in Bačka Topola, University Dzon Nezbit

There are 3 higher agricultural professional schools with accredited programs in the area of agriculture:

1. Higher agricultural professional school in Šabac
2. Higher agricultural professional school in Prokuplje
3. Higher technical school in Požarevac

Table 1 summarizes the data on number of study programs and number of students enrolling the first year of studies for different types of HEIs. In the first accreditation cycle was accredited in total 99 programs and in the second 95. The majority (c.a. 70%) of all study programs are held at faculties. The number of students for enrolling the first year of studies has increased from 4032 in the first to 4470 in the second accreditation cycle, primarily due to the increase of students enrolling at HEI units.

Table 1. Number of study programs and number of students in 2 cycles of accreditation in different types of HEIs

HEI	First round of accreditation (2007-2011)		Second round of accreditation (2012-2015)	
	Number of study programmes	Number of students	Number of study programmes	Number of students
Faculties	74	2928	67	3299
Higher professional schools	20	905	21	865
HEI units	5	199	7	306
Total	99	4032	95	4470

Table 2 provides the numbers of accredited study programs of different types (basic, master, specialist, academic and professional). The majority of study programs (75-80%) belong to the academic studies based upon both number of programs and number of students in both cycles. The increase in the number of students in the second accreditation cycle is evident in all types of study programs, especially in basic studies. The only exception are specialist studies.

Table 2. Number of study programs and number of students in different type of study programs: BPS – Basic professional studies, SPS – Specialist professional studies, BAS – Basic academic studies, MAS – master academic studies, SAS – Specialist academic studies, DS – PhD

	First round of accreditation (2007-2011)		Second round of accreditation (2012-2015)	
	Number of study programmes	Number of students	Number of study programmes	Number of students
BPS	12	680	18	755
SPS	8	225	6	185
BAS	31	1967	31	2265
MAS	37	921	28	971
SAS	2	64	3	78
DS	9	175	9	216
Total	99	4032	95	4470

Table 3 presents the number of study programs and number of accredited students in state and private HEIs. It is obvious that the contribution of private sector in higher education in the area of agriculture is small in both accreditation cycles. It is to the great extent restricted to the HEI units, especially in the second cycle.

Table 3. Number of study programs and number of students in state and private HEIs with programs in agriculture

		Faculties		Higher professional schools		HEI units	
		Number of study programmes	Number of students	Number of study programmes	Number of students	Number of study programmes	Number of students
First round of accreditation (2007-2011)	State	74	2928	19	805	-	-
	Private	-	-	1	100	5	199
Second round of accreditation (2012-2015)	State	67	3299	21	865	2	134
	Private	-	-	-	-	5	172

Analysis of programs in different areas of agriculture

Further analysis was done on the accreditation outcomes in both cycles of accreditation in different areas of agriculture (agronomy understood as primary production of crops and domestic animals; food processing; agro-economy including marketing and related agro-business studies; agro-machinery and soil management). Table 4. presents number of programs and corresponding number of students enrolling the first year of studies in the first and second accreditation cycle. It is obvious that more than half of all programs are in the area of Agronomy in both cycles, and that contribution of other areas is, also, very similar in 2 cycles. Total number of students is higher in the second cycle due to the increase of students enrolling Food technology. Number of students enrolling programs in other areas has not changed in the second cycle.

Table 4. Number of study programs and number of students in different areas of agriculture

	First round of accreditation (2007-2011)		Second round of accreditation (2012-2015)	
	Number of study programmes	Number of students	Number of study programmes	Number of students
Agronomy	58	2588	56	2558
Food technology	15	538	17	1047
Agroeconomy	16	627	13	630
Agromachinery and soil sciences	10	279	9	235
Total	99	4032	95	4470

Additional analysis was made on accreditation outcomes in 2 cycles of accreditation for different areas of Agronomy divided as presented on Table 5. Total number of programs in this area has not changed in the second cycle, as well as the number of programs in various areas. However, the number of students has increased for general agronomy, organic agriculture and biotechnology and decreased in programs for plant and animal production and plant protection. This results in the similar total number of students enrolling Agronomy in two cycles of accreditation.

Table 5. Number of study programs and number of students in different areas of agronomy

	First round of accreditation (2007-2011)		Second round of accreditation (2012-2015)	
	Number of study programmes	Number of students	Number of study programmes	Number of students
General agronomy	13	799	14	998
Field and vegetable crop production	7	329	6	270
Fruit production and viticulture	9	289	7	200
Animal production	10	399	9	342
Plant protection	7	351	7	274
Organic agriculture and environmental protection	8	301	9	341
Biotechnology	4	120	4	133
Total	58	2588	56	2558

Conclusions

- Agricultural HEIs well spread geographically in Serbia
- Good diversity of programs / by subject and by types (levels) maintained in both cycles
- Higher education sector of agriculture in general stable in number and type of programs in 2 cycles of accreditation
- Sub-sector of agronomy also stable in number and type of programs and in total number of students
- Around 70% of programs are held in faculties
- Around 80% of programs belong to academic studies
- Contribution of the private sector in this area small
- Total number of students in the sector of agriculture increased in the second cycle for about 10%

- Higher demand for some programs in the second cycle observed in both: sector of agriculture and its area agronomy
- Increase in the number of students in the second cycle of accreditation evident in food technology, biotechnology, organic agriculture and general agronomy, while decrease was recorded for programs in plant and animal production and plant protection

References

1. System-wide analysis of higher schools of professional studies in Serbia (<http://www.kapk.org/images/stories/dokumenta/HIGHER-PROFESSIONAL-SCHOOLS.pdf>)
2. Spasić S., Pavlović D., Živančević – Simonović S. 2015. Comparative analysis of accreditation outcomes in the first and second accreditation cycle in the field of medical sciences. Proceedings of XXI Conference TRENDS IN DEVELOPMENT: Changing University. pp 36-40

LOCAL SUSTAINABLE DEVELOPMENT: THE 21TH CENTURY PARADIGM OF SMART COMMUNITIES AND SMART TERRITORIES

Adriano CIANI^{1*}, Antonio BOGGIA¹, Donatello CARUSO², Annalisa GAMBARDELLA³,
Filippo Fiume FAGIOLI³

¹Perugia University, Italy

²Foggia University, Italy

³Freelance

*Corresponding author: adriano.ciani@unipg.it

Abstract

The Sustainable Development Goals 2015-2030 approved 25th September 2015 by the United Nation General Assembly insists in the 2- *End hunger, achieve food security and improved nutrition, and promote sustainable agriculture* and in the 8- *Promote Sustained, Inclusive and Sustainable Economic Growth, Full and Productive Employment and Decent Work for All*. Both of them attributes us the task to build up a model of development which take into account the potentiality of each area. This work , after an analysis of the role of Commons and the options proposed by EU with the Bottom Up and Community Led Local Development(CLLD), propose a new governance instrument of the Territorial Management Contracts (TMC) based on-Drivers-Pressure-State-Impact-Response approach (DPSIR) .The authors demonstrate, with several comparison, that from the hold Management of the Commons, thanks to the experience of the Local Action Group (LAG) and with the new CLLD approach of the Leader Program, is it possible to reach a new Governance of the TMC, in which the diffusion of the ICT is a concrete way for Local Community to design their own future in a Sustainable Strategy Approach .The paper point out that the Smart Communities in a Smart Territories are the new paradigm for the 21th Century of the Local Sustainable Development.

Keywords: *Sustainable Development, Local Development, ICT, Smart Communities, Smart land*

Introduction

The updating situation all around the world present two opposite direction. In the first, there are international Institutions as the UN which are able to propose in 2015 additional pillar to the approval, with the document “Transforming our world: the agenda for sustainable development for 2030 “(*UNGASS, 2015* and the COP 21 Paris Agreement (*UN FCCC, 2015*). These documents design a very attractive and modern roadmap for all the nations and peoples all around the world, to achieve the sustainable development targets and to improve the economic, environmental, cultural, managerial and social level of life.

On the other hand, the operative situation in many countries, especially in the last weeks, shows the difficulties of the National Governments to drive the internal issues toward the roadmap of Sustainable Development. (*WEF, 2016*)

Many issues like non-equity distribution of wealth, the radicalization of the culture the financial crisis, the difficulties to create an update and a suitable model of development and new governance which able to promote the introduction of innovations with traditions, prevents to the National Governments of drive the citizens toward a possible prosperity, peaceful and happiness future (*McMichael P.,2016*). This demonstrates that we have strong difficulties about the identification of an appropriate, transferable and repeatable model, to

achieve a successfully sustainable development by success in all areas of the world. The objective of the paper is to demonstrate that, the updating experiences of some Institutions as the European Union with the Bottom Up approach of the Local Communities linked in a virtuous combination with tradition and innovation of the new vision of Smart Lands and Smart Communities, appear the possible way for a concrete subsidiarity, which can drives the local populations toward the future that they freely choose, implements and manages.

Material and Methods

The method is an exploratory logical tentative to approach the issues related to a new governance for the 21th Century. From the logical derivation of the literature, direct experiences and the will to create a modern and update vision, are derived the results and discussion of the contribute. The material used are reports, books, articles, projects, programs which were derived the logical elements to implement the present contribute.

Results and discussion

The Era of Sustainable Development

After 30 years from the launch of the concept of Sustainable Development (SD) (WECD, 1987), the model it's clearly designed.

After the publication of the *Our Common Future* many skeptics were not convinced about the driving force and innovative change (Ruttan V., 1998) and given the demand if SD was poetry, politics or science.

Nowadays the SD present four paradigms and for this reason it's possible to affirm that it have a scientific approach. The four paradigms are: 1) the direct relation between development and environment; 2) the multi-criterial approach; 3) the inter and intra-generational approach; 4) the measurability (Pearce. D.W et al., 1996)(Sachs J.,2015).Consequently it has been accepted by all at the world that current we are in the Era of Sustainable Development .It is changed also the consciousness of the approach by the policymakers and civil societies. Thanks the role played by the UN, we are passed from the vision of "Our Common Future" to "The Future we want" (UN Rio+20, 2012) and "Transforming our World" (UNGASS, 2015).This title have the message. People around the world must not delegate to policy makers or to Central Government the implementation of the Strategy, but take the opportunity to be actor directly. The 17 Sustainable Development Goals and the 167 targets (UNGASS, 2015) for 2030 are a big challenge to achieve a true economic democracy where the local populations (Local Community) are the creator of the own destiny. The Local Community consequently has the duty to build up, for the future generations, the Era of Sustainable Development.

The role of the Commons all around the world

In this vision of course it's necessary to change the approach about the role of the ownership of the Territory (Ciani A. et al., 2015) and the mission of it. The ownership can't not to be an absolute right of the single man which have in his hand, and he can exercise to decide outside of the needs of the society and /or Community. . We must, at this level, take into account, the juridical differentiation about the goods concerning the principles of the accessibility and the rivalry

To understand well this concept it's useful to see the Table 1.

Table 1. The Juridical differentiation of the Goods in relation at the Rivalry and Accessibility

Private Goods	Club Goods	Common Goods	Public Goods
-Rivalry Absolute -Accessibility only for the owner	-Not Rivalry when member of the Club -Accessibility only for the Members of Club	-Rivalry managed by the principle that the use is payed following the concept of Equity -Accessibility for all.	-Not Rivalry -Accessibility open for all.

*Source: Authors' elaboration

It's know by all that the Private Goods as the Club Goods, are main issues under the lens of sustainable development because the management is strictly far from the social function that the goods must have in an equal, democratic and modern society (Papa Francesco, 2015).,Public Goods, at the same time, because the markets failures (Pareto,1994), especially for the natural resources, free riders phenomena and the erosion and unsustainability of the use doesn't create the right base to build a Sustainable Development Model. In front of this big dilemma nowadays it's useful, .), try to contribute at the enlargement with the awareness and direct participation of the Local Community at the use and vision of the Territory as Common Goods. About the role of the Common Goods we must take into account that also the EU with the *Europe 2020* (E.U. Commission, 2010), with the slogan "to build an Europe sustainable, smart and inclusive" implemented the CAP 2014-2020 where the agriculture , territory and natural resources are understanding as Common Goods. In this approach it's very relevant the work of the Economic Nobel Prize Elinor Ostrom (Ostrom E., 1990,1993 , etc..) who dedicate to this topic, which is currently rediscovery as the base to set-up local participative project of development.

Local Development and Local Community

After the world financial crisis, from 2007, the International Agencies as UNEP and FAO and Institutions as UNGAS proposed reports and solutions to create a society that could guarantee the prosperity, decent work conditions for all, access at the minimum vital services (education, health, electricity, water, and nowadays the ICT network) we need, to empower the role of the Local Community. In the vision of the Common goods historically have gain a relevant role the form of Agricultural Communities in Italy (Comunanze Agrarie) and the Mir in the Slavian lands. Currently in Italy there is a rediscovery and an empowerment of this form of ownership around Local Communities which achieve some unbelievable targets.(Ciani A., 2001).The SDG 2015-2030 and the EU Regulation 1303/2013 support the role of the CLLD. More or less all SDG's drive nations to put at the center of Sustainable Development the Local Communities, and stress with a road map for an easy access and a friendly use of the updating Information Communications Technologies in an innovative social networking approach. The article 9 of EU Regulation n.1303/2013 affirm : *In order to contribute to the Union strategy for smart, sustainable and inclusive growth as well as the Fund-specific missions pursuant to their Treaty-based objectives, including economic, social and territorial cohesion, each ESI Fund shall support the following thematic objectives:.....(Omissis)*In the Chapter II, from the articles 32-to 35, the same Regulation strengthens unequivocally the leading role that the Local Communities must have in local development processes.Consequently the approach of the CLLD it's one of the model that represent the base of the new paradigm for the 21th Century to implement the SD.

From Smart Cities and Communities Toward Smart Territories

In the last years many international Institutions as the same EU Commission stress the attention about the growing and the improvement of the Strategy of the Smart Cities (*EU Commission, 2010*), (*UCLG, 2016*). Of course this has caused a the big attention around the issue concerning the urban areas, particularly because the prevision that in 2050 the world urban population will be around 66% of the total.

In this way the main investments , supports, policies, etc. are spent for the urban areas and the city population, meanwhile the small local settlement and the world rural communities face the risk to decrease the right policy for a sustainable development and then for the future. Consequently it's more correct and appropriated to understand that to avoid the gradually and continuous loss of the role of the all areas, and not only the urbanized, it's necessary to realign the development policies, in order to search some better equitable paradigms of development to trigger. It is therefore considered that the Age of Sustainable Development must be based on innovation and creative networking. For this reason we have to opt for a significantly more holistic and inclusive vision that placed the Local Communities as true drivers of the local development.



Fig1-The option of Smart Cities, Smart Rural Areas and the of Smart Communities and Smart Territories.

Source: Smart Cities and Smart Rural Areas, (EU.Commission); Smart Communities and Smart Territories (Our Elaboration)

The *new paradigm for the 21th Century* is for that the *Smart Communities and Smart Territories*. (Fig 2). This signify to reallocate all territories to the center of the development process, with all its layering of natural potentialities, economic, social, cultural, identity, etc. aspects.

The Territorial Management Contracts Proposal

For all above discussed the authors propose the following new instrument for the governance of the territory, using an holistic approach. It's time to significantly change the governing models. From an "*emergency management*" to an "*innovative preventive management*" of the territory with a proactive participation and a "*bottom up*" approach. The financial crisis, which still rages in the management of public finances all over the world, implies that public bodies do not have and will not have, perhaps for decades, the ability to enable direct political intervention for a proper and effective management in the territories. Consequently it's the time to move, with the necessary process of public involvement, to the model of the territory management by counting on the ability of self-management of local communities, who have always given and give wonderful examples (*Ostrom E.,1993*) . The European Union itself with the Strategic Framework Unique derived by the various Funds (ERDF, EAFRD, ESF, etc.) pushes to encourage the active participation of citizens and communities with good practices linked at the targets of the goals of development.

This analysis leads us directly to use as possible, within this framework, tools that provide, through the mechanisms of Participatory Planning, Management Agreements between the

Public and Private to apply a preventive territory management. The farmer or the operator in rural and urban environment would perform actions agreed in the territory, useful to the pursuit of proper preventive management (the program must be established and participated), the public body (State, Region, Province, Municipality, Consortium, Community) would recognize an economic incentive (direct payment or tax relief) per hectare (or any other parameter provided simple, responsive and effective), with a system of strict control. On these principles is based the strong assurance that the Participatory management through Territorial Management Contracts-TMC's can guarantee a new era for preservation of the territory, to become intelligent, sustainable, inclusive. The approach to land management cannot be sectorial and partial but must be holistic and the TMC can be used of course to protect but also to manage and promote the territory in a vision of suitable Sustainable Local Development Strategy. The Territorial Management Contracts are the General Program of *defense, management and promotion the local territory* in which all the components (rivers, lakes, landscapes, forests, etc) can and must find a place. The idea therefore intends to turn the weaknesses of territories, due to the high risk, into intelligent opportunities, inclusive, sustainable, transparent, proactive, concrete. The TMC's approach needs, first of all, the implementation of the following stakes: *a model of governance, instruments and supports for decision making, strategic plan of the TMC, Project Financing and Project Management*. The model of governance must be participative for the local population with the involvement of all stakeholders in the *ideation, design, project, implementation and monitoring following the Iterative and interactive approach*. About the instruments and support for decision making, they are pillars to calculate the economic benefits that the single operator produce for the territory and the community (taking into account particularly the environmental benefit) and how much and how these benefits will be recognized. For this purpose the approach of DPSIR, proposed by the EEA-European Environment Agency (EEA, 1999), can help.

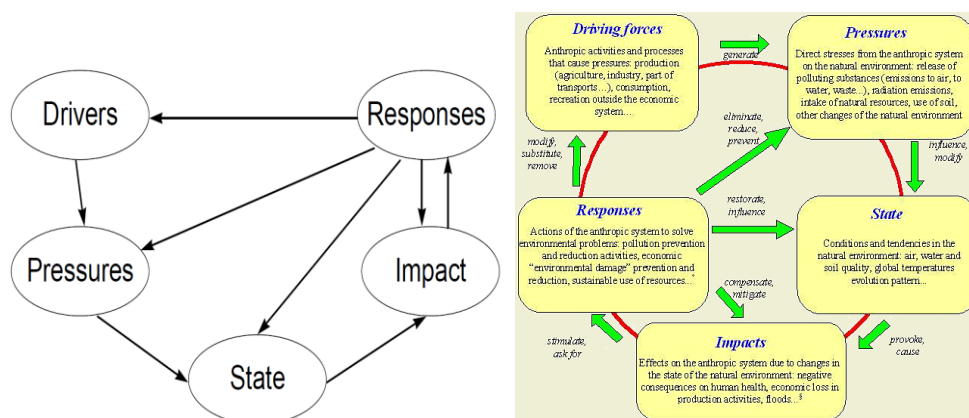

Fig 2- The DPSIR Framework for Reporting on Environmental Issue
Source: Our elaboration from EEA, 1999

Concerning the evaluation of alternatives for decision making a suitable approach is Multi-Criteria Decision Aid –MCDA. This approach can support decision makers to find solutions to problems at the preparation, implementation and monitoring level. The next phase is the preparation of the Plan, joint to the negotiation between the territorial higher-level government and the TMC organization. All of this must be coupled by a proper Project Financing that must respect the criteria *who, make, when*, between all the subjects involved as singles, privates or public bodies. The Financial Management must have a clear position and should be the only Committee Board of the Organization of the TMC. The implementation of a TMC is a concrete way to give a central role in the Sustainable

Development Strategy to the Local Population. With a proper dissemination policy of a friendly use of ICT local population can turn in a *Smart Community*, contributing to the validation of a *Smart Territory, which means an advanced and happy Territory..*

Issues and outstanding problems

The first open issue for research is to work in the future for the direct experience in the field to validate the approach to the empowerment of the role of the Local Communities in the implementation of the Local Sustainable Development Programs.

The proposal of the TMC needs the validation on the field with some specific Project.

However, this approach will not work if the access to the education and at the ICT will not be deeply diffuse.

Conclusions

This paper showed as that the approach of Smart Cities and/or Smart Rural Areas is not suitable to achieve the Sustainable Development Strategy in light of the *SDG 2015-2030* and of EU Commission Document *A strategy for smart, sustainable and inclusive growth*, because there is the risk to exclude and not to include all population and stakeholders, particularly regarding the great network of the Local Communities and Local Territories.

The authors stressed that there is a need for a new paradigm for the option of the Age of sustainability that must be "*Smart Communities and Smart Territories*". In this framework the proposal is that the TMCs-Territorial Management Contract are the realistic and logic solution for the protection, management and promotion of each area willing to achieve the goals and target of the Document of the UNGASS 2015 "*Transforming Our World: the Agenda 2030 for Sustainable Development*".

References

- Ciani A., (2001) Usi civici e proprieta' collettive in Umbria il Caso dell' Università Agraria di Viterbo (Civic and collective ownership uses in Umbria: the case of the Agricultural Community of Viterbo, in) in *Analisi degli Aspetti economico-estimativi e giuridici delle terre soggette al diritto di godimento collettivo*(Analysis of the economic and legal aspects of quantities of the lands subject to the collective right of use), Ce.S.E.T., a cura di Paolo Gajo e Francesco Nuvoli,Atti del XXXI Incontro di Studio Sassari(Proceedings of the XXXI Study Meeting of Sassari), 14-15 Settembre , 2001.
- Ciani A., Fagioli. F.F. (2015) ,Territory: A Living Book To Be Able To Read Which Inspires and Contaminates Feelings of Wellbeing,Florence "Sustainability of Well-being" International Forum 2015: "Food for sustainability and not just food " Florence SWIF 2015 , 4-6 June 2015,Agriculture and Agricultural Sciences Procedia, Elsevier , 8(2016) Pag 339-335
- EEA-European Environment Agency, (1999), Environmental Indicators: Typologies and Overview, Technical Report n 25, Pag. 1-19, <http://www.eea.europa.eu/publications/TEC25>
- E.U. Commission, Closing the loop. An EU action plan for the Circular Economy,COM(2015) 614 ,(2.12.2015),Bruxelles
- E.U. Commission, Community Led Local Development, Cohesion Policy 2014-2020, Factsheets,http://ec.europa.eu/regional_policy/sources/docgener/informat/2014/community_en.pdf, doi: 10.277622575, (2014)
- E.U. Commission, (2012), Smart Cities and Communities –European Innovation partnership, Communication from the Commissione, Brussels, 10.7.2012, C(2012) 4701 final

- E.U. Commission ,(2010), Europe 2020: A strategy for smart, sustainable and inclusive growth, COM(2010) 2020 final., <http://eur-lex.europa.eu/LexUriServ/LexUriServ.do?uri=COM:2010:2020:FIN:EN:PDF>
- Francis Pope, (2015), Encyclical Letter “Laudato si” on the holy Father Francis on care for our Common Home , Libreria Editrice Vaticana, Vatican City , Rome, ISBN 978-88-209-9578-2
- McMichael P.,(2016). Development and Social Change: A Global Perspective, VI Edition, SAGE Publications, Newbury Park , 91320 California - 424 Pages ,
- Ostrom E., (2006) Governing the Commons: The Evolution of Institutions for Collective Action, Cambridge University Press, 1990. Traduzione italiana: Governare i beni collettivi, Marsilio, Venezia, 2006.
- Ostrom E., (1993) (con Larry Schroeder e Susan Wynne): Institutional Incentives and Sustainable Development: Infrastructure Policies in Perspective, Oxford: Westview Press.
- Ostrom E., (1994) (curatrice, con Roy Gardner e James Walker): Rules, Games, and Common Pool Resources, Ann Arbor, University of Michigan Press.
- Ostrom E., (1998) A Behavioral Approach to the Rational Choice Theory of Collective Action: Presidential Address, American Political Science Association, 1997., The American Political Science Review 92(1): 1-22.
- Pareto W., (1994) Manuale di economia politica (Manual of Political Economics), Ed.Studio Tesi, Collana Saggi e documenti (Collection Essays and documents),, ISBN-13: 9788876923968 Pages: 650
- Pearce D, Hamilton K., and Atkinson G.,(1996) Measuring sustainable development: progress on indicators, in Environment and Development Economics / Volume 1 / Issue 01 / February 1996, pp 85-101,Cambridge University, Press,DOI:<http://dx.doi.org/10.1017/S1355770X00000395>
- Ruttan V. W., (1991) "Sustainable Growth in Agricultural Production: Poetry, Policy, and Science", in Agricultural Sustainability, Growth, and Poverty Alleviation: Issues and Policies; Proceedings of the Conference held from 23 to 27 September 1991 in Feldafing, Germany, eds. Stephen A. Vosti, Thomas Reardon, Winfried von Urff and Julie Witcover, (Feldafing, Germany: German Foundation for International Development, Food and Agriculture Development Centre, December 1991), pp. 13-30
- Sachs J., (2015, The Age of Sustainable Development, Columbia University Press, ISBN-13: 978-0231173155,Pag 543, New York , (2015)
- UCLG-United Cities and Local Governments, Draft Outline of the Global Agenda of Local and Regional Governments for Habitat III. https://www.uclg.org/sites/default/files/eng_uclg_global_agenda_outline.pdf
- UNCSD-United Nations Conference on Sustainable Development ,Rio+20, (2102), The future we want , Agenda item 10 , Outcome of the Conference , Rio de Janeiro, Brazil, 20-22 June 2012, A/CONF.216/L.1
- UNFCC-United Nations Framework Convention on Climate Change, Adoption of the Paris Agreement, COP21-Conference of the Parties Twenty first session, Paris, 30 November to 11 December 2015, FCCC/CP/2015/L.9/Rev.1
- UNGASS-United Nations General Assembly, Transforming Our World: the Agenda 2030 for Sustainable Development, 25 September 2015, New York, A/RES/70/1
- WCED -World Commission on Environment and Development, (1987), Our Common Future, Oxford: Oxford University Press.
- K, Webster K. (2005). The Circular Economy: A Wealth of Flows, ISBN-13: 978-0992778422, Ellen Macarthur Foundation Publishing, New York.
- WEF-World Economic Forum,(2016) , Global Risk Report , 11th Edition , Davos, CH

IRRIGATED FOOD SYSTEMS IN MARADI, REPUBLIC OF NIGER: A COMPARISON BETWEEN OPERATING ACCOUNTS

Ludovic ANDRES^{1*}, Lawali DAMBO², Sambo BODE², Awal BABOUSSOUNA², Martha POPULIN³, Boubacar YAMBA², Philippe LEBAILLY¹

1Department of Economy and Rural Development, University of Liege – Gembloux Agro Bio Tech, Belgium

2Department of Geography, Abdou Moumouni University of Niamey, Niger

3IFAD Country Programme, (Programme de Développement de l'Agriculture Familiale), Niger

Abstract

In Niger, most food systems are based on pluvial crops (millet, sorghum and cowpea). However, during the last decade, agricultural policy and technical and financial partners focused on increasing the productivity of irrigated food products. The region of Maradi, located in the Centre-South of Niger, is an area traditionally dedicated to agriculture. Some parts of this region are particularly adapted for irrigation, especially the Goulbi of Kaba and the Goulbi of Maradi valleys. The goal of this study is to establish the socio-economic situation of the main irrigated food productions, based on the following indicators: (i) the crop management techniques used; (ii) the results of the operating account; and (iii) the comparison between the village and the adoption of new technique (farmer field school). This paper is based on direct surveys conducted in three areas of the Maradi's region: Soumarana (commune of Safo, department of Madarounfa); N'Yelwa (commune of Madarounfa, department of Madarounfa); Madarounfa (commune of Madarounfa, department of Guidan Roumdji). The software used is Minitab and Excel. The results highlight a good perspective for the irrigation system but this food system is conditioned by the petroleum price and some other input (fertilizer and seed). The operating accounts show that irrigation is a non-negligible income source, which increases the resilience of the farmers.

Keywords: *Maradi, irrigated food system, operating account.*

Introduction

The Maradi's Region located in the center of Republic of Niger is characterized by a rainy agricultural food system. Nevertheless some valleys, Goulbi N'Kaba and Goulbi of Maradi, are in favor of irrigation food system (Issaka M., 2001; Andres L. and Lebailly Ph., 2013). In Maradi, the population is mainly rural and represented 3.3 % of total Nigerian population (KarimouBarké M. et al., 2015). The spatial evolution is characterized by a forest decrease in favor of an agricultural land increase (Mahamane A., 2001). During the last decade, agricultural policy and technical and financial partners focused on the increase of productivity of irrigated food products. The irrigable land in the Maradi's region is estimated by KarimouBarké M. et al., 2015. This study identifies four irrigable areas: the Goulbi Maradi; the Goulbi N'Kaba, the Tarka valley and the flooding areas. The fossil valley (N'Kaba and Maradi) represents 33,576 hectares (ha) and 217,174 ha respectively. The Tarka Valley, located in the North of the department, is 150,002 ha. Finally, the flooding areas are defined by the temporary and permanent pond and their environment as the Madarounfa Lake. This area represents 102,922 ha (KarimouBarké M. et al., 2015). The study's area located on the Goulbi Maradi is divided in 3 areas: Soumarana, Madarounfa and N'Yelwa in the commune of Safo and Madarounfa (Figure 1).

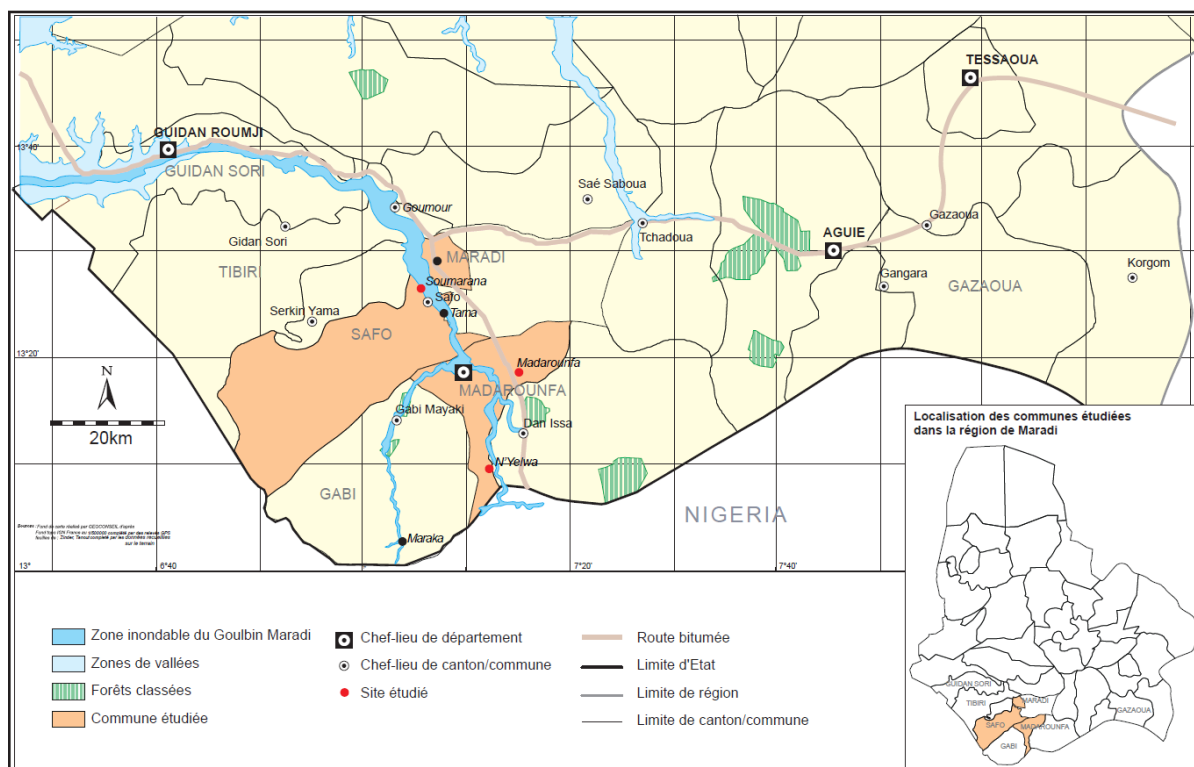

Figure 25. Location of the study's areas in the Maradi Region

Material and method

This paper was realized by an indirect survey in three irrigated areas. The survey tries to answer the question about a socioeconomics' status, a characterization of farm; the factor who compose the operating account. In fact, the goal is to demonstrate the economic aspect of the irrigated food system. It was realized during November 2015 but also during January and February 2016. These periods are equivalent to the irrigated season: September to November; December to February. The questionnaire is composed in three parts: socio-economic characteristics; irrigated production; project factors (farmer field school). Forty farmers located in three different areas on the Goulbi Maradi did participate: Soumarana (15); Madarounfa (11); N'Yelwa (14). The survey is an exploratory phase. The number of interviewed farmers varied in function of the area: fifteen for Soumarana; fourteen for N'Yelwa; eleven for Madarounfa. The variation did not affect the analysis because the number of farmers is very low and the main goal of this study is to consider a preliminary analysis of the irrigated food system. This preliminary study is linked and integrated to a partnership with International Fund for Agricultural Development (IFAD) and two research centers (University of AbdouMoumouni in Niamey and University of Liege Gembloux Agro Bio Tech). This research tries to establish the impact of the agricultural intensification.

Results and discussion

We observed that only two agricultural chiefs are female and one agricultural chief is Kanuri whereas the other chiefs are Hausa and male. There is no big difference between the three areas. The average age of the sample is 43 years old. The area is smaller than below 1 hectare (0.88 ha). The member's number per household is estimated to 11 members and the work force is 2 farmers.

Table 18 : Socio-economic characteristics

Location	Age	Area	Member	Agricultural worker
Soumarana	43	0.97	9	2
N'Yelwa	38	0.79	12	2
Madarounfa	48	0.89	12	3
Mean	43	0.88	11	2

The distribution of rainy and irrigated areas in each domain is different. The farmers of Madarounfa have more rainy areas (36 %) than them irrigated areas (64 %), while Soumarana and N'Yelwa present a balance between the rainy and irrigated area (Figure 2). In average, they area of Soumarana practiced the irrigation since 22 years old. N'Yelwa and Madarounfa practice respectively the irrigation since 16 and 8 years old. In average, the Soumarana's farmers have two plots whereas the two other areas are constituted by only one plot. The average of irrigated areas are respectively estimated to 0.95 (Soumarana); 0.79 (N'Yelwa); 0.89 (Madarounfa).

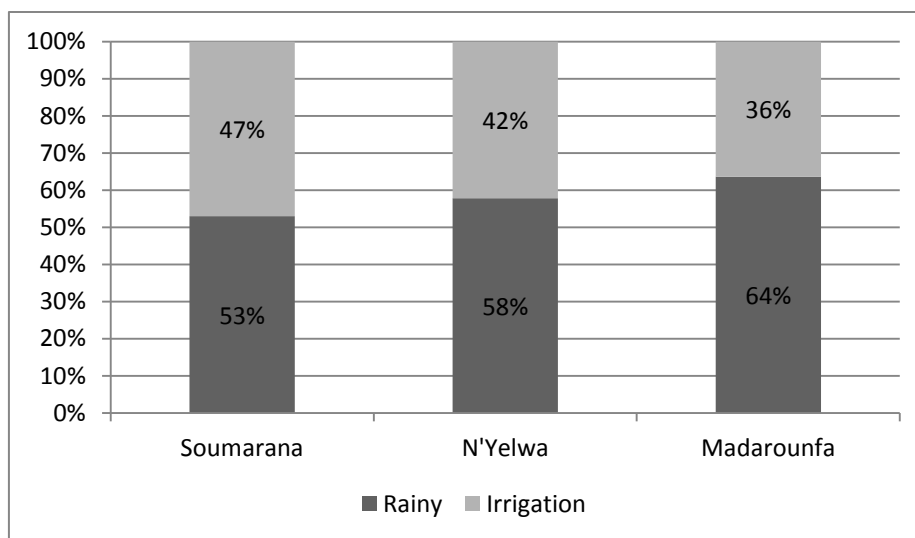

Figure 26 : Distribution of the rainy and irrigated area in a farm

Usually, the way to acquire land is by legacy or legacy adds with another mode such as purchase, loan and rental. Only 25 per cent of the farmers has land tenure to prove the property.

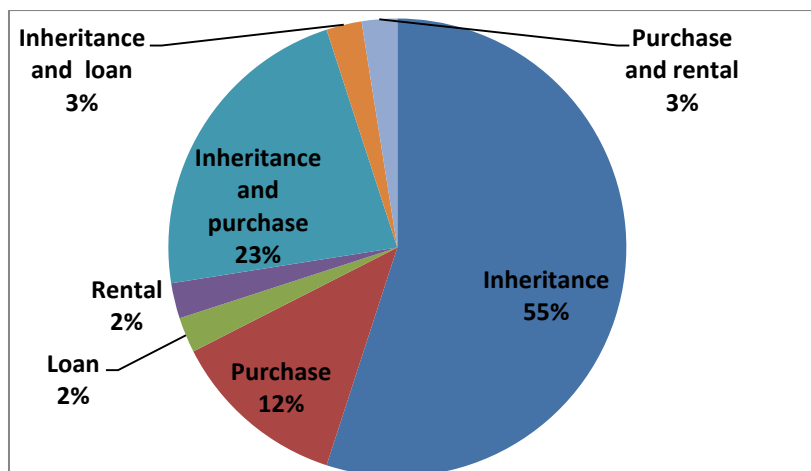

Figure 27 : Distribution of the transmission method

The operating accounts are calculated with the fees and the estimated income. The fees assemble the cost of seed, phytosanitary products, fertilizers, worker force, irrigation maintenance and usage fee. The income has been estimated with the farmer and regroups the estimated income per campaign. In the first time, we would like to develop the operating account per product but some costs were used for all production during the irrigated campaign. The fuel is the first charge concerning for the irrigated food system and is due to the introduction of motopump in this system. The second and third principal fees are the fertilizer and the seed. Before the last decade, the fertilizer and the phytosanitary goods were produced by the Nigeria Market but actually, most of the farmers buy them in the Maradi's market. According to this observation, the benefit of the irrigated activities depends on on the price of the fuel (figure 4).

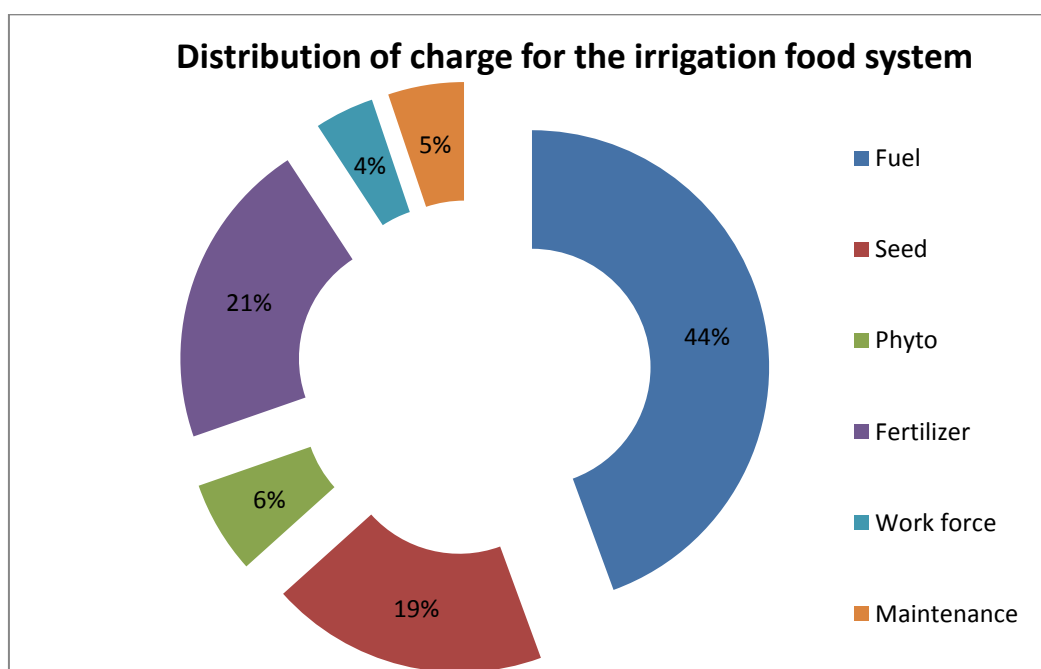

Figure 28. Distribution of charges for the irrigation food system

Each farmer from each village has presented a benefit per campaign. This average of benefit has been estimated to 412 euros in Soumarana; 377 euros in N'Yelwa and 582 euros in Madarounfa (table 2).

Table 19. Charge and income of each studying area

	Charge	Income	Benefit
Soumarana	134,543	404,600	270,057
N'Yelwa	98,025	345,161	247,136
Madarounfa	112,227	493,955	381,727

The comparison of mean has been established to distinguish the difference between the targeted villages. The variance and normality test confirm the possibility to realize the test of equality of mean. The results in Figure 5 show a significant difference between the level of the income and the benefit in function of the village.

ANOVA Table^a

			Sum of Squares	df	Mean Square	F	Sig.
Income * Village	Between Groups (Combined)		386675,509	2	193337,754	4,380	,020
	Within Groups		1633130,866	37	44138,672		
	Total		2019806,375	39			
Benefit * Village	Between Groups (Combined)		292182,568	2	146091,284	3,233	,051
	Within Groups		1672032,807	37	45190,076		
	Total		1964215,375	39			
Charge * Village	Between Groups (Combined)		9,832E9	2	4,916E9	2,597	,088
	Within Groups		7,004E10	37	1,893E9		
	Total		7,987E10	39			

a. The grouping variable Village is a string, so the test for linearity cannot be computed.

Figure 29 : Comparison in function of the village

We compared the fees, the income and the benefit regarding to the activities of the farmer field school. Two activities are evolved with the charge, income and benefit. Those concern the visit of the Farmer field school and the support advice. The comparison of means is not significant for the advice and the farmer field school. But all farmers of the enquiry need a farmer field school and the indirect impact of the project is perhaps the causes of this non-difference between the beneficiaries and the non-beneficiaries.

Conclusion

In conclusion, in the Maradi' region, the irrigated food system presents an interest to ensure a food security and a better income. The impact of the IFAD project is not clear, especially for the quantitative data (income, benefit). But the qualitative analysis demonstrates some impact of the project, especially for a crop management technic and the purchase of good fertilizer and phytosanitary, and improved seeds. The comparison of means is largely affected by the indirect impact. In fact, some non-beneficiary's farmers have adopted some innovation because the transfer is linked by the observation and discussion between the farmers.

References

- Andres L. and Lebailly Ph., 2013. Le sésame dans le département d'Aguié au Niger: analyse d'une culture aux atouts non-négligeables dans une zone agricole à forte potentialité (Sesame in the department of Aguié in Niger: analysis of a culture with non-negligible assets in a farming area with high potential). *Tropicultura*, 31, 4, 238-246.
- Issaka M., 2001. Evolution à long terme de la fertilité de sol dans la région de Maradi (Long-term evolution of soil fertility in the Maradi region). United Kingdom, Somerset, Crewkerne: Drylands Research, working paper 30.
- Karimou Barké M., Ambouta K.J.M., Tydjani A.D., 2015. Cartographie des potentialités agricoles et forestières de la région de Maradi (Mapping agricultural and forestry potential of Maradi region). Maradi: Colloque scientifique international « Maradi Kwaliya », coexistence intercommunautaire et la construction de la paix dans l'histoire de la région de Maradi (International scientific symposium "Maradi Kwaliya", intercommunity coexistence and construction of peace in the history of Maradi region).
- Mahamane A., 2001. Usages des terres et évolutions végétales dans le département de Maradi (Land use and plant evolution in Maradi department). United Kingdom, Somerset, Crewkerne: Drylands Research, working paper 27.

PREVALENCE OF CENTRAL OBESITY IN SCHOOL STUDENTS (AGED 8-16 YEARS) OF RURAL SOUTHERN WEST BENGAL, INDIA: BASED ON ANTHROPOMETRICAL STUDIES

Ratnabali SENGUPTA*¹, Narayan GHORAI¹, Saikat Kumar BASU², Peiman ZANDI³, Siniša BERJAN⁴, Shahram Khademi CHLALARAS³, Silanjan BHATTACHARYYA¹

¹Department of Zoology, West Bengal State University, Kolkata-700126, West Bengal, India

²Department of Biological Sciences, University of Lethbridge, Lethbridge AB Canada

³Institute of Crop Science, Chinese Academy of Agricultural Sciences, Beijing 100081, P. R. China

⁴Faculty of Agriculture, University of East Sarajevo, East Sarajevo, Bosnia and Herzegovina

*Corresponding author: email-rsg1@rediffmail.com; z_rice_b@yahoo.com

Abstract

Prime focus of the study was to reveal the prevalence of central obesity (CO) in school students (age group 8-16 years) using anthropometric indicators. Interschool survey of four large primary and secondary schools of rural southern West Bengal (WB) North 24 Parganas were done, representative for the cross sectional study. Total 551 subjects were screened (based on PCI) among 690 students among which 283 are boys and 268 girls. The major indicators and indices considered here are BMI, waist circumference (WC), hip circumference (HC), waist-hip ratio (WHR), waist-height ratio (WHtR), and conicity index (C.I.), respectively. The main outcome measure is to reveal the prevalence of central obesity among students aged 8-16 years. One way ANOVA was performed to test the differences in mean anthropometric characteristics for age and gender. Pearson's correlations were done to find out the trends of the anthropometric indices with age. Statistical analysis was performed by using SPSS v. 16. Findings of the study highlighted that BMI is the best indicator of overall obesity, whereas WC, WHR, WHtR and C.I are very good indicators of central obesity, which are the probable precursors of cardiovascular diseases (CDVs), Kidney diseases, diabetes, hypertension etc. in adulthood. Growth of hip is higher than waist in both genders. WHR and WHtR show a negative correlation with age. Girls' waist and hip grow rapidly than boys' upto 12-13 years, boys outperformed after that. Girls exhibit a greater WHtR and C.I. than boys.

Keywords: *Central obesity, rural school students, Southern West Bengal*

Introduction

Obesity is a worldwide problem today. Childhood obesity is a rapid increasing problem in both developing and developed countries which may lead to adulthood obesity (Bose et al., 2007). A new word "globesity" is coined referring universal health burden of obesity (Mukhopadhyay et al., 2005). Pattern of overweight and obesity, differ by age and gender, rural or urban residence and socioeconomic pattern (SEP) and vary between and within countries (Matijavsevich et al., 2009). Number of studies undertook to assess the prevalence of students' overweight and obesity. Unfortunately, most of those dealt with height and weight only to investigate regional adiposity (Das et al., 2001). So, there was a strong need to deal with central obesity anthropometric indices other than considering height and weight only. Computed Tomography (CT) scan and Magnetic Resonance Imaging (MRI) can directly measure intra-abdominal fat, but are very costly. Anthropometry is the most reliable measure (based on cross sectional studies) to link fat distribution to health and its consequences (Bose et al., 2005).

Although this health burden is well documented in most developed and some developing countries, there is paucity of data in respect to the prevalence of overweight and obesity in school students of rural southern West Bengal. There is also less data available on sexual dimorphism in overweight and obesity, especially for Bengali community (de Onis et al., 2004). The present investigation is a unique approach based on anthropometric indices; to find out the level of overweight and obesity among rural school students (of lower and middle socioeconomic classes; Dudala et al., 2014) of southern West Bengal. This database may be compared with national and international prevalence levels for other population.

Materials and methods

Study design

A cross sectional study has been done during June 2012 to September 2013 among school going boys and girls from lower and middle socio economic class (Dudala et al., 2014) of age range 8-16 in 4 secondary schools of 24 Parganas (N) of rural southern WB. Ages were verified from respective school records. Anthropometric measurements of 551 rural school-going subjects (283 boy and 268 girl subjects, considering PCI) were taken from a total of 690 students selected. The values of anthropometric measurements such as weight, height, waist hip circumference were recorded for every subject in the study sample, indices like BMI, WHR, WHtR and C.I. are derived (Hu, 2002). Age and sex break-up were studied and compared with the World Health Organisation (WHO) standards (WHO, 2007). Correlations among age, sex and anthropometric parameters were considered individually to derive their patterns of growth. Statistical analysis was done with SPSS v. 16 include correlation and one way analysis of variance (ANOVA). Information was collected after an interview with the help of a semi structured questionnaire. Parental consents were taken from the all participating subjects and all necessary ethical protocols were followed accordingly. Students between the age group of 8 to 16 were selected because in the new generation subjects who were born after 2000 AD, age of adolescence has shifted/changed from 10 to 8 years (Kipke, 1999; Hagen et al., 2014). The logic behind limiting the upper age boundary of the subjects' to 16 years as secondary school students' upto class ten (X) commonly falls within this age. Only healthy subjects are included (without any physical deformities). Students belonging to Upper (S.E) classes (based on PCI) were not considered for this survey.

Anthropometrical Measurements

Anthropometric measurements were conducted twice on the same day for each student in same session to avoid technical errors with criterion accredited by the International Society for the Advancement of Kinanthropometry in anthropometry (ISAK, 2011). Method described in the manual was followed for taking all the measurements (Brožek et al., 1963).

- Height: Height was measured with an Anthropometric Rod (GPS) up to 1 mm. (Esrey, 1996).

- Weight: Body mass was calculated in minimal clothing. The subject stood on the centre position of the scales without support with the weight distributed evenly on both feet. Weighing was taken with a digital scale (calibrated beforehand, capacity 150 kg) having a precision of 0.5 kg. Time of taking weight was also noted (Waterlow, 1972).

- Body Mass Index (BMI): BMI was derived by dividing weight (kg) by height (m) squared. BMI categories were based on age specific cut-offs in adolescent. World Health Organization (WHO) based classification for global database on Body Mass Index (BMI) was used as a cut points for BMI (Gallagher et al., 1996).

- Waist-Hip ratio (WHR): The waist circumference of the abdomen was the narrowest point between the lower costal border and the top of the iliac crest, perpendicular to the long axis to the trunk. The hip circumference was the circumference of the buttocks at the level of their

greatest posterior protuberance, perpendicular to the long axis to the trunk (Visscher et al., 2001). Waist hip ratio was a better anthropometric index than BMI. It is a measure of relative adiposity in abdomen. It is measured as = waist (cm)/hip (cm)

- Waist Height Ratio (WHtR): The waist height ratio is a good indicator of body shape and future chronic diseases. WHtR= waist (cm)/height (cm)

- Conicity index (C.I.): Good indicator central obesity (Goran & Malina, 1999). C.I. = waist (cm)/, 0.109* sq root of weight (kg) /height (m).

Results and Discussion

Consistent increasing trend in central obesity (circumferences) is evident from 12-15 years of age. Similar findings have been observed among children in Baharian (Kaul, 1975; Eveleth & Tanner, 1991) and Jamaica (ICMR, 1972). Those studies have also reported a consistent increasing trend with age. There is also a trend of consistent fat deposition at central sites. Similar results found in adolescent students of Midnapore district of West Bengal, India (Das et al., 2001). Stagnation was absent in overall obesity (BMI acts as the best indicator) in both boys and girls.

Table 1. BMI for Age

Category for BMIZ	Frequency	Percentage
> -2 SD	65	11.7
SD-2<=Median	254	46.2
Median=> SD+2	192	34.8
>SD+2	40	7.3
Total	551	100.0

The z scores of BMI for age are presented in Table 1, compared to international standards (WHO, 2007). 92.7% of students belong to a normal range of BMI. Obese students are 7.3%. Rate of obesity is lower than other developing countries. It might be due to lack of awareness of healthy food habits. These results are consistent with earlier studies done in India in respect to children of the same age group (Subramanyam et al., 2003; Khadilkar and Khadilkar, 2004; Marwaha et al., 2006; Sadhukhan et al., 2007; WHO, 2007; Kaur et al., 2008).

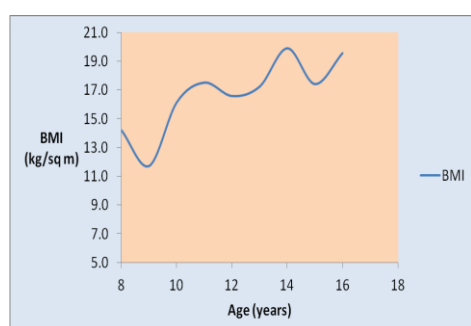

Figure 1. Pattern of BMI with age (Boys)

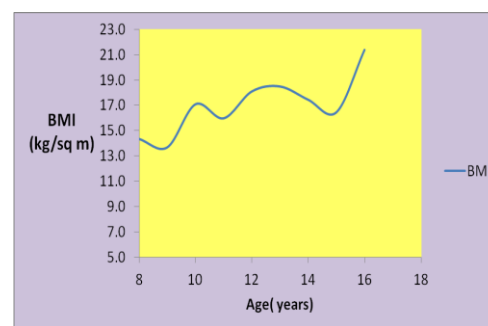

Figure 2. Pattern of BMI with age (Girls)

On the contrary, higher prevalence of overall adiposity found from abroad, developed countries. A study performed in Netherland demonstrated that there was no association between puberty and BMI (Tremblay et al., 2002; Vignolo et al., 2004). Adolescent men are significantly taller and heavier than women (Bhadra et al., 2002). Rapid growing trend of BMI with age is seen in Figure 1 (in boys, avg. =16.6, 12 years of age) and slow increasing growth pattern of BMI with age is depicted in Figure 2 (in girls, avg. =17.0, at 10 years of age). Greater accumulation of body fat in the abdominal region might be the main determinant of obesity related diseases like Coronary heart diseases, type II diabetes and hypertension (Sadhukhan et al., 2007).

Table 2. Cross-tabulation between different age group in relation to gender and waist circumference (cm)

Age Group (in years)	Sex	Mean	SD	Max	Min	SE	Sig value
8	Boy n ₁ = 28	55.3348	7.02655	73.00	48.80	1.46514	.354
	Girl n ₁ = 28	58.1529	11.89297	82.00	49.00	2.88447	
9	Boy n ₂ = 27	49.9071	4.23092	57.60	44.70	.79957	.045*
	Girl n ₂ = 27	52.0400	2.64987	56.50	47.60	.48380	
10	Boy n ₃ = 27	60.9000	7.01010	75.00	49.70	1.32478	.261
	Girl n ₃ = 27	58.5750	8.62274	73.80	49.00	1.52430	
11	Boy n ₄ = 30	60.6286	8.10267	78.80	52.70	1.53126	.530
	Girl n ₄ = 30	59.2387	8.71147	78.70	49.70	1.56463	
12	Boy n ₅ = 32	60.0180	5.40263	74.40	51.00	.76405	.060*
	Girl n ₅ = 32	62.3545	8.35069	74.00	51.20	1.78037	
13	Boy n ₆ = 34	62.6533	8.63732	80.80	50.90	1.57695	.306
	Girl n ₆ = 34	60.3133	8.92091	83.50	50.90	1.62873	
14	Boy n ₇ = 34	68.1286	10.02626	85.90	50.90	1.89478	.045*
	Girl n ₇ = 34	63.0462	7.88118	80.80	52.20	1.26200	
15	Boy n ₈ = 36	61.6964	5.61588	75.50	53.00	1.06130	.410
	Girl n ₈ = 36	60.3235	7.11026	83.30	51.80	1.21940	
16	Boy n ₉ = 28	68.6125	8.71086	92.00	59.90	1.24603	.023*
	Girl n ₉ = 27	63.8212	8.87911	83.50	50.40	1.54565	

N =551; *implies significant at .05 level of significance & ** implies significant at .01 level of significance

The mean and S.D. of waist circumference by age and gender are presented in Table 2. It is evident that at 8 and 9 years of age mean waist circumference of the girls was slightly higher than boys. In age group of 9 (late childhood), 12 (early teenage), 14 and 16 (late teenage), here significant differences in waist breathe between the boys and girls ($p < 0.05$) is evident. But for the age group 10, 12 & 13 no significant difference in waist breath was observed among the subjects. Boys have a general tendency of having a higher waist circumference with age than girls. Correlation studies showed that WC is more correlated with diseases like cardiovascular diseases and chronic diseases like diabetes and hypertension. Similar findings recorded in earlier studies on this age group in Indian subcontinent (Bhadra et al., 2002).

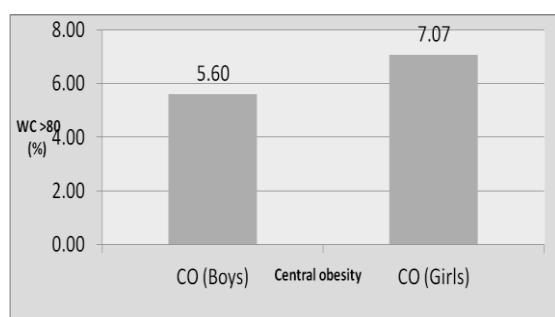

Figure 3. Rate of central obesity (CO) based on WC (Boys and Girls)

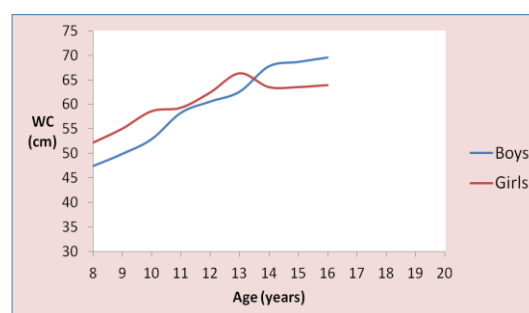

Figure 4. Rate of increase of WC with age (Boys and Girls)

Central obesity (CO) is the most consistent risk factor for hypertension (Mukhopadhyay et al 2005). Figure 3 exhibits a greater tendency of central obesity (7.07%) in girls than boys (5.60%). Classification of CO is based on WC > 80 cm (Dasgupta & Hazra, 1999). Girls are generally taller and heavier than boys in the age group of eight (8) to 16 (sixteen) years (Freedman et al., 2007). Significant sex difference in central obesity found among young Punjabi students in Chandigarh, North India (Sanjeev et al., 1991). Sexual dimorphism existed in central obesity, irrespective of the level of overall adiposity (BMI) (Goran & Malina, 1999). Increase of WC with age is evident in boys and girls. Rate of increase is higher in girls (peak at 13 years), then it decreases. Boys show an increase in WC from 14 years of age. In both cases the two rates exhibit steady growth and become parallel thereafter 14 (Figures 3 & 4).

Table 3. Cross-tabulation between different age group in relation to gender and hip circumference (cm).

Age Group (in years)	Sex	Mean	SD	Max	Min	SE	Sig Value
8	Boy n ₁ = 28	60.5957	7.31738	75.00	52.30	1.52578	.325
	Girl n ₁ = 28	63.2294	9.39879	89.00	55.00	2.27954	
9	Boy n ₂ = 27	57.4321	2.76607	64.10	54.80	.52274	.000**
	Girl n ₂ = 27	61.0433	3.80686	67.00	57.80	.69503	
10	Boy n ₃ = 27	68.8714	6.28436	81.90	60.10	1.18763	.242
	Girl n ₃ = 27	67.1438	5.03657	76.00	60.00	.89035	
11	Boy n ₄ = 30	70.4571	6.48476	90.80	62.90	1.22551	.235
	Girl n ₄ = 30	68.1194	8.26359	90.90	57.60	1.48418	
12	Boy n ₅ = 32	68.0180	5.14205	80.20	58.00	.72720	.000**
	Girl n ₅ = 32	76.9273	7.54644	88.00	60.80	1.60891	
13	Boy n ₆ = 34	74.0367	11.39045	95.50	32.00	2.07960	.931
	Girl n ₆ = 34	73.8200	7.56445	92.00	60.80	1.38107	
14	Boy n ₇ = 34	79.3893	12.36819	94.00	30.00	2.33737	.064*
	Girl n ₇ = 34	75.0154	6.41563	90.80	65.00	1.02732	
15	Boy n ₈ = 36	78.8893	8.53704	94.00	65.90	1.61335	.032*
	Girl n ₈ = 36	71.3971	13.23083	103.00	31.80	2.26907	
16	Boy n ₉ = 28	81.9275	7.88058	99.00	60.00	1.24603	.252
	Girl n ₉ = 27	79.4636	10.33313	92.00	66.00	1.79877	

N =551; *implies significant at .05 level of significance & ** implies significant at .01 level of significance

Table 3 describes the mean and S.D. of hip circumference by age and gender. A much higher growth rate of HC in girls is seen up to 12 years of age, afterwards which gradually decreases up to 15 years and again grows steadily after 15 years of age. In age 12, most significant difference in HC is evident in boys and girls, whereas other age groups didn't exhibit that. The higher prevalence of hip circumference among girls may be related to adolescent growth spurt and the effects of hormonal surge which occurs earlier in girls (Chhatwal et al., 2004). A study from Israel found similar pattern of obesity among boys and girls (Seidman et al., 1991; Wang et al., 2002). Similar studies were done at Hoorn, Netherlands, where large hip and thigh circumferences are found to be associated with a lower risk of type 2 diabetes in girls in comparison to boys, independently of BMI, age, and waist circumference, whereas a larger waist circumference is associated with a higher risk (Snijder et al., 2003).

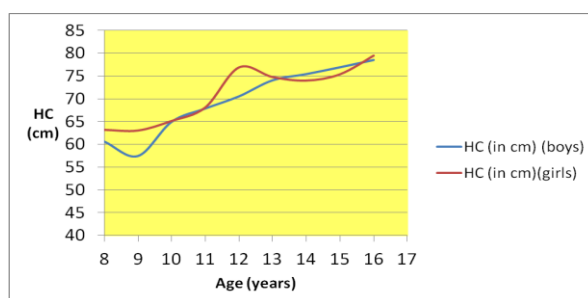

Figure5. Rate of increase of HC with age (Boys and Girls)

A much higher growth rate of HC in girls is seen up to 12 years of age, afterwards which gradually decreases up to 15 years and again grows steadily. In boys, a slow but steady hip growth rate is seen up to age 16, where it meets the growth curve of girls (Figure 5). Waist and hip circumferences measure different aspects of body composition and fat distribution and have independent and often opposite effects on cardiovascular disease risk factors. A narrow waist and large hips may both protect against cardiovascular disease. These specific effects of each girth measure are poorly captured in the waist-to-hip ratio (Seidell et al., 2001).

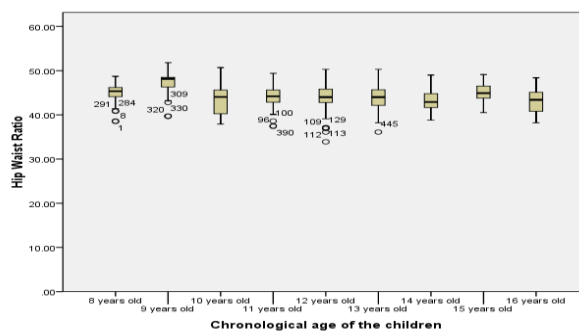

Figure 6. Relation of waist-hip ration (WHR) with the age of the subjects

Figure 6 discovered that median of the waist-hip ratio (WHR) was higher among the younger subjects and it falls down with increase in age. A zigzag relationship was visible in the box plot with 9 years group. These findings suggested that younger subjects got more attention and nourishments in comparison to the elder subjects in the study area. With respect to central body fat distribution, there was a significant decreasing trend with age in mean WHR. This indicated differential pattern and intensity of fat deposition at these two levels (Das et al., 2001). A study done among Sikh boys of India, in which a decrease of mean WHR is found (Sikri, 1972). Similar results also reported from Baharian (Kaul, 1975). Since WHR is influenced by age and sex (Walker et al., 1996), similar studies have undertaken on Bengalee girls. Longitudinal investigations of regional adiposity and WHR are needed to understand the dynamics of the change in them from childhood to adulthood. Figures 7 and 8 reveal tendency of WHR and C.I. in boys and girls, respectively. As it is clear, WHR decreases and C.I. increases with age in both genders. Both are good indicators of central obesity.



Figure 7. Pattern of growth of WHR and C.I. (Boys)

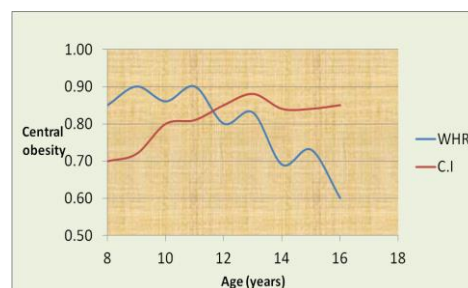

Figure 8. Pattern of growth of WHR and C.I. (Girls)

Table 4 describes the correlation of major CO indicators with age. BMI, WC, HC and C.I. are positively correlated. WHR (Figures 7 & 8) and WHtR (Figures 9 & 10) show negative correlations; increase of hip with age is always greater than waist after attaining puberty. BMI is the indicator of overall obesity. From the clinical perspective, central obesity (approximated by the waist circumference, hip circumference, waist hip ratio) provides more information than general obesity (BMI). Because of their high correlation, from the statistical perspective, those indicators are unlikely to yield different answers (Vazquez et al., 2007).

Table 4. Binary correlation of major CO indicators with age (gender-wise)

Anthropometric parameters	N (boys)	r value	Sig value	N (girls)	r value	Sig value
BMI	268	0.82**	.001	283	0.79**	.005
WC	268	0.9**	.001	283	0.81**	.001

HC	268	0.97**	.001	282	0.9**	.001
WHR	268	-0.68*	.005	283	-0.62*	.005
WHtR	268	-0.49*	.005	283	-0.45*	.005
C.I.	268	0.82**	.001	283	0.84**	.001

*significant at 0.05 level and ** significant at 0.01 level of significance

The correlations between various anthropometric measures of obesity are presented in Table 4. WC, WHtR, C.I. were all highly correlated with weight and BMI, with the Pearson correlation coefficients varying from 0.82 to 0.9; WHR and WHtR showed much weaker correlations with weight and BMI. The indicators of central adiposity appeared to be more strongly associated with CHD (Coronary heart disease) risk than did BMI. No previous study has investigated WHtR in relation to risk of CHD. But WHtR has been shown to be a useful predictor of multiple CHD risk factors (Hsieh & Yoshinaga, 1995). In a study of correlations of selected anthropometric variables, including WHtR, WC, BMI, and WHR, with intra-abdominal fat measured by computed tomography, WHtR showed the highest correlation. These findings seem to provide some biological explanations for our observations that WHR and WHtR were strongly predictive of CHD. More body composition studies are needed to clarify the biologic relevance of these anthropometric indexes, particularly among different age groups. Such information is critical for interpreting the statistical associations between anthropometric measurements and disease risk. WC has been proposed to replace WHR as an indicator of abdominal obesity, because it is highly correlated with visceral fat and easier to measure and interpret. Several cross-sectional studies comparing WC, BMI, and WHR have shown that WC was the best indicator (Zhang et al., 2004).

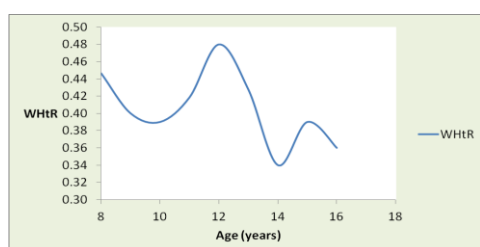

Figure 9. Pattern of WHtR with age (Boys)

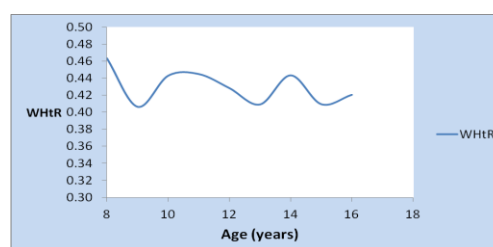

Figure 10. Pattern of WHtR with age (Girls)

WHtR (Figures 9 & 10) shows negative correlations in both boys and girls as hip increase is greater with age than waist after attaining puberty. WHtR is a good indicator of body shape and chance of chronic diseases in adulthood. Incident diabetes rates were higher for people from US countries (13.5 new cases per 1000 person per year) and lowest for the people from Asian countries (5.2 new cases per 1000 person/year). WHtR provide information about body shape and type II diabetes. WHtR and C.I. are significantly associated with more chronic kidney diseases and cardiovascular diseases than increasing BMI. Increasing BMI and WC were associated with only a minority of risk factors for kidney diseases but WHR, WHtR and C.I. were associated among each others with multiple factors. BMI has a limitation there; it tends to decrease with age, but kidney diseases tend to increase with the same. Anthropometric measurements that include a measure a central fat deposition may be of greater importance as a risk factor in CKD (Coronary kidney disease) than BMI which might underestimate the risk of those chronic kidney or cardiovascular diseases (Evans et al., 2012). Conicity (C) is an index of body fat distribution which expresses an individual's waist circumference relative to the circumference of a cylinder generated with that person's weight and height assuming a constant for body density (Valdez et al., 1993). The more central a person is in fat distribution, the higher the value of C. In a pilot study of cardiovascular reactivity and dimensions of anger and hostility in 60 African and Hispanic-American

adolescents, anthropometry and sexual maturation were determined to assess their mediating influence on the relation between anger and cardiovascular risk. C and WHR are highly related (0.85) yet differ in important respects in both sexes. C relates not only to body shape but also to body fat. Indices of central fat such as circumference and skinfold ratio may “over-correct” for total fatness and thus miss important aspects of risk prediction. Conicity may be a useful indicator of body fat distribution in studies of adolescents (Mueller et al., 1996).

Conclusion

Moderate rate of obesity is found in rural southern West Bengal as compared with international standards (WHO, 2007), which might be due to lack of awareness of healthy food habits. WHR and WHtR are lower, exhibiting a less chance of acquiring cardiovascular disease (CVDs). BMI, WC, HC and C.I. exhibit a general increasing trend with age, especially in girls in pre-teenage and early teenage in boys. Afterwards, a parallel pattern is found showing a steady growth in both genders. The Cut-off point and boundary values of waist-to-height act as an indicator for coronary heart diseases in Chinese adults (Zhang et al., 2004). Girls are taller and WC is greater than boys up to age 13, then boys’ growth spurt starts. Among anthropometric indicators, significance growth difference seen in Central Obesity (Ghosh et al., 2004). Among many possible outcomes higher prevalence of obesity could be the role of change in dietary pattern and physical activities. We recommend using the dietary pattern of subjects to get a clearer picture on obesity situation in India. An obesity map can be formed by using those databases which can be useful for health intervention at the government and non government level.

Acknowledgements

The authors are indebted to the following individuals in various capacities for completing the study: Dr. S. Biswas (Dept. of Anthropology, WBSU, India), Prof. R. Das (RS College, Barrackpore, India), Dr. A. K. De (ISCA, India), Prof. N. Ali and P. Dasgupta (RKM, India) and P. Patra (WBSU, India). The authors also express sincere gratitude to Prof. Sikha Sengupta (RBU, India), A. Das (DBHS, India), A. Das (JDS, India) and S. K. Mondal, T. Mukherjee, A. Bhattacharya, K. Das, Ms. R. Banerjee, Ms. S. Ghosh (the Authorities of the schools). Above all, the researchers sincerely thank all the students who participated in this study and encouraged them with their endless support and kind cooperation.

References

- Bhadra, M., Mukhopadhyay, A., Bose, K. (2002). Adiposity, central body fat distribution and blood pressure among young bengalee adults of Kolkata, West Bengal: sexual dimorphism. *J. Physiol. Anthropol.*, 1(4): 731-276.
- Bose, K., Bisai, S., Das, P., Dikshit, S., Pradhan, S. (2007). Relationship of income with anthropometric indicators of chronic energy deficiency among adult female slum dwellers of Midnapore town. *J. Hum. Ecol.*, 22(2):171-176.
- Bose, K., Ghosh, A., Roy, S., Gangopadhyay, S. (2005). The relationship of age, body mass index and waist circumference with blood pressure in Bengalee Hindu male jute mill workers of Belur, West Bengal, India. *Anthropol. Anz.* 63(2): 205-212.
- Brožek, J., Grande, F., Anderson, J.T., Keys, A. (1963). Densitometric analysis of body composition: revision of some quantitative assumptions. *Annals of the New York Academy of Sciences*, 110(1): 113-140.
- Chhatwal, J., Verma, M., Riar, S.K. (2004). Obesity among pre-adolescents of a developing country (India). *Asia Pac. J. Clin. Nutr.*, 13(3): 231-235.

- Das, K., Mondal, D., Bose, K., Mukhopadhyay, A. (2001). Age variations and central body fat distributions among 12-15 year old Bengalee boys of Palta-Icchapur, West Bengal. *Journal of Departmental Anthropology, University of Calcutta*, 7(1, 2):162-168.
- Dasgupta, S., Hazra, S.C. (1999). The utility of waist circumference in assessment of obesity. *Indian J. Public Health*, 43(4): 132-135.
- de Onis, M., Blössner, M., Borghi, E., Morris, R., Frongillo, E.A. (2004). Methodology for estimating regional and global trends of child malnutrition. *Int. J. Epidemiol.*, 33(6):1260-1270.
- Dudala, S.R., Reddy, K.A.K., Prabhu, G.R. (2014). Prasad's socio-economic status classification-An update for 2014. *Int. J. Res. Health Sci.*, 312(3): 875-878.
- Evans, P.D., McIntyre, N.J., Fluck, R.J., McIntyre, C.W., Taal, M.W. (2012). Anthropomorphic measurements that include central fat deposition are more closely related with the key risk factors than BMI in CKD stage 3. *PLoS One*, 7(4):e34699. doi: 10.1371/journal.pone.0034699.
- Eveleth, P.B., Tanner, J.M. (1991). *Worldwide variation in human growth*. Cambridge University Press, London, UK
- Esrey, S.A. (1996). Water, waste, and well-being: A multi-country study. *Am. J. Epidemiol.*, 143(6): 608-623.
- Freedman, D.S., Mei, Z., Srinivasan, S.R., Berenson, G.S., Dietz, W.H. (2007). Cardiovascular risk factors and excess adiposity among overweight children and adolescents: the Bogalusa Heart Study. *J. Pediatr.*, 150(1): 12-17.
- Gallagher, D., Visser, M., Sepulveda, D., Pierson, R.N., Harris, T., Heymsfield, S.B. (1996). How useful is body mass index for comparison of body fatness across age, sex, and ethnic groups?. *Am. J. Epidemiol.*, 143(3): 228-239.
- Ghosh, A., Bose, K., Chakravarti, S., Chaudhury, A.B.D., Chattopadhyay, J., Dasgupta, J., Sengupta, S. (2004). Adiposity measures and their relationship with metabolic risk factors for coronary heart disease in Bengalee Hindu Men, Kolkata, India. *Anthropological Sciences*, 112(2):115-119 doi: 10.1537/ase.00093
- Goran, M.I., Malina, R.M. (1999). Fat distribution during childhood and adolescence: implications for later health outcomes. *Am. J. Hum. Biol.*, 11(2):187-188.
- Hagen, C.P., Sørensen, K., Aksglaede, L., Mouritsen, A., Mieritz, M.G., Tinggaard, J., Wohlfart-Veje, C., Petersen, J.H., Main, K.M., Rajpert-De Meyts, E., Almstrup, K., Juul, A. (2014). Pubertal onset in girls is strongly influenced by genetic variation affecting FSH action. *Science Reporter*, 4: 6412. doi:10.1038/srep06412
- Hsieh, S.D., Yoshinaga, H. (1995). Waist/height ratio as a simple and useful Intern predictor of coronary heart disease risk factors in women. *Intern. Med.*, 34(12):1147-1152.
- Hu, F.B. (2002). Dietary pattern analysis: a new direction in nutritional epidemiology. *Curr. Opin. Lipidol.*, 13(1): 3-9.
- ICMR (Indian Council for Medical Research) (1972) *Growth and physical development of Indian infants and children*. ICMR, Technical Report Series no 18, New Delhi, India
- ISAK (International Society for the Advancement of Kinanthropometry) (2011) *International Standards for Anthropometric Assessment*. Available at: <http://www.isakonline.com/>
- Kaul, S. (1975). Growth of three anthropometric measures in Kashmiri Pandit School going bys with some observations on the efficiency of mixed longitudinal analysis of human growth. *Ind. J. Med. Res.*, 63(4): 590-596.
- Kaur, S. Sachdev, H.P., Dwivedi, S.N., Lakshmy, R., Kapil, U. (2008). Prevalence of overweight and obesity in school children In Delhi, India. *Asia Pac. J. Clin. Nutr.*, 17(4): 592-596.
- Khadilkar, V.V., Khadilkar, A.V. (2004). Prevalence of obesity in affluent school boys in Pune. *Indian Pediatr*, 41(8): 857-858.

- Kipke, M.D. (1999). Adolescent development and the biology of puberty: Summary of a workshop on new research. The National Academic Press, USA, pp. 1-2. Available online at: <http://www.nap.edu/catalog/9634.html>
- Marwaha, R.K., Tandon, N., Singh, Y., Aggarwal, R., Grewal, K., Mani, K. (2006). A study of growth parameters and prevalence of overweight and obesity in school children from Delhi. *Indian Pediatr*, 43(11): 943:952.
- Matijavsevic, A., Victoria, C.V., Golding, J., Barros, F.C., Menezes, A.M., Araujo, C.L., Smith, G.D. (2009). Socioeconomic pattern and overweight among adolescents: data from birth cohort studies from Brazil and the U.K. *BMC public health*, 9:105.
- Mueller, W.H., Meininger, J.C., Chandler, P.S., Liehr, P., Chan, W., Chandler, P.S. (1996). Conicity: A new index of body fat distribution—what does it tell us?. *Am. J. Hum. Biol.*, 8(4): 489-496.
- Mukhopadhyay, A., Bhadra, M., Bose, K. (2005). Physical exercise, body mass index, subcutaneous adiposity and body composition among Bengalee boys aged 10-17 years of Kolkata, India. *Anthropologischer Anzeiger*, 63(1): 93-101.
- Sadhukhan, S.K., Bose, K., Mukhopadhyay, A., Bhadra, M. (2007). Age variations in overweight, obesity and hypertension among adult men and women of Dearha, Hooghly district, West Bengal, India. *Indian J. Public Health*, 51(1):59-61.
- Sanjeev, I., Indech, J.D., Jit, I., Johnson, F.E. (1991). Skinfold thickness and body circumferences and their relationship to age, sex and SE status from Northwest India. *Am. J. Hum. Biol.*, 3(5):469-477.
- Seidell, J.C., Pérusse, L., Després, J.P., Bouchard, C. (2001). Waist and hip circumferences have independent and opposite effects on cardiovascular disease risk factors: the Quebec Family Study 1–3, 2001. *Am. J. Clin. Nutr.* 74:315–21.
- Seidman, D.S., Laor, A., Gale, R., Stevenson, D.K., Danon, Y.L. (1991). A longitudinal study of birth weight and being overweight in late adolescence. *Am J. Dis. Child*, 145(7):782-785.
- Sikri, S.D. (1972). A comparative study of height and weight of government and public school children of Punjabi population. *Indian J. Med. Res.*, 60: 491-500.
- Snijder, M.B., Dekker, J.M., Visser, M., Bouter, L.M., Stehouwer, C.D., Kostense, P.J., Yudkin, J.S., Heine, R.J., Nijpels, G., Seidell, J.C. (2003). Associations of hip and thigh circumferences independent of waist circumference with the incidence of type 2 diabetes: the Hoorn Study. *Am. J. Clin. Nutr.* 77(5): 1192-1197.
- Subramanyam, V., Jayashree, R., Rafi, M. (2003). Prevalence of Overweight & Obesity in Affluent adolescent school girls in Chennai in 1981 and 1998. *Indian Pediatr*, 40(8): 775-779.
- Tremblay, M.S., Katzmarzyk, P.T., Williams, J.D. (2002). Temporal trends in overweight and obesity in Canada, 1981-1996. *Int. J. Obes. Relat. Metab. Disord.*, 26(4): 538-543.
- Valdez, R., Seidell, J.C., Ahn, Y.I., Weiss, K.M. (1993). A new index of abdominal adiposity as an indicator of risk for cardiovascular disease. A cross-population study. *Int. J. Obes Relat. Metab. Disord.*, 17(2): 77–82.
- Vazquez, G., Duval, S., Jacobs, D.R.J., Silventoinen, K. (2007). Comparison of body mass index, waist circumference, and waist-hip ratio in predicting incident Diabetes: A Meta – Analysis. *Epidemiol. Rev.*, 29:115-128.
- Vignolo, M., Pitorio, A., Torrici, C., Parodi, A., Grassi, S., Aicardi, G. (2004). Overweight and obesity in a group of Italian children and adolescents: prevalence estimates using different reference standards. *Ital. J. Pediatr.*, 30:53-57.
- Visscher, T.L., Seidell, J.C., Molarius, A., van der Kuip, D., Hofman, A., Witteman, J.C. (2001). A comparison of body mass index, waist-hip ratio and waist circumference as

- predictors of all-cause mortality among the elderly: the Rotterdam study. *Int. J. Obes. Relat. Metab. Disord.*, 25(11): 1730-1735.
- Walker, S.P., Grantham-McGregor, S.M., Himes, J.H., Williams, S. (1996). Anthropometry in adolescent girls in Kingston, Jamaica. *Ann. Hum. Biol.* 23(1): 23-29.
- Wang, Y., Monterio, C., Popkin, B.M. (2002). Trends of obesity and underweight in older children and adolescents in the U.S, Brazil, China and Russia. *Am. J. Clin. Nutr.* 75(6): 971-977.
- Waterlow, J.C. (1972). Classification and definition of protein-calorie malnutrition. *Br. Med. J.* 3(5826): 566-569
- WHO (World Health Organization) (2007). Growth reference data for 5-19 years. Available online at: www.who.int/growthref/en/
- Zhang, X., Shu, X.O., Gao, Y.T., Yang, G., Matthews, C.E., Li, Q., Li, H., Jin, F., Zheng, W. (2004). Anthropometric predictors of coronary heart disease in Chinese women. *Int. J. Obes.*, 28(6): 734-740.

ECONOMIC EFFECTS OF PLUM PRODUCTION ON FAMILY FARMS IN THE REPUBLIC OF SERBIA

Jasmina FILIPOVIĆ¹, Sladjan STANKOVIĆ², Dragan RAHOVIĆ², Ivana BAKIĆ², Robert
RADIŠIĆ^{2*}, Vedran TOMIĆ²

¹Agricultural Advisory Service of Jagodina, 21 Koce Kapetana Street, Jagodina, Serbia

²Institute for Science Application in Agriculture, 68b Blvd despota Stefana, Belgrade, Serbia

*Corresponding author: rradistic@ipn.bg.ac.rs

Abstract

Plums are the most-widely spread fruit and the most important stone-fruit in Serbia. They are used for fresh consumption, dried, and for brandy, marmalade or jam production. It is important for farmers to be introduced to the economic effect of a certain production. Gross margin (GM) is a quick and efficient indicator for comparing production lines in different conditions. Gross margin was used as an indicator of economic effects of production. Data for GM calculations were collected through the questionnaire from the representative plum farms in city of Jagodina (Pomoravlje region, Serbia) in the period 2011-2014. For calculating the basic elements of gross margin, the following data were used: data on yield and price, by-product price, quantity and value of fertilizers, pesticides, and fuel, and costs for contracted services. GM does not indicate profits and it does not include the size, and value of fixed costs. It represents the total value of a production line subtracted by the direct costs for the production line in question (purchased inputs). Within the period 2011-2014, GM varies from 175,038 RSD/ha (2011), to 261,288 RSD/ha (2014). At the same time, the total variable costs did not change as much, ranging from 132,279 (2012) to 169,963 RSD/ha (2011). With the average yield for the observed sample (28.2 t/ha) and significantly higher price, an outstanding GM for plum was obtained.

Key words: *gross margin, plum, variable costs, yield, price.*

Introduction

Analysis of the farm management is essential. It enables farmers and advisors to understand how the farm works, as well as to determine its profitability. Diagnostic techniques that can be applied at a farm level can help farmers and agricultural advisors to identify critical issues that limit the profitability of farms. Many of the conventional tools for farm management fit into this category. They include analysis of limitations, gross margin analysis, budgeting, cash flow analysis, as well as more specialized methods of farm management, such as financial reports, balance sheet and risk management. Gross margin is an indicator of the profitability of agricultural holdings and individual production lines. It is a result obtained by subtracting the variable costs of the gross income.

Calculation of gross margin is essential when deciding between different production lines. If a farmer wants to know whether to proceed with a particular production line, he can compare gross margins of two different lines of production. If the farmer plans on changing the line of production, fixed costs are not likely to change, but the production value and variable costs are about to change. Using gross margin will help agricultural producers to determine whether the change of production lines will be profitable or not.

Possible indicators are: gross income per hectare, the total variable costs per hectare, the cost of labour per hectare, the cost of machine operations per hectare, the cost of fertilizer per hectare, and gross margin per hectare.

There are many farmers who continue to speak about the biggest yield per hectare, the largest increment or production per head of livestock and so on. However, the highest yield is often not the production level that generates the biggest profit. A farmer who wants to be competitive in the market needs to think about gross margins, profits, costs, and not only on maximum yields. (Kahan, 2008).

When using gross margin as an indicator of profitability, two factors that limit operations on the farm the most, should be considered when deciding. He must decide whether to use the total gross margin per hectare, the total gross margin per person per day, or a total gross margin per unit of capital (Kahan, 2010).

Materials and methods

Bearing in mind the nature and significance of research, several methods were used:

- Case study method with the use of examples based on research conducted on the territory of Pomoravlje region (Serbia), by the collection of gross margin calculations of 34 selected farms during the period of 4 years, with a fifth year as a control year.
- Method of analysis by which an influence of structural elements of gross margin on the gross margin result was established.
- A method of statistical analysis which was applied in order to establish connection between an influence of individual elements of gross margin on a gross margin end result.

Factors that influence gross margin result, such as yield, price and variable costs were recorded. Calculating the indicators of descriptive statistics in a certain period, average value, variation interval, coefficient of variation and rate of change are determined. In order to determine connection between parameters of research through degree, shape of influence and level of dependence, a method of regression and correlation analysis was applied. Significance of previously determined values was established by t-test. Poll method, by which farms were examined in order to calculate gross margin at the end of each production year.

Total number of plum gross margin calculations is 34, with the following structure: 4 farms in 2011, 7 farms in 2012, 12 farms in 2013, 10 farms in 2014, 1 farm in 2015. Out of these 34 farms previously analyzed, for 2015 one farm was picked to compare with average results of these previous 4 years. It was done in order to establish the importance of advisory work on these farms, since agricultural advisors, according to their program of work did not work with the same producers, after 2014.

Results and discussion

Plum is still the queen of stone fruits. The dominant variety used to be *Požegača*, but there are “new” varieties which have been introduced in the last few decades, such as *Stanley* and some of the varieties deriving from Čačak, that have now become the most common (Mladenović et al, 2013). The average yield of plums on the observed farms, in the analysed period was at the level of 28.2 t/ha, and ranged from minimum 20 t/ha up to a maximum recorded yield of 36 t/ha. Plum yield shows a tendency to increase at an average annual rate of 1.02%, while a yield variability is within the normal variability. During the same period average yield in the whole of Serbia was only about 5,2 t/ha, ranging from 3,8 in 2012, up to 7,3 in 2013. This is a very poor result, since, for comparison, average yield of plum in Bosnia and Herzegovina in 2012. was somewhat over 35 t/ha, and was actually 38% lower than in 2011 (Alic-Dzanovic et al, 2014). During the period 2011-2015, plum had an average value of about 12,700RSD/ha. When it comes to price, it can be concluded that price in the reporting period showed a slight tendency to increase, which can be observed on the basis of rate of change (0.68%). Total variable costs of plum production amounted to an average of almost

141.000 RSD¹/ha and showed a tendency to decrease at a rate of 0.45% per annum. Another positive feature is the relative stability of variable costs depicted by the coefficient of variation (Cv = 12.07%). Gross margin, as a result of production value averaged around 232.300 RSD/ha. If one compares gross margin/variable costs ratios, it can be seen that in our case, it was at a level of 1.64. These results are somewhat similar to those of Stirbu&Draghici(2010), where this ratio was 1.49 to 1.74, depending on the technology applied, and to a degree different than those established by Day *et al.* (2009), where this ratio was 1,06. Characteristic of gross margin is that it had significantly higher variability compared to other production parameters (Cv = 60%). Since a higher value of gross margin is a sign of greater profitability of production, when it comes to plum, an important characteristic is that it shows a tendency of growth at an annual rate of 5,82%.

Table 1. Basic indicators of production parameters of plum during the 2011-2014 period

Production parameters	Average value	Interval variation		Coefficient of variation (%)	Rate of change (%)
		Minimum	Maximum		
Yield (t/ha)	28.20	20.00	36.00	15.74	1.02
Price (rsd/t)	12.677	8.000	15.000	16.79	0.68
Variable costs (rsd/ha)	140.872	105.185	174.800	12.07	-0.45
Gross margin (rsd/ha)	232.275	88.145	373.600	59.99	5.82

In order to quantify the impact of yield, price and variable costs, a regression analysis was introduced in plum production. Results of the analysis (Table 2) show that the yield and price have a positive impact on the value of the gross margin, while there is a negative impact of variable costs. The increase in yield of plums for 1 ton will lead to the increase in gross margin to 21.250 RSD/ha. The increase in prices for plums 1 RSD/ha increase in gross margin to 36 RSD/ha. Variable costs in plum production have a slightly greater impact than in some other cultures, so that the increase in variable costs per 1 RSD/ ha, decreased gross margin by 2 RSD/ha. Beta value, and standardized regression coefficients show that the greatest relative impact on the change of gross margin of plums has yield, prices show somewhat of a lesser influence, while the impact of variable costs is twice less than the impact of yield. The corrected coefficient of determination is only 58.3%.

¹ Serbian Local Currency – Serbian dinar

Table 2. Regression analysis of yield, price and variable costs of the gross margin in plum production

N=34	Regression analysis results in plum production R= ,78792754 R2= ,62082981 Corrected R2= ,58291279					
	Beta	Std.Err.of Beta	B	Std.Err.of B	T(30)	p-level
			-487030	164430,0	-2,96193	0,005930
Yield	0,677981	0,131027	21250	4106,8	5,17438	0,000014
Price	0,551190	0,112545	36	7,4	4,89751	0,000031
Var. costs	-0,292989	0,131022	-2	1,1	-2,23619	0,032928

To check the assumption that the analysed results are to some extent influenced by the work of advisory services, and to confirm the importance of the advisory service work a comparison between the years in which these farms were cooperated with advisory service and the control year of 2015 has been made. To check this assumption a t-test was executed (Table 3). It is noted that in the reporting period value of gross margin was continually increasing year by year, which leads to the conclusion that plum producers applied advices given by the advisory service. In 2015, the highest value of gross margin was achieved and it is significantly different from the value of gross margins in the previous years. Since this is the case of permanent crops it is certain that the recommendations of advisors in the years preceding 2015, had they been adopted by the farmers, had an impact on the result achieved.

Table 3. t- test for significant difference two middle

Years		Average value in the first year	Average value in the second year	t- quotient	p- value
2011	2015	175.038	913.225	-29,33540*	0,000087
2012	2015	195.579	913.225	-11,65861*	0,000024
2013	2015	191.838	913.225	-8,15783*	0,000005
2014	2015	261.288	913.225	-11,66022*	0,000001

*P <0.05, significant difference between the compared values

Conclusion made on the basis of indicators of descriptive statistics and based on the performed test of the significance of differences, are confirmed by a graphical presentation of trends in gross margins of plum in the analyzed period (Graph 1).

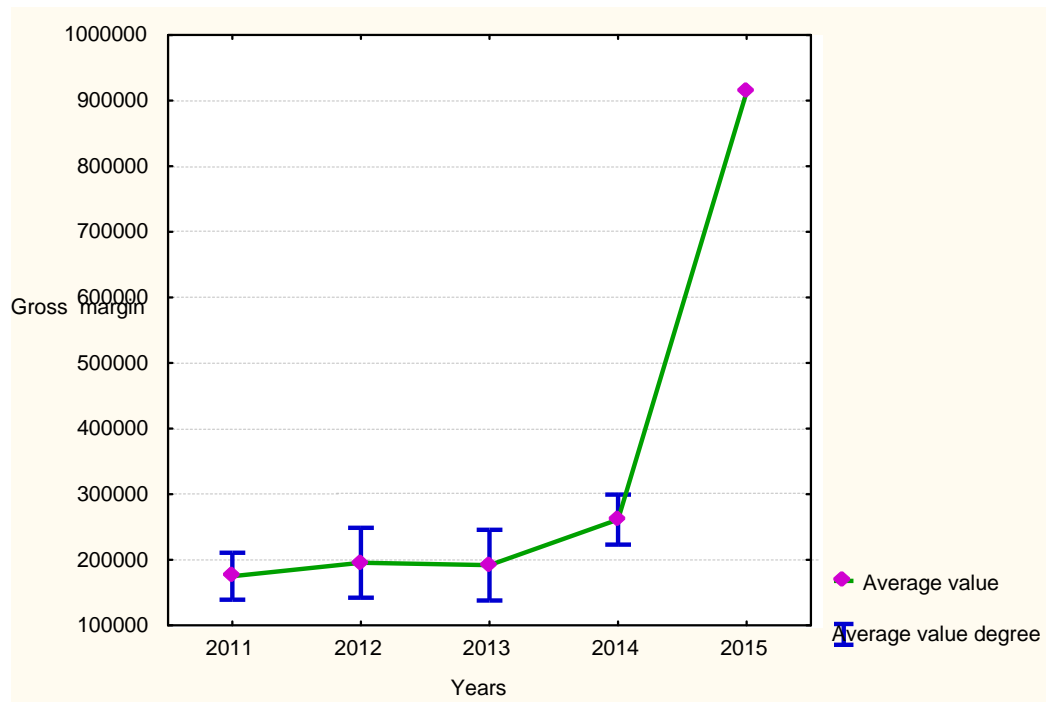

Graph 1. A trend of the average value of gross margin per year in plum production

Conclusion

Gross margin is a very useful tool for determination of economic efficiency of agricultural production. The average yield on the observed farms is a lot bigger than the average of Serbia. The records show that during the whole observed period 2011-2014, gross margins in plum production were positive, with yield and price having positive, and variable costs value having negative implications on the gross margin value. Gross margin value was especially high in the last year (2014), since this is the case of a permanent crop, while positive effects of advisory service measures could also be seen in 2015, in which gross margin was significantly higher than in 2014.

References

- Alic-Dzanovic, Z., Radovic, M., Gacesa, B., Kulina, M., Kurtovic, O. (2012). Pomological properties of cultivar "Čačanskarodna" in conditions of Sarajevo. Book of proceedings of the Vth International Symposium „Agrosym 2014“. University of East Sarajevo. Faculty of agriculture. Republic of Srpska, East Sarajevo. pp. 421-425.
- Kahan D.G. (2008). Farm management extension guide. Economics for farm management extension. Food and Agriculture Organization of the United Nations, Rome.
- Kahan D.G. (2010). Farm business analysis using benchmarking. Farm management extension guide series. Food and Agriculture Organization of the United Nations, Rome.
- Stirbu, R & Draghici, M. (2010). Economic aspects of the application of integrated plum crop protection schemes in Bihor country. Lucraristintifice. Seria I. Vol. XIV (2), pp. 205-208.

GROSS MARGIN OF PEPPER PRODUCTION IN THE POMORAVLJE REGION, SERBIA

Jasmina FILIPOVIĆ¹, Snezana JANKOVIĆ², Sladjan STANKOVIĆ^{2*}, Janja KUZEVSKI²,
Robert RADIŠIĆ², Vedran TOMIĆ²

¹Agricultural Advisory Service Jagodina, 21 Koce Kapetana Street, Jagodina, Serbia

²Institute for Science Application in Agriculture, 68b Blvd despota Stefana, Belgrade, Serbia

*Corresponding author: sstankovic@ipn.bg.ac.rs

Abstract

Peppers are significant vegetable species produced in Serbia. They are considered to be the economically most effective plant in Serbia. Peppers are mostly produced in Vojvodina province and in the south of Serbia (city of Leskovac), being a product that is exported to Germany, Belgium, Slovenia, Croatia, but also imported from Macedonia. Gross margin (GM), or the calculation of variable costs, was used as a tool for determination of economic effects of this production. Data analyzed in this paper were collected through the questionnaire from the representative pepper producers in city of Jagodina (Pomoravlje region, Serbia) for the period 2011-2014. The basic elements of calculation, obtained by this form of GM, were: data on yield and price, quantity and price of inputs used, such as fertilizers, pesticides, and fuel, and costs of contracted services. GM is a simple, yet useful tool to indicate the profitability of a single production line. By neglecting the amount of fixed costs, it gives farmers an idea of the amount of money they can earn from a single product, after covering production costs. Within the period 2011-2014, GM for pepper varies from 4.323 EUR/ha (2011), to 18.978 EUR/ha (2014). At the same time, the total variable costs ranged from 5.513 (2011) to 7.041 EUR/ha (2013). With the average yield of 53 tonnes/ha in 2014 and a price of 430 EUR/t, an outstanding GM for pepper was obtained in the last of the analysed years.

Key words: *gross margin, pepper, variable costs, yield, price.*

Introduction

Gross margins in agriculture and their importance for farm and agricultural production were analyzed in numerous works and research worldwide, but in Serbia as well. Kahan (2008, 2010, 2013) shows in his works the significance of the GM, as well as a number of authors, both in the plant (Broad *et al.*, 2009; Nash *et al.*, 2013), as well as in the livestock and milk production (Valvekaret *et al.*, 2010; Valvekaret *et al.*, 2011; Bozicet *et al.*, 2012; Heikkilä and Peippo, 2012). Authors in Serbia also observed gross margin as a significant indicator of the business of agricultural households (Ivkovet *et al.*, 2008; Anđelić, *et al.*, 2010; Jankovićet *al.*, 2007, 2009; Munćan and Božić, 2013; Munćanet *et al.*, 2010), as well as Tomicet *al.* (2013) and Filipovićet *al.* (2013). All these and other studies, and work relating to agricultural extension and gross margins in agricultural production, highlights the importance of extension services in agriculture as an inevitable element of the development of the agricultural sector, but also the importance of calculating the gross margin line of production on the farm as an important indicator of the profitability.

Pepper is considered as the most profitable crop culture in Serbia; it is the most cultivated in Vojvodina province and southern Serbia (Leskovac), in the open field and in greenhouses. Average area under pepper in Serbia in the reporting period range from 12.5 to 11.8 thousand hectares and have a trend of annual decline.

The average yield for the period, amounted to 8.3 t/ha, and except in the dry year 2012, showing an upward trend. Compared to other vegetables, pepper is the only that showed growth in production and average yield of 14% as compared to the yield in 2013, were up to 9.6 t/ha. The average yield in the reporting period for the Region was 9.7 t/ha, which is 15% higher than the average in Serbia in the same period. Compared to the average yields of other countries, including the CEFTA countries, Serbia has an exceptionally low average yield of pepper. EU countries have up to four times higher average yields in relation to Serbia. The biggest problems in the cultivation of pepper in Serbia, in addition to poor irrigation and crop management are inadequate measures of protection and seed production of traditional varieties. More emphasis should be given incentives in vegetable production, for the purposes of greenhouse production and processing of vegetables, including peppers.

Materials and Methods

GM, or the calculation of variable costs, was used as a tool for determination of economic effects of this production. Data analyzed in this paper were collected through the questionnaire from the representative pepper producers in Jagodina (Pomoravlje region, Serbia) for the period 2011-2014. The basic elements of calculation, obtained by this form of gross margin, were: data on yield and price, quantity and price of inputs used, such as fertilizers, pesticides, and fuel, and costs of contracted services. All prices are given in EUR, but original data were collected in Serbian dinars (RSD). Prices were calculated based on Serbian National Bank average exchange rate against major world currencies for particular year (www.nbs.rs/internet/cirilica/scripts/kl_prosecni.html). Indicators of the value of production, total variable costs and gross margin were calculated according to the methodology provided by the website of the Serbian Agriculture Advisory Service (www.psss.rs). *Microsoft Excel* was used for processing data and calculating GM, and the program was set to calculate the average value of each element of the calculation. GM is the difference of total revenue and total variable costs, achieved in a line of agricultural production per unit of production area.

Results and discussion

Pepper yield at observed farms varied considerably, from a minimum of 28 to a maximum of 80 t/ha and 50t/ha on the average. Also, the yield showed a distinct tendency to rise and annual average of 32 %. The average price of peppers has been 390.95 Euro/t (with annual increase of 1,4%) and average yield per year had an increase of 2 %.

Total variable costs were 648.000RSD/ha on the average, but still show significant fluctuations ($C_v = 25.59\%$) and a negligible tendency of yearly reduction by 0.11% (Table 1). Reduced variable costs, even symbolically, represent a favorable characteristic for farmers. Gross margin in pepper production at observed farms averaged around 1.695.000 RSD/ha. Significant variability is one of the characteristics of these gross margin calculations, represented by high value of variance coefficient of almost 57%, although slight variations in gross margin values were obtained, this parameter shows a growth tendency at a rate of 5.74% annually. Listed characteristics of pepper production parameters are observed based on calculated values of basic indicators of descriptive statistics, which are shown in table 1.

Table 1. Basic economic parameters in pepper production (2011-2014).

Production parameters	Average	Variation interval		Variation coefficient (%)	Rate of change (%)
		Min	Max		
Yield (t/ha)	50,00	28,00	80,00	31,62	2,01
Price (Euro/t)	376,59	231,92	662,62	25,51	1,39
Variable costs (Euro/ha)	5.365,89	3.167,32	8.067,40	25,59	- 0,11
Gross margin (Euro/ha)	14.041,56	2.409,62	37.298,44	56,72	5,74

Impact of yield, prices and variable costs on a gross margin value, has been established and quantified through the application of regression analysis. All three of factors listed show statistically significant influence on a gross margin level. 96.3 % of gross margin value can be explained by the influence of yield, price and variable costs. Single most significant influence on gross margin comes from the yield obtained and if it rises for 1 ton, gross margin shall increase for a little over 48.000 RSD/ha. Next factor by significance of its impact is price, and if it gets higher for just 1 dinar, it will affect the increase of gross margin for 42 RSD/ha. Totally opposite from yield and prices, which have a positive influence on gross margin, that is – their increase results in an increase of gross margin, the influence of variable costs is negative, meaning that their increase decreases gross margin value.

Table 2. Regression analysis of yield, price and variable costs on gross margin in pepper production

N=45	Regression analysis results in pepper production R= ,98238421 R2= ,96507873 Corrected R2= ,96252351 F(3,41)=377,69 p<0,0000					
	Beta	Std.Err. of Beta	B	Std.Err. of B	t(41)	p-level
			-1863789	144253,5	-12,9202	0,000000
Yield	0,793728	0,033620	48122	2038,3	23,6088	0,000000
Price	0,509000	0,030771	42	2,6	16,5418	0,000000
V.costs	-0,205604	0,033171	-1	0,2	-6,1983	0,000000

Table 3. T-test of significance of average value differences

Year		Average value for the 1st year	Average value for the 2nd year	t- test	p- value
2011	2015	440.744	3,392.744	-28,58440*	0,000000
2012	2015	2,004.120	3,392.744	-2,37933	0,036544
2013	2015	1,876.986	3,392.744	-1,97801	0,071351
2014	2015	2,226.335	3,392.744	-1,11666	0,296553

* p< 0,05, significance between compared values

Based on the aforementioned results of the research some conclusions related to the assessment of the effects of advisory work can be drawn, through changes in gross margins of the particular production lines on selected farms. Generally, all gross margins in all lines of production followed by a five-year period indicate significant increase. The annual growth rate of pepper production gross margin is significant (66.5% to 5.74%). This data clearly shows that there is a difference in the profitability among farms, but also differences in individual effectiveness of each advisor. The research results point to another important element that significantly affects the argument that the effects of advisory service, can measure the changes in gross margins. In fact, observed lines of crop production had the lowest gross margin in the first year (2011). Still, in control year (2015) gross margins continue to grow, although in that year advisors were not active on these farms, which proves that the previous work of the advisors gave positive results and that the producers accepted the advice on the right way and continue to achieve positive economic results in its production. Prices of products (eg. 2012) had some effect on the less significant increase or decrease of gross margins in period 2011 to 2015. As a reason for the lower gross margins of some production lines at a certain year, it is necessary to include climatic factors - rainfall and temperature, which is particularly reflected in field crops (Munćan and Živković, 2006) and significantly affect the quality and reduce the yield of the product. Typical example is the year 2012, as a dry year with very high temperatures (Tomice *et al.*, 2013), and 2014 as the year of spring floods in Serbia and a high average rainfalls. Unfavourable weather conditions in certain stages of development of different crops have an effect on the reduction in gross margin by increasing variable costs in terms of consumption of plant protection products (Filipović *et al.*, 2015). Although the results of the research show that on gross margin the largest influence had yield and price, while variable costs had less importance, it is clear that the increase in variable costs reduces the amount of gross margin. Nevertheless, the importance of advisory was determinant and very important in proper terms of timely and cost-effective advice in the field of plant protection (Stanković *et al.*, 2016). The increase in gross margin, related to advisory work, could be reached primarily through increased yields in vegetable production. Summarized results of the study are presented in Table 4.

Table 4. Comparative overview of average pepper yield (2011 - 2015) in different locations

Crop	Yield (t/ha) for period 2011 - 2015			
	Serbia	Šumadija and Western Serbia Region	Pomoravlje district	Advisory Service Jagodina – selected (Leader) farms
Peppers	8,30	9,70	45,00	50,00

Source: Authors desk research and questionnaire results summary

Based on the data in Table 4, it can be concluded that the average yield for the investigated period is highest at farms that are selected and advised by Agricultural Advisory Service Jagodina. For a table of yield averages all selected (leader) farms with production lines investigated were taken in calculation. The fact that advisors, when selecting a leader farms selected mostly "good" farms and farmers with whom they can achieve adequate cooperation, may affect the significance of the above-mentioned data, as it can be said that they are already selected farms with higher yields and more serious production. However, the survey results show that all the farms involved in the survey had the lowest yields in the first year of research (2011), after which they had a more pronounced a level of growth. Results of this survey of pepper production can point to the conclusion that advisory work has a very significant impact on the improvement of production and economic factors on farms. Through the increase of gross margin on the monitored farms, it is clear that the effects of consultation

can be determined on the basis of the gross margin of dominant production lines, individually for each of advisers, and for advisory service in general.

Conclusion

The agricultural sector in Serbia has excellent resources and conditions for agricultural production. It is the only sector of the economy in Serbia that actively participates and achieves a positive trade balance. In contrast, the Serbian agriculture is burdened by a series of structural problems. One of them is the performance of the basic agricultural production on small farms. The consequences of such situation, beside low production, are unprofitability and the lack of competitiveness of agricultural products, as well as unsatisfactory transfer of knowledge and new technologies to small and fragmented farms. Direct contact with farmers and the transfer of knowledge and skills, could be done only through Serbian Agricultural Advisory Service. Measuring of the results of knowledge transfer is quite difficult in all areas, including the advisory/ extension system. Therefore, it is possible in Serbia, as well as in other extension systems worldwide, to assess results of advisory work using gross margins of the dominant line of production on farms working with extension agents.

References

- Anđelić, B., Janković, S., Tomić, V. (2010): Uticaj strukture ratarske proizvodnje na bruto maržu porodičnih gazdinstava /The influence of crop production structure on the gross margin of family farms/, *Poljoprivredneaktuelnosti*, Institut za primenu nauke u poljoprivredi, Beograd, br. 1-2, pp. 92-104.
- Barnard, C. S. & Nix, J. S. (1979): *Farm Planning and Control*, Cambridge University Press, Cambridge.
- Filipović J, Stanković, S., Ceranić, S. (2015): Gross margin as an indicator of the significance of farmer education on the WCR risk assessment in repeat sowing. *Ekonomika poljoprivrede*, Vol. LXII, No (1-284), str. 137-155, ISSN.
- Filipović, J., Stanković, S., Ceranić, B. (2015). Bruto marža kao pokazatelj značaja edukacije poljoprivrednika o proceni rizika od kukuruzove zlatice u ponovljenoj setvi /Gross margin as an indicator of the significance of farmers' education on risk assessment of corn rootworm in repeat sowing/. *Ekonomika poljoprivrede* vol. 62, br. 1, str. 137 - 155
- Iurchevici, L., Chetroui, R. (2011): Standard Gross Margin for Cattle. *International Scientific Meeting - Sustainable Agricultural and Rural Development in Terms of the Republic of Serbia Strategic Goals Realization within the Danube Region*, Belgrade, Serbia, Vol. 59, pp. 111-117
- Janković S., Anđelić B., Kuzevski J., Kosanović N. (2009): Analiza brutomarže ozime pšenice u 2006. i 2009. Godini /Analysis of gross margins of winter wheat in 2006 and 2009/. *Poljoprivredneaktuelnosti*, Vol. 8, br. 1-2, str. 56-64.
- Kulhman, P., Shannon, D. & Casement, D. (2012): *Farm gross margin and enterprise planning guide*. Rural Solutions. Government of South Australia.
- Milić, D., Kalanović, B., Veljković, B. (2013). Menadžment i organizacija voćarsko – vinogradarske proizvodnje /Management and organization of fruit - grape production/. *Agroekonomski fakultet, Čačak*, str. 22 – 59.
- Munčan, P. I Živković, D. (2006) Menadžment ratarske proizvodnje /Management of crop production/, Beograd, str. 127
- Stanković, S., Janković, S., Kuzevski, J., Radišić, R., Tomić, V., Ljiljanić, N., Filipović, J., (2016). Značaj upravljanja rezistentnošću štetnih organizama u proizvodnji krompira I praćenje efekata kroz izračunavanja bruto marži /The importance of resistance management of harmful organisms in the potato production and monitoring the effects of the calculation of gross margins/. *Zbornik naučnih radova Instituta PKBA groekonomik*.

- Tomić, V., Janković, S., Kuzevski, J., Ljiljanić, N., Radišić, R. (2013): Maize Gross Margins in Different Environmental Conditions in 2011 and 2012, Book of Proceedings, Seminar on Agriculture and Rural Development – Challenges of Transition and Integration Processes, Belgrade, Serbia, pp. 226-234.
- Tomić, V., Janković, S., Kuzevski, J., Ljiljanić, N., Radišić, R. (2013), Bruto marže u različitim groekološkim uslovima – 2011i 2012.godina /Gross margins in the different agro-ecological conditions - 2011 and 2012/, 50th Anniversary Department of Agricultural Economics, Belgrade - Zemun

ADVISORY SERVICES: VARIOUS MODELS OF FINANCING

Snezana JANKOVIĆ¹, Sladjan STANKOVIĆ¹, Robert RADIŠIĆ^{1*}, Vedran TOMIĆ¹, Nikola LJILJANIĆ¹, Nenad KATANIĆ², Bratislav PEŠIĆ³

¹Institute for Science Application in Agriculture, Belgrade, Serbia

²Ministry of Agriculture and Environmental Protection of the Republic of Serbia, Belgrade, Serbia

³College of Agriculture and Food Production, 1 Cirila and Metodija Street, Prokuplje, Serbia

*Corresponding author: rradisic@ipn.bg.ac.rs

Abstract

Modern agricultural advisory can be traced back to the late 18th and the early 19th century, being more important in the 20th century. It emerged in the times when rural population had a greater percentage in total population, and when a need for transfer and dissemination of new technologies to farmers went along with the industrial revolution. Advisory first came up as a link between those in power, who were trying to implement certain agrarian policies, and farmers who did not perceive them as something positive. The current situation is characterised by the process of globalisation, which brings along progress and development in the field of communication and transportation. In such circumstances, a room for wider spreading of transnational capital emerges. A “shift of power” from public to private ownership has happened in this period. There were numerous objections against publicly-owned advisory services related to their inefficiency, lack of flexibility and high operational costs. Other reasons for privatisation of advisory were a need for charging costs and having cheaper advisory services. These and other arguments led to a diverse ways of organizing and financing advisory services in different countries, or even in different regions within the same country. Today, there are many ways to finance advisory: state budget, direct payments, voluntary contributions, agricultural chamber fees, etc. This paper presents the examples of financing advisory services in a larger number of the EU countries and in the USA.

Key words: *Advisory service, public, private, financing.*

Introduction

The first written records on the beginnings of agricultural advisory can be traced back to 1.800 B.C., when clay tables with scriptures on irrigation and crop protection were found on the territory of ancient Mesopotamia, present-day Iraq.

Although the data on the beginnings of advisory are diverse, advisory we know today originally comes as a result of the work of Philipp Emanuel von Fellenberg, who purchased an estate in Switzerland in 1799 and started to open agricultural schools. These schools, although not the first of that kind, had an impact on spreading the idea of advisory across Denmark, Germany, France and Great Britain. At the universities of Cambridge and Oxford, the idea of agricultural advisory gained importance in the 1890s, from where it moved to the USA, where agricultural advisory services were organized within land-grant universities. The Morrill act from 1862 established land-grant universities in the USA, within which advisory services were formed. The Smith-Lever act from 1914 formalised agricultural advisory tasks, as well as ways of their financing. Presuming a partnership between agricultural universities and the US Department of Agriculture, this act prescribes the sources of financing of agricultural advisory from the federal level, through the U.S. Department of Agriculture that approves funding for each state based on a formula related to the size of the population of each state in the USA.

Materials and methods

In this paper, various ways of financing agriculture advisory services around the world are observed. Evolution of agricultural advisory is presented, its transition from state owned to privately owned and financed, as well as the reasons for that transition are given in this paper. Various examples of models of financing agricultural advisory in European countries as well as in the USA are mentioned in this paper. Information given here are collected from a correspondent relevant literature – scientific articles, books on a related topic and FAO publications.

Results and discussion

Authors often mention that the most important counter-argument to the existence of state-owned agricultural advisory services is their inefficiency when it comes to cost-management. An information was given in the World bank study from 1992 (Saliu, 2009), which reveals that around 60% of costs for implementation of agricultural projects funded by the World bank were spent for advisory, while the governments of those countries absorbed around 18.5% of these costs. As a result, around 80% of total project costs of foreign financial assistance to advisory in 1992 went to sustaining a seemingly everlasting state administrative structure.

Although advisory emerged at the late 19th century, most countries did not have a formalized system of advisory before the 1950s and 1960s. A significant turn point in agricultural advisory occurred in the 1980s. Common objections against state-owned agricultural advisory services are related to their inefficiency and high operational costs. Although at the state level costs for engaging an agricultural advisor are not high, costs for engaging a great number of advisors have become a significant financial burden. According to the FAO web page data for 1990, there were about 600,000 agricultural advisors worldwide, 95% of which were employed in publicly owned agricultural systems. At the same time, there were 9,000 advisors employed in the USA, 4,000 of them specialised for a certain area, 1,000 directors and administrative staff (Swanson et al, 1990).

Modern times are characterized by globalization that carries along progress and development in the area of communication and transportation. Such circumstances leave some space for spreading of transnational corporate capital. Some authors, (Mathews, 1997) suggest this led to a so-called “shift of power” from public to private property. Along with this process, some bad sides of state-funded institutions came to surface – fiscal problems, reduced budgets which led to a decrease in their efficiency and productivity, thus making the costs exceed the benefits. The nature of advisory work is basically about advisors being the link between those in power, who are trying to implement a certain agrarian policy, and direct farmers, to whom such a policy is not always favourable. Advisors can implement a certain agrarian policy only if farmers who cooperate with those advisors are really willing to implement that policy, accepting the changes it brings. As an example, one can mention the limitations to the production of food surpluses, and imposing of more strict ecological rules in agriculture. This is mentioned as one of the reasons for privatisation of agricultural advisory services in Holland (Tacken, 1998).

In addition to the above-mentioned arguments, another argument in favour of privatisation of agricultural advisory services is also that advisory costs should be covered by farmers, since they are the ones who benefit from advice, and given that state budgets for public services are constantly decreasing. Another argument in favour of privatisation is that an increased competitiveness in this market would reduce the prices for these services (Quamar, 2005). When it comes to privatisation of public services, there are 3 scenarios proposed:

- 1) Public financing from tax payers, exclusively for services that contribute to the society as a whole;

- 2) Direct charging for individual services that have some specific results in terms of increased income, with the possibility of using different rates, depending on the specific situation or target group;
- 3) Mixed financing, depending on the contribution of public and private professional associations, in areas such as applied research, training of farmers and advisors and improvement of advisory methods and tools.

These methods of privatisation are typical for France, Great Britain and Holland.

Table 1. Different ways of organising and financing agricultural advisory services around the world

Advisory system	Relevant institutions	Sources of financing	Country
Public advisory			
State-run	Advisory work is carried out by public organisations, most often at regional level.	Fully financed from the national budget.	Belgium, Italy, Greece, Slovenia, Sweden, southern Germany, Spain, Portugal, Luxemburg
Partly state-run	Increasing role of advisory services rendered by private consultancy companies.	Farmers are partially or completely charged for services; It could be in centralised or decentralised forms.	Ireland, Czech Republic, Poland, Slovakia, Hungary, Estonia
“Semi-autonomous” advisory	Advisory services offered by national organisations.	Limited state subsidising.	Lithuania, Latvia.
Private advisory			
Farmers’ autonomic advisory	Advisory services offered by agricultural chambers, farmers’ organisations and associations.	Finances from farmers’ membership fees and direct payments.	Austria, France, Denmark, Finland, northern and western regions of Germany.
Commercial	Advisory services offered by commercial companies or private individuals.	Paying for services through project implementation or grants.	England, Holland, northern and eastern of Germany.

*Source: Agricultural Advisory Institutions on European Union countries, Mis, T. (2004), authors presentation based on Kania 2006, Riviera 2001

FAO, in its chapter 22 on privatisation of agricultural extension mentions different ways of financing, varying on the sector which provides advisory services.

In countries where the public sector provides advisory services, there could be some alternative ways of financing, such as:

- 1) General financing based on taxing, which is a traditional way of financing advisory;
- 2) Public taxing of certain goods (through tolls or parafiscal taxes), for example for agricultural products, such as coffee in El Salvador;
- 3) Public financing based on provision, where fees are charged for advisory services, usually to bigger farmers, like, for example in a crop-productive area of northern Mexico;
- 4) On a contract-based commercialization of public services, where there are contracts between the agricultural producer and public advisory services, like in New Zealand, for example.

In countries where private sector provides services, alternative ways of financing include:

- 1) State vouchers based on income, provided to farmers, who in turn conclude contracts from advisors from the private sector in order to get advisory service (information), such as in Chile;
- 2) An income-based coupon scheme derived from public loans, in connection with agricultural loans, which obliges the farmer who takes a loan to spend a certain amount of that money on agricultural advisory services;
- 3) Fees and commissions, including financing by taxing certain goods, where farmers pay the fee and customer services, while private organization (for example the agricultural chamber) also benefits from public tolls or parafiscal taxes payed on agricultural products, which are later being forwarded to organisations in the private sector. The private sector then provides agricultural services. Advisors from the private sector usually participate in steering committees of these agricultural chambers.
- 4) Fees in combination with sponsorships from certain groups or input suppliers, where educational advisory services are provided to groups of farmers by a consortium of consultants – private advisors, whose financing is partly provided from the sector of rural commercial sponsors;
- 5) Privatisation, where providing services and advisors' wages are in a domain of farmers' associations or other private entities.

A list of ways of financing agricultural advisory services is given below (A.W. van den Ban, 2000):

- 1) State-owned service financed by tax payers;
- 2) State-owned service financed through tolls on a certain agricultural product;
- 3) Commercial company that sells inputs to farmers or buys their products;
- 4) Farmers' association that pays for advisory services from fees;
- 5) Farmers' association subsidised by the state;
- 6) Non-governmental organisation financed from donations of residents and non-residents and/or from the commercial companies for public relations;
- 7) Non-governmental organisation financed by state subsidies, whether from the national government or the government of the donor;
- 8) Consultant company that charges provision to farmers who are its clients;
- 9) Publishing company that sells agricultural newspapers or similar publications to farmers;
- 10) Different combinations of ways from numbers 1 to 9.

Conclusion

Agricultural advisory services developed from a necessity of improvement of agricultural production in terms of both its quality and quantity, on a course desired by a wider community. Based on such needs, first they were organized within different state institutions. However, global trends of development of market economy, insisting on private property as a dominant form of ownership in the world, from economically strongest nations in the world gradually imposes trends of privatization also to some of conditionally speaking "smaller" countries in all areas of economy, as well as in the agricultural advisory. From this point of view, the knowledge which agricultural advisors transfer to farmers is observed as a form of intellectual property – a product, which is being exchanged between business partners represented by agricultural advisor and a farmer and which should have its market price. Participation of a greater number of suppliers of this service should lower its price, while gradual governmental withdrawal out of the sponsors role in this, affected the development of various ways of organizing, and thus financing of organization that provide these kind of

services. Therefore, currently in the world there is a pluralism of providing and financing of services of agricultural advisory.

References

- Mathews, J. T. (1997). Power shift. *Foreign Affairs*, Vol. 76(1), pp. 50-66.
- Mis, T. (2007). Agricultural advisory institutions on European Union countries, 249. Faculty of Economics, University of Rzeszow.
- Saliu, O.J. (2009). Privatization of agricultural extension services in Nigeria-Proposed guidelines for implementation. *Journal of sustainable development in Africa*. Volume 11, Number 02.
- Swanson, B. E., Farner, B. J., & Bahal, R. (1990). The current status of agricultural extension worldwide. In B. E. Swanson (Ed.), *Report of The Global Consultation on Agricultural Extension*. Rome: FAO.
- Tacken W. (1998). Consultancy service in Netherlands. In: I. Wallace (ed.). *Rural knowledge systems for the 21st century; Rural extension in Western, Central and Eastern Europe*. Reading, AERDD: 199-203.
- Van den Ban, A.W. (2000). Different ways of financing agricultural extension. *Agricultural research and extension network paper*, Vol. 106b, pp. 8-19.
- <http://www.fao.org/docrep/w5830e/w5830e0o.htm>. Retrieved 20.08.2014.

MARKET PERFORMANCE OF SELECTED PEPPER SPICES IN IBADAN METROPOLIS, OYO STATE, NIGERIA

Catherine A. AKINPELU^{1*}, Kemisola O. ADENEGAN²

¹Spices Improvement Program, National Horticultural Research Institute, Idi-Ishin, Ibadan, Oyo State, Nigeria

²Department of Agricultural Economics, University of Ibadan, Oyo State, Nigeria

*Corresponding author: adkate1@yahoo.com

Abstract

Hot pepper – *Capsicum frutescens* (HP), Black Pepper – *Piper guineense* (BP), Alligator pepper – *Afframomum melegueta* (AP) and Guinea pepper - *Xylopiya aethiopica* (GP) were assessed in year 2014 for their market performance in Ibadan, Oyo State, Nigeria. Eighty spice marketers were interviewed using a structured questionnaire which captured the socio-economic characteristics and marketing indices for the selected spices from four (4) prominent markets in Ibadan namely; Bodija, Bode, Aleshinloye, and Oje markets respectively. Data were analyzed using descriptive statistics, marketing efficiency and regression analysis. Results showed that 96% of the marketers were women with most been middle-aged (46.3%) and married (81.3%). About 53% of the marketers had an average family size of between 1 and 5 people and the highest educational attainment was the primary education (38.8%). The marketing efficiency analysis revealed that spices with the highest average total revenue in the four markets sampled were in the descending order black pepper > alligator pepper > guinea pepper > hot pepper. The analysis showed the markets with the highest prominence in sales of these (4) pepper spices within Ibadan metropolis in the ascending order; Bode < Aleshinloye < Oje < Bodija. The regression analysis revealed family size, years of experience and cost price of spices as socio-economic factors affecting revenue generated from spices. However, to fully harness the benefits inherent in the utilization and marketing of these pepper spices, there should be a synergy in cost and selling price of the pepper spices in order to boost their market performance in the study area.

Keywords: *Pepper spices, Market performance, Condiments*

Introduction

Spices are aromatic and pungent herbal substances used as condiments. These substances generally give a characteristic smack, flavor, color and aroma (Gurib-Fakim, 2006; Khan and Balick, 2001). The story of spices and other flavorings' materials is one of the most interesting chapters in the history of vegetable products (Obadoni and Ochuko, 2002). Spices are used to season insipid foods and to add zest to an otherwise monotonous diet. They stimulate the appetite and increase the flow of gastric juice. For this reason they are often referred to as food accessories or adjuncts. They also play a role in many of the industries, and are used in perfumery, soaps, incense, as dyes in histology and in various acts (Onyesom and Okoh, 2006). Hot pepper/birds eye chillies (*Capsicum frutescens*) are one of the hottest pepper varieties found globally. It is produced in Eastern Africa (Malawi, Zimbabwe, Zambia, Kenya, and Uganda) as well as Nigeria and Ghana in West Africa (Kenya Horticultural Competitive Project, 2011). The bird's Eye chilli plant is a small bush that can grow to a height of 4 feet and sometimes more with a productive life of two to three years. Among others, bird's eye chillies are used as curry ingredient, pharmaceuticals, organic pest control spray and in making tear gas. Most Bird's Eye chillies are processed to extract the oleoresins for sale to the food and pharmaceutical industries (ADC, 2001).

Black pepper (*Piper guineense*) is commonly referred to as African black pepper or Ashanti pepper, is very similar to *Piper nigrum*. Black pepper (*Piper guineense*) nutritionally, is an excellent source of manganese, a very good source of iron and vitamin K, and a good source of dietary fiber (Nelson and Eger, 2009). Many *Piper* species have been found to have insecticidal properties, especially *P. nigrum*, *P. guineense*, and *P. tuberculatum* (Scott *et al.*, 2005). Piperine in black pepper has also been discovered to possess some anti-fat effects which invariably reduces fat levels in the bloodstream and has other beneficial health effects (Goldberg, 2012).

Alligator Pepper (*Aframomum melegueta*), is a perennial herb commonly found in tropical regions, particularly in West Africa. They have been used extensively in the treatment of several ailments such as measles and leprosy. The fruit, apparently, also has an aphrodisiac property which is used to improve sexual stimulation and sexual performance (Oguntola, 2010). Guinea pepper has been reported to be recommended to women who have newly given birth as a tonic in the Ivory Coast as a woman remedy, it is taken also to encourage fertility and for ease of childbirth (Ogbe *et al.*, 2009)

Guinea Pepper (*Xylopia aethiopica*), is a tree of 20 meter high or more with a clear straight bole to 75cm girth (Burkill, 1985). It has an English name of African Pepper. In Nigeria: (Yoruba) it is called Eeru; in (Igbo) it is called Uda. Negro Pepper has been reported in literature to possess medicinal and nutritional values (Nwachukwu, 2000). The fruit is used for soup making, particularly for nursing mothers. In folk-medicine, it is used for the treatment of biliousness, bronchitis and dysentery (Ogbe *et al.*, 2009).

Despite the medicinal and nutritional potentials of these pepper spices, their demand and supply in Nigeria are still relegated to the background. It is against this backdrop that this research work was carried out to harness information on performance of spices marketing in Ibadan metropolis with a view of achieving the following objectives; to determine the demographic characteristics of the marketers, to assess the performance of three selected pepper spices in Ibadan metropolis and to determine the factors which influence the selling price of spices in the study area.

Materials and methods

The study area was Ibadan, the capital city of Oyo State which is located between 7°N and 9°N of the equator, longitude 3°E and 5°E of the Greenwich Meridian. Four (4) prominent markets in Ibadan namely; Bodija, Bode, Aleshinloye and Oje markets respectively in Oyo State were covered by the study. A purposive sampling technique was employed which led to the choice of four markets within the metropolis due to the concentration of these spice marketers within the markets.

Primary data for the study were obtained with the aid of a semi-structured, pre-tested questionnaire. distributed randomly to a selected number of marketers in each market via sampling proportionate to size thereby, giving a total sample size of 80 respondents which captured the socio-economic characteristics, marketing factors, benefit and cost parameters of the marketers in the study area.

The data collected were analyzed using descriptive statistics, marketing margin analysis and regression to capture socio-economic characteristics, performance of spices marketing and factors affecting spices marketing in the study area. Regression analysis was used to determine the level of relationship/significance between the gross margin (dependent variable), demographic characteristics and marketing activities (independent variables). The regression model is specified in the general form:

$$Y = f(x_1, x_2, \dots, x_8)$$

Where: Y = Revenue/selling price of spices in ₦/ bag

X₁ = Age

X₂ = Sex

X₃ = Marital Status

X₄ = Education level

X₅ = Family Size

X₆ = Ethnicity

X₇ = Years of Experience

X₈ = Purchase/Cost price of spices (₦/ bag)

For the purpose of this study, four (4) pepper spices were exclusively analyzed. The marketing margin and efficiency procedure are as follows:

$$MM = \frac{TR - TMC}{TR} \dots \dots \dots (i)$$

$$ME = \frac{TR}{TMC} \dots \dots \dots (ii)$$

Where, TR = Total Revenue; TMC = Total Marketing cost:

MM = Marketing Margin and ME = Marketing efficiency.

TMC comprises of purchase cost in Naira per bag, cost of transportation in Naira/bag and cost of storage in Naira/bag

TR = Price/bag x quantity sold.

Results and Discussion

Socio-economic Characteristics of Marketers

The results of the analysis in table 1 showed that majority of the marketers (96.3%) were females, which implied that women are more into the marketing of pepper spices than men. Those who are middle-aged and active constitute the largest percentage (46.3%) amongst the marketers.

Majority of the marketers (81.3%) were married, which establishes the fact by Mafimisebi *et al.*, (2000) that married people tend to have more financial commitment and home up-keep. Ninety three percent of the respondents had one form of formal education or the other with primary level of education ranking highest (38.8%). This depicts that a substantial number of the marketers had basic knowledge of how to read and write which could further enhance their marketing capabilities.

More than half of the respondents (52.5%) had an average family size of between (1-5) members, depicting that proceeds from the sales of spices will most likely meet the needs of the household due to the moderate size. Most of the respondents (85%) were from the Southwestern part of Nigeria. and highest revenue generated (52.5%) was within the range (0-5000) which implies that most of the marketers were low income earners.

Table 1: Socio-economic Characteristics of Spices Marketers in Ibadan, Oyo State

<u>Items/Variables</u>	<u>Frequency</u>	<u>Percentage (%)</u>
<u>Gender</u>		
Female	77	96.3
Male	3	3.8
<u>Age Group</u>		
22 - 40	36	45.0
41 - 60	37	46.3
61 – 80	7	8.8
<u>Marital Status</u>		
Single	6	7.5
Married	65	81.3
Divorced	1	1.3
Widowed	8	10.0
<u>Educational Status</u>		
Primary	31	38.8
Secondary	29	36.3
Tertiary	4	5.0
Illiterate	16	20.0
<u>Family size</u>		
1 – 5	42	52.5
6 – 10	35	43.8
11 – 15	1	1.3
16 – 20	2	2.5

Field survey 2012

Performance of Spices Marketers in Ibadan, Oyo State

The market performance of spices in Ibadan was measured using the marketing margin and efficiency analysis procedure. Fig.1 showed that the pepper spice that was topmost on the supply chain was black pepper (1.26%) which was followed closely by guinea pepper (1.25%). Negro pepper was next with a marketing efficiency of (1.16%) and then lastly hot pepper (0.62%). This implies that, if ₦1 is invested in the marketing of black pepper, guinea pepper and negro pepper respectively, a gain of 26k, 25k and 16k will be realized, depicting that the marketing performance of the pepper spice is high and profitable. This study agrees with Usman *et al.*, (2007) on the marketing analysis of *Thaumatococcus danielli* in Ibadan, Oyo state of Nigeria which showed that the trade was highly profitable. It is also in agreement with Usman *et al.* (2006) on the marketing analysis of cabbage in Jos South Local Government area of Plateau State, which indicated that there was large marketing margin of sellers with significantly high returns.

However, the demand for these pepper spices in the markets under survey revealed sales in an ascending order of lowest to highest (Bode < Aleshinloye < Oje < Bodija) depicting that supply of these pepper spices was highest in Bodija market, probably due to the fact that it is one of the major food markets in Ibadan metropolis.

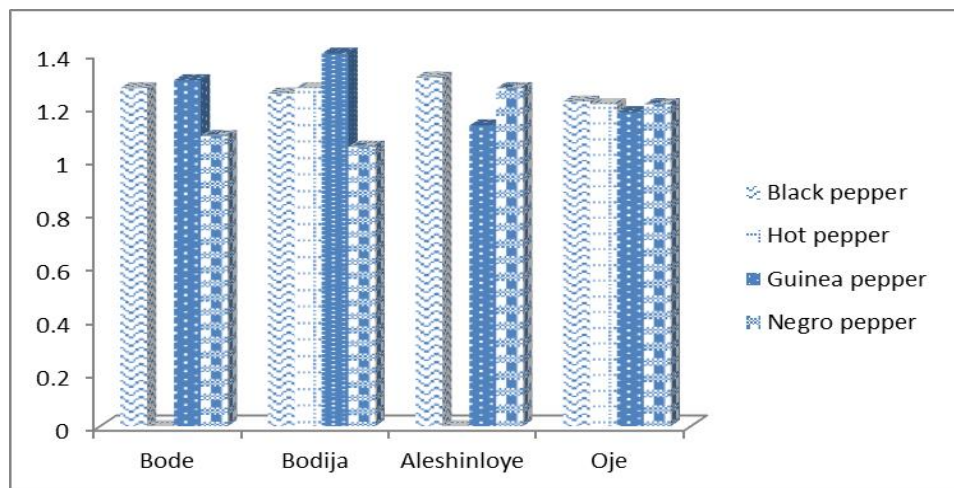

Fig 1: Marketing Efficiency of four pepper spices in Ibadan metropolis

Factors affecting Income Generated on Spice Marketing

The regression results in table 2; revealed family size, years of experience in spices marketing and cost price of spices as significant variables affecting gross margin/revenue on spices marketing. The family size of spices marketers had a significantly negative effect on income generation. This implies that the smaller the family size, the higher the income and vice-versa. The years of experience in spices marketing ($P < 0.05$) was a significant factor affecting revenue generated from spices signifying that the lesser the number of years involved in marketing of spices, the higher the income generated will be and vice versa.. Using the coefficient values, the cost price significant explanatory variable on the selling price of spices could mean that a ₦1 increase in the cost price (X_i) of spices, will lead to ₦0.99 increase in revenue generated on spices in Ibadan. This buttresses the theory that selling price is a direct function of cost price. Other socio-economic variables; age, gender, marital status educational level and state of origin, affects revenue generated from spices marketing in Ibadan positively but the effect was not significant. Therefore, the null hypothesis which states that there is no significant relationship between the socio-economic characteristics of marketers and their generated revenue from spices is rejected and the alternative accepted which states otherwise.

Table 2: Result of linear regression analysis showing demographic characteristics affecting spices revenue

Variable	Coefficients	Standard Error	Y-Value
Constant		6217.438	1.084
Gender	(.018)	7239.560	(.861)
Age	(.028)	177.951	(1.415)
Marital status	.022	2117.173	.982
Educational level	.015	995.713	.667
Family size	(.040)	2084.225	(1.862)*
State of origin	.003	584.366	.124
Years of experience	(.052)	146.014	(2.422)**
Cost price of spices	.991	.028	47.088**
R Squared = 0.974	Adjusted R ² = 0.971	**Significant at 5%	*Significant @ 10% () signifies – ve

Source: Field survey, 2012

Conclusion and Recommendation

Most marketers of these pepper spices in Ibadan metropolis were married women with basic primary education. The performance of pepper spices marketing revealed that it was a profitable enterprise. Therefore, to promote profitability of spices marketing in Ibadan, there

should be a synergy in the cost and selling price of spices by marketing boards in the state while taking into consideration other marketing costs such as transportation cost, storage cost e.t.c in order to boost the market performance of pepper spices in the study area.

References

- ADC (2001) Dried Bird's Eye Chillies, ADC Commercialisation Bulletin No. 3.
- Burkhill, H.M. (1985). *The useful plants of West Tropical Africa*. The white friars Press Ltd., Kent, 959pp.
- Goldberg, C. (2012): Behind the fat fighting effects of black pepper. www.Archives.commonhealth.wbur.org.
- Gurib-Fakim, A. (2006). Medicinal plants: Traditions of yesterday and drugs of tomorrow. *Mol. Aspects Med.*, 27: 1-93.
- Mafimisebi, T.E; Okunmadewa, T.Y and Adebayo S.K (2000); Structure, Conduct and Performance of sun-dried meat trade in Ibadan Metropolis. *Journal of Technology and Education in Nigeria* Vol.5, No. 1 & 2.
- Nelson, S.C., and K.T. Eger.(2009): Farm and Forestry Production and Marketing Profile for Black Pepper (*Piper nigrum*). In: Elevitch, C.R. (ed.). *Specialty Crops for Pacific Island Agroforestry*.
- Nwachukwu, N. (2000): Nutritional and Antinutritional substances in some selected indigenous spices Ph.D Thesis, FUTO, Nigeria.
- Iwu, M.N. (1993: Handbook of African Medicinal plants, CRC Press Bole Ralvon and Arbour, Tokyo, 244.
- Kenya Horticultural Competitive Project (2011): www.GrowKenya.org
- Khan, S. and M.J. Balick, (2001): Therapeutic plants of Ayurveda: A review of selected clinical and other studies for 166 species. *J. Altern. Complement. Med.*, 7: 405-515.
- Obadoni BO, Ochuko O (2002): Phytochemical studies and comparative efficacy of the crude extracts of some homeostatic plants in Edo and Delta States of Nigeria. *Global J. Pure Appl. Sci.*, 8(2): 203–208.
- Ogbe, F.D; Eruogun, O.L and Uwagboe, M. (2009): “Plants used for Female Reproductive Health care in Oredo Local Government Area, Nigeria. *Scientific Research and Essay* 4 (3): 077-081, 2009.
- Oguntola, S. (2010): Alligator pepper, Guinea pepper have sex stimulating effects. *Nigerian Tribune*. March 04, 2010.
- Onyesom I, Okoh PN (2006): Qualitative analysis of nitrate and nitrite contents in vegetables commonly consumed in Delta State, Nigeria. *Br. J. Nutr.*, 96(5): 902-905.
- Scott, I. M. (2005) Efficacy of botanical insecticides from *Piper* species (Piperaceae) extracts for control of European chafer (Coleoptera: Scarabaeidae). *Journal of Economic Entomology* 98, 845-855.
- Usman, M.B; Omoayena, B.O and Ishaya, B. E. (2006): Marketing analysis of Cabbage (Brassicica Alleraea) in Jos South Local Government Area of Plateau State. In *Technology and Agricultural Development in Nigeria. The Proceedings of the 20th Annual National Conference of Farm Management Association of Nigeria* Ed. By Adepaju, S.O and Okuneye, P.B Pp 227 – 281.
- Usman, J.M; Adebisi-Adelani, O; Olomola, A; Adeoye, I.B; Akoun, J, Sobayo, R.A; Abiola, I.O. and Adams, B.A. (2007): Marketing Analysis of *Thaumatococcus danielli* Benn. In Ibadan. In- Horticulture and Nigeria's millennium Development Goals. *Proceedings of the 25th Annual Conference of the Horticultural Society of Nigeria*. Edited by A.O. Olufolaji and V.C. Umeh. Pp. 258 – 262.

7. FORESTRY AND AGRO-FORESTRY

GLOBAL CLIMATE CHANGE AND FORESTRY

Michal V. MAREK,

CzechGlobe-Global Change Research Intitute, Academy of Sciences, Czech Republic, Bělidla 3a, 603 00 Brno,
Czech Republic marek.mv@czechglobe.cz,

Abstract

Forest ecosystems are composed mainly of trees, shrubs, plants and other autotrophic organisms. Thus, photosynthetic activity is a crucial and significant physiological process in this type of ecosystem. Photosynthetic activity is directly connected to carbon dioxide absorption. Thus, CO₂ in the atmosphere, which is regarded as the main source of carbon, is regarded as the “inorganic nutrient” for photosynthesis. Because CO₂ is the principal greenhouse gas, the photosynthesis could be regarded as the crucial “massive biological pump” of carbon from the atmosphere. It means that photosynthesis of plants is strongly related to global climate change, which is regarded as the crucial phenomenon of the current environment on the planet Earth. The ability of different ecosystems to be long-term carbon storages varies substantially. In particular, forests are of great importance. The long-term carbon storage in woody biomass and especially in the forest soil is significant. This carbon storage is strongly dependent on environmental impacts and anthropogenic activities. These silvicultural activities substantially affect carbon storage. Thus, it is possible to formulate a special set of forest practices named “carbon forestry”, which focus on enhancing carbon storage and reducing carbon losses.

Keywords: *Carbon capture by forest, Carbon storage, Carbon forestry*

Introduction

Global Climate Change (GCC) is regarded as the crucial problem of the current environment on the planet Earth. GCC is coupled with the atmospheric CO₂ content, because of the role of CO₂ in the warming. The permanent exchange of carbon between the atmosphere and different ecosystems plays a very important role in the biosphere function. Autotrophic organisms, via the process of photosynthesis activity, are “pumping” huge amount of CO₂ from the atmosphere into biomass. Especially forest ecosystems are particularly important. Forest stands play a crucial role in the long-term carbon storage in the landscape. Forests are distinctive spatial bodies, they are long living organisms and occupy large areas. Carbon is stored in the forest biomass and a huge amount of carbon is stored in the forest soil (Janssens et al. 2003). Thus, it is possible to define a new forest ecosystem service which is related to the ability of forest ecosystems to be a huge and long-term terrestrial carbon stock. According to the Millennium Ecosystem Assessment, this service is classified as an ecosystem regulation service, i.e. carbon sequestration can be regarded as an important ecosystem service and a tool that contributes to meeting CO₂ mitigation objectives. Anthropogenic factors are having long-term impacts on European forests and forest management is regarded as a very important external factor which mainly affects the composition, stability and vitality of forest stands. Silviculture practices are affected by different external (nutrition status, air pollution, insect and pathogens impact, global warming, water deficit) and internal (ontogeny and vitality of trees) factors. These events can be negatively strengthened by the unsuitable forest management activity. Despite these negative consequences, European forests are generally showing a substantial increase in tree growth as a result of the positive combination of

increased nitrogen storage, increased atmospheric carbon dioxide and improved forest management practises. Therefore, a continued increase in the carbon stock stored in forest tree biomass across the European continent has been reported (Nabuurs et al. 2003). The final carbon accumulation in forest ecosystems is the sustained difference between the net primary productivity (which remarkably, has been increasing during the past decades) and carbon losses by active ecosystem respiration, decomposition and harvest (which has increased less over the same period) (Luysaert et al. 2010). It is known that carbon sequestration is sensitive to the impact of environmental factors, particularly microclimatic and external synoptic factors. These factors are responsible for the large carbon storage dynamics between individual growing seasons (Marek et al. 2011). Moreover, forest stands are composed from different tree species, roughly from two basic types, i.e. coniferous and broadleaf species, respectively. It is possible to expect some differences in the seasonal course of carbon storage between these basic forest types. The presented paper focuses on the manifestation of environmental effects on carbon accumulation in different ecosystem types and highlights the potential of special silviculture management, i.e. carbon forestry.

Material and methods

Carbon storage indifferent ecosystem types of the Czech Republic is permanently evaluated at a set of sites which are the part of EU ESFRI infrastructure, ICOS (www.icos-infrastructure.eu), and Czech national infrastructure, CZECHCOS (www.czechglobe.cz). These sites are located in different parts of the Czech Republic and they represent the principal ecosystem types found in the country. The investigated set of ecosystems includes a mountain spruce stand (910m a.s.l.), mountain grassland (905m a.s.l.), mountain beech stand (720m a.s.l.), highland spruce stand (480m a.s.l.), agrosystem (510m a.s.l.) and wetland (420m a.s.l.).

The evaluation of carbon storage in all the investigated ecosystem types was based on the application of the eddy covariance technique (Aubinet et al. 2000). Unified eddy-covariance systems were applied for CO₂ flux measurement in investigated forest stands (Urban et al. 2007). CO₂, water vapour, sensible and latent heat exchange between the forest stand and adjacent atmospheric layer was measured using a closed-path IRGA (LI-7000, Li-Cor. USA) and an ultrasonic anemometer (Gill-R3, Gill Instruments UK). The eddy-system is located on a measurement tower at a height where acceptable observations can be made (Havránková and Sedláčková 2004). After data post-processing (based on Aubinet et al. 2000 with several modifications according to recent CarboEurope and FLUXNET project protocols), half-hourly averages were available. Missing and bad-quality data were gap-filled according to interconnected models of the light response curve (Prioul and Chartier 1977) and Arrhenius type respiration function. For the purposes of this paper, daily sums of CO₂ fluxes (NEP) were used. Data were not filtered according to a limiting friction velocity (u^*), as we used only daytime data, while problems with low turbulence appear predominantly during nighttime. Only data with quality flags 0 (excellent) and 1 (good quality, according to CarboEurope codes) were used for the study. CO₂ efflux from stem, branch and soil was measured continuously over the whole growing season by the automatic closed gasometrical system SAMTOC (Pavelka et al. 2004). The adjusted chambers were connected to an infrared gas analyser WMA-3 (PP-Systems, UK) and closed only during measurement (150-200 seconds). Stem and branch temperatures in the cambium layer were measured by a set of sensors (calibrated thermocouples). Soil temperature measurements (thermistor model Pt100, Treston, Czech Republic) were conducted at a depth of 3 cm and randomly positioned within the investigated forest area. CO₂ efflux rates were correlated against corresponding temperatures. The air temperature within the investigated stands was measured at the 5m level (thermistor model Pt100, Treston, Czech Republic). Incoming Global radiation (GS) was

measured by a solarimeter (CM5, Kipp & Zonnen, Holland) located 5m above the upper stand crown layer. Air temperature and incident precipitation were measured by standard sensors located on the measurement tower at each site.

Results and discussion

Carbon absorption is strongly dependent on the season as is shown during the example year of 2014 (Fig.1). Forests are the most important ecosystem from the carbon storage point of view (Marek et al. 2011). In particular, the time of active carbon accumulation is of great importance. For example in the year 2014, the active growing season in the mountain spruce stand was 240 days, in the highland spruce it was 265 days and in the mountain beech it was 166 days. The annual amounts of accumulated carbon at each site in 2014 were:

➤ Mountain spruce forest:	6.5	tC ha ⁻¹ year ⁻¹
➤ Mountain beech forest:	3.4	
➤ Mountain grassland:	0.4	
➤ Highland spruce forest:	4.6	
➤ Floodplain forest:	4.8	
➤ Agrosystem:	4.1	
➤ Wetland:	3.1	

Carbon accumulation is a process which is very sensitive to environmental events. During the year 2015, the Czech Republic was suffering from an extreme drought. A period with limited precipitation and drought soil was evident during the middle of June until the end of September.

The final effect of the drought on the soil is strongly related to the altitude and vegetation type. The spruce in mountain location (cca 950m a.s.l.) suffers from the drought in small measure compared to the spruce highland (altitude cca 500 m a.s.l.). The type of the vegetation is important in determining the response of mountain beech stand to the drought, while the deep root penetration into the soil is responsible for negligible response to the drought. The NEE values were always negative, i.e. the stand was always a carbon sink, without the drought effect. However the investigated highland spruce stand was sometimes a source of carbon (positive values of NEE).

A very important environmental factor affecting the carbon uptake and storage, especially in coniferous stands, is the solar radiation type, i.e. direct beam or multidirectional diffusive radiation. The latter is deeper penetrating radiation, which illuminates more leaf area within the crown body, resulting in higher carbon uptake and storage. Moreover, diffusive solar conditions are mostly connected with cooler days and thus the respiration is lower. (Urban et al. 2007). Because of the crucial and significant role of forests in GCC mitigation, the application of some special management approaches are imperative. Thus, special silvicultural practices supporting this forest ecosystem service – climate regulation, are needed. This system, named “Carbon forestry” is focused on all silvicultural activities which are responsible for maximization of carbon storage in the forest ecosystem biomass and in the soil and minimization of carbon losses from the system. The system of carbon forestry covers all principal silvicultural activities, which are realized during the whole life span of the forest stand, i.e. site preparation before forest planting, thinning – an extremely effective tool increasing photosynthetic assimilation and harvest.

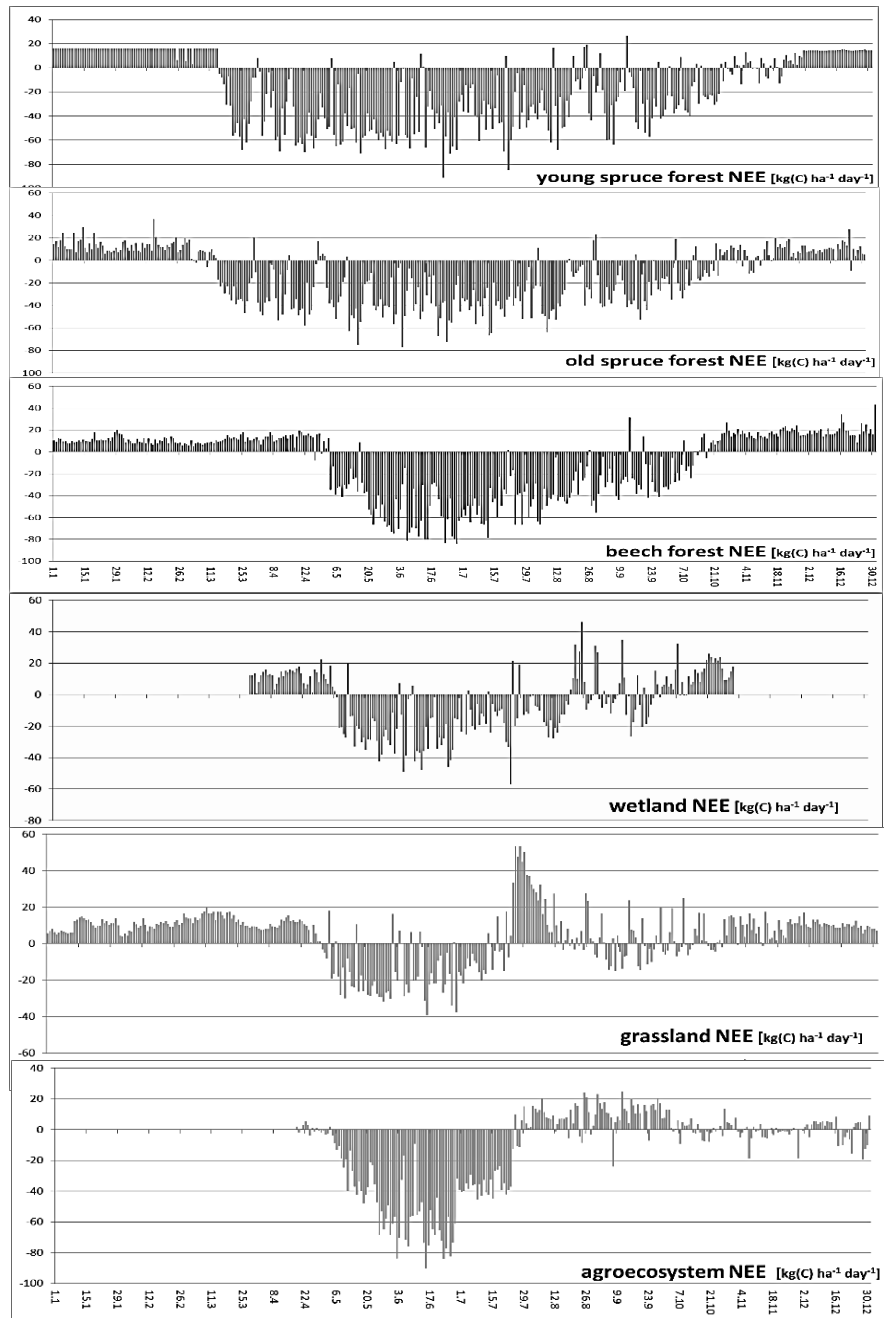

Fig. 1: Seasonal course of the Net Ecosystem Carbon Exchange (NEE) in different ecosystem types of the Czech Republic. The negative values indicate the situation when carbon is removed from the atmosphere

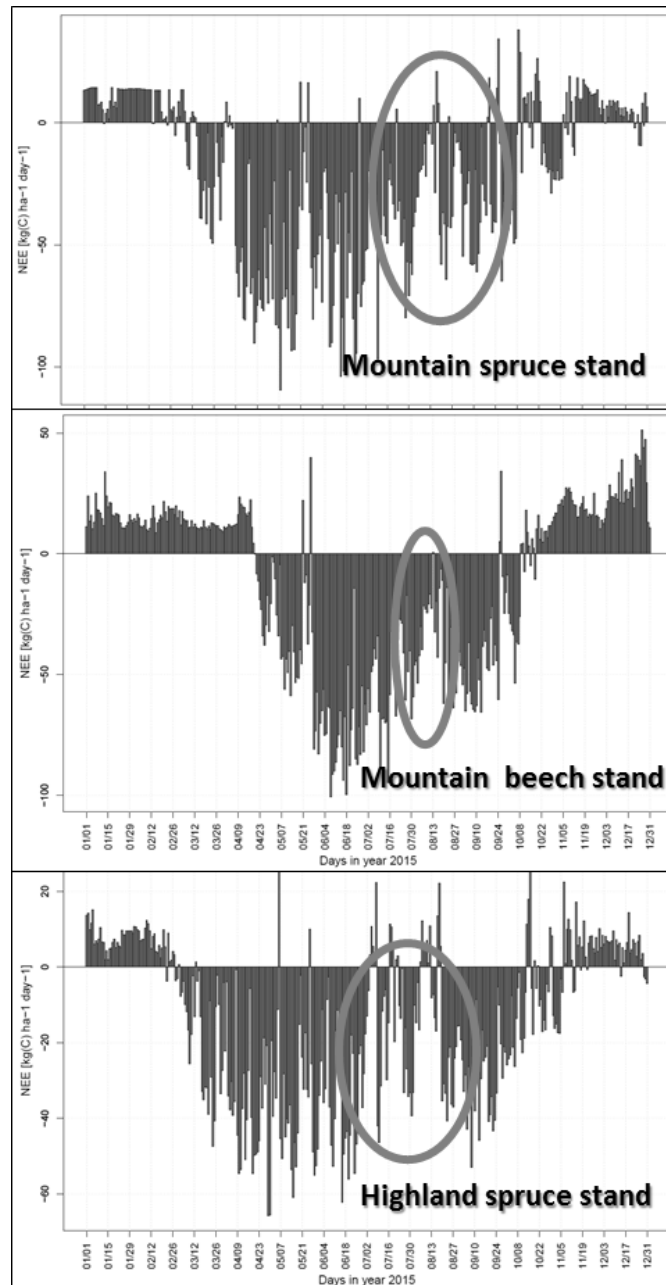

Fig.2: Comparison of the drought effect on spruce and beech stand NEE in different localities, different vegetation zones and altitudes

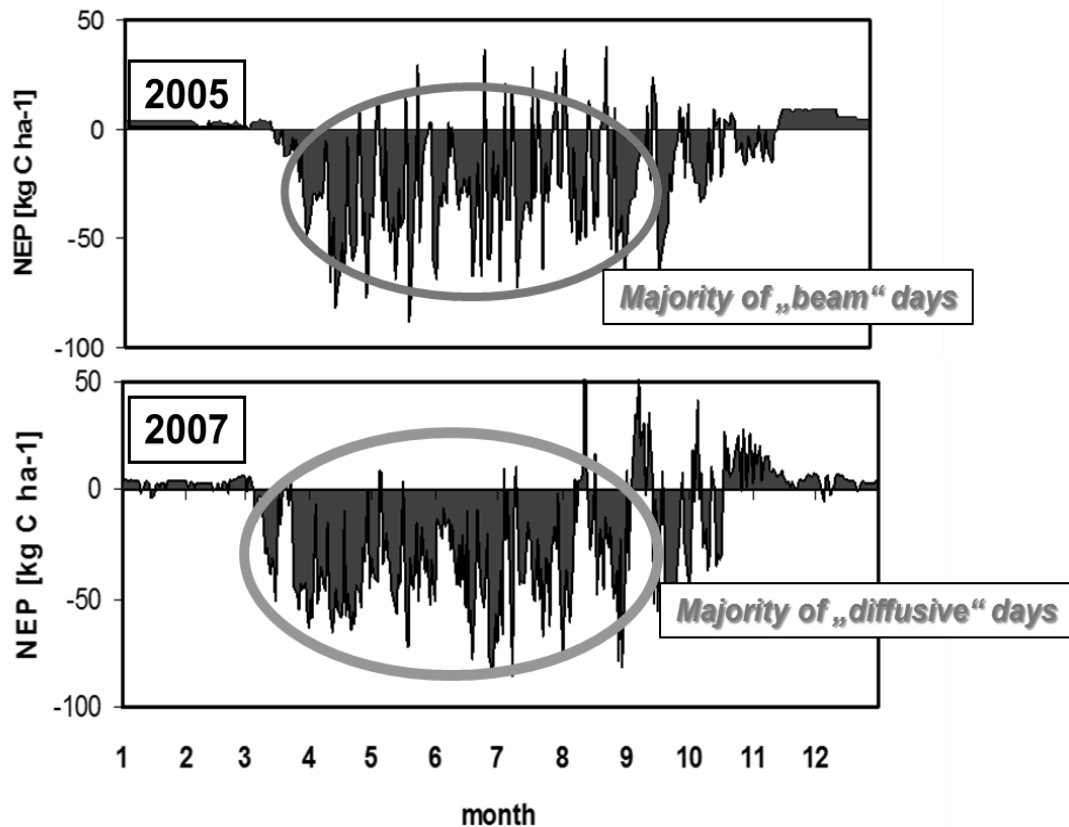

Fig.3: Comparison of the NEE, i.e. Net Ecosystem Exchange, on the longer seasonal scale, i.e. for two years which differ in the number of clear and difussive radiation

All mentioned activities have a significant impact on the carbon balance. Thinning as a “queen” of sylvicultural skills can significantly improve the assimilation “power” of a forest stand. Changing forest structure by the selective elimination of individual trees, results in the improvement of solar radiation penetration into the stand canopy resulting in the stimulation of the photosynthetic activity of lower crown parts. Thus the carbon assimilation “factory” is increasing its output, which enhances the carbon accumulation and finally biomass formation. Thus, thinning can be regarded as a tool for increasing forest stand carbon storage ability. Thus, it is really possible to utilize forestry (soil damage avoidance, soft harvest techniques and thinning) practises to increase carbon storage in the forest ecosystem. The role of forests in the mitigation and adaptation to GCC is undoubted.

Conclusions

Global climate change is a reality of the current world and its impact on forestry is extremely significant because of the role of forests in climate regulation and potential carbon storage in forest ecosystems. The storage capacity is strongly dependent not only on the conditions of the given locality, but is affected by the climate conditions. The seasonal course of carbon storage is different between individual seasons, depending on the actual temperature and precipitation conditions of the given season. The potential of forestry practises to positively influence the carbon storage of a forest in both important parts, i.e. biomass and soil, is very promising. In particular, thinning could be utilized to permanently enhance the production potential of forest stands.

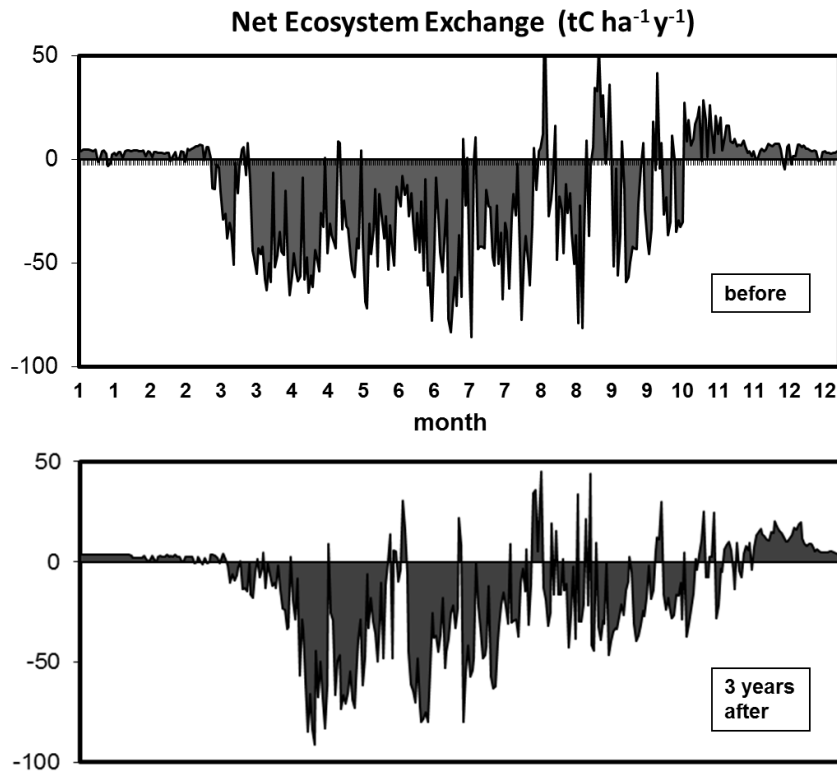

Fig.4: Comparison of the NEE, i.e. Net ecosystem exchange, before and 3-years after thinning in the young spruce stand

References

- Aubinet M, Grelle A, Ibrom A, Rannik U, Moncrieff J, Foken T, Kowalski AS, Martin PH, Berbigler P, Bernhofer C, Clement R, Elbers J, Granier A, Grunwald T, Morgenstern K, Pilegaard K, Rebmann C, Snijders W, Valentini R, Vesala T (2000) Estimates of the annual net carbon and water exchange of forests: the EUROFLUX methodology. *Advances in Ecological Res.* 30:113-175
- Havrankova K, Sedlak P (2004) Wind velocity analysis for mountainous site Bily Kriz. *Ecology-Bratislava* 23: 46-54
- Hikosaka K (1997) Modelling optimal temperature acclimation of the photosynthetic apparatus in C-3 plants with respect to nitrogen use. *Annals of Botany* 80:721-730
- Janssens IA, Feibauer A, Ciais P (2003) Europe's terrestrial biosphere absorbs 7 to 12% of European anthropogenic CO₂ emissions. *Science* 300:1538-1542
- Luyssaert S, Ciais P, Piao SL, Schulze ED, Jung M, Zaehle S, Schelhaas MJ, Reischstein M, Churkina G, Papale D, Abril G, Beer C, Grace J, Loustau D, Matteucci G, Magnani F, Nabuurs GJ, Verbeeck H, Sulkava M, van der Werf GR, Janssens IA (2010) The European carbon balance. Part 3: Forests. *Global Change Biol.* 16:1429-1450
- Marek MV, Janous D, Taufarova K, Havrankova K, Pavelka M, Kaplan V, Markova I (2011) Carbon exchange between ecosystems and atmosphere in the Czech republic is affected by climate factors. *Environmental Pollution* 159: 1035-1039
- Nabuurs GJ, Schelhaas MJ, Mohren GMJ, Field CB (2003) Temporal evolution of the European forest carbon sink from 1950 to 1999. *Global Change Biol.* 9:152-160
- Pavelka M, Acosta M, Janouš D (2004) A new device for continuous CO₂ flux measurement in forest stand. *Ecology-Bratislava* 23, supplement 2: 88-100.

- Prioul JL, Chartier P (1977) Partitioning of transfer and carboxylation components of intracellular resistance to photosynthetic CO₂ fixation: A critical analysis of the methods used. *Annals of Botany* 41: 789-800
- Urban O, Janous D, Acosta M, Czerny R, Marková I, Pavelka M, Navrátil M, Šprtová M, Špunda V, Zhang R, Grace J and Marek, MV (2007) Ecophysiological controls over the net ecosystem exchange of mountain spruce stand. Comparison of the response in direct. Comparison of the response in direct versus diffuse solar radiation. *Global Change Biol.* 13:157-168

SEASONAL VARIABILITY OF THE CHEMICAL COMPOSITION OF BIRCH SAP OBTAINED THROUGH TAPPING (*Betulae sucus recens*)

Srdjan LJUBOJEVIĆ^{1*}, Ladislav VASILIŠIN², Goran VUČIĆ², Aleksandar SAVIĆ², Dušan MIODRAGVIĆ³

¹ The Independent University of Banja Luka, Faculty for Ecology & Institute for Scientific Research, Bosnia and Herzegovina

²University of Banja Luka, Faculty of Technology, Bosnia and Herzegovina

³University of Banja Luka, Faculty of Forestry, Bosnia and Herzegovina

*Corresponding author: ljuboje@blic.net

Abstract

This work analyzes the variability of the chemical composition of birch sap, which is obtained through a traditional tapping method in discontinuous time intervals in seasons: 2000, 2010 and 2016. The subject of research are two stands of silver birch (*Betula pendula* Roth, Syn. *B. verrucosa* Ehrh.). The first one on the Eocene flysch, in the belt of forests where sessile oak (*Quercus petraea*) alternates with European beech (*Fagus sylvatica*). Another one on silicate substrata, where birch trees form patches between spruce forest belt (*Piceetum montanum*) and pastures. Samples of fresh birch sap (*Betulae sucus recens*) were measured in the following parameters: total solids, total sugars, total acids, tannin compounds, organic nitrogen, specific weight, refractive index, ash, Na, K, Ca, Mg, P, Fe, Cu, Zn, Mn, As, Cd, Co, Pb, Hg, Ni, Se. Also analyzed but not proven, were the presence of fat, flavonoids and vitamin C. Sugars were analyzed in qualitative and quantitative terms. Presence of individual sugars were determined applying thin layer chromatography, while the impact of terrain and stand conditions on total sugar concentration in birch sap was evaluated using the Kruskal-Wallis test. Having in mind that birch sap is consumed by people as a refreshing and healing beverage, standard microbiological analysis has also been carried out.

Keywords: *birch sap, chemical composition, tapping*

Introduction

Living trees sap exploitation, known as tapping is as old as human civilization. Tree sap is believed to have been used as early as neolith as a source of potable water in pile dwellings in marshes. The therapeutic use of birch sap probably goes back in the times of ancient Greeks and Romans (Anon, 2006). Nowadays birch sap is used as a refreshing beverage, either fresh or fermented in the form of beer or wine. Also, it is used in traditional medicine as a healing drink (Kûka et al., 2013; Łuczaj et al., 2014; Ljubojević, 2002; Semjonovs et al., 2014; Svanberg et al., 2012). According to the European Medicines Agency (Anon., 2006), birch sap provokes a week antiinflammatory activity to rats for a short period. According to the same source an antimicrobial activity of birch sap against *Staphylococcus aureus* can be observed only with undiluted sap as well as weak anti-inflammatory and antipyretic effect. In comparison to anti-inflammatory drugs, the mentioned birch sap feature is quite inferior.

Birch sap is sold commercially in Scandinavia, Belarus, Russia, Ukraine and China (Helfferich, 2003). In our region, companies, “Šumaprodukt” Šamac and “Pliva” Zagreb had traded with birch sap. Slovenian company “Mariborske lekarne” produced “Birch Hair Water” whose main component was birch sap (Ljubojević, 2002). Today, birch sap is not yet in commercial production in our country.

Only a few works have dealt with sap exploitation from standing trees in Bosnia and Herzegovina (Alibabić et al., 1980, Ljubojević et al., 2002, 2002a). The aim of our work was to further explore the content of common birch sap (*Betula sucus recens*) in order to provide a solid scientific base

for forestry and agricultural practice to eventually start tapping and select an appropriate way of processing. With that regard, this paper presents chemical composition and microbiological characteristics of birch sap, as well as influence of terrain and stand conditions on total sugars concentration.

Material and method

Field work

Silver birch, common birch (*Betula pendula* Roth., syn. *B. verrucosa* Ehrh.) belongs to Euro - Siberian floral elements. In our climate silver birch most often occurs as a pioneer species on felling sites and fire-affected areas, forming a smaller or larger groups of trees. Birch is also known to form pure forests on acid brown (Dystric Cambisol) and podzolic soils. We carried out research on two locations in three tapping seasons: 2000, 2010 and 2016. One was a hilly terrain Gavranovac in the northern part of the Republic of Srpska. Here birch builds pure sparse (light) groves on Eocene flysch, occupying borderline between sessile oak (*Quercus petraea*) and beech (*Fagus sylvatica*) forests at latitude 240 - 275 m (fig. 1). Another one was situated at locality Kneževo, at 1,050 m. Here birch trees form sparse patches at the border between pastures and the Norway spruce (*Picea abies*) forests on silicate substrata.

At the locality Gavranovac we selected 24 birch trees in a subjective manner, trying to cover variability of local factors considered to have some impact on flow regime and sap yield, such as breast height diameter (b.h.d.), branchnees, closure of canopy, inclination and exposition. In early spring 2000 we drilled holes of 1 cm in diameter and 5 cm deep at breast height, slanting them upward. We inserted plastic tubes into each hole and attached them to 20-litre tapping containers (fig. 2). The first drops of sap appeared as early as the same day, which means that trees had already accumulated a certain amount of sap. After some period of time we took 200 ml samples from each tree on the same day to determine total sugars and total acidity.



Figure 1: Tapping locality Gavranovac
(photo: S. Ljubojević)



Figure 2: Birch tree prepared for tapping
(photo: D. Miodragović)

Quantity of sap was measured by 1,000 ml graduated glass cylinder, with +/- 10 ml measuring accuracy. The number of wounds on trees was in dependence with b. h. d. One wound per tree was opened when diameter was thinner than 30 cm, two wounds on trees with diameter between 30 – 40 cm and three wounds on trees thicker than 40 cm. In the same place and with the same trees, we took two samples in the season 2016, one in the initial stage and another in the final stage of the tapping season. Collected sap have been consolidated into a collective

sample. At the locality Kneževo we selected in the year 2010 six birch trees in a subjective manner just for the chemical analyzes of sap.

Lab research

Lab research comprised chemical and microbiological analysis of birch sap. Dry matter content was determined by a refract meter. Ash content was determined by annealing at 600 °C. Organic acids and vitamin C were determined by HPLC with UV-VIS detector. Content of total sugar was determined by adapted Schoorl method based on Czech Standard ČSN 56 0016-7. Thin-layer chromatography was applied to identify sugars. Determination of organic nitrogen was done by the Kjeldahl method and of fat content by the Soxhlet method. Qualitative analysis of flavonoids and tannins was performed in accordance with Ph. Yug. IV. Sample preparation for determination of mineral substances was done by “wet” incineration with perchloric and nitric acids according to Trajković et al., (1983). Determination of mineral matter in prepared samples was done by analytical technique - inductively coupled plasma optical emission spectrometry on the instrument Optima 8000 ICP-OES Spectrometer, “Perkin Elmer”. Arsenic (As) was determined by hydride method and Mercury (Hg) by cold streams method.

Microbiological analysis of samples from the years 2000 and 2010 had been carried out at the Public Health Institute or the Republic of Srpska. On that occasion were tested presence of: *Salmonella* spp., *Clostridium* spp., *Proteus mirabilis*, *Escherichia coli*, *Staphylococcus* spp., molds and yeast, and total microorganisms. Samples from the year 2016 were analyzed in the following way: after pasteurization (80 °C for 5 min), sap was tested for antimicrobial activity. Testing was performed on two bacteria: Gram (+) *Staphylococcus aureus* and Gram (-) *Escherichia coli*. In addition to the above bacteriological test, measurement of inhibition of the growth of mold *Asperillus niger* was performed. Antimicrobial activity was also tested by the minimum inhibitory concentration (MIC) and minimum bactericidal concentration (MBC) in microbiological growth medium MHB (Mueller Hinton Broth).

Data processing

In order to investigate whether and to what extent terrain and stand conditions influence total sugars concentration, we performed the categorization of these characteristics in accordance with the criteria listed in table 1. After that, we applied Kruskal-Wallis non-parametric test. We calculated test statistics (H) using the standard procedure (Pranjic 1986), compared them with table value of $\chi^2_{0.05}$ and drew certain conclusions based on the observed differences.

Table 1: Tree distribution according to basic characteristics of study area

Feature	Category of feature	Description of feature	Number of trees
Burdening with wounds	1 - Low	$D_{1.30} < 30$ cm 1 hole per tree	13
	2 - Medium	$D_{1.30} = 30 - 40$ cm 2 holes per tree	9
	3 - High	$D_{1.30} > 40$ cm 3 holes per tree	2
Branchness	1 - Low	Length of crown up to 1/3 of tree height	2
	2 - Medium	Length of crown from 1/3 to 1/2 of tree height	19
	3 - High	Length of crown over 1/2 of tree height	3
Closure of canopy	1 - Open	Degree of canopy closure 0.0 – 0.2	8
	2 - Interrupted	Degree of canopy closure 0.3 – 0.6	10
	3 - Full	Degree of canopy closure 0.7 – 1.0	6
Terrain inclination	1 - Small	Inclination 0 - 20%	2
	2 - Medium	Inclination 21 - 40%	9
	3 - Big	Inclination > 40%	13
Terrain exposition (direction)	1 - Cold	N	6
	2 - Moderate	E, W, Ø	13
	3 - Warm	S	5

Results

Birch sap obtained from individual trees at the same time and locality, differs a lot in total sugars and acidity, most certainly due to genetic factors. The concentration of total sugars and acids were as follows: tree No. 1 - 0.33 % sugars/0.01 % acids, No. 2 - 0.64/0.03, No. 3 – 0.84/0.06, No. 4 – 0.69/0.07, No. 5 – 0.40/0.04, No. 6 – 0.84/0.07, No. 7 – 0.25/0.04, No. 8 – 0.36/0.06, No. 9 – 0.72/0.09, No. 10 – 0.43/0.12, No. 11 – 0.28/0.05, No. 12 – 0.53/0.01, No. 13 – 0.46/0.11, No. 14 – 0.41/0.05, No. 15 – 0.83/0.08, No. 16 – 0.79/0.04, No. 17- 0.64/0.07, No. 18 – 1.16/0.07, No. 19 – 0.98/0.04, No. 20 – 0.28/0.03, No. 21 – 0.33/0.04, No. 22 – 0.35/0.08, No. 23 – 0.64/0.06, No. 24 – 0.51/0.10.

Collective samples taken from the same locality and season, but in different times of the season, differs very little in terms of chemical parameters (tables 2 & 3). Seemingly, earlier collected sap is somewhat more “dense” than latter sap. Seasonal variations in observed parameters are more expressed, especially with total acidity. Even greater differences are observed when looking at samples from different localities. Apparently, sap from higher altitudes (Kneževo) is somewhat more “dense” than sap from lower heights (Gavranovac). In absolute terms, the average sugar content in our climate is generally lower than in other, mainly northern climates. So, in Lithuania sugars in birch sap amounted 1.1 % (Viškelis, et Rubinskienė, 2011), in Finland and Russia around 1.0 % (Kallio et al., 1985; Zyryanova et al., 2011), in Poland even 2.46 % with *Betula pendula* and 2.62 % with *Betula pubescens* (Łuczaj et al, 2014). When viewed tanning compounds, their concentration is quite low, and in the last season they are not even detected. Flavonoids, considered as main constituents of birch leaves (Anon., 2006), are not detected at all. The same is with fat, organic nitrogen and vitamin C.

Table 2: Chemical parameters of birch sap – part 1

Locality	Tapping season	Dry matter	Ash	Total acids	Total sugars
		%			
Gavranovac	2000	0.8	0.020	0.12	0.53
	2016 early s.	0.7	0.0238	0.036	0.56
	2016 late s.	0.6	0.0236	0.035	0.48
Kneževo	2010	0.8	0.032	0.154	0.61

Table 3: Chemical parameters of birch sap – part 2

Locality	Tapping season	Tanning compounds	Specific weight	Refractive index	pH
		%	g/cm ³		
Gavranovac	2000	0.072	n.m.	n.m.	n.m.
	2016 early s.	n.d.	1.0034	1.3334	n.m.
	2016 late s.	n.d.	1.0033	1.3333	n.m.
Kneževo	2010	0.067	1.002	n.m.	3.71

n.d. – measured but not detected

n.m. – not measured

Sugar concentration in birch sap from trees on small and medium slopes is higher in comparison with trees on very steep slopes (table 4). The same can be said for birch trees from stands with full or interrupted canopy when compared to trees from open spaces (table 5), as well as for trees from southern and western positions compared to trees from eastern and northern expositions (table 6). We did not prove that b.d.h. and branchnees have significant impact on sugar despite earlier established positive linear correlation ($r = 0.73$) between b.h.d. and sap yield (Ljubojević et al., 2002b).

Table 4: Variation of total sugars in birch sap in relation to terrain inclination

Description of feature	Number of observations (trees)	Average rank according to total sugars (R_i)
Small and medium terrain inclinations ($i \leq 40\%$)	11	8.85
Big terrain inclinations (very steep slopes) ($i > 40\%$)	13	15.10

H (test statistic of Kruskal-Wallis test) = $4.58 > \chi^2_{0.005} = 3.84$ indicates that the differences between average ranks are statistically significant, i.e. that samples do not belong to the same source.

Table 5: Variation of total sugars in birch sap in relation to closure of canopy

Description of feature	Number of observations (trees)	Average rank according to total sugars (R_i)
Full or interrupted closure of crown canopy (degree of canopy closure between 0.3 - 1.0)	16	10.28
Open stands (degree of canopy closure between 0.0 - 0.2)	8	16.94

$H = 4.74 > \chi^2_{0.05} = 3.84$

Table 6: Variation of total sugars in birch sap in relation to terrain exposition

Description of feature	Number of observations (trees)	Average rank according to total sugars (Ri)
Southern and western expositions (S,W)	12	8.58
Eastern expositions (E)	6	14.58
Northern expositions (N)	6	20.2

$$H = 10.48 > \chi^2_{0.05} = 5.99$$

In sap samples from observed sites, we find five sugars: glucose, fructose, sucrose, arabinose and galactose. Glucose and fructose were found in all samples. Sucrose was found in two localities in two different seasons, but was missed in the last season (table 7). In earlier work Alibalić et al. (1980) had found three sugars in fresh birch sap taken from the locality Koševo/Nahorevo near Sarajevo - glucose, fructose and small quantity of sucrose.

Table 7: Presence of sugars in the fresh birch sap

Locality	Tapping season	Glucose	Fructose	Sucrose	Arabinose	Galactose
Gavranovac	2000	+	+	+	+	+
	2016 early s.	+	+	n.d.	n.d.	n.d.
	2016 late s.	+	+	n.d.	n.d.	n.d.
Kneževo	2010	+	+	+	n.d.	n.d.

In view of sugars, Essiamah (1980) and Horvat (1980) have arrived to similar results. Glucose and fructose are two main sugars, and sucrose joins them in small quantities. Kalliou et al. (1985) assert that the content of these two monosaccharides in birch sap in Finland is 4 - 7 times higher than content of sucrose. Apart from these sugars they have also found galactose, while Sauter et al. (1986) have also established stachiose. According to the latter authors, sugars concentration in birch sap is distributed in the following descending order:

D-fructose > D-galactose > sucrose > stachiose

Sauter and Ambrosius (1986) have found two new sugars in phloem sap: maltose and raffinose and established the following descending order:

D-fructose > sucrose > stachiose > D-glucose > maltose > raffinose

When we look at similar birch species, downy or white birch (*B. pubescens* Ehrh.), we can notice the same relation between sap sugars. According to Kūka et al. (2013), one liter of birch sap in Latvia contains 5.39 g of fructose (51.7 %), 4.46 g of glucose (42.7 %) and 0.58 g of sucrose (6.3 %).

Birch sap obtained from the same locality and season, but in different times of the season, differs very little in terms of mineral composition (tables 8). When comparing different seasons at the same locality, differences become very large. Certainly, the same is when we look at different locations in different seasons. Similar situation is with trace elements (table 9), but in another context. Instead of differences in terms of quantity, simple difference appears in terms of “detected” or “not detected”.

Table 8: Analysis of minerals in birch sap

Locality	Na	K	Ca	Mg	P	Fe	Cu	Zn	Mn
	mg/l								
Gavran, 2010	30.2	114.8	203.4	n.d.	n.d.	1.6	n.d.	n.d.	8.7
Gav. 2016, e.s.	143	667	81.2	22	19.2	0.8	0.5	0.9	3.5
Gav. 2016, l.s.	148	656	82.4	22.8	18.4	0.9	0.5	1.0	3.8
Kneževo, 2010	53.2	383.9	266.7	31	26.5	1.3	0.04	0.37	0.22

Table 9: Trace analysis of birch sap

Locality	As	Cd	Co	Cr	Pb	Hg	Ni	Se
	mg/l							µg/l
Gavran. 2010	< 0.05	n.d.	n.d.	n.d.	0.047	< 0.001	n.d.	n.d.
Gav. 2016, e.s.	n.d.	b.l.d.	n.d.	b.l.d.	b.l.d.	n.d.	n.d.	0.98
Gav. 2016. l.s.	n.d.	b.l.d.	n.d.	b.l.d.	b.l.d.	n.d.	n.d.	1.00
Kneževo	< 0.05	< 0.05	< 0.05	n.d.	< 0.05	< 0.001	< 0.05	n.d.

b.l.d. – below limit of detection (of instrument)

The heavy metals concentrations are below limits determined by the local authorities and by WHO for drinking water (table 9).

Results concerning anti-microbial activity of the birch sap, like previous chemical features are not unison. In some respects they are even contradictory. And so, no microorganisms were found either in fresh or in a year old sap samples taken from Gavranovac locality in season 2000 (table 10). The sap was kept in a simple bottle at room temperature and was opened occasionally to monitor color and odor. Atypical, intense and unpleasant smell lead to a conclusion that microorganisms may have colonized the sap shortly and then their autolysis occurred. This phenomenon can be explained through an already known fact that other portions of birch tree, such as leaves and buds (*Folia et Gemma Betulae*) already contain compounds which are effective against some microorganisms (Anon., 2006). More realistic option is that this effect was caused by penicilium grown in the sap, provoking destruction of existing and secondary populated microorganisms.

Table 10: Microbiological analysis of birch sap collected from the locality Gavranovac during season 2000 (analysis performed at the Public Health Institute or the Republic of Srpska)

Microorganism	Observed concentration	Fresh sap	One year old sap
<i>Salmonella</i> spp.	25 ml	not found	not found
<i>Clostridium</i> spp.	0.1 ml	not found	not found
<i>Proteus mirabilis</i>	0.1 ml	not found	not found
<i>Escherichia coli</i>	0.1 ml	not found	not found
<i>Staphylococcus</i> spp.	0.1 ml	not found	not found
Molds and yeast	1 mg	0	0
Total microorganisms	1 mg	0	0

To avoid imposed dilemmas, sap samples collected in the year 2016 were pasteurized prior to the microbiological analysis. Pasteurized sap showed no activity against the tested microorganisms, neither further measured MIC and MBC values.

Conclusions

Bich sap is a non-wood forest product with undisputed refreshing and certain healing attributes. Considering the physiological role performed by the sap (transport of materials from the roots to the photosynthetically active parts of the tree), its chemical composition is strongly influenced by the time and the place of collecting. At the beginning of the tapping season, amount of material to be transported is greater which explains higher “density” of the sap at that moment. Terrain and stand conditions affect the amount of synthesized materials, part of which is transported by sap. Birch trees on small and medium slopes, from stands with full or interrupted canopy on southern and western positions are capable to produce more sugars, as viewed in a broader sense, more “building materials” and nutrients.

Most of the variations in chemical composition between individual trees, beyond any doubt, are attributed to genetic factor. This attitude is strongly documented in a number of scientific papers. If one goes to a market-oriented production, at least two problems appear: shelf life and uniformity of the final product. And while the first question can be solved by known processing, the another one is difficult to be solved without “chemical intervention”, in which case the product may compromise the attribute “organic”.

References

- Anonymus (2006): *Betula pendula* Roth; *Betula pubescens* Ehrh. Folium, Assesment report for the development of community monographs and for inclusion of herbal substance(s), preparation (s) or combination thereof in the list. European Medicines Agency. Evaluation of Medicines for Human Use. 1-20
- Alibalić Š., Murko D., Ramić S. (1980): Contribution to the knowledge of carbohydrate content in birch tree sap (*Betula verrucosa* Erhr.) (Original title: Prilog poznavanju sadržaja ugljenih hidrata u soku stabala breze) Šumarstvo i prerada drveta 4-6, Sarajevo. 143-146
- Essiamah S.K. (1980): Spring sap of trees. *Berichte der Deutschen Botanischen Gesellschaft*, 93. 257-267
- Horvat I. (1980): Common birch (*B. pendula* Roth.). (Original title: Breza obična). Šumarska enciklopedija, JAZU, Zagreb. 191-192
- Kallio H., Antonen S., Raulo J., Linko R.R. (1985): Identification of the sugars and acids in birch sap. *Journal of Food Science*, 50. 266-267
- Kūka M., Čakste I., Geršebeka E. (2013): Determination of bioactive compounds and mineral substances in Latvian birch and maple sap. *Proceedings of the Latvian Academy of Scinece. Section B.*, Vol. 67, No.4/5. 437-441
- Łuczaj Ł., Bilek M., Stawarczyk k. (2014): Sugar content in the sap of birches, hornbeams and maples in southeastern Poland. *Central European Journal of Biology*. 9 (4). 410-416
- Ljubojević S. et al. (2002): Chemical composition and microbiological characteristics of common birch sap (*Betulae sucus recens*) (Original title: Hemijski sastav i mikrobiološke karakteristike soka breze). *Ekosilva – naučni časopis za šumarstvo i ekologiju*, No 1. 5-16
- Ljubojević S. et al. (2002a): Flow regime and yield of sap obtained from common birch tree (*Betula pendula* Roth) (Original title: Dinamika lučenja i prinos soka iz stabala obične breze. *Ekosilva – naučni časopis za šumarstvo i ekologiju*, No 1. 51-75
- Pranjić A. (1986): Forest Biometrics (Original title: Šumarska biometrika). Sveučilište u Zagrebu. Šumarski fakultet, Zagreb. 1-204
- Sauter J.J., Ambrosius T. (1986): Changes in the partitioning of carbohydrates in the wood during bud break in *Betula pendula* Roth., *Journal of Plant Physiology*, 14. 31-34
- Semjonovs P. D. et al. (2014): Development of birch (*Betula pendula* Roth.) sap based probiotic fermented beverage. *International Food Research Journal* 21(5). 1763-1767
- Svanberg I. et al. (2012): Uses of tree saps in northern and eastern parts of Europe. *Acta Societatis Botanicorum Poloniae*, 81(4). 343–357
- Trajković, J. et al. (1983): Analysis of food products (Original title: Analize životnih namirnica). Tehnološko-metalurški fakultet, Univerzitet u Beogradu. 1-650
- Viškelis P., Rubinskiene M. (2011): Chemical composition of birch sap (Original title: Beržu sulos chemine studetis). *Sodininkyste ir Daržininkyste*. Vol. 30, No 3/4. 75-81
- Zyryanova O. A. et al. (2010): White birch trees as resource species of Russia: Their distribution, ecophysiological features, multiple utilizations. *Eurasian Journal of Forest Research*, 13(1). 25–40

ANALYZE OF RATIONALITY OF SETTINGS WATCHTOWERS BY GEOGRAPHIC INFORMATION SYSTEM TOOLS

Radenko PONJARAC¹, Zoran GALIĆ², Alen KIŠ³, Rasko GRUJIĆ⁴, Milko OSTOJIĆ⁴

¹Public Enterprise "Vojvodinašume" Serbia

²University of Novi Sad Institute of Lowland Forestry and Environment, Serbia

³Institute for Nature Conservation of Vojvodina Province, Serbia

⁴State Enterprise "Šume Republike Srpske", Bosnia and Hercegovina

*Corresponding author: radenko.ponjarac@gmail.com

Abstract

Forest fires destroy forests worldwide. Anthropogenic factors are the most frequent causes of forest fire. Negative consequences of forest fires in environmental and economic aspects are immeasurable and incalculable. Various preventive measures could be effectively used only if forest fires occurrence were discovered in the early stages (spatial and temporal). The use of modern technology can help in the forecast, detection, localization and fire extinguishing. Analysis of the vulnerability to forest fires is possible using Geographic Information System tools. Which provide thorough, time and spatial related analysis of parts of forest endangered by forest fire. Space surveillance and fire detection at an early stage might be carried with a watchtower or equipped by video surveillance. GIS tools provide the ability to set up an observation post simulation or camera system for identifying fire. Their use is obtained by covering the surface of each observation point, where it can be determined whether more observation posts or camera covering the same surface (location). The aim of this work is to analyse a rationality of settings of watchtowers by GIS tools.

Key words: *forest fires, GIS tools, watchtowers.*

Introduction

Forest fires destroy forests worldwide. In Bosnia and Herzegovina forest fires are the most significant cause of forest damage. In the period from 2008 to 2012 by forest fires 1118000 m³ of timber volume were damaged (FAO, 2015). High percentage of damages are consequence of ignoring the risk fires and preventive measures (FAO, 2015).

Various preventive measures can be used to minimize risk of forest fires outbreak or discover the occurrence in the early stages (spatial and temporal). The use of modern technology can help in the forecast, detection, localization and fire extinguishing. Analysis of the vulnerability of forest fires is possible using GIS tools (Fatih et al. 2014). In the analysis is needed to process the information about topography, vegetation, the usage of the ground, population and settlements (Xu et al., 2006), what is base for making the map of vulnerability. According to Ganteaume et al. (2013) the causes of forest fires are varied and their spatial and temporal distribution discerns from one to another country, and it also differs within the same country. One of the most common causes of the forest fires is human factor. Prevention measures are one of the most effective methods used in the wildfire protection (Fatih et al., 2014). The most commonly used method in prevention is forest monitoring (from the air or land). In this work the analysis of land monitoring and fire watchtowers will be done. The watchtowers are usually used by the man, but recently surveillance is used more often. In both cases fire watchtowers must be positioned on the sites with best visibility covering the biggest area. The aim of this work is to determine the most effective and convenient position of watchtowers.

Materials and methods

Research area: The area under the management unit of Forest Estate “Romanija“, Sokolac, (Entity of Republic of Srpska, Bosnia and Herzegovina) is located in 43° 56′ 09″N and 18° 47′ 45″E. It covers municipalities of Sokolac and Istočni Stari grad with surface of 794.23 km². It is a highland with distinguished configuration of the ground, where altitudes vary from 525 m to 1625 m.

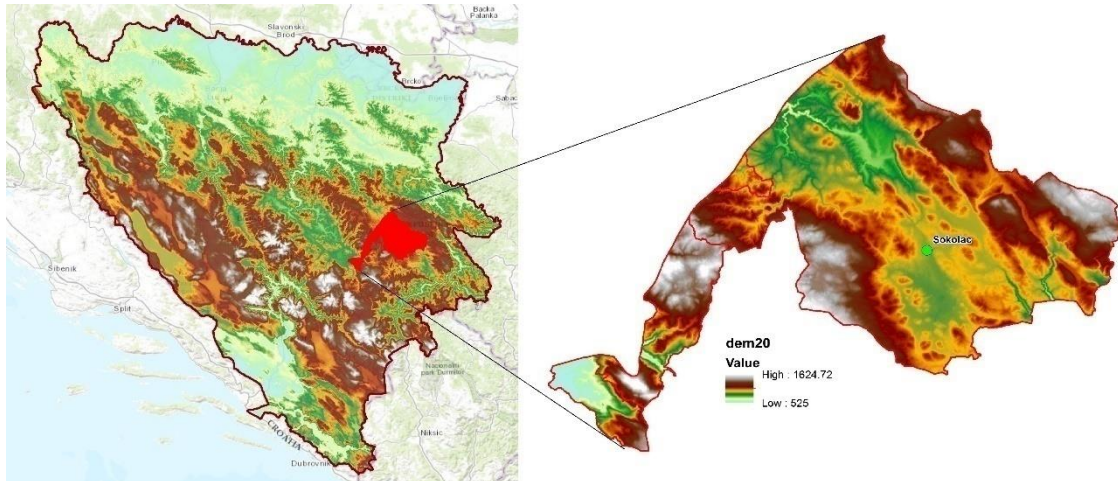

Figure 1. Object of research

Collecting data: In this work DEM (Digital Elevation Models) with resolution of 20m is used and it is made with Army-topographical maps. Data about roads and towns are taken from the base OpenStreetMap (2016). The position of the present watchtowers and forest density are taken from contemporary thematic maps used in Forest Estate “Romanija” (2013).

GIS preparation and analysis: The analysis is made with tools for raster analysis in frames of ArcGIS Platform. The height of watchtowers used for the analysis is 5 m. ArcGIS tools were used in calculation of surface which can or cannot be seen. In the part which cannot be seen from the watchtowers the altitudinal difference between the surface of the land and the height of the visible part is calculated due to be seen the largest depth of the invisible part (Above Ground Level). The Above Ground Level (AGL) result is a raster where each cell value is the minimum height that must be added to an otherwise nonvisible cell to make it visible by at least one observer.

The first thing done was to distinguish the sites where watchtowers might be built. These could be ridges, peaks and hills, and position of the watchtowers is on the highest altitude amongst them. Ridges and the highest points in the areas are gained via Topographic Position Index (TPI). Topographic Position Index (TPI) is an adaptation of this method which compares the elevation of each cell in a DEM to the mean elevation of a specified neighborhood around that cell (Abdollah, 2014; Weiss, 2001). Local mean elevation is subtracted from the elevation value at centre of the local window. Algorithm is provided as an ESRI tools.

$$TPI_i = Z_0 - \frac{\sum_{1-n} Z_n}{n}$$

Where;

Z_0 = elevation of the model point under evaluation,

Z_n = elevation of grid within the local window,

n = the total number of surrounding points employed in the evaluation

Positive TPI values represent locations that are higher than the average of the local window e.g. ridges. Negative TPI values represent locations that are lower e.g. valleys. TPI values

near zero are either flat areas (where the slope is near zero) or areas of constant slope (where the slope of the point is significantly greater than zero), high positive values relate to peaks and ridges.

The watchtower positions in ArcGIS are determined in three ways:

- I. Using DEM only - The watchtowers positions are provided in the places where TPI showed a ridge or a hill, not counting any other factors.
- II. Analysing DEM, roads, towns or areas covered with forests - A ridge or some other hill is gained via TPI, and then watchtowers are placed in the sites not covered by forests, near settled places (towns to 2 km, villages to 1 km) or roads (to 150 m)
- III. Positioning already existing watchtowers - From contemporary forest fire maps are taken the locations of present watchtowers which are gained without the use of modern technologies.

While analysing each method the surface visible from every watchtower is calculated, and then these surfaces are lapped. We threw away the watchtowers or locations which were largely lapped with others, and having minimal covering surface because of their insignificant influence.

Results and discussion

In the next part, for each particular method, are shown results in tables which present mutual lapping of the fields visible from the watchtowers, and surfaces visible just from one single watchtower. On the photos is shown DEM with marked surfaces which are not covered from watchtowers and with gained values AGL.

Method I - Using this method we gained the locations of 24 watchtowers, which after mutual lapping and affirmed surfaces covered by them, were reduced to 6, covering 74053.18 ha or 93.23% of the overall research surfaces. The overall surface which can be seen from one watchtower is 18446.23 ha or 23.23% of the surface of the research area. The maximum value Above Ground Level is 254.19 m.

Table 1. Mutual lapping of the visible surfaces from watchtowers for method I

WATCHTOWERS (ha)	Elevation	WATCHTOWERS (ha)						Covered area
		WT_03	WT_08	WT_13	WT_18	WT_19	WT_24	
WT_03	1129.61	2327.33	24748.37	26604.58	12644.11	13767.04	3654.59	35224.79
WT_08	1317.36		3337.70	29630.25	12506.16	26017.22	3573.87	45356.64
WT_13	1387.48			1892.36	19378.75	17496.07	5827.12	42658.33
WT_18	1504.96				1550.32	6884.04	7429.71	24060.29
WT_19	1166.37					2973.37	1841.14	30488.50
WT_24	1629.11						6365.16	12222.13

Original data

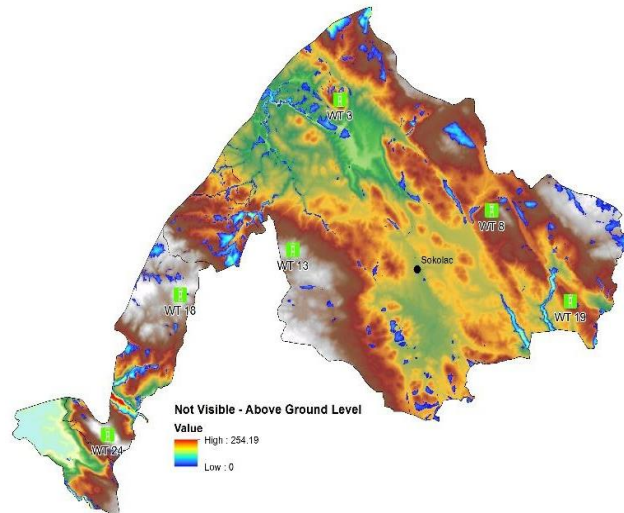

Figure 2. Method I – Spatial distribution not visible area with ABL

Method II - By spatial analysis of data about towns, roads, areas under the forests near ridge or hills we gained 16 locations which may be used for setting the watchtowers. Further proceeding of the data and reduction of watchtowers whose fields of visibility are mostly lapping with others, the number of the watchtowers is reduced to 6. The surface of the fields of visibility covered from one watchtower positioned by this method is 69005.56 ha or 86.88%. The overall surface which can be seen from one watchtower is 24236.29 ha or 30.51%. The maximum value Above Ground Level is 259.28 m

Table 2. Mutual lapping of the visible surfaces from watchtowers for method II

WATCHTOWERS (ha)	Elevation	WATCHTOWERS					Covered area
		WT_03	WT_06	WT_08	WT_09	WT_16	
WT_03	1025.00	1678.16	22701.11	6637.07	20483.56	3143.45	29339.92
WT_06	1317.36		8535.63	7066.53	29630.25	3573.87	45356.64
WT_08	1157.10			759.07	10862.88	3651.10	12128.23
WT_09	1387.49				5293.21	5827.12	42658.33
WT_16	1629.11					7970.21	12222.13

Original data

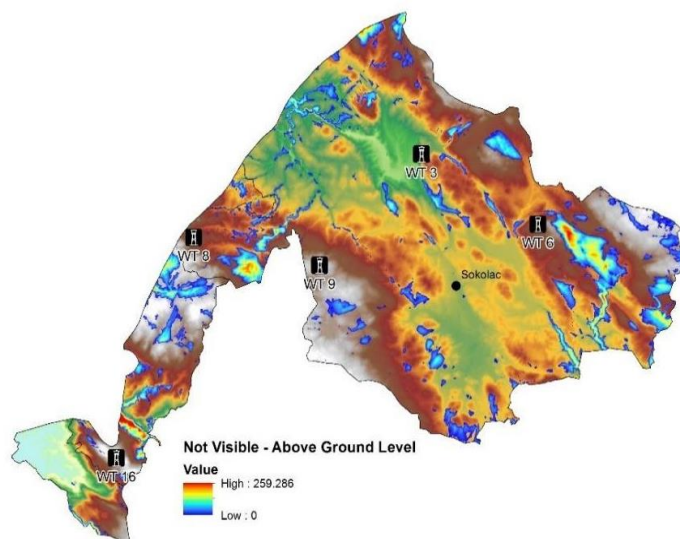

Figure 3. Method II - Spatial distribution not visible area with ABL

Method III - Seven existing watchtowers are proceeded using this method. They cover the surface of 70486.18 ha or 88.75% of overall surface. The overall surface which can be seen from one watchtower is 18690.21 ha or 23.53%. The maximum value Above Ground Level is 252.42 m.

Table 3. Mutual lapping of the visible surfaces from watchtowers for method III

WATCHTOWERS (ha)	Elevation	WATCHTOWERS							Covered area
		WT_01	WT_02	WT_03	WT_04	WT_05	WT_06	WT_07	
WT_01	912.08	1026.95	11176.32	12880.78	1191.11	6049.26	8895.39	2643.11	17285.16
WT_02	1112.16		1100.82	26648.03	1927.23	17647.12	8796.14	2979.87	31347.34
WT_03	1317.36			3720.23	6135.87	27666.70	12506.16	3573.87	45356.64
WT_04	1117.03				1182.67	4914.50	3142.70	1166.19	7588.19
WT_05	1294.89					2265.21	12150.45	4070.37	35055.82
WT_06	1504.96						2955.72	7429.71	24060.29
WT_07	1629.11							6438.62	12222.13

Original data

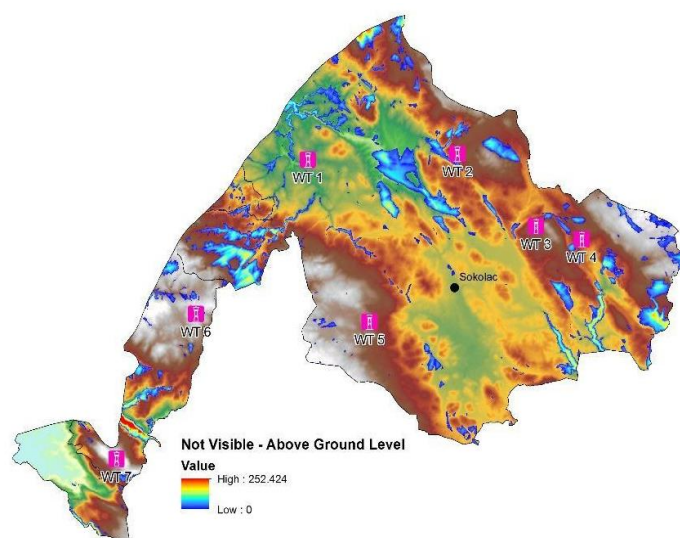

Figure 4. Method III - Spatial distribution not visible area with ABL

With the first method we provided largest visibility fields, while with the third way we got the smallest. During positioning of watchtowers in the first method we analysed only DEM, while other factors were not concerned. Here the watchtowers are located in the places of the highest ridges or peaks. Because the fact that these points may be situated in the forests, visibility might be declined or additional costs for setting the watchtower or opening the space around it might be needed. These watchtowers can also be far from the roads or towns and even unavailable in every moment. Opposite to this method, the second method covers smaller surface, but the watchtowers are located near the roads, towns and are not inside the forests. We did not locate all of the towers on the highest altitude points, but partly on the ridge or a hill depending on the free space which is not covered by forests. The number of the watchtowers is smaller, what can reduce the cost of the preventive measures. In the third method the number of the watchtowers is the largest. While setting the watchtowers the modern methodologies were not used, but they were settled according to the experience of the staff working on these job positions or on topographical maps.

While considering the surfaces covered just with one watchtower, id est the surfaces which are not overlapped with others, we can see that the largest surface is gained with method II. It can be concluded from the fact that the number of watchtowers is the smallest. With other methods we have larger number of watchtowers set in order to have better coverage of the

surface, accompanied with higher costs of maintenance. When we compare the position of watchtowers it can be seen that the location for two is identical in all three methods. In all three methods the highest value AGL is on the same location of the research object. These locations are usually canyons, valleys or depressions. On this place, when the forest fire starts, the smoke must reach certain height to be seen from watchtowers, regardless to the method used because AGL is in all three cases pretty same. Beside all these fact, the support of local people who can be very helpful while doing everyday jobs. They are able because of configuration of the land, what can be seen in DEM.

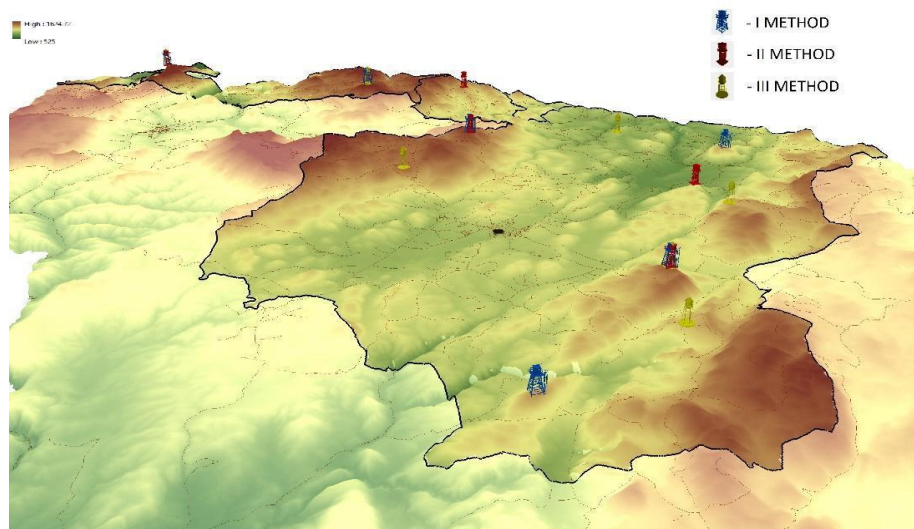

Figure 5. Spatial distribution watchtowers

Conclusions

When we consider all the information which can be accessed in every moment, it can be concluded that the use of contemporary methodologies in watchtowers settings can be helpful in their distribution. With first method we gained the largest visibility field, while with third the smallest.

The largest coverage surface with the smallest number of watchtowers is provided with method II. It can be seen from the fact that the number of watchtowers is the smallest.

In other methods we have larger number of watchtowers set to obtain better coverage, but with higher cost of their maintenance.

Locations got for watchtowers settings can be used for video surveillance which can detect automatically the smoke and then start the fire alarms.

Acknowledgments

Authors would like to thank State Enterprise “Šume Republike Srpske” and Forest Estate “Romanija” Sokolac for technical and expert support.

References

- Abdollah S. (2014). Using Topography Position Index for Landform Classification (Case study: Grain Mountain). Bull. Env.Pharmacol. Life Sci., Vol 3 [11]: 33-39
- FAO (2015): Analiza sektora šumarstva u Bosni i Hercegovini. Projekat “Priprema analiza sektora šumarstva i ribarstva u Bosni i Hercegovini u svrhu IPARD-a”, finansiran sredstvima Evropske unije.
- Fatih S. Bülent S. , Abdullah E. A. , Nuri B. (2014). Evaluation of Forest Fire Risk with GIS. Pol. J. Environ. Stud. Vol. 23, 187-194

- Ganteaume, A., Camia, A., Jappiot, M., San-Miguel-Ayanz, J., Long-Fournel, M., & Lampin, C. (2013). A Review of the Main Driving Factors of Forest Fire Ignition Over Europe. *Environmental Management*, 51(3), 651–662.
- Xu D., Guofan S., Dai L., Hao Z., Tang L., Wang Hui. (2006). Mapping forest fire risk zones with spatial data and principal component analysis. *Science in China: Series E Technological Sciences*. Vol.49 Supp. I 140—149
- Weiss, (2001). “Topographic Positions and Landforms Analysis” (Conference Poster). *ESRI International User Conference*. San Diego, CA, pp. 9-13.
- Map: “Degree of vulnerability forest” 1:25000 (2013), State Enterprise “Šume Republike Srpske”, Forest Estate “Romanija” Sokolac
www.openstreetmap.org Visited 28.04.2016.

STUDY OF THREE DIFFERENT METHODS FOR SUPPRESSION OF ASH WEEVIL

Milan DREKIĆ*, Leopold POLJAKOVIĆ - PAJNIK, Verica VASIĆ, Andrej PILIPOVIĆ, Predrag PAP

Institute of Lowland Forestry and Environment, University of Novi Sad, Serbia

*Corresponding author: mdrekic@uns.ac.rs

Abstract

The ash weevil is the most important insect pest of ash in South East Europe. Mass occurrence of the ash weevil causes defoliation of ash that lead to growth reduction. The feeding of this pest has direct influence to physiological weakening of colonized trees and creates preconditions for the development of secondary pests. This paper presents the examination results of three different methods for control of ash weevil adults. In field trials, we tested the effects of the use of cardboard niches, sticky tree belts and a biological insecticide containing conidia of fungi *Beauveria bassiana*, to the suppression of the ash weevil. As the direct protective measures the application of artificial cardboard niches for the overwintering adults proved to be much more attractive than the moss, that represent the natural shelter of the insect. Burning of the hibernating adults inside the cardboard niches would significantly reduce the population density. Despite the fact that high number of adults was recorded on the sticky bands applied to the stand-leaved ash trees, serious defoliation occurred. Due to the high number of caught beetles it may be presumed that sticky tree bands application could reduce the population density at certain level when used continuously, and this should be checked by further studies. Control of the ash weevil by applying a biological insecticide containing conidia of *B. bassiana* gave no positive results in suppression of the population density.

Keywords: *ash, weevil, Stereonychus fraxini, control*

Introduction

Outbreaks of the ash weevil *Stereonychus fraxini* De Geer (Coleoptera, Curculionidae) in ash stands and plantations are very frequent in Serbia. The ash weevil is distributed in Europe, North Africa and Asia Minor (Wingelmüller, 1921). In Serbia, it is registered on the narrow leaf ash, common ash and green ash (Drekić, 2011). Ash weevil outbreaks lead to defoliation of trees and ash stands, which causes growth reduction and physiological weakening. Published research data about the possibilities of ash weevil suppression are quite rare (Mikloš, 1954; Marović, 1963; Spaić and Mikloš, 1981; Cankovet *al.*, 1990; Liovićet *al.*, 2001). Additional problem is that a large number of previously used insecticides today are not allowed for use in FSC certified forests. More recent studies have indicated the possibility of a successful application of fenthion, thiacloprid and bifenthrin insecticides for suppression of the ash weevil larvae and fenthion, thiamethoxam and bifenthrin for the suppression of adults of this insect species (Drekićet *al.*, 2015).

Due to the fact that the chemical insecticides represent the contaminants for the environment we studied the possibilities of ash weevil control with the use of environmental friendly measures. The aim of this study was to investigate the possibility of protecting the ash using artificial niche, sticky belts and biological insecticide containing spores of the entomopathogenic fungus *Beauveria bassiana*.

Material and methods

Artificial cardboard niches were handmade and applied on total number of 54 ash trees in the forest of Branjevina near Odžaci(Serbia)on24th of April, 2009. The nicheswere placed around the trunk,atthe breast height of a standing person(Fig. 1).



Figure 1 Artificial cardboard niche on ash tree

The total surfaceof all mounted artificial cardboard nicheswas 9.36 m². The main aim of their use was to check their suitability as shelters for overwintering adults of the ash weevil. Artificial niches were removed from the trees on December 22nd 2009 and thoroughly observedin order to determine the number of hibernating ash weevil adults found insidethe artificialwinter shelter. The moss, that serves as natural shelter was removed from 41 trees mounted with cardboard niches and from 40 trees without artificial niches in order to determine the ratio betweenthe number of adults in the moss from the trees with and without available artificial niches. Collected moss was inspected in the laboratory for determination of number of adults.

Thesticky tree bands were set on 22 ash trees inthe forest of Branjevinaon February 27th2009. The belts were seton the trunk at the breast height of a standing person, onrepresentinga mechanical barrier for overwintered adults crossing from the ground and lower parts of the trunk to the tree crown and thereby to prevent defoliation of trees. The belts were inspected every 6-8 days and the adult ash weevils were counted. Assessment of damage to the leaves on the trees with sticky tree bands was performed at the end of June 2009.

Investigation of the possibility for thesuppression of adults overwintering in the moss was conducted on the 20thof November 2008in the Branjevina forest. The treatment was conducted by application of the biological insecticide containingthe spores of *Beauveria bassiana*in concentration of 2.11×10^{10} conidia/ml (commercial product:

BotaniGard SC). The test included 60 ash trees covered with moss: 30 trees were treated with 0.5% concentration of the product, while other 30 trees remained untreated as a control group. The insecticide was applied with the hand sprayer. Moss was removed from treated and control trees on 21st January 2009 and inspected in the laboratory in order to determine the number of dead beetles infected by *Beauveria bassiana*.

Results and discussion

After the inspection of 54 artificial cardboard niches, 525 adults of ash weevil were found, resulting in the average number of 56,1 adults per square meter of cardboard niches surface. The moss was removed from 41 trees with cardboards, with the total moss surface of 12.73 m² and with 52 adults recorded in the moss, resulting in the average number of 4.1 adults per square meter of moss. The number of adults per square meter of artificial niche was 13.7 times higher than the number of adults per square meter of natural niche. Such results indicate that the artificial niches were more attractive to the adults for overwintering than the moss on the same trees.

If we compare the average number of beetles per surface unit of moss removed from trees with and without set cardboard niches, the calculated number of 7.45 adults per square meter of moss on the trees without artificial niches was higher, but still significantly lower than the average number of adults recorded in the cardboards. Such results contribute to the presumption that the artificial cardboard niches are more attractive to the ash weevil as overwintering shelter than mosses and therefore their control can be improved with the appropriate use of artificial, cardboard niches. Displacement and burning of the artificial niches with overwintering adults could significantly reduce the population density of overwintering adults.

Setting of the sticky belts on trees was conducted in order to test the possibility of their use to prevent the crossing of beetles which overwintered in the litter and in lower part of the tree trunk (below the belts) to the crown, and thus to prevent the damages. Adults of the ash weevil were recorded on sticky belts from the beginning of April to the first decade of July (Fig. 2). The peak of the population density registered by this method was from the end of May to mid-June, when adults of the new generation appeared in high number on sticky belts. Despite the high number of adults trapped on the sticky belts, a significant defoliation over 50% was recorded. On the basis of obtained results, it can be concluded that the majority of adults in the spring flies to the crowns of trees. Such behavior resulted in low effectiveness of the applied sticky belts. However, the large number of adults caught on sticky belts demonstrate that this method, if used continuously, could serve as additional tool to reduce the population density. However, further studies related to the most effective use of this method are needed.

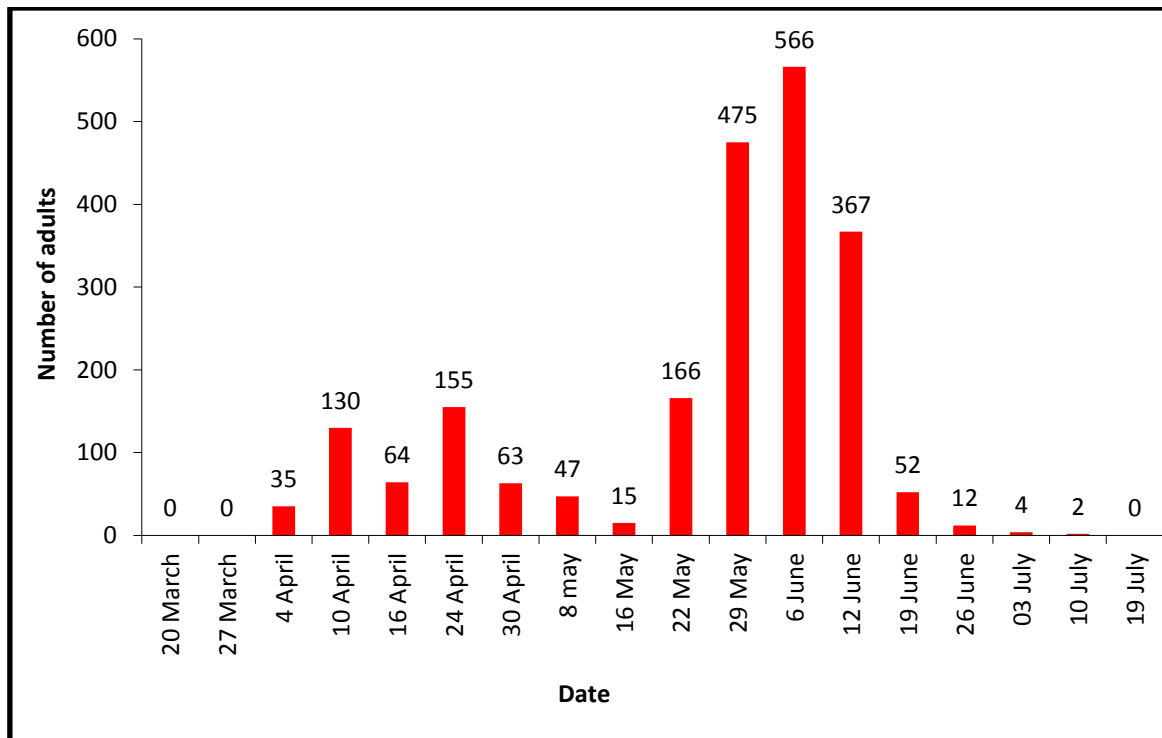

Figure 2 Total number of adults recorded on sticky belts set on 22 ash trees in the forest of Branjevina (Odžaci, Serbia) during the season of 2009

After the detailed examination of the hibernating adults in the moss taken from trees treated with the bioinsecticide BotaniGard SC none of the recorded beetles shown signs of infection by the mycelia of *B. bassiana*. The occurrence of infected adults in untreated moss was not recorded, as well. On the basis of such results, it can be concluded that the conducted application of this bioinsecticide was not effective in reducing the ash weevil population. In the researches conducted by other authors (Markova, 1992; 1998; Pernek and Lacković 2011) *B. bassiana* was identified as a significant factor in reducing of ash weevil populations. On the other hand, the study of Lacković and Pernek (2012) conducted in laboratory conditions shown that an experimental strain of *B. bassiana* from Hungary had no effect on mortality of adults, while the contamination with spores of dead adults infected with *B. bassiana* autochthonous strain from Lipovljani (Croatia) resulted in the mortality rate of 83% of ash weevil adults. According to these authors, such results indicated the existence of a strain of *B. bassiana*, pathogenic for the local population of the ash weevil. This assumption may explain the lack of treatment efficacy of the applied product BotaniGard SC containing the unknown and probably non compatible strain of *B. bassiana* for the targeted insect population. Therefore, the future studies of biological control of the ash weevil should give priority to the strains of entomopathogenic fungi isolated from the local populations of the pest.

Conclusions

Artificial cardboard niches were very attractive for overwintering of adults of the ash weevil. High number of recorded adults clearly demonstrated that artificial cardboard niches can be successfully used for the suppression of ash weevil population density. For this purpose niches should be placed on the trees starting from mid-May when adults of the new generation start to emerge. The cardboards with overwintering weevils have to be removed and burnt at the beginning of autumn, at the latest until the beginning of March next year.

Sticky bands placed at breast height of the trunk in the early spring did not prevent defoliation of ash trees. Control of the ash weevil by applying a commercial bioinsecticide containing conidia of *B. bassiana* gave no positive results.

Acknowledgments

This paper is part of the research done within the project III 43002 of the Ministry of Education, Science and Tehnological development of the Republic of Serbia.

References

- Cankov, G., Mircev, P., Rasev, S.(1990).Studying aspects of the biology of ash weevil (*Stereonychus fraxini* De Geer) and controlling activities, *Nauka za gorata*3, 77 - 81. (In bulgarian with english summary)
- Drekić, M.(2011).The study of bioecology and methods of controlling the ash weevil - *Stereonychus fraxini* De Geer (Coleoptera, Curculionidae) in Serbia,Ph. D. thesis, University of Belgrade, 1-97. (In serbian with english summary)
- Drekić, M., Poljaković – Pajnik L., Vasić, V., Kovačević, B., Marković, M. (2015).Investigation of efficacy of some insecticides for control of *Stereonychus fraxini* De Geer,Proceedings of the Biennial International Symposium “Forest and Sustainable Development”, University of Braşov, 97-100.
- Lacković, N., Pernek, M. (2012).Possibility of using entomopathogenic fungi *Beauveria bassiana* for controlling the ash weevil (*Stereonychus fraxini*), *Radovi* 44(2), 101-111.(In crotian with english summary)
- Liović, B., Novak – Agbaba, S., Matošević, D., Pernek, M., Županić, M.(2001). Contribution to improvement of forest protection methods and determination of pest population density, *Radovi* 36(1), 101 - 112.(In crotian with english summary)
- Markova, G. (1992).*Beauveria bassiana* Vuillemin as a patogen of ash weevil, *Stereonychus fraxini* Deg. (Col, Curculionidae) in Bulgaria, *Journal of Appliad Entomology* 114, 275–279.
- Markova, G. (1998). Biotic faktors affecting *Stereonychus fraxini* populations in Longoza forests, Bulgaria, *Population dynamics, Impact and Integrated manegement of Forests Defoliating Insects*, USDA Forests Service General Tehnical Report NE – 247, 345.
- Mikloš, I.(1954). Ash weevil *Stereonychus fraxini* Degeer,Šumarski list 78, 11 - 21. (In crotian with german summary)
- Marović, R. (1963). The occurrence of ash weevil in the forests of Srem,Plant doctor 6-7, 12 - 14. (In serbian with english summary)
- Pernek, M., Lacković, N. (2011). *Beauveria bassiana* on overwintering adults of *Stereonychus fraxini* in Croatia, *IOBC-WPRS Bulletin* 66, 205-207.
- Spaić, I., Mikloš, I.(1981). The first experiments to supression of ash weevil (*Stereonychus fraxini* DeGeer) using Dimilin, *Proceedings of Societies of Plant Protection of Yugoslavia* 3, Beograd, 473 - 477. (In serbian with english summary)
- Wingelmüller, A.(1921). Bestimmungstabelle der paläarktischen Cionini (Curculionidae) nebst Beschreibungen neur Arten,*Koleopterologische Rundschau*Bd. 9, 102 - 124.

SPECIAL NATURE RESERVE “KOVILJ-PETROVARADIN MARSHES” – REVIEW AND ANALYSIS OF THE PROCLAMATION PROCESS, OBJECTIVES AND INTEGRATED MANAGEMENT MEASURES

Albina TARJAN TOBOLKA^{1*}, Mirjana STEVANOV², Zoran GALIĆ², Alen KIŠ³

¹Public Company Vojvodinasume, Petrovaradin, Serbia

²Institute of Lowland Forestry and Environment, Novi Sad, Serbia

³Institute for Nature Conservation of Vojvodina Province, Novi Sad, Serbia

*Corresponding author: albina.tarjan.tobolka@uns.ac.rs

Abstract

Forest management in protected areas requires multidisciplinary approach of both forestry and nature protection planning. The complexity of protected area management requires investigation of the issue from various aspects, including evolutionary analysis, program analysis (review of proclamation documents, plans for protection realization) and result analysis (that has been achieved by). When forests are managed in protected areas, one of the most important aspects is the harmonization of the goals set in forest management plans and in nature protection documents. To be able to cope with such a challenging situation, it is necessary to take a broader perspective, i.e. to look in detail at the bio ecological condition of the respective protected area, to analyse previous management regimes and to identify main problems to be worked on in the future in order to achieve the goals of sustainability and integral management. The aim of this paper is to analyse key aspects of the proclamation, the proclamation process, the participation and cooperation of stakeholders in that process, the legal base and other relevant documents about the proclamation and management by taking the case of the Special Nature Reserve “Kovilj-Petrovaradin Marshes” as a prominent protected area with significant share of forests. The paper also presents the main characteristics of the marshy wetland ecosystems, and analyse the primary objectives of protection, together with the measures already taken for their achievement. The analyses should serve as a base for later deeper investigation and analysing of potentials for integrated resource management.

Keywords: *Special nature reserve, Protection, Forests, Integrated management.*

Introduction

The need of people to protect natural areas for specific purposes reaches far into the past (Martinić, 2010). In India, some specific areas have been protected two thousand years ago with the aim to protect natural resources. In Europe, lots of forests have been protected as hunting areas about hundred years ago (Martinić, 2010). Nature protection presents a multidisciplinary approach of managing natural resources, which was created in order to solve numerous issues for the nature management in a sustainable manner (Panjković *et al.*, 2016). Special Nature Reserve “Kovilj-Petrovaradin Marshes” is a spacious flooded area by the River Danube in the south-east part of Vojvodina province in Serbia, with the total area of 5.895 ha (“Sl. Glasnik RS”, br. 44/11). It spreads in the alluvial plane of the River Danube, in length of 25,6 km. It includes three divided unities: Petrovaradin marshes, that spreads on the right bank of the river (1.411 ha), Kovilj marshes, that spreads on the left bank of the River Danube (3.430 ha) and Krčedin island and a part of Gardinovci marshes (1.050 ha). The first regime of protection is established on 373 ha (6%), the second one on 1.738 ha (29%), and the

third one is established on 3.784 ha (65%). It is managed by the public company “Vojvodinašume”.

Regarding the land use, it is mostly covered by forests (69 %), then by meadows and pastures (15 %), the share of water surfaces is about 8 %. The ownership of the land is as follows: state 4062 ha, other (Serbian Orthodox Church) 736 ha, mixed (Serbian Orthodox Church) 290 ha, mixed 357 ha, social 254 ha, private 194 ha (Panjković *et al.*, 2010).

Mosaic of aquatic, marshy, wetland, meadow and forest ecosystems are the main characteristics of this area. The flow of the Danube has typical lowland characteristics that excels slow flow and small slope of the river. Sedimentation and deposition of the material transferred by the river resulted different orographic and hydrographic forms of relief with islands, elevated coastal beams and depressions in the lower parts. The whole area is cut by backwaters, meanders, ponds and swamps. Hydrological characteristics are defined by the permanent influence of flooding and groundwater (Panjković *et al.*, 2010).

Depending on the relief and water regime, a variety of wildlife has been developed. 39 priority habitat types have been identified for protection on national and international level. 29 functionally instable and sensitive to degradation habitats are recorded, there are 6 rare habitats which regenerate slowly, and also two especially isolated habitats: forests of pedunculate oak and narrow-leaved ash (*Quercus robur*, *Fraxinus angustifolia*), and forests of elm (*Ulmus campestris*). 7 priority NATURA 2000 sites have been registered.

International importance: IBA area (9.594 ha), IPA area (142.376 ha including the Mountain Fruška gora), Ramsar area since 2012 (8.292 ha), ICPDR area by the Danube, DNPA area, EMERALD area (4.841 ha). Ecologically important area in Serbia: Fruška gora and Kovilj marches (“Sl. glasnik RS, br. 102/10).The affirmed conservation status dedicates the area a priority in process of NATURA 2000 network designation, which is obligatory for all EU countries.

The reserve presents the biggest preserved wetland complex by the Danube in Serbia, which spreads in an inundation area and is in direct influence of the water level of the river. The aim of this paper is to provide analyses of the proclamation of the protected area as a base for further investigation of improved integrated resource management.

Materials and methods

Document analysis presents an iterative process which involves skimming (overview), reading (thorough examination) and interpretation. It combines elements of content analysis and thematic analysis. Content analysis is the process of organizing information into categories related to the central questions of the research (Bowen, 2009).

Different documents can be included for systematic evaluation as part of the study, such as advertisements, agendas, attendance registers, minutes of meetings, manuals, background papers, books and brochures, diaries and journals, event programs, letters and memoranda, maps and charts, newspapers press releases, program proposals, application forms and summaries, radio and television program scripts, organizational or institutional reports, survey data and various public records (Bowen, 2009).

Materials for this paper are all publications related to the examined protected area, the Study for the protection at the first place, but also other publications about the protected areas or nature protection both in Vojvodina province and Serbia. Management plans and revision documents have also been examined. All legal framework presented by Serbian laws or other legislation have been overviewed. Complete documentation about the protected area in the archive of the Institute for Nature Conservation of Vojvodina province has been prospected.

The main method of the research is analytical-deductive. Based on the existing knowledge in the references, documents, books, brochures, management plans and programs an analysis of the proclamation and the proclamation process of Special Nature Reserve “Kovilj-

Petrovaradin Marshes” have been done. The analytic procedure entails finding, selecting, appraising, and synthesizing data contained in these documents.

Results and discussion

The first recordings about the history of protection of Kovilj-Petrovaradin marches date from 1970. The Municipal Assembly of Novi Sad made a Rescript of protecting a part of Kovilj marches as a scientific research reserve “Kozjak” on 43,66 ha. The initiative to protect the whole area of Kovilj marches has been propounded by the Institute for Nature Conservation of Vojvodina province in 1971. They have made an elaborate about the valorisation of the area and the natural values of it. Suddenly it haven’t been accepted a proclaimed as a protected area. In 1979/80 the Institute for Nature Conservation of Vojvodina province has made a new valorisation of the natural resources of Kovilj-Petrovaradin marches as an important, wider natural complex and proposed to protect it as a regional park. The municipalities in which the proposed protected area spreads didnt show any interest for the establishment of the spatial protection, and they didnt give their permission for it. Ten years later, in 1989/90, at the initiative of the City of Novi Sad, the Institute for Nature Conservation of Vojvodina province has again made a revision of the natural resources Kovilj-Petrovaradin marches. On the basis of this revision, it has begun the writing of the professional documentation for the proclamation of the protection of this area. In the meantime, there have been some changes in the territorial organisation of the municipalities on which the potential protected area spreads, so the protection wasnot proclaimed again.

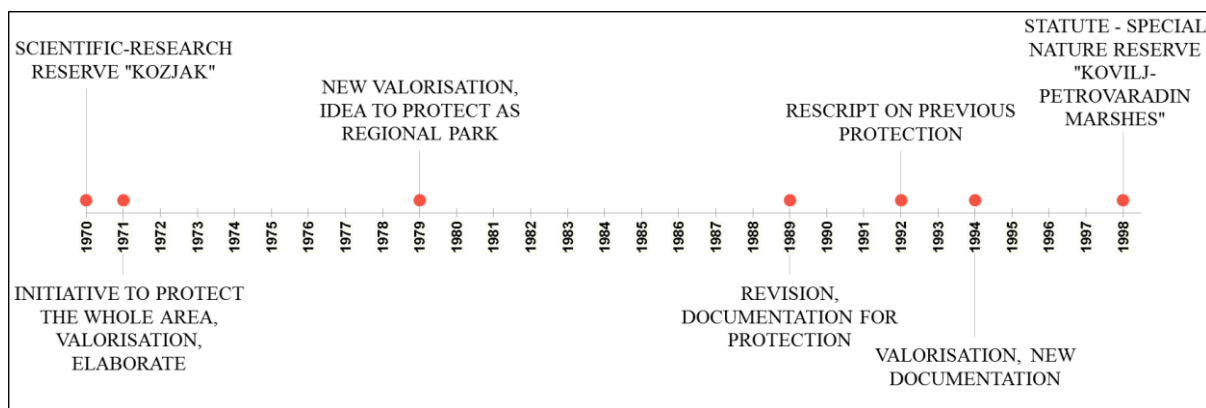

Scheme 1 Proclamation process of Special Nature Reserve “Kovilj-Petrovaradin Marshes”

Regarding the crucial natural resources of this area and the necessity of the protection of the Danube wetland areas, and the marshy wetland areas in general, accordingly to the former initiative of the City of Novi Sad, the Institute for Nature Conservation of Vojvodina province on the base of 42. Clause of the Law on Environmental Protection (“Sl. Glasnik RS” 66/91, 83/92), issued a Rescript on previous protection of Kovilj-Petrovaradin marches. On the base of field examinations and evaluations in 1994, a new professional documentation about the protection has been made. The Statute about the protection of Special nature reserve “Kovilj-Petrovaradin marches” has been proclaimed in 1998. (“Sl. glasnik RS” 27/98). After that, two changes have been made to it about the list of cadastral parcels and the name of the manager of the natural resource („Sl. glasnik RS”, 91/06, 81/08).

In the process of the revision of the protection and the expansion of the boundaries of the Special nature reserve “Kovilj-Petrovaradin marshes” several groups of stakeholders have been included for the participatory approach. They can be legal and natural persons who can have great influence on the success of the protection. The stakeholders are: the owners of the area (country folk, Serbian Patriarchate in Sremski Karlovci, Serbian Monastery of Holy

Archangels in Kovilj), managers and/or users (the protected area manager, Water Management Company “Šajkaška”, Associations of stockbreeders from Kovilj and Beška, fishing associations, hunting associations from Kovilj, Beška, Gardinovci and Krčedin, weekend cottage villages), state and regional government with institutions (Institute for nature conservation of Vojvodina province, Secretariat for Environmental protection and sustainable development, Ministry of Environmental Protection and spatial planning), local government (municipality of Novi Sad, Sremski Karlovci, Inđija, Titel, local communities Kać, Kovilj, Petrovaradin, Gardinovci, Čortanovci, Beška and Krčedin), media, NGOs (Society for protection and study of birds of Vojvodina. Arka, Epar, etc.). Some of these stakeholders are actively included in the process of protection, others are passively included (the protection affects them). The stakeholders can influence the protection and to support it, and also they can be against it (Panjković et al., 2010). Because of the great number and diversity of stakeholders, this area can serve as an assay protected area as an example of functioning of the needs of protection, owners, users and managers.

The stakeholders have been included into the process of proclamation through several meetings. On these meetings the representatives of the Institute for Nature Conservation of Vojvodina province presented the boundaries and the regimes of protection. They explained each measure of protection, and tried to harmonise the protection with the needs of the stakeholders. Public company “Vojvodinašume”, as the manager of the protected area, Serbian Monastery of Holy Archangels in Kovilj (which owns 1094 ha of land in the protected area), and the Association of Stockbreeders “Dunav” have taken part in these meetings. The process of proclamation included a public hearing, too, where the study of protection was presented in detail to the interested stakeholders.

Urban and Spatial Planning Institute of Vojvodina has made the Spatial plan of the area of Special natural reserve “Kovilj-Petrovaradin marshes”. They wanted to include the local community in the drafting of it, so they organised a meeting in the local community “Kovilj”. Beside the Institute for Nature Conservation of Vojvodina province and the Secretariat for Environmental Protection and Sustainable Development, numerous stakeholders took part in it: representatives of the managers, Serbian Monastery of Holy Archangels in Kovilj, Associations of Stockbreeders “Dunav”, local community “Kovilj”, association of citizens “Ekofarmer”, The Planning Institute of Vojvodina, Public company “Institute for City Development” and NGO “Arka”.

The main questions about the management, use and promotion of protected areas are defined by the provisions of the Law on Nature Protection (“Sl. glasnik RS”, 36/09, 88/10, 91/10). In the means of this Law, for every protected area a special act about the protection has to be done. This act defines the measures and the regimes of protection, and defines the legal entity, the manager of the protected area, who implements the regimes of protection and prepares a management plan.

The regimes and the measures of protection have been defined to protect water, marshy, meadow and forest flooded habitats as priority habitat types, aimed to conserve the protected species characteristic for those habitats (Panjković *et al.*, 2010). According to Puzović et al., the main objectives and methods of conservation in the “Kovilj –Petrovaradin marshes” are:

- Preservation and enhancement of natural resources by using active protection measures;
- Restoration and conservation of natural habitats and their mosaic layout;
- Ensuring of flooding of fish habitats and supply of the marshes with fresh river water by maintaining the channels and backwaters;
- Revitalisation and maintenance of sensitive habitats of ponds, wet meadows, pastures and swamp forests;
- Traditional using of wet meadows and pastures, encouraging grazing and mowing;

- Increase in forest area of autochthonous tree species, with reduction of the share of clonal plantations of poplars and willows, and invasive tree species;
- Preservation of trees, and groups of trees with pedunculated oak, narrow-leaved ash, elm and black poplar, as edificator species in natural forests of the marshes;
- Repression and prevention of the spread of invasive species;
- Development of a program of ecological education and promotion of the protected area.



Picture 1 Panorama of the wetland¹



Picture 2 Panorama of the wetland²

Since the protection was proclaimed, numerous projects included in the multi-annual programs have been carried out. They were oriented on site and species protection, on improvement on water regime, construction of infrastructure for education, recreation and promotion of the protected area. These activities have made significant contribution to the improvement of natural resources and to strengthening ecosystem services of this protected area (Stojnić *et al.*, 2015.).

Puzović *et al.*, (2015) highlights some activities as major ones since the protection was proclaimed. These are dredging of the canals of the old Danube, ecological restoration of wet habitats on the Kurjačka beam (a natural rise in the wetland), revitalization of wet and swamp habitats of Šlajz-Tikvara location and grazing and promotion on Krčedinska island.

Conclusions

Special Nature Reserve “Kovilj-Petrovaradin Marshes” is a spacious flooded area by the River Danube which spreads on 5.895 ha, managed by the Public company “Vojvodinašume”. It presents the biggest preserved wetland complex by the Danube in Serbia, which spreads in the inundation area and is in direct influence of the water level of the river. Mosaic of aquatic, marshy, wetland, meadow and forest ecosystems is the main characteristic of this area. Depending on the relief and water regime, a variety of wildlife has been developed; more than 70 habitat types have been identified to be important for protection on national and international level.

The first recordings about the history of protection of Kovilj-Petrovaradin marches dates from 1970, when a scientific research reserve “Kozjak” has been established on 43,66 ha. In 1971 the Institute for Nature Conservation of Vojvodina province made an elaborate about the valorisation of the area and the natural values of it with the aim to protect the whole area of Kovilj-Petrovaradin marshes. Since it wasn't accepted, they have done a review first in 1979/80, then in 1989/90 years. In 1994 the Institute for Nature Conservation of Vojvodina province issued a Rescript on previous protection of Kovilj-Petrovaradin marches. Finally, the

¹ Source: <http://goo.gl/td0L8y>, accessed June 2016.

² Source: <http://goo.gl/yhdex9>, accessed June 2016.

Statute about the protection of Special nature reserve “Kovilj-Petrovaradin marches” has been proclaimed in 1998.

Great number and different stakeholders, such as state institutions, managers and users of the protected area, associations and NGOs are interested in the use of the area of the reserve so it can serve as an example for examination of the harmonisation of their goals and needs.

The regimes and the measures of protection have been defined to protect water, marshy, meadow and forest flooded habitats as priority habitat types aimed to conserve the protected species characteristic for those habitats. Since the protection was proclaimed, numerous projects oriented on site and species protection, on improvement on water regime, construction of infrastructure for education, recreation and promotion of the protected area have been carried out. These activities have made significant contribution to the improvement of natural resources and to strengthening ecosystem services of the protected area.

Acknowledgement

Authorsthank the Institute for Nature Conservation of Vojvodina Province for the possibility of using data from their Archive and library for the purpose of thisstudy.

References

- Archive documentation of the Institute for Nature Conservation of Vojvodina Province
- Bowen, G. A. (2009): *Document Analysis as a Qualitative Research Method*. Qualitative Research Journal, vol. 9, no. 2, 27-40.
- Martinić, I. (2010): *Upravljanje zaštićenim područjima prirode, planiranje razvoj i održivost.*(The management of protected areas, planning, development and sustainability.) Sveučilište u Zagrebu, Šumarski fakultet, Zagreb.
- Panjković, B., Stanišić, J., Kovačev, N., Perić, R., Kiš, A., Pil, N., Galamboš, L., Dobretić, V., Stojnić, N., Delić, J., Majkić, B. (2010): *Studija zaštite:Specijalni rezervat prirode “Koviljsko – petrovaradinski rit” predlog za stavljanje pod zaštitu kao zaštićeno područje I kategorije.*(Study of protection: Special Nature Reserve “Kovilj - Petrovaradin Marshes”protection proposal as first category protected area.) Pokrajinski zavod za zaštitu prirode, p. 155.
- Panjković, B., Šipka, S., Maksimović, D. (2016): *Zaštićena područja prirode u AP Vojvodini: Status zaštite i finansiranje u kontekstu evropskih integracija.*(Protected areas in the AP Vojvodina: Protection status and funding in the context of European integrations.) Ekološki centar Stanište, Vršac.
- Puzović, S., Panjković, B., Tucakov, M., Stojnić, N., Sabadoš, K., Stojanović, T., Vig, L., Marić, B., Tešić, O., Kiš, A., Galamboš, L., Pil, N., Kicošev, V., Stojšić, V., Timotić, D., Perić, R., Bošnjak, T., Delić, J., Dobretić, V. I Stanišić, J. (2015): *Upravljanje prirodnom baštinom u Vojvodini.* (Management of natural heritage in Vojvodina.)Pokrajinski sekretarijat za urbanizam, graditeljstvo I zaštitu životne sredine I Pokrajinski zavod za zštitu prirode. Novi Sad.
- Stojnić, N., Pil, N., Kicošev, V., Stanišić, J., Plemić, Z., Galamboš, L., Delić, J., Timotić, D., Kiš, A., Predojević, J., Milenić, B., Bošnjak, T., Mudri-Stojnić, S., Trifunov, S., Sabadoš, K. (2015): *Ekonomsko vrednovanje ekosistemskih usluga Specijalnog rezervata prirode “Koviljsko – Petrovaradinski rit”.*(Economic valuation of the ecosystem services of the Special Nature Reserve “Kovilj - Petrovaradin Marshes”.) Pokrajinski zavod za zaštitu prirode, UNDP, GEF, Novi Sad, 63p.
- Službeni Glasnik RS 66/91, 83/92, 27/98, 91/06, 81/08, 36/09, 88/10, 91/10, 102/10, 44/11.

THE EFFECTS OF ENVIRONMENTAL IMPACT ON CONIFEROUS FORESTS OF THE WESTERN PART OF LATVIA

Oskars ZALĶKALNS^{1,2*}, Imants LIEPA¹

¹Department of Silviculture, Forest Faculty, Latvia University of Agriculture, Latvia

²State Forest Service, Latvia

*Corresponding author: oskars.zalkalns@dienvidkurzeme.vmd.gov.lv

Abstract

The quality of Latvia's environment is influenced by many natural and anthropogenic factors whose proportions and intensity depends on local and global processes. Effective and quick evaluation of environment's quality with bioindication methods allows obtaining a concept of the real situation that derives from a sum of factors affecting the environment. Therefore nowadays not only felling of trees and recreation are affecting forest ecosystems, but also changes of environmental conditions, including chemical and physical factors. It must be emphasised that environmental factor impact on forest ecosystems is accumulating gradually and visually it is difficult to be discovered. The territory of the research covers Kurzeme region, which is located in the west part of Latvia or in the east of the European Union. Previous researches in this field in Kurzeme have fragmental features – they include impact evaluation of separate factors in separate stands. The analysis of environmental impact on forest ecosystems has theoretical and practical characteristics. Additional increment has been used to evaluate how stand has formed in a specific period of time. To demonstrate the accumulation course of environmental impact (or impact trend) the additional cumulative volume increment m^3m^{-2} per year has been used, which allows comparing different component and stand densities, or their parts. Total impact of environmental factors were evaluated in two categories: in the first category are those impact parts that can be explained with a common parameters for all sample plot stands. Second category is represented by only specific (local) factor impacts of each sample plot stands. A pronounced both category fluctuation of environmental impact in the territory of Kurzeme has been observed. The economic losses that results from the wood losses estimates 198 EUR ha^{-1} per year on average.

Keywords: *environmental impact, Norway spruce, dendrochronology, volume increment.*

Introduction

There are only few places in Latvia where forests are not growing. But without an anthropogenic impact these wooded areas would have been much greater. The highest forest cover percentage in Latvia was reached approximately nine thousand years ago when forests covered 90 % of the present day national territory. Humans have increased their material welfare with the use of forest resources. At the beginning forest was used with explicit restrictions, but with time the sphere of activities has increased. The environmental diversity of Latvia depends on the impact of not only Latvian, but also transboundary pollution, climate and other global process activities.

Environmental quality, including air quality, in Latvia is affected by stationary and mobile emission sources of pollutants, and also transboundary air pollution, which by its volume can be compared to the local pollution created in the territory of Latvia. The quality of air, chemical composition of precipitation, and sedimentation of substances on soil and in water are impacted by the composition and concentration of pollutant substances. Air pollution is

causing or favouring such environmental phenomena as acidification, eutrophication, air-ground ozone formation and accumulation of dangerous chemical substances in living organisms.

Therefore nowadays not only tree felling and recreation are affecting forest ecosystems, but also changes of environmental conditions, including chemical and physical factors. It must be emphasised that environmental factor impact on forest ecosystems accumulates gradually and is visually hard to detect. When the visual signs of destruction appear (discoloration, defoliation, dieback of tree tops and branches) most likely it is too late to do something in the context of forest protection. The dendroindication has an advantage – impact effect is accumulating in the annual growth rings of a tree and it is possible to estimate impact volume of environmental changes starting from its first years. Electromagnetic radiation (high-voltage power lines, mobile communication transmitters, different types of radio transmitters) and radioactive radiation belongs to the physical factors, but air pollution with such dangerous impact sources as heavy metal, sulphur, nitrogen and other compounds are known as chemical factors. Sulphur and nitrogen compounds in a moist (with precipitation) and dry (aerosol) form produce sediments that change the reaction of precipitation and pH, thus, affects ecosystems (soil, surface waters, forests), and also buildings and cultural objects.

The method of environmental parameters provides a value determination of the assessed environmental factors and their comparison with critical or normative values. In most of the cases the normative values are adopted by the national parliament or government, surely, if possible, taking into account the statements of ecological studies. It must be noted, that not always they reflect the real situation. Furthermore, significant role is to the subjective option of decision makers, namely, with the increase of the level of normative values it is possible to manipulate with the evaluation of environmental quality, when hazardous environments are “made” safe. Secondly, the intercorrelation of the numerous environmental factors is very important. In the result, the same level of a factor in one growing conditions can show a different impact in other conditions. It must be taken into account when assessing territorially wider regions. Thirdly, one of the specific characteristics of environmental factors is their dynamics; complexes of factors and the impact level of separate factors are changing over time. Thus, once adopted normative values cannot be permanent. The usage of environmental parameter methods is limited by the second component – the accuracy of determination of environmental factor value, which, despite the use of standard procedures, cannot entirely exclude the stochastic nature of ecological factors (Лиєпа, 1980).

The results of all the environmental factors are present in Kurzeme, furthermore, they have pronounced features of territorial and temporal fluctuations. Previous studies in this field in Kurzeme have a fragmentary character – they include assessment of factor impact in separate forest stands. The research of this study is connected to a development of a continuous network of bioindication stands and assessment of the complex impact of environment in the territory of Kurzeme in the period from 1989–2008. The analysis of environmental impact on forest ecosystems has a theoretical (ecological aspects) and practical (silvicultural and economical assessment) nature. Such problems affect many countries. When dealing with these common problems, solutions that were obtained in relation to the impact of changes of environment and its diversity in Kurzeme, has an informative value for interpreting the condition of the European forest ecosystems.

Materials and methods

The territory of the research covers Kurzeme region, which is located in the west part of Latvia or in the east of the European Union. It borders with the Baltic Sea in the west and with the Gulf of Riga in the north and northeast, with Zemgale and Riga region – in the east, and with Lithuania in the south. Territory of the region is 13 607 km² or 21% from the territory of Latvia¹.

Forests stands, which contain bioindication plots, are located in Kurzeme and some of them are located in the northwest of Zemgale. Sample plots are located both in maritime lowlands and Kurzeme highlands reaching the tilt of the middle of Latvia (Fig. 1.1).

In Kurzeme the dominant wind direction changes depending on the season. Such wind directions can ensure the transfer of air pollution from industrial objects (in Liepāja, Mažeikiai) to forest stands in the research territory. The dominant tree species in forests of Kurzeme, according to the State Forest Service data (CD 2010)² is pine (*Pinus sylvestris* L.) which grows in 45% of the total forest area, second most common species is birch (*Betula* sp.) 26%, and third most common species is Norway spruce with 18%. that most of the plots are established in the most suitable type for spruce – *Oxalidos* (36%). Then follows the *Hylocomiosa* forest site type with 30% of plots. Other forest site types in total cover 34% from all the sample plots of the study. After assessment of existing industrial objects that could discharge pollution into environment (Tabors et al, 2001; Nikodemus et al., 2004) and also cause a pollution impact on trees, a data about these industrial objects were collected from public data basis, where companies have decelerated them. After analysing these data, and also the experience of other scientists (Ashby, Fritts, 1972; Ловелиус, 1979; Скудра, 1982; Шевякова, Кузнецов, 2000; Tabors et al, 2001; Pärn, 2006), the potential impact of pollutants on the environment in Kurzeme forest stands can be analysed. Special attention has been turned to the amounts of NO_x and SO₂ emissions. These chemical substances are active participants in the processes of photosynthesis and are affecting plants directly.

In the region of this study the major air pollution with SO₂ is produced by Mažeikiai oil refining factory. Considerably smaller SO₂ emission amounts are produced by Brocēni cement producer Cemex Ltd. and JSC Liepājas metalurģs. Some of the stands that are included in this study are exposed to the impact of SO₂ emissions, which are brought by the dominant winds. Sample plots were created in the summer–autumn period of year 2008 and the spring of year 2009. To represent all Kurzeme region – two transects were chosen with 15 sample plots on each of them (Fig.1). The area of each sample plot is 400 m² (20x20 m) with a condition that there are at least 20 bioindicator sample trees in it (overstory trees with no visual signs of damage), if the number of trees is insufficient, then size of sample plot was increased so that the needed number of trees would be included. The centres of the sample plots were selected so that they would represent larger variety of stand densities.

Height measurements were performed with Suunto type clinometer with a precision of ±0.5 m, and with a 20 m measurement base, giving a higher probability to avoid errors. Samples were extracted at 1.3 m height above root collar. Boring was performed from S or SW direction, perpendicular to the stem growth axis in the direction to pith, additionally marking trees with signs of rot. In total, 655 core samples were collected. For each bioindication sample plot one common reference stand was selected (coded with symbol K) with similar growth conditions and without deformation, defoliation and wind damage signs. In this research, the last 40 annual rings from year 1969 to 2008 were used, which correspond to 20 years of assessment and 20 years of retrospection period. To evaluate the environmental impact – the Norway spruce response reaction was used and expressed with cumulative and current additional volume increments.

¹ http://www.liepaja.lv/upload/Bizness/Attistiba/kurzemes_planoshanas_doc1.pdf. Viewed on 10/02/2012.

² <http://www.vmd.gov.lv/?sadala=762>. Viewed on 03/02/2011.

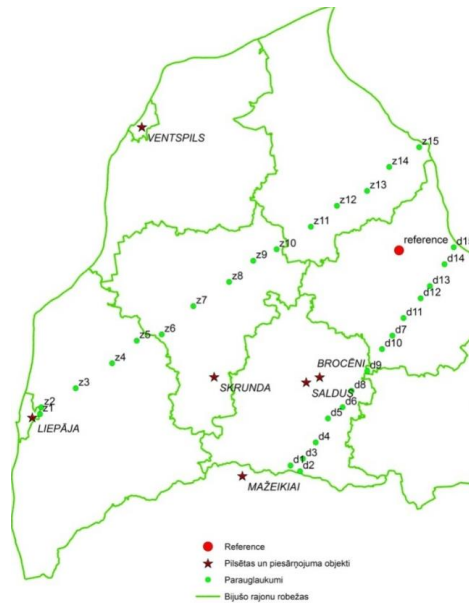

Fig. 1 Location of sample plots

The additional volume increment is understood as an increase or loss of growing stock, which has originated in the influence of the researched factor (Liepa, 1996). Thereby, in the increase of tree or stand taxation parameters two components can be divided: uninitiated increment, which would have been produced even without the realisation of the assessed impact, and additional increment, which has been produced exactly due to this factor's impact. Only additional increment reflects the characteristics and magnitude of the assessed impact. The sum of both – components or the integral increment gives incomplete information, because natural fluctuations are partially evening out the impact effect of a factor.

Results and discussion

To demonstrate the accumulation rate of environmental impact (or impact trend) the reduced cumulative additional increment m^3m^{-2} has been used, but to reflect the annual changes of impact – the reduced current additional increment m^3m^{-2} per year was used, which allows to compare stands (or parts of stands) of various composition and stand densities.

Forest stands with various age, composition and stand densities can be compared with the usage of reduced current and reduced cumulative additional increments. It is possible, because additional increments are attributed to 1 square meter of stand's basal area. For example, Figure 2 shows the accumulation rate of reduced additional increment of five different stands in a 20-year period.

Environmental factors can either improve or aggravate the physiological condition of a tree, and that shows in the tree reaction. Researched stands according to the characteristics of spruce response reaction trend can be divided into three groups: positive, negative and neutral. The positive response reaction of stand shows a positive impact of the researched factor, but negative value indicates to a decreased biomass production. If the value is zero, then the impact is equal to the background level (Liepa, 1996). The Figure 2 shows previously mentioned groups. What could affect the growth and development of spruce stands in Kurzeme? Firstly, it could be air pollution that can enter the atmosphere from industrial companies in Latvia and Lithuania.

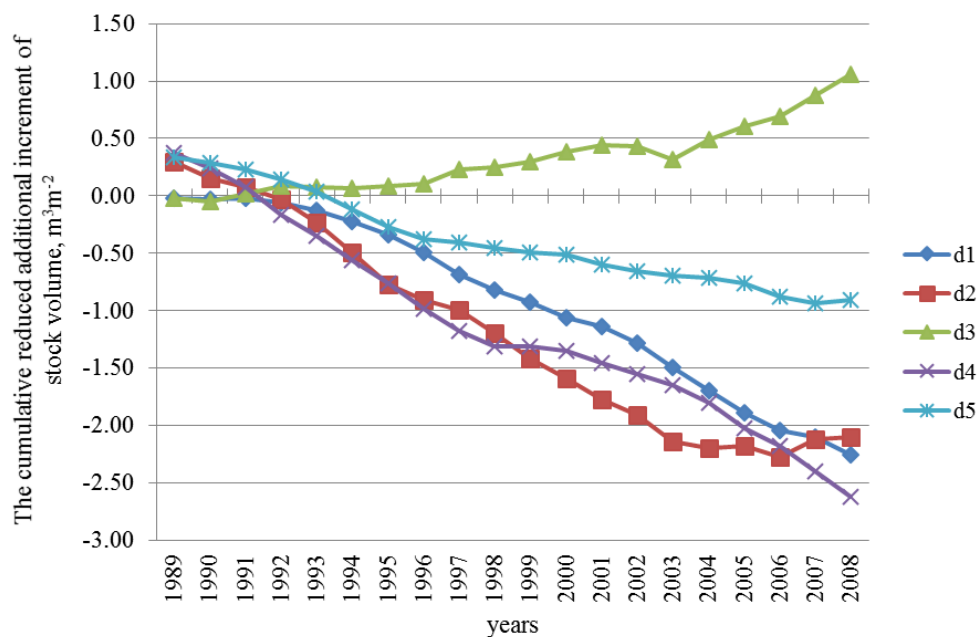

Fig. 2 Changes of cumulative reduced additional increment in a 20-year period

The impact of these and other abiotic factors on coniferous tree stands and their mineral supply has been researched also in Estonia, (Pärn, 2006), Lithuania (Stravinskiene, Erlickyte, 2009), Russia (Шевякова, Кузнецов, 2000), and other countries. The response reaction of coniferous trees is similar to the control trees, or even showing some fertilisation effect from cement dusts (Lukjanova et al., 2010). This impact has to be taken into account when analysing the impact of air pollutions in Kurzeme – due to the Brocēni cement factory – not taking into account that closest spruce stands are located more than 10 km away from this factory (the closest sample plot from Brocēni cement factory is d8 with a distance 11.5 km from factory). P. Skudra in his research, already, in 1960s–1970s has observed similar tendencies. In the planning of the research, an idea about the substantial impact of polluted air from industrial objects, which are located near Mažeikiai, Liepāja and Brocēni, was considered. If that is the case, the values of cumulative additional increment should show a trend dependency on the location of plot with the distance from the pollution source. There is dependence, but not a trend, which clearly shows its local origin with intensifications.

The economic effect assessment of the total environmental factor impact in monetary terms has been reflected show the gained or lost value of wood of separate stands in the whole assessment period in total and as an average value of loss per year. The average wood prices of year 2009 and 2012 in Kurzeme were used for the evaluation; prices are presented in data bases of Central Statistical Bureau. Since wood prices of separate years can differ greatly, then prices of two years were used in the economic calculations. The prices of 2009 were selected because 2008 is the last year of assessment period, however, 2012 was selected because it is the most recent information available in the data bases. Such solution is better compatible with the assortment outcome.

Losses, estimated by the prices of 2012 for the not produced wood due to various environmental factors in transect “D” in 20 year period on average comprises -3877.83 EUR ha⁻¹ or -193.89 EUR ha⁻¹ per year. In the same time, the average losses of transect “Z” in 20 years comprises -4011.80 EUR ha⁻¹ or -200.59 EUR ha⁻¹ per year.

Conclusion

1. The spruce stands included in the research, they are located in different edaphic, orographic and of other abiotic and biotic conditions. The dendroindication method was used for evaluation of total environmental impact. The response reaction of spruce to the impact of environmental change in a 20 year period (1989–2008) was expressed with the cumulative and current additional increments.
2. Total impact of environmental factors were assessed in two categories: first category consisted of those impact parts that can be explained with parameters common for all sample plots. The impact of these parameters was expressed with a multiple linear regression. Second category is represented by only specific (local) impacts of each sample plot.
3. According to response reaction the spruce stands of Kurzeme can be divided into three groups: with a positive impact trend; with negative impact trend; stands with a background trend.

References

- Ashby, W. C., & Fritts, H. C. (1972). Tree growth, air polluton, and climate near LaPorte, Ind. Bulletin American Meterological Society, Vol.53, No.3, p.246-251.
- Liepa, I. (1996). Pieauguma mēcība (In Latvian) [*Forest Increment Science*]. Jelgava, Latvija: LLU.
- Lukjanova, A., & Mandre, M. (2010). Effects of Alkalization of the Environment on the Anatomy of Scots Pine (*Pinus sylvestris*) Needles. *Water Air Soil Pollut*, Vol.206, No. 14, p. 13-22. doi:10.1007/s11270-009-0080-2
- Nikodemus, O., Brūmelis, G., Tabors, G., Lapiņa, L., & Pope, S. (2004). Monitoring of Air Pollution in Latvia Between 1990 and 2000 Using Moss. *Journal of Atmosferic Chemistry*, Vol. 49, No. 13, p. 521-531.
- Pärn, H. (2006). Radial growth of conifers in regions of different cement dust load. *Proceedings of the Estonian Academy of Sciences: Biology, Ecology*, Vol.55, p. 108-122
- Stravinskiene, V., & Erlickyte-Marciukaitiene, R. (2009). Scots pine (*Pinus sylvestris* L.) Radial growth dynamics in forest stands in the vicinity of “AKMENES CEMENTAS” plant. *Journal of environmental engineering and landscape management*, Vol.17, No. 3, p. 140-147
- Sujetovienė, G. (2009). Acidification and Eutrophication of Pine (*Pinus sylvestris* L.) Forests Demonstrated by Indicator Species Analysis. *Environmental Research, Engineering and Management*, Vol.3, No.49, p. 29-35.
- Tabors, G., Brūmelis, G., Liepiņa, L., Nikodemus, O., & Pope, S. (2001). Atmosfēras piesārņojuma monitorings Latvijā no 1990 gada līdz 2000 gadam ar *Pleurozium schreberi* sūnām. Latvijas Universitāte, Bioloģijas fakultāte. (In Latvian)
- Ли́епа, И. (1980). Динамика древесных запасов. Прогнозирование и экология (In Russian). [*Stand Volume Dynamics. Forecasting and Ecology*]. Рига: Зинатне.
- Ловелиус, Н. В. (1979). Изменчивость прироста деревьев. Дендроиндикация природных процессов и антропогенных воздействий. Ленинград: Наука. (In Russian). [*Dendroindication of Natural Processes and Anthropogenic Influences*]
- Скудра, П. (1982). Таксация производительности хвойных древостоев в зоне цементнопроизводственного загрязнения. Елгава: Латвийская Ордена Трудового Красного Знамени сельскохозяйственная академия. (In Russian). [*Taxation of productivity coniferous stands in the area of cement production contamination*.. Phd thesis]
- Шевякова, Н., & Кузнецов, Д. (2000). Причины и механизмы гибели зелёных насаждений при действии техногенных факторов городской среды и создание стресс-устойчивых фитоценозов (In Russian). [*The reasons and mechanisms of destruction green areas under the influence of anthropogenic factors of the urban environment and the creation of stress-resistant phytocenoses*]. Лесной вестник, No. 6(15), pp.25-33.

AREA POTENTIALLY AVAILABLE AND ITS CORRELATION WITH GROWTH OF TREES IN THE PLANTATION OF POPLAR CLONE B-229

Siniša ANDRAŠEV^{1*}, Vladislava GALOVIĆ¹, Martin BOBINAC²

¹University of Novi Sad, Institute of Lowland Forestry and Environment, Antona Čehova 13, Novi Sad, Serbia

²University of Belgrade, Faculty of Forestry, Kneza Višeslava 1, Belgrade, Serbia

*Corresponding author: andrasev@uns.ac.rs

Abstract

Defining growing space is one of the basic elements of the plantations of fast growing tree species, such as poplars, because of it depends on the length of the production cycle, the dimensions of the trees and the economic profitability of plantations. The paper shows possibility of using the area potentially available (APA), as an expression of growing space of trees, in the poplar plantation of clone B-229 which has been established in planting space of 5 x 5 m and where in a part of plantation after 8 years thinning has been performed. The experiment was established in a block design with three replications with the control and the experimental sample plots each of 0.1225 ha, or total of 0,735 ha, where diameters at breast height of all trees were measured after 8 and 11 years, as well as the elements of the spatial position of the trees. Area potentially available is defined as a polygon that is determined by the position and diameter of the tree and its neighbors by the method of Moore et al (1973). The results showed that area potentially available was an average of 26.6 m² in the part of plantation where thinning operation has not been implemented and 52.1 m² in the part where thinning was conducted. Correlation of diameter and basal area increment with area potentially available on the control plot is positive and highly significant, ie. 0.7 and 0.76, respectively. However, the correlation is very low (0.2 and 0.35) and not significant in the experimental plot

Keywords: *area potentially available, increment, correlation, poplar, thinning.*

Introduction

Competition among individual trees is a fundamental ecological process that shapes plant growth, plays a major role in population dynamics, survival, growth and species replacement and provides the basis for density management of tree plantations (Peet & Christensen, 1987; Vanclay et al, 2013). Competition may be defined as an interaction between individuals, leading to a reduction in the survival, growth and reproduction of the competing individuals (Begon et al, 2006) and is summarized as the action on, and reaction to, their living environment (Ford & Sorrensen, 1992). Tree compete for a variety of resources including light, water, nutrients and physical space. As trees grow, they modify their surrounding environment and alter the ability of their neighbors to acquire resources (Weiskittel et al, 2011).

Competition processes have been defined according to two basic models: symmetric/asymmetric and one-sided/two-sided competition. In two-sided competition resources are shared (equally or proportionally to size) by all the trees while in one-sided competition larger trees are not affected by smaller neighbours. When there is perfect sharing relative to size, competition is symmetric (Soares and Tome, 1999)

The effect of local neighbors is usually expressed by some mathematical formulation, commonly referred to as a „competition index“, representing how much each tree is affected by its neighbors (Burkhart and Tome, 2012).

Such an index should properly account for the size of the subject tree and size and spatial pattern of neighboring trees, and it should both reflect the current competitive status of the subject tree and changes in that status over time. According to Nance et al (1983), such index exist in the form of „area potentially available“ (APA).

Brown (1965) introduced a measure, termed area potentially available (APA), that partitions the total stand area (and, thus, associated resources) into that potentially available for each tree (Daniels et al, 1986). This involves computation of the Dirichlet-Thiessen tessellation, as a special way of defining neighbourhoods, which involves „tiling“ the plane according to the position of plant individuals, so that each of them has a polygonal area around it. Polygon determined in this way, also called a Voronoi polygon, is a set of points closer to that focal individual than to any other (Czaran and Bartha, 1992). Polygons are mutually exclusive and collectively exhaustive of the total area. Thus, the individual polygon areas sum to the total area (Daniels et al, 1986).

The Dirichlet tessellation assumes equal weighting of individuals, since the boundary between any two points is a perpendicular bisector. When individual plants in a population vary in size, however, interest may focus on methods to weight the polygons to account for size differences. Moore et al. (1973) developed a competition index for use in forestry based on a weighted polygon model. Their model has the following properties: (a) like Dirichlet tiles, weighted polygons are mutually exclusive; and (b) the weighting is proportional to the relative size of neighbouring trees. As a weight authors used basal area of trees. A given polygon border is perpendicular to the line joining two individuals, but passing through the weighted distance instead of the bisector. The resulting tessellation has the undesirable property of not being space-exhaustive: there remain areas which are not assigned to any individual. Polygon overlap is avoided by having lines nearest the target individual take precedence over those further away (Kenkel, 1991).

Poplars, as a light demanding tree species, strongly react to density of plantation, ie. a space for tree growth, which allows the establishment of plantations with different densities for different purposes. Plantation density is the main element which conditions the purpose of production and targeted assortment, and thus the quantity and quality of timber volume and length of rotation. Thinnings are carried out in poplar plantations, as one of main silvicultural measure, with the aim of obtaining the previous yield in the form of pulpwood or thinner technical assortments, and it is expected that the remaining trees in the longer rotations achieve more quality assortments.

The aim of this work is to examine the possibility of using area potentially available in poplar plantation with different thinning regimes (with and without thinning) by finding a correlation of current increment of trees, as one of the reliable criteria of competitive relations in plantation, and the area potentially available of the same trees.

Materials and methods

Researches were conducted in an experimental plantation of the clone "Bora" (*Populus deltoides* Bartr. Ex Marsh.), working name B-229, which was established with one year old plants type 1/1 at planting distance of 5×5 m. Plantation is located in Forest holding „Sremska Mitrovica“ (Serbia), Management unit „Čenjin – Obreške širine“, in department 13 (N 44°42', E 19°57'). In the first eight years, before establishment of experimental plots, in the plantation were performed usual tending measures: the row disking was done every year, and filling in and hoeing area with a width of 1 m around the plants was done two years after planting. The pruning of lower branches to the height of 6 m was also carried out in plantation, in order to obtain the best quality assortments at the end of the production cycle.

The experimental field is in the form of three blocks with two experimental plots, each the size of 0.1225 hectares, which are separated by a so-called „protective“ row. In each block on

an experimental plot the selective thinning was carried out (experimental plot - EP), by defining and marking so-called „perspective trees“, approximately uniformly distributed over the area with an average distance of 7×7 m, ie. 204 trees ha⁻¹. All remaining trees in the experimental plot were removed. The remaining three plots were control plots (CP).

On the experimental and control plots all trees were numbered, and after 8 and 11 years their two cross diameter at breast height were measured, with an accuracy of 1 mm, as well as the elements of the spatial position of the trees.

Area potentially available is defined as the area of an irregular polygon constructed around a subject tree. The polygon is formed by intersecting lines (influence lines) that are located between and perpendicular to the lines connecting the subject tree and each of its competitors (Nance et al, 1983).

Computationally, the construction of Voronoi polygons is quite complex (Green and Sibson, 1977). Basically, the computations consist of two tasks: the location of a set of nearest neighbors for each tree, and the construction of the edges or sides of each polygon. In establishing the location of each edge, lines connecting the subject tree with each of its nearest neighbors are established, and perpendicular lines are then formed to cut these connecting lines. The intersecting perpendiculars form the sides of the polygon. We use weighted tessellation, so the perpendicular bisectors are displaced away from the larger tree and closer to the smaller tree by an amount proportional to their diameter difference. Computations were performed using a program developed by the authors.

For a construction of area potentially available only inner trees were used, so size of each plot is 0.0625 ha. Descriptive statistics, regression analysis and t-test were used in the data processing.

Results and discussion

The area potentially available (APA) of poplar clone B-229 trees on the sample plots is shown in Figure 1, while Table 1 shows their descriptive statistics. On the control plots (CP) an area potentially available ranged from 10.4 to 39.6 m², an average of 26.65 m², while on the experimental plots (EP), where the thinning operation was performed, ranged from 34.2 to 109.7 m², an average of 52.13 m². On the control plot is determined two time less standard deviation of APA in comparison to experimental plot, while the coefficient of variations was 26-28%. The asymmetry of the distribution of APA is negative and leptokurtic on both, the CP, and the EP.

Table 1. Descriptive statistics of an area potentially available for research plots.

Plot	n [*] [trees]	mean [m ²]	min [m ²]	max [m ²]	sd [m ²]	cv [%]	skew	kurt
CP	69	26.65	10.38	39.65	6.94	26.0	-0.310	-0.367
EP	42	52.13	34.16	109.68	14.71	28.2	1.871	4.868

* *n* – number of trees in plots; *mean* – arithmetic mean; *min* – minimum; *max* – maximum; *sd* – standard deviation; *cv* – coefficient of variation; *skew* – skewness; *kurt* – kurtosis.

On the EP is determined twice the mean size of the APA as a result of thinning operation, which reduced 45% of the number of trees (Andrašev et al, 2011). While the trees in the inner part of the EP had less APA with slight differences in the length of sides of polygons, the other trees had great sides of polygons in parts of sample plot where competitors are removed (Figure 1).

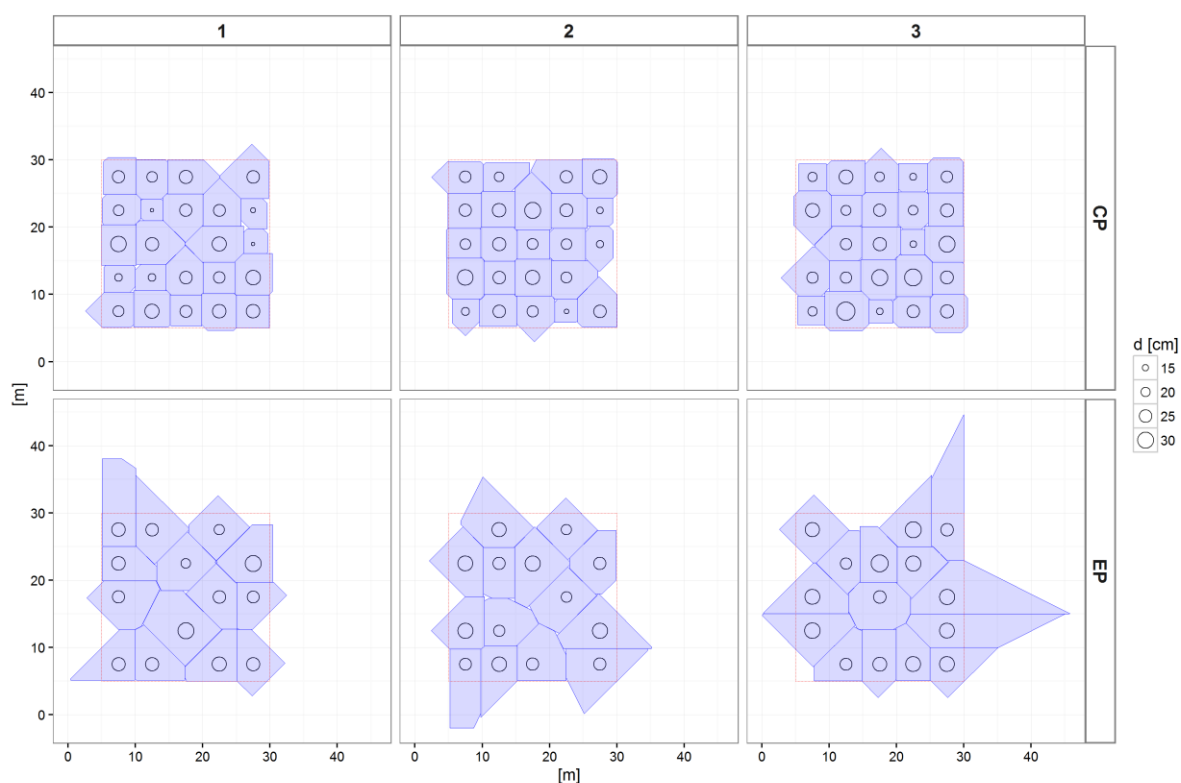

Figure 1. Area potentially available for the research plots.

Correlation of the current diameter increment over the next three years (from 8 to 11 year) with the APA defined in the eighth year shows high significant positive correlation of 0.7 on the CP. On the EP correlation is 0.2, and is not significant (Figure 2, Table 2).

Correlation of the current increment of the basal area of trees is also positive and highly significant, and higher (0.76) compared to the correlation of the diameter increment. However, the correlation on the EP was not significant (Figure 3, Table 2).

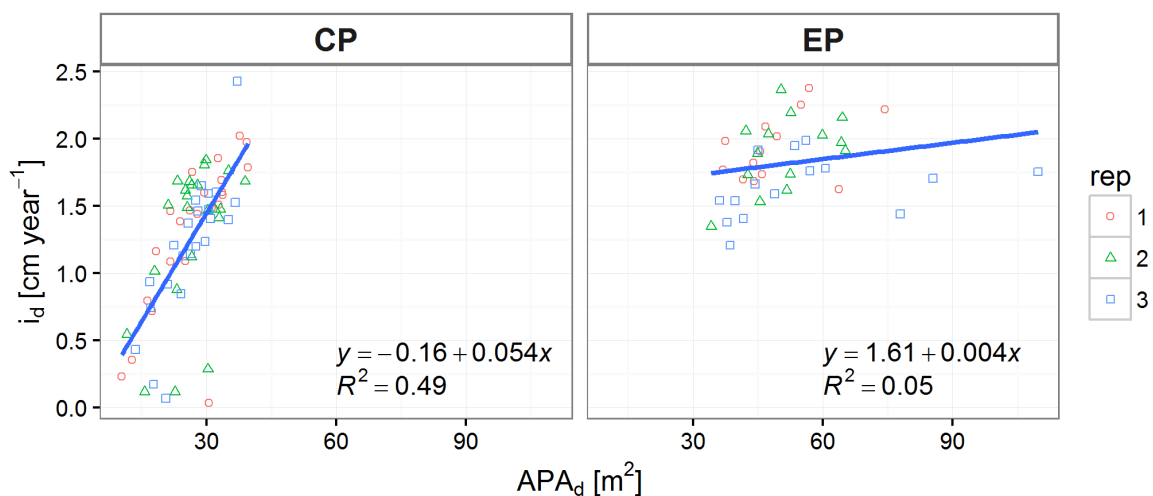

Figure 2. Relationships between current diameter increment and APA for researched experimental (EP) and control plots (CP).

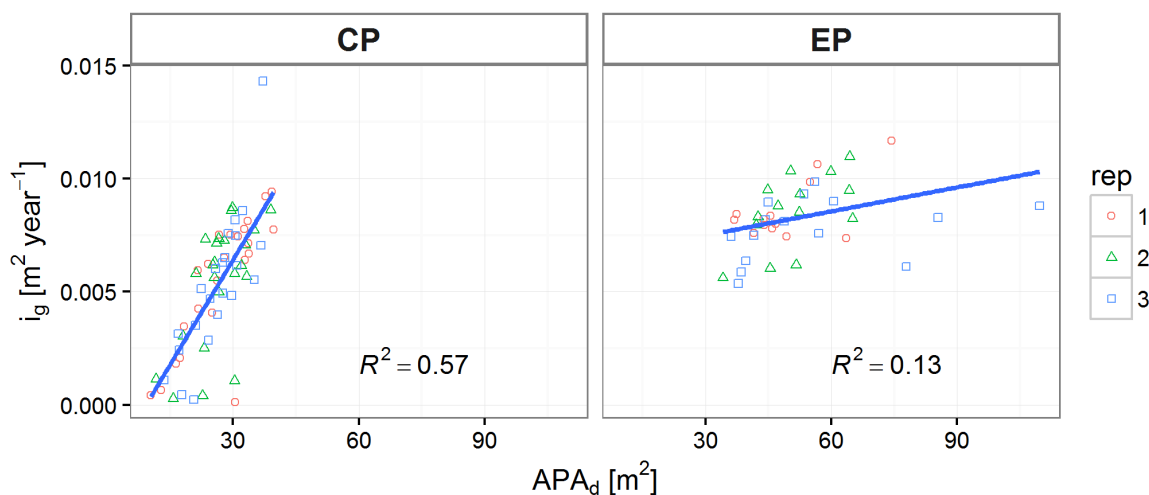

Figure 3. Relationships between current basal area increment and APA for researched experimental (EP) and control plots (CP).

Table 2. Test of correlations between diameter and basal area increment, and area potentially available (APA) in research plots.

	Plot	n*	R ²	R	t	p
i _d [cm yr ⁻¹]	CP	69	0,49	0,70	8,07	0,0000
	EP	42	0,05	0,20	1,38	0,1755
i _g [m ² yr ⁻¹]	CP	69	0,57	0,76	9,51	0,0000
	EP	42	0,13	0,35	2,39	0,2015

*n – number of trees in plots; R² – coefficient of determination; R – coefficient of correlation; t – result of t-test; p – p-value.

The high correlation of the current increment of the diameter and basal area with the APA were found in Daniels et al (1986) for loblolly pine trees, Tome and Burkhart (1989) and Soares and Tome (1999) for eucalyptus plantations, and Wimberly and Bare (1996) for Douglas fir and western hemlock basal area growth following silvicultural treatment. Wimberly and Bare (1996) stated that the strength of APA lies in the fact that they contain unique information about the spatial pattern of a given tree with respect to its neighbors, which cannot be captured by the non-spatial indices. In addition, tessellation-based indices are the only spatial indices that capture the influence of interactions between competitors on the subject tree (Kenkel, 1991).

Conclusion

Area potentially available, obtained as the weighted polygons, in the poplar plantation of clone B-229 at the age of eight years was an average of 26.6 m² in the part of plantation where thinning operation has not been implemented and 52.1 m² in the part where thinning was conducted. Current increment of diameter and basal area of trees for a period of three years and area potentially available on the control plot is in the high correlation indicating the possibility of using the APA in making growth model. In the experimental plot correlation of current increment of diameter and basal area of trees with the APA was not significant, indicating that the APA on the experimental plot, where the thinning operation was carried out, is not reliable regressor.

Acknowledgement

This paper was realized as a part of the project financed by the Ministry of Education and Science of the Republic of Serbia.

References

- Andrašev, S., Bobinac, M., Rončević S., Stajić, B., Janjatović, G., (2011): Properties of thinning applied to a stand of poplar clone B-229 (*Populus deltoides* Bartr. ex Marsh.) established in lower Srem. *Poplar*, 187/188: 99-121. (in Serbian with English summary)
- Begon M., Townsend C.R., Harper J.L. (2006): *Ecology: From Individuals to Ecosystems*, 4th ed. Blackwell Publishing Ltd, Oxford.
- Brown G.S.(1965): Point density in stems per acre. New Zealand Forest Research Note 38. New Zealand Forestry Service, Forest Research Institute, Rotorua, New Zealand.
- Burkhardt H.E., Tome M. (2012): *Modelling forest trees and stands*. Springer, Dordrecht, pp. 447.
- Czaran T., Bartha S. (1992): Spatiotemporal Dynamic Models of Plant Populations and Communities. *Trends in Ecology & Evolution* 7(2): 38-42.
- Daniels R.F., Burkhardt H.E., Clason T.R.(1986): A comparison of competition measures for predicting growth of loblolly pine trees. *Canadian Journal of Forest Research* 16, 1230–1237.
- Ford E.D., Sorrensen K.A. (1992): Theory and models of inter-plant competition as a spatial process. In DeAngelis, D.L., Gross, L.J. (Eds.), *Individual-Based Models and Approaches in Ecology*. Chapman & Hall, New York, NY, pp. 363–407.
- Green P.J., Sibson R. (1977): Computing dirichlet tessellations in the plane. *The Computer Journal*, 168-173.
- Kenkel N.C. (1991): Spatial competition models for plant populations. In: E. Feoli and L. Orloci (Editors), *Computer Assisted Vegetation Analysis*. Kluwer, Dordrecht, Netherlands, pp. 387-397.
- Moore J.A., Budelsky C.A., Schlesinger R.C. (1973): A new index representing individual tree competitive status. *Canadian Journal of Forest Research* 3, 495–500.
- Nance W.L., Land Jr. S.B., Daniels R.F. (1983): Concepts for analysis of intergenotypic competition in forest trees. In: *Proceedings of the Seventeenth Forest Tree Improvement Conference; 1983 June 6-9; Athens, GA; University of Georgia*. p. 131-145.
- Peet R.K., Christensen N.L.(1987): Competition and tree death. *BioScience* 37: 586-595
- Soares P., Tome M.(1999): Distance-dependent competition measures for eucalyptus plantations in Portugal. *Annals of Forest Science* 56, 307–319.
- Tome M., Burkhardt H.E. (1989): Distance-dependent competition measures for predicting growth of individual trees. *Forest Science* 35(3): 816-831.
- Vanclay J.K., Lamb D., Erskine P.D., Cameron D.M. (2013): Spatially explicit competition in a mixed planting of *Araucariacunninghamii* and *Flindersiabrayleyana*. *Annals of Forest Science* 70:611–619
- Weiskittel A.R., Hann D.W., Kershaw J.W., Vanclay J.K. (2011): *Forest growth and yield modeling*. Wiley, New York
- Wimberly M.C., Bare B.B. (1996): Distance-dependent and distance-independent models of Douglas-fir and western hemlock basal area growth following silvicultural treatment. *Forest Ecology and Management* 89: 1-11.

APHID FEEDING EFFECTS ON PHYSIOLOGICAL PARAMETERS OF POPLAR CULTIVARS

Leopold POLJAKOVIĆ-PAJNIK¹, Olivera PETROVIĆ-OBRADOVIĆ², Milan DREKIĆ¹,
Saša ORLOVIĆ¹, Verica VASIĆ¹, Branisav KOVAČEVIĆ¹, Magdalena KACPRZYK⁴,
Nataša NIKOLIĆ³

¹Novi Sad University, Institute of Lowland Forestry and Environment, Novi Sad, Serbia

²University of Belgrade, Faculty of Agriculture, Belgrade, Serbia

³Novi Sad University, Faculty of Science, Department of Biology, Novi Sad, Serbia

⁴University of Agriculture in Krakow, Institute of Forest Ecosystems Protection, Department of Forest Protection, Entomology and Forest Climatology, Krakow, Poland

*Corresponding author: leopoldpp@uns.ac.rs

Abstract

Aphid feeding effect on poplar leaves has been studied by three physiological characteristics. Different clones of *Populus deltoides* and *Populus alba* have been tested. Investigations were carried out on a fully formed uncolonized and colonized leaves with three aphid species: *Chaitophorus leucomelas* (poplar aphid), *Chaitophorus populialbae* (white poplar leaf aphid) and *Chaitophorus populieti* (poplar shoot aphid). The studies of net photosynthesis, dark respiration were carried out using completely developed leaves of one-year-old plants of *Populus deltoides* cl. 101-1 and *Populus alba* 'L-12'. Net photosynthesis and dark respiration were determined polarographically. Stomatal diffusive resistance was measured by Li-600 in leaves of two Eastern cottonwood clones (*Populus deltoides*) 'S1-8' and '181/82' on adaxial and abaxial leaf surface, in both colonized and uncolonized leaves. In plants colonized with aphids the a decrease of the photosynthesis in the range of 25-75% depending on the aphid species, cultivars and age (leaf) was recorded. Dark respiration was considerably higher, as well as stomatal diffuse resistance in the leaves colonized with aphids. The results indicate that aphid colonization reduced the stomatal conductance and then photosynthesis, probably resulting in negative effect on assimilation, biomass accumulation and other important physiological processes.

Key words: *aphids, poplars, net photosynthesis, respiration, stomatal diffusive resistance*

Introduction

Aphids (*Aphididae*, *Hemiptera*) have long been the subject of interest of entomologists and experts engaged in plant production due to the abundance and distribution of the species, the number of plant species they colonize, specific development and the way of life, specific morphological and anatomical characteristics and the consequences of feeding on the host plants.

Numerous aphid species developing and feeding on different forest tree species, with their harmful effects particularly emphasized, has been cited in the literature. According to the available literature data the effect of the presence of aphids on growth elements, which are certainly economically the most important, has not been quantified up to date. Elements of growth (diameter at breast height and plant height) used to determine the degree of negative influence of aphids feeding on plant host are just not reliable enough due to their dependence on other external and internal factors, such as site conditions (presence and absence of nutrients and water in the soil, temperature, light), human interventions (soil preparation, weed and pest control, tending operations, sanitation), host resistance (specific genotype traits for particular conditions), respectively biotic factors (defoliators, bacteria, fungi), etc. All

these factors may exert strong influence on host plant and therefore "mask" the negative influence of aphid feeding. Hence it is necessary to study and to bring into direct connection the influence of aphids on the processes of photosynthesis, the respiration and transpiration, and by using the degree of disturbances of these processes to determine the degree of harmful effect of the aphids.

Previous studies have shown that aphids are responsible for changes in plant physiology in a number of agricultural crops, but little is known about how aphids elicit these changes and the physiological mechanisms associated with injuries (Macedo et al. 2003). The synthesis and accumulation of organic matter is achieved by the process of photosynthesis. Therefore, researchers have focused on the influence of aphids feeding on photosynthetic potential which may consequently affect plant productivity in plant species of economic importance, such as soybean (Macedo et al. 2003), wheat (Rafi et al. 1997, Haile et al. 1999, Macedo et al. 2003), and sugar beet (Hurej et al. 1993). Photosynthesis can be limited by a series of factors, due to the direct action on photosynthetic processes or to a reduction of stomatal conductance or both (Hajji et al. 2009). Haile et al. (1999) reported that limitations in photosynthetic efficiency of wheat injured by Russian wheat aphid, *Diuraphis noxia* (Mordvilko), were not related to the CO₂ assimilation phase, indicating that inhibitions occur before CO₂ assimilation with Rubisco (ribulose-1,5-bisphosphate carboxylase). Aphids cause direct injury to the host plant by the removal of the plant sap, which contains essential food materials that promote aphid and plant growth. Because phloem sap is richer in sugars than amino acids, which aphids need for growth, much of the sap is excreted as honeydew, which can cover the leaf surface, and consequently reduce the efficiency of respiration and photosynthesis (Shannag 2007). Aphids can also alter light interception and photochemistry *via* changes in chlorophyll content and metabolism leading to limitation in light-driven electron fluxes (Burdand Elliott 1996), Ni et al. (2002), Wang et al. (2004). Reduced photosynthetic rates were also observed following aphid feeding on soybean [*Glycine max* (L.) M.], wheat (*Triticum aestivum* L.), and cotton (*Gossypium hirsutum* L.) (Shannag et al. 1998, Macedo et al. 2003). Furthermore, aphid feeding may hinder normal phloem transport, which interferes with the delivery of nitrogen to cells and disrupts the flow of assimilates (Peterson and Higley 1993).

Foliar pathogens often alter leaf stomatal conductance, and these changes could affect photosynthesis and water regime of infested plants. Riedell (1989) reported that barley leaves previously infested with aphids had lower relative water content, reduced stomatal conductance, more negative water potential and lower levels of chlorophyll than corresponding leaves from uninfested plants. However, stomatal conductance and transpiration were enhanced considerably by aphid feeding on broad bean plants (Shannag 2007). The authors concluded that an increase in transpiration may result from increasing the size of stomatal apertures rather than from damage of the leaf tissues. Such inconsistent results among plant species infested by aphids suggest species specific responses to colonization of these pests.

This paper presents the results of investigations of feeding effect of three aphid species (*Chaitophorus leucomelas*, *Chaitophorus populeti* and *Chaitophorus populialbe*) on some physiological parameters (net photosynthesis, dark respiration and stomatal diffusive resistance) of two different poplar species (*Populus alba* and *Populus deltoides*).

Material and method

Net photosynthesis and dark respiration

The studies of net photosynthesis and dark respiration were carried out using fully developed leaves of one year old plants of *Populus deltoides* cl. 101-1 and *Populus alba* 'L-12' grown at the field trial of the Institute of Lowland Forestry and Environment. Plants of *Populus deltoides*'101-1' were colonized by aphids of *Chaitophorus leucomelas*, and those of *Populus alba* 'L-12' by *C. populialbae*. Net photosynthesis and dark respiration were determined polarographically, using the Hansatech DW1 electrode (Jones & Osmond 1973, Walker 1987). The rate of photosynthesis was evaluated by the quantity of released oxygen ($\mu\text{molO}_2\text{cm}^{-2}\text{h}^{-1}$), while the rate of dark respiration was determined by the rate of oxygen uptake in the dark ($-\mu\text{molO}_2\text{cm}^{-2}\text{h}^{-1}$). Leaf segments used for analysis were taken from both infested and healthy leaves, avoiding main veins, and suspended in the buffer pH 7.6-7.8 containing 10 mM NaHCO_3 . The process of photosynthesis in the samples was carried out under complete saturation with white light produced by quartz-iodine lamp (Stanković & Wolker 1977), while the rate of respiration was observed in dark. The measurements were performed at three different plants per host x pest combination and on each plant were measured physiological parameters.

Stomatal diffusive resistance

Measurements of stomatal diffusive resistance were made by LI-600 in leaves of two Eastern cottonwood clones (*Populus deltoides*) 'S₁-8' and '181/82' at adaxial and abaxial leaf surface, in both colonized and uncolonized leaves on the leaf spots with the highest aphid density of the species *Chaitophorus leucomelas*. The measurements were performed at three different plants per host x pest .

Results and discussion

Two aphid species were found at adaxial leaf surface as follows:

- on *Populus deltoides* '101-1', 'S₁-8' and '181/82': *Chaitophorus leucomelas*;
- on *Populus alba* 'L-12': *C. populialbae* and *C. populeti*.

The results of respiration and net photosynthesis in leaves colonized and uncolonized by aphids are shown in Table 1. The results showed that aphids affected the process of respiration and photosynthesis by their presence i.e. feeding practice, as the values obtained in colonized and uncolonized leaves differed. It can be observed that in all cases mentioned in table 1. the photosynthesis was lower and respiration was higher in leaves colonized by aphids regardless of poplar clone, and of aphid species. The results showed that *Chaitophorus leucomelas* had greater influence on decreased intensity of photosynthesis in leaves of *Populus deltoides*'101-88' (59.22%), and lesser on increased respiration intensity (16.36%). *C. Populialbae* with its feeding practice on leaves of *Populus alba*'L-12' caused the greatest change in intensity of respiration and photosynthesis. The respiration intensity was higher by 56.77%, and that of photosynthesis by 76.63% (Table 1). At the same time this aphid caused increased respiration intensity and somewhat lesser decrease in photosynthetic rate of older leaves of the same clone (respiration intensity was increased by 15.74% and that of photosynthesis by 28.57%).

C. populeti caused increased respiration by 21.31% and decreased photosynthesis by 25.71%.

Table 1. Average values of respiration and photosynthesis, percentage of increased respiration values and decreased intensity of photosynthesis

Clone	Aphid species	Respiration $\mu\text{mol CO}_2\text{m}^{-2}\text{h}^{-1}$	Increase d respirati on* %	Photosynthe sis $\mu\text{mol CO}_2\text{m}^{-2}\text{h}^{-1}$	Decreased photosynthe sis* %
<i>P. deltooides</i> '101-88	-	10.27		6.45	
<i>P. deltooides</i> '101-88'	<i>C. leucomelas</i>	11.94	16.36%	2.63	59.22
<i>P. alba</i> 'L-12'	-	6.64		6.89	
<i>P. alba</i> 'L-12'	<i>C. populialbae</i>	10.41	56.77%	1.61	76.63
<i>P. alba</i> 'L-12'	-	7.18		7.00	
<i>P. alba</i> 'L-12'	<i>C. populeti</i>	8.78	21.31%	5.02	25.71

* Change between colonized and uncolonized leaves related to the value obtained on uncolonized leaves

The results of measurement of stomatal diffusive resistance were showed in fig. 3. It can be observed that stomatal diffusive resistance was always higher in leaves colonized by aphids of *Chaitophorus leucomelas* regardless of clone or side of the leaf. This indicated that the presence of aphids caused increased stomatal diffusive resistance, i.e. reduced conductance.

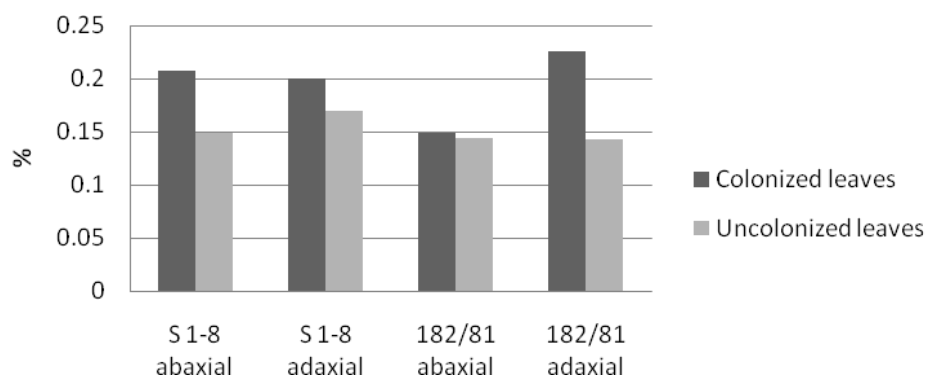

Figure 1. Diffusive stomatal resistance in colonized and uncolonized leaves

If we compare stomatal diffusive resistance (Figure 1) in clone 'S₁-8' and clone '182/81' only in the colonized leaves, we can observe that the difference in stomatal diffusive resistance on the adaxial and abaxial sides in clone '182/81' was higher in comparison to clone 'S₁-8'. These differences were probably due to differences in number of stoma. Values of stomatal diffusive resistance in uncolonized leaves in both clones were approx. at the same level on both the adaxial and abaxial sides of leaf.

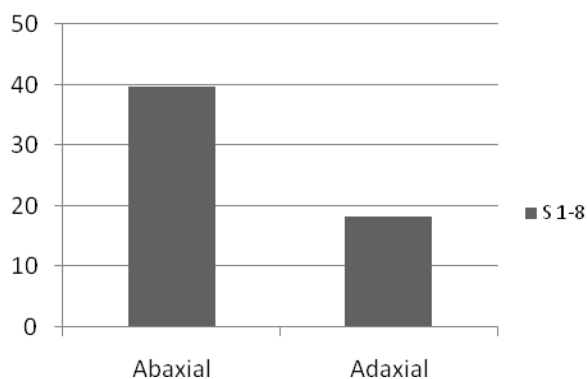

Figure 2. Ratio of adaxial to abaxial stomatal diffusive resistance in colonized and uncolonized leaf of *P. deltooides* cl. S1-8

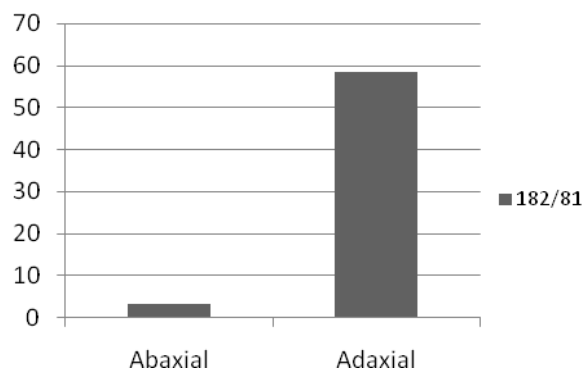

Figure 3. Ratio of adaxial to abaxial stomatal diffusive resistance in colonized and uncolonized leaf of *P. deltooides* cl. 182/81

The ratio of adaxial to abaxial stomatal diffusive resistance of leaves colonized and uncolonized by aphids was specific for clone 'S₁-8', on the one hand and clone '182/81', on the other hand (Figures 2 and 3). It was much higher in clone '182/81'. The ratio of stomatal diffusive resistance in colonized and uncolonized leaves in clone '182/81' was much higher on the adaxial in relation to abaxial side of leaf, while that difference was less pronounced in clone S₁-8. In this case it was clear that there were differences among clones and that it may result in varying degree of tolerance to negative influence of aphids on plant transpiration, or in response to water loss. The differences in stomatal diffusive resistance values in studied clones could be caused by a higher degree of preselection of *Chaitophorus leucomelas* for one of the clones with better feeding, growth and development conditions.

Plant productivity largely depends on the intensity of photosynthesis since the synthesis of organic substances takes place during this process. Variability within the genus *Populus* represents an important factor in selection of fast-growing, i.e. genotypes with high biomass accumulation. Therefore, it is essential to define the individual cultivars according to their physiological traits like net photosynthetic rate per unit leaf area, stomatal conductance, chlorophyll content, and total leaf area, particularly when a significant correlation between the photosynthetic rate x total leaf area and growth traits in trees is known (Mebrahtu and Hanover 1991). A survey of variability of these characters is focused on selecting genotypes with desirable traits as one of breeding tasks. Photosynthetic response of colonised leaves may answer questions related to plant tolerance and productivity. The results obtained in this study revealed the reduced rate of photosynthesis in plants infested by aphids, which was consistent with the studies of other authors. In soybean, photosynthetic rates of leaves infested by *Aphis glycines* were considerably lower than the rates of uninfested leaves (Macedo et al. 2003). Reductions in photosynthesis may be caused by stomatal limitations in CO₂ availability or mesophyll limitations (Macedo et al. 2003). Stomatal diffusive resistance in our study was increased in the presence of aphids in both two clones, which indicated that the reduction in photosynthetic rate was at least partially caused by stomatal limitations. Cotton aphid populations of approximately 300 per leaf did not significantly alter photosynthesis of cotton leaves (Gomez et al. 2006) while Godfrey et al. (1997) reported that aphid infestations of 400–550 per leaf reduced photosynthesis by 6.4% compared to the uninfested leaves. Shannaget al. (1998) also showed that photosynthetic rates in cotton were reduced in proportion to the number of aphids and the length of infestation period. Reduced photosynthetic rates were also observed following aphid feeding in wheat (Macedo et al. 2003b).

The plant tissue becomes mechanically damaged by the stylet protrusion, and later on saliva secreted during stylet penetration is forced out through salivary canal and further damages the tissues during feeding. Aphid saliva is composed primarily of plant hormones, phenolic substances and enzymes influencing the plant metabolism (Miles 1965). Plants respond to these injuries by accumulation of phenolics which are transferred to toxic quinones during oxidative process (Miles 1987). An investigated physiological parameters are the major indicators of plant physiological condition and are the part of the complex process of photosynthesis. Even the smallest change in some of the tested parameters may diminish, and in extreme cases stops the process of photosynthesis. Results and values of the tested physiological parameters obtained in uninfected plants of poplar clones were consistent with those obtained by Orlović (1996) and Ceulemans and Saugier (1991). Results obtained by testing the net photosynthesis, respiration and stomatal diffusive resistance revealed regularity in terms of plant responses to aphid colonization. The results of these studies are consistent with the studies regarding the influence of *Pemphigus bursarius* and *Pemphigus spyrotaecae* on photosynthesis, respiration, and transpiration obtained by Cichocka et al. (1992). Intensity of photosynthesis in studied clones was higher in leaves with no colonization, while the intensity of respiration was lower. The influence of aphids on plants depends on plant variety, plant age and developmental stage of aphids. It is certain that abundance of aphids affects the plant physiological state, and it is well known that even the slightest change in plant water regime affects the process of photosynthesis. According to available data a small number of researchers were engaged in studying the influence of plant aphids on some of the basic physiological processes in plants.

In plants infected by aphids the reduction in the rate of photosynthesis of 25-75% was observed, depending on aphid species, variety and plant (leaf) age, which was consistent with the findings of Miles (1968). At the same time the respiration was higher in infected plants by 15-56.77%. Stomatal diffusive resistance was higher in leaves with aphids indicating that the presence of aphids reduced stomatal conductance, and hence the other physiological processes as well. It can be assumed that altered values of studied physiological parameters affected the growth elements and plant vigor as well.

Conclusion

The tested physiological parameters are important indicators of the physiological status of the plant and are an integral part of the complex process of photosynthesis. The slightest change in any of the examined parameters can highly reduce and even block the process of photosynthesis. The results obtained for examined parameters showed regularity in terms of plant response to the aphids colonization. Stomatal diffusive resistance is an indicator of the water regime in plants or leaves. It can be also represented as the reciprocal of the stomatal conductance. The impact of aphids on the plant depends on the cultivar, plant age and developmental stage of plant. It is certain that a high number of aphids affect the physiological state of the plant, a well-known fact that the slightest change in plants water regime lead to reduction the process of photosynthesis. In plants colonized with aphids we recorded a decrease of the photosynthesis of 25-75% depending on the aphid species, cultivars and plant age (leaf). At the same time processes of respiration are higher from 15 to 56.77%. Changes in stomatal diffuse resistance is an indication of a specific water regime of plants or leaves of the investigated clones. This parameter was higher in the leaves colonized with aphids. The results indicate that aphid colonization reduced the stomatal conductance and thus probably other physiological processes.

Acknowledgements

This paper was financed by the Ministry of Education and Science of the Republic of Serbia and project „Forest Protection“ financed by the PE Vojvodinasume.

References

- Blackman, R.L. and Eastop, V.F. 1994. Aphids on the world's trees; an identificational and informational guide. CAB International, 987 pp.
- Burd, J.D. and Elliott, N.C. 1996. Changes in chlorophyll a fluorescence induction kinetics in cereals infested with Russian wheat aphid. *Journal of Economic Entomology* 89 (5):1332-1337.
- Ceulemans, R. and Saugier, B. 1991. Photosynthesis. In: Raghavendra AS (ed.). Physiology of trees, John Wiley & Sons, p.21-50.
- Cichocka, E., Goszczyński, W. and Chacińska, M. 1992. The effect of aphids on host plants. I. Effects on photosynthesis, respiration and transpiration. *Aphids and Other Homopterous Insects* 3: 59-64.
- Cichocka, E. and Goszczyński, W. 1992. Effect of *Pemphigus bursarius* (L.) and *Pemphigus phenax* Börn. at Blunck (Homoptera, Pemphiginae) on the contents of some components in plants. *Aphids and Other Homopterous Insects* 3:65-70.
- Godfrey, L.D., Fuson, K.J. and Wood J.P. 1997. Physiological and yield responses of cotton to mid-season cotton aphid infestations in California. In Dugger, P. and Richter, D.A. (Eds.): Cotton Insect Research and Control Conference. Proceedings of Beltwide Cotton Conferences, 6–10 January 1997, National Cotton Council, Memphis, New Orleans, LA.: 1048-1051.
- Gomez, S.K., Oosterhuis, D.M., Hendrix, D.L., Johnson, D.R. and Steinkraus, D.C. 2006. Diurnal pattern of aphid feeding and its effect on cotton leaf physiology. *Environmental and Experimental Botany* 55: 77-86.
- Haile, F.J., Higley, L.G., Ni, X. and Quisenberry, S.S. 1999. Physiological and growth tolerance in wheat to Russian wheat aphid (Homoptera: Aphididae) injury. *Environmental Entomology* 28 (5): 787-794.
- Hajji M., Dreyer E. and Marçais, B. 2009. Impact of *Erysiphe alphitoides* on transpiration and photosynthesis in *Quercus robur* leaves. *European Journal of Plant Pathology* 125: 63-72.
- Hurej, M. and Werf, Van der W. 1993. The influence of black bean aphid, *Aphis fabae* Scop. and its honeydew on the photosynthesis of sugar beet. *Annals of Applied Biology* 122 (2):189-200.
- Jones, H.G. and Osmond, C., B. 1973. Photosynthesis by thin leaf slices in solution. I. Properties of leaf slices and comparison with whole leaves. *Australian Journal of Biological Sciences* 26: 15-24.
- Macedo, T.B., Bastos, C.S., Higley L.G., Ostlie, K.R. and Madhavan, S. 2003. Photosynthetic responses of soybean to soybean aphid (Homoptera: Aphididae) injury. *Journal of Economic Entomology* 96(1): 188-193.
- Mebrahtu, T. and Hanover, J.W. 1991. Family variation in gas exchange, growth and leaf traits of black locust half-sib families. *Tree Physiology* 8 (2): 185-193.
- Miles, P.W. 1965. Studies on the salivary physiology of plant-bugs: The salivary secretions of aphids. *Journal of Insect Physiology* 11: 1261-1268.
- Miles, P.W. 1968. Insect secretions in plants. *Annual Review Phytopathology*, 6: 137-164.
- Miles P.W. 1987. Feeding Process of Aphidoidea in Relation to Effects on their Food. In: Minks A.K., Harrewijn P., (ed.). *Aphids Their Biology, Natural Enemies and Control*, 2A, p. 321-335.

- Ni, X., Quisenberry, S.S., Heng-Moss, T., Markwell, J., Higley, L., Baxendale, F., Sarath, G. and Klucas, R. 2002. Dynamic change in photosynthetic pigments and chlorophyll degradation elicited by cereal aphid feeding. *Entomologia Experimentalis Et Applicata* 105: 43-53.
- Orlovic S. 1996. An investigation of variability of characters of black poplars which are important for selection on fast growth. PhD thesis, Faculty of Forestry Belgrade.
- Peterson, R.K. and Higley, L.G. 1993. Arthropod injury and plant gas exchange: current understandings and approaches for synthesis. *Trends in Agricultural Sciences* 1: 93-100.
- Petrović-Obradović, O. 2003. Biljne vaši (Homoptera: Aphididae) Srbije. Poljoprivredni fakultet Univerziteta u Beogradu, 153 pp.
- Poljaković-Pajnik, L. 2005. Biljne vaši (Aphididae, Homoptera) na topolama. Magistarski rad, Poljoprivredni fakultet, Novi Sad, 102 pp.
- Poljaković-Pajnik, L., Petrović-Obradović, O., Vasić, V., Vučetić, A. And Drekić, M. 2011. Aphids of genus *Chaitophorus* on poplars in Serbia. *Biljni lekar* 6: 645-656.
- Rafi, M.M., Zemetra, R.S. and Quisenberry, S.S. 1997. Feeding damage of Russian wheat aphid on resistant and susceptible wheat genotypes. Budapest. *Cereal Research Communications* 25: 63-68.
- Riedell, W.E. 1989. Effects of Russian wheat aphid infestation on barley plant response to drought stress. *Physiologia Plantarum* 77(4): 587-592.
- Shannag, H.K., Thorvilson, H. and El-Shatnawi, M.K. 1998. Changes in photosynthetic and transpiration rates of cotton leaves infested with the cotton aphid, *Aphis gossypii*: unrestricted infestation. *Annals of Applied Biology* 132(1): 13-18.
- Shannag, H.K. 2007. Effect of black bean aphid, *Aphis fabae*, on transpiration, stomatal conductance and crude protein content of faba bean. *Annals of Applied Biology* 151(2): 183-188.
- Stankovic, Z. and Walker, D.A. 1977. Photosynthesis by isolated pea chloroplasts. Some effects of adenylates and inorganic pyrophosphate. *Plant Physiology* 59(3): 428-432.
- Walker, D.A. 1987. The use of the oxygen electrode and fluorescence probes in simple measurements of photosynthesis. University of Sheffield print Unit, 145, Sheffield.
- Wang, T., Quisenberry, S.S., Ni, X. and Tolmay, V. 2004. Aphid (Hemiptera: Aphididae) resistance in wheat near-isogenic lines. *Journal of Economic Entomology* 97: 646-653.

**THE COMPARISON OF GREY ALDER'S (*ALNUS INCANA* (L.) MOENCH)
VEGETATION ON ABANDONED AGRICULTURAL LANDS AND RIPARIAN
FORESTS IN LATVIA**

Inga STRAUPE*, Liga LIEPA, Santa SIRMOVICA

1Department of Silviculture, Forest Faculty, Latvia University of Agriculture, Latvia

*Corresponding author: inga.straupe@llu.lv

Abstract

The objective of the research is to compare grey alder's (*Alnus incana* (L.) Moench) vegetation on abandoned agricultural lands and riparian forests. Grey alder occupies 7 % of total forest area in Latvia. It has an essential ecological role in forest: it grades soil and enables succession of forest but the most valuable forest habitats of grey alder develop in riparian forests. Total of 12 sampling plots (each - 0.04 ha) have been conducted in grey alder's stands. The type of forests' growing conditions is rich deciduous forest *Aegopodiosa*. The inventory of growing trees, dead wood and vegetation is carried out in each sampling plot. The average volume of growing trees on abandoned lands is 318.8 m³ ha⁻¹, and in riparian forests – 399.4 m³ ha⁻¹. The average volume of dead wood is accordingly 14.4 m³ ha⁻¹ and 85.8 m³ ha⁻¹. In total, 196 species of vascular plants and bryophytes are listed: 16 species – in the tree layer, 15 – in shrub layer, 116 – in herb layer and 27 – in the moss layer. The average projective cover of vegetation in grey alder's forests on abandoned agricultural lands is bigger than it is in riparian forests. Plant species of nemoral forest group characterize stands of grey alder: the most common species are *Alnus incana*, *Fraxinus excelsior* L., *Padus avium* Mill. and *Corylus avellana* L.

Keywords: *Alnus incana*, vegetation, dead wood, abandoned agricultural lands, riparian forests.

Introduction

During last few decades the changes in political and economic conditions in many countries of Europe, also in the Baltic States, the agriculture lands have shifted to abandoned and overgrown with forests. For instance, in Latvia abandoned agriculture lands make up approximately 300, 000 ha (Liepins et al., 2008), in Estonia - 300,000 ha (Astover et al., 2006). A major part of such abandoned agricultural lands consists of deciduous tree species, including *Alnus incana* (L.) Moench which is commonly abundant on former agricultural lands. The growth of *A. incana* on former agriculture lands has been studied in Latvia (Liepins et al., 2008) and also in several countries such as Estonia (Uri et al., 2002), Lithuania, Sweden, Finland and Russia (Shvidenko et al., 1997). *A. incana* is fast-growing species with short rotation period, and it can reach their biological age until 60 years, but it is suggested to fell until age of 30 years. After this age *A. incana* develops wood decay fungi (Daugavietis, 2006).

Riparian zones in forest facilitate high biodiversity as transition zones between terrestrial and aquatic ecosystems (Gregory et al., 1991). *A. incana* is also a common tree species in riparian buffers which can transform nutrient fluxes from adjacent arable lands (Mander et al., 1997). Riparian forests are periodically flooded, where understory plant species tolerates such disturbances. Riparian forest canopies are relatively rich with species and are commonly dominated by deciduous tree species. Only in riparian zones *A. incana* can form persistent

stands, but due to the channelizing of streams in areas of *A. incana*, forests has decreased in the region.

There is a lack of studies on vegetational diversity in *A. incana* forests. Grey alder forms river floodplain habitats rich in biodiversity. They fall into the category of European nemoral broadleaved forests.

The aim of the study was to analyse how the vegetation on abandoned agricultural lands and riparian forests deviates between different stand ages in forest stands dominated by *A. incana*. We focus on forest structural characteristics and vegetation in moss, herb, shrub and tree layers, with the following specific objectives:

1. To compare the changes in forest structural characteristics on abandoned agricultural lands and riparian forests with different stand ages.
2. To compare the changes in plant diversity on abandoned agricultural lands and riparian forests with different stand ages.

Materials and methods

Research was conducted in forests dominated by *A. incana* on abandoned agriculture lands and riparian zones in eastern Latvia (Fig.1.). All study plots where conducted in *Aegopodiosa* forest type, which grows on the richest mineral soils in the region (Skudra and Dreimanis, 1993). In forest, formed on abandoned agriculture lands, a permanent sample plots with size 20×20m (400m²) were located randomly, avoiding edge effects, while in riparian forests three types of transects were established. The distance between these transects was 1 km and on each transect one or two permanent sample plots where established with size 20×20m (400m²).



Fig.1. Location of study areas in eastern Latvia (1 - Viesīte municipality; 2 - Jēkabpils municipality).

Stand structure. Properties of each tree in a stand were measured in all sample plots. Trees, snags and stems (≥ 6 cm diameter at breast height, breast height=1.3m), where measured in all sample plots and also we recorded species, diameter at breast height and the height of the tree. In addition, the stage of decay was recorded for snags and stems. Diameter, length, species and decay stage were noted for all pieces of downed logs. Decay stages were rated from 1 to 5

according to Siitonen (2001). Volume of living trees and coarse woody debris was calculated for each of tree species using the volume calculation followed by Liepa (1996).

Vegetation survey. Projective cover (%) for each species and in total was measured using Braun-Blanquet approach (Braun – Blanquet, 1964; Mueller-Dombois and Ellenberg, 1974) in moss, herb, shrub and tree layers. The nomenclature for vascular plants followed Gavrilova and Šulcs (1999) and that for mosses – Āboliņa (2001). Plant functional characteristics were chosen to show the differences in plant communities between *A. incana* forests on abandoned agricultural lands and riparian forests. To test whether there are PFTs features that react to differences between two types of *A. incana* forests, species were grouped by plant type characteristics. For the analysis we used plant geographical distributions and Ellenberg indicator values. The classification of PFTs was obtained from Flora Database of Central Russia (www.jcbi.ru) – for Ellenberg indicator values: light, moisture, nitrate and soil pH. First, we used projective coverage (%) in analysis and results. We calculated the mean coverage and species richness \pm standard deviation to show the differences between vegetation layers. Ellenberg indicator values for light, moisture, nitrogen and soil pH were calculated separately for each species in each sample plot. Second, we used species richness for each vegetation layer to find differences between two types of *A. incana* stands. We also calculated mean values for each vegetation layer including \pm standard deviation. Since forest structural characteristics, species cover and richness per vegetation layers followed normal distribution, we used ANOVA to test for significant differences in living trees, dead wood, species cover and species richness, Ellenberg indicator values and plant geographical distribution. Tukey's HSD post-hoc test was used to find differences between treatments (abandoned agriculture lands versus riparian forests) in each age category (32-42 and 53-63 years). Differences were considered significant when $P \leq 0.05$. All statistical analyses were performed in R (R development core team, 2013).

Results and discussion

Stand structural characteristics. In all studied sites the largest part of stand structural characteristics comprise living trees, but small proportion are dead wood (Fig.2.). The total abundance of living trees varied notably between two types of grey alder stands, respectively on average 318.8 m³ per 1 ha in sites on abandoned agricultural lands and 399.4 m³ per 1 ha in riparian forests. Riparian forests have more diverse composition with different tree species, which benefits timber volume in a stand. In younger grey alder stands (32-42 years old) on abandoned agricultural lands timber volume is 234.8 m³ per 1 ha, but in older ones (53-63 years old) it reaches 402.7 m³ per 1 ha. In riparian forests these numbers are 311.2 m³ per 1 ha and 487.6 m³ per 1 ha respectively. In younger stands on abandoned lands other tree species are almost absent, but in older stands this admixture can reach 20-44%, mostly *Betula pendula* Roth., *Populus tremula* L., *Alnus glutinosa* L. and *Picea abies* L. This is in line with the theory that *A. incana* is a successional species which colonizes agricultural lands and create favourable growing conditions for other species (Miezite, 2008). However, in younger riparian forest stands is 43-66%, but in older ones – 9-52%. This confirms that *A. incana* overshadows weeds and thus facilitate the development of other tree species (Miezite, 2008).

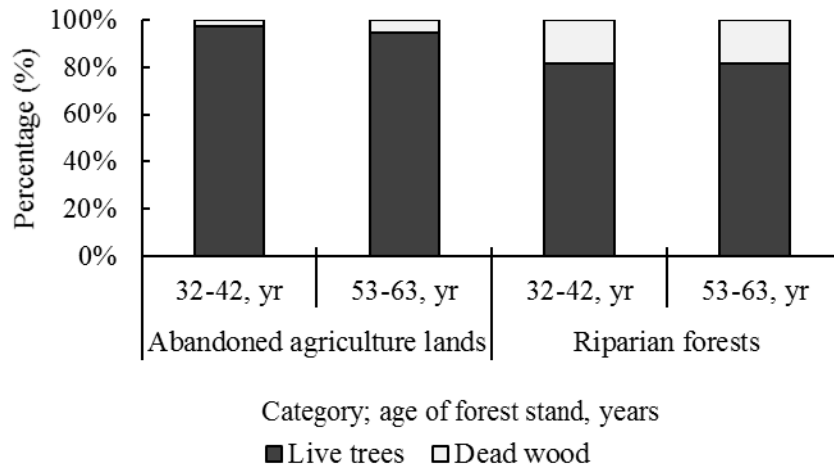

Fig.2. The proportion in percentage (%) of live trees and dead wood in the *A.incana* forests on abandoned agriculture lands and riparian forests within different age 32-42 years and 53-63 years.

Dead wood. The average amount of dead wood exceeded 14.4 m³ per 1 ha in studied sites on former agricultural lands and 85.8 m³ per 1 ha in riparian forests. Species diversity of dead wood was low and the main species was *A. incana* (98 % on abandoned agriculture lands and 73% in riparian forests). Other species are *B. pendula*, *P. abies* and *Salix alba* L. Average dead wood volume in study sites on former agricultural lands was 6 m³ per 1 ha at stand age of 32-42 years and 22.7 m³ per 1 ha - at the age of 53-63 years. These differences can be explained with the fact that at the age of 40 the majority of trees have a rot and they are gradually dying (Daugavietis, 2006). In riparian forests the average volume of dead wood was 61.9 m³ per 1 ha at the age 32-42 years, and 109.6 m³ per 1 ha in sites at the age of 53-63 years. However, the mean volumes of dead wood were much smaller in studied sites at the age of 32-42 on former agriculture lands, but significantly higher at the age 53-63 in riparian forests. Complex structural diversity such as uneven stand structure, diversity of dead wood and species composition provided by small-scale disturbances is characterized by gap dynamics. Canopy gaps plays an important role in maintaining biodiversity and providing long-term ecosystem functioning (Peterken, 1996).

Vegetation survey. The mean number of species in vegetation layers was affected by stand age, but did not differ between forests on abandoned agricultural lands and riparian sites. The largest species number was detected in riparian forests – 82 species, but number of species in the study sites on former agriculture lands was 78. In total 12 species at moss layer, 54 species at herb layer, 16 species at shrub layer and 7 species at tree layer were found in sample plots within *A. incana* forests on riparian zones of abandoned agricultural lands.

Moss layer. The lowest coverage of mosses was detected in riparian sites at the age of 53-63 years. The mean number of species was being rather similar in both riparian forests and on former agricultural lands (Fig.3.). Data analysis showed no differences between the studied sites and different age classes. The most abundant species was *Brachythecium oedipodium*.

Herb layer. The mean number of species in herb layer did not differ between study sites in both former agricultural lands and riparian forests, but it was lower at the age of 32-42 on abandoned agriculture lands (Fig.3.). The coverage of herbs was different between age of grey alder stands, but the effect was rather small, and no significant differences were found between treatments and different age classes. The abundance of nemoral herb layer with species dominated by *Aegopodium podagraria* L., *Urtica dioica* L., *Geum rivale* L. were detected in all studied sites. The coverage of nemoral species in grey alder stands on abandoned agricultural lands and riparian forests is similar and thus the succession of broad-leaved forest

is possible. However, the significant amount of boreal species occurred in riparian forests with stand age of 53-63 years. The coverage of swamp forest species was higher in grey alder stands on abandoned agriculture lands at the age of stand 32-42 years, but surprisingly decreased in riparian forests at the age of stand 53-63 years. Environmental condition according to Ellenberg (1992) in all studied sites were similar and calculated values expressed: warm half-shade and moist, pH-neutral soil rich in nitrogen.

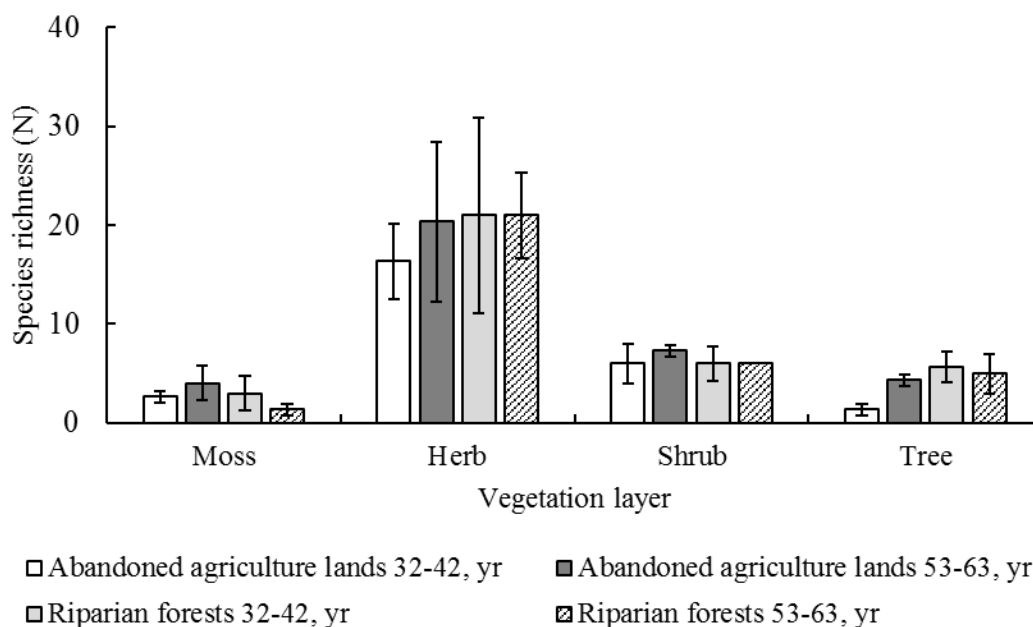

Fig.3. Numbers of species in different vegetation layers in the *A. incana* forests on abandoned agriculture lands and riparian forests within different age 32-42 years and 53-63 years. Values are means \pm standart deviation.

Shrub layer. The number of of shrub species was similar in *A. incana* forests on abandoned agricultural lands and riparian forests (Fig.3.). We found that there were no statistically significant differences between the number of species and coverage in shrub layer in *A. incana* forests on abandoned agricultural lands and riparian forests. The high abundancia of species in shrub layer with *Padus avium* L., *Corylus avellana* L. and *Sorbus aucuparia* L. were detected in all studied sites.

Tree layer. The number of species were significantly lower in the *A. incana* forests at the age 32-52 years, but number of species increased within the age of forest stands. The mean number of tree species in all studied plots was 4.1. (Fig.3.). The most abundant species in tree layer was *A. incana*, *Fraxinus excelsior* L. and *Quercus robur* L. The projective cover of tree was not influenced by treatments and different age classes of forest stands. The highest projective coverage values were found in *A. incana* forests on abandoned agriculture lands (average 90%), but in riparian forests – average 80%.

Conclusion

The present results show that there are minor differences between grey alder stands on abandoned agriculture lands and riparian forests within different age of stand. The average volume of grey alder stands on abandoned agricultural lands is 318.8 m³ per 1 ha, riparian forests – 399.4 m³ per 1 ha. These differences can be explained by greater tree species diversity in riparian forest sites. *A. incana* is fast-growing tree species, occupying 7 %

(207,000 ha) of total forested area in Latvia. It have an important ecological role as European floodplain broadleaved forests. The average volume of dead wood on abandoned agricultural lands is 14.4 m³ per 1 ha, but in riparian forests it is almost six times larger – 85.8 m³ per 1 ha. When comparing *A.incana* stands with different age it is evident that wider representation among habitat groups is found in riparian forests. In total, 107 species of vascular plants were found in *A.incana* stands: 12 in tree layer, 19 in shrub layer, 79 in herb layer and 15 in moss layer. In *A.incana* stands on abandoned agricultural lands 78 vascular plant species were found; on riparian forests – 82 species. The average projective coverage for all layers of vegetation was higher in grey alder stands on abandoned agricultural lands compared to riparian forests. In general the species in grey alder stands belong to nemoral and nitrophyle groups.

References

- Astover A., Roostalu H., Lauringson E., Lemetti I., Selge A., Talgre L., Vasiliev N., Penu P. (2006). Changes in agricultural land use and in plant nutrient balances of arable soils in Estonia. *Archives of Agronomy and Soil Science*, 52(02), pp.223-231.
- Āboloņa A. (2001). List of bryophytes of Latvia. *Latvijas Veģetācija*, vol.3, pp. 47-87.
- Braun – Blanquet J. (1964). *Pflanzensoziologie. Grundzüge der Vegetationskunde*. Berlin, Springer – Verlag, Wien, New York.
- Daugavietis M. (2006). Rate of grey alder growth. *Grey Alder in Latvia*, LVMI Silava.
- Ellenberg H., Weber H. E., Düll R., Wirth V., Werner W., Paulißen D. (1992). *Zeigerwerte von Pflanzen in Mitteleuropa*. Verlag Erich Goltze KG, Göttingen.
- Ellenberg H., Weber H.E., Dull R., Wirth V., Werner W., Pauliben D. (1992). *Zeigerwerte von Pflanzen in Mitteleuropa*. *Scripta Geobotanica*, vol. 18, pp. 3-258.
- Gavrilova, G., Sulcs V. (1999). *Flora of Latvian vascular plants. List of taxa*. Institute of Biology of University of Latvia, Laboratory of Botany, Riga.
- Gregory S.V., Swanson F.J., McKee W.A., Cummins K.W. (1991). An ecosystem perspective of riparian zones. *BioScience*, 41 (8), pp. 540-551.
- Liepa I. (1996). *Increment science*. Jelgava: LLU, pp.1-123.
- Liepins K., Lazdins A., Lazdina D., Daugaviete M., Miežite O. (2008). Naturally afforested agricultural lands in Latvia–assessment of available timber resources and potential productivity. In: *Environmental engineering. Proceedings of the 7th international conference*, pp. 194-199.
- Mander Ü., Kuusemets V., Lõhmus K., Muring T. (1997). Efficiency and dimensioning of riparian buffer zones in agricultural catchments. *Ecological Engineering*, 8(4), pp.299-324.
- Miežite O. (2008). *Structure and Productivity of Grey Alder Stands*. Resume of the Ph. D. Paper. For the Scientific Degree of Dr. Silv. Forest Sciences, Jelgava, Latvia, pp.1-154.
- Muller – Dombois D., Ellenberg H. (1974). *Aims and Methods of Vegetation ecology*. John Willey & Sons, 1974.
- Peterken G.F. (1996). *Natural woodland: ecology and conservation in northern temperate regions*. Cambridge University Press.
- R Development Core Team (2013). *R language and environment for statistical computing*.
- Shvidenko A., Nilsson S., Roshkov V. (1997). Possibilities for increased carbon sequestration through the implementation of rational forest management in Russia. *Water, Air, and Soil Pollution*, 94(1-2), pp.137-162.
- Skudra P., Dreimanis A. (1993). *Fundamentals of Forestry*. Zvaigzne, Riga.
- The data base *Flora of Vascular Plants of Central Russia*. <http://www.jcabi.ru/eco1>.
- Uri V., Tullus H., Lõhmus K. (2002). Biomass production and nutrient accumulation in short-rotation grey alder (*Alnus incana* (L.) Moench) plantation on abandoned agricultural land. *Forest Ecology and Management*, 161(1), pp.169-179.

CONTRIBUTION TO KNOWLEDGE OF STRUCTURE OF MIXED BLACK LOCUST AND COMMON HACKBERRY STANDS IN THE AREA OF SUBOTICA-HORGOS SANDS (SERBIA)

Siniša ANDRAŠEV^{1*}, Martin BOBINAC², Karoly REDEI³

¹Institute of Lowland Forestry and Environment, University of Novi Sad, Serbia

²Faculty of Forestry, University of Belgrade, Serbia

³Forest Research Institute, Sárvár, Hungary

*Corresponding author: andrasev@uns.ac.rs

Abstract

The paper shows elements of growth and structure of mixed black locust and common hackberry stands, 28 years old and mixed origin in the area of Subotica-Horgos sands (Serbia) by measuring of all trees on three experimental plots, each of 0.0625 ha (25 x 25 m). Black locust trees in the stand are predominantly of coppice origin, and common hackberry trees are predominantly of seed origin. On the experimental plots 5000-6380 trees per hectare were determined, with the dominant share of black locust with 3100-4200 trees per hectare, or 62-71%. Basal area is 32.2 m²ha⁻¹ and wood volume is 200 m³ha⁻¹ on average, where black locust account for 73-80%. The dominant height of the black locust is 13.4-16.0 m and common hackberry is 14.8-15.9 m, while the mean height of black locust and common hackberry are approximately identical in all experimental plots and amount 11.4-12.8 m, indicating that stands belong to the V site class by Redei et al, (2014). The mean diameter of black locust trees ranged from 8.6 to 9.9 cm and the dominant from 16.8 to 19.3 cm, while the mean diameter of the common hackberry trees ranged from 70 to 94%, and dominant 92-122% of the black locust trees. Having in mind achieved heights of common hackberry trees, its abundance in the stand and representation in all crown classes, as well as its biological properties to a greater extent tolerated shading compared to black locust, it is estimated its dominance in the future of mixed black locust and common hackberry stands in the area of Subotica-Horgos Sands. Accordingly, it is necessary to adjust silvicultural and management measures in these stands, having in mind the natural succession of species and different planned orientations with them in the management plans in this area.

Keywords: *black locust, common hackberry, mixed stands, growth elements, stand structure.*

Introduction

Subotica-Horgos sands located in the northern part of Backa plain and in the wider area surround the city of Subotica (Serbia) on the north side, to the border with Hungary. It was created during the the younger Pleistocene (Diluvium) at the time of glaciation, when the rivers brought sand and mud from the Alps and the Carpathian mountains in summer, while when the river retreated to its riverbed in winter the wind diffused this material and deposited it in the form of sand or loess on the terrain of the existing sands and loess plateaus. In this way various forms of sands were formed: gray-yellow sand, brown sand, black sand, black-loamy sand and salinated sand. On these lands, primarily black sands and in the ravines, there were natural forests of oak and white and black poplar, while other parts were covered with grass vegetation (pastures) or barren land, so-called. "live" sands and caused wind erosion in a wider area with negative effects on the agricultural land and settlements (Pavićević and Stankević, 1962; Šijak, 1980).

At the end of the eighteenth century the first work on the binding of sand were begun with species of trees that grow rapidly: willow, poplar, linden, black locust and tree of

heaven. Initial establishment of forest stands was done with more or less success, due to inadequate choice of tree species or inappropriate technique of establishment. Milestone represented 1870 year when introduction of black locust with prior trenching terrain was begun mainly on the gray-yellow sand where could not grow any other species. After the First World War predominance in afforestation is given to Austrian pine (Peruničić, 1956).

In the 1969 year black locust was the tree species that was the most distributed in the area of Subotica-Horgos sands and occupied an area of 2450 ha of 3500 ha how occupied forests and forest plantations. Other tree species were: poplars on 470 ha, Austrian pine on 500 ha, oak (pedunculate and Turkey) on 42 ha and other broadleaves on approximately 140 ha (Šijak, 1980).

Today (inventory in 2009), black locust stands are represented with about 1750 ha, of which pure black locust stands account for nearly 600 ha, and the rest are mixed stands with black locust and other tree species. Having in mind the limitations of the methodology of allocation and measurements of stands by the inventory, especially in young coppice of black locust, which in inventory of the management unit "Subotica forests" in 1999 were allocated as pure coppice stands of black locust on the area of over 2100 ha, it is evident that these data indicate introduction and succession of species, especially common hackberry, which in inventory in 2009 was recorded that builds pure stands on an area of over 620 ha (16.6%), and in inventory in 1999 year an area of pure common hackberry stands were 88.8 ha (2.5%). Based on the existing relationship the largest share by volume of all species recorded in this management unit has an Austrian pine with 33.8%, followed by black locust with 22.7% and common hackberry with 10.6%.

Cited literature does not mention the planned, artificial introduction of common hackberry on the area of Subotica-Horgos sands. Common hackberry (*Celtis occidentalis* L.) is a non-native tree species that has introduced into Europe in 1636 year, and on area of the Pannonian Plain (Hungary) is assumed to be introduced in the first half of the XIX century, first as a park tree species in settlements. At the beginning of XX century common hackberry is used for afforestation in the wider area of Hungary (Bartha & Csiszar, 2008). Having in mind that the area of Subotica-Horgos sands in the early twentieth century belonged to Hungary (Austria-Hungary), it can be assumed that it is used for afforestation in sands, as has proved to be very resistant to drought (Tiborcz et al., 2011). Unlike common hackberry, black locust (*Robinia pseudoacacia* L.) is a widely cultivated species in Serbia and represents an important tree species for forest management, which has wide utility value (Banković et al, 2009; Andrašev et al, 2014).

The aim of the research is to examine stand structure and emphasize mutual relationships in the growth of represented tree species in mixed stands of black locust and common hackberry in the area of Management unit (MU) "Subotica forests".

Materials and methods

The structure of mixed stands of black locust and common hackberry has been studied at three permanent sample plots, sized of 0.0625 ha (25 × 25 m), in autumn 2014, when the stand (MU „Subotica forests", department 59) was 28 years old. Black locust trees in the stand are predominantly of coppice origin, and common hackberry trees are predominantly of seed origin. The study stands are with special purpose and have a priority function of soil protection of the first degree, because they represent the forest ecosystems in the habitat that is subject to erosion. The most represented species in the stand is black locust, and common hackberry is mainly in understorey layer.

Two cross diameters at breast height with an accuracy to 1 mm were measured on all trees in the experimental plots, and heights were measured on a certain number of trees in all diameter degrees with altimeter type Vertex III (Haglof). During the measurement, crown class (CC)

was estimated for every tree based on the classification by Assmann (1970): (1) tree crown is in upper storey, (2) tree crown is in middle storey, (3) tree crown is in lower storey.

Data analysis included standard procedure for processing the experimental plots in order to obtain the quadratic mean diameters (d_g), the dominant diameters (mean diameter of the 100 thickest trees per hectare, D_{100}), mean height by Lorey (h_L) and dominant (top) height (mean height which corresponds to the diameter of the 100 thickest trees per hectare in the plantation, H_{100}) for each studied tree species. The function of Mihajlov was used for the construction of height curves ($h = a \cdot e^{-b/dbh} + 1.3$). Stand volume was obtained using constructed height curves and volume table for black locust (Cestar and Kovačić, 1982).

Results and discussion

In the studied mixed black locust and common hackberry stands was determined high number of trees, on average over 5,700 trees per hectare, as a result of lack of tending measures. Total basal area amounted $32.19 \text{ m}^2 \text{ ha}^{-1}$, and total volume $200 \text{ m}^3 \text{ ha}^{-1}$. Number of black locust trees amounted 3100-4200 per hectare, or an average twice than the common hackberry trees, while the total basal area and volume of black locust are 3 times higher (Table 1).

Table 1. The basic growth elements of black locust and common hackberry trees in the stands.

Tree species	Exper. plot	H_{100}^*	h_L	D_{100}	d_g	N	G	V
		[m]	[m]	[cm]	[cm]	[trees ha^{-1}]	[$\text{m}^2 \text{ ha}^{-1}$]	[$\text{m}^3 \text{ ha}^{-1}$]
black locust	EP-1	15.99	12.57	18.7	8.9	4224	26.08	166.00
	EP-2	15.33	12.81	19.3	9.9	3104	23.68	153.59
	EP-3	13.43	11.42	16.8	8.6	4144	24.33	141.05
common hackberry	EP-1	15.88	12.02	17.3	6.4	2160	6.85	41.74
	EP-2	15.18	12.75	20.5	6.9	1904	7.05	45.53
	EP-3	14.80	12.32	20.5	8.1	1664	8.56	53.41
Total	EP1-3					5733	32.19	200.44
black locust	EP1-3	14.92	12.27	18.3	9.1	3824	24.70	153.55
common hackberry	EP1-3	15.29	12.36	19.4	7.1	1909	7.49	46.89
t-test		-0.45	-0.20	-0.89	3.13	4.93	19.18	13.36
p value		0.6895	0.8531	0.4274	0.0382	0.0219	0.0001	0.0011

Legend: H_{100} – mean height of the 100 thickest trees in the stand; h_L – mean height by Lorey; D_{100} – mean breast height diameter of the 100 thickest trees in the stand; d_g – mean quadratic breast height diameter; N – total number of trees in a stand per hectare; G – total basal area per hectare; V – total wood volume per hectare.

The mean diameter of black locust trees is 9.1 cm and is significantly greater than the common hackberry trees. However, the dominant diameter of common hackberry trees is greater than the black locust, but without significant difference. Mean heights of black locust and common hackberry trees are similar and amount 12.3 to 12.4 m, and dominant height is also close and amount 14.9 to 15.3 m (Table 1). Achieved height at the age of 28 years indicates that stands belong to the V site classes of black locust by Redei et al (2014).

Height curves, obtained by the function of Mihailov, show good agreement for both tree species. The coefficient of determination is slightly higher in common hackberry compared to black locust and indicates a better fit of empirical values with the model (Table 2, Figure 1). Height curves of black locust and common hackberry are very similar on all three experimental plots, have a greater curvature in thin diameters and indicate the presence of trees with smaller diameters and heights (Figure 1). This indicates similar height and diameter growth of these two tree species on sandy habitats in Subotica-Horgos sands.

Table 2. The parameters of the height curve models and the elements of model assessment.

Experimental plot	Tree species	Model: $h = a \cdot e^{-b/dbh} + 1.3$		Model assessment		
		a	b	R ²	s _e	n
EP1	black locust	22.02823	6.977001	0.846	1.232	34
	common hackberry	19.17465	5.450404	0.951	0.982	11
EP2	black locust	17.45727	4.684647	0.867	0.958	32
	common hackberry	16.55410	4.187416	0.944	1.062	12
EP3	black locust	15.52303	4.223530	0.847	0.791	29
	common hackberry	17.31759	5.588089	0.902	0.786	14
EP1-3	black locust	18.38385	5.350667	0.824	1.161	95
	common hackberry	16.59348	4.433145	0.909	1.124	37

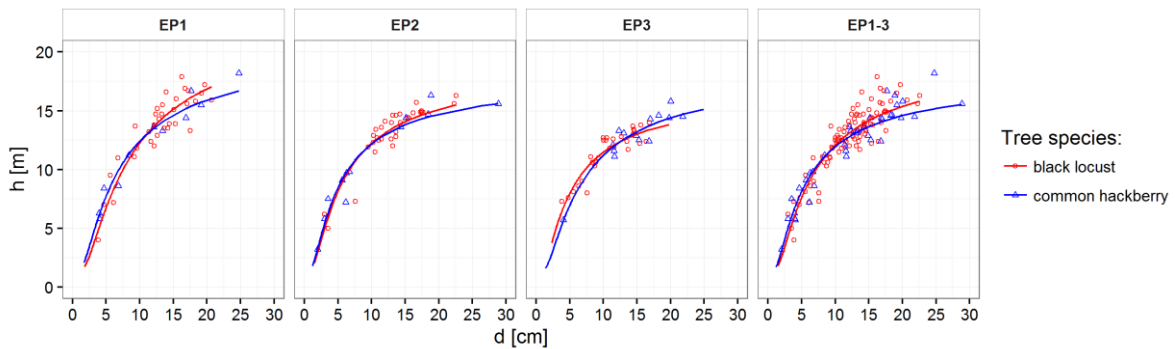

Figure 1. Height curves in experimental plots.

Diameter distribution is unimodal, with an expressed right asymmetry on all three studied plots. The largest number of trees are in the diameter degree of 5-10 cm, from 2000 to 2800 trees per hectare, followed by the thinnest trees with breast height diameter under 5 cm from 1700 to 2350 trees per hectare (Figure 2).

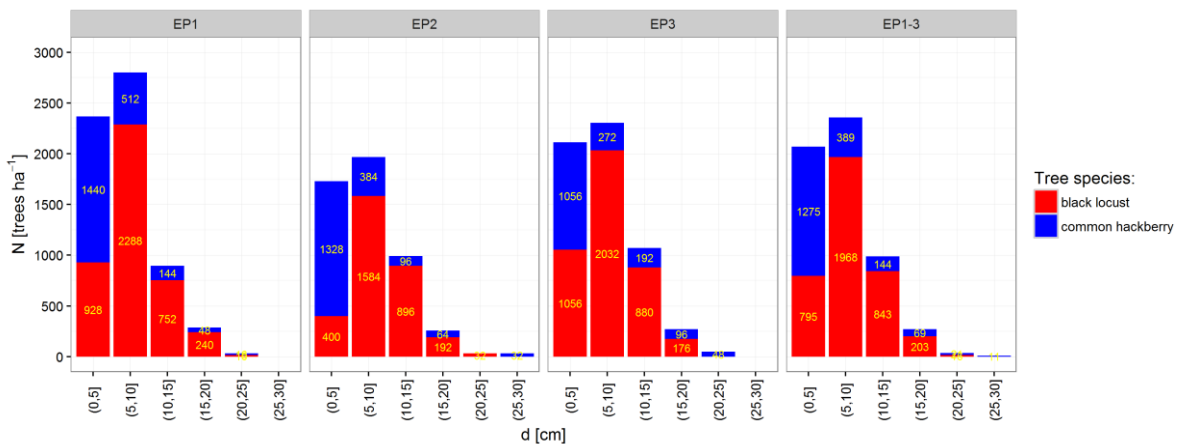

Figure 2. Diameter distribution.

Black locust trees dominated in the diameter degree of 5-10 cm, from 1580 to 2280 trees per hectare, while common hackberry trees are the most numerous in the thinnest diameter degrees, from 1050 to 1440 trees per hectare. On all three experimental plots there are a smaller number of trees with a diameter larger than 20 cm in both tree species (Figure 2).

The number of trees in crown class I amount 1,259 per hectare, or 22%, while the most numbered were trees in crown class III, with 3500 trees per hectare or 61.2%. The largest

number of trees which crown is in upper storey were black locust trees and consists of over 1,000 trees per hectare, as well as trees which crown is in middle storey with 780 trees per hectare, what is significantly higher than the number of common hackberry trees in the aforementioned storeys. In the crown class III were almost 2,000 black locust trees and over 1,500 common hackberry trees per hectares. Statistical t-test showed no difference in the number of black locust and common hackberry trees which crowns were in lower storey (Table 3, Figure 3).

Table 3. Number of trees in different crown classes per hectare and results of t-test.

Tree species	Measurement unit	Crown classes (CC)		
		CC-1	CC-2	CC-3
Total	[trees ha ⁻¹]	1259	965	3509
black locust	[trees ha ⁻¹]	1067	784	1973
common hackberry	[trees ha ⁻¹]	192	181	1536
ratio		5.56	4.32	1.28
t-test		7.05	8.01	1.14
p-value		0.0081	0.0094	0.3382

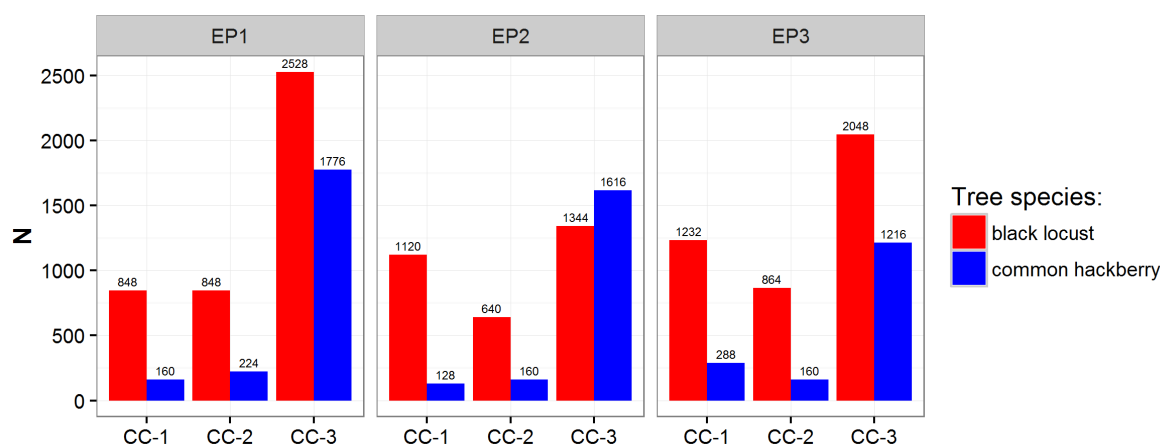

Figure 3. Number of trees in different crown classes per hectare.

Conclusion

The results show that on research sandy habitats black locust achieved lower productivity (V site class), and that a high number of trees per hectare may arise from lack of tending measures.

Common hackberry trees on average account for 1/3 of the number of trees, and for 1/4 of basal areas and volume of stands. Achieved mean and dominant heights were at the level of height of black locust trees, participating in all crown classes, and most of them were in a lower storey.

Having in mind achieved heights of common hackberry trees, its abundance in the stand and representation in all crown classes, as well as its biological properties to a greater extent tolerated shading compared to black locust, it is estimated its dominance in the future of mixed black locust and common hackberry stands in the area of Subotica-Horgos Sands.

Accordingly, it is necessary to adjust silvicultural and management measures in these stands, having in mind the natural succession of species and different planned orientations with them in the management plans in this area.

Acknowledgement

This paper was realized as a part of the project financed by the Ministry of Education and Science of the Republic of Serbia.

References

- Andrašev S., Rončević S., Ivanišević P., Pekeč S., Bobinac M. (2014): Productivity of black locust (*Robiniapseudoacacia* L.) stands on chernozem in Vojvodina. Bulletin of the Faculty of Forestry 110: 9-32.[in Serbian with English summary]
- Assmann E., (1970): The principles of forest yield study. Pergamon Press, Oxford, New York, 506 pp.
- Banković S., Medarević M., Pantić D., Petrović N. (2009): The national forest inventory of the Republic of Serbia - The growing stock of the Republic of Serbia. Ministry of Agriculture, Forestry and Water Management of the Republic of Serbia – Forest Directorate, Belgrade.
- Bartha, D., Csiszár, Á. (2008): Common hackberry (*Celtis occidentalis* L.). In: Botta-Dukát, Z., Balogh, L. (eds.) 2008. The most invasive plants in Hungary. Institute of Ecology and Botany, Hungarian Academy of Sciences, Vácrátót, Hungary, pp. 95-102.
- Cestar D., Kovačić Đ. (1982): Volume tables of black alder and black locust. Works 49, Zagreb.[in Croatian]
- Pavičević N., Stankević P. (1962): Pedological characteristics of the Subotica-Horgos sands. Institute of wooden industry of Serbia, Special edition 17. Belgrade. [in Serbian]
- Peruničić, Branko (1956): Forests in the surrounding of Subotica, their origin and development. Forestry (Belgrade), IX (1-2); 86-88. [in Serbian]
- Rédei K., Csiha I., Keserű Z., Rásó J., Kamandiné Végh Á., Antal B. (2014): Growth and Yield of Black Locust (*Robiniapseudoacacia* L.) Stands in Nyírség Growing Region (North-East Hungary). SEEFOR 5(1) (13-22)
- Šijak, Milorad (1980): Contribution to the knowledge dendroflora of Subotica-Horgos sands. Forestry (Belgrade), XXXIII (3); 39-46. [in Serbian]
- Tiborc, V., G. Zagyvai, M. Korda, D. Schmidt, Á. Csiszár, D. Šporčić, B. Teleki, D. Bartha, 2011: Distribution and significance of some invasive alien woody plant species in Hungary. Available from: https://www.google.rs/url?sa=t&rct=j&q=&esrc=s&source=web&cd=1&cad=rja&uact=8&ved=0CCEQFjAA&url=http%3A%2F%2Fwww.wsl.ch%2Fepub%2Fwrs%2Fsessions%2Fdownload%3Fp%3D1160%2F6-217-final-278_Tiborc_Distribution_of_invasive_correction.pdf%26o%3D278_Tiborc_Distribution_of_invasive_correction.pdf%26sid%3D13195606191161433218288459086&ei=V5rkVMXmN8jOygPDrIKoAw&usg=AFQjCNFyVKAprP7DGML1Ym6yDpGan5gig&bvm=bv.85970519,d.bGQ.
- ***(1999): Forest management plan for the management unit “Suboticaforest” for period of 2000-2009. Public Company “Vojvodinašume”, Forest Holding Sombor.[in Serbian]
- ***(2009): Forest management plan for the management unit “Suboticaforest” for period of 2010-2019. Public Company “Vojvodinašume”, Forest Holding Sombor.[in Serbian]

THE EFFECT OF MEDIUM pH ON WHITE POPLAR SHOOTS' GROWTH *IN VITRO*

Vanja VUKSANOVIĆ¹, Branislav KOVAČEVIĆ^{2*}, Saša ORLOVIĆ², Dragana MILADINOVIĆ³, Marina KATANIĆ², Marko KEBERT²

¹University of Novi Sad, Faculty of Agriculture, Novi Sad, Republic of Serbia

²University of Novi Sad, Institute of Lowland Forestry and Environment, Novi Sad, Republic of Serbia

³Institute of Field and Vegetable Crops, Novi Sad, Republic of Serbia

*Corresponding author: branek@uns.ac.rs

Abstract

The effect of initial medium pH on shoot growth and development of five white poplar (*Populus alba* L.) genotypes was tested. After 35 days of culture *in vitro* following characters were measured: shoot height, number of new shoots, percentage of survival and percentage of multiplication, fresh mass of shoots, dry mass of shoots, and shoot moisture content. The effect of four media buffered with sodium citrate buffer with following initial pH: 3.0, 4.0, 5.5 and 7.0, as well as of standard multiplication medium with pH 5.5 with no citric acid added were tested. In order to achieve agar solidification in medium with pH 3.0 media were sterilized in microwave oven. Results of analysis of variance indicated that there is significant effect of the media pH on the most of examined characters. There was no significant effect of interaction clone x medium pH, but according to LSD test, clones significantly differed in their reaction on medium with pH3 in relation to medium with pH5.5, especially by shoot height and fresh shoot mass. Generally, significantly lower values of the shoot height, number of new shoots, percentage of multiplication, fresh and dry shoot mass were recorded on a medium with initial pH 3.0 and pH 4 compared to the medium with pH 5.5. Most of the examined white poplar genotypes had a significantly lower percentage of the multiplication on low pH medium than on the control medium and medium with a higher pH values. Medium with initial pH 7.0 achieved inhibitory effect on fresh shoot mass and shoot moisture content.

Keywords: *Populus alba*, micropropagation, acidity, microwave sterilization

Introduction

White poplar (*Populus alba* L.) is a tree species that, in spite of its high adaptability, is considered to be a threatened species and an indicator of biodiversity (Kovacevic *et al.*, 2010b). Beside its use for wood and biomass production, this species has a wide implementation in horticulture and landscaping, especially the genotypes with a pyramidal tree shape (Eggens *et al.*, 1972; Kovacevic *et al.*, 2010a). In addition, white poplar (*Populus alba* L.) is one of the most interesting model tree species in biotechnology, where the tissue culture is an important propagation technique (Confalonieri *et al.*, 2000). It is known that different genotypes of the same species differ in their requirements for growth in *in vitro* conditions (Kovacevic *et al.*, 2013).

Medium pH is an important factor of physicochemical environment during the development of plant tissues *in vitro* (De Klerk *et al.*, 2008). However, the most effective pH value is specific to the individual plant species and even cultivars, and has to be determined experimentally (Ostrolucká *et al.*, 2010; Ruzic and Cerovic, 2001).

Tissue culture has been extensively used to evaluate the abiotic stress tolerance of many species. It is a good tool to test the *in vitro* ability of the species to form roots and growth in

the low pH conditions as most of the factors affecting *in vitro* growth are similar to those limiting the growth *in vivo* (Kovacevic *et al.*, 2013).

In this research, the growth and development of shoots of five different white poplar genotypes were observed in order to optimize the procedure of testing and test white poplar genotypes on grow *in vitro* on media with different initial pH.

Materials and methods

Plant material

Five white poplar genotypes, interesting for wood production, horticulture and landscaping were examined: widespread Italian selection “Villafranca”, and Serbian selections in experimental phase: L-12, L-80, LBM and LCM.

Shoots of all five tested genotypes were multiplied by culture of axillary buds, as described by Ahuja (1984). The cultures were sub-cultured at 4-week intervals and kept at 26 ± 2 °C, under a 16 h photoperiod (cool white fluorescent lamps, 3500 lx), till their use in the experiment.

Media preparation

Sterilization was provided by microwave oven. The media were treated until they reached boiling point, and then poured in sterilized jars in laminar chamber. In this way the jellification potential of agar was preserved in media with pH3 and pH4 (Kovačević *et al.*, 2013). Mineral growing medium ACM (Aspen Culture Medium) described by Ahuja (1984), supplemented with 9gL^{-1} agar, 20gL^{-1} sucrose and with no growing hormones in it, was used in the experiment. The pH of the medium was adjusted to 3.0, 4.0, 5.5 or 7.0 before sterilization. Citric acid/Na-citrate buffer was used in order to provide pH stability of media (Skirvin *et al.*, 1986). This buffer system provided us relatively wide pH spectrum for testing.

Influence of medium pH on shoot growth and development

In order to investigate the effect of medium initial pH on shoot growth and development of tested genotypes, 1.0-1.5 cm long shoot tips of the previously multiplied shoots were placed on media with different initial pH: pH 3.0, pH 4.0, pH 5.5, pH 7.0 and control (standard medium for multiplication, without citric acid and with pH 5.5). Five shoot tips were cultured per 190 ml jar with 25 mL of culture medium. There were three jars per examined medium within a genotype. The cultures were kept at 26 ± 2 °C in the white fluorescent light (3500 lx) with a 16-hour photoperiod. After 35 days of culture, the shoot growth and development was assessed by the shoot height (SH), number of new shoots (SN), percentage of survival (PS) and percentage of multiplication (PM), fresh mass of shoots per jar (FM), dry shoots mass per jar (DM), as well as the moisture content of shoots (CM).

Statistical analysis

Examined characters were measured either per jar (FM, DM, PS, PM and CM) or the average value per jar was calculated after the measurement of individual plants (SH and SN). There were three repetitions within each genotype for each tested initial pH. The design of the experiment was totally randomized. Number of new shoots was transformed by square transformation ($\sqrt{X+1}$), while the percentage of survival and multiplication of the percentage of transformed arcsin transformation ($\arcsin\sqrt{X}$) in order to meet normal distribution of frequencies. The obtained data were analyzed by two-way ANOVA and LSD test with STATISTICA 10 (StatSoft Inc., 2012) statistical program.

Results and discussion

The research of the influence of low pH on growth and development has mainly been limited by the problems in jellifying of agar on low pH, especially on pH 3 and lower. That was

mainly resolved by sterilization of media with low initial pH in microwave oven (Kovacevic et al., 2013). While Kovacevic et al. (2013), worked on the examination of growth and development of rooted white poplar shoots *in vitro* on medium with low pH, in this work we attended to examine the influence of media with initial pH ranging from pH3 up to pH 7 on shoot tip explants. Also, considering that tissue culture is poorly buffered (De Klerk *et al.*, 2008) and that plants tend to buffer the medium during the cultivation (Kovacevic et al. (2013), we used sodium citrate buffer in order to stabilize desired medium pH until the end of cultivation.

According to the results of analysis of variance, the strongest influence of examined morphological and biomass characters was made by the initial pH of the media. All characters, except of percentage of survival and shoot moisture content were significantly affected by this factor. There were no significant effect of the interaction Clone x Initial pH; while the effect of Clone was significant only for shoot height and fresh shoot mass (Table 1).

Table 1. The results of two-way analysis of variance for examined white poplar genotypes and initial pH ^{a)}

Character	F-test		
	Clone (A)	Initial pH (B)	Interaction A × B
Shoot height	4,96 ^{**b)}	19,69 ^{**}	1,49
Shoot number	1,26	8,80 ^{**}	0,64
Percentage of survival	1,45	1,34	1,21
Percentage of multiplication	0,91	29,88 ^{**}	0,52
Fresh shoot mass	3,669 [*]	8,756 ^{**}	1,333
Dry shoot mass	0,952	7,958 ^{**}	1,095
Shoot moisture content	1,045	1,354	1,044

^{a)} Degrees of freedom for genotype was $DF_A = 4$, degrees of freedom for pH $DF_B = 4$, degrees of freedom for interaction genotype × pH $DF_{A \times B} = 16$, degrees of freedom for error $DF_{ERR} = 43$ and degrees of freedom for total $DF_T = 67$.

^{b)} Labels for F-test: * - significant at the level $\alpha=0,05$; ** - significant at the level $\alpha=0,01$

Results of the Least significant difference test (LSD) showed that there was almost no significant effect of addition of citric acid in the medium, as the difference between Control (no citric acid and pH 5,5) and pH5,5 (with citric acid and pH5,5), except for number of new shoots. In that sense, it could be assumed that differences between treatments are almost solely due to differences in the pH of the medium and quantity of sodium ion (Table 2 and 3). The most significant differences in shoot height are due to the highest shoots of “Villafranca”. Difference in fresh shoot mass between the same clone (that had the lowest fresh mass accumulation) and others also contributed to the significant effect of factor clone for this character. Despite the fact that the effect of interaction Clone x Initial pH was not significant, some results of LSD test suggest that there could be detected differences in reaction of examined clones on Initial pH treatments. Generally, the highest inhibitory effect was achieved by medium with initial pH3, but some genotypes did not reacted as strong. This is not in concordance to the results of Kovačević et al. (2013) who found stimulant effect of medium with initial pH3 on growth of rooted shoots of white poplar genotypes. However, they did not use any means to enforce buffering capacity of their medium. It seems that in their experiment the low pH was provided for just a limited time during cultivation, and in this case produced even stimulant effect on shoot growth. However, the presented obtained results suggest that method described in this work would be more appropriate for further studies and tests on low pH tolerance.

Table 2. LSD-test for measured morphological characters of examined white poplar clones¹⁾

Clone	Initial pH	Shoot height (mm)	Number of new shoots	Percentage of survival	Percentage of multiplication
“Villafranca”	Control	16,73 ^{ab}	1,10 ^a	100,00 ^a	100,00 ^a
“Villafranca”	3,0	12,67 ^{cde}	0,86 ^{abcd}	100,00 ^a	53,35 ^{efgh}
“Villafranca”	4,0	12,13 ^{def}	0,89 ^{abcd}	100,00 ^a	81,09 ^{bcde}
“Villafranca”	5,5	19,70 ^a	0,93 ^{abcd}	100,00 ^a	100,00 ^{ab}
“Villafranca”	7,0	14,07 ^{bcd}	0,89 ^{abcd}	100,00 ^a	100,00 ^a
L-12	Control	16,53 ^{ab}	1,06 ^a	100,00 ^a	100,00 ^a
L-12	3,0	7,50 ^h	0,64 ^d	97,63 ^{ab}	20,00 ^h
L-12	4,0	8,73 ^{fgh}	0,94 ^{abcd}	100,00 ^a	73,80 ^{cdefg}
L-12	5,5	16,00 ^{abc}	0,90 ^{abcd}	94,88 ^{ab}	100,00 ^a
L-12	7,0	14,80 ^{bcd}	1,01 ^{ab}	97,63 ^{ab}	97,63 ^{abc}
L-80	Control	16,07 ^{abc}	0,95 ^{abcd}	100,00 ^a	100,00 ^a
L-80	3,0	9,93 ^{efgh}	0,64 ^d	100,00 ^a	40,00 ^{fgh}
L-80	4,0	11,93 ^{defg}	0,64 ^d	100,00 ^a	60,00 ^{defgh}
L-80	5,5	15,13 ^{bcd}	0,90 ^{abcd}	100,00 ^a	100,00 ^{ab}
L-80	7,0	13,80 ^{bcde}	0,86 ^{abcd}	100,00 ^a	88,73 ^{abcde}
LBM	Control	13,67 ^{bcd}	1,11 ^a	100,00 ^a	100,00 ^a
LBM	3,0	8,93 ^{fgh}	0,64 ^d	100,00 ^a	32,91 ^{gh}
LBM	4,0	13,67 ^{bcd}	0,78 ^{bcd}	100,00 ^a	94,88 ^{abc}
LBM	5,5	14,40 ^{bcd}	0,95 ^{abc}	100,00 ^a	100,00 ^a
LBM	7,0	13,97 ^{bcd}	0,72 ^{cd}	86,05 ^b	100,00 ^a
LCM	Control	12,50 ^{cdef}	1,06 ^{ab}	100,00 ^a	94,72 ^{abcd}
LCM	3,0	7,98 ^{gh}	0,64 ^{cd}	94,72 ^{ab}	32,27 ^{fgh}
LCM	4,0	9,60 ^{efgh}	0,64 ^{cd}	100,00 ^a	81,62 ^{abcdef}
LCM	5,5	11,90 ^{defg}	0,93 ^{abcd}	100,00 ^a	100,00 ^{ab}
LCM	7,0	13,90 ^{bcde}	0,99 ^{abc}	100,00 ^a	100,00 ^{ab}
Clone	Villafranca	14,73 ^a	0,94 ^a	100,00 ^a	93,51 ^a
	L12	12,71 ^{bc}	0,92 ^{ab}	98,85 ^a	87,60 ^a
	L80	13,34 ^{ab}	0,80 ^b	100,00 ^a	83,73 ^a
	LBM	12,93 ^{bc}	0,86 ^{ab}	99,42 ^a	94,46 ^a
	LCM	11,18 ^c	0,87 ^{ab}	99,79 ^a	89,60 ^a
Initial pH	Control	15,29 ^a	1,06 ^a	100,00 ^a	99,89 ^a
	3,0	9,50 ^c	0,68 ^c	99,56 ^{ab}	35,55 ^c
	4,0	11,33 ^b	0,80 ^{bc}	100,00 ^a	79,45 ^b
	5,5	15,37 ^a	0,92 ^b	99,72 ^{ab}	100,00 ^a
	7,0	14,15 ^a	0,90 ^b	98,47 ^b	99,22 ^a

^{a)} The differences among values of particular characteristic marked with the same letter are not significant at the level $\alpha_{0.05}$.

The most sensitive clone appeared to be clone L-12 as it achieved the lowest percentage of multiplication (20 %) and shoot height that was almost 2.5 times lower than in Control. Also, number of new shoot was almost half of the number of new shoots that appeared in Control, which was the case with all other clones except “Villafranca”. On the other side, the most tolerant was the clone “Villafranca” that achieved more than 50% of percentage of multiplication, and relative mild decrease of shoot height growth, while the number of shoots on pH3 did not differ significantly from that of Control. Almost the same situation was for

fresh and dry shoot mass, where the severe decrease of biomass accumulation on pH3 was found for L-80, LBM and LCM, and relatively mild reaction of “Villafranca”.

Table 3. LSD-test for properties of the biomass of examined white poplar clones ^{a)}

Clone	Initial pH	Fresh shoot mass (g)	Dry shoot mass (g)	Shoot moisture content (g g ⁻¹)
“Villafranca”	Control	0,199 ^{defgh}	0,022 ^{bcdefg}	0,892 ^{ab}
“Villafranca”	3,0	0,087 ^{gh}	0,008 ^g	0,894 ^{ab}
“Villafranca”	4,0	0,115 ^{gh}	0,012 ^{fg}	0,892 ^{ab}
“Villafranca”	5,5	0,231 ^{defgh}	0,022 ^{bcdefg}	0,904 ^{ab}
“Villafranca”	7,0	0,176 ^{efgh}	0,039 ^{abc}	0,809 ^c
L-12	Control	0,461 ^{abc}	0,052 ^a	0,888 ^{ab}
L-12	3,0	0,066 ^h	0,008 ^g	0,886 ^{ab}
L-12	4,0	0,142 ^{fgh}	0,017 ^{defg}	0,883 ^{ab}
L-12	5,5	0,340 ^{abcdef}	0,029 ^{bcdefg}	0,909 ^{ab}
L-12	7,0	0,271 ^{cdefg}	0,026 ^{bcdefg}	0,905 ^{ab}
L-80	Control	0,320 ^{bcdef}	0,033 ^{abcdef}	0,896 ^{ab}
L-80	3,0	0,247 ^{defgh}	0,023 ^{bcdefg}	0,901 ^{ab}
L-80	4,0	0,270 ^{cdefgh}	0,027 ^{bcdefg}	0,901 ^{ab}
L-80	5,5	0,391 ^{abcd}	0,039 ^{abcd}	0,901 ^{ab}
L-80	7,0	0,257 ^{cdefgh}	0,026 ^{bcdefg}	0,894 ^{ab}
LBM	Control	0,533 ^a	0,043 ^{ab}	0,916 ^{ab}
LBM	3,0	0,173 ^{efgh}	0,018 ^{cdefg}	0,889 ^{ab}
LBM	4,0	0,238 ^{defgh}	0,021 ^{cdefg}	0,908 ^{ab}
LBM	5,5	0,521 ^{ab}	0,038 ^{abcde}	0,927 ^{ab}
LBM	7,0	0,175 ^{efgh}	0,021 ^{cdefg}	0,878 ^b
LCM	Control	0,364 ^{abcdef}	0,041 ^{abcde}	0,871 ^{bc}
LCM	3,0	0,120 ^{fgh}	0,007 ^g	0,947 ^a
LCM	4,0	0,135 ^{efgh}	0,014 ^{efg}	0,900 ^{ab}
LCM	5,5	0,189 ^{defgh}	0,020 ^{bcdefg}	0,894 ^{ab}
LCM	7,0	0,373 ^{abcde}	0,037 ^{abcdef}	0,896 ^{ab}
Clone	Villafranca	0,156 ^b	0,021 ^a	0,876 ^a
	L12	0,256 ^a	0,026 ^a	0,894 ^a
	L80	0,300 ^a	0,030 ^a	0,899 ^a
	LBM	0,328 ^a	0,028 ^a	0,903 ^a
	LCM	0,236 ^{ab}	0,024 ^a	0,901 ^a
Initial pH	Control	0,376 ^a	0,038 ^a	0,894 ^{ab}
	3,0	0,140 ^c	0,013 ^b	0,900 ^{ab}
	4,0	0,183 ^{bc}	0,018 ^b	0,897 ^{ab}
	5,5	0,354 ^a	0,031 ^a	0,908 ^a
	7,0	0,240 ^b	0,030 ^a	0,873 ^b

^{a)} The differences among values of particular characteristic marked with the same letter are not significant at the level $\alpha_{0,05}$.

On the other side, although the effect of shoot moisture content was not under significant effect of differences between initial pH treatments, the LSD test suggest significantly lower shoot moisture content on the medium with pH7, then on pH5.5. This effect was particularly obvious in clone L-80, although the effect in this case was not statistically significant. Our assumption goes to the positive influence of high pH of the xylem sap on the aperture of stomata and reduced ABA sequestration ability of epidermis and mesophyll cells described by Wilkinson and Davies (1997). However, this effect was not noticeable in other clones, suggesting higher reaction of clone L-80 on rise of xylem sap pH.

Conclusions

The effect of initial medium pH on shoot growth and development of five white poplar (*Populus alba* L.) genotypes was tested. There is significant effect of the initial media pH on the most of examined characters, but not on interaction clone x medium pH. However, according to LSD test, clones significantly differed in their reaction on medium with pH3 in relation to medium with pH5.5, especially by shoot height and fresh shoot mass. Media with initial pH3.0 and pH4.0 achieve inhibitory effect on the most of examined characters compared to the medium with pH 5.5. Most of the examined white poplar genotypes had a significantly lower percentage of the multiplication on low pH medium than on the control medium and medium with a higher pH values. Medium with initial pH 7.0 achieved inhibitory effect on fresh shoot mass and shoot moisture content.

Acknowledgements

This paper was realized as a part of the projects „Studying climate change and its influence on the environment: impacts, adaptation and mitigation“ (43007) financed by the Ministry of Education and Science of the Republic of Serbia and project „Improvement of lowland forests' management“ financed by the PE Vojvodinašume.

References

- Ahuja M.R. (1984). A commercially feasible micropropagation method for aspen, *Silvae Genet.* 32, (174-176)
- Confalonieri M., Belenghi B., Balestrazzi A., Negri S., Facciotto G., Schenone G., Delledonne M. (2000). Transformation of elite white poplar (*Populus alba* L.) cv. "Villafranca" and evaluation of herbicide resistance, *Plant Cell Rep.* 19, (978-982)
- De Klerk G., Hanecakova J., Jasik J. (2008). Effect of medium-pH and MES on adventitious root formation from stem disks of apple, *Plant Cell Tiss. Organ Cult.* 95, (285-292)
- Eggens C.F., Loughheed E.C., Hilton R.J. (1972). Rooting of hardwood cuttings of boleana poplar, *Can. J. Plant Sci.* 52, (599-604)
- Kovačević B., Miladinović D., Katanić M., Tomović Z., Pekeč S. (2013). The effect of low initial medium pH on in vitro white poplar growth, *Bulletin of the Faculty of Forestry*, 108, (67-80)
- Kovacevic B., Orlovic S., Roncevic S., Miladinovic D. (2010a). The effect of silver ion, 1-naphthalene acetic acid and 6-benzylaminopurine on micropropagation of „Fastgate“ tree shape variety *Populus alba* cl. LBM, *Acta Hort.* 885, (197-202)
- Kovacevic B., Tomovic Z., Stajner D., Katanic M., Drekić M., Stojnic S. (2010b). Restoration of autochthonous poplar species (*Populus* sp.) in riparian zone – genofond establishment, *Topola/Poplar 185/186*, (61-68) [In Serbian]
- Ostrolucká M.G., Gajdošová A., Ondrušková E., Lateěková M., Libiaková G. (2010). Effect of medium pH on axillary shoot proliferation of selected *Vaccinium vitis-idaea* L. cultivars, *Acta Biol. Cracov. Bot.* 52 (2), (92-96)
- Ruzic Dj., Cerovic R. (2001). Changes in the pH value of the medium after autoclaving and during culture of sweet cherry rootstocks in vitro, *Jugosl. Vocar.* 35, (27- 37)
- Skirvin R.M., Chu M.C., Mann M.L., Young H., Sullivan J., Fermanian T. (1986). Stability of tissue culture medium pH as a function of autoclaving, time and cultured plant material, *Plant Cell Rep.* 5, (292-294)
- StatSoft Inc. (2012). STATISTICA (data analysis software system), version 12. www.statsoft.com.
- Wilkinson S., Davies W.J. (1997). Xylem sap pH increase: a drought signal received at the apoplastic face of the guard cell that involves the suppression of saturable abscisic acid uptake by the epidermal symplast, *Plant. Physiol.* 113, (559–573)

**COMPARISON ON THE DENDROMETRIC PROPERTIES OF SILVER BIRCH
BETULA PENDULA ROTH AND DOWNY BIRCH *B. PUBESCENS* EHRH.
 GROWING IN THE SIMILAR CONDITIONS**

Imants LIEPA, Olga MIEZĪTE, Dagnija BĒRZIŅA, Aigars INDRIKSONS*, Linards
 SISENIS

Latvia University of Agriculture, Jelgava, Latvia

*Corresponding author: aigars.indriksons@llu.lv

Abstract

Both of these commercial birch species are present in Latvia, growing as mixed forest stands, often without the admixture of other tree species. Birch groves occupy 28% of the Latvian forest area. It is believed that the silver birch is more common in fertile and mesic mineral soils, but downy birch prefers wetlands and nutrient-poorer areas. Often birch groves are characterized by spruce second floor and undergrowth. From dendrological point of view silver birch and downy birch are two separate tree species. But in forestry practice these ideas are ignored. This is evidenced, for example, by the fact that in forest inventory to determine parameters of individual trees and forest stands for both species are used common regulations (tables, formulas, coefficients). Another case shows the round timber market with similar prices for both species timber assortments. Objective of this research is to analyze the dendrometric differences between both birch species growing in the same environmental conditions. The empirical material was collected in the two naturally regenerated forest stands represented by two birch species. For every tree of each plot has been assessed: species belonging, tree height, the first green branch height, trunk diameter at the height of 1.3 m above the root collar, stem sinuosity. To determine tree age and course of tree growth the increment cores were obtained by using Presler's increment borer. The main dendrometric parameters including annual increment dynamics for both birch species are found to be statistically different.

Key words: *silver birch, downy birch, dendrometric parameters.*

Introduction

Four species of genus *Betula* L. are found in Latvia territory: silver birch *Betula pendula* Roth, downy birch *B. pubescens* Ehrh., low birch *B. humilis* Schrank., dwarf birch *B. nana* L. Of these the first two species have commercial importance (Mauriņš, Zvirgzds, 2006). Both of these tree species take up to 28% of the total Latvian forest area. It is believed that the silver birch make up the best site indexes stands on the loose, evenly moist and humus-rich mineral soils, while the downy birch is more common in more wet and nutrient-poor places - terrain depressions and even fens. Silver birch also demands slightly more summer warmth than does downy birch (Niemistö, 2013). However, the two species are usually found in one place, forming of mixed stands with the Scots pine *Pinus sylvestris* L., Norway spruce *Picea abies* (L.) Karst. and aspen *Populus tremula* L. On mineral soils birch stems in mixed stands are slightly larger than those in pure birch stands. On peatlands, however, birch stems in pure stands are larger than those in mixed stands. The average stem form of silver birch was straighter than that of white birch (Heräjärvi, 2001). Often, birch groves are characterized by spruce second floor and undergrowth.

From dendrological point of view silver birch and downy birch are two separate tree species. But in forestry practice this idea is ignored. This is evidenced, for example, by the fact that in

forest inventory to determine parameters of individual trees and forest stands for both species are used common regulations (tables, formulas, coefficients). The round timber market with similar prices for both species timber assortments shows another case. In addition, such attitude can raise some questions, the answers to which could lead to reconsider the current practice. According to the article topic here just we note some informative dendrometric uncertainties. Are there statistically significant differences between the two species parameters (stem and forest stand volume, stem quality, current and mean increment of volume, the reference reaction to the management regime change and to various natural risk factors)? Failing that, two birch species practical use as one species is considered to be correct. Otherwise, it would assess the economic effect of this difference.

Materials and methods

The empirical material was collected in 2015 in two naturally regenerated forest stands near City Jelgava in Latvia composed by two birch species with small admixture of Scots pine (*Pinus sylvestris* L.). Medium thick and 2 to 3 m tall brushwood consisted of the alder buckthorn (*Frangula alnus* Mill.), bird cherry (*Padus avium* Mill.), rowan (*Sorbus aucuparia* L.) and common hazel (*Corylus avellana* L.). Ground vegetation was dominated: in the first forest stand - by bilberry (*Vaccinium myrtillus* L.), *Calamagrostis arundinacea* (L.) Roth, purple Moor-grass (*Molinia caerulea* (L.) Moench) and bracken (*Pteridium aquilinum* (L.) Kuhn); in the second forest stand – by purple small-reed (*Calamagrostis canescens* (Weber) Roth), wood small-reed (*C. epigeios* (L.) Roth) and purple moor-grass (*Molinia caerulea* (L.) Moench). The research forest areas were drained twice (the previous century thirties and sixties) as a result, have developed drained mineral soils with up to 20 cm thick layer of well decomposed peat. According to Latvian forest typology (Liepa et al., 2014) currently the forest stands belong to forest site type *Myrtillosa mel*. The analysed trees grow in the municipal forests of city of Jelgava (Latvia). First forest stand coordinates: lat. 56.6217, lon. 23.7191; the second forest stand coordinates: lat. 56.6233, lon. 23.7098.

One rectangular sampling plot with an area of 0.18 and 0.20 ha respectively has been established in each stand. For each tree were collected dendrometric indicators: height, diameter at breast height, the first green branch height, rugged bark height for *B. pendula*. The separate tree trunk quality (stem sinuosity, double wooden top, branching, pest and disease injuries) and forest stand general sanitary state were visually assessed. From each tree was taken woody core 1.3 m above the root collar. The cores were sampled randomly with a Pressler's increment borer. For every cored sample ring width measurements were performed within 0.01 mm accuracy using measuring equipment Lintab4 (Schweingruber, 1996). Values at forest stand level were calculated accordingly to dendrometric algorithms, the analysis and interpretation of results were performed by graphical and statistical methods (Liepa, 1996; Philip, 1994).

Location of trees for both forest stands totally and for individual birch species separately was established randomly and evenly. The dominant tree species at the first forest stand was silver birch which according to number of trees comprised 64.0%, but regarding growing stock 81.3% (58.7% and 69.6% respectively at the second forest stand). These results corresponded with publications of other authors (Liepiņš et al., 2013), who pointed out the similar data. Research forest stands survived intensive self-thinning process, which resulted in developing to medium stocking level (0.58 and 0.54 respectively) in the age of 65 years.

We draw attention to the fact that the thinning for silver birch has been faster. This was indicated by the tiny values of number of trees (growing stock) in the smaller diameter classes, when compared with downy birch. (Fig. 1).

Results and discussion

The calculated data for mean values of established sample plots are shown in table 1.

Table 1. Characteristics of the studied forest stands

Parameters	Sample plot			
	1.		2.	
	Bs	Bd	Bs	Bd
Forest site type	Am		As	
Class of site index	Ia		Ia	
Species composition	7Bs2Bd1P		6Bs3Bd1P	
Stocking level	0.58		0.54	
Age, years	65		65	
Number of trees, ha ⁻¹	178	100	135	95
Average height, m	30.09	26.44	30.18	28.86
Average squared diameter, cm	31.60	21.20	32.54	26.05
Average tree trunk volume, m ³	1.0622	0.4327	1.1191	0.6942
Basal area, m ² ha ⁻¹	13.94	3.53	11.23	5.06
Growing stock, m ³ ha ⁻¹	188.8	43.3	151.1	66.0
Average green branch height, m	15.0±0.5	15.6±0.5	12.2±0.6	12.8±0.7
Average rugged bark height, m	1.6±0.2	-	2.4±0.3	-
Average slenderness ratio (hd ⁻¹)	1.00±0.03	1.32±0.07	0.97±0.04	1.14±0.03
Number of drilled trees	32	18	27	19

Notes: Bs – Silver birch, Bd – Downy birch, P –Scots pine, Am – *Vacciniosa mel.*, As – *Myrtillosa mel.*

It establishes a presumption that 65 years ago the two birch species were similar represented because seed trees in the surrounding mixed forest stands have been always richly found, but thinning have never been performed. Slenderness ratio i.e. h, m/d, cm between two species was markedly different (Fig. 2). This could be indicated that the downy birch on drained soils might be more sensitive to windthrow in the newer forest stands, but silver birch - in older stands.

The growing intensity of both birch forest stands have been compared using the last 30 years annual tree ring width (Fig .3). Trees were aged (35-65 years), when the radial growth had culminated and it continued to gradually decline. Except for a temporary period from 1989 to 1993 years, silver birch was indicated markedly greater increment values. This was especially true of the three time intervals: 1986 - 1989, 1994 - 2002 and 2006-2014. It is possible that this was due to a different distribution of rainfall. As is known, the two species of birch reference reaction to humidity has been partially reversed (Hynynen et. al., 2010). Moreover, the interpretation of the data have been complicated by the fact that in the neighborhood of second forest stand since the last century sixty years well functioned repeatedly renovated deep ditch.

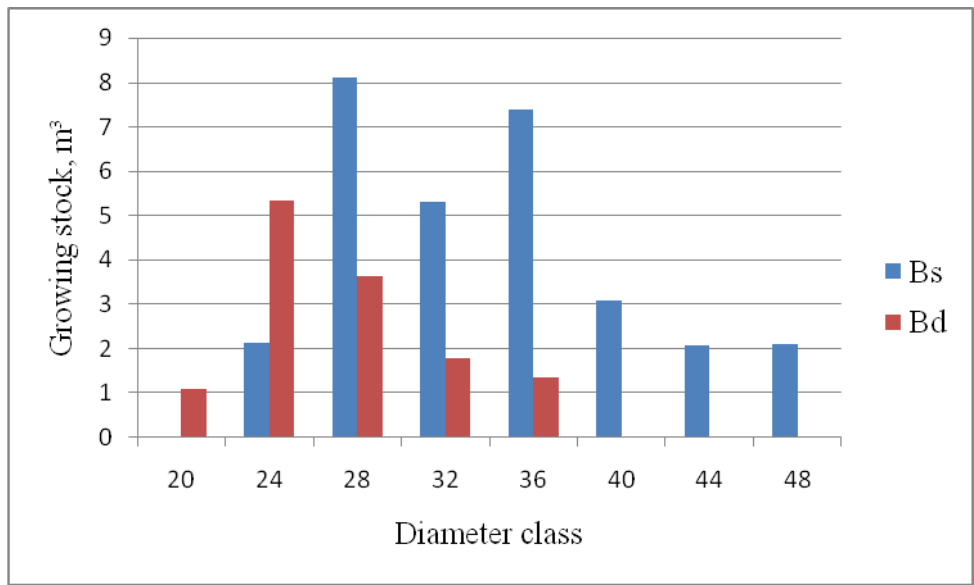

Fig. 1. The growing stock distribution among the diameter classes (second plot).

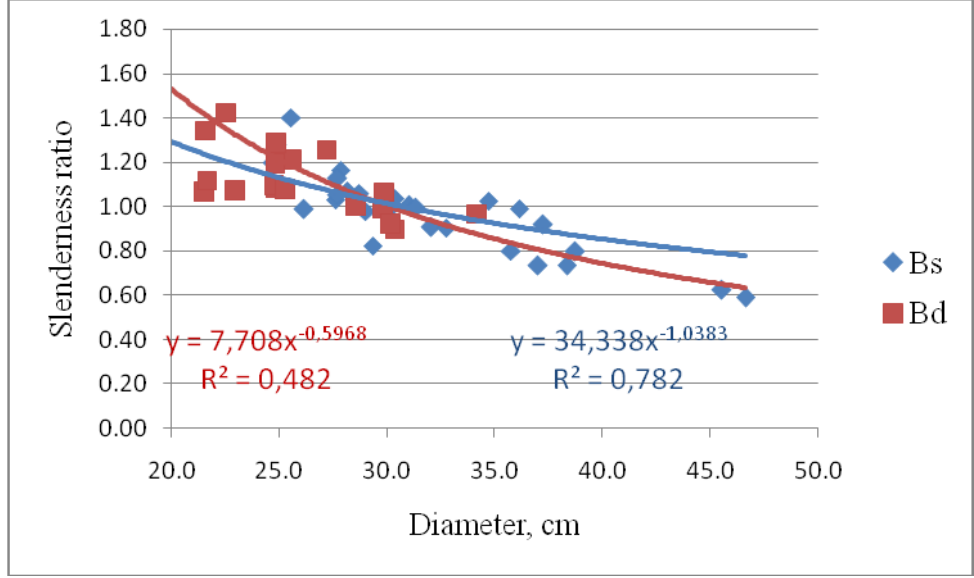

Fig. 2. The change of slenderness ratio along the tree diameter (second plot).

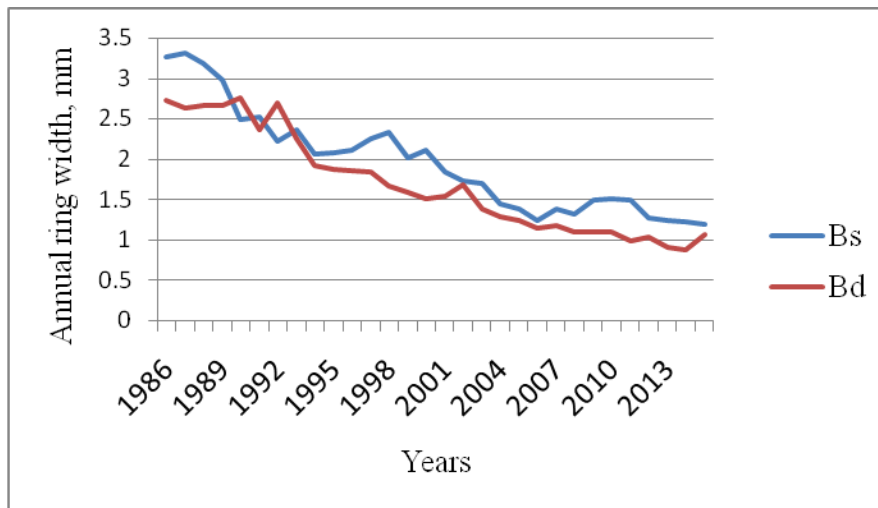

Fig. 3. Dynamics of annual tree ring width in the last thirty years, mm (second plot).

Conclusion

Our study showed that dendrometric properties between two birch species - silver birch *Betula pendula* Roth and downy birch *B. pubescens* Ehrh. growing in the similar environmental conditions (on the same places) in Latvia were remarkably different. These conclusions were not ecological and silvicultural novelty, but only proof that it is in sight to carefully decide evaluation aspects related to forest inventory. Of course, in the context of the rational use of forest resources the more important is to compare the wood mechanical and chemical qualities of two birch species.

References

- Heräjärvi H. (2001). Technical properties of mature birch (*Betula pendula* and *B. pubescens*) for saw milling in Finland. *Silva Fennica*. Vol. 35 (No. 4), article id 581.
- Hynynen J., Niemistö P., Viherä-Aarnio A., Brunner A., Hein S., Velling P. (2010). Silviculture of birch (*Betula pendula* Roth and *Betula pubescens* Ehrh.) in northern Europe. *Forestry*. Vol. 83: 103-119.
- Liepa I. (1996). *Pieauguma mācība (Increment science)*. Latvia University of Agriculture. Jelgava.
- Liepa I., Miezīte O., Luguza S., Šulcs V., Straupe I., Indriksons A., Dreimanis A., Saveljevs A., Dreska A., Sarmulis Z., Dubrovskis D. (2014). *Meža tipoloģija (Forest typology)*. Studentu biedrība „Šalkone”. Jelgava.
- Liepiņš K., Daugaviete M., Zālītis P. (2013). *Bērza plantācijas lauksaimniecības zemēs (Birch plantations on agricultural land)*. Latvijas valsts mežzinātnes institūts „Silava”, Salaspils.
- Mauriņš A., Zvirgzds A. (2006). *Dendroloģija (Dendrology)*. LU Akadēmiskais apgāds. Jelgava.
- Niemistö P. (2013). Effect of growing density on biomass and stem volume growth of downy birch stands on peatland in Western and Northern Finland. *Silva Fennica*. Vol. 47 (No. 4), article id 1002.
- Philip M. S. (1994). *Measuring trees and forests*. University Press, Cambridge, UK.
- Schweingruber F.H. (1996). *Tree rings and environment dendroecology*. Haupt. Berne, Stuttgart, Vienna.

VARIABILITY OF MORPHOLOGICAL CHARACTERISTICS OF FRUITS AND SEEDS OF WILD CHERRY (*PRUNUS AVIUM* L.) IN NATURAL POPULATIONS IN THE REPUBLIC OF SRPSKA (BOSNIA AND HERZEGOVINA)

Milena STANKOVIC^{1*}, Vasilije ISAJEV², Sasa ORLOVIC³, Srdjan STOJNIC³

¹ Department for Forestry, Faculty of Agriculture, University of East Sarajevo, Bosnia and Herzegovina

² Faculty of Forestry, Belgrade, Serbia

³ Institute of Lowland Forestry and Environment, Novi Sad, Serbia

*Corresponding author: stankovic.milena08@yahoo.com

Abstract

The paper presents the results of the research into the intra and inter-population variation in the morphological characteristics of the fruits and seeds of five populations of wild cherry (*Prunus avium* L.) in the Entity of the Republic of Srpska. The fruits and seeds were collected from 10 trees of five wild cherry populations in municipalities of Kalinovik, Višegrad, Milici, Ribnik and Prnjavor in the summer 2015. The studied morphological properties were: fruit length, fruit width, seed length, seed width and petiole length. The population "Ribnik" was characterized by the highest coefficient of variation regarding petiole length (10.6%). On the other hand, the lowest variation coefficient was observed in the population "Milici" for seed width (3.9%). The ANOVA showed that the variation between populations as well as the variation between the genotypes within the populations were highly significant ($p < 0.001$) for all of the analysed traits. Statistically significant correlation was observed between fruit and seed traits studied, as well as between petiole length and fruit length. The conducted research can serve as a starting point for further researches when it comes to breeding wild cherry in the Republic of Srpska and beyond.

Key words: *wild cherry, population, half-sib lines, morphology, the Republic of Srpska*

Introduction

Wild cherry (*Prunus avium* L.) is one of many wild fruit trees that can be found in the forests of the entity of Republic of Srpska (RS), Bosnia and Herzegovina (B&H) (Mataruga et al., 2013). The tree usually grows up to 20 m high, and it is rarely bigger than 50 cm in diameter. It belongs to the fast-growing species with life span of 40 to 60 years. It produces rich blossom early in spring, with prominent white blossoming due to which trait it is present in bee keeping. The fruit is small, 1 cm thick, of roundish shape (Jovanovic, 2000). Edible fruits ripen from June to August and are red or black, often distributed by birds and small mammals (Pilipovic et al., 2011). Wild cherry (*Prunus avium* L.) has manifold significance for the economy of the RS. Back in 1954, it was proclaimed the "Tree of the Future" (Bejdl, 1954), but this species was not given sufficient attention in our areas. The Law on Forestry forbade cutting of wild fruit trees, wild cherry included, but in the post-war period, from 1996 to 2000, all wild cherry trees that could be used for processing were cut down in B&H (Ballian et al., 2007). The first researches of variability of wild cherry in B&H started in 1990. Plentiful material was collected and *half-sib* posterity grown to over 200 families. The researches were stopped because of war activities in B&H, while data and grown/bred posterity destroyed. In the post-war period, the lack of resources prevented extensive studies of the wild cherry, but local researches of morphological and genetic parameters were undertaken (Ballian, 2000, 2004). Among the great number of species having stone fruits, wild cherry excels as the most significant one with great economic value. Branches produced by the form of smooth crust, small, bitter and black fruits that ripen late (Ballian et al., 2007).

Use value of the wild cherry trunk as raw material for wood-processing industry and pomology significance should be directed towards raising progeny tests, while seed material shall serve for raising dedicated cultures for the purpose of production of raw materials for food processing industry, pharmaceutical and chemical industry.

In order to preserve the wild cherry genetic resources, the primary aim is to determine the richness of its gene pool as the basis for the conduct of measures of preserving, measures of breeding and commercial use (Nonić et al., 2013). This research focuses on studying the morphological parameters of the fruit and seed of wild cherry originating from five natural populations in the RS. The main aim of the research is to determine variability of studied characteristics within the population and among the populations, as well as the level of connectivity between the studied characteristics. The researches have been conducted with the aim of preserving the wild cherry on the territory of the RS and beyond.

Material and method

Material for the morphological analysis (fruits and seeds) of the fruit and the seed was collected from five natural populations in the RS: Kalinovik, Višegrad, Milići, Ribnik and Prnjavor municipalities. At each of these locations, 10 trees were selected, and thirty healthy, normally developed and ripe fruits with petioles were collected from each fruit tree. The trees were selected on the basis of phenotypic characteristics and the volume of fruiting (Isajev et. al., 2011). Fruits and seeds were collected during the month of June and July 2015, depending on the altitude where the above indicated populations are found. The first fruits for the research were collected in the middle of June, from the population Prnjavor, which is at the altitude of 185 m, while the fruits that were last collected were collected from the population Kalinovik (1070 m above the sea level), in the end of July. Measuring of the fruits was done by nonius with accuracy of 0,01 mm.

Morphometric analyses comprised the following parameters: fruit length (FL), fruit width (FW), seed length (SL), seed width (SW) and the fruit petiole length (PL). The measured morphological characteristics are described through descriptive statistical indicators: mean value (\bar{x}), standard deviation (SD), coefficient of variation (CV). In order to determine intra and inter-population variability of the wild cherry, Nested ANOVA. The analysed variability factors were "population" and "tree" (tree factor nested inside of population factor). Correlation among studied characteristics was determined using Pearson's correlation ($p < 0.05$). Collected data were processed by means of statistical programme Statistica 10.0 (StatSoft, Inc.).

Results and discussion

Results of descriptive statistical analyses indicated that the mean value of the fruit length varied from 9.4 mm in the population Kalinovik up to the maximum of 12.2 mm in the population Višegrad. The lowest variation in the fruit length characteristics was found in the wild cherry from the population Višegrad (5.5%), while the population Kalinovik indicated the highest variation in the fruit length (6.9 %).

When it comes to the fruit width characteristic, the mean value varied from 8.6 mm in the population Kalinovik up to 11.9 mm in the population Višegrad. Variation coefficient for the fruit length characteristic showed that the lowest variability of this studied characteristic was observed with the population Višegrad (6.3%), while the highest variability was observed with the population Ribnik (8%).

Results of the descriptive analysis for the seed length characteristic indicate that the mean value of the seed length varied from 5.9 mm in the population Kalinovik, up to 6.6 mm in the population Višegrad. Minimum length of seeds was recorded in the population Ribnik and amounted to 5.0 mm, whereas the maximum length of seeds was recorded in the population

Višegrad and amounted to 7.2 mm. Average deviations by population varied from the minimum of 0.30 mm for the population Milići up to the maximum of 0.40 mm for the population Ribnik. The lowest variability in the seed length was recorded in the population Višegrad and amounted to 4.6%, while the highest variability was recorded in the population Ribnik and amounted to 6.8%.

The mean value in the seed length characteristic varied from 4.8 mm in the population Kalinovik up to 5.5 mm in the population Prnjavor. Variability coefficient for this studied characteristic indicates that the lowest variability was observed in the population Milići (3.9%), while the highest one was observed in the population Kalinovik (6.5%).

For the petiole length characteristic, the results of descriptive statistics showed that the mean value of petiole length by population varied from 34.7 mm in the population Kalinovik up to 39.9 mm in the population Prnjavor. The lowest variability coefficient of the petiole length was recorded in the population Višegrad (8.0 %), while the highest one was recorded in the population Ribnik (10.6 %). Results of descriptive statistics for average mean values and variations are presented in Table 1.

Table 1. Descriptive statistical analysis of studied fruit and seed morphological traits. Means followed by the same letters within a variable are not significantly different ($p < 0.05$).

Trait	Parameter	Kalinovik	Milići	Prnjavor	Ribnik	Višegrad	All populations
PL	\bar{x} (mm)	34.7 ^b	37.5 ^{ab}	39.9 ^a	34.8 ^b	37.9 ^{ab}	37.0
	SL (mm)	3.32	3.63	3.22	3.70	3.04	3.4
	CV (%)	9.6	9.6	8.1	10.6	8.0	9.2
FL	\bar{x} (mm)	9.4 ^c	10.9 ^b	11.2 ^b	10.7 ^b	12.2 ^a	10.9
	SL (mm)	0.64	0.64	0.69	0.63	0.68	0.7
	CW (%)	6.9	5.8	6.1	5.9	5.5	6.1
FW	\bar{x} (mm)	8.6 ^d	10.9 ^b	10.5 ^b	9.6 ^c	11.9 ^a	10.3
	SL (mm)	0.60	0.73	0.70	0.77	0.76	0.71
	CV (%)	7.0	6.7	6.7	8.0	6.3	6.9
SL	\bar{x} (mm)	5.9 ^b	6.4 ^a	6.5 ^a	5.9 ^b	6.6 ^a	6.3
	SL (mm)	0.37	0.30	0.37	0.40	0.31	0.35
	CV (%)	6.2	4.7	5.7	6.8	4.6	5.6
SW	\bar{x} (mm)	4.8 ^c	5.2 ^{ab}	5.5 ^a	5.0 ^{bc}	5.4 ^a	5.2
	SL (mm)	0.32	0.21	0.28	0.30	0.26	0.27
	CV (%)	6.5	3.9	5.1	6.0	4.9	5.3

The research results show high level of variability of studied characteristics. Analysis of variance (ANOVA) indicated highly significant differences ($p < 0.001$) for all studied characteristics, both between the populations of wild cherry and between the genotypes within the populations (Table 2).

Table 2. Results of Nested designed ANOVA analysis for investigated fruit and seed characteristics.

		df	PL	FL	FW	SL	SW
Between populations	<i>F</i>	4	117.0	671.6	861.9	240.8	269.5
	<i>p</i> ($<$)		0.001	0.001	0.001	0.001	0.001
Within populations	<i>F</i>	45	43.4	48.6	41.5	48.2	45.3
	<i>p</i> ($<$)		0.001	0.001	0.001	0.001	0.001

Correlation analysis results conducted at individual level indicate highly significant correlation of the length and the width of the fruit ($p < 0.001$), length of the fruit and width of the seed ($p < 0.001$), length of the fruit and the width of the seed ($p < 0.001$), width of the fruit and length of the seed ($p < 0.001$), width of the fruit and the width of the seed ($p < 0.001$), as well as for the length and the width of the seed ($p < 0.001$) and the length of petiole and the length of the fruit ($p < 0.015$) (Table 3).

Table 3. Correlation matrix was made at individual level for all investigated characteristics. Bold values indicate significant correlations at $p < 0.05$.

	FL	FW	SL	SW
PL	0.3436 p<0.015	0.2355 p=0.100	0.1180 p=0.415	0.1268 p=0.380
FL		0.9017 p<0.001	0.6877 p<0.001	0.5794 p<0.001
FW			0.7737 p<0.001	0.6730 p<0.001
SL				0.9196 p<0.001

Legend:

PL- petiole length, FL- fruit length, FW-fruit width, SL-seed length, SW-seed width

The results showed that the size of fruit and seed were in accordance to the values found by other authors. Ballian (2000) states that the mean of length of seeds of selected trees amounts to 8.63 mm, and the seed width is 7.15 mm, Nonić et al. (2013), state the results of their researches indicating that the length of the seed varies from 6.48 to 8.31 mm. Jovanović (2000) and Šilić (1983) state that dimensions of the fruit vary by around 1 cm for the fruit petiole length characteristic. Noćajević et al. (2012) found that the fruit petiole length varied from 33.6 mm to 42.3 mm (results for the year 2006), and also from 36.3 to 53.3 mm (results for the year 2007). Analysis of morphological characteristics of fruits and seeds in five natural populations of wild cherry in the Republic of Srpska (Bosnia and Herzegovina) was conducted with the aim of determining intra- and inter-population variability which would presents the grounds for further work on breeding of this species. Results of the research indicate that the highest mean length of fruit petiole was recorded in the population Prnjavor, and that this population significantly defers when compared to the populations Kalinovik and Ribnik, unlike other populations, that are similar. Study of the fruit length indicated that the populations Višegrad and Kalinovik differ between each other significantly, as well as that these populations differ when compared with other populations. Also, similarity of this

studied characteristic is found among the populations Milići, Prnjavor and Ribnik. For the fruit width characteristic, the results of the research indicated that the populations Kalinovik, Višegrad and Ribnik differ among each other as well as that these populations differ in relation to the populations Prnjavor and Milići, among which there is a similarity. The research conducted for the seed length characteristic indicated that the populations Milići, Prnjavor and Višegrad significantly differ in relation to the populations Kalinovik and Ribnik. The study of the seed width characteristic showed that the populations Višegrad and Prnjavor significantly differ in relation to the populations Kalinovik and Ribnik. Results of this research proved that there are significant differences in all studied characteristics, both among the populations of wild cherry and between genotypes within the populations. Similar results were also reached by Ballian (2000); Ballian (2007); Ballian (2013). The conducted research studies indicate that statistically significant differences were found between analysed populations and genotypes within the same populations. Statistically significant differences that appeared between genotypes and populations indicate the impact of both the genotypes and the environmental factors. Namely, when the above stated results are analysed, they show that there is a similarity between the populations Ribnik and Kalinovik in all three studied characteristics (the fruit petiole length, seed length and width), as well as that there is a similarity between the populations Milići and Prnjavor in all studied characteristics. Namely, the populations Ribnik and Kalinovik are found at higher altitudes that vary by above 500 m of altitude compared to the populations Milići, Prnjavor and Višegrad.

Conclusion

The analyses of variance indicated highly significant difference ($p < 0.001$) in all studied characteristics, both between the genotypes within the populations and among the populations of wild cherry.

Results of morphometric analysis indicate that the fruit petiole length (PL) is the most variable characteristic; the lowest coefficient of variance for petiole length was recorded in the population Višegrad (8.0 %), while the highest one was recorded in the population Ribnik (10.6 %). According to the variation coefficient value, the lowest variance was found in the seed width (SW), and it was found in the population Milići (3.9%).

The lowest average means for all studied characteristics (fruit length, fruit width, seed length, seed width and the fruit petiole length) was found in the population Kalinovik.

For the petiole length and seed width characteristics, the highest mean values were found in samples taken from the populations from Prnjavor, while the population from Višegrad indicated the highest mean values for the length and width of the fruit, as well as for the seed length.

The lowest deviations from the mean value was found in the population Milići (0.21 mm) for the seed length characteristic, while the highest deviation was found in the population Ribnik for the petiole length characteristic (3.70 mm).

Statistically significant correlations were recorded between the fruits and the seeds for all studied characteristics, as well as between the petiole length and the fruit length.

The following phase in our researches shall be to establish the tests of wild cherry posterity by collecting seeds from the populations that have been the subject of our research presented in this paper. Better knowledge of genotypes and production of seedlings at the level of half-sib lines would help us achieve the set aims in terms of raising cultures for special purposes at various habitats.

Acknowledgement

This paper has been produced within the project “Genetic diversity and variability of wild cherry (*Prunus avium* L.) in the Republic of Srpska“, financed by the Ministry of Science and

Technology of the RS. We are also grateful to the Public Enterprise “Forests of the Republic of Srpska” (JPS „Šume Republike Srpske“) for their support during the field work.

References

- Ballian D. (2000). Initial research into the variability of the morphological properties of the wild cherry seed (*Prunus avium* L.), Forestry Journal Zagreb, no. 5-6.
- Ballian D. (2002). The variability of the characteristics of the wild cherry blossom (*Prunus avium* L.) in the region of the central Bosnia, Analysis – Forestry, Zagreb, no. 25/2, p. 19.
- Ballian D. (2004). The variability of the microsatellite DNA in wild cherry populations (*Prunus avium* L.) from the central Bosnia. Forestry Journal Zagreb, no. 11-12.
- Ballian D., Čabaravdić A. (2007). Some correlations between the properties of buds, flowers and seeds of the wild cherry (*Prunus avium* L.) from the population of Mrkovići, Works of the Faculty of Forestry, University of Sarajevo, No 1, p. 28-30.
- Ballian D., Mujagić -Pašić, A. (2013). Morphological variability of the fruit and seed of wild cherry (*Prunus avium* L.) in a part of its natural distribution in Bosnia and Herzegovina, Biologica Nisana 2013, p. 15-17.
- Bejdl R. (1954). *Prunus avium*, The tree of the future, Lesen, Prace 33 (8): p. 354-357.
- Isajev V., Šijačić – Nikolić M. (2011). Practical course from Genetics with Crop Improvement. Faculty of Forestry of the University of Belgrade, Belgrade
- Jovanović B. (2000): Dendrology. University of Belgrade, p. 303.
- Mataruga M., Isajev V., Orlović S. (2013). Forest Genetic Resources, Banja Luka, p. 44.
- Mikić T. (1991). The application of methods of crop improvement in breeding the intensive cultures of forest trees with the aim of increasing the wooden mass with short productive period, Faculty of Forestry Sarajevo, Annual Report, p. 7-14.
- Mikić T. (2007). Analysis of the morphological parameters of the wild cherry (*Prunus avium* L.) leaf in Bosnia and Herzegovina. Doctoral Thesis. Banja Luka.
- Noćajević S., Ferhatović Dž., Smailhodžić H., Karić S. (2012). Morphometric and meristic characteristics of the fruit of wild cherry (*Prunus avium* L.) autochthonous genotypes in the surroundings of Tuzla, The Second International Colloquium “Biodiversity – Theoretical and Practical Aspects”, Sarajevo, p. 284-287.
- Nonić M., Popović V., Kerkez I., Šijačić-Nikolić M. (2013). The variability of morphometric characteristics of the seed of different wild cherry test trees (*Prunus avium* L.) from the region of Belgrade, Forestry no. 1-2, Belgrade 2013, p. 113-123
- Pilipović A., Orlović S., Stojnić S., Galović V., Marković M. (2011). Inventorization of the wild cherry (*Prunus avium*) genofond in Serbia with aim of a directed use of genetic potential, Topola p. 187/188, Institute for Lowlands Forestry and Environment, Novi Sad, p. 53-63.
- Šilić Č. (1983). Atlas of Trees and Bushes, “Svjetlost”, OOUR Institute for Course Books and Teaching Materials Sarajevo and Institute for Course Books and Teaching Materials Belgrade, p. 115.
- Statistica 10.0 (StatSoft, Inc.)

FOREST AREAS AS KEY INDICATOR FOR SUSTAINABLE FOREST MANAGEMENT IN SERBIA

Zvonimir BAKOVIĆ^{1*}, Branko STAJIĆ², Vladimir VASIĆ¹

¹State enterprise (SE) "Srbijašume" Belgrade, Department for Silviculture, Serbia

²Faculty of Forestry, University of Belgrade, Serbia

*Corresponding author: zvonimir.bakovic@srbijasume.rs

Abstract

Forests and forest land belong to the most important natural resources in Serbia. The area under forest represents one of the key indicators of sustainable forest management. Forests in Serbia are spread over a surface area of 2,252,400 ha. One of the main problems related to the state of forests and forest land and their sustainable management in Serbia is the inadequacy of its forest coverage (29.1%) in relation to the optimum level of 41%. From the global point of view, it is close to the world's average forest cover of 30%, but drastically lower than the 46% in Europe (TBFRA 2000). The forest cover in Serbia needs to be raised to its optimum level by year 2050. Sustainable forest management has its own requirements that can be fulfilled only if we provide certain preconditions. As regards the forest cover, the goal is to increase it by afforestation. According to the provisions of the Spatial Plan, the operational objective of the Republic of Serbia implies that, with respect to global space regionalization and categorization, 450 km² of new forests were to be established in the period 2010 - 2014. Operational objectives are by nature specific, measurable, time-framed, "real" and susceptible to analysis. In this context, two main objectives are contained in this paper. Based on the data available, the first objective is to do an analysis on the area size of new forests in Serbia that were established through afforestation of barren land in the period 2010 - 2014. In this regard, an assessment will be made of whether the afforestation level and trend represent a sufficiently secure framework to ensure sustainable forest management in Serbia. The second objective of this paper is to analyze the resources of the Budgetary Fund for Forests of the Republic of Serbia allocated for the purpose of afforestation on barren lands for the period 2010 - 2014. For this purpose, an analysis will be carried out (growth / decline trend) of allocated funds and the by-laws related to the conditions for their granting, allocation and justification. The paper shall give specific recommendations on how to improve the current situation in this field, given the conditions in Serbia.

Keywords: *afforestation, sustainable forest management, Serbia*

Introduction

Intense exploitation and partial "degradation" of forests in Serbia and most of South-East Europe began as early as the 18th century, especially in the 19th century (Stajić et al. 2009), which may explain a significant part of the total anthropogenic impact on forests. Forests in Serbia play a very important role in environmental protection, with a large number of regulatory and protective functions (protection of waters and water supply, protection against erosion, improving soil hydrological properties, balancing the hydrological cycle, biodiversity protection, etc.) (Aleksić et al. 2013).

Based on the provisions of the Draft Spatial Plan of the Republic of Serbia (RS), "the assessment of the conditions relating to spatial development of Serbia has been carried out according to the integral method which involves understanding of interinfluence among economic, social and physical-environmental development". According to this draft, and in

the spirit of sustainable development, the top-priority should be conservation of nature (forest ecosystems) and the environment.

Forests are one of the most important natural resources in the RS. Primarily, environmental quality depends largely on the forest cover. The preservation and improvement of the current forest conditions are directly related to the quality of the living environment. Increasing the forest area in a sustainable manner in order to increase biomass (green and wood), and their correct spatial zoning represent a challenge for both the state and profession.

The forest coverage of the RS is 29.1%, which is below expectations as compared to the plans. The planned optimal forest cover for the RS is 41.4%, and it is to be reached by the year 2050.

Important prerequisites to reach the required / planned percentage of forest cover are: the harmonization of the legal framework and planning provisions, development and adoption of the National Forestry Action Programme (NFAP) and securing the necessary funding for the establishment of new forests.

One of the key indicators for assessing the sustainability of forest management is the forest surface area, i.e. whether it decreases or increases over time.

This paper has two main operational objectives. The first objective is to analyse the area size of new forests in Serbia that were established through afforestation of barren land in the period 2010 – 2014, and the second one is to analyze the resources of the Budgetary Fund for Forests of the Republic of Serbia allocated for the purpose of afforestation on barren lands for the same period.

Materials and methods

Background

In order to realize the set goals, different empirical (statistical) data on the forest conditions were used (see their overview by surface area). In some depictions, there are certain differences in relation to the data of the National Forest Inventory of the Republic of Serbia (NFIRS), in terms of both methodology and time.

The data on the establishment of new forests has been obtained on the basis of records of performed work kept by the users. Through grouping, the data is presented in tables and analyzed using graphs, aiming at full comprehension.

Method of work

Acknowledging the stated research problem, the methodological procedure used in the preparation of this paper has been basically analytical-synthetical in its character. International and national professional literature relating to the field of interest has been used.

The most frequently used scientific methods in research have included: the method of analysis and synthesis, comparative method and, lastly, method of induction and deduction.

Results and discussion

Forests and forest lands in Serbia

Prior to the presentation on the conditions of forests and forest land in the RS, an overview of area structure according to land type (land use model) is given in Table 1 below.

Table 1. Area Structure by Land Type (Land Use Model)

Land Type (Land Use Model)	Area	
	ha	%
Forest	2,252,400.00	29.10
Other Forest Land	382,400.00	4.90
Barren Land	92,000.00	1.20
Agricultural Land	3,594,800.00	46.40
Meadows and Pastures	1,029,600.00	13.30
Urban Land	312,000.00	4.00
Water Surfaces	85,200.00	1.10
Total	7,748,400.00	100.00

Source: NFIRS (2009)

Considering the data presented in Table 1, we may conclude that the forest coverage of the RS is 29.1%.

Se “Srbijašume” – condition of forests and forest land

SE “Srbijašume” manages forests and forest land in a total area of 896,266.06 ha, of which 767,523.87 ha of wooded area and 128,742.19 ha of unwooded area (Table 2). The ratio between wooded (under trees) and unwooded areas (forest land) at SE “Srbijašume” is 86% : 14%, which can be assessed as relatively favourable. SE “Srbijašume” manages 40% of a total of 2,252,400 ha (Banković et al. 2009) under forests in Serbia.

Table 2. Area Conditions at the Level of SE “Srbijašume”

SE “Srbijašume”	Total Area	Forests & Forest Land				Other Land			Usurped	Other People's Land	Wooded		Unwooded		Total
		Total	Forests	Forest Culture	Forest Land	Total	Barren	For Other Purposes			ha	%	ha	%	
	ha	ha	ha	ha	ha	ha	ha	ha	ha	ha	ha	ha	ha	ha	
1	2 (3+7+10+11)	3 (4+5+6)	4	5	6	7(8+9)	8	9	10	11	12 (4+5)	13	14(6+7+10)	15	16 (12+14)
Total SE	927,113.83	847,196.44	743,467.38	24,056.49	79,672.57	47,701.54	26,752.53	20,949.01	1,368.08	30,847.77	767,523.87	86	128,742.19	14	896,266.06

Source: Internal database of SE “Srbijašume” – Belgrade, as of 31st Dec. 2014; data taken from forest stand inventory of SE “Srbijašume”.

SE “Srbijašume” performs professional-advisory activities in forests under private ownership - private forests over an area of 1,176,139 ha, covering about 3.5 million cadastral parcels and about 1,000,000 owners. Professional-advisory activities acc. to the Forest Law, include as follows: registration, tree marking for harvest, issuing logging permits, issuing shipping documentation for wood assortments, organizing activities on forest protection, training of forest owners etc.

SE “Srbijašume” manages forests and forest land owned by the state and performs professional work in private forests in the total area of 2,072,405.06 ha, which make up 92% of the total forest area in the RS (2,252,400 ha).

Condition of forests and forest land in Central Serbia (other users)

The condition of forests and forest land, owned by the state on the territory of Central Serbia, without Autonomous Province of Vojvodina (APV) and Autonomous Province of Kosovo and Metohija (AP K&M) is shown in Table 3 below.

Table 3. Condition of Forests and Forest Land, Central Serbia without SE “Srbijašume” – State Owned

Institution / State enterprise (SE)	Wooded		Unwooded		Total
	ha	%	ha	%	ha
SE National park (NP) “Kopaonik”	7,077.02	75.38	2,311.16	24.62	9,388.18
SE NP “Tara”	12,821.29	97.79	289.80	2.21	13,111.09
SE NP “Đerdap”	45,240.00	70.94	18,528.48	29.06	63,768.48
Faculty of Forestry-Belgrade	5,531.12	94.87	299.13	5.13	5,830.25
Monastery Forests-Loznica	2,348.87	97.30	65.10	2.70	2,413.97
Fornet d.o.o.	7,457.64	96.56	265.58	3.44	7,723.22
SE “Borjak”	7,758.43	94.73	431.42	5.27	8,189.85
Total	88,234.37	79.90	22,190.67	20.10	110,425.04

Source: Internal database of the institutions/SEs (June 2016)

Condition of forests and forest land - AP Vojvodina

On the territory of the Autonomous Province of Vojvodina, forests and forest land occupy a total area of 174,413 ha, of which 140,718 ha of wooded area and 33,696 ha of unwooded area (Table 4). The ratio between wooded and unwooded areas in AP Vojvodina is 93.5% : 6.5%, which can be assessed as extremely unfavourable.

Table 4. Area Conditions at the Level of APV

User	Area (ha)	Share of total Vojvodina Land Area (%)
SE “Vojvodinašume”	130,589.00	6.10
Private Forests	5,567.00	0.30
Water Management Organizations	7,575.00	0.40
Agricultural Organizations	5,989.00	0.30
Local Communities	722.00	0.03
Military Facility “Karadordevo”	2,243.00	0.10
SE NP “Fruška Gora”	22,450.00	1.00
Forests - Total	140,718.00	6.50
Unwooded -Total	33,696.00	1.60
Total of Forests & Forest Land	174,413.00	8.10
Vojvodina Land Area	2,150,600	

Source: <http://www.vojvodinasume.rs/sume/procena-optimalne-sumovitosti-u-vojvodini/> (2016)

Forests under private ownership - private forests

The State of Serbia, through its Ministry of Agriculture and Environmental Protection (MAEP) - Forest Directorate has entrusted the expert-advisory affairs in private forests to state enterprises for state forest management by forest areas and state enterprises - national parks on the territory of which the private properties are found. The forest owners themselves are responsible for the management of private forests in Serbia. Private forest area in RS without AP K&M is given in Table 5 below.

Table 5. Private Forest Area by Competent Institutions

Institution	Area under Forest	
	ha	%
SE “Srbijašume”	1,176,139	95
SE “Vojvodinašume”	5,567	0.5
SE National Parks*	25,000	2.0
SE National Parks “Tara”**	25,725	2.1
PUC Borjak	4,000	0.3
Private Forests - Total	1,236,431	100

Source: Internal database PE (2008), SE “Srbijašume” (2016).

*SE National Parks: Data from 2008; Internal documentation without NP “Tara”;

**Database NP “Tara” – Development Plan for the Tara National Park (2012-2021).

Based on Table 5, we conclude that SE “Srbijašume” performs professional-advisory activities in approximately 95% of the private forest area, while all other enterprises perform these tasks in the remaining 5% of the area. The entrusted professional-advisory activities in private forests are financed from the Budget of RS at MAEP – Forest Directorate.

Afforestation 2010 – 2014; PLAN: implementation report

Observing the forest conditions in the Republic of Serbia, it is assessed that the forest cover insufficiency (29.1%) compared to its optimum percentage (41.4%) represents the leading problem of Serbian forestry.

One of the basic assumptions of sustainable forest management is to increase the forest area through afforestation. According to the provisions of the Draft Spatial Plan of the Republic of Serbia (DSPRS) 2010-2014-2021, respecting the global zoning and space categorization, afforestation from 2010 to 2014 was to include 450 km² or 45,000 ha (Table 6).

Table 6. Forest Surface Area, Forest Cover & Afforestation Plan by 2014 in RS

Area / Province	Total Area Surface	Forest Area	Forest Cover	Optimal Forest Cover	Forest Area 2014
	km2	ha	%	%	ha
Serbia without AP K&M	77,474	2,252,400	29.1	41.4	2,297,400
AP Vojvodina	21,506	154,000	7.1	14.3	171,600
AP Kosovo & Metohija	10,887	460,800	42.1	52.7	
Serbia without APV and AP KM	55,968	2,098,400	37.5	49.8	2,125,300

Source: Draft Spatial Plan of the Republic of Serbia 2010-2014-2021, p. 73

According to data available for the period 2010 - 31st December 2014 (five-year period), new forests were established in the RS as shown in Table 7.

Table 7. Overview of Activities on Afforestation of Barren Lands & Raising of New Cultures and Plantations 2010-2014

No.	User	WorkType	Execution by Years					Total
			2010	2011	2012	2013	2014	
1	SE "Srbijašume"	Afforestation on barren lands in state-owned forests	208.00	106.00	76.00	180.00	74.00	644.00
2		Raising of new cultures and plantations on state-owned areas	16.00	19.00	47.00	70.00	54.00	206.00
3		Afforestation on barren lands in private forests	712.00	819.00	593.00	468.00	280.00	2,872.00
Total SE "Srbijašume"			936.00	944.00	716.00	718.00	408.00	3,722.00
4	SE NP "Kopaonik"	Afforestation on barren lands in state-owned forests	8.34	7.00				15.34
5	SE NP "Tara"	Afforestation on barren lands in state-owned forests	5.00					5.00
6	SE NP "Derdap"							0.00
7	Faculty of Forestry - Belgrade	Afforestation on barren lands in state-owned forests				1.00	1.40	2.40
8	Monastery Forests - Loznica	Afforestation on barren lands in state-owned forests	0.60		1.02			1.62
9	Fornet d.o.o.		6.00					6.00
10	SE Borjak							0.00
11	AP Vojvodina*							
Total RS without AP			955.94	951.00	717.02	719.00	409.40	3,752.36

* Data on the establishment of new forests in the period 2010-2014 by users managing forests in AP Vojvodina (Table 4) were not available.

Based on the data in Tables 6 and 7, drastic deviation is evident from the afforestation plan and its implementation for the period 2010 - 2014. For the space of Serbia without APV and AP K&M the difference is -23,170 ha, which means the fulfillment of the plan is 13.9%. If this trend in establishing new forests continues, by year 2050, on the territory of Serbia without APV and AP K&M there will be 26,266 ha of new forests or a forest coverage of 37.9%. Viewed through this model, the optimal forest cover of Central Serbia following this afforestation trend will be reached in several centuries from now. Considering that this is the area comprising 93% of the total forest area in the RS, this projection can be transferred to the entire RS land area with great certainty. The problem of plan non-conformities in the establishment of new forests within the conditions in Serbia is very complex and particularly noticeable.

Budgetary funds for Serbian forests

In the period 2010 - 2014 the assets of the Budgetary Fund for Forests of the Republic of Serbia (BFFRS) allocated to afforestation varied in the unit price and amount, as well as by types of work. Types of afforestation work, for which the assets were allocated by regulations and through competitions, are as follows: (I) afforestation of barren land (2010-2014), (II) raising (intensive) plantations (2010-2014, except for 2011), (III) afforestation of barren land in private forests - distribution of forest seedlings to individuals (2010 -2014), (IV) rehabilitation of surfaces through afforestation (2010-2013), (V) reforestation (2013), (VI) reclamation of degraded forests (2010-2013) and (VII) recruiting/repair planting (2013).

The amount of funds allocated to afforestation also varied, and in certain years it was not defined for each work type separately. Bearing this in mind, the fund total amount allocated to afforestation was taken into account for the purpose of analysis.

Since SE "Srbijašume" manages state-owned forests and forest land and performs expert tasks in private forests on a surface that makes up 92% of the total forest area in the RS, SE "Srbijašume" database was used in the analysis of the contract funds. Each year, during the said period, the contracted scope of work was lower than anticipated.

Since 2013, unit prices have increased (e.g. unit price for afforestation of barren land before 2013 was 110,000 dinars/ha, since 2013 - 120,000 dinars/ha). However, if one takes into account that the average price for afforestation in 2014 amounted to 236,885.46 dinars/ha, it can be concluded that the share of BFFRS assets in the overall price of afforestation of barren lands per hectare was approx. 51%. It is also necessary to point out that in 2014 the BFFRS Regulations (Regulations on detailed terms, method of allocation and use of assets from the Annual Programme for the use of the Budget Funds) were applicable, which provided an addition to the afforestation prices in terms of tending measures up to 5 years of age. Considering the above mentioned, it can be concluded that the share of the unit price in the total price of afforestation per one hectare of barren land was not 51% but 45%. When talking about raising plantations and intensive plantations, this ratio was far more favourable. The unit price of 120,000 dinars/ha was about 91% of the calculated average price (131,774.13 dinars/ha). When tending measures up to 5 years of age are added to the average price, the participation of the unit price was around 77%. Since 2016, by entering into force of amendments to the BFFRS Regulations, the situation has been somewhat better. Namely, by the above amendments, it was defined that the tending measures up to 5 years of age were to be financed separately from afforestation.

The scope of work allocated to afforestation varied from year to year, but from 2012 to 2014 a drastic downward trend was noticeable. It should be noted that in 2014 no contract was signed for afforestation of barren lands in private forests - distribution of forest seedlings to individuals, yet these works were contracted during 2015. Also, in 2014 the contracted amount of 5,817,600 dinars was related to the works carried out in 2013. The competition in 2014 did not anticipate the funding of afforestation in state forests which was included within the works agreed for the year 2015.

Table 8 shows the financial assets allocated by regulation, as well as financial assets contracted in the period 2010 - 2014.

Table 8. Allocations & Contract Funding

Year	Total by Regulation	Afforestation Anticipated by Regulation	Contracted
	din	din	din
2010	462,681,863	amount not defined separately	80,894,011
2011	577,969,400	199,570,000	106,330,184
2012	1,500,000,000	379,500,000	54,080,255
2013	809,998,929	46,000,000	18,120,493
2014	510,000,000	8,681,053	5,817,600

A lack of financial resources can be cited as one of the main reasons for the above stated. When talking about the assets of the BFFRS, it should be noted that, when compared to 2013 and 2014, there has been a considerable increase in asset allocation to afforestation by regulations in the last two years. Also, an increase in contracted assets for afforestation works has been noticed.

Conclusions

The area under forest represents a major indicator of sustainable forest management. This fact is gaining in importance in the times of current climate changes, especially when viewed through the prism of the conclusions from the Paris Conference COP 21, the Conference of the Parties (COP 21) to the United Nations Framework Convention on Climate Change.

The forest area in the Republic of Serbia (without AP K&M) is 2,252,400 ha, which means that it is close to the world's forest cover of 29.1%.

The Spatial Plan of the Republic of Serbia anticipates 41.4% of forest cover by 2050. Five-year operational plans (DSPRS) for the period 2010 – 2014 envisaged the establishment of 450 km² of new forests. These were to be established through: protection forests (against erosion = 100 km², protection of roads = 10 km², emissions reduction = 23 km², protection of agricultural crops = 20 km², water protection = 135 km², rehabilitation of tailing ponds = 18 km²) afforestation on degraded lands (6th and 7th land capability class) on a total area of 119 km² and planting of new forests in suburban zones on a total area of 25 km².

Initial afforestation activities in Serbia started back in 1818. The technologies and requirements for the establishment of new forests in Serbia have been changing during its 200-year-long tradition.

When it comes to the extent of afforestation in Serbia, the “golden” period is linked to the end of the 20th century. The afforested areas by periods were as follows: 1975 – 1980 = 18,930 ha; 1980 – 1985 = 15,150 ha; 1985 - 1990 = 8,720 ha. There has been a declining trend ever since.

In the period 2010 – 2014, on the territory of Serbia (without APV and AP K&M, which represents 97% of the total forest area), a total of 3,752.36 ha of new forests was established, i.e. the plan fulfillment was 13.9%. If this trend continues, Central Serbia will reach its optimal forest cover of 49.8% in several centuries from now. Viewed through this perspective, the trend can be assessed as highly unfavourable.

For the purposes of establishing new forests in Serbia, mostly the assets from the Budget Fund for Forests of the RS are used. In the period 2010 - 2014 the assets allocated to afforestation varied in the unit price and amount, as well as by types of work. The share of BFFRS assets in the overall price of afforestation of barren lands per hectare was in the range between 45% and 51%. The difference up to the full price was covered by the users from their own resources. Asset allocation is defined by the Regulations. According to the regulations, in the observed period tending measures up to 5 years of age were to be added to the price of afforestation. The amount of assets for the purpose of establishing forests in Serbia in the observed period can be assessed as insufficient.

The general conclusion is that the afforestation for the observed five-year period has not satisfied the SMART matrix. To be more precise, the afforestation plan has met the test requirements of this matrix in the first part (**S**pecific - clear and defined; **M**asurable - can be estimated on the basis of quality, timing, quantity or resources). However, it has failed in the second part of the matrix (**A**ttainable; **R**ealistic – the society, institutions and individuals should have control / direct responsibility and the opportunity to achieve the planned level of afforestation; **T**imely – the planned goal of afforestation should include clear deadlines for implementation).

The problem of plan non-conformities in the establishment of new forests within the conditions in Serbia is very complex and particularly noticeable.

With the adoption of amendments to the Forest Law in 2015, and the new Regulations in 2016 the situation has slightly changed for the better. The very regulatory amendments have introduced the provision according to which the tending measures up to 5 years of age are to be financed separately from afforestation. Also, an increase in contracted assets for afforestation works is noticeable, which is an encouraging sign and announces a new era in afforestation in Serbia. This will ensure a considerable increase of the forest area in Serbia, which is one of the key indicators of sustainable forest management.

References

- Aleksić P., Baković Z., Kisin B. (2013). Strategic assessment of environmental impact in strategic planning in Serbian forestry on the example of Južni Kučaj forest area, "Environmental protection between science and practice - Status and perspectives", Institute of Protection, Ecology and Informatics, Banja Luka, 13 December, 2013; ISBN 978-99938-56-27-6, COBISS.BH-ID 3756824, pp. 415-424.
- Banković S., Medarević M., Pantić D., Petrović N. (2009). National Forest Inventory of the Republic of Serbia – Growing Stock of the Republic of Serbia. pp. 43-93, Ministry of Agriculture, Forestry and Water Management of the Republic of Serbia - Forest Directorate, Belgrade.
- Forest Law ("Off. Gaz. RS", Nos. 46/91, 83/92, 53/93, 54/93, 60/93 - amendments, 67/93, 48/94, 54/96 and 101/05, 30/2010, 93/2012, 89/2015).
- Medarević M. (2001). Forests of Đerdap. National Park "Đerdap". Ecolibri, Belgrade, p. 168.
- Nonić D., Milijić V. (2008). Analysis of the current situation of the private forest sector in Serbia and its role in the process of defining the Forestry Development Strategy (FDS) and the National Forest Programme (NFP). PROFOR CEPF p. 8.
- Stojkov B. (2010). Spatial Plan of the Republic of Serbia 2010-2014-2021 - Draft, Republic of Serbia - Ministry of Environment and Spatial Planning, Republic Agency for Spatial Planning.
- Stajić B., Zlatanov T., Velichkov I., Dubravac T., Trajkov, P. (2009). Past and recent coppice forest management in some regions of south-eastern Europe. *Silva Balcanica* 10, pp. 9-19.
- Stajić B., Baković Z., Kisin B. (2014). Inventory of carbon in the forests of the State Enterprise "Srbijašume" - an important factor in the protection and improvement of the environment. Higher Education Technical School of Professional Studies in Novi Sad, Faculty of Technical Sciences, University of Novi Sad, Department of Environmental Engineering, Ministry of Labour and Social Policy of the Republic of Serbia. ISBN 978-86-6211-091-6, COBISS.SR-ID 283099911, pp. 419-428.
- Development Plan for the Tara National Park 2012-2021 (2012). National Park "Tara" – Tara. Regulations on detailed terms, method of allocation and use of assets from the Annual Programme for the use of the Budget Fund for Forests of the Republic of Serbia and the Budget Fund for Forests of the Autonomous Province ("Off. Gaz. RS" No. 32/2011).
- Regulations on detailed terms, method of allocation and use of assets from the Annual Programme for the use of the Budget Fund for Forests of the Republic of Serbia and the Budget Fund for Forests of the Autonomous Province ("Off. Gaz. RS" No. 17/2013, 20/2016);
- http://www.sfb.bg.ac.rs/index.php?option=com_content&view=article&id=251&Itemid=116&lang=sr. visited 13 June 2016.
- <http://www.srbijasume.rs/privsume.html>. visited 15 June 2016.
- <http://www.vojvodinasume.rs/sume/procena-optimalne-sumovitosti-u-vojvodini/> visited 14 June 2016.
- Internal documentation SE "Srbijašume" Belgrade.

HYDROLOGICAL PROPERTIES OF EUGLEY SOIL IN THE MIDDLE DANUBE BASIN

Saša PEKEČ^{1*}, Marina KATANIĆ¹

¹ Institute of Lowland Forestry and Environment, University of Novi Sad, Antona Cehova 13,
21000 Novi Sad, Serbia

*Corresponding author. pekecs@uns.ac.rs

Abstract

The paper presents hydrological characteristics of eugley soil in the middle basin of the Danube river. Eugley soil was analyzed at three sites within the part of the alluvial plain, which is protected from flood waters and wetting of this soil is under the influence of groundwater. The level of groundwater in the first profile ranged from 130 to 230 cm below the soil surface, in the second profile movement of groundwater amounted from 90 to 240 cm, while the third profile had amplitude varying from 95 to 185 cm below the soil surface. During the measurement of soil moisture at the depth of 10 cm it was noted that moisture values ranged from 8.96 to 72.65% vol., at the measurement depth of 40 cm soil moisture ranged from 12.24 to 47.74% vol., while at a depth of 70 cm soil moisture was in the range from 13.83 to 54.80% vol.. The measurement results show that the highest value of soil moisture is in the surface horizon at 10 cm depth, while soil moisture values at 40 and 70 cm are periodically increased due to the influence of groundwater capillary rising, especially in dry summer months.

Key words: *Soil moisture, Ground water, Eugley, Soil*

Introduction

In the area of distribution of alluvial plains greatest impact on the water regime of soil have water levels of nearby rivers. Part of the soil located behind embankment has totally different hydrological characteristics because moistening occurs only by underground water and rainfall, in relation to the part that is not protected by an embankment and where moistening, in addition to these two ways, takes place through floodwater. On the hydrological characteristics of the soil in this protected part the underground water has the greatest impact, and its variations during the year, while on the variation of groundwater in the protected part influence has the nearby river water stream. These soils are found at the lowest parts of the preterrace part of the alluvial plain as a representative soil from hydromorphic order (usually Gleysols according to WRB, 2006). Bearing in mind that the soil of type eugley found in preterrace part of alluvial plain are the furthest from the river bed and are located at the lowest forms of relief and depressions according to Antić et al (1968), their hydrological characteristics depend on direct moistening of profile with groundwater and indirect influence or capillary rising of groundwater through various horizons and layers of soil. These eugley soils are classified by Miljković (1996) in gley or hypogley soils according to the way of wetting. Given the depth of groundwater, in these soils due to the reduction phase and moistening of the bottom of the profile, gley horizon is located at different depths according to Antić et al. (1969). The greatest impact on pedogenetic processes and properties of eugley soils studied in this area has groundwater regime (Pekeč, 2010). Since these are floodplain soils, they have a pronounced variability of granulometric composition, which together with the variability of relief forms on which they are located, give a very variable productive values (Pekeč and Katanić, 2015)

Material and method

Research of eugley soils was carried out in 2012.on the left bank of the middle course of the Danube in an area protected with the embankment from the flood waters. At three selected sites piezometerswere placed to measure the depth of groundwater. The level of groundwater was measured once per month. Along with the measurementof groundwater, soil samples were taken monthly in disturbed condition to measure soil moisture. Samples of soil were taken from a depth of 10, 40 and 70 cm, measured in wet condition, dried in the oven at 105 °C, and measured in dry condition.

Results and discussion

The analysis of thegroundwater level ofeugley soil presentby profile 1 (Fig. 1), showed that the highest level of ground water was130 cm below ground, while the lowest level was 230 cm. The level ofgroundwater rose toApril, then declined until June after that was noticed a slight increase in its level.

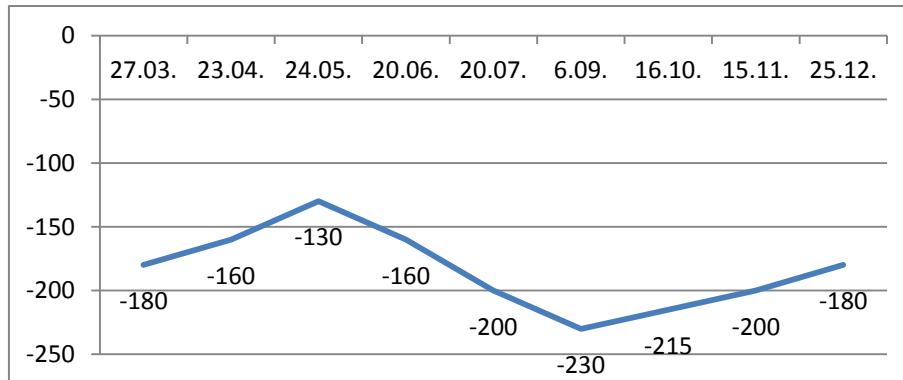

Figure 1 The level of groundwater in profile P1

The analysis of soil moisture in profile 1 (Fig. 2) showedthat moisture value wasthe highestat a depth of 10 cm and ranged from 16.56 to 72.65% vol.. Lower values of moisture content were recorded at the lower depths. The soil moisture value at the depth of 40 cm was in the range from 13.77 to 45.67% vol.and at the depth of 70 cm from 19.98 to 40.80% vol. Trend of soil moisture movement at all three depths showed an increase in the moisture value until the end of May and decline until the beginning of September, after that it was noticed an increase in moisture value in the soil at all depths.

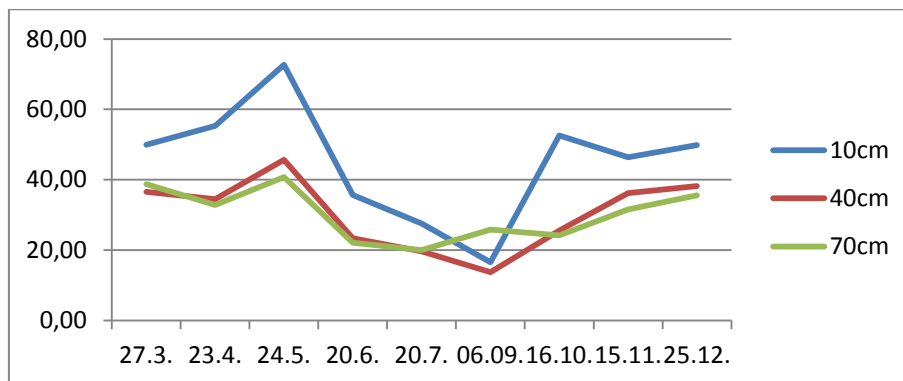

Figure. 2 The soil moisture in profile P1

In the eugley soil presented by profile P2 (Figure 3) the ground water level was highest at 90 cm below ground level and the lowest at 240 cm. Trend of groundwater is such that the level of groundwater was in decline until mid-November, after that there was a decline.

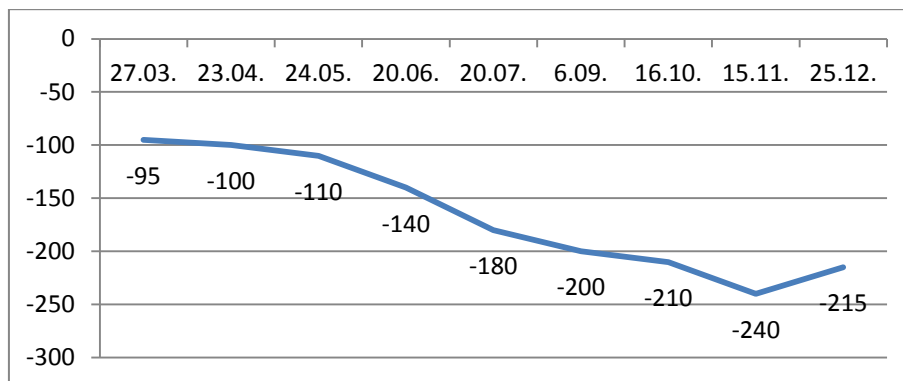

Figure. 3 The level of groundwater in profile P2

Analyzing the dynamics of soil moisture in profile P2 (Fig. 4) it was noticed that the level of soil moisture ranged from 8.96 to 54.80% vol. at 10 cm depth, from 121,24 to 47,74% vol. at 40 cm depth, and from 13.83 to 54.80% vol. at a depth of 70 cm. Soil moisture significantly increased in period from the beginning of the year to the end of May, especially in the deeper parts of the profile, then declined until the beginning of September, after that was increased until the end of the studied period.

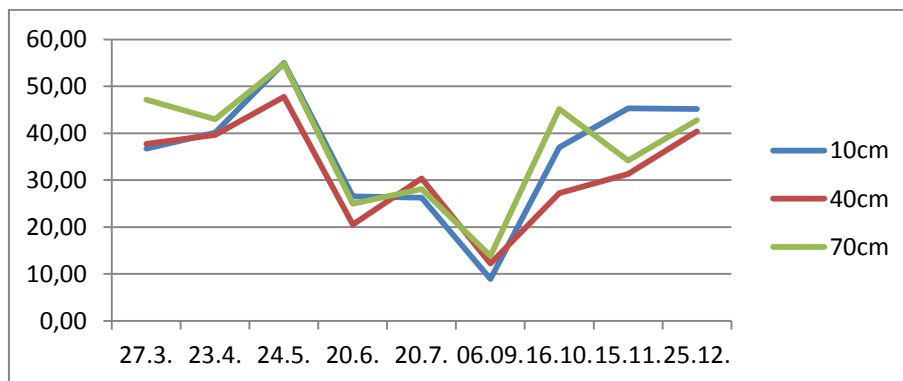

Figure 4 The soil moisture in profile P2

Groundwater level in eugley soil of profile P3 (Fig. 5) decreased until mid-November, after that increased slightly until the end of the measured period. The values of groundwater level ranged from minimum depth of 95 cm in the middle of the studied period up to 185 cm at the beginning and 170 cm depth below the soil before the end of the studied period.

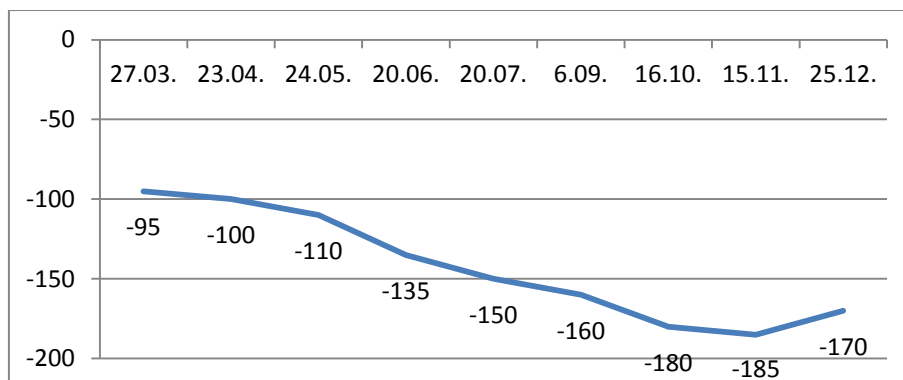

Figure. 5 The level of groundwater in profile P3

Soil moisture level in the profile P3 (Fig. 6) at 10 cm depth ranged from 15.06 to 51.58 % vol.. At a depth of 40 cm, soil moisture was in the range from 18.68 to 43.43% vol. while at a depth of 70 cm it was oscillated from 18.68 to 42.12% vol.. At all depths there is a noticeable increase of soil moisture until the end of May, then a decline until the beginning of September, and after that the value of moisture level increased again until the end of the measured period.

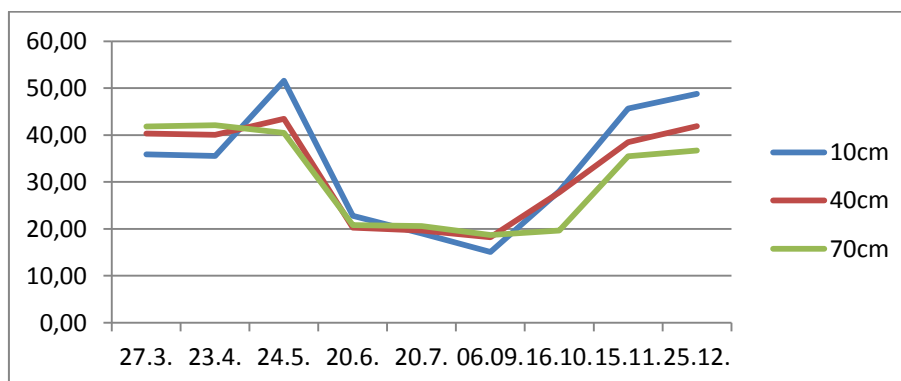

Figure 6 The soil moisture in profile P3

It was noted that the level of groundwater in the first profile ranged from 130 to 230 cm below the soil surface, in the second movement of groundwater amounted from 90 to 240 cm, while the third profile had amplitude varying from 95 to 185 cm below the soil surface. Pekeč et al (2011) recorded that in eugley soil during 2006 the groundwater level was in the range of 20 cm above the soil surface to 137 cm below the soil surface, while in 2007 the groundwater level was lower and 1 cm above the soil surface to 180 cm below ground level. In terms of soil moisture it can be seen that the highest humidity was still at a depth of 10 cm within profile P1 and P3, which can be connected to precipitation during the year. Looking at the three soil profiles of eugley soil can be seen that during the period of measurement soil moisture at 10 cm depth had values of 16.56 to 72.65% vol. in the first profile, 8.96 to 54.80 % vol. in the second profile, and 15.06 to 51.58% vol. in the third profile. In the mean of measurements at the depth of 40 cm, soil moisture ranged from 13.77 to 45.67% vol. in the first profile, 12.24 to 47.74% vol. in the second profile, and 18.68 to 43.43% vol. in the third profile. At a depth of 70 cm soil moisture ranged in first profile from 19.98 to 40.80% vol., 13.83 to 54.80% vol. in the second profile, and 18.68 to 42.12% vol. in the third profile.

Pekeč et al. (2011) studied eugley soil for the cultivation of the black cottonwood and found movement of immediate moisture at the depth of 0-30 cm in the range of 54.77 to 63.54% vol., while at a depth of 30-60 cm in the range 56.35 to 77.90% vol. which was located in the zone accessible to plants during the entire measurement period. The movement of soil moisture in the measured period was in accordance with the movement of groundwater. In the profile P2, during the entire period the highest moisture content of soil was measured at a depth of 70 cm. In the same period the profile P3 had a moisture content of soil at 70 cm depth greater than at 40 cm until the beginning of September, which can be explained by the influence of groundwater at greater depth, or capillary rise of moisture in the lower parts of the profile.

It can be noted also that the trend in soil moisture movement is almost identical at all three depths, where it rose until the end of May and then notably declined until the beginning of September, after that increased again the amount of moisture in the soil. The measurement results showed the highest value of soil moisture in the surface horizon at 10 cm depth, while volume of soil moisture at 40 and 70 cm periodically increased, due to the influence of capillary rise of groundwater, especially pronounced in the summer dry periods. Increased

soil moisture at 10 cm depth can be explained by the influence of rainfall that increase the measured moisture at this depth.

Bearing in mind the manner of moistening in these soils, Skoric et al (1985), ranked these soils among the hypogley soils or soils where the humidification occurs exclusively by groundwater. Pekeč et al (2010) have noted that the dependence of the groundwater dynamics on water level dynamics is higher when the water level is higher.

Conclusion

The paper presents hydrological characteristics of eugley soil at three locations in the middle Danube basin. The soil was located in the zone of the alluvial plain which is protected by an embankment of the flood waters so the moistening of the studied area is only possible by groundwater. The values of soil moisture varied at different measured depths. The measurement results show the highest value of soil moisture in the surface horizon at 10 cm depth, while periodically increased value of soil moisture at 40 and 70 cm was due to the influence of capillary groundwater particularly pronounced in the summer dry periods.

Acknowledgement

This paper was realized as a part of the project financed by the Ministry of Education and Science of the Republic of Serbia within the framework of integrated and interdisciplinary research for the period 2016-2019.

References

- Antić M, Munkačević V, Jović N (1968). Contribution to the classification of alluvial plains on the example of alluvial plane of Danube and Drava rivers in Baranja. Jelen bulletin. 7: 47-59.
- Antić M, Jovanović B, Jović N, Munkačević V, Nikolandić S (1969). Phytocenology-pedology studies in flooded region of Baranja. Jelen bulletin. 8: 99-114.
- Miljković N (1996). Basic Pedology. PMF. Novi Sad. Institute of Geography
- Pekeč, S. (2010): Pedological and hydrological characteristics of protected part of alluvial plain in Middle Danube Basin, Ph.D Thesis, Faculty of Agriculture, University of Novi Sad, pp. 221, Novi Sad.
- Pekeč, S., Orlović, S., Ivanišević, P., Galić, Z., Kovačević, B (2010): Moisture and air characteristic and the regime of underground water of eugley soils, First Serbian Forestry Congress „Future with forest“, 11-13, November, 2010. Proceedings, p. 1015-1020, Faculty of Forestry, University of Belgrade, Belgrade, Serbia.
- Pekeč S., Vrbek B., Orlović S., Kovačević B. (2011): Production potential of black poplars (Section *Aigeiros* Duby) on eugley. Bulletin of Forestry, No 1-2: 29-37, 2011. Zagreb
- Pekeč S., Belić M., Nešić Lj., Orlović S., Ivanišević P. (2011): Water physical properties of eugley in a protected part of alluvial plains of the central Danube Basin, African Journal of Agricultural Research Vol. 6(7), pp. 1717-1725.
- Pekeč S., Katanić M. (2015): Properties of eugley soil and the possibility of their reforestation, Proceedings "Sustainable use of land", p. 21-31, Scientific Expert Conference, 10 September, 2015, Rimski Šančevi, Serbia
- Škorić, A., Filipovski G., Ćirić M.(1985): Classification of soil, Yugoslav Academy of Science and Arts of Bosnia and Herzegovina, Special issue, 73 p., Sarajevo
- WRB, FAO, ISRIC and ISSS (2006): World reference base for Soil Resources, World Soil Resources Reports, 103

EDUCATIONAL PERSPECTIVES IN URBAN FORESTRY - OVERVIEW IN THE FEDERATION OF BOSNIA AND HERZEGOVINA

Selma HARAČIĆ-BERBIĆ¹, Senka MUTABDŽIJA BEĆIROVIĆ^{1*}

University of Sarajevo, Faculty of Forestry, Bosnia and Herzegovina

*Corresponding author: senka.mutabdzija@gmail.com

Abstract

As relatively new concept in Western Balkan countries (WBC), urban forestry is facing with vast number of challenges that are stemming from both institutional and legislative shortages as well as poor human resource capacities. What is more, current situation of this sector in the Federation of Bosnia and Herzegovina (FBiH) arises an arguable question whether urban forestry can be treated as a separate sector or not. Scattered jurisdictions between public and private sector, lack of legislative framework that is strictly focused to urban forestry, small number of professionals with educational background in urban forestry and even an arguable definition of basic terms this sector operates with (i.e. "urban forest") can justify the fact that urban forestry is in its initial phase in this part of Bosnia and Herzegovina (BiH). On the other side, it is needless to speak about immense positive effects of urban forests to our society, both ecologically and socially.

Due to the complex situation in which the employees of enterprises responsible for urban forestry are operating, the goal of this paper is to identify main burning issues they are facing with. Identification of these problems could help in preparation of case-specific educational programs for professionals in urban forestry. Finally, it will lead to the improvement of overall conditions of urban forests and, consequently, it will increase the level of satisfaction of local population as users of urban forests.

Key words: *urban forestry, the Federation of Bosnia and Herzegovina, education, professional trainings*

Introduction

Urban forestry (UF) represents a relatively new concept for the WBC. Generally, UF is interpreted as a rather vague concept that has no common definition. One of the interpretations of this concept defines UF as the art, science and technology of managing trees and forest resources in and around urban community ecosystems for the psychological, sociological, economic, and aesthetic benefits trees provide society (Konijnendijk et al., 2006 in Hansmann et al., 2016). Onward, urban forest has been described as the sum of all woody and associated vegetation in and around dense human settlements, ranging from small communities in rural settings to metropolitan areas (Miller, 1997 in Hansmann et al., 2016). Urban forests accordingly comprise different elements, such as urban woodlands, parks, civic squares, green corridors and single trees (Hansmann et al., 2016).

Citizens usually consider that the main purpose of urban forests is to make nice and comfortable life-environment. Certainly, urban greenery mostly has nonmaterial, spiritual functions such as decorative-aesthetic, sanitary-hygienic and cultural-educational (LjujićMijatović and Mrdović, 1998 in Brajić et al., 2012b). Trees and forests are an essential part of urban development that contribute to vibrant cities, public health, and functioning ecosystems and watersheds, while mitigating risks of floods and landslides (Brajić et al., 2012b).

Most of the national and regional UF-related scientific and professional literature is focused on biological and ecological aspects of urban and peri-urban forests. Dendrological

characteristics of urban forests and its role in spatial planning (Janjić, 2002; Anastasijević and Vratuša, 2000; Anastasijević, 2002; Aničić and Rechner, 2004; Dobrilović, 2009; Turalija, 2005, Haračić-Berbić, 2015), health condition of urban greenery (Treštić, et al., 2003; Mujezinović et al., 2011;), spatial planning issues (Beus and Mekić, 2007; Hadžidervišagić, 2010; Brajić et al., 2012a; Brajić et al., 2012b) make cornerstones of national and regional scientific literature related to UF, urban forests and urban greenery. On the other hand, sociological approach to concept of UF and urban greenery have been strictly focused to phenomenon of sociological demands toward forests and urban forests (Avdibegović et al., 2006; Fazlić, 2010; Brajić, 2011; Polić, 2013; Hanić, 2014; Polić, 2015).

Despite of the indisputable importance of the urban forests, UF in the FBiH is facing with vast number of challenges that are stemming from both institutional and legislative shortages as well as poor human resource capacities. Scattered and highly decentralised jurisdictions between public and private sector and different governmental levels, lack of UF-focused legislative framework, insufficient number of professionals with educational background related to UF depict the current legislative and institutional environment for the implementation and further development of this concept in the FBiH. For example, in the Canton Sarajevo, as the most urban administrative unit of the FBiH, urban and peri-urban forests are governed and managed by following institutions: cantonal public utility enterprise "Park", cantonal public institution for protected areas, cantonal public forest enterprise "Sarajevo šume" as well as municipalities of Canton Sarajevo. Having in mind that urban forests are usually shaped and managed by professionals from different disciplines and public authorities (Pütz et al., 2015; Konijnendijk, 2011 in Hansmann et al., 2016), underdeveloped competent institutions in terms of insufficient human resource capacities makes governing and managing of urban forests more demanding and challenging.

Due to the complex situation in which the employees of enterprises responsible for UF are operating, the goal of this paper is to identify main burning issues they are facing with. Identification of these problems could help in preparation of case-specific educational programs for professionals in urban forestry. Finally, it will lead to the improvement of overall conditions of urban forests and, consequently, it will increase the level of satisfaction of local population as users of urban forests.

Materials and methods

As already emphasized, UF represents a rather innovative concept for the FBiH. Despite of its characteristic as being a concept that implies joint endeavour of various sectors and professions, specific socio-political and institutional occasions in the FBiH makes this concept rather decentralised. That is the reason why the survey conducted for the purpose of this paper was created in order to assess specific needs for professional trainings of the employees of the companies registered for maintenance, establishment and protection of urban forests and urban greenery. Having in mind particular institutional setup UF has been operating with, survey included enterprises that are, in any way, responsible for planning, management or usage of green areas for different purposes be it public or privately owned enterprises. Therefore, the research was conducted with representatives of following types of institutions: municipalities, utility companies, cantonal forest management enterprises, cantonal planning institutes, and privately owned project offices. Due to their specific concerns over urban greenery, it had been decided to contact representatives of coal mine from Kakanj municipality, tobacco factory Sarajevo and cement factory from Kakanj that are responsible for green spaces. The purpose of this questionnaire was to assess current needs of professionals responsible for urban forests and/or urban greenery for specific educational programmes.

Questionnaire is consisted out of two groups of questions. The first group of questions are socio-demographic ones (such as gender, age, and age of working experience, education and current job position). The second group of questions were created in order to assess burning issues of each identified enterprise which are related with UF, urban forests and urban greenery. Additionally, questions from this group had a purpose to assess the specific "enterprise's ethnography" and working ethics related to educational programmes and long life learning concepts. Research had been conducted in period April - May 2016. Finally, representatives of 15 institutions answered the questionnaire. Having in mind current situation in UF of the FBiH, such response rate is sufficient for making general conclusions over this issue.

Results and Discussions

UF in the FBiH falls into competences of various types of institutions and enterprises. This caused expected diversity of experiences, attitudes and opinions regarding the issue of educational perspectives.

In comparison to the male dominance in forestry sector (Mutabdžija, 2013), research showed significant domination of females in UF (64% females and 36% males). Concerning the age structure, it can be concluded that UF engages rather younger people (average age is 33 years). Consequently, years of working experience are rather small as well (average years of working experience is 8 years). Most of the respondents have university diploma. Yet, they have rather different educational background which can be concluded based on their working positions and specific reference to the UF and urban greenery.

When it comes to the assessment of current presence of professional development and educational programs within enterprises, 65% of the respondents answered that such mechanisms are underrepresented in their enterprises. On the other hand, 78% of the respondents stated that professional development and education plays very important role for accomplishment of their working tasks. Such discrepancies between needs and realisation of these activities indicate high demand for creation and implementation of appropriate educational programs for UF professionals in the FBiH. Yet, respondents' answers related to the influences of their professional improvements that will be obtained by attending the educational programs depict specific work ethics within enterprises responsible for urban forestry and urban greenery. Answers led to the conclusion that professionals lack motivation for further professional improvements. For example, 35% of the respondents stated that their additional education will not result in improvements of urban forests and urban greenery. Same percentage of respondents thought that their education will not contribute to change in citizens' perception of urban greenery. Surprisingly, around 20% of the respondents stated that their additional education will not help in increasing the competences of employees. Such results indicate two main conclusions - UF professionals do not have a bigger picture related to the influences of their institutions and their professional engagement on citizens as final beneficiaries of urban forests and urban greenery and UF is marginalised in portfolios of responsible enterprises.

In order to assess needs for preparation and realisation of specific educational programs, respondents were asked to rate the importance of various aspects related to planning and management of urban green spaces. These are the following aspects: urban greenery management, professional literature, guidelines for establishment, management and improvement of urban greenery, planning of urban greenery, cooperation with citizens and local communities, preparation of project applications, application of various tools and software solutions (e.g. GPS, GIS etc). These aspects can be grouped in following categories:

- Planning and management of urban green spaces
- Soft skills related to management of urban green spaces

- Funding opportunities in UF

Assessment of these aspects of UF helped in identification of bottlenecks in professional knowledge and competences of respondents. Respondents rated urban greenery management and guidelines for establishment, management and improvement of urban greenery with highest rates (only for these two categories, respondents gave the two greatest rates). On the other hand, in case of preparation of project applications, around 45% of the respondents thought it is not important aspect of UF. Having in mind the perspective of BiH as EU candidate country, this result indicates insufficient awareness of UF professionals regarding opportunities for additional funding that can be utilized for improvement of urban greenery.

Generally, one can conclude that variations of rates for different aspects of planning and management of urban green spaces depend upon the competences and authorities of the institutions that respondents represented. This can be concluded based upon the rates for importance of cooperation with citizens and local community. Successful cooperation with local community is a cornerstone of concept of UF. On the other hand, respondents rated its importance differently based upon their duties and responsibilities related to the planning and/or management of urban greenery. Same also holds for the application of various tools and software solutions - respondents rated its importance based on their frequent usage of such technical solutions in day-to-day professional activities. Still, professional literature has the biggest percentage of the lowest rates for its importance. Such rating indicates low awareness on importance of continuous professional improvement that can be achieved through constant updating on new achievements in area of expertise. That is crucial bottleneck of current professional ethics in UF in the FBiH. Future educational programs need to be created with purpose to increase professionals' awareness on importance and benefits from constant learning and updating related to their field of expertise and professional interests.

On the other hand, cross tabulation of these answers with those related to the questions on rating the importance of additional education revealed strong positive correlation of these two questions. Most of the respondents that rate importance of the additional education with highest rates also rated aforementioned aspects of planning and management of urban forests and urban greenery with highest rates. Such answers justify the actual need for preparation and implementation of appropriate educational programs for UF professionals.

Conclusion

Results of the research revealed need for preparation and implementation of appropriate educational programs for UF professionals in the FBiH. This was also concluded based on the respondents' needs for additional education and actual realisation of such activities in their enterprises.

Furthermore, results of this research brought up an important issue of overall work ethics and work environment within enterprises. Despite of their formal expression of educational programs as important aspects for their professional improvements, analysis of respondents' answers led to the conclusion that professionals actually lack motivation or further professional improvements. Such conclusions represent an important input for defining the strategy for advocating the importance of educational programs for UF professionals in the FBiH. Future educational programs need to be created with purpose to increase professionals' awareness on importance and benefits from constant learning and updating related to their field of expertise and professional interests.

Another important aspect of UF in the FBiH that was also brought up by results of this research can be described as "disconnectedness" of UF professionals from the final beneficiaries of urban forests and urban greenery. Such state of mind clearly indicates the

status of UF as recently introduced concept in the FBiH which is rather marginalised in portfolios of responsible institutions.

Onward, respondents expressed the expected predominance of technical expertise related to UF. It was concluded based upon their ratings of specific aspects of planning and management of urban forests and urban greenery. Most of them rated the aspects of planning and management of urban green spaces with highest rates while importance of soft skills and funding opportunities are insufficiently recognized. Having in mind overall strategic and socio-political trends in the FBiH as well as essence of UF as society-based concept of management of natural resources, these two aspects of planning and management of urban greenery and urban forests need to be particularly emphasized in future educational programs for UF professionals in the FBiH.

References

- Anastasijević, N., Vratuša, V., (2000): O najvažnijim pravcima razvijanja funkcionalnog sistema gradskih zelenih površina (The most important directions for development of functional systems of urban green spaces), Proceeding of 6th Symposium on Flora of the South-eastern Serbia, Sokobanja; pp. 285-296
- Anastasijević, N., (2002): Ukrasno drveće i osvetljenost središnjeg dijela Beograda, (Ornamental trees and illumination of central Belgrade), Proceedings of the 7th Symposium on Flora of Southeastern Serbia and Neighbouring Regions, Dimitrovgrad; pp. 141- 145
- Aničić, B., Rechner, I., (2004): Značaj drvoreda u strukturi grada (The importance of tree lines in the city structure), Croatian society of agronomist – Zagreb; pp.227- 248
- Avdibegović, M., Vuletić, D., Krilašević, E., (2006): Karakteristike posjetitelja i razlozi posjeta šumskim područjima u kantonu Sarajevo (Characteristics of visitors and the reasons for visiting forest areas in Canton Sarajevo), Works of the Forestry Institute Jasterbarsko vol. 41, no. 1-2; pp. 65-72
- Beus, V., Mekić, F., (2007): Kritički osvrt - šume i šumska zemljišta u Prostornom planu Kantona Sarajevo (Critical review of forests and woodlands in Sarajevo Canton), Naše šume, god VI, br. 8-9, p. 39
- Brajić, A., (2011): Utvrđivanje zahtjeva posjetilaca prema javnom gradskom zelenilu - studij slučaja "Vrelo Bosne" (Assessment of visitors' demands toward public green spaces - Case study "Vrelo Bosne"), Završni rad drugog ciklusa studija, Šumarski fakultet Univerziteta u Sarajevu
- Brajić, A., Bećirović, Dž., Mutabdžija, S., Marić, B., Avdibegović, M. (2012a): Planing in urban forestry based on visitors' demands – case study „Vrelo Bosne“, Forest for cities, forests for people, perspectives on urban forest governance, IUFRO Conference, Book of abstracts, 27-28, September 2012, Zagreb, p. 26
- Brajić, A., Mutabdžija, S., Marić, B., Avdibegović, M., Delić, S., Bećirović, Dž. (2012b): Ensuring social cohesion – citizens as planners of urban green spaces, 1st International Green Design conference on green cities, buildings, and products, 27-30 September 2012, Sarajevo; pp.151-155
- Dobrilović, M., (2009): Urbani drvoredi – odabir drvorednih vrsta na osnovi morfoloških mjera (Urban tree lines - morphological characteristics as a factor in tree selection) Agronomski glasnik br. 2; pp.111-126.
- Fazlić, S., (2010): Utvrđivanje zahtjeva stanovništva prema šumi kao osnova za kreiranje smjernica šumarske politike u kantonu Sarajevo (Assessment of the population demands towards the forests as a basis for formulaton of forest policy guidelines), magistarski rad, Šumarski fakultet Univerziteta u Sarajevu
- Hadždervišagić, D., (2010): Valorizacija i tipizacija zelenih površina Sarajeva prema funkciji, značaju i položaju unutar fizičke strukture grada (Valorization of urban green spaces in Sarajevo by their function, significance and position within physical structure of the City), Master rad, Šumarski fakultet Univerziteta u Beogradu

- Hanić, N., (2014): Ekonomsko vrednovanje funkcija javnog gradskog zelenila na lokalitetu Velikog parka u Sarajevu (Economic valuation of functions of urban greenery within Veliki park in Sarajevo), Završni rad drugog ciklusa studija, Šumarski fakultet Univerziteta u Sarajevu
- Hansmann, R., Whitehead, I., Ostoić Krajer, S., Živojinović, I., Stojanovska, M., Jones, N., Bernasconi, A., Benamar, S., Lelieveld, C., Barstad, J. (2016): Partnerships for Urban Forestry and Green Infrastructure Delivering Services to People and the Environment: A Review on What They Are and Aim to Achieve. SEEFOR 7 (1): 9-19. DOI: <http://www.seefor.eu/vol-7-no-1-hansmann-et-al-partnerships-for-urban-forestry.html>
- Haračić-Berbić, S., (2015): Model razvoja krošnje srebrene lipe (*Tilia tomentosa*, Moench) u urbanim zelenim površinama grada Sarajeva (Model of the Silver linden (*Tilia tomentosa*, Moench) crown development in urban green areas of Sarajevo), magistarski rad, Šumarski fakultet Univerziteta u Sarajevu
- Janjić, N., (2002): Šesti prilog poznavanju nesamonikle dendroflora Sarajeva i okoline, Radovi Šumarskog Fakulteta br. 1 (53-97). (Janjić, N., 2002: Sixth contribution to the knowledge of Sarajevo's Dendroflora, Faculty of Forestry works no. 1 (p.53-97).)
- Konijnendijk CC, (2011): Innovations in urban forest governance in Europe. In: Johnston M, Percival G (eds) Trees, people and the built environment, Proceedings of the Urban Trees Research Conference 13–14 April 2011. Forestry Commission Scotland, Edinburgh, pp 141-148. URL: <http://goo.gl/OeGJHc>
- Konijnendijk CC, Richard Rm, Kenney A, Randrup TB, (2006): Defining urban forestry - a comparative perspective of North America and Europe. Urban For Urban Green 4 (3-4): 93-103. DOI: <http://dx.doi.org/10.1016/j.ufug.2005.11.003>
- Ljujić Mijatović, T., Mrdović, A. (1998): Proizvodnja cvijeća i ukrasnog bilja (Production of Flowers and ornamental plants), Sarajevo (univerzitetska knjiga), p. 36
- Miller RW, (1997): Urban forestry: planning and managing urban green spaces. Second edition, Prentice Hall, New Jersey, USA, p.27
- Mujezinović, O., Čabaravdić, A., Treštić, T., Dautbašić, M., (2011): Zdravstveno stanje urbanog drveća Sarajeva sa posebnim osvrtom na štete od snijega (The health status of urban trees in Sarajevo with special retrospect on damages caused by snow), Radovi šumarskog fakulteta Univerziteta u Sarajevu , br.1/11, str.101-110, Sarajevo.
- Mutabdžija, S., (2013): Cross sectoral perception of the forest governance principles in the Federation of B-H, Završni rad drugog ciklusa studija, Šumarski fakultet Univerziteta u Sarajevu, p.65
- Polić, A., 2013: Public involvement in decision-making for management of protected area "Vrelo Bosne", master thesis, Faculty of forestry University of Sarajevo.
- Polić, A., 2015: Utvrđivanje zahtjeva posjetilaca prema javnog gradskom zelenilu: studij slučaja Vilsonovo šetalište, završni rad II ciklusa studija, Šumarski fakultet Univerziteta u Sarajevu
- Pütz, M., Schmid, S., Bernasconi, A., Wolf, B., (2015): Urban Forestry: Definition, Trends und Folgerungen für die Waldakteure in der Schweiz. Schweizerische Zeitschrift für Forstwesen 166 (4): 230-237.
- Treštić, T., Usčuplić, M., Dautbašić, M., Kunovac, S., Ponjavić, M., (2003): Sistem praćenja štetočina i uzročnika bolesti na šumskom i urbanom zelenilu (System for monitoring pests and pathogens on forest and urban greenery), Prvi simpozij poljoprivrede, veterinarstva i šumarstva, Neum, 14.-17. 05. 2003.; pp. 213-220
- Turalija, A. (2005): Mogućnosti podizanja drvoreda unutar gradskih aglomeracija (Possibilities for growing trees within urban agglomerations), Agronomski glasnik 2-4/2005; pp. 99-106

USING PINE (*Pinus*) AND SPRUCE (*Picea*) STUMP SURFACE PATTERNS FOR THE DETERMINATION OF FELLING TIME

Aleksandr ROMANOV*, Igor SMIRNOV

The Perm State Agricultural Academy 23 Petropavlovskaya, Perm 614990 Russia

*Corresponding author: moraposh@mail.ru

Abstract

To determine of the timeline of tree felling is one of a number of investigative leads of illegal logging and superfelling of the forest. The study of literature and electronic sources showed a lack of methodology for the study of these problems along with results of such research. From June through September 2015 an exploration of diagnostic capability for determining the timeline of tree felling using the pine and spruce stumps. For the study cutover areas of spruce shamrock forest were selected. The age of felled forests is upwards of 80 years. The felling was carried out in September (2014), December (2014), February (2015), May (2015) and June (2015). Stumps on permanent plots were selected from every cut over area. There are 40-47 stumps in each cut over plot. Research stumps have a diameter range from 20 to 60 cm. Every stump was photographed in July, August and September. Stumps were grouped by species, degree of decay, diameter and stump surface condition. The change of stump surface condition was determined by climactic factors during summer. There are resin, water-dissolved available nutrients and metabolites on a stump surface after pine and spruce felling. They form a characteristic pattern on the stump surface. As for the pine felled in June (2015) the stumps are characterized by a heavy resin discharge (70 % of the total number of stumps). The May (2015) felling promotes a discharge pattern of water-dissolved nutrients and metabolites along with pine resin. The spruce stump surface has a more complicated pattern depending on the felling time.

Keywords: *illegal logging, stump analysis, common pine, spruce, shamrock spruce forest.*

Introduction

Forests cover approximately 45 % of the territory of Russia. Therefore the felling and the utilization of wood are a traditional activity in our country. The large forest area incites individuals to illegal fell trees who wish to make a profit. The illegal felling comprises anywhere from 10 to 35 % of the total timber harvested in Russia depending on the region [1-2]. Permskii krai is heavily forested territory which has illegal felling problems as well. According to unpublished data of the Ministry of Natural Resources of Permskii krai, there have been 8295 occurrences of illegal felling from 2008 to 2015. The illegally cutover timber is 463000 m³ with a loss that is more 3 million rubles.

In 2008 the detection rate of illegal logging was 39% and increased to 75% in 2015. The proceeding of these actions is difficult. The measures of an investigation may continue for 4-5 years. The cause is the imperfect tools for gathering evidence. A superfelling is another wrong that is proceeding in courts. It is illegal aggrandizement of a legal felling plot. In this case, the superfelling is incorrectly ascribed to an honest businessman and is perpetrated by illegal loggers or "black lumbermans". They fell a forest near a made timber road.

Initial attributes of illegal logging investigation are 1) a location of felling plot and a measurement of its area; 2) a location of cut trees (stumps); 3) a felled stand volume inventory and wood quality; 4) a felling time determination; 5) a tool and persons determination who performed this felling [1-2]. Reliable data of the first two attributes are provided by surveyors.

The felled stand volume inventory is calculated using stumps with specific volume tables [4]. A felling time determination isn't resolved at this time. Tool identification is difficult problem too. There are preliminary research results for felling time determination in this article.

Material and methods

Research was undertaken from June through September 2015. The cutover areas are in the Karagai forest district of Permskii krai (Russia). The aim of our research is an express-method explanation for felling time determination. The primary objective is a determination of the differences between patterns on stump surface that emerged based on the physiological status of trees at felling time. For the study cutover areas of spruce shamrock forest were selected. Study objects are legal logging plots in forest compartments (numbers 22, 26 and 83) of Karagai forest district in Permskii krai (fig. 1). The subject of the study were surfaces of spruce and pine stumps remaining after different felling times. Pine stumps were studied in plots in which felling occurred in September (2014), May (2015) and June (2015). Spruce stumps were studied in plots in which felling occurred in September (2014), December (2014), February (2015), May (2015) and June (2015). Felled trees were aged more than 80 years. The plots had identical species composition of the stand (spruce – 50 %, pine – 30 %, fir – 20 %). The degree of density was approximately 0.6 or 60%. Pine and spruce stumps numbering between 45-59 were selected in each felling plot. Diameters of studied stumps were 20, 40 and 60 cm. The distribution of studied stumps on felling plots is in table 1. The photographs of the studied stumps were taken every month from July to September 2015. Each photograph was taken with the stump oriented to the north, it was protected with specific screen and was supplied the dividing rule. Then photographs were visually sorted by the pattern on the stump surface.

Results and discussion

The different physiological condition of pines and spruces at felling time promotes a different pattern on the stump surface. This is due to the resin, water-dissolved available nutrients and metabolites exudation on a stump surface after pine and spruce felling. This allows the use of the stump surface pattern for the expert study of illegal logging. The pine and spruce each have unique features for the felling reaction. The resin exudation is distinctive on the pine stump surface. The spruce stump surface has a complex pattern. For description stump surface we use term “alburnum”. The “alburnum” is peripheral part of wood (live wood or sapwood [3]) with moving resin and water-dissolved available nutrients.

The pine resin exudes on a stump surface is consistent with four types: I) the resin spreads over the entire alburnum zone (fig. 2a); II) the resin exudes by way of small droplets on each annual growth ring (fig.2b); III) the resin exudation covers a portion of alburnum zone (fig. 2c); IV) the resin exudation is absent (fig. 2d).

The June (2015) pine felling was accompanied the resin exudation for the first (I) type (70 %) and 30 % of studied stumps had the second (II) type (table 1). The resin covers the alburnum zone in a complete ring. The resin exudes by way of small droplets on each annual growth ring (II type) for the May pine felling (88-100 % of stumps). The resin exudation of third (III) type is indicative for the September pine felling (53-67 %).

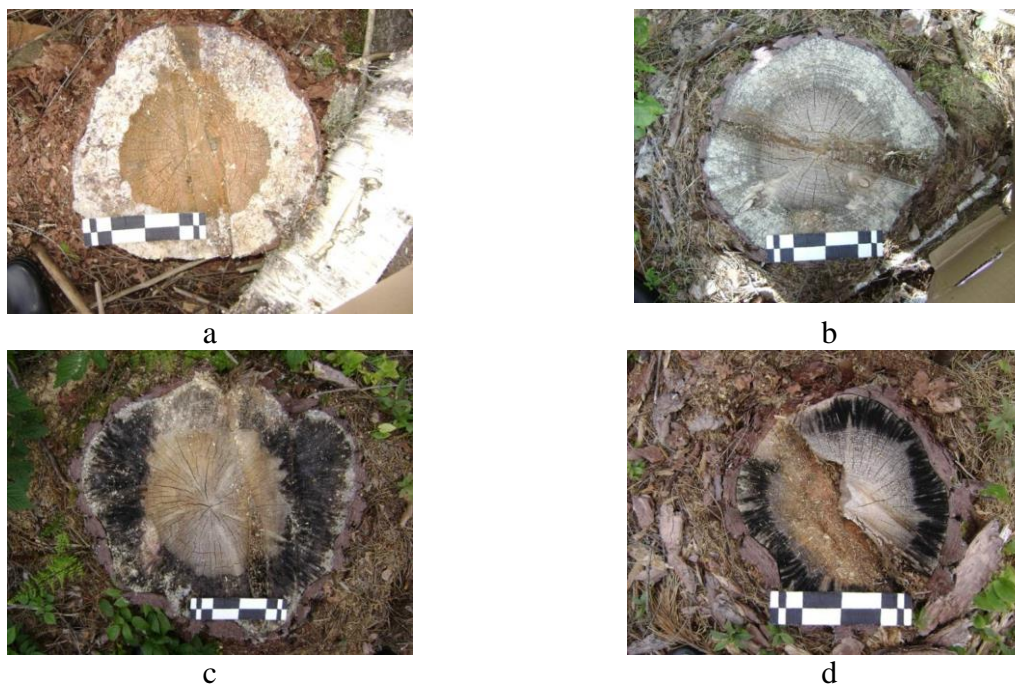

Figure 2 – Type of resin exudation on pine stump surface (see text for full description)

Table 1. Allocation of pine stumps based on the resin exudation type, %

Felling time	Type of the resin exudation			
	I	II	III	IV
September (2014)	0	28	62	10
May (2015)	0	94	4	2
June (2015)	70	30	0	0

Water-dissolved available nutrients and metabolites create specific pattern on stump surface as well. For the pine stumps we used four types of patterns: I) the alburnum zone has an unbroken black color (fig. 2c); II) the alburnum zone has an unbroken grey color (fig. 3); III) the alburnum zone has a radiating lines of black spots (fig. 2d); IV) the alburnum zone has a color of wood (fig. 2a and 2b). The allocation of pine stumps with color of alburnum zone is in table 2.

Table 2. Allocation of pine stumps based on coloration of alburnum zone, %

Felling time	Type of coloration of alburnum zone			
	I	II	III	IV
September (2014)	41	0	59	0
May (2015)	28	34	30	8
June (2015)	0	0	0	100

The specific view of pine stump surface for the June felling is in figure 2a. The stump surface for the September felling looks like figure 4 in more causes. The May pine felling has a specific resin exudation as the third type (fig. 2b) the view of alburnum zone may be different types.



Figure 3 – The view of alburnum zone for type number II



Figure 4 – The typical view of a pine stump surface for the September felling

There is a resin exudation on spruce stumps in any time of felling. Therefore the first position of our classification for spruce stump surface is characteristic of water-dissolved nutrients and metabolites exudation zone (fig. 5). We used four types of patterns for a spruce stumps: I) the alburnum zone has an unbroken black color (fig. 5-I); II) black spots have direction along annual growth ring (fig. 5-II); III) the alburnum zone has radiating lines of black spots (fig. 5-III); IV) the alburnum zone has a color of wood (fig. 5-IV).

The second position is the resin occupation density on water-dissolved nutrients and metabolites exudation zone. It has two types. Type “A” is a resin covers all surface of this zone. Type “B” is a resin covers fewer than half of one. But the verification shows both types took place for any felling time. This position is not the time index. There are five types of a resin exudation in the third position of our classification. Type “W” has all-round wide resin ring. Type “N” has all-round narrow resin ring. Type “G” has group resin exudation. Type “DW” is the resin exudes by way of small droplets on each annual growth ring. Type ‘DN’ is the resin exudes by way of small droplets on each annual growth ring.



I



II

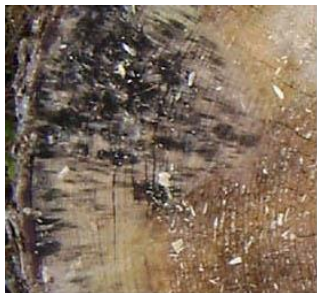

III



IV

Figure 5 – Type of water-dissolved nutrients and metabolites exudation zone coloring on spruce stump surface (see text for full description)

The allocation of spruce stumps according the coloration of alburnum zone can be seen in Table 3. Radiating lines of black spots are the peculiarity for September, February and May felling times. Spruce stumps after December felling have I type of the alburnum zone coloration. In June the vertical moving of water-dissolved nutrients was weak in weather states of 2015. The alburnum zone does not have the coloration. Table 4 contains facts about resin exudation peculiarities for different spruce felling time.

Table 3. Allocation of spruce stumps based on coloration of alburnum zone, %

Felling time	Type of coloration of alburnum zone			
	I	II	III	IV
September (2014)	20	4	76	0
December (2014)	64	2	30	4
February (2015)	37	4	55	4
May (2015)	22	6	66	6
June (2015)	6	2	3	89

Table 4. Allocation of spruce stumps based on the resin exudation type, %

Felling time	Type of the resin exudation				
	W	N	G	DW	DN
September (2014)	27	51	17	0	0
December (2014)	45	44	8	2	1
February (2015)	24	44	16	9	7
May (2015)	13	19	7	43	18
June (2015)	21	58	6	9	6

Usually the spruce resin exudes as a narrow ring along the stump border (39-66 %). But the resin exudes produce a wide ring on the alburnum zone for December felling as well. In May the felling of spruce trees furthers to form the resin exudation as wide ring with small droplets on each annual growth ring.

Conclusions

1. Typical sign of June pine felling is the abundant resin exudation on the alburnum zone of stump surface. Water-dissolved nutrients and metabolites exudation is absent.
2. The resin exudation was weak and the alburnum zone coloring had many radiating black spots (53-67 %) or an unbroken black cover (39-43 %) for the September pine felling.
3. In pines felled in May, the resin exudes as a wide ring with small droplets on each annual growth ring (88-100 %).
4. Typical sign of June spruce felling is the absence of water-dissolved nutrients and metabolites exudation. The resin exudes usual as narrow ring.
5. The coloration of alburnum zone is black for the December spruce felling (51-81 %).
6. September, February and May spruce felling is dimly by stump surface. Researches need to continue.

References

Golovan O.M. Ekspertiza nezakonnoi rubki lesa (Expertise of forest illegal felling) Federacia Sudebnih Ekspertov [electronic source] online: <http://sud-expertiza.ru> (accessed date: 20.03.2016)

- Klennikova O.S., Zinoveva I.S. Nezakonnaia rubka lesa I nelegalnii oborot drevesini v RF: osnovnie prichini I meri po obespecheniu borbi s nimi (Illegal felling and illegal wood cycle in Russia: main causes and measures of struggle against them), *Uspehi sovremennogo estestvoznania*, Vol. 4, 2012, P. 187-189
- Ugolev B.N. (2001) Wood technology with principles of wood merchandizing. Moskow, MGUL, 340 pp.
- Vice A.A. Normativi dlia opredeleniia zapasov virublennih drevostoev po pniam v usloviah Sibiri (Standards for Determination of Cut Stands Resources according to Stumps in Condition of Siberia), *Lesnoi jurnal*, Vol. 4, 2011, P. 24-28

**SPATIAL GENETIC PROFILE OF MARGINAL POPULATION OF SILVER FIR
(*Abies alba* (var. *Pyramidalis*)) FROM SERBIA USING SSR MARKERS**

Branislav TRUDIĆ^{1*}, Alen KIŠ², Srđan STOJNIC¹, Saša ORLOVIĆ¹, Biljana PANJKOVIĆ²

¹ Institute of Lowland Forestry and Environment, University of Novi Sad, Antona Čehova 13d, Serbia

² Institute for Nature Conservation of Vojvodina, Radnička 20a, Novi Sad, Serbia

*Corresponding author: btrudic@uns.ac.rs

Abstract

Considering that the pyramidal fir is of high conservation importance for Serbia forest diversity, the aim of this study was to determine, using SSR marker analysis, spatial genetic profile of the endemic and marginalised *Abies alba* population from Ogorijevac, Serbia. Leaf samples from nineteen *Abies alba* individuals from Ogorijevac site were collected, where nine of them were determined by morphological traits as *Abies alba* f. *'Pyramidalis'* and ten as a typical, silver fir, (*Abies alba* Mill.). PCR amplification was done with the 19 SSR primers in three multiplex mixes (16 EST-SSRs divided in 2 multiplexes and three genomic SSRs as a separate multiplex mix). Successful amplification was obtained for 17 out of 19 markers. Fragment analysis of PCR products was done on capillary electrophoresis automatic sequencer where, afterwards, scoring of resulted peaks was obtained using the GeneMarker V2.4.0 and MicroChecker software. Spatial genetic profile analysis was evaluated via BAPS software. The results of spatial BAPS showed the presence of two clusters (7/12) among 19 sampled individuals, indicating significant difference in genetic profile between selected silver fir (taxa) samples. Cluster differentiation within marginalised population of silver fir showed the results of such genetic profile which will be used as a platform for further molecular genetic research and conservation strategies of this endemic species. This research was done on STSM project within COST Action FP 1202 (MaP-FGR).

Keywords: *Abies*, SSRs, genetic profile, spatial analysis

Introduction

Silver fir is an ecologically valuable and indigenous tree species in many European mountain forests. It occupies a wide variety of ecological sites ranging from the East Carpathians to the Pyrenees and from the Beskides in Poland to the mountains of northern Greece (Larsen 1986). In the course of several episodes of silver fir decline during the past century, its populations have decreased in size and number and currently are scattered throughout the entire European range (Konnert and Bergmann 1995).

Although silver fir in the Western Balkans area very rarely forms pure stands, it is the most important constituent element of mixed forests of fir and beech (*Abieti-Fagetum* s.l.) (Ballian et al. 2012). Its significance, but also its threatened status and decline caused by atmospheric and soil pollution, especially in the Slovenian Dinaric Alps, in Gorski Kotar (Croatia) and western Bosnia (Tikvić et al. 1995, Seletković and Tikvić 1996, Ušćuplić et al. 2007) has made it the subject of numerous studies (Ballian et al. 2012).

The first scientific observation and probably the first written record of the site with the excessively narrow habitus of silver fir in Ogorijevac were done by Tošić (1963). From the mid-nineteenth century, when the first case of the pyramidal variety of the *Abies alba* Mill. was described, only few individual specimens of this variety, whose habitus has a pyramidal shape, survived until today. Discovery of the population of this extremely rare variety of silver fir attracted the attention of scientists and the general public, followed by a several authors who have studied and described in details mainly morphometric characteristics of the variety (Tošić

1963, 1995, 1997, Matović et al. 1996, Tošić and Vilotić 1998). Ecological characteristics of the site were analysed too, giving the insight of possible influence of environment and its properties on development of the phenotype (Kiš et al. 2009, Ratknić et al. 2013). The main phenotypic characteristic of the variety is growth of lateral branches directional upward, at a relatively acute angle to the longitudinal axis of the trunk. This development resulted that the tree has an unusual narrow - pyramidal shape of crown which is developing with the age of the tree (Matović et al. 1996). Tošić (1995) observed that pyramidal fir has a slower growth than other tree species in the reserve, which is often overgrown by the surrounding trees. As one of the characteristics of the variety is the occurrence of multiple centres of apical dominance. According to this, pyramidal fir could possess some genes that induce morphogenesis due to surrounding conditions, similar to the genera *Cupressus* and *Juniperus* (Tošić 1995). According to terrain research data of Kiš et al. 2009, and Panjković et al. 2010, entire population of silver fir in Nature reserve “Paljevine” consists of 20 individuals in total, from which 14 are in juvenile and 6 in adult phase from which two are almost completely dry. We succeed to take enough vital plant leaf samples from 19 individuals. The aim of this study is to assess spatial genetic structure of small population of silver fir from Ogorijevac site, through simple sequence repeats (SSR) marker analysis.

Materials and methods

Sampling of the needles from 19 individuals belonging of two *Abies* varieties from Ogorijevac site, for the comparative genetic profile analysis has been done on 20th July 2013. All leaf samples were stored on silica gel in sterile safety bags until isolation of genomic DNA. One 50 mg of completely dried needles for every tree was homogenized in Retsch homogenizer (frequency=28, 90 seconds duration for homogenization of dried samples). Isolation of total, genomic DNA from collected plant material was done with STRATEC-INVITEK plant kit (for 250 samples). Quality and quantity control of total isolated DNA was done with the NanoDrop® ND-1000 spectrophotometer (with the following NanoDrop® ND-1000 Spectrophotometer user software) and on agarose gel electrophoresis on 1 % agarose. 1% agarose gel was prepared with 1g of agarose (GE Healthcare) in 100 ml of 1 X TAE buffer (Tris Acetate EDTA 1X, made from 50X stock). TAE buffer used in our analysis consisted of 242 g Tris base (2-Amino-2-hydroxymethyl-propane-1,3-diol), 57.1 ml Acetic acid (100%) dissolved in 100 ml 0,5 M Na₂EDTA. PCR amplification was successful for all 19 SSR markers. Only for 17 SSRs (14 Expressed Sequence Tags-SSRs (EST-SSRs) and 3 genomic SSRs (gSSR)) we succeed to proceed with fragment analysis (Table 1 and Table 2). Information about all primers design and sequences are available in Postolache et al. (2014). It was impossible to correctly score the peaks for two EST-SSR markers, contig28516 and contig04529, resulted after capillary electrophoresis sequencer analysis. PCR was performed on PCR System 9700 GeneAmp machine (PE Applied Biosystems) in 3 multiplex mixes (Mix A: consisted of 8 EST-SSRs, MixB: consisted of 8 other EST-SSRs and Mix C: consisted of 3 genomic SSRs). PCR amplification for all multiplexes was proceeded due to the following protocol: 95^oC-5min, 95^oC-30sec, 57^oC (for genomic SSRs=59^oC)-90sec, 72^oC-30sec (30 cycles for those three temperatures repeated), 60^oC-30min, 4^oC-hold. PCR products were diluted 1:1, denatured at 95^oC for 2 minutes with formamide and Liz 500 as internal standard. Fragment analysis of PCR products was performed on Applied Biosystems/HITACHI 3500 Genetic Analyser capillary electrophoresis automatic sequencer (hereinafter: AB 3500). Scoring of resulted peaks of analysed fragments was done with GeneMarker V2.4.0 and MicroChecker software. Population structure analysis was performed using spatial BAPS (Corander et al. 2008).

Table 1. List of the selected 16 EST-SSR markers for *Abies* spp.

Number of marker	Name of the marker	Repeated motif	Size bp	Color/label of the marker
1	contig03469	(GCG)10	129	FAM (blue)
2	contig17708	(CAG)7	140	VIC (green)
3	contig22092	(TCA)8	169	NED (yellow)
4	contig07179	(AT)9	169	PET (red)
5	contig18873	(CAG)11	187	FAM (blue)
6	contig21334	(GCA)7	206	VIC (green)
7	contig00103	(GCA)8	224	NED (yellow)
8	contig28516	(AT)11	233	PET (red)
9	contig19702	(AT)12	248	FAM (blue)
10	contig10345	(AAC)9	273	VIC (green)
11	contig19362	(AT)9	324	NED (yellow)
12	contig04529	(AG)12	338	PET (red)
13	contig26739	(AG)8	350	FAM (blue)
14	contig20606	(TA)9	374	VIC (green)
15	contig16137	(AGA)8	380	NED (yellow)
16	contig24748	(GAA)7	447	PET (red)

Table 2. PCR protocol for Multiplex Mix C consisted of three genomic SSR for *Abies* samples

Color/label of the marker	Size	Multiplex C primer pairs	Working primer dilution	X 1 sample [μl]
VIC	140-170	NFF_7 FW	10μM	0.08
		NFF_7 RW	10μM	0.08
PET	190-215	BO3KK FW	10μM	0.0896
		BO3KK RW	10μM	0.0896
PET	110-120	SF_324 FW	10μM	0.15
		SF_324 RW	10μM	0.15
		Total volume for 3 primer pairs [μl]		0.6392
		Water [μl]		1.3608
		Final volume [μl]		2.00

Results and discussion

The results of spatial BAPS (Figure 2) indicate the presence of two clusters (7/12) among 19 sampled individuals. For four out of seven analysed individuals in first indicated cluster, morphometric traits were showing that those are *Abies alba* var. *pyramidalis* (Carrière) Voss individuals (1, 2, 5, 18). Figure 1 and Figure 2 give geographical complementarity of BAPS genetic profile. This will additionally support efforts in conservation of this species, making a significant contribution to the selection of individuals for future breeding management and construction of genetic linkage map.

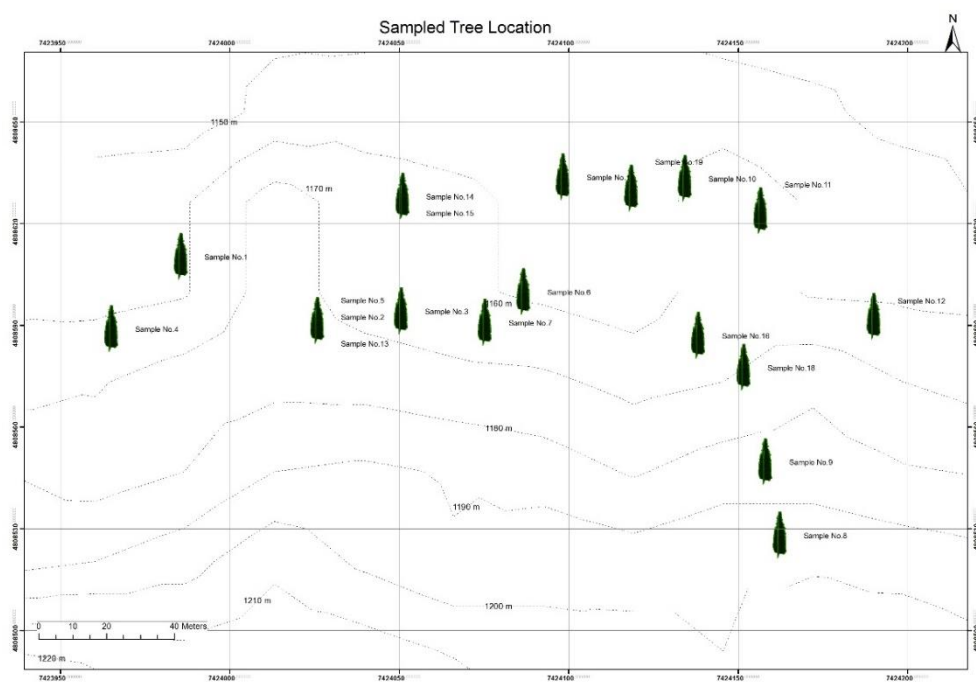

Figure 1. Spatial GPS map of sampled tree individuals

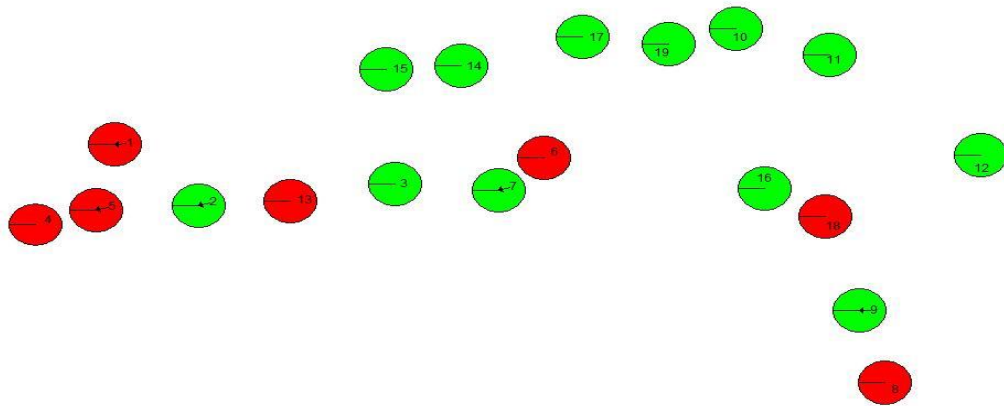

Figure 2. BAPS spatial genetic model analysis of *Abies* samples from Ogorijevac site. Two different colours clearly indicate existing of two *Abies* genetic clusters on the site. For better overview, while constructing this map, we separate individuals 2, 5, 13, 14 and 15 since they are on site physically very near each other, which is presented on standard GPS map (Figure 1)

Western Balkan countries are burdened with the problem of inadequate system of fir management, which significantly contributes to its rapid decline. This is the reason why it's urgent to investigate both the healthy and damaged fir stands (Ballian et al. 2012). Using the newly developed markers in ongoing studies, it would be possible to tackle the dynamics of genetic diversity in silver fir between closed stands and large-sized forest gaps in Serbia. Ballian et al. (2012) showed that some allele's characteristic of the Balkans occur in central Europe, and *vice versa*. Hence, they concluded that silver fir derived from the Balkan refuge may have been more widely distributed in the past, but is now constantly retreating, while the Apennines-derived silver fir takes its place, or, on the other hand, it may have reached southern Germany through past gene flow similar to the central Dinaric Alps. The finding of *Abies alba* var. '*Pyramidalis*' at Ogorijevac in Serbia is very specific regarding the habitat and stand characteristics. Also the range of distribution of pyramidal fir should be extended by afforestation. In order to successfully protect and preserve silver and pyramidal fir with *in situ* and *ex situ* methods, it is essential to have an in-depth knowledge of its genetic constitution. BAPS analysis gave us primarily insight in genetic variability of sampled individuals. Spatial model gave clear picture of two genetic clusters existing on that particular site. Further marker assisted analysis is needed to clarify the correlation between different genetic structure and phenotype difference.

Conclusions

For the future of pyramidal fir on the protected area, it is necessary to identify the tending and protection measures, which will favour the regeneration and development of its individual trees. This would include the following:

- Removal of competitive trees which disturb the regular development of pyramidal fir trees and the ensuring of the favourable biological position in all stages of development;

- For having fully reliable information on taxonomic determination of varieties, it is always needed to have both morphometric measurements and marker analysis. For further taxonomic research of confirming possibility of two different varieties of silver fir on this site, ITS region detection and sequencing will be preferable to be used;
- It is possible to increase the area of pyramidal fir if it would be provided a sufficient number of seedlings by producing seed and planting material of pyramidal fir in forest nurseries. Modern planting stock production techniques should be applied because it provide good results even with the small amount of seed obtained from regular crops. There are large areas in this region whose site conditions allow reforestation with the pyramidal fir.

Acknowledgement

This research was done during short term scientific mission: "Conservation platform of marginalized *Abies alba* and endangered peripheral *Quercus robur* from Serbia using DNA fingerprint and SNP analysis." It was supported within COST Action FP 1202 (MaP-FGR) "Strengthening conservation: a key issue for adaptation of showing marginal/peripheral populations of forest trees to climate change in Europe" and implemented from July 14th to August 18th, 2014, on hosting Institute of Biosciences and BioResources, Division of Florence, National Research Council, - Via Madonna del Piano, 10 - 50019 Sesto Fiorentino (Firenze), Italy. I would like to thank Giovanni Giuseppe Vendramin, Ilaria Spanu, Francesca Bagnoli, Dragos Postolache from CNR, Florence for their support during short term scientific mission.

References

- Ballian D, Boguni F, Bajri M, Kajba D, Kraigher H. and Konnert M (2012). The genetic population study of Balkan Silver Fir (*Abies alba* Mill.), *Periodicum Biologorum* 114(1): 55–65.
- Corander J, Sirén J, Arjas E (2008). Bayesian spatial modelling of genetic population structure, *Computational Statistics*, 23(1): 111-129.
- Kiš A, Panjković B, Galić Z (2009). Ecological and structural characteristics of the Strict Nature Reserve "Paljevine", International Conference "Forestry in achieving millennium goals", ILFE, 289-294.
- Konnert M and Bergmann F (1995). The geographical distribution of genetic variation of silver fir (*Abies alba*, Pinaceae) in relation to its migration history, *P. Syst. Evol.* 196: 19-30.
- Larsen JB (1986). Das Tannensterben. Eine neue Hypothese zur Klirung dieser ritselhaften Komplexkrankheit der WeiBtanne (*Abies alba* Mill.), *Forstw. Centralbl.* 105: 381-396.
- Matović M, Pavlović BP, Čokeša V, Grbović N, Nikolić B, Stojičić D (1996). Doprinos poznavanju morfoloških karakteristika piramidalne i obične jele sa Ogorijevca. Institut za šumarstvo, Zbornik radova, 40-41: 159-166. (Contribution to knowing of morphometric characteristics of pyramidal and ordinary fir from Ogorijevac. Institute for forestry. Proceedings, 40-41: 159-166.)
- Panjković B, Kiš A, Perić R, Šehovac E, Kovačev N, Banjac M, Čalakić D (2010). Specijalni rezervat prirode "Paljevine". Studija - predlog za stavljanje pod zaštitu (Special Nature Reserve " Paljevine ". The study - a proposal for placing under protection), *Zavod za zaštitu prirode Republike Srbije, Beograd*, 7-41.
- Postolache D, Leonarduzzi C, Piotti A, Spanu I, Roig A, Fady B, Roschanski A, Liepelt S, Vendramin GG (2014). Transcriptome versus genomic microsatellite markers: highly informative multiplexes for genotyping *Abies alba* Mill. and congeneric species, *Plant molecular biology reporter*, 32(3): 750-760.

- Ratknić M, Rakonjac LJ, Braunović S, Stajić S, Lučić A, Ćirković-Mitrović T (2013). Ecological and morphological characteristics of pyramidal fir (*Abies alba* var. *pyramidalis*) in the locality of Ogorijevac (The Pester plateau), Arch. Biol. Sci. 65(4): 1609-1617.
- Seletković Z and Tikvić I (1996). Oštećenost šumskih ekosustava različitih stanišnih prilika u Republici Hrvatskoj. (Damage of forest ecosystems of different habitat conditions in the Republic of Croatia) U: Sever S (ed.), Zaštita šuma i pridobivanje drva, Šum. Ins. Jastrebarsko, 81–88.
- Tikvić I, Seletković Z, Anić I (1995). Propadanje šuma kao pokazatelj promjene ekoloških uvjeta u atmosferi, (Degradation of forests as an indicator of changes in environmental conditions in the atmosphere) Šum. List. 11-12: 361–371.
- Tošić M (1963). O nalazu piramidalnog varijeteta jele (*Abies alba* Mill.) u okolini Sjenice, (About finding pyramidal varieties of fir (*Abies alba* Mill.) in the vicinity of Sjenica) Šumarstvo, 10-12: 387-392.
- Tošić M (1995). Novi varijeteti šumskog drveća i mogućnosti njihovog korišćenja (New varieties of forest trees and possibilities of their use). Zbornik rezimea II Simpozijum o flori Srbije, Vranje, Zbornik radova, Niš. 35-43
- Tošić M (1997). Morfološka i fiziološka svojstva šišarica i semena piramidalnog varijeteta jele (*Abies alba* Mill. var. *elegantissima* Tošić) (The morphological and physiological properties of cone and seed varieties pyramidal fir. (*Abies alba* Mill. var. *elegantissima* Tošić)), Peti Simpozijum o flori jugoistočne Srbije i susednih područja, Zaječar, Zbornik abstrakata, 49.
- Tošić M and Vilotić D (1998). Morphological-Anatomical Characteristics of Needles of Fir *Abies alba* Mill. Narrow Fastigate Form, Progress in Botanical Research, 443-446.
- Ušćuplić M, Dautbašić M, Treštić T, Selman E, Mujezinović O, Nišić T, Jokanović B (2007). Bolesti i štetnici obične jele (*Abies alba* Mill.) u Bosni i Hercegovini, (Diseases and pests of silver fir (*Abies alba* Mill.) in Bosnia and Herzegovina) Društvo za zaštitu bilja u BiH, Sarajevo.

ECTOMYCORRHIZAL FUNGI ON BEECH IN SERBIA

Marina KATANIĆ^{1*}, Saša ORLOVIĆ¹, Marko BAJC², Tine GREBENC², Bratislav MATOVIĆ¹, Saša PEKEČ¹, Hojka KRAIGHER²

¹Institute of Lowland Forestry and Environment, University of Novi Sad, Novi Sad, Serbia

²Slovenian Forestry Institute, Ljubljana, Slovenia

*Corresponding author: katanicm@uns.ac.rs

Abstract

Knowing mycorrhizal community structure can provide valuable information about functioning of forest ecosystems. Beech forests make almost one half of forestry fond in Serbia and have important influence on environmental status. The aim of this study was to identify types of ectomycorrhizae in natural managed beech (*Fagus sylvatica* L.) stands from four different sites in Serbia: Homolje Mountains, Čemernik-Ostrozub, East Boranja and Fruška gora in two seasons: early winter and spring. Identification of fungal partner in ectomycorrhiza was obtained with morphological and anatomical characterization according to published descriptions and with molecular identification based on PCR amplification and sequencing of the ITS regions within nuclear ribosomal DNA. In all soil samples from investigated sites in two seasons total number of analysed fine roots was 54636 while total number of vital ectomycorrhizal roots was 8373. In examined beech stands 36 ectomycorrhizal types were recorded. Twenty seven types of ectomycorrhizae were identified with molecular methods from which 14 types to the species level, 4 types to the genus, 6 types to the family and 3 types to the ordo level. Genera *Russula* and *Lactarius* were the most species-rich genera, while type *Cenococcumgeophilum* was the most frequently found. Most of recorded ectomycorrhizal fungi are commonly found on beech.

Keywords: ECM, *Fagus sylvatica* L., morphological-anatomical characterization, ITS rDNK, Serbia

Introduction

In the most temperate forests, establishment, growth and survival of trees depend on colonization with ectomycorrhizal (ECM) fungi (Smith et Read, 2008). Mycelium of ECM fungi is the main component of forest ecosystems which links biotic with abiotic factors influencing sustainability, productivity and vitality of forests (Kraigher, 1996).

Ectomycorrhizal fungi successfully take water, organic and inorganic nutrients from soil and translocate them to fine roots of plants from which they obtain carbohydrates in return (Smith et Read, 2008). Functional compatibility and stress tolerance of ectomycorrhizae are species specific and depend on both partners, therefore the information on the ECM community structure can provide valuable information about physiology of forest trees and functioning of forest ecosystems (Kraigher et al., 2007).

In Serbia beech forests make almost one half of forestry fond. They have important function in biomass production and significant influence on environmental status (Vučićević, 2004). Diversity of ECM fungi on beech in Serbia was firstly described on Stara planina (Katanić et al., 2011). Ten types of ectomycorrhizae were preliminary described and identified with morphological and anatomical methods in natural managed beech (*Fagus sylvatica* L.) stands from Homolje mountains, Čemernik-Ostrozub, East Boranja and Fruška gora in early winter 2011 (Katanić et al., 2012).

In this work, previous results were supplemented with molecular methods of identification and studies were repeated at the same sites in spring 2012.

Material and methods

Ectomycorrhizal types were analysed in four pure or mixed natural uneven-aged managed beech (*Fagus sylvatica* L.) stands in Serbia at Homolje Mountains (site Majdan Kučajna), Čemernik-Ostrozub (site Predejane), East Boranja (site Krupanj) and Fruška gora (site Iriški venac). Characteristics of studied sites were given in Katanić et al. (2012). Beech was main and dominant woody species at all sites, but at sites Krupanj and Iriški venac other tree species were found in minor percentage.

At selected sites soil samples were collected in December 2011 (early winter) and May 2012 (spring). A soil corer of 274 ml volume was used for taking standardized samples (Kraigher, 1999). The total number of samples was 24. Three samples were taken per each site in each season. Roots were carefully washed from soil and vital ECM root tips were separated from old, nonturgescient and nonmycorrhizal roots in water under a dissecting microscope. Types of ECM were analyzed and ECM fungi identified after morphological and anatomical characteristics with a binocular (light source Olympus Highlight 3100, daylight filter) and microscope Olympus BX 51 (enlargement 100-2000x) according to published descriptions (Agerer, 1987-2002; Agerer et Rambold, 2004–2016) and methodology described by Agerer (1991) and Kraigher (1996).

Identification of fungal partner in ectomycorrhiza using molecular methods was based on PCR amplification of fungal nuclear rDNA ITS region. Total genomic DNA was extracted from ethanol-stored ectomycorrhizal root tips by using a Plant DNeasy Mini Kit (Qiagen, Hilden, Germany). Amplification was performed with ITS 1f (Gardes et Bruns, 1993) and ITS 4 primer pair (White et al., 1990). PCR reaction was optimized in the way that the optimal quantity of DNA extract was determined in order to give the best product in the reaction. Amplification reaction was performed on GeneAmp® PCR System-u 9700 (Applied Biosystems) according to protocol described in Kraigher et al. (1995) and modified by Grebenc et Kraigher (2007). The amplification success was checked and selection of samples for further analyses was performed by gel electrophoresis (1.5% agarose). Amplified DNA samples were excised and separated from the agarose gel and purification was performed with Wizard SV Gel and PCR Clean-Up System, PROMEGA. Sequencing was performed in a commercial sequencing laboratory (MacroGen inc., Seoul, Republic of Korea). Species, genus or family of ECM fungi were determined by comparing our sequence to the ones deposited in GenBank (<http://www.ncbi.nlm.nih.gov/genbank/index.html>) and Unite (Abarenkov et al. 2010) database.

Results and discussion

Average number of vital ECM roots per soil sample ranged from 95.3 ± 6.1 (347.8 dm^{-3}) recorded in Majdan Kučajna in spring to 757.7 ± 224.3 (2783.9 dm^{-3}) counted in Predejane in early winter (Table 1). These values are much lower than values recorded on beech grown at sites contaminated with Pb, Cd and S (4095.5 – 7288.5 dm^{-3} (Al Sayegh Petkovšek et Pokorný, 2006)) as well as in mature beech (5412.9 dm^{-3} (Mašek et Grebenc 2011)) and spruce stands (4309 – 6716 dm^{-3} (Kraigher 1999)) in Slovenia. However, they are comparable with values obtained in Germany under two-fold ozone fumigated beech trees (1.993 dm^{-3}) and in the control plot (1.266 dm^{-3}) (Grebenc and Kraigher, 2007). Also, our results can be compared to the ones obtained on white poplar (1106 dm^{-3} – 1570 dm^{-3}) (Katanić et al., 2015).

Number of vital ectomycorrhizal roots, old non-turgescient and non-mycorrhizal roots and total number of fine roots differed among sites, while percentage of vital roots differed between spring and early winter (data not shown). This value decreased in spring compared to

early winter which is in accordance to De Roman et De Miguel (2005) who found that the percentage of mycorrhizal tips reached a maximum in winter and a minimum in autumn.

Table 1 Average values (\pm standard error) for number of vital ectomycorrhizal (ECM) roots, old non-turgescient and non-mycorrhizal roots (ONN), total number of fine roots and percentage of vital ECM roots per sample in beech stands from different sites in Serbia in two seasons. Fisher LSD test was used to assess differences among sites and seasons.

site/season	vital ECM	ONN	total	%
MKw	346.0 \pm 42.6 ab	2335.0 \pm 52.2 ab	2681.0 \pm 93.0 abc	12.8 \pm 1.1 abc
MKs	95.3 \pm 6.1 c	2131.3 \pm 17.8 ab	2226.7 \pm 218.1 abc	4.4 \pm 0.5 d
Pw	757.7 \pm 224.3 a	2241.7 \pm 342.6 ab	2999.3 \pm 486.1 ab	24.9 \pm 5.5 a
Ps	716.7 \pm 245.3 a	3173.0 \pm 1022.0 a	3889.7 \pm 1207.8 a	18.0 \pm 4.0 ab
Kw	113.7 \pm 9.9 bc	1384.3 \pm 300.3 bc	1498.0 \pm 290.5 cd	8.3 \pm 1.9 bcd
Ks	284.7 \pm 111.8 bc	1723.0 \pm 46.8 abc	2007.7 \pm 135.8 bcd	13.5 \pm 5.0 abcd
Fgw	172.3 \pm 49.8 bc	868.0 \pm 74.0 c	1040.3 \pm 110.1 d	16.0 \pm 3.9 ab
FGs	99.7 \pm 23.7 bc	1829.0 \pm 558.5 abc	1928.7 \pm 564.8 bcd	6.5 \pm 2.7 cd

(IV=Iriški venac; MK=Majdan Kučajna; K=Krupanj; PR=Predejane; w=winter, s=spring)

In all (24) soil samples from investigated sites in two seasons total number of analysed fine roots was 54636 (24478 in winter and 30158 in spring) while total number of vital ECM roots was 8373 (4784 in winter and 3589 in spring). From all vital ECM roots, 36 ECM types were identified. With molecular methods 27 ECM types were identified from which 14 types to the species level, 4 types to the genus, 6 types to the family and 3 ECM types to the ordo level (Table 2). With morphological and anatomical methods 9 ECM types were identified (*Cenococcum geophilum* Fr., *Fagirhiza cystidiophora*, *Fagirhiza tubulosa*, *Geastrum fimbriatum* Fr., *Genea hispidula* Berk. & Br., *Genea verrucosa* Vitt., *Lactarius blennius* Fr., *Piloderma croceum* Erikss. & Hjortst., *Russula illota* Romagn). Detailed descriptions of these ECM types were given in Katanić et al. (2012).

Cenococcum geophilum Fr. was recorded at all studied sites, a few ECM fungi occurred at one site in both seasons (*Inocybe* sp., *Entolomataceae* sp. *Fagirrhiza tubulosa*, *Lactarius blennius* and *Lactarius camphoratus*), but the majority of them were characteristic for one site and were recorded only ones.

Table 2. Ectomycorrhizal fungi on beech from selected sites in Serbia identified on the basis of the similarity with the sequences from internet databases GenBank and UNITE

ECM type	GenBank accession number of best DNA based hit with the percentage % of identity	UNITE accession number of best DNA based hit with the % percentage of identity	Site and season
<i>Boletus edulis</i> Bull.	<i>Boletus edulis</i> KP031596.1 99%,	<i>Boletus edulis</i> Estonia <u>UDB015697</u> 99%	PRw
<i>Boletus reticulatus</i> Schaeff.	<i>Boletus reticulatus</i> KC422595.1 98%	<i>Boletus reticulatus</i> Estonia <u>UDB011455</u> 98%	PRw
<i>Cortinarius fuscescens</i> Kytov., Niskanen & Liimat.	<i>Cortinarius fuscescens</i> KP165548.1 99%	<i>Cortinarius rubroviroleipes</i> Finland <u>UDB001457</u> 96%	PRs
<i>Craterellus cornucopioides</i> (L.) Pers.	<i>Craterellus cornucopioides</i> JF907967.1 100-98%	<i>Craterellus cornucopioides</i> Estonia <u>UDB015535</u> 89%	MKw
<i>Hydnum rufescens</i> Pers.	<i>Hydnum rufescens</i> AJ535304.2 99-100%	<i>Hydnum</i> Estonia <u>UDB019722</u> 93%	PRs
<i>Hygrophorus eburneus</i> (Bull.) Fr.	<i>Hygrophorus eburneus</i> AY463485.1 99%,	<i>Hygrophorus eburneus</i> Sweden <u>UDB000555</u> 97%	Kw
<i>Hymenogaster niveus</i> Vittad.	<i>Hymenogaster niveus</i> GU479255.1 99%	/	IV s
<i>Laccaria laccata</i> (Scop.) Cooke	<i>Laccaria laccata</i> KM067834.1 99%	<i>Laccaria laccata</i> Estonia <u>UDB015789</u> 99%	IVs
<i>Lactarius camphoratus</i> (Bull.) Fr.	<i>Lactarius camphoratus</i> GU550113.1 99%	<i>Lactarius camphoratus</i> Estonia <u>UDB011414</u> 99%	PRw, PRs
<i>Lactarius subdulcis</i> (Pers. ex Fr.) Gray	<i>Lactarius subdulcis</i> HM189797.1 100%	<i>Lactarius subdulcis</i> Denmark <u>UDB000048</u> 100%	MKw, IVs
<i>Russula ionochlora</i> Romagn.	<i>Russula ionochlora</i> HM189873.1 100%	<i>Russula ionochlora</i> Finland <u>UDB022526</u> 96%	MKs
<i>Russula nigricans</i> (Bull.) Fr.	<i>Russula nigricans</i> KM085390.1 99%	<i>Russula nigricans</i> Estonia <u>UDB011331</u> 100%	Kw
<i>Russula ochroleuca</i> Fr.	<i>Russula ochroleuca</i> KR019855.1 100%	<i>Russula ochroleuca</i> Finland <u>UDB022551</u> 99%	Kw
<i>Tricholoma lascivum</i> (Fr.) Gillet.	<i>Tricholoma lascivum</i> EU186281.1 99%	<i>Tricholoma lascivum</i> Denmark <u>UDB000005</u> 99%	Kw
<i>Inocybe</i> sp.	Uncultured <i>Inocybe</i> FR750640.1 99%	<i>Inocybe cookei</i> Sweden <u>UDB00063777</u> 99%	IVw, IVs
<i>Russula</i> sp.	Uncultured <i>Russula</i> JF519199.1 99%	<i>Russula</i> Papua New Guinea <u>UDB013241</u> 96%	MKs
<i>Thelephora</i> sp.	<i>Thelephora</i> sp. KM576612.1 99%	<i>Thelephora palmata</i> Estonia <u>UDB015185</u> 99%	MKw
<i>Tomentella</i> sp.	Uncultured <i>Tomentella</i> HQ336676.1 99%	<i>Tomentella</i> Slovenia <u>UDB020341</u> 99%	IVw
Entolomataceae sp.	Entolomataceae sp. KM576402.1 98%	<i>Entoloma politum</i> Finland <u>UDB021900</u> 93%	IVw and IVs
Hyaloscyphaceae sp.	uncultured Hyaloscyphaceae HF674637.1 100%	/	MKs
Sebacinaeae sp.	<i>Sebacina</i> sp. YM2885 94-98%;	<i>Sebacina</i> Japan <u>UDB014142</u> 85%	MKs
Thelephoraceae sp. 1	Uncultured Thelephoraceae JF519201.1 99%	<i>Thelephora friulana</i> Italy <u>UDB023372</u> 92%	MKs
Thelephoraceae sp. 2	Uncultured Thelephoraceae JF519275.1 100%	<i>Tomentella papuae</i> Papua New Guinea <u>UDB023788</u> 95%	PRw, Kw

Thelephoraceae sp. 3	Uncultured Tomentella JF748069.1 100-93%	Tomentella Turkey <u>UDB004955</u> 92%	MKw
Helotiales sp.	Helotiales sp. HM190117.1 99%	/	Ps, Ks
Pezizales sp. 1	Pezizales sp. LB-P4 AJ969617.1 100%	Peziza phyllogena Estonia <u>UDB024369</u> 84%	Kw
Pezizales sp. 2	Pezizales sp. LM2356 KM576477.1 97%,	Peziza succosa Estonia <u>UDB024734</u> 86%	IVw

(IV=Iriški venac; MK=Majdan Kučajna; K=Krupanj; PR=Predejane; w=winter, s=spring)

Most of recorded ECM types are commonly found on beech (Grebenc, 2005; Grebenc et Kraigher, 2007; Kraigher et al., 2007). Genus *Lactarius* with three and *Russula* with five ECM species/types were most species-rich genera at investigated sites, which is in accordance with previous research (Grebenc, 2005; Grebenc et Kraigher, 2007). *Cenococcum geophilum* has a world-wide distribution with a wide range of plant partners (Smith et Read, 2008). Its mycorrhiza is very common on seedlings and mature trees but it is rarely dominant type on root system (Ingleby et al., 1990). However, *C. geophilum* is frequent and abundant on sites under the influence of stress factors (LoBuglio, 1999). Also, it is known as an indicator of drought and ozone stress on beech and spruce (Kraigher et Al Sayegh Petkovšek, 2011). At investigated sites *C. geophilum* was frequently found but not abundant, so it can be assumed that these sites were not affected by stress. *Hydnum rufescens* is suggested as pollution sensitive ECM species in beech forest, *Russula illota* as an indicator of ozone stress on beech and *Fagirhiza spinulosa* as an indicator of polluted air and drought on Norway spruce (Kraigher et Al Sayegh Petkovšek, 2011). Therefore, in future studies attention should be paid on these ECM types and their abundance.

Conclusion

This paper gives the information about diversity of ECM fungi on beech in Serbia obtained with DNA based methods. These results could be helpful in estimating site condition of particular stands and detecting their potential changes in future. In order to reveal potential disturbance of ECM fungal diversity on analysed sites, the ECM monitoring should be continued.

Acknowledgement

This paper was realized as a part of the project financed by the Ministry of Education and Science of the Republic of Serbia, the Research programme P4-0107 of the Slovenian Research Agency and STSM under COST Action FP1305 for Marina Katanić.

References

- Abarenkov, K, Nilsson, RH, Larsson, K-H, Alexander, IJ, Eberhardt, U, et al. (2010). The UNITE database for molecular identification of fungi - recent updates and future perspectives, *New Phytologist* 186 (2), 281–285
- Agerer, R, Rambold, G, (2004–2016). [first posted on 2004-06-01; most recent update: 2016-03-25]. DEEMY – An Information System for Characterization and Determination of Ectomycorrhizae, www.deemy.de – München, Germany
- Agerer, R, (1987-2002). *Colour Atlas of Ectomycorrhizae* 1st-12^h Edition, Einhorn-Verlag, Schwäbisch Gmünd, Germany
- Agerer, R, (1991). Characterisation of ectomycorrhizal, *Techniques for the study of mycorrhiza*, Norris, J R, Read, D J, Varma, A K, (Eds): *Methods in Microbiology* 23, 25-72

- Al Sayegh Petkovšek, S, Pokorny, B, (2006). Glive kot odzivni in akumulacijski bioindikatorji onesnaženosti gozdnih rastišč v Šaleški dolini (Fungi as responsive and accumulative bioindicators of forest site pollution in the Šalek valley), Zbornik gozdarstva in lesarstva, 61-71
- De Roman, M, de Miguel, A M, (2005). Post-fire, seasonal and annual dynamics of the ectomycorrhizal community in a *Quercus ilex* L. forest over a 3-year period, *Mycorrhiza* 15, 471–482
- Gardes, M, Bruns, T D, (1993). ITS primers with enhanced specificity for basidiomycetes - application to the identification of ectomycorrhizae and rusts, *Molecular ecology* 2, 113-118
- Grebenc, T, (2005). Tipi ektomikorize na bukvi (*Fagus sylvatica* L.) v naravnem in gospodarskem gozdu (Types of ectomycorrhizae on beech (*Fagus sylvatica* L.) in natural and managed forest), Doctoral dissertation, University of Ljubljana, Biotechnical faculty, Ljubljana
- Grebenc, T, Kraigher, H, (2007). Types of ectomycorrhiza of mature beech and spruce at ozone-fumigated and control forest plots, *Environmental Monitoring and Assessment* 128, 47–59
- <http://www.ncbi.nlm.nih.gov/genbank/index.html>, accessed 25.03.2016.
- Ingleby, K, Mason, PA, Last, F T, Fleming, L V, (1990). Identification of ectomycorrhizas, Institute of Terrestrial Biology research publication no. 5, HMSO, London
- Katanić, M, Orlović, S, Grebenc, T, Galić, Z, Stojnić, S, Kraigher, H, (2011). Tipovi ektomikorizenabukvisa Stare planine (Ectomycorrhizal types on beech from Stara planina), *Topola (Poplar)* 187/188, 85-98
- Katanić, M, Matović, B, Pekeč, S, Grebenc, T, Kraigher, H, (2012). Diversity of ectomycorrhiza in beech stands from different localities in Serbia, *Proceedings of International Scientific Conference: „Forest in future, sustainable Use, Risks and Challenges*, Institute of Forestry, Belgrade, Republic of Serbia, 187-194
- Katanić, M, Grebenc, T, Orlović, S, Matavuly, M, Kovačević, B, Bajc, M, Kraigher, H, (2015). Ectomycorrhizal fungal community associated with autochthonous white poplar from Serbia, *iFOREST Biogeosciences and Forestry* vol. 9, 330-336
- Kraigher, H, (1996). Tipi mikorize: taksonomija, pomen, aplikacija (Types of ectomycorrhizae - their taxonomy, role and application), *Zbornik gozdarstva in lesarstva*, 49, 33-66
- Kraigher, H, Agerer, R, Javornik, B, (1995). Ectomycorrhizae of *Lactarius lignyotus* on Norway spruce, characterized by anatomical and molecular tools, *Mycorrhiza* 5, 175-180
- Kraigher, H, (1999). Diversity of types of ectomycorrhizae on Norway spruce in Slovenia, *Phyton* 39(3), 199-202
- Kraigher, H, Al Sayegh-Petkovšek, S, Grebenc, T, Simončič, P, (2007). Types of ectomycorrhiza as pollution stress indicators: case studies in Slovenia, *Environmental Monitoring and Assessment* 128(1), 31–45
- Kraigher, H, Al Sayegh-Petkovšek, S, (2011). Mycobioindication of stress in forest ecosystems. V: RAI, Mahendra (ur.), VARMA, Ajit (ur.). *Diversity and biotechnology of ectomycorrhizae (Soil biology, vol. 25)*, Heidelberg New York, Springer, 301-322
- LoBuglio, K F, (1999). *Cenococcum* In: *Ectomycorrhizal Fungi Key Genera in Profile*, Springer, Berlin, Heidelberg, 287–309
- Mašek, A, Grebenc, T, (2011). Beech (*Fagus sylvatica* L.) ectomycorrhiza and fine roots in mature forests, regeneration stands and on seedlings, *Les (Ljublj.)* 63(5), 192-196
- Smith, S E, Read, D J, (2008). *Mycorrhizal symbiosis*, Third edition, Elsevier-Academic Press, London, 787

- Vučičević, S. (2004). Melioracija bukovih šuma Srbije u funkciji unapređenja životne sredine (Reclamation of beech forests in Serbia in the function of environmental protection), Šumarstvo (Forestry) 3, 149-158
- White, T J, Bruns, T, Lee, S, Taylor, J, (1990). Amplification and direct sequencing of fungal ribosomal RNA genes for phylogenetics, PCR Protocols, A guide to methods and applications (315–322), Academic Press San Diego

BIOCLIMATIC MAPPING OF RURAL AREAS IN BOZKURT, TURKEY, FOR RECREATION

Mehmet CETIN¹, Ilknur ZEREN^{2*}

¹Kastamonu University, Faculty of Engineering and Architecture, Department of Landscape Architecture, Kastamonu, Turkey

²Kastamonu University, Faculty of Forestry, Department of Forestry Engineering, Kastamonu, Turkey

*Corresponding author: ukizeren@gmail.com

Abstract

Human beings tend to feel healthy and active in regions that have environmental conditions such as overall nominal temperature, precipitation, humidity, and wind within a range called the biocomfort threshold. Beyond the biocomfort threshold, people start to feel uncomfortable and want to move from the area. Hence, bioclimatic mapping of rural areas can help people find the best possible place for recreation. In this study, bioclimatic mapping of Bozkurt's rural areas was conducted with the aim of building upon similar studies in the rural areas of similar structures. To this end, Bozkurt's climatic data was collected from meteorological stations and used to produce biocomfort maps showing temperatures equivalent to the physiological index. The RayMan 1.2 program was used to evaluate the climatic data to determine a field's biocomfort structure, and the geographic information system (GIS) was used to produce thermal perception maps. Based on the psychological equivalent temperature, the most appropriate time and area for outdoor recreation activities were identified on the thermal perception maps.

Keywords: *Rural area, Bozkurt, biocomfort.*

Introduction

How people spend their leisure time has social, psychological and economic importance, especially in developing countries such as Turkey. Because economic and environmental pressures on people are increasing in this country, recreational activities can reduce the stress caused by difficult living conditions. Therefore, recreation can contribute positively to people's physical and mental health. Through such activities, people can also contribute to their personal and social development and share knowledge and experiences with others. In pursuing the health benefits of recreational activities during their leisure time, people can continue to be productive in their jobs and contribute to the economy through recreational spending. Thus, recreation has positive economic impacts in the field of business creation (Cetin, et al., 2010; Milne 2013; Cetin, 2015a; Cetin, 2015b; Cetin, 2015c; Olgyay 2015; Cetin & Zeren 2016).

However, the physical environment that people live in can limit outdoor recreational activities. Among environmental factors that have a huge impact on human activity are ever changing weather and climate conditions. For example, high humidity can prevent body sweat from evaporating, causing heat to be trapped in the body and raising body temperature. In high-temperature or low-temperature environments, dry throat and burning eyes can occur. Dust, smoke, pollen, and other harmful substances can pollute the air and cause difficulty breathing. A recent study describes the variables for bioclimatic comfort that ensure the comfortable breathing and well-being of human beings. According to the widely accepted research, people are comfortable within a certain range of temperature and humidity in a clean air environment. This range is called the comfort zone (Topay, 2012; Olgyay 2015; Cetin, 2015c; Cetin & Zeren 2016).

Construction and urban development can endanger the natural wildlife and ecosystem. An ecological corridor of landscape elements can help to link habitat areas. According to recent studies, Turkey has a richness of flora because of different geographical conditions in different regions (Cetin, 2015a; Cetin, 2015b; Cetin & Sevik 2016a; Cetin & Sevik 2016b; Cetin, 2016a, Cetin, 2016b). A study mentioned that some reasons for the destruction of the natural environment in Turkey include population growth rate, lifestyle, and cultural features. The study demonstrated that these factors were found to affect the formation of biomass. Furthermore, human actions affect ecosystems; thus, the environment in Turkey has been altered drastically (Cetin, 2015c; Cetin, 2015d; Cetin & Sevik 2016c; Cetin, 2016a, Cetin, 2016b).

In 2000, 47% (2.9 billion people) of the world's population lived in urban areas. It is predicted that 60% of the world's population will be living in cities in 2030. In Europe, more than two thirds of the total populations live in urban areas. Increasing population and industrialization has brought about air pollution, and in some cities, air pollution has reached levels that can threaten human health and has become one of the most important current topics of today (Cetin, 2015a; Cetin, 2015e; Cetin, 2016a, Cetin, 2016b).

Human health is adversely affected by air pollution. Carbon dioxide, CO₂, is one of the most common gases investigated in studies of global warming. Furthermore, the amount of carbon dioxide, particularly in areas that have had a population explosion, goes up as motor vehicle emissions rise, becoming a menace to human health in some cities (Cetin, 2015a; Cetin, 2015e; Cetin, 2016a, Cetin, 2016b).

To determine the bioclimatic comfort conditions such as temperature, relative humidity, and radiation, it is also necessary to determine and evaluate the wind conditions. In the evaluation of outdoor recreational activities, defining features include climate, topographic conditions, vegetation and animal life, which are limiting and controlling factors in these activities. In addition to these basic factors, the number of hot days, rainfall situation, emerging pests and diseases, and air pollution also affect human comfort. All of these factors can be used to determine the bioclimatic comfort status. This study uses the situation of Bozkurt as an example to determine the bioclimatic comfort zone.

In urban planning and design, the creation of a comfortable urban environment requires the consideration of thermal conditions for thermal comfort, and the evaluation of the effects of designated green areas in the outdoor environment. Because the urban environment can greatly change the natural landscape, the shading effect and open green spaces can offset the influence of climate elements by providing moisture to the environment, thereby preventing the formation of extreme hot and cold environments. In this study, an attempt has been made to investigate the influence of the landscape and climate on the urban design for recreational activities, and the effects of environmental factors on bioclimatic comfort.

Materials and methods

This study used the climate values of Bozkurt district as the main research material. Data from the township's meteorological station revealed Bozkurt's bioclimatic comfort status. A database of field information was created to produce maps for analysis to connect geographically referenced data and GIS data using ArcView and Rayman 1.2 software. Bozkurt, in the north of Turkey, is situated between 41° 57' North latitude and 34° 01' East longitude. Fig. 1 shows Bozkurt's global location.

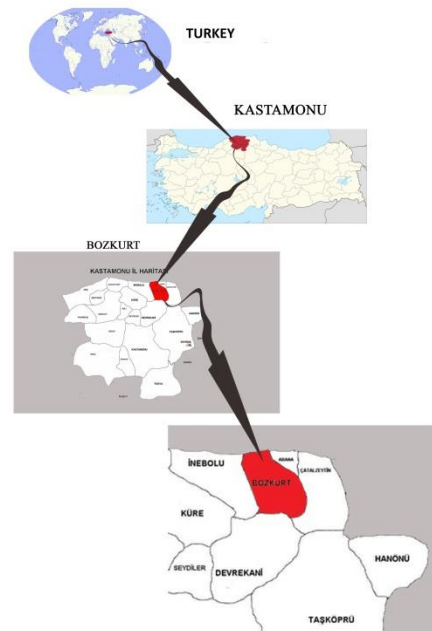

Figure 1.Bozkurt's global location

Bozkurt, Kastamonu province, Turkey, is a Black Sea port city with traditional domestic architecture. The town is situated two kilometers inland from the sea, and Ezine River flows through the valley. Abana is a town situated in the north, Devrekani in the south, Çatalzeytin in the east, and Inebolu in the West. The research area spans 296 square kilometers at an altitude of 30 meters. Ezine River and Ilisi River are the major rivers, Ezine River being 60 km long, and Ilisi River 40 km long. The major mountains are Yarali Goz (2018 meters) and Goynuk (1770 meters), and the main hill in the district of Belen, Hena, Yılmaz, is Karabalçık, where the peak reaches 1,300 meters (Municipality, 2016).

The average temperature in Bozkurt over many years was 17.1 degrees. For the extreme temperatures, the highest temperature occurred in August 1997 and was 32.3°C, and the lowest temperature occurred in February 1989 and was -7.4°C. The average annual rainfall of the county was around 989 mm. From the town center, rainfall usually continues to increase at higher altitudes despite falling snow. The melting of snow in the district would often last a few days. The most snowfall in the city was 133 cm in 1992. The average number of rainy days in a year is 134 days, and rainfall occurs mostly between December and March. Precipitation tends to be regular and heavy. The district saw 23 days of fog and 2 days of frost in a year. Of the number of days of precipitation, the number of days that had negative temperatures was 17. The dominant wind direction was south-southwest, and the average temperature of sea water was 12.5°C.

Higher temperatures dominate coastal areas. At altitudes of up to 210–330m, a combination of porphyry rock with some high scrub elements is common. Chestnut and oak woods can be found further inland on the plateau. Beech forests can be found in the northern plateau, while south oak is more common in the mountainous areas of the field. At higher altitudes, larch forests are common.

This study provides the most accurate map of the climatic data field. In the mapping formula, the universal option of linear kriging interpolation was performed using ArcView, Esri's GIS mapping software, and Rayman 1.2. Bozkurt and its climatic factors were compared, and the appropriate bioclimatic areas were identified in terms of assessed comfort levels. The meteorological station Turkish State Meteorology Affairs General Directorate in Bozkurt in the Western Black Sea (Meteorology 2016) (measured at 14:00) had records of the temperature and relative humidity data in 1981 and in 2016. In this study, higher temperatures

were compared to temperatures with humidity (air temperature was typically above 20°C). Eq. 1 (Steadman, 1979) calculates the conditions for bioclimatic comfort as follows.

$$Te = -42.379 + (2.04901523xT) + (10.1433127xRH) - (0.2247554xTxRH) - (6.83783x10^{-3}xT^2) - (5.481717x10^{-2}xRH^2) + (1.22874x10^{-3}xT^2xRH) + (8.5282x10^{-4}xTxRH^2) - (1.99x10^{-6}xT^2xRH^2) \quad (1)$$

Where T_e is the effect of temperature, T is the ambient dry-bulb temperature (in degrees Fahrenheit), and R_h is the relative humidity (percentage value between 0 and 100).

According to the calculation of the formula for determining the suitable bioclimatic comfort areas, the comfortable temperature range is 15–20°C, relative humidity is 30–60%, and wind speed is 1–3 m/sn.

With the help of GIS, the bioclimatic comfort conditions in areas of intensive settlement were found to decrease in comfort, while a decrease in the density of settlements increased comfort. In some studies, data assessments were made on the average annual temperature, humidity, and wind. This study found a favorable environment in terms of bioclimatic comfort conditions and obtained limited results. The monthly average of the hourly sensed temperature values was obtained, and the average annual sensed temperature was obtained from the monthly sensed temperature maps. Thus, Bozkurt’s residential areas are suitable considering the temperature sensed in the province.

With the development of software technology today, programs can perform easy-to-use calculations and estimates of many outdoor comforts. Based on formulas and indices created by comfort factors, programs also include the leading rail bearing (Matzarakis et al., 2007; Matzarakis et al., 2010).

Results and discussion

Design features and meteorological parameters for a new residential location were chosen as the materials for analysis and were examined using the GIS method. Thus, in this study of climatic elements, bioclimatic comfort parameters were determined by evaluating temperature, humidity, and wind speed. Data maps presented in Fig. 2, 3, 4, and 5 were prepared by applying the daily maximum temperature measurements observed at 14:00 in Bozkurt and its environment between 1981 and 2016 in Eq. 1.

Fig.2 shows the Annual Average Temperature Maps. In the creation of the climate maps, the ArcView software used the Kriging Interpolation extension of the Universal Linear option to provide the most accurate distribution area of climatic data.

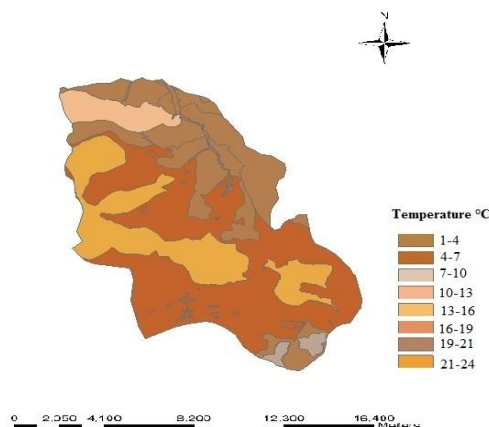

Fig. 2 Annual Average Temperature

According to this map of the study area, the resulting average annual temperature values range from 16–19°C. From the north to the south, the area shows that the average annual temperature values tend to decrease with the increase in other factors.

Fig.3 is annual average relative humidity map showing the relative humidity values obtained. The map of the study area shows that the relative humidity values vary between 49–58%. The percentage of relative humidity values tends to increase toward the south of the area because of the sea.

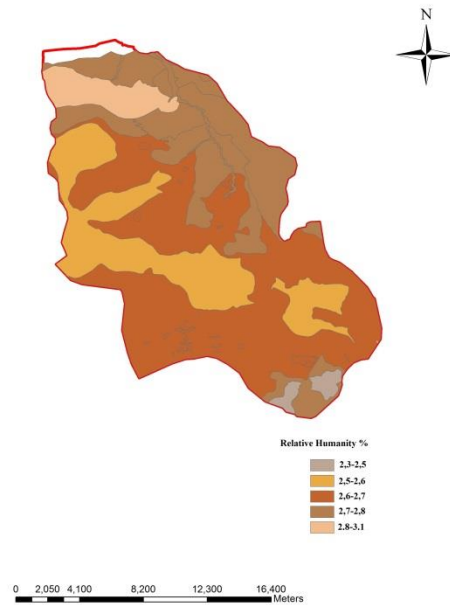

Figure 3. Annual Average Relative Humidity

The average wind speed map shows the field research values are 1.1–2.8 m/sec. The average wind speed values are increasing toward the northern and inland areas (Fig. 4).

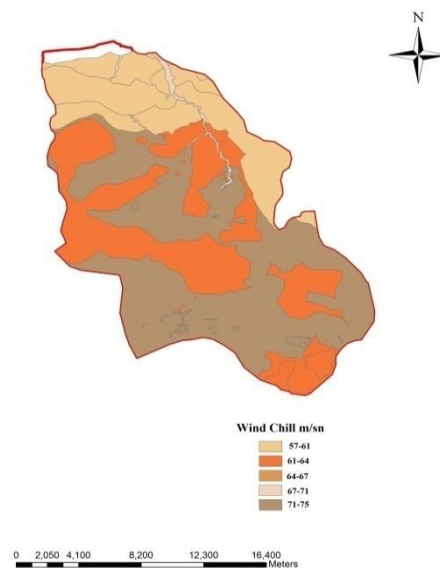

Figure 4. Annual Average Wind Speed Map showing the average wind speed values.

In this study of bioclimatic comfort, the value of each of the climatic elements is determined based on the most extensive range. The purpose of investigating Bozkurt district's bioclimatic comfort is also to investigate the surrounding areas. For this reason, climate maps of Bozkurt district were prepared. Fig. 5 shows the values in terms of bioclimatic comfort.

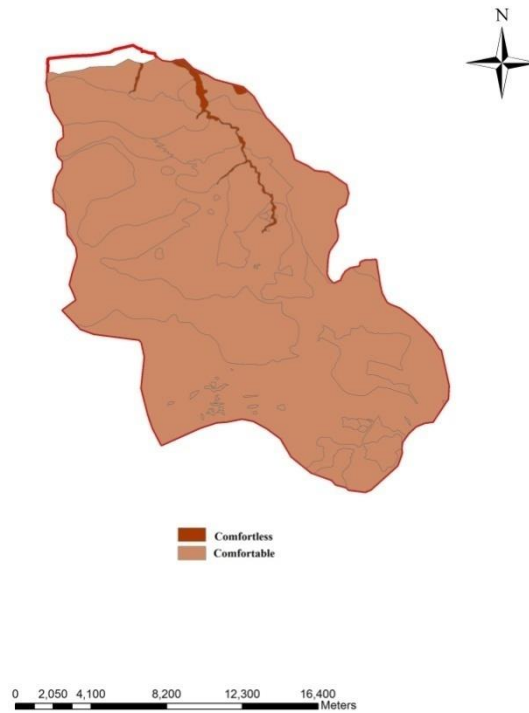

Figure 5. Biocomfort areas

According to the mapping of a large portion of Bozkurt, the town's location appears to be suitable for bioclimatic comfort. This area shows the distribution of more provinces in the eastern and northern parts. The areas suitable for bioclimatic comfort include part of Bozkurt's area of 296km², and the areas which are not suitable for bioclimatic comfort are located mostly in the northwest part of the province. The area covering 73 km² was found to be unsuitable for bioclimatic comfort, and the reason for this is that the relative humidity in the area is not within the range for bioclimatic comfort. In this study, the results showing Bozkurt's bioclimatic comfort zones can be used to facilitate furtherer development of the provinces around the Bozkurt region to construct comfortable limits, human settlements, recreation, and so on. A practical application of this study is to plan the most accurate distribution area for environmental sustainability and human comfort.

Conclusion

Studies on human bioclimatic comfort usually tried to make an annual distribution in terms of a comfort zone and recommend the appropriate periods in terms of comfort for human activities such as tourism and outdoor recreation. Exterior planning and design is an interest of modern landscape architecture disciplines. Another advantage of the knowledge of the period for bioclimatic comfort is that such knowledge can be used to lay out options for outdoor activities. In this way, space utilization can be tailored to the appointed period.

As can be understood from the study of human bioclimatic comfort conditions, they are affected by a lot of their own characteristics and parameters. Therefore, small changes in one of the variable parameters can affect the total result too much. Due to the characteristics of the people, it is impossible to fix the direction of outside intervention. Therefore, non-factors

affect the bioclimatic comfort conditions are kept under control through various measures and adjustments.

Bioclimatic comfort conditions can be improved with the implementation of the principles of landscape architecture and planning and design criteria. The plan and design in every area of bioclimatic comfort conditions in terms of landscape architecture and design is for a balanced distribution, and there is sufficient basis for the release of open green spaces. Adequate and appropriate plantation areas can produce shade effects, and water vapor spray can prevent heat stress in summer. The deciduous plants in winter can help to get rid of the cold stress field by not shielding the sun's rays. This and many other measures and arrangements should be considered in landscape planning and design. The wrong planning and design of bioclimatic comfort conditions may result in extremely adverse circumstances. The areas of heat or cold stress under natural conditions, due to the destruction of dense natural vegetation and bioclimatic conditions can become inappropriate in terms of comfort. Design in terms of planning and intensive land use with insufficient green areas produces a negative situation for bioclimatic comfort.

As a result, outdoor design is important in the creation of suitable areas in terms of bioclimatic comfort. Therefore, every step of the landscape planning and design should be done with great care and without compromising the conditions for bioclimatic comfort.

References

- Cetin M, Topay M, Kaya LG, Yilmaz B. (2010). Efficiency of bioclimatic comfort in landscape planning process: the case of Kutahya. Suleyman Demirel University. Journal of Faculty of Forestry, A(1), 2010; 83–95. Isparta.
- Cetin, M. (2015a). Using GIS analysis to assess urban green space in terms of accessibility: case study in Kutahya. International Journal of Sustainable Development & World Ecology 2015; 22 (5): 420-424. DOI: 10.1080/13504509.2015.1061066
- Cetin, M. (2015b). Evaluation of the sustainable tourism potential of a protected area for landscape planning: a case study of the ancient city of Pompeipolis in Kastamonu. International Journal of Sustainable Development & World Ecology 2015; 22 (6): 490-495. DOI: 10.1080/13504509.2015.1081651
- Cetin, M. (2015c). Determining the bioclimatic comfort in Kastamonu City. Environmental Monitoring and Assessment. 2015; 187 (10): 640. DOI: 10.1007/s10661-015-4861-3
- Cetin, M. (2015d). Consideration of permeable pavement in landscape architecture. Journal of Environmental Protection and Ecology 16 (1), 385–392.
- Cetin, M. (2015e). Chapter 55: Using Recycling Materials for Sustainable Landscape Planning. Environment and Ecology at the Beginning of 21st Century. Ed.: Prof. Dr. Recep Efe, Prof. Dr. Carmen Bizzarri, Prof. Dr. İsa Cürebal, Prof. Dr. Gulnara N. Nyusupova, ST. Kliment Ohridski University PRESS, Sofia; 2015. p. 783-788, ISBN: 978-954-07-3999-1.
- Cetin, M. & Sevik, H. (2016a). Evaluating the recreation potential of Ilgaz Mountain National Park in Turkey. Environmental Monitoring and Assessment 2016; 188 (1): 52. DOI: 10.1007/s10661-015-5064-7
- Cetin, M. & Sevik, H. (2016b). Chapter 5: Assessing Potential Areas of Ecotourism through a Case Study in Ilgaz Mountain National Park, Tourism - From Empirical Research Towards Practical Application. InTech, Eds: Leszek Butowski, pp.190, ISBN: 978-953-51-2281-4, Chapter pp. 81-110
- Cetin, M. & Sevik, H. (2016c). Measuring the Impact of Selected Plants on Indoor CO₂ Concentrations. Polish Journal of Environmental Studies 25: (3), 973–979.
- Cetin, M. (2016a). A Change in the Amount of CO₂ at the Center of the Examination Halls: Case Study of Turkey. Studies on Ethno-Medicine 10: (2), 146–155.

- Cetin, M. (2016b). Peyzaj Çalışmalarında Kullanılan Bazı Bitkilerde Klorofil Miktarının Değişimi. *Kastamonu Üniversitesi Orman Fakültesi Dergisi* 16: (1), 239–245.
- Cetin M, Zeren I. (2016). Evaluation of the value of biocomfort for Kastamonu-Inebolu”. International Conference GREDIT’2016 – Green Development Infrastructure Technology, Poster section 4: Management of Urban and Industrial Waste, Climate Change – Biodiversity – Efficiency, ISBN 978-608-4624-21-9, 31.03 and 01.04 2016, p4–35, page: 310, Skopje, Macedonia.
- Matzarakis A, Rutz F, Mayer H. (2007). Modelling Radiation fluxes in simple and complex environments – Application of the RayMan model. *International Journal of Biometeorology* 2007, 51, 323-334.
- Matzarakis A., Rutz F., Mayer H. (2010). Modelling radiation fluxes in simple and complex environments: basics of the RayMan model. *International Journal of Biometeorology* 2010, 54, 131-139.
- Meteorology (2016), Ministry of Forestry and Hydraulic Works. General Directorate of Meteorology. Bozkurt district for the 1981 - 2015 covering the meteorological data.
- Milne M. 2013. Climate consultant 5.4, UCLA, Los Angeles: Energy design tool group. 2013
- Municipality (2016), Bozkurt Municipality <http://www.bozkurtbelediyesi.com/>, (Accessed: 17/06/2016)
- Olgay V. (2015). Design with climate: bioclimatic approach to architectural regionalism, Princeton University Press. 2015.
- Steadman, R. G. (1979). The assessment of sultriness, part I: temperature-humidity index based on human physiology and clothing science. *Journal of Applied Meteorology*, 18, 861-873.
- Topay M. (2012). Importance of thermal comfort in the sustainable landscape planning, *Journal of Environmental Protection and Ecology*, 2012, 13(3), 1480-1487.

ECOLOGY OF SPIDERS IN DIFFERENT ORCHARDS AT THE HUNTING RESERVE OF ZERALDA (ALGERIA)

Salma CHAIB¹, Badea BASSA¹, Amina SAADI¹, Ahlem RAYANE¹, Ourida KHERBOUCHE-ABROUS¹, Lynda BELADJAL²

¹ Laboratory dynamic and biodiversity, Sciences Biology faculty, university of sciences and technology Houari Boumedienne, BP 32 El alia, Bab Ezouar, Algeria.

² Ghent University, Department of Biology, Terrestrial Ecology Unit, K.L. Ledeganckstraat 35, B-9000, Belgium.

¹ Corresponding author: selmach88@gmail.com

Abstract

Spiders are an important group of invertebrates in all terrestrial ecosystems. They are the most abundant with very high species richness. They are known to lodge various ecological niches. The aim of the present work is to study the ecology of the ground spiders in three different orchards (Medlar tree, Clementine tree and Fig tree) located in the hunting reserve of Zeralda (suburb of the city of Algiers in northern Algeria). The epigean spiders were collected using thirty pitfall traps, filled third with a formaldehyde solution (4%) as fixative. The traps were emptied monthly during 8 months between 2014-2015. A total of 354 individuals were collected belonging to 14 families. The Gnaphosidae were represented by 6 species, the Lycosidae and the Dysderidae with 5 species each. The other families were collected with less species number. Out of all sampled species, none of them was constant (frequency of occurrence). 6 species were considered as accessory, 9 as accidental and 23 were sporadic. The changes in richness and species diversity might be the results of the richness of the litter's flora. From our results we can consider the sampling sites as being organized according 2 abiotic factors: the soil humidity and the recovery rate of the herbaceous layer. However, this dual ordination did not explain the species distribution.

Keywords: *Spiders, richness, Ecology, orchards, Zéralda.*

Introduction

The biodiversity is part of the natural resources threatened by human and in particular by agriculture. In order to preserve and to encourage the species contributing to the agricultural outputs and healthy agricultural product, it is very important to well know the statute of the biodiversity in agro-ecosystems (Sarhou *et al.*, 2013). Arthropoda are much diversified and the most numerous. In fact, approximately 80% of the known species belong to this phylum (Gambaiani, 1999). Among the Arthropoda, the Arachnida are the most widespread class, in which the order of spiders is the largest (Roberts, 2001), since it is the most abundant and the most affluent (Buschholz, 2009). The spiders are important in agro-ecosystems (Oberg *et al.*, 2007), as they are used as indicators of the invertebrates diversity (Gravesen, 2000; Cardoso *et al.*, 2004). They are generalist predators and can be used as auxiliary in biological control in different environments. In Algeria, some studies related to the ecology of spiders in various ecosystems were carried out (kherbouche-Abrous, 2006; Kherbouche *et al.*, 2008; Alioua *et al.*, 2012) and only one work is related to the agroecosystemes (Bouseksou *et al.*, 2015). The present work is an ecological study of Araneae group in three orchards of the hunting reserve of Zeralda (suburb of the city of Algiers in northern Algeria). This reserve was chosen for the diversity of the habitats, moreover, no preliminary arachnological data biotope are done. These three yards (Medlar tree, Clementine tree and Fig tree) were chosen

in order to compare the composition, the diversity and the abundance of spiders and have an idea on the impact of these diverse habitats on the spiders distribution.

Materials and methods

Sampling sites

The region of Zeralda is located at 40 km in the North-East of Tipaza and at 25Km North-West of Algiers (Suburb of the city of Algiers in northern Algeria) (Fig.1). The Zeralda hunting reserve (2°51'44.60"N-36°41'53.55") covers an area of 1034 ha

It is characterized by a Mediterranean climate (sub-humid bioclimatic to mild winter). Three orchards were chosen as study site, the name derives from the cultivated fruit tree. The following abbreviations were used: (i) FG: Fig tree (*Ficus carica*); (ii) CL: Clementine tree (*Citrus clemantina*) and (iii) NF: Medlar tree (*Eriobotrya japonica*).

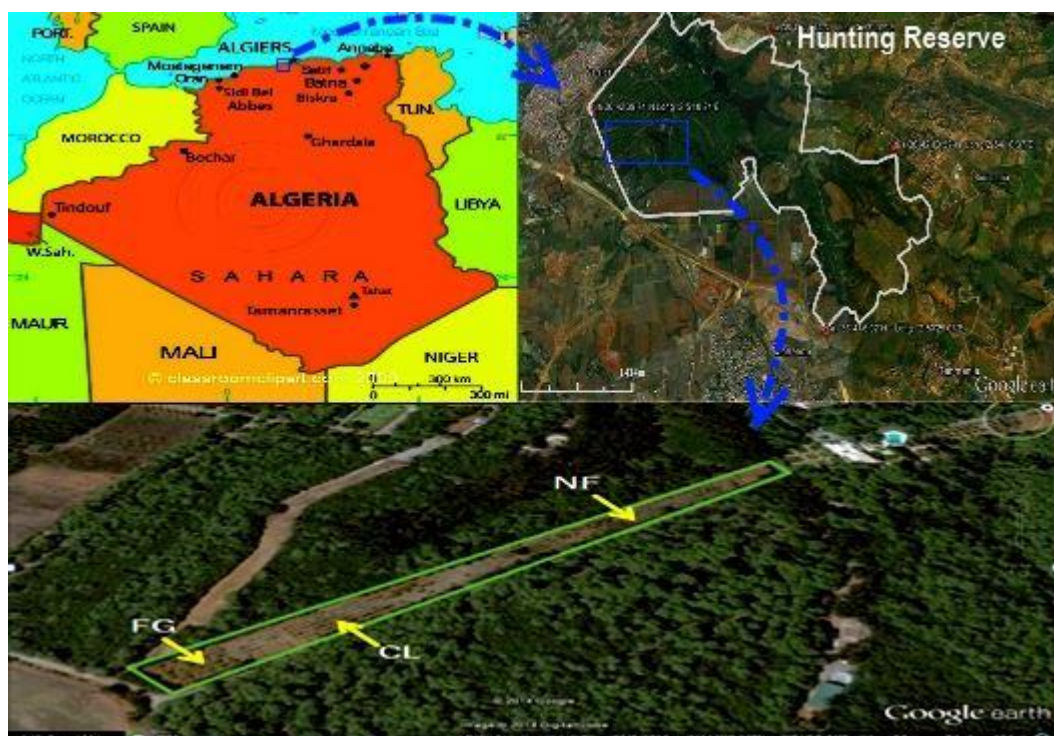

Fig.1 : Geographical location of the hunting reserve of Zeralda and the different sampling sites (FG, CL and NF)

Sampling method

To get an overall idea on the presence and the richness of the soil fauna, the appropriate sampling methods is very important (Southwood, 1978).

Pitfall Barber traps were used in the present study as it is the efficient method for collecting soil invertebrates (Coulson & Butterfield, 1985) and the main sampling method to study spiders community (Maurer & Hanggi, 1990). At each site, 10 trees were selected, around which was placed following the linear transect model. The traps consists of plastic containers (10 cm deep, 7.5 cm diameter) dug, leveled with the soil surface, and 1/3 filled fixative solution (4% formaldehyde). The traps were emptied monthly from April 2014 to April 2015. The identification to species level was performed using Ledoux & Canard (1981), Bosmans & Abrous (1990), Bosmans & Abrous (1992) and Word Spider catalog (2015).

For specific diversity, the Shannon-Weaver index was used (Ramade, 2003).

Results and discussion

In total 1647 individuals belonging to different zoological groups were collected: 55% Isopoda, 26% Arachnida and 19% Myriapoda. The Araneae order represented 83% of the sampled Arachnida with 352 individuals, followed by the order Opiliones with 65 individuals (15%), and 7 individuals only for the order of Scorpionida (2%) (Fig.2).

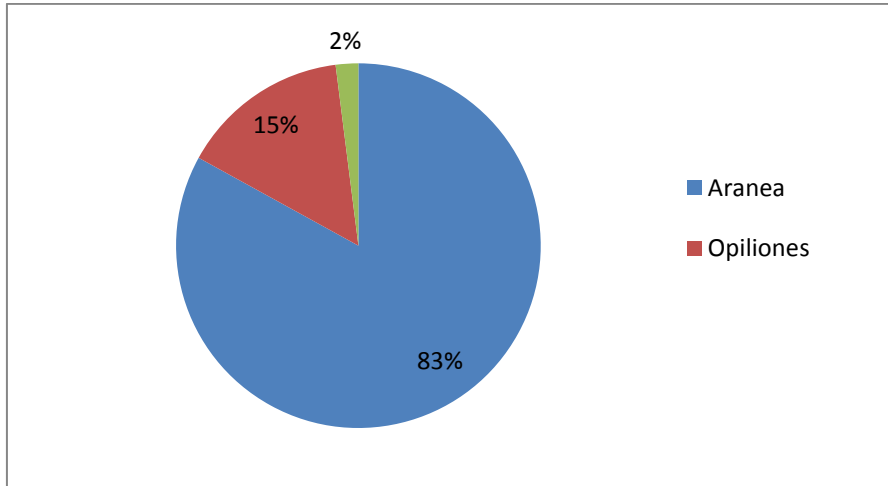

Fig.2: Percentage of different Arachnida in the three study sites.

From the whole 354 individuals spiders sampled 271 were adults and 83 juvenile. Only the adult are taken into account, since the identification of the juvenile spiders is impossible or at least extremely difficult (Valverde & Lobo, 2006; Zulka *et al.*, 1997). Among 271 adults collected 190 were males and 81 were females. They belong to 14 families, 26 genus and 38 species.

Table 1: Number of individuals collected in the three study stations.
(FG (Fig tree), CL (Clementine tree) and NF (Medlar tree))

Families	Genus	Species	FG	CL	NF	Total
Agelenidae	<i>Textrix</i>	<i>Textrix sp</i>	0	1	1	1
Clubionidae	<i>Clubiona</i>	<i>Clubiona sp</i>	0	0	1	1
Ctenizidae	<i>Cyrtocarenum</i>	<i>Cyrtocarenum sp</i>	0	9	0	9
Cybaeidae	<i>Cybaeus</i>	<i>Cybaeus sp</i>	0	0	1	1
Dysderidae	<i>Dysdera</i>	<i>Dysdera sp1</i>	3	3	20	20
		<i>Dysdera sp2</i>	2	3	10	10
		<i>Dysdera sp3</i>	0	1	1	1
	<i>Harpactea</i>	<i>Harpactea sp1</i>	0	0	1	1
		<i>Harpactea sp2</i>	2	1	4	4
Gnaphosidae	<i>Drassodes</i>	<i>Drassodes lutescens</i>	1	0	1	1
	<i>Trachyzelotes</i>	<i>Trachyzelotes mutabilis</i>	2	1	6	6
		<i>Trachyzelotes sp</i>	0	1	1	1
		<i>Zelotes aeneus</i>	5	2	8	8
		<i>Zelotes poecilochroaformis</i>	5	2	10	10
		<i>Zelotes spadix</i>	2	12	18	18
Linyphiidae	<i>Pelecopsis</i>	<i>Pelecopsis bicephalus</i>	1	3	4	4
	<i>Palludiphantes</i>	<i>Palludiphantes labilis</i>	1	0	1	1
	<i>Tenuiphantes</i>	<i>Tenuiphantes tenuis</i>	2	2	7	7
	<i>Sintula</i>	<i>Sintula pseudocorniger</i>	0	0	1	1
Families	Genus	Species	FG	CL	NF	Total
Liocranidae	<i>Scotina</i>	<i>Scotina celans</i>	0	1	1	1
Lycosidae	<i>Alopecosa</i>	<i>Alopecosa albofasciata</i>	3	10	28	28
	<i>Pardosa</i>	<i>Pardosa sp1</i>	9	39	50	50
		<i>pardosa sp2</i>	2	8	10	10
		<i>Pardosa sp3</i>	0	1	1	1
<i>Trochosa</i>	<i>Trochosa sp</i>	9	25	45	45	
Palpimanidae	<i>Palpimanus</i>	<i>Palpimanus gibbulus</i>	0	1	1	1
Salticidae	<i>Aelurillus</i>	<i>Aelurillus sp</i>	1	0	1	1
	<i>Chalcoscirtus</i>	<i>Chalcoscirtus infimus</i>	0	0	1	1
	<i>Synageles</i>	<i>Synageles sp</i>	0	0	1	1
Theriididae	<i>Crustullina</i>	<i>Crustullina sp</i>	1	0	1	1
	<i>Enoplognatha</i>	<i>Enoplognatha sp</i>	0	0	1	1
	<i>Euryopsis</i>	<i>Euryopsis sp</i>	1	0	1	1
Thomisidae	<i>Ozyptila</i>	<i>Ozyptila leprieuri</i>	2	0	2	2
		<i>Ozyptila nigella</i>	0	1	2	2
		<i>Ozyptila pauxilla</i>	7	1	8	8
	<i>Xysticus</i>	<i>Xysticus albimanus</i>	1	1	2	2
Zodariidae	<i>Zodarion</i>	<i>Zodarion algericum</i>	2	2	4	4
		<i>Zodarion ludibundum</i>	5	1	6	6
Abundance			69	132	70	271

The results show that the males are more abundant than the females (190 individuals *versus* 81 individuals) with a sex-ratio of 2.34. No female were collected for 16 species, while for 6 others species no male were sampled.

Six species are considered as accessory and nine species as accidental. The 23 species over are considered as sporadic. The sporadic species is represented by a larger number of individuals is simply due to the randomly captures rather than the absence of the species.

Total abundance by site

The total abundance of 271 individuals varies between 69 and 132 individuals (Table 1). The orchard CL has a higher abundance (49%), this can be explained by the fact that the plant species are much more abundant than in the two other orchard (FG and NF), which provide a better ecological niche to the installation of a diversified fauna.

Species richness and Diversity

The total species richness is 38 species and it varies between 19 and 25. CL has the larger species richness (25) followed by FG and NF (23 and 19 respectively) (Table 2).

Out of the total collected species, 17 are considered as abundant, as the number of individuals is higher than the number of sampled habitats (Maelfait *et al.*, 1990). Among the 38 sampled species, 18 are represented by a single individual. They are probably little active or rare, or the chosen sampling method seems inefficient for these species (Saadi, 2010). The specific diversity varies between 3.40 and 4.12 bit/individuals (Table 2). The stations ranked according to the increase order of diversity H' as follows CL, NF and FG.

Table 2: Species richness, diversity (H') and maximum diversity (H_{max}).

Stations	FG	CL	NF
Specific richness (S)	23	25	19
Abundant species	6	6	5
H'	4,12	3,4	3,43
H_{max}	4,52	4,64	4,24

Low diversity has an abundant population, and a strong diversity characterise by small population (Bachelier, 1978). Despite a low abundance and a low species richness in the Fig tree orchard (FG) compared to those found in Clementine tree (CL), FG orchard has the highest diversity index. This can be explained by the equal distribution between individuals from the different species. According to Uetz (1991), the structure of the vegetation can determine the differences between the spiders settlements. It can influence them through several biotic and abiotic factors, namely web structure, temperature, humidity, sunshine, abundance and the type of prey (Wise, 1993). The Lycosidae family is the most abundant; followed by the Gnaphosidae and Dysderidae. The comparison of the distribution of Araneofaune between the three orchards, allow us to conclude that the Clementine tree has most abundant and the largest species richness, followed by Fig tree and Medlar tree. The Fig tree site has the highest diversity index. The variations of species richness and diversity can be explained by the flora richness and the litter of the orchards.

Conclusion

Our work is a new knowledge of Aranea fauna in the hunting reserve of Zeralda, since no similar study has been done in this region yet. The chosen sites have a species richness lower than in similar ecosystems in our country.

References

Alioua Y., Bissati S., et Kherbouche-Abrous O., 2012. - Place des araignées dans l'écosystème palmeraie de la cuvette de Ouargla (nord-est Algérien) (Place of spiders in the palm

- ecosystem grove of the bowl of Ouargla (Algerian northeast)). *Revue des BioRessources*, II : 21-32.
- Bachelier G., 1978. - La faune des sols son écologie et son action (The fauna of the soil its ecology and its action). Ed. O.R.S.T.O.M., Paris, 391p.
- Bosmans R., et Abrous O., 1990. - The genus *Typhocrestus* SIMON 1884 in North Africa (Araneae : Linyphiidae) *Bull. Inst. r. SCI. Nat. Belg.*, 66: 19-37.
- Bosmans R., et Abrous O., 1992. - Studies on North Africa Linyphiidae VI. genera *Pelecopsis* SIMON, *Trichopterna* KULCZYNSKI and *Ouadia* gen. (Araneae: Linyphiidae) *Bull. Br. arachnol. Soc.* 9: 65-85.
- Bouseksou S., Kherbouche-Abrous O., et Beladjal I., 2015. - Ecology of araneae (arthropoda, arachnida) populations in two agroecosystems: wheat and oilseed rape in the Mitidja plain (Algeria). *Life and environment*, 65 (4) : 257-264.
- Buchholz S., 2009. - Community structure of spiders in coastal habitats of a Mediterranean delta region (Nestos Delta, NE Greece). *Animal Biodiversity and Conservation*, 32 : 101-115.
- Cardoso P., Silva I., De Oliveira N.G et Serrano A.R.M., 2004. - Indicator taxa of spider (Araneae) diversity and their efficiency in conservation. *Biol. Conserv.*, 120 : 517–524.
- Coulson J.C., et Butterfield J.E.L., 1985. - The invertebrate communities of peat and upland grasslands in the north of England and some conservation implications. *Biol. Conserv.*, 34 : 197–225.
- Gambaiani S., 1999. - les principaux Arachnides élevés en captivité, physiologie et pathologie (the main arachnid reared in captivity, Physiology and pathology). Thèse de doctorat. Lyon, 79p.
- Gravesen E., 2000. - Spiders (Araneae) and other invertebrate groups as ecological indicators in wetland areas. *Ekol. Bratislava*, 19 : 39–42.
- Kherbouche-Abrous O., 2006. - Les Arthropodes non insectes du parc national de Djurdjura : diversité et écologie (The non-insect arthropods of the national park of Djurdjura : diversity and ecology). Thèse Doctorat d'Etat., F.S.B., U.S.T.H.B., Alger, 173p.
- Kherbouche-Abrous O., Beladjal L., et Maelfait J.P., 2008. - Ecologie et biodiversité des araneides (Arachnides, Arthropodes) dans les cèdres du parc national de Djurdjura (Algerie) (Ecology and biodiversity of the araneides (Arachnids, arthropods) in the cedraies of the national park of Djurdjura (Algeria)). *Actes du congrès International sur la diversité biologique des Invertébrés en milieux agricoles et forestiers*, Institut National Agronomique, El-Harrach Alger, 14-17 avril 2008 : 205-218.
- Ledoux J.C., et Canard A., 1981. - Initiation à l'étude systématique des araignées (Introduction to the systematic study of the spiders). Ed. Domazan, Paris, 56p.
- Maelfait J.P., Joqué R., Baert L., et Desender K., 1990. - Heathland management and spiders. *Acta Zoologica Fennica*, 190 : 261-266.
- Maurer R., et Hänggi A., 1990. - Katalog der schweizerischen Spinnen. *Documenta Faunistica Helvetiae* 12, CSCF, Neuchâtel, 412 p.
- O'berg S., Ekbohm B., et Bommarco R., 2007. - Influence of habitat type and surrounding landscape on spider diversity in Swedish agroecosystems. *Agriculture, Ecosystems and Environment*, 122 : 211-219.
- Ramade F., 2003. - Elément d'écologie. Ecologie fondamentale (Element of ecology. Basic ecology). Ed. Dunod, Paris, 379p.
- Robert M.J., 2001. - Spiders of Britain and Northern Europe. Ed. Harper Collins publishers, London, 383p.
- Saadi A., 2010. - Structuration des peuplements d'Aranéides épigés (Arthropodes, Arachnides) et évolution spatio-temporelle le long de la rive sud-ouest du lac de Réghaïa (Structuring of

- stands of Araneides epigeal (arthropods, Arachnids) and spatio-temporal evolution along the Southwest shore of the Lake of Reghaia). Mémoire de Magistère. U.S.T.H.B., Alger, 107p.
- Sarthou J.P., Choisis J.P., Amossé A., Arndorfer M., Bailey D., Balázs K.6., Balent G., Deconchat M., Dennis P., Eiter S., Fjellstad W., Friedel J.K., Jeanneret P., Jongman R.H.G., Kainz M., Moreno G., Ouin A., Paoletti M.G., Pointereau P., Stoyanova S., Viaggi D., Vialatte A., Wolfrum S., et Herzog F., 2013. - Indicateurs de biodiversité dans les exploitations agricoles biologiques et conventionnelles des Vallées et Coteaux de Gascogne (biodiversity indicators in organic and conventional farms of the valleys and hillsides of Gascogne), cas d'étude français du projet européen BIOBIO. *Innovations Agronomiques*, 32 : 333-349.
- Southwood T.R.E., 1978. - *Ecological methods*. Ed. Chapman and Hall, London, 524p.
- Uetz G.W., 1991. - Habitat structure and spider foraging. *Popul. Community Biol. Ser* : 325-348.
- Valverde J.A., et Lobo J.M., 2006. - Establishing reliable spider (Araneae, Araneidae and Thomisidae) assemblage sampling protocols: estimation of species richness, seasonal coverage and contribution of juvenile data to species richness and composition. *Acta Oecologica*, 30 : 21-32.
- Wise D.H., 1993. - *Spiders in Ecological Webs*. Cambridge University Press, Cambridge, 328p.
- World Spider Catalog, 2015. - *World Spider Catalog*. Natural History Museum Bern, online at <http://wsc.nmbe.ch>, version 16.5, last accessed on 12/10/2015.
- Zulka K.P., Milasowszky N., et Lethmayer C., 1997. - Spider biodiversity potential of an ungrazed and a grazed inland salt meadow in the National park 'Neusiedler See- Seewinkel (Austria): implications for management (Arachnida: Araneae). *Biodivers. Conserv.*, 6 : 75-88.

ECOLOGY AND BIODIVERSITY OF ISOPODA (ARTHROPODA, CRUSTACEA) IN DIFFERENT ORCHARDS AT HUNTING RESERVE OF ZERALDA (ALGERIA)

Ahlem RAYANE¹, Meriem KROUN¹, Salma CHAIB¹, Ilham SAHKI¹, Ourida KHERBOUCHE-ABROUS¹, Lynda BELADJAL²

¹Laboratory dynamic and biodiversity, Sciences Biology faculty, university of sciences and technology HouariBoumediene, BP 32 El alia, Bab Ezouar, Algeria.

²Ghent University, Department of Biology, Terrestrial Ecology Unit, K.L. Ledeganckstraat 35, B-9000, Belgium.

*Corresponding author: rayane.ahlem@hotmail.fr

Abstract

The hunting reserve at Zeralda (suburb of the city of Algiers in northern Algeria) is characterised by different type of habitats. Besides the natural ecosystems, the reserve has several agricultural ecosystems (cereal crops and orchards). This diverse environment is very favourable to different fauna in particular soil fauna. Terrestrial Isopoda (Arthropoda) were collected from 3 different orchards (Fig trees, Medlar trees and Clementine trees) in the hunting reserve. The Isopoda were sampled using the pitfall traps. Ten traps were used per sampling site for a period of 8 months between 2014 and 2015. A total of 903 specimens were collected of which 857 were mature (406 males and 451 females) and 46 were juveniles. Five families, 5 genera and 7 species were determined. *Armadillidium vulgare* and *Philoscia muscorum* were the most abundant species (82.93% and 11.84% respectively). No difference in species richness was found between the 3 different orchards, while the highest diversity was in the fig orchard. According to Kruskal-Wallis test, there is no significant difference between species activity in the 3 orchards. Also the biotopes have no effect on this activity.

Keywords: *Isopoda*, *Richness*, *Orchards*, *Ecology*, *Zeralda*.

Introduction

In Algeria, agriculture has become one of the most important factors of economic growth leading to sustainable solutions to hunger and poverty and generating a consequent increase in the use of agricultural land. Soil is the principal habitat for plant's roots and a wide range of macroscopic and microscopic organisms which help maintaining the balance and the productivity of agro-ecosystems (Paoletti and Hassall, 1999). According to recent investigations, the pedofauna represent up to 23% of the total divers organism known up to date (Decaenset *al*, 2006). The relationship between agriculture and soil isopods (Oniscoides) was studied by different authors: Paoletti (1987, 1988); Hassall (1996); Paoletti and Hassall (1999). Recently, other work was carried out on different types of semi-natural grasslands subjected to different types of farming (Souty-Grossetet *al*, 2005a, b;. 2008). No studies have been performed on the Isopoda in agro-ecosystems in Algeria. The present work investigated the structural heterogeneity and the ecological needs of Oniscoides species by comparing the abundance and species richness in relation with the selected crop type in the Zeralda hunting reserve.

Materials and methods

Zéralda hunting reserve which is represented by forests, land crops and maquis is located at 40 km in the North-East of Tipaza and at 25Km North-West of Algiers (Suburb of the city of Algiers in northern Algeria) (Fig.1). The Zeralda hunting reserve (2°51'44.60"N-

36°41'53.55") is characterized a dry season from the end of May till the end of September with a subhumid to mild winter.

Three orchards sites were chosen in the reserve and names derive from the cultivated fruit tree. The fig Tree (*Ficus carica*) which is dominant by low litter and abbreviated as FG. The second stite Clementine (*Citrus reticulata*) is characterize by the dominant physiognomically species and abbreviated as CL, and the third site Medlar tree (*Eriobotrya japonica*) abbreviated as NF, is covered by abundant litter.

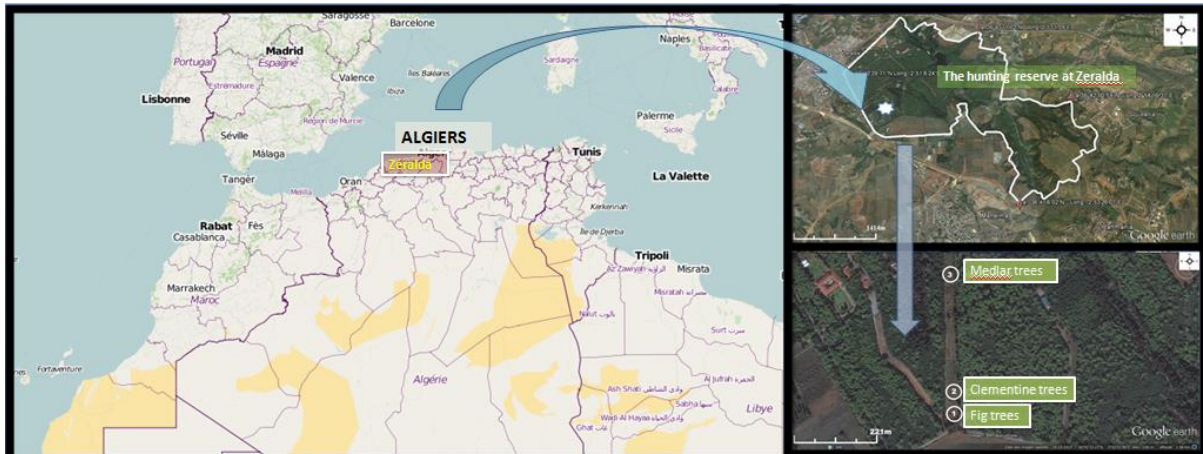

Figure 1: Geographical location of Zeralda hunting reserve and the sampling sites

Pitfall Barber traps (Barber, 1931) were used in the present study as it is the efficient method (Chergui F. & Abrous O. 1988) for collecting soil invertebrates. Ten (10) pitfall traps were used for each selected habitats.

The traps consists of plastic containers (10 cm deep, 7.5 cm diameter) dug, levelled with the soil surface and 1/3 filled with fixative solution (4% formaldehyde).

The traps were separated at least 3 meters from each other, and were operational between April 2014 and April 2015 and monthly emptied. The collected Isopoda were separated from the rest and identified using a Stroomicroscope, Hopkin (1991) determination key.

For ecological studies of harvested Oniscoides species, we considered the abundance and relative abundance (Ramade, 2003), distribution of individuals in their populations (Dajoz, 2006), species richness (Barbaut, 2008) the diversity index (Shannon) (Peet, 1974) and the index of equitability (Blondel, 1979; Magurran, 2004).

Results and discussion

Out of the 903 Isopoda specimens collected, 857 were adults and 46 juvenile. Only the adults were taken into account (406 males and 451 females).

The Figsite had the highest abundance (241 individuals) followed by the Clementine site (295 individuals) and the Medlarone (321 individuals). Taking into account the relative abundance of the sampled species *Armadillidium vulgare* is the most abundant species (82.93%), followed by *Philoscia muscorum* (11.84%), *Oniscus asellus* (2.36%), *Armadillidium sp.* (2.01%), *Porcellio dilatatus* (0.47%), *Oniscus sp.* (0.23%) and *Ligidium sp.* (0.11%) (Table 1). This abundance can be explained by the adaptation of *Armadillidium vulgare* and *Philoscia muscorum* to different types of habitat and to their low requirement with regard to the recovery and to the nature of the soil. However, the other five species (*Oniscus asellus*, *Armadillidium sp.*, *Porcellio dilatatus*, *Oniscus sp.*, *Ligidium sp.*) are considered as rare species with more demanding and they are located in areas considered as not being their natural habitats.

Table 1: abundance of species collected in the three sampling sites in Zeralda hunting reserve.

Families	Species	Fig trees	Clementine trees	Medlar trees	Total
Armadillidiidae	<i>Armadillidium sp.</i>	6	6	5	17
	<i>Armadillidium vulgare</i>	149	251	300	700
Ligiidae	<i>Ligidium sp.</i>	1	0	0	1
Oniscidae	<i>Oniscus asellus</i>	9	3	8	20
	<i>Oniscus sp.</i>	0	2	0	2
Philosciidae	<i>Philoscia muscorum</i>	62	34	4	100
Porcellionidae	<i>Porcellio dilatatus</i>	0	0	4	4
	Total	227	296	321	844

The homogenous species richness (index = 5) in the three orchards indicate the specific stability. The diversity index is variable with the highest one (1.26) recorded in the Fig tree site. This is due to the low trees density allowing a higher sun rays penetration and as results an increase in soil temperature, and poor litter. These conditions inhibit the isopods night activity. The medlar tree orchard has low diversity index (0.45). This can be explain by the high density of fruit trees, less sun penetration leading to low soil moisture and thick litter. The Evenness (Table 2) of the three orchards indicates strong imbalances within the region.

Table 2: Species richness, diversity and evenness in the three sampled sites in Zeralda hunting reserve.

Index	Fig trees	Clementine trees	Medlar trees
Species richness	5	5	5
H'	1.26	0.79	0.45
H'max	2.32	2.32	2.32
Evenness (H' / H max) (H'/H'max)	0.54	0.34	0.2
	Strong	imbalance	imbalance

The Kurskal-Wallis test allows us to compare several averages for its simplicity and eco-efficiency. Since the calculated p-value (0.97) is higher than the significance level of alpha = 0.05, we can validate the null hypothesis: The samples are from the same population. We can then say that there is no significant difference between species activity in the three areas, that is to say the nature of the site has no effect on the species activity.

Comparing our results with similar studies in cultivated areas in some regions of the world, the species richness in the present work is low (5 species) in comparison to agro-ecosystems one located north of Africa but remains similar to the results obtained in Europe.

Recently, in the Maghreb region, Achouri et al. (2008) collected 12 species of Oniscoides in natural and uncultivated habitats. In a similar study Hamaied-Melkiet al. (2011), were able to identified 11 species Oniscoïdes. In Europe, three species were collected in a cultivated field (Paoletti and Hassall, 1999) and 7 ones in grasslands (Souty-Grosser et al., 2005b).

Comparing the species abundance in relation to the type of habitat, the sampled species are present in the orchard where the litter is more important. Our study showed that the diversity of Oniscoides decreases with the less abundant litter. Several studies showed that the species

richness and the high diversity are much important in the agro ecosystems with low agricultural activity than in those with intensive one (Souty-Grosset et al, 2005a, b;. 2008). Isopods preferring humidity and mainly are present in the litter are more active during the night. According to Muchan et al. (2012) the diversity of macrofauna in farmland is less than in meadows and forests.

Conclusion

Isopods are very important pedofauna in the agro-ecosystems, their roles as bio indicators is not to be underestimated. The present study is the first on soil Isopoda in Algeria. Six species have been recorded in Zeralda hunting reserve, they are in close relationship to the diversity of the vegetation and the ecological conditions.

References

- Achouri M.S., Hamaied S., Charfi-Cheikhrouha F. 2008. Diversity of terrestrial isopoda in the Berkoukech area. *Kroumirie, Tunisia. Crustaceana*, 81 : 917 - 929.
- Barbault R. 2008. *Ecologie generale* . Ed. DUNOD , Paris : 390p.
- Barber H.S. 1931. Traps for cave inhabiting insects .J. Elisha Michell Sci. Soc : 59-266.
- Blondel J. 1979. *Biologie et écologie*. Ed. MASSON, Paris : 173 p.
- Chergui F., Abrous O. 1988. Etude écologique, systématique et biogéographique des Araignées dans six stations à différentes altitudes du parc national de CHREA (Ecological study , systematic and biogeographic Spiders in six stations at different altitudes of CHREA national park) .Thèse de D.E.S., I.S.N., U.S.T.H.B, Alger : 179p.
- Dajoz R. 2006. *Precis d'ecologie*. Ed. DUNOD, Paris : 631p.
- Decaëns T., Jiménez-Gioia J.J.C., Measey G.J., Lavelle P. 2006. The values of soil animals for conservation biology. *European Journal of Soil Biology*, 42 : 23 - 38.
- Hamaied-melki S., Achouri M.S., El Aroui O., Bohli, D., Charfi-Cheikhrouha, F. 2011. Terrestrial isopod diversity in the wadi Moula-Bouterfess catchment area (Kroumirie, North-West of Tunisia). *African Journal of Ecology*, 49: 31 - 39.
- Hassall M. 1996. Spatial variation in favorability of a grass heath as a habitat for woodlice (Isopoda: Oniscidea). *Pedobiologia*, 40 : 514 – 528
- Hopkin S.P. 1991. A key to the woodlice of Britain and Ireland. Ed. *FIELD STUDIES*, 7: 559-650.
- Magguran, A. E., 2004-Measuring ecological diversity. Ed. BLACKWELL SCIENCE.UK : 256p.
- Muchan M.N., Karanja D., Wambugu G.M., Mutahi J.M., Mugoya C., Muchai M. 2012. Land use practices and their implications on soil macro-fauna in Maasai Mara ecosystem. *International Journal of Biodiversity and Conservation*, 4: 500 - 514.
- Paoletti M.G. 1987. Terrestrial isopods in the agroecosystems of the low-lying plain in North-eastern Italy. In Striganova, B.R. (ed), *Soil Fauna and Soil Fertility. Proc. 9th. Int. Coll. Soil Zoology, Moscow Nauka*, 423 - 426.
- Paoletti M.G. 1988. Soil invertebrates in cultivated and uncultivated soils in northeast Italy. *Redia*, 71, 501 - 563.
- Paoletti M.G., Hassall M. 1999. Woodlice (Isopoda: Oniscidea): their potential for assessing sustainability and use as bioindicators. *Agriculture, Ecosystems and Environment*, 74 : 157 - 165.
- Peet R.K. 1974. The measurement of species diversity. *Ann. Rev. Eco l. Syst.*, 5 : 285-307.
- Ramade F. 2003. *Eléments d'écologie. Ecologie fondamentale* .Ed. DUNOD. Paris : 379p.
- Souty-Grosset C., Badenhassler I., Reynolds J., Morel A. 2005a. Investigations on the

- potential of woodlice as bioindicators of grassland habitat quality. *European Journal of Soil Biology*, 41 : 109 - 116.
- Souty-Grosset C., Badenhauer I., Reynolds J., Morel A., Losdat S. 2005b. Managed grassland habitats in relation to woodlouse biodiversity in Western France. In : R. Lillak, R. Viiralt, A. Linke & V. Geherman (eds.). *Proc. Integrating Efficient Grassland Farming and Biodiversity Congress. Grassland Science in Europe*, 10. Tartu Estonia.
- Souty-Grosset C., Corre S., Freyssinel G., Aubert V., Donque V., Raimond R. 2008. Diversity of terrestrial isopods and habitats in Poitou-Charentes (western France). In: R.M. Zimmer, F. Charfi-Cheikhrouha & S. Taiti (eds). *Proc. 7th International Symposium of Terrestrial Isopod Biology*, 21-32.

COENOLOGICAL ADAPTABILITY AND VITALITY OF ARTIFICIALLY ESTABLISHED BROADLEAF STANDS IN HUNGARIAN OAK AND TURKISH OAK FOREST TYPE IN LIPOVICA NEAR BELGRADE, SERBIA

Rajko MILOŠEVIĆ, Marijana NOVAKOVIĆ-VUKOVIĆ

University of Belgrade Faculty of Forestry, Serbia
*Corresponding author: rajko.milosevic@sfb.bg.ac.rs

Abstract

The paper presents the results of a research of coenological adaptability and vitality, and in those terms the planning of sustainability of species in artificially established stands on the forest type of Hungarian oak and Turkish oak (*Quercetumfarnetto-cerris* Rud.1949), on brown forest soil in the forest complex of Lipovica near Belgrade. The research results clearly confirm that it is justified to introduce some individual species into this site, because they show marked coenological flexibility and vitality, and accordingly apply the regular planning process. These are primarily pedunculate oak, largeleaf linden and white ash. The coenological inadaptability and unsustainability under the site conditions of the Hungarian oak and Turkish oak (*Quercetumfarnetto-cerris* Rud.1949) forest type on brown forest soil is primarily shown by green ash, which is ecologically and coenologically unsustainable in this site, as well as maple and black locust. Guided by the priority objectives of forest management in the complex "Lipovica" and in order to ensure biological stability and multifunctional contents, these species should primarily be substituted either by the species of the primary typological composition (Hungarian oak, Turkish oak) or the ones which have shown coenological stability and vitality (largeleaf linden, white ash and oak).

Key words: *artificially established broadleaf stands, vitality, Hungarian oak and Turkish oak forest type, Serbia*

Introduction

Artificially established stands in Serbia cover areas that primarily belong to a number of different types of forests and consequently show different ecological-coenological adaptability to specific site conditions, which further affects the overall production and protective effects and overall site potentials.

Artificially established stands cover primary and secondary sites (Milošević, 2011, Milošević, 2012a) with a different organic-coenological optimum. That further has an effect on planning and the planning process, i.e. rotation and finally the conservation and sustainability of the overall functional resources and biodiversity structure, although in recent years there have been different opinions on the impact of artificially established stands on the conservation of biodiversity (Bremer, L.L., Farley, K.A., 2010).

Artificially established stands account for 6.1% of the total forest area in Serbia, with an average volume (conifer and broadleaf plantations) of 127 m³ ha⁻¹ (Banković et al., 2009).

In the area of Belgrade, artificially established stands and plantations are located on a total area of 6795.42 ha, which represents 42.2% of the total forest covered area (Milošević, 2012b).

In the forest complex "Lipovica" artificially established stands are present on the total area of 127.85 ha, or 11% of the total area (Bićanin, 2015).

The largest area is covered by artificially established broadleaved stands of pedunculate oak, white ash, largeleaf linden and locust (Milošević, 2012b).

Broadleaved species represented in the artificially established stands have different bio-ecological characteristics in relation to the ecological conditions of the primary forest type, that is, in the conditions of the Hungarian oak and Turkish oak forest type (*Quercetumfarnetto-cerris*) on brown forest soil, which affects their stability and coenological vitality. The determination of coenological flexibility and vitality of the broadleaved species to the forest type Hungarian oak and Turkish oak (*Quercetumfarnetto-cerris*) forest on brown forest soil in the Lipovica forest complex will provide a realistic basis for management plans related to this category of stands in terms of dynamics and periodicity of management procedures (management objectives, ecological and coenological assessment of the current state in relation to the priority functional objective of the forest complex "Lipovica", silvicultural and management measures, rotation, etc.). This will serve to estimate the justification of retention of certain broadleaved species that build the artificially established stands or their restitution with the species of the primary typological composition or the existing species that in the concrete conditions of the primary forest type, proved to be coenologically more stable and more vital.

Material and method

The "Lipovica" forest complex is located in the central part of Serbia, 20 km away from the capital city, Belgrade. It is located at an altitude between 160-290 m. The basic exposure is southwest, while a significant part of the terrain consists of creek banks and landforms with northern and eastern exposures.

The mean annual air temperature in the submontane belt (200 m altitude) of forests in Serbia, including Lipovica is 11.0 ° C. In the warmest month of July, the average temperature is 20.8 ° C. In the vegetation period, the air temperature ranges from 11.2 to 20.8 ° C (Krstić et al., 2013). In the area of Lipovica forest the parent rock in the highest percent consists of clays and sands followed by limestones, dolomites, green sandstone, sandy limestone and Upper Cretaceous flysch (Kanjevac, 2015). Two soil types were described: brown acid soils and lessive brown forest soil. In the area of Lipovica the climatogenic community of Turkish oak and Hungarian oak (*Quercetumcerris-farnetto* Rudski 1949) is the most common. It is mainly of coppice origin and beech forests in the form of groups of ecological units of submontane beech forests (*Fagetummoesiacaesubmontanum* B.Jov . 1967) account for a smaller percentage.

The research investigated artificially established stands of pedunculate oak (*Quercusrobur* L.) largeleaf linden (*Tiliaplathyphyllos* Scop.), White ash (*Fraxinus excelsior* L.), maple (*Acer pseudoplatanus* L.), green ash (*Fraxinus pennsylvanica* Marsch.), black locust (*Robinia pseudoacacia* L.) aged 50 years on the forest type of Hungarian oak and Turkish oak forest (*Quercetumcerris-farnetto* Rud. 1949.) on brown forest soil in FMU "Lipovica".

A total of 14 phytocoenological relevés taken from literature were used for the analysis of the floristic composition of the investigated areas using the standard Braun–Blanquet method (Braun-Blanquet, J. 1964). Five phytocoenological relevés were made in a natural forest of Hungarian oak and Turkish oak -*Quercetumfarnetto-cerris* Rud. 1949 (Novaković- Vuković, M. Perović, 2014), and nine in artificially established broadleaf stands established in the site of the Hungarian oak and Turkish oak forest type (*Quercetumcerris-farnetto*) on brown forest soil in FMU "Lipovica" (Bićanin, M.). Syntaxa names were given after Tomić (2004). DCA vegetation data analysis was performed using the CANOCO 4.5 statistical software (Leps, J., Šmilauer, 2002).

Results and Discussion

Figure 1. shows that the majority of species grouped in the right part of the figure belong to the group characteristic for the order *Quercetalia pubescentis*: *Quercus frainetto*, *Fraxinus ornus*, *Quercus cerris*, *Crataegus monogyna*, etc. Going down towards the left corner of the coordinate system, we can see that mesophilic species characteristic of the order *Fagetalia sylvaticae* and class *Querco-Fagetea*: *Carpinus betulus*, *Melica uniflora*, *Tilia platyphyllos*, etc. stand out. Such grouping of species clearly indicates that the phytocoenological relevés that approach the left side of the coordinate system differ a lot by their floristic composition from the natural Hungarian oak and Turkish oak forests, i.e. they are characterized by a significant presence of species that are indicators of mesophile site conditions. The greatest deviation from the forest of Hungarian oak and Turkish oak was found in the artificially established stands of pedunculate oak, white ash, largeleaf linden.

The dominance of species typical of Hungarian oak and Turkish oak forests is particularly pronounced in artificially established stands of green ash (phytocoenological relevé 10), black locust (phytocoenological relevé 6) and maple (phytocoenological relevé 8) (Figure 1).

Artificially established stands of pedunculate oak (phytocoenological relevés 2, 9) (Table 1) are characterized by a significant presence of species that are indicators of mesophile site conditions (*Cornus sanguinea*, *Circaea lutetiana*, *Carpinus betulus*, *Ajuga reptans*, etc.), i.e. species characteristic of pedunculate oak forest types, while the share of species typical of the forests of Hungarian oak and Turkish oak is reduced.

Artificially established stands of largeleaf linden (phytocoenological relevés 1, 4, 5) (Table 1) with respect to representation and differentiability show even more pronounced mesophile character and coenological stability and adaptability to specific site conditions compared to the artificially established stands of pedunculate oak (Figure 1). In all the storeys of these stands, the presence of mesophilic species (*Tilia platyphyllos*, *Fraxinus angustifolia*, *Sanicula europaea*, *Asperula odorata*, *Mycelis muralis*, etc.) is significant, i.e. very large deviations are noticeably from Hungarian oak and Turkish oak forests (*Quercetum farnetto-cerris*) on brown forest soil.

Artificially established stands of white ash (phytocoenological relevé 7) (Table 1), on the type of Hungarian oak and Turkish oak forest (*Quercetum farnetto-cerris*) on brown forest soil, show a very strong coenological stability and vitality (Figure 1). They show a significant difference in terms of their distinct mesophile character from the characteristic set of the primary forest type. White ash is dominant in the first storey, has a preserved canopy and also appears in the third floor (Table 1).

Coenological stability of white ash in site conditions of the forest type of Hungarian oak and Turkish oak forests (*Quercetum farnetto-cerris*) on brown forest soil in FMU "Lipovica" has also been found in previous research (Bićanin, M., Milošević, R., 2015).

A significant difference in terms of coenological relations in the forest type of Hungarian oak and Turkish oak forests (*Quercetum farnetto-cerris*) on brown forest soil in FMU "Lipovica" is shown by artificially established stands of green ash, black locust and maple as compared to previous species in the artificially established stands (Figure 1).

The floristic composition of these stands contains species typical of forests of Hungarian oak and Turkish oak and the order *Quercetalia pubescentis*: *Quercus frainetto*, *Fraxinus ornus*, *Quercus*, *Crataegus monogyna* et al. (Figure 1).

In those terms, artificially established green ash stands (phytocoenological relevé 10) (Table 1) show a very strong coenological instability and vitality under the given site conditions (Figure 1). In the first storey of the 50-year-old stand, only individual specimens of this species were found, while they are entirely absent from the second and third storey. Species that are typical representatives of Hungarian oak and Turkish oak forests were

recorded within these stands, including *Quercus cerris*, *Fraxinus ornus*, *Acer campestre*, *Rosa arvensis*, *Tamus communis*, *Helleborus odorus*, etc.

Coenological - ecological inadaptability and poor vitality of green ash in the forest type of Hungarian oak and Turkish oak forest (*Quercetum farnetto-cerris*) on brown forest soil has also been found in previous research (Bićanin, M., Milošević, R., 2015), where this species could not survive under the specific site conditions. Identical coenological relations and coenological stability in the forest type of Hungarian oak and Turkish oak forest (*Quercetum farnetto-cerris*) on brown forest soil was shown by the artificially established stands of black locust and maple (phytocoenological relevés 6 and 8). They are not significantly different from the characteristic set of the primary type, i.e. their floristic composition contains typical representatives of the alliance *Quercion farnetto*: *Quercus cerris*, *Acer campestre*, *Lonicera caprifolium*, *Rosa arvensis*, etc.

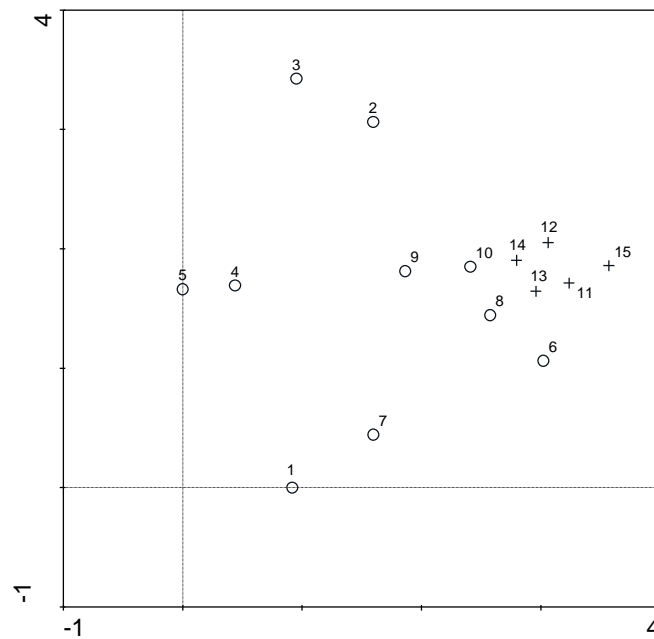

Figure 1: DCA ordination biplot+ -phytocoenologicalrelevés in the natural forest of Hungarian oak and Turkish oak; ○ -phytocoenologicalrelevésin the artificially established stands 2,9-pedunculate oak; 1,4,5, -largeleaf linden, 6- black locust; 8-maple ; 7-white ash, 10- green ash;

Table 1. Phytocoenological table of studied stands

Community Phytocoenological relevé number	<i>Quercetum farnetto-cerris</i> Rud. 1949.														Degree of presence
	1	2	3	4	5	6	7	8	9	10	11	12	13	14	
	TREE STOREY														
<i>Carpinus betulus</i>		2		+				+	+	+	1	1			III
<i>Quercus cerris</i>					1		+		+	3	1	2	2	2	III
<i>Quercus farnetto</i>					+					1	3	2	2	2	II
<i>Robinia pseudoacacia</i>					+	+	+	+	+						II
<i>Fraxinus ornus</i>					2			1	2	+		+			II
<i>Acer campestre</i>					+		1				+			+	II
<i>Tilia platyphyllos</i>	5		2	1											I
<i>Fraxinus excelsior</i>	1					4									I
<i>Quercus robur</i>		3						4							I
<i>Ulmus minor</i>			+												I
<i>Tilia tomentosa</i>			1	1											I
<i>Acer pseudoplatanus</i>			+			+	+								I
<i>Fraxinus angustifolia</i>				2											I
<i>Populus tremula</i>				+											I
<i>Acer monspessulanum</i>					+										I
<i>Crataegus monogyna</i>							+								I
<i>Malus sylvestris</i>							+								I
<i>Pyrus pyraster</i>							+								I
<i>Prunus avium</i>								1							I
<i>Fraxinus pensylvanica</i>									+						I
	SHRUB STOREY														
<i>Acer campestre</i>		+			+	2	1	1	1	+	+	2	1		IV
<i>Carpinus betulus</i>		+	+	+				+		1	1				III
<i>Ulmus minor</i>			1		+	+			+			+	2		III
<i>Cornus mas</i>										+		+	+	1	II
<i>Acer pseudoplatanus</i>				1	+	+									II
<i>Fraxinus ornus</i>										1	+	2		3	II
<i>Crataegus monogyna</i>		+					+		+		+				II
<i>Tilia platyphyllos</i>	+		+	+											I
<i>Robinia pseudoacacia</i>						+	+		+						I
<i>Tilia tomentosa</i>			+							+					I
<i>Fraxinus angustifolia</i>				+											I
<i>Quercus cerris</i>	+														I
<i>Populus tremula</i>				+											I
<i>Fraxinus excelsior</i>					+	+									I
<i>Acer obtusatum</i>					1										I
<i>Prunus cerasifera</i>					+		+								I
<i>Cornus sanguinea</i>							+	1							I
<i>Crataegus oxyacantha</i>							+		+						I
<i>Prunus avium</i>								+							I
<i>Evonymus europaeus</i>									+						I
<i>Lonicera caprifolium</i>										+					I
	GROUND FLORA STOREY														
<i>Acer campestre</i>	+	+		+	+	+	+		+	+	+	1	+		IV
<i>Brachypodium silvaticum</i>	5		+	1	+	5	1	+				+	+	+	IV
<i>Carpinus betulus</i>	+	+		2			+	+	+	+		1			III
<i>Fraxinus ornus</i>	1	+			1			1	+	+		2	1	1	III
<i>Quercus cerris</i>	+				1		+		+	2	+	1	1	+	III
<i>Rosa arvensis</i>	+					+	+			+	+	+	+	+	III
<i>Viola silvestris</i>		+				+	+		+		+	+	+		III
<i>Crataegus monogyna</i>		+			+	+	+	+			+			+	III
<i>Geum urbanum</i>				+	+	+	+			+	+	+			III

- Bremer L.L., Farley, K.A. (2010): Does plantation forestry restore biodiversity or create green Deserts. A synthesis of the effects of land-use transitions on plant species richness, *Biodivers.Conserv.*19, 3893-3915.
- Gomez-Aparicio, L., Zavala, A. M., Bonet, J. F., Zamora, R. (2009): Are pine plantations valid tools for restoring Mediterranean forests? An assessment along abiotic and biotic gradients, *Ecological applications* 8, Vol. 19, 2124-2141.
- Hofstede, R.G.M., Groenendijk, J.P., Coppus, R., Fehse, J.C., Sevink, J. (2002): Impact of pine plantations on soils and vegetation in the Ecuadorian High Andes, *Mountain research and Development* 2, vol. 22, No. 2, 159-167.
- Kanjevac, B, (2015): Possibility of optimization tending operations using silviculture analytics through visualization and simulation, Master thesis, University of Belgrade, Faculty of forestry. (In Serbian).
- Krstić, M., Babić, V., Kanjevac, B. (2013): A contribution to the study of climate-vegetation characteristics of the submontane area in Serbia. *Forestry* 3-4, 113-124 (In Serbian).
- Krstić, M., Vukin, M., Bjelanović, I. (2010): Basic problems of reclamation of forests of Hungarian and Turkey oak on the territory of Belgrade, International scientific conference Forest ecosystems and climate changes, 9.-10. march 2010, Institute of Forestry, Belgrade. Proceedings, Volume 1, 59-65
- Lepš, J., Šmilauer, P. (2002): Multivariate analysis of ecological data. Faculty of biological sciences, University of south Bohemia, České Budějovice..Milošević R. (2011): Typological classification and the existing condition of artificially established sycamore maple and norway maple stands in the protective forest belt. *Bulletin of the Faculty of Forestry* 104, 143-154 (In Serbian).
- Milošević R. (2012b): Tipološko definisanje šuma Beograda – osnovno polazište namenskog klasifikovanja i predlog mera sa ciljem unapređenja i održivosti kvaliteta životne sredine stanovnika Beograda- studija, Šumarski fakultet Univerziteta u Beogradu- Sekretarijat za zaštitu životne sredinaa- Gradska uprava grada Beograda- Beograd
- Milošević, R. (2012a): Tipologija šuma. Praktikum. Univerzitet u Beogradu-Šumarski fakultet, Beograd.
- Nagaike, T. (2002): Differences in Plant Species diversity between Conifer (*Larix kaempferi*) Plantations and Broad-Leaved (*Quercus crispula*) Secondary Forests in Central Japan, *For. Ecol. Manag.* 1, vol. 168, 111-123.
- Novaković-Vuković, M., Perović, M. (2014): A comparative analysis of the floristic composition of the Turkey oak and Hungarian oak forest and an artificially-established Austrian pine stand in Lipovica near Belgrade, *Forestry* 3-4, vol. LXVI, 75-89 (In Serbian).
- Tomić, Z. (2004): Šumarska fitocenologija, udžbenik, Univerzitet u Beogradu-Šumarski fakultet, Beograd.

ECOLOGICAL-COENOLOGICAL RELATIONS OF BLACK PINE IN SITE CONDITIONS OF DIFFERENT FOREST TYPES IN THE VICINITY OF BELGRADE, SERBIA

Rajko MILOŠEVIĆ

University of Belgrade, Faculty of Forestry, Serbia
*Corresponding author: rajko.milosevic@sfb.bg.ac.rs

Abstract

The distribution and share of black pine in the growing stock of Serbia is related to its primary and secondary sites. According to the typological classification of forest sites in Serbia, black pine sites are natural finds of black pine in which black pine is at its coenological optimum, i.e. biological black pine characteristics are adaptable to specific extreme site conditions. However, considerable areas in artificially established stands in sites of different forest types are occupied by black pine. Most commonly those are areas whose primary ecological and stand structure is endangered or areas of priority purpose and planned zoning (protective forest belts and various other purpose units). Depending on the typology of black pine sites black pine shows different ecological and coenological flexibility and vitality in artificially established stands under the site conditions of different forest types. This is further reflected in its functional sustainability and overall multi-functional effects. In the vicinity of Belgrade, black pine covers significant areas in the sites of various forest types of different multifunctional purposes. Therefore, the analysis and study of vitality and ecological and coenological stability gives full importance to the management, i.e. realistic assessment of planning procedures, when this species under specific site and typological conditions is at issue. In the Hungarian oak and Turkish oak forest type (*Quercetum frainetto-cerris*) on brown forest soil, black pine achieves significantly higher production effects at the age of 50 years, compared to site conditions of the forest of pedunculate oak and white linden (*Tilio-Quercetum crassiuscula* typicalum Slavnić 1952) on medium deep to deep carbonate chernozem, also being more coenologically stable. Actually, even in artificially established stands biological characteristics of black pine have been manifested under the specific site conditions of different forest types.

Keywords: *black pine, typology of sites, ecological and coenological stability, forest types, Serbia.*

Introduction

Artificially established stands in Serbia are located in sites of different forest types. For this reason, they are characterized by different eco-coenological adaptability depending on the typology of sites and bioecology of species used for afforestation, which further has an impact on the management plans and finally the sustainability of overall functional potentials.

Artificially established stands account for 6.1% of the total forest area in Serbia (Banković, S. et al., 2009). Most commonly, protective forest belts in urban areas are located in secondary sites, i.e. their afforestation was carried out without a prior typological classification of sites and therefore the selection of tree species is inappropriate for the current typological (at this stage of typological classification ecological) definition of the given site conditions. Protective belts in secondary sites are coenologically unstable and less vital in terms of the complex of environmental factors falling out of the scope of the coenological and ecological optimum (Milošević, R. 2012). In the area of Belgrade, artificially established stands and

plantations cover a total area of 6,795.42 ha, which accounts for 42.2% of the total forest covered area (Forest management plan of FE "Beograd" - Belgrade). In the vicinity of Belgrade, black pine can be found in artificially established stands, covering large areas of forest complexes with different ecological and protective functions. In addition, black pine in artificially established stands in the Belgrade area covers a variety of areas in terms of the ecological and typological affiliation of their site conditions, i.e. forest types ranging from the most xerothermic to more mesophile site conditions. Therefore, considering the biological characteristics of black pine, its typological affiliation and ecological-typological characteristics of forest complexes in the vicinity of Belgrade, i.e. the typology of sites where black pine stands are located, this species is expected to show different ecological and coenological relations and ecological-coenological vitality and stability.

The research of ecological-coenological vitality and adaptability of black pine in site conditions of different forest types will further serve to make a realistic assessment of the justification of keeping this species in the particular forest type, particularly bearing in mind the need for a multifunctional sustainability of forest complexes in urban areas and the need to ensure the planned priority function of the area.

Materials and method

The research was conducted in artificially established stands of black pine in the area of forest complex "Lipovica" and in the protective forest belt along the "Belgrade-Zagreb" highway. The artificially established stand of black pine in the forest complex "Lipovica" is aged 50 years, characterized by a closed canopy (0.7), good health condition and a share of other broadleaf species. The terrain is flat, and the parent rock is clay substrates. The artificially established stand of black pine in the protective forest belt along the "Belgrade-Zagreb" highway is 50 years old, has a canopy closure of 0.6-0.7, good health condition and mostly contains species of the primary typological composition. The terrain is flat, and the parent rock is loess. Site typology was defined using the standard methodological procedure appropriate for the methodology of typological definition of artificially established stands (Jovic, N. et al., 2009, Milošević, R., 2012). The artificially established stands of black pine in Lipovica are located in the forest type of Hungarian oak and Turkish oak forest (*Quercetum frainetto-cerris*) on brown forest soil (Bićanin, M., 2015). The artificially established black pine stand along the "Belgrade-Zagreb" highway is in the forest type (ecological unit) of pedunculate oak forest (*Tilio-Quercetum crassiuscula typicum* Slavnić 1952.) on deep to medium deep carbonate chernozem (Milošević, R. 1996; Milošević, R. 2011).

The actual current production effects (current state) of the artificially established stands of black pine in these forest types at the specified age and their adaptability to the specific ecological and typological site conditions, as well as ecological vitality were expressed through taxation indicators. Taxation indicators were determined by the standard dendrometric method. The statistical analysis of data was performed using the SPSS Statistics 17.0 software package. The correlations between the achieved values of mean stand heights of black pine in these forest types were examined using the Pearson's coefficient of linear correlation.

Results and discussion

Site conditions in the artificially established black pine stands in the Lipovica forest complex near Belgrade are of extremely xerothermophile character in terms of expressed synergistic effect and reciprocity of environmental factors of the primary forest type. In this sense, according to the typological classification of forests of Serbia (Jović, N. et al., 2009) the forest type of Hungarian oak and Turkish oak forest (*Quercetum frainetto-cerris*) on brown forest soil (Bićanin, M., 2015) belongs to the complex xerothermophile Hungarian oak and Turkish oak and other forest types, i.e. the coeno-ecological group of forest types of Hungarian oak and Turkish oak (*Quercion frainetto Horv. 54*) on brown and lessive soils, which occupy the largest area in the Lipovica forest complex. Black pine in the artificially established stand in the protective forest belt near the "Zagreb-Belgrade" highway is located in completely different site conditions concerning the expressed synergistic effect and correlation of environmental factors of the primary forest type. More precisely, the research stand of black pine is located in the forest type (ecological unit) of pedunculate oak forest (*Tilio-Quercetum crassiuscula typicum* Slavnić 1952.) on medium deep to deep carbonate chernozem (Milošević, R. 1996; Milošević, R. 2011). According to the typological classification of forests (Jović, N., et al., 2009), this type belongs to the complex of xerothermophile Hungarian oak and Turkish oak and other forest types, i.e. the coeno-ecological group of forest types of pedunculate oak and tatar maple (*Aceri tatarici-Quercion Zolyomi & Jakucs 1957*) on chernozem, pararendzina on loess, brown forest soils and lessive brown forest soils. This coeno-ecological group of forest types spatially borders with the flood-prone pedunculate oak forests, but takes slightly higher positions, out of the reach of high water on the edges of loess plateaus (Tomić, Z., Rakonjac, Lj. 2013).

Chernozems belong to the class of humus accumulative soils which include all soil types with a characteristic A horizon which transforms to a substrate via the A /C horizon or directly (Škorić, A. et al., 1985). Chernozems are soils with a very high-production potential (Antić, M. et al., 2007).

This soil type is characterized by very favorable physical and chemical characteristics and a very high organic-production potential. In terms of texture and mechanical composition of the soil, it belongs to clay loams (clay content + powder ranges from 58 to 62%). CaCO₃ content is present in the whole profile and gets increased with depth. This is accompanied by an increase in pH value ranging from 8.18 to 8.55 (Milošević, R. 1996). Different typology of sites in which black pine is found in artificially established stands in the study sites in the vicinity of Belgrade affected the eco-coenological relations and vitality of black pine in the specific site conditions (belonging to a specific forest type).

The currently (recorded) achieved production effects and in that respect ecological adaptability and coenological vitality are expressed through taxation indicators. Black pine in the artificially established stand in the forest type of pedunculate oak (*Tilio-Quercetum crassiuscula typicum*) on medium deep to deep calcareous chernozem accounts for 48.7% of structural composition, while the rest are various species of both primary typological composition and other broadleaf species with different adaptability to specific site conditions and pioneering character. In this sense, and considering the age, black pine shows very little coenological adaptability to specific site conditions.

Mean stand heights can be used as a reliable indicator of differentiation of the eco-production potential of a site (Milošević, R. 2006; Milošević, R. 2012) and the assessment of ecological and typological adaptability of a species to specific site conditions (Stamenković, V., Miscevic, V. 1979). Mean stand heights for black pine on the type of pedunculate oak forest (*Tilio-Quercetum crassiuscula typicum*) on medium deep to deep carbonate chernozem were significantly lower than the mean stand heights of the species that builds the primary coenological typological structure, i.e. pedunculate oak and the species of more mesophile

bio-ecological features, which is an indicator of a more marked eco-coenological vitality and adaptability of these species compared to black pine (Table 1).

Table 1. Taxation indicators of the artificially established black pine stand in the site of pedunculate oak (*Tilio-Quercetum crassiusculaetypicum*) forest type (ecological unit) on medium deep to deep calcareous chernozem-protective forest belt of the "Belgrade-Zagreb" highway.

Tree species	t	N	g	dg	hg	V	V	I _{vt}	I _{vt}
	years	pieces	m ² ·ha ⁻¹	cm	m	m ³ ·ha ⁻¹	%	m ³ ·ha ⁻¹	%
Black pine	50	275	8,6	19,5	17,1	77,2	48,7	4,1	67,2
Largeleaf linden		42	1,5	21,0	19,2	13,8	8,7	0,4	6,6
Other hard broadleaves		81	2,4	18,0	14,0	15,0	9,5	0,4	6,6
Ash-leaved maple		50	1,7	19,0	17,0	13,5	8,5	0,3	4,9
Other soft broadleaves		20	0,9	22,0	21,4	9,0	5,7	0,0	0,0
Birch		75	2,1	19,2	15,0	16,2	10,2	0,6	9,8
Maple		15	0,5	21,0	17,0	4,7	3,0	0,1	1,6
Pedunculate oak		10	0,7	30,0	20,5	9,0	5,7	0,2	3,3
In total		568	18,4			158,4	100	6,1	100

Depending on the environmental and typological affiliation of site conditions (the primary forest type) black pine shows different eco-coenological adaptability. Actually, black pine achieves higher total-production effects and is coenologically more stable in the type of Hungarian oak and Turkish oak forest (*Quercetum frainetto-cerridis* Rudski 1949) on brown forest soil (Table 2) at the stand age of 50 years in the Lipovica forest complex, i.e. in more xerothermic site conditions.

Mean stand heights of black pine in the forest type of Hungarian oak and Turkish oak forest (*Quercetum frainetto-cerridis*) on brown forest soil are 19.1 m, while in the pedunculate oak forest type (*Tilio-Quercetum crassiusculaetypicum*) on medium deep to deep carbonate chernozem at the identical age they are 17.1 m.

Table 2. Taxation indicators of the artificially established black pine stand in the site of forest type of Hungarian oak and Turkish oak forest (*Quercetum frainetto – cerridis* Rudski 1949) on brown forest soil - forest complex "Lipovica"

Tree species	t	N	g	dg	hg	V	V	I _{vt}	I _{vt}
	years	pieces	m ² ·ha ⁻¹	cm	m	m ³ ·ha ⁻¹	%	m ³ ·ha ⁻¹	%
Black pine	50	458	22,88	25,1	19,1	178,1	63,25	7,5	72,82
Black locust		34	0,81	17,0	12,7	5,6	1,99	0,2	1,94
Cherry		33	0,84	14,7	12,2	5,1	1,81	-	-
Field maple		27	0,55	16,3	12,2	3,7	1,31	0,1	0,97
Other hard broadleaves		60	1,28	16,4	12,1	7,9	2,81	0,3	2,91
Black ash		3	0,04	13,0	13,6	0,3	0,11	0,0	0,0
Largeleaf linden		55	2,35	16,0	17,3	10,9	3,87	0,4	3,88
White ash		32	2,23	19,0	15,6	11,3	4,01	0,4	3,88
Field maple		20	1,85	34,0	20,2	21,3	7,56	0,4	3,88
Norway maple		17	0,53	20,0	19,2	6,6	2,34	0,2	1,94
Hungarian oak		5	0,41	33,0	21,2	4,6	1,63	0,1	0,97
Turkish oak		9	0,99	38,0	21,8	8,3	2,95	0,2	1,94
Hornbeam		6	0,17	18,2	13,6	0,9	0,32	0,0	0,0
Maple		25	2,01	18,7	14,5	17,0	6,04	0,5	4,85
In total		784	36,94			281,6	100	10,3	100

Mean stand heights of black pine in the forest type of Hungarian oak and Turkish oak forests (*Quercetum frainetto-cerridis*) on brown forest soil at the identical age (50 years) are significantly higher than the mean heights of black pine in the pedunculate oak forest type (*Tilio-Quercetum crassiuscula subsp. typicum*) on medium deep to deep calcareous chernozem, which is represented by a strong positive correlation, $r = 0.54$ (Table 3).

The share of black pine in the structural composition of the forest type Hungarian oak and Turkish oak forest (*Quercetum frainetto-cerridis*) on brown forest soil is significantly higher and accounts for 63.3% (Table 2). In addition, (Bićanin, 2015) mean stand heights of black pine in the forest type of Hungarian oak and Turkish oak (*Quercetum frainetto-cerridis*) forest on brown forest soil in the forest complex "Lipovica" are closer to the mean stand height of edificators of the primary forest type (Hungarian oak, Turkish oak) compared to the mean stand heights of black pine and pedunculate oak in the pedunculate oak forest type (*Tilio-Quercetum crassiuscula typicum*) on medium deep to deep carbonate chernozem. All this points to different ecological-coenological black pine adaptability depending on the typological affiliation of forests where this species is found in artificially established stands.

The research Vučković, M. (1989) suggests a different dynamics of development and productivity of black pine in artificially established stands in different environmental conditions and ecological and productive site potentials. Accordingly, the author concludes that a rotation with a maximum production volume in sites of high ecological value should not be below 80 years, and that in well stocked stands in weaker sites it should be considerably longer, reaching about 120 years.

Considering that recently there have been different opinions on the impact of artificially established stands on biodiversity conservation (Bremer, L.L., Farley, K.A., 2010), and

fulfillment of multiple functional needs in urban zones, eco-coenological stability and vitality of species that build protective belts, i.e. species in sites of other forest types are of great practical importance in terms of ensuring multifunctional sustainability and stability expressed through management plans. In this sense, black pine in artificially established stands shows different eco-coenological stability and vitality depending on the type of forest in which it is located and the typological conditions of the site.

Table 3.- Pearson's coefficient of linear correlation

		Protective belt	Lipovica
Prot. belt	Pearson Correlation	1	,541
	Sig. (2-tailed)		,107
	N	40	40
Lipovica	Pearson Correlation	,541	1
	Sig. (2-tailed)	,107	
	N	40	40

Conclusion

Black pine in the artificially established stands in the vicinity of Belgrade shows various ecological and coenological stability and vitality. In this sense, ecological-coenological vitality and stability of black pine in artificially established stands is correlated with the site conditions of the primary forest type. The typological affiliation of the primary forest type has an impact on the overall ecological and coenological adaptability of black pine in specific site conditions. Black pine in artificially established stands on the forest type of pedunculate oak forest (*Tilio-Quercetum crassiuscula typicum*) on deep to medium deep carbonate chernozem in the protective forest belt near the Belgrade-Zagreb highway has a significantly reduced ecological and coenological vitality and adaptability and biological stability compared to the site conditions in the forest type of Hungarian oak and Turkish oak forest (*Quercetum frainetto-cerridis*) on brown forest soil in the forest complex "Lipovica".

Ecological and coenological vitality under specific site conditions also affected the overall production effects of black pine. Mean stand heights are an indicator of production differentiation of a site in the typological classification of forests and the overall assessment of production effects of forest types. The mean stand heights of black pine in artificially established stands in the site of forest type of Hungarian oak and Turkish oak forests (*Quercetum frainetto-cerridis*) on brown forest soil in the forest complex "Lipovica" are significantly higher than the mean stand heights of black pine in the artificially established stands in the pedunculate oak forest type (*Tilio-Quercetum crassiuscula typicum*) on medium deep to deep carbonate chernozem in the protective forest belt near the Belgrade-Zagreb highway.

Different ecological-coenological adaptability of black pine depending on whether the site where the artificially established stands are located belongs to the primary forest type affects the overall planning and management measures given the need to ensure the multi-functional contents and their ongoing sustainability when forests and forest complexes in urban areas are concerned.

References

- Antić, M., Jović, N., Avdalović, V. (2007): Pedologija. Univerzitet u Beogradu-Šumarski fakultet, Beograd.
- Banković, S., Medarević, M., Pantić, D., Petrović, N., Šljukić, B., Obradović, S. (2009): Šumski fond Republike Srbije, Glasnik Šumarskog fakulteta br. 100, Univerzitet u Beogradu-Šumarski fakultet, Beograd (str. 7-30)
- Bićanin, M. (2015): Tipološka pripadnost i stanje veštački podignutih sastojina u g.j. "Lipovica". Master rad. Univerzitet u Beogradu Šumarski fakultet, Beograd.
- Bremer L.L., Farley, K.A. (2010): Does plantation forestry restore biodiversity or create greendeserts? A synthesis of the effects of land-use transitions on plant species richness, *Biodivers. Conserv.* 19, (crp. 3893-3915)
- Jović, N., Tomić, Z., Jović, D. (2009): Tipologija šuma. Univerzitet u Beogradu Šumarski fakultet, Beograd
- Milošević R. (2006): Definisavanje tipova bukovih i bukovo-jelovih šuma na Velikom Jastrepcu. Doktorska disertacija. Univerzitet u Beogradu, Šumarski fakultet, Beograd.
- Milošević R. (2011): Tipološka pripadnost i zatečeno stanje veštački podignutih sastojina javora i mleča u zaštitnom šumskom pojasu, Glasnik Šumarskog fakulteta br. 104, Univerzitetu Beogradu-Šumarski fakultet, Beograd (str.143-153)
- Milošević R. (2012): Tipologija šuma. Praktikum. Univerzitet u Beogradu, Šumarski fakultet, Beograd.
- Milošević, R. (1996): Uticaj lišćarskih sastojina na umanjenje nivoa saobraćajne buke. Magistarski rad. Univerzitet u Beogradu, Centar za multidisciplinarnu studiju, Beograd,
- Stamenković, V., Mišćević, V. (1979): Elementi razvoja i produktivnosti sastojina kod tipološkog-proizvodnog diferenciranja šuma, Glasnik Šumarskog fakulteta br. 53, Univerzitet u Beogradu - Šumarski fakultet, Beograd (str. 77-81)
- Škorić, A., Filipovski, Č., Ćirić, M. (1985): „Klasifikacija zemljišta Jugoslavije“. AN i umetnosti B i H, posebno izdanje, knj. LXXVIII, odel. prirodnih i mat. nauka, knj. 13, Sarajevo.
- Tomić, Z., Rakonjac, LJ. (2013): Šumske fitocenoze Srbije, Institut za šumarstvo, Univerzitet Singidunum-Fakultet za primenjenu Ekologiju Futura, Beograd.
- Vučković, M. (1989): Razvojno proizvodne karakteristike crnog bora u veštački podignutim sastojinama na Južnom Kučaju i Goču. Doktorska disertacija. Univerzitet u Beogradu Šumarski fakultet, Beograd.
- ***Osnove gazdovanja šumama (2011-2020). JP za gazdovanje šumama „Srbijašume“ Beograd. ŠG „Beograd“, Beograd.

AUTHOR INDEX

A. H. El-Heneidy	1631	Ali Rahmi KAYA	276, 440
Abdelghani NABLOUSSI	990	Ali Rıza ONGUN	2059
Abdelhak RHOUMA	1780	Ali SHAHNAZARI	941
ABD-ELMOITY	1697	Alice GARNIER	2569
Abderrezak CHEBOUTI	45	Alma MIČJEVIĆ	1295
Abdulbaset Zidane. SHRIF	2527	Alma RAHIMIĆ	972
Abdullah ÖKTEM	662, 768	Altay Ugur GUL	729
Abhishek KUMAR	2689	Altay Uğur GÜL	669
Abuzer. YUCEL	1514	Amela ŠERO	1863
Adel ALY	2131	Amina A. THAKAHOVA	2487
Adem DOGAN	1184	Amina SAADI	2932
Adem EROL	440, 775	Amina THAKAHOVA	2437, 2482
Adnan TÜLEK	268, 1392	Amir Hasan TAGHILLOOFAR	2391
Adriana RADOSAVAC	2636	Amir RAHIMI	1228
Adriano CIANI	2279, 2756	Anna BIJEDIĆ	1295
Adrijana FILIPOVIĆ	965	Ana MANDIĆ	965
Agatino RUSSO	1529	Ana NIKOLIĆ	735
Agnes CSIVINCSIK	2522	Ana VELIMIROVIĆ	165, 520
Agneš BOLJEVIĆ	2735	Anatoliy SMYKOV	207
Agnieszka JASIŃSKA	200	Andrea TILLYNÉ MÁNDY	859
Agnieszka JUDZIŃSKA	2560	Andrej PILIPOVIĆ	2825
Ahlem RAYANE	2932, 2939	Andrey SKRYABIN	165
Ahmed ABDU HAMED AMIN	1345	Andrzej SAŁATA	337
Ahmed BAHAULDDİN	742	Anetta SIWIK-ZIOMEK	704
Ahmed JEMMALI	1422	Angelina TAPANAROVA	304
Ahmet ERTEK	1905	Ankica SARAJLIĆ	1669
Ahmet ÖZÇELİK	781	Anna AMBROSZCZYK	149, 323
Ahmet SAHİN	2286	Anna RADÓ-TAKÁCS	859
Aida ABAZA	2043	Anna SEREDA	104
Aida BANI	2225	Anna STĘPNIOWSKA	337
Aida DERVISHI	1954	Annalisa GAMBARDELLA	2279, 2756
Aigars INDRIKSONS	2874	Antonije ŽUNIĆ	1263, 1451
Aissa ABEDLEGUERFI	45	Antonio BOGGIA	2756
Ajla MRKULIĆ	1863	Anyo MITKOV	1256, 1339
Alban IBRALIU	1975	Ardian MAÇI	1914
Albina TARJAN TOBOLKA	2830	Arezki MOHAMMEDI	2233
Aleksandar LEPOSAVIĆ	1480	Ariola BACU	1167, 1172
Aleksandar PAUNOVIĆ	467, 762	Ariola DEVOLLI	1429
Aleksandar PETROVIĆ	413	Arzu SEZER	1312
Aleksandar SAVIĆ	2810	Asiyat BITTIROVA	2437
Aleksandar SEDLAR	1056, 1640	Asma NAJAR	1422
Aleksandar SIMIĆ	406	Assoc.Prof. Mehmet Arif ŞAHINLI	2665
Aleksandar STANOJKOVIĆ	711, 2109	Atanas VUCHKOV	2271
Aleksandar TEPAVAC	2155	Atef HAMDY	2131, 2643
Aleksandar VUKOVIĆ	2125	Atilla TASKIN	2286
Aleksandr ROMANOV	2904	Attila TOMÓCSIK	1982
Aleksandra GOVEDARICA-LUČIĆ	51, 972	Audrius RADZEVIČIUS	1720
Aleksandra SILOVSKA-NIKOLOVA	2541	Audrius SASNAUSKAS	1720
Aleksandra STANOJKOVIĆ-SEBIĆ	2008, 2109	Awal BABOUSSOUNA	2763
Alen KIŠ	2818, 2830, 2910	Aya TRIFONOVA	136
Alexey L. LUKIN	1712	Ayat M. ALI	1697
Alfred MULLAJ	1954	Ayhan İSTANBULLU	2588
Ali A. İŞIKBER	1319, 1475	Aylin AGMA OKUR	2547
Ali Arda İŞIKBER	1276, 1283, 1332, 1464, 1470	Ayşe Gülgün ÖKTEM	662, 768
Ali GÜLÜMSER	1126	Aysel ÖZCAN	901, 1019
Ali İKİNCİ	627	Aysun BOZA	717
Ali Murat TATAR	2342, 2369	Babar HASSAN	1567

Badea BASSA	2932	Cevdet KAPLAN	1446
Bahadır ALTUN.....	889	Cevdet KELOGLU	2588
Bahar ARGUN KARSLI	2398	Chavdar DOCHEV	1339
Bahar AYDIN CAN	2595	Cherif HANACHI.....	1755, 1775
Bahattin AKDEMIR.....	612, 1498	Chérif HANNACHI.....	750
Bahattin KARAKUŞ	89, 1073	Chiara CIANNAMEA	2643
Bahia DOUMANDJILMITICHE.....	1582	Chourouk ZAHAF	1755
Baia THEODOSIOU	866	Claire BERNARD.....	2569
Baki AYDIN	2472	Coskun GULSER.....	2052
Barış EREN.....	89, 803, 1073	Coskun GÜLSER.....	2032
Başak ÖZYILMAZ	919	Cumali OZASLAN.....	1682
Behrouz ESMAEILPOUR	122	Dafinka IVANOVA.....	502
Bekir ATAR.....	676	Dagnija BĒRZIŅA.....	2874
Berna DOĞRU ÇOKRAN	1092	Dalibor TOMIĆ.....	491, 537, 1120
Bernadett FEHÉR.....	1982	Damir MRĐENOVIC	2155
Besmira MEDOLLI	2569	Danguole JUŠKEVIČIENĒ	1720
Bilal KESKİN.....	89, 602, 803, 1073	Danica GLAVAŠ-TRBIĆ	2745
Biljana JANOŠEVIĆ.....	386	Daniela BELICHOVSKA	2297, 2541
Biljana PANJKOVIĆ	2910	Daniela DIMOVSKA.....	851
Blagoj GORGIEVSKI.....	2610, 2658	Danijel PANTELIĆ	815
Bochra BOUHENDJEUR.....	2675	Danijela JUNGIC	1988
Bojan ANĐELKOVIĆ.....	2353	Danijela KONDIC.....	1299
Bojana ČURKOVIĆ.....	1586, 1592, 1610, 1616	Danijela PETKOVIĆ.....	2706
Bojana PETROVIC	1769	Danijela RISTIĆ	1270, 1363
Bojana VUKOVIĆ.....	1610, 1616, 1621	Danuta KRÓL	1799
Bora DINIĆ.....	261, 2303, 2353	Darinka BOGDANOVIĆ	427
Bora UNLU.....	2391	Darko JEVREMOVIĆ	1480
Boris PISINOV.....	2037, 2082	Darko VUJIČIĆ.....	2517
Borislav BANJAC.....	193	David JOVOVIĆ.....	2718
Borislav RAJKOVIC.....	2741	Dejan ĐUROVIĆ.....	789
Borivoj PEJIĆ	142	Dejan POPOVIĆ.....	2425
Borut BOSANČIĆ.....	373, 2310, 2467	Dejan SOKOLOVIC	406
Boško GAJIĆ.....	304	Dejan ŠKORJANC	2431
Boualem MALIKA.....	1662	Dejana TEŠANOVIĆ.....	1249
Boubacar YAMBA.....	2763	Denis E. SHEVTSOV	1712
Božena NOSECKA	2629	Denisa ŽUJO ZEKIĆ.....	2043
Božidar MILOŠEVIĆ.....	2718	Desimir KNEZEVIC	1299
Branisav KOVAČEVIĆ.....	2848	Desimir KNEŽEVIĆ	467, 587, 1120, 1408
Branislav KOVAČEVIĆ.....	2868	Dhimiter PEČI	1954
Branislav TRUDIĆ	2910	Dhurata FETA	1429
Branislava SIVČEV	413	Diana BILIĆ-ŠOBOT.....	2431
Branka GOVEDARICA	298, 1192, 1200, 1221	Dijana MIHAJLOVIĆ.....	977
Branka KRESOVIĆ.....	304, 1493	Dimitar NAKOV	2297
Branko MARINKOVIĆ	644	Dimitrije MARA	796
Branko MILOŠEVIĆ	491	Djelouah K.....	1631
Branko STAJIĆ	2885	Dobrivoj POŠTIĆ.....	479, 815, 931
Bratislav MATOVIĆ	2917	Dogan ARSLAN.....	1228
Bratislav PESIC.....	2385	Domagoj RASTIJA	71
Bratislav PEŠIĆ	2790	Donatello CARUSO	2756
Buket AŞKIN.....	1392	Dorota PASIŃSKA.....	2325
Bülent TUNA.....	268, 1392	Dovilē KALKĒ.....	1879
Bunyamin YILDIRIM.....	276	Doytcho DIMOV	2271
Burcu KÜLEY	2497	Dragan ĐUROVIĆ	467, 537
Burcu TUNCER.....	170	Dragan KOVAČEVIĆ	895
Cafer GENÇOĞLAN	1823	Dragan MANDIĆ	977, 1610
Çağatay TANRIVERDİ.....	1961	Dragan MILATOVIĆ.....	789, 839
Çağlar SAĞMAKLI	1905	Dragan PSODOROV	1645
Celalettin GÖZÜAÇIK.....	1369	Dragan RAHOVIĆ	2779
Cengiz KARACA	1922	Dragan TERZIĆ	261, 392, 433, 1120, 1152, 1306, 2303
Cetin CEKİC	188	Dragana BJELIĆ	1733

Dragana BRANKOVIĆ RADOJČIĆ.....	946	Esmail CHAMANI.....	122
Dragana IGNJATOVIĆ-MIČIĆ.....	735	Etleva DELIA.....	2359, 2375
Dragana JOŠIĆ.....	2109	Ewa OSIŃSKA.....	149, 323
Dragana KALABA.....	1456	Ewelina WOJCIECHOWSKA.....	200
Dragana KOVAČIĆ JOŠIĆ.....	1610, 1616, 1621	Eymen DEMİR.....	2504
Dragana LATKOVIĆ.....	644, 1160	Fahad AL-JUHAIMI.....	594
Dragana MILADINOVIĆ.....	2868	Falah NAHER.....	1561
Dragana MRĐEN.....	735	Farid BOUNACEUR.....	1545, 1582
Dragana RUŽIĆ-MUSLIĆ.....	711	Farida BENZINA.....	2233
Dragana ŠUNJKA.....	1056, 1263, 1451, 1523, 1640, 1856	Fatih SEYİS.....	245, 901, 1019, 1043
Dragić ŽIVKOVIĆ.....	2651	Fatima GABOUN.....	1133
Dragiša MILOŠEV.....	427	Fatima Zohra BISSAAD.....	1545, 1582
Drago SPREMO.....	1592	Fatma AYDIN.....	1415
Dragoja RADANOVIĆ.....	1085	Fatma Sara DOLAR.....	1312
Dragoslav DJOKIĆ.....	1306	Fatma Zohra TAIBI.....	2675
Dragoslav ĐOKIĆ.....	2303	Fehmi GÜREL.....	2398
Dragutin A. ĐUKIĆ.....	1408	Ferdaws SMARI.....	1775
Dubravka ŽIVODER.....	2554	Ferdi BRAHUSHI.....	1243, 1888
Dunja DEMIROVIĆ.....	2636, 2729	Ferenc OROSZ.....	531
Dunja KRSTIĆ.....	2149	Ferit ERTAŞ.....	170
Durdanappa M. MANNUR.....	1598	Fethiye OZBERK.....	1514
Dürdane YANAR.....	699, 1739	Fidanka ILIEVA.....	1079
Dušan ADAMOVIĆ.....	1733	Fikret YASAR.....	883
Dušan KOVAČEVIĆ.....	692	Filippo Fiume FAGIOLI.....	2756
Dušan KOVAČEVIĆ.....	815	François LERIN.....	2569
Dušan MIKIĆ.....	508	Funda ATİLA.....	2116
Dušan MIODRAGOVIĆ.....	2810	Funda GENCLER.....	669, 729
Dušanika BUGARSKI.....	549	G.M. MAGOMEDSHAPIEV.....	2510
Duška SLIJEPAC.....	2425	Gábor NAGY.....	2522
Dzoko KUNGULOVSKI.....	851	Georg DREZNER.....	71
Dženita ŠEHIĆ.....	1863	Georgia NTATSI.....	827
Đorđe FIRA.....	1363	Givko TODODROV.....	1870
Đorđe LAZAREVIĆ.....	537	Gjokë DUHANAJ.....	2002, 2019
Đorđe MORAVČEVIĆ.....	692, 1115	Gjoko BUNEVSKI.....	2385
Đorđe SAVIĆ.....	2310, 2467	Gledjan CAKA.....	1954
Đura KARAGIĆ.....	491	Godan N. F.....	1631
E.A. RUDAKOVA.....	2510	Gökhan Osman CENGİZ.....	775
Ebru Sandal TANRIVERDI.....	594	Göknur ŞAHİN.....	1576
Edlira SHAHINASI.....	1243, 1429	Goran BEKAVAC.....	427
Edmond HALA.....	2359	Goran DUGALIĆ.....	955
Eleni WOGIATZI-KAMWOUKOU.....	866	Goran ĐURAŠINOVIĆ.....	977
Elisabeta SUSAJ.....	2019	Goran JAĆIMOVIĆ.....	644, 1160
Elpiniki SKOUFOGIANNI.....	95, 215, 227, 1142, 1147	Goran JEVTIĆ.....	556, 2353
Emilija RASPUDIĆ.....	1669	Goran MAKSIMOVIĆ.....	2700, 2718
Emine BAYRAM.....	2391	Goran PERKOVIĆ.....	51, 972
Emine ŞAHİN.....	2315, 2504	Goran TODOROVIĆ.....	525
Emine YURTERI.....	245, 1019	Goran VUČIĆ.....	2810
Emine YURTERİ.....	901	Gordan ZEC.....	789, 839
Emna JEDIDI.....	1422	Gordana BABIĆ.....	1586, 1592, 1610, 1616
Emre ŞAHİN.....	2101	Gordana BRANKOVIC.....	1299
Ercan EFE.....	2497	Gordana DOZET.....	1152
Erdem GULUMSER.....	1012	Gordana DRAŽIĆ.....	996
Ergent PIRE.....	2347	Gordana KULIĆ.....	2095, 2139
Ergin DURSUN.....	2161	Gordana RADOVIĆ.....	2729
Erik DIAZ-AVILA.....	2450	Gordana ŠEKULARAC.....	2125
Erkan GÜMÜŞ.....	2472	Gorica CVIJANOVIĆ.....	1085
Ersin DİLBER.....	292	Gorica PAUNOVIĆ.....	508, 926, 955
Ersin GÜLSOY.....	1092	Grigor GJEČI.....	2347, 2477
Ertugrul TURGUTOGLU.....	454	Gülşay ZULKADİR.....	484
Esin UNVER.....	2547	Gülbahar ÇULHA.....	315

Güngör YILMAZ.....	912, 919	Igor ĐURĐIĆ.....	298, 1192, 1200, 1221
Günseli ACAR.....	2442	Igor ILJOVSKI.....	851
Gvozden MIĆIĆ.....	1863	Igor SMIRNOV.....	2904
H. Deniz ŞIRELİ.....	2342, 2369	Igor SPASOJEVIĆ.....	366
Hakan BAŞAK.....	2101	Ildikó KOHUT.....	859
Hakan ENGIN.....	176	Ildikó RISZTER.....	859
Hakan ENGİN.....	562	Ilham SAHKI.....	2939
Hakan KARADAĞ.....	461, 514	İlhan ÜREMİŞ.....	1178
Hakan SEVIK.....	2603	Ilija KOMLJENOVIC.....	71
Hakan ULUKAN.....	220	Ilija RISTESKI.....	580
Hakima OULEBSIR-MOHANDKACI.....	2233	Ilijan MALOLLARI.....	1929, 1948
Hakkı AKDENİZ.....	602, 1935	Ilijana BOCI.....	2144
Hakkı YILMAZ.....	803	Iliyan ZHELJAZKOV.....	1555
Halil HATİPOĞLU.....	1025	İlknur AYAN.....	399
Halil KAKÇI.....	637	İlknur DURSUN.....	2161
Halina BUCZKOWSKA.....	337	İlknur ZEREN.....	2603, 2924
Hamena BOUZERZOUR.....	45	Imam MECCA.....	1514
Hamid DOROSTI.....	1215	Imants LIEPA.....	2836, 2874
Hamid MAZOUZ.....	990	Imtiaz BOUZARRAA.....	2527
Hammadi ROUISSI.....	2527	Inga STRAUPE.....	2856
Hanadija OMANOVIC.....	1295	Irena DUKA.....	1888, 1914, 2225
Hanen JENDOUBI.....	1529	Irfan OZBERK.....	1514
Hanun KURTAGIĆ.....	1295	İrfan ÖZTÜRK.....	268, 1392
Hasan DEĞİRMENCI.....	1961	Irina V. OSTANKOVA.....	1712
Hasan Hüseyin İPÇAK.....	2391	Isabel C.F.R. FERREIRA.....	827
Hasan TUNAZ.....	1276, 1283, 1319, 1464, 1470, 1475	Iskra ARAPOVIĆ.....	977
Hassan F. DAHI.....	1675	Ismet BEQIRAJ.....	1948
Hassan N.....	1631	Iuliia IVASHCHENKO.....	207
Hassiba FRAJ.....	750	Ivan GLIŠIĆ.....	508, 955
Hatice BASMACIOĞLU MALAYOĞLU.....	2391	Ivan STANČIĆ.....	2310, 2467
Hatice BOZOĞLU.....	419	Ivan VUČUROVIĆ.....	1270
Hatice BOZOĞLU.....	315	Ivan YANCHEV.....	502
Hatice SARI.....	1126	Ivan ZHALNOV.....	1401
Hazem BEN BRAHİM.....	1755	Ivana BAKIĆ.....	2779
Hazem S. HASAN.....	1505	Ivana BOŠKOVIĆ.....	972
Hiba ALLAGUI.....	1780	Ivana KAŠIČKOVÁ.....	757
Hilmi KOCATAS.....	238	Ivana MAJIĆ.....	1669
Himanshu ADHIKARI.....	2256	Ivana MOMČILOVIĆ.....	815
Hojka KRAIGHER.....	2917	Ivana RAŠEVIĆ.....	972
Homeira HADIZADEH.....	122	Ivica DIMKIĆ.....	1363
Hristina NEDEVA.....	232	Ivica DJALOVIC.....	427
Hristina YANCHEVA.....	232	Ivica DJALOVIC.....	142
Hristofor KIRCHEV.....	352	Ivica ĐALOVIC.....	433, 1733
Hüseyin ARSLAN.....	1025	J. Ignacio R. CASTANON.....	2419
Hüseyin BAYKAL.....	245	Jamal CHARAFI.....	990
Huseyin CAYAN.....	2286	Jameleddine BEN ABDA.....	1005
Hüseyin ÇELİK.....	889	Jan BOČANSKI.....	142
Hüseyin Göktuğ FİDAN.....	2315	Ján TOMKA.....	2380
Huseyin ONEN.....	1682	Jan TURAN.....	1056, 1640
Hussain. ALRUBEAI.....	1561	Janko ČERVENSKI.....	549
I. SHANKERGOUDA.....	1598	Jasmina KNEŽEVIĆ.....	1120
Ibolya DEMETER.....	1982	Jasmina FILIPOVIĆ.....	2779
İbrahim BOLAT.....	627, 723	Jasmina KNEŽEVIĆ.....	537
İbrahim GENCISOYLU.....	380, 574	Jasmina MILENKOVIC.....	261, 556, 1306
İbrahim H. YILMAZ.....	1073	Jasmina OLJAČA.....	497, 815, 931
İbrahim Hakkı YILMAZ.....	602	Jasmina RADOVIC.....	406
İbrahim HOSAFLIOĞLU.....	1935	Jasmina RADOVIC.....	556
İbtissem BEN SALEM.....	1780, 1790	Jasmina SABOTIC.....	1184
Ibtissemben SALEM.....	1650	Jasmina ŽIVKOVIĆ.....	1645
Igor BALALIĆ.....	1160	Jasminka ŽUROVEC.....	77, 1863

Jasna KOJIĆ.....	479, 525, 946	Ksenija MAČKIĆ	142
Jasna SAVIĆ	996	Kübra YAZICI.....	912
Jayant SINGH.....	2243, 2250	Kudret KEVSEROĞLU	245
Jela IKANOVIĆ.....	261, 650, 996	Kyriakos D GIANNOULIS	866
Jelena ČABARKAPA.....	2517	Ladislav VASILIŠIN	2810
Jelena MAKSIMOVIĆ	2008, 2109	LALOVIC.....	2491
Jelena MARINKOVIĆ.....	1733	Larisa KOMAR-TYOMNAYA ¹	136
Jelena MESAROVIĆ	895	Lawali DAMBO.....	2763
Jelena MESAROVIĆ	386, 735	Lazar PAVLOVIC.....	1056, 1640
Jelena MIHIĆ SALAPURA.....	1610, 1616, 1621	Lazar PAVLOVIĆ.....	2088
Jelena MILIVOJEVIĆ.....	392, 433, 762, 2026	LazarPAVLOVIĆ	2149
Jelena NIKITOVIC.....	2363, 2385	Leka MANDIĆ.....	1408
Jelena PREMOVIĆ.....	2735	Leonida NOVICKIENĚ.....	1208
Jelena TOMIĆ	808, 834	Leopold POLJAKOVIĆ - PAJNIK.....	2825
Jelena VANČETOVIĆ.....	735, 935	Leopold POLJAKOVIĆ-PAJNIK.....	2848
Jelena VASIĆ.....	1616, 1621	Levent YAZICI.....	912, 919
Jelena VLAČIĆ	2517, 2534	Leyla IDIKUT	1066
Jelica GVOZDANOVIĆ-VARGA.....	549	Leyla İDİKUT	484
Jerzy KRUK.....	1689	Lidia SAS PASZT	1689
Joanna PAWŁOWSKA-TYSZKO.....	2681	Liga LIEPA	2856
Jonas ABROMAS.....	1879	Lina PAKALNIŠKYTĚ	1208
Jordan MARKOVIĆ.....	1306, 1480, 2303	Linards SISENIS	2874
Jorgaq KAÇANI.....	1929	Linda LUARASI	1290
José I.R. CASTANON	2450	Lirim BEKTESHI	1843
Josipa PAVIČIĆ	2554	Liudmila A. NAPISANOVA	2487
Jovan CRNOBARAC	644, 1160	Livija MAKSIMOVIĆ	142, 1152
Jovana STANKOVIĆ.....	796	Lorina LIÇI.....	1929, 1948
Jovica VASIN.....	1836, 2088, 2149	Ludovic ANDRES	2763
Jovo STOJČIĆ.....	1592	Luis REY	2419
József MÉSZÁROS.....	1982	Luiza DAWIDOWICZ	1689
Julian SHEHU	1914	Łukasz ZAREMBA	2629
Julijana MIJALOVIĆ.....	2706	Luljeta PINGULI	1290
Julius Akinyemi FAGBAYIDE.....	1031	Lumturi PAPA	2291
JüriOLT.....	63	Lumturi SENA.....	2461
Kadri YUREKLI.....	1850, 2066	Lush SUSAJ	2002, 2019
Kamenko BRATKOVIĆ	821	Lütfi PIRLAK	684, 845
Kaouther BEN MAHMOUD.....	1422	Lynda BELADJAL.....	2932, 2939
KARIĆ	549	Ljiljana ARSIĆ	2735
Karolina KOCOSKA.....	580	Ljiljana BOŠKOVIĆ-RAKOČEVIĆ.....	955
Karoly REDEI	2862	Ljiljana NESIC.....	1836
Kasisviswanathan MUTHUKUMARAPPAN	2071	Ljiljana NEŠIĆ.....	2088, 2149
Katarina GAŠIĆ	1270, 1363	Ljubiša ŽIVANOVIĆ.....	996
Katarina MILUNOVIĆ	2088	Ljubomir ŽIVOTIĆ	304
Katarzyna KRAJEWSKA	200	M. Atilla GÜR	1025
Katerina BELICHOVSKA	2297, 2541	M. İkbal ÇATAL.....	245
Kazim GUNDUZ.....	330, 1373	M. Kazım KARA.....	1935
Kazim GUNDUZ.....	655	M. Kubilay ER.....	1319, 1475
Kazim MAVI.....	1178, 1727	M. MAHIBOBSA	1598
Kazimir MATOVIĆ	2319, 2353	M. MILOJEVIĆ	2534
Kemal AKIN.....	268	M. Safa HACIKAMİLOĞLU.....	568, 872
Kemal KARABAĞ	2315, 2504	M. Seckin KURUBAS	1184
Ketil STOKNES.....	200	M.V. ARISOV	2510
Khan CHAND	2575	Magdalena KACPRZYK.....	2848
Konstantina FASOLI.....	827	Mahendra THUDI.....	1598
Konstantinos MARTINOS	95, 215, 227, 1142, 1147	Maher SOUGUIR	750
Krasimir IVANOV.....	1870	Mahfuz ELMASTAŞ	1576
Krasimir TRENDAFILOV	84	Mahmoud M. M. SOLIMAN.....	1675
Kristaq KUME.....	2291	Mahmoud M'HAMDI.....	1790
Kristina LEONTIĆ.....	413	Mahmoud RAEINI-SARJAZ	941
Kristina LUKOVIĆ.....	821, 1385	Maja KARAMAN	549

Maja MALNAR.....	2037, 2082, 2095, 2139	Mehmet Salih SAYAR.....	283
Maja MITROVIĆ.....	1192	Mehmet Seckin KURUBAS.....	1049
Maja PETRIČEVIĆ.....	2455	Mehmet SÜTYEMEZ.....	461, 514
Małgorzata BUŁKOWSKA.....	2616	Melekber SULUSOGLU DURUL.....	2595
Małgorzata SZCZEPANEK.....	704	Memis BOLACALI.....	2446
Manish PANT.....	2575	Meriem KROUN.....	2939
Marcin ŻEKAŁO.....	1705	Mersida JANDRIĆ.....	2651
Marek GAJEWSKI.....	104	Mert SULAR.....	1332
Margarita DODEVSKA.....	386	Merve GÖRE.....	568, 872
MargusARAK.....	63	Metin DEMIRTAS.....	2588
Maria Fátima ALPENDURADA.....	1263	Metodija TRAJCHEV.....	2297
Maria P. FLORES.....	2450	Michael DAVIDSON.....	1037
Maria. S. LAVLINSKAYA.....	1712	Michal V. MAREK.....	2802
Maria. C. MUÑOZ.....	2450	Michal VLČEK.....	2380
Marianna MAKÁDI.....	1982	Mića MLADENOVIĆ.....	2353
Marija GJOSHEVA KOVACHEVIKJ.....	2610, 2658	Mihailo NIKOLIĆ.....	808, 834
Marija JOVIČIĆ.....	2310, 2467	Mihailo RATKNIĆ.....	1808
Marija MILIVOJEVIĆ.....	935, 946	Milan BRANKOV.....	366, 386, 1493
Marija ŠKRINJAR.....	1733	Milan DREKIĆ.....	2825, 2848
Marija UROSEVIC.....	2741	Milan LUKIĆ.....	255
Marija ZDRAVKOVSKA.....	851	Milan MIROSAVLJEVIĆ.....	621, 644
Marijana NOVAKOVIĆ-VUKOVIĆ.....	2944	Milan STEVANOVIĆ.....	735, 935
Marijana PEŠAKOVIĆ.....	808	Milena ĐORĐEVIĆ.....	255, 472
Marijenka TABAKOVIĆ.....	479, 525, 931, 946	Milena SIMIĆ.....	692
Marin ŠEGO.....	965	Milena SIMIĆ.....	366, 386, 497, 1493
Marina KATANIĆ.....	2868, 2893, 2917	Milena STANKOVIC.....	2879
Marina R. sasikova.....	2335	Milenko ŠARIĆ.....	2310
Marinko VEKIĆ.....	2310, 2467	Milica AĆIMOVIĆ.....	181, 796, 1085
Mariola KODRA.....	1429	Milica BUĆKOVIĆ.....	165, 520
Mariyan YANEV.....	1256, 1339	Milica PANTELIĆ.....	1523
Marjeta ČANDEK-POTOKAR	2431	Milivoj BELIĆ.....	2088, 2149
Mark E. MANKOWSKI.....	1567	Milivoje MILOVANOVIĆ.....	433, 821, 1380, 1385
Marko BAJC.....	2917	Milko OSTOJIĆ.....	2818
Marko CINCOVIC.....	2491	Milomirka MADIĆ.....	467, 762
Marko JOSIPOVIĆ.....	1669	Milos PETROVIC.....	2491
Marko KEBERT.....	2868	Miloš CREVAR.....	479
Marko LAZIC.....	2363, 2385	Miloš LUKIĆ.....	2455
Marko PETROVIĆ.....	2636	Miloš NOŽINIĆ.....	621, 1592
Marouane CHAAMI.....	2675	Miloš STEVANOVIĆ.....	1270
Marsela ALIKAJ.....	1888, 1914, 2225	Milovančević ZORAN.....	2651
Marta BARBERÁ.....	2419, 2450	Milun PETROVIC.....	2385, 2491
Marta PUDZIANOWSKA.....	104	Miodrag DIMITRIJEVIĆ.....	193, 587
Martha POPULIN.....	2763	Miodrag JELIĆ.....	392, 467, 762, 2026
Martin BOBINAC.....	2842	Mirela MATKOVIC.....	1299
Martin BOBINAC.....	2862	Mirela MATKOVIĆ.....	587
Maya DIMITROVA.....	1555	Mirela QYRA.....	1929
Medin ZEQRIRI.....	2347, 2477	Mirela TOMAŠ-SIMIN.....	2745
Mehdi MOHEBODINI.....	122	Mirjana BOJCEVSKI.....	2623
Mehmet Ali ÇULLU.....	1815	Mirjana CVETKOVIĆ.....	796
Mehmet Ali GUNDOĞDU.....	1325	Mirjana JOVOVIĆ.....	56, 298
Mehmet Arif ŞAHINLI.....	781	Mirjana PETROVIĆ.....	2303
Mehmet ATAK.....	1178, 1727	Mirjana RADOVIC.....	839
Mehmet AYBEKE.....	268	Mirjana RADOVIĆ.....	77, 789, 926
Mehmet CAN.....	399	Mirjana STALETIĆ.....	392, 433, 1380, 1385
Mehmet CETIN.....	2603, 2924	Mirjana STEVANOV.....	2830
Mehmet DAVUT SAHIN.....	1066	Mirjana VASIC.....	1769
Mehmet GÜNEŞ.....	1576	Mirko KULINA.....	926
Mehmet KARAKUŞ.....	1025	Miroljub AKSIĆ.....	1120, 2125
Mehmet Kubilay ER.....	1276, 1283, 1464, 1470	Miroslav KOSTIĆ.....	2319
Mehmet Musa ÖZCAN.....	594	Miroslav LALOVIĆ.....	2517

Miroslav TITYANOV	1256	Nenad DUŠANIĆ	1160
Miroslav UROSEVIĆ	181	Nenad KATANIĆ	2790
Miroslav UROŠEVIĆ	796	Nešet ARSLAN	912, 919
Mirta RASTIJA	71	Nesho NESHEV	1256, 1339
Mirzeta KAŠIĆ-LELO	2043	Neslihan EKINCI	1415
Miša MARKOVIĆ	2319	Neslihan EKINCI	1325
Mladen ALMALIEV	84	Nesrin KARATAS	238
Mladen TATIC	996	Nevena DOJČINOVIĆ	181
Mladen TATIĆ	1152	Neziha ARSLAN	1658
Mohamed EL FECHTALI	990	Nicholas G. DANALATOS	95, 215, 227, 1142, 1147
Mohamed ELRAEE	1995	Nickolaos GOUGOULIAS	866
Mohamed MEFTI	45	Nihal ÖZDER	1536
Mohamed Z. Y. ALY	1675	Nikola BOKAN	491, 537
Mohammad HOSSEINI	941	Nikola LJILJANIĆ	2790
Mohammad Reaza ZARDASHTI	1228	Nikola STOLIC	2385
Mohammed HUSSEIN	1995	Nikollaq ROŠANJI	2019
Mohammed KHALAF	1561	Novo PRŽULJ	621, 977
Mona TAGHOUTI	1133	Nur KOC	906
Monika SITAREK	104	Nurdoğan TOPAL	419
Morteza BARMAKI	100	Nurdoğan TOPAL	315
Mouna BEN AMARA	1005	Nurper GUZ	1625
Muammer DEMIROZ	380	Nursen USTUN	1658
Mücahit PEHLUVAN	1092	Nusret ÖZBAY	446
Muhammad MISBAH-UL-HAQ	1567	Oguzhan CALISKAN	238, 330, 655, 1373
Muhammed İkbal CATAL	1043	Oguzhan CALISKAN ¹	129
Murat ŞEKER	1325, 1415	Oladiran OLALEYE	1031
Murat Soner BALCIOĞLU	2315, 2504	Olga B. MARAEVA	1712
Murat TUNCTURK	276	Olga FEDOROVA	207
Murat YALÇIN	699	Olga KOSAKOWSKA	149, 323
Muruvvet İLGİN	238	Olga MIEZĪTE	2874
Mustafa ÇÖLKESEN	484	Olga MITROVIĆ	255
Mustafa ERKAN	1049, 1184	Olga SOBOCIŃSKA	104
Mustafa GÜLER	292	Olga v. Rudneva	2335
Mustafa JUMAA	1561	Olga V. RUDNEVA	2487
Mustafa SAHİN	723	<small>Olivera ĐORĐEVIĆ</small>	935
Muzaffer İPEK	684, 845	Olivera PETROVIĆ-OBRAĐOVIĆ	2848
Myriam R. VENTURA	2419, 2450	Omer SOZEN	343, 1099
Nada ZAVIŠIĆ	984	Ömer Süha USLU	440, 775
Nadeem A.RAMADAN	1352	Omowumi.M. ODELEYE	961
Nadia BENBRAHİM	1133	Orhan BELDEK	699
Naim REXHAJ	2291	Orhan KURT	568, 872
Naima BOUGHALLEB-M'HAMDI	1650, 1780, 1790	Orhan Onur AŞKİN	1392
Narayan GHORAI	2768	Orhan YILMAZ	2404, 2413
Nasir. MEHMOOD	1567	Oskars ZAĻKALNS	2836
Nastasija MRKOVAČKI	1733	Osman GEDİK	440
Natalia ATANASOVA - PANCHEVSKA	851	Osmane BADIAA	1662
Natalya MESYATS	1439	Otilija MISECKAITE	1968
Natasa BRATIC	1895	Ourida KHERBOUCHE-ABROUS	2932, 2939
Nataša BRATIĆ	1942	ovana PRIJIĆ	1621
Nataša GUNOVA	1079	Oyeboade.S ADEBAYO	961
Nataša NIKOLIĆ	2848	Özgür SAĞLAM	1283, 1332, 1536
NavinC.SHAHI	2689	Ozlem UZAL	883
Nebiha METOUI	1422	P. M. GAUR	1598
Nebojša GUDŽIĆ	1120, 2125	Pedro SAAVEDRA	2419
Nebojša MOMIROVIĆ	366, 815, 931	Peiman ZANDI	1215, 1233, 1237, 2768
Nebojša NEDIĆ	2319, 2353	Penda SISSOKO	2722
Néji TARCHOUN	1790	Peris T. AKRAWI	1352
Neli PRODANOVA-MARINOVA	1555	Petrit DOBI	2569
Nemanja MANDIĆ	2037, 2082, 2095, 2139	Philippe LEBAILLY	2722, 2763
Nemanja MIŠIĆ	373	Pınar OZDEMİR	2391

Pinar SOYCAN.....	1369	S. K. JAYALAKSHMI.....	1598
Pompeo SUMA.....	1529	S. Seçkin TUNCER.....	2342, 2369
Poyraz ÜLGER.....	1829	Sabah RAZI.....	1582
Pramod- Kumar- Omre.....	2015	Sabrija ČADRO.....	1863
Pranas VIŠKELIS.....	1720	Sabrija ČADRO.....	77
Pranvera LAZO.....	1843	Sabrine ABDELLI.....	1005
Predrag PAP.....	2825	Sabriye BELGÜZAR.....	1739
Prof. Ahmet ÖZÇELİK.....	2665	Sadegh TGHIPOUR.....	1228
R. K. VARSHNEY.....	1598	Sadiye Ayse CELIK.....	906
Rachida GHEZAL.....	1422	Sadiye GOZLEKCI.....	454
Rada GRBIĆ.....	373	Safder BAYAZIT.....	129, 238, 330, 655, 1373
Rade MILETIĆ.....	808, 834	Saiah FARIDA.....	1662
Rade STANISAVLJEVIĆ.....	479, 525, 931, 1306	Saikat Kumar BASU.....	1215, 1233, 1237, 2768
Radenko PONJARAC.....	2818	Salma CHAIB.....	2932, 2939
Radenko RADOVIĆ.....	1249	Salvador V. LOPEZ GALARZA.....	337
Radivoje JEVTIĆ.....	1762	Sambo BODE.....	2763
Radka IVANOVA.....	232, 1870	Santa SIRMOVICA.....	2856
Radmila ILIĆ.....	508, 955	Sanja ĐUKIĆ.....	2745
Radmila PIVIĆ.....	2008, 2109	Sanja LAZIĆ.....	1056, 1263, 1451, 1523, 1640, 1856
Radmila STIKIĆ.....	56	Sanja RADIČEVIĆ.....	255, 472
Radmila VUKADINOVIC.....	935	Sanja SIKORA.....	965
Radojica DJOKOVIC.....	2491	Sasa ORLOVIC.....	2879
Radojica RAKIĆ.....	650	Saša BARAĆ.....	1306
Radojko LUKIC.....	2710	Saša LALIĆ.....	51
Radosav CEROVIĆ.....	472	Saša ORLOVIĆ.....	2848, 2868, 2910, 2917
Radoslava SPASIĆ.....	1249	Saša PEKEČ.....	2893, 2917
Radovan KASARDA.....	2380	Savo SKOČIĆ.....	2095
Radovan PEJANOVIĆ.....	2729, 2745	Sebahattin YILMAZ.....	461, 514, 637
Rahal ELKAHKAHI.....	990	Seit SHALLARI.....	1914
Rajesh U. MODI.....	2243	Selma HARAIĆ-BERBIĆ.....	2898
Rajko BUGARIN.....	1056, 1640	Semeton Akinduro AMOSU.....	1031
Rajko MILOŠEVIĆ.....	2944, 2952	Sengül ALTUNDAL.....	1514
Rajnarayan PATERIYA.....	2256	Senka MUTABDŽIJA BEĆIROVIĆ.....	2898
Ramazan ACAR.....	906	Şennan YÜCEL.....	2442
Ranko KOPRIVICA.....	1306	Serap AKDEMIR.....	1829
Raoudha KHANFIR.....	1005	Serdar MEMIS.....	2595
Raoudha KHANFIR BEN JENANA.....	1755, 1775	Serdar TEZCAN.....	1446
Rasa KARKLELIENĖ.....	1720	Sergey KHOKHLOV.....	1435
Rasko GRUJIĆ.....	2818	Sergey N. SELYAVKIN.....	1712
Rastislav BUŠO.....	757	Serhat ÖZTÜRK.....	1829
Ratibor ŠTRBANOVIĆ.....	479, 525, 931	Serpil Arslan YILDIZ.....	514
Ratko NIKOLIĆ.....	2751	Serpil GENÇOĞLAN.....	1823
Ratnabali SENGUPTA.....	2768	Serra HEPAKSOY.....	717, 742
Recai METIN.....	446	Servet ABRAK.....	1025
Redi BUZO.....	1929	Seydi DOĞAN.....	2588
Remzi AVCI.....	268, 1392	Şeyma ARIKAN.....	845
Renata NURZYŃSKA-WIERDAK.....	337	Sezai DELİBACAK.....	2059
Resit ALDEMİR.....	276	Sezai GÖKALP.....	919
Reyhan KARAYEL.....	315	Shahid FAROOQ.....	1682
Rezana PENGU.....	2359, 2375	Shahram Khademi CHALARAS.....	1215, 1233
Ridvan KIZILKAYA.....	2052	Shahram Khademi CHLALARAS.....	2768
Robert MROCZEK.....	2560	Sherehan A. R. SALEM.....	1675
Robert POKLUDA.....	1769	Silanjan BHATTACHARYYA.....	2768
Robert RADIŠIĆ.....	2779, 2790	Simeon RAKONJAC.....	2455
Roland BARDHI.....	1975, 2569	Simonida DJURIC.....	1769
Roman HAŠANA.....	757	Simonida ĐURIĆ.....	556
Romina KOTO.....	1888, 1914, 2225	Sinem ÇAMURCU.....	2264
Rosanna QUAGLIARIELLO.....	2643	Siniša ANDRAŠEV.....	2842
Rozana TROJA.....	1290	Siniša ANDRAŠEV.....	2862
S. B. YERI.....	1598	Siniša BERJAN [†]	2768

Siniša CINCAR.....	2155	Suat ONUR.....	2588
SKRYABIN.....	520	Süleyman ŞİMŞEK.....	877
Sladjan STANKOVIĆ.....	2779, 2790	Süleyman TEMEL.....	89, 803
Sladjana PETRONIC.....	1895	Suleyman ZEYBEK.....	359
Sladjana PETRONIĆ.....	1942	Sultan KIYMAZ.....	1905, 2101
Sladjan STANKOVIĆ.....	1085	Süreyya Gülfem ALTUNBAY.....	950, 1061
Sladana MARIĆ.....	255, 472	Suvad LELO.....	2043
Slaven PRODANOVIĆ.....	821	Suzana ĐORĐEVIĆ MILOŠEVIĆ.....	650
Slavica SPASIĆ.....	2751	Svetlana M. PAUNOVIĆ.....	808, 834
Slavica VUKOVIĆ.....	1263, 1451, 1523, 1856	Svetlana TURUDIJA ŽIVANOVIĆ.....	525
Slaviša GUDŽIĆ.....	2125	Svetlana ŽIVKOVIĆ.....	1270, 1363
Slaviša STANKOVIĆ.....	1363	SvetlanaTURUDIJA-ŽIVANOVIĆ.....	1115
Slawomir POSKROBKO.....	1799	Sveto RAKIĆ.....	650
Slimane BEDRANI.....	2675	Svjatlana MIČIĆ.....	2517, 2534
Slobodan DRAŽIĆ.....	1115	T.K BHATTACHARYA.....	2243
Snezana ANDJELKOVIĆ.....	406	Taki KARSLI.....	2315, 2504
Snezana BABIĆ.....	406	Tamer ERYIGIT.....	276
Snezana JANKOVIĆ.....	996	Tamer YAVUZ.....	877
Snezana JANKOVIĆ.....	2790	Tanja JAKIŠIĆ.....	298, 1200, 1221
Snezana OLJAČA.....	181	Tanja PETROVIĆ.....	946
Snežana ANDJELKOVIĆ.....	1480	Tanja VASIĆ.....	406
Snežana ANĐELKOVIĆ.....	556	Tanja VASIĆ.....	261, 556, 1480, 2303
Snežana BABIĆ.....	556, 1480	Tatjana BLAZEVSKA.....	1108
Snežana BOGOSAVLJEVIĆ-BOŠKOVIĆ.....	2455	Tatjana IGNJIĆ.....	1192
Snežana BRANKOVIĆ.....	392	Tatjana IVANOVIĆ.....	2700, 2718
Snežana JANKOVIĆ.....	650	Tatjana JOVANOVIĆ-CVETKOVIĆ.....	373
Snežana JOVANOVIĆ.....	479, 946	Tatjana MARKOVIĆ.....	2319
Snežana MLADENOVIĆ DRINIĆ.....	895	Tatjana PANDUREVIĆ.....	2363
Snežana MLADENOVIĆ DRINIĆ.....	1493	Tatjana PANDUREVIĆ.....	2517, 2534
Snežana OLJAČA.....	692	Tatjana RATKNIĆ.....	1808
Snežana OLJAČA.....	497	Tatyana LATSKO.....	110
Snežana PAVLOVIĆ.....	1115	Tatyana SHISHOVA.....	207
Snežana TANASKOVIĆ.....	1408	Tawfik H.....	1697
Snežana V. JOVANOVIĆ.....	525	Temuçin Göktürk SEYHAN.....	2264
Sobhy.a. TEMERAK	1486	Tibor ARANYOS.....	1982
Sofija BOŽINOVIĆ.....	735, 935	Tijana BANJANIN.....	116
Sofija PEKIĆ QUARRIE.....	2751	Timothy Alaba FARIYIKE.....	961
Sofija PETROVIĆ.....	193, 587	Tine GREBENC.....	2917
Sohail AHMED.....	1567	Todor MANILOV.....	1401
Soňa GAVURNÍKOVÁ.....	757	Tomislav ŽIVANOVIĆ.....	1115
Sonila VITO.....	2144	Tomo MILOŠEVIĆ.....	508
Sonnur TAD.....	1682	Tonyo TONEV.....	1256, 1339
Sonja BRAUNOVIĆ.....	1808	Trajče STAFILLOV.....	1843
Souhail CHANNAOUI.....	990	Tuncay KAYA.....	1092
Spyridon PETROPOULOS.....	827	Turgut ATAY.....	699
Srdjan ATANASIJEVIC.....	1299	Turhan KAHRAMAN.....	268, 1392
Srdjan LALIC.....	2710	Ufuk KARADAVUT.....	343, 1099, 2286
Srdjan LJUBOJEVIĆ.....	1745, 2810	Umesh Chandra LOHANI.....	2071
Srdjan STOJNIC.....	2879	Ümit DÖLEK.....	1576
Srdan STOJNIĆ.....	2910	Vadim KORZIN.....	1439
Srdan ŠEREMEŠIĆ.....	427	Valentina GORINA.....	1439
Srdana PETROVIĆ.....	1451	Valentina KUBALE.....	2431
Sreten MITROVIĆ.....	2534	Valentina PAVLOVA.....	1108
Sretenka SRDIC.....	1299	Valerii ADAMCHUK.....	63
Stavroula ANESTI.....	827	Vanya DELIBALTOVA.....	543
Stefaan WERBROUCK.....	750	Vanja VUKSANOVIĆ.....	2868
Stefan STOŠIĆ.....	1270	Vasilije ISAJEV.....	2879
Stela PAPA.....	1167, 1172	Vasilios ANTONIADIS.....	827
Stjepan HUSNJAK.....	1988	Vedat Çağlar GİRĞİN.....	1392
Stoja JOTANOVIĆ.....	2310, 2467	Vedran TOMIĆ.....	2779, 2790

Vele TEŠEVIĆ	796	Vladimir ZORNIĆ	1480
Velimir MLADENOV	193	Vladislava GALOVIĆ	2842
Veljko GAVRILOVIĆ	1270, 1363	Vlado KOVACEVIC	2623
Venelina POPOVA	1870	Vlado KOVAČEVIĆ	71
Vera BEREZKO	2437, 2482	Voja MIHAILOVIĆ	491
Vera ĐEKIĆ.....	392, 433, 762, 1152, 1380, 1385, 2026	Vojislav TRKULJA	1586, 1592, 1610, 1616, 1621
vera K. berezhko	2335	Vojislava MOMČILOVIĆ.....	621
Vera K. BEREZHKO	2487	Vojka BABIĆ	895
Vera POPOVIĆ	261, 392, 433, 996, 1085, 1152	Volodymyr BULGAKOV	63
Vera RAJIČIĆ	261	Vyacheslav A. KUZNETSOV	1712
Verica VASIĆ.....	2825, 2848	Wiesława ROSŁON	149, 323
Veselin PETRIČEVIĆ.....	2455	William CETZAL-IX	1237
Veslinka ZECEVIC	1299	Xhaklina CANI.....	1929, 1948
Veslinka ZEČEVIĆ	587, 821	Xhensila METKO	1954
Vesna DRAGIČEVIĆ.....	692	Xhuljeta HAMITI.....	2144
Vesna DRAGIČEVIĆ.....	366, 386, 497, 1493	Y. Erdal ERTURK.....	2413
Vesna ĐUROVIĆ	1408	Yahya ÖZTÜRK.....	2446
Vesna GOJKOVIĆ	1456	Yaşar AKÇA	461, 514, 637
Vesna GRŠIĆ.....	181	Yasin AYDIN	2588
Vesna GUNOVA	1079	Yasin KAHYA	2264
Vesna KALABA	1456	Yİli BIÇOKU.....	2347, 2477
Vesna KRNJAJA	711	Yosra ABDELKHALEK.....	1790
Vesna MILIĆ	298, 621, 1192	Yosraben M'HENNI	1650
Vesna PERIŠIĆ	2026	Yuksel KAN.....	906
Vesna RADOJIČIĆ	2037, 2082, 2095, 2139	Yüksel ŞAHİN.....	1815
Vesna TUNGUZ.....	1769, 1836	Yunus CAVDIR	574
Vežir JANUZI	2461	Yusuf BAYAN.....	251
Victor N. SEMENOV.....	1712	Yusuf NİKPEYMA	1604
Vida VLADIMIR.....	1988	Yusuf SAVSATLI	1043
Vijay SUNDARAM.....	2071	Yusuf ŞAVŞATLI	245, 901
Viktor I. ELISEEV	1745	Yusuf YANAR.....	699, 1739
Viktor LUKASHEVICH	1968	Z. Selcen OZMEN	188
Viktória OROSZ.....	1982	Zdenka ŠKRBIĆ	2455
Vincent Onah EBRE.....	1031	Zdenko LONČARIĆ	1669
Violeta ANĐELKOVIĆ	895	Zekeriya AKMAN	676
Violeta CARO-PETROVIĆ	711	Zeki ACAR	359, 399, 1012
Violeta DIMOVSKA.....	1079	Zeliha GÖKBAYRAK.....	176, 562
Violeta MANDIĆ.....	711	Zlatko PEJKOVSKI.....	2541
Violina ANGELOVA.....	1870	Zoi PAPAĐOULI	866
Virgijija GAVELIENĖ.....	1208	Zoran BROČIĆ.....	815
Višnja VASILJ.....	965	Zoran DINIĆ.....	2008, 2109
Vjollca VLADI.....	1243	Zoran GALIĆ.....	2818, 2830
Vladan ĐERMANOVIĆ	2534	Zoran ILIĆ.....	2491
Vladan UGRENOVIĆ	1085	Zoran JERKOVIĆ.....	1762
Vlade ZARIC.....	2741	Zoran JOVOVIĆ	692
Vlade ZARIĆ.....	2706	Zoran JOVOVIĆ.....	165, 520
Vladeta STEVOVIĆ	491, 537	Zoran LUGIĆ.....	406
Vladimir AĆIN.....	644	Zoran LUGIĆ.....	2303, 2353
Vladimir ĆIRIĆ	2088, 2149	Zoran NJEGO VAN	2729
Vladimir DOSKOVIĆ.....	2455	Zoran RAJIĆ	2651
Vladimir F. SELEMENEV	1712	Zoran SIMIĆ	2026
Vladimir FILIPOVIĆ.....	181, 796, 1085, 1152	Zoran, JOVOVIĆ	977
Vladimir JOVANOVIĆ	2741	Zorica BIJELIĆ.....	711
Vladimir JOVANOVIĆ	2706	Zorica JOVANOVIĆ.....	56
Vladimir KURCUBIĆ.....	2491	Zorica RANKOVIĆ-VASIĆ.....	116, 413
Vladimir PERIŠIĆ.....	1385	Zorica TOMIĆ.....	711
Vladimir SIKORA	142, 1152	Zorica VASILJEVIĆ	2623
Vladimir VASIĆ	2885	Zsuzsanna RÓNAI	2522
Vladimir VIŠACKI.....	1056, 1640	Zvonimir BAKOVIĆ.....	2885
Vladimir ZHALIAZKO	1968	Zvonko NJEŽIĆ	1645

Zvonko SPASIC.....	2385	Željko DŽELETOVIĆ	2008
Žaklina KARAKLAJIĆ-STAJIĆ	808, 834	Željko LAKIĆ.....	996
Željana PRIJIĆ.....	1762	Željko ROSIĆ	984
Željka MARJANOVIĆ BALABAN	1456	Živan JOKIĆ	2534
Željko DOLJANOVIĆ.....	692	Mira MILINKOVIĆ.....	834
Željko DOLJANOVIĆ.....	165, 181, 386, 497, 520, 931	Marija MENKINOSKA.....	1108

Regional Rural Development Standing Working Group (SWG) in Southeastern Europe

Introduction to SWG GIZ project

What is the SWG? The “SWG” stands for Regional Rural Development Standing Working Group in South Eastern Europe. It is an International Intergovernmental Organization consisted of governmental institutions responsible for agriculture and rural development in respective countries and territories. It is a platform for networking and regional co - operation among the SEE countries and territories in the field of agriculture and rural development. It was founded on the basis of a common wish to establish an organization for sustainable rural development in SEE. As an organization the SWG is a non-political body, acting in a spirit of friendship and good neighborliness and enhances mutual respect and confidence, dialogue and cooperation among the Member Institutions.

Vision: Innovative and sustainable agriculture and rural development through cohesive regional co-operation for improvement of rural livelihoods in the SEE countries

Mission: To increase horizontal collaboration among respective countries and territories of SEE, coordinating regional initiatives related to agriculture and rural development and support the process of economic development in rural areas of Southeastern Europe

General Objective: To facilitate close cooperation among the Ministries of Agriculture and other stakeholders in the field of agriculture and rural development and to support the EU integration

Specific Objectives:

- To improve the common understanding of EU agriculture and rural development policies;
- To assist the improvement of implementation structures and systems for agriculture and rural development in rural areas, with specific emphasis on cross border cooperation;
- To improve the understanding and use of implementation tools for agriculture and rural development;
- To identify and share information and application of good practice in agriculture and rural development to broaden the rural agenda.

Contacts:

Mr. Boban Ilic, SWG Secretary General
SWG Head Office/ Secretariat
Blvd. Goce Delcev 18
Macedonian Radio Television Building 12th Floor
P.O.Box 659, 1000 Skopje, Republic of Macedonia
Tel: + 389 2 3 217 708, Fax: + 389 2 3 217 244
E-mail: swgsecretariat@swg-seerural.org; Website: www.seerural.org

The AGROSYM 2016 has been organized with the assistance of the Regional Rural Development Standing Working Group (SWG) in South-Eastern Europe within the SWG GIZ project: “*Strengthening regional capacities for rural development through integrated forest and water resources management in southeast Europe*”.



Rural Development through Integrated Forest and Water Resources Management in Southeast Europe LEIWW

The regional project includes the countries Albania, Bosnia and Herzegovina, Kosovo, Macedonia, Montenegro and Serbia. LEIWW is a joint project of the Standing Working Group for Regional Rural Development in South Eastern Europe (SWG) and the Deutsche Gesellschaft für Internationale Zusammenarbeit (GIZ).

Context

The rural population of Southeast Europe is strongly dependent on the preservation and sustainable use of soil, forests, water and biodiversity. Degradation due to unsustainable management practices and climate change is threatening the bases of income generation, employment and development in rural areas, which in turn affects development opportunities and migration. In light of the encounter between the use of natural resources and efforts to conserve them, there is a need for an integrated approach as well as coordination between the important sectors and institutions.

Accession to the European Union (EU) is a declared policy goal in all the countries of Southeast Europe. To achieve this they need to harmonise their strategies, policies and legislation with those of the EU, and to put in place necessary conditions for their implementation.

Natural resources management is a cross-border issue and the process of EU accession provides a common framework for it. In addition to their own national challenges related to sustainable rural development, the countries of Southeast Europe are now also required to cooperate and coordinate their actions across national borders.

Objective

The overall objective of the project is to strengthen regional capacities for rural development and natural resources management in Southeast Europe.

Project name	Rural Development through Integrated Forest and Water Resources Management in Southeast Europe (LEIWW)
Commissioned by	Bundesministerium für wirtschaftliche Zusammenarbeit und Entwicklung (BMZ)
Project region	Southeast Europe: Albania, Bosnia and Herzegovina, Kosovo, Macedonia, Montenegro and Serbia
Lead executing agency	Standing Working Group for Regional Rural Development in South Eastern Europe (SWG)
Duration	01.01.2015 – 31.12.2017

Approach

The project contributes to the improvement of technical, methodological and implementation competencies for the management of natural resources and for the use of their economic potential in rural areas.

The cooperation between the SWG and GIZ contributes structurally to rural development, the promotion of agri-businesses and the sustainable use of natural resources.

The project operates in three areas:

Improving coordination between the environment, forestry, water sectors and rural development / agriculture

SWG introduces positions to the regional dialogue that have been developed by its member institutions, working groups and networks. This entails coordination of the competent ministries, departments and authorities in the Southeast European countries. The topics addressed include the EU directives and their implementation in the context of the EU Common Agricultural Policy and the protection of natural resources. Results and solutions are taken back to the member institutions.

Integrating environmental objectives in rural development and agricultural policies

Here, the aim is to develop inputs that support evidence-based and EU-compliant policymaking for the integration of environmental objectives in agricultural and rural development policies. To this end, the project uses the capacities of the SWG networks to develop practically applicable policy recommendations. This process involves expert staff from various ministries, as well as academics and practitioners; and it includes the private sector and non-governmental organisations.

The regional composition enables fruitful exchanges and learning, particularly since the countries find themselves at different stages of the EU accession process.

Planning and implementing measures for rural economic development and natural resource management in cross-border regions

In four pilot regions across all countries (Drina-Sava, Drina-Tara, Prespa and Sharra), the project supports measures for integrated natural resources management that reconcile the conservation and use of natural resources.

Examples include grants for income generation and natural resource management to contribute to nature conservation while generating incomes. For example through so-called green value chains or through rural tourism. These measures pay special attention to the economic activities of women.

Further education and training as well as on-the-job consulting are provided for policy and administrative actors, as well as the private sector and civil society. This equips them to implement measures, use EU support mechanisms and develop models for sustainable rural economic development.

By working with the media, holding events and organising people to people activities, the project raises awareness among the general public, decision makers, the private sector and civil society regarding the importance of forests, water and biodiversity to sustainable development.

The SWG

“SWG” stands for Regional Rural Development Standing Working Group in South Eastern Europe and is an International Intergovernmental Organization, consisted of governmental institutions responsible for rural development in respective countries and territories.

SWG is working to empower and promote sustainable principles on rural development, through networking and permanent cooperation between all stakeholders of rural development in SEE region.

It acts as independent agency for coordination and implementation of joint projects, as well as for carrying out project activities. Through them, the SWG serves as the facilitator in the process of strengthening regional institutions necessary to support long-term agricultural and rural development.

Moreover, the teamwork by SWG members reinforces their individual efforts to mainstream or incorporate regional rural development concerns into all of their policies and programs.

Impressum

Deutsche Gesellschaft für
Internationale Zusammenarbeit (GIZ) GmbH

Sitz der Gesellschaft
Bonn und Eschborn

Rural Development through Integrated Forest and Water
Resources Management in Southeast Europe (LEIWW)
Antonie Grubisic 5
1000 Skopje, Macedonia

T +389 2 3103 560
F +389 2 3103 587
E Benjamin.Mohr@giz.de
I www.giz.de