

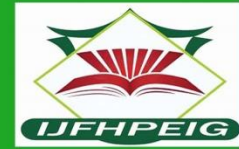

Volume : 5 - No: 2  
Half - Yearly  
July 2018 - Dec 2018



ISSN 2349 - 722x

# International Journal of Fitness Health, Physical Education & Iron Games

Published by  
International Federation for Fitness, Health, Physical Education & Iron Games

**Approved by UGC**

**New Delhi Approved Journal No:- 63896**

Thomson Reuters ID O - 6684 - 2015

ISRA Journal Impact Factor: 2.045

IP Indexing Impact Factor: 2.64

[icrtfhss@gmail.com](mailto:icrtfhss@gmail.com)



## GLIMPSES

Dr.Kaukab Azeem had attended as speaker at the 18th International Scientific Conference „Perspectives in Physical Education and Sport”, 17-19 of May, 2018, Constanta, Romania. This International conference was organized by Ovidius University of Constanța. Dr.Kaukab Azeem receives award of Distinction of Excellence from Prof. Mirela Damian , Dean Faculty of Physical Education sports, OVIDIUS UNIVERSITY of Constanta., Romania,



**In picture** - Right to Left

Prof. Mirela Damian , Dean Faculty of Physical Education and sports, OVIDIUS UNIVERSITY of Constanta.

Dr.Kaukab AZEEM

Prof. Alin Larion, Organizing secretary,OVIDIUS UNIVERSITY of Constanta.

**1st Telangana Strength lifting Chmapionship 2018, Org by PRO 6 Gym, Moula Ali**



**From L to R, Mr.Saquib Azeem President TSA,  
Md Ameer Hussain, Strong man Senior, Aamir Hussain Strong Man Junior,  
Dr.Kaukab AZEEM, Chief Guest, and Mr.M.Sabir General Secreatry TSA.**

# Golden Fitness System

Manufacturing Home Gym & Gym Equipment

Welcome to Golden Fitness Systems!

Golden Fitness System specializes in top-of-top-line fitness equipments and accessories with cutting-edge technologies.

Founded in 1992, Golden Fitness Systems has served innumerable customers and helped set up fitness center's across India. The Company has even supplied fitness equipment for prestigious COLLEGES and elite institutions and many gyms.

Browse through our products and have them installed at your home, gym, club or office for maimum fitness results. you will find our range of Treadmills, Ellipically, Bikes and Gym Stations cost-efficient and within your budget.

Happy exercising....

COMMERCIAL EQUIPMENTS, Home EQUIPMENT, FITNESS ACCESSORIES.

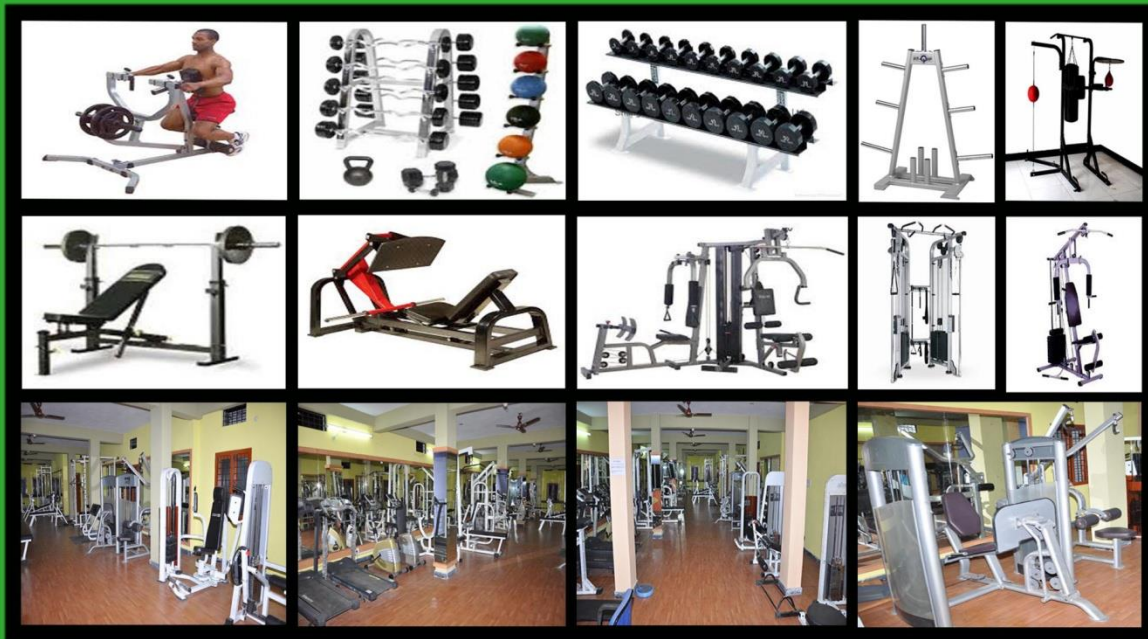

Contact

SEEMAB AZEEM

9849407866,8801358352.

Email us at:- [Getsimmu@gmail.com](mailto:Getsimmu@gmail.com)



## **Dr. Kaukab Azeem**

Editor-in-Chief, IJFPE&IG  
Faculty, Physical Education Department  
King Fahd University of Petroleum & Minerals  
Saudi Arabia  
**[drakbodybuilding@gmail.com](mailto:drakbodybuilding@gmail.com)**

## CHIEF PATRON

**Prof. Syed Ahmed Hashmi**

Former first principal PG College of Physical Education, Osmania University,  
Hyderabad, India, and Goodwill Ambassador for USA.

## PATRON

**Prof. Grace Helina**

Vice Chancellor, Tamil Nadu Physical Education and Sports University, Chennai, India

## Associate Editors

<b>Prof. Vesna Babic</b>	Vice Dean	Croatia
<b>Prof. R. Subramanian</b>	Member, VC Convener Committee, TNSU	India
<b>Prof. Shaik Shafiuddin</b>	Dean	India
<b>Prof. Loka Bavoji Laxmikanth Rathod</b>	Principal, PG college, O.U	India
<b>Dr. Reena Poonia</b>	Manipal University, Jaipur	India

## Reviewers

<b>Reviewers</b>	<b>Country</b>	<b>Reviewers</b>	<b>Country</b>
<b>Dr. Arif Ali Khan</b>	India	<b>Prof. Nurtekin Erkmen</b>	Turkey
<b>Dr. Chittibabu</b>	India	<b>Prof. Metin Dalip</b>	Macedonia
<b>Dr. M. Barnabas</b>	India	<b>Dr. Carl Petersen</b>	New Zealand
<b>Dr. Syed Farooq Kamal</b>	India	<b>Prof. Sadiq Alhayek</b>	Jordan
<b>Dr. K. Kamalakkannan</b>	India	<b>Dr. Leyla Rad</b>	Iran
<b>Dr. J. Suganthi</b>	India	<b>Dr. Mohammed M. Ahmed</b>	U.S.A
<b>Prof. S Bakhtiar Choudhary</b>	India	<b>Dr. Abdulhameed Al Ameer</b>	Saudi Arabia
<b>Prof. Dr. Khaled Ebada</b>	Egypt	<b>Dr. Yvonne Paul</b>	South Africa
<b>Prof. B. Sunil Kumar</b>	India		

## Members

<b>Mr. Saquib Azeem (Treasurer)</b>	India	<b>Prof. Nusret Smajlovic</b>	Bosnia
<b>Dr. Benedict Atakpu</b>	USA	<b>Dr. Ratko Pavlović</b>	Bosnia and Herzegovina
<b>Dr. Tarin Hampton</b>	USA	<b>Dr. Abdelmalik Serbout</b>	Algeria
<b>Dr. Paul Chahal</b>	Canada	<b>Dr. Firica Jean</b>	Romania
<b>Prof. Sanaa Hussien</b>	Egypt	<b>Dr. Badriya Al-Hadabi</b>	Oman
<b>Dr. Saidia Houari</b>	Algeria	<b>Mr. Tetsuro Kita</b>	Japan
<b>Mr. Anantayah Kistamah</b>	Mauritius		
<b>Mr. Henry Cordero Daut</b>	Philippines		
<b>Mr. Seemab Azeem</b>	India		
<b>Mr. Meer Abbas Hyder</b>	Bangkok		

## SUBSCRIPTION RATES ( Print + Online)

Sl.no	Membership details for foreigners	Amount
I	<b>Life time membership</b>	
a	Researchers	750 us dollars
b	Organizations\ Gyms \ Health Clubs	1000 us dollars
II	<b>Five Years membership</b>	
a	Researchers	250 us dollars
b	Organizations\ Gyms \ Health Clubs	500 us dollars
III	<b>Annual Membership</b>	
a	Researchers	100 us dollars
b	Organizations\ Gyms \ Health Clubs	150 us dollars
a	Publish single research paper	50 us dollars

Sl.no	Membership details for INDIANS	Amount
I	<b>Life time membership</b>	
a	Researchers	35000 RS
b	Organizations\ Gyms \ Health Clubs	50000 RS
II	<b>Five Years membership</b>	
a	Researchers	15000 RS
b	Organizations\ Gyms \ Health Clubs	20000 RS
III	<b>Annual Membership</b>	
a	Researchers	3500 RS
b	Organizations\ Gyms \ Health Clubs	3500 RS
a	Publish single research paper	2000 RS

- RATES OF THE JOURNAL MAY BE VARY FROM TIME TO TIME AND UPDATED.
- (POSTAL CHARGES FOR FOREIGNERS WILL BE CHARGED 50 US DOLLARS )

### IN THE FAVOR OF:

**INTERNATIONAL FEDERATION FOR FITNESS, HEALTH, PHYSICAL EDUCATION & IRON GAMES**

Current Account number: 33866093430









Bank name: State Bank of India

Address : Tolichowki Branch (05095), Hyderabad, India

IFSC CODE: SBIN0005095

SWIFT CODE: SBININBB321

## Journal is indexed with

University Grant Commission (UGC), India		
IP Indexing		2.64
International Society for Research Activity (ISRA), Journal Impact Factor (JIF)		2.045
J-Gate		
SJIF (Scientific Journal Impact Factor)		
Research gate		
Google Scholar		
International Scientific Indexing (ISI)		0.836
Directory of Research Journals Indexing (DRJI)		
ICI World of Journals		



## SUMMARY ABOUT THE INTERNATIONAL JOURNAL

International Journal of Fitness, Health, Physical Education & Iron Games (IJFHPEIG) is an Academic, online peer-reviewed, refereed Journal and published by IFFHPEIG. The Journal had inspires lot of researchers from the globe to contribute in the field of sports, Physical Education and Iron Games to published their research work. It is great honor to receive lot of responses from the contributors for contributing and sharing their knowledge. We take privilege in inviting our colleagues/students/ researchers/ Faculty members to send their research work to publish in our esteemed Journal.

### Table of Content

Sl.n	Title's	Page no's
1	<b>Differences in morphological, motor and functional parameters of students</b> Ratko Pavlović <sup>1</sup> , Marko Joksimović <sup>1</sup> , Aleksandar Simeonov <sup>2</sup>	01-08
2	<b>Anthropometric amounts and their contributions to fatigue of isometric extensor endurance (trunk or knee) among sportswomen</b> Mohammed Zerf <sup>1</sup> , Gourari Benali <sup>1</sup> , boras Fatima Zohra <sup>1</sup> , Sidimohamed koutchouk <sup>2</sup> , Mohamed Hadjarkherfane <sup>2</sup> , Abd-el-Kader Benchehida <sup>2</sup> , Remaoun Mohamed <sup>3</sup>	09-19
3	<b>Efficacy of various training on stride length, explosive power and elastic power development</b> R. Saravana Prabha	20-36
4	<b>Towards a didactic model of learning in a training context of young footballers: game configurations and debates of ideas socio-constructivist approach</b> Bourenane Cherif, <sup>2</sup> djennad, <sup>3</sup> kedadra	37-42
5	<b>Sporting events among the disabled between excellence and ideal in motor performance</b> Analytical descriptive study in some Paralympic sports Guebli Abdelkader <sup>a</sup> , Reguieg Madani <sup>b</sup> , Belkadi Adel <sup>b</sup> , Sbaa Bouabdellah <sup>a</sup>	43-49
6	<b>A comparative study of pre competitive anxiety between female players and male players in different games and events</b> Jaswinder Singh	50-53
7	<b>Performance in connection with self-esteem in sports &amp; physicals activities</b> psycho- sociological approach .Sadek Smail <sup>1</sup> & Mustapha Cherif Bourenane <sup>2</sup>	54-56
8	<b>Motives for physical activity and leisure participation of Filipino pre-service Physical Educators</b> Julius Ceazar G. Tolentino	57-64

9	<b>Impact of Reducing Training Load (Deload) and its Importance In Muscle Building and Maintaining the Level of Achievement of Special Needs Players In the Effectiveness of Discus</b> <b>Hamid Abdulsada Kadhim Al-Akrh</b>	65-68
10	<b>Philosophical Evolution Physical Sport Activity</b> <b>Zahaf Mohamed</b>	69-73
11	<b>Speed, Velocity and Recovery Levels of High School and University Male Handball Players</b> <b>Erkut TUTKUN<sup>1*</sup> Osman İMAMOĞLU<sup>2</sup> Hakan ACAR<sup>3</sup></b>	74-84
12	<b>Relationship Between Hand Grip Strength and Finger Ratio (2d:4d) In 10-12 Age Swimmers</b> <b>Nebahat Eler</b>	85-94
13	<b>Constructing Norms for Selected Physical Fitness for Sports Potential among High School Boys</b> <b>Byregowda. N, Syed Kareemulla</b>	95-99
14	<b>Relationship between Physical Fitness and Academic Achievement of Private School Girls</b> <b><sup>1</sup>Harpreet Kour, <sup>2</sup>Rina P, <sup>3</sup> Nagesh Janu</b>	100-103
15	<b>An Electronic Equipment to Assess the Reaction time of Sprinters – A Study</b> <b>V.Ravi Kumar</b>	104-111
16	<b>Mental Toughness Among Inter College Players In Relation To Gender</b> <b>Jaskaran Singh Sidhu</b>	112-116
17	<b>A Comparative Study of Aggression Between Champion and Non-Champion Players.</b> <b>Jaskaran Singh Sidhu</b>	117-121
18	<b>Prevalence of Pre-Competition Anxiety In Athletes of Urban Area, Hisar</b> <b>Saleem<sup>2</sup>, Shabnam Joshi<sup>1</sup>, Sonu Punia<sup>1</sup>, Sivachidbaram Kulandaivelan<sup>1</sup></b>	122-129
19	<b>The Effect of Training Program on Mixed Contractions on Both the Maximum Force and Explosive Force of the Lower Limbs</b> <b>Dani Hakim, Loucine Sliman, Zakaria Azizi Mansour, Saidia Houari; Nahal Hamid</b>	130-143
20	<b>A Study of Mindfulness And Meaning of Life of Tihar Jail Prisoners</b> <b><sup>1</sup>Ashish Kumar, <sup>2</sup>Meenu Dabas &amp; <sup>3</sup>Dr. Pardeep Kumar</b>	144-149
21	<b>Assessment of Peace of Mind and Anxiety Level Between Male and Female Prisoners of Tihar Jail</b> <b><sup>1</sup>Meenu Dabas, <sup>2</sup>Ashish Kumar <sup>3</sup>Pardeep Kumar</b>	150-155
22	<b>A Study of Dribbling Ability in Football In Relation to Agility Technique of Govt. Degree College Boys of Nalgonda Dist, Telangana</b> <b>M.A.Alem</b>	156-160
23	<b>Comparison on Physical Fitness of Private School and Government School of Imphal West-Ii Of Manipur</b> <b>Thambal Singh, N. Robin Singh</b>	161-165

24	<b>Database Design for Sports Related Information, Resources &amp; Experts to Facilitate Competitive Sports.</b> S. P. Deshpande , M. S. Chendke, D. P. Vaidya, N. V. Wankhade	166-172
25	<b>Gender Discrimination In Sports: <i>From Subjugation To Self- Realization</i></b> Arzoo Ashok Rode	173-178
26	<b>The 4<sup>th</sup> Umpire - “Hawk-Eye” Modern Technology in Cricket</b> Shweta N.Dave	179-185
27	<b>Effect of 8 Week Training Programme on Agility and Power of Swimmers</b> Pratima Bhonde	186-194
28	<b>Sports Media And Journalism – A Profession</b> Deepak V. Phadnis, Vijay V. Pande	195-198
29	<b>A Critical Analysis of the Sports Facilities Provided by the Namdhari Sports Academy.</b> Charan Singh, Monika Verma	199-211
30	<b>The Relationship of Selected Kinematical Variables to The Performance of Basketballers in Jump Shot</b> Sunil Dabas, Rakesh Kumar	212-219
31	<b>A Comparative Study of Social Adjustment of Male and Female Sportsperson</b> Ravinder Singh	220-222
32	<b>Effect of Ideokinetic Imagery Training on Body Posture</b> Rakesh Kumar, Sunil Dabas	223-228
33	<b>Comparison Of Physical Fitness Variables Between Individual Games And Team Games Players.</b> Subhash Rewatkar*	229-235
34	<b>Comparison of Physical Fitness Levels and Skill Ability of Field Hockey Players Between National and Club Teams</b> Oinam Bhagat Singh, L. Thambal Singh, Loitongbam Sitaljoy Singh	236-246
35	<b>Significant Differences of Aerobic and Anaerobic Capacity Between Handball and Basketball Players.</b> L. Thambal Singh, S. Vinay Kumar Singh, Kangjam Inaotombi	247-250
36	<b>The Effect of Sports Recreation in Alleviating Anxiety among the Elderly (60/65) years</b> Benali Gourari, Fatima Zohra Bouras,	251-259

## DIFFERENCES IN MORPHOLOGICAL, MOTOR AND FUNCTIONAL PARAMETERS OF STUDENTS

Ratko Pavlović<sup>1</sup>, Marko Joksimović<sup>1</sup>, Aleksandar Simeonov<sup>2</sup>

<sup>1</sup>Faculty of Physical Education, University of East Sarajevo, Bosnia and Herzegovina

<sup>2</sup> Faculty of Physical Education, Sport and Health, University Ćirilo and Metodije in Skopje, Macedonia

[pavlovicratko@yahoo.com](mailto:pavlovicratko@yahoo.com)

### *Abstract*

Morphological, motor and functional spaces are often the subject of research in the field of physical education and sports. Their analysis can detect certain psychosomatic changes, the trend of their development and possible differences. The current research has been carried out with the aim of determining the differences between the morphological, motor and functional parameters of the student population. The sample includes a population of 46 male students from the Faculty of physical education and sports in East Sarajevo, aged 21-22, and divided into two sub-samples. A total of 8 parameters have been measured, which have assessed morphological, motor and functional space. The analysis of the T-test has revealed differences between different generations, and in 50% of the parameters, these differences have been statistically significant.

**Key words:** morphological space, features, age differences, students

### INTRODUCTION

An important segment of the anthropological space consists of motor skills based on which information about the motor functioning of a person is obtained and as such plays an important role in achieving sport results (Radinović, & Pavlović, 2013). In nature, there is no absolute deadlock, so that the movement of a man can be observed as a mean of motor development and survival, because without movement there is not development of motor skills and therefore its existence is endangered (Sertić, Segedi, & Baić, 2008). Every motor skill has its own characteristic. It is possible to influence every motor skill, which is especially important for sports activities, whether it is recreational or top sport (Koppes, Twisk, & Kemper, 2004). However, the influence on certain motor abilities is significantly genetically determined, the speed is just a good example (over 95% of heredity), or explosive power, while in static and repetitive power this influence is far smaller (Stojiljković, 2003). Motor skills are known as the basic characteristics of athletes since the very beginning of the sport. If the motor skills of an athlete are not properly matched to their ability to perform the technique, mistakes will prevent them from reaching top results (Radulović, Pavlović, Mihajlović, Šolaja, & Gušić, 2017). The consequences which are connected to motor abilities are measurable in terms of coordination and energy-specific abilities (De Toia, Klein, Weber, et al. 2009), and anthropometry is a method for measuring the human body, that is, individual parts of the body, which quantitatively determine morphological properties and show us the objective image on state of growth of the examined person (Jakonić, 2003). It is logical to conclude that anthropometric characteristics participate in explaining the overall psychosomatic status of younger and older students, especially in the relation to motor skills, which are a key factor in assessing the ability to participate in sport activities (Bratić, Pavlović, Kostić, & Pantelić, 2012). Because of its utilization, anthropometry has found application in many fields, e.g. sports kinesiology, recreational and educational kinesiology,

sports medicine, pediatrics and school medicine. It has been used for monitoring growth in children and adolescents, as part of practical standard procedures for assessing nutritional status, in research of specific morphological traits during growth and development, correlation of body dimensions with other anthropological characteristics and anthropological studies of the structure of the population (Mišigoj-Duraković, 2008; Peršun, Miholić, & Vrbik. 2011).

An unavoidable segment are the morphological dimensions that represent the primary information on the psychosomatic status of a person which are determined by the system of basic anthropometric latent dimensions, whether or not these dimensions are developed under the special influence of the outside environment (eg. training) (Stupar, 2012). Some authors have researched the differences in this region (morphological and motoric) of student population of the same age, but from different urban or rural areas (Nićin, & Kalajdžić, 2000; Krsmanović, Jakonić, Pelemiš, et al., 2000; Reyes, Tan, & Malina, 2000; Kukulj, Bokan, Koprivica, & Ugarković, 2001; Pavlović, Dragutinović, & Kovačević, 2015). Very often, as a research problem, differences in the morphological and motor dimensions of different populations of the same age are defined (Silva, Benedetti, Ferreri, et al., 2012; Radinović, & Pavlović 2013). This research that has been conceptually defined to analyze differences in the morphological and motor parameters of students in order to record statistical differences in certain segments of anthropological space.

## **METHOD**

The research has included the population of students of the Faculty of Physical Education and Sport in East Sarajevo (Bosnia and Herzegovina). The sample consists of 46 students, ages 21-22 years, divided into two sub-samples: the first sample consists of 24 students of the school year 2010/11 (average height  $184 \pm 6,22$  cm, body weight  $81 \pm 9,08$  kg) and 22 students of the school year 2011/12 (average height  $179 \pm 8.23$  cm, body weight  $75 \pm 11.58$  kg), who have regularly attended practical classes and were present at the practical teaching at the moment of measurement. The testing has been carried out at the teaching room at the Faculty of Physical Education and Sport.

Variables used for analysis of the somatic status are:

1. body height (AVIS-cm),
2. body weight (AMAS-kg).

Variables used for testing of motor and functional abilities are:

1. standing long jump (MSDM-cm),
2. standing triple jump (MTRS-cm),
3. standing forward bend (MPET-cm),
4. 15m running, standing start (MT15V-sec),
5. squat (MČUČ 10" -iter)
6. maximal anaerobic ability (MARG-W).

Statistica 8.0 has been used for data processing. The basic central and dispersion parameters have been calculated, and the T-test module for small independent samples has been used to

determine the differences. Margaria-Kalamen Power Test has assessed by using following formula (Mackenzie,2005):  $Power (W) = mass(kg) \times 9,81(m/s^2) \times stair\ height (m) / time(s)$ .

### RESULTS AND DISCUSSION

Table 1 shows descriptive statistics of morphological, motor and functional parameters of the sample. The numerical indicators of the dispersion of sub-sample of students from 2010/11 have shown a normal distribution of results. The symmetry analysis of the results have shown the positive and negative asymmetry of the function in the variables (AVIS, MSDM, MTRS, MPET, MČUČ i MARG) while the positive asymmetry is present in (AMAS, MT15V).

In terms of homogeneity, a mild platykurtic function is present in variables (AVIS, AMAS) , whereas only in the variable (MČUČ) a leptokurtic curve has been formed. In the generation of students from 2011/12, the asymmetric function is present in variables (AVIS, MSDM, MČUČ). In the variables (AMAS, MTRS, MT15V) frequency distribution with statistically insignificant positive asymmetry has been formed while in the variable (MPET) statistically insignificant negative asymmetry has been formed. Kurtosis has formed a mild platykurtic curve in variables (AVIS, MČUČ and MARG), while the leptokurtic curve has been formed in variables (MSDM, MPET, MT15V).

**Table 1. Basic statistical parameters of the sample (N=46)**

Parameters	<i>The</i>							
	<i>school year</i>	<i>Mean</i>	<i>Min.</i>	<i>Max.</i>	<i>Range</i>	<i>Std.Dev.</i>	<i>Skew.</i>	<i>Kurt.</i>
AVIS (cm)	2010/11	184	170	195	25	6,22	-,16	-,21
	2011/12	179	160	194	34	8,23	-,26	-,20
AMAS (kg)	2010/11	81	65	101	36	9,08	,57	-,06
	2011/12	75	57	106	49	11,58	,82	,88
MSDM (cm)	2010/11	231	181	270	89	19,48	-,28	,87
	2011/12	235	152	300	148	29,14	-,56	2,37
MTRS (cm)	2010/11	722	550	855	305	69,14	-,16	,73
	2011/12	696	510	880	370	77,96	,10	1,01
MPET (cm)	2010/11	1233	900	1425	525	19,66	-,64	1,05
	2011/12	1138	1145	1550	405	21,47	-2,86	11,46
MT15V (sec)	2010/11	2,48	2,23	2,95	,72	,16	,91	1,83
	2011/12	3,04	2,60	3,86	1,26	,27	1,15	2,50
ČUČ10'' (iter)	2010/11	12	8	14	6	1,06	-1,83	7,29
	2011/12	10	9	12	3,00	,93	-,09	-,69
MARG (W)	2010/11	792,63	536,49	988,23	451,74	90,51	-,31	1,51
	2011/12	756,10	496,62	1073,14	576,52	136,75	,20	-,09

**Table 2. Differences between morphological and motor features of the students (T-test)**

<i>Parameters</i>	<i>The school year</i>	<i>Mean± SD</i>	<i>t-value</i>	<i>p- level significantly</i>
<b>AVIS (cm)</b>	2010/11	184±6,22	2,16	0,036*
	2011/12	179±8,23		
<b>AMAS (kg)</b>	2010/11	81±9,08	1,97	0,049*
	2011/12	75±11,58		
<b>MSDM (cm)</b>	2010/11	231±19,48	-,42	0,677
	2011/12	235±29,14		
<b>MTRS (cm)</b>	2010/11	722±69,14	1,21	0,231
	2011/12	696±77,96		
<b>MPET (cm)</b>	2010/11	1233±19,66	1,60	0,117
	2011/12	1138±21,47		
<b>MT15V (sec)</b>	2010/11	2,48±,16	-9,12	0,000**
	2011/12	3,04±,27		
<b>ČUČ10'' (iter)</b>	2010/11	12±1,06	4,93	0,000**
	2011/12	10±,93		
<b>MARG (w)</b>	2010/11	792,63±90,51	1,14	0,261
	2011/12	756,10±136,75		

**\*\*p<0,001; \*p<0,05**

The average body height of the students from sub-sample 2010/11 was 184 cm and they were higher 5 cm on average than students from sub-sample 2011/12 (Mean 179 cm), which is also evident in the range of minimum and maximum results from 25 to 34 cm. In terms of body weight, the students from sub-sample 2010/11 were 6 kg heavier than the students from sub-sample 2011/2012 with a range of results from 36 kg to 49 kg. Motor space has shown somewhat different redistribution of results, but still the sub-sample of students from 2010/11 have shown to be dominant in most motor skills. They have achieved better results in the sprint speed (MT15V = 2.48 sec), the repetitive legs power (MČUČ10'' = 12iter), the explosive power of the legs (MTRS = 722cm; MPET = 1233cm), while they have shown weaker results in standing long jump (Mean = 235cm) than students from the sub-sample 2011/12. When it comes to the functional capabilities which have been tested by the Margaria-Kalamen Power Test, the 2010/11 generation has cumulatively achieved better

result on average (Mean = 792.63W) than generation 2011/12 (Mean= 756, 10W) with a range of results from 451.74W to 576.52W. These results have shown significant advantage of 2010/11 generation.

Table 2 shows differences in the motor and morphological parameters of students which have been identified by the T-test for independent samples. By analyzing the values of the T-test, statistically significant differences have been found between the results in 50% of the analyzed parameters. The body height and body weight, from the morphology area for the significance level  $p < 0.05$  (AVIS,  $T = 0.036$ ; AMAS,  $T = 0.049$ ) have been identified as dominant in the generation of students 2010/11. From the motor parameters, the variables 15 m running standing start (M15V;  $T = 0,000$ ) and number of squats for 10sec. (MČUČ10 ";  $T = 0,000$ ) have been chosen and the level of significance is  $p < 0.001$ ). The students from 2010/11 generation have been more successful in this parameter since they have shown a better explosive and repetitive force of caudal extremities. Differences have been noticed in other parameters, but they have not been statistically significant.

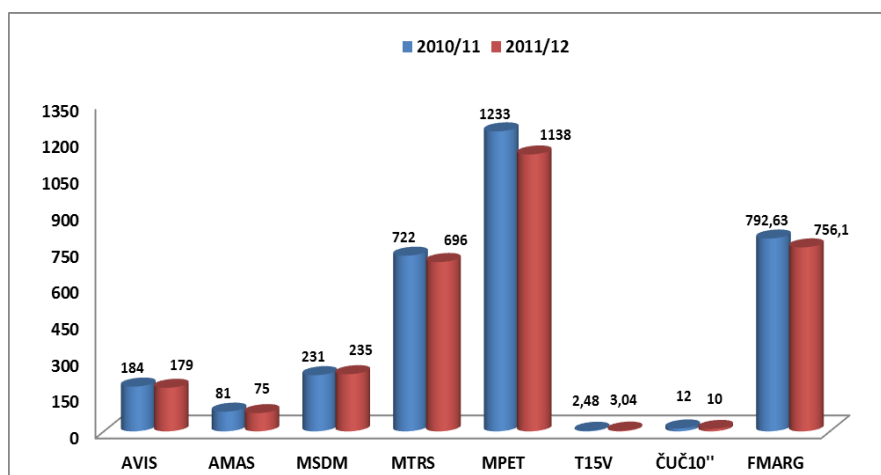

**Figure 1. Differences of mean values morphological characteristics and motoric abilities students**

The study analyzed differences in morphological, motor and functional parameters of two generations of students of the Faculty of Physical Education and Sport. As it has been pointed out previously, students from the sub-sample of 2010/11 have been more successful in the majority of explosive tests, and they had higher body height and body weight. The well-known fact is that for all jumps, the height of the center of gravity of the body at the beginning of the jump is very important, and all that depends on the height of the jumper and its position at the end of the bounce phase (Pavlović, 2016). The negative effect of body weight, and especially subcutaneous fat tissue, on success in the realization of various motor tasks was confirmed in a large number of scientific researches (Mota et al., 2002, Deforche, Lefevre, De Bourdeaudhuij, et al., 2003; Kim, Must, & Fitzmaurice, 2005; Strel, 2006 Stojanović, Mijanović, Stojanović, et al., 2012). This has not been the case for explosiveness and speed that are highly genetically determined. Force and power can be significantly influenced by muscle architecture (Blazevich, Cannavan, Coleman & Horne, 2007), that is, the relationship between the length of muscle fibers and the surface of their physiological



cross-section. The length of the fibers has a particular effect on the extent of movement that the muscle can perform, the maximum shortening speed, and the force-length relationship (Knežević & Mirkov, 2011; Stojanović et al., 2012). The strength displayed by the muscle depends on the number of activated motor units, as well as the frequency of activation of motor units in the unit of time (Bjelica, & Fratić, 2011), or the development and status of the CNS. Also, the force of contraction depends on the lever on which the muscle is attached, whether it is a lever of force or a lever of velocity. If the force prong of the lever is larger, less power is needed for its launch and otherwise. Higher muscle strength is required if the work is performed over one joint (McGinnis, 1999). However, in the body, most movements are carried out mainly by two or more joints, so contractions are less compared to the force applied and energy is saved which is not the case when engaging two and three muscles (Jovović, 2006; Pavlović, Idrizović, Dragutinović, et al., 2017). According to some authors (Zatsiorsky, & Kraemer, 2006), muscles with a large cross section produce more force than similar muscles with a smaller cross-section. This applies regardless of the length of the muscle. Power is an important component of flexibility. Strength and flexibility are compatible because flexibility depends on muscle intersection, length of ligaments and their condition, and the strength of how much muscle can stretch (Bompa, 2006). Flexibility provides better muscle elasticity and a greater range of joint movements (Nelson, & Kokkonen, 2007), that is, flexible muscle and connective tissue allows more relaxed, coordinated and controlled movements (Medina-Jiménez, 2003). For students of school year 2010/11 it has been confirmed to have higher body height and body mass. Also, students of the 2010/11 have achieved better results in running at a 15 m standing start and in performing squats in 10 seconds. An explosive force has been found to lead to great acceleration and affects the development of the speed of movement (Milošević, Kreft, & Mučibabić, 2014). The length of the steps generally depends on the height of the body or the length of the leg and force, developed from the extensor of the hip, knee and ankle joint in the contact phase (Čoh, 2001). Sprint run is a complex cyclical movement defined by the frequency and length of the step, which are interdependent and individually conditioned by the processes of central regulation of movement (Čoh, 2009). Milosevic, Kreft, & Mucibabic (2014) found that the explosive power of the lower extremities determined by the CMJ test leads to high values of the length of the steps and their frequency and directly affects the result of the sprinting run. Climbing the stairs has validity for measuring explosive power (Clemons, & Harrison, 2008). Anaerobic power and capacity depend on the age of the respondents, sex, morphological characteristics and training conditions (Ostojić, 2011). The current research is in accordance with the results of the research (Nićin, Kalajdžić, 2000; Krsmanović, Jakonić, Pelemiš, et al., 2000; Pavlović, Dragutinović, & Kovačević, 2015), which also defines the trend of changes in the psychosomatic and motor-functional status of the research population.

### **CONCLUSION**

The research has been carried out with the aim of determining quantitative and qualitative differences between two generations of students of the Faculty of Physical Education and Sport in East Sarajevo in terms of morphological, motor and functional parameters. A total of 46 students have been analyzed, and on the basis of the obtained results, statistically significant differences were found in 50% of the variables in favor of the generation of

students 2010/11. That generation of students was higher and heavier, had better results in motor parameters that assessed the explosiveness of the lower extremities (15m running standing start and squatting for 10 sec). Also, in other variables, there are obvious differences, but they have not shown statistical significance. This is an indication that there is a trend of differences, regardless of whether it is the same population, which is a consequence of changes in all segments of the anthropological space of the individual from the aspect of the influence of endogenous and exogenous factors.

## REFERENCES

1. Arnold, G. N., & Kokkonen, J. (2007). *ISTEZANJE Anatomija*. [In Serbian].Data status. Beograd
2. Bjelica, D. & Fratić, F. (2011). *Sportski Treninga - teorija, metodika i dijagnostika*. [ Sports Training - Theory, Methodology and Diagnostics. In Serbian]. Podgorica. Fakultet za sport i fizičko vaspitanje
3. Blazevich, A. J., Cannavan, D., Coleman, D. R., & Horne, S. (2007). Influence of concentric and eccentric resistance training on architectural adaptation in human quadriceps muscles. *Journal of Applied Physiology*, 103(5), 1565–1575
4. Bompa, O.T. (2006). *Periodizacija; Teorija i Metodologija treninga Periodization* [Theory and Methodology of Training. In English]. Robert Schwartz, Zagreb
5. Bratić, M., Pavlović, R., Kostić, R., & Pantelić, S. (2012). Anthropometric characteristics – the determinants of vertical and horizontal jumping ability. *Acta Kinesiologica*. 6 (2), 13-19
6. Clemons, J & Harrison, M. (2008). Validity and reliability of a new stair sprinting test of explosive power. *J Strength Cond Res* 22: 1578–1583
7. Čoh, M. (2001). *Biomehanika atletike*. [Biomechanics of athletics. In Slovenian]. Ljubljana. Fakultet za šport.
8. Čoh, M. (2009). Sodobni diagnostični postopki v treningu atletov. [Modern diagnostic procedures in athletic training. In Slovenian]. Ljubljana: Fakulteta za šport.
9. De Toia, D., Klein, D., Weber, S., Wessely, N., Koch, B., Walter Tokarski, W., Dordel, Strüder, H., & Graf, C. (2009). Relationship between anthropometry and motor abilities at pre-school age. *The European Journal of Obesity*; 2:221–225
10. Deforche, B., Lefevre, J., De Bourdeaudhuij, I., Hills, A. P., Duquet, W., & Bouckaert, J. (2003). Physical fitness and physical activity in obese and nonobese Flemish youth. *Obesity Research*, 11, 434–441
11. Eduardo, Medina Jiménez. (2003). *Actividad física y salud integral*. Barcelona
12. Jakonić, D. (2003). *Osnove Sportske Medicine*. [Fundamentals of Sports Medicine. In Serbian]. Univerzitet u Novom Sadu, Fakultet Fizičke Kulture. Novi Sad
13. Jovović, V. (2006). *Atletika biomehanika - tehnika i metodika* [Athletics biomechanics technique and methods. In Serbian] Nikšić. Filozofski fakultet.
14. Kim, J., Must, A., Fitzmaurice, G. M., et al. (2005). Relationship of physical fitness to prevalence and incidence of overweight among schoolchildren. *Obes Res*. 13(7), 1246-1254
15. Knežević, O., & Mirkov, D. (2011). Sila i snaga mišića opružača u zglobu kolena [The force and strength of extensor muscles in the knee joint. In Serbian]. *Fizička kultura*, 65 (2), 5–15
16. Koppes, L.L.J., Twisk, J.W.R., & Kemper, H.C.G. (2004). Longitudinal trends, stability and error of biological and lifestyle characteristics. In: Kemper, H.C.G. (ed.): Amsterdam Growth and Health Longitudinal Study. *Medicine and Sport Science*, 47, 44-63
17. Krsmanović, B., Jakonić, D., Pelemiš, M., Jasnić, S., & Dolga, M. (2000). Antropološke razlike učenika urbane i ruralne sredine [Anthropological differences of students in urban and rural areas. In Serbian]. U zborniku *Kongresa Antropologa Republike Srpske* pp. 105-116.
18. Kukolj, M., Bokan, B., Koprivica, V., & Ugarković, D. (2001). Međusobna povezanost motoričkih sposobnosti učenika mlađeg školskog uzrasta u periodima njihovih značajnih promena [Interconnection motor abilities of younger school-age students in their periods of

- significant changes. In Serbian] *Zbornik radova „Fis komunikacije“* (pp. 70-78). Niš: Fakultet fizičke kulture.
19. Mackenzie, B. (2005) *Margaria Kalamen Power Test* [WWW] Available from: <http://www.brianmac.co.uk/powerest.htm> [Accessed 25/2/2013]
  20. McGinnis, P.M. (1999). *Biomechanics of sport and exercise*. Champaign, IL: Human Kinetics.
  21. Milošević, N., Kreft, R., & Mučibabić, M. (2014). The connection between the test of explosive strength and running speed. *Četvrta međunarodna konferencija "Sportske nauke i zdravlje"* Zbornik radova, 79-84
  22. Mišigoj-Duraković, M. (2008). Kinantropologija–biološki aspekti tjelesnog vježbanja[Kinanthropology-Biological Aspects of Physical Exercise. In Croatian] Zagreb: Kineziološki fakultet Sveučilišta u Zagrebu
  23. Mota, J., Guerra, S., Leonardo, C., Pinto, A., Ribeiro, J., & Durante, J. A. (2002). Association of maturation sex and body fat in cardiorespiratory fitness. *American Journal of Human Biology*.14, 707-712
  24. Nićin Đ., & Kalajdžić, J. (2000).Usporedna analiza motoričkih sposobnosti i antropometrijskih karaktersitika učenika VI razreda osnovne škole različitih regiona Srbije [Comparative analysis of motor abilities and anthropometric characteristics of the pupils of the sixth grade of primary school different regions of Serbia. In Serbian].*U Zborniku radova II i III simpozijum sa međunarodnim učešćem: Efekti različitih modela nastave fizičkog vaspitanja na psihosomatski status dece i omladine* (pp.60-63),Novi Sad:Fakultet fizičke kulture.
  25. Ostojić, M. S., (2011). *Osnovi Fiziologije Sporta* [Basics of Sport Physiology. In Serbian]. Fakultet za sport i turizam. Novi Sad
  26. Pavlović, R. (2016). Atletika 2.[Athletics 2. In Serbian].Udruženje književnika Branko Miljković. Niš
  27. Pavlović, R., Dragutinović, S., & Kovačević, M. (2015).Differences of segments of morphological and motor space of middle scholers.*Acta Kinesiologica*. 9(2), 37-43
  28. Pavlović, R., Idrizović, K., Dragutinović, S., Bjelica, B., & Joksimović, M. (2017).Skeletal muscles: physiological-bioelectric and energy features, contraction intensity and strength. *European Journal of Physical Education and Sport Science*.3 (2),1-18.
  29. Peršun, J., Miholić-Srna, J., & Vrbik, I. (2011). Differences in morphological characteristics and motor skills between high school girls and boys. Conference paper:*Milanović, Dragan, Sporiš, Goran (Eds.) 6th International Scientific Conference onKinesiology - Integrative power of Kinesiology*, Opatija, pp.284-289. Faculty of Kinesiology,University of Zagreb
  30. Radinović, Z., & Pavlović, R. (2013). Differences between the students and athletes-juniors in certain motor capabilities.*Physical culture*. 67 (1), 40-47
  31. Radulović, N., Pavlović, R., Mihajlović, I., Šolaja, M., &Gušić, M. (2017).The influence of motor skills on the manifestation of speed in the children of a younger school age. *Jou.Spo. Sci. Med.*. 1, 20-32
  32. Reyes, M.E., Tan, S.K., &Malina, R.M. (2000).*Urban-rural contrasts in the growth status of school children in Oaxaca*. Mexico: Escuela Nacional de Antropologia e Historia.
  33. Sertić, H., Segedi, I., & Baić, M. (2008.): Praćenje promjena motoričkih i funkcionalnih sposobnosti te antropometrijskih karakteristika učenika tijekom dvogodišnje nastave tjelesne i zdravstvene kulture. U: Neljak,Boris (ur.) *Zbornikradova 17.ljetne škole kineziologa Republike Hrvatske, Poreč 24.-28. lipnja*, str. 192.-198.Zagreb: Hrvatski kineziološki savez.
  34. Silva, D.A., Benedetti, T.R., Ferrari, E.P., Meu-rer, S.T., Antes, D.L., Silva, A.M.,Santos,D.A., Matias, C.N., Sardinha, L.B., Vieira, F., &Petroski, E.L. (2012). Anthropometric profiles of elite older triathletes in the Ironman Brazil compared with those of young Portuguese tri-athletes and older Brazilians. *Journal of Sports Sciences*, 5(14), 479–484
  35. Stojanović, N., Mijanović, M., Stojanović, T., & Perić, D. (2012).Defferences in the Explosive and Repetitive strength of twelve-year-old schoolchildren with different morphological characteristics. *Sport Logia*. 8(2), 142-150
  36. Stojiljković, S. (2003).*Osnove opšte Antropomotorike* [ Basics of General Anthropomotorics. In Serbian].Niš: Studentski kulturni centar.
  37. Strel, J. (2006). Correlation of physical characteristics and general endurance: A compression of 7 to 19 year-old pupils between 1983, 1993 and 2003. *Anthropological Notebooks*. 12(2), 113-128
  38. Stupar, D. (2012). Razlike u antropometrijskim karakteristikama dečaka i devojčica [Differences in the anthropometric characteristics of boys and girls.In Serbain] *TIMS Acta* 6, 57-64.
  39. Zatsiorsky,M,V & Kraemer, J.W. (2006). Nauka i Praksa u Treningu Snage[ Science and Practice in Power Training. In Serbian]. Data Status. Beograd.

## ANTHROPOMETRIC AMOUNTS AND THEIR CONTRIBUTIONS TO FATIGUE OF ISOMETRIC EXTENSOR ENDURANCE (TRUNK OR KNEE) AMONG SPORTSWOMEN

Mohammed Zerf<sup>1</sup>, Gourari Benali<sup>1</sup>, boras Fatima Zohra<sup>1</sup>, Sidimohamed koutchouk<sup>2</sup>, Mohamed Hadjarkherfane<sup>2</sup>, Abd-el-Kader Benchehida<sup>2</sup>, Remaoun Mohamed<sup>3</sup>  
<sup>1,2,3</sup>Sports Training, Physical Education Institute Laboratory OPAPS, University of Mostaganem, Mostaganem 27000, Algeria

Corresponding author: Zerf Mohammed; <http://orcid.org/0000-0001-5013-5446>;  
biomeca.zerf@outlook.com; Physical Education Institute Laboratory, phone number: 213773450124,  
Web Page Institute affiliation: <http://graduation-iepsar.univ-mosta.dz/index.php/depares3>

### Abstract

**Background:** anthropometric characteristics are an important clinical consideration in the analysis of mechanical disorders of the musculoskeletal system. Although strength and endurance tests are important for both clinical practice and research as key to assess injury and athletic performance for example the lumbar extensor musculature. **Objective:** this study projected to determine the association of anthropometric measures of adiposity amounts with the levels of the endurance isometric extensor trunk or knee among sportswomen. **Methods:** To reach this goal, 39 women's soccer team of Relizane under 20 years at the Algerian football championship participates in this controlled study. Their homogeneity was considerate based on age, sex, weight, height and football as a speciality. Divided into equal groups, according to their body fat. Tested by Bearing-Sorensen and the Kelly test as a lumbar extensor strength. **Results:** Our results support the intra-abdominal pressure as a superior factor influencing the postural support and stability relative to levels trunk extensor endurance. It's paired with BMI revealed their impact on knee extensor endurance. **Conclusion:** Our result admits the central abdominal obesity as a critical amount allied to the reduction of trunk or knee Extension Endurance among sportswomen. Strongly associated with the abdominal structures and musculature. Its large compared to increase of BMI rate via sportswomen decrease the isometric endurance extensors (trunk or knee).

**Keywords:** Anthropometric, musculoskeletal, isometric endurance extensor, sportswomen.

### INTRODUCTION

A multitude of factors can influence the risk of developing certain diseases among the lifestyle of women. The case of obesity as the most common in recent years, where 300 million women are now thought to be clinically obese with causes significant health problems (Nir Y. Krakauer, Jesse C. Krakauer, 2016). Such as functional limitations in muscle performance mobility, strength, postural and dynamic balance limitations. Estimate among strength and endurance tests as important for both clinical practice and research owing to the key role they play in musculoskeletal function the example of lumbar extensor musculature associated with low back pain (LBP). Admit by some authors via the reduction in physical activity, which caused muscle atrophy, because of disuse of the lumbar extensors. Cancelled by other as no differences in the physical activity levels of participants with chronic low back pain compared with asymptomatic controls (Rebecca Conway, Jessica Behennah, James

Fisher, Neil Osborne, and James Steele, 2016). Through this contradiction, as well as anthropometric measurements that predicate obesity or overweight associated with the weakness of the musculoskeletal system and health risks remain controversial and inconclusive (Chimaobi James Ononamadu, PhD, Godwin Okwudiri Ihegboro, PhD, Chinwe Nonyelum Ezekwesili, PhD, Onyemaechi Faith Onyeukwu, MSc, Uchenna Francis Umeoguaju,, MSc, and Obiajulu Christian Ezeigwe, PhD, 2017). Support in the measurement of BMI that is not a valid measure for assessing or monitoring body composition in elite female athletes, (Rothman KJ, 2008). The opposite of skinfold measurement that may be better measured to monitor device to indicate changes in body composition over time (Thomas T Samaras, Andrzej Bartke, Christopher David Rollo, 2007). Moreover, all the recent health risk anthropometric measurements and body control or loss merged the BMI in their formulas, to inspect health risk, well-being, physical profile or appearance (Nuttall, Frank Q, 2015).

Despite the importance of anthropometric measurements and the costs of laboratory tests compared to field test anthropometric or physical to estimate the levels of health allied to welfare physical exercise (Barbara Brehm, 2014). As a simple practical method, which does not require a specialist to monitor the body fat or composite to control the body weight loss (John Porcari, Cedric Bryant, Fabio Comana, 2015). Evidence guides the research team to support the hypothesis that the associations between anthropometric measures and health risk are explained by the corresponding ability of anthropometry to predict body composition in particular, body fat distribution independent of gender, age, and race. Depending on the evaluation of the amount of adipose in the lower body, hips (Jeffrey S. Orringer, Murad Alam, Jeffrey S. Dover, 2014), waist size and waist-to-hip circumference ratio. As wider measurements to inspect the regional adipose tissue distribution and their association with the excess of body weight gain (Ohan Karatoprak MD, 2014) on body fitness. Indicated by Walter Willett (Walter Willett, 2013) in the use of percent body fat as the criteria for assessing body mass index. Account by height, weight, age, and other factors according to Steven R. Gamber (2010) (Steven R. Gamber, 2010). Described by Sharma Sowmya, et al (2014) in the body shape type as the ratio of lean body mass to fat (Sharma Sowmya, Tinku Thomas, Ankalmadagu Venkatsubbareddy Bharathi and Sambashivaiah Sucharita, 2014). Thoughtfulness by Lawrence F. Ditmier (Lawrence F. Ditmier, 2006) in both distributions of fat via body build and the size of the adipose tissue deposits. Report in preventing study as an indicator influencing the body joint with a decline in mobility and stability of motion simply to move and stretch in certain positions. Advising by Michael Bradley, et al (Michael Bradley, Matt Brzycki, 2004) as amounts fat weight contributing to injury and weakening of athletic performance. Owing to decreased trunk extensor endurance appears to be a predictor of future of Imbalance between flexion and extension trunk muscle endurance time, more important than isolated trunk endurance deficits, which are expensive isometric testing. In the opposite of Biering-Sorensen: isometric endurance of trunk extensor (BT) or Killy test "isometric knee extensor endurance" (KT) recently advocated because they may be more useful, and better mimics the demands imposed by sport (Michael P. Reiman, Amber D. Krier, Julie A. Nelson, Michael A. Rogers, Zachariah O. Stuke and Barbara S. Smith, 2012).

According to the above, the present study was aimed to inspect the amounts of anthropometric parameter on performance of isometric endurance extensor (BT or KT) among sportswomen. Built on lumbar extensor as predictors of the athlete's performance associated with its endurance of isometric extensor trunk or knee strength performance (Arthur D. Stewart, Laura Sutton, 2012 ). Advanced by similar studies in the superiority of waistlines as an indicator of abdominal obesity (Brigham Young University Alton L Thygerson and Steven M Thygerson, 2016), relates to body joint problems (Hsiang-Chuan Liu, Wen-Pei Sung, Wenli Yao, 2014) and muscle fatigue interconnected with index body composition (Microfilms, University, 2008). Revoked in similar via the BMI as a measurement may be inaccurate for athletes who are healthy.

## **METHOD**

### **Participants**

Our total sample consisted of 39 women's soccer team of Relizane under 20 years at the Algerian football championship. Their homogeneity was drawn by age  $18 \pm 1.56$ , sex-female and football speciality, divided into equal groups, according to their body fat, weight, and height. Evaluated by Bearing-Sorensen and the Kelly test as a lumbar extensor strength. All participants are engaged in a planned physical activity (3 sessions of 1 hour 30 minutes training per week) with any medication. They were informed of the procedures and all provided their written consent. Controlled in the same conditions by a specialised team.

### **Procedure**

Ours arises in this present study centred on the Bearing-Sorensen and the Kelly test as a Lumbar Extensor Strength. Admit recently by researchers as acceptable clinical tests that measure the strength, endurance or power component of trunk stability (Paolo Buttà, Guido Cavallaro, Carlo Marchioro, 2015).

For the proposal, the study protocol design was acknowledged by the laboratory OPPAS, Institute of Physical Education and Sports, Department sports training university Mostaganem. Were randomly selected according to the succeeding criteria and test protocol.

#### ➤ **Inclusion criteria**

All selected samples are football female players, at Relizane senior team, Algerian football championship; their homogeneity was founded on growth characteristic age, sex, weight, height and football as sports activities.

#### ➤ **Exclusion criteria**

All participants are volunteers. They were evaluated in the same conditions and procedure. Founded on saving baseline measurement field tests, as Biering-Sorensen test: isometric endurance of boot extensor and Killy test “isometric knee extensor endurance”, confirmed in clinical studies by involuntary flexion or extension that is allowed based on the body distribution, abnormal movements record in the wrist and torsion spasms of the neck (John H. Menkes, Harvey B. Sarnat, 2000).

➤ **Test protocol**

- **Anthropometric parameters**
  - **Body fat percentage Calculator**

The Body Fat Calculator was developed used to estimate the total body fat based on body size. To get the best results, measured to the nearest 1/4 inch (0.5cm). We used equations developed by Drs. Hodgdon and Beckett at the Naval Health Research be approved by the U.S. Navy method:

**Body fat calculator formula for man:**

$$495/(1.0324-0.19077(\text{LOG}(\text{waist-neck}))+0.15456(\text{LOG}(\text{height}))) - 450$$

**Body fat calculator formula for woman:**

$$495/(1.29579-0.35004(\text{LOG}(\text{waist+hip-neck}))+0.22100(\text{LOG}(\text{height}))) - 450$$

Thus, different measurements are required.

- ✓ Measure the circumference of your waist at a horizontal level around the navel for men and at the level with the least width for women. Do not pull your stomach in.
- ✓ Measure the circumference of the neck. Start below the larynx with the tape sloping slightly downward to the front. Avoid flaring your neck out.
- ✓ For women only: Measure the circumference of the hips, at the largest horizontal measure (calculator.net, 2008 - 2016). More than 1 minute and 30 seconds is the mark of an excellent level.

- **Physiological stress parameters**
  - **Biering-Sorensen: isometric endurance of trunk extensor (BT)**

In the prone position, the legs are fixed subject to the anterior superior iliac spines (EAIS) by straps at the ankles and hips, upper body with no support. The arms are crossed on his chest and the hands rest on his shoulders. The test measures the hold time of the sternum of the subject above a virtual horizontal line extending (Menad Fodil, Zerf Mohammed, 2016). More than 1 minute and 30 seconds is the mark of an excellent level.

- **Killy test "isometric knee extensor endurance" (KT)** (Menad Fodil, Zerf Mohammed, 2016)

The subject pressed his back against the wall, hips, knees and ankles are flexed to 90 °. The arms are crossed on his chest, hands resting on the shoulders. The test measures the length of maintaining sitting without a chair leaning control wall.

**Statistical analysis**

Statistical analyses were performed using SPSS Statistics for Windows, Version 20.0. Chicago, IL: SPSS and P-values < 0.05 were considered statistically significant. The homogeneity was calculated based on the independent t-test and Levene's statistic, initiated on behalf of BFP categories. The regression analysis was used to predict the amounts of the anthropometric characteristics in the interpretation of musculoskeletal system weakness associated with isometric endurance extensor among sportswomen.

## RESULTS

Based on Levene's test for equality of variances, our samples are homogeneous in all variables based on BFP categories, listed in **Table 1**. Whereas the independent t-test is insignificant through age, height and weight. In the opposite of other variables used in the present study. Although all results support that soccer women with a large waist and upper BMI or BFP, have a tendency to accumulate more fat inside his body (Charles B. Corbin, Ruth Lindsey, 2007), its upper amounts decrease time endurance in the both tests strongly negative with levels physical activity (Steven J. Kirsh, 2010). Predictable in the present study as supplementary stress, influencing the body joints related to the abdominal stocks region. Record as a negative factor among the group with acceptable (BFP) in the opposite of group with essential fat (Priscilla T LeMone and Karen M. Burke, 2008). Expected as an inverse correlation between isometric extensor endurance and the others anthropometric measurement, due to excess body fat and distribution see **Table 2**.

**Table 1 Baseline characteristics of the study population**

	<b>SAMPLE</b>	<b>N</b>	<b>Mean</b>	<b>S.D</b>	<b>Levene's</b>	<b>P</b>	<b>T</b>	<b>P</b>
<b>WB</b>	<b>Essential fat</b>	<b>18</b>	<b>65.59</b>	<b>4.01</b>	<b>0.77</b>	<b>0.38</b>	<b>-1.42</b>	<b>0.16</b>
	<b>Acceptable</b>	<b>21</b>	<b>67.70</b>	<b>5.06</b>				
<b>WH</b>	<b>Essential fat</b>	<b>18</b>	<b>175.88</b>	<b>5.75</b>	<b>0.87</b>	<b>0.35</b>	<b>0.97</b>	<b>0.97</b>
	<b>Acceptable</b>	<b>21</b>	<b>175.95</b>	<b>4.83</b>				
<b>BMI</b>	<b>Essential fat</b>	<b>18</b>	<b>20.80</b>	<b>1.742</b>	<b>1.16</b>	<b>0.28</b>	<b>-5.63</b>	<b>0.00</b>
	<b>Acceptable</b>	<b>21</b>	<b>24.19</b>	<b>1.97</b>				
<b>WC</b>	<b>Essential fat</b>	<b>18</b>	<b>73.28</b>	<b>3.47</b>	<b>1.29</b>	<b>0.16</b>	<b>-3.36</b>	<b>0.00</b>
	<b>Acceptable</b>	<b>21</b>	<b>80.71</b>	<b>8.78</b>				
<b>BT</b>	<b>Essential fat</b>	<b>18</b>	<b>136.39</b>	<b>11.96</b>	<b>1.09</b>	<b>0.25</b>	<b>3.15</b>	<b>0.00</b>
	<b>Acceptable</b>	<b>21</b>	<b>120.19</b>	<b>18.81</b>				
<b>KT</b>	<b>Essential fat</b>	<b>18</b>	<b>136.33</b>	<b>17.99</b>	<b>1.03</b>	<b>0.28</b>	<b>2.53</b>	<b>0.00</b>
	<b>Acceptable</b>	<b>21</b>	<b>120.81</b>	<b>19.92</b>				
<b>BFP</b>	<b>Essential fat</b>	<b>18</b>	<b>11.98</b>	<b>0.95</b>	<b>1.22</b>	<b>0.32</b>	<b>-9.70</b>	<b>0.00</b>
	<b>Acceptable</b>	<b>21</b>	<b>15.83</b>	<b>1.42</b>				

**WB: weight (kg), WH: height(cm), BMI (kg/m<sup>2</sup>), BFP (%), BT or KT (seconds)**



**Table 2 Correlation of endurance isometric of extensor with anthropometric measures.**

N=39		BMI	WC	BT	KT	BFP
BT	Pearson Correlation	-0.504**	-0.782**	1	0.916**	-0.528**
KT	Pearson Correlation	-0.418**	-0.723**	0.916**	1	-0.442**

\*\* . Correlation is significant at the 0.01 level (2-tailed).

While to predict the amount of the anthropometric parameters associated with the endurance of isometric extensor trunk or knee among our total sample, we chose the regression as model analyses with significant  $P \leq 0.05$ . Through the **Table 3. (a)** Case BT: endurance trunk relating to the other variables chosen in this study. Model 1, the program showed the waist size as the independent variable able to explain the changes in time endurance of trunk extensor. Confirmed by F, T, R,  $R^2$ , and adjusted  $R^2$ , which are significant at  $P < 0.001$ , in the opposite of others anthropometric excludes. Agreed by M Fogelholm, et al. In the functional muscle fitness of the upper body, trunk and lower extremities allied with abdominal musculature relative to the amount of central abdominal obesity (M Fogelholm, J Malmberg, J Suni, M Santtila, H Kyröläinen, M Mäntysaari, 2006). Estimate in similar above abdominal obesity might induce resistance to venous backflow from the lower limbs. Due to central obesity appears to result in increased intra-abdominal pressure (Gregory L. Moneta, 2012). Interpret by Christopher Madden, et al. In upper limbs more affected than lower limbs, due to the pelvis and lower extremities (Christopher C Madden, Margot Putukian, Eric C McCarty, Craig C Young, Frank H Netter, 2017).

In the case of knee extensor endurance, as predictors' variable, all the relationships analysed between independent variables and predictors are significant at  $P \leq 0.05$ . The regression analyses, **Table 3. (b)** Model 1 and 2, the program showed that WC and BMI were able to explain the changes in the performance of knee extensor endurance, where F, T, R,  $R^2$ , and adjusted  $R^2$  are significant at  $P < 0.001$ . While our results line with the proof, that greater increases in fat-free mass correlate to total body mass, increase the isometric knee extension, according to Martin L. Albert, et al (Martin L. Albert, Janice E. Knoefel, 2011).

Although the reverse is true, deduce in the present to the increase of fat mass in the waist circumference as abnormal abdominal adiposity (Wei Shen, Mark Punyanitya, Jun Chen, Dympna Gallagher, Jeanine Albu, Xavier Pi-Sunyer, Cora E. Lewis, Carl Grunfeld, Stanley Heshka, Steven B. Heymsfield, 2006). As well as total body fat record via upper BMI as amounts of body fat gain reducing the joint range motion, due to the adipose tissues around joints obstruct (Bhupinder Singh, 2013) and angular deviations of joints (HANNAH C. DEL PORTO, CELIA M. PECHAK, DARLA R. SMITH, REBECCA J. REED-JONES, 2012). Described at 6% decrease in the strength less than prior (Jerome Frank Strauss, Jerome F. Strauss, III, Robert L. Barbieri, 2014 ) among fatness women, according to (J J McComb, R Norman, M Zumwalt, 2014). Support in this study as a negative fat amount contributing to decreased of trunk extensor endurance allied to Imbalance between flexion and extension

trunk muscle endurance time (Michael P. Reiman, Amber D. Krier, Julie A. Nelson, Michael A. Rogers, Zachariah O. Stuke and Barbara S. Smith, 2012).

**Table 3. (A-b) regression analyses relating isometric extensor endurance with anthropometric parameters.**

<b>(a) By BT: endurance trunk as Predictors variable</b>								
<b>Model</b>	<b>R</b>	<b>R<sup>2</sup></b>	<b>Adjusted R<sup>2</sup></b>	<b>Coefficients</b>	<b>T</b>	<b>P</b>	<b>F</b>	<b>P</b>
<b>STEPWISE</b>								
<b>1</b>	<b>0,74<sup>a</sup></b>	<b>0,61</b>	<b>0,60</b>	<b>(Constant)</b>	<b>14.57</b>	<b>0.00</b>	<b>58.18</b>	<b>0.000<sup>b</sup></b>
				<b>WC</b>	<b>-7.628</b>	<b>0.00</b>		

**A: Variable dependent: BT(endurance trunk)**

**B: Predictors: (Constant), WC (Waist Size)**

**Variables entered Age, Waist Size, height, weight, BFP, BMI.**

<b>(b) By KT: knee extensor endurance as Predictors variable</b>								
<b>Model</b>	<b>R</b>	<b>R<sup>2</sup></b>	<b>Adjusted R<sup>2</sup></b>	<b>Coefficients</b>	<b>T</b>	<b>P</b>	<b>F</b>	<b>P</b>
<b>STEPWISE</b>								
<b>1</b>	<b>0,72<sup>a</sup></b>	<b>0,52</b>	<b>0,51</b>	<b>(Constant)</b>	<b>11.85</b>	<b>0.00</b>	<b>40.53</b>	<b>0.000<sup>b</sup></b>
				<b>WC</b>	<b>-6.36</b>	<b>0.00</b>		
<b>2</b>	<b>0,75<sup>b</sup></b>	<b>0,57</b>	<b>0,55</b>	<b>(Constant)</b>	<b>1.47</b>	<b>0.14</b>	<b>24.37</b>	<b>0.000<sup>c</sup></b>
				<b>WC</b>	<b>-6.59</b>	<b>0.00</b>		
				<b>BMI</b>	<b>2.11</b>	<b>0.04</b>		

**A: Variable dependent: KT**

**B: Predictors: (Constant), WC**

**C: Predictors: (Constant), WC, BMI**

**Variables entered age, Waist Size, height, weight, BFP, BMI.**

## DISCUSSION

This study was designed to examine the amounts of anthropometric parameters contribute to fatigue of isometric extensor endurance (BT or KT) among sportswomen. Based on differences noted in body fat, record among our sample between essential fat to acceptable (Marie A. Boyle, Sara Long Roth, 2012) as well as WC size and BMI categories. Our results confirm the impact of body fat gain or distribution as deconditioning of the lumbar extensor musculature trunk or knee in both tests. Established in the case BT in the weakness of trunk musculature endurance, due to fat accumulates in the waist, lower abdomen, and chest. Admit

by Mohammed Zerf as abdominal obesity depots within the abdominal cavity correlates (Zerf Mohammed, Bengoua Ali, Mokkedes Moulay Idris, Hakim Hamzaoui, Lakhdar Messaliti, 2016). It higher influenced the distribution of total body fat reported as additional excess fat among overweight category compared to the acceptable group (Zerf, M., Atouti, N. & Ben Farouk, A, 2017). While in the case of isometric knee extensor endurance, our results show that amounts fat WC and BMI are able to determine the weakness of lumbar extensor musculature (Mohammed Zerf, 2017) associated with strength and absolute endurance regarding lumbo-pelvic function during extension (Rebecca Conway, Jessica Behennah, James Fisher, Neil Osborne, and James Steele, 2016). Approved by previous in the accumulates of fat around hips, thighs and buttocks prominent in later life, joint pain, loss of the cartilage, pain, swelling, and limitation of joint mobility (Jennifer Cook, Michael D. Wolf, 1984). Described in prevention studies as a problem of body shape returning to waist size adjustment for height manifesting a bad distribution of body fat (Patrícia Feliciano Pereira, Hiara Miguel Stanciola Serrano, Gisele Queiroz Carvalho, Sônia Machado Rocha Ribeiro, Maria do Carmo Gouveia Peluzio, Sylvia do Carmo Castro Franceschini , Silvia Eloiza Priore, 2015).

Advised in the case of our both physiological stress test via the impact of abdominal muscles as the prime movers of trunk flexion to regulate intra-abdominal pressure, postural support and stability of the lumbar spine. Agreed in our case in the relationship between strength and fatigability of the trunk extensor muscles endurance allied to abdominal muscle structure and strengthening to offset fatigability. Admit by Rita E. Deering et al (2017) (Rita E. Deering, Jonathon W. Senefeld, Tatyana Pashibin, Donald A. Neumann, and Sandra K. Hunter, 2017) for greater muscle mass in the upper body as well as more abdominal muscle, during movements of the upper and lower extremities. Deduce in the present study via amounts of fat accumulate in the abdominal and back area, as potential risks influencing the body hips and thighs as waist size increases (Dianne Hales, 2015). Support in prior studies as excess weight contributing to the fragility of lumbosacral angle joints (Klaus Schwanbeck, 2012), lumbar straightening and its muscles strengthening association with hip osteoarthritis, knee degenerative joint disease and knee osteoarthritis in both genders. Admit by Joel A. DeLisa, et al via the menace appears to be greater in overweight women than less (Joel A DeLisa, Bruce Michael Gans, Nicolas E Walsh, 2004).

## **CONCLUSION**

Our results confirm the benefits of reduction in visceral abdominal among sportswomen. Admit by waist size as a useful measurement to estimate the proportion of abdominal or upper-body fat often correlate with intra-abdominal pressure for maintaining spinal stability under various conditions (BT or KT). Reported by previous studies in the advantage of strong abdominal muscles to protect lumbar discs from excessive loads. Its allied with the lumbodorsal fascia contributes to reducing the stress at the body joints. Support in the present study as significant amounts of body fat composite or distribution accumulates in the periphery or central body, inflicting the trunk or knee extension muscles associated with the strength of the abdominal and pelvic muscles as well as endurance time of these muscles.

## **Acknowledgements**

The authors would like to thank all the Relizane club technical staff, which contributed to the realisation of this study.

## **Author Contributions**

The authors have written, designs, measures, calculus, read and approved the manuscript sent

## **REFERENCES**

1. Arthur D. Stewart, Laura Sutton. (2012 ). *Body Composition in Sport, Exercise and Health*. US: Routledge.
2. Barbara Brehm. (2014). *Psychology of Health and Fitness*. Philadelphia: F.A. Davis Company.
3. Bhupinder Singh. (2013). *The Interplay Between Obesity, Biomechanics and Fitness Within the Reverse Causation Hypothesis*. US: thesis, University of Iowa. Retrieved from <http://ir.uiowa.edu/etd/4912>
4. Brigham Young University Alton L Thygerson and Steven M Thygerson. (2016). *Fit to Be Well*. US: Jones & Bartelt learning.
5. calculator.net. (2008 - 2016). *body-fat-calculator*. Retrieved 13, 2015, from <http://www.calculator.net/body-fat-calculator.html>
6. Charles B. Corbin, Ruth Lindsey. ( 2007). *Fitness for Life*. US: Human Kinetics.
7. Chimaobi James Ononamadu, PhD, Godwin Okwudiri Ihegboro, PhD, Chinwe Nonyelum Ezekwesili, PhD, Onyemaechi Faith Onyeukwu, MSc, Uchenna Francis Umeogaju., MSc, and Obiajulu Christian Ezeigwe, PhD. (2017). Comparative analysis of anthropometric indices of obesity as correlates and potential predictors of risk for hypertension and prehypertension in a population in Nigeria. *Cardiovasc J Afr*, 28(2), 92–99. doi:10.5830/CVJA-2016-061
8. Christopher C Madden, Margot Putukian, Eric C McCarty, Craig C Young, Frank H Netter. (2017). *Netter's sports medicine*. Philadelphia: Elsevier.
9. Dianne Hales. (2015). *An Invitation to Health: Live It Now! Brief Edition*. UK: CengageBrain.com.
10. Gregory L. Moneta. (2012). *The year book of vascular surgery*. 2012. Philadelphia: Elsevier Mosby.
11. HANNAH C. DEL PORTO, CELIA M. PECHAK, DARLA R. SMITH, REBECCA J. REED-JONES. (2012). Biomechanical Effects of Obesity on Balance. *International Journal of Exercise Science*, 5(4), 301-320. Retrieved from <http://www.intjexercisci.com>
12. Hsiang-Chuan Liu, Wen-Pei Sung, Wenli Yao. (2014). *Computer, Intelligent Computing and Education Technology*. UK: CRC Press.
13. J J McComb, R Norman, M Zumwalt. (2014). *The Active Female: Health Issues Throughout the Lifespan*. New York: Springer.
14. Jeffrey S. Orringer, Murad Alam, Jeffrey S. Dover. (2014). *Body Shaping, Skin Fat and Cellulite: Procedures in Cosmetic Dermatology Series*. US: Elsevier Health Sciences.
15. Jennifer Cook, Michael D. Wolf. (1984). *Rectangles need waist definition*. US: Contemporary Books.
16. Jerome Frank Strauss, Jerome F. Strauss, III, Robert L. Barbieri. (2014 ). *Yen and Jaffe's Reproductive Endocrinology*. Philadelphia: Elsevier/Saunders.
17. Joel A DeLisa, Bruce Michael Gans, Nicolas E Walsh. (2004). *Physical medicine and rehabilitation medicine: principles and practice*. Philadelphia: Lippincott Williams & Wilkins.
18. John H. Menkes, Harvey B. Sarnat. (2000). *Child Neurology*. US: Lippincott Williams & Wilkins.
19. John Porcari, Cedric Bryant, Fabio Comana. (2015). *Exercise physiology*. Philadelphia: F.A. Davis Company.

20. Klaus Schwanbeck. (2012). *The Ultimate Nordic Pole Walking Book*. UK: Meyer & Meyer Verlag.
21. Lawrence F. Ditmier. (2006). *New Developments in Obesity Research*. United States or United Kingdom: Nova Science Publishers.
22. M Fogelholm, J Malmberg, J Suni, M Santtila, H Kyröläinen, M Mäntysaari. (2006). Waist circumference and BMI are independently associated with the variation of cardio-respiratory and neuromuscular fitness in young adult men. *International Journal of Obesity*, 30, 962–969. doi:10.1038/sj.ijo.0803243
23. Marie A. Boyle, Sara Long Roth. (2012). *Personal Nutrition*. US: CengageBrain.com.
24. Martin L. Albert, Janice E. Knoefel. (2011). *Clinical neurology of ageing*. New York: Oxford University Press.
25. Menad Fodil, Zerf Mohammed. (2016). Impact of the Changed Eating Habits on the Health Risks among the Algerians University Female. *Anatomy & Physiology*, 6(3), 218. doi:10.4172/2161-0940.1000218
26. Michael Bradley, Matt Brzycki. (2004). *The Female Athlete: Train for Success*. US: Wish Publishing.
27. Michael P. Reiman, Amber D. Krier, Julie A. Nelson, Michael A. Rogers, Zachariah O. Stuke and Barbara S. Smith. (2012). COMPARISON OF DIFFERENT TRUNK ENDURANCE TESTING METHODS IN COLLEGE-AGED INDIVIDUALS. *Int J Sports Phys Ther*, 7(5), 533–539. doi:PMCID: PMC3474305
28. Microfilms, University. (2008). *Dissertation Abstracts International*. University Microfilms International: AbeBooks.
29. Mohammed Zerf. (2017). Obesity degrees and their relationships with weakness of musculoskeletal system among the obese housewife. *Saudi J Sports Med*, 17(1), 7-13. doi:10.4103/1319-6308.197458
30. Nir Y. Krakauer, Jesse C. Krakauer. (2016). An Anthropometric Risk Index Based on Combining Height, Weight, Waist, and Hip Measurements. *Journal of Obesity*, ID 8094275, 9. doi:http://dx.doi.org/10.1155/2016/8094275
31. Nuttall, Frank Q. (2015, May/June). Body Mass Index: Obesity, BMI, and Health: A Critical Review. *Nutrition Today*, 50(3), 117–128. doi:10.1097/NT.0000000000000092
32. Ohan Karatoprak MD. (2014). *Weight Loss Tailored for Women*. US: eBookIt.com Store.
33. Paolo Buttà, Guido Cavallaro, Carlo Marchioro. (2015). *Mathematical Models of Viscous Friction*. UK: Springer Shop.
34. Patrícia Feliciano Pereira, Hilaria Miguel Stanciola Serrano, Gisele Queiroz Carvalho, Sônia Machado Rocha Ribeiro, Maria do Carmo Gouveia Peluzio, Sylvia do Carmo Castro Franceschini, Silvia Eloiza Priore. (2015). Measurements of body fat distribution: assessment of collinearity with body mass, adiposity and height in female adolescents. *Rev. paul. pediatri*, 33(1), 5. doi:http://dx.doi.org/10.1016/j.rpped.2014.11.011
35. Priscilla T LeMone and Karen M. Burke. (2008). *Medical-surgical Nursing: Critical Thinking in Client Care*. US: Pearson/Prentice Hall,
36. Rebecca Conway, Jessica Behennah, James Fisher, Neil Osborne, and James Steele. (2016). Associations between Trunk Extension Endurance and Isolated Lumbar Extension Strength in Both Asymptomatic Participants and Those with Chronic Low Back Pain. *Healthcare (Basel)*, 4(3), 70. doi:https://dx.doi.org/10.3390%2Fhealthcare4030070
37. Rita E. Deering, Jonathon W. Senefeld, Tatyana Pashibin, Donald A. Neumann, and Sandra K. Hunter. (2017). Muscle function and fatigability of trunk flexors in males and females. *Biol Sex Differ*, 8, 12. doi:https://dx.doi.org/10.1186%2Fs13293-017-0133-y
38. Rothman KJ. (2008). BMI-related errors in the measurement of obesity. *Int J Obes (Lond)*, 32 Suppl(3), S56-9. doi:10.1038/ijo.2008.87
39. Sharma Sowmya, Tinku Thomas, Ankalmadagu Venkatsubbareddy Bharathi and Sambashivaiah Sucharita. (2014). A Body Shape Index and Heart Rate Variability in Healthy Indians with Low Body Mass Index. *Journal of Nutrition and Metabolism*, 2014, 6. Retrieved from http://dx.doi.org/10.1155/2014/865313
40. Steven J. Kirsh. (2010). *Media and Youth: A Developmental Perspective*. US: Wiley-Blackwell; 1 edition.

41. Steven R. Gombert . ( 2010 ). *Be Fit For Life: A Guide To Successful Aging* (1 ed.). (WSPC, Ed.) USA : World Scientific.
42. Thomas T Samaras, Andrzej Bartke, Christopher David Rollo. (2007). *Human body size and the laws of scaling: physiological, performance, growth, longevity and ecological ramifications*. New York: Nova Science Publishers.
43. Walter Willett. (2013). *Nutritional Epidemiology*. UK: Oxford University Press.
44. Wei Shen, Mark Punyanitya, Jun Chen, Dymrna Gallagher, Jeanine Albu, Xavier Pi-Sunyer, Cora E. Lewis, Carl Grunfeld, Stanley Heshka, Steven B. Heymsfield. (2006). *Waist Circumference Correlates with Metabolic Syndrome Indicators Better Than Percentage Fat*. *Obesity (Silver Spring)*, 14(4), 727–736. doi:10.1038/oby.2006.83
45. Zerf Mohammed, Bengoua Ali, Mokkedes Moulay Idris, Hakim Hamzaoui, Lakhdar Messaliti. (2016). *Impact of fat mass distribution body shapes on muscles strength and the joints pain*. *BLDE Univ J Health Sci*, 1(2), 81-88. doi:10.4103/2468-838X.196084
46. Zerf, M., Atouti, N. & Ben Farouk, A. (2017). *Abdominal obesity and their association with total body: fat distribution and composition. Case of Algerian teenager male high school students*. *Physical education of students*, 21(3), 146–151. doi:10.15561/20755279.2017.0308

## **EFFICACY OF VARIOUS TRAINING ON STRIDE LENGTH, EXPLOSIVE POWER AND ELASTIC POWER DEVELOPMENT**

**Dr. R. Saravana Prabha**

Assistant Professor (SG) in Physical Education, Avinashilingam Institute for Home Science and Higher Education for Women, Coimbatore. India

### **Abstract**

The present study was designed to identify the efficacy of various training methods and detraining effect on stride length, explosive power and elastic power development. For the purpose of the study fifty female students were selected as subjects. The age of the subjects' ranged from 17 to 20 years; height ranged from 150 to 160 centimeters and weight is 40 to 55 kilograms. The experimental design used in this study was random group design. The selected subjects were divided at random into five groups of ten each (n=10). **Group I** underwent speed training, **Group II** underwent explosive power training, **Group III** underwent combined training, **Group IV** underwent complex training and **Group V** acted as control group. All the subjects were tested prior to and after the training and during detraining period the data were collected at the end of third and sixth week for all the selected variables. The collected data from the five groups on pre-post experimentation and detraining (two cessation) were statistically analyzed by using two way (5x4) factorial ANOVA with last factor repeated measures. Hence, it is concluded from the results of the study that systematically and scientifically designed combined training program may be given due recognition and be implemented properly in the training program of all the disciplines in order to achieve maximum performance.

**Key Words:** Isolated Training, Detraining, Combined Training, Complex Training, Speed & Explosive Power

### **INTRODUCTION**

Sport is intimate, profound and even spiritual. It reached the root of human existence and, as such, provided an area for the discovery of personal truth. Neither man alone nor did sport alone provide the completeness by existence. Sport and man, revealed to each other the opportunity of determining meaning. In this way, once again, man located a realm of value formation. It was a source of worth and meaning. Isolated training is one of the training methods that develop the motor qualities by means and methods of applying one mode of training. In this study, speed and power training are used as isolated training. Combined training one of the training methods that develop the motor qualities by means and methods of applying two modes of training. In this study, speed and power trainings are combined and given one after other in alternative days. Complex training is a training comprising of a speed training immediately followed by matched power training in the same session. Detraining effect was done to know how changes in the body undergoes in response to a reduction or cessation of regular physical training. The loss of training effects following the cessation of training. (Azeem K, & et al, 2011) study has revealed improvement in the selected fitness variables.

(K.Azeem, 2016), reveals in his study that the influence of different intensity of resistance training on selected strength, anaerobic power and explosive power among participants had shown improved performance.

**Purpose of the study:** present study was designed to identify the proficient training method and its detraining effect on development of speed and power.

1. The ultimate goal of research in physical education is to help coaches and physical educators to train their athletes and players based on new concepts to improve their performance.

2. The findings of the study would reveal the extent to which the speed and power training improves the overall performance.

### **Hypotheses**

1. There would be a significant improvement on selected independent variables due to the effect of isolated, combined and complex training.

2. There would be a significant difference in selected dependent variables of experimental groups due to detraining impact.

### **Review of related literature**

**Zafeiridis (2005)** examined the effects of resisted (RS) and un-resisted (US) sprint training programs on acceleration and maximum speed performance. It appears that each phase of sprint run demands a specific training approach. **Hoffman (2005)** explored the effects of five weeks of eccentrically loaded and unloaded jump squat training in experienced resistance-trained athletes during the strength/ power phase of a 15-week periodized off-season resistance training program. Results evidenced that the benefits of the jump squat exercise during a short-duration (5-week) training program for eliciting strength and power gains. **Onyewadume (1994)** compared the effects of combined and isolated broad and vertical jump training on the long jumping abilities of secondary school students. The analysis revealed that a combination of vertical jump and broad jump training improved the long jumping abilities of the students. **Jensen (2003)** conducted a study on kinetic analysis of complex training rest interval effect on vertical jump performance. In conclusion, complex training does not appear to enhance jumping performance significantly. **Luebbers (2003)** examined the effects of two plyometric training programs, equalized for training volume, followed by a four-week recovery period of no plyometric training on anaerobic power and vertical jump performance. A four week program may not be as effective as a seven week program if the recovery period is not employed.

### **METHOD**

For the purpose of the study fifty female students were selected as subjects. The age of the subjects' ranged from 17 to 20 years; height ranged from 150 to 160 centimeters and weight is 40 to 55 kilograms. The experimental design used in this study was random group design.



The selected subjects were divided at random into five groups of ten each (n=10). Group I underwent speed training, Group II underwent power training, Group III underwent combined training, Group IV underwent complex training and Group V acted as control group. All the subjects were tested prior to and after the training and during detraining period the data were collected at the end of third and sixth week for all the selected variables. The collected data from the five groups on pre-post experimentation and detraining (two cessation) were statistically analyzed by using two way (5x4) factorial ANOVA with last factor repeated measures (Broota, 1989).

**Table I Tests Selection**

S. No	Criterion variables	Test items	Unit of measurements
1	Stride length	50 meters run	In meters
2	Explosive power	Standing broad jump	In meters
3	Elastic Power	Bunny hop test	In meters

**Analysis of the data:** The influence of independent variables on each criterion variables were analyzed and presented below.

**Variable I – Stride Length**

**Table II, The Mean And Standard Deviation On Stride Length Of Pre Test, Post Test And Two Cessations Data Of Experimental And Control Groups**

Groups		Pre Test	Post Test	First Cessation	Second Cessation
Speed Training	Mean	1.62	1.72	1.66	1.63
	± SD	0.04	0.09	0.07	0.07
Power Training	Mean	1.62	1.69	1.65	1.62
	± SD	0.06	0.09	0.07	0.07
Combined Training	Mean	1.61	1.82	1.65	1.65
	± SD	0.07	0.10	0.08	0.11
Complex Training	Mean	1.62	1.80	1.66	1.64
	± SD	0.06	0.10	0.08	0.08
Control Group	Mean	1.62	1.61	1.62	1.61
	± SD	0.09	0.08	0.07	0.06

(Stride length scores are expressed in Meters)

The data of stride length have been analyzed by two way factorial ANOVA (5x4) with repeated measures on last factor and the obtained results are presented in Table III.

**Table-III , Two factor ANOVA on stride length of speed training, power training, combined training, complex training and control groups at three different stages of testing periods**

Source of Variance	Sum of Squares	Df	Mean Squares	F-ratio
A factor (Groups)	0.114	4	0.029	1.45
Error I	0.743	45	0.017	
B factor (Tests)	0.347	3	0.116	40.00*
AB factor (Interaction) (Groups and Tests)	0.171	12	0.014	4.67*
Error II	0.381	135	0.003	

\*Significant at .05 level

From the table III and the obtained F-ratio, Factor A (Groups) did not differ significantly. The result of the study indicates that there is no significant difference among the paired means of Factor A (Groups) on Stride length and observed that differences among the paired means of Factor B (Tests) on stride length are statistically significant ( $P < 0.05$ ).

From the table III, the obtained F value of Interaction- A x B (Groups x Different stages of Tests) show that there is significant difference existing among the paired means of interaction A x B on stride length ( $P < 0.05$ ). The results of the study indicated that there was a significant difference in the interaction effect (between rows (Groups) and columns (Tests)) on stride length.

**Table IV-A, The Scheffe's test for the differences between paired means of post-test with different groups on stride length**

Speed Training Group	Power Training Group	Combined Training Group	Complex Training Group	Control Group	Mean difference	Confidence interval
1.72	1.69				0.03	0.08
1.72		1.82			0.10*	0.08
1.72			1.80		0.08*	0.08
1.72				1.61	0.11*	0.08
	1.69	1.82			0.13*	0.08
	1.69		1.80		0.11*	0.08
	1.69			1.61	0.08*	0.08
		1.82	1.80		0.02	0.08
		1.82		1.61	0.21*	0.08
			1.80	1.61	0.19*	0.08

\*Significant at .05 level.

The table IV A clearly indicates that the mean difference between pre test and post test, post test and first session values & post test and second session values are Speed training and combined groups, speed training and complex groups, speed training and control groups,

power training and combined groups, power training and complex groups, power training and control groups, combined training and control groups, and complex training and control groups were 0.10, 0.08, 0.11, 0.13, 0.11, 0.08, 0.21 and 0.19 respectively. The values are greater than the confidence interval value 0.08, which shows significant difference at .05 level of confidence.

**Table IV– B, The scheffe’s test for the differences between paired means of speed training group with different tests on stride length**

Pre Test	Post Test	First Cessation	Second Cessation	Mean Difference	Confidence Interval
1.61	1.72			0.11*	0.07
1.61		1.66		0.05	0.07
1.61			1.63	0.02	0.07
	1.72	1.66		0.06	0.07
	1.72		1.63	0.09*	0.07
		1.66	1.63	0.03	0.07

\*Significant at .05 level

The above table clearly indicates that the mean difference between pre test and post test, and post test and second cessation values are 0.11 and 0.09 respectively which are greater than the confidence interval value of 0.07 at .05 level of confidence.

The results of the study showed that there was a significant difference between pre test and post test, and post test and second cessation values of speed training group on stride length.

**Table IV– C, The scheffe’s test for the differences between paired means of power training group with different tests on stride length**

Pre Test	Post Test	First Cessation	Second Cessation	Mean Difference	Confidence Interval
1.62	1.69			0.07*	0.07
1.62		1.65		0.03	0.07
1.62			1.62	0.00	0.07
	1.69	1.65		0.04	0.07
	1.69		1.62	0.07*	0.07
		1.65	1.62	0.03	0.07

\*Significant at .05 level

The above table clearly indicates that the mean difference between pre test and post test, and post test and second cessation values are 0.07 and 0.07 respectively which are greater than the confidence interval value of 0.07 at .05 level of confidence.

The results of the study showed that there was a significant difference between pre test and post test, and post test and second cessation values of power training group on stride length.

**Table IV– D, The scheffe’s test for the differences between paired means of combined training group with different tests on stride length**

<b>Pre Test</b>	<b>Post Test</b>	<b>First Cessation</b>	<b>Second Cessation</b>	<b>Mean Difference</b>	<b>Confidence Interval</b>
1.61	1.82			0.21*	0.07
1.61		1.65		0.04	0.07
1.61			1.65	0.04	0.07
	1.82	1.65		0.17*	0.07
	1.82		1.65	0.17*	0.07
		1.65	1.65	0.00	0.07

\*Significant at .05 level

The above table clearly indicates that the mean difference between pre test and post test, post test and first cessation values, and post test and second cessation values are 0.21, 0.17 and 0.17 respectively which are greater than the confidence interval value of 0.07 at .05 level of confidence.

The results of the study showed that there was a significant difference between pre test and post test, post test and first cessation values, and post test and second cessation values of combined training group on stride length.

**Table IV– E, The scheffe’s test for the differences between paired means of complex training group with different tests on stride length**

<b>Pre Test</b>	<b>Post Test</b>	<b>First Cessation</b>	<b>Second Cessation</b>	<b>Mean Difference</b>	<b>Confidence Interval</b>
1.62	1.80			0.18*	0.07
1.62		1.66		0.04	0.07
1.62			1.64	0.02	0.07
	1.80	1.66		0.14*	0.07
	1.80		1.64	0.16*	0.07
		1.66	1.64	0.02	0.07

\*Significant at .05 level

The above table clearly indicates that the mean difference between pre test and post test, post test and first cessation values, and post test and second cessation values are 0.18,

0.14 and 0.16 respectively which are greater than the confidence interval value of 0.07 at .05 level of confidence.

The results of the study showed that there was a significant difference between pre test and post test, post test and first cessation values, and post test and second cessation values of complex training group on stride length.

### **Variable II: Explosive Power**

The mean and standard deviation values on explosive power of speed training, power training, combined training, complex training and control groups at four different stages of tests have been analyzed and presented in Table V.

**Table – V, The mean and standard deviation on explosive power of pre test, post test and two cessations data of experimental and control groups**

Groups		Pre Test	Post Test	First Cessation	Second Cessation
<b>Speed Training</b>	<b>Mean</b>	1.83	2.05	1.92	1.89
	<b>± SD</b>	0.14	0.16	0.13	0.36
<b>Power Training</b>	<b>Mean</b>	1.81	2.02	1.93	1.83
	<b>± SD</b>	0.06	0.06	0.09	0.11
<b>Combined Training</b>	<b>Mean</b>	1.86	2.30	1.94	1.91
	<b>± SD</b>	0.19	0.22	0.13	0.12
<b>Complex Training</b>	<b>Mean</b>	1.90	2.22	2.01	1.98
	<b>± SD</b>	0.13	0.12	0.11	0.10
<b>Control Group</b>	<b>Mean</b>	1.78	1.81	1.78	1.80
	<b>± SD</b>	0.09	0.06	0.11	0.11

**(Explosive Power scores are expressed in Meters)**

The data of explosive power have been analyzed by two way factorial ANOVA (5x4) with repeated measures on last factor and the obtained results are presented in Table V.

**Table- VI, Two factor ANOVA on explosive power of speed training, power training, combined training, complex training and control groups at three different stages of testing periods**

Source of Variance	Sum of Squares	df	Mean Squares	F-ratio
A factor (Groups)	1.375	4	0.34	5.67*
Error I	2.611	45	0.06	
B factor (Tests)	1.733	3	0.58	58.00*
AB factor (Interaction) (Groups and Tests)	0.655	12	0.05	5.00*
Error II	1.290	135	0.010	

\*Significant at .05 level

From the table VI and the obtained F-ratio, Factor A (Groups) differ significantly. The result of the study indicates that there is significant difference among the paired means of Factor A (Groups) on Explosive power and also indicates that there is significant differences among the paired means of Factor B (Tests) on Explosive power are statistically significant ( $P < 0.05$ ).

From the table VI, the obtained F value of Interaction- AxB (Groups x Different stages of Tests) show that there is significant difference existing among the paired means of interaction A x B on Explosive power ( $P < 0.05$ ). The results of the study indicated that there was a significant difference in the interaction effect (between rows (Groups) and columns (tests)) on explosive power.

**Table VII – A, The scheffe’s test for the differences between paired means of post test with different groups on explosive power**

Speed Training Group	Power Training Group	Combined Training Group	Complex Training Group	Control Group	Mean difference	Confidence interval
2.05	2.02				0.03	0.14
2.05		2.31			0.26*	0.14
2.05			2.22		0.17*	0.14
2.05				1.81	0.24*	0.14
	2.02	2.31			0.29*	0.14
	2.02		2.22		0.20*	0.14
	2.02			1.81	0.21*	0.14
		2.31	2.22		0.09	0.14
		2.31		1.81	0.50*	0.14
			2.22	1.81	0.41*	0.14

\*Significant at .05 level.

Table VII B shows that the mean difference between speed training and combined groups, speed training and complex groups, speed training and control groups, power training and combined groups, power training and complex groups, power training and control groups, combined training and control groups, and complex training and control groups were 0.26, 0.17, 0.24, 0.29, 0.20, 0.21, 0.50 and 0.41 respectively. The values are greater than the confidence interval value 0.14, which shows significant difference at .05 level of confidence.

**Table VII –B, The scheffe’s test for the differences between paired means of first cessation with different groups on explosive power**

Speed Training Group	Power Training Group	Combined Training Group	Complex Training Group	Control Group	Mean difference	Confidence interval
1.92	1.93				0.01	0.14
1.92		2.01			0.09	0.14
1.92			1.94		0.02	0.14
1.92				1.78	0.14*	0.14
	1.93	2.01			0.08	0.14
	1.93		1.94		0.01	0.14
	1.93			1.78	0.14*	0.14
		2.01	1.94		0.07	0.14
		2.01		1.78	0.22*	0.14
			1.94	1.78	0.15*	0.14

\*Significant at .05 level.

The above table clearly indicates that the mean difference between speed training and control groups, power training and control groups, combined training and control groups, and complex training and control groups were 0.14, 0.14, 0.22, and 0.15 respectively. The values are greater than the confidence interval value 0.14, which shows significant difference at .05 level of confidence. It may be concluded from the results of the study that there is a significant difference between the means of speed training and control groups, power training and control groups, combined training and control groups, and complex training and control groups on explosive power at first cessation period.

**Table VII – C, The scheffe’s test for the differences between paired means of speed training group with different tests on explosive power**

Pre Test	Post Test	First Cessation	Second Cessation	Mean Difference	Confidence Interval
1.83	2.05			0.22*	0.13
1.83		1.92		0.09	0.13
1.83			1.89	0.06	0.13
	2.05	1.92		0.13*	0.13
	2.05		1.89	0.16*	0.13
		1.92	1.89	0.03	0.13

\*Significant at .05 level

The above table clearly indicates that the mean difference between pre test and post test, post test and first cessation values, and post test and second cessation values are 0.22, 0.13 and 0.16 respectively which are greater than the confidence interval value of 0.13 at .05 level of confidence.

The results of the study showed that there was a significant difference between pre-test and post-test, post-test and first cessation values, and post-test and second cessation values of speed training group on explosive power.

**Table VII – D, The scheffe’s test for the differences between paired means of power training group with different tests on explosive power**

<b>Pre Test</b>	<b>Post Test</b>	<b>First Cessation</b>	<b>Second Cessation</b>	<b>Mean Difference</b>	<b>Confidence Interval</b>
1.81	2.02			0.21*	0.13
1.81		1.93		0.12	0.13
1.81			1.83	0.02	0.13
	2.02	1.93		0.09	0.13
	2.02		1.83	0.19*	0.13
		1.93	1.83	0.10	0.13

\*Significant at .05 level

The above table clearly indicates that the mean difference between pre- test and post-test, and post-test and second cessation values are 0.21 and 0.19 respectively which are greater than the confidence interval value of 0.13 at .05 level of confidence.

The results of the study showed that there was a significant difference between pre-test and post-test, and post-test and second cessation values of power training group on explosive power.

**Table VII– E, The scheffe’s test for the differences between paired means of combined training group with different tests on explosive power**

<b>Pre Test</b>	<b>Post Test</b>	<b>First Cessation</b>	<b>Second Cessation</b>	<b>Mean Difference</b>	<b>Confidence Interval</b>
1.86	2.31			0.45*	0.13
1.86		1.94		0.08	0.13
1.86			1.91	0.05	0.13
	2.31	1.94		0.37*	0.13
	2.31		1.91	0.40*	0.13
		1.94	1.91	0.03	0.13

\*Significant at .05 level

The above table clearly indicates that the mean difference between pre- test and post -test, post-test and first cessation values, and post-test and second cessation values are 0.45, 0.37 and 0.40 respectively which are greater than the confidence interval value of 0.13 at .05 level of confidence.



The results of the study showed that there was a significant difference between pre-test and post- test, post- test and first cessation values, and post-test and second cessation values of combined training group on explosive power.

**Table VII– F, the scheffe’s test for the differences between paired means of complex training group with different tests on explosive power**

<b>Pre Test</b>	<b>Post Test</b>	<b>First Cessation</b>	<b>Second Cessation</b>	<b>Mean Difference</b>	<b>Confidence Interval</b>
1.90	2.22			0.32*	0.13
1.90		2.01		0.11	0.13
1.90			1.98	0.08	0.13
	2.22	2.01		0.21*	0.13
	2.22		1.98	0.24*	0.13
		2.01	1.98	0.03	0.13

\*Significant at .05 level

The above table clearly indicates that the mean difference between pre- test and post-test, post- test and first cessation values, and post- test and second cessation values are 0.32, 0.21 and 0.24 respectively which are greater than the confidence interval value of 0.13 at .05 level of confidence.

The results of the study showed that there was a significant difference between pre-test and post-test, post-test and first cessation values, and post-test and second cessation values of complex training group on explosive power.

**Variable III: Elastic Power**

The mean and standard deviation values on elastic power of speed training, power training, combined training, complex training and control groups at four different stages of tests have been analyzed and presented in Table VIII.

**Table- VIII, The mean and standard deviation on elastic power of pre test, post test and two cessations data of experimental and control groups**

Groups		Pre Test	Post Test	First Cessation	Second Cessation
Speed Training	Mean	8.71	9.23	8.97	8.80
	± SD	0.52	0.66	0.54	0.50
Power Training	Mean	8.77	9.56	9.05	8.93
	± SD	0.68	0.42	0.65	0.69
Combined Training	Mean	8.83	10.07	9.18	9.00
	± SD	0.02	0.100	0.01	0.01
Complex Training	Mean	8.79	9.72	9.14	8.99
	± SD	0.01	0.96	0.01	0.01
Control Group	Mean	8.77	8.81	8.70	8.71
	± SD	0.33	0.52	0.50	0.48

(Elastic Power scores are expressed in Metres)

The data of elastic power have been analyzed by two way factorial ANOVA (5x4) with repeated measures on last factor and the obtained results are presented in Table VIII.

**Table- IX, Two factor anova on elastic power of speed training, power training, combined training, complex training and control groups at three different stages of testing periods**

Source of Variance	Sum of Squares	df	Mean Squares	F-ratio
A factor (Groups)	6.694	4	1.67	0.51
Error I	147.108	45	3.27	
B factor (Tests)	14.303	3	4.77	71.19*
AB factor (Interaction) (Groups and Tests)	4.746	12	0.40	5.97*
Error II	9.011	135	0.067	

\*Significant at .05 level

From the table IX and the obtained F-ratio, Factor A (Groups) did not differ significantly. The result of the study indicates that there is no significant difference among the paired means of Factor A (Groups) on Elastic power and also indicates that differences among the paired means of Factor B (Tests) on Elastic Power are statistically significant (P<0.05).

From the table IX, the obtained F value of Interaction - A x B (Groups x Different stages of Tests) show that there is significant difference existing among the paired means of interaction A x B on Elastic power ( $P < 0.05$ ). The results of the study indicated that there was a significant difference in the interaction effect (between rows (Groups) and columns (Tests)) on elastic power.

**Table X-A, The scheffe’s test for the differences between paired means of post test with different groups on elastic power**

<b>Speed Training Group</b>	<b>Power Training Group</b>	<b>Combined Training Group</b>	<b>Complex Training Group</b>	<b>Control Group</b>	<b>Mean difference</b>	<b>Confidence interval</b>
9.23	9.56				0.33	0.36
9.23		10.67			1.44*	0.36
9.23			9.72		0.49*	0.36
9.23				8.81	0.42*	0.36
	9.56	10.67			1.11*	0.36
	9.56		9.72		0.16	0.36
	9.56			8.81	0.75*	0.36
		10.67	9.72		0.95*	0.36
		10.67		8.81	1.86*	0.36
			9.72	8.81	0.91*	0.36

\*Significant at .05 level.

The above table clearly indicates that the mean difference between speed training and combined groups, speed training and complex groups, speed training and control groups, power training and combined groups, power training and control groups, combined training and control groups, combined training and complex groups, and complex training and control groups were 1.44, 0.49, 0.42, 1.11, 0.75, 0.95, 1.86 and 0.91 respectively. The values are greater than the confidence interval value 0.36, which shows significant difference at .05 level of confidence.

It may be concluded from the results of the study that there is a significant difference between the post-test means of speed training and combined groups, speed training and complex groups, speed training and control groups, power training and combined groups, power training and control groups, combined training and control groups, combined training and complex groups, and complex training and control groups on elastic power at post test period.

**Table X-B, The scheffe’s test for the differences between paired means of first cessation with different groups on elastic power**

Speed Training Group	Power Training Group	Combined Training Group	Complex Training Group	Control Group	Mean difference	Confidence interval
8.97	9.05				0.08	0.36
8.97		9.18			0.21	0.36
8.97			9.14		0.17	0.36
8.97				8.70	0.27	0.36
	9.05	9.18			0.13	0.36
	9.05		9.14		0.09	0.36
	9.05			8.70	0.35*	0.36
		9.18	9.14		0.04	0.36
		9.18		8.70	0.48*	0.36
			9.14	8.70	0.44*	0.36

\*Significant at .05 level.

The above table clearly indicates that the mean difference between power training and control groups, combined training and control groups, and complex training and control groups were 0.35, 0.48, and 0.44 respectively. The values are greater than the confidence interval value 0.36, which shows significant difference at .05 level of confidence.

It may be concluded from the results of the study that there is a significant difference between the means of power training and control groups, combined training and control groups, and complex training and control groups on elastic power at first cessation period.

**Table X– C, The scheffe’s test for the differences between paired means of speed training group with different tests on elastic power**

Pre Test	Post Test	First Cessation	Second Cessation	Mean Difference	Confidence Interval
8.71	9.23			0.52*	0.33
8.71		8.97		0.26	0.33
8.71			8.80	0.09	0.33
	9.23	8.97		0.26	0.33
	9.23		8.80	0.43*	0.33
		8.97	8.80	0.17	0.33

\*Significant at .05 level

The above table clearly indicates that the mean difference between pre- test and post-test, and post- test and second cessation values are 0.52, and 0.43 respectively which are greater than the confidence interval value of 0.33 at .05 level of confidence.

The results of the study showed that there was a significant difference between pre-test and post -test, and post- test and second cessation values of speed training group on elastic power.

**Table X– D, The scheffe’s test for the differences between paired means of power training group with different tests on elastic power**

<b>Pre Test</b>	<b>Post Test</b>	<b>First Cessation</b>	<b>Second Cessation</b>	<b>Mean Difference</b>	<b>Confidence Interval</b>
8.77	9.56			0.79*	0.33
8.77		9.05		0.28	0.33
8.77			8.93	0.16	0.33
	9.56	9.05		0.51*	0.33
	9.56		8.93	0.63*	0.33
		9.05	8.93	0.12	0.33

\*Significant at .05 level

The above table clearly indicates that the mean difference between pre- test and post-test, post-test and first cessation values, and post-test and second cessation values are 0.79, 0.51 and 0.63 respectively which are greater than the confidence interval value of 0.33 at .05 level of confidence.

The results of the study showed that there was a significant difference between pre-test and post- test, post-test and first cessation values, and post-test and second cessation values of power training group on elastic power.

**Table X– E, The scheffe’s test for the differences between paired means of combined training group with different tests on elastic power**

<b>Pre Test</b>	<b>Post Test</b>	<b>First Cessation</b>	<b>Second Cessation</b>	<b>Mean Difference</b>	<b>Confidence Interval</b>
8.83	10.07			1.24*	0.33
8.83		9.18		0.35*	0.33
8.83			9.00	0.17	0.33
	10.07	9.18		0.89*	0.33
	10.07		9.00	1.07*	0.33
		9.18	9.00	0.18	0.33

\*Significant at .05 level

The above table clearly indicates that the mean difference between pre test and post test, pre test and first cessation values, post test and first cessation values, and post test and second cessation values are 1.24, 0.35, 0.89 and 1.07 respectively which are greater than the confidence interval value of 0.33 at .05 level of confidence.

The results of the study showed that there was a significant difference between pre test and post test, pre test and first cessation values, post test and first cessation values, and post test and second cessation values of combined training group on elastic power.

**Table X– F, The scheffe’s test for the differences between paired means of complex training group with different tests on elastic power**

<b>Pre Test</b>	<b>Post Test</b>	<b>First Cessation</b>	<b>Second Cessation</b>	<b>Mean Difference</b>	<b>Confidence Interval</b>
8.79	9.72			0.93*	0.33
8.79		9.14		0.35*	0.33
8.79			8.99	0.20	0.33
	9.72	9.14		0.58*	0.33
	9.72		8.99	0.73*	0.33
		9.14	8.99	0.15	0.33

\*Significant at .05 level

The above table clearly indicates that the mean difference between pre test and post test, pre test and first cessation values, post test and first cessation values, and post test and second cessation values are 0.93, 0.35, 0.58 and 0.73 respectively which are greater than the confidence interval value of 0.33 at .05 level of confidence.

The results of the study showed that there was a significant difference between pre test and post test, pre test and first cessation values, post test and first cessation values, and post test and second cessation values of complex training group on elastic power.

### CONCLUSION

The results of the study indicate that all the experimental groups namely speed training, power training, combined training and complex training significantly improved in their performance as selected dependent variables namely stride length, explosive power and elastic power when compared to the control group. It is also found that the improvement caused by combined training was greater when compared to the complex training, speed training and power training in all the selected dependent variables.

Hence, it is concluded from the results of the study that systematically and scientifically designed combined training program may be given due recognition and be

implemented properly in the training program of all the disciplines in order to achieve maximum performance.

## **References**

1. Andrew D. Lyttle, Greg J Wilson and Karl J Ostroski, "Enhancing Performance: Maximal Power versus Combined Weight and Plyometric Training", *Journal of Strength and Conditioning Research*, 10:3, (August 1996), 173-179.
2. Azeem K, Al Ameer A. Effect of weight training on sprinting performance, flexibility and strength. *British Journal of Sports Medicine* 2010;**44**:i22.
3. Azeem K. P-78 Influence of different intensities of resistance training on strength, anaerobic power and explosive power among males. *Br J Sports Med* 2016;**50**:A75.
4. Conroy .R. "Plyometric training and its effects on Speed, Strength and Power of Inter Collegiate Athletes – Abstract, Ibid. **72**
5. Daryl Sidentop(1998), Introduction to physical Education, Fitness and Sport, 3<sup>rd</sup> Edition, Mayfield Publishing Company, Mountain View, California.
6. Donald A. Chu, (1996), Explosive Power and Strength Complex Training for Maximim Results – A Better Way to Train, Human Kinetics.
7. Onyewadume, I.U. "A Comparative Analysis of Effects of Combined and Isolated Broad and vertical Jump Trainings on Long Jump Abilities of Secondary School Students", *SAI Scientific Jurnal*,17:3, (July 1994),10.
8. Skarbalius A. & Astrauskas M., "Alterations of detraining of handball players aged 17-18 years during five and ten weeks of transition period", Article in Lithuanian, Education, Physical Training, 2000, 3(36), 33-41.

## TOWARDS A DIDACTIC MODEL OF LEARNING IN A TRAINING CONTEXT OF YOUNG FOOTBALLERS: GAME CONFIGURATIONS AND DEBATES OF IDEAS SOCIO-CONSTRUCTIVIST APPROACH

<sup>1</sup>Dr: BOURENANE CHERIF Mustapha, Algiers University 3  
[musbourenane1969@gmail.com](mailto:musbourenane1969@gmail.com)

El Mihoub Street, 1 lot 149 PB: 16210 Baraki, Algiers, Algeria

<sup>2</sup>DJENNAD Djamal, Universty of Bedjaia, (STPSA)

<sup>3</sup>KEDADRA Chaouki , Hamma Lakhdar University, El-Oued,

### Abstract

Research in didactics of physical and sports activities raises the question of how knowledge is developed (co-constructed) in the interaction between the subject and the context. Secondly, they aim to analyze and understand how the dialogue between thought and action is manifested. In fact, the reflection on acting in human motricity concerns both behaviors (objectifiable as observables and motor behaviors as long as underlying intentional processes situated in context, this reflection assumes a multidisciplinary approach, ranging from the philosophy of action and knowledge, to semiotics, the didactics of disciplines, and the sciences of intervention ( William et al, 2004). It is in this thought that our research work is closely related to the teaching / learning process in didactics of physical and sports activities, and especially in collective sports, hence our study on teaching - learning in football didactics Ball in the school environment, a first in Algeria in this field of research in didactics. In fact, in the socio-constructivist approach where the student is placed at the center of the teaching-learning system, the subject is called to construct his own strategies of action. So our study shifts from an interpersonal process to an intra-personal process through verbal exchanges between educator / student (s) and students / peers.

**Key words:** didactic, Game, debates of ideas, Socio-constructivist



## INTRODUCTION

### Problem

Using a program of eight sessions in a learning situation, young Algerian footballers between the ages of 10 and 12 will be able to confront their information and knowledge in order to progress using a didactic model centered on the debate of ideas.

### Hypotheses

**General Hypothesis** .Verbalization and the debate of ideas have a direct impact on the learning of football Ball.

#### Secondary hypothesis

1- The verbalization and the debate of ideas between students have an incidence on the learning in football.

2- The verbalization and the debate of ideas in the presence of the teacher have an impact on the learning in football.

### Purpose of the research

The aim of our research is to give another scientific approach to football learning for young people aged 10 to 12 and to use a learning theory - social constructivism - based on the co-construction of students to study the direct effects of student verbalization during a football learning cycle.

### Study population

For this, the participants in this study are 20 students (boys) of 5<sup>th</sup> fundamental year (average age = 11 years) of the primary school Ouahchi Arezki Guendouza, Akbou, province of Bejaia all enrolled in the football school of the directorate of the youth, at the province.

**Overall Structure of the Test:** The sessions consist of the organization of match inter manpower which includes three situations of play (8mn) each interspersed by two sequences of verbalization (5mn) each, the first in the absence of the educator and the second in his presence.

<b>Game 8 mn</b>	<b>Ideas debate 5mn</b>	<b>Game 8 mn</b>	<b>Ideas debate 5mn</b>	<b>Game 8 mn</b>
------------------	-----------------------------	------------------	-----------------------------	------------------

### Data processing.

In order to interpret our sessions, we used a camcorder to film all the situations of play, all the sequences of verbalizations are recorded using a camcorder to identify the interlocutors and are subsequently transcribed in writing for speech analysis.

**Our study is based on two distinct stages.**

**The first** is based on the collection of digital data and this from the analysis of the game sequences made by the audiovisual method from a software Dartfish (version 5.5) which gives us the figures of the 5 indicators of the game of knowledge (played balls, lost balls, conquered balls, shots and goal), the statistical processing will be done through computer software SPSS (version 23) (repeated measures ANOVA)

**The second part** with textual data (students' speech) or the statistical processing will always be applied thanks to the SPSS software and the Kerbrat -Orecchioni 1998 model (no answer, no subject, a start of decision, a decision with justification and at least one alternative with decision) which will allow us to identify the decision-making methods of the students and their evolutions.

**Experimental Part**

Results of evolution of game indicators over eight sessions

	<b>Match 1</b>	<b>Match 2</b>	<b>Match 3</b>
<b>Successful passes</b>	448	535	557
<b>Recovered balls</b>	175	225	217
<b>Lost balls</b>	173	136	87
<b>Shots</b>	76	80	90
<b>Goals</b>	19	30	35

### Results total of the five indices during the three meetings

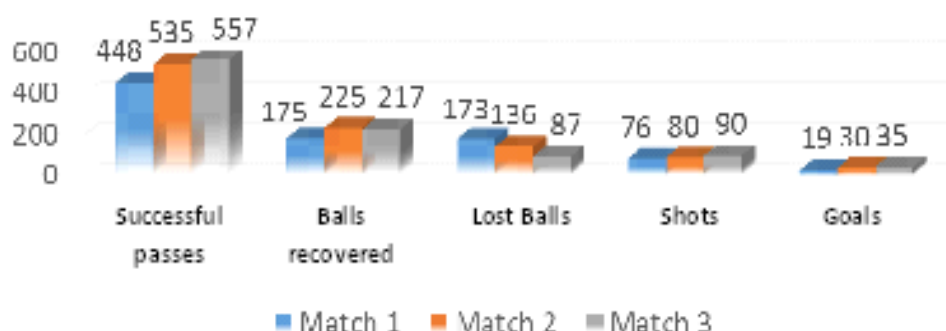

### Numerical data progress of the verbal productions during the 8 sessions between students and with presence of the educator

Sessions	S1		S2		S3		S4		S5		S6		S7		S8	
	E	Ed	E	Ed	E	Ed	E	Ed	E	Ed	E	Ed	E	Ed	E	Ed
Answers																
No answers	3	20	4	20	2	10	6	6	5	5	6	2	3	3	1	4
Out of subject	4	4	2	4	2	3	2	2	1	2	1	2	1	2	0	1
Beginning of decision	8	16	6	20	12	13	15	15	15	17	16	16	8	6	8	8
Decision with justification	13	12	14	12	10	14	11	17	12	20	14	20	15	22	14	22
At least one alternative with justification	5	5	4	6	3	6	4	7	4	8	5	11	6	10	5	12

So from the grids of observation and the results obtained in relation to the indicators retained on the evolution of the game that are, balls played, balls lost, balls recovered, number of shots and number of goals one can say the five indicators underwent a significant increase during the cycle or throughout the eight sessions offered to students by the educator.

The observation grids provide information on the evolution of the game before and after each verbalization session (Gréhaigne, Billard and Laroche.1999).

The results obtained confirm our hypotheses and allow us to observe an observable change in the indicators of the evolution of play. Students acquire the ability to interpret their actions and opt for opposition situations that can be realized as they go along of the sessions proposed, their only concern or goal was to put in place action plan schemas to be solved

individually or collectively, depending on the situations encountered along the way. The validation of these action plans boils down to the progress that is being made result in the increase in the number of balls played between the students during the verbalization sessions throughout the eight sessions, the decrease in the number of balls lost, the increase in the balls recovered, the number of shots that automatically translate into number of goals scored.

For the part concerning the discourse of the last pupils begin to think about and to negotiate the possible solutions in the form of collective action projects allowing to solve the problem in its context (Sieber, 2003), because if we look at the number of answers emitted by students in the category "decision with justification" and "at least one alternative with justification" we note a significant evolution we go from twelve (12) answers to twenty-two (22) of "decision with justification" and five ( 5) at twelve (12) "at least one alternative with justification" and this in the presence of the educator. These quantitative observations collected throughout the cycle lead us to say that we are moving from a silent but receptive stance to an active contribution to exchanges.

That said, apart from the two categories of "non-response" and "off-topic" responses, the other types of responses have evolved during the debates of ideas within students, so they have acquired a set of language skills at the along the cycle.

The latter gained insight and knowledge as verbalization gave rise to a wide range of response modalities in which opinions were opposed, thus generating a rich and consistent debate.

Students interpret opposition situations better; verbalizations constitute a beginning of reflexive practice on action and admit the explanation of the determinants and intentions of the action (Polkinghorne, 1983, Vermersch, 1995).

Thus, during verbalization, in addition to interdependence, there is a verbal interaction that is privileged between the members of the same group. To accomplish a specific task, the learners present their ideas in turn, analyze the situations of play, formulate hypotheses and propose answers with a view to reaching a final decision that is unanimous among the various students. Adams and Hamm's (1990, p.41) sentence gives credence to what we have said: « *Verbal interaction is valid when group discussion promotes directed attention and develops skills to select, recall, analyze, integrate and evaluate information* »

## **CONCLUSION**

We can say that the debate of idea is an effective tool which allows the pupils to progress and especially to understand the situations of game, in fact the diminution of balls lost after debate of idea proves the understanding of the internal logic of the game and an improvement in the defensive and offensive organization of the game, the use of knowledge during the action allows a more relevant resolution of the problem encountered and the organization of the game is better planned and gives a greater dynamic to the game. Zerai, 2010). Verbalization facilitates the development of students' cooperative behaviors. In fact, the students during a verbal inter-exchange sequence begin to identify the problems encountered, explain the reasons they encountered these difficulties and finally propose solutions and suggestions in the form of collective action projects.

## **References**

1. Adams, D., & Hamm, M.E. (1990). Cooperative learning: Critical thinking and collaboration across the curriculum. Springfield, IL: Charles C. Thomas Publisher.
2. Gréhaigne, J.F., Billard, M., & Laroche, J.Y. (1999). Teaching team sports at school. Paris.
3. Sperber D., & Wilson D, (1989). Relevance. Communication and cognition. Paris: Midnight.
4. Wallian, N. & Gréhaigne, J.F. (2002). Towards a semio-constructivist approach to motor learning. InG. Carlier (Dir.) If we talked about the pleasure of teaching physical education. Paris: AFRAPS.

## **SPORTING EVENTS AMONG THE DISABLED BETWEEN EXCELLENCE AND IDEAL IN MOTOR PERFORMANCE**

Analytical descriptive study in some Paralympic sports

**Guebli Abdelkader<sup>a</sup>, Reguieg Madani<sup>b</sup>, Belkadi Adel<sup>b</sup>, Sbaa Bouabdellah<sup>a</sup>**

a. Laboratory APS, Society, Education and Health, faculty of physical education and sports, Hassiba Benbouali University of Chlef.

b. SMAH Laboratory, faculty of physical education and sports, Abdelhamid Ibn Badiss University of Mostaganem 27000

### **Abstract**

---

The identification of mechanical variables in the motor performance trajectory has a prominent role in improving skill performance, error-exceeding, it contributes seriously to solving some problems of learning and training. The study Aims to highlight the indicators of motor performance for Paralympic athletes during the practicing sports between modelling and between excellences in motor performance, this by taking into account the distinction of athlete practicing with special behavioral skills for the Paralympic athletes. In the study we relied on the analysis of some previous research of biomechanical performance indicators during some of the events sports (shooting activities in the Paralympic athletics, shooting skill in the wheelchair basketball). The results of the study highlight the distinction of disabled practitioners of sporting events identified in motor performance during practice, by overcoming some physics indicators in human movement, as a lower center of body weight, Increase in offset distance, such resistance which requires them to redouble their efforts. However, the results of the study highlighted the strength of the correlation between biomechanical variables of motor performance and the digital level achievement similar to the other practitioners normal.

**Key words : Sports, The disabled, Motor Performance, Paralympic.**

## **INTRODUCTION**

Adaptive sports also known as disability sports, are sports played by persons with a disability, including physical and intellectual disabilities. As many disabled sports are based on existing able bodied sports, modified to meet the needs of persons with a disability, they are sometimes referred to as adapted sports. Organized sport for athletes with a disability is generally divided into three broad disability groups: the deaf, people with physical disabilities, and people with intellectual disabilities. Each group has a distinct history, organization, competition program, and approach to sport [1]. While sport has value in everyone's life, it is even more important in the life of a person with a disability. This is because of the rehabilitative influence sport can have not only on the physical body but also on rehabilitating people with a disability into society. Furthermore, sport teaches independence. Nowadays, people with a disability participate in high performance as well as in competitive and recreational sport [3]. The number of people with disabilities involved in sport and physical recreation is steadily increasing around the world with organized sports for athletes with disabilities divided into three main disability groups, sports for the deaf, sports for persons with physical disabilities, and sports for persons with intellectual disabilities [2]. From the late 1980s, organizations began to include athletes with disabilities in sporting events such as the Olympic Games and Commonwealth Games.

However, many sports are practiced by persons with a disability outside the formal sports movements, for example: Wheelchair basketball, Wheelchair dancing, Weightlifting, Swimming, and many other sporting activities you can join if you are mentally or physical disabled. The global Special Olympics movement got its start on 20 July 1968, when the First International Special Olympics Games were held at Soldier Field, Chicago, Illinois, USA. But the concept of Special Olympics was born much earlier, when Eunice Kennedy Shriver started a day camp for people with intellectual disabilities at her home in 1962 [3].

Biomechanical analysis of sport performance provides an objective method of determining performance of a particular sporting technique. In particular, it aims to add to the understanding of the mechanisms influencing performance, characterization of athletes, and provide insights into injury predisposition. Whilst the performance in sport of able-bodied athletes is well recognized in the literature, less information and understanding is known on the complexity, constraints and demands placed on the body of an individual with a disability. This paper provides a dialogue that outlines scientific issues of performance analysis of multi-level athletes with a disability, including Paralympians [4]. Paralympic Games - A multi-sport event for athletes with physical, mental and sensorial disabilities. This includes mobility disabilities, amputees, visual disabilities and those with cerebral palsy. The Paralympic Games are held every four years, following the Olympic Games, and are governed by the International Paralympic Committee [5].

## Method

The aim of this study is a comparative analysis of the kinematic parameters of the shot put, disc throw, shooting skill in wheelchair basketball of some athlete's in different national elite in the world, and they are the best competitors in the Paralympic & world games, where also recorded the best digital level. We used the resultants of last researches for analysis the motor performance of these athletes, and for compare this values biomechanics of disabled athletes with the values of normal athletes.

## RESULT AND DISCUSSION

**Shot Put;** The main difference in the gliding technique was found to be a reduction of the acceleration path of the shot, which is indicated by a reduced horizontal distance travelled by the shot in the gliding and the release phase. No major differences were found for the durations of each functional phase. Therefore ID athletes conduct the gliding technique with a lower average speed, since they cover a shorter distance in the glide and release phase in approx. [6]. The same amount of time. It is a well - accepted theory, that a longer accelerative path of the implement is a positive contributor to release velocity in all throwing events (see for example Zatsiorsky et al 1981).

As a result of the reduced length of the accelerative path, release speed of the shot is reduced for ID athletes, which explains most of the differences found for the official distance reached by the athletes. This could be a result of a poor execution of the gliding technique. Technique acquisition might be one major factor which is restricted by an intellectual disability. Nonetheless performing the gliding technique properly calls for a high potential force producing, especially for the muscle tendon units of the lower extremity. Without the using of further information concerning for example force producing capacities or training history of the athletes no conclusions concerning the exact reasons of the lower performance of the ID athletes can be drawn [7]. The most basic kinematic differences in shot putting techniques of male athletes with a disability compared to athletes of different levels basic result was that the poorer performance of ID athletes was associated with a reduction of the acceleration path of the shot resulting in a lower speed of the shot at release. We can be see concerning the roots of this poor execution of the gliding technique unless further individual information of the athletes is included into the biomechanical analysis.

The final release velocity of the shot is the culmination of all the movement units across the circle up to, and including the power position. Poorly executed movement units across the circle negatively affect the final release velocity [15].

Release velocity and release angle are inversely related. As one parameter increases, the other decreases. Release angle can be manipulated depending on the throwers strength and anthropometrics. The goal is to determine the release angle that optimizes the total distance



for the release velocity attained for the thrower. For the shot put, the optimum angle of release is between  $31^\circ$  and  $36^\circ$  (Fig 1) [14].

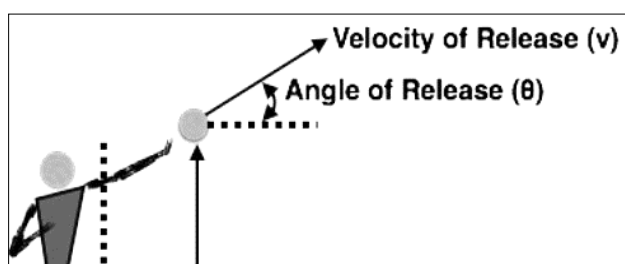

Fig. 1 Parameters affecting horizontal release distance

**Disc Throw;** the aerodynamic forces are significant factors on Paralympics discus flight. The correlation between drag, lift and range (in some cases) has good significant levels. Aerodynamic factors (in low speed of discus) have a true influence on flight distance so that it can be measured and used in equations to predict the range [8]. Other conditions such as atmospheric and wind positions deserve more attention. The drag free equation must be applied only in low velocities and short trajectories (for example e shot put) or high velocity projects with low aerodynamic influences (for instance, the hammer throw). In this case, the drag free equations demonstrate significant differences to official range and can't be applied to predict flight distance on Paralympics discus throw [9].

The throw-like movement pattern of the kinetic chain contributes largely in the performance of a discus throw. This movement allows the sequential motion of the joints to create the greatest release speed. Newton's third law of motion allows forces to be generated through the reaction to the ground allow for increased force transferred into the discus. Angular motion and arm length combined together to allow for the release speed to be as large as possible. With increase angular motion and the longest possible arm length the release speed will be at its greatest, allowing for peak performance to occur. Finally the optimum height release is said to be at shoulder height at the point where the discus is leaving the hand, to allow for the discus to reach the highest release speed and the optimum angle of release to be created. The optimum angle of release is individual but is aimed to be between 35 and 45 degrees (Fig 2) [16].

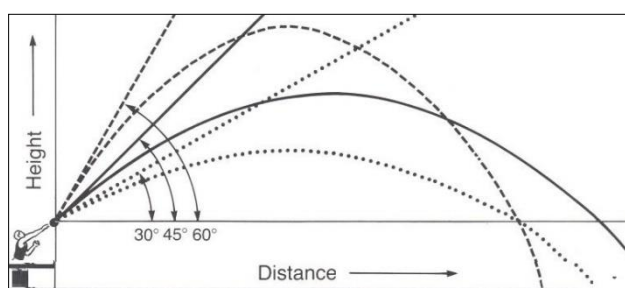
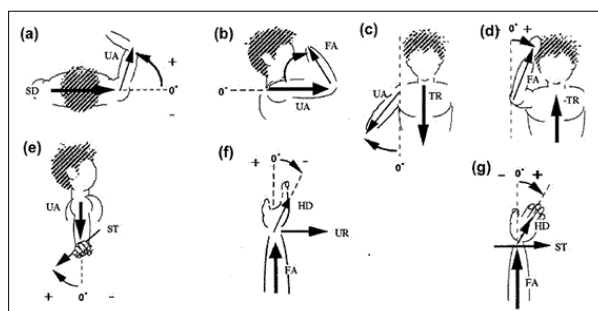

Fig. 2 The parabolic flight path for various release angles

**Shooting wheelchair Basketball;** significant differences were observed between the players classes in FT shooting mechanics employed for a clean shot. Players from different Classes tended to release the ball from a lower height, with greater velocity and release angle. They demonstrated a smaller shoulder flexion angle at release and a greater maximum velocity at the shoulder and elbow [10].

The clean shots of Classes demanded greater accuracy with respect to release velocity and angle, yet the resulting ball trajectory displayed a greater margin for error than the shots observed in the upper classes. However, based on overall shooting percentage, the upper classes did not appear to take advantage of the predicted benefits provided by a higher ball release height [11].

The Pictorial definitions of seven joint angles used to detect upper-limb motions during basketball shooting (Fig 3); (a) Shoulder horizontal adduction (+)/horizontal abduction (-), (b) elbow extension, (c) shoulder abduction, (d) shoulder internal rotation (+)/ external rotation (-), (e) forearm pronation (+)/ supination (-), (f) wrist flexion (+)/ extension (-), and (g) wrist ulnar flexion (+)/ radial flexion (-)[17].



**Fig. 3 Pictorial definitions of seven joint angles used to detect upper-limb motions during basketball shooting**

Biomechanical studies in wheelchair sports mainly aim at optimizing sport performance or preventing sport injuries. The sports performance optimization question has been approached from an ergonomic, as well as a skill proficiency perspective. Sports medical issues have been addressed in wheelchair sports mainly because of the extremely high prevalence of repetitive strain injuries such as shoulder impingement and carpal tunnel syndrome. [12]Sports performance as well as sports medical reflections are made throughout the review. Insight in the underlying musculoskeletal mechanisms of hand rim wheelchair propulsion has been achieved through a combination of experimental data collection under realistic conditions, with a more fundamental mathematical modelling approach. Through a synchronized analysis of the movement pattern, force generation pattern and muscular activity pattern, insight has been gained in the hand rim wheelchair propulsion dynamics of people with a disability, varying in level of physical activity and functional potential. The limiting environment of a laboratory, however, has hampered the drawing of sound conclusions. Through mathematical modelling, simulation and optimization (minimizing

injury and maximizing performance), insight in the underlying musculoskeletal mechanisms during wheelchair propulsion is sought. The surplus value of inverse and forward dynamic simulation of hand rim stroke dynamics is addressed. Implications for hand rim wheelchair sports are discussed. Wheelchair racing, basketball and rugby were chosen because of the significance and differences in sport-specific movement dynamics. Conclusions can easily be transferred to other wheelchair sports where movement dynamics are fundamental [13].

The players having less functional ability (Classes 1 and 2, whose typical disabilities include level L1 and upper paraplegia) tended to release the ball from a lower release height using a greater ball release velocity. Therefore, the vertical component of the ball velocity should be used. Using the average ball velocities and projected angles.

The kinematic features of wheelchair basketball players in compared with those of able-bodied basketball players in shooting skills. The reduced ball release velocity for the wheelchair players depended on an insufficient angular velocity of the wrist flexion motion, which may be restrained by dysfunction of available musculature. Moreover, for shoulder horizontal abduction motion near the time of shoot ball there is a larger range of shoulder abduction motion and larger displacements of the right shoulder in the tetraplegia players. Maximize the function of available musculature around the elbow and shoulder joints, thereby compensating for dysfunction of the wrist flexor muscles and contributing to the resultant ball release velocity [17].

### CONCLUSION

This study tried to analysis of some variables biomechanics of motor performance and interpretation of kinetic performance variables compared to ordinary athletes, Where I discuss the results of the analyses of previous studies to clarify the nature of the link in the values of selected variables Between ideal and perfect, so emphasizing studies that link the values of kinetic performance variables remains constant in both cases, add highlighting the extra effort for disabled persons in order to achieve performance excellence perfectly.

### REFERENCES

1. “Commonwealth games federation - commonwealth sports - elite athletes with a disability (ead).” [Online]. Available: <https://www.thecgf.com/sports/ead.asp>. [Accessed: 10-mar-2018].
2. “history of adaptive and disabled sports | adaptive sports for anyone with a disability | disabled sports USA,” 05-feb-2016. [Online]. Available: <https://web.archive.org/web/20160205185150/http://www.disabledsportsusa.org/disabled-sports-early-history/>. [Accessed: 10-mar-2018].
3. “History of the Paralympics,” 02-aug-2009. [Online]. Available:<https://web.archive.org/web/20090802152653/http://www.paralympiceducation.ca/content/history/11%20history%20of%20the%20paralympics.asp?langid=1>. [Accessed: 10-mar-2018].
4. g. International society of biomechanics in sports and I. E. Holt, “isbs - conference proceedings archive,” isbs - conf. Proc. Arch., vol. 1, no. 1, pp. 8–9, 1983.
5. “Paralympics history - history of the Paralympic movement,” international Paralympic committee. [Online]. Available: <https://www.paralympic.org/the-ipc/history-of-the-movement>. [Accessed: 10-mar-2018].

6. k. E. Y. Words, l. P. Games, i. P. Committee, b. Ag, and v. M. X. Control, “shot put kinematics of world class athletes with an intellectual disability institute of biomechanics and orthopedics , German sports university,” vol. 11, pp. 431–434, 2011.
7. a. Greenhalgh, l. Frossard, s. Miller, and a. O. Riordan, “biomechanics of seated shot put overview • background to seated throwing • pilot study 1 & 2 – methods – results • overall conclusions & applications.”
8. f. Morrien, m. J. Taylor, and f. J. Hettinga, “biomechanics in paralympics: implications for performance,” *int j sports physiol perform*, pp. 1–34, 2016.
9. k. E. Y. Words, “kinematics and aerodynamics parameters on paralympic discus throw túlio banja cenesp , universidade de pernambuco , recife , brasil faculdade católica do ceará , fortaleza , brasil universidade federal do ceará , fortaleza , brasil,” *symp. Q. J. Mod. Foreign lit.*, no. 3, pp. 521–524, 2007.
10. a. Gil-agudo, a. Del ama-espinosa, and b. Crespo-ruiz, “wheelchair basketball quantification,” *phys med rehabil clin n am*, vol. 21, no. 1, pp. 141–156, 2010.
11. f. S. Yousef, mohanad abdesatar, and Ali kamel houcién, “limiting standards for some defending tests against shooting for basketball juniors players,” vol. 2, no. 26, pp. 12–34, 2014.
12. l. A. Malone, p. L. Gervais, and r. D. Steadward, “patterns of segment co-ordination in wheelchair basketball shooting,” *j. Hum. Mov. Stud.*, vol. 43, no. 3, pp. 211–227, 2002.
13. y. Vanlandewijck, d. Theisen, and d. Daly, “wheelchair propulsion biomechanics: implications for wheelchair sports,” *sports med*, vol. 31, no. 5, pp. 339–367, 2001.
14. Terzis, G, Kyriazis, T, Karampatsos, G & Georgia, G. Muscle strength, Body composition, and performance of an elite shot-putter. *International Journal of Sports Physiology and Performance*, 7(4), 394–396, 2012.
15. Young, M., & Li, L. *Athletics. Sports Biomechanics*, 4(2), 131–148, 2005.
16. J. Ellidge, “Biomechanics of a Discus Throw: Biomechanics within Discus,” *Biomechanics of a Discus Throw*, 19-Jun-2014.
17. W. Doyo, S. Sakurai, Y. Ikegami, K. Yabe, “A kinematic study of the upper-limb motion of wheelchair basketball shooting in tetraplegic adults” *Journal of Rehabilitation Research and Development.*, vol. 39, no. 1, pp. 63–71, 2002.

## A COMPARATIVE STUDY OF PRE COMPETITIVE ANXIETY BETWEEN FEMALE PLAYERS AND MALE PLAYERS IN DEFFRENT GAMES AND EVENTS

JASWINDER SINGH

Assistant Professor, Baba Farid College Bathinda, India

### Abstract

The purpose of the study was to find out pre competition anxiety between players of Female Players and Male Players. During competition, athlete's mental state greatly affects their neuromuscular coordination, which finally influences the outcome of final competition. Anxiety in sports is considered as an important issue for many athletes. It refers to nervousness and fear emotion formed by frustration of self-esteem and self-confidence, or increasing of the sense of failure and guilty, which is resulted by the threat from being unable to achieve goals or to overcome obstacles at the right time. For the purpose of the study, the investigator selected the subjects from inter-college competition held at Punjab University Chandigarh. To measure the pre-competition anxiety, Sports Competition Anxiety Test (SCAT Martens et al., 1990) developed by Rainer Marten was applied. Thirty (n=30) Female Players and thirty (n=30) Male Players were selected. Students T-test was used to find the difference between both groups. The study was significant at 0.05 significance level.

**Key words:** Pre- competitive Anxiety, Female and Male Players

### INTRODUCTION

By nature human beings are competitive and ambitious for the excellence in all athletic performances. Not only every man but every nation wants to show their supremacy by challenging other Male, state, group or nation. This challenge stimulates, inspires and motivates the entire nation to strive for faster, higher, and further. It compels to exaggerate, strength, endurance and skills in the present competitive sports world. A highly competitive sport environment leads to anxiety among players .Competitive anxiety is one of the factors to decrease athlete's performance (Esfahani & Soflu., 2010). Anxiety is among the many adverse effects of stress. It is the process during which a person become scared and apprehensive of what lays ahead and often manifesto itself in physical anxiety labeled as a "distrusted State" of body and mind or state of "nervousness" anxiety is apprehension of danger accompanied by restlessness and oppression in the digestive tract and viscera. Feelings of tension, thinking of upcoming events in their mind, nervousness, and worry and involved in physiological changes such as increase in heart rate response are common response for the athletes prior to the competition (Hackfort & Spielberger, 1989). Trait anxiety, an athlete disposition to interpreting a situation as threatening and responding than with lower trait anxiety and so respond with a high state anxiety, this is known as competitive trait anxiety. Anxiety has both psychological and physiological implications in sport performance. For example, once arouse level of the player to such an extent that he finds it hard to concentrate on his game due to constant bombardment on his nervous system. The ability of the player to monitor and judge situations correctly is reduced. His information processing mechanism gets over-stressed resulting either in wrong or slow response even to

emergent situations. He loses control over his body and mind. Douglas et al (2006) stated that the major sources of pre-competitive anxiety include: fear of failure, thinking too much on what people may say about the performance, and lack of confidence. The ability to cope with pressure and anxiety is an integral part of sports, particularly among elite athletes. It is also seen that most of experience athletes and team players having better coping skills. Some coping skill such as mental imagery goal setting and positive self-talk are important to deal with stress and competitive anxiety both in Female and Male Players.

### **METHOD**

For the purpose of present study, total sixty (60) players were selected. In the category of Female and male Players there were 30 individual players i.e. (15) Athletics players, fifteen (15) Boxing players; and for teams games there were 30 players i.e. (15) Hockey players and fifteen (15) Kabaddi players were randomly selected to serve as subjects of the study. The subjects were selected from inter-college competition held at Jammu University. Age of the subjects ranged between 20-28 years. For data collection, Sports Competition Anxiety Test (SCAT Martens et al., 1990) was used to measure Sports Competition Anxiety.

### **RESULTS**

Table-1 shows that the mean and standard deviation of Female Players was  $22.20 \pm 2.01$  and the mean and standard deviation of Male s was  $18.57 \pm 2.45$ . The t-value was 6.297 . After analyzing data, significant difference was found between Male and Female players.

**Table-1: Significance of Differences of Mean, Standard deviation and 't' test on pre-competition Anxiety between Female Players and team**

	<b>N</b>	<b>Mean</b>	<b>Std. Deviation</b>	<b>t-test</b>
<b>Female Players</b>	<b>30</b>	<b>22.20</b>	<b>2.01</b>	<b>6.291</b>
<b>Male Players</b>	<b>30</b>	<b>18.57</b>	<b>2.45</b>	

*Level of significance at 0.05, Degree of freedom (58) = 2.001*

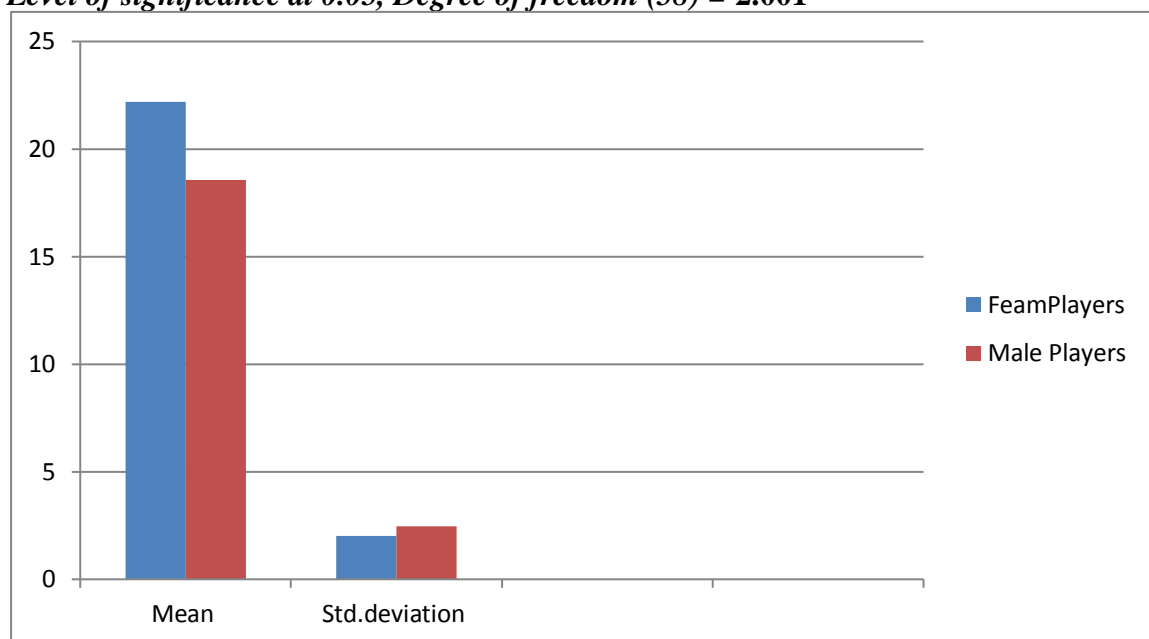

*Graphical representation of mean and standard deviation (N=30) between Female Players and male Players.*

**Discussion of finding:** Anxiety play important role in sports performance. The present study revealed that Female Players have more pre competitive anxiety than male players. The success of athlete depends upon how he is able to control his anxiety during competition and keep it at optimum level. Psychological training should aim at mental stability, a coach should expose the athlete to competition situation repeatedly so that the athlete could accustomed with new situations and circumstances arises during competition as new situations arises anxiety. In male players the accountability of a player is less than an Female Players because spectators will evaluate the performance of a male not player and consequently Male athletes as well as their coaches are much more worried about their mistakes than team athletes.

## CONCLUSION

Based on the findings of the present study, it is concluded that Female Players are more prone to pre-competitive anxiety due to fear of failure, thinking too much on what people may say about the performance, and lack of confidence, if there is defeat than a player is responsible. Female Players are subjected to less pre-competitive anxiety due to share of responsibility, diffusion of accountability and adjustable ability with the environment as spectators will evaluate the performance of a team not a single player.

## **References**

### **Books**

1. Clifford T. Morgan, Richard A. King, John R. Weiss & John Schopler.(2002),Introduction to psychology, Pp 321-322, Published by Tata Mc Graw-Hill publishing company limited, 7 West Nagar, New Delhi 110 008.
2. Dr. Sheokand Daisy (2007), Psychology of team sports, Pp111-121, EMCA House, Ansari road, Darya Gang, New Delhi.
3. Mohan J., Ch02adha N.K., Akhtar S. S. (2005),Psychological of sports, Pp 40-43, Friends publication (india) publishers of books on physical education and sports sciences New Delhi.
4. Verma J.P. (2009), *A Text Book On Sports Statistics*, (Sports Publication, New Delhi).

### **Journals and Periodicals**

1. D.W. Rainey, L.Hardy (1997), “Rating of stress by rugby referees”, Journal of Perceptual and motor Skills,”Vol. 83 Num.3, Pp 728-730.
2. Dr. Singh K., Zala S. R, Dr. Choudhary R., Prakash O. (2010), “Comparison of life stress among different teaching professions, genders and their interactions”, AMASS, Vol. 2 Num. 2, Pp. 46-50.
3. Hanton S., Fletcher D. & Coughlan G. (2005), “Stress in elite sport performers: A comparative study of competitive and organizational stressors”, Journal of Sports Sciences, Vol. 23, Issue 10, Pp. 1129-1141.
4. Dr. Prasad Sahu Deba (2016),“A comparative study on pre-competition anxiety between Male.
5. Games and Female Players”, International Journal of Multidisciplinary Research and Development, Volume



## PERFORMANCE IN CONNECTION WITH SELF-ESTEEM IN SPORTS & PHYSICALS ACTIVITIES PSYCHO- SOCIOLOGICAL APPROACH

**.Sadek Smail<sup>1</sup> & Mustapha Cherif Bourennane<sup>2</sup>**

ISTAPS, University of Djilali Bounaama, Khemis-Miliana, Algeria (1)

IEPS, University of Algiers 3, Algeria (2)

### **Abstract**

The main issue of this study is to determine and elaborate the appropriate strategies that allow us master, control and adjust the performance skills. This is being done through the description, the explanation and the measuring of their self-esteem in its socio-economic context as an external factor in the relationship between performance and self-esteem.

**Keywords:** self-esteem, performance skills, sports & physical activities, socio-economic factors

**Abbreviations:** P.S: performance, S E: self-esteem, F.A.T.S: family attitudes towards sports

### **INTRODUCTION**

Self-esteem is a major psychological parameter in any human being's life. It's, in fact, the way people perceive themselves and it includes emotions as self-confidence, self-acceptance and "aptitude". In sports psychology, several researchers are interested in an existing connection between self-esteem and the different notions they are studying such as good health, joining in the practice of a physical activity and physical aptitudes. Actually, this connection has been targeted by many studies mainly those about self-esteem and performance. However, there's a divergence in opinions as far as the causal of these two variables is concerned. Some researchers consider that self-esteem is mainly a consequence of performance. Yet, there's a third opinion advocating the existence of a more realistic compromise on the model of reciprocal effects according to which self-esteem influences future achievement and the latter influences future self-esteem (Famose,90). In fact, the challenge of our investigation is to check up the validity of all these opinions in young football players and to highlight the relation between self-esteem, performance skills and family attitudes towards sport. This study is based on the socio-cognitive theory of Bandura (1986) which claims that self-esteem is partly conditioned by "the adequacy of a person's behaviour with his personal criteria in terms of merit" and is formed through his interpretations of experiences within his environment with all its factors.

To achieve this purpose, we've tried to respond to the following questions: does a person have to be skilled to get a positive self-esteem? Or, is self-esteem a requirement to get skill? Moreover, do external factors, such as family attitudes towards sports, have any kind of influence on this relation?

## METHOD

### Participants

The study has been done on a sample of 145 young football players aged between 15-17 evolving in the Algerian football championship.

### Procedures & tasks

To establish this connection, we have used a football technical tests battery (wanderhof battery) so as to evaluate participants' performance skill. We have also used "Tennessee questionnaire test of self-esteem" (T.S.C.S) in its Arabic version according to (Allaoui & Redouan, 1987) in addition to a questionnaire elaborated by our research team aiming at measuring the participants families attitudes towards sport.

The statistic study was based on the calculation of the values of "Student test" to reply to the first two questions after having defined two distinct levels separated by a theoretical arithmetic average for each test (T.S.C.S & Wanderhof battery).

As concerns the third question, we've used the multiple correlation coefficient to check up the link between the three variables.

## RESULTS AND DISCUSSION

**Table1:** "t" value of self-esteem between the two levels of football players skill.

performance skill	Self-Esteem				t	sig
	n	$\Sigma$	$\bar{X}$	S		
Good level	125	46570	372.56	6.66	4.26	0.01
Less good level	20	2718	135.9	1.85		

**Table 2:** "t" value of skill between the two levels of football players self esteem.

Self-Esteem	performance skill				t	sig
	n	$\Sigma$	$\bar{X}$	S		
Good level	97	5630	58.04	4.87	2.326	0.01
Less good level	48	1623	33.81	3.85		

**Table 3:** correlation coefficient between performance skill, self esteem & sport interest.

	n	$\Sigma$	$\bar{X}$	r <sub>12</sub>	r <sub>13</sub>	r <sub>23</sub>	R	F	Sig f $\alpha$
P.S	145	7253	50.02	0.941	0.911	0.882	0.954	36.911	0.01
S.E		49288	339.91						
F.A.T.S		3346	23.07						

The findings showed that: (tab1) significant difference of self-esteem between the two levels of performance skill in favor of the good level; (tab2) significant difference of performance skill between the two levels of self-esteem in favor of the good level. This explains the fact that the participants with a good level in performance skill are more likely to have a better self-esteem than those with a less good level in performance skill and the contrary, participants with a good level of self-esteem do have better performance skill compared with those with a less good level of self-esteem; (table 3) strong positive correlation between performance skill, self-esteem & family attitudes towards sport.

### **CONCLUSION**

The heart of the matter in this study has been to bring out the fact that self-esteem and performance skill are deeply linked and get stronger mutually. Indeed, better self-esteem results in better performance skill and in contrast to that, better performance skill lead to a better self-esteem. This study has also focused on the influential effect of family attitudes towards sport as far as the relation self-esteem and performance skill is concerned. All this leads us for the setting up of explicit interventions of self-esteem in a variety of sports competitions training programs and we impel parents to promote suitable conditions so as to attract and motivate their children for sport practice.

### **References**

1. Allaoui, M, H., & Redouan, M, N. (1987). *Skills end Psychology tests in sport domain* (pp. 632-648). Le Caire: Dar el fikr el Arabi.
2. Bandura, A. (1986). *Social Foundations of Thought and Action: A Social Cognitive Theory*, Englewood Cliffs (pp. 410). N.J: Prentice-Hall.
3. Jowett, S., & Lavallee, D. (2008). *Psychologie sociale du sport* (Christophe Billon, Traducteur) (pp.189). Paris: De Boeck.

## MOTIVES FOR PHYSICAL ACTIVITY AND LEISURE PARTICIPATION OF FILIPINO PRE-SERVICE PHYSICAL EDUCATORS

**Julius Ceazar G. Tolentino, LPT, MPES**

College of Education, Don Honorio Ventura Technological State University,  
Bacolor, Pampanga, Philippines  
juliusceazartolentino@yahoo.com

### **Abstract**

Inasmuch as motives for physical activity and leisure participation have been a well-explored research area in occidental and oriental countries, a very limited data was available in the Philippines specifically on pre-service physical educators. The aim of this study was to analyze the motives for physical activity and leisure (PAL) participation of pre-service physical educators of a certain Philippine state university. One hundred ten Filipino pre-service physical educators (male = 34; females = 76) with a mean age of 19.7 years old responded to the Physical Activity and Leisure Motivation Scale (Morris & Rogers, 2004). Mean scores revealed that physical condition is the most identified motive while competition/ego is the least. T test independent sample revealed no significant differences between male and female perceptions on their PAL participation. Also, ANOVA indicated no significant differences on any subscale when grouped according to their age. Lastly, through Pearson correlation, certain subscales revealed significant relationship with the others except for psychological motive as can be seen in the study. This may serve as a baseline data in crafting plans and targets to further the PAL participation of Filipino pre-service physical educators putting into premium their motives to undertake such.

**Keywords:** physical activity, leisure participation, pre-service physical educators, PALMS

### **INTRODUCTION**

Physical activity is defined as any movement carried out by the skeletal muscles that require energy above the basal metabolic rate (Fahey, Insel, & Roth, 2004). A considerable attention was given to the concept of physical activity (PA) as a well-explored area of interest in the human movement sciences. Recent studies related it to dietary habits among low-income children (Goodrum, Brusseau, Shaw & Burns, 2018); to motor competence among teenagers (Campos, Queiroz, Da Silva, Feitoza & Cattuzzo, 2017); or its contribution to the “life’s seven metric” in older rural adults (Hart, 2017). These imply a dynamic and established area of study where various populations were considered.

Modern society is witnessing a sharp decline in individual adherence to physical activity and leisure (PAL). In fact, it was reported by the World Health Organization that “80% of the adolescent population is insufficiently physically active” (WHO, 2017). With the beginning and excessive use of technology, people have become contented to engaging in sedentary lifestyle and leisure activities. This is one of the major causes of lifestyle-related illnesses. Physical inactivity is linked to many major causes of mortality and morbidity, including heart disease, cancer, diabetes, and depression (Armstrong, Bauman, & Davies, 2000). Thus, it is imperative to motivate people to undertake more physical activities (Lloyd-Jones, Yuling, Labarthe, Mozaffarian, Appel, & Van Horn, 2010; Frederick Recascino & Morris, 2004).

Motivation is one of the most prominent factors that encourage and maintain individuals' participation in PA. For instance, individuals who are intrinsically motivated to participate in a PA (e.g., who are motivated by factors, that are about the activity, such as enjoyment or skill development and mastery), tend to participate over a longer period of time, as compared to extrinsically motivated individuals, who engage in a PA due to factors that are not related to the activity itself, such as rewards, improved health, looking good (Frederick & Ryan, 1993).

To evaluate why some people are physically active while others are not, researchers have examined their motives for sport and exercise involvement (Bartholomew, Ntoumanis, and Thøgersen-Ntoumani, 2009; Biddle, Wang, Kavussanu, and Spray, 2003; Frederick, Recascino & Morris, 2004). In general, current measures of participation motivation present in Physical Activity and Leisure is using PALM. In this way, by studying people's motivation in PAL, health researchers can utilize this information to create awareness that will not only prove beneficial on an individual level, yet additionally help the group by lessening way of life related ailments. All the more particularly, outfitted with this information, wellbeing experts, for example, physical education and health teachers, can create intervention or well organize lesson to inspire individuals to take part in physical activity, in this way expanding physical movement adherence.

Consequently, a shorter measure, called the Physical Activity and Leisure Motivation Scale (PALMS), was developed by selecting the five strongest items on each of the eight factors in the REMM, producing a 40-item measure (Morris & Rogers, 2004). Relative to this, Chowdhury (2012) confirmed a strong positive correlation ( $r = 0.9$ ) between the two instruments.

Motivation may assume a key part in expanding and keeping up PA levels. Understanding the motivation in PA and Leisure may give significant data to recreation providers who need to empower and even increment the level of PA among their population including Physical Educators. Because of the evolving socioeconomics and generational qualities of adolescent, it is vital to keep on tracking reasons why individuals partake in the diverse kind of PA and utilize this data to help drive wellbeing programming. This study gathered information on PALM. The point of present research was to look at whether the thought processes are identified with the amount PA individuals do and furthermore whether PA intentions anticipated the real measure of PA at a later time.

In the Philippines, several authors explored the area of participation motivation and motives for exercise as perceived by Filipino youth. The study of Sanchez (2008) for one revealed that challenge, social recognition, affiliation, and competition emerged as five most common motives to undertake sports activities; whereas "ill-health avoidance" was identified as the leading motive to do exercise participation. The study of Cagas, Torre and Manalastas (2014), identified weight management, health pressures, strength and endurance, appearance, and positive health as Filipinos' motives for exercise.

The general aim set in this study was to analyze the motives for physical activity and leisure participation of pre-service physical educators from a certain Philippine state university. Moreover, it sought to describe the PAL participation of the respondents in terms of mastery, enjoyment, physical, psychological, appearance, others' expectation, affiliation, and competition. This will pave the way towards the development of comprehensive physical activity plans that best suits their interests and motives.

## METHOD

### Respondents

For this study, 110 Bachelor of Physical Education major in School Physical Education (BPE-SPE) students of a certain state university in Pampanga, Philippines during the Academic Year 2017-2018 took part in the study. A convenience sampling was employed as sampling technique. Majority of the student-respondents are females ( $n = 76$ ) or 69.09% of the population while the rest are males ( $n = 34$ ) or 30.91%. This implies that there is a higher distribution of female pre-service teachers in teacher education institutions, even for Physical Education as a major. Respondents also have a mean age of 19.7 years old.

### Instrument

#### *The Physical Activity and Leisure Motivation Scale*

The Physical Activity and Leisure Motivation Scale (PALMS) (Morris & Rogers, 2004) was the lone instrument used in the study. Permission to use the questionnaire was granted by the authors. The PALMS is a forty-item questionnaire that is divided into eight subscales: (a) mastery, (b) enjoyment, (c) psychological condition, (d) physical condition, (e) appearance, (f) others' expectation, (g) affiliation, and (h) competition/ego. The PALMS is a reliable instrument with a Cronbach's alpha of 0.79 as it was tested on a large international sample from a wide range of activities (Chowdhury, 2012). Moreover, the respondents' profile such as their age and sex were also asked which constituted the first part of the questionnaire.

The respondents' motives for physical activity and leisure participation were analyzed using a four-point Likert scale with 1 to mean strongly disagree and 4 as strongly agree. For this study, it was modified to a 4-point Likert scale instead of 5 to abstain from neutrality (1 = Strongly Disagree; 2 = Disagree; 3 = Agree; 4 = Strongly Agree).

### Procedures

Permission was sought from the authorities of the University which included the chairperson of the program and the dean of the college to administer the PALMS. Since the author was also the instructor of the participants, this provided ease of administration following ethical considerations before, during, and after the conduct of the data-gathering procedures, like explaining the purpose of the study, and the assurance of the anonymity of the participants after obtaining data from the questionnaire.

In order to provide ease of administration, the author administered the questionnaire via an online survey platform (Google Drive) where items in the PALMS survey were entered. Respondents were notified of the link to access the online survey form through an educational social group page and they were given two weeks to accomplish it considering students who have no direct access to the internet. After two weeks, data were exported in Microsoft Excel and were treated statistically using the Statistical Package for the Social Sciences (SPSS).

### Statistical Analysis

In order to describe the categorical variables such as sex and age, frequency and percentage were used. Descriptive statistics such as mean and standard deviation were utilized to describe the motives for physical activity and leisure participation of the respondents. In order to provide meaningful verbal interpretations to the respondents' assessment, the following ranges with corresponding description and interpretation were used, to wit: 1.00-1.75 (Strongly Disagree), 1.76-2.5 (Disagree), 2.51-3.25 (Agree), and 3.26-4.00 (Strongly Agree).

T test independent sample was used to determine if there is significant difference with the results when grouped according to sex. Analysis of variance was employed to test significant differences with the results when grouped according to age. Lastly, Pearson correlation was utilized to test relationship between and among the subscales.

## RESULTS

### Description of the Pre-service physical educators motives for physical activity and leisure participation

**Table 1.** Mean, SD and verbal interpretation of the motives for physical activity and leisure participation

No.	Others' expectation	Mean (SD)	VI	No.	Affiliation	Mean (SD)	VI
1	to earn a living	2.92 (0.76)	A	4	because I enjoy spending time with others	3.23 (0.84)	A
7	because I get paid to do it	2.08 (0.79)	D	8	to do activity with others	3.06 (0.81)	A
18	to manage medical condition	3.15 (0.76)	A	20	to do something in common with friends	2.91 (0.80)	A
21	because people tell me I need to	2.35 (0.83)	D	30	to talk with friends exercising	2.85 (0.77)	A
26	because it was prescribed by doctor, physio	2.47 (0.84)	D	38	to be with friends	3.04 (0.79)	A
<b>Average Mean</b>				<b>Average Mean</b>			
<b>2.59 (0.80)</b>				<b>3.02 (0.80)</b>			
<b>A</b>				<b>A</b>			
No.	Psychological Condition	Mean (SD)	VI	No.	Mastery	Mean	VI
2	because it helps me relax	3.22 (0.82)	A	5	to get better at an activity	3.26 (0.87)	SA
9	to better cope with stress	3.08 (0.86)	A	16	to improve existing skills	3.34 (0.88)	SA
35	to take mind off other things	3.10 (0.80)	A	19	to do my personal best	3.21 (0.87)	A
14	to get away from pressures	3.15 (0.83)	A	24	to obtain new skills/activities	3.32 (0.85)	SA
22	because it acts as a stress release	3.11 (0.82)	A	31	to keep current skill level	3.10 (0.71)	A
<b>Average Mean</b>				<b>Average Mean</b>			
<b>3.13 (0.82)</b>				<b>3.25 (0.84)</b>			
<b>A</b>				<b>A</b>			
No.	Physical Condition	Mean (SD)	VI	No.	Competition/ Ego	Mean	VI
12	be physically fit	3.35 (0.87)	SA	6	because I perform better than others	2.47 (0.77)	D
15	to maintain physical health	3.38 (0.86)	SA	17	to be best in the group	2.55 (0.84)	A
10	to better cope with stress	3.28 (0.85)	SA	39	to be fitter than others	2.60 (0.85)	A
33	to improve cardiovascular fitness	3.30 (0.84)	SA	27	to work harder than others	2.67 (0.74)	SA
28	because it keeps me healthy	3.24 (0.79)	A	29	to compete with others around me	2.35 (0.90)	D
<b>Average Mean</b>				<b>Average Mean</b>			
<b>3.31 (0.84)</b>				<b>2.53 (0.82)</b>			
<b>SA</b>				<b>A</b>			
No.	Enjoyment	Mean (SD)	VI	No.	Appearance	Mean	VI
3	because it's interesting	3.31 (0.85)	SA	11	to define muscle, look better	3.03 (0.76)	A
25	because it's fun	3.29 (0.88)	SA	23	to improve body shape	3.05 (0.80)	A
13	because it makes me happy	3.29 (0.90)	SA	40	to maintain trim, toned body	3.04 (0.77)	A
34	because I enjoy exercising	3.27 (0.79)	SA	32	to improve appearance	3.08 (0.78)	A
37	because I have a good time	2.99 (0.76)	A	36	to lose weight, look better	2.96 (0.82)	A
<b>Average Mean</b>				<b>Average Mean</b>			
<b>3.23 (0.83)</b>				<b>3.03 (0.79)</b>			
<b>A</b>				<b>A</b>			

Note: SA = Strongly Agree; A = Disagree; D = Disagree; SD = Strongly Disagree

Table 1 presents the mean, standard deviation (SD) and verbal interpretation (VI) of each item in each subscale motive. It could be noted that in terms of “others’ expectation”, three items (7, 21, & 26) were disagreed by the respondents while the other two (1 & 18) were agreed by them. In terms of psychological condition as a motive, respondents agreed with all the statements. In physical condition, the respondents affirmed a strong agreement on almost all items (12, 15, 10, & 33) except for one with which they agree (28). A similar result was shown with that of enjoyment as a motive where they also strongly agreed on four items (3, 25, 13, & 34) and agreed on one (37). All items under the subscale “affiliation” were agreed by the respondents. Moreover, in terms of mastery, three items were strongly agreed

(5, 16, & 24) and the rest were agreed (19 & 31). Competition/ ego as a motive received an average mean of 2.53 which implies an agreement by the respondents even though two items were disagreed (6 & 29), the other items were still agreed (17 & 39) and strongly agreed (27).

In general, the pre-service physical educators are motivated to participate in physical activities and leisure primarily due to physical condition as it ranked first among the eight subscales having obtained an average mean of 3.31 as shown in table 1. On the other hand, competition/ ego ranked the lowest having, obtained a mean score of 2.53 among the subscales, which implies that the respondents considered it as their least motive.

**Differences of the motives for PAL participation when grouped according to sex**

**Table 2.** Significant differences of the motives for PAL participation when grouped according to sex

		<b>F</b>	<b>Sig.</b>	<b>t</b>	<b>df</b>	<b>Sig. (2-tailed)</b>
<b>Mastery</b>	Equal variances assumed	4.902	0.29	.318	108	.751
	Equal variances not assumed			.284	49.696	.778
<b>Enjoyment</b>	Equal variances assumed	7.238	.008	.510	108	.611
	Equal variances not assumed			.447	48.203	.657
<b>Physical</b>	Equal variances assumed	5.959	.016	.630	108	.530
	Equal variances not assumed			.557	48.920	.580
<b>Psychological</b>	Equal variances assumed	6.048	.016	1.317	102	.191
	Equal variances not assumed			1.158	38.920	.254
<b>Appearance</b>	Equal variances assumed	3.023	.085	-.169	108	.866
	Equal variances not assumed			-.159	55.329	.874
<b>Others' Expectation</b>	Equal variances assumed	.628	.430	-1.820	108	.072
	Equal variances not assumed			-1.767	59.33	.082
<b>Affiliation</b>	Equal variances assumed	2.835	.095	-.487	108	.627
	Equal variances not assumed			-.457	55.045	.650
<b>Competition</b>	Equal variances assumed	.915	.341	-2.038	108	.044
	Equal variances not assumed			-1.921	55.598	.060

Table 2 shows the significant difference on each subscale when grouped according to sex. Through the use of T test independent sample, it evidently reveals that there are no statistically significant differences between the assessment of male and female pre-service physical educators on any of the motives for PAL participation. This only implies that both groups have closely similar perception or assessment regardless of their sex.

**Differences of the motives for PAL participation when grouped according to age**

Table 3 reveals the significant difference on each subscale when grouped according to age. Through the use of Analysis of Variance (ANOVA), it evidently reveals that none of the subscales has an identified significant difference between the assessments of pre-service physical educators considering their age. This only implies that regardless of their age, they still have similar perception or assessment on their motives for PAL participation.



**Table 3.** Significant differences of the motives for PAL participation when grouped according to age

		<b>Sum of Squares</b>	<b>df</b>	<b>Mean Square</b>	<b>f</b>	<b>Sig.</b>
<b>Mastery</b>	Between Groups	3.4161	9	.385	.685	.721
	Within Groups	56.112	100	.561		
	Total	59.573	109			
<b>Enjoyment</b>	Between Groups	4.059	9	.451	.795	.622
	Within Groups	56.756	100	.568		
	Total	60.815	109			
<b>Physical</b>	Between Groups	3.648	9	.405	.762	.651
	Within Groups	53.194	100	.532		
	Total	56.842	109			
<b>Psychological</b>	Between Groups	2.761	9	.307	.571	.818
	Within Groups	50.509	94	.537		
	Total	53.270	103			
<b>Appearance</b>	Between Groups	4.790	9	.532	1.222	.290
	Within Groups	43.335	100	.435		
	Total	48.335	109			
<b>Others' Expectation</b>	Between Groups	1.687	9	.187	.603	.792
	Within Groups	31.070	100	.311		
	Total	32.757	109			
<b>Affiliation</b>	Between Groups	3.577	9	.397	.833	.543
	Within Groups	45.027	100	.450		
	Total	48.604	109			
<b>Competition</b>	Between Groups	3.899	9	.433	.999	.446
	Within Groups	43.348	100	.433		
	Total	47.247	109			

### **Correlation between subscale motives for physical activity and leisure participation**

The correlation between and among subscale motives for physical activity and leisure participation of the pre-service physical educators can be seen in table 4. It could be noted that there is a very high, direct correlation between mastery and enjoyment; mastery and physical; mastery and appearance; and mastery and affiliation, in which the relationships are significant at  $\alpha = 0.01$ . A similar evaluation was observed between physical and enjoyment; physical and appearance; physical and affiliation; and enjoyment and affiliation.

However, there is a high relationship and a positive correlation noted between the following motives: appearance and enjoyment; appearance and others' expectation; appearance and affiliation; others' expectation and affiliation; and others' expectation and competition. Results are also significant at  $\alpha = 0.01$ .

Moreover, a moderate positive correlation was revealed among the following subscales: others' expectation and mastery; others' expectation and enjoyment; others' expectation and physical. Also, a similar evaluation was noted for competition and mastery; competition and affiliation; competition and appearance; competition and enjoyment; and competition and physical.

Consequently, psychological motive has an extremely low, inverse relationship with all the other subscale motives. The results are not significant at  $\alpha = 0.01$ .

**Table 4.** Correlation between each subscale motive

		Mastery	Enjoyment	Physical	Psychological	Appearance	Others' Expectation	Affiliation	Competition
<b>Mastery</b>	Pearson r	1	.938**	.940**	-.164	.822**	.546**	.827**	.464**
	Sig. (2-tailed)		.000	.000	.097	.000	.000	.000	.000
	N	110	110	110	104	110	110	110	110
<b>Enjoyment</b>	Pearson r	.938**	1	.954**	-.134	.793**	.528**	.864**	.431**
	Sig. (2-tailed)	.000		.000	.175	.000	.000	.000	.000
	N	110	110	110	104	110	110	110	110
<b>Physical</b>	Pearson r	.940**	.954**	1	-.140	.827**	.557**	.846**	.412**
	Sig. (2-tailed)	.000	.000		.158	.000	.000	.000	.000
	N	110	110	110	104	110	110	110	110
<b>Psychological</b>	Pearson r	-.164	-.134	-.140	1	-.189	-.003	-.150	-.143
	Sig. (2-tailed)	.097	.175	.158		.055	.973	.128	.148
	N	104	104	104	104	104	104	104	104
<b>Appearance</b>	Pearson r	.822**	.793**	.827**	-.189	1	.608**	.741**	.516**
	Sig. (2-tailed)	.000	.000	.000	.055		.000	.000	.000
	N	110	110	110	104	110	110	110	110
<b>Others' Expectation</b>	Pearson r	.546**	.528**	.557	-.003	.608**	1	.625**	.718**
	Sig. (2-tailed)	.000	.000	.000	.973	.000		.000	.000
	N	110	110	110	104	110	110	110	110
<b>Affiliation</b>	Pearson r	.827**	.864**	.846**	-.150	.741**	.625**	1	.594**
	Sig. (2-tailed)	.000	.000	.000	.128	.000	.000		.000
	N	110	110	110	104	110	110	110	110
<b>Competition</b>	Pearson r	.464**	.431**	.412**	-.143	.516**	.718**	.594**	1
	Sig. (2-tailed)	.000	.000	.000	.148	.000	.000	.000	
	N	110	110	110	104	110	110	110	110

\*\*Significant at  $p < 0.01$

## DISCUSSION

A detailed motive will predict the amount of PAL people do. This is because behavior is determined by the motivation. People do the behavior that they are motivated to do (R. Ryan, E. Deci, 2002). Thus, motives that are high will lead to more of the behaviour related to those motives, in this study. Self-directed motives for a particular behaviour will result in increased levels of that behaviour, and there is extensive research to support this prediction. Intrinsic and identified motives have been linked with increased exercise participation [M. Standage, S. Sebire, T. Loney, 2008] and higher levels of PA [P.M. Wilson, D. Mack, S. Muon, M. LeBlanc. 2007].

Research on participation motivation suggests that there are systematic differences between participation motives and some demographic variables. The results, in the present study, indicated no significant gender difference on specific subscales of the PALMS. Future research should use broader samples to show the difference between males and females in terms of motivation in PAL. Motivation is accepted as an important determinant for behavior.

Fun, enjoyment and social support for aspects of identity were reported more often as predictors of participation and non-participation than perceived health benefits. For young children and teenage girls in particular, pressure to conform to social stereotypes is a key motivator. Along with older groups, children see enjoyment and social interaction with peers as reasons to be physically active. Although girls report a willingness to be active, this must be on their own terms in a safe non-threatening environment.

In addition, Emir et al. (2013) indicated that positive relationship between frequency of participation and motivation. When frequency of participation was increased, motivation points were increased. Frequency of participation also effects moderately and highly involvement in a physical activity (Kyle et al., 2004) and loyalty to leisure sport centers (Bodet, 2012). These findings are important for companies working in this sector. So, we can say that to increase the participation frequency is important element for recreation service sector.

Little is known about the reasons why people do and do not participate in physical activity and the relationship between their levels of participation and different stages in their lives. A number

of the papers reviewed (Coakley & White, 1992) found that significant shifts in the life course have implications for participation in physical activity. A mix of quantitative and qualitative methods could build an evidence base to understand changes to sport and physical activity at critical transitional phases during childhood, adolescence and adult life.

As a result, this descriptive research showed that “physical condition” and “physiological condition” dimensions were the most important motivators for university students to participate in the leisure physical activities and “mastery” and “enjoyment” dimensions followed these dimensions. The same results were valid for the gender. This means physical wellbeing and physiological wellbeing is important for the physical activity participants. Literature for sport and leisure studies mostly indicated that physical activity participation has positive effect on physical and physiological wellbeing (Güngörmüş et al., 2014; Aaltonen et al., 2012; Çağlar et al., 2009).

### **CONCLUSION**

A proposed physical activity and leisure plan may be developed in accordance with the results of the study since no significant differences were noted in terms of their PAL participation when grouped according to the categorical variables. Consider the prevailing motives that makes the pre-service physical educators motivated as they undertake physical activities to foster their total development.

### **ACKNOWLEDGMENTS**

The authors are immensely thankful to Asst. Prof. Christian Wisdom M. Valleser of the University of the Philippines Diliman; Dr. Riza B. Lintag, Dr. Jumel C. Miller, and Mr. Eddiebal P. Layco of the Don Honorio Ventura Technological State University, Bacolor, Pampanga.

### **References**

1. Cagas, J. Y., Torre, B. A., and Manalastas, E. J. (2014). Why do Filipinos exercise? exploring motives from the perspective of Filipino youth. *Youth in Physical Education and Sport*. Retrieved from [http://www.academia.edu/240919/Why\\_do\\_Filipinos\\_exercise\\_Exploring\\_motives\\_from\\_the\\_perspective\\_of\\_Filipino\\_youth](http://www.academia.edu/240919/Why_do_Filipinos_exercise_Exploring_motives_from_the_perspective_of_Filipino_youth) on May 9, 2018
2. Campos, C. M. C., Queiroz, D. dR., Da Silva, J. T. N., Feitoza, A. H. P., and Cattuzzo, M. T. (2017). Relationship between organized physical activity and motor competence in teenagers. *American Journal of Sports Science and Medicine*. 5(4), 82-85. DOI: 10.12691/ajssm-5-4-4
3. Chowdhury, D. R. (2012). Examining reasons for participation in sport and exercise using the physical activity and leisure motivation scale (PALMS). Published Doctoral Dissertation. *School of Social Science and Psychology, Faculty of Arts, Education and Human Development, Victoria University*
4. Goodrum, S. A., Brusseau, T. A., Shaw, J. M. and Burns, R. D. (2018). Relationship between after-school physical activity and dietary habits with cardio-metabolic risk in low-income children. *Journal of Physical Activity Research*. 3(1), 28-34. DOI: 10.12691/jpar-3-1-5
5. Hart, P. D. (2017). Contribution of physical activity to the life's simple 7 metric in older rural adults. *American Journal of Cardiovascular Disease Research*. 5(1), 1-4. DOI: 10.12691/ajcdr-5-1-1
6. Sanchez C. (2008). *Participation motivation for sport and for exercise among St. Paul University Manila service physical education students*. Unpublished Thesis. University of the Philippines, Diliman, Philippines

## **IMPACT OF REDUCING TRAINING LOAD(DELOAD) AND ITS IMPORTANCE IN MUSCLE BUILDING AND MAINTAINING THE LEVEL OF ACHIEVEMENT OF SPECIAL NEEDS PLAYERS IN THE EFFECTIVENESS OF DISCUS**

**MR.HAMID ABDULSADA KADHIM AL-AKRH**

**IARQ \ Al\_Qadisiyah**

**Specialization: Physical therapy and sports medicine**

### **Abstract**

Sport achievement is one of the most important duties of sports training and its achievement requires knowledge of many causal factors. And the impact of the lack of achievement to neglect some of the factors and therefore the achievement of achievement of the most difficult things facing Sports training and those in the field . "The world sports watchdog believes that sport is in a constant development .The study aimed at identifying the effect of using the trainees' training load reduction for the purpose of healing the body and the comfort of the musculoskeletal system in order to raise the efficiency of training in the coming periods for special needs players in the discus throwing activity at Al-Rafidain Sports Club in Qadisiyah Governorate in Iraq , The researcher used the survey method to suit the nature of the study, the society of the study of the total of 10 players, conducted the study on 29/3/2018 and for two weeks on the players of special needs in the Rafidain Sports Club in the province of Qadisiyah in Iraq, and the study proved that reducing the pregnancy training leads to The stability of the achievement and stability of the level reached by the players of special needs in the Rafidain Sports Club in the effectiveness of discus.

Key words: Training, load, Muscle building, achievement, performance

### **INTRODUCTION**

The world is witnessing a wide-ranging scientific renaissance in all fields, including the field Al-Riyadi, which is witnessing the whole cycle of this scientific renaissance thanks to the benefit of researches and studies. It stands at the forefront of research is the science of sports training, which means developing the physical efficiency of the individual. Skill and mobility in order to meet the requirements of athletic achievement. Among the sporting events that have received great attention in athletics are the great progress .In the digital achievement of athletics competitions, especially the effectiveness of discus .The effect of reducing the training load and its importance in building muscle for special needs players and modern techniques in training and the correct scientific curricula and investment of human energies in all its dimensions. The effectiveness of throwing disc in athletics has its own physical properties that you should enjoy .By throwing disc, such as speed, strength and power characteristic of speed and explosive force as the development of all capabilities .And to suit the requirements of achievement. The training process must be fruitful .Its results are reinforced through the use of modern science and modern techniques, from training in style .Reducing the training load and keeping pace with development calls for the search for new solutions and innovative means to help drive the wheel .Progress forward by finding alternative ways more useful than traditional methods used in .Sports field. "Reducing the training load improves muscle strength, muscle building, endurance, flexibility and agility, all

of which contribute to improving the athlete's performance in his or her original sport, especially the effectiveness of discarding special needs players' importance of studying

The importance of research is the need to use the reduction of the training load of the trainee for the purpose of healing the body and the comfort of the nervous system muscular to raise the efficiency of training during the upcoming periods of special needs players in the effectiveness of discus and in accordance with the training muscle .Necessary for these events, which works to develop the ability of the muscles working during the motor performance of. During the same performance or work similar to the performance in the race or competition and in the same direction of muscle work .So that they are appropriate with the nature of effectiveness .Which is intended to develop and give a greater result and hence came the idea that the use of reducing the training load of the trainee for the purpose of healing the body and the comfort of the nervous system muscular to raise the efficiency of training during the upcoming periods of special needs players in the effectiveness of discus and in accordance with the training muscle. This has an impact on the digital achievement of disk-throwing effectiveness.

#### Objective of the study

The aim was to identify the impact of the use of reducing the training load of the trainee for the purpose of healing the body and build muscle and comfort of the nervous system muscular to raise the efficiency of training during the upcoming periods of special needs players in the effectiveness of discus and in accordance with the training and maintain the stability of the stability of the results of special needs players study Problem

That many of the special needs players suffer from the exercise and the excess of the existing muscle growth muscle loses muscle growth which has reached the problem has emerged in the use of reducing the training load of the trainee for the recovery of the body and the comfort of the nervous system to increase muscle training and muscle building during the coming periods of players Special requirements in the effectiveness of discus.

#### Study hypotheses

1 - the use of reducing the training load of the trainee for the purpose of healing the body and the comfort of the nervous system to increase muscular training efficiency has a positive impact on the stability of the results reached by special needs players

2 - The use of reducing the training load of the trainee helps to build muscle and maintain muscle growth

#### Study Approach

The researcher used the survey method to suit the nature of the study problem

#### The study sample:

- The society of the study included players of special needs in the discus throwing of the club of 10 athletes in the province of Qadisiyah in Iraq fields of study

Human Field: Special Needs Players in Discus Throwing for Rafidain Sports Club

Time Field: 29-3-2018 to 11.4-2018

Place Field : Al-Rafidain Sports Club in Qadisiyah Governorate in Iraq

Study terms

**Deload:** In the use of reducing the training load of the trainee for the recovery of the body and the comfort of the nervous system to increase muscular training and muscle building during the upcoming periods of special needs players

**Special needs players:** It is a broad term that starts from people who have a slight dysfunction in growth, sense or perception to people with obvious physical, mental or psychological disabilities of all ages and races, which spread in many different types and names, ranging from simple to slow learning Such as mental retardation, bone sensitivity to osteoporosis, and therefore the importance of knowing the type of disability unit experienced by each individual with special needs in order to determine the quality of appropriate treatment and the methods used.

### Frequency Table

#### Better

	Frequency	Percent	Valid Percent	Cumulative Percent
Valid 1	6	60.0	100.0	100.0
Missing System	4	40.0		
Total	10	100.0		

#### Bad

	Frequency	Percent	Valid Percent	Cumulative Percent
Valid 2	6	60.0	100.0	100.0
Missing System	4	40.0		
Total	10	100.0		

#### Tried

	Frequency	Percent	Valid Percent	Cumulative Percent
Valid 3	2	20.0	100.0	100.0
Missing System	8	80.0		
Total	10	100.0		

#### Benfiet

	Frequency	Percent	Valid Percent	Cumulative Percent
Valid 4	7	70.0	100.0	100.0
Missing System	3	30.0		
Total	10	100.0		

## **CONCLUSIONS**

In the light of the results of the study, the researcher found that the use of reducing the training load of the trainee for the purpose of healing the body and muscle building and the comfort of the muscular nervous system to raise the efficiency of training have a positive and effective effect in the development of the completion of disc and other physical qualities of special needs players.

## **RECOMMENDATIONS**

The need to take into accounts the physical fitness of player's special needs and not to use high weights and throughout the week and must be increase Graduated.

The need to emphasize (by trainers) on. Reduce the training load of the trainee for the purpose of healing the body and the comfort of the musculoskeletal system to increase the training efficiency

Stress the importance of warm-up exercises (public and private) to avoid injuries.

Attention to the trainers certainly on the preparation of the muscles of the arm and hand to develop muscular construction and to protect him from the actual effort during the use of high weights.

Conduct similar research in the development of rehabilitation courses for people with chronic pain in other areas of the body.

## **REFERENCES**

1. International Law, the events of the arena and the field 2012
2. Abd al-Fattah, Abu al-'Ela Ahmad. Physical training of physiological bases. Cairo Arab Thought House, 1997.
3. International Federation of Athletics Federations: Biometric Training, Athletics Bulletin, No. 25, 1999.
4. Bureka, Mohamed Jaber, Badawi, Ehab Fawzi, casual training, Egypt, knowledge facility Alexandria, 2016.
5. Ahmed, Bastoise; rules and foundations of sports training and its applications. Alexandria, Egypt.
6. Al-Fadhli, Rashed Abdul Karim; Impact of changing resistance training in improving workmanship and ability

## PHILOSOPHICAL EVOLUTION PHYSICAL SPORT ACTIVITY

**Prof .Zahaf Mohamed**  
**Maître de conférences. ISTAPS.**  
**University of m'sila, Algeria**  
*Abstract*

This study aimed to identify the philosophy of physical activity sports through its history, And to highlight the roles played by these sports activities since the primitive man until our time and this in view of the developments that I saw. And also it aims to philosophical analysis of the factors active physical sports development. We reached the philosophy of physical activity and content, and all aspects of its activity formed and shaped according to the needs of people and different philosophies.

**Keywords:** Philosophical evolution, physical activity and sports.

### INTRODUCTION

The development of human society has made physical activities appear to be in constant evolution, We note the growth and prosperity of multiple practices that have not existed before at least before the 21st century, And this development does not just mean increasing the creation and creation of new physical activities But also means the deterioration and atrophy of some other activities .Therefore, we should look at the physical and sporting activities of our time and think about them in a pluralistic manner. In order to analyze this multiplicity, we should see in the field of practices how this pluralism appears as one of its pillars and pillars in creation and creativity, because human life in its past and present is an organic unit in which the various elements interact and integrate, We may find that the exercises practiced by, people in ancient times and the subject of the struggle for survival and survival is today means many topics of education, play, competition, recreation.

#### **Problem of Study**

The physical activity and sports aspects vary in terms of quantity and type on different covenants and in various parts of the world according to the philosophy adopted by the people of that region in different times. It is known that the most important factors in shaping the philosophy of a people are his vital needs, his temperament and his type of culture (Zahaf M. 2009, 36).

Because the value of real sports activity is shown if it is used as a means to get a better life, although it is a means of movement, but its purpose varies by the number of activities, programs and goals, but it is implemented with the ability and wisdom that suits the nature of society.



### **Research Questions**

Says (H.Lamour1986, 253)The developed societies consider the movement- physical activity- And represent them through the sequence of goals and the dominant goal (live, play, education ...) historically linked exercise physical activity goal and purpose to be achieved in place and time. The quantitative and qualitative development of physical activities is also related to the contribution and investment of different social strata classes.

From this will touch on the most important roles that went through physical activity Since the primitive man until our time, We hope to see how the philosophy of physical activity and its content, and aspects of its activity are all formed and formed according to the needs of different peoples and philosophies.

### **Purpose of the Study**

The purpose of this study is to achieve a number of objectives:

Presentation of the intellectual and theoretical framework of the concept of philosophical development of physical and sporting activities, through the provision of modern scientific knowledge about them.

To identify the most important roles played by these sports activities since the primitive man until our time and this in view of the developments that I saw.

Demonstrate the philosophy of physical activity and its content, and its activities according to the needs of different peoples and philosophies.

### **Research Methods**

The researcher used the analytical historical method, based on the collection of facts and information.

### **Findings**

To learn about this topic and answer these questions, we have highlighted the following:

#### **Physical Sport activity in human primitive:**

Primitive man was not thinking about sports physical activity as we think now, , Although the activity encompassed most of his daily life, there was no particular purpose of primitive man's exercise of motor activity, but one vital purpose was life itself and its motives from seeking food to satisfying hunger, maintaining self-reproduction and building Shelter and escape for the preservation of type..

#### **-physical Sport activity in China:**

In the ancient times, the people of China were distinguished by civilization, intellectual superiority tranquility, and practiced quiet colors of sports activity. They have avoided violence.

#### **Physical Sport activity in the Indian civilization**

Indians had a negative attitude towards physical activities based on the teachings of Buddhism, which called for attention to spiritual values and neglect of the body And therefore reflected on the level of physical fitness is weak, as it is not known about the Indians military tendencies, This encourage the practice of yoga (the union of the human soul with gods) and included 84 diffèrent modes of strength in conjunction with organise breathing, He also encouraged sports that rely on patience such as carrying high and cold temperatures and maintaining painful conditions of the body. This did not prevent that the Indians in certain periods exercice Horseback riding, elephants, wrestling and dancing.

### **Physical activity in Persia**

The people of a warrior absorbed the lessons of the invasion that has been exposed throughout his history and reflected on his thought and culture.

-They are the owners of the first Eastern civilization that adopted a special system of physical education.

-One of the most popular games was the ball game and the scepter, which is the origin of polo, According to (Karnamak) scepter sport is the most important aspect of the educational program for princes.

### **Physical Sport activity in the country of the Greek**

Physical sports activity of the Greeks was a great affair that no nation had ever known, This maximization of sports activity is due to its association with religion, one of the most important institutions of society, Religion is one of the most important social and cultural codes, which can prevent or grant activity such as physical activity in the right to exist.

Greece has known several religious ceremonies, which were athletic in appearance, but they are ritualistic and ideological in essence, the most important of these was the Olympic Games, which were held to honor the great idol Zeus. On the other hand, the philosophical doctrine supported the Physical sports activity with the views and ideas of great Greek philosophers such as Plato and Aristotle.

The Greeks dedicated a number of facilities to train young people and adults on physical sports activities and raised them with music and philosophy, such as Bali and gymnastic, to achieve perfection in terms of aesthetics and physicality (That is to say, to obtain a proper balance, both mentally and physically). One of the most important games that was prevalent in the country of the Greeks running, threw disc, wrestling, horse riding, Threw a spear, and riding carts with horses and raced by, and learned to swim and Throwing arc.

### **-physical Sport activity in the Roman country:**

At the beginning of its establishment, the State provided sports facilities for health and military reasons, this country believed in military expansion and conquest and therefore had to have a strong army as a tool to carry out these purposes. This necessitated the practice of violent physical training; Physical education was also used to implement the philosophy of the state. Among their activities was the race of chariots, wrestling to death, wrestling with monsters, playing ball and swimming. And in the late Roman era spread sports professionalism, and bribes athletes and referees, and the control of entertainment and pleasures on the lives of people and neglected fitness and physical training.

### **Physical Sport activity in the Dark Ages**

This period began after the fall of the Roman Empire by the Totonites, This period was accompanied by a delay in science and governance, Nevertheless, the Tuttonian tribes have contributed to the promotion of body power, simple life characterized by movement and moderate food.

Christianity then adopted the austerity movement in the pleasures the body, it limited the spread of the color of the titans that the Tuttons began to broadcast in the world. As well as the spread of theological philosophy, these calls for the facts that are the most important elements in the education of man, if man knows the facts, he has the key to a successful life,

and it is clear that this philosophy greatly reduces the body, so that schools considered physical sports activities as insignificant.

### **Physical Sport activity during Renaissance**

The 14th-16th century was known as the Age of Prosperity Progress, This renaissance has an impact on physical activity, has increased interest in the enjoyment and strengthening of the body, The philosophy of austerity has lost its control and a philosophy has been spread that says that the body and soul can not be separated and that the safety of one is necessary to ensure that the other function in the best way. He claimed that learning would become higher if the body was correct. And that the person needs to rest and recreation as a need to work and collection.

### **Physical Sport activity in the modern era**

Used physical activity sports in modern times wider in diverse fields , and they have retained as part of the people and individuals' lives , and has been always reflecting the philosophy of each people and meet its needs to achieve many of them, and what follows is a model of the image of human activity in modern countries.

**Germany:** After Napoleon came Frederick Yan dedicated his life to reunite the country again and free it from foreign domination. He chose sports physical activity as a means to achieve this national goal. He created the Association of Gymnasts and worked to create a strong and strong German youth to expel the colonizer.

**Sweden:** The name of Sweden is associated with the name of Leng (Berhnik Leng), who believed that physical and athletic education should be based on scientific foundations through basic sciences such as anatomy, physiology, and the use of sports activities in educational and military purposes.

**England:** England was known as the home of outdoor games; It also used a full program of games and organized sports. But in the late 19th century” Archibald McLaren” introduced physical exercise and gymnastics to train the military. He also worked to become a physical education and sports science exists in itself, He asked that reason and body can not be separated, and that one of them affects the other.

**USA:** The conditions were not favorable to the Americans during the occupation of England to organize the program of physical activity, and this is due to the intervention of the occupation and the commitment of me in some states, which affected the color of activity.

After the civil war, the sporty sport activity began to flourish, and it began to take on a higher status. Gymnastics associations were established for boys and girls, and they played games and exercises for the purpose of strengthening and training social and moral.

When industry and urbanization prevailed some aspects of recreation activity have emerged for leisure time, And its exploitation in aspects of educational and social benefit.

The socio-economic development of the human society makes physical activities appear as if they are constantly evolving, and we observe the growth and prosperity of multiple practices. This evolution not only increases the creation and creativity of new physical activities, but also the deterioration and degeneration of some other activities' in the sense that the development of social culture has made physical activities evolve in quantity and type and even in quality, The activity of the primitive man, whose theme is "struggle for survival", today is concerned with many subjects (education, play, competition... Arnaud (p)1981, 145-

**148).** The development of physical activities is also linked to a number of reasons, which revolve around the subject of motivation, Primitive human exercise was undoubtedly a catalyst for what we call primary motivations or primary needs, but at the moment, people are stimulated to work out of a consensus and so-called (cultural needs) (Pociello (C)1981 ,68-78).

Sees (h.lamour1986.260) Cultural needs are the sum total of motives of a social context (created by the social environment) it is an activity that is acquired in order to satisfy it. It is therefore acquired entirely by the social culture, where it is found in the individual and nourished by it .

## **CONCLUSION**

We concluded that the philosophy of sport physical activity and its content and aspects of activity were all formed according to the needs of different peoples and their philosophy, and their view of life and the conditions they live.

It is based on being a physical activity, social, recreational and competitive whose purpose is to prepare the individual in an integrated manner, to give him happiness and fun, and to address most aspects and spheres of life of the individual to make them balanced. Where he became in his modern image and systems and rules sound and its multiple colors is an important field of education, and an active component in the preparation of the good citizen, provides him with expertise and skills that enable him to adapt to his community and makes it able to form his life to keep pace with the times in its development and growth.

It is the philosophy of the people that determines their actions towards life and its different angles and problems. It determines the type of physical activity that the athlete needs, accepts and exercises, and also determines the amount of time spent in this practice.

## **References**

1. Lamour (H) (1986) **pedagogical theme of Lé.p.s.** Paris.ed vigot ,p253.
2. Arnaud (p) (1981) **contribution to the history of didactics of physical exercise**, in the body in motion ,Toulouse: Ed Privat, p145-148.
3. Pociello (C) 1981) **Sport and Society New Approaches.** Paris.Ed. vigot .p68-78.
4. Kholy Amin,(2001) **Fundamentals of physical education and sports : Introduction, History, Philosophy,**\_Dar Arab Thought, Cairo,p
5. Zahaf Mohamed(2009) **Emotional traits and their relationship to the level of performance during physical sports activity**, Unpublished PhD thesis ,Istaps ,university of m'sila ,algeria.p36

## SPEED, VELOCITY AND RECOVERY LEVELS OF HIGH SCHOOL AND UNIVERSITY MALE HANDBALL PLAYERS

Erkut TUTKUN<sup>1\*</sup> Osman İMAMOĞLU<sup>2</sup> Hakan ACAR<sup>3</sup>

<sup>1</sup> Faculty of Sport Science, Uludag University, Bursa/Turkey,

<sup>2</sup> Faculty of Sport Science, Ondokuz Mayıs University, Samsun/Turkey,

<sup>3</sup> Physical Education and Sport Department, Bulent Ecevit University, Zonguldak/Turkey

**\*Corresponding Author:** Erkut TUTKUN, Faculty of Sport Science, Uludağ University, Bursa/Turkey;

### Abstract

**OBJECTIVE:** This study examines the speed, velocity and recovery levels of high school and university student male handball players.

**METHODS:** 18 male handball players studying at university and 20 male handball players studying at high school, all of whom were playing in club teams, participated in the study. Consecutive 10 repeated 20 m sprint and vertical jump test was applied to the handball players. 15-second-long breaks were given in-between each sprint. Measurements were compared according to independent t-test.

**RESULTS:** It is determined that the average age of university student handball players was 23,36±3,04 years, average height was 185,16±3,06 cm, average weight was 81,73±2,96 kg, average vertical jump was 68,63±6,08 cm and anaerobic power was 127,16±12,04 kg-m/sec., while average age of high school student handball players was 16,66±1,73 years, average height was 177,95±8,1 cm, average weight was 71,89±18,05kg, average vertical jump was 64,30±6,56 cm and anaerobic power was 116,32±15,56 kg-m/sec. The average value of the first two sprints was 2,77 sec in university student handball players and 3,06 sec in high school student handball players, while the average value of the last two sprints was 3,15 sec in university student handball players and 3,61 sec in high school student handball players. The difference between average values was 0,38 sec in university student handball players and 0,58 sec in high school student handball players, which were accepted as the level of tiredness. Significant difference at the level of  $p < 0.001$  was found in age, height and weight parameters of handball players and after minutes 1 and 3 of recovery. Significant difference was found between the two groups in vertical jump and anaerobic power and at minute 5 of recovery ( $p < 0.05$ ).

**CONCLUSIONS:** According to this study, it was considered that in 10 repeated 20 meter sprint runs, an active rest of 15 seconds between sprints was adequate for male university handball players, while it was considered that 20 seconds would be more suitable for high school handball players. In consecutive sprints, acceleration, maximum speed and velocity protection skills of handball players of different categories should be examined and preliminary information should be formed for training.

**Key Words:** Handball, speed, velocity, recovery

## **INTRODUCTION**

Handball is an Olympic sport branch played in the whole world (1). In Europe, handball is the most popular team sport after football, basketball and volleyball (2). As in all sport branches, there are many factors at the heart of success in handball such as theoretical knowledge, psychological, technical, tactical and motoric sport characteristics (3). In handball, it is necessary to examine not only technical and tactical practices, but also different issues such as training and training plans, motoric and technical tests. Measuring speed is at the same time measuring anaerobic power. In handball, players' changing their places as quickly as possible, meeting the ball and using the ball won't give the opponent sufficient time for defense. Thus, the ability of speed or velocity comes to the forefront as the most important motoric characteristic of handball. Recently, some international studies have been conducted to find out handball players' physical characteristics and the dynamic factors of moves during handball game, to find out top level performance criteria and to show the suitable physical make up (4).

Physical contacts occur frequently among players in handball (5). Shots, changing direction, jumps, turns, fakes, variations and similar moves characterized with the game increase the frequency of these physical contacts. In handball, the player has to jump to the highest point during jump pass, block and jump shots to the goal. Handball players' vertical jump and standing long jump performance affect their jump pass and goal shot techniques. Vertical jump, standing long jump and leg strength developing training methods developed for this purpose are contemporarily used (6). In addition, speed training is a basic ability indispensable for each sport. A runner reaches the highest speed after an acceleration speed of at least 20 meters (7). Injuries in handball occur during competition with a higher rate (8). In literature, there is conflicting information about the time of injuries which occur during competitions. Some authors report that most of the injuries occur in the first half, while some others report that they occur in the second half (9). Injuries in handball occur at the end of the second half at most as a result of muscular system fatigue and decrease in source of energy. In injuries in handball, a great number of internal and external risk factors are effective such as the opponent's state, the significance of the competition, the characteristics of the field and physical and physiological state of the athlete (10). In case of speed and velocity when the athlete is tired, the risk for injury may increase. For these reasons, it is

important to find out the recovery of handball players in short distance based on their categories.

The purpose of this study is to examine the speed and velocity recovery levels of male handball players who have similar characteristics in different ages and categories due to their sprint performances in competitions. This study was planned to contribute to trainers in preparing training programs.

## **METHOD**

**2.1 Choosing the samples:** 18 university student and 20 high school student male handball players who were playing in clubs participated in the study.

**2.2 Length and Weight Measurements:** Length was measured with Holtain make stadiometer with 0,1 cm precision. Weight was measured with Tanita make scale with a precision of 100 gr with bare feet and with only a short and t-shirt on. Age was asked to the athletes during the measurements.

**2.3 Vertical Jump and Anaerobic Power Measurement:** Vertical jump measurements were made with 0,1 cm precision digital Jump meter and the better of two repeated measurements was taken.

Anaerobic power was found with the following formula (11).

$P = \sqrt{4.9 (W) \sqrt{D}}$  (W = Weight (kg), D = Vertical jump distance (m), P = Anaerobic power (kg-m/sec)

**2.4 Heart rate measurement:** Electronic blood pressure monitor (OMRON R3) was used in post sprint resting blood pressure measurements.

**2.5 20 Meter Sprint Measurements:** Measurements were made with New test make photocell. Following 20-minutelong warm up, the athletes started with a high start 1 meter behind the start. This test was modified from Bangsbo's (1994) multiple sprint test. Handball players were given consecutive 10 repeated 20 m sprint test. About 15-second interval was given between each sprint. Chronometer was used for the time of resting in-between sprints.

**2.6 Statistical Analyses:** SPSS 21 program was used. t-test was used to find out the difference between sprints.

**RESULTS**

**Table 1: Comparison of Physiological and Motoric Features of Handball Teams**

Variable	Level	Mean	Sd	Min	Max	t
Age (years)	University Student	23,36	3,04	18	34	9,13**
	High School Student	16,66	1,73	14	17	
Length (cm)	University Student	184,30	3,95	180	194	3,89**
	High School Student	177,95	8,10	170	185	
Weight (kg)	University Student	81,73	2,96	71	105	5,13**
	High School Student	71,89	18,05	65	80	
Vertical Jump (cm)	University Student	68,63	6,08	55	85	2,15*
	High School Student	64,30	6,56	51	78	
Anaerobic Power (kg-m/sn)	University Student	127,16	12,04	94	152	2,48*
	High School Student	116,32	15,56	88	150	

\*p<0,05 \*\* Significance between the two groups at the level of p<0.001.

**Table 2-10 repeated 20 meter sprint times of the handball teams**

Variables	Level	Mean	Sd	T
Sprint-1 (Sec)	University Student	2,76	,11	-8,12**
	High School Student	3,02	,13	
Sprint –2 (Sec)	University Student	2,78	,11	-5,66**
	High School Student	3,05	,12	
Sprint –3 (Sec)	University Student	2,81	,16	-5,98**
	High School Student	3,09	,14	
Sprint –4 (Sec)	University Student	2,83	,13	-5,62**
	High School Student	3,11	,18	
Sprint –5 (Sec)	University Student	2,86	,10	-5,38**
	High School Student	3,16	,21	
Sprint –6 (Sec)	University Student	2,93	,14	-4,19**
	High School Student	3,29	,22	
Sprint –7 (Sec)	University Student	3,02	,15	-4,19**
	High School Student	3,37	,31	
Sprint –8 (Sec)	University Student	3,09	,18	-5,02**
	High School Student	3,53	,40	
Sprint –9 (Sec)	University Student	3,13	,16	-5,25**
	High School Student	3,6	,47	
Sprint –10 (Sec)	University Student	3,17	,26	-4,97**



	High School Student	3,62	,40		
--	---------------------	------	-----	--	--

\*\* Significance at the level of  $p < 0.001$ .

**Table 3- Comparison of average running time of the first two and the last two sprints**

Sprint	Level	Mean	Sd	T
First two sprints average	University Student	2,77	,12	-10,67**
	High School Student	3,08	,13	
Last two sprints average	University Student	3,15	,17	-6,02**
	High School Student	3,61	,48	
Difference between the first two and last two averages	University Student	-0,38	---	---
	High School Student	-0,58	---	

\*\* Significance at the level of  $p < 0.001$ .

**Table 4- Comparison of rested and post-sprint and recovery heart rates of handball teams**

Variables	Level	Mean	Sd	Min.	Max.	T
Resting heart rate (Beat/Minute)	University Student	63,92	5,78	57	72	-2,55 *
	High School Student	68,23	4,88	60	77	
Heart rate at the end of 10 Sprints (Beat/Minute)	University Student	173,25	8,67	159	185	2,33*
	High School Student	166,29	8,31	154	183	
Heart rate after 1 minute (Beat/Minute)	University Student	165,16	7,09	149	177	5,60**
	High School Student	148,09	7,82	139	167	
Heart rate after 3 minutes (Beat/Minute)	University Student	146,75	7,20	136	160	6,54**
	High School Student	131,64	7,09	121	146	
Heart rate after 5 minutes (Beat/Minute)	University Student	109,75	6,19	101	116	-2,74*
	High School Student	116,18	6,39	103	135	

There is difference between the two groups at the level of \*  $p < 0.05$ , \*\*  $p < 0.001$ .

**Graph 1: 10 repeated 20 Meter Average speed**

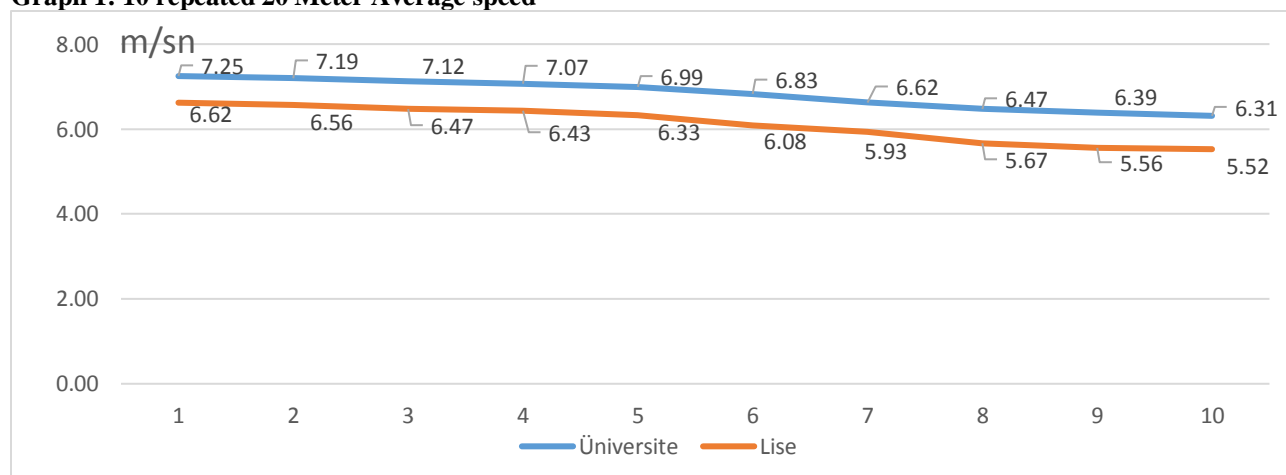

## **DISCUSSION**

Average age of university students was found as  $23,36 \pm 3,04$  years, while their average height was found as  $185,16 \pm 3,06$  cm, and their average weight was found as  $81,73 \pm 2,96$  kg. Average age of high school students was found as  $16,66 \pm 1,73$  years; while their average height was found as  $177,95 \pm 8,1$  cm, and their average weight was found as  $71,89 \pm 18,05$  kg (Table1). Statistical differences were found between the age, height, weight, vertical jump and anaerobic strength values of university and high school student handball players ( $p < 0,05$  and  $p < 0,001$ ). Albay et al. (2008) found the average height of handball players in university teams as 180,05 cm, while they found their average weight as 82,29 kg. (13). In their study, İmamoğlu and Kışhalı (2004) found that the average age of Bafra Belediyespor handball players was 23,69 years, their average height was 184,31 cm, and their average weight was 81,94 kg, while the average age of Bafra High School handball team was 14,71 years, their average height was 178,35 cm, and their average weight was 72,29 kg. Oğuz and Sevim (1992) found the average age of senior Turkish handball players as 24,53 years, senior Polish handball players as 24,64 years, senior Finn handball players as 25,51 years and average age of senior Danish players as 25,48 years (14). Kaldırımçı (2000) found the average height of experimental group athletes as 180,31 cm, pre-workout weight as 77,00 kg and post-workout weight as 76,50 kg (15). In literature, the ideal height of handball players is stated as 188 cm and it is reported that higher values can negatively affect explosive strength which is an effective factor in handball (16). While the average heights of male handball players in the study are lower than the literature, they can be accepted within normal limits.

In one study, pre-workout vertical jump value of experimental group athletes was 66,58 cm, while this value increased to 76,25 cm after the work-out (3). Albay et al. (2008) found the vertical jump value of university team athletes as 53,80 cm. (13). Savucu et al. (2006) found the vertical jump value of elite female handball players as 41,75 cm. (17). Average vertical jump value of İnönü University handball team players was found as 56,91cm (18). In their study, İmamoğlu and Kışhalı (2004) found the average vertical jump value of Bafra Belediyespor handball players as 67,63 cm and the average vertical jump value of Bafra high school handball team as 64,70 (4). In the present study, average vertical jump value of university students was found as 68,63 cm, while average vertical jump value of high school

students was found as 64,30 cm. Significant difference was found in the vertical jump values of both groups ( $p < 0,05$ ).

Albay et al. (2008) found the anaerobic capacity values of handball players in university teams as 133,39 kg-m/sec. (13). Savucu et al. (2006) found anaerobic power in elite female handball players as 114,16 kg-m/sec. (17). In their study, İmamoğlu and Kışalı (2004) found that the average anaerobic power of Bafra Belediyespor handball players was 122,27kg-m/sec and average anaerobic power of Bafra high school handball team was 116,49kg-m/sec (4). In the present study, average anaerobic power of university students was found to be 127,16 kg-m/sec, while the average anaerobic power of high school students was 116,32 kg-m/sec. Significant difference was found in anaerobic power between the two groups ( $p < 0.001$ ). The result that vertical jump and anaerobic power values, which are indicators of leg strength, were high in university students can be explained with more developed leg muscles in university students when compared with high school students.

Albay et al. (2008) found the 20 meter sprint value of handball players in university teams as 3,09 sec. (13). Savucu et al. (2006) found 20 meter running time as 4,93 sec in elite female handball players (17). İmamoğlu and Kışalı (2004) found 10 consecutive 20 meter values as between 2,73 sec and 3,23 sec in Bafra Belediyespor handball players and as between 3,06 and 3,50 sec in Bafra high school handball team (4). In the present study, while the values were between 2,76 and 3,12 sec in university students, they were found to be between 3,02 and 3,62 sec in high school students (Table 2). In this study, the lowest and the highest 20 meter sprint values were 6,31 and 7,25 m/sec in university students, while they were 5,52 and 6,62 m/sec in high school students. In both groups, there was a high drop in speed after the fifth sprint. In high school students, a second drop occurred after the eighth sprint (graph 1). In their study, İmamoğlu and Kışalı (2004) found the average value of the first two sprints of both teams as 2,74 sec for Bafra Belediyespor and as 3,07 sec for Bafra high school; while they found the average value of the last two sprints as 3,21 sec for Bafra Belediyespor and as 3,48 sec for Bafra high school (4). In the present study, the average value of the first two sprints was 2,77 sec in university student handball players and 3,06 sec in high school handball players, while the average value of the last two sprints was 3,15 in university student handball players and 3,61 sec in high school handball players. University student handball players were found to have better running time and recovery time when compared

with high school handball players. The reason for this can be the fact that they are better trained and they have a longer sport history.

Bangsbo (1994) reported that the average fatigue index was 0.64 seconds with an interval of 0.15-0.92 seconds for 11 top-level Danish football players, while Albay (1999) reported average fatigue index in 20 meter sprint as 0.01 sec in Professional football players and as 0.09 sec in amateur football players (30 second active resting was performed in-between the sprints). İmamoğlu and Kışhalı (2004) found the difference between the first two sprints of and the last two sprints average values as 0,46 sec for Bafra Belediyespor and as 0,41 sec for Bafra high school (4). In the present study, the difference between average values was 0,38 sec in university student handball players and 0,58 sec in high school players and these values were accepted as fatigue level (Table 3). According to these results, we can say that fatigue increased from the first sprint to the last. This increase is higher in high school handball players. In addition, the reason why fatigue was found to be higher in this study can be due to less time between sprints. Different results can also be due to the fact that the tests were conducted in different places and times or due to the difference in loading and the differences between development rates of handball players. This difference between high school and university student handball players can be the partly renewal of phosphate stores in young samples and very little renewal in high school handball players during sprints performed once in 20 seconds and the decreases in the power of the high school players to push the ground during the sprint when compared with university student players due to their being less trained and having less muscle and due to different anthropometric structure of the two groups (19, 20). In the multiple sprint test, university student handball players were found to have faster recovery skills when compared with high school student players. Differences between groups can be explained with reaching the highest level of maximal functioning capacity after the age of 18 and the fact that young players have more muscle or fat-free muscle than juniors (4).

Pollock et al. found the heart rates of male athletes between the ages of 20 and 28 as 63 per minute and they stated that these values could be developed with training (11). Kaldırımçı (2000) found that while resting heart rate was 69,43 beat/minute in pre-training measurements, it was 66,62 beat/minute in post-training measurements of Samsun Canik Belediyesi handball team. İmamoğlu and Kışhalı (2004) found the average resting heart rate

of Bafra Belediyespor handball players as 64,82 beat/minute, while they found the average resting heart rate of Bafra high school handball players as 69,24 beat/minute. In the present study, resting heart rate was found as 63,92 in university student handball players and as 68,23 in high school handball players. The difference in heart rates of the two groups can be resulting from the differences in their ages and training levels. In their study, İmamoğlu and Kışhalı (2004) found the average heart rate at the end of tenth sprint as 172,25 beat/minute in Bafra Belediyespor players and as 165,29 beat/minute in Bafra high school players. Average heart rate post-sprint first minute was found as 164,13 beat/minute in Bafra belediyespor players and as 147,59 beat/minute in Bafra high school players. Average heart rate post-sprint third minute was found as 148,75 beat/minute in Bafra belediyespor players and as 130,64 beat/minute in Bafra high school players. Average heart rate post-sprint fifth minute was found as 112,75 in Bafra belediyespor players and as 117,18 beat/minute in Bafra high school players. No significant difference was found between the two groups in terms of post-exercise resting heart rates ( $p>0.05$ ). In the present study, average heart rate at the end of 10 sprints was found as 173,25 beat/minute in university students and as 166,29 beat/minute in high school students (Table 4). Average heart rate post-sprint first minute was found as 165,16 beat/minute in university students and as 148,09 beat/minute in high school students. Average heart rate post-sprint third minute was found as 146,75 in university students and as 131,64 in high school students. Average heart rate post-sprint fifth minute was found as 109,75 beat/minute in university students and as 116,18 in high school students. There were significant differences between the two groups in terms of resting heart rate, heart rate at the end of 10 sprints, and resting heart rates at post-sprint minutes 1, 3 and 5 ( $p<0,05$  and  $p<0,001$ ).

The time for the pulse to get back to normal after effort depends on the work load during exercise and the individual's condition level. In individuals who have good condition, the pulse returns to normal faster after exercise (21). A heart rate below 115 beat/minute five minutes after the loading is over means that at athlete has a good performance value, while a value less than 105 beat/minute means very good performance and a value less than 100 beat/minute means high performance training (22). The response given to muscular exercise by the circulatory system is affected by various factors such as age, gender, bodily composure, and the individual's level of condition (21). In our study, the heart rates of

university students during recovery were found to decrease quicker. This can be resulting from the differences in the conditions of handball players. The result that heart rates of university students during exercise were higher can be thought to result from the fact that these athletes push their maximal capacity more. Their quicker recovery can be commented as their having better condition than high school student athletes.

With the start of exercise, the increase in pulse gets graphically straight in a few seconds and following this stage, increase in pulse due to exercise begins to occur. As the load increases, the pulse also increases in parallel to load. If the individual has high condition, “steady-state”(the moment when the amount of lactic acid in blood is equal to the amount of lactic acid that is removed from the blood) value of the pulse in the same load is lower when compared with the no-condition state. With the intensity of the exercise, the pulse reaches a maximum flatness (21). In this study, heart rates continued by approaching to maximal.

### **CONCLUSION**

As a conclusion, while 15-second active resting time between sprints in training university student male handball players with 10 consecutive 20 meter sprint is considered as sufficient, it is thought that 20 seconds is more suitable in high school students. For handball, different numbers of resting periods should be given in different categories and normative information should be formed. The changes in physical and speed abilities should be researched with test at the beginning, during and at the end of season. The effect of consecutive sprints on maximum speed should be associated with success in handball and acceleration, maximum speed and ability to protect speed should be analyzed and pre-information should be formed for workout. In speed workouts, the distance, intensity, repetition number and resting time of sprint for each age group and each athlete should be determined as a result of multiple sprint measurements.

### **Conflicts of interest**

There is no conflicts of interest.

### **References**

1. Marques, M.C., Van Den Tillaar, R., Vescovi, J.D., Gonzálezbadillo, J.J. Relationship between throwing velocity, muscle power, and bar velocity during bench press in elite handball players. *Int J Sport Psychol Perform*, 2007. 2(4):p.414–422.
2. Langevoort, G., Myklebust, G., Dvorak, J., Junge, A. Handball injuries during major international tournaments. *Scand J. Med. Sci. Sports*, 2007. 17(4): p.400-407.
3. Sevim, Y. *Futbolda Antrenman Bilgisi, Beden Terbiyesi Genel Müdürlüğü Yayını*, Ankara, 1986. 20-30.
4. İmamoğlu, O., Kışhalı, N.F. The Level of Speed and Recovery For Male Handball Players in Different Categories, The 10th ICHBER SD. Europa Congres-The TSSA 8 International Sports Science Congress, Abstract Book, Antalya-TURKEY, 2004. p.59.

5. Salman, A.F. Comparison of injuries between male and female handball players in junior and senior and teams. The Swedish Journal of Scientific Research, 2014. 1(4): p.1-15.
6. Turan M.B. Pliometrik Antrenmanın 14-15 Yas Grubu Erkek Hentbolcuların Dikey Sıçrama, Durarak Sıçrama, Uzun Atlama ve Anaerobik Güç Üzerinde Etkisi, 4. Uluslararası Spor Bilimleri Öğrenci Kongresi, Marmara Üniversitesi, 2012. p.111.
7. Bompa, T.O. Antrenman Kuramı ve Yöntemi Çeviri: İknur Keskin, Burcu Tüner. Birinci baskı. Bağırhan Yayımevi, 1998. 362-391.
8. Olsen, Oe., Myklebust, G., Engebretsen, L., Bahr, R. Injury pattern in youth team handball: A comparison of two prospective registration methods. Scand J. Med. Sci. Sport, 2006. 16(6): p.426-432.
9. Pirly, H., Alizade, M.H., Nasiri, K.H., Rahimi, M. Injury rates in Iranian handball players. World Applied Sciences Journal, 2011. 11(11):p.1670-1677.
10. Atay E., Çetinkaya E., Tanır H., Çatıktaş F. Genç Hentbolcularda Görülen Spor Sakatlıkları, Uluslararası Hakemli Ortopedi Travmatoloji Ve Spor Hekimliği Dergisi, 2017. (11), 1-11. Doi: 10.17372/OTSHD.2017.3.3.
11. Tamer, K., Zorba, E., Baltacı, G. ODTÜ İngilizce Hazırlık Okulu Erkek Öğrencilerin Çeşitli Fizyolojik Özellik Ve Kapasitelerinin Ölçülmesi ve Değerlendirilmesi, Spor Hekimliği Dergisi, 1991. 26 (3), p. 87-92.
12. Bongsbo, J. Physiological Demands, Handbook of Sport Medicine and Science Football (Soccer), Blackwell Scientific Publication, Edited Björn Ekblam, Oxford-England, 1994. p. 47-57.
13. Albay M. D., Tutkun E., Ağaoğlu Y.S., Cenikli A., Albay F. Hentbol, Voleybol ve Futbol Üniversite Takımlarının Bazı Motorik ve Antropometrik Özelliklerinin İncelenmesi, Spormetre Beden Eğitimi ve Spor Bilimleri Dergisi, 2008. VI (1), 13-20.
14. Oğuz, Ş., Sevim, Y. Elit Türk Hentbol Oyuncularının Bazı Kondisyonel Değerlerinin Ölçümü Ve Yabancı Ülke Sporcuları İle Karşılaştırılması, Spor Bilimleri II. Ulusal Kongresi Bildirileri, Ankara, Özet, 1992. p.420.
15. Kaldırım M. Ağırlık Topuyla yapılan Plyometrik Antrenmanın Hentbolcuların Dikey Sıçrama ve Kol İtme Kuvvetine Etkisi, Ondokuz Mayıs üniversitesi, Sağlık Bilimleri Enstitüsü, Yayınlanmamış Yüksek Lisans Tezi, Samsun, 1999.
16. Çamlıyer, H., Enişler N., İşleğen Ç. 11-18 Yaş Grubu Futbol Alt Yapı Antrenmanlarına Katılan Çocuk ve Gençlerin Sprint Özellikleri, Beden Eğitimi Spor Bilimleri Dergisi, 1996. 2(2): p.11-17.
17. Savucu Y., Erdemir C., Akan İ., Cenikli A. Elit Bayan Basketbol ve Hentbol Oyuncularının Fiziksel Uygunluk Parametrelerinin Karşılaştırılması, Spormetre Beden Eğitimi ve Spor Bilimleri Dergisi, 2006. IV(3), p.111-116.
18. Yamaner F., Kartal A. *Beden Eğitimi Bölümlerinde Okuyan Hentbol 1. liginde Oynayan Hücum ve Savunma Oyuncularının Seçilmiş Fiziksel ve Fizyolojik Profilleri* Atatürk Beden Eğitimi ve Spor Bilimleri Dergisi, 2001. 1(2), p. 113.
19. Bompa T.O. Theory and Methodology of Training, Kendal / Hunt Publishing Com. Keskin İ., Tüner B., Bağırhan Yayımevi, Ankara 1996.
20. Fox, E.L. et al. The physiological basis of physical education and athletics, SounderCollege Publishing, 1988. 62-82, 675.
21. Akgün, N. Egzersiz ve Spor Fizyolojisi, Altıncı Baskı, İkinci Cilt, Ege Üniversitesi Basımevi, İzmir, 1996.
22. Frintz Z.L. Ausdauer–Training Grundlagen, Methoden, Trainingssteuerung BLV-Sportwissen-Verlagsgesellschaft München, Germany, 1994. p.151.
23. Albay, F. Futbolculara Uygulanan Tekrarlı Sürat Koşularının Yorgunluğa Etkisi, Ondokuz Mayıs Üniversitesi, Sağlık Bilimleri Enstitüsü, Yayınlanmamış Yüksek Lisans Tezi, Samsun, 1999.

## RELATIONSHIP BETWEEN HAND GRIP STRENGTH AND FINGER RATIO (2D:4D) IN 10-12 AGE SWIMMERS

Nebahat Eler

Physical Education and Sports, Bulent Ecevit University, Zonguldak, Turkey.

[nebahateler@gmail.com](mailto:nebahateler@gmail.com)

### ABSTRACT

It is assumed that finger ratio (2D:4D) is related to strength, which is one of the physical fitness parameters. Hand grip strength is an indicator of total muscle strength and physical strength. The aim of this study is to analyze the relationship between 2D:4D and hand grip strength in 10-12 age group female and male swimmers. 72 female and 51 male swimmers from the 10-12 age group have voluntarily participated in the study. The athletes' height, body weight, body mass index, body fat percentage, right-left hand 2D:4D measurements and right hand grip strength and left hand grip strength tests have been carried out. The obtained data has been recorded in the SPSS 16 software program and data in the level of  $p < 0.05$  has been accepted as statistically significant. A negative correlation ( $r = -, 221$ ;  $r = -, 218$ ) has been determined between the right-left hand grip strength and right hand 2D:4D of the male athletes. A positive relationship has been determined between sports age and RHGS ( $r = 0.19$ ), between height and RHGS ( $r = 0.23$ ) of male athletes and between height and RHGS ( $r = 0.25$ ), between body weight and RHGS ( $r = 0.21$ ) and BMI and RHGS ( $r = 0.35$ ) of the female athletes. There is a positive relationship between the BMI and right hand 2D:4D of the female athletes. The right-left hand 2D:4D of the 10-12 age group male athletes has been found to be lower and their right-left hand grip strength has been found to be higher compared to the female athletes. In the female athletes of this age group, it may be stated that 2D:4D influences body weight and BMI and that 2D:4D of the male athletes influences grip strength and therefore strength, however 2D:4D in female athletes should not be an indicator of strength performance.

**Keywords:** 2D:4D, handgrip strength, boys, girls.

### INTRODUCTION

Swimming is different in many aspects as an exercise from the other branches of sports. The most significant difference of swimming is spending energy to achieve a horizontal position by using the arms and legs at the same time or separately to be able to float on water (Çelebi, 2008).



In order to be able to efficiently advance on water and increase the efficiency of the pull of water, the dimensions of the hands and the feet and to prevent sinking and to reduce friction, body weight and fat percentages are important (Geladas et. al, 2005; Anderson et. al, 2008; Cicchella et. al, 2009).

Hand grip strength shows the total muscle strength in children, teenagers and young adults and is an indicator of general well-being and physical strength (Gros Lambert, 2002; Foo, 2007; Wind et. al., 2010; Tamiya et al., 2012). In swimming, anthropometric characteristics influence in particular the upper extremity strength. Elite swimmers have longer arms and wider hand surface areas (Troup, 1999). Arm muscle strength is important for swimmers. Therefore, it is important that grip strength which is regarded as an indicator of physical strength in swimmers is analyzed together with anthropometric measurements and 2D:4D rate (Geladas et. al, 2005).

Finger proportion (2D:4D) is influential in many aspects such as the individual's psychological state (Manning and Fink, 2011), risk of having cancer or heart attacks (Fink et. al, 2006), sexual preference and mathematical and verbal intelligence, besides being an indicator for inclination for sports (Tester and Campell, 2007). The negative relationship between 2D:4D and physical strength is assumed to influence sports performance (Hönekopp et. al, 2006; Malas et. al, 2006). Low rate of 2D:4D is accepted as being related to high performance level in many sports branches (Manning and Taylor, 2001; Manning, 2002; Paul et. al, 2006; Bennett et. al, 2010; Longman et. al, 2011). Performance in sports depends both on a developed cardiovascular system and muscle strength.

There is a more direct relationship between 2D:4D and muscle strength (Tamiya et. al, 2012). For the determination of 2D:4D finger proportion and becoming a criterion in the selection of skill, further studies should be carried out on children. If it is taken into consideration that the proportion of finger lengths are determined in the womb and do not change in the adolescent and adult periods (Çelik et. al, 2010) and that it is highly important to determine skills in the early ages besides physical parameters to be able to reach the uppermost level of performance in sports, the importance of the relationship between 2D:4D rate which has been found to be related to high performance levels and strength will be better understood (Acar and Eler, 2018).

The purpose of this study is to analyze the relationship between 2D:4D and hand grip strength in 10-12 age group female and male swimmers.

## **METHOD**

72 female and 51 male swimmers from the 10-12 age group have voluntarily participated in the study. Detailed information about the study has been given to the families of the athletes and the sports clubs they are in and their permission has been taken. The athletes who participated in the study do regular swimming exercise for 4 days a week.

For the measurements, the Holtain anthropometric set has been used. The athletes' weight has been measured with a sensitive digital scale which has a sensitivity level of 0,1 kg; their height was measured with a height scale with a 0.01 m. sensitivity and their BMI has been calculated with the body weight (kg) / body height (m<sup>2</sup>) formula. In the measurement of body fat percentage, the skinfold caliper has been used and the triceps and subscapular skin fold has been measured and calculated (Lohman, 1992). After the photocopy of the athletes' right hands were taken, the area between the basal line and the pulpal section in the proximal part of the index finger and the ring finger on the palmar side of the right and left hands has been determined and their finger lengths were measured using a vernier caliper which can measure up to 0.05 mm. The measurements have been taken by the same person twice in millimeters (mm) to guarantee reliability. To determine the proportion, the index finger length has been divided into the ring finger length. The hand grip strength values have been measured using a hand dynamometer in international standards. The measurements taken with the Jamar hydraulic dynamometer (Sammons Preston, USA) were started with the dominant side. The measurements were taken while the athlete was in sitting position and in 90° forearm flexion, without getting support from the trunk. Two separate measurements were taken for the right and left hands and the best value was recorded as kilograms.

The obtained data has been evaluated in the SPSS 16 software program. The mean and standard deviations of all data has been calculated; in the determination of the difference between the averages of the female and male groups, the Independent Samples T-Test has been used. In the determination of the statistical relationship between anthropometrical characteristics and physical fitness parameters, the Pearson Correlation Coefficient analyses have been used.

## RESULTS

Table 1: The anthropometric characteristics of male and female athletes

	( male; n-72)	( female; n-51)	t	p
	Mean ± Std. Deviation	Mean ± Std. Deviation		
Age(year)	11,13±1,01	11.02±0.21	0.765	0.44
Sport age (month)	34.15±11.03	32.43±8.14	0.945	0.34
Boy (cm)	142.31±8.75	143.08±6.71	-0.527	0.59
Height(cm)	38.43 ±5.47	40.29 ±7.73	-1.563	.012
BMI (kg/m2)	18.35±6.89	20.98±7.14	-2.05	0.04*
Body Fat Ratio (%)	19.19±7.46	22.14±6.79	-2.24	0.02*

p<0.05

Table 2: The hand grip strengths and 2D:4D values of female and male athletes

	( male; n-72)	( female; n-51)	t	p
	Mean ± Std. Deviation	Mean ± Std. Deviation		
Right Hand Grip Strength (kg)	21.85 ± 7.43	19.05 ± 6.84	2.12	0.03*
Left Hand Grip Strength (kg)	19.95 ± 5.76	16.41 ± 6.04	3.29	0.00*
Right hand 2D:4D	0.95±0.04	0.98±0.05	-3.69	0.00*
Left hand 2D:4D	0.99±0.03	1.01±0.04	-2.46	0.01*

p<0.05

In the study, it has been found that the right-left hand grip strength of the male athletes was higher than the right-left hand grip values of the female athletes and that their right-left 2D:4D averages were lower than the 2D:4D averages of the female athletes.

Table 3: The relationship between right-left hand grip strength and 2D:4D in female and male athletes

		Right Hand Grip Strength (kg)		Left Hand Grip Strength (kg)	
		r	p	r	p
Female	Right hand 2D:4D	r	0,06	r	-0,02
		p	0,23	p	0,07
	Left hand 2D:4D	r	-0,05	r	0,12
		p	0,31	p	0,58
Male	Right hand 2D:4D	r	-0,221	r	-0,118
		p	0,04*	p	0,05*
	Left hand 2D:4D	r	-0,043	r	-0,334
		p	0,92	p	0,88

p<0.05

A statistical relationship between right-left hand grip strength and right-left hand 2D:4D in the female athletes and right-left hand grip strength and left hand 2D:4D in the male athletes has not

been found. A negative correlation has been found in the right-left hand grip strength and right hand 2D:4D in the male athletes ( $r = -, 221$ ;  $r = -, 218$ ).

Table 4: The relationship between some of the anthropometric measurements and 2D:4D and grip strength of female and male athletes

		Male				Female			
		Right hand 2D:4D	Left hand 2D:4D	RHGS (kg)	LHGR (kg)	Right hand 2D:4D	Left hand 2D:4D	RHGS (kg)	LHGR (kg)
Age (year)	r	-0,07	0,06	0,11	0,24	0,31	0,40	0,01	0,04
	p	0.12	0.15	0.09	0.11	0.09	0.16	0.09	0.11
Sport age (month)	r	0,11	0,31	0,19	0,13	0,36	0,04	0,07	0,15
	p	0.07	0.17	0.05*	0.06	0.11	0.14	0.14	0.11
Height (cm)	r	-0.23	0.13	0.23	0.05	-0.47	0.09	0.25	-0.16
	p	0.06	0.22	0.05*	0.09	0.06	0.14	0.05*	0.07
Weight (kg)	r	0.03	0.08	0.31	0.11	0.14	0.09	0.21	0.12
	p	0.19	0.21	0.02	0.07	0.07	0.21	0.05*	0.18
BMI (kg/m <sup>2</sup> )	r	-0.14	-0.10	0.08	0.11	0.41	0.11	0.35	-0.16
	p	0.31	0.26	0.31	0.12	0.00*	0.41	0.02*	0.09
Body Fat Ratio (%)	r	0.06	0.09	0.29	0.06	0.06	0.18	0.08	0.19
	p	0.13	0.17	0.07	0.19	0.12	0.45	0.11	0.28

$p < 0.05$

In the male athletes, a positive relationship has been found between sports age and RHGS ( $r = 0.19$ ); height and RHGS ( $r = 0.23$ ) and in the female athletes, a positive relationship has been found between height and RHGS ( $r = 0.25$ ); body weight and RHGS ( $r = 0.21$ ) and BMI and RHGS ( $r = 0.35$ ). There is a positive relationship between BMI and right hand 2D:4D ( $r = 0.41$ ) in the female athletes.

## DISCUSSION

In this study, the males athletes' RHGS has been determined as  $20.85 \pm 7.43$  kg, the LHGS as  $19.45 \pm 6.76$  kg and the female athletes' RHGS has been determined as  $25 \pm 7.83$  and LHGS as  $17.40 \pm 6.04$  kg. It has been found that the averages of the female athletes' right and left hand grip strength were lower in comparison to the male athletes. Ranson et. al (2015) have determined the right-left hand grip strength of male and female students, with an age average of  $10.8 \pm 1.01$  (years) and  $10.07 \pm 1.00$  (years) successively as  $16.94 \pm 4.47$  kg,  $15.65 \pm 4.27$  kg; Pekel et. al (2006) have determined the RHGS value of male athletes with an age average of  $11,5 \pm 1,1$  years (n- 44) as  $20,8 \pm 6,5$  kg and LHGS as  $19,9 \pm 5,8$  kg; the RHGS value of female athletes with an age average of  $11,5 \pm 0,8$  years as  $20,8 \pm 6,5$  kg and LHGS value as  $19,9 \pm 5,8$  kg; Eghbali (2016) has determined the RHGS value of male students aged 7-13 as  $15.88 \pm 5.38$

kg; Bilgiç et. al (2016) have determined the RHGS value of children with an age average of 11.79 ± 0.41 (n=247) who participate in football, volleyball, basketball and swimming sports as 19.32 ± 4.48 kg and LHGS value as 17.98 ± 4.23 kg; Ölücü et. al (2010) have determined the dominant hand grip strength of 30 students who do not participate in sports and 30 students who participate in sports aged 10-14 as 25,73 ± 5,10 kg, their recessive hand grip strength as 23,01 ± 4,07 kg and Selçuk, (2013) has determined hand grip strength of the group who did swimming and thera-band exercises with an age average of 12.00 ± 0.60 (n=12) as 17,25 ± 4,39 kg.

In this study, the right hand 2D:4D of the male athletes has been determined as 0.95 ± 0.04 kg, and left hand 2D:4D as 0.99 ± 0.03 kg, whereas the right hand 2D:4D of the female athletes has been determined as 0.98 ± 0.05 kg and left hand 2D:4D as 1.01 ± 0.04 kg. It has been found that the right and left hand 2D:4D averages of the male athletes were lower in comparison to the female athletes. Manning (2002), Lutchmaya et. al, (2004), van Honka et. al, 2011 have determined in their studies that the male athletes 2D:4D rate in both hands in male athletes was lower in comparison to female athletes.

In the study, a relationship between right-left hand grip strength and right-left hand 2D:4D has not been found in the female athletes, however a negative relationship has been found between the right-left hand grip strength and right-left hand 2D:4D of the male athletes. Zhao et. al have expressed that there is a strong relationship between the prenatal testosterone exposure and cardiovascular system in males, along with muscle strength, however there is no relationship in females. Between 2D:4D and strength parameters, the strength determined through the most studied grip strength is static strength (Ranson et. al, 2015; Bilgiç et. al, 2016; Eghbali, 2016; van Anders, 2007; Zhao et. al, 2012). Fink et. al, (2006) and Zhao et. al, (2012) have verified that there is a negative relationship between 2D:4D and grip strength in males and Zhao et. al (2012) and Hone and McCullough (2013) have verified that there is no relationship in females. In addition, there are numerous studies which have shown that there is no relationship between static strength and 2D:4D in females (van Anders, 2007; Gallup et. al, 2007, Halil and Gürel, 2012).

Peeters et. al (2013), in their study involving young females aged 13-18, have suggested that the left hand 2D:4D ratio does not have any relationship with physical fitness parameters and that 2D:4D should not be a part of criteria in the selection of skills in young females for that reason. Eghbali (2016), in his study involving male children aged 7-13, has analyzed the relationship

between 2D:4D rate and physical fitness and has determined that strength, endurance, speed, agility and flexibility do not have a significant correlation with 2D:4D rate; in Bilgiç et. al's study (2016), it has been determined that there was no relationship between the 2D:4D of 39 female and 57 male children aged 11-13 in different sports branches and strength, speed and endurance parameters. Ranson et. al (2016), in their study in which 922 male and 835 female students participated, have analyzed the relationship between physical fitness and 2D:4D and found a negative relationship between 2D:4D and strength, endurance and speed in male students.

In the male athletes, a positive relationship has been found between sports age and RHGS, height and RHGS and in the female athletes, a positive relationship has been found between height and RHGS, body weight and RHGS and between BMI and RHGS. Grip strength is important in terms of catching and throwing the ball/equipment in different branches of sports. It is a physiological variable which is influenced by a series of factors such as age, gender and body height. There is a strong correlation between grip strength and various anthropometric characteristics (weight, height, hand length, etc.) (Singh et. al, 2009, Koley et. al, 2009; Jurimae et. al, 2008; Kaur, 2009). There is a positive relationship between BMI and right hand 2D:4D in females. While Fink et. al (2003) have determined a positive relationship between 2D:4D and BMI and waist and hip circumference in adult males (n=50) and females (n=70), Müller et. al (2013) have not determined a significant relationship between 2D:4D and various anthropometric measurements in adults (n = 14,916). This discrepancy might be related to the group numbers involved in the studies. Ranson et. al (2105) have found a significant relationship between 2D:4D and height-weight-BMI and waist circumference in female children, while they have not found a relationship in male children. Peeters et. al (2013), in their study involving young female gymnasts, have found that left hand 2D:4D rate does not have a relationship with anthropometric variables (height, mass, BMI and somatotype components).

### **CONCLUSION**

Although results of the studies on 2D:4D and strength display differences, this is considered to be related to the number of the subjects, their age and participation rate in sports. As a result, the right-left hand 2D:4D of male swimmers aged 10-12 have been found to be low compared to the female swimmers and their right-left hand grip strength to be higher. A negative relationship between right-left hand 2D:4D and right-left hand grip strength and a positive relationship

between sports age and RHGS and height and RHGS has been found in the male swimmers. A positive relationship between height and RHGS, body weight and RHGS, BMI and RHGS, BMI and right hand 2D:4D in the female athletes has been found. In swimming, it can be stated that 2D:4D in female athletes in this age group is related to body weight and BMI and that 2D:4D of the male athletes influences grip strength and therefore strength, however 2D:4D in female athletes should not be an indicator of strength performance.

## References

1. Çelebi, Ş. (2008). Yüzme Antrenmanı Yaptırılan 9-13 Yaş Grubu İlköğretim Öğrencilerinde Vücut Yapısal ve Fonksiyonel Özelliklerinin İncelenmesi. Yüksek Lisans Tezi. Erciyes Üniversitesi Sağlık Bilimleri Enstitüsü. Kayseri.
2. Geladas, N. D., Nassis, G. P., Pavlicevic, S. (2005). Somatic And Physical Traits Affecting Sprint Swimming Performance In Young Swimmers. *Internatiol Journal Of Medicine*, 26:139-144.
3. Andersen LB, Lawlor DA, Cooper AR, Froberg K, Anderssen SA(2008). Physical Fitness İn Relation To Transport To School İn Adolescents: The Danish Youth And Sports Study. Department Of Sports Medicine, Norwegian School Of Sport Sciences, Oslo, Norway. *Scand J Med Sci Sports*. 2008
4. Cicchella A, Jidong L, Jürimäe T, Zini M, Passariello C, Rizzo L, Stefanelli C (2009). Anthropometric Comparison Between Young Estonian And Chinese Swimmers." *Journal Of Human Sport And Exercise Online*, 4(2): 154-160.
5. Gros Lambert. A., M. Nachon, And J.D. Roitllon. Influence Ofthe Age On Self-Regulntion Of Static Grip Forces From Perceived Exertion Values. *Neurosci. Lett.* 325:52-56. 2002.
6. Foo, L.H. (2007). Influence Of Body Composition, Muscle Strength, Diet And Phy-Sical Activity On Total Body And Forearm Bone Mass İn Chinese Adolescent Girls. *Br. J. Nutr.*, 98, 1281-1287.
7. Anne E. Wind, Tim Takken, Paul J. M. Helder, Raoul H. H. Engelbert (2010) Is Grip Strength A Predictor For Total Muscle Strength İn Healthy Children, Adolescents, And Young Adults? *European Journal Of Pediatrics* 169, (3), 281–287.
8. Tamiya, R., Lee, S. Y., & Ohtake, F. (2012). Second To Fourth Digit Ratio And The Sporting Success Of Sumo Wrestlers. *Evolution and Human Behavior*, 33, 130-136. <https://doi.org/10.1016/j.evolhumbehav.2011.07.003>
9. Troup J.P. (1999). The Physiology And Biomechanics Of Competitive Swimming. *Clinics İn Spor Medicine*; 18 (2): 267 – 285.
10. Manning, J.T., Fink, B. (2011) Digit Ratio (2D:4D) And Aggregate Personality Scores Across Nations: Data From The BBC İnternet Study, *Personality And Individual Differences*51(4), 387-391
11. Fink, B., Thanzami, V., Seydel, H., Manning, JT. (2006), Digit Ratio And Hand-Grip Strength İn German And Mizos Men: Cross-Cultural Evidence For An Organizing Effect Of Prenatal Testosterone On Strength. *Am J Hum Biol.*, 18(6): 776-782. 10.1002/Ajhb.20549 [Doi].
12. Tester N, Campell A (2007) Sporting Achievement: What İs The Contribution Of Digit Ratio? *J Pers* 75:663–677, Doi:10.1111/J.1467-6494.2007.00452.X
13. Hönekopp, J, Manning, JT, And Muller, C. Digit Ratio (2D:4D) And Physical Fitness İn Males And Females: Evidence For Effects Of Prenatal Androgens On Sexually Selected Traits. *Horm Behav* 49: 545–549, 2006.
14. Malas, MA, Dogan, S, Evcil, EH, And Desdicioglu, K. Fetal Development Of The Hands, Digits And Digit Ratio (2D:4D). *Early Hum Dev* 82: 469–475, 2006.

15. Manning, J. T., & Taylor, R. P. (2001). Second To Fourth Digit Ratio And Male Ability In Sport: Implications For Sexual Selection In Humans. *Evolution And Human Behavior*, 22, 61–69.
16. Manning, JT. (2002). *Digit Ratio: A Pointer To Fertility*. Behavior And Health. Rutgers University Press, New Jersey. 3.
17. Paul SN, Kato BS, Hunkin JL, Vivekanandan S, Spector TD (2006). The Big Finger: The Second To Fourth Digit Ratio Is A Predictor Of Sporting Ability In Women. *British Journal Of Sports Medicine*, 40:981-983.
18. Bennett, M., Manning, J. T., Cook, C. J., & Kilduff, L. P. (2010). Digit Ratio (2d:4d) And Performance In Elite Rugby Players. *Journal Of Sports Sciences*, 28, 1415\_1421.
19. Longman D, Stock JT, Wells JC Digit Ratio (2D:4D) And Rowing Ergometer Performance In Males And Females *Am J Phys Anthropol*. 2011 Mar; 144(3):337-41.
20. Çelik, A., Aksu, F., Tunar, M., Daşdan Ada, E. N., Topaçoğlu, H., 2010, Master Atletlerin Fiziksel Performans Düzeylerinin Eldeki Parmak Oranlarıyla İlişkisi, *DEÜ Tıp Fakültesi Dergisi*, 24: 5-10.
21. Acar, H., Eler, N. (2018). The Relationship of Digit Ratio (2D:4D) with Cerebral Lateralization and Grip Strength in Elite Swimmers. *Journal of Education and Training Studies*, 6(4), 84-89., Doi: 10.11114/jets.v6i4.3040.
22. Lohman, T.G. (1992), *Advances In Body Composition Assessment*. Champaign, Ill: Human Kinetics.
23. Ranson, R., Strattonb, G., Taylor, S.R. (2015), Digit Ratio (2D:4D) And Physical Fitness (Eurofit Test Battery) In School Children. *Early Human Development*, 91: 327-331. 10.1016/J.Earhumdev.2015.03.005[Doi].
24. Pekel, H.A., Bağcı, E, Nevin Atalay Güzel, N.A., Onay, M.(2006). Spor Yapan Çocuklarda Performansla İlgili Fiziksel Uygunluk Test Sonuçlarıyla Antropometrik Özellikler Arasındaki İlişkilerin Değerlendirilmesi, *Kastamonu Eğitim Dergisi*, 14 (1): 299-308
25. Eghbali, E. (2012), The Relationship Between Digit Ratio (2D:4D) And Physical Fitness In Boys 7 To 13 Years. *Physical Activity Review*, 4: 154-162. 10.16926/Par.2016.04.19[Doi].
26. Bilgiç, M., Biçer, M., Özdal, M. (2016). Farklı Branşlarda Spor Yapan 11-13 Yaş Grubu Çocukların 2D:4D Parmak Oranlarının Sportif Performansla İlişkisinin İncelenmesi. *Gaziantep Spor Bilimleri Dergisi*, 1(1), 48-56.
27. Ölçücü, B., Canikli, A., Ağaoğlu, S., Erzurumluoğlu, A. (2010). 10-14 Yaş Çocuklarda Tenis Becerisinin Gelişimine Etki Eden Faktörlerin Değerlendirilmesi, *Beden Eğitimi Ve Spor Bilimleri Dergisi*, 12(2): 1-11.
28. Seçuk, H. (2013). 11-13 Yaş Grubu Erkek Yüzücülerde 12 Haftalık Terabant Antrenmanının Bazı Motorik Özellikler İle Yüzme Performansına Etkileri. *Y.Lisans Tezi, Selçuk Üniversitesi Sağlık Bilimleri Enstitüsü, Konya*.
29. Manning, J. T. (2002). The Ratio Of 2nd To 4th Digit Length And Performance In Skiing. *Journal of Sports Medicine Physical Fitness*, 42, 446-450.
30. Lutchmaya, S., Baron-Cohen, S., & Raggatt, P. (2004). 2nd And 4th Digit Ratio, Fetal Testosterone And Estradiol. *Early Hum Dev.*, 77(1-2), 23–28. <https://doi.org/10.1016/J.Earhumdev.2003.12.002>
31. Van Honka, J., Schutter, D. J., Bos, P. A., Kruijt, A. W., Lentje, S E. G., & Baron-Cohen, S. (2011). Testosterone Administration Impairs Cognitive Empathy In Women Depending On Second-To-Fourth Digit Ratio. *Proceedings Of The National Academies Of Sciences Of The United States Of America*, 108, 3448-3452. <https://doi.org/10.1073/Pnas.1011891108>
32. Zhao, D., Li, B., Yu, K., Zheng, L. (2012), Digit Ratio (2D: 4D) And Handgrip Strength In Subjects Of Han Ethnicity: Impact Of Sex And Age. *American Journal Of Physical Anthropology*, 149(2): 266-271. 10.1002/Ajpa.22130 [Doi].
33. Van Anders, S.M. (2007), Grip Strength And Digit Ratios Are Not Correlated In Women. *American Journal Of Human Biology.*, 19(3): 437-439. 10.1111/J.1600-0838.2009.01031.X [Doi].



34. Hone, L.S.E., Mc Cullough, M.E. (2012), 2D:4D Ratios Predict Hand Grip Strength (But Not Hand Grip Endurance) In Men (But Not Women). *Evol Hum Behav.*, 33: 780-789. <https://doi.org/10.1016/j.evolhumbehav.2012.07.003>
35. Gallup, A.C., White, D.D., Gallup, G.G. (2007), Handgrip Strength Predicts Sexual Behavior, Body Morphology, And Aggression In Male College Students. *Evolution And Human Behavior*, 28: 423-429.
36. Halil, M., Gürel, E.I., Kuyumcu, M.E., Karaismailoglu, S., Yesil, Y., et al. (2012). Digit (2D:4D) Ratio Is Associated With Muscle Mass (MM) And Strength (MS) In Older Adults: Possible Effect Of In Utero Androgen Exposure. *Arch Gerontol Geriatrics*, 56(2): 358-363. [10.1016/j.archger.2012.11.003](https://doi.org/10.1016/j.archger.2012.11.003) [Doi].
37. Peeters, M.W., Van Aken, K., Claessens, A.L. The Left Hand Second To Fourth Digit Ratio (2D:4D) Is Not Related To Any Physical Fitness Component In Adolescent Girls. *Plos One*, 8(4): E59766. [10.1371/journal.pone.0059766](https://doi.org/10.1371/journal.pone.0059766)[Doi].
38. Singh, A. P., Koley, S., & Sandhu, J. S. (2009). Association Of Hand Grip Strength With Some Anthropometric Traits In Collegiate Population Of Amritsar. *Orient. Anthropologischer Anzeiger*, 9, 99-110.
39. Koley, S., Kaur, N., & Sandhu, J. S. (2009). Association Of Hand Grip Strength And Some Anthropometric Traits In Female Labourers Of Jalandhar, Punjab, India. *Journal Of Life Science*, 1, 57-62. <https://doi.org/10.1080/09751270.2009.11885135>.
40. Jürimäe, T., Voracek, M., Jürimäe, J., Lätt, E., Haljaste, K., Saar, M., & Purge, P. (2008). Relationships between Wnger-length ratios, ghrelin, leptin, IGF axis, and sex steroids in young male and female swimmers. *European Journal of Applied Physiology*, 104, 523-529. <https://doi.org/10.1007/s00421-008-0801-z>
41. Kaur, M. (2009). Age-related changes in hand grip strength among rural and urban Haryanvi Jat females. *J. Copmar. Journal of Comparative Human Biology*, 60, 441-450. <https://doi.org/10.1016/j.jchb.2009.06.002>
42. Fink, B., Neave, N., Manning, J.T. (2003). Second to fourth digit ratio, body mass index, waist-to-hip ratio, and waist-to-chest ratio: their relationships in heterosexual men and women. *Ananals of Human Biology*, 30(6), 728-738. [10.1080/03014460310001620153](https://doi.org/10.1080/03014460310001620153)[doi].
43. Muller, D.C., Manning, J.T., Hopper, J.L., English, D.R., Giles, G.G., Severi, G. (2013). No strong association between second to fourth digit ratio (2D:4D) and adult anthropometric measures with emphasis on adiposity. *Ananals of Human Biology*, 40(2), 201-204. [10.3109/03014460.2012.751127](https://doi.org/10.3109/03014460.2012.751127)[doi].

## CONSTRUCTING NORMS FOR SELECTED PHYSICAL FITNESS FOR SPORTS POTENTIAL AMONG HIGH SCHOOL BOYS

**BYREGOWDA. N**

Research Scholar (Ph.D.),

**Prof. SYED KAREEMULLA,**

Research supervisor / Director of Physical Education, Dravidian University, Kuppam

[dr.kareemulla@gmail.com](mailto:dr.kareemulla@gmail.com)

### **Abstract**

In developed countries of the world, variety of test batteries have been developed in accordance with their own environment. With the help of these test batteries, they are successfully selecting players for different games or event. The optimal level of physical fitness in high school students is considered as an important factor in the prevention of non-communicable diseases resulting from the unhealthy lifestyle. The evaluation of physical fitness in children at schools is objectively possible only by using available field methods. In recent years, numerous of different test batteries assessing physical fitness have been designed. The aim of the work is to compare the selected test batteries assessing physical fitness in high school students in the Bengaluru. The presented study promotes the practical implementation of physical fitness testing to the complex physical education program and also enables physical education teachers to make the decision for selecting the appropriate test battery based on their individual requirements.

**Keywords:** *Development, Physical Fitness, Test, High School.*

### **INTRODUCTION**

Physical fitness has been considered as one of the most important aspects of human existence. A sound body and an active mind are interrelated. This relationship has given respectability to physical education. No education is complete without good physical health as it makes a person efficient and fit to work in any area of human activity. The concept of physical fitness has become a point of attraction in our country. The Government and the people are becoming aware of its importance in present day living because physical fitness underly productive power of its citizens and a high level of efficiency in techniques and tactics in most of the sports are not possible without a high level of physical fitness.

### **OBJECTIVE OF THE STUDY**

1. To help boys move in skilful and effective manner in all the selected activities in which they engage in the physical education program.
2. To develop an understanding and appreciation of movement in boys and you're so that their lives will become more meaningful purposive and productive.
3. To develop an understanding and appreciation of certain principles concerned with movements.
4. To develop better inter personal relationship through the of games of sports
5. To develop various organic system of the body so that they will respond in a healthful way.

### **STATEMENT OF THE PROBLEM**

The purpose of the study was to construct norms to measure the health related physical fitness of the high school boys of age twelve to fifteen years in Bangalore city.

### **SIGNIFICANCE OF THE STUDY**

1. This study will help to prepare the health related physical fitness norms which will serve as a ready reference service and also as instant information for the needy one.
2. It may help to physical education teacher to know health standard of students.
3. To find out the relationship between the health related physical fitness and father's occupation.

### **DELIMITATIONS**

1. This study was conducted for the High School Boys in Bangalore City.
2. The study was further delimited to measure AAHPERD, heath related Fitness test.
3. The Subjects for the study nearly 2016 boys were selected.
4. The study was conducted only to the boys of age ranging from twelve to fifteen years.
5. The variables for this study Nine Minutes Run / Walk test, Sit-ups, Sit and Reach and Skin fold test were selected for the construction of the study.

### **LIMITATION**

1. This study was limited to certain factors like habits, diet, temperature, height; routine activities were not taken into considerations while interpreting the results.
2. All subjects were taken from the same atmosphere of living.

3. Subject's academic standard and their economic status were not into consideration.

## **METHOD**

### **SELECTION OF SUBJECTS**

This study was designed to construct norms for the health- related physical fitness of high school boys of age group of twelve to fifteen years in Bangalore City. To achieve the above purpose, two thousand sixteen boys were selected randomly. The subjects were selected from the following schools: St. Frances school, Chirst School, Govt. High School, Beratena Agrahara, NET Public School, National Public School, Oxford School, Govt. High School, Begur, Cambridge School, Venus International School and St. Anns School, Bangalore.

### **SELECTION OF VARIABLES**

The research scholar reviewed the available scientific literature pertaining to the health related physical fitness from books, journals, periodicals, magazines and research papers. Taking in to consideration the following variables were selected from American alliance for health, physical education, recreation and dance, health related physical fitness.

The AAHPERD health related physical fitness <sup>1</sup> test consists of the following four components.

Test I: Nine minute run for cardio respiratory fitness.

Test II: Sit - ups for muscular strength.

Test III: Sun of triceps and sub- scapular skin folds for body composition.

Test IV: Sit and Reach for flexibility.

### **STATISTICAL TECHNIQUE**

The mean and standard deviation associated to construct Hull Scale Norms were used in this study. The obtained data were analysed by using Hull scale as suggested by Garret.

## **CONCLUSIONS**

On the basis of the hull scale constructed for components like nine minute run, muscular strength, body composition and flexibility, the following conclusions were drawn:

1. In nine minute run as per the qualitative grading for the constructed hull scale values out of 2016 subjects 107 subjects were poor, 172 subjects were fair, 688 subjects were average, 7.57 subjects were good, 203 subjects were very good and 89 subjects were excellent.
2. In sit-ups as per the qualitative grading for the constructed hull scale values 60 subjects were poor, 241 subjects were fair, 663 subjects were average, 765 subjects were good, 227 subjects were very good and 60 subjects were excellent.
3. In body composition as per the qualitative grading for the constructed hull scale values 61 subjects were poor, 214 subjects were fair, 881 subjects were average, 599 subjects were good, 164 subjects were very good and 97 subjects were excellent.
4. In flexibility as per the qualitative grading for the constructed hull scale values 112 subjects were poor, 158 subjects were fair, 554 subjects were average, 950 subjects were good, 169 subjects were very good and 73 subjects were excellent.

### **RECOMMENDATIONS**

On the basis of the findings and conclusions of the investigation, the following recommendations were drawn.

1. The researcher has constructed norms for youth physical fitness for High school boys. It is recommended at the time of admission these norms may be used to select the students in the High school boys.
2. A similar study may be conducted to construct norms for the High school girl's students.
3. A study of similar nature may be conducted to construct norms of the College Men Students.
4. A similar study may be conducted to construct National norms for women.

### **References**

1. Anayanwa, Smule Uwazuruonye. "Physical Fitness of Nigerian Youth." Dissertation Abstract International (1997), Vol.38(5): 2642.
2. B.C. Mohite. "Computation of Physical Fitness Norms for Girls the Junior Colleges in Barshi Taluk." Indian Streams Research Journal (Research Paper - Physical Education) (2011), Vol.1(II): 49-50.
3. Bitcon, L.E. "Validation of a Four Item Fitness Test and Norms for High School Boys in the State of Iowa." Completed Research in Health, Physical Education and Recreation (1995), 8: 37.
4. Desouza, S. "Standardization of Norms for Physical Fitness Tests for Girls in the Age Group of 13 to 16 years in the State of Goa." Unpublished Doctoral Thesis in Physical Education, Pune University, Pune, India, 1993.
5. Kumar Dinesh "A Normative Study of Physical Fitness of Himachal Pradesh High and Higher Secondary School Boys." Ph.D. Thesis Submitted to the Punjab University Chandigarh December, 1998.
6. O.M. Toriola and M.A. Monyeki. "Health-Related Fitness, Body Composition and Physical Activity Status among Adolescent Learners: The PAHL Study." African Journal for Physical, Health Education, Recreation and Dance (2012), Vol.18, No.4(1): 795-811.
7. Pushpendra Purashwani; A.K. Datta and Manoj Purashwani. "Construction of Norms for Skill Test Table Tennis Players." International Journal of Table Tennis Sciences (2010), No.6: 93-98.

8. Singh, Jaspal. "Construction and Standardization of Specific skill test Battery for male Handball Players." Unpublished Ph.D. Thesis, Punjabi university Patiala, Punjab, 2006.
9. Singh, Reet Mohinder. "Physical Fitness Norms of Punjab High School Boys," Unpublished Doctoral Thesis, Punjab University, Chandigarh, 1986.
10. Sunil Dutt. "Health Related Physical Fitness of Boys Aged 8 to 18 Years." Journal of Exercise Science and Physiotherapy (2005), Vol.1(1&2): 12-22.
11. Verma, A., Rana, D. and Singh, A. "To Develop Physical Profile of Kabaddi Players: The Descriptive Study." Indian Journal of Movement Education and Exercises Sciences (2011), Vol.I(1).
12. Yadav, B.S. "Standardization of Physical Fitness of the School Children of Haryana (13 to 16 year of age)." Ph.D Thesis, Kurukshetra University, Kurukshetra, 1986.
13. Yadav, J.S. "Construction of Specific Physical Fitness Test for National Level MaleJudokas." Unpublished Doctoral Thesis, Panjab University, Chandigarh, 2002.

## RELATIONSHIP BETWEEN PHYSICAL FITNESS AND ACADEMIC ACHIEVEMENT OF PRIVATE SCHOOL GIRLS

<sup>1</sup>Harpreet Kour, <sup>2</sup>Dr. Rina, <sup>3</sup>Dr. Nagesh Janu

<sup>1</sup>Research Scholar, Dept of Physical Education, JECRC University, Jaipur Rajasthan.

<sup>2</sup>Associate Prof., Dept of Physical Education, Manipal University, Jaipur Rajasthan.

<sup>3</sup>Asst.Prof., Dept of Physical Education, JECRC University, Jaipur, Rajasthan

### ABSTRACT

**Objective:-** The purpose of this study was to determine whether there was a meaningful relationship between physical fitness and academic achievements of private school girls of Jaipur. **Methods:** The AAHPER (1976) Youth Physical Fitness Test (Standing Broad Jump and 50 yard Dash) was conducted on 300 school girls students ranging between 10 to 16 years girls in different private schools (N=300) area of Jaipur (Rajasthan). To compare the relationship between physical fitness and academic achievements of private school girl's correlation was computed with the help of SPSS Software. The level of significance chosen was 0.05. **Results:** There were significant differences obtained between physical fitness and academic achievements private school girls. Researcher found the negative correlation between physical fitness and academic achievements.

**Keywords:** Physical fitness, academic achievement, AAHPER Fitness test.

### INTRODUCTION

Physical Fitness is an important as the man himself. By physical fitness, we mean fitness in terms of health and skill based performance. A person can be said to be physically fit if he has the ability to perform physical activities which required strength, flexibility or Endurance. In this fast pacing life, everyone has a very hectic schedule. A person does not get much time for himself. But if one wants to stay health and fit, he must make regular exercise a part of his life. One must schedule at least 30 minute for physical activity, physical fitness can be achieved through the need of exercise, correct nutrition and proper amount of rest. People that does not get enough of physical activity or exercise will quickly put on weight and became fat vary soon. Thus results in joining weight loss program later on exercise helps in a very healthy way to make a person stay healthy way to make a person stay healthy and happy line longer. It also helps in chances of various kind of disease. One can include practice like dancing, swimming, walking, gardening, playing etc. Fitness is a key of quality of life. It is a need of modern age to prevent pollution and unhealthy lifestyle. It plays vital role to maintain and development of child it means all round development (affective, cognitive, psychomotor, social, ethical etc. Fitness gives the value of the life of growing child. It is not only for physical fitness but also is based for motor fitness other activities to enhance the athlete performance. The term fitness is defined in a various manner offer it is considered in terms of physical aspect of living. Fitness is today's

world is not a matter of more muscular or physical capacity. A true concept of physical fitness mental, emotional, social positive fitness must mean the optimum development of each of these aspects and emphasize the ability of person to line more effective with in his potentialities. The word ‘Fitness’ has been discussed and explained by physical educators, coaches and medical professional in numerous ways in relation to performed in games and sports and organic health. The literature on ‘fitness’ is most confusing. Each one of the professional stated above keeps in mind his own expectations from a human body and defines fitness in his own way and therefore, different terminologies like physical fitness, motor fitness, motor-physical fitness, general fitness, total fitness, athletic fitness, organic fitness and health-related physical fitness are in practice. In today’s fast –passed world, people deal with stress on a daily basis between the pressure of work and family. Life can often become quite overwhelming. Mental and physical demands may leave you feeling totally exhausted at the end of the day. As a result, keeping your fitness important among all the stresses of everyday life may not be a top priority. Many individual simply take fitness for granted. They have no desire to work at keeping fit others know they should exercise regularly yet they tend to push fitness aside indefinitely. They have good intentions of greeting around to it someday, when they have more time and energy yet, as days and weeks pass by, fitness continues to be for gotten and left out of their daily schedules<sup>4</sup>

#### **MATERIALS AND METHODOLOGY**

In this current study, a sample of 300 girls students ranging between 10 to 16 years studying in different private schools (300 girls students) area of Jaipur was taken as subjects for this study. AAPER Youth Physical Fitness Test Battery (1976) was used to measure Physical Fitness Status (Muscular strength and speed) of the subjects. The test battery consist these two test items: Standing Broad Jump, 50 yard Dash. To relationship between physical fitness and academic researcher used the correlation and graphical representation of the data. The level of significance chosen was .05.

#### **Data Analysis**

SPSS (software) was used to analyze the data. The relationship between physical fitness and academic achievement of school students was determined by using correlation. In all the cases, 0.05 level of confidence was fixed to test the significance, which was considered as an appropriate.

#### **Descriptive Statistics of Standing Broad Jump**

**Table-1, shows Mean and S.D. of Standing Broad Jump (Meter)**

	GROUP	N	Mean	Std. Deviation	Std. Error Mean
SBJ	Private	300	1.37	.13	.007

Table no.1 indicates the values of descriptive statistics of the private school girls for standing broad jump (muscular strength), which shows that the mean and S.D. values of Private school girls are found to be 1.37 and 0.13 respectively.



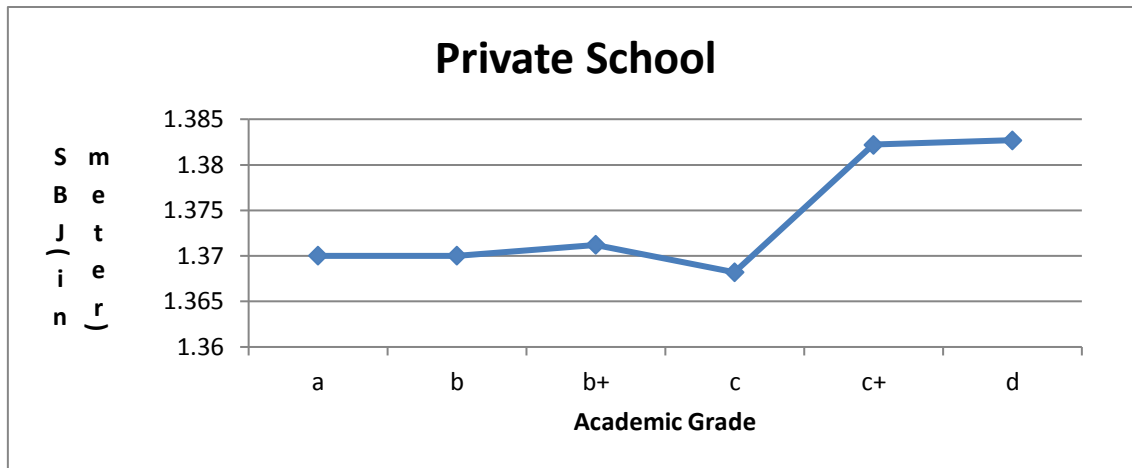

Figure- 1 Graphical presentation between Standing Broad Jump and academic grades of Private schools Girls.

**Descriptive Statistics of 50m dash**

Table 2, shows Mean and S. D. of 50 m. Dash (sec)

	GROUP	N	Mean	Std. Deviation	Std. Error Mean
50 m dash	Private	300	11.12	1.11	.064

Table no.3 indicates the values of descriptive statistics of the private school girls for 50 m. Dash, which shows that the mean and S.D. values of Private schools girls are found to be 11.12 and 1.11 respectively.

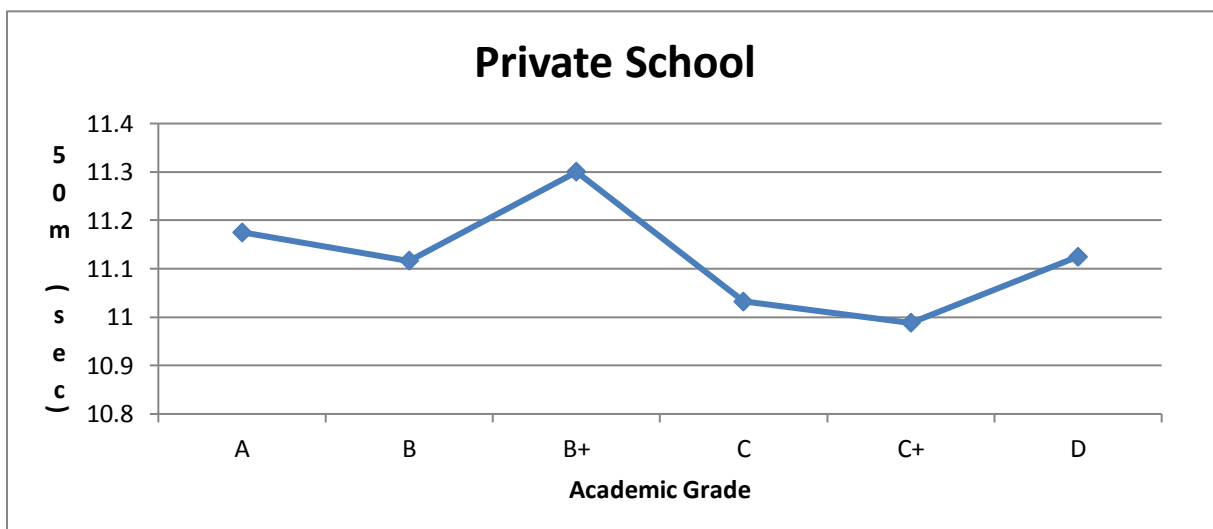

Figure- 2 Graphical presentation between 50 m. Dash and academic achievement of Private schools Girls.

**RESULTS AND DISCUSSION**

The data collected by adopting above procedure were statistically analyzed. The results are presented in the following tables. For testing the significance in Standing Broad Jump and 50 yard Dash, the level of significance chosen was .05. The Comparison between physical fitness and academic achievement of private schools girls. The data pertaining to the same is presented in Table 1.

**DISCUSSION:** There are significant differences between physical fitness variables and academic achievement. After finishing research, Researcher found that keeping the low grade students of high physical fitness level and those students had good grades, their physical fitness was significantly low.

**CONCLUSIONS:** In the light of the findings and limitations of the present study the following conclusions were drawn: There were significant difference obtained on 50 yard Dash of Private school girls. There were no significant differences obtained on standing broad jump of Private school girls.

#### **ACKNOWLEDGEMENT**

I would like to express my deepest gratitude to my supervisor Dr. Rina (Department of Physical Education, Manipal University, Jaipur) and Dr. Nagesh Janu (Department of Physical Education, JECRC University, Jaipur), for their excellent guidance and also grateful to Dr. Kaukab Azeem, Faculty at King Fahd University, Saudi Arabia for his priceless suggestions to pen down this paper.

#### **Reference**

1. Ahmed Y., MacDonald H., Reed K., Naylor PJ., Liu-Ambrose T, McKay H, school Based physical activity does not compromise children's academic performance. *Medicine and Science in Sports and Exercise*, Vol. No. 39, pp 317-376, (2007).
1. Barrett H., " Health education Guide: A design for teaching" Philadelphia Lea And Febeger, Vol.No.14, pp 115-125, (1974).
2. Barrow H.M; "Man and Movement". Principles of physical education, Philadelphia Lea and Febiger, Vol.No.10, pp 238-254, (1983).
3. Coe DP, Pivarnik, JM. Womark C J., Reeves MJ., Malina RM., "Effect of physical education and activity levels of academic achievement in children". *Medicine and Science in Sports and Exercise*, Vol.No.38, pp 15-19, (2006).
4. Linder, K.J. The Physical Activity Participation--Academic Performance Relationship Revisited: Perceived and Actual Performance and the Effect of Banding. (Academic Tracking). *Pediatric Exercise Science*, Vol.No.14, pp 155-170, (2002).
5. Peter V. Karpovich, "Our primary task is to pursuit of physical fitness". *Journal of Psychosomatic Research*, Vol.No.7, pp 81–85, (1961).
6. Sallis JF., McKenzie TL, Kolody B, Lewis M, Marshall S, Rosengard P. " Effect of health-related physical education on academic achievement: Project SPARK". *Research Quarterly for Exercise and Sports*, Vol.No.70, pp 127-134, (1999) .
7. Sanjay K P & Anoop K S, " A survey of physical fitness of school girls." *Futuristic Trends in physical Education*, Vol. No. 1, pp 206-210, (2012).
8. Sigfusdottir, I.D., Kristjansson, A., & Allegrante, J.P "Health Behavior & Academic Achievement in Icelandic School Children." *Health Education Research*, Vol. No. 22, pp 70-80, (2007).
9. Tremblay, M.S., Inman , J.W., & Willim, J. D. " The Relationship Between Physical Activity, Self-Esteem, and Academic Achievement in 12-Year-Old Children ". *Pediatric Exercise Science* , Vol.No.12, pp 312-324, (2000).

## AN ELECTRONIC EQUIPMENT TO ASSESS THE REACTION TIME OF SPRINTERS – A STUDY

**Dr.V.Ravikumar**

Director of Physical Education, Hindusthan College of Engineering and Technology  
Othakkalmandapam, Coimbatore.

[ravidpe@gmail.com](mailto:ravidpe@gmail.com)

### ABSTRACT

In this modern world each and every field was automated by the support of electronic gadgets these are added accurate and consistent to bring out the work effectively. The present investigator made an attempt to construct an electronic gadget to assess the reaction time of athletes in sprinting events. Presently reaction times are not taken in any sprinting events in district, divisional and state level meets because of unavailability of relevant equipment. The reaction time will influence over the performance of sprinters. To obtain such things Electronic Equipment has been invented with accurate starting and finishing technique using the following core parts 1.Microphone 2.Micro switch, 3.Interfacing Unit, 4.Computer and appropriate power feeding unit. To attain scientific genuineness of the gadget 120 subjects were chosen from Hindusthan College of Engineering and Technology, Coimbatore and the appropriate data were collected using the newly invented equipment while the subjects were running in the 50m race. The collected data were treated with appropriate statistical techniques and obtained Reliability and objectivity of the device.

**Key Words:** Microphone, Micro switch, Interfacing Unit, Computer, Reliability and objectivity.

### INTRODUCTION

Technical inventions and the studies keep enhancing the world as incomparable proportions in all days. We remain enjoyably shocked and surprised by the progress in various fields.

While all the fields gain the benefit of the scientific blessings, the investigator taught to implement such innovations in the field of athletics. This idealistic thinking motivated him; consequently this device was raised to assess the reaction timings of athletes in sprinting events.

Currently mostly the timings are taken for sprinting events by manually using stop watches, which may not be used to find out the reaction times of sprinters. Hence such Electronic Equipment was invented, and it is having accurate starting and finishing technique. So we can find out perfect reaction timings of the sprinter.

## **STATEMENT OF THE PROBLEM**

The purpose of the study was to construct an Electronic Equipment to obtain reaction timings of sprinting events.

## **DELIMITATIONS**

The Study was delimited in these following factors.

An instrument was constructed as per the requirement of obtaining reaction time of sprinting events. 120 subjects were used to establish reliability and Objectivity of the instrument.

## **LIMITATIONS**

The following uncontrollable factors associated with the study was accounted as limitations of this study,

1. Due to unavailability of affordable device to find out reaction time simultaneously using along with newly device, the validity of the device was not able to assess as limitations.

## **HYPOTHESIS**

It was hypothesized that the newly designed gadget will be valid, reliable and objective in assessing the reaction time of the subjects in various sprinting events.

## **SIGNIFICANCE OF THE STUDY**

1. This study gives surplus information to the area of research.
2. The results of the study would be useful to coaches and administrators to assess the reaction time of sprinters more accurately.
3. This study will help the participants to know their accurate reaction time.

## **METHOD**

### *Details about Electronic Equipment*

The following are the vital parts of Electronic Equipment.

1. Microphone
2. Micro switch
3. Interfacing Unit

4. Computer

5. Power feeding device.

### MICRO SWITCH

It is a special type of switch whenever fed appropriate power supply to the switch it will activate. When the switch is at normal condition the output signal is very low. If the switch gets operated the output signal of micro switch is high, which signal induces the corresponding timer to stop and record the timings and the switch is shown in following figure 1.

FIGURE 1

### CIRCUIT DIAGRAM OF MICRO SWITCH

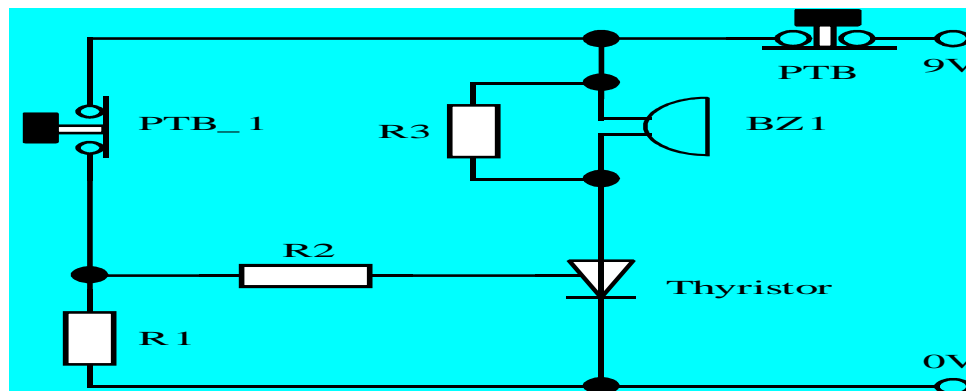

#### Components

PTB = Push type micro-switch (normally closed)

PTB\_1 = Push type micro-switch (normally closed)

Thyristor = TIC106D, BZ1 = Buzzer, R1 = 10k ohm

#### Interfacing unit

This is the brain of the equipment. This unit contains a special micro controller which is programmed with appropriate timers. Whenever the switches gets operated, electrical signals passed to the micro controller and it encodes the unit and influencing over the timers. This encoded signals converted as data signals and sending it to the computer for displays.

#### Computer

This is a normal computer, which was installed with special software according to our program. The computers receive the data signal from interfacing unit and it encodes the software, which decoding the signals and displays the exact reaction time of every athlete with precision.

#### FUNCTIONING METHOD

#### **ASSESSING THE REACTION TIME OF SPURTERS FROM STARTING POSITION ON THE TRACK**

To assess the sprinters reaction time, eight starting blocks were used. All the starting block's rear side resisting pad is fixed with a special micro switch. The output terminals of each switch are connected with interfacing unit for appropriate function. Its photography is presented in the figure 2.

**FIGURE 2**

#### **MICRO SWITCHES FITTED WITH STARTING BLOCKS**



At the starting point of each lane, 8 athletes were directed to do sprint in a track with crouch starting position. To start the race, starting gun attached with condenser microphone was used, when the starting gun was triggered the sound was observed by the microphone and the signal sent to microcontroller instantly to start all the 8 timers. The computer flashed it through monitor. On hearing the gun sound, the athletes kicked the starting block to commence the race, while the special micro switches observe the movement and sent a signal to interfacing unit to stop the timer. Based on every athlete's

response, corresponding timer unit seized and it was recorded in microseconds. These recorded times are the reaction time of sprinters which are shown in figures 4.

**FIGURE 3**  
**ASSESSING REACTION TIME OF SPRINTERS**  
**IN STARTING POSITION**



## **RESULTS AND DISCUSSIONS**

Computation of descriptive statistics

**Mean and Standard Deviation on reaction time of Sprinters (Sec.)**

<b>Trials</b>	<b>Mode of Assessment</b>	<b>Reaction Time</b>	
1	New Device	Mean	0.27
		SD	0.04
2	New Device	Mean	0.29
		SD	0.05
3	New Device	Mean	0.24
		SD	0.03

The above table shows that the mean values of the subject's reaction during the 1 to 15 trials are 0.27, 0.29 and 0.24, and with standard deviations of 0.04, 0.05, and 0.03 respectively.

**Reliability of 100m speed performance**

**Analysis of variance with repeated measures for  
 Reaction Time (sec.) sprint performance**

<b>VARIABLES</b>	<b>ANALYSIS OF VARIANCE WITH REPEATED MEASURES</b>						
	<b>Source</b>	<b>SS</b>	<b>Df</b>	<b>MS</b>	<b>F</b>	<b>MS<sub>E</sub></b>	<b>R</b>
Reaction Time (sec.)	Subjects	0.555	119	0.005	<b>3.59</b>	0.002	<b>0.96</b>
	Trials	0.001	1	0.001			
	Residual	0.018	119	0.0002			
	<b>The table value is 4.78</b>					<b>The table value is 0.234</b>	

The above table specifies that the obtained F ratio 3.59 is less than the table value of 4.78 required at 0.01 level of significant. This showed that there is no significant difference between the test and re-test scorers signifying that the process of testing of the reaction time is perfect and consistent. Hence intraclass correlation was obtained for reaction time, which indicates that the obtained intraclass (R) value 0.96 is higher than the table value 0.234 required at 0.01 level of significant. It denotes that the reaction time assessed by the device during the test and re-test are significantly related.

The above results proved that the newly constructed electronic device is reliable to assess the reaction of sprinters on the track simultaneously for eight athletes.



**Objectivity of Reaction Time**

**Analysis of variance with repeated measures**

**For Reaction Time (sec.).**

VARIABLES	ANALYSIS OF VARIANCE WITH REPEATED MEASURES						
	Source	SS	df	MS	F	MS <sub>E</sub>	R
Reaction Time (sec.)	Subjects	0.990	119	0.00	<b>3.82</b>	0.0002	<b>0.98</b>
	Trials	0.001	2	0.00			
	Residual	0.050	238	0.00			
	<b>The table value is 4.78</b>					<b>The table value is 0.234</b>	

The above table indicates that the obtained F ratio 3.82 is less than the table value of 4.78 required at 0.01 level of significant. This proved that there is no significant difference among three different testers. It reveals that the process of testing the reaction time is perfect and consistent. Hence, Intraclass correlation was obtained and the (R) value 0.98 is higher than the table value 0.234 required at 0.01 level of significant. It denotes that the reaction time recorded by the three testers using the newly constructed electronic device at three different periods is significantly related.

The above results strongly proved that the newly constructed electronic device possess objectivity to assess reaction time of sprinters.

**Analysis of Data and interpretation of the study**

The main purpose of the study was to construct an electronic equipment to assess the reaction time of the sprinters and also to establish scientific authenticity of the instrument. The setting up of scientific authenticity involves establishment of reliability, objectivity and validity. Reliability was established by test and retest method. In this procedure data were collected on two occasions with a gap of two days using the newly designed instrument, the same subjects, providing similar conditions data were collected again. The obtained two sets of scores were subjected to univariate correlation procedure which resulted in a coefficient of correlation of 0.96 indicating that 94% association between these scores.

Objectivity was established by collecting data using the same subjects, and same instrument, similar conditions were provided but two different testers were used. Thus two sets of scores were

obtained and they were subjected to univariate correlation procedure which resulted in a coefficient of correlation of 0.98 indicating that 97% association between these scores.

### **CONCLUSION**

It is concluded that the device is more reliable and objective to assess the sprinting events.

### **RECOMMENDATION**

Device may be designed to measure the reading of track and field events.

Similar gadget may be designed to measure various motor fitness components.

### **REFERENCES.**

1. Anuparna Shah and Sushmita Mandal, (1994). Effectiveness of three Instructional Strategies for Education Experiments in Education.
2. Arlott, J. (1975), *Medicine and Science in Sports and Exercise*, Saint Louis: Oxford Companion to Sports and Games, PP. 203-209.
3. Balasubramanian and Yoganandam, “Trained teacher vs technology’ A Comparative Study effectiveness in Improving English pronunciation“, *Journal of Research in Educational Media*, 94, 25-30.
4. Baumann, W. (1976), **Kinetic and Dynamic Characteristics of the Sprint Start Biomechanics**, saint Louis: The C.V.Mosby company, PP.195-198.
5. Cheng, L. et.al. (2010), A Low-cost, Accurate Speed Tracking System for Supporting Sprint Coaching, *Journal of Sports Engineering and Technology*, 3, PP. 149-152.
6. Korchemny, R. (1992), A New Concept for Sprint Start and Acceleration Training. **New Studies in Athletics** 7, PP. 65-72.
7. Mero P.V. Komi & Gregor R.J. (1992), **Biomechanics of Sprint Running**, Illinois: Human Kinetics, PP. 376-392.
8. Salo, A. & Bezodis, I.N. (2004), *Sports Biomechanics*, Saint Louis: The C.V.Mosby company, PP. 43-54.
9. Suzuki, M. et. al. (1991), *Analysis of the Race Patterns of Men*, Saint Louis: The C.V.Mosby company, PP. 14 – 24.
10. Thomas, Jerry R. & Nelson, Jack K. (1996), *Research Methods in Physical Activity*, Illinois: Human Kinetics, PP. 234-240.

[http://en.wikipedia.org/wiki/Fully\\_automatic\\_time](http://en.wikipedia.org/wiki/Fully_automatic_time)

[http://en.wikipedia.org/wiki/Photo\\_finish](http://en.wikipedia.org/wiki/Photo_finish)

<http://www.answers.com/topic/photo-finish-camera#ixzz1tJtQH13j>

## MENTAL TOUGHNESS AMONG INTER COLLEGE PLAYERS IN RELATION TO GENDER

**Dr Jaskaran Singh Sidhu**

Assistant Professor Enlightened college of Physical Education Jhunir.

[jaskaransidhu@rediffmail.com](mailto:jaskaransidhu@rediffmail.com)

### Abstract

**Aim-** The Aim of this study is to find the mental toughness level between male and female players. **Methodology-** For present research work a sample of 50 male sport persons and 50 female sports women were taken from different sports events from mansa district. **Tools.-** Mental toughness was assessed using the Sport Mental Toughness questionnaire (SMTQ) (Sheard, Golby & Wersch, 2009). The SMTQ is a 14-item self-report questionnaire for the assessment of mental toughness in sport. **Statistical Analysis-** To find out the relationship among the research variables exists or not, t- test was used to test the significance of difference between the variables. Statistics for each characteristic were calculated; Mean, Standard deviation, Standard error of Mean. Data was analyzed using SPSS (statistical package for the social sciences). Statistical significance was set at  $p < 0.05$ . **Results-**no significant difference exist on the variable of confidence, constancy and control between male and female player. The results also reveal that there is no significant difference exists between male and female players regarding mental toughness. **Conclusion.** Mental toughness is psychological preparation which increases with the level of competition.

**Keywords:** Mental toughness, confidence, constancy, control.

### INTRODUCTION

Every top sportsperson knows that their best performances come from their mind as much as from their body. Top sports persons today understand that winning goes far beyond just technique and encourage a new attribute known as the ‘psychology of winning’ which includes mental skill development to counter any situation. There's a thin line that exists between mentally-strong sporting success and under-pressure failure, The determining factor between a good athlete and a great athlete can come down to the quality and extent of their psychological preparation and how well these athletes apply their skills during high pressure game situations. Gucciardi, Gordon, and Dimmock<sup>[3]</sup> (2009) use the concept ‘Mental Toughness’ as an umbrella term for athletes who are considered to possess superior mental characteristics and they believe that it is the mental game that will differentiate the performers. It can be simply put that “Mental Toughness sets apart good and great athletes when physical, technical and tactical skills are equal”.

The quest for excellence in sport embraces the continuing development of four key aspects of performance, namely physical, technical, tactical, and mental skills. However, when

physical, technical, and tactical skills are equally matched, which commonly occurs in competition especially at the highest level, performers who possess more of what is commonly referred to as “mental toughness” appear to dominate more often than those with less mental toughness.

### **Defining Mental Toughness**

Jones Graham<sup>[1]</sup> (2002) Defined mental toughness as “the natural or developed psychological edge that enables you to generally cope better than your opponents with the many demands that sport places on a performer. Specifically, be more consistent and better than your opponents in remaining determined, focused, confident, and in control under pressure”. Jones views mental toughness as a defining trait in which “people who become champions aren’t necessarily more gifted than others; they’re just masters at managing pressure, tackling goals, and driving themselves to stay ahead of the competition”

Some of the characteristics that are evident when a player is mentally tough include:

- Self-confidence
- Self-motivation
- Focus
- Concentration
- Composure
- Calmness
- Poise
- Self-control
- Positive Energy
- Determination
- Persistence
- Leadership

### **Developing Mental Toughness**

Thelwell et.al.<sup>[2]</sup> (2005) and Jones Graham<sup>[1]</sup>(2002) concluded following attributes for mentally tough athlete

- (a) Having self-belief in one’s ability to achieve goals.
- (b) Being able to recover from set backs and having an extra determination to succeed.
- (c) Having a high amount of self belief that one has better abilities and more qualities than their opponents.
- (d) Having a high amount of motivation and desire to succeed.
- (e) Being fully-focused on the task even when there are distractions.

- (f) Having the ability to regain psychological control following uncontrollable events.
- (g) Having the ability to overcome emotional and physical pain.
- (h) Being able to accept and cope with the anxiety experienced in competition.
- (i) Thriving on pressure.
- (j) Having the ability to not be affected by good or bad performances.
- (k) Having the ability to remain fully focused even in the face of distraction.
- (l) The ability to switch the focus on your sport on and off.

**Aim of the Study:** The purpose of this study is to find the mental toughness level between male and female players at intercollegiate level of Mansa District.

## **METHOD**

**Sample-** For present research work a sample of 50 male sports persons and 50 female sports of inter college level was taken randomly from all games and sports events. The subjects were selected randomly from Mansa District (Punjab).

**Limitation-** The study is limited to inter college level sports persons of Mansa District only.

### **Tools**

Mental toughness was assessed using the Sport Mental Toughness questionnaire (SMTQ) (Sheard, Golby & Wersch,<sup>[4]</sup> 2009). The SMTQ is a 14-item self-report questionnaire for the assessment of mental toughness in sport. The SMTQ responses are rated on a 4-point likert scale with responses ranging from Very true(A) to not at all true(D). The SMTQ also contains **3 subscales:**

Confidence (6 items) represent question-1, 5, 6, 11, 13 and 14.

Constancy (4 items) represent question-3,8,10 and 12.

Control (4 items)represent question-2,4,7 and 9.

### **Administration of Test**

Questionnaire schedule was distributed among sports persons and the purpose of the test was explained to the sports persons any difficulty in filling the questionnaire was sought out, the scoring pattern was explained to the sports persons. After completing the test the questionnaire schedules were collected for scoring.

### **Scoring**

Scoring was done by using the 4 point scale showing mental toughness level among sports persons. Items 1 to 8 were positively scored i.e. A=4, B=3, C=2 and D=1 and items 9 to 14 were reverse scored i.e. A=1, B=2,C=3 and D=4. Scores range between 14-56 with higher scores indicating higher levels of mental toughness. Each questionnaire was tabulated into three categories (a) Confidence (b) Constancy (c) Control. Scores range between 14-56 with higher scores indicating higher levels of mental toughness.

### **Statistical Analysis –**

To find out the relationship among the research variables exists or not, t-test was used to test the significance of difference between the means. Statistics for each characteristic were calculated; Mean, Standard deviation, Standard error of Mean. Data was analyzed using SPSS (statistical package for the social sciences). Statistical significance was set at  $p < 0.05$ .

Table-1

Male	Female						t-value
	Mean	SD	S.E <sub>m</sub>	Mean	SD	S.E <sub>m</sub>	
<b>Confidence</b>	16.5	5.28	0.75	15.7	4.94	0.7	0.8606
<b>Constancy</b>	10.9	3.51	0.5	10.8	2.86	0.41	0.1247
<b>Control</b>	11.6	2.70	0.36	12.2	2.58	0.37	1.13426
<b>Total</b>	39	7.23	1.02	38.6	5.37	0.76	0.283

$P < 0.5$

From the above table 1 indicates male sports persons have more confidence than female players having mean value of 16.5 and 15.7 respectively, But this difference does not make a difference statistically showing non-significant t-value 0.8606 at  $p < 0.05$ . The results reveal that male sports persons show more confidence the reason being more exposed to social environment than female counterparts. The results of Crust, L, and Keegan, R<sup>[5]</sup> (2010) support the above study. Another component of mental toughness is constancy in this component male shows slightly more mean value of 10.9 than female counterparts having mean value of 10.8 indicating non-significant t-value 0.1247, The findings of Sheard Michael et al<sup>[4]</sup> (2009) also reveal that male and female sports persons show no static difference in constancy, the mild higher mean value of male shows that male being more emotionally stable than female counterparts. Evident from control shows that female sports persons show more mean value of 12.2 as compared to male sports persons showing mean value of 11.6 showing non-significant t-value of 1.1342 at  $p < 0.05$ . The results reveal that female sports persons had more control over their emotions as compared to male counterparts. Zeiger JS and Zeiger RS<sup>[12]</sup> (2018) studies had shown lower levels of self-esteem in females and confidence and control as compared to male sports persons their findings do not correspond with the present study, The score in total mental toughness reveals that males indicate more mean value of 39 than female players showing mean value of 38.6 indicating non-significant t-value of 0.283. The investigation done by Bahari Fahimeh et al<sup>[7]</sup> (2016) and Kalkavan Arslan et al<sup>[11]</sup> (2017) corresponds with the above results. The results indicate that male players were more mentally tough than female players the reason being natural instincts and social environment. From the above data it is clear that inter-college level male and female sports persons possess moderate mental toughness.

### **CONCLUSION**

From the above study following conclusion were drawn. The male player's shows more mean value on the variable of confidence and constancy as compared to female counterparts but female players show higher mean value on the variable of control, showing non significant differences at  $p < 0.05$ . The result also reveals that no significant differences exist on variable mental toughness between male and female players. From the above study it was concluded that male and female players do not differ in terms of mental toughness the reason being both male and female players were engaged in lower level of competition and were less mature to manoeuvre the psychological tactics during competition. It is also evident that mental toughness increase with the increase in the level of competition.

### **References**

1. Jones Graham (2002) What Is This Thing Called Mental Toughness? An Investigation of Elite Sport Performers *Journal Of Applied Sport Psychology*, 14: 205–218.
2. [Thelwell, Richard](#) , [Weston, Neil](#) and Greenlees (2005) [Defining and understanding mental toughness within soccer](#). In: *Journal of Applied Sport Psychology*. Vol. 17, No. 4. pp. 326-332.
3. [Daniel F. Gucciardi](#) , [Sandy Gordon](#) , [James A. Dimmock](#) & [Clifford J. Mallett](#)(2009)[Journal of Sports Sciences](#), [Volume 27](#), [Issue 13](#).Published Online: 25 Sep 2009.
4. Sheard Michael, Golby Jim, and Wersch Anna van (2009) Progress Toward Construct Validation of the SportsMental Toughness Questionnaire (SMTQ) *European Journal of Psychological Assessment*; Vol. 25(3):186–193.
5. Crust, L, and Keegan, R. (2010). Mental toughness and attitudes to risk-taking. *Personality and Individual Differences*, 49(3), 164-168.
6. Cowden Richard G , Fuller Dana K And Anshel Mark H (2014) Psychological Predictors Of Mental Toughness In Elite Tennis: An Exploratory Study In Learned Resourcefulness And Competitive Trait Anxiety. *Perceptual & Motor Skills: Exercise & Sport*,Vol 119, 3, 661-678.
7. Bahari Fahimeh, Biyabani Meysam, Zandi Hassan Gharayagh(2016) Relationship between Mental Toughness and Behavioral Regulation among University Student-athletes. *IOSR Journal of Sports and Physical Education (IOSR-JSPE)*.Volume 3, Issue 4, PP 06-10.
8. Golby, J, and Wood, P. (2016). The Effects of Psychological Skills Training on Mental Toughness and Psychological Well-Being of Student-Athletes. *Psychology*, 7, 901-913.
9. Cowden Richard Gregory (2017)Mental Toughness and Success in Sport: A Review and Prospect. *The Open Sports Sciences Journal*, Vol , 10, 1-14.
10. Cowden Richard G (2017) On the mental toughness of self-aware athletes: Evidence from competitive tennis players. *South African Journal of Science* Volume 113, Number ½.
11. Kalkavan Arslan, Mehmet and Gökhan (2017) Investigation of the Mental Endurance Levels of the Athletes Participating in the Table Tennis Championship of Universities in Turkey.*International Journal of Science Culture and Sport*, Vol: 5(4)
12. Zeiger JS, Zeiger RS (2018) Mental Toughness latent profiles in endurance athletes. *PLoS ONE* 13(2): e0193071.

## A COMPARATIVE STUDY OF AGGRESSION BETWEEN CHAMPION AND NON-CHAMPION PLAYERS

**Dr Jaskaran Singh Sidhu**

Assistant Professor Enlightened college of Physical Education Jhunir.Punjab

[jaskaransidhu@rediffmail.com](mailto:jaskaransidhu@rediffmail.com)

### Abstract

**Aim-** The purpose of this study is to find the aggression level between champion and non champion players at intercollegiate level of Mansa District. **Methodology-** For present research work the sample was taken from all sports events from Mansa District (Punjab) Total 40 male sports persons were taken 20 champion and 20 non champion players of inter college level. The subjects were selected randomly. **Tools.-** Aggression was measured using the 29 item version of the BPAQ (Buss & Perry, 1992). The Aggression scale consists of 4 factors ; Physical Aggression (PA), Verbal Aggression (VA), Anger (A), Hostility (H). The total score for Aggression is the sum of the factor scores. **Statistical Analysis-** To find out the relationship among the research variables exists or not, t-test was used to test the significance of difference between the means. Statistics for each characteristic were calculated; Mean, Standard deviation, Standard error of Mean. Data was analyzed using SPSS (statistical package for the social sciences). Statistical significance was set at  $p < 0.05$ . **Results-** shows significant differences at  $p < 0.5$  on the variable of vocal aggression between champion and non champion players. No significant differences exist on the variable of physical aggression, anger and hostile between champion and non champion players. **Conclusion-** From the above study it was conclude that champion player were instrumental aggressive and this helps them to become champions.

**Keywords:** Physical Aggression. Verbal Aggression. Anger. Hostility

### INTRODUCTION

The word aggression comes from Latin root raggedy, ad (to or toward) and grad or walk, literally then the word means to walk or approach, to “move against” or to “move with intent to hurt or harm”. Most psychologists describe with aggression in terms of behavior. Aggression has a long history in both sport and non-sport circumstances. Different Psychologist define aggression in their own words but it is commonly agreed that aggression is a verbal or physical behavior that is directed intentionally toward another individual and has the potential to cause psychological or physical harm.

Causes of Aggression? The main cause of Aggression is still the matter of research but three theories were given by different psychologist to elaborate the cause of aggression.

#### 1. Instinct Theory of Aggression

#### 2. Frustration Aggression Hypothesis

#### 3. Social Learning Theory.



Apart from above theories Cox<sup>[7]</sup>(1995) has listed several factors associated with the occurrence of aggression in sport-specific context.

### **The list includes**

- (1) Environmental temperature,
- (2) Perception of opponent's, intentions to aggress,
- (3) Fear of retaliation, and
- (4) Structure of the game (closer the physical contact between the opponents, greater the chance of the retaliatory aggression). Game variables which often lead to aggressive behavior are summarized as (a) point differential; (b) playing at home or away; (c) outcome of participation; (d) league standings and (e) periods of play.

In sport, aggression is a characteristic that can have many negative as well as positive effects on performance. Most people view aggression as a negative psychological characteristic, however some sport psychologists agree Widmeyer & Birch<sup>[4]</sup> 1984 and Bredemeier<sup>[6]</sup> 1994 that aggression can improve performance, this is called an assertive behavior, where a player will play within the rules of the sport at a very high intensity, but will have no intention to harm an opponent. In sport, aggression has been outlined into two categories: hostile aggression and instrumental aggression (Silva<sup>[3]</sup> 1983). Hostile aggression is when the main aim is to cause harm or injury to your opponent. Instrumental aggression is when the main aim is achieve a goal by using aggression. In Instrumental aggression you can only punish mistakes as your opponent makes them, and here is where it's important to understand your own skill level. Whether you are champion or competitor, aggression works other than depending on where you are in the skill ambit:

### **Passive Aggression in lower-level play**

In the lower levels, it will be to your advantage to play more defensively and wait for the other player(s) to make the mistakes – because rest assured, they will. Being patient may not be flashy, but it's a great way to learn the game and win while you're at it.

### **Active Aggression in higher-level play**

As you progress up the ladder, you'll find that players tend to be more experienced and make far fewer mistakes. Now, it's up to you to be the aggressor and initiate more frequently, applying pressure and forcing your opponent to react to your decision making. This way, they're more likely to break, and finally make a mistake you can punish them for.

In the present study we try to find the aggression level between champion and non champion players at university level.

**Aim of the Study:** The purpose of this study is to find the aggression level between champion and non champion players at intercollegiate level of Mansa District.

## METHOD

**Sample-** For present research work the sample was taken randomly from all games and sports events of Mansa District (Punjab) Total 40 male sports persons were taken 20 champion and 20 non champion players of inter college level. The subjects were selected randomly.

**Limitation:** The study is limited to the Male sports persons who participated and scored positions at inter college level of Mansa District only.

### Statistical Analysis :

To find out the relationship among the research variables exists or not, t-test was used to test the significance of difference between the means. Statistics for each characteristic were calculated; Mean, Standard deviation, Standard error of Mean. Data was analyzed using SPSS (statistical package for the social sciences). Statistical significance was set at  $p < 0.05$ .

### Tools

Aggression was measured using the 29 item version of the BPAQ (Buss & Perry<sup>[5]</sup> 1992). The Aggression scale consists of 4 factors

- (1) Physical Aggression (PA).
- (2) Verbal Aggression (VA).
- (3) Anger (A).
- (4) Hostility (H).

The total score for Aggression is the sum of the factor scores.

### Physical Aggression (PHY)

The Physical Aggression (PHY) score is a measure of the tendency to use physical force when expressing anger or aggression. The PHY score indicates that the sports person may find it difficult to control urges toward physical aggression. Physical aggression score also shows the tendency of antisocial personality characteristics and difficult in focusing the attention and controlling impulses.

### Verbal Aggression (VER)

The Verbal Aggression (VER) score measures the tendency to be verbally argumentative. He may feel extremely frustrated or be under an extreme amount of stress. A high VER score can signal the neurological impairment.

### Anger (ANG)

The AQ Anger (ANG) score measures anger-related arousal and sense of control. It is the AQ score that is most responsive to building an effective set of coping strategies.

### Hostility (HOS)

The AQ Hostility (HOS) score is a measure of feelings of resentment, suspicion, and alienation—feelings that seriously undermine both physical and psychological health.

### Total Score

The AQ Total score is a summary measure of the overall level of anger and aggression reported by sports persons.

### Administration of Test

Questionnaire schedule was distributed among sports persons and the purpose of the test was explained to the sports persons any difficulty in filling the questionnaire was sought out, the scoring pattern was explained to the sports persons. After completing the test the questionnaire schedules were collected for scoring.

### Scoring

Scoring was done by using the 5 point scale shown below; indicate how uncharacteristic or characteristic each of the following statements is in describing ones aggression level.

- 1 = extremely uncharacteristic of me
- 2 = somewhat uncharacteristic of me
- 3 = neither uncharacteristic nor characteristic of me
- 4 = somewhat characteristic of me
- 5=extremely characteristic of me

**Table-1**

	Champion		Non-champion				t-value
	Mean	S.D	S.E	Mean	S.D	S.E	
Physical Aggression	26.50	3.28	0.73	27.10	3.62	0.81	0.50
Vocal Aggression	13.05	1.70	0.38	16.00	2.41	0.54	4.48*
Anger	15.75	2.94	0.66	16.50	4.37	0.98	0.64
Hostile	19.25	4.25	0.95	19.50	4.06	0.91	0.19
Total	18.64	5.96	0.666	19.76	5.73	0.64	1.22

\*P<0.05

Table 1 Indicates non champion players have more physical aggression than champion players having mean value of 27.10 and 26.50 respectively, showing non-significant t-value 0.50 at  $p < 0.05$ . Higher physical aggression among non-champion players indicates that they find it difficult to control urges toward physical aggression and it is difficult for them to focus their attention and controlling impulses. Fruchart Eric and Rulence-Pâques Patricia<sup>[9]</sup> (2014) investigate in their study that profession players shows less physical aggression as compared to common people. In case of verbal aggression non champion players indicates higher mean value of 16 as compared to champion players showing mean value of 13.05 indicating significant t-value 4.48 at  $p < 0.05$  level. Higher verbal aggression score indicates that non champion player's shows the sign of frustration or under stress, non-champion players should do stress reduction techniques and include them in his daily routine. The results of Dunn John G.H. and Dunn Janice Causgrove<sup>[8]</sup>(1999) also shows that elite sports persons were less aggressive. Anger score measures anger-related arousal and sense of control, non-champion player show the tendency of higher anger then champion player showing mean value of 16.50 and 15.75 indicating non-significant difference at t-value of 0.64. The result reveals that both champion and non-champion players do not show unusual amount of anger. Morgan Willam P and Pollock Micheal L<sup>[1]</sup> (1977) reveals that elite runners shows less anger as compared to normal population. Regarding hostile the non-champion players were more hostile than champion players having mean value of 19.50 and 19.25 respectively showing non-significant t-value of 0.19 the results reveal that high on hostile scale shows the feeling of resentment, suspicion, and alienation—feelings that seriously undermine both physical and psychological health. Jacobs Larry Wallace<sup>[2]</sup>(1978) was also of the view that hostile players were served more penalties than others. In totality the aggression level of non-champion players more than the non-champion players indicating mean value of 19.76 and 18.64 showing non-significant t-value of 1.22. The investigation done by Jaswant<sup>[11]</sup> (2015) supports the results of the above study.

### **CONCLUSION**

From the above study following conclusion were drawn. Significant differences exist at  $p < 0.5$  between champion and non champion players on the variable of vocal aggression. No significant difference exists on the variable of physical aggression, anger and hostile but non champion were high on the aggression scale on the variable of physical aggression, vocal aggression and were more hostile than champion players. In totality non champion players were high on aggression scale than the champion players. From the above study it was conclude that champion player were instrumental aggressive and this helps them to become champions.

### **References**

1. Morgan Willam P and Pollock Micheal L (1977) Psychologic characterization of the elite distance runner. Annals of the new york academy of sciences. Vol 301 issue1
2. Jacobs Larry Wallace(1978) Aggression and performance in ice hockey. The University of Montana Presented in partial fulfillment of the requirements for the degree of Master of Science.
3. Silva, J. M. (1983). The perceived legitimacy of rule violating behaviour in sport. Journal of Sport Psychology, 5, 438-448.
4. Widmeyer [W. Neil](#) and Birch [Jack S.](#) (1984)Aggression in Professional Ice Hockey: A Strategy for Success or a Reaction to Failure? [The Journal of Psychology](#) Interdisciplinary and Applied. Volume 117, 1984 - [Issue 1](#).Pages 77-84.
5. Buss, A.H., & Perry, M. (1992). The Aggression Questionnaire. Journal of Personality and Social Psychology, 63, 452-459.
6. Brenda Jo Light Bredemeier (1994)Children's Moral Reasoning and Their Assertive, Aggressive, and Submissive Tendencies in Sport and Daily Life. Volume: 16 Issue: 1 Pages: 1-14.
7. Cox, R. H., & Yoo, H. S. (1995). Playing position and psychological skill in American football. Journal of Sport Behavior, 18(3), 183-194.
8. Dunn [John G.H.](#) and Dunn [Janice Causgrove](#)(1999) Goal Orientations, Perceptions of Aggression, and Sportspersonship in Elite Male Youth Ice Hockey Players. The sports psychologist [Volume 13 Issue 2](#).
9. Fruchart Eric and Rulence-Pâques Patricia (2014) Condoning Aggressive Behaviour in Sport: A Comparison between Professional Handball Players, Amateur Players, and Lay People. *Psicológica* Vol 35, 585-600.
10. Gencheva Nezabravka(2015)Aggression in youth Athletes. *Research in Kinesiology*. Vol. 43, No. 2, pp. 205-209
11. Jaswant (2015)A comparative study of aggression and emotional intelligence among medalist judo players of M.D.U.,Rohtak, C.D.L.U., Sirsa, K.U., Kurukshetra and Haryana senior state level judo championship. *International Journal of Multidisciplinary Research and Development* Volume 2; Issue 12; Page No. 528-531
12. [Andrew M. Sherrill](#), [Lauren T. Bradel](#), (2017) "Contact sport participation predicts instrumental aggression, not hostile aggression, within competition: quasi-experimental evidence", *Journal of Aggression, Conflict and Peace Research*, Vol. 9 Issue: 1, pp.50-57.
13. Sofia Rui and Cruz José Fernando A. (2017)Unveiling anger and aggression in sports: The effects of type of sport, competitive category and success leve.l *Research Center of Psychology, School of Psychology, University of Minho,Portugal. Journal of Sport Psychology*. Vol. 26, núm 2 pp.21-28
14. Ozlem Keskin(2018)Effect of Sports Satisfaction on Aggression and Stress in Judokas and Swimmers.*Journal of Education and Training Studies*. Vol 6, No 6.

## PREVALENCE OF PRE-COMPETITION ANXIETY IN ATHLETES OF URBAN AREA, HISAR

Saleem<sup>2</sup>, Shabnam Joshi<sup>1</sup>, Sonu Punia<sup>1</sup>, Sivachidbaram Kulandaivelan<sup>1</sup>,  
Assistant Professor, Dept. of Physiotherapy, GJUST, Hisar-125 001.Haryana. India  
Student, Dept. of Physiotherapy, GJUST, Hisar-125 001.Haryana. India  
[sonu.punianeuropt@gmail.com](mailto:sonu.punianeuropt@gmail.com)

### Abstract

**Background:** In athlete, Sports Anxiety defined as a disinterest situation that was arising due to stress of performing well in competition. Anxiety is a symptom not a disease i.e associated with established any disease. Presentations of anxiety in form of physiological parameters like sweating, increased heart rate; behavioral parameters like biting nail; cognitive like loss of concentration, dividend attention, inappropriate thoughts

**Aim:** The objective of the study was to examine anxiety level among athlete of hisar.

**Methods:** The sample size consists of 262 male and female athlete aged between 18 to 31 years. The participants completed sports competition anxiety scale before the competition.

**Results:** The mean age of participating athlete was  $19.77 \pm 3.02$  years and mean anxiety score of the athlete was  $19.61 \pm 2.80$ . 87% of athletes were male and 13% were females. Out of 262 athletes, 63% of athlete from running; 6.5% of athlete from throwing; 6.5% of athlete from jumping; 15.3% of athlete from team sports and 8.7% of athlete from individual sports. When we categorized anxiety score in to three categories depending on score of anxiety, 85.1% have moderate level of anxiety; 10.7% have low anxiety and 4.2% have high level of anxiety.

**Conclusions:** The present study concludes that maximum numbers of athletes have optimal level of anxiety depending on level of score.

**Key words:** Sports competition anxiety; Athlete; Performance; Competition

### INTRODUCTION

In general, anxiety can be defined as psychological stress due to some unpleasant environmental situation. General anxiety can be of two types; one is trait anxiety and other is somatic anxiety. Trait anxiety is one's stable behavior to stress but on the other hand somatic anxiety is situation specific or temporary<sup>1</sup>. Anxiety is a symptom not a disease i.e. it is associated with any established disease. Anxiety presents in the form of physiological parameters like sweating, increased heart rate; behavioral parameter symptoms like biting nail, cognitive symptoms like loss of concentration, divided attention and inappropriate thoughts<sup>2</sup>.

In athletes, sports anxiety is defined as a disinterest situation that arises due to stress of performing well in competition. Different terms used for sports anxiety are competitive state anxiety, competitive trait anxiety, performance anxiety, competition anxiety, and pre-competition anxiety and post competition anxiety<sup>3</sup>.

Extensive work has been done on relationship between performance and anxiety in sports. Previous researchers state that low level of anxiety leads to decrement in performance and higher level of anxiety leads to increase in performance. The reversal theory suggested that athlete may take anxiety as inhibitive or accelerative to performance as per his own choice<sup>4,5,6</sup>.

Presently, situation is different as suggested by many multi-conceptual models like multidimensional anxiety theory, catastrophe theory, the Individual Zones of Optimal

Functioning and Smith and Small. These models described an imbalance between performance and anxiety. Anxiety may be due to stress response affected by above mentioned cognitive and physiological parameters. They state that there is negative relation between cognitive state and performance, whereas somatic state anxiety and performance is related in an inverted-U shaped manner<sup>7,8</sup>.

Since intensive research has been done on impact of sports competition anxiety on athlete's performance but there is gap in literature regarding prevalence study on pre competition anxiety in athletes. The aim of the present study was to know the prevalence of anxiety in participants of different games in Hisar, an urban city of Haryana.

## **METHOD**

**2.1 Study Participants:** This chapter presents the study participants, instrumentation used and procedure of the study. A total of 262 athletes aged 18–31 years (228 males, 34 females) were recruited from Hisar city. Participants were excluded from the study if they had any major health issues and chronic disability diseases that prevent the athlete to participate in the study. They were further categorized into five subcategories: 40 team-sport athletes (cricket, football, basketball, volleyball, handball); 23 individual-sport athletes (boxing, shooting, badminton, judo, table tennis); 165 running athletes (race, hurdle); 17 throwing athletes (disc throw, javelin throw) and 17 jumping athletes (long jump, high jump and triple jump).

**2.2 SCAT Instrumentation:** Sports Competition Anxiety Test (SCAT) was used to examine the anxiety level among athletes (262). SCAT is a generalized universal instrument, designed to measure Pre and Post competition anxiety. Out of 15 descriptive questions in SCAT questionnaire, 5 questions (1,4, 7, 10 and 13) score zero regardless of the athlete response; 5 questions (8, 9, 12, 14, and 15) evaluated physical component of competitive anxiety, and 5 questions (2, 3, 5, 6, and 11) evaluated cognitive component of competitive anxiety. Score of all ten questions is calculated on the response received on a basis of 3-point nominal scale (from 1–rarely; 2–sometimes; 3–often). Score values range from 10 to 30 (less than 17 indicates low level of anxiety; 17 to 24 indicates average level of anxiety and more than 24 indicates high level of anxiety). SCAT questionnaire test-retest reliability has been already approved (Cronbach's alpha coefficient=0.89 and test- retest reliability=0.98).

### **2.3 Procedure**

Prior to data collection, aim & objective of the study and detailed procedures were explained to the athletes and a written informed consent was obtained from athletes. Confidentiality of participants was maintained and athletes were assured about privacy of the data and other information. Participants completed the SCAT questionnaire two hours before the competition in the stadium.

### **Statistical Analysis**

We analyzed data with 22.0 SPSS version software. The significance level was set at  $p < .05$ . Chi square test was used to see the relation between CatSCAT and type of game, age and sex.

## RESULTS

### 3.1 Descriptive Statistics

The mean age of participating athletes was  $19.77 \pm 3.02$  years and mean anxiety score of the athlete was  $19.61 \pm 2.80$ . About 87% of athletes were males and 13% were females. Out of 262 athletes, 63% of athletes were runners; 6.5% of athletes were throwers 6.5% of athletes were jumpers; 15.3% of athletes from team sports and 8.7% of athlete from individual sports. When we categorized anxiety score into three categories depending on score of anxiety, 85.1% had moderate level of anxiety; 10.7% had low anxiety and 4.2% had high level of anxiety. Cross tabulation between Cat SCAT and type of game, age and sex did not show any significant results (showing in table 1, 2, 3 and 4).

**Table 1: Crosstabulation between CatSCAT and Type of Game**

Type of Anxiety	SCAT	Running	Throwing	Jumping	Team Sports	Individual Sports	Total
Low Anxiety	Count	17	3	2	3	3	28
	% within CatSCAT	60.7%	10.7%	7.1%	10.7%	10.7%	100%
	% within type of game	10.3%	7.1%	11.8%	7.5%	13.0%	10.7%
	% of Total	6.5%	17.6%	0.8%	1.1%	1.1%	10.7%
Optimal Anxiety	Count	141	14	15	35	18	223
	% within CatSCAT	63.2%	6.3%	6.7%	15.7%	8.1%	100
	% within type of game	85.5%	82.4%	88.2%	87.5%	78.3%	85.1%
	% of Total	53.8%	5.3%	5.7%	13.4%	6.9%	85.1%
High Anxiety	Count	7	0	0	2	2	11
	% within CatSCAT	63.6%	0.0%	0.0%	18.2%	18.2%	100.0%
	% within type of game	4.2%	0.0%	0.0%	5.0%	8.7%	4.2%
	% of Total	2.7%	0.0%	0.0%	0.8%	0.8%	4.2%
Total Anxiety	Count	165	17	17	40	23	262
	% within CatSCAT	63.0%	6.5%	6.5%	15.3%	8.8%	100.0%

	% within type of game	100.0%	100.0%	100.0%	100.0%	100.0%	100.0%
	% of Total	63.0%	6.5%	6.5%	15.3%	8.8%	100.0%

The table shows the level of anxiety in different game such as Running, Throwing, and Jumping. There is different level of anxiety such as low, optimum and high level of anxiety. There are high anxiety in running person is 63.6% in seven player and and two person of individual and team support has high level of anxiety is 18.2%. There are low anxiety in Running person is 60.7% in 17 player.

**Table 2: Cross tabulation between CatSCAT and SEX**

Type of Anxiety	CatSCAT	Sex		Total
		M	F	
Low Anxiety	Count	26	2	28
	% within CatSCAT	92.9%	7.1%	100.0%
	% within Sex	11.4%	5.9%	10.7%
	% of Total	9.9%	0.8%	10.7%
Optimal Anxiety	Count	193	30	223
	% within CatSCAT	86.5%	13.5%	100.0%
	% within Sex	84.6%	88.2%	85.1%
	% of Total	73.7%	11.5%	85.1%
High Anxiety	Count	9	2	11
	% within CatSCAT	81.8%	18.2%	100.0%
	% within Sex	3.9%	5.9%	4.2%
	% of Total	3.4%	0.8%	4.2%
Total Anxiety	Count	228	34	262
	% within CatSCAT	87.0%	13.0%	100.0%
	% within Sex	100.0%	100.0%	100.0%
	% of Total	87.0%	13.0%	100.0%



The table 2 is compare the level of anxiety in men and women person .The table show the low level of anxiety in male is 92.9% in 26 people and in female the low level of anxiety is 7.1% in 2 player. The high level of anxiety in male is 81.8% in 9 players and 18.2 in 2 female players.

**Table 3: Cross tabulation between Cat SCAT and Cat Age**

Type of Anxiety	Cat SCAT	Cat Age			Total
		<18 years	18-21 years	>21 years	
Low Anxiety	Count	6	18	4	28
	% within CatSCAT	21.4%	64.3%	14.3%	100.0%
	% within CatAge	14.0%	11.4%	6.6%	10.7%
	% of Total	2.3%	6.9%	1.5%	10.7%
Optimal Anxiety	Count	36	133	54	223
	% within CatSCAT	16.1%	59.6%	24.2%	100.0%
	% within CatAge	83.7%	84.2%	88.5%	85.1%
	% of Total	13.7%	50.8%	20.6%	85.1%
High Anxiety	Count	1	7	3	11
	% within CatSCAT	9.1%	63.6%	27.3%	100.0%
	% within CatAge	2.3%	4.4%	4.9%	4.2%
	% of Total	0.4%	2.7%	1.1%	4.2%
Total Anxiety	Count	43	158	61	262
	% within CatSCAT	16.4%	60.3%	23.3%	100.0%
	% within CatAge	100.0%	100.0%	100%	100.0%
	% of Total	16.4%	60.3%	23.3%	100.0%

The table 3 is cross tabulation in between different age group such as below 18, 18-21 and above 21 age group will show the low level of anxiety is above 21 age group and the high level of anxiety is in 18-21 year group is 63.6% person.

**Table 4: Chi square test variables**

	<b>Value</b>	<b>Df</b>	<b>Significance</b>
Type of game	4.09 <sup>Ns</sup>	8	.848
Age	2.04 <sup>Ns</sup>	4	.728
Sex	1.15 <sup>Ns</sup>	2	.56

**\*, means p values ≤0.05; <sup>Ns</sup>, means nonsignificant**

### **DISCUSSION**

Based upon evidences from previous research, sports anxiety is defined as a disinterest situation that arises due to stress of performing well in competition. Different terms used for sports anxiety are competitive state anxiety, competitive trait anxiety, performance anxiety, competition anxiety, and pre-competition anxiety and post competition anxiety<sup>3</sup>.

Purpose of present study was to determine the prevalence and relationship between performance and pre competition anxiety level in the athletes.

Findings of this study showed that younger athletes (85.1%) had moderate level of anxiety (score lies between 17-24). The results of present study are supported by results of previous studies which report that there was an inverse and significant relationship between the athlete's anxiety and their performance<sup>24-31</sup>.

Abolghasemi et al. concluded that higher level of competitive anxiety results in reduction of athletic and performance and academic achievement<sup>13</sup>. Zamani and Moradi compared the different types of anxiety i.e state and trait types of anxiety and suggested that individual sport athletes had higher anxiety and less self-confidence than team athletes and they found no significant gender differences and the different levels of anxiety pre and during a competition in volleyball players<sup>14,15</sup>. Previous studies concluded that competitive anxiety is higher in adolescent in individual sports than team sports but some studies deny this relationship<sup>16, 17</sup>.

Previous study literature showed a positive relationship between the anxiety level of coaches' and the athletes' means higher level of coaches' anxiety has a positive effect on athletes' anxiety<sup>18-22</sup>.

Research suggested that social motivation in competition can have impact on attention and memory and performance<sup>10</sup>. Based on the findings of the study, sports authority or coordinator should arrange well planned organized sports program activity for athletes that helps them in reducing the negative effects of anxiety. Developing a coping strategy to improve healthy lifestyles and planning to devote time for leisure physical activity among athletes may help to reduce stress levels. The findings of study cannot be generalized to the entire athlete population, because the sample was recruited from hisar city only. Thus, future research should also include athletes from rural areas in order to achieve a greater generalizability of the results.

### **CONCLUSION**

The present study concludes that maximum number of athletes have optimal level of anxiety depending on level of score.

## References

1. Hanton S, Mellalieu S, Williams JM. Understanding and managing stress in sport. In: Williams JM, Krane V, editors. *Applied Sport Psychology: Personal Growth to Peak Performance*. 7th ed. New York, NY: McGraw-Hill; 2015:207–239.
2. Weinberg RS, Gould D. *Foundations of Sport and Exercise Psychology*. 6th ed. Champaign, IL: Human Kinetics; 2015.
3. Jessica L Ford, Kenneth Ildefonso, Megan L Jones, Monna Arvinen-Barrow. Sport-related anxiety: current insights. *Journal of Sports Medicine* 2017;8 205–212
4. Yerkes RMD, Dodson JD. The relation of strength of stimulus to rapidity of habit formation. *J Comp Neurol Psychol* 1908;18(5):459–482.
5. Hull CL. *Principles of behavior: An Introduction to Behavior Theory*. New York, NY: Appleton-Century-Crofts; 1943.
6. Apter MJ. *The Experience of Motivation: The Theory of Psychological Reversals*. London: Academic Press; 1982.
7. Cheng WKN, Hardy L, Markland D. Toward a three-dimensional conceptualization of performance anxiety: rationale and initial measurement development. *Psychol Sport Exercise* 2009;10(2):271–278.
8. Smith RE, Smoll FL. Sport performance anxiety. In: Leitenberg H, editor. *Handbook of Social and Evaluation Anxiety* New York, NY: Plenum Press; 1990:417–454.
9. Petra DOLENC. Anxiety, self-esteem and coping with stress in secondary school students in relation to involvement in organized sports. *Zdrav Var* 2015; 54(3): 222-229. doi 10.1515/sjph-2015-0031
10. Brynne C. DiMenichi, Elizabeth Tricomi. The power of competition: Effects of social motivation on attention, sustained physical effort, and learning. *Frontiers in Psychology* 2015; 6:1282.
11. Simon M. Rice, Alexandra G. Parker, Simon Rosenbaum, Alan Bailey, Daveena Mawren, Rosemary Purcell. Sport-Related Concussion and Mental Health Outcomes in Elite Athletes: A Systematic Review. *Sports Med* 2018; 48:447–465. <https://doi.org/10.1007/s40279-017-0810-3>
12. Mottaghi M, Atarodi A, Rohani Z. The relationship between coaches' and athletes' competitive anxiety, and their performance. *Iran J Psychiatry Behav Sci* 2013; 7(2): 68-76.
13. Abolghasemi A, Kiumarsi A, Arya Puran S, Dortaj F. Relationship between role ambiguity, role conflict and anxiety in competitive sports performance and athletic development of students. *J Res Plan in Higher Educ* 2006; 5(40): 39-54.
14. Parnabas VA, Mahamood Y. Competitive anxiety level before and during competition among Malaysian athletes. *Pertanika J Soc Sci Hum* 2010; 18(2): 399-406.
15. Zamani AR, Moradi A. Compare trait anxiety, state anxiety and confidence men athletes in individual sports and team sports. *J Knowl Resin Appl Psych* 2009; 11(40): 63-72.
16. Arianepooran S, Abolghasemi A. The relationship of coping strategies, goal orientation and competitive athletic performance anxiety, individual and group student athlete. *J Res SportsSci* 2006; 13(4): 141-55.
17. Behzadi F, Hamzei M, Nori S, Salehian MH. The Relationship between Goal Orientation and Competitive Anxiety in Individual and Team Athletes Fields. *Annals of Biological Research* 2011; 2(6): 261-8.

18. Coudevylle GR, Martin Ginis KA, Famose JP, Gernigon CH. Effects of self-handicapping strategies on anxiety before athletic performance. *Sport Psychol* 2008; 22(3): 304-15.
19. Dominikus F, Sofian Omar Fauzee M, Chong Abdullah M, Meesin CH, Choosakul CH. Relationship between mental skill and anxiety interpretation in secondary school hockey athletes. *European Journal of Social Sciences* 2009; 9(4): 651-8.
20. Esfahani N, Gheze Soflu H. The Comparison of pre-competition anxiety and state anger between female and male volleyball players. *World Journal of Sport Sciences* 2010; 3(4): 237
21. Hanton S, Thomas O, Maynard I. Competitive anxiety responses in the week leading up to competition: the role of intensity, direction and frequency dimensions. *Psychol Sport Exerc* 2004; 5: 169-81.
22. Lorimer R, Westbury T. Physical self presentation and competitive anxiety in male master divers. *Psychol Rep* 2006; 99(3): 773-80.
23. Mamassis G, amassis G. The effects of a mental training program on juniors precompetitive anxiety, self-confidence, and tennis performance. *J Appl Sport Psychol* 2004; 16(2): 118-37.
24. Loupos D, Fotini M, Barkoukis V, Tsorbatzoudis H, Grouios G, Taitzoglou I. Psychological and physiological changes of anxiety prior a swimming competition. *The Open Sports Medicine Journal* 2008; 2(41): 6.
25. Pigozzi F, Spataro A, Alabiso A, Parisi A, Rizzo M, Fagnani F, et al. Role of exercise stress test in master athletes. *Br J Sports Med* 2005; 39(8): 527-31.
26. Bawa HS. Personality hardiness, burnout and sport competition anxiety among athletics and wrestling coaches. *Br J Sports Med* 2010; 44: 57-58.
27. Varun Singh, Shashwat Prakash, Sonu Punia, Sivachidambaram Kulandaivelan Relationship between pre-competition anxiety and performance levels in inter-university women football teams". *International Journal of Physical Education, Sports and Health* 2017; 4(5): 136-139[P-ISSN: 2394-1685; E-ISSN: 2394-1693].
28. Varun Singh, Sonu Punia. Measurement of pre-competition anxiety in women football players among universities of central zone of India. *International Journal of Physical Education, Sports and Health* 2017; 4(5): 221-223[ P-ISSN: 2394-1685; E-ISSN: 2394-1693].
29. Varun Singh, Sonu Punia. Measurement of competition level anxiety of university level players by using scat in north zone in India. *International Journal of Yoga, Physiotherapy and Physical Education*; 2018; 3 (2); Pp: 07-09. [ISSN: 2456-5067].
30. Varun Singh, Sonu Punia. Impact of Pre-Competition Anxiety on Performance of University Level Female Football Players in different Zone of India. *International Journal of Physiology, Nutrition and Physical Education* 2018; (Article Ref. No: JOS-3-1-280).
31. Varun Singh, Sonu Punia. Prevalence of Pre-Competition Anxiety among University level female football players in South zone in India. *International Journal of Physiology, Nutrition and Physical Education* 2018; (Article Ref. No: JOS-3-1-276).

## **THE EFFECT OF TRAINING PROGRAM ON MIXED CONTRACTIONS ON BOTH THE MAXIMUM FORCE AND EXPLOSIVE FORCE OF THE LOWER LIMBS**

**Conducted study to the football players under the age of 17 years-Tiaret, Algeria**

**Dani Hakim, Loucine Sliman, Zakaria Azizi Mansour, Saidia Houari; Nahal Hamid  
The Laboratory of Modern Sciences of sports and physical activities, Institute of  
Physical Education and Sports; Université Akli Mohned Oulhadj -Bouira, Algeria.**

**The laboratory of measurement and evaluation of sports and physical activities;  
Tissemsilt university center. Algeria.**

[drsaidia@hotmail.com](mailto:drsaidia@hotmail.com)

### **Abstract**

The aim of the research is to propose a training program (mixed contractions) in order to develop the maximum power and explosive power levels of the lower limbs of the football players of the state university of Tiaret under the age of 17 years, as well as experimenting with some tests that allow the evaluation and development of the two classes of maximum strength and strength this study was conducted in the period from 10/11/ 2016 to 15/ 03/2017 .the two researchers conducted their studies on the middle of the Olympic football team under the age of 17 years for the 2016 /2017 sports season. Representing members of the research sample consisting of 25 under the age of 17 years Five players out the basic research sample included the pilot study remained 20 players applied to the proposed program, the maximum of them two players for injury, which included the program 18 players under the age 17 years after the parity process, Such as the selection of tests suitable for the explosive power of the maximum force after the proposal of the group of the tests on the on the arbitrators and choose the appropriate fit with is intended for development, using the application of the proposed training program (mixed contractions) the total of two training courses in week (Saturday and Wednesday) the size of a courier is estimated to one hour for the training courses for six weeks, after the tests were carried out after the result, and then recorded with the appropriate statistical means. The results show that explosive force requires rapid and strong muscle contractions during performance. This is characteristic of weight training, and the researchers believe that is result is in maximum force and explosive force and that the program well-designed strength training in mixed contractions (isometric and anisometric) is one of the best, fastest and most effective means of developing.

**Keywords:** Proposed Training-Mixed Contraction-Explosive Force-Maximum Force.

### **INTRODUCTION**

The game of football is one of the global sports activities that have witnessed a remarkable development in recent years in the physical, technical, rhetorical and psychological aspects, so the modern play in different teams and international teams quickly and forcefully in the exact technical performance, and this is due to the interest of international coaches.

The good training of the players during the youth stage at the level of various aspects to develop all the techniques that have a great effectiveness in competitions according to scientific methods studied. The muscle strength plays a very important role achieving the performance player during the game and it is clear the need for the player in many situations, especially when jumping to hit the ball head or the goal on the goal or long passes of different types and in the performance of various skills by force and speed appropriate to the possession of the ball or the control of the court of the court while overcoming the body weight during the game it is known that the stronger the muscles of the athlete and the reduced joints injuries, and the strength increases energy saving such as Latin phosphate and glycogen, and develop the player for a game football volitional qualities of the most important of courage, determination And self-confidence. There are also some skill movements that cannot be performed without a certain level of strength, so the development of power may affect the effectiveness of the long-term training system.

## **2-The problem**

The success of any training program is based on the proper progression of the successive training programs of the force. The weight training for some sports activities should be in the direction of specialized training for the type of activity, the correlation of the exercise with the skill objective chosen from the exercise (Dynamic or Fixed), type of contraction (Central and non-Central)and performance, (Fast or slow), in many sports it is necessary to have sufficient strength, ability and tolerance at the competitive level. The problem experienced by football coaches age groups less than 17 years old where they need to know you can de exposed to this age group high-intensity drills using resistors and what are the effects of these exercises.

In order to be strength training is effective in the development of maximum strength must know the direction of movement in the basic game first and then the most important muscle working in particular,

Those muscles, which is the burden of motor work during the competition and thus can be formed or build movements exercise weights on the basis of correct to benefit the player from this exercise without losing its effort (Mufti Ibrahim, 1996:152).Since football sports depends heavily on the development of strength for the lower limbs where the muscles of the four thighs play the quadriceps and the ichcio-jambie muscle muscles play an important role in producing a large muscle force used by the athlete to jump and kick.

In strength training, (Mare house and Rash and Loy) states that strength in any muscle functions is a determinant factor of pregnancy and that physical pregnancy can easily overcome weak stresses quickly by strength muscles and stress that the development of muscle Strength in weight is a key factor in increasing injury prevention the Hara program that the weight training program can be designed for various types of sports activities and easily control the resistance to muscle groups. Aut 1990 controysaid resistance training can have an impact on bone growth in both boys and girls. Research has shown that those who exercise weight training from young people have bones that are more intense than those who do not exercise weightlifting. Next one: Is the training program in the combination of isometric and anisometric impact on the maximum force and explosive force of the football team less than 17 years?

**2-1-Partial questions:**

- ✓ Are there statistically significant differences between the pre-test and post-test of the study sample for the maximum force test?
- ✓ Are there statistically significant differences between the pre-test and post-test for the 30meter test?
- ✓ Are there statistically significant differences between the pre-test and post-test of the study sample for the Sargent test explosive force test?

**3- General Hypothesis:**

The proposed training program in mixed contractions (Isometric and Anisometric) has a positive effect on the two extremes of maximum force and explosive force of the lower limbs of football players under 17 years?

**3-1-Partial assumptions:**

**The first hypotheses:** There are statistically significant differences between the pre-test of the study sample for the maximum force test and for the post-test.

**The second hypotheses:** There are statistically significant differences between the pre-test of the study sample for the 30-metertest and for the post-test.

**The third hypotheses:** There are statistically significant differences between the pre-test of the study sample for the explosive force test (Sargent test)and for the post-test.

**4- Objectives of the study:** The objectives of the research are as follows:

- Knowledge of the effect of a training program on mixed contractions (Isometric and Anisometric) on the extreme strength of raising the level of football players under 17 years.

- Know the impact of the training program of the explosive power of lifting football level less than 17years.
- Experimentation of some test that allow for the evaluation and development of the maximum power and explosive power levels of the lower of football players under the age of 17 years.

## **5- Identification of concepts and terms:**

### **5-1- Training Program:**

✚ **Definition of the term:** defined as the executive steps in the form of detailed activities to be done to achieve the goal, so we find that the program is one of the elements of the plan and without it planning is incomplete.

✚ **Procedural definition:** a structured educational process planned according to the principles and scientific foundations aimed at developing physical abilities and skill and rhetorical and cognitive to achieve a high level of achievement in sports activity.

### **5-2- Isometric Exercise:**

✚ **Definition of the term:** the exercise of isometric muscle strength is based on exercises of muscle contraction fixed.

✚ **Procedural definition:** Isometric training is based on the strength of muscle exercises constant muscle contraction, which does not occur any changes in length of muscle during the contraction and does not occur the movement of the result of this contraction.

### **5-3- Isometric contraction:**

✚ **Definition of the term:** a contraction that refers to the relationship with the speed above the full rate, and the resistance in it, however, according to the angle of payment and degree of fatigue.

✚ **Procedural definition:** Other terms that can be explained are central and decentralized contraction, the movement of the muscles decentralized is one of the movements in which the muscle development and intensity of the length (sometimes called passive work) the movement of the central muscle is the development of muscle but the intensity but shorten (called positive action), (Zaki Mohamed Darwish, 1998:97).

### **5-4- Explosive force:**

✚ **Definition of the term:** Muscle or muscle group ability to produce the maximum possible strength against resistance, or the maximum effort that can be produced to perform one muscular contraction. (Abu Alaa Abdel Fattah, Ahmed Nasr El Din El Sayed,1993:87)



✚ **Procedural definition:** Strength is the ability to exert muscle strength and the possibility of use, and is intended to develop muscle strength, especially the muscles used play.

#### **5-5- Maximum force:**

✚ **Definition of the term:** Muscle strength is one of the most important and most factors related to performance in all sports, and these factors are through the maximum mobilization of all physical fitness, skill, planning and psychological.

✚ **Procedural definition:** The greatest strength that muscles can general from the maximum constriction.

#### **5-6- Age range under 17 years:**

✚ **Definition of the term:** The stage of the completion of the final and mature and rationalized the adolescent physically, mentally and socially and thus begins to change the teenager's dress wear the dress of manhood. (Ahmed, Mathematical Psychology, 1985:26).

✚ **Procedural definition:** It is the age of the individual to move from childhood to adulthood, characterized by several physiological changes, mental, emotional and social.

### **6- The previous and similar study's**

**-The first study:**(Iyad Hamid Rachid El khazrarji, 2001): the effect of using circle training style to develop the force featured with speed and some principal handball skills to the players under the age of 17 years.

**-The second study:**(Othman Adnan El Bayati, Iraq university,2004), the effect of force training with using the fixed and moving and mixed muscular constriction in some muscular force faces and functional variables to the player of handball under the age of 17 years.

### **7- The field procedures of search:**

The researchers adopted the experimental curriculum to fit with requirements of search.

### **8-The sample and society of search:**

The researchers conducted them study's intentionally on football players of Madrisa olympique team, (Tiaret) under the age of 17 years to the championship 2016/2017, where they selected randomly 20 players they representing the sample of search them estimated number is 25 players under the age of 17 years, which participated in the regional section (West) Saida Association, and participated too in the republic cup, we selected the sample of search according to the following conditions:

- The relation of researchers with team board directors.
- Participate in the sport competitions (the champion) regional (West) in addition to the republic cup.
- The nearness of facilities (the Stadium /bodybuilding hall).

As the researchers conducting to the equality between the two experimental and witness samples of search and study the variables which would effect on the experimental sample where the researchers get by the way the homogeneity between the two samples and variables of weight and height and physical variables.

### **9-The Temporal period:**

- ✓ The limit period of search 02/10/2016 to 15/03/2017.
- ✓ Conduct the tools search (Measurements, Tests, and the Applicable Training Program with mixed contractions. (Isometric and Anisometric).
- ✓ In 01/01/2017 we ended the theory of study.
- ✓ In November 2016 we chose the tools search (measurements, tests) after the expert consult.
- ✓ In 01/01/2017 to 14/02/2017 we have achievement set the training program with mixed contractions.
- ✓ 18/02/2017 to 15/03/2017 were-measure again, then we collect and analyse and discuss the data.

### **10-The Space:**

- Residence and stadium of team, in addition to the bodybuilding hall.

### **11-Human Resources:**

- Team of Madrisa (Tiarat) of football under the age of 17 years,Algeria.
- The total number of study is 20 players.

### **12-Tools search:**

- Sources and References in (Arabic, and French, and English).
- The direct and personal interviews.
- Questionnaire distributor for trainers (specialists in football) to built the problematic.

### **12-1-Tests and measurements:**

- Measurements of (Height, Weight, Age, Sex).
- Tests of (RM-1), (Speed 30m), (Sargent Test).
- The applicable training program (mixed contractions).

<b>Cycle1 / Rising pyramid strength</b>		
A maximum Speed, Accustom, the organization on construction auxotonique		
Intensity (%de RM)	50%+60%70%	2 <sup>nd</sup> session the same exercises as the cycle1.
Nombre of repletion	Blockof (8+6+4)	
Recovery	1 min with in the block and 2 min inter series	
Nombre de series	3	

<b>Cycle2 / Maximum forceconstruction auxotonique</b>		
Intensity (%de RM)	92%	2 <sup>nd</sup> session of week.  Same exercises as cycle1.
Nombre of repletion	3	
Nombre of series	3	
Recovery	3-4 min	

<b>Cycle3 / sinusoidale, sesion 1 :</b>		
the explosive force intention of maximum accelerator, throw him from helm		
Intensity (%de RM)	<b>30%</b>	1 session of week for the second meeting here is the following  - Exercises closer to  Activity (squat heiden, fentes , rowing with one arm ).
Numberof repeton	<b>5</b>	
Numberof séries	<b>3</b>	
Recovery	2 min	

<b>Cycle4 / sinusoidale, session 1 the dynamic –stato</b>		
Intensity (%de RM)	60%	

Numberof repetition	6	*the second session of cycle 4 uses method oriental force development but with lighther broadsin order to limit the constrains on muscles.
Numberof séries	3	
Recovery	2 min	

(Didier Reiss.PascalPrevost 2013)

### 13- Presentation and discussion of research:

#### 13-1- Discuss the results of the tribal and remote it's of research sample:

The exams	Pre -test		Post -test		T calculator	Degree of freedom	T table	Significance level 0,01
	X	Y	X	Y				
RM-1 test (kg)	165,11	9,27	171,94	9,41	11,8	17	2,89	Indicates
30M test (m)	4,66	0,12	4,36	0,26	5,09			Indicates
Sargent test (cm)	33,88	4,77	37,22	3,56	6,14			Indicates

**Table (01) shows the averages calculation and values of study's variables to the first measurement.**

#### 13-1-1-Discussion of results of the first hypothesis:

The table number (01) indicates that there is a moral difference at the level of significance 0.01 to test the maximum iteration in the pre-and post-measurement to the group of search, the two researchers indicates that this result back to the effectiveness of the proposed program though the number of duplicates and intensity applied in adversely, as the players got a good morphology structure can eye observed, as we register improvement at the level of general total

duplicates to the applicable program by the mixed contractions, (Isometric and Anisometric) to the lower parts of body (legs) and this is what the previous study's indicated.(Madjid El Mawla, 2000), the importance of totals muscular (trunk) to the movement transport which done from trunk and belly to another totals and control her accuracy, and this is what the young coaches neglects on foxes to develop this muscular totals.

This phase it's the most suitable phase to improve the maximum force as what stated in book of (Bastouiasia Ahmed): basis and theories of movement during the adolescence there is the best chance, and most suitable times for training on force, it's in general the growth moving in this phase mainly from transverse side, so we observe increase in size of muscles with knowing that there are a differences between the totals muscles, and then between the level of evolution, females they up to the maximum force muscular, In general in the age of 15 to 17 years, while males in the age of 17 to 22 years during this weightlifting phase, and the training ways used, it can be on the base of the adult with taking the importance to weights lift-out, it's a important principal to force training, especially at this sensitive phase.

### **13-1-2-Discussion of results of the second hypothesis**

The table number (01) indicates that there is a moral difference at the level of significance 0.01 to test 30m speed in the pre-and post-measurement to the total search, and the two researchers indicates though the number of duplicates and the intensity applied adversely, as the players got a good morphology structure can eye observed, as we register improvement at the level of general total duplicates to the applicable program by the mixed contractions , and this is what the previous study's indicated .

### **13-1-3-Discussion of results of the third hypothesis**

The table number (01) indicates that there is a moral difference at the level of significance 0.01 to test of Sargent testin the pre-and post-measurement to the group of search. The current evolution in the explosive force to arms and legs, in reason of exercises effectiveness during periods by using force exercises like exercises of jump and shoot, by using different resistors like body weight in jump exercises, and using the medicine balls in jump exercises, the affect to develop this character "that the exercises which used in a large resistance is one from the most suitable method for develop the components of explosive force "(Hosine and Ankabi,

113,188),so the force exercises increases the muscle ability to activate the possible number from the fibers as (Alawi and Abd el Fatah) indicated that “ whenever the possible number of muscular fibers increasing , whenever led to increase the force which the muscle able to produced “(Alawi and Abd el Fatah, 2003:122), whenever Mathews and Fox explained that the muscular ability of arm and shoulder can be developed by using the periods training program , includes weight trainings with a fast performance of arm, as the muscular ability of legs it’s more important in basketball, for this reason must building periods training program. By using the speed trainings and jump on the stairs and cord jump and verticals jumps and something like that from trainings (Mathews & Fox, 1974:199).

#### **14- Facing the results with hypotheses:**

Depending on the previous results the table number (01) shows the calculated values (T) of physical tests that represented (max iteration test RM-1, and speed test 30m, test ofSargent test)in addition to the post test to the experimental search group in a row where is show that all the large values from (T) table this indicates the appearance of differences function for the benefit of the post measurement in total tests which show the positive affect of the applicable training program of mixed contractions (Isometric, Anisometric) specialist for develop the maximum force and explosive force to the lower part of body (legs).

The researchers seen that this result agree with what the previous studies indicate, in addition to the personnel observation about force program which designed well, result to develop the maximum force and explosive force if it’s selected the appropriate measurement of work especially the study’s which took up training effect of maximum force and explosive force in the different phases to the football players under age of 17 years, each of Masaad Ali Mahmoud & Fox & West cottindicate that the scientific research which conducted in domain of training by weights most of their results indicated that the training by weights become from the effectiveness element to develop the different kinds of muscular force especially to the professional players in the world countries. The researchers indicates the reasons of the moral differences which appeared with maximum force test (RM-1) and 30m speed test, and test of explosive force (Sargent) which measuring the quality of maximum and explosive force to develop this quality for the persons of the experimental group and reasons of organizing curriculum of training, the training process dependent on his organized, which creating case of development in the level of

players performance through the harmony of the proposed curriculum training with the ability and capabilities members of search sample, as a result the positive evolution become visible to them. This is what (Carioux, 2008) confirmed, he said that his content contains exercises of Anisometric natural, thing that help on develop the speed of movements units to the muscle , and increase the nervous alert frequency, and improve the synchronization units movements, whenever it's more compatible , whenever the force be big.

As (Zaki Mohamed, 2007) indicated that the Anisometric training characterized its ability to effect on the nervous system that's includes the muscles by his training to affects quickly on the activity of muscle, and then produce intraday explosive force. According to (Amishand Salah, 1990)“football coaches are advised to develop the own muscular totals to the direction of speed that's mean the development of speed force for their importance in games”.

And (Goutouk) agree that this research and study's have proved in the current time that it's possible to develop the force in the early age but in condition of using exercises fit with structural characteristics and capacity and functional and psychological and not reflected negatively on their health (Goutouk, 2011:290).The researchers indicates the reasons of the moral differences which appeared the measurements of maximum force and explosive force quality to the development of the two own qualities of the experimental members group, it can be traceable to the reasons of the proposed organizing curriculum of training, the process training depend on his organized which creating case od evolution in the level of players performance through the harmony of the proposed organizing curriculum of training with capabilities and ability of search sample members (the experimental group),as a result it's become clear them positive evolution and that's what ( Hosine)confirmed that's the training process is “ those organized process and continuous which earn the person knowledge or skill or ideas or opinions to perform a particular work or reaching a particular goal, in addition to achieve regulatory goals and adaptation with work, and what submit to the person from a particular information or skills or moral directions required in regulatory view to achieve the ruler goals” (Hosine, 2007:178)and that's what showed the results of experimental group as the effect of program in them physical performance in moral way which indicate on the rise of physical side and it's have a more importance to the football player and it's principal feature from attributes of the modern game, and the real reason from the training is access the person to the highest levels of

sports by create a case of harmony between components and capabilities of youth players with the following program if the response of this group to the content of program be a positive response, which led to develop and improve the physical level the result of the application of the scientific basis through the work and his force, and comfort times, and duplicates, and the number of totals, and bonding between them, and that's what the researcher followed in the training program. "Due to the importance of these kinds of force to the football players, so it's represents a large proportion from own time to develop the muscular force in the trainings programs" (El Khashab and others, 2005:29).

"And football trainers are advised to develop the own muscular totals to be in the direction of speed so develop the seep force for their importance in games" (Amish, 2007:31), and implementation of (6-9) exercises in one training session, and must be the exercise performs quickly and the repeat of this exercise from (3-6) within the repetition (6-9).

## **CONCLUSIONS**

### **15-1-From the results of form distributed to coaches:**

Despite the coaches have a long qualifications and experiences in the field, but they still missing some modern scientific ways in the trainings especially force trainings (maximum force) and explosive force, in addition these coaches they don't seen the natural of this trainings in way of how develop the muscle force which they nominated from the principal physical characteristics to the football player as they don't gives importance to training this characteristics to the ages phase less than 17 years old.

✓ Lots of coaches they using the traditional ways and materials in them trainings so they foxes on the individual free exercises and twin exercises (with colleague) to develop the muscle force and especially ages phase (U17) and neglecting weightlifting exercises.

✓ Lots of coaches are against this exercises because it's leads to the hypertrophy muscles and reducing the movement and hardening the muscle and dangers of accidents and it's affect negative on the movements skills and some physical qualities like agility and speed and flexibility, which shows that the coaches are not interest to seen what's new in the field of football sport training, especially in field of force training.



### **15-2 From the results of tests:**

- ✓ The results of statistical treatment produced show that there are a differences of statistics significant between the pre-and post to the sample of search in the program with the mixed constrictions (Isometric, Anisometric) for the benefit of post- test in the physical tests in measuring the maximum force to the totals of lower muscular and explosive force test and test of 30m speed.
- ✓ Must the movements of trainings with weights or exercises converge from competitions movements for example: running with weights on the back.
- ✓ The achievement of sample it's a moral increase in the test of study and that's refer the experimental test which is designed with the mixed constrictions for develop the maximum force and explosive force to the totals of lower muscular.

The two researchers indicates that the explosive force need a quick constrictions and stronger in the muscle during the performance, and this is what features the trainings of weightlifting, and the researcher see that the result agree with what indicated the results of study's that there are a stronger and direct link between the maximum force and explosive force, and that the program of force training designed well, it's from the quick and best tools and much effectiveness in development of maximum force and achieve the consistency and the control of body parts, and makes muscles in more response to mastering the principal movements skills perfectly and become in high level, and the researcher agree that this statistical collection match with results of research and previous study's to prove important facts that the program of weightlifting training which designed well, will result in develop the performance and improving the movements compatibility skills and improving the compatibility between the working muscles collections.

### **SUGGESTIONS AND RECOMMENDATIONS**

- 1- The two researchers suggest the program force affects under long time conditions of which done in the current study.
- 2- also the researcher Recommended makes some study's in order to put a specialist program for develop the force individually to the players to achieve individually privacy

principal, and the program be according to individually privacy ( Physiological , Morphology, Genetic Factors, The training age....)

3- The two researchers suggest to makes another study's in order to measure the maximum force by using new equipment like: (Electro- stimulation) device which develop the totals muscles, we suggest too to the officials in our universities the necessity of providing this device.

### **17- The most important sources and references:**

#### **17-1-List of Sources and References in Arabic:**

- 1- AmerFakhirshagati and FadelKamel (2011): the Modern Directions in strength prolonged calming training, Library of Arabic Society for Publication, Amman.
- 2- IsamAbd El Khalik (2003): sport training Theories \_ Applications.
- 3- IsamAbd El Khalik (2005): sport training Theories Applications, EL Maarif Facility.
- 4- KamelDjamilArbadi (2004): sport training of the twenty-first century, first edition, Amman, Department of publications and publishing.
- 5- Mohamed DjabirBarkiaa (2005), the system of integrated in force training and endurance muscular, Dar El Kitab for publishing, Cairo.
- 6- ZakiMohemedHasan (2007): Autopsy descriptive function for muscle strength exercises. The Egyptian library for printing and publishing. Alexandria.

#### **17-2-List of Sources and References in French:**

- 1- Carrio.C. (2008): Echaufement. Sheathing and plyometric, Amphora Edition, Paris.
- 2- Bertrand Choffat (2005): Fitness. The Intermittent Method Training.
- 3- Didier Reissi. Pascal Prevost (2013): The Bible of the Physical Preparation. Amphora.
- 4- Daniel Le Gallais. Gregoire Millet (2007): The Physical preparation. Masson.

## A STUDY OF MINDFULNESS AND MEANING OF LIFE OF TIHAR JAIL PRISONERS

<sup>1</sup>Ashish Kumar, <sup>2</sup>Meenu Dabas & <sup>3</sup>Dr. Pardeep Kumar

<sup>1</sup>Ph.D. Research Scholar, DUDPESS, University of Delhi

<sup>2</sup>Corresponding Author: Ph.D. Research Scholar, DUDPESS, University of Delhi

<sup>3</sup>Supervisor: Associate Professor IGIPSS, University of Delhi

### Abstract

The Purpose of the Present Study was to assess the state of mindfulness and meaning of life between male and female prisoners of Tihar jail, Delhi. For the purpose of the study thirty four (N=34) male and thirty four female (N=34) from Tihar jail of Delhi were selected. A pre permission and consent were taken from compitent authority and prisoners of Tihar jail. To collect the data from prisoners two standard questionnaires of Mindfulness- 5 items with 6 point likert scale, respondents answer each item ranging from 1 (almost always) to 6 (almost never). The Meaning in Life Questionnaire (MLQ) consist of 10-item self-report inventory designed to measure life meaning on 7 points likert scale from absolutely true to absolutely untrue. Descriptive Statistics and Independent t-test were employed. The result of the study came as insignificant in variables of mindfulness(.24) means there was difference between the male and female prisoners in awareness and mindfulness, and meaning of life, sub variable the Presence t-test (-1.34), Search (-1.48) between male and female Prisoners found significant. The level of significance was set at 0.05 level.

**Key words:-** Mindfulness, Meditation, Meaning of life, Awareness, Tranquility

### INTRODUCTION

To know the meaning of life has become a topic of concern in modern times because of the increase in materialistic thinking and downfall of the religious values. Prior to 19<sup>th</sup> Century we find very few sections of society talking about the meaning of life (**Blocker 1974**). Nowadays, meaning of life possesses a threat to many people. We hear more people talking about the sexual matter rather than the meaning of life itself (**Freedman 1978**). Meaning in life can be defi ned in a variety of ways. Steger, Frazier, Oishi, and Kaler (2006 ) defi ned meaning in life as the sense and significance of life from one's personal point of view to experience being and existence. Reker (2000 ) defined meaning in life as a multidimensional cognitive system influencing the order, coherence, and purpose in one's life, the pursuit and fulfilment of one's goals, and the accompanying sense of goal achievement. Without meaning and purpose in their day-to-day lives, people may begin to question the value of their existence and lose interest in taking action ( Pope, 1999 ; Frankl, 2011 ; Sezer, 2012 ). Frank (2006 ) wrote that people have an instinctual drive to search for meaning or significance in their existence. Those people who have found meaning make sense of their life and have a clear view of themselves ( Reker, 2005)

Mindfulness can be defined as an awareness or consciousness of individual when we focus more on non- judgmental way of life. We often associate mindfulness with the world of meditation but

it is much more than that. Mindfulness is simply being present in the moment, feel the moment, which can be done anytime and anywhere. The central crux of mindfulness practice is being kind and a person of non- judgmental thinking. It is about your complete involvement in the moment.

Mindfulness training can be understood as a meta-cognitive skill whereby an individual becomes more aware of the nature of attention and their own processing of internal and external stimuli. Mindfulness has been defined as “paying attention in a particular way: on purpose, in the present moment” (Kabat-Zinn, 1994, p.4).

### **STATEMENT OF THE PROBLEM**

The Purpose of the present study was to assess the state of mindfulness and meaning of life between male and female prisoners of Tihar jail of Delhi.

### **METHOD**

**Sample selection & and Sampling Technique:** A total of sixty eight (N=68) thirty four (N=34) female prisoners and thirty four (N=34) male prisoners from Tihar jail were selected to collect the data. A pre permission and consent were taken from compitent authority and prisoners of Tihar jail. The prisoners were brief about the research study, and interested prisoners were selected for the study. They were also explicitly explained about the tools used in regard to purpose and instruction of the questionnaires. The subjects were sit in a comfortable place and copy of questionnaires were distributed and asked for honest and fair answer to the items. After completing the questionnaires the copy were collected from the subjects, after scoring as per the key the data was analysis on the SPSS-20.

**Selection of Variables:** The two standardized questionnaires were selected for the purpose of the study and the sub variables selected for the study were as under:

<b>S. No.</b>	<b>Variables</b>	<b>Sub- Variables</b>
1	Mindfulness	-
2	Meaning of Life	Presence & Search

**Tools and Techniques:** The Purpose of the study was to assess the state of mindfulness between male and female prisoners. To fulfill the purpose of the study descriptive statistics was employed. To collect the data from prisoners Questionnaire on Mindfulness and Meaning in life was employed. A 10-item questionnaire designed to measure two dimensions of meaning in life: (1) Presence of Meaning (how much respondents feel their lives have meaning), and (2) Search for Meaning (how much respondents strive to find meaning and understanding in their lives). Respondents answer each item on a 7-point Likert-type scale ranging from 1 (Absolutely True) to 7 (Absolutely Untrue). The Meaning in Life Questionnaire (MLQ) is a 10-item self-report inventory designed to measure life meaning. The MLQ has good internal consistency, with coefficient alphas ranging in the low to high .80s for the Presence subscale and mid .80s to low .90s for the Search subscale. A main focus of logotherapy is the discovery of life meaning.

Along these lines, logo therapy posits that: 1. there is meaning in life, 2. people are motivated by the Will to Meaning, and 3. people are free to find their own meaning.

The Mindfulness Questionnaire used to assess the state of mindfulness of prisoners. This instrument is based on a factor analytic study of five items independently developed mindfulness questionnaires. The analysis yielded five items that appear to represent elements of mindfulness as it is currently conceptualized.

**Data Collection:** The data was collected from Prisoners of Tihar jail, Delhi. A pre permission and consent were taken from competent authority and prisoners of Tihar jail. The selected above questionnaire were employed to collect data and scoring was done as per the instruction provided in manual of the respective questionnaires.

**Statistical Techniques:** To assess the status of state of mindfulness and meaning of life between male and female prisoners of Tihar jail, Delhi Descriptive statistics and t-test was employed and Presented in form of Tables, Graphical Illustration and Explanation of the Result.

**Table- 1. Descriptive statistics of Meaning of Life of Male and Female Prisoners.**

MOL, Sub-Variables	Mean & SD	Standard Error
Presence (Female)	3.14±1.22	.21
Presence (Male)	3.57±1.38	.23
Search (Female)	2.86±1.59	.27
Search (Male)	3.41±1.42	.24

The table 1 indicates the descriptive statistics of Meaning of life in male & female prisoners. The mean value of the sub variable Presence (female) 3.14, (male) 3.57. The mean value of the second sub variable of meaning of life that is search is greater in male 3.41 and lesser in female 2.86. Whereas, the standard deviation is highest for the sub-variable Search(female) 1.59, followed by male 1.42, Presence (male) 1.38 and female 1.22.

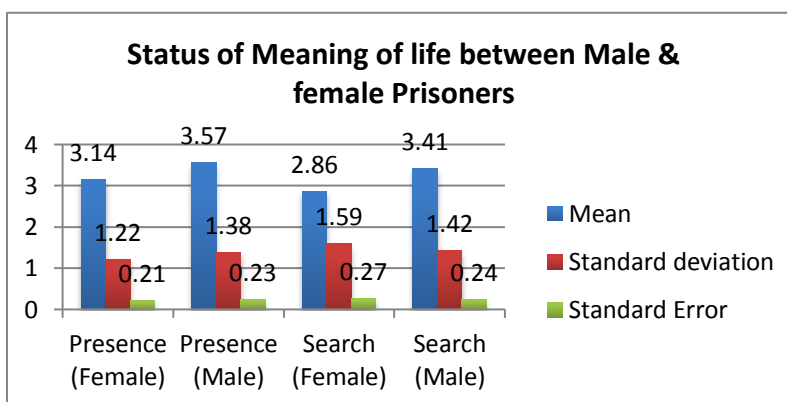

**Illustration 1: Graphical representation of Meaning of life between Male and Female Prisoners.**

**Table 2: Descriptive statistics of Mindfulness between Male and Female Prisoners**

Variables	Mean & SD	Standard error

Mindfulness (Female)	19.33±6.78	1.16
Mindfulness (Male)	18.91±7.34	1.26

The table 2 represents the mean value of Mindfulness between male and female prisoners. Where we found the mean value to be higher in case of female as 19.33 and male as 18.91. The standard deviation is higher in case of male as 7.34, followed by female as 6.78.

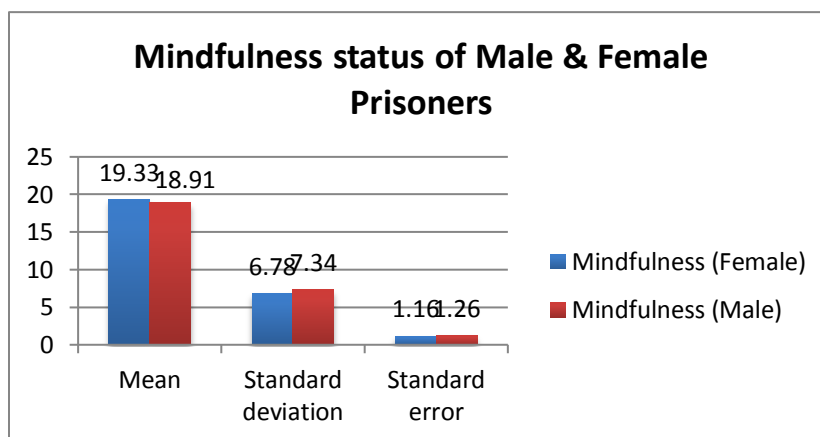

**Illustration 2: Graphical representation of Mindfulness between Male and Female Prisoners.**

**Table- 3: Descriptive statistics of Meaning of Life & Mindfulness between Male and Female Prisoners.**

Variables	Mean & S.D.-male	Mean & S.D.-female	Std. Error-M/F
MOL- Presence	3.57± 1.38	3.14± 1.22	1.38 / 0.23
MOL- Search	3.41± 1.42	2.86± 1.59	1.42 / 0.24
Mindfulness	18.91±7.34	19.33±6.78	1.26/1.16

The table 3 shows the statistics of meaning of life and mindfulness between male and female prisoners. The mean value of meaning of life sub- variable presence is 3.57, followed by search 3.41 and mindfulness 18.91 for male prisoners. Whereas for female prisoners the mean value is highest in case of mindfulness as 19.33, followed by meaning of life sub- variable presence 3.14 and search as 2.86.

**Table 7: Calculation of Independent ‘t’ test between male and female prisoners.**

S. No.	Variables	‘t’ Values	Mean Different	Significances
1.	MOL, Presence	-1.34*	-.42	.000

	MOL, Search	-1.48*	-.54	.000
2.	Mindfulness	.24*	.42	.000

As shown in the table there are significant differences found meaning in life (both sub variables- presence and search) and mindfulness at targeted .05 level of significant, but they significant at .000 level.

### **DISCUSSION OF THE FINDINGS**

The purpose of the study was to find the state of mindfulness / awareness and meaning of life in male and female prisoners. As indicated in result of the study that in case of understanding the meaning of life in male and female, the male has higher thinking than female. The variables of meaning in life are presence and search, the male were found better than the female prisoners. In case of state of mindfulness female are more mindful and higher awareness about their environment and surrounding as compared to the male. If we compare both the variables meaning of life and mindfulness in female than we can see that they are more mindful as compared to the state of understanding meaning of life.

On the basis of the analysis and findings the following conclusion were drawn-

- The female prisoners of Tihar jail were reflecting better dispositional mindfulness and awareness in regards to the environment and surrounding than the male prisoners.
- In case of meaning in life sub variable presence, the male prisoners make tier life and existence felt more important and significant then the female prisoners.
- The overall mindfulness and awareness is better in combine score of male and female as crime needs high level of attention-concentration and awareness.
- In case of meaning in life sub variable search, the male prisoners make their life search for betterment and existence felt well was more important and significant then the female prisoners.
- The overall meaning of life was very gloomy and not very meaningful as their combine score id less than fifty percentage.

### **References**

1. FRANKL , V. E. ( 2006 ) Man's search for meaning: an introduction to logo-therapy. (I. Lasch, Transl.) Boston, MA : Bacon Press .
2. FRANKL , V. E. ( 2011 ) The unheard cry for meaning: psychotherapy and humanism . New York : Simon & Schuster .
3. FRAZIER , et.al. (2003). Assessing optimal human functioning . In W. B. Walsh (Ed.), Counselling psychology and optimal human functioning . Mahwah, NJ :Erl baum . Pp. 251 - 278.

4. Kabat-Zinn J. (1994). *Wherever you go there you are*. New York: Hyperion.
5. Lane, A.M., Harwood, C. & Nevill, A.M. (2005). Confirmatory factor analysis of the Thought Occurrence Questionnaire for Sport (TOQS) among adolescent athletes. *Anxiety, Stress, and Coping* 18(3): 245-254.
6. Orlick, T. (1990). *In Pursuit of Excellence: How to Win in Sport and Life Through Mental Training*. Champaign: Leisure press.
7. Oxford English Reference Dictionary. (2003). Edited by Pearsall J and Trumble B. Oxford University Press.
8. Moran, A.P. (2004). *Sport and Exercise Psychology : A Critical Introduction*. Hove, Routledge.
9. POPE, S. L. (1999) Meaning of life among persons with advanced cancer . Unpublished doctoral dissertation, Univer. of Kentucky , Lexington, KY .
10. REKER , G. T. (1977). The Purpose-in-Life test in an inmate population: an empirical investigation . *Journal of Clinical Psychology* , 33 ( 3 ), 688 - 693 .
11. REKER , G. T. (2000). Theoretical perspective, dimensions, and measurement of existential meaning . In G. T. Reker & K. Chamberlain (Eds.), *Exploring existential meaning: optimising human development across the life span*. Thousand Oaks, CA: Sage . Pp.39-55.
12. Segal, Z.V., Williams, J.M.G., & Teasdale, J.D. (2002). *Mindfulness-Based Cognitive Therapy for Depression. A New Approach to Preventing Relapse*.
13. Guildford, London.
14. <http://renewyourmind.co.nz/introduction-mindfulness/>
15. [www.random.org/integers/](http://www.random.org/integers/)



## ASSESSMENT OF PEACE OF MIND AND ANXIETY LEVEL BETWEEN MALE AND FEMALE PRISONERS OF TIHAR JAIL

<sup>1</sup>Meenu Dabas, <sup>2</sup>Ashish Kumar & <sup>3</sup>Dr. Pardeep Kumar

<sup>1</sup>Ph.D. Research Scholar, DUDPESS, University of Delhi

<sup>2</sup>Corresponding Author: Ph.D. Research Scholar, DUDPESS, University of Delhi

<sup>3</sup>Supervisor: Associate Professor IGIPSS, University of Delhi

### Abstract

The purpose of the present study was to assess and compare the anxiety level and the status of Peace of mind among male and female prisoners of Tihar jail, Delhi. Peace of mind was defined as an internal state of peacefulness and harmony. For the purpose of the Study Thirty four (N=34) Male and Thirty four (N=34) female from Tihar jail of Delhi were selected after taking prior permission from prisoners and competent authority of tihar jail. For collecting data from prisoners standard questionnaire on anxiety – 7 items with 3 point likert scale as (0- not at all to 3- nearly everyday) The Peace of mind questionnaire consist of 7 item assessing prisoners with 5 point likert scale (1- not at all, 5- all off he time) was employed. Descriptive Statistics and Independent t-test were employed to analyse the results. The result of the study came as significant difference in case of Anxiety level (-2.06) between male and female Prisoners and the level of peace of mind among both the gender were Insignificant at (1.29). The level of significance was set at 0.05 level.

**Key words:** Anxiety, Peacefulness, Mental state, Mood swings

### INTRODUCTION

Anxiety is defined as a emotion. We can simply put anxiety as a state of human being. Anxiety brings with itself a lot of physiological changes such as change in heart rate, sweating in palm, butterflies in stomach. An Individual experiences anxiety from mild to severe level. For example, being sad is the mild emotion whereas being under depression is the intense emotion. In the initial stages of anxiety the changes are normal and the individual gets easily adapted to the changes. Every human beings perception towards unexpected circumstances and the resulted response towards them is different in terms of its overall experience. We often get anxious when we fear something. Therefore fear can be put as the synonym of anxiety. The fine line between anxiety and fear is that fear is the first response or first action towards the situation whereas anxiety can be seen as anticipation of the problem or danger in future.

The Fight or Flight Response:- When we talk about fear, we point towards the physiological response of human being to fear. As clear from the word itself, flight means when we are under

dangerous or potential dangerous situation we may try to escape from the situation. But sometimes we hit hard, face the hurdles and go ahead. Only the above two occur as a result of fight or flight response.

Peacefulness is a state of mental level of an individual. Peace of mind was defined as an internal state of peacefulness and harmony. For the purpose of It keeps an individual from extreme sadness and extreme happiness. It helps the individual to be normal in every situation. Being peaceful brings a state of tranquility to the mind. People adopt various methods to bring a balanced state of mind in themselves. For this they practice breathing exercises, focusing on any external object or internal state. Calmness is a quality of an individual, which can be taken to a higher level, but only with the help of practice. Individuals who are aware of the state of calmness and how one feels during that are easily able to manage any situation with less difficulty. Because we believe that the PoM measures affective well-being, and frequency scales have been demonstrated as being useful for capturing affective well-being (Diener et al. 1991)

**PROBLEM STATEMENT:-** The Purpose of the present study was to assess the Anxiety level and level of peace of mind between male and female prisoners of Tihar jail of Delhi.

### **METHOD**

**Sample selection and Sampling Technique:-** A total of Sixty Eight (N=68), Thirty four (N=34) Female prisoners and Thirty four (N=34) male prisoners from Tihar jail were selected to collect the data for the study. A pre- permission was taken from the prisoners and competent authority to collect the data. The prisoners were briefed about the complete study and its purpose. The questionnaires were completely explained to the prisoners. The subjects were made comfortable and each prisoner was given with the questionnaire. The subjects were asked to be seated comfortably and in case of any doubt they must feel free to ask. After successful completion of the questionnaire by prisoners the questionnaires were collected. The data was collected using random sampling technique. After scoring as per the manual the data was analyzed with the help of software SPSS -20.

**Selection of Variables:** To fulfill the purpose of the study standardized questionnaire on anxiety and peace of mind was applied on the prisoners. The following variables selected for the purpose of the study are:

<b>S. No.</b>	<b>VARIABLES</b>
1	Anxiety
2	Peace of Mind

**Tools and Techniques:** The Purpose of the study was to assess the level of anxiety and level of Peacefulness between male and female prisoners. To fulfill the purpose of the study Descriptive statistics and t-test was employed. To collect data from prisoners Questionnaire on anxiety and Peace of mind was employed. A 7 item questionnaire assessing the generalized anxiety disorder was used. The respondents answered each item on a 3 point likert scale ranging from (0-not at all, 3- nearly every day) The GAD-7 originates from Spitzer RL, Kroenke K, Williams JB, et al; A brief measure for assessing generalized anxiety disorder. The GAD-7 score is calculated by assigning scores of 0, 1, 2, and 3, to the response categories of 'not at all', 'several days', 'more than half the days', and 'nearly every day', respectively, and adding together the scores for the seven questions. Using the threshold score of 10, the GAD-7 has a sensitivity of 89% and a specificity of 82% for GAD. It is moderately good at screening three other common anxiety disorders - panic disorder (sensitivity 74%, specificity 81%), social anxiety disorder (sensitivity 72%, specificity 80%) and post-traumatic stress disorder (sensitivity 66%, specificity 81%). The peace of mind questionnaire assess through 7 item with 5 point likert scale ranging from (1-not at all, 5- all of the time).

**Data Collection:** The data was collected from Prisoners of Tihar jail, Delhi. A pre- permission was taken from prisoners and competent authorities to collect the data. The above described and selected questionnaires were employed on prisoners to collect data and scoring was done as per the instruction provided in manual of questionnaires.

**STATISTICAL TECHNIQUES:-** To assess the status of anxiety and peacefulness between male and female prisoners of Tihar jail, Delhi Descriptive statistics and t-test was employed and Presented in form of Tables, Graphical presentation and explanation of the result.

**Table 1: Descriptive statistics of Peace of Mind between Male and Female Prisoners.**

<b>Variable</b>	<b>Mean &amp; S.D.</b>	<b>Standard Error</b>
POM (Male)	2.88+.97	.16
POM (Female)	2.58+.92	.15

Note:- POM- Peace of Mind, S.D.- Standard Deviation

The table 1 indicates the Descriptive statistics of level of peacefulness between male and female prisoners. The mean value is higher in case of male 2.88, followed by female as 2.58, Whereas Standard deviation for male .97, female .92.

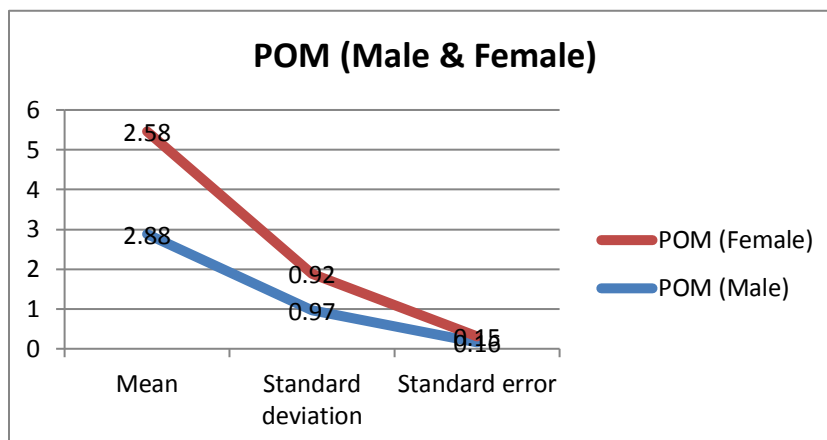

**Illustration 1: Graphical representation of Peace of Mind between Male and Female Prisoners.**

**Table 2: Descriptive statistics of Anxiety level between Male and Female Prisoners.**

Variable	Mean & S.D.	Standard error
Anxiety (Male)	8.85+5.12	.87
Anxiety (Female)	11.50+5.46	.93

Note: POM- Peace of Mind, S.D.- Standard Deviation

The table 2 indicates the status of anxiety level between male and female prisoners. As shown in the table the mean value of female is higher than male as 11.50, followed by male as 8.85 and standard deviation of male is 5.12 and female is 5.46.

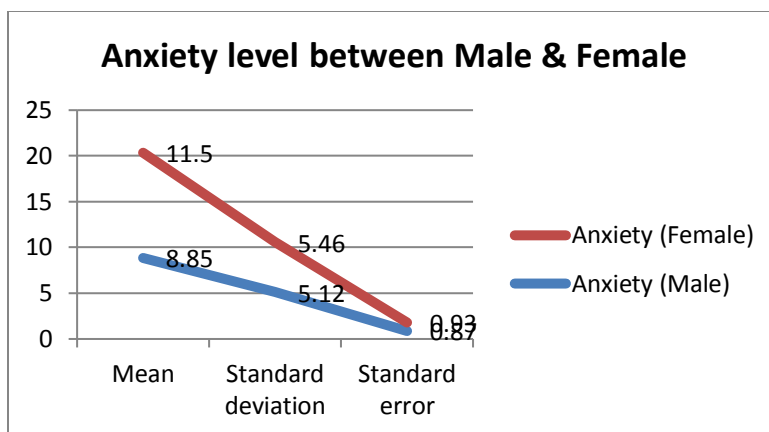

**Illustration 2: Graphical representation of Anxiety level between Male and Female Prisoners**

**Table 3: Descriptive statistics of Peace of Mind and Anxiety level of Male and Female Prisoners**

Variables	Mean & S.D. Male	Mean & S.D. Female
POM	2.88+.97	2.58+.92
G. Anxiety Disorder	8.85+5.12	11.50+5.46

Note: POM- Peace of Mind, S.D.- Standard Deviation

The table 3 indicates the state of peace of mind and Anxiety level of male and female Prisoners. As a result of this we got mean value of Peace of mind for male as 2.88 and Anxiety level as 8.85. The mean value of female in case of peace of mind is 2.58, Anxiety 11.50. The male has mild anxiety level range 5-9, but female has moderate level of anxiety ranging 10-14 as per the norms of the tool. The norms for general Anxiety disorder- score up to 5 = mild, 10 = moderate and 15 above = severe.

**Table 4: Calculation of Independent ‘t’ test between male and female prisoners.**

S. No.	Variables	‘t’ Values	Mean Different	Significances
1.	Anxiety	-2.06*	-2.64	.000
2.	Peace of Mind	1.29	.29	.080

As shown in the table there is significant difference found in anxiety levels between male and female at 0.05 level. There is no significant difference found between male and female in peace of mind.

## DISCUSSION OF THE FINDINGS

The study focused on measuring the level of anxiety and peace of mind between male and female prisoners of Tihar jail, Delhi. As indicated in Table -1 Peace of mind in male is higher as compared to peace of mind in female. In case of anxiety it is seen as higher in female than in male. When both the variables are compared in female that is peace of mind and anxiety, we can see from the table above that anxiety level is more in female as compared to the other variable that is peace of mind. In case of male also anxiety level is higher as compared to the state of peace of mind. There is no significant difference found in the variable peace of mind between male and female. Whereas, there is significant difference in anxiety levels between male and female. The calculated value in case of anxiety is -2.06 whereas the tabulated value at degree of freedom 66 is 2.00. Thus, the calculated value is higher than the tabulated value, therefore the anxiety level between male and female was found significant.

On the basis of the findings the following conclusions were drawn:

- There is significant difference between the anxiety level of male and female prisoners of the Tihar jail. Female prisoners were found high level of anxiety than male prisoners.
- In case of Peace of mind there is no significant difference between the male and female prisoners. But the peace of mind was found high in male prisoners than the female prisoners as shown in the mean value.

## References

1. Kroenke K, Spitzer R L, Willium JB et.al. (2007). Anxiety disorder in primary care: Prevalence, impairment, comorbidity and detection. *Ann Intern Med.*, 146 (5):317-25.
2. Spitzer, RL, Kroenke et.al. (2006). A brief measure of assessing anxiety disorder: GAD-7. *Arch. Intern. Med.*: 166:1092-7.
3. .Jump up ^ "*Calm – Definition of Calm by Merriam-Webster*".
4. Jump up to: <sup>a</sup> <sup>b</sup> "*Calmness – definition of calmness by The Free Dictionary*". *TheFreeDictionary.com*. Retrieved 2016-04-01.
5. "*Archived copy*". Archived from the original on May 13, 2011. Retrieved April 23, 2009.
6. "*Calmness Synonyms, Calmness Antonyms – Merriam-Webster Thesaurus*".
7. [https://www.gulfbend.org/poc/view\\_doc.php?type=doc&id=38467&cn=1](https://www.gulfbend.org/poc/view_doc.php?type=doc&id=38467&cn=1)

## A STUDY OF DRIBBLING ABILITY IN FOOTBALL IN RELATION TO AGILITY & TECHNIQUE OF GOVT. DEGREE COLLEGE BOYS OF NALGONDA DIST, TELANGANA

**M.A.Aleem**

Football Coach, Sree Vidyapeeth Residential School, Nalgonda.

[aleemzi10r@gmail.com](mailto:aleemzi10r@gmail.com)

CELL NO: 9966313729

### **Abstract**

The main of this study was to determine the relationship of the dribbling ability in football with the agility and technique. The investigator was also interested to find out whether agility or technique had more relationship with the dribbling ability. To achieve this purpose, 15 male students from the age group of 18 to 20 years were randomly selected as subjects from the football specialization group of Govt.Dgree College of Nalgonda and Deverkonda. To test the aim of this study the investigator conducted the following standard tests to measure the following standard tests to measure the agility, technique and dribbling ability in football. Technique was measured subjectively by the help of three experts while they were dribbling in a competitive spirit. After the collection of data, data were analyzed statistically by using the correlation coefficient. It was found that agility and technique had close relation with the dribbling ability. It was also found that the agility had more relationship than the technique with the dribbling ability in football. This study may also be conducted at different age levels and standard players with different age groups.

**Keywords:** Agility, dribbling, tackling, dodging.

### **INTRODUCTION**

The game of football has been defined as outdoor game played on a mud, grass surface, turf ground. A crude form of a stock game was played by the ancient Persian from whom it was acquired by Greeks who in turn passed it on the Romans. Football was introduced in India by the British during the third quarter of the last century. Football is pyramid great skills which calls or keen physical age techniques results and speed of movements. Skillful technique results from careful and constructive individual and the team practice and adds the enjoyment to the game for both players and spectators. The game has also become fast after the introduction of artificial turf, and the latest changes in the rules and regulations of the game. There are many skills in Football and they are hitting, stopping, dribbling, passing, flicking, he or she should learn all these skills correctly room the basic level. When a player learns these basic skills efficiently, he or she becomes a better player, which in turn makes his or her team stronger. Dribbling is one of

the important fundamental skills in football which cannot be neglected by any player. For the perfect execution of the skill, dribbling, one has to improve the agility and proper technique. Agility is generally defined as the “ability to change direction quickly and effectively moving as nearly as possible at full speed” Technique can be defined as the specific approach followed to do the work concerned”. In the game situation, one has to be perfect in the skill “dribbling” and should be able to move in any direction at any time with a good control on the ball. (K.Azeem, 2014) reveals significant changes from pre to post test on the selected fitness variables among untrained males.

**STATEMENT OF THE PROBLEM:** The purpose of this study was to find out the dribbling ability in football in relation to the agility and technique.

### **HYPOTHESIS**

- There would be a relationship between technique and dribbling ability in football.
- There would be a relationship between agility and dribbling ability in football.
- There would be a high relationship between the scores of the dribbling ability and the combination scores of agility and technique

### **SIGNIFICANCE**

- This study might be useful for the physical educationists and coaches to understand the degree of importance of agility and technique in relation to football dribbling ability.
- This study might motivate the coaches to formulate a training programmed for improving the agility and technique so as to improve the dribbling ability.

### **LIMITATIONS**

This study was limited in the following respects and limitation should be taken into consideration while interpreting the results of the match.

- Agility of the individual is measured through the agility test recommended by Hardayal Singh that is the 6x10 meters shuttle run test.
- Technique is measured through the subjective ratings of the football experts. But an effort was made by the investigate to make it more objective
- The subjects drawn for this study are the beginners from the Govt. Degree College, Deverkonda who are specializing the game football.

### **REVIEW OF RELATED LITERATURE**

The purpose of this study was to find out whether agility and technique had any relationship on the dribbling ability in football. No previous investigation seems to have been conducted, particularly in this area. Very few research studies have been carried out in these related areas.



It is found that the agility and technique are important or efficient dribbling. Most of the literatures are in favour of agility alone whereas there are some experts in favour of the techniques also. Therefore, they made an attempt in this study to understand that how far agility and technique contribute for efficient dribbling in football

### THE FITNESS PYRAMID

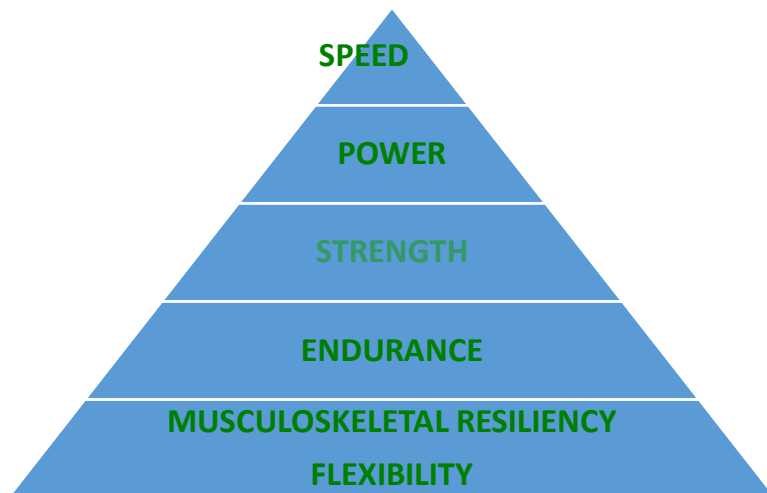

### METHOD

The purpose of this study was to determine the dribbling ability in football in relation to the agility and technique. To achieve the purpose 15 male students were randomly selected as subjects from the total male student's population of the football specialization group of the Govt. Degree College Nalgonda. As far as the subjects were concerned they were players who had played matches at the inter-division, District and state level tournaments. They were trained players practicing the game to achieve better level performance. To test the said hypothesis of the study tests were administrated to measure the parameters selected or this study namely dribbling ability in football in relation to the agility and technique. The details procedure and methodology adopted are given in this chapter. To find out the agility of an individual shuttle run is required.

#### AGILITY TEST (6x10 mts Shuttle Run):

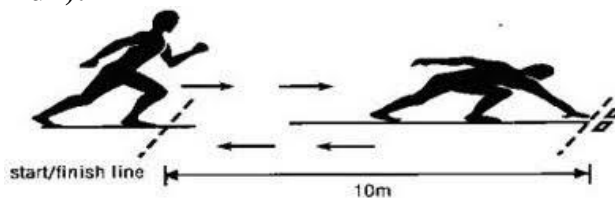

Excellent	:	5 points
Good	:	4 points
Fair	:	3 points
Average	:	2 points



The coefficient of correlation of the parameter studied, namely Football, dribbling ability in relation to agility and technique was found to be significant at .01 level of confidence. The ranking of the test scores of the dribbling and technique are presented in it.

### **CONCLUSION**

Subjected to the limitation and delimitation in this study the investigator arrived at the following conclusions:

- Dribbling performance was better if the player had a good agility and technique and both the components are contributing much to the dribbling ability in football.
- It was also found that the agility had more relationship than the technique with the dribbling ability in football
- It was found that the technique also had relationship with the dribbling ability as the rk value was .540 at .05 level of confidence.

### **References**

1. Aggiss, Richard, Coaching the football the Australian way (South Melbourne, Australian football Association 1984).
2. Antony, P. classroom notes (football coach, NIS West centre, Gandhinagar, 1989).
3. Allen, Philips A., & Hornak James E., Measurement and evaluation in physical education (New York: John Wiley & Sons 1979)
4. Bates, Barry T., "The relationship of performance in lateral change of direction agility test" completed research, vol.13, 1972
5. Barrow, Horald W., & m CGee, Rosemary, A practice approach to measuring in physical education 1964
6. Cadman John. Football the skill of the game (New York: crowd press 1986).
7. Gupta, S.P., Statistical methods, (New Delhi: sultan hand & sons 1975).
8. Decocco, John P., The Psychology of learning and instruction (New Delhi: prentice hall pvt.ltd. 1970).
9. Glen cross, Devil, 100 football tips (New York: Rigby publishers, 1985).
10. Kaukab Azeem (2014). Effect of soccer training on the selected health related fitness variables and motor learning among untrained males". Published in the proceedings in the world conference on soccer and science at Portland University, Portland, U.S.A. Pg.51
11. Football Association teaches you football (London: the English university press, 1969).
12. Hunt, Virginia, "The relationship of balance and agility "completed research, vol.6:1964.
13. Wien, Horst, The science of football (New Delhi: S. Chand & Co, ltd. 1973.
14. Whitaker, David, Coaching Football (Wilshire: the Crowod press, 1986).
15. Merriam, Sports Dictionary (Springfield: Massachusetts: Webster's Inc., 1976).

## COMPARISON ON PHYSICAL FITNESS OF PRIVATE SCHOOL AND GOVERNMENT SCHOOL OF IMPHAL WEST-II OF MANIPUR

**Dr. L. Thambal Singh<sup>1</sup> N. Robin Singh<sup>2</sup>**

<sup>1</sup>Assit Professor Department of Physical Education and Sports Science, Manipur University

<sup>2</sup>Research Scholar Dept of Physical Education and Sports Science, Manipur University

---

### ABSTRACT

*Objective: The purpose of the present study is to compare the difference in physical fitness of Government and Private school boys of Imphal West (Zone II) of Manipur.*

*Methods: Five items of physical fitness test i.e. Vertical Jump, Sit-up, Push-ups, 300 m run and 1.5 mile run were conducted on the age ranges between 12 to 15 years of 600 Grade VII boys' students i.e., Government school (N= 300 ) and Private school (N= 300). The data are computed using statistical technique SPSS Software and the level of significance was fixed at 0.05 level of significant. Results: It is found that Private school boys are younger and lighter but greater in height than the Private school boys. Their age and weight average were 13.3 and 13.6 years and 43.49 and 43.58 kg, whereas in height, average was 159cm and 155cm. The findings on Physical fitness parameter like Vertical Jump, Sit-ups, Push ups, 300m run and 1.5 mile run were  $15.96 \pm 2.82$ ,  $28.73 \pm 6.75$ ,  $26.99 \pm 6.0$ ,  $1.18 \pm 0.26$  and  $12.15 \pm 0.69$  respectively for Private school boys and that of Government school boys are  $14.85 \pm 2.84$ ,  $22.33 \pm 4.17$ ,  $20.86 \pm 3.63$ ,  $1.43 \pm 0.22$  and  $12.47 \pm 0.22$  respectively. The comparison of these scores by using statistical technique found that, the Private school boys were fit than the Government school boys. The differences in all respect of body parameter and physical fitness parameter were statistically significant at ( $P < 0.05$ ) level of significance between Government school and Private school boys of Imphal West (Zone II) of Manipur. The finding reveals that Private school boys dominate in their physical fitness from the Government school boys.*

**Key Words:** Physical fitness, Vertical Jump, Sit-ups, Push ups, 300 m and 1.5 mile run.

---

### INTRODUCTION

Physical activity is essential for the development of wholesome personality of a child which would depend upon the opportunities provided for wholesome development of the mental, physical, social and spiritual aspects. Hence, a well organized and properly administered physical education programme for school children is very essential. Physical fitness varies according to the nature of work, individual's size, shape of the body, age and sex. For physical fitness, we require an efficient motor mechanism, efficient organic function and an efficient mental fitness. A physically fit individual should possess a sufficient reserve of energy to meet the demands of emergencies in which a person is unexpectedly called upon to perform activities demanding unusual expenditure of strength, energy and adaptive ability under unfavourable environment

Young children are enjoying active play. Most young children play or invent active ways of passing their time that involve physical activity (L. H. Epstein et al., 1995). These forms of play provide a large volume of activity incorporating a wide variety of movements and many muscle groups, thereby promoting cardiorespiratory development, muscular strength, muscular endurance, speed, power and flexibility (Colin Boreham and Chris Riddoch, 2001). Participation of children in daily physical education have been shown to perform better academically and having a better attitude toward school (Sadler et al 1993) and suggested that physical activity and fitness actually help students do better in the classroom. Children who are physically fit can absorb and retain new information more effectively than children who are out of shape. Students who are physically fit can settle and pay attention in school or at home, with salutary effects on academic performance. Physical fitness can help children cope with stress (N. Robin et al., 2018). It also promotes: healthier growth and development, stronger bones, muscles and joints, better posture and balance, a stronger heart, a healthier weight range, social interaction with friends, learning new skills, better focus and concentration during school. And moreover “A sound mind is found in the sound body”. Thus, the purpose of the present study was an effort to find out the difference in physical fitness level of Government and Private schools’ boys of Imphal West (Zone II) of Manipur.

## **MATERIALS AND METHODS**

### **Subjects**

For the present study 600 boys’ students who were studying in Grade VII, age ranging between 12 to 15 years of 15 Government Schools(300 boys) and 15 Private Schools(300 boys) of Imphal West( Zone II) of Manipur was taken as subjects on random basis.

### **Selection of Tools**

For this study Vertical Jump, Sit-ups, Push ups, 300m run and 1.5 mile run were selected to measure the physical fitness status of the subjects.

### **Purpose of Tools**

Vertical Jump was assessed to measure the explosive strength of legs, Sit ups was assessed to measure strength of the abdominal muscle, Push ups was assessed to measure the muscular endurance of the upper body muscles in the shoulders, chest, and back of the upper arms (the extensors). 300 m run and 1.5 mile run was assessed to measure speed endurance and cardio-vascular endurance.

### **Statistical Approach**

To compare the mean difference of the variables employed for the study i.e. body parameter- Age, Height and Weight and physical fitness parameter- Vertical Jump, Sit-ups, Push ups, 300 m run and 1.5 mile run of the Government and Private School boys simple ‘t’ test was applied by using Statistical Product and Service Solution (SPSS) Software. The result was statistically interpreted at 0.05 level of significance.

### RESULTS AND DISCUSSIONS

**Table 1: Body Parameters’ Mean, SD and ‘t’ Values of the Study Subjects**

Private School(N=300)				Government School(N=300)		t values
Sl. No.	Parameters	Mean	SD	Mean	SD	
1	Age	13.3	.53	13.6	.63	<b>-6.88*</b>
2	Height	159	7.28	155	6.12	<b>6.97*</b>
3	Weight	43.49	5.04	43.58	5.82	-0.19

**\*Significant at 0.05 levels.**

**Table 1** shows the Mean, SD and ‘t’ values of the body parameter of Private and Government School boys of this study. The Private school boys (mean=13.3 ± .53) was found to be younger than Government School boys (mean=13.6 ± .63) with ‘t’ value = -6.88. The height of the Private School boys (mean=159±7.28) was higher than the Government School boys (mean=155±6.12) which was statistically significant at (P<0.05) with ‘t’ value of 6.97, whereas weight is less than the Government School (mean 43.58±5.82) with ‘t’ value -0.19.

**Table 2: Physical Fitness Parameters’ Mean, SD and ‘t’ Values of the Study Subjects**

Private School(N=300)				Government School(N=300)		t values
Sl. No.	Parameters	Mean	SD	Mean	SD	
1	Vertical Jump	15.96	2.82	14.85	2.84	<b>5.25*</b>
2	Sit ups	28.73	6.75	22.33	4.17	<b>14.03*</b>
3	Push ups	26.99	6.00	20.86	3.63	<b>15.21*</b>
4	300 m	1.18	0.26	1.43	.22	<b>14.56*</b>
5	1.5 mile	12.15	0.69	12.47	.22	<b>7.83*</b>

**\*Significant at 0.05 levels.**

**Table 2** shows the Mean, SD and ‘t’ values of the physical fitness parameters of the Government and Private School boys. Private School boys dominated in all the physical fitness parameters from Government School boys which was significant at (P < 0.05) with ‘t’ value 5.25, 14.03, 15.21, 14.56 and 7.83 respectively for Vertical jump, Sit-ups, Push- ups, 300 m run and 1.5 mile run/walk. The analysis further shows significant difference in all the physical fitness parameters as the obtained ‘t’ value 5.25 for Vertical jump, 14.03 for sit-ups, 15.21 for Push- ups, 14.56 for 300 m run and 7.83 for 1.5 mile run were greater than the tabulated ‘t’ value (1.97).

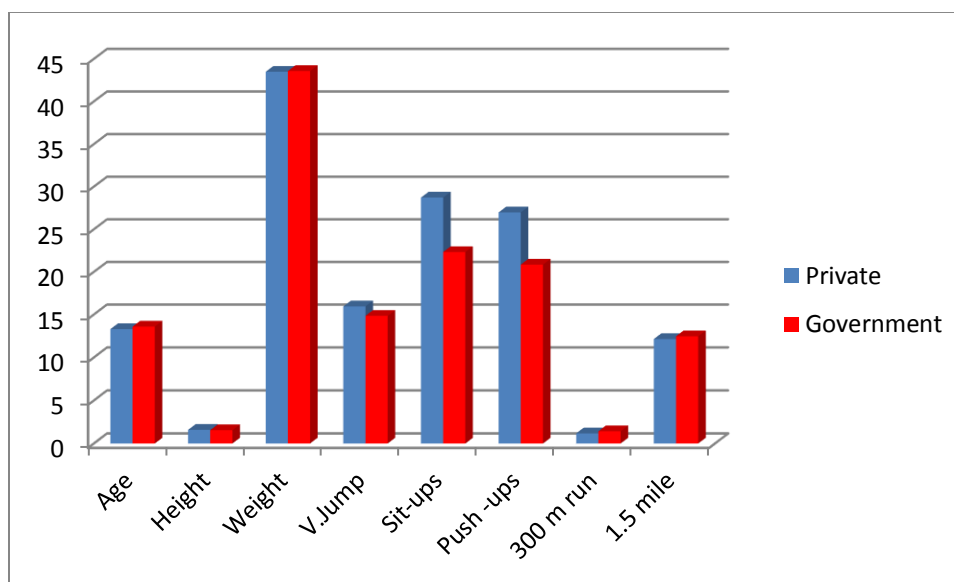

**Fig. 1: Diagrammatic Presentation of Body Parameters and Physical Fitness Parameters of Government and Private Schools:**

Thus, from the above findings and results, it is observed that the differences in all respect of body and physical fitness parameters were statistically significant at ( $P < 0.05$ ) level of significance between Government school and Private school boys of Imphal West (Zone II) of Manipur. Further, it can also be mentioned that the older in age and heavier in weight of the Government school boys might be due to late enrollment in the school for formal education as well as improper physical activity. The probable reason in the variation of physical parameters- Vertical Jump, Sit-ups, Push-ups, 300 m run and 1.5 mile run that leads to significant difference of this study population may also be due difference in their growth and development during this days, which can also be the effect of their differences in food habit, standard of living, life style, proper guidance for performing physical fitness activity and healthy environment at home as well as school.

### CONCLUSIONS

The result of the present study confirmed that Government school boys dominate in age and weight while Private school boys dominate in height. Further, Private school boys dominate in all respect of physical fitness parameter. Therefore, it can be concluded that the Private school boys were more fit than the Government school boys.

**Reference**

1. L.H. Epstein et al., (1995). “Effects of decreasing sedentary behavior and increasing activity on weight change in obese children” *Health Psychology*, 14, pp.109-115.
2. Colin Boreham and Chris Riddoch, (2001) “The physical activity, Fitness and health of children” *Journal of Sports Sciences*, 19, pp.915-929.
3. Sadler et al., (1993), “America 2000: Implications of physical education” *Physical Educator*, 50, 77-87.
4. M. Chourjit, T. Inaobi, N. Robin Singh (2018) “Physical Fitness of School Children of Imphal West District of Manipur” *International Journal of Humanities and Social Science Invention*, 7(02), pp. 16-19.
5. Singh O. Jiten and Thapa Sumit kr (2015) “A Comparative Study of Selected Health Related Physical Fitness between Teaching and Non-Teaching Staff in Dibrugarh University, Assam, India”, *Research Journal of Physical Education Science*, 3(6), pp.6-8, June (2015).
6. U.S. Department of Health and Human Services, Physical Activity Guidelines Advisory Committee report, Washington, DC: U.S. Department of Health and Human Services, 2008.
7. Rajkumar Sharma (2015) “A Study of Body Mass Index in Relation to Motor Fitness Components of School Going Children Involved in Physical Activities”, *International Journal of Scientific Research*, 4(1), January 2015.
8. *Anthropologist*, 12(1), pp. 17-21, 2010.
9. Pertti Huotari, Arja Saakslahli, Anthony Wattal (2009). “ Association between the self-estimated and actual physical fitness scores of Finnish Grade 6 students”, *Facta Universitatis Physical Education and Sports*, Vol. 7, No. 1, pp. 27-36, 2009.
10. Stuart Fairclough (2003). “ Physical activity, perceived competence and enjoyment during secondary school physical education”, *The European Journal of Physical Education*, 8(1), pp.5-18, 2003.
11. Sunil Dutt (2005). “Health related physical fitness of boys aged 8 to 18 years”, *Journal of Exercise Science and Physiotherapy*, Vol. 1, No.1 and 2: pp. 12-22, 2005.
12. Susi Kriemler, Lukas Zahner, Christian Schindler, Ursina Meyer, Tim Hartman, Hans Peter Brunner La Rocca, William Van Mechelen, Jardena J Puder (2010). “Effect of school based physical activity programme (KISS) on fitness and adiposity in primary schoolchildren: cluster randomized controlled trial”, *BMJ* 2010;340:c785.
13. V.K. Sharma. *Health and Physical Education*, Saraswati House Pvt. Ltd, CBSE Syllabus.
14. Virginia R. Chomitz Slining MM, Mc. Gowan RJ, Mitchell SE, Dawson GF, Hacker KA (2009). “Is there a relationship between physical fitness and academic achievement? Positive results from public school children in the Northeastern United States”, *Journal of School Health*, January 2009, vol.79, no.1.
15. Zach Constance, Katie Smith, Katy Struble (2007). “Difference in health related physical fitness of elementary school children”, *Proceeding of the 3rd Annual GRASP*
16. Symposium, Wichita State University, 2007.



## DATABASE DESIGN FOR SPORTS RELATED INFORMATION, RESOURCES & EXPERTS TO FACILITATE COMPETITIVE SPORTS

### **Dr. S. P. Deshpande**

P.G. Dept. of Comp. Sci.  
& Tech., Degree College  
Of Phy. Edu.,  
H.V.P.M. Amravati  
shrivasdeshpande68@gmail.com

### **Dr. M. S. Chendke**

Degree College of Phy.  
Edu., H.V.P.M.,  
Amravati  
madhuri\_chendke@rediffmail.com

### **Prof. D. P. Vaidya**

P.G. Dept. of Comp. Sci.  
& Tech., Degree College  
Of Phy. Edu.,  
H.V.P.M. Amravati  
deepa\_vaidya@rediffmail.com

### **Prof. N. V. Wankhade**

P.G. Dept. of Comp. Sci.  
& Tech., Degree College  
Of Phy. Edu.,  
H.V.P.M. Amravati  
nitinvankhade@gmail.com

### **Abstract**

The competitive sports information needs to be recorded systematically and retrieved simply and quickly. The statisticians keep record of performance of the players and analyze the past events. In the changing scenario the information about the player performance as well as information about the equipments, rules regulations, experts, different organizations contributing for sports, etc. is essentially required for development of sports. Media is playing very important role in the promotion of competitive sports. It requires lot of information quickly and accurately to promote the activity. The authentic source of information may be web portals. ICT can contribute greatly in development of competitive sports. A database which contains information about every aspect of competitive sports and games will be a great contribution. The task of designing database for storing the information of all games as well as all the stakeholders of sports field is tedious. In this paper, a database is designed for the information about organizations, players' information, sports competition information, and freelancer expert details, etc. This information system is very unique and useful as it keeps information about sports competition and also provides information about different stakeholders, technical details, and players' performance data. The web pages developed and reports generated are self explanatory. Due to it's availability on the web, the information has wide spread reach and available to anybody, anywhere, any time.

**Key words;** Competition, database, information, sports

### **INTRODUCTION**

The different Universities, Associations, Federations are generally the organizers of the sports competitions in different competitive sports & games. The Universities, Associations, Federations, Sport Clubs and Individuals participate in the competitions. At the place of competitions the organizers are required to verify the personal record of the player, seek

assistance of professional experts from other universities and professional bodies, grounds and equipments, publish the schedule of competition, result of the competition, and circulate the report of competition to all associated sport bodies and authorities. At present, there is no information center in existence that maintain and provides the information regarding the above mentioned aspects. The Information system for this purpose could be used by the sport bodies and authorities and also helpful to the professional experts, media, sports industries, placement centers, sports analysts & research scholars.

In the current scenario, the resources for organizing the sports events are gathered/procured independently. Government invests lot of amount in building the sports infrastructure and also procuring high cost sports equipments. Many a time after competition this infrastructure and equipment either remain idle or underused. Lack of information to the organizers about the availability of the infrastructure at different places, its condition and its technical details is the main problem faced by the organizers.

The Sports Competition organized by various sport bodies and authorities in India need to be preserved in the database. The Database design presented here can keep track of sports competitions organized at different levels viz. Zonal, Inter-zonal, Intersports and National etc. The information includes participating Universities, players, team details, schedules, results of competitions etc. It also keeps information on other associated aspects like: sports infrastructure, equipments, experts, rules of different games, game plans, diet plans etc. This information is useful for players to analyze their performance against the performance of other players. The profile of the organizations (universities, colleges, sport clubs, etc.) along with the competition they are organizing can be stored and publicized. The individual experts (coaches, physiotherapist, sport psychologist, dietitians, sport journalist) like to propagate their expertise information, this database is useful to them.

- **Objective of the Database Design:** The objectives of database design are:
  1. To maintain the record of the various Inter University Sports competitions.
  2. To maintain and update profile of players, coaches, experts, technicians.
  3. To verify information of the players.
  4. To provide and update technical information such as rules, equipments, accessories regarding games.
  5. Technical support in preparing various playfields.
  6. Various sports product information.
  7. To maintain huge record of players, experts, organizations, Universities etc.
  8. Provide information to placement centers.
  9. Online reporting to media
  10. To control the inventory of sports equipments.

### **Design of Information system to facilitate competitive sports**

The information system proposed under this project is mainly for the information about University sports competitions recognized by AIU (Association of Indian Universities). The project is entitled as AIUSIS (All Indian University Sports Information System). It keeps track of sports competitions organized at different levels viz. Zonal, Inter-zonal, Intervarsity and National etc. The information includes participating Universities, players, team details, schedules, results of competitions etc. It also keeps information on other associated aspects like: sports infrastructure, equipments, experts, rules of different games, game plans, diet plans etc. This system will found very useful for the universities, sports clubs, Institutions, players, professionals, coaches, physiotherapist, sport psychologist, dietitians, sport journalist, sport industries and recruitment agencies.

### **Methodology and Technology for developing and implementing database of Sports related information**

ICT tools like Dot Net Technology and Sql Server Database are used in developing this database system. The user interfaces and data entry forms are developed in Visual studio 2005 supported by SQL Server 2005 at the backend. This application is web application and therefore can be available at anytime, anywhere. The data can be gathered using the web forms and stored in the database accessible to the users. The University, other organization, players and experts can register themselves and upload information. They can retrieve information as per their need from this database. Multi-dimensional reports are provided to facilitate information to different stakeholders.

The proposed users and the possible services those can be rendered to the users are as given below.

**Media:** Summarized Results, News Matter, Event Schedule, Photographs etc.

**Placement Center:** Profiles of Players, Coach, Technician, Physician etc with their achievements.

**Physician:** Information about Injuries and treatments, Medicines, Instruments for Treatments.

**Sports Industries:** Standards/Norms of game/sport, Requirements of Sports wear, Sports Equipments, Ground specifications.

**Sports Club:** Profiles of Players, Coaches, Technicians, Physicians. Norms/ Standards/ Requirements for Ground, Equipment, Sports wears. Competition Schedule.

**Technicians:** Ground Specifications, Game Rules, Events being organized, Information about Sports club, Placement Agencies, Sport Industries.

**Coaches:** Profiles of Players, Game Plans, Ground Specifications, Game Rules, Competition Schedule, Information about Coaching Institutes/Centers, Sports club, Placement Agencies, Sport Industries.

**Dietician:** Games Information, Diet Plan, Players profile, Placement Agencies.

**Sports Psychologists:** Information about Problems and treatment, Medicines, Instruments for Treatments, Players profiles.

**Players:** Games Information, Rules, Ground Specifications, Coaches, Game Rules, Competition Schedule, Sports club, Placement Agencies, Sport Industries, Dietician, Diet Plan, Physician, Players profile, Records, Standard/Norms, Game Plans.

**College:** Games Information, Rules, Ground Specifications, Coaches, Game Rules, Events being organized, Sports club, Placement Agencies, Sports Industries, Dietician, Diet Plan, Game Plan, Physician, Technician, Players profile, Records, Standard/Norms.

**Universities:** Games Information, Rules, Ground Specifications, Coaches, Game Rules, Events being organized, Sports club, Placement Agencies, Sports Industries, Dietician, Physician, Technician, Players profile, Records, Standard/Norms.

**AIU :** Players profiles, Games Information, Rules, Ground Specifications, Coaches, Game Rules, Events being organized, Information about Sports club, Placement Agencies, Sports Industries, Dietician, Diet Plan, Game Plan, Physician, Technician, Performance Records, Standard/Norms.

### **Implementation documents**

The web application includes various input screens and output reports for handling the information.

**Input Screens designs:** This system has 32 input screen designs. Some sample screen designs are given here:

1) Home Page

2) User Roles



### 3) Organizational Entry



### 4) Player Entry



### 5) Expert Entry



### 6) Configuring Competition



### Sample Output Reports:

This system can generate fifteen different reports. Some sample reports are given here:

- 1) Eligibility pro-forma for Inter-University
- 2) Competition Result

## Tournament

The left screenshot displays the 'Home' page of the AIUSIS system. It features a navigation menu on the left with options like 'Experts Exam', 'Player', 'Approve/Block User', 'Configure Competition', 'Assign Experts', 'Upload Result', 'Achievement', 'Advertise', and 'Feedback'. The main content area shows a table with columns for 'Competition Level Name', 'From Date', 'To Date', 'Org. Name', 'Organized At', and 'Schedule Result'. Below the table, there are 'Print' and 'Close' buttons.

The right screenshot shows the 'Competition Results' page. It has a dropdown menu for 'Competition' set to 'West Zone Tournaments Male Swimming'. Below this, there is a table with columns for 'Round', 'Result Date', 'Result/Case University', 'Player Name', 'Score/Time/Result', and 'Rank'. The table shows a result for Round 2 on 16/01/2010, with a score of 2:15 and a rank of 1. There are 'Print' and 'Close' buttons at the bottom.

### 3) Schedules & Results

This screenshot shows the 'List Of Schedules and Results (Competition wise)' page. It includes a search box for 'Game Name' with 'Swimming' entered. Below the search box is a table with the following data:

Sl. No.	Competition Level Name	From Date	To Date	Org. Name	Organized At	Schedule Result
1	Inter University Tournaments	08/03/2010	25/03/2010	Sanj Gadge Baba Amravati University	Shajapur	
2	Inter University Tournaments	11/01/2010	18/01/2010	Sanj Gadge Baba Amravati University	Amravati	Sube
3	Inter University Tournaments	21/03/2011	25/03/2011	Nagpur University	Shivaji College	
4	West Zone Tournaments	14/01/2010	16/01/2010	Nagpur University	Nagpur	

At the bottom of the table, there are 'Print' and 'Close' buttons.

### 4) Game wise Player List

This screenshot shows the 'Game Wise Players List' page. It includes dropdown menus for 'Organization', 'Game', and 'Event'. Below these is a table with the following data:

Sl. No.	Event	Student Name	Enrollment No.	Organization Name	Emailid	Contact No./Mobile No.	Add
1	Swimming 50 Meters	Pranav Shrivastava		Sanj Gadge Baba Amravati University			
2	Swimming 50 Meters	Pranav Shrivastava		Sanj Gadge Baba Amravati University	player1@gmail.com	2578945/989812345	DCE HVF
3	Swimming 50 Meters	Pranav Shrivastava		Sanj Gadge Baba Amravati University	player1@gmail.com	2578945/989812345	DCE HVF
4	Swimming 50 Meters	Pranav Shrivastava		Sanj Gadge Baba Amravati University		456456456/565656565	SH
5	Swimming 50 Meters	Pranav Shrivastava		Sanj Gadge Baba Amravati University	player@gmail.com	2651433/9098123456	DCE
6	Swimming 50 Meters	Pranav Shrivastava		Sanj Gadge Baba Amravati University	player@gmail.com	2651433/9098123456	DCE
7	Swimming 50 Meters	Pranav Shrivastava		Sanj Gadge Baba Amravati University		334234/234234	SH

## CONCLUSION

This information system is unique of its kind, which not only keep information about sports competition but also provides information about different stakeholders, technical details, players' performance data and thereby useful for organizers, players, associations, free lancer experts, professionals, researchers and media. It is user friendly and is very easy to operate even by the novice users. The forms and reports are self explanatory. Due to it's availability on the web, the information has wide spread reach and available to anybody, anywhere, any time. As the information providers are sport department of the Indian Universities which are member of Association of Indian Universities and recognized by the UGC, New Delhi, the information available is authentic.

**References**

1. Abraham Silberschatz, Henry F. Korth, S. Sudarshan, Database System Concept, Fifth edition, McGraw-Hill, 2006
2. Raghu Ramkrishnan, Johannes Gehrke, Database Management system, Third Edition McGraw-Hill, 2003
3. C. J. Date, An Introduction to Database system, Third Edition Vol. 1, Narosa publishing House, 1998
4. Jeffrey A. Hoffer, Marry B. Presscott, Fred R. McFadden, Modern Database Management, Pearson publication, 6th edition.
5. Thomos Canolly, Carolyn Begg, Database system-A practical approach to design, Implementation and management, Pearson publication, 4th edition.

**GENDER DISCRIMINATION IN SPORTS:  
FROM SUBJUGATION TO SELF- REALIZATION**

**ARZOO ASHOK RODE**

Asst.Prof., Department of English, DCPE, HVPM,  
Amravati, Maharashtra.  
arzoorode@gmail.com

**Abstract**

Sports has always been regarded as a male preserve. It is always associated with muscle power and so women have always had a secondary status in sports activity. Gender inequality is one of the many issues because of which India is not being able to progress at a faster rate. Women are very much interested in participating in games and sports but due to male dominated world, women are getting less chances for better exposure in participation. Moreover, they are asked to participate and be judged in sports that have a male history and male structure of control. Pandit Nehru has said that, ‘to awaken the people, it is the woman who must be awakened, once she is on the move the family moves.’ Focusing on the inter-relationship between gender and sports the paper aims to unfold the strategic engagement with gendered self from its subjugation to self- realization. At the outset the innumerable problems were studied from the sources available and the study designed where women will rise up and know herself for her future prospect.

**Key words;** Gender, Sports, Discrimination, participation

**INTRODUCTION**

Women traditionally had been regarded as inferior to men physically and intellectually. Both the law and theology had ordered their subjection. According to the traditional values, women were expected to be good wives and mothers and have pride in the accomplishments of duties towards their husbands and children. With the rise in feminism, the Indian woman also became aware of the fact that her inferiority is not ordained in heaven, and that gender bias is neither natural nor immutable, but it is a creation of patriarchy. The women had realized that the system of the patriarchy which existed since long time, no longer served the needs of the rapidly changing society where women were trying to emancipate themselves and define their potential. They have started revolting against their marginalization and have started questioning the politics and gender arrangement. They also came to know that, women are portrayed from male point of view in literature, in art and also in sports. Over the years, the age-old image of the Indian woman seems to be slowly blurring and gradually shading off into the new image. Now when a



swift change is going on all over the country, it has become necessary for a woman to redefine her new role and determine its parameters to herself and to the society, in every walk of life and perhaps revolutionize the concept of womanhood itself, to project: her desires, her anguish, her subjugation and her self-realisation. The realisation in women of their capacity to go beyond the confines allotted to them by the society and the indifferent response of the patriarchal set up to the extraordinary abilities makes women recognize their 'self'. Focusing on the interrelationship between Gender, feminism and sports, the paper aims to unfold the strategic engagement with gendered self from its subjugation to self- realisation. In India, women's interest had been crushed by the multicultural conflicts and polarities for which the country had become a sweltering ground for the last eight hundred years. Neither during the six hundred years of Mughal rule nor during the two hundred years of British Raj, there was any programme or intention to empower women with their due credentials. India has achieved independence more than 60 years back. We boast about progressing in every field and aim to be listed as one of the 'developed' countries. But on the whole, our mentality hasn't changed much. Females in this country face discrimination in every phase, right from the time they are born and continue to face discrimination even in their careers. One such field where discrimination is rampant is sports. Although India boasts of several sportswomen who have achieved accolades and made India proud, female discrimination is far more common in the field of sports than in other field.

Sport in India is yet to reach its peak. This is the area where gender inequality is strongly evident. The problem is more socio-psychological than anything else. Overtime the emphasis shifted from 'women and sport' to 'gender and sport'. The old question of early feminism is now outdated and surpassed by some new relevant concerns of sporting lives in the twenty first century. Today, as we stand at the start of a new millennium it is deplorable that men and women are treated so differently, especially in sport. The differences are seen in sports participation which are carried out by family, media and school. Girls are socialized into feminine activities such as netball, gymnastics, or hockey and boys are socialized into masculine sports such as football, rugby or cricket. Sports organization and governing bodies opened up opportunities for women which was seen in the 2012 Olympic and Paralympic Games in London which was heralded as the most 'female friendly' games, with every team having women competitors, women taking part in previously male only events such as boxing, etc. Despite these advances, women had less opportunity to compete, with fewer medals and

unequal funding. This approach accepts men's sporting practices and defines women as the problem requiring change.

A society, which does not allow a girl to do something simple as primary education, is unlikely to let her participate in sport without any hurdles. Even before taking part in 400meter hurdles the girl has to pass so many more social hurdles. To become an athlete, especially a skilled athlete, one can change the way a woman sees herself. It can make her feel physically stronger, more competent, and more in control of her life as an independent individual. Sport participation also provides girls and women with opportunities to reconnect with the power of their own bodies. Unfortunately, this way of thinking about gender and sports still exists. Many people continue to compare women and men in terms of performance differences and then go on to say that differences will never disappear because men are simply physically superior to women. It was observed that female participation in sport was discouraged and also that those who played faced innumerable problems. Just to keep playing against the wishes of the family and the society is a Herculean task. Excelling in sport is even more courageous. The advantages of sport are manifold. In order for India to become a stronger and a more wholesome nation, we need to fight gender inequality. Things did change after the 1970s when Title IX was introduced but there is a lot of scope for improvement. However, Indian female sports persons have fared better than the men, ex. Anju Bobby George, PT Usha, Sanya Mirza, Anjali Bhagwat, but the achievements of Sachin Tendulkar, Prakash Padukone, Pallela Gopichand, and Leander Paes cannot be overlooked. All that is implied is that women are making a mark for themselves in the world of sport and are gaining respect.

If examined from critical feminist perspective, influence of women's involvement in sport and physical exercise is seen. The activities like aerobics and bodybuilding represent two opposite ends of a conceptual continuum. Aerobics is considered an acceptable physical activity for women to participate in because the aim is to lose fat, reduce the body and create the body beautiful, slim, toned and sexy. In contrast, the aim of bodybuilding is to build muscles and make the body larger and stronger, which is not acceptable, because it is not consistent with the ideology of femininity. As a result, the women who participate in both of these activities face different dilemmas that are similar in their mandate to conform with pressures from family, friends, governing bodies and wider society to look beautifully feminine. As a result, women are

not empowered by participation in sport and physical exercise. They are, in fact, disempowered, discouraged from participating and prevented from attaining psychological health that comes from pride and pleasure in their physically active bodies. Players have good postures, excellent bone structure, they walk straight, and they could also be more muscular. In India girls are not supposed to walk straight, with head held high, they should definitely not be muscular or show strength. If this happens then they are called masculine. This may keep the girls away from playing a game.

Also women have been complaining about the lack of coverage for sport by media since a very long time. This has had a very bad effect on the development of sport. In Tennis, media pays more attention to the costumes of the women players and their looks than their game. Today's women players are also considered to be more charismatic than today's male Tennis players, who play more like machines. In India the condition is worse. Though Indian women are winning more medals for the country than men, still they hog more lime light than the women players. For ex: Indian women's Hockey team won a final against the Japanese team fighting against many odds, the same day India's Male Cricket team lost a match to the Australians in Australia, and this losing team got more coverage than the winning ladies Hockey team.

When people participate in sports and think ideologically and structurally, they often learn a form of common sense that leads to the conclusion that women are naturally inferior to men. As for women, myths about sport and the physiology of women have kept them out of sports. The notion that men and women are naturally different has been used for many years to justify the exclusion of women from some or all sports. Another belief promoted by the gender logic underlying many sports was that, men are naturally strong and aggressive and women are naturally weak and passive. For the last fifty years, this conclusion has prevented or slowed the development of professional sports for women. It has taken many years to break down these gendered forms of common sense.

Today we see girls and women going out, being educated and making careers. They are at par compared to man. We see them in all possible careers and professions, we also see them in sport. We see the women golfers like Nonita Laal, tennis players like Sanya Mirza and Badminton players like Aparna Popat. It is a great struggle and requires great efforts to become so proficient and successful in any game. The women/girls have realized and done it and reached

the place where they are now. Still it must be said that they are few and the group is very small. These girl/women players in India are those who decided to play and who keep on practicing' their chosen game in spite of all the social, psychological, economical and physical hurdles.

Sports is ultimately about the human body, it is a remarkable barometer of the physical differences between men and women and the social perceptions about these differences. The reason for such discrimination is again the present scenario. Will the parents allow their daughters to pursue Hockey or Tennis as a career amidst the current scenario? Why do we have only one Sania Mirza, one Saina Nehwal, or one PT Usha? The answer lies in the deplorable condition of the women in the Sports Industry. As Diana David, cricketer quotes: "Men are definitely treated better than women in cricket. For every Ranji game, we are paid extremely little, perhaps 10 per cent of what the men would be getting. Most of us continue to play only for the love of the game." Again, Sania Mirza's recent accusation about the All India Tennis Association's handling of the Olympics selection being based on male chauvinism has opened a Pandora's box and renewed the debate of gender discrimination in sports. Numerous examples can be cited to depict the deplorable state of affairs as far as female discrimination in sports is concerned. For example, the Squash Rackets Federation of India didn't even recommend Dipika Pallikal, India's number 1 squash player for the Arjuna award even after she became the first Indian in World Top 15. Similarly, Jwala Gutta, India's number 1 doubles player in badminton criticized the Badminton Association of India president V.K. Verma for not congratulating her even after she won the Commonwealth Games gold medal.

Exploring the varied notion of the gendered subject, the paper highlights how gender, women's physicality, ideology, structure, myths, and culture are deeply implicated in each other. It is a matter of great pride that Indian women's sport has come of age and is recognized with a substance. Over the past few decades women have contributed significantly to sports by interrogating and exploring their own lives and that of other women. Rio 2016 made history for India, as our women Olympian took over P.V Sindhu and Sakshi Malik snatched their wins at badminton and wrestling respectively. Dipa Karmarkar did at gymnastics and Aditi Ashok battled on at golf. This year Olympics proved that Indian sports future could lie very much in female hands. This speaks volumes about their self realization and determination to succeed against odds.

## CONCLUSION

India has never lacked women athletes, but in a country where sports infrastructure barely exists, it's never been easy for a woman to break through, particularly if she comes from a rural or poor background, with families and neighbours who believe that girl's just don't do sport. In order to live as dignified human beings and liberated women, women have to fight against many powerful agencies of patriarchal society. It is a well known fact that sports can emancipate and empower women. It can simply raise their earning power and status in society. Although these women are at odds with the environment, they also realize the fact that the same has been a source of strength and courage to tide over their dilemmas even though to a limited, but none the less, real victory. They face formidable challenges to gain their rightful place in the society. The tendency of self realization springs from within and overcomes the commotion arising from the confrontation with the existing world. India needs people who will fight the cause for Indian sportswomen so that they are as glorified as their male counterparts. *We need to applaud our sportswomen just the way we idolize our cricketers. Only then will we see many more Sania Mirzas and P.T Ushas.*

## References

1. Bhartiya Stree Shakti, 'A Study on Gender Issues in Sport in India', National Commission for Women, New Delhi.
2. Kane, M.J.(1996). Media coverage of the post Title IX female athlete: A feminist analysis of sport, gender, and power.
3. Kane, M.J. and Greendorfer, S. (1994). The media's role in accommodating and resisting stereotyped images of women in sport.
4. Lenskyj, H. (1994). Sport and Female Values. Women in Sport and Physical activity journal.
5. Miller, J.L., Levy, G.D. Gender role conflict, gender-typed characteristics, self-concepts, and sport socialization in female athletes and non athletes.
6. Nelson, M. B.(1991). 'Are we winning yet? How women are changing sports and sports are changing women', New York: Random House.
7. Physical Activity and Sport in the Lives of Girls: Physical and Mental Health Dimensions from an Interdisciplinary Approach.
8. Report of 'The National Commission for Youth' (Volume I) 2004, Government of India, Ministry of Youth Affairs and Sports.
9. <https://feminisminindia.com>.
10. <https://womanatwork.in>.

## THE 4<sup>TH</sup> UMPIRE - “HAWK-EYE” MODERN TECHNOLOGY IN CRICKET

**Dr.Shweta N.Dave**

Assistant Professor in Physical Education

Dharmendrasinhji Arts College (Government), Rajkot, Gujarat, India

[pti.dhcollege@gmail.com](mailto:pti.dhcollege@gmail.com)

Abstract

The game of Cricket, and the use of technology in the sport, has grown rapidly over the earlier period decade. though, technology-based systems introduce to arbitrate decisions in run outs, stumpout, boundary decisions and short leg and close catches are still prone to human error, and hence their acceptance has not been fully embrace by cricketing administrators in modern day of sports used most popular and trustable technology who name is “Hawk-eye”, the word “Hawk-Eye” is grouping of two words is ,”HAWK” and “EYE” and that original means is Birds view .In modern sports this technology being used in not only Cricket but used in many sports like Tennis, badminton, golf etc. This technology helps the umpires, match referees in taking the correct decision Hawk-Eye is the most innovative and modern technology contributor in sports related broadcasting. This machinery is used by the majority of television network to path the trajectory of balls in flight. The aim of this study is use of Wavelets in rising crickets’ edge-detection adjudication system. Live audio sample of ball-on-bat ,LBW and ball-on-pad events from a cricket match, will be recorded. Wavelet analysis and feature extraction will then be working on these sample. Results will show the ability to differentiate between these different audio events.

**Keywords:** OUT, LBW, Hawk-Eye, Technology

### INTRODUCTION

Hawk Eye who used in many sport like Cricket, Tennis, Snookers and Badminton. This technology is based on Computer system who visually tracks the path of the ball. Hawk Eye is also known as DRS Decision Review System. in DRS method, a player can request a review of decision taken by the umpires concerning whether or not a batsman is dismissed, with the exception of 'Timed Out'. in today technology’s world Hawk –Eye is the most innovative and technology contributor in sports broadcasting and is a development that will reinforce the group’s presence and influence. It is primarily used by the majority of television networks to track the trajectory of balls in flight. The Hawkeye system was invented by a young British computer expert Paul Hawkins, and they was launched in 2001.It was first used in television

coverage of sporting events such as Test cricket, and has now reached the stage of being used by officials in tennis to assist in adjudicating close line calls [1]

The Nasdaq-100 Open in Miami was the first tour event to officially use the technology. The 2006 US Open was the first Grand Slam event to feature the system, followed by the 2007 Australian Open. At the Australian Open, only centre court matches utilize the technology. [2] Devising tactics in opposition to opponent teams or definite players is also very regular in present day cricket. And all this possible to advance technology in current sports science word. And this Technological development have been harnessed to accumulate a variety of data specifically use it for various purposes. The Hawk-Eye is one such technology which is considered to be really top notch within cricket. The fundamental idea is to examine the trajectory of the cricket ball through the entire duration of play.

## 2. Abilities:

[A]Hawk-Eye can track any of bounce, spin, swing, and seam movement of the ball [3].

[B] Hawk-Eye Give a prediction as accurate ratio is 99.99%.

[C]Hawk-Eye is used for referring decision to the third umpire in LBW.

[D] In tennis Hawk-Eye helps the impact of the ball whether the ball is “IN” or “OUT”.

[E] Chances of wrong decisions can make right after seeing the actual movement.

## 3. Hawk-eye Methodology:-

Hawk eye is also calling as the name of calling system, which traces a ball's path and sends it to a Virtual reality machine.

It is a complex computer system which works via 6 or 7 high performance camera normally positioned in predefined places around the stadium. These cameras track the ball from different angles the video from the cameras is triangulated and combined to create a 3 dimensional representation of the trajectory of the ball. It is accurate within 5mm but is generally trusted as an impartial second opinion in sports. [4]

Cricket is played with ball who play within a predetermined area .The all data helps coaches and players for analysis of their performance and also in improve performance. The tracking system consists of High Speed vision processing cameras to track the ball from the bowler's hand to the batsman. In this Hawk-eye technology used 6 high speed vision processing cameras.

The system will automatically calculate the following step:

1. The speed of the ball leaving the bowler's hand.
2. The reaction time for the batsman.
3. The swing of the ball from the bowler's hand to where the ball pitched.
4. Where the ball was bowled from.
5. How much the ball bounced?
6. How much the ball deviated sideways off the wicket (i.e. seam or spin)
7. A prediction of where the ball would have passed the stump.[5]

### 3.1 Camera:

In Hawk-Eye technology used 6 high vision cameras. The camera placed high above the ground to track the trajectory path followed of the ball. It can spot out the bounce of the ball upto the precision of 3.6 mm and That cameras should record the high level movement of ball and its ratio is at the rate of 200 frames per second.

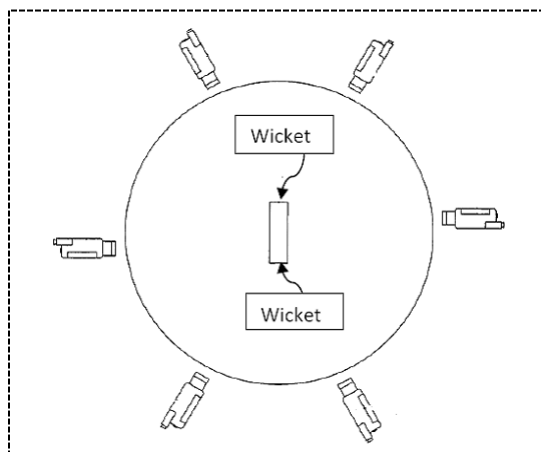

Figure 1. Hawk-Eye camera's positions

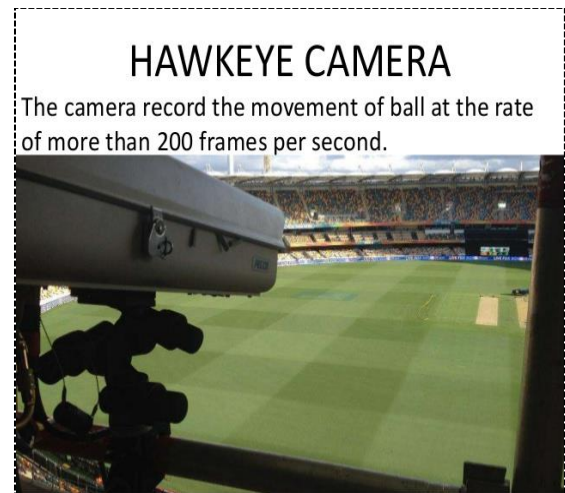

Figure 2. Hawk-Eye camera

### 3.2 Speed gun / Radar gun:

Speed gun known also as radar gun. Radar gun measures moving object speed of moving objects. Hawk-eye camera shoots a very short burst of infra-red and receives it back.

A speed gun measures the ball speed. It shoots a very short burst of infra-red laser and receives it back. The gun, counts the nanoseconds it took for the light to travel to and from the ball, divides it by two and gives the speed of the ball.[6]





Figure 3. Speed gun

### 3.3 Video Replay System

In Hawk-eye Captured the matches video and stored in digital hard disk and this data provide to coaches and players for analysis and its help to know about their performance it is very helpful to all players keep they record and measured they record year by year.

### 3.4 Principle of Hawk-Eye

The figure 4. Shows the flow of hawk eye technology. It started with the calibration of the cameras. This is required to deal with the problem about the non-uniform distance of the cameras from the playing area due to various sizes of the pitch. The next step is to start processing the video input which we get from the cameras. In each of the images obtained, the first aim is to find the ball in it. Once this is done, a geometric algorithm is used to look at multiple images (which are 2D) and then combine them cleverly to get the co-ordinates in 3D space. This process is now repeated for multiple times every second (typically at the rate of 100 times per second). Thus, we have the position of the ball in 3D space at many moments in every second. The final step is to process these multiple positions and find a suitable fitting curve which best describes the flight of the ball. As we have sampled the positions of the ball at very short time intervals, the flight of the ball can be very accurately determined. This is the outline of Hawkeye technology.[7]

#### 3.4.1 Flow diagram of Hawkeye

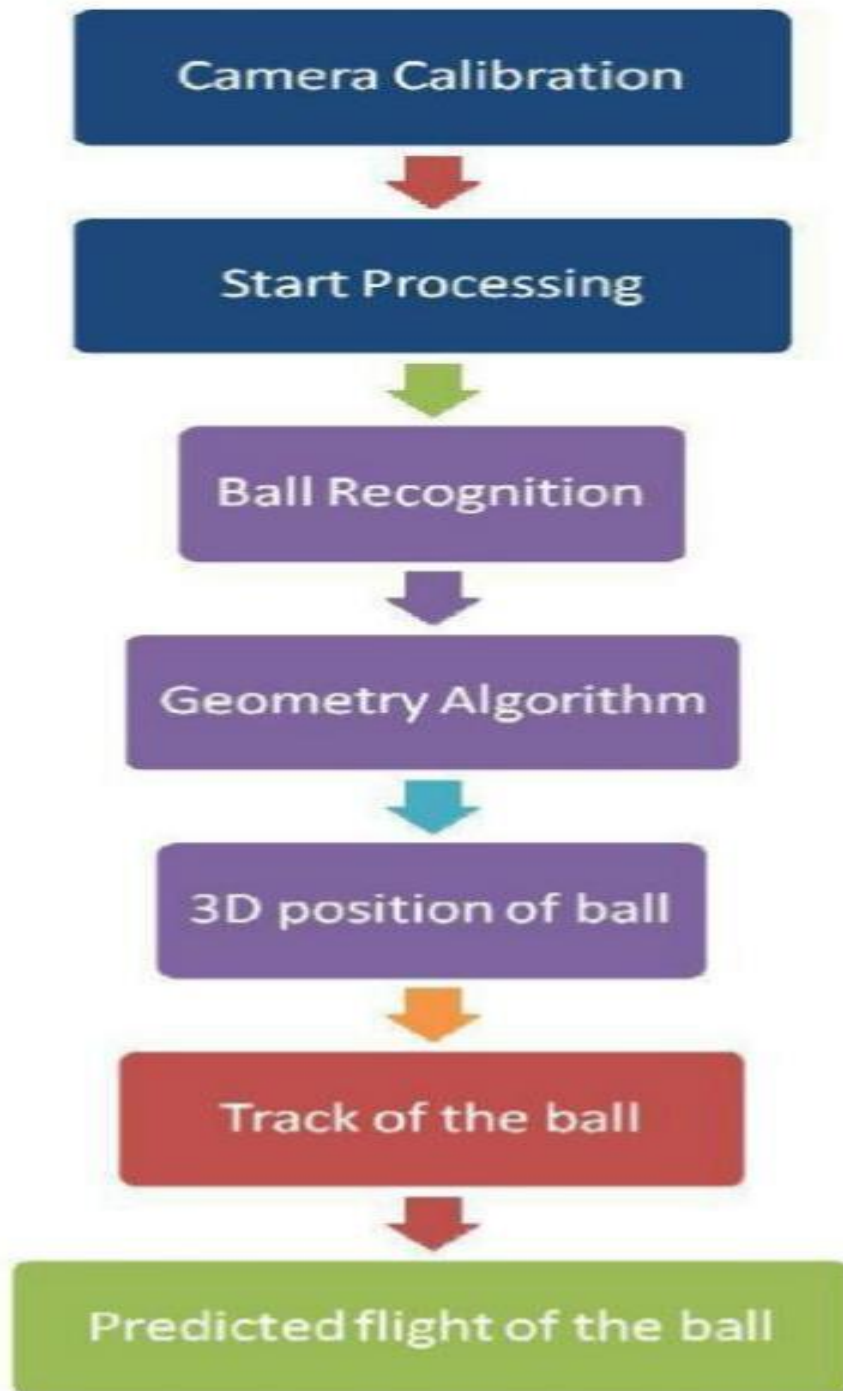

Fig. 4: Hawk-Eye Flow Diagram

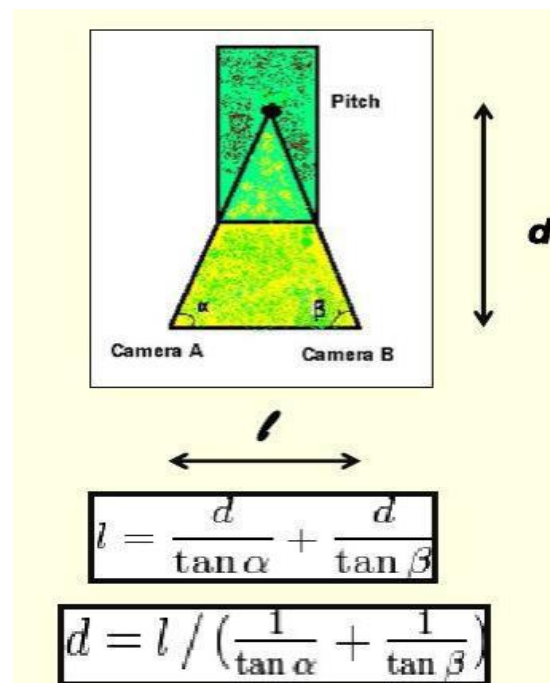

Fig 5: Triangulation

The Hawk-Eye system is based on triangulation principles that make use of visual images and timing data provided by high-speed video cameras placed at strategically locations and angles around the sports arena.

#### 4. APPLICATIONS IN CRICKET

##### 4.1 LBW

Hawkeye can accurately figure out the trajectory of the ball and predict the direction of the ball using mathematical calculations. This is used to decide whether a batsman was out. Thus, the system determines the exact point at which the ball struck the batsman. Using the trajectory of the ball up to that point, the system predicts the path the ball would have taken had the batsman not been present in the way. Thus one can know the lateral position of the ball with respect to the stumps as well as the height of the ball at the point when it reaches the line of the stumps. The figure 4 gives an example of the trajectory of the ball being predicted.

Note that in this picture, the system has got rid of the batsman from the picture so as to give us a complete view of the path of the ball since it left the bowler's hand. This is exactly what one needs to decide if the ball would have hit the stumps and if that is the case, the batsman has a chance of being given out. [8]

##### 4.2 Wagon Wheels:

The trajectories which the ball has taken after being hit by the batsman are recorded by the hawk-eye system. This is used to generate a graphic showing 1s, 2s, 3s, 4s, and 6s all in different colours for a batsman. These details allow the commentators, spectators and players to analyze the scoring areas of the batsman and also judge if he has played more shots along the turf or in the air. Such information is vital for a fielding captain, who might alter his field placement in subsequent matches to adapt to the hitting pattern of a particular batsman.[8]

#### 5. Advantages:

1. Help players to study their past performance and they can improve.
2. Help Coaches to study players skill and after they can make plan to improve performance
3. Ball prediction as accurate as 99.99%
4. Human Error chance is minimum
5. It is very effective system which works in real time

### CONCLUSION

In this paper a variety of aspect of Hawk-Eye technology are discussed. The technology working in seven steps. Which workings on diverse numerical and signal dealing out tools like geometry algorithm, Kalman filter to give speed, angle and deviation of the ball. This technology extensively is used in current days, especially in Cricket. As the system runs in accurate time, there is no extra time required to see the visualizations and graphics. The system is also a great tool which can be used by players, coaches to analyze previous games and come up with strategies for subsequent ones. After all tests on this technology, it has always come out to be successful and provided as a boon to world.

#### References

1. <http://www.hawkeyeinnovations.co.uk>
2. "Home :: Hawk-Eye". Hawkeyeinnovations.co.uk. Retrieved 2012-06-02.
3. Manish Duggal, "Hawk Eye Technology," Journal of Global Research Computer Science & Technology (JGRCST) ISSN: 2349 – 5170 Volume: I, Issue: II, July 2014.
4. "Hawk-Eye at Wimbledon: it's not as infallible as you think". The Guardian. 8 July 2013. Retrieved 2013-08-16.
5. Aishwarya Pathak, Prof K. G. Purohit, Ashish Thakre "international journal for engineering application and technology a review on hawk-ey technology" IJFET
6. Aishwarya Pathak, Prof K. G. Purohit, Ashish Thakre "international journal for engineering application and technology a review on hawk-ey technology" IJFET
7. "Hawkeye technology" - Journal of global research computer science and technology, ISSN: 2349-5170 DOI : July 2014.
8. <http://www.dailymail.co.uk/sport/rugbyunion/article-3194743/Hawk-Eye-technology-used-Rugby-World-Cup-bid-resolve-debates-contentious-tries.html>

## EFFECT OF 8 WEEK TRAINING PROGRAMME ON AGILITY AND POWER OF SWIMMERS

**Dr. Pratima Bhonde,**

Assistant Professor, D.C.P.E., Amravati.

[Pratimahiwase@gmail.com](mailto:Pratimahiwase@gmail.com).

### Abstract

A training program is the essence of the sports performance. The main purpose of the study was find out the effect of 8 week swimming training program on school going children. Required data for this study were collected on the school going mail swimmers who used to come for regular practice to Shree Hanuman Vyayam Prasarak Mandal's Swimming pool, Amravati. Forty School going male swimmers were selected as subjects by using purposive sampling Technique. The main purpose of the study was to find out the effect of swimming training on agility and power among the swimmers. To measure the power of the selected subjects, Soft Ball Throw test was administered and the score was recorded in mts. To measure the agility of the selected subjects Semo-Agility test was administered and the score was recorded in seconds. The training was given after pre-test for 8 weeks, six days in a week i.e. Monday to Saturday from 5:30 to 7:30p.m. The training volume increased along with the duration of training program. No training was given to the control group. to determine the significant difference between the means of the control and experimental groups, independent t-test was employed for pre-test and post-test separately for each variables. To test the hypothesis the level of significance was at 0.05. No significant difference was found in between pre and post test means of control group ( $t=0.543 < Tab\ t = 2.021$ ) in Agility. But experiential group showed significant difference in means of pre and post test ( $t=15.425 > Tab\ t = 2.021$ ). Similarly post test means of control and experimental groups showed significant difference ( $t=15.572 > Tab\ t = 2.021$ ). The mean of Agility score for control and experimental groups were 13.49 and 13.17 in pre-test .while 13.32 and 9.52 in post-test respectively. In the case of power insignificant difference was found in between pre and post-test means control group ( $t=0.446 < Tab\ t = 2.021$ ). But experimental group showed significant difference in means of pre and post test ( $t=2.365 > Tab\ t = 2.021$ ). Similarly, post-test control and experimental groups showed significant difference ( $t=2.134 > Tab\ t = 2.021$ ). Means of power scores for control and Experimental groups were 12.59 and 12.60 in pre-test while 12.98 and 14.83 in post-test respectively.

**Keywords:** Agility, power, beginners, swimming training.

## **INTRODUCTION**

In the modern society, the term physical education and physical fitness are more popular and it very essential for healthy survival of an individual. Physical education contributes a lot in preparing the young to achieve their personal fulfillment with respect to physical, social and mental qualities. Now a days sports become a part and parcel of life. Millions on fans follow different sports events all over the world with an enthusiasm bordering on devotions. Many people participate in sport and games for happiness, pleasure health and fitness. Today the preparation of an athlete for top notch achievement is a completely dynamic state, characterized by a high level of physiological efficiency and degree of perfection of the necessary skills and knowledge, technique and tactical preparation. An athlete arrives at this state only as a result of appropriate training. Thus, an athlete's training today is a multisided process of expedient use of aggregate factor so as to influence the development of athletes and ensure the necessary level of participation.

## **METHOD**

The school going male swimmers who used to come for regular practice at Hanuman Vyayam Prasarak Mandal's swimming pool, Amravati served as the sources of data. Total 40 beginning swimmers were selected by employing purposive sampling method, who had the ability to swim at least 500 meters in survival stroke. The average age of the subjects were thirteen (13) years, ranging between 12 to 14 years. Their age was verified from the school admission register. The subjects were divided randomly into two groups' viz. Experimental and Control Groups; each group consisted of 20 subjects each.

### **Significance of the Study**

The present study would be significant to get an idea about the selected psychomotor variables of beginners. The finding would provide guidelines to health instructors, physical education teachers and coaches, parents and students to enhance health and fitness through swimming training. The result of study may help to maintain the health of the

beginners, swimmers through swimming training program which could be suggested to include in school curriculum.

### **Purpose of the study**

The main purpose of the study was to find out the effect of swimming training on agility and power among the swimmers.

Sources of data and selection of subject:

1. For this study 40 school going male swimmers age between 12 to 14 years who used to come to Shree Hanuman Vyayam Prasarak Mandal's Swimming pool, Amravati for regular practice were selected by using purposive sampling Technique.
2. Only beginner swimmers were selected who were able to swim at least 500 meters in any survival stroke. The subject were divided into two groups viz. Experimental group and control group , each group consisted of twenty subjects.

Selection of test and criterion measure:

**Power:** Arm and shoulder power of the subject's Soft ball throw test was administered and score was recorded in meters.

**Agility:** To measure the agility of the selected subjects semo-agility test was administered and the score was recorded in seconds.

### **Administration of Training Program:**

The training was conducted for two hours per day it was for 2 month continuously (a sample of swimming training program is given below). The training program was corrected and modified before and during the training as per the requirement after discussion with expert and guide.

1. The result pertaining to the above variables are presented separately under the following tables. Table -1 The training was given after pre test for 8 weeks, six days in a week i.e. Monday to Saturday from 5:30 to 7:30 p.m.
2. The training volume increased along with the duration of training program.
3. No training was given to the control group.

**Analysis of the Data:**

To determine the significance of difference between the means of the control and experimental groups, independent t-test was employed for pre-test and post-test separately for each variables. All the data were analyzed by using (SPSS) Statistical Package for Social Sciences. To test the hypothesis the level of significance was at 0.05

**Findings**

**Table-1**

Mean, standard deviation and t-ratio of the control and Experimental groups for the pre and post test in power.

<b>Groups</b>	<b>Mean</b>	<b>Standard Deviation</b>	<b>Mean Difference</b>	<b>Standard Error</b>	<b>t-ratio</b>
Pre Test Control	12.59	2.8017	0.39	0.8820	0.446 <sup>@</sup>
Post Test Control	12.98	2.7766			
Pre Test Experimental	12.60	3.2484	2.23	0.9431	2.365*
Post Test Experimental	14.83	2.6902			
Post Test Control	12.98	2.7766	1.85	0.8645	2.134*
Post Test Experimental	14.83	2.6902			

@ Not significant at 0.05 level

Tabulated  $t_{0.05(38)} = 2.021$

\* Significant at 0.05 level

From the above Table it is evident that, there is no significant difference between Control group mean of Pre and Post test in Power as the calculated t-value 0.446 is less than the tabulated t-value of 2.021 at 0.05 level of confidence for the 38 degrees of freedom. But Experimental group shows significant difference in mean Pre and Post test in Power as the calculated t-value 2.365 is greater than the tabulated t-value. Similarly Post test Control and Experimental groups shows significant difference with calculated 't' value of 2.134.

From the table it is also observed that the mean Power scores for Control and Experimental groups are 12.59 and 12.60 in Pre-Test while 12.98 and 14.83 in Post-Test respectively. From the above table, it can be clearly inferred that Control group does not differ significantly in respect to Power in Pre and Post Test. Hence there is no significant change in the Power of Control group swimmers. But in Post Test, Control and Experimental groups differ significantly. Moreover, there is a significant difference in Pre and Post Test mean Power of



Experimental group. It is also observed that, Post Test mean Power of Experimental group is greater than the Pre Test value which clearly shows that the training program has positive affect on the Power of swimmers. The mean values of Power are graphically depicted in Figure-3.

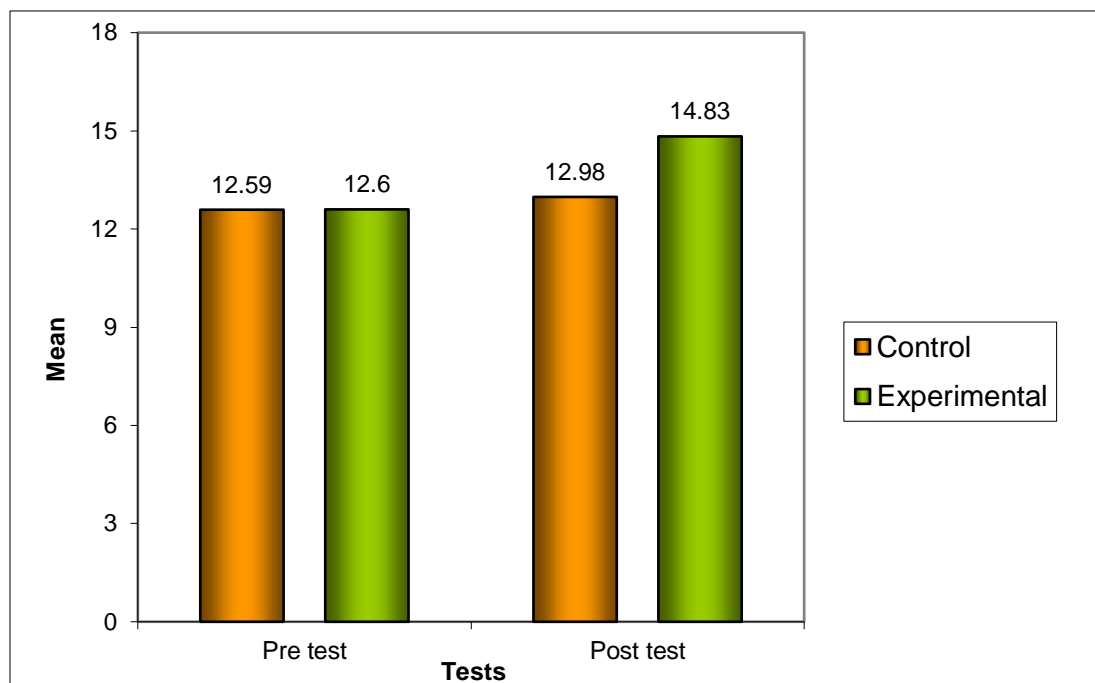

**Figure – 1** Comparison of Means among the pre and post test of control and experimental groups in power

**MEAN, STANDARD DEVIATION AND t-RATIO OF THE CONTROL AND EXPERIMENTAL GROUPS FOR THE PRE AND POST-TEST IN AGILITY**

Groups	Mean	Standard Deviation	Mean Difference	Standard Error	t-ratio
Pre Test Control	13.49	0.9705	0.16	0.2983	0.543 <sup>@</sup>
Post Test Control	13.32	0.9151			
Pre Test Experimental	13.17	0.8727	3.64	0.2362	15.425*
Post Test Experimental	9.52	0.5953			
Post Test Control	13.32	0.9151	3.80	0.2441	15.572*
Post Test Experimental	9.52	0.5953			

@ Not significant at 0.05 level

Tabulated  $t_{0.05(38)} = 2.021$

\* Significant at 0.05 level

From the above Table it is revealed that, there is no significant difference between Control group mean of Pre and Post test in Agility as the calculated t-value 0.543 is less than the tabulated t-value of 2.021 at 0.05 level of confidence for the 38 degrees of freedom. But Experimental group shows significant difference in mean Pre and Post test in Agility as the calculated t-value 15.425 is greater than the tabulated t-value. Similarly Post test Control and Experimental groups shows significant difference with calculated 't' value of 15.572.

From the table it is also observed that the mean Agility scores for Control and Experimental groups are 13.49 and 13.17 in Pre-Test while 13.32 and 9.52 in Post-Test respectively.

From the above table, it can be clearly inferred that Control group does not differ significantly in respect to Agility in Pre and Post Test. Hence there is no significant change in the Agility of Control group swimmers. But in Post Test, Control and Experimental groups differ significantly. Moreover, there is a significant difference in Pre and Post Test mean of Agility of Experimental group. It is also observed that, Post Test mean of Agility of Experimental group is less than the Pre Test value which clearly shows that the training programme has positive affect on the Agility of swimmers. The mean values of Agility are graphically depicted in Figure-2

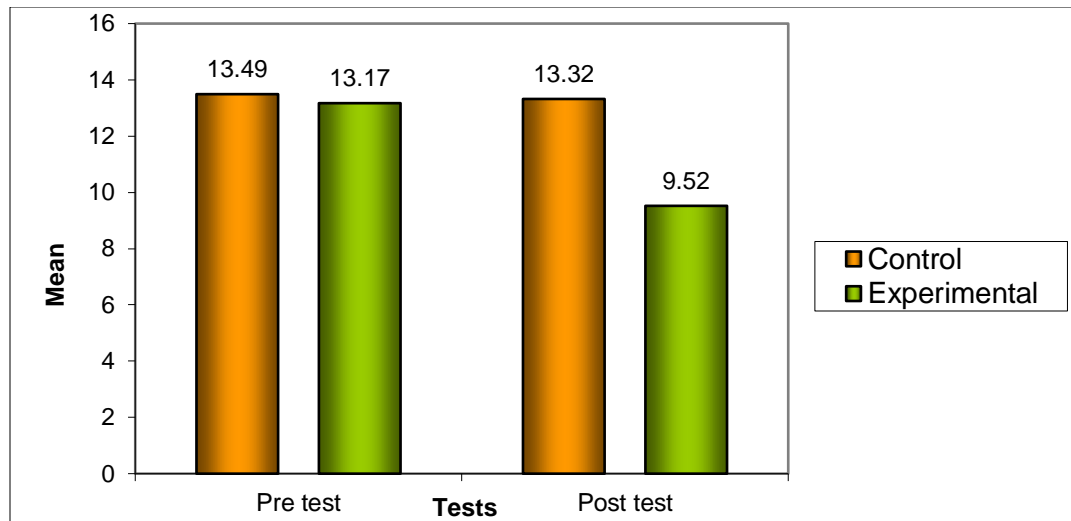

Comparison of means among the pre and post-test of control and experimental groups in Agility

### DISCUSSION ON FINDING

The findings of statistical analysis that significant improvement was found in the power and agility of the selected subjects of experimental group due to 2 month of swimming training program. This improvement in the selected power and agility might be attributed to the nature of experimental treatment given to the experimental group.

From the statistical finding it was also learnt that control and experimental groups were significantly different in post test. Finding of the statistical analysis revealed that control group did not differ significantly in respect to power in pre and post tests. But in post test control and experimental groups were found significantly different. It was also observed that post test mean of power of experimental group was given to the beginners. Hence the training program had positive effect on the power and agility of swimmers. This significant improvement in the agility of the selected group might be accredited to the nature of training which consisted of different

exercises improving agility. The finding of the study showed significant effect on power. The finding of the study showed significant effect on Agility.

### **CONCLUSIONS**

With the limitation of the present study and on the basis of the finding, the following conclusions are drawn-

1. Only experimental group has shown significant improvement in power after experimental treatment, where as no significant development occurred with the subject of control group.
2. Significant improvement has been shown by the experimental group in Agility due to training program, where as no significant improvement has been shown in control group.

### **RECOMMENDATION**

On the basic of the conclusion drawn, the following recommendations are made:

- It was recommended that swimming training is an effective means to improve power and agility by means of which lightness of the swimmers are improved.
- To develop muscular strength of the beginners, swimming is strongly recommended.
- It is further recommended that similar study may be undertaken with the subject of different age and sex groups other than those employed in the present study.
- Similar study may be repeated by selecting parameters other than those employed in the present study.
- Similar study may be conducted by selecting duration of training programme other than those employed in the study.

### **Reference**

1. **Gabrielsen M.A., Betty Spears and B.W. Gabrielsen**, Aquatics Handbook, 2<sup>nd</sup> Edition (Prentice-Hall Inc.1968).
2. **Garry D. And Yanker**, The Complete Book of Exercise Walking, (Chicago : Contemporary Book, 1983).

3. **Ghosh Chandan**, Encyclopedia of Sports and Games, (New Delhi : Hinduisa Foundation, Konark Publisher Pvt. Ltd., 1997).
4. **Hannula Dick and Nort Thorton**, The Swim Coaching Bible, (Champaign, IL: Human Kinetic Publishers Inc., 2001).
5. **Hannula Dick**, Coaching Swimming Successfully, (Champaign, I.L. : Human Kinetics Inc, 2003).
6. **Hines Emmett W.**, Fitness Swimming (Human Kinetics Publication, US. 1999).
7. **Morrow James R.** “The Importance of Strength, Speed and Body Size For Team Success in Women’s Inter-Collegiate Volleyball”, Research Quarterly, Vol. 50, (October 1979), P. 429.
8. **Myers David Anthony**, “The Effect of a Virtual Skill and Fitness Trainer in Physical Education Classes on Student Heart Rates, Body Mass Index, Fitness Level, and Student Perceptions”, Dissertation Abstracts International, Vol. 69, No.05, Suppl.1, (2008).
9. **Nederh E.**, “The Effect of High Load Training on Psychomotor Speed”, The Effect of Int. Sports Medicines, (2007), P. 595.
10. **Newton R.U.**, “Strength and Power Training of Australian Olympic Swimmers”, Strength and Conditioning Journal, Vol. 24, No.3, (Jun. 2002), P.P. 7-15.
11. **Nunney Derek N.**, “Relation of Circuit Training to Swimming”, Research

## “SPORTS MEDIA AND JOURNALISM – A PROFESSION”

**Dr. Deepak V. Phadnis**

D. C. P. E. Amravati

**Dr. Vijay V. Pande**

D.C.P.E. Amravati

### **Abstract**

Sports journalism is concerned with reporting of various sports events and activities. It is highly recognized form of journalism nowadays. The sports journalism may include various media for the coverage of sports events. Most prominent among them are as follows; Sports and the press i.e. sports pages, magazine etc, sports and radio, sports and television , sports and the internet.. The relationship between sports, media, and the advertising industry is symbiotic— a mutually dependent relationship. This means that all elements in that system get a fair share, a share everyone only gets with the help of others while helping others.

Key words: Media, Sports, Journalism, Achievements

### **INTRODUCTION**

Sports journalism is a form of writing reports on sporting topics and games. While the sports departments within some Newspapers have been mockingly called as the “Toy departments” because the sports journalists do not concern themselves with the serious topics covered by the News desks. Sports coverage has grown in importance as sports has grown in wealth, power and influence. Sports journalism is an essential element of any news media organization. Sports journalism includes organizations developed entirely to sports reporting.

The “very symbiotic relationship” between the media and sports has profoundly affected both participants and the advertising industry forms an important part of the relationship. Both sports and mass media keep trying to reach people as spectators, fans, and consumers; both actively affect the audience as well as the advertising market (including the sponsors).

Sport refers to a playful self development, self actualization, and competitive use of physical and mental skills. The history of sport activities is as long as the history of humans. Fitness played an important role in human evolution. Most civilizations know sport activities of an elementary nature: running; boxing; wrestling; animal fights; horse races; throwing the javelin, the discus, or stones; archery; swimming; dancing; etc. No wonder self control to collective values like sportsmanship and fairness, and generally accepted values like the belief in effort and productivity.

There are the various types of media to playing efficient role in sports journalism. Such as

- 1) Sports and the press i.e. sports pages, magazine etc.
- 2) Sports and radio
- 3) Sports and television
- 4) Sports and the internet.

### **Sports and the Press**

The press is oldest medium regularly informing people about sports. From the beginning, sports terms showed keen interest in print media coverage. Newspapers formed the principal means of bringing news of coming events and results of past events. News of coming events built audiences for sporting contests and, together with the results of past events.

It is also divided in three categories of print media dealing with sports:

- Sports pages in daily newspapers
- Sports papers and magazines
- Periodicals published by sport clubs and associations.

### **Sports and the Radio**

Up to the early 20th century, the only way to share the immediate drama of a sports event was either to play or to attend. But then came radio. The added value of the radio compared to the print media is the opportunity of live reporting. From the very beginning the radio took advantage of this asset. Live radio reporting gave the impression of being there, of being a witness of something emotional and suspenseful. Announcers learned very quickly to give the impression of dense and dramatic events. Another advantage of the radio was and still is its very fast speed. Results and scores can be diffused instantaneously in a very flexible program. And the radio medium can reach people at any time anywhere, i.e., in the car, at the workplace, on the beach, etc.

### **Sports and Television**

Television has clearly become the leading medium in the context of sports. Like the radio, this medium allows live reporting, but because it transmits not only sound but also live images, the feeling of “being there” is even stronger for television spectators than for radio listeners. So, with television, major sporting contests are no longer available just to spectators witnessing the event in person, but also to many millions more who can view the spectacle in their own homes, the added value stemming from this medium is evident: close-ups, replays, slow motion, the different angle cameras, and cameras that follow the action. It can be more exciting to be a spectator in front of the television screen than to be a spectator in the stadium, far away from the playing field or the arena floor. And, what is most important, television shows live people, sportsmen and women, usually perfectly built, completely fit, attractive, and highly trained young

people.

The mass media is the most significant development in modern sports, a development in the context of market forces. The relationship between sports, media, and the advertising industry is symbiotic mutually dependent relationship. This means that all elements in that system get a fair share, a share everyone only gets with the help of others while helping others. Sporting events underwent dramatization and personalization, and became producers of sensations and stories of human interest. The medium of radio following the telegraph—allowed live transmissions and added speed to sports reporting. Television added the personal experience of authenticity and offered the possibility of witnessing sporting events without going to the stadium or arena. In addition to that, with the help of different techniques (close ups, slow motion), it created new media realities. At the end television changed sports into a money-making show business.

Since the category “sports” plays such an important role for the media, they improved the professional competence of the persons who cover sports events and their actors. Sports reporters became well regarded and highly respected journalists in their media concerns.

### **Sports and the Internet**

Since the mid-1990s, not only television but also the Internet can transmit live pictures of sports events. However, the memory capacities of personal computers and data transfer rates have set limits to this kind of sports broadcasting so far. Therefore television still remains the most important medium for sports reporting. But the Internet already offers a lot of interesting options for sports fans today The Internet allows a fast worldwide transfer of data, so it is well suited to the transmission of short sports news.

Websites are comparatively easy to produce and use; with the aid of a search engine, fans can easily find even detailed information about special topics. So the World Wide Web is also an ideal place for sports information and for those sports neglected in other media. One of the first websites successfully covering a sports event did not deal with one of the major sports: The event was the Whitbread around-the-world sailing race in 1997.

### **CONCLUSION**

The rise of the mass media is the most significant development in modern sports, a development in the context of market forces. The relationship between sports, media, and the advertising industry is symbiotic— a mutually dependent relationship. This means that all elements in that system get a fair share, a share everyone only gets with the help of others while helping others. Since the category “sports” plays such an important role for the media, they improved the professional competence of the persons who cover sports events and their actors. Sports reporters became well regarded and highly respected journalists in their media concerns. Their main good is entertainment.

Sports have the capacity of creating strong and long lasting images for athletes and their countries. Performances of sportsmen and -women quite often are the filters through which the whole world sees a nation, a country, a society, or a party. No wonder that politicians show interest in apolitical events. Good performances, fine success, and glorious athletes create—with the help of the media—identity and integration. And this, after all, is something every social unit needs.



## References

1. Maguire, J. (1999). *Global sport: Identities, societies, civilisations*.
2. Cambridge: Polity Press.
3. McKay, J., Lawrence, G. A., Rowe, D., & Miller, T. (2001). *Globalization and Sport*. London: Sage.
4. O'Donnell, H. (1994). Mapping the mythical: A geopolitics
5. of national sporting stereotypes. *Discourse and Society*, 5, 345-380.
6. Puijk, R. (Ed.). (1997). *Global spotlights on Lillehammer*.
7. Luton: University of Luton Press.
8. Pütz, W. (1993). *Das Italienbild in der deutschen Presse. Eine Untersuchung ausgewählter Tageszeitungen*. München: Ölschläger.
9. Randy, M., & Miller, T. (Eds.). (1999). *SportCult*. Minneapolis: University of Minnesota Press.
10. Rees, R. C., & Miracle, A. W. (Eds.). (1986). *Sport and social theory*. Champaign, IL: Human Kinetics Publishers.
11. Riggs, K. E., Tyler Eastman, S., & Golobic, T. S. (1993). Manufactured conflict in the 1992 Olympics: The discourse of television and politics. *Critical Studies in Mass Communication*, 9, 253-272.
12. Riordan, J., & Krueger, A. (Eds.). (1999). *The international politics of sport in the 20th century*. London: E & FN.

## **A CRITICAL ANALYSIS OF THE SPORTS FACILITIES PROVIDED BY THE NAMDHARI SPORTS ACADEMY**

\*Charan Singh

\*\*Dr. Monika Verma

\*Ph.D. Scholar Dept. of Physical Education Ch. Devi Lal University, Sirsa

\*\*Professor Department of Physical Education Ch. Devi Lal University, Sirsa

### **Abstract**

Sports academies play an enormous role in developing the overall game of a player. They look into each and every aspect of a sportsman that helps not only improve the physical aspect of the sport, but also the mental size of things. A number of academies are functioning to promote national game such as Maharaja Ranjeet Singh Hockey Academy, Surjeet Hockey Academy, Punjab and Sind Bank Academy, Ramesh Academy, Karam Chand Thapar Hockey Academy Sansarpur, SAI (Sports Authority of India) Centre of Excellence, Netaji Subash National Institute of Sports, Sports Academy in Jarkhar, RCF (Rail Coach Factory) academy in Kapurthala and an unending list. Among these academies there is one academy namely Namdhari Sports Academy which is functioning day and night to promote hockey and to uplift the status of hockey players and for this purpose they provide various kinds sports facilities. In this paper, we will study the different kinds of sports facilities provided by Namdhari Sports Academy to their players.

**Key words :-** Hockey, Astro-turf, Namdhari Academy, Sports kit, Facility, etc.

### **INTRODUCTION**

Namdhari Sports Academy was incepted in 1975. And since then it has been working for the development and betterment of the game hockey. They have produced many international and national players. In fact, 2017 Rajiv Gandhi Khel Ratan Awardee Sardar Singh belongs to the Namdhari Sports Academy. Namdhari Sports Academy is the first private organization which owns its personal Synthetic Astro-turf. They also have one another Astro-Turf at village Sant Nagar in District Sirsa. They provide many facilities to their players in the academy. From sports equipments to job assurance they provide all the things. The players of the Namdhari Hockey got various jobs in various departments for their outstanding performance and achievements by the different state and central Governments.

## **Statement of the Problem**

Namdhari Sports Academy is a voluntary social institution dedicated to the promotion of national game Hockey and for this very purpose they provide many facilities to their players. Hence, it is felt high time to look into query of such a great Institute. Thus the problem is stated as “**A Critical Analysis of the Sports Facilities provided by the Namdhari Sports Academy**”.

## **Objectives of the study**

The objective of the study is to critically examine the sports facilities provided by Namdhari Sports Academy to their players.

## **Significance of the study**

- i) The study would certainly be helpful for those scholars, teachers and students who are interested to do innovative work on the Namdhari Hockey.
- ii) Through this investigation, the contribution made by Namdhari Academy for the improvement of Hockey in India as a whole, would be known.
- iii) The study also reveals the sports facilities provided by Namdhari Sports Academy to their hockey players.

**Table 1, shows about NSA provides grassy ground to the players**

<b>Opinions</b>	<b>Responses</b>	<b>Percentage</b>	<b>Mean</b>	<b>S.D.</b>
<b>Strongly Disagree</b>	0	0	4.18	0.768
<b>Disagree</b>	0	0		
<b>Neutral</b>	44	22.0		
<b>Agree</b>	75	37.5		
<b>Strongly Agree</b>	81	40.5		
<b>Total</b>	200	100.0		

Source: Survey (SPSS-16.0)

**Table 1** The table shows that majority of the respondents i.e. 81 (40.5%) out of 200 (100%) are ‘Strongly Agree’ with the statement followed by 75 (37.5%) are ‘Agree’ with the statement, 44 (22.0%) are ‘Neutral’ with the statement and not even a single respondent is ‘Disagree’ and ‘Strongly Disagree’ with the statement. The overall average value is 4.18 and S.D. 0.768. Thus, the results undoubtedly indicate that NSA provides grassy ground to the players. And the Standard Deviation indicated that how much the responses are different from the mean value for the group.

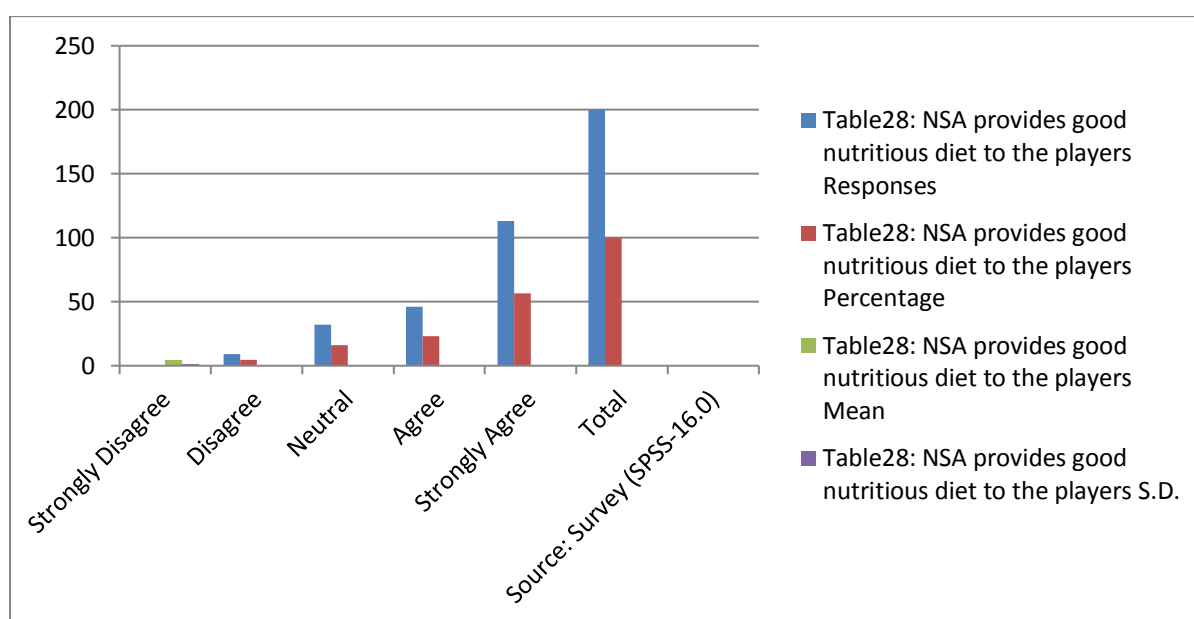

**Figure 1: NSA provides grassy ground to the players**

**Table 2, shows about NSA provides synthetic Astro-turf to the players**

<b>Opinions</b>	<b>Responses</b>	<b>Percentage</b>	<b>Mean</b>	<b>S.D.</b>
<b>Strongly Disagree</b>	0	0	4.21	0.690
<b>Disagree</b>	0	0		
<b>Neutral</b>	31	15.5		
<b>Agree</b>	96	48.0		
<b>Strongly Agree</b>	73	36.5		
<b>Total</b>	200	100.0		

Source: Survey (SPSS-16.0)

**Table 2** The table shows that majority of the respondents i.e. 96 (48.0%) out of 200 (100%) are ‘Agree’ with the statement followed by 73 (36.5%) are ‘Strongly Agree’ with the statement, 31 (15.5%) are ‘Neutral’ with the statement and not even a single respondent is ‘Disagree’ and ‘Strongly Disagree’ with the statement. The overall average value is 4.18 and S.D. 0.768. Thus, the results unquestionably show that NSA provides Astro-turf to the players. And the Standard Deviation indicated that how much the responses are different from the mean value for the group.

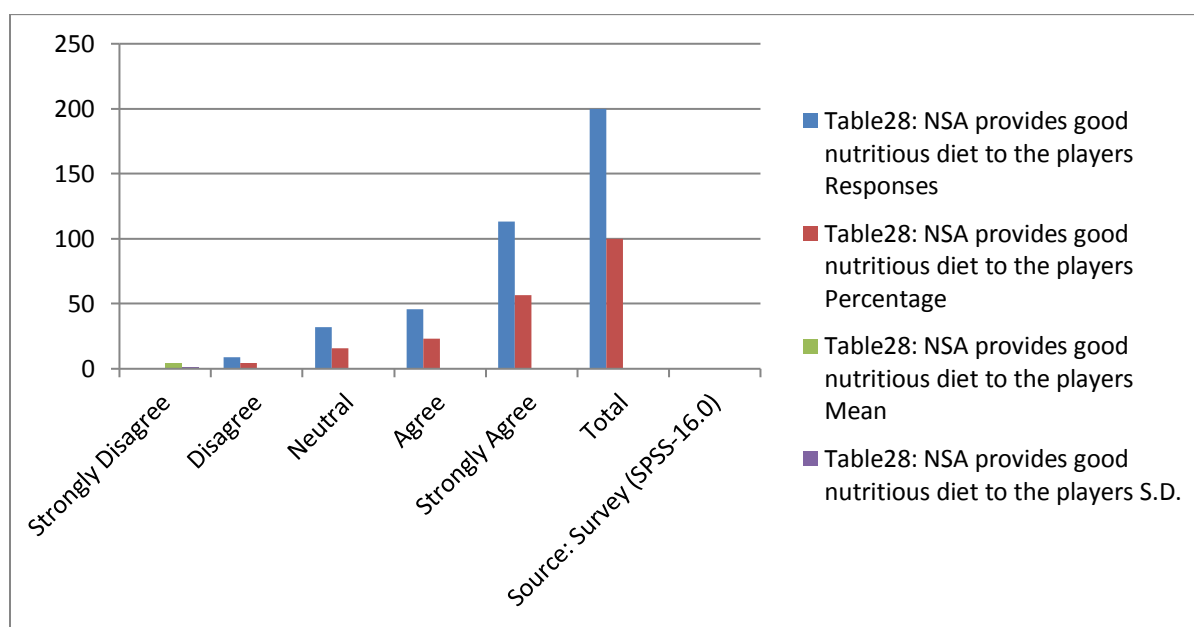

**Figure 2: NSA provides synthetic Astro-turf to the players**

**Table 3, shows about NSA provides good sports equipments to the players**

Opinions	Responses	Percentage	Mean	S.D.
<b>Strongly Disagree</b>	0	0	4.5	0.500
<b>Disagree</b>	0	0		
<b>Neutral</b>	16	8.0		
<b>Agree</b>	68	34.0		
<b>Strongly Agree</b>	116	58.0		
<b>Total</b>	200	100.0		

Source: Survey (SPSS-16.0)

**Table 3** The table shows that majority of the respondents i.e. 116 (58.0%) out of 200 (100%) are ‘Strongly Agree’ with the statement followed by 68 (34.0%) are ‘Agree’ with the statement, 16 (8.0%) are ‘Neutral’ with the statement and not even a single respondent is ‘Disagree’ and ‘Strongly Disagree’ with the statement. The overall average value is 4.18 and S.D. 0.768. Thus, the results unquestionably show that NSA provides good sports equipments to the players. And the Standard Deviation indicated that how much the responses are different from the mean value for the group.

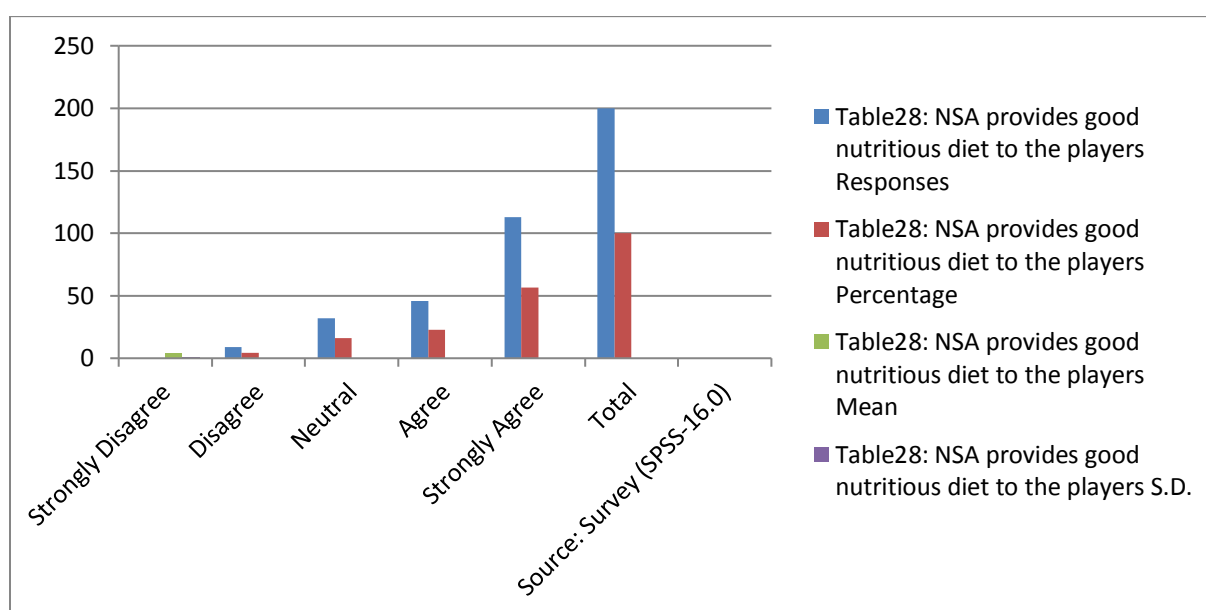
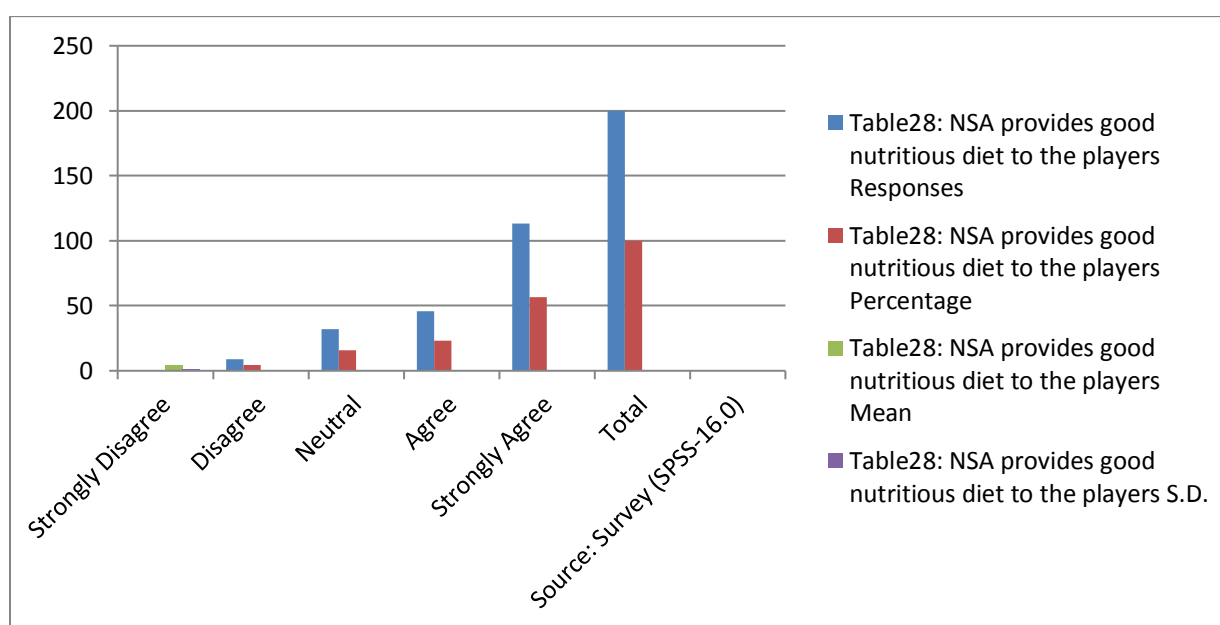

**Figure 3: NSA provides good sports equipments to the players**  
**Table 4, shows about NSA provides First-aid Kit to the players**

Opinions	Responses	Percentage	Mean	S.D.
<b>Strongly Disagree</b>	1	.5	4.25	0.861
<b>Disagree</b>	9	4.5		
<b>Neutral</b>	22	11.0		
<b>Agree</b>	75	37.5		
<b>Strongly Agree</b>	93	46.5		
<b>Total</b>	<b>200</b>	<b>100.0</b>		

Source: Survey (SPSS-16.0)

**Table 4** The table shows that majority of the respondents i.e. 93 (46.5%) out of 200 (100%) are ‘Strongly Agree’ with the statement followed by 75 (37.5%) are ‘Agree’ with the statement, 22 (11.0%) are ‘Neutral’ with the statement, 9 (4.5%) are ‘Disagree’ with the statement and remaining 1 (0.5%) respondent is ‘Strongly Disagree’ with the statement. The overall average value is 4.25 and S.D. 0.861. Thus, the results unquestionably show that NSA provides First-aid Kit to the players. And the Standard Deviation indicated that how much the responses are different from the mean value for the group.



**Figure 4: NSA provides First-aid Kit to the players**

**Table 5, shows about NSA provides coaches to the players**

Opinions	Responses	Percentage	Mean	S.D.
Strongly Disagree	5	2.5	3.92	0.934
Disagree	12	6.0		
Neutral	30	15.0		
Agree	101	50.5		
Strongly Agree	52	26.0		
<b>Total</b>	<b>200</b>	<b>100.0</b>		

Source: Survey (SPSS-16.0)

**Table 5** The table shows that majority of the respondents i.e. 101 (50.5%) out of 200 (100%) are ‘Agree’ with the statement followed by 52 (26.0%) are ‘Strongly Agree’ with the statement, 30 (15.0%) are ‘Neutral’ with the statement, 12 (6.0%) are ‘Disagree’ with the statement and remaining 5 (2.5%) respondents are ‘Strongly Disagree’ with the statement. The overall average value is 3.92 and S.D. 0.934. Thus, the results clearly indicate that NSA provides coaches to the players. And the Standard Deviation indicated that how much the responses are different from the mean value for the group.

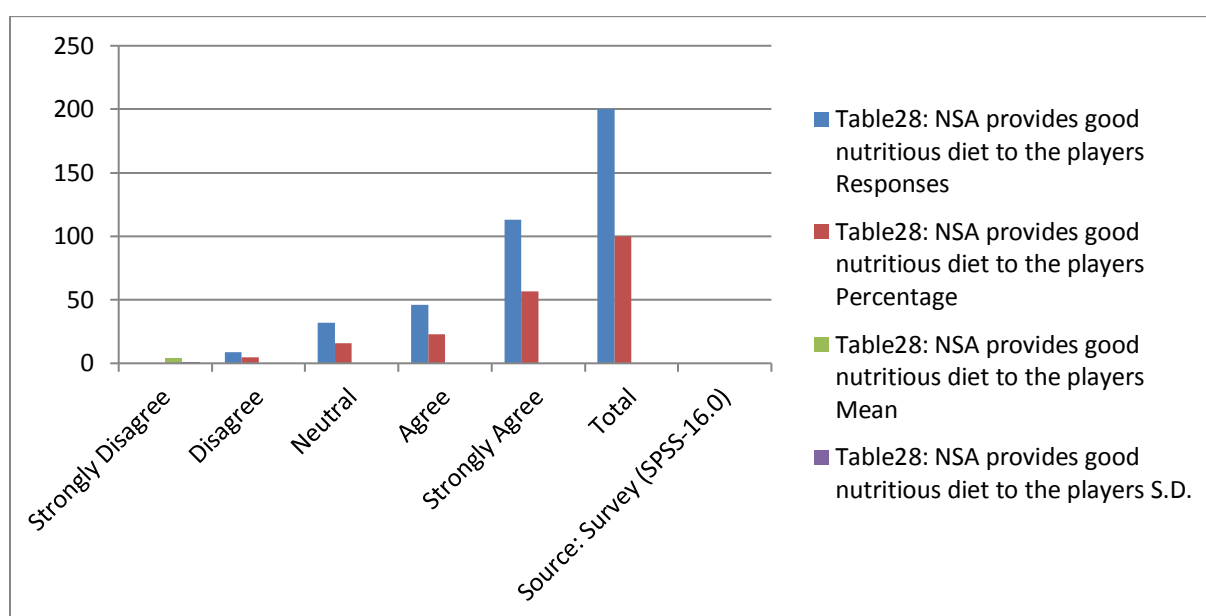

**Figure 5: NSA provides coaches to the players**

**Table 6: NSA provides trainer to the players**

Opinions	Responses	Percentage	Mean	S.D.
<b>Strongly Disagree</b>	7	3.5	3.7	0.946
<b>Disagree</b>	11	5.5		
<b>Neutral</b>	53	26.5		
<b>Agree</b>	93	46.5		
<b>Strongly Agree</b>	36	18.0		
<b>Total</b>	200	100.0		

Source: Survey (SPSS-16.0)



**Table 6** The table shows that majority of the respondents i.e. 93 (46.5%) out of 200 (100%) are ‘Agree’ with the statement followed by 36 (18.0%) are ‘Strongly Agree’ with the statement, 53 (26.5%) are ‘Neutral’ with the statement, 11 (5.5%) are ‘Disagree’ with the statement and remaining 7 (3.5%) respondents are ‘Strongly Disagree’ with the statement. The overall average value is 3.7 and S.D. 0.946. Thus, the results clearly indicate that NSA provides trainer to the players. And the Standard Deviation indicated that how much the responses are different from the mean value for the group.

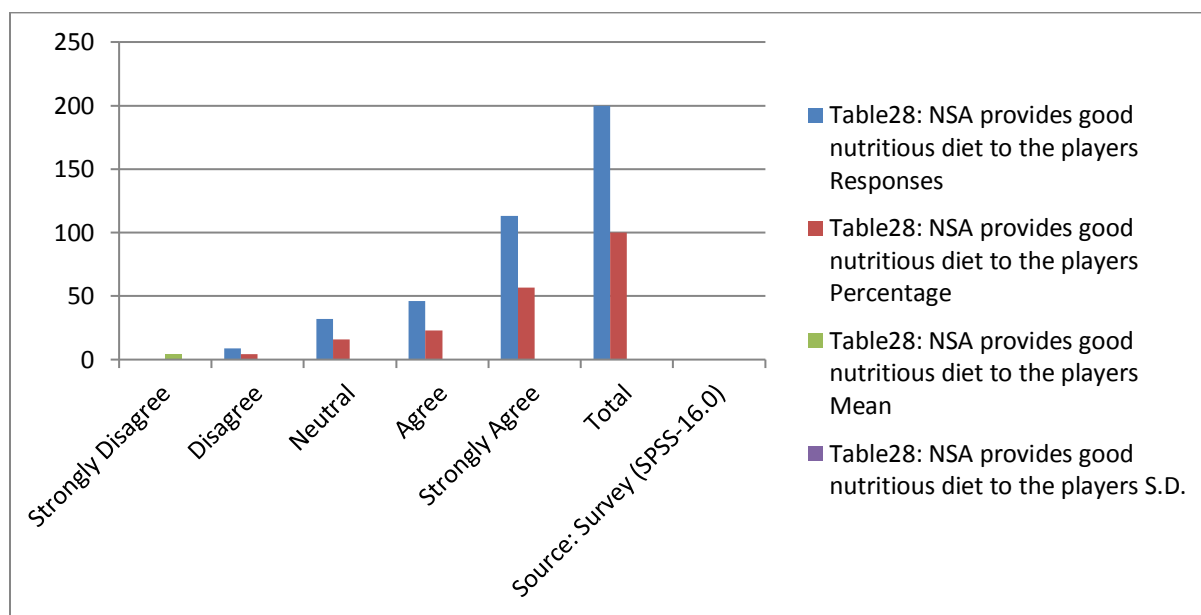

**Figure 6: NSA provides trainer to the players**

**Table 7: NSA provides accommodation to the players**

Opinions	Responses	Percentage	Mean	S.D.
<b>Strongly Disagree</b>	7	3.5	3.6	0.993
<b>Disagree</b>	24	12.0		
<b>Neutral</b>	41	20.5		
<b>Agree</b>	99	49.5		
<b>Strongly Agree</b>	29	14.5		
<b>Total</b>	200	100.0		

Source: Survey (SPSS-16.0)

**Table 7** The table shows that majority of the respondents i.e. 99 (49.5%) out of 200 (100%) are ‘Agree’ with the statement followed by 29 (14.5%) are ‘Strongly Agree’ with the statement, 41 (20.5%) are ‘Neutral’ with the statement, 24 (12.0%) are ‘Disagree’ with the statement and remaining 7 (3.5%) respondents are ‘Strongly Disagree’ with the statement. The overall average value is 3.6 and S.D. 0.993. Thus, the results clearly indicate that NSA provides accommodation to the players. And the Standard Deviation indicated that how much the responses are different from the mean value for the group.

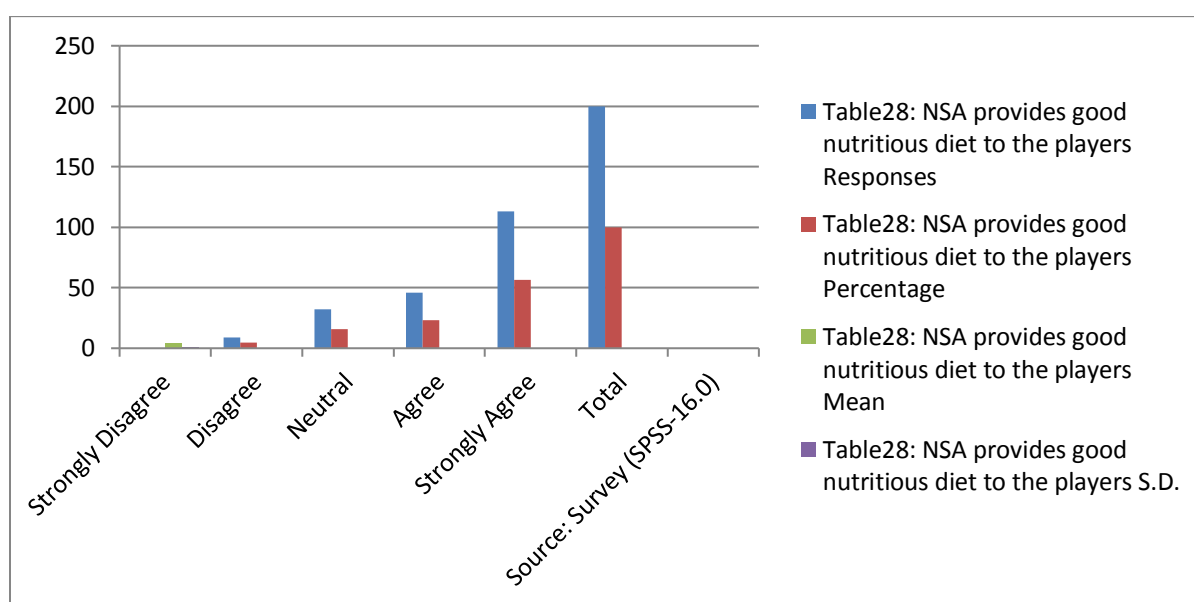
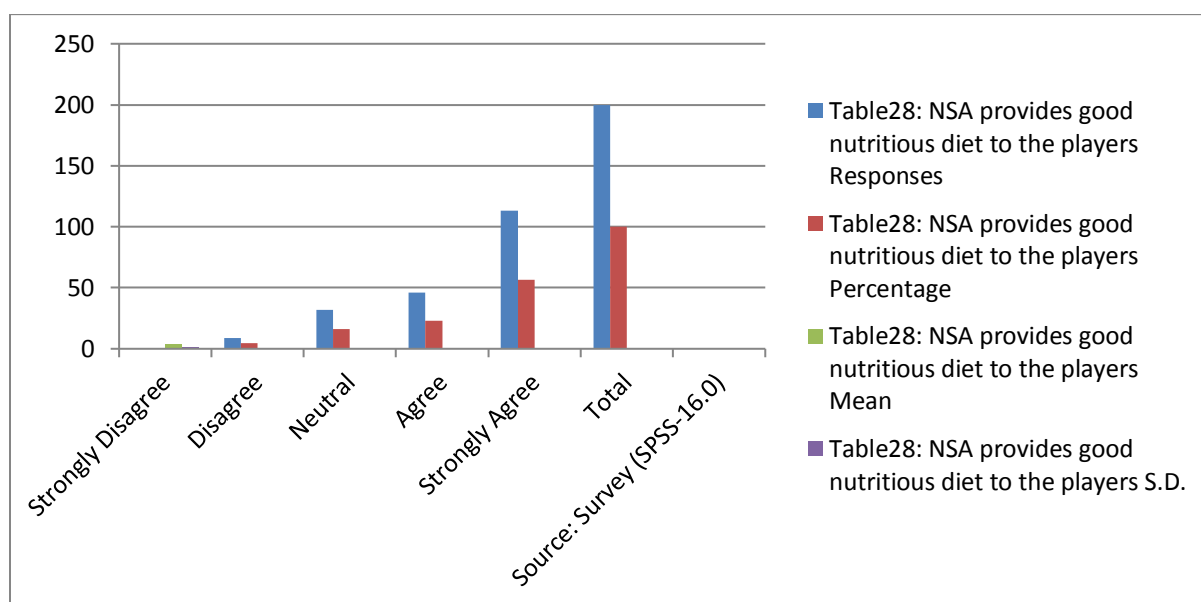

**Figure 7: NSA provides accommodation to the players**  
**Table 8: NSA provides good nutritious diet to the players**

Opinions	Responses	Percentage	Mean	S.D.
Strongly Disagree	0	0	4.31	0.897
Disagree	9	4.5		
Neutral	32	16.0		
Agree	46	23.0		
Strongly Agree	113	56.5		
<b>Total</b>	<b>200</b>	<b>100</b>		

Source: Survey (SPSS-16.0)

**Table 8** The table shows that majority of the respondents i.e. 113 (56.5%) out of 200 (100%) are ‘Strongly Agree’ with the statement followed by 46 (23.0%) are ‘Agree’ with the statement, 32 (16.0%) are ‘Neutral’ with the statement, 9 (4.5%) are ‘Disagree’ with the statement and none respondents is ‘Strongly Disagree’ with the statement. The overall average value is 4.31 and S.D. 0.897. Thus, the results clearly indicate that NSA provides good nutritious diet to the players. And the Standard Deviation indicated that how much the responses are different from the mean value for the group.



**Figure 8: NSA provides good nutritious diet to the players**

**Table 9: NSA provides medical facility to the players**

Opinions	Responses	Percentage	Mean	S.D.
Strongly Disagree	3	1.5	3.96	1.012
Disagree	13	6.5		
Neutral	49	24.5		
Agree	58	29.0		
Strongly Agree	77	38.5		
<b>Total</b>	<b>200</b>	<b>100.0</b>		

Source: Survey (SPSS-16.0)

**Table 9** The table shows that majority of the respondents i.e. 77 (38.5%) out of 200 (100%) are ‘Strongly Agree’ with the statement followed by 58 (29.0%) are ‘Agree’ with the statement, 49 (24.5%) are ‘Neutral’ with the statement, 13 (6.5%) are ‘Disagree’ with the statement and remaining 3 (1.5%) respondents are ‘Strongly Disagree’ with the statement. The overall average value is 3.96 and S.D. 1.012. Thus, the results clearly show that NSA provides medical facility to the players. And the Standard Deviation indicated that how much the responses are different from the mean value for the group.

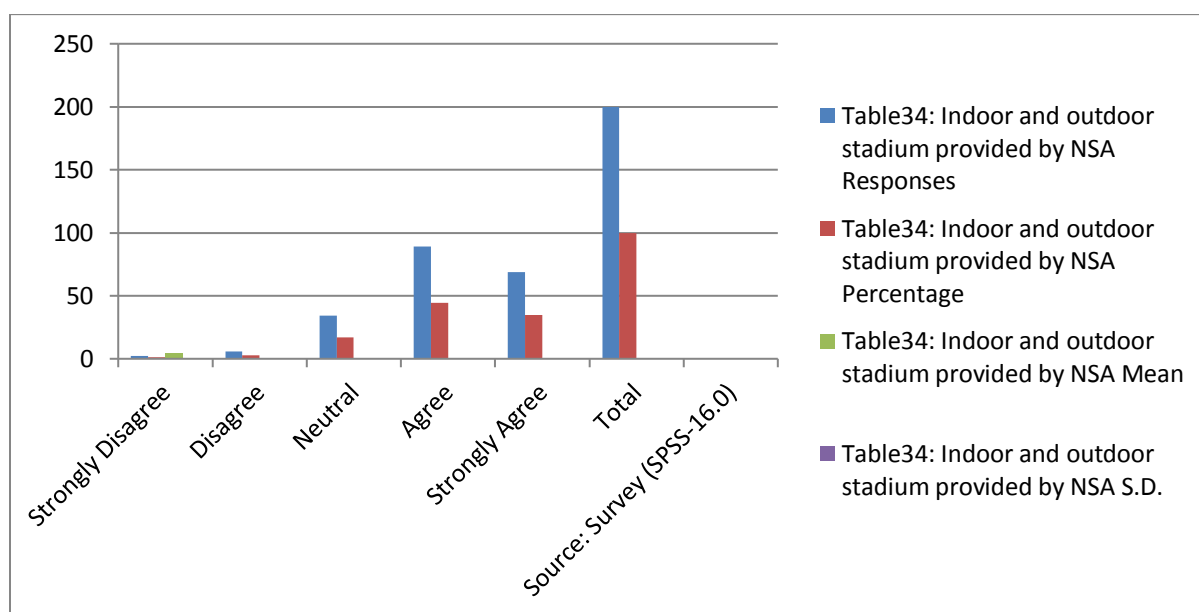

**Figure 9: NSA provides medical facility to the players**

**Table 10: NSA provides transportation facility to the players**

Opinions	Responses	Percentage	Mean	S.D.
Strongly Disagree	3	1.5	4.06	0.941
Disagree	10	5.0		
Neutral	35	17.5		
Agree	77	38.5		
Strongly Agree	75	37.5		
<b>Total</b>	<b>200</b>	<b>100.0</b>		

Source: Survey (SPSS-16.0)

**Table 10** The table shows that majority of the respondents i.e. 77 (38.5%) out of 200 (100%) are ‘Agree’ with the statement followed by 75 (37.5%) are ‘Strongly Agree’ with the statement, 35 (17.5%) are ‘Neutral’ with the statement, 10 (5.0%) are ‘Disagree’ with the statement and remaining 3 (1.5%) respondents are ‘Strongly Disagree’ with the statement. The overall average value is 4.06 and S.D. 0.941. Thus, the results plainly show that NSA provides transportation facility to the players. And the Standard Deviation indicated that how much the responses are different from the mean value for the group.

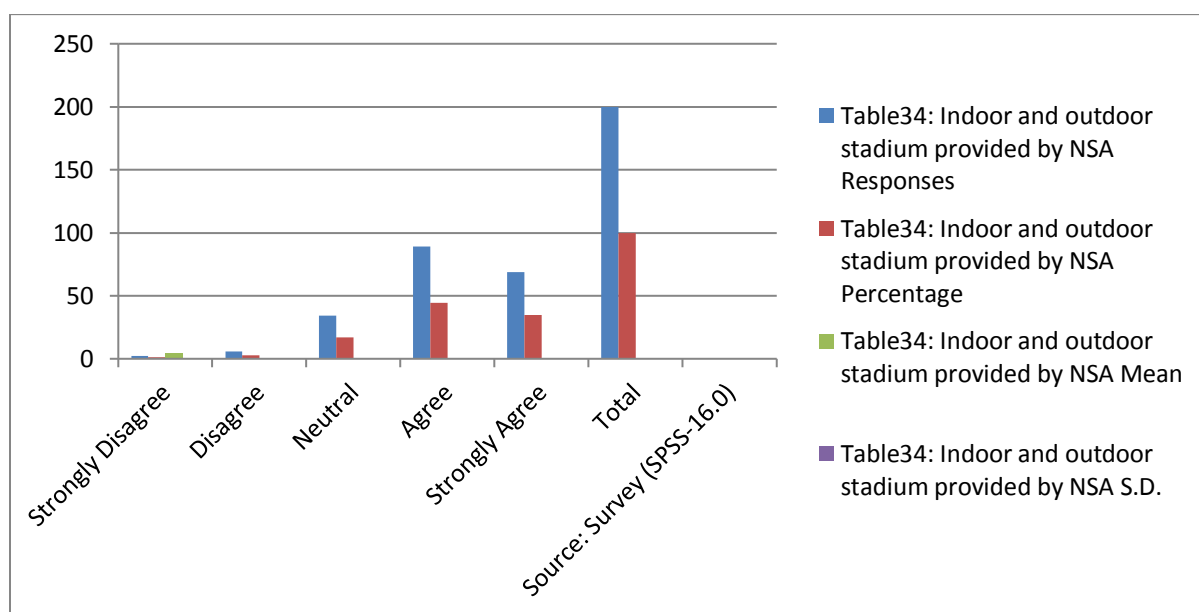

**Figure 10: NSA provides transportation facility to the players**

### CONCLUSION

Thus, it can be safely concluded that Namdhari Sports Academy provides various kinds of sports facilities. They provide synthetic astro-turf along with the grassy ground to the players for the practice. Apart from this they also provide well trained coaches and trainers to teach the basics of hockey. Namdhari Sports Academy also provides the complete hockey kit to their players along with medical and transportation facility. In fact, they also provide good nutritious

diet to their players and they only provide vegetarian diet to their players. Hence it can be said that Namdhari Sports Academy provides various kinds of sports facilities to their players so that they can focus on their game.

### **References**

1. Kaur, Paramjeet. "Indian Sports". Web. 17 May 2016.
  - a. <<http://new-indiansports.blogspot.in/2012/08/indiansports-thehistory-of-sports-in.html>>
2. Gupta, Shashank. "Private but aggressive team, the Namdharis". Web. 16 May 2016.
  - a. <<http://www.stick2hockey.com/Article/Private-but-aggressive-team,-the-Namdharis-/7561.html>>
3. Vaidya, Madhuri P. "Evaluation of Efforts and Achievements of Shree H.V.P. Mandal in Physical Education and Sports. Thesis. July 2013. Print.
4. Manjunath, Sahadevappa. "Indian hockey a case study of Karnataka Hockey players". Thesis. 2015. Print.
5. Duggal, Saurabh (8 September 2013). "*Indian hockey's newest nursery*". Hindustan Times. Retrieved 20 May 2018. Ganguly, Adit (11 September 2015). "*Hockey team from Haryana's Sant Nagar expects players to eat vegetarian food, wear traditional clothes*". DNA India. Retrieved 24 May

**THE RELATIONSHIP OF SELECTED KINEMATICAL VARIABLES TO THE  
PERFORMANCE OF BASKETBALLERS IN JUMP SHOT**

**Dr. Sunil Dabas**

Padma Shri & Dronacharya Awardee  
H.O.D in Physical Education, D. Govt. P.G. College, Gurgaon.

**Dr. Rakesh Kumar**

Asstt. Prof. in Physical Education, NCPE, Noida

**Abstract**

The purpose of this study was to measure the relationship of selected kinematical variables to the performance of Basketballers in Jump shot. The subjects for this study were ten female Basketballers of Chaudhary Charan Singh University, Meerut, who represented Mahrishi Dayanand University, Rothak in Intervarsity Championship. The age ranged from eighteen to twenty two years. Selected kinematic variables were: ankle joint, knee joint, hip joint, shoulder joints, elbow joints, body inclination and standing height. The scores of the subjects in jump shot were used as criterion variable in this study. The performance of the subjects were assessed by three judges and there average was taken as the score. In case of Ankle Joint (Right and Left) , Knee Joint (Right and Left), Shoulder Joint (Right and Left), Elbow Joint (Right and Left) and Wrist (Right and Left), and Hip Joint (Left and Right) showed insignificant relationships with the performance of subjects in jump shot.

**Keywords:** Performance, Basketball, Fitness, Kinematical

**INTRODUCTION**

Physical education seems to have taken a new turn in the form of sport sciences. The sport sciences in turn have taken their substance and methodology from various basic sciences. For many years the research in sport was being undertaken within these basic sciences but with the advancement of knowledge the new specialization and micro-specializations have evolved a respectable position. As a matter of fact that the research now a days embraces knowledge from

various disciplines of human sciences. In India too in the recent years some research work had been going on in the basic discipline, pertaining to sport. Physical education and sport, being an integral part of education have also experienced the impact of scientific advancements. Now the sportsman has been able to give outstanding performance because of involvement of new scientifically substantiated training methods and means of execution of sport exercises such as sports techniques and tactics, improvement of sportswear and equipments as well as other components and conditions of the system of training<sup>1</sup>.

Training in sports and games is no longer a myth and it has no casual approach, but it provides opportunities for scientific process and verification. Training has been accepted as a highly specialized science. Physical education scientists are striving to understand the various factors affecting skeletal and muscular activity, during variation of human movements with the help of electro-myography, and are engaged in analysing the biomechanics of the performances of top athletes by focusing their attention upon the analysis of sports skills. They are consistently studying factors like strength, limb length, mass, inertia proportions and angular and linear velocity, that influence these movements, to get a better insight into the complexities of human motion and performance. The latest approach is aimed at the construction of a mathematical model of a skill in a form which is suitable for computer analysis so that it could be simulated under several carefully controlled conditions for predicting more effective techniques for higher performances.

The shortest and swiftest running events are sprints. Indoor sprints are run over distances of 50 and 60 m (50 and 60 yd). Outdoors, the distances are 100, 200, and 400 m (110, 220, and 440 yd). In running the sprints, the athlete crouches at the starting line, leaps into full stride at the crack of the starter's pistol, and races to the finish line at top speed. A fast start is especially important in sprinting. Basketballers gain traction by placing their feet against metal or plastic starting blocks located behind the starting line. Starting blocks can also electronically indicate basketballers who manage to start before the starter's pistol is sounded; this early anticipation of

---

<sup>1</sup>John T. Powell, "Development of Olympic Athletes" Olympic Review 193 (November 1983) : 752.



the start can be penalized with disqualification. The chief characteristics of efficient sprinting style are high knee lift, free-swinging arm movements, and a forward lean of about 25 degrees. The outcome of a sprinting race is greatly affected by the speed of the start. Before the race begins, basketballers crouch into position and place their feet against blocks (left), which they push against as they leap into a start (right). Runners may employ various strategies during sprints. In a 400 m contest a runner may achieve top speed in the first 200 m, “coast” or “float” for another 150 m, then finish the race in a final burst of speed. Some runners prefer to sprint at top speed for the first 200 or 300 m, then coast through the remaining distance. In coasting, runners conserve energy by relaxing, lengthening their stride, and allowing their momentum to carry them along at close to top speed.<sup>2</sup>

The photographing human movement is widely employed in biomechanics as a means of recording the events. It provides a pictorial record of events that occurs so rapidly that careful analysis is impossible by observation alone. The human eye is a notoriously poor recorder; accounts of the same action by several observers frequently result in discrepancies. However with the use of special photographic equipment, a record can be obtained of the movement that can be used later for detailed analysis. Properly done, motion pictures provide data that will yield to lengthy analysis; infect, they may be so extensive that a major difficulty is to delimit the problem to manageable proportions. A difficulty of photographic research is the expense of providing the equipment, including the practice and development of film; if the camera is operating at high-speed, film will be moved at a rather rapid rate. It will be found that cost mount quickly<sup>3</sup>.

### **Statement of the Problem**

---

<sup>2</sup> Microsoft® Encarta® Encyclopedia. © 1993-2001 Microsoft Corporation. All rights reserved.

<sup>3</sup> David H. Clarke and H. Harrison Clarke, Research Process in Physical Education (Prentice Hall, Englewood Cliffs : New Jersey, II<sup>nd</sup> Edition, 1984), P. 225

The purpose of this study was to measure the relationship of selected kinematical variables to the performance of Basketballers in Jump shot.

### **Delimitations**

1. The study was delimited to ten female university players of eighteen to twenty two years of age of Mahrishi Dayanand University, Rothak .
2. The jump shot was recorded in one plane only.
3. Selected kinematic variables were: ankle joint, knee joint, hip joint, shoulder joints, elbow joints, body inclination and standing height.

### **Subjects**

The subjects for this study were ten female Basketballers of Mahrishi Dayanand University, Rothak who represented Mahrishi Dayanand University, Rothak in Intervarsity Championship. The age ranged from eighteen to twenty two years. All the subjects were left footed starters. Subjects were familiarized with the testing equipments and procedures by the research scholar.

### **Criterion Measure**

The scores of the subjects in jump shot were used as criterion variable in this study.

### **Scores of Subjects on Jump shot**

The performance of the subjects were assessed by three judges and there average was taken as the score<sup>4</sup>.

### **Reliability of Data**

The equipments used in the study were standard and calibrated that is camera and geometrical instruments.

---

<sup>4</sup> "Appendix F"

The camera used in this study was a standard Nikon Model D-100. The sequence photographs were taken by a professional photographer.

### **Collection of Data**

The data was collected by the help of digital photography, and the scores of the subjects in Jump shot.

### **Filming Protocol**

Digital photography was employed for conducting kinematical analysis of the jump shot. The jump shots were filmed with a Nikon Model D-100, which was positioned at 2.44m from the subject at a height of 1.38m from the subject on an extension of restricted area line. Clear images were obtained. The subjects were made to take three starts only. The kinematical variables of the body were calculated at moment take off.

### **Analysis of the Film**

The photographs as obtained by the use of digital photography were analyzed (the best trial) by standard analysis method. Only one-selected moments was analyzed. Selected variables were as under:

### **Kinematical Variables**

The selected kinematical variables were divided in two parts i.e.

- a) Linear Kinematic Variables were:
  - i. Height of Center of Gravity at moment take off.
- b) Angular Kinematic Variables were represented by the angles at selected joints i.e.
  - i. Ankle joints
  - ii. Knee joints
  - iii. Hip joints

- iv. Shoulder joints
- v. Elbow joints
- vi. Wrist joints

The scholar developed stick figures on the photographs, from which selected kinematical variables were calculated. The stick figures were developed by using Joint-point method. The center of gravity of each subject, at one selected moment.

### **Hypothesis**

It was hypothesized that there may not be significant relationship between the selected kinematic variables with the performance of Basketballers in Jump shot.

### **Definition and Explanation of Terms**

#### **Kinematics**

1. A branch of physics concerns with the description of the motion of objects without considering the forces that causes or result from the motions. It is a study of motion that aims to provide a description of the spatial position of points in moving bodies<sup>5</sup>.
2. For the purpose of this study Kinematical variables were represented by the selected angles of the various joints of human body.

#### **Analysis of Data**

The data was analyzed by use of Pearson's Product Moment Correlation. The level of significance chosen to test the hypothesis was .05.

#### **Findings**

The score of each independent variable of angular and linear kinematic variables were correlated with the performance of subjects in jump shot. The relationship of selected angular

---

<sup>5</sup> Encyclopedia Britannica 15<sup>th</sup> ed. "S.V. Kinematics"

biomechanical variables at the moment take off with the performance in jump shot as presented in table-1.

**Table – 1, relationship of selected angular kinematical variables at moment take off with the performance of subjects in jump shot, (N = 10)**

S.No.	<i>Variables</i>	Coefficient of Correlation “r”
1.	Ankle Joint (Left)	-0.152
2.	Ankle Joint (Right)	-0.175
3.	Knee Joint (Left)	0.025
4.	Knee Joint (Right)	0.063
5.	Hip Joint (Left)	0.337
6.	Hip Joint (Right)	0.337
7.	Shoulder Joint (Left)	0.025
8.	Shoulder Joint (Right)	0.040
9.	Elbow Joint (Left)	0.337
10.	Elbow Joint (Right)	-0.063
11.	Wrist Joint (Left)	0.00
12.	Wrist Joint (Right)	-0.088

As shown in Table-3 that the values of coefficient of correlation incase of all the selected kinematic variables were found insignificant at the selected level of significance of 0.05. Since the required value of coefficient of correlation for 8 degree of freedom is 0.632 and the obtained values of coefficient of correlation of selected variables less than the required value.

### **Discussion of Findings**

In case of Ankle Joint (Right and Left) , Knee Joint (Right and Left), Shoulder Joint (Right and Left), Elbow Joint (Right and Left) and Wrist (Right and Left), and Hip Joint (Left and Right) showed insignificant relationships with the performance of subjects in jump shot.

This trend does not mean that the angle of different joints at moment take off do not play any important role while executing or performing jump shot. Since the researcher has calculated the relationship individually.

On the whole it may be ascertained that low value of coefficient of correlation shown by selected variables does not mean that these variables are not contributing to the performance of subjects in jump shot.

#### Discussion of Hypothesis

As shown by the results of the study that none of the selected kinematic variables have shown insignificant relationship with the performance of subjects in jump shot hence the hypothesis as stated earlier that there may not be significant relationship between the selected kinematic variables with the performance of basketballers in jump shot is accepted.

#### References

1. H. Becker, "Relationship of Sports and Peace" International Journal of Physical Education 2nd Issue 25 (1988): 27.
2. Warren R. Johnson et. al., Science and Medicine of Exercise and Sports (New York: Harper and Row Publishers, 1974), P.94.
3. Laurence E. Morehouse and Augusts T. Miller, Physiology of Exercise (Saint Louis: The C.V. Mosby Company, 1976), p.225.
4. Robert N. Singer et. al., Physical Education an Interdisciplinary Approach (New York: The Mc Milan Company, 1972), p.16.
5. L. Matveyer, Fundamentals of Sports Training (Moscow: Progress Publishers, 1981), P.22.
6. Johanne Reh, Introduction into Sports Biology. (Leipzig: German College for Physical Mm, 1972), p. 161.
7. Lucien Brouha, Norman Co. Fradd and Beatrice M. Savage, "Studies in Physical Efficiency of College Students" Research Quarterly 15:3 (Oct. 1944),p.211.
8. David H. Clarke and Harrison Clarke, Research Process in Physical Education 2<sup>nd</sup> ed. (Inglewood Cliffs, N. J.: Prentice Hall Inc., 1984), p.219.
9. Lin ZP, Chen YH, Fan C, Wu HJ, Lan LW, Lin JG. Am Effects of auricular acupuncture on heart rate, oxygen consumption and blood lactic acid for elite netball athletes. Journal of Chin Med. 2011;39(6):1131-8.
10. Otsuka Y, Shima N, Moritani T, Okuda K, Yabe K. Orthostatic influence on heart rate and blood pressure variability in trained persons with tetraplegia. European Journal of Applied Physiology. 2008 Sep;104(1):75-8. Epub 2008 Jun 10.
11. Goosey-Tolfrey V, Foden E, Perret C, Degens H. Effects of inspiratory muscle training on respiratory function and repetitive sprint performance in wheelchair Cricket Openers. British Journal of Sports Medicine 2011 Jul;44(9):665-8. Epub 2008 Jul 4.

## A COMPARATIVE STUDY OF SOCIAL ADJUSTMENT OF MALE AND FEMALE SPORTSPERSON

**Dr. Ravinder Singh**

Department of Physical Education, CDLU, Sirsa

### **Abstract**

The purpose of the present study was to compare the Social Adjustment between male sportsperson and female sportsperson of University College Kurukshetra, Kurukshetra. For the present study total 50 male and female players (25 each) from University College Kurukshetra were selected randomly as a subject and the age ranging between 16 to 24 years. For the present study the independent variable (male and female sportsperson) and dependent variable (Social Adjustment) were selected as a variable. To measure the Social Adjustment, the Social Adjustment Questionnaire was used which was made by Charles C. Cowell. To know the significant difference between male and female sportsperson, descriptive statistics and independent t-test was used for the analysis of data with the help of SPSS (version 16.0) software and the level of significance was set at 0.05. The calculated data mean score of the male sportsperson is 3.33 and SD is 1.70 and mean score of female sportsperson is 1.42 and SD is 2.73 respectively and calculated 't' value is 7.336 which is greater than tabulated 't' value (2.01), it reveals that male sportsperson mean score is higher than the female sportsperson and it is also reveals that there is significant difference in Social Adjustment of male sportsperson and female sportsperson, because the calculated value is greater than the table value and it is significant at 0.05 level. The results indicate that there is significance difference of Social Adjustment between male and female sportsperson of University College kurukshetra , Kurukshetra.

**Keywords:** Male sportsperson, Female sportsperson and Social Adjustment.

### **INTRODUCTION**

In our society, a big need for every person is the stability in life process. It is an important variable of a person that influences the human relationship. Social adjustment is a state of person when he can meet the various social situations in which he finds himself without deviating from the basic standard of conduct. Change is a ceaseless procedure by which a man fluctuates his conduct to deliver a more agreeable connection amongst himself and his condition (Gates). Alteration endeavors to fulfill require by beating both inward and external block and by embracing conditions. The idea of change was first given by Darwin, who utilized it as 'adjustment' to make due in the physical world. The term change is regularly utilized as an equivalent word for convenience and adjustment. Entirely, the term signifies the aftereffects of balance, which might be influence by both of these procedures (Monroe, 1990). Entirely, the term means the consequences of harmony, which might be influence by both of these procedures (Monroe, 1990). Shafer (1961) underscored that modification is the procedure by which a living being keeps up a harmony between its needs and the conditions that impact the fulfillment of these requirements. Kulshrestha (1979) clarified that the modification procedure is a manner by which the individual endeavors to manage pressure, strains, clashes and so forth. and address his

or her issues. Great (1959) states that alteration is the way toward finding and receiving methods of conduct reasonable to nature or the adjustments in the earth.

**Selection of Subjects:** For the present study total 50 male and female sportsperson from University College kurukshetra , Kurukshetra were selected randomly as a subject and the age ranging between 18 to 24 years. In this study Social Adjustment Questionnaire (Charles C. Cowell) was used to measure Social Adjustment level of an individual.

**Statistical Analysis:** To compare the Social Adjustment (behaviour) level between male and female sportsperson, ‘t’ test was applied. The level of significance was set at 0.05.

### **MATERIAL AND METHODS**

Social Adjustment Questionnaire is developed and standardized by Charles C. Cowell. The test consisted of 20 items (10 positives and 10 negatives questions) and it measures the social behaviour (good and poor adjustments). Ten of the pairs of positive and negative behaviour trends were retained as common denominators underlying good and poor adjustment. These positive and negative scales (forms A and B, respectively) appear in Social Adjustment Questionnaire. Questionnaires distributed to participants and instruct to fill the questions according to their own choice. Thus, a socially well-adjusted pupil would get a high positive score; a socially maladjusted pupil would receive a high negative score. Each question contain four alternatives choice to be marked by student viz. markedly, somewhat, only slightly and not at all and the point allotted was +3, +2, +1 and +0 for form A and -3,-2,-1 and 0 for form B respectively. The total index score is the sum of the points for the 10 items in form A minus the sum of the points for the 10 items in form B.

### **RESULTS AND DISCUSSION**

The scores were obtained by using the key as suggested by Charles C. Cowell. All the individual Social Adjustment score was used to judge the level of social adjustment (behaviour).

#### **Criterion Measures**

Sr. No.	Variables	Questionnaire	Measuring Unit
1	Social Adjustment (Behaviour)	Social Adjustment Questionnaire by Charles C. Cowell	In Count



**Table – I, Comparative and descriptive table of male and female sportsperson in relation to social adjustment (behaviour) level.**

Groups	N	Mean	SD	MD	t- ratio
Male Sportsperson	25	3.33	1.70	4.76	7.33
Female Sportsperson	25	1.42	2.73		

*\*Significant at 0.05 level*

Table-1 shows that the calculated t-value 7.33 on social adjustment (behaviour) observed “t” values are compared with the critical value 2.01, 48 degree of freedom. It was cleared that the value 7.33 was found as higher than the table value 2.01. This confirms that significant difference exists between the means of male and female sportsperson in relation to social adjustment (behaviour) level.

### CONCLUSION

On the basis of result following conclusions have been made:

1. Significant difference was found between the male and female sportsperson of University College Kurukshetra, in relation to social adjustment. 2. The male sportsperson were having more positive social adjustment (behaviour level) than the female sportsperson.

### References

1. **Singh, M. & Singh, D.** “A study of adjustment of male and female volleyball players”. Scientific Culture in Physical Education & Sports. Twenty first Century Publications, Patiala, (2016) : 1040-1042.
2. **Barman, P. & Mridha, S.** “A comparative study on psychosocial adjustment of the students of different category schools”. Asian Journal of Physical Education and Computer Science in Sports. 10 : 1 (2014): 75-77.
3. **Kulshrestha, S. P.** Educational Psychology. Meerut. India. Loyal Book Depot, 1979.
4. **Monroe, P.** International encyclopaedia of education. New Delhi. Cosmos Publications, 1990.
5. **J. R., Nelson J. K., & Silverman, S. J.** "Research Methods in Physical Activity". USA (6th Ed.), 2005.
6. **Verma, J. P. & Ghufuran, M.** Statistics for Psychology. Tata McGraw Hill Education Private Limited, New Delhi, 2012.
7. **Good, C. V. (1959).** Dictionary of education. New York. Mc Graw. Hill Book Company, 1959, P.6.
8. **Monroe, P.** International encyclopaedia of education. New Delhi. Cosmos Publications, 1990.
9. **Mangal, S. K. (2007).** Essential of Educational Psychology.
10. **Dubow, Eric F.;** and Capps Constance L. (1988) :Peer social status and reports of children's adjustment by their teacher, by their peers and by their self-rating. Journal of Social Psychology, Vol 26(1), 63-75.
11. **Erickson, Erick. H. (1963):**Childhood and Society, (2nd Ed) New York : Norton.

## **EFFECT OF IDEOKINETIC IMAGERY TRAINING ON BODY POSTURE**

**Dr. Rakesh Kumar**

Asstt. Prof. in Physical Education, NCPE, Noida

**Dr. Sunil Dabas**

**Padma shri & Dronacharya Awardee**

H.O.D in Physical Education, D. Govt. P.G. College, Gurgaon.

### **Abstract**

The purpose of the study was to find out the effect of Ideokinetic Imagery training on body posture. Thirty boys belonging to the age group of 14-17 years were selected randomly from Government School, Narela, Delhi to act as subjects for the study. The New York state posture-rating test was used to analyze the posture of the subjects. The t-ratio was used to find out the difference between pre test and post test of both the experimental and control group. On the basis of the results following conclusions were drawn:

- Ideokinetic imagery training is very much effective for the improvement of the body posture especially in younger children.
- Six weeks Ideokinetic imagery training was sufficient enough to make marked improvements in the body postural profiles of the school children.

### **INTRODUCTION**

If a person has a high degree of body intelligence, it usually means that he or she is very skilled at some physical activity. A person with a lot of body intelligence might be an Olympic swimmer, a marathon runner, or a well known dancer. Many might assume that these trained individuals have a good deal of control over their bodies, and that they have intentionally learned to perform the desired action. All of us have some level of body intelligence, but some naturally, have more than others. An alternative interpretation of body intelligence eliminates the role of intent and even consciousness in body movement. Why is it so? Our shoulder muscles get tight when we are under a great deal of stress. Why do we inadvertently hold our breath during a scary scene in a movie? The body naturally responds to specific situations in specific ways, without requiring consciousness of these responses. These unconscious movements are indications that the human body can respond tactically to the condition of its environment. As infants, we learn specific movement patterns that become more efficient and ingrained with practice. As we get older, however we learn new neuromuscular habits that often subtly combine to impact negatively the efficiency of our bodies. The kind of clothes we wear, the furniture we

use, our daily stress and emotions, our preoccupation with our looks, and images in the media all contribute to a habitual body alignment which is tiring, inefficient and ultimately injury prone. A number of kinesiologists, or movement scientists have developed different approaches to kinesthetic re-education. The goal of these approaches is better postural alignment and more efficiency in movement. Dancers and athletes require efficient body movement in order to increase their skill level and prevent injury. Others may simply want to learn how to live a more relaxed, stress-free and well-aligned life. Ideokinesis is one powerful approach to kinesthetic education and reeducation. As a concept, ideokinesis may seem fanciful. Actually, the underlying mechanism of the phenomenon is based on well-defined neurological principles. Movement, however, is not an either / or phenomenon. Movement in daily life is, “integrated activity of the entire nervous system –the voluntary and the involuntary modulated by innate and condition reflex activity and feedback mechanism”. In other words, learned movement, although at first highly voluntary, can become mechanized and autonomous through repeated practice. Some movements, like walking, become so habitual and automatic that the mover infact does not need any conscious effort to maintain balance. At this stage, the nervous system has developed what sweigard refers to as subcortical patterning, or the co-ordination of muscle action on an unconscious level. Take for example, a gymnast walking on a narrow beam. With information from the proprioceptor, the subcortical systems strive to automatically maintain balance. It would be very difficult for the gymnast to achieve balance if he constantly had to think about how to move his body to stay upright. The subcortical system provides immediate, involuntary response to the immediate situation.

Ideokinesis and Body Posture described by some of the authors are as follows: -

- Ideokinesis: The idea of movement occurring with one’s body in a specific place and direction, but not being voluntarily performed.
- Kyphosis: The term “kyphosis” (KI-Fo-Sis) is usually applied to the curve that results in an exaggerated “round – back”.
- Kinesthetic: The sensation felt in muscle when it is contracting, awareness of movement of activity in muscles or joints; sense of position or movement mediated in large part the posteriors columns and medial lemniscuses.

- Visualization: Visualization as in any technique for creating images, diagrams or animations to communicate any message.
- Relaxation: A method of solving simultaneous equation by guessing a solution and then reducing the errors that results by successive approximations. Until all the errors are less then some specified amount concentric contraction. It is the contraction of muscle occurs when the tension generated by the muscle is sufficient to over come a resistance and to move the body segment one attachment toward the segment of its other attachment.
- Eccentric contraction: A muscle is in eccentric contraction when slowly lengthens as it gives into external force that is better than the contractile for existing on it.

### **METHOD**

Thirty boys belonging to the age group of 14-17 years were selected randomly from Government School Narela, Delhi to act as subjects for the study. The New York state posture rating test was used to analyze the posture of the subjects. The New York state posture rating test provides for posture analysis based on a five point rating scale for thirteen body areas of the body. The subjects were further divided into two groups by equating them with equal body posture scores on the basis of initial postural analysis test. Group one acted as experimental group and group two acted as a control group. In addition to their daily routine work, the experimental group was trained with imagery exercises for six weeks. The control group carried out their daily normal routine work only. After six weeks both groups were tested on their body postural profiles using New York Posture rating test.

### **ANALYSIS OF DATA AND RESULTS OF THE STUDY**

The t-ratio was used to find out the difference between pre test and post test of both the experimental and control group and are presented in Table-1

**Table 1, significance of difference between pre- test and post test scores on New York posture rating test of experimental group**

Test	Mean	SD	df	t-value	Probability (p)
Pre test	42.6	4.85	14	11.225	0.00
Post test	47.4	4.91			

The obtained t – value (11.225) on comparing pre test and post test of experimental group showed significant difference ( $P < 0.05$ ).

Comparison of mean scores of pre test and post test on New York posture rating test of experimental group has been illustrated in Figure 1.

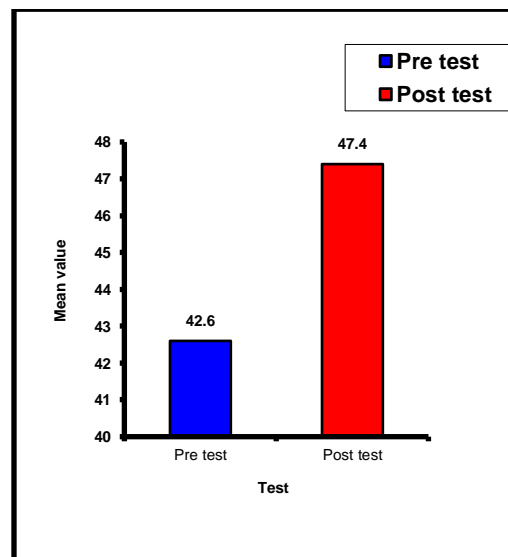

**Figure-1, comparison of mean scores of pre -test and post- test on New York posture rating test of experimental group**

Significance of difference between pre test and post test scores on New York Posture rating test of control group has been presented in Table 2.

**Table 2, significance of difference between pre- test and post test scores on New York posture rating test of control group**

Test	Mean	SD	Df	t-value	Probablity (p)
Pre test	44.07	4.13	14	0.367	0.719
Post test	43.93	4.06			

The obtained t – value (0.367) on comparing pre test and post test of control group showed no significant difference ( $P > 0.05$ ). Comparison of mean scores of pre - test and post -test on New York posture rating test of control group has been illustrated in Figure 2.

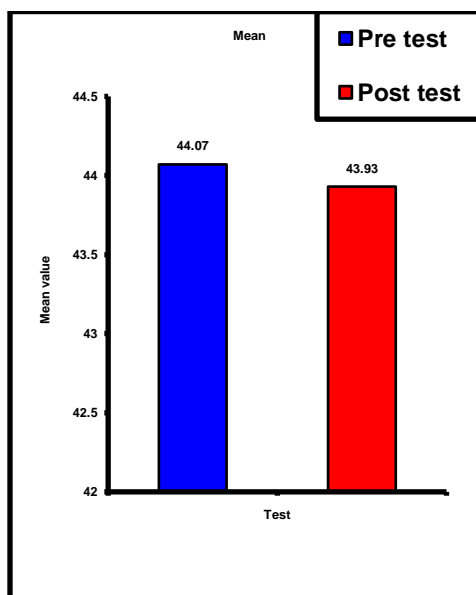

**Figure 2, comparison of mean scores of pre- test and post- test on New York posture rating test of control group**

## **CONCLUSIONS**

Within the limitations of the study following conclusions may be drawn: -

1. Ideokinetic imagery training is very much effective for the improvement of the body posture especially in younger children.
2. Six weeks Ideokinetic imagery training was sufficient enough to make marked improvements in the body postural profiles of the school children.

## **References**

### **Books**

1. Clarke, H. Harrison and Clarke, H. David. Application of Measurement to Physical Education. Vth edition USA: Prentice Hall Inc. (1987)
2. Gabbard, Carl et al. Physical Education for Children IInd edition USA: Prentice Hall Inc. (1999).
3. Jonson, Barry, L. and Nelson, Jack K. Practical Measurements for Evaluation in Physical Education IIIrd edition. Delhi Surjeet Publication. (1982).
4. Kerigh Baum, Elen and Barthels, Katharine M. Bio Mechanics IV edition U.S.A (1996).
5. Klein, A. and Thomas, L. C. Posture and Physical Fitness Children's Bureau Publications (Washington D.C. Govt. Printing Office): 205
6. Ryan, Allen J. et al. Sports Medicine 2<sup>nd</sup> edition U.S.A: Academic Press. (1989).
7. Wells, Katherina F. and Luttgens, Kathyryn, Kinesiology Scientific Basic of Human Motion. 6<sup>th</sup> edition WB Saunders Company. Philadelphia: (1976).

### **Journals and Periodicals**

1. Anderson, Gerald Lee. "Significance of Laterality in cervical variance." Completed Research in Health, Physical Education and Recreation 7 (1965): 42.
2. Barr, Kathryn and Hall Craig (1999). "The use of imagery by rower". Journal of Sports and Exercise Psychology: 95.
3. Corlee B. Munson. "An Evaluation of posture screening Techniques for children". Completed Research in Health, Physical Education and Recreation. 9: (1967). 64-67.
4. Douglas P. Jowdy and Harris V. Dorothy. "Muscular response during mental imagery as a function of motor skill level". Journal of Sports Exercise Psychology. 12: (1990). 191-201.
5. Geraldine H. Vangyn, Wenger A. Howard and Gaul A. Catherine. "Imagery as a method of enhancing transfer from training to performance". Journal of Sports Exercise Psychology. 12: (1990). 366-375.
6. Kathleen A. Martin and Hall R. Craig "Using mental imagery to enhance intrinsic motivation". Journal of Sports Exercise Psychology. (1995). 54.

## COMPARISON OF PHYSICAL FITNESS VARIABLES BETWEEN INDIVIDUAL GAMES AND TEAM GAMES PLAYERS

**Subhash Rewatkar\***

Research Scholar, North Maharashtra University, Jalgaon

### Abstract

The purpose of this investigation was to compare the physical fitness variables between individual games and team games players. For the aim of the investigation, fifty subjects (twenty five team games and twenty five individual games) were selected randomly from team and individual games players. The age level of the subjects ranged from 18 to 25 years. For the aim of the investigation fitness variables were considered for this study as muscular strength, agility, explosive strength, speed and cardio-vascular endurance. It was measured by using the standard test items of pull-ups, shuttle run, standing broad jump, 50m dash and 600 yard run and walk. The data thus collected were put to statistical treatment computing independent t test to find out the differences, if any between the team and individual games players. Further the level of significance was set at 0.05. Results: There was significant difference of muscular strength and explosive strength between team and individual games players. There was insignificant difference of agility, speed and cardio-vascular endurance between team and individual games players. The basic fitness levels of individual games players were better than the team games players.

**Keywords:** physical fitness, individual, team games athletes.

### INTRODUCTION

Physical fitness is used as one of the modes through which the aim of physical education is achieved (a complete wholesome individual). A man's life is full of physical and mental stresses which can be relieved only if he is physically fit. Thus, physical fitness is a matter of concern for optimum development of an individual; it brings up the optimum health and also helps the society to create a healthy environment to grow to the maximum. It is the pride of the nation; a healthy and fit society also fulfils the W.H.O. objective: "live most and serve best". By means of physical fitness programmer performance of games and sports is also improved. Every country is struggling hard for the apex position in games and sports. To achieve this top position every effort is done. The scientific and systematic ways of training are followed to improve the standards of physical fitness, so that the best result should be achieved Apart from this, a healthy living also makes a person a good citizen. One has rightly said "Physical fitness is



one's richest possession; it cannot be purchased but it has to be earned through daily routine of physical exercises".[1]

It is the capacity of an individual to do work effectively with joy and pleasure. After the work is over, he still has sufficient capacity to do more work without any exertion. Moreover, his recovery is faster and quicker. There are different views regarding physical fitness. Some say it is related to task or work. Some consider it as good-looking physique. Many consider it as proper functioning of physiological systems. But, it is a term with a wider meaning. It is more than the possession of strength, speed and endurance. The person who remains energetic, enthusiastic and cheerful in doing his work is said to be physically fit. The level of physical fitness varies from person to person. It depends upon the nature of work, size, shape, structure, age, sex and adaptability of an individual. Different games require different levels of physical fitness depending upon the type of activity, event, game and sports. Physical fitness requires efficient motor mechanism (movement of body), efficient organic mechanism (physiological functioning) and efficient mental functioning (psychological set-up). A fit individual possesses all these.[2]

### **METHOD**

**Selection of Subjects:** For the aim of the investigation, fifty subjects (twenty five team games and twenty five individual games) were selected randomly from team and individual games players. The age level of the subjects ranged from 18 to 25 years.

#### **Selection of Games and Players**

<b>Games Type</b>	<b>Games</b>	<b>Players</b>	<b>Total Players</b>
<b>Team Games</b>	Basketball	7	25
	Handball	8	
	Korfball	10	
<b>Individual Games</b>	Wrestling	5	25
	Taekwondo	8	
	Judo	12	
<b>Total</b>	<b>6</b>	<b>50</b>	<b>50</b>

**Criterion Measures:** For the aim of the investigation fitness variables were considered for this study as muscular strength, agility, explosive strength, speed and cardio-vascular endurance. It

was measured by using the standard test items of pull-ups, shuttle run, standing broad jump, 50m dash and 600 yard run and walk.

**Analysis of the Data:** The data thus collected were put to statistical treatment computing independent t test to find out the differences, if any between the team and individual games players. Further the level of significance was set at 0.05.

**Table-1:** comparison between team and individual games players in muscular strength

Group	N	Mean	SD	SE	MD	Ot	df	Tt
Team Games	25	10.60	1.68	0.47	1.00	2.15*	48	2.01
Individual Games	25	11.60	1.61					

Table No.1 reveals that there is difference between means of team and individual games because mean of team games players is 10.60 which is less than the mean of individual games players which is 11.60 and calculated value of ‘t’ is found as 2.15, is greater than tabulated ‘t’ which is 2.01 at 0.05 level of significance. This shows individual games players are having more muscular strength than team games players.

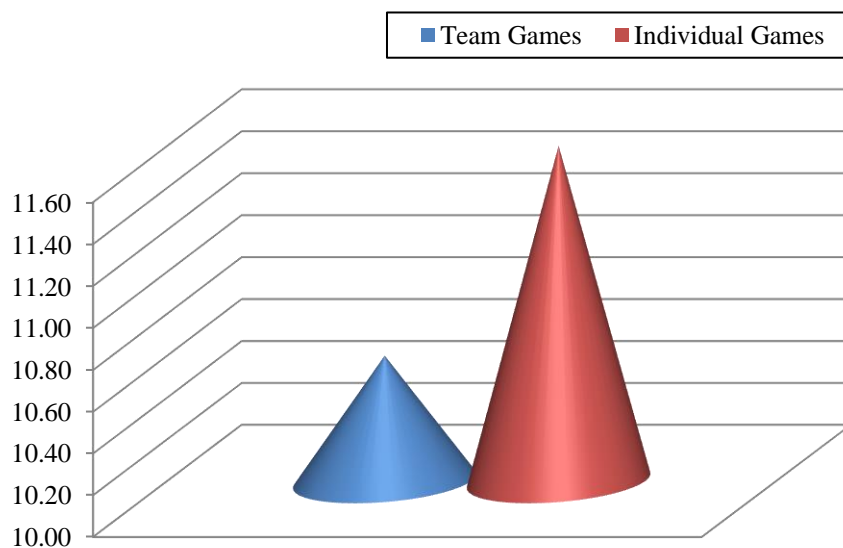

**Graph-1:** Mean of muscular strength between team and individual games players

**Table-2:** comparison between team and individual games players in explosive strength

Group	N	Mean	SD	SE	MD	Ot	df	Tt
Team Games	25	224.72	25.90	6.63	13.92	2.10*	48	2.01
Individual Games	25	210.80	20.71					

Table No.2 reveals that there is difference between means of team and individual games because mean of team games players is 224.72 which is greater than the mean of individual games players which is 210.80 and calculated value of ‘t’ is found as 2.10, is greater than tabulated ‘t’ which is 2.01 at 0.05 level of significance. This shows team games players are having more explosive strength than individual games players.

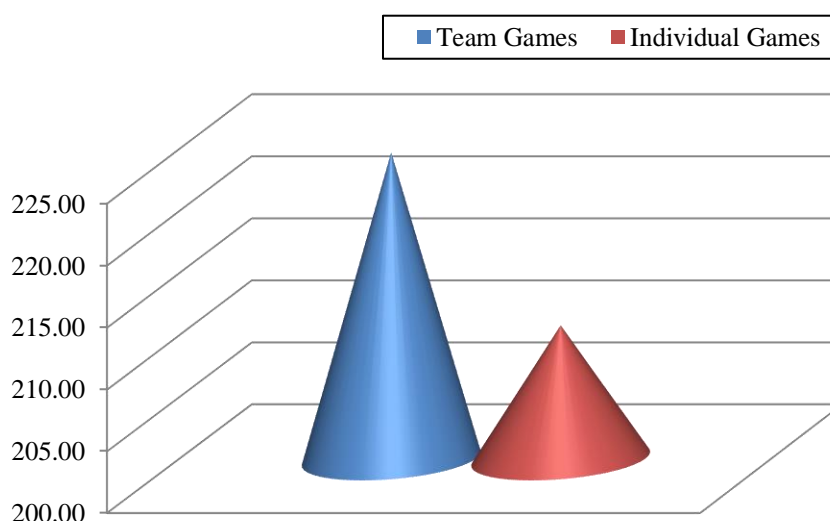

**Graph-2:** Mean of explosive strength between team and individual games players

**Table-3:** comparison between team and individual games players in agility

Group	N	Mean	SD	SE	MD	Ot	df	Tt
Team Games	25	11.39	1.09	0.37	0.26	0.70	48	2.01
Individual Games	25	11.13	1.47					

Table No.3 reveals that there is difference between means of team and individual games because mean of team games players is 11.39 which is greater than the mean of individual games players which is 11.13 and calculated value of ‘t’ is found as 0.70, is lesser than tabulated

‘t’ which is 2.01 at 0.05 level of significance. These shows in individual games players are having more agility than team games players.

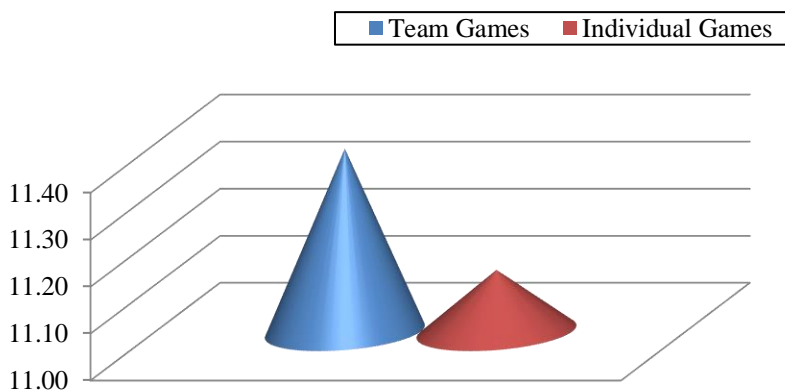

**Graph-3:** Mean of agility between team and individual games players

**Table-4:** comparison between team and individual games players in speed

Group	N	Mean	SD	SE	MD	Ot	df	Tt
Team Games	25	8.70	0.59	0.17	0.28	1.67	48	2.01
Individual Games	25	8.42	0.60					

Table No.4 reveals that there is difference between means of team and individual games because mean of team games players is 8.70 which is greater than the mean of individual games players which is 8.42 and calculated value of ‘t’ is found as 1.67, is lesser than tabulated ‘t’ which is 2.01 at 0.05 level of significance. These shows in individual games players are having more speed than team games players.

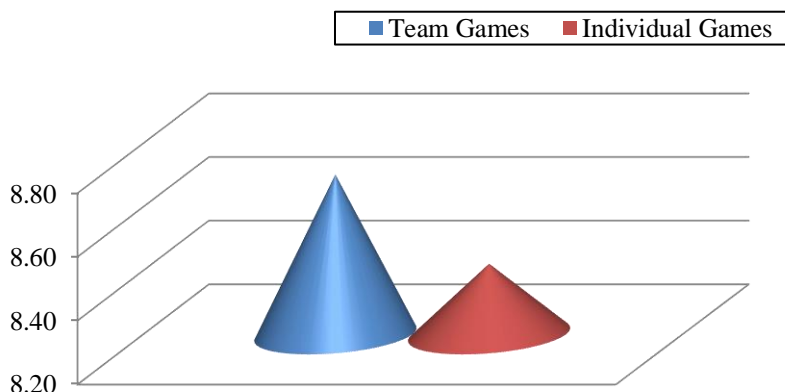

**Graph-4:** Mean of speed between team and individual games players

**Table-5:** comparison between team and individual games players in cardio-vascular endurance

Group	N	Mean	SD	SE	MD	Ot	df	Tt
Team Games	25	2.70	0.41	0.12	0.13	1.11	48	2.01
Individual Games	25	2.83	0.43					

Table No.5 reveals that there is difference between means of team and individual games because mean of team games players is 2.70 which is lesser than the mean of individual games players which is 2.83 and calculated value of ‘t’ is found as 1.11, is lesser than tabulated ‘t’ which is 2.01 at 0.05 level of significance. These shows in team games players are having more cardio vascular endurance than individual games players.

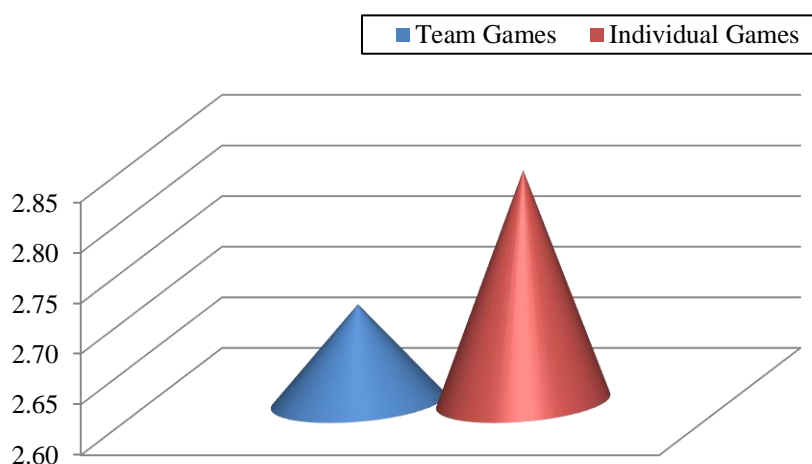

**Graph-5:** Mean of cardio vascular endurance between team and individual games players

### CONCLUSION

From the analysis of the data the following conclusions are drawn

1. There was significant difference of muscular strength between team and individual games players.
2. There was significant difference of explosive strength between team and individual games players.
3. There was insignificant difference of agility between team and individual games players.
4. There was insignificant difference of speed between team and individual games players.

5. There was insignificant difference of cardio-vascular endurance between team and individual games players.
6. The basic fitness levels of individual games players were better than the team games players.

### **References**

1. Corbin, Charles B. & Lindsey, Ruth. (2003). *Fitness for Life*, California: Human Kinetics Publishers, Inc., Fourth Edition, 3.
2. Kundra, Sanjay. (2009). *Physical Education*. New Delhi: Evergreen Publications, Third Edition, 4.
3. Vishaw, G., Singh, A. & Singh, S. (2011). Comparison of physical fitness variables between individual games and team games athletes. *Indian Journal of Science and Technology*, 4(5), 547-549. Available online at <http://www.indjst.org>
4. Singh, Ningombam A. (2014). Comparison of Selected Physical Fitness and Physiological Parameters of Footballers belonging to North-East and Other States. *International Journal of Interdisciplinary and Multidisciplinary Studies (IJIMS)*, 1(5), 158-160. Available online at <http://www.ijims.com>.
5. Kuroda, Y., Suzuki, N., Dei, A., Umebayashi, K., Takizawa, K., Mizuno, M. (2015). A comparison of the physical fitness, athletic performance, and competitive achievements of junior and senior tennis players, *Movement, Health & Exercise*, 4(1), 39-50.
6. Woldeyes, E. T., Deyou, M., Rani, S., (2014). Comparative study of health related physical fitness components of urban and rural female students of guder secondary and preparatory school, ethiopia, *International Journal of Physical and Social Sciences*, 4(2), 123. <http://www.ijmra.us>
7. Demirkan, E., Unver R., Kutlu M. & Koz M. (2012). The comparison of physical and Physiological characteristics of junior Elite wrestlers, *Nigde University Journal Of Physical Education and Sport Sciences*, 6(2), 138-144.
8. Zabihi, E. & Alavi S. H. (2015). The comparison of physical fitness in secondary male students in altitude and coastal areas, *Turkish Journal of Sport and Exercise*, 17(3), 10-15. <http://dergipark.ulakbim.gov.tr/tsed/index>.
9. Jourkesh, M., Sadri, I., Ojagi, A., & Sharanavard, A. (2011). Comparison of Physical fitness level among the students of IAU, Shabestar Branch, *Annals of Biological Research*, 2(2), 460-467. Available online at [www.scholarsresearchlibrary.com](http://www.scholarsresearchlibrary.com).
10. Sehgal, N. (2013). Comparison between Physical Fitness Variables and Adjustment of Handball, Volleyball and Hockey Female Players, *International Multidisciplinary Research Journal*, 3(8), 290-298.

## COMPARISON OF PHYSICAL FITNESS LEVELS AND SKILL ABILITY OF FIELD HOCKEY PLAYERS BETWEEN NATIONAL AND CLUB TEAMS

**Oinam Bhagat Singh**  
Research Scholar,  
Department of Physical  
Education and Sports Science,  
Manipur University, Imphal

**Dr. L. Thambal Singh**  
Asst. Professor,  
Department of Physical  
Education and Sports  
Science,  
Manipur University, Imphal

**Loitongbam Sitaljoy Singh**  
Master of Physical  
Education and Sports  
D.M College of Science,  
Imphal.

### Abstract

The objective of this study was to investigate the significant difference on physical fitness levels and skill abilities of male hockey players between National and Club team's players of Manipur. For this study 40 (N= 40) national and state clubs level male hockey players between 18 to 25 year of age were selected. 20 players represented Manipur state at National level competitions and another 20 players from different top clubs of Manipur were selected purposively. AAHPERD Physical Fitness and SAI Hockey Skill Tests were administered to obtain the data and to determine the significant difference t-test was employed and tested at 0.05 level of confidence. Significant differences were found in case of abdominal strength ( $t=2.91$ ) and speed ( $t=4.34$ ) and no significance was found in case of explosive strength ( $t=0.74$ ), agility ( $t=1.56$ ), strength ( $t=0.61$ ), strength endurance ( $t=0.47$ ) and flexibility ( $t=0.26$ ), which were compare with tabulated value of  $t=2.025$  at 0.05 level of confidence. No significance difference was found in case of skill abilities between the State and Club teams players.

**Key words:** Field Hockey, National, Club, AAHPER, SAI

### INTRODUCTION

Sports performance solely depends on the different fitness parameters like strength, endurance, speed, flexibility and coordinative abilities. Above the performance limited fitness parameters, skill abilities are the most important factors to give a peak performance by the players. Field hockey is a team game and considered among the extreme games, which possess various types of physical fitness parameters and skill abilities. This game requires the high qualities of speed, muscular strength, muscular endurance, cardio-respiratory endurance, flexibility, explosive strength, speed, agility, kinaesthetic ability, reaction time etc. In the training of hockey game, these factors emphasize to improve as well as to achieve the high skill performance too. Even though, it is predicted by the structure and nature of the games that there may be similarities or significant difference in terms physical fitness among these games.

### Objective of the Study

The objective of this study was to investigate the significant difference on physical fitness levels and skill abilities of male hockey players between National and Club team's players of Manipur.

### Hypothesis

H<sub>1</sub> – It was hypothesized that there might be significant difference of Physical fitness level between the National and Clubs players of Manipur.

H<sub>2</sub> – It was also hypothesized that there might be significant difference in Skill ability between the National and Clubs players of Manipur.

## METHOD

### 4.1 Selection of Subjects

For this study 40 (N= 40) national and state clubs level male hockey players between 18 to 25 year of age were selected. 20 players represented Manipur state at National level competitions and another 20 players from different top clubs of Manipur were selected purposively. The data pertaining to this study were collected by administering AAHPERD Physical Fitness test and SAI Hockey Skill Test. The mean (M) and standard deviation (SD) were calculated, and t- test statistical technique was applied to find out the significant difference of physical fitness and skill abilities between the National and Clubs hockey players, and tested at 0.05 level of confidence.

## RESULTS

The mean (M), standard deviation (SD) and t-test of Pull-ups of National and Club players are shown in table 1.

**Table – 1, shows Mean (M), Standard Deviation (SD) and t-test for Pull-ups**

Groups	M	SD	MD	SE	t-value
National	12.05	2.21	0.66	0.40	0.61
Club	11.65	1.93			

*Insignificant at 0.05 level, where,  $t_{0.05(38)}=2.025$ , and  $N=20+20=40$*

Table-1 reveals that the means (M) and standard deviations (SD) of pull-ups of National and Club players were  $12.05 \pm 2.21$  and  $11.65 \pm 1.93$  respectively, and the t- value was found to be 0.61. Therefore, no significant difference was found in case of pull-ups as the calculated  $t=0.61$  is lesser than tabulated  $t=2.025$ . The mean differences are graphically represented in figure 1.



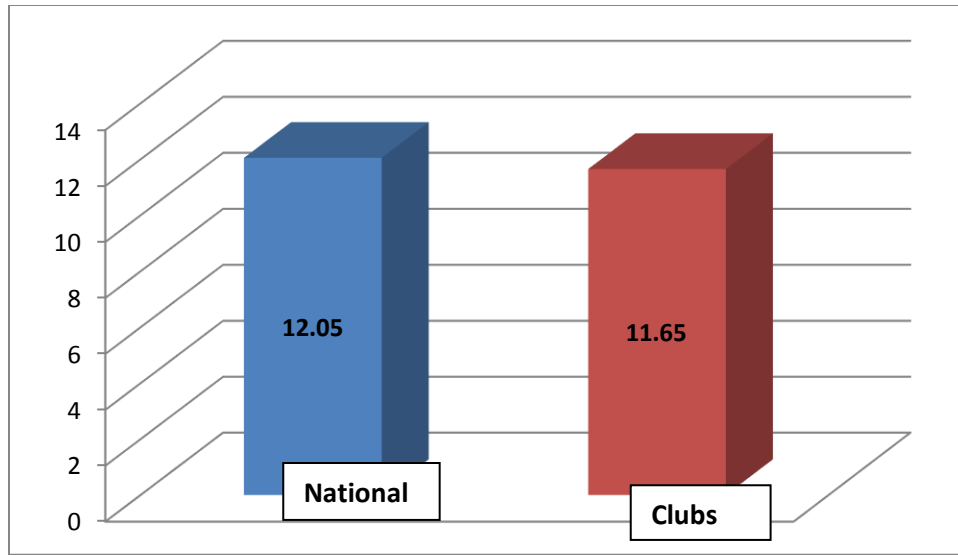

**Figure – 1, Mean Difference of Pull-ups test between National and Club Players**

The mean (M), standard deviation (SD) and t-test of bent knee sit ups for abdominal strength of National and Club players are shown in table 2.

**Table – 2, shows Mean (M), standard deviation (SD) and t-test of Bent Knee Sit-up**

Groups	M	SD	MD	SE	t-value
National	44.95	4.62	1.48	4.30	2.91*
Clubs	40.65	4.72			

*\*Significant at 0.05 level, where,  $t_{0.05(38)}=2.025$ , and  $N=20+20=40$*

Table-2 reveals that the means (M) and standard deviations (SD) of bent knee sit-up of National and Clubs players were  $44.95 \pm 4.62$  and  $40.65 \pm 4.72$  respectively, and the t- value was found to be 2.91. Therefore, significant difference was found between the National and Club players in case of bent knee sit-up as the calculated  $t=2.91$  is greater than tabulated  $t=2.025$ . The mean differences are graphically represented in figure 2.

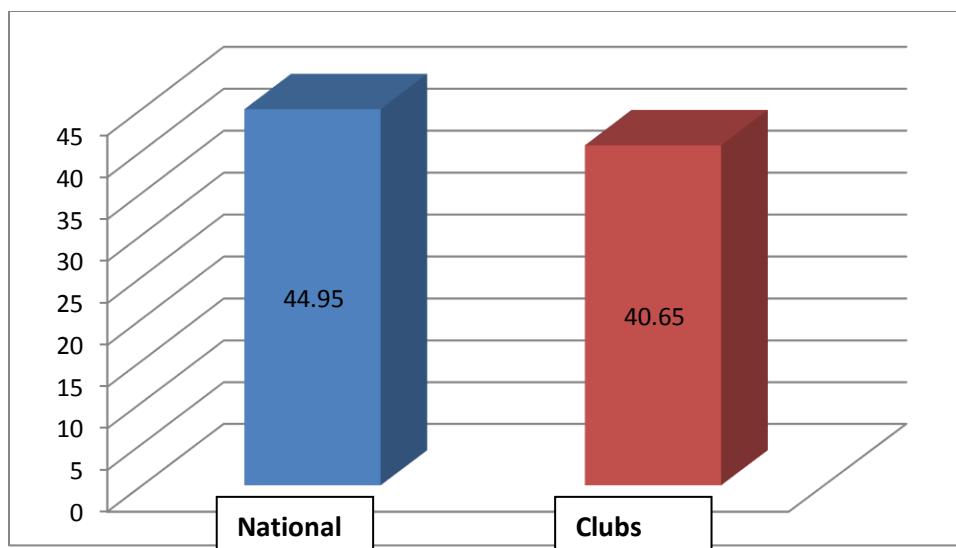

Figure – 2, shows Mean Difference of bent knee sit-ups test between National and Club players

The mean (M), standard deviation (SD) and t-test of standing broad jump for explosive strength of National and Club players are shown in table 3.

Table – 3, shows Mean (M), Standard Deviation (SD) and t-test for Standing Broad Jump

Groups	M	SD	MD	SE	t-value
National	8.02	0.64	0.19	0.14	0.74
Clubs	8.16	0.55			

Insignificant at 0.05 level, where,  $t_{0.05(38)}=2.025$ , and  $N=20+20=40$

Table-3 reveals that the means (M) and standard deviations (SD) of standing broad jump of National and Club players were  $8.02\pm 0.64$  and  $8.16\pm 0.55$  respectively, and the t- value was found to be 0.74. Therefore, no significant difference was found between the National and Club players in case of standing broad jump as the calculated  $t=0.74$  is lesser than tabulated  $t=2.025$ . The mean differences are graphically represented in figure 3.

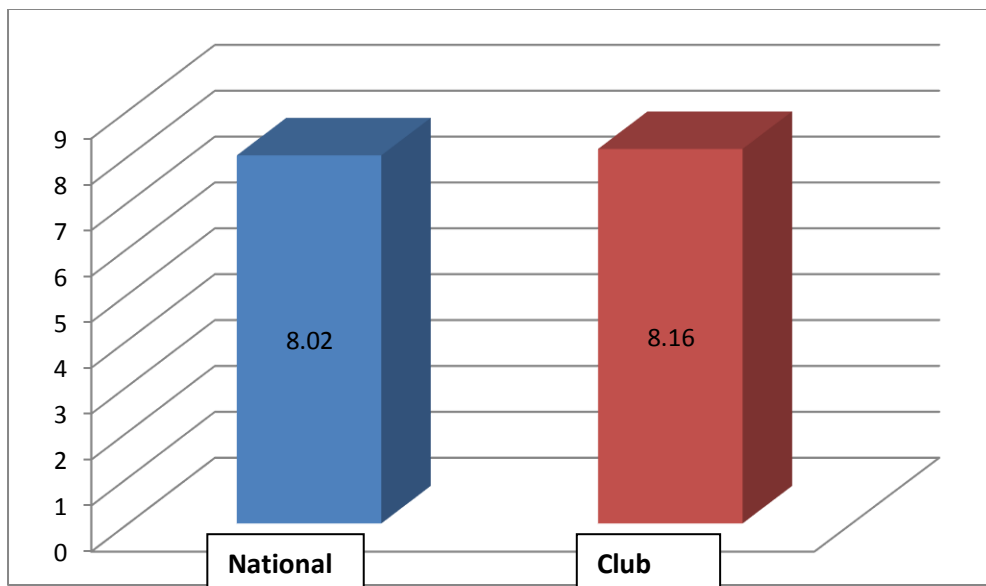

**Figure – 3, shows Mean Difference of standing broad jump National and Club Players**

The mean (M), standard deviation (SD) and t-test of sit and reach for flexibility of National and Club players are shown in table 4.

**Table – 4, shows Mean (M), Standard Deviation (SD) and t-test for Sit and Reach**

Groups	M	SD	MD	SE	t-value
National	60.75	2.63	0.78	0.20	0.26
Clubs	60.55	2.31			

*Insignificant at 0.05 level, where,  $t_{0.05(38)}=2.025$ , and  $N=20+20=40$*

Table-4 reveals that the means (M) and standard deviations (SD) of sit and reach test of National and Club players were  $60.75 \pm 2.63$  and  $60.55 \pm 2.31$  respectively, and the t- value was found to be 0.26. Therefore, no significant difference was found between the National and Club players in case of sit and reach test as the calculated  $t=0.26$  is lesser than tabulated  $t=2.025$ . The mean differences are graphically represented in figure 4.

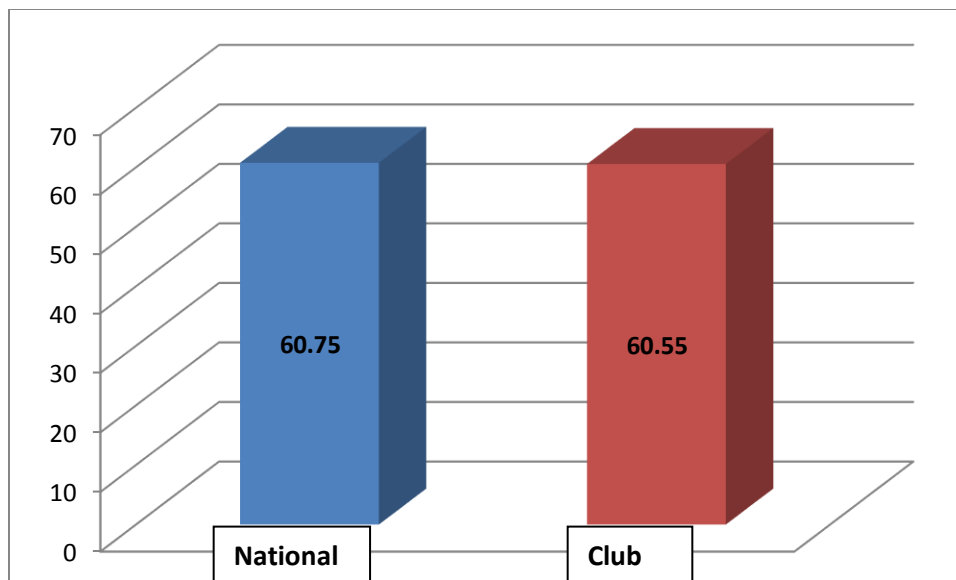

**Figure – 4, shows Mean Difference of sit and reach test National and Club Players.**

The mean (M), standard deviation (SD) and t-test of shuttle run for agility of National and Club players are shown in table 5.

**Table – 5, shows Mean (M), Standard Deviation (SD) and t-test for Shuttle Run**

Groups	M	SD	MD	SE	t-value
National	12.98	3.12	0.71	1.11	1.56
Clubs	14.09	0.68			

*Insignificant at 0.05 level, where,  $t_{0.05(38)}=2.025$ , and  $N=20+20=40$*

Table-5 reveals that the means (M) and standard deviations (SD) of shuttle run of National and Club players were  $12.98 \pm 3.12$  and  $14.09 \pm 0.68$  respectively, and the t- value was found to be 1.56. Therefore, no significant difference was found between the National and Club players in case of shuttle run as the calculated  $t=1.56$  is lesser than tabulated  $t=2.025$ . The mean differences are graphically represented in figure 5.

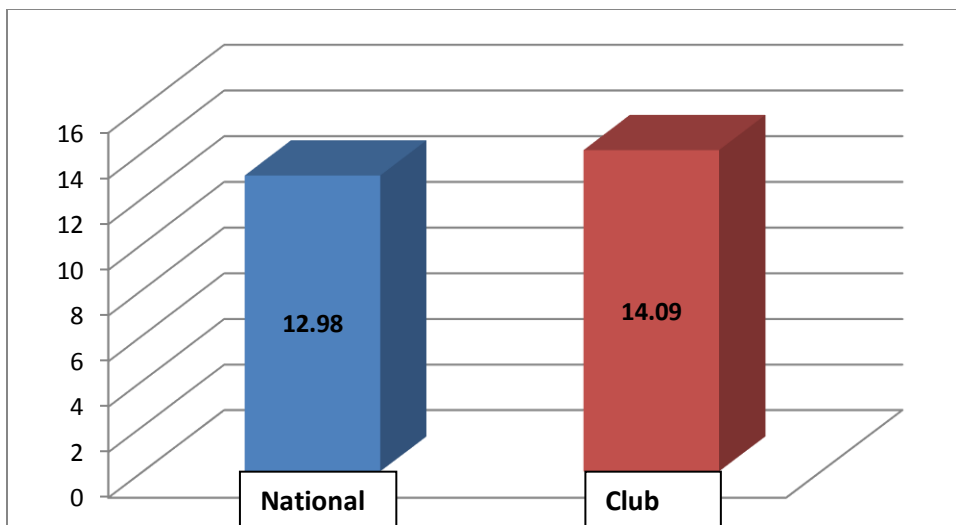

**Figure – 5, shows Mean Difference of shuttle run test National and Club Players**

The mean (M), standard deviation (SD) and t-test of 50 yard run of National and Club players are shown in table 6.

**Table – 6, shows Mean (M), Standard Deviation (SD) and t-test for 50 yard run**

Groups	M	SD	MD	SE	t-value
National	6.17	0.34	0.11	0.47	4.34*
Club	5.70	0.35			

*\*Significant at 0.05 level, where,  $t_{0.05(38)}=2.025$ , and  $N=20+20=40$*

Table-5 reveals that the means (M) and standard deviations (SD) of 50 yard run of National and Club players were  $6.17 \pm 0.34$  and  $5.70 \pm 0.35$  respectively, and the t- value was found to be 4.34. Therefore, significant difference was found between the National and Club players in case of 50 yard run as the calculated  $t=4.34$  is greater than tabulated  $t=2.025$ . The mean differences are graphically represented in figure 6.

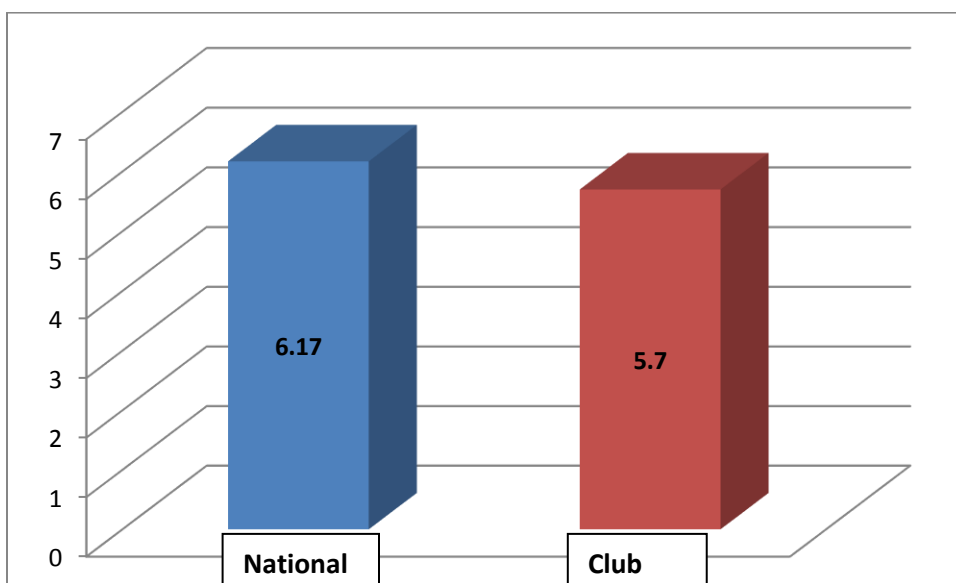

**Figure – 6, shows Mean Difference of 50 yard run between National and Club players.**

The mean (M), standard deviation (SD) and t-test of 600 yard run and walk test of National and Club players are shown in table 7.

**Table – 7, shows Mean (M), Standard Deviation (SD) and t-test for 600 yard run and walk test for Cardiovascular Endurance**

Groups	M	SD	MD	SE	t-value
National	2.72	0.32	0.12	0.06	0.47
Club	2.67	0.42			

*Insignificant at 0.05 level, where,  $t_{0.05(38)}=2.025$ , and  $N=20+20=40$*

Table-7 reveals that the means (M) and standard deviations (SD) of 600 run and walk test of National and Club players were  $2.72\pm 0.32$  and  $2.67\pm 0.42$  respectively, and the t- value was found to be 0.47. Therefore, no significant difference was found between the National and Club players in case of 600 yard run and walk test as the calculated  $t=0.47$  is lesser than tabulated  $t=2.025$ . The mean differences are graphically represented in fig. -7

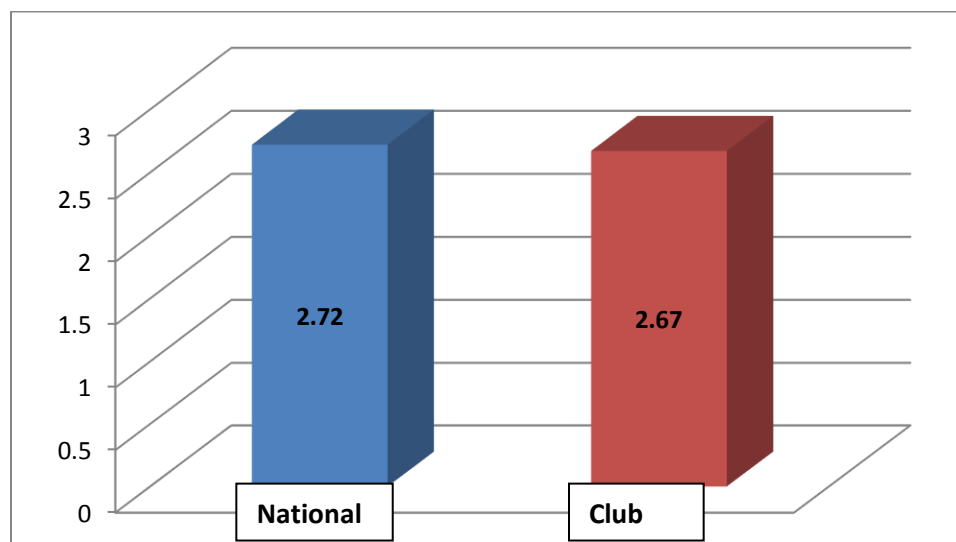

**Figure – 7, shows Mean Difference of 600 yard run test National and Club players.**

The mean (M), standard deviation (SD) and t-test on SAI Hockey Skill Test are shown in table 8, 9 and 10.

**Table – 8, shows Mean (M), Standard Deviation (SD) and t-test for Shooting in the Target**

Groups	M	SD	MD	SE	t-value
National	7.60	1.54	0.71	0.10	0.14
Club	7.70	2.79			

*Insignificant at 0.05 level, where,  $t_{0.05(38)}=2.025$ , and  $N=20+20=40$*

Table-8 reveals that the means (M) and standard deviations (SD) of shooting in the target of National and Club players were  $7.60 \pm 1.54$  and  $7.70 \pm 2.79$  respectively, and the t- value was found to be 0.14. Therefore, no significant difference was found between the National and Club players in case of shooting target accurate hit as the calculated  $t=0.14$  is lesser than tabulated  $t=2.025$ . The mean differences are graphically represented in figure 8.

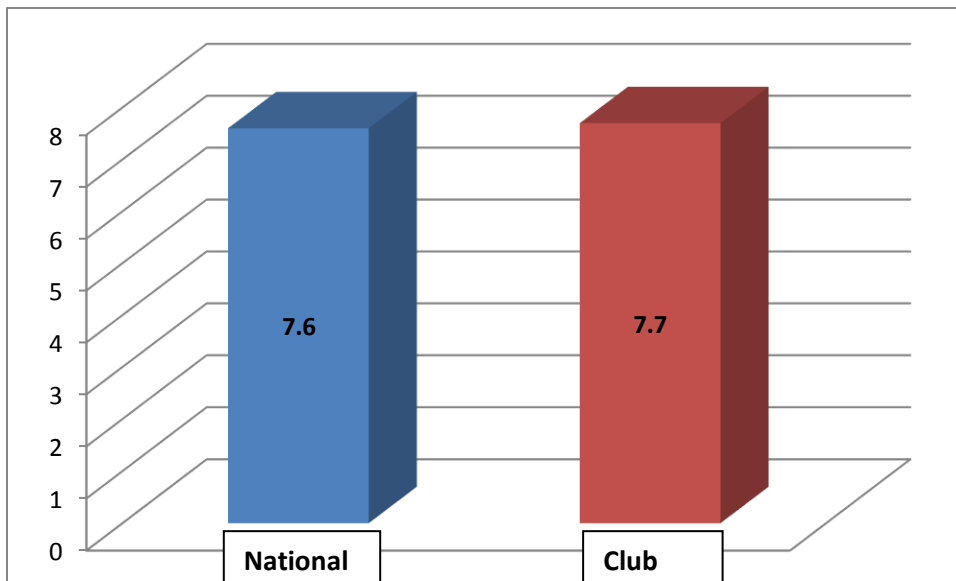

**Figure – 8, shows Mean Difference of shooting target accurate hit National and Club players.**

**Table – 9, Mean (M), Standard Deviation (SD) and t-test for Balancing of Ball**

Groups	M	SD	MD	SE	t-value
National	187.83	45.66	14.43	20.85	1.44
Club	208.68	45.59			

*Insignificant at 0.05 level, where,  $t_{0.05(38)}=2.025$ , and  $N=20+20=40$*

Table-9 reveals that the means (M) and standard deviations (SD) of balancing of ball of National and Club players were  $187.83 \pm 45.66$  and  $208.68 \pm 45.59$  respectively, and the t- value was found to be 1.44. Therefore, no significant difference was found between the National and Club players in balancing of ball as the calculated  $t=1.44$  is lesser than tabulated  $t=2.025$ . The mean differences are graphically represented in figure 9.

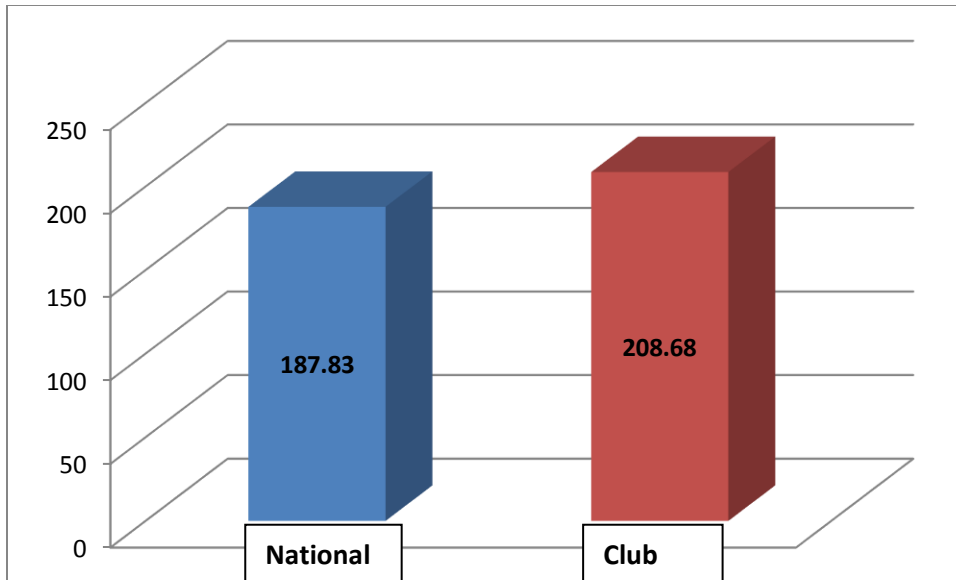

Figure – 9, shows Mean Difference of balancing of ball the National and Club players.

Table – 10, shows Mean (M), Standard Deviation (SD) and t-test for moving with ball

Groups	M	SD	MD	SE	t-value
National	4.51	0.69852	0.278	0.16	0.75
Club	4.35	0.67956			

Insignificant at 0.05 level, where,  $t_{0.05(38)}=2.025$ , and  $N=20+20=40$

Table-10 reveals that the means (M) and standard deviations (SD) of moving with ball of National and Club players were  $4.51 \pm 0.699$  and  $7.70 \pm 0.680$  respectively, and the t- value was found to be 0.75. Therefore, no significant difference was found between the National and Club players in moving with ball as the calculated  $t=0.75$  is lesser than tabulated  $t=2.025$ . The mean differences are graphically represented in figure 10.

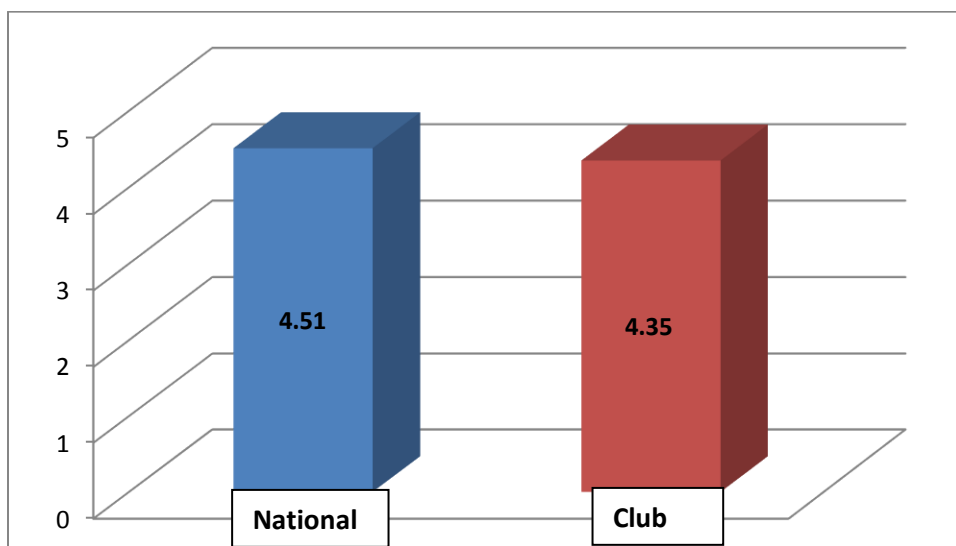

Figure – 10, Mean Difference of Moving with Ball the National and Club players.



## **DISCUSSION**

The finding of statistical analysis reveal that in the table no. 1,3,4,5&7 , it is shown that pull ups, standing broad jump, sit and reach, shuttle run and 600 yard run and walk of physical variables have no significance difference between the National and Club players. This insignificance difference occurred may be attributed to the fact that the subjects for this study were attending regular and systematic conditioning and skill training programmes. However, table no. 2 & 6, the bent knee sit up and 50 dash run have significant differences. The differences might be due to the better performance in 50 yard dash and Bent knee Sit ups, interest of the subject in the test and time and situation. Therefore, by employing the / independent 't' test, significant difference was found in case of abdominal strength and speed and alternative hypothesis is accepted and null hypothesis is rejected. Further, in case of explosive strength, agility, strength endurance and flexibility, so null hypothesis is accepted and alternative hypothesis is rejected. In Hockey Skill Ability, no significant difference was found between the National and Club players for the test item of shooting in the target, balancing the ball and moving with ball. Hence, Hypothesis stated earlier is rejected and null hypothesis is accepted.

## **CONCLUSION**

1. Significant difference in abdominal strength and speed between National and Club of Manipur.
2. Insignificant difference in explosive strength, agility, strength endurance and flexibility between National and Club of Manipur.
  1. Further, no significant differences in skill abilities National and Club of Manipur.
  2. National players have better abdominal strength than Club players.
  3. Club players have better performance in speed than National players.

## **References**

1. Anderson Bob , Strength Yourself for Health and Fitness, (U.B.S. Publishers Distributor Ltd. 1993), p.1.
2. Astrand P. O. ,Department of Physiology Gymnastic-OchIdrottshogskolan Stockholm, Sweden, 1977, p.7
3. Bucher C. A. , Foundation of Physical Education and Sports, (Toronto: The C. V. Mosby Co., 1983), p.7.
4. Presidents Council on physical fitness and sports, Physical fitness research Digest (1<sup>st</sup> July 1977)
5. Sharma B. J. , A Study of Personality Traits of Defending and Attacking Soccer Players, (Unpublished Master's Dissertation, Amravati University 2007), p.7.
6. Singh Hardyal , Science of Sports Training (D.V.S. Publications, New Delhi, 1993), p.1.
7. Seaton Doncash et. al., Basic Book of Sports, (Englewood Cliffs, N. J. Prentice Hall, 1956), p.1.
8. Waiteched N. , Conditioning for Sports, (West Yorkshire: EP Publishing Ltd. 1975), p.12.

## SIGNIFICANT DIFFERENCES OF AEROBIC AND ANAEROBIC CAPACITY BETWEEN HANDBALL AND BASKETBALL PLAYERS

**\*Dr. L. Thambal Singh**  
Assistant Professor,  
Dept. of Physical Education  
and Sports Science  
Manipur University, Imphal

**\*\*Dr. S. Vinay Kumar Singh**  
Guest Lecturer,  
Dept. of Physical Education  
and Sports Science  
Manipur University, Imphal

**\*\*\*Kangjam Inaotombi**  
Research Scholar  
Dept. of Physical Education  
and Sports Science  
Manipur University, Imphal

### Abstract

*The main purpose of the study was to compare aerobic and anaerobic capacity between Handball and Basketball Players. Total twenty (20) intercollegiate male players were selected each from Basketball and Handball from Manipur University and different colleges of Manipur. The age of the subjects ranged between 18 to 25 years. To measure the aerobic and anaerobic capacity, Cooper's 12 minutes run/walk test and RAST test were employed respectively. To determine the significance difference between Handball and Basketball, the independent 't' values was computed with the help of SPSS software. The result of the study indicates that there was found the significant difference on aerobic capacity and insignificant difference on anaerobic capacity between Handball and Basketball players.*

**Keywords: Aerobic, Anaerobic, Cooper test, RAST**

---

### INTRODUCTION

In the last few decades, sports have gained tremendous popularity all over the globe. The popularity of sports is still increasing at a fast pace and this happy trend is likely to continue in the future also. When one looks at the history of the Modern Olympic Games one sees that the number of sports for which competitions are held at Olympic Games has increased steadily. Most often when we think about exercise we concern aerobic. For most people, low to moderate exercise or exertion is generally aerobic. So what is the difference between aerobic and anaerobic exercise? In the simplest terms the difference comes down to the oxygen. With aerobic exercise, oxygen is carried through your breath to the muscles giving them the energy needed to sustain the effort. Oxygen is not present with anaerobic exercise. In anaerobic, oxygen is not present with exercise. When we exercise anaerobically glycogen is used as fuel. During anaerobic exercise, the body builds up lactic acid, which causes discomfort and fatigue at sustained levels. For this reason, anaerobic exercise or high intensity exercise happens in short bursts.

Handball and Basketball are the team games, which carry the similar objective, nature, tempo and high intensive physiological work efficiencies. Among these similarities, it is quite impressive to find out the distinctions in cases of aerobic and anaerobic efficiencies.

### Objectives of the Study

The objective of the study was to find out the significant differences if any, in aerobic and anaerobic capacities between handball and basketball players.

### Hypothesis of the Study

It was hypothesized that there would be significant differences in aerobic and anaerobic capacity between basketball and handball players.

### Methodology

For the purpose of the study, total forty (N=40) male players were selected randomly, 20 each handball and basketball players those participated at least intercollegiate level from Manipur University and different colleges of Manipur. The age of the subjects ranged between 18 to 25 years. To investigate the aerobic and anaerobic capacity, Cooper’s 12 minutes run/walk test and RAST test were employed respectively. To determine the significant differences of aerobic and anaerobic capacity between handball and basketball players independent ‘t’ values were computed with the help of SPSS software. For testing hypothesis, the level of significance was chosen at 0.05.

### Findings

The findings of the study are presented in table 1.

**Table – 1**  
**COMPARISON OF AEROBIC AND ANAEROBIC CAPACITY BETWEEN BASKETBALL AND HANDBALL PLAYERS**

Variables	Groups	M	SD	MD	SE	‘t’
Aerobic Capacity	Handball	56.45	2.14	2.15	0.59	3.64*
	Basketball	54.30	1.56			
Anaerobic Capacity	Handball	449.25	45.21	20.6	16.21	1.27
	Basketball	469.85	56.68			

\*Significant at 0.05 level, ‘t’<sub>0.05(38)</sub>=2.024

From the table 1, it has been revealed that the mean (M) and standard deviation (SD) of aerobic capacity for handball and basketball players were 56.45±2.14 and 54.30±1.56 respectively, and the ‘t’ value was found to be 3.64\* at 0.05 level confidence. Therefore, significant difference was found between the handball and basketball players in case of aerobic capacity as the calculated ‘t’= 3.64 is greater than tabulated ‘t’= 2.024. The mean difference is

graphically represented in figure 1. Insignificant difference could be observed in case of anaerobic capacity between handball and basketball players as the calculated  $t=1.27$  is lesser than tabulated  $t= 2.025$  at 0.05 level of confidence. The mean difference is graphically represented in figure 2.

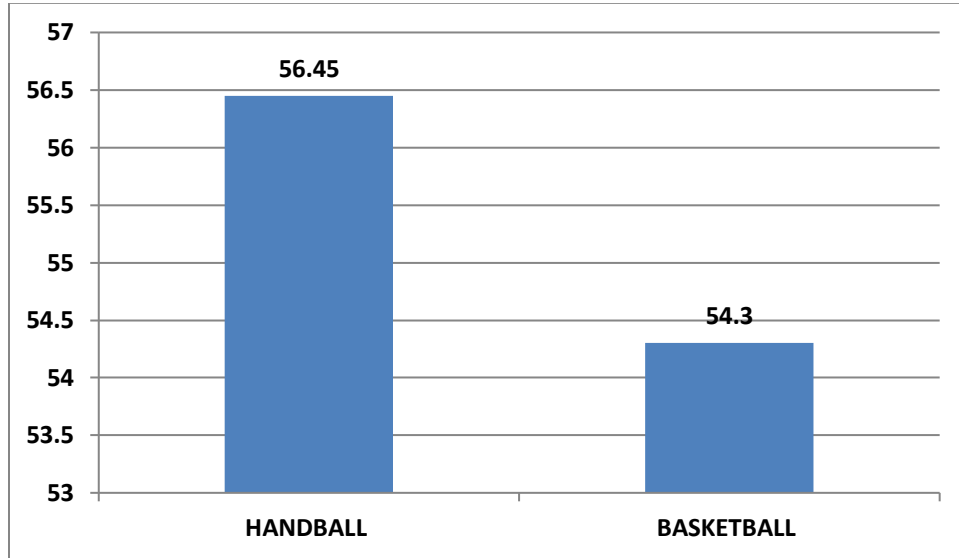

**Figure - 1**  
**Mean Difference of Aerobic Capacity between Handball and Basketball**

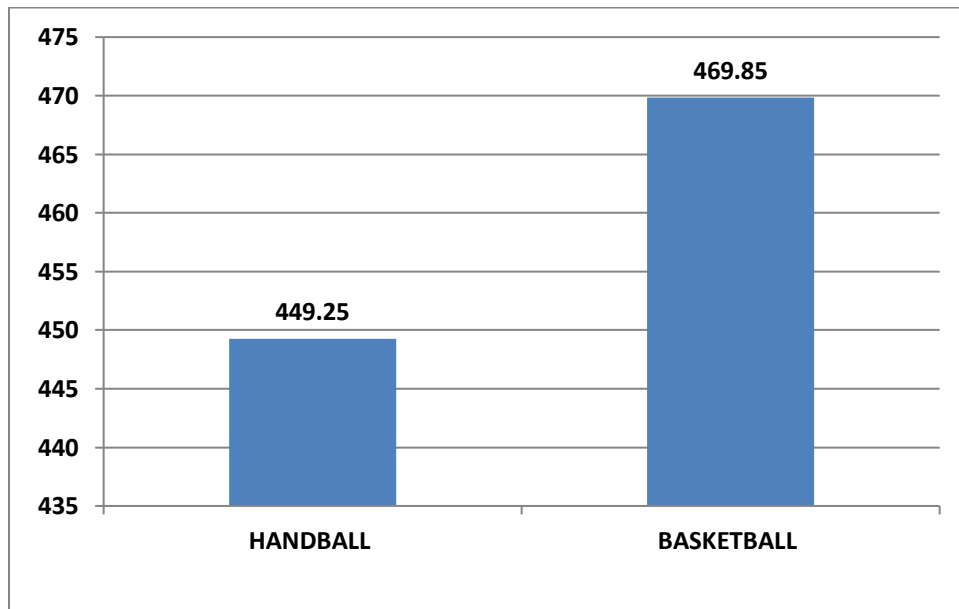

**Figure - 2**  
**Mean Difference of Anaerobic Capacity between Handball and Basketball**

### Discussion of Findings

The findings of the study revealed that there was significant difference in case of aerobic capacity between the basketball and handball players. Handball players was significantly superior to the basketball players; the reason for this significant difference may be attributed to the fact due to the nature of game. In comparison to basketball game, handball have greater playing area and a duration of 30 minutes playing in a single half, as compare to basketball has 15 minutes per quarter. It shows that handball need more aerobic capacity than basketball. It has been observed that there was insignificant difference found in anaerobic capacity between the basketball and handball players. This insignificant difference may be due to the nature of games. Basketball and handball games are very similar pattern, as all the games are played with the hands only and both are time-bounded games. Moreover, both the games are highly required of anaerobic capacity. Hence, such results occurred in this study.

### **Hypothesis Testing**

In the beginning of the study it was hypothesized that there would be significant difference in aerobic and anaerobic capacity between basketball and handball players. The result of the study showed that the aerobic capacity between basketball and handball players differed significantly; hence, the hypothesis stated earlier is accepted. However, no significant difference was found in case of anaerobic capacity; hence, the hypothesis stated earlier for this variable is rejected.

### **Conclusions**

On the basis of findings the following conclusions are drawn:

4. The findings of the study revealed that there was significant difference in aerobic capacity between handball and basketball players.
5. There was insignificant difference in anaerobic capacity between handball and basketball players.
6. Handball players possessed higher aerobic capacity in average than that of basketball players.
7. Basketball and handball players possessed somewhat similar anaerobic capacity.

### **References**

1. **B. J. Sharma (2007)**, “A Study of Personality Traits of Defending and Attacking Soccer Players”, (Unpublished Master’s Dissertation, Amravati University), p.7.
2. **Bob Anderson (1993)**, “Strength Yourself for Health and Fitness”, (U.B.S. Publishers Distributor Ltd.), p.1.
3. **Hardyal Singh(1993)**, “Science of Sports Training” (D.V.S. Publications, New Delhi,), p.1.
4. **Presidents Council on Physical Fitness and Sports**, Physical fitness research Digest (1<sup>st</sup> July 1977).
5. **D.L.Tomlin, and H.A.Wenger (2002)**, “The relationships between aerobic fitness, power maintenance and oxygen consumption during intense intermittent exercise”, Journal of Science and Medicine In Sport. 2002;5(3).
6. **H.K.Rusko (1992)** , “Physiological profile of aerobic and anaerobic of field Hockey”, Medicine and Science in Sports and Exercise, 24(9):1040-1047.
7. **I.Tabata, et.al. (1996)**, “Effect of moderate intensity endurance and high-intensity intermittent training on anaerobic capacity and VO<sub>2</sub>max”, Medicine and Science in Sports and Exercise, 28, 1327-1330.

## THE EFFECT OF SPORTS RECREATION IN ALLEVIATING ANXIETY AMONG THE ELDERLY (60/65) YEARS

**Benali Gourari, Fatima Zohra Bouras,**

Physical Education Institute Laboratory OPAPS, University of Abdel Hamid Ibn Badis.

Corresponding author Benali Gourari,

[abdejghanigou@yahoo.fr](mailto:abdejghanigou@yahoo.fr)

### **A b s t r a c t**

Sports recreation is one of the most important means of recreation, as it helps the elderly to fill the emptiness that they are living because this phase has its special nature, there are many changes and mental disorders occurring at this stage of life, importantly anxiety and tension due to the routine behavior (Reynold Garson & Janet Mackline). From this point of view, this study adopted the advantage of sports recreational programs on reduction of anxiety among retirees 60/65 years. Using the Taylor test to measure the degree of anxiety among our total sample. To archive this objective. Our program was done in a period of three months at the rate of two weeks per week, from 18 February to 12 May 2016 at the retirement home of Oran in the benefits of ES group. After processing the statistical analysis and discussion of the results, we concluded the following: The proposed sports recreation program has reduced the anxiety level of older people practicing sports activity to a lower level than before the experiment. Which indicates that the practice of sports recreational activities play an important role in maintaining the balance of the individual, especially the elderly from the psychological. In the benefits of ES group in complaisance with the control group.

**Keyword:** Sports Recreation, Anxiety, Elderly (60/65) Years.

### **INTRODUCTION**

It is known that aging is inevitable, and that the consequences become more serious for the elderly when they are affected by a permanent disability which lead to a difficult psychological situation, for this reason States has given continued attention to maintain the mental and physical balance of this group of society thus keeping them away from the negative effects of marginalization, isolation and indifference and even the United Nations Educational, Scientific and Cultural Organization (UNESCO) has paid great attention to the welfare of the elderly, and has enacted laws in order to maintain a decent living for this important group of our societies.

The importance of recreation as a basic and necessary requirement for life, whether for the healthy or for patients where some research findings and studies indicate the importance of sports recreation on the psychological and social aspects of their practitioners, helping them to adapt to the different situations they face (Reynold Garson and Janet Mackline). The stressors experienced by most members of the community resulting from several factors that it is health,

psychological, social, occupational, etc. have been reflected on them and have generated some negative behaviors and reactions, which makes the individual seek an outlet to relieve himself of these accumulations and There is a wide variation in the degree of pressure according to the results of some studies (motivations of sports activity for the Algerian citizen / 2013 Master of Sayad Hajj), where it varies from woman to man and from one age to another and from one profession to another, etc.

Our interest in this study focused on a segment of the society, which is the category of retired elderly. This stage of life is considered a period of stagnation, disability and despair for many elderly people because they are suffering from emptiness and deadly routines due to lack of interactive activity with society and lack of wide friction with the rest of the members of the society as they were before their retirement, which gave rise to a kind of anxiety, which usually negatively affects their health, as we found out through the survey conducted on a group of elderly retired in some cities in the west of Algeria.

The idea of this study came as one of the attempts to solve the problem of anxiety among retired retirees (60/65) years through the development of a range of recreational sports activities (ball games, mini games, simple racing games ...) based on scientific data and selected according to the wishes and The requirements of this segment of the society in order to reduce the level of anxiety for this category and to find an answer to the question:

**General question: Does the proposed sports recreation program reduce anxiety among older people?**

**Side questions:**

- 1) Are there statistically significant differences in the level of anxiety between the experimental sample and the control sample?
- 2) Does the exercise of sports recreational activities play an important role in maintaining the psychological and physical balance of the elderly?

**Research assumptions**

**General assumption:**

The sports recreation program plays an important role in alleviating anxiety among older retirees.

**Side assumptions**

- 1) There are statistically significant differences in the level of anxiety between the experimental group (those who practiced sports recreational activity) and the control group (non-practicing) in favor of the experimental sample.
- 2) The exercise of recreational sports contributes significantly to maintaining the psychological and physical balance of the elderly.

**Research goals:**

\* Building and designing a sports recreation program that works to reduce the level of anxiety among older people (retirees).

\* To highlight the importance of recreational sports activity and its role in maintaining psychological and social stability and mental and physical balance in the elderly and retirees in particular.

**Exploratory experiment:** Before starting the sample selection, we conducted an exploratory experiment, which is considered the first stage of the basic study. **The Taylor** test was conducted to measure the anxiety of a large group of older persons, there were 460 elderly contracted and the aim of this action is to determine the degree of anxiety in these patients and to try to select the sample group that has a high degree of anxiety for the study.

Through the results of the exploratory study and after the statistical treatment 240 individuals were selected representing the basic study sample divided into two groups (120 individuals representing the sample to which the recreational program is applied and the second consisting of (120 individuals representing the control group that does not exercise any sports activity).

**Research Methodology:** We used the experimental approach using the experimental design of two groups, one experimental and the other one a control group following pre and post-measurements to suit the nature of this study.

**Human domain**

**Table (1) Sample size and percentage of the original population**

		<b>Number of elderly persons</b>	<b>percentage</b>
<b>1</b>	<b>Scientific studies (honesty and persistence)</b>	30	06,52%
<b>2</b>	<b>Basic studies</b>	240	52,17%
<b>3</b>	<b>Excluded</b>	190	41,30%
<b>Total community</b>		460	100%

**Locative domain:** The research was carried out in the elderly’s neighborhood playgrounds in the cities of (Mostaganem city - Oran - Relizane - Mascara).

**Time domain:** Phase I: data and theories collection for the crop and the conducting of the exploratory experiment which took place from 20 November 2015 to 15 January 2016.

Phase 2: The field experience where the pre- tests were conducted on the experimental group (to which the proposed recreational program was applied) and the control group (who does not exercise any sport) the two groups were put in the same circumstances. The proposed recreational program consisted in (group games and non-regulatory mini games) For three months at a rate of two sessions per week (for 1, 1/4 hour to one and half an hour sometimes) this was from 18 February until 12 May 2016.



**The procedural adjustment of the research variables: (homogeneity) of the two basic study samples:**

Sample	Number	Average Weight	Average Height	Average Age	Level of Anxiety
The control group does not exercise any sport	120	82.80	1.72	61.7	very important
The experimental group which used the proposed recreational program	120	79.30	1.73	63.8	very important

**Table (2) represents the specifications of the research sample (basic)**

**External variables**

- **The** taking into account of homogeneity of the two samples in terms of level of anxiety.
- The removal of individuals that has little to do with anxiety.
- Most of them were departmental staff.
- They have no chronic diseases.
- Sample were from same environment.
- The same standard of living (according to payrolls ).

**Research tools:** - Sources and references - Interviews with some specialized professors to take some opinions and information about the subject of the study - Interviews with the sample members to know their tendency to try to satisfy their desires according to their physical and psychological abilities in the construction of the recreational program- Camera to record some training sessions- The contents of the program are a collection of small games and balls games and a types racing games (simple)- Taylor test to measure the level of anxiety (This measure is classified from the measures of paper and pen . Contains fifty questions and the answer is either (true) or (false) and then calculate the number of correct answers and compare them to the results recorded in the following table: The lower the score, the lower the level of anxiety.

Degree from -- to	Level of anxiety
From 0 to 16	Not anxious
From 17 to 20	Simple anxiety
From 21 to 26	Moderate anxiety
From 27 to29	Important anxiety
From 30 to 50	Very important anxiety

**Table (3) shows the criteria for level of anxiety by grade of the Taylor test**

**Team:** The team that followed the application of the program consists of the research professors related with the study with the assistance of three students preparing the doctorate.

**The scientific basis of the test used: Conducting the test on one group and after 10 days, the test was repeated on the same group and under the same conditions (Taylor test to measure the level of anxiety).**

The Test	Sample	The degree of Freedom	Coefficient of Stability		Level of Significance	Significance
Anxiety Scale	30	29	1.90	1.1	0.05	Significant statistically

**Table (04) shows the stability of the test in question**

**Analysis and discussion of results**

Mean averages and standards deviations of the pre and post degrees of anxiety scores of the two Samples

	Sample size	Pre-Test			Post-Test		
		Total score	Average arithmetic	Standard Deviation	Total score	Average arithmetic	Standard Deviation
Control group	120	3854	32.12	05.10	3930	32.75	05.58
Experimental group	120	3808	31.47	05.67	1980	16.50	13.04

**Table (5) shows the total scores and arithmetical averages of the pre and post- tests of the two samples**

The table shows the results of the overall scores of the two samples. It is observed that they are very close to the pre- tests. The total score of the control group is 3854 with an average of 32.12 of the degree of anxiety and a standard deviation of 05.45. The experimental group has a total score of 3808 with an average of 31 , 47 for anxiety level and a standard deviation of 05.32.

In the post-test, the results differed between the control sample and the experimental sample. There were statistically significant differences in favor of the experimental group, where total score was estimated in 1980, average arithmetic was 16, 50 and a standard deviation of 13.04. The control sample did not differ between the pre-test and the post-test the total score was 3930 with an average of 32.75 and a standard deviation of 05.58.

It is clear that there are significant differences between the experimental sample and the control sample in the post-tests. This is due to the experimental factor or the independent variable (the proposed sports recreation program) which affected the experimental group because the total

scores of the latter were low .The lower the measurement in the test, the lower the level of anxiety in the individual.

	Sample size	Pre- test		Post-test		T Calculated	T Tabular value	Statistical significance
		S	G	S	G			
Control sample	120	32.12	5.45	32.75	5,58	01.15	2.40	significant
Experimental Sample	120	31.47	5.32	16.50	13.04	06.24	2.40	Significant

**Table (06) shows the results of the pre and post-test of the two samples under study of the level of anxiety**

After using the significance of the differences, we found that the calculated "T" in the control sample was 01.15, which is less than the score of T table 2.40 which indicates that there is no statistical significance therefore, there is no significant difference between the results of the pre and the post-test.

As for the experimental sample, the calculated "T" was 06.24, which is greater than the numerical value of 2.40, which indicates a statistical significance then a significant difference between the averages.

It is clear to us through the results of the table that there are statistically significant differences in the degree of anxiety between the pre and the post - tests performed on the elderly, in favor of the experimental sample, unlike the control sample, which has not changed, and on this basis we find that the recreational program has reduced the level of anxiety.

**Comparison of the results of the two pre-tests of the two samples under study:**

	Sample size	SM A	standard deviation	Calculate d	Degree of freedom	Level of significance	Tabular value	Statistical significance
Control sample	120	.3275	58.5	23.01	238	0.01	40.02	Significant
Experimental Sample	120	.1650	04.13	06.24				

**Table (07) shows the comparison of the results of the level of anxiety of the control and experimental sample**

Table (3) shows:

The calculated T value is 13.45 and is greater than the tabular value of 2.36 at the level of 0.01 and 158 degree of freedom this value is statistically significant, indicating the non-homogeneity of the two research samples and it shows the positive effect of the proposed sports recreation program in alleviating the level of anxiety of the sample that applied the program.

In general, the results achieved show the effectiveness of the sports recreation program in alleviating the level of anxiety among the experimental sample. This indicates the positive effect of recreational sport activity on its practitioner in general, which confirms that the exercise of sports activities of any kind helps the elderly to resist the pressure caused by several influences could it be external or internal, as well as help in self-recreation and work on the social treatment in terms of behavioral change towards the positive and moving away from negative things and that the individual can live his life more effectively.

**Discuss of Hypotheses**

**The general hypothesis:** The results of tables (5-6-7) showed that the sports recreation program reduced the degree of anxiety in the experimental sample regarding to the total score obtained in the post-test (1980) with an average of 16, 50 where the calculated T is 24.24 and is larger than the tabular value 20.40 compared with the control group that obtained the total score of 3980 and an average of 05.58 and the calculated T of 10.23 it is the smaller than the tabular value as to point out that the lower the total measurement scores obtained in tests, the lower the level of anxiety in individuals. This is what happened in the experimental sample, which leads us to conclude that the exercise of recreational sports plays a large role in reducing the level of anxiety in the elderly practitioners.

**The side hypothesis:**

1) The first hypothesis was confirmed by the results obtained, as shown in Table (7), where the statistical differences were significant in the post- tests in favor of the experimental group(to which the proposed recreational program was applied) compared to the control sample the proposal positively affected the experimental sample and reduced the level of anxiety among the older age group practicing recreational activity.

2) The second hypothesis. The results obtained coincided with the second hypothesis, as sports activity is of great importance in maintaining the psychological and physical of the elderly this is what we observed by analyzing the video clips we took during the sessions, showing that continuous friction with the group through play and Competition brings a kind of happiness and fun that affects them positively in their daily lives.

### **RECOMMENDATIONS**

Encouraging the exercise of sports activities for the elderly because of their great importance in maintaining physical and psychological balance.

Developing an information strategy that will contribute to raise awareness of the importance of the exercise of sports activities of any kind for the elderly.

Thinking of promoting residential neighborhoods with sports facilities to encourage individuals to practice sports.

To urge the authorities and bodies responsible for the sport sector to plan special programs and sports events for the elderly to encourage them to exercise.

Creating sports associations for the elderly that will care about the health and the activity of this class of society.

### **References**

1. Research of the Sixth Conference of the Organization of Arab Cities on recreation in the Arab cities - A sociological analysis of the phenomenon of recreation and its importance in our contemporary Arab society - Doha - Qatar 2008
2. Bahaa Abdel Rahman, Omar Badr Mohammed: "Encyclopedia of sports recreation" University of El Mina 2014
3. Tahani Abdel Salam Mohamed: "Recreation and recreational education" 1 Arab Thought House - Cairo 201
4. Helmy Ibrahim Farhat El Sayed "The Recreation and Needs of the Individual"
5. Ramadan Mahmoud Abdel-Al: "physical activity sports recreational and recreational" Faculty of Physical Education Department of recreation University of Mabna 2015.
6. Mohamed Abdel Aziz: (2013 / pp - 12-13) recreation and leisure \* House knowledge \* Alexandria.
7. Saad Jalal: "psychological guidance, educational and professional" I 1 Arab Thought House - Cairo 1992
8. Selima Saihi: The Effectiveness of Guidance Programs to Reduce the Level of Concern in the Examination of Secondary School Students 3 Unpublished Master Thesis - University of Ouargla - Algeria 2004
9. Sossen Majid Shaker: personal effects, patterns, measurement, Dar Safa Amman 2008
10. Diaan Abdel-Hamid Al-Husani: I 1 "Recreation and Sports Education" Dar al-Maaref scientific - Baghdad - Iraq 2001
11. Diaan Abdel-Hamid Al-Husani: Sports Recreation Education "I 2 Dar al-Maaref Scientific - Baghdad Iraq 2005
12. Abdullah, Mohammed Qasem: "theories of counseling and psychotherapy" Dar Al-Fikr for printing, publishing and distribution - Amman - Jordan 2012

13. Mohamed Abdel Aziz Salama, Amani Metwally Al-Batrawi: Introduction to recreation and leisure - Mahe for publication and distribution Egypt 2013
14. Mohammed Shafiq: Social Psychology between Theory and Practice, Dar Al - Maarefah Al - Jami'ah, Egypt 2004
15. Mohammed Wajih Al-Sawy: educational goals at home Damascus University Syria 2014
16. Mustafa Al - Sayeh Mohammed: Sports and Social Education "Dar Al - Wafa for Printing and Publishing Alexandria Egypt 2007
17. Mansouri Mustafa: Sources of Work Stress and its Relation to Professional Satisfaction, Concern and Hypertension (unpublished doctoral dissertation) pp. 14-89-116-117 / University of Constantine Algeria 2004
18. Nabih Ibrahim Ismail: "Factors of sound mental health" 1 - Itrak for printing and publishing - Cairo - Egypt 2001
19. Nader Ahmed Abu Sheikha: "The motives according to the theory of needs ladder to Abraham Mazlo as seen by the lighthouse Volume 13 Issue 2 pp. 152-167 (2007)
20. Huda Hassan Mahmoud Mohamed: recreation and importance (pp. 120-121) Dar Warka for printing and publishing 2011.
21. Rober ,la personnalité normale et pathologie ; Ed Masson paris 2004.
22. Michel Hansenne ;psychologie de la personnalité Paris 2003