

# OPTIMAL CONFIGURATION ASSESSMENT OF HYBRID ENERGY SYSTEM

**Sofija Nikolova-Poceva**

*Faculty of Electrical Engineering and Information Technologies,  
Ss. Cyril and Methodius University in Skopje,  
e-mail(s): nsofija@feit.ukim.edu.mk  
Republic of North Macedonia*

**Abstract:** In this paper, an off-grid hybrid energy system consisting of photovoltaic system, wind turbines, diesel generator as a back-up power source, batteries and converters is presented. The objective of this study is to obtain the optimal configuration of the system, which will meet the electrical load, respecting the total net present costs. HOMER software is used to achieve this purpose. Sensitivity analysis is also performed in order to examine how the average annual wind speed, average annual solar radiation and the fuel price will affect the configuration of the system.

**Key words:** hybrid energy system, optimal configuration, net present cost.

## 1. INTRODUCTION

Hybrid energy system combine several (two or more) energy sources with appropriate energy conversion technology connected together to feed power to the local load/grid. Hybrid energy systems with integrated renewable energy capacities can be independent of large centralized power grids and can be used in remote areas. A hybrid energy system generally consists of a primary renewable source working in parallel with a standby secondary non-renewable power generation component and storage units [1].

When designing hybrid energy system, off-grid or grid-connected, it is necessary to decide about the configuration of the projected system. This includes deciding on the following questions: what type of technologies will be used for energy generation? Which components will be part of the system? How many, what size and with what characteristics will be the used components? The large number of

alternative technologies, the differences in technology costs as well as the energy resources availability make the decision itself difficult.

In this paper, an off-grid hybrid energy system is considered. In order to determine the configuration of the system that will meet the needs of consumers, and as a design solution that will meet the requirements of the investor, the software tool HOMER is used [10]. Sensitivity analysis is also performed in HOMER in order to examine how the average annual wind speed, average annual solar radiation and the fuel price will affect the configuration of the system.

HOMER's optimization and sensitivity analysis algorithms make it easier to evaluate the many possible system configurations [11].

In HOMER a system model is provided by entering the type of resources that are planned to be used, the resource availability, the technology options and the related costs for each of the components. Based on the input data, different system configurations, or a combination of components, are simulated and a list of feasible system configurations sorted by net present cost is created.

## 2. RELATED WORK

Much research has been done regarding the hybrid energy systems. In [1], focus was given on hydrogen-based hybrid energy systems as an emerging technology for use in stand-alone applications in St John's, Newfoundland. Various energy sources (wind, solar, and diesel generator) and storage systems (battery, and electrolyzer-tank) were considered in this analysis. NREL's optimization tool HOMER was used in identifying probable hybrid configurations and their applicability. In [2], the authors proposed an optimization method to manage the optimal energy management of the PV-wind-diesel-battery hybrid system with respect to both economic benefits and its reliability. The Dynamic Programming approach was used to establish the optimal schedule of power sources. This method can minimize the operation cost of the hybrid system and CO<sub>2</sub> emission while satisfying the technical conditions such as reliability, safety, etc. in scenarios with the different initial states of charge.

A research carried by [3] presents a techno-economic feasibility study of hybrid energy systems (PV/wind turbine/diesel system with storage batteries) for electricity generation. The incorporation of storage units also reduced the net present cost, excess energy fraction and CO<sub>2</sub> emission. They found out that the use of hybrid energy systems in such locations improved the standard of living and economic activities of the rural populace. Gelma in [4] described the design information of solar PV and wind turbine hybrid energy system to provide electricity to a model community of 100 households and health clinic and elementary school. The study was started through investigating solar and wind sources potentials of the area of interest. The optimal simulation result showed that PV/wind turbine/diesel generator/battery and converter configured system.

The authors in [5] used a generic algorithm on a PV and wind turbine hybrid energy system to minimize the lifecycle cost, dump energy, and CO<sub>2</sub> emissions. They used small split diesel generators instead of a big single diesel generator. Their results achieved 28%, 46%, 82% and 94% reduction in cost of energy, life cycle cost, CO<sub>2</sub> emissions, and dump energy, respectively, when compared to the single big diesel generator system. In [6] a simple sizing algorithm for stand-alone PV/wind/battery hybrid microgrid systems to determine the number of wind turbine and PV array generating units and the storage capacity required for a stand-alone microgrid is developed. Bekele and Palm conducted a feasibility study, presented in [7], for a standalone solar/wind based hybrid energy system to supply electricity for rural areas in Ethiopia. This paper presented the simulation of PV/wind/diesel and battery system to supply electricity demand for 200 household's model community. The paper showed the most cost efficient combination from the hybridizing of diesel generator/battery and converter with no contribution of renewable sources fractions.

Ahadi et al. [8] investigated several hybrid renewable energy system combinations of solar, wind and energy storage free of diesel generators to supply energy for remote communities. The study showed that the wind turbine operations range must be considered. Increasing the wind turbine fraction could also lead to significantly lower costs as well as the PV solar cell number and number of batteries. Nasser Yimen et al. [9] proposed a two-step methodology to optimize and analyze a PV/wind/battery/diesel hybrid energy system to meet the power demand of Fanisau, a remote and off-grid village in northern Nigeria. In the first step, the MATLAB was used to run simulations and optimize the system via the genetic algorithm with a time interval of 1h over a year for the load demand and energy output. Then, techno-economic and emissions analysis was carried out in the second step to compare the obtained optimized system to the traditional modes of rural electrification in sub-Saharan Africa.

### **3. HOMER SOFTWARE FEATURES**

The optimization and sensitivity analysis algorithms in HOMER simplifies the task of evaluating designs of both off-grid and grid-connected hybrid energy systems for a variety of applications [10], [11]. After obtaining the simulation results, the feasible system configurations can be compared and evaluated on their economic and technical merits. There are three core capabilities: simulation, optimization, and sensitivity analysis.

Taking into account the input data, the tool simulates the operation of the system by making energy balance calculations in each hour of the analyzed period. For each hour, HOMER compares the thermal and electric demand to the energy that the system can deliver at the appropriate hour, and calculates the energy that each component can generate. These energy balance calculations are performed for each consider system configuration. After determining the feasible solutions of the hybrid

energy system, which meet the requirements under the specified conditions, the costs for installation and operation of the system over the lifetime of the project are estimated. The system cost calculations account for costs such as: capital, replacement, operation and maintenance (O&M), fuel, and interest.

HOMER has an optimization algorithm and the optimization step follows all simulations in order to search for the least cost system. The simulated feasible system configurations are sorted by net present cost, that facilitate their comparison and enable their evaluation from an economic and technical point of view.

The system model under consideration can be used to perform sensitivity analyzes, in order to explore the impact of changing certain factors such as resource availability or economic conditions on the cost-effectiveness of different system configurations. To perform a sensitivity analysis, it is necessary to define the sensitivity variables as inputs. The program repeats the optimization process for each specified sensitivity variable. The obtained results can be used to identify the factors that have the greatest impact on the system design and operation.

A component that can be modeled is a part of a system that generates, stores or transmits electricity or thermal energy. The following components are included: wind turbine, photovoltaic system (PV), generator: diesel, biogas, gasoline, natural gas, ethanol, methanol, propane, stored hydrogen, microturbine, fuel cell, conventional hydro power plant, run-of-river hydro power plant, electric utility grid, electrolyzer, hydrogen tank, reformer, batteries, converter etc.

### **3.1. Necessary data for starting the simulations**

Before performing the simulations, several steps need to be realized. First it is need to define the type of the system (combination of technologies) and its configuration (which components, how many and with which characteristics would figure in the model) and enter their respective input data.

It is also necessary to enter the data for the system load and the energy resources availability over the analyzed time period. The types of available loads are: electrical load, thermal load, hydrogen load and deferrable load. Deferrable load is electrical load that must be met within some time period, but the exact timing is not important.

Necessary data to determine the net present costs are the costs of each of the installed components (capital, replacement, operating and maintenance costs) as well as the data entered in the block economic parameters.

There is the possibility to define a dispatch strategy which is a set of rules that govern the operation of the generator(s) and the battery bank. HOMER can model two dispatch strategies: load following and cycle charging. Which is optimal depends on many factors, including the sizes of the generators and battery bank, the price of fuel, the O&M cost of the generators, the amount of renewable power in the system, and the character of the renewable resources. If both are chosen then HOMER will simulate each system using both dispatch strategies and it will be able to see which is optimal. Under the load following strategy, whenever a generator is needed it

produces only enough power to meet the demand. Load following tends to be optimal in systems with a lot of renewable power, when the renewable power output sometimes exceeds the load. Under the cycle charging strategy, whenever a generator has to operate, it operates at full capacity with surplus power going to charge the battery bank. Cycle charging tends to be optimal in systems with little or no renewable power. A setpoint state of charge can be applied to the cycle charging strategy. When a setpoint state of charge is applied, the generator(s) will not stop charging the battery bank until it reaches the specified state of charge [10].

Emissions can also be analyzed. Use the emissions inputs window a cost penalty for a particular pollutant, or a limit on the emissions of a pollutant can be specified.

The constraints menu allows to modify system constraints which are conditions the system must satisfy. HOMER discards systems that do not satisfy the specified constraints, so they do not appear in the optimization results or sensitivity results. Here the: maximum annual capacity shortage, minimum renewable fraction, operating reserve can be defined. Operating reserve is surplus operating capacity that ensures reliable electricity supply even if the load suddenly increases or renewable power output suddenly decreases. HOMER calculates the required operating reserve for each time step based on the values entered on the constraints window. Whenever possible, HOMER ensures that enough dispatchable capacity is available to keep the operating reserve equal to or greater than the required operating reserve. It records any shortfall as a capacity shortage.

#### **4. PROPOSED RESEARCH**

Photovoltaic systems and wind turbines can be integrated in the hybrid energy system in areas where there are favorable conditions for the use of wind and solar energy resources. However, due to the stochastic nature of solar radiation and wind speed, diesel generators and batteries are usually included in the system to ensure a reliable supply to consumers. The batteries store the excess electricity produced, while in adverse weather conditions part of the consumption is satisfied by the previously accumulated electricity in the batteries.

In this paper, an off-grid hybrid energy system (Fig.1.) consisting of diesel generator, wind turbines, photovoltaic system, batteries and converters will be analyzed. The objective of this study is to obtain the optimal configuration of the system, which should satisfy the given load of electricity, respecting the total net present costs. For this purpose the software tool HOMER is used. Lifetime of the project is 25 years, while the interest rate is 6%. In the paper the emissions are not analyzed. As dispatch strategy load following is selected. The possibility for inclusion of multiple generators in the system, multiple generators to operate simultaneously and system with two types of wind turbines is allowed.

The characteristics of the individual components that are part of the system as well as the data on the availability of wind and solar energy resource are given in the

further part of the paper. All presented graphs and figures in the paper are exported from the HOMER software after making personal modeling and simulation of the analyzed hybrid energy system.

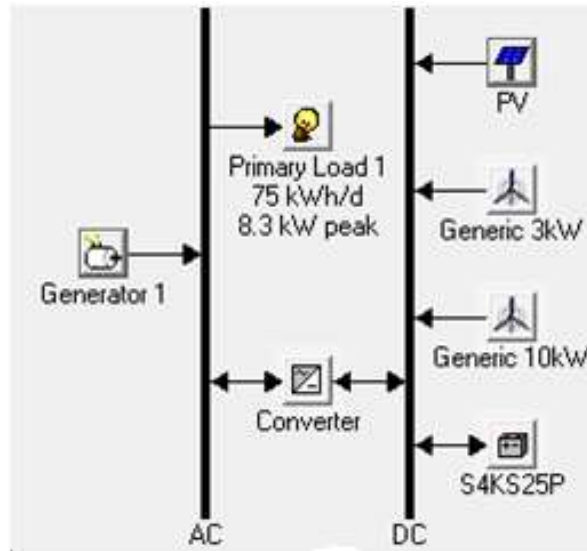

Fig. 1. Schematic representation of the hybrid energy system under consideration

#### 4.1. Load data

Figure 2 presents the average daily load profile for a year.

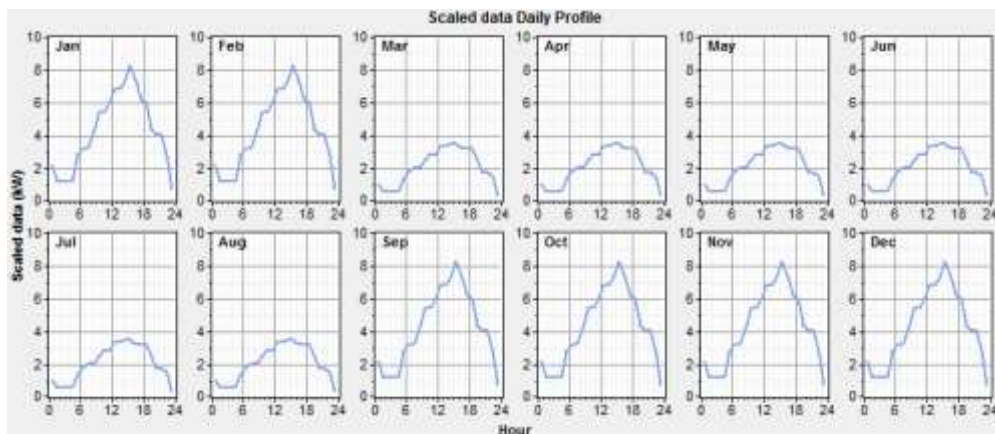

Fig.2. Average daily load profile for a year

#### 4.2. Characteristics of the components

##### PV system

Table 1 provides the data of photovoltaic system costs: capital costs ( $C_c$ ), replacement costs ( $C_R$ ), operation and maintenance costs ( $C_{O\&M}$ ), [13]. The derating factor of the photovoltaics is chosen to be 90%. Photovoltaics are modeled with a fixed slope of placement. Lifetime of the photovoltaics is 20 years.

Table 1. Photovoltaic system costs

Size (kW)	$C_c$ (\$)	$C_R$ (\$)	$C_{O\&M}$ (\$/yr)
1	2710	2300	54

**Wind turbines**

Generic 10 kW and Generic 3 kW have been selected as the types of wind turbine. The power curve for these types of wind turbines is presented in Figure 3. Lifetime is set to be 20 years. The hub height of Generic 10 kW wind turbine is 15 m, while of Generic 3 kW wind turbine is 12.5 m. The data of wind turbine costs are given in Table 2, [14].

Table 2. Wind turbine costs

	Quantity	$C_c$ (\$)	$C_R$ (\$)	$C_{O\&M}$ (\$/yr)
Generic 10 kW	1	30000	25500	450
Generic 3 kW	1	10000	7000	150

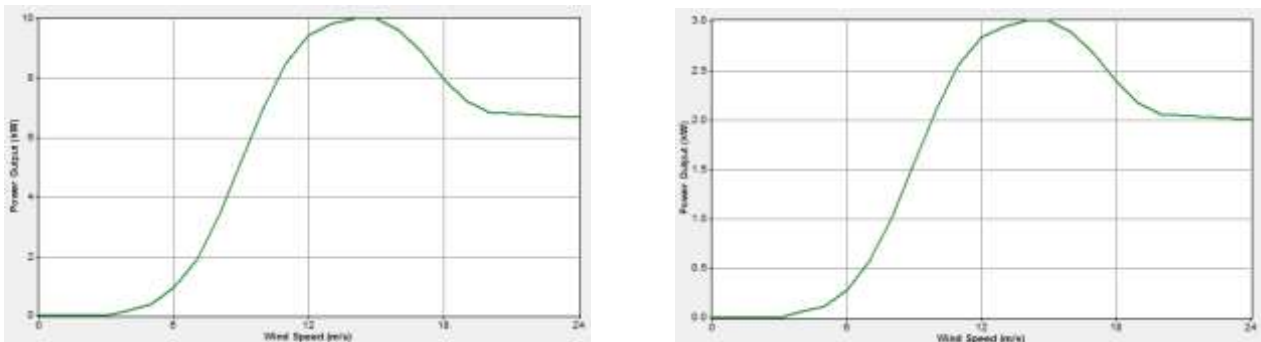

Fig.3. Power curve of Generic 10 kW and Generic 3 kW wind turbine

**Diesel generator**

There is a wide range of diesel generators that can be applied. Different manufacturers provide different information which makes their comparison difficult. The costs for this component are given in Table 3. Lifetime is 12000 hours. The fuel price is 1.1 \$/L .

Table 3. Diesel generator costs

Size (kW)	$C_c$ (\$)	$C_R$ (\$)	$C_{O\&M}$ (\$/hr)
1	500	430	0.01

**Batteries**

There are 5 types of storage models in HOMER, [11]. For the considered system Surrette 4KS25P, a kinetic model of batteries, is chosen as the battery type. 10 units of these batteries are considered. Table 4 presents the costs for this type of batteries.

Table 4. Battery costs

Quantity	$C_c$ (\$)	$C_R$ (\$)	$C_{O\&M}$ (\$/yr)
1	950	950	19

### Converters

Due to the need to adjust the voltage in the system it is planned to have an inverter and a rectifier. The inverter and rectifier have efficiency 90% and 88% respectively. The costs for the converters used are given in Table 5. 10 kW size of converter is considered. Lifetime is 15 years.

Table 5. Converter costs

Size (kW)	$C_c$ (\$)	$C_R$ (\$)	$C_{O\&M}$ (\$/yr)
5	1000	1000	15

### 4.3. Energy resources availability data

Solar energy as a resource is used for our location. Data for solar radiation are taken from the NASA website, [12]. The average annual solar radiation for the selected location is 4.73 kWh/m<sup>2</sup>/d. Figure 4 shows the profile of the average daily solar radiation in the individual months during a year. The graph also shows the data on the clearness index.

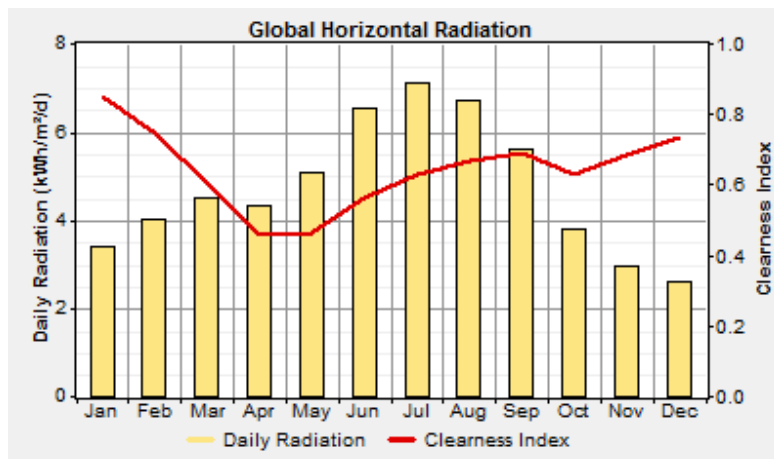

Fig.4. Profile of the average daily solar radiation in the individual months

Figure 5 shows the average monthly wind speed over a year for this location. According to the entered data, at anemometer height of 10 m, the average annual wind speed in the considered case is 5.899 m/s. The parameters of the Weibull distribution are  $k = 2.01$  and  $c = 8.15$  m/s. Figure 6 presents the Weibull distribution for the given input data of wind speeds.



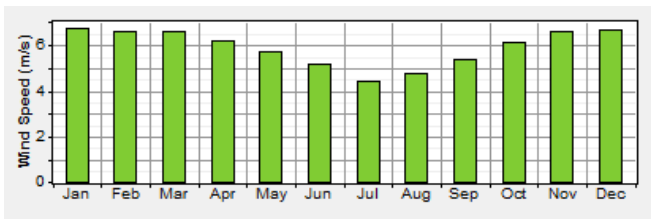

Fig.5. Average monthly wind speed

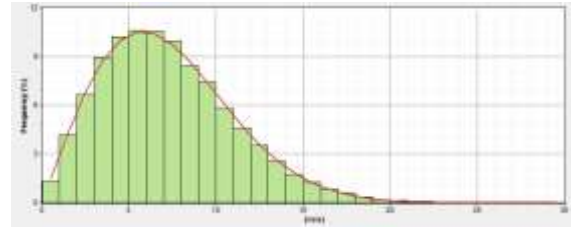

Fig. 6. Weibull distribution

#### 4.4. Results and discussion

At first the basic electricity generation scenario, for an off-grid hybrid energy system consisting of 1 wind turbine Generic 10 kW (G10), 5 kW photovoltaic system, 8 kW diesel generator and 10 units of batteries, is considered. The net present cost by cost type is presented in Figure 7. The net present cost for the whole hybrid system is 135,435 \$. Also the salvage value is presented on the figure. Monthly average electricity production is given in Figure 8. The expected electricity production from the wind turbines is 20,951kWh/yr, from the PV system is 8,637 kWh/yr and from diesel generator is 6,868 kWh/yr. The renewable fraction is 0.812. Levelized Cost of Energy is  $COE = 0.385 [$/kWh]$ .

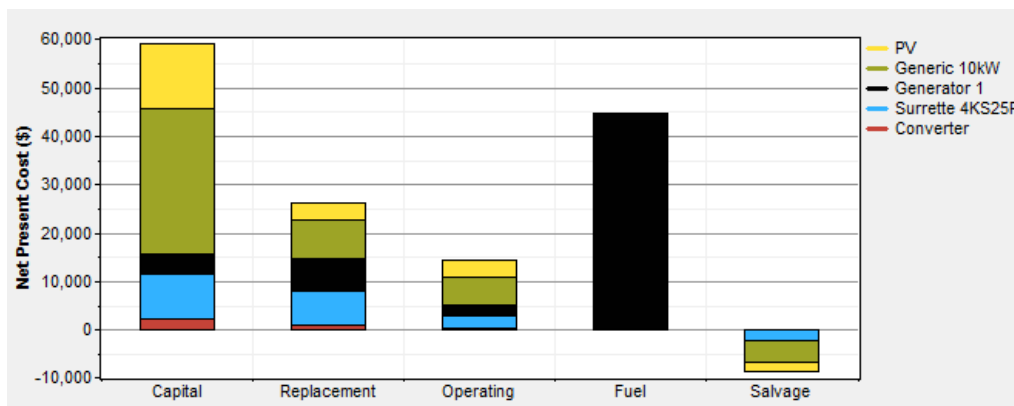

Fig. 7: Net present cost by cost type

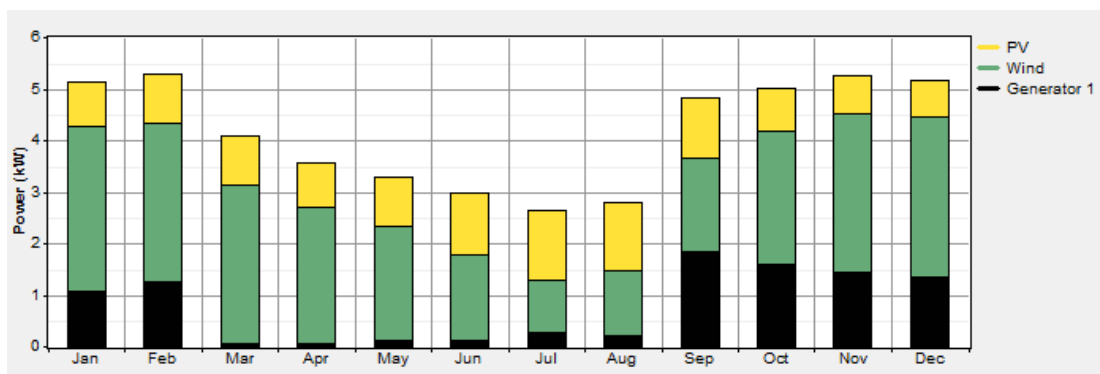

Fig. 8. Monthly average electricity production

Another case that is further analyzed is with the following inputs for the renewable components: size of photovoltaic system: 5 kW, 6 kW, 7 kW, 8 kW, 9 kW, allow system with two types of wind turbines Generic 10 kW (1, 2) and Generic 3 kW (1, 2, 3), and system with the presence and absence of photovoltaics and wind turbines. The first 16 feasible solutions (of total 72 listed) from the generated list for this analyzed case, which are sorted by total net present cost are given in Figure 9. The simulation results show that the optimal system is the system with 8 kW PV system, 1 wind turbine G10, 8 kW diesel generator and 10 storage batteries. For the first 4 system configurations the excess electricity is larger than in the basic system previously described. This excess electricity can be used to serve a thermal load by means of resistive heating if thermal load is added in the system.

	PV (kW)	G3	G10	Gen1 (kW)	S4KS25P	Conv. (kW)	Initial Capital	Operating Cost (\$/yr)	Total NPC	COE (\$/kWh)	Ren. Frac.	Capacity Shortage	Diesel (L)	Gen1 (hrs)
	8		1	8	10	10	\$ 67,180	5,054	\$ 131,789	0.375	0.88	0.00	2,320	1,699
	7		1	8	10	10	\$ 64,470	5,287	\$ 132,055	0.376	0.86	0.00	2,551	1,858
	9		1	8	10	10	\$ 69,890	4,868	\$ 132,117	0.376	0.89	0.00	2,125	1,566
	6		1	8	10	10	\$ 61,760	5,570	\$ 132,965	0.378	0.84	0.00	2,820	2,036
	5		1	8	10	10	\$ 59,050	5,975	\$ 135,435	0.385	0.81	0.00	3,177	2,281
	6	1	1	8	10	10	\$ 71,760	5,087	\$ 136,783	0.389	0.88	0.00	2,301	1,662
	7	1	1	8	10	10	\$ 74,470	4,882	\$ 136,875	0.390	0.90	0.00	2,090	1,525
	8	1	1	8	10	10	\$ 77,180	4,706	\$ 137,343	0.391	0.91	0.00	1,903	1,396
	5	1	1	8	10	10	\$ 69,050	5,380	\$ 137,824	0.392	0.86	0.00	2,577	1,849
	9	1	1	8	10	10	\$ 79,890	4,545	\$ 137,991	0.393	0.92	0.00	1,725	1,270
	9	3		8	10	10	\$ 69,890	5,333	\$ 138,063	0.393	0.86	0.00	2,501	1,838
	8	3		8	10	10	\$ 67,180	5,561	\$ 138,265	0.394	0.84	0.00	2,727	1,994
	7	3		8	10	10	\$ 64,470	5,817	\$ 138,831	0.395	0.82	0.00	2,974	2,159
	9	2		8	10	10	\$ 59,890	6,316	\$ 140,629	0.400	0.79	0.00	3,383	2,477
	6	3		8	10	10	\$ 61,760	6,193	\$ 140,924	0.401	0.80	0.00	3,311	2,390
	8	2		8	10	10	\$ 57,180	6,606	\$ 141,629	0.403	0.77	0.00	3,655	2,660

Fig. 9. First 16 feasible solutions sorted by total net present cost for the second analyzed case

Sensitivity analysis is also performed in HOMER in order to examine how the average annual wind speed, average annual solar radiation and the fuel price will affect the configuration of the system. Let the average annual wind speed ( $V_a$ ) change from 4 m/s; 5 m/s; 5.9 m/s and 6.2 m/s, the average annual solar radiation ( $S_a$ ) change from 2.2 kWh/m<sup>2</sup>/d; 3 kWh/m<sup>2</sup>/d and 4.73 kWh/m<sup>2</sup>/d and let's reduce the price of diesel to 0,9 \$/L. The Figures 10 and 11 present the optimal system type graph when diesel price is 0.9 \$/L and 1.1 \$/L respectively.

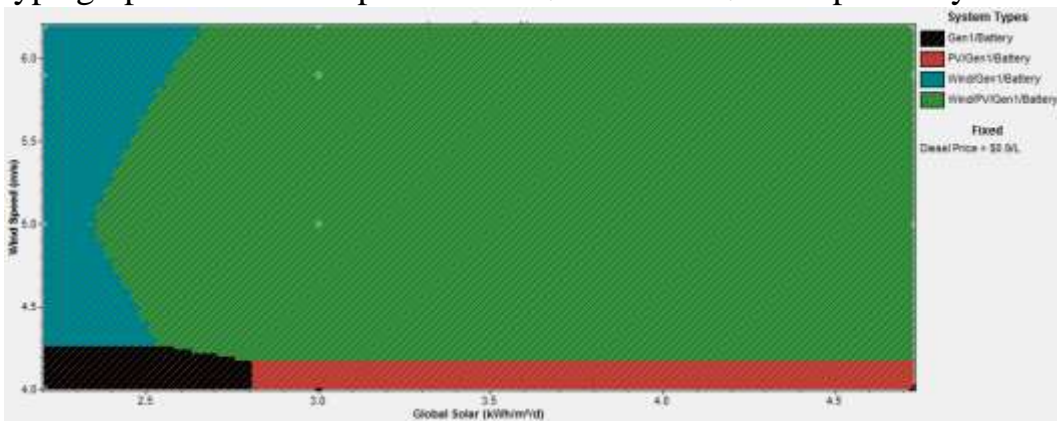

Fig. 10. Optimal system type graph when diesel price is 0.9 \$/L

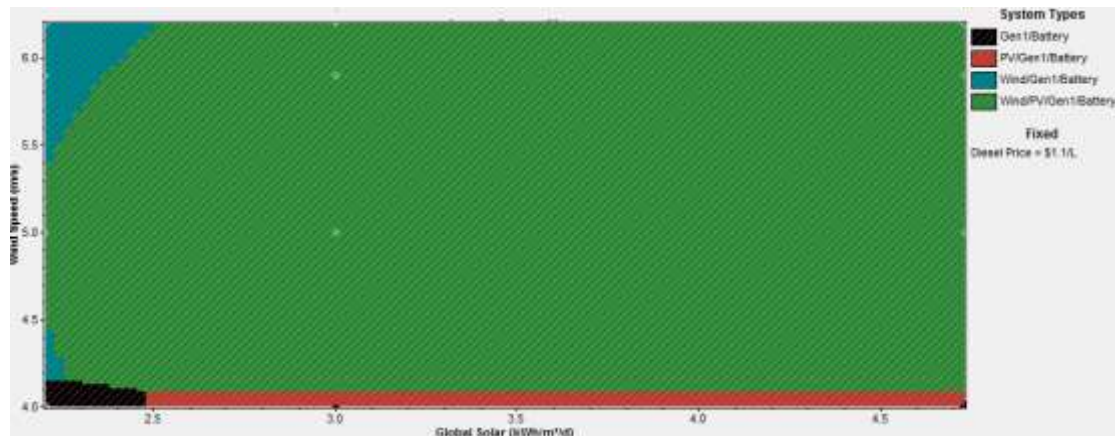

Fig. 11. Optimal system type graph when diesel price is 1.1 \$/L

It is clear that the price of the fuel significantly affects costs. The results and obtained optimal system type graph, when diesel price is 0.9 \$/L, show that if  $V_a = 4$  m/s and  $S_a = 3$  kWh/m<sup>2</sup>/d or  $S_a = 4.73$  kWh/m<sup>2</sup>/d the optimal system is the system with 5 kW photovoltaic system and 8 kW diesel generator as electricity production capacities. If the average annual solar radiation is very low under 2.8 kWh/m<sup>2</sup>/d and the average annual wind speed is lower than 4.3 m/s then the optimal system is only with 8 kW diesel generator. If  $S_a = 2.2$  kWh/m<sup>2</sup>/d then the optimal system is without photovoltaics, only 8 kW diesel generator and wind turbine(s): 1 G10 for  $V_a = 5$  m/s, and 1 G10 and 1 G3 for  $V_a = 5.9$  m/s and  $V_a = 6.2$  m/s.

## 5. CONCLUSION

An off-grid hybrid energy system consisting of photovoltaic system, wind turbines, diesel generator as a back-up power source, batteries and converters has been investigated. In order to determine the most appropriate combination of renewable energy resources, the software tool HOMER has been applied. The software allows the comparison of different combinations of components, their different quantities and performance. Feasible solutions are listed and sorted by total net present cost.

In the program, the simulations are realized based on the input data for the components that are modeled, data for the electrical load, data of the energy resources availability (in this case for solar radiation and wind speed), fuel price as well as the economic parameters for the project.

Sensitivity analysis is also performed in HOMER in order to examine how the average annual wind speed, average annual solar radiation and the fuel price will affect the configuration of the system.

The conducted analyzes within the paper and the corresponding results and discussion are presented in section 4.4.

## REFERENCES

- [1] Khan, M.J., Iqbal, M.T. (2005). Pre-feasibility study of stand-alone hybrid energy systems for applications in Newfoundland. *Renewable Energy, Elsevier*, vol. 30, No.2, pp.835–854.
- [2] Luu, N.A., Tran, Q.T. (2018). Dynamic Programming for Optimal Energy Management of Hybrid Wind–PV–Diesel–Battery, *Energies*, vol. 11, pp.1-16.
- [3] Maatallah, T., Ghodhbane, N., Nasrallah, S.B. (2016). Assessment viability for hybrid energy system (PV/wind/diesel) with storage in the northernmost city in Africa, Bizerte, Tunisia. *Renewable and Sustainable Energy Reviews, Elsevier*, vol. 59, pp.1639–1652.
- [4] Boneya, G. (2011). *Design of a Photovoltaic-Wind Hybrid Power Generation System for Ethiopian Remote area*, PhD thesis, Institute of Technology Department of Electrical and Computer Engineering, Addis Ababa University.
- [5] Ogunjuyigbe, A.S.O., Ayodele, T.R., Akinola, O.A. (2016). Optimal allocation and sizing of PV/Wind/Split-diesel/Battery hybrid energy system for minimizing life cycle cost, carbon emission and dump energy of remote residential building. *Applied Energy, Elsevier*, vol. 171, pp.153–171.
- [6] Li, J., Wei, W., Xiang, J. A. (2012). Simple Sizing Algorithm for Stand-Alone PV/Wind/Battery Hybrid Microgrids. *Energies*, vol. 5, pp.5307-5323.
- [7] Bekele, G., Palm, B. (2010). Feasibility Study for a Standalone Solar–Wind-Based Hybrid Energy System for Application in Ethiopia. *Applied Energy, Elsevier*, vol. 87, No.2, pp. 487–495.
- [8] Ahadi, A., Kang, S.-K., Lee, J.-H. (2016). A novel approach for optimal combinations of wind, PV, and energy storage system in diesel-free isolated communities. *Applied Energy, Elsevier*, vol. 170, pp. 101–115.
- [9] N. Yimen, T. Tchotang, A. Kanmogne, I. A. Idriss, B. Musa, A. Aliyu, E.C. Okonkwo, S.I. Abba, D. Tata, L. Meva’a, O. Hamandjoda, M. Dagbasi. (2020). Optimal Sizing and Techno-Economic Analysis of Hybrid Renewable Energy Systems—A Case Study of a Photovoltaic/Wind/Battery/Diesel System in Fanisau, Northern Nigeria, *Processes*, Vol.8, pp.1-25.
- [10] HOMER Software, National Renewable Energy Laboratory (NREL), Colorado (*available at: <http://homerenergy.com/>* ).
- [11] HOMER User Manual, 2016 (*available at: <http://homerenergy.com/>* ).
- [12] NASA Surface Meteorology and Solar Energy Data Set, (*available at: <http://eosweb.larc.nasa.gov/>* ).
- [13] <https://www.nrel.gov/docs/fy21osti/77324.pdf>
- [14] <https://news.energysage.com/small-wind-turbines-overview/>